

TC-1006380



AERONAUTICAL INFORMATION MANUAL

Effective 0901Z, October 8, 2020 to 0901Z, March 25, 2021

TP 14371E
(2020-2)



Transport Canada Transports Canada

Canada 

1. Aeronautical Information Manual - AIM 2020-2
Effective 0901Z, October 8, 2020 to 0901Z, March 25, 2021
2. Next Edition:
AIM 2021-1 March 25, 2021
Printed in Canada
3. Please direct your TC AIM comments and inquiries to:

TC AIM Co-ordinator (AARTT)
Transport Canada
330 Sparks Street
Ottawa ON K1A 0N8

Telephone:613-993-4502

Fax: 613-952-3298

E-mail:.....[TC.AeronauticalInformationManual-
Manueldinformationaeronautique.TC@tc.gc.ca](mailto:TC.AeronauticalInformationManual-Manueldinformationaeronautique.TC@tc.gc.ca)

For general Civil Aviation inquiries please contact:

Civil Aviation Communications Centre (AARC)
Transport Canada
Place de Ville
330 Sparks Street
Ottawa, ON K1A 0N8

E-mail:.....services@tc.gc.ca

4. © Her Majesty the Queen in Right of Canada, as represented by the Minister of Transport 2020

All rights reserved. No part of this publication may be reproduced, stored in a retrieval system, or transmitted, in any form or by any means, electronic, mechanical, photocopying, recording, or otherwise, without prior written permission of the Department of Transport, Canada. Please contact the Civil Aviation Communications Centre at 1-800-305-2059 (EST) for assistance.

The information in this publication is to be considered solely as a guide and should not be quoted as or considered to be a legal authority. It may become obsolete in whole or in part at any time without notice.

5. ISSN: 1715-7382
TP 14371E
(02/2020)
TC-1006380
6. Publication Mail agreement number 40063845



Transport
Canada

Transports
Canada

TP 14371E

Transport Canada

Aeronautical Information Manual

(TC AIM)

OCTOBER 8, 2020

Canada

TRANSPORT CANADA AERONAUTICAL INFORMATION MANUAL (TC AIM)

EXPLANATION OF CHANGES EFFECTIVE—OCTOBER 8, 2020

NOTES:

- Editorial and format changes were made throughout the TC AIM where necessary and those that were deemed insignificant in nature were not included in the “Explanation of Changes”.
- Effective March 31, 2016, licence differences with ICAO Annex 1 standards and recommended practices, previously located in LRA 1.8 of the TC AIM, have been removed and can now be found in *AIP Canada (ICAO)* GEN 1.7.

AGA

- [AGA 7.9 Rapid-Exit Taxiway Indicator Lights \(RETIL\)](#)
Updated information on RETIL was added so that this subpart is in line with *Aerodromes Standards and Recommended Practices (TP 312)*.
- [AGA 7.9 Rapid-Exit Taxiway Indicator Lights \(RETIL\)](#)
Figure 7.14 — *Rapid-Exit Taxiway Indicator Lights* was added to illustrate the configuration of the RETIL.
- [AGA 7.10.2 Taxiway Centreline Lights](#)
Additional information was added regarding the colours and location of the taxiway centreline lights.

COM

- [COM 1.3 Language](#)
The link was changed to bring the reader directly to the *Glossary for Pilots and Air Traffic Services Personnel (AC 100-001)*.
- [COM 4.11.7 Caution Regarding Use of Instrument Landing System \(ILS\)](#)
Information in (e) *Glide path fluctuations* was added regarding critical areas and glide path fluctuations when flying an approach using an instrument landing system (ILS). The text of other paragraphs was revised for clarity.
- [COM 6.3.9 Required Navigation Performance Approach \(RNP APCH\)](#)
A sentence was removed regarding the GNSS multi-sensor system so that the section is in line with *Required Navigation Performance Approach (RNP APCH) (AC 700-023)*.
- [COM 6.4.1 Radius To Fix \(RF\) Path Terminator](#)
The text was reworded for clarity.
- [COM 9.6 Operational Considerations](#)
In paragraph (h), some links were added to provide more details on TCAS RA and reportable incidents.

MET

- [MET 4.11 Clouds and Weather Chart](#)
Additional text was added to clarify forecasts of cloud layers.
- [MET 4.11 Clouds and Weather Chart Figure 4.4\(e\)—Multiple Cloud Layers](#)
“AS” was removed from the image since altostratus (AS) is not specified in any chart.
- [MET 7.2 General](#)
A sentence related to significant weather was added.
- [MET 8.3 Sample Message](#)
In (f)(i) *Wind gusts*, information on wind gusts was improved by specifying the wind gust averaging period.
- [MET 12.1 Mid-Level Charts](#)
The title of this subpart was renamed.

RAC

- [RAC 4.2.8.1 Air Traffic Control \(ATC\) Phraseology When a Runway is Temporarily Shortened Due to Construction](#)
A subsection was added A subsection was added to provide information on the phraseology used by ATC in the context of a shortened runway during the take-off phase of the flight.
- [RAC 4.2.8.2 Clearance for Aborting a Takeoff](#)
Text was added to provide information about requests from ATC to abort a takeoff.
- [RAC 4.4.3.1 Air Traffic Control \(ATC\) Phraseology When a Runway is Temporarily Shortened Due to Construction](#)
A subsection was added to provide information on the phraseology used by ATC in the context of a shortened runway during the landing phase of the flight.
- [RAC 7.5 Standard Instrument Departure \(SID\)](#)
Information about noise abatement procedures was added for clarity.
- [RAC 7.7.2 Low, Close-in Obstacles](#)
A definition of low, close-in obstacle was introduced to match the standards in *Criteria for Development of Instrument Procedure Design (TP308)*.
- [RAC 8.6 Air Traffic Control \(ATC\) Assignment of Altitudes](#)
Additional text was added regarding minimum altitudes and obstacle clearance to incorporate information from *AIP Canada (ICAO) Aeronautical Information Circular (AIC) 19/17*.

(vii) [RAC 9.2.1 Minimum Sector Altitude \(MSA\)](#)

The word validated was replaced with inspected at the request of NAV CANADA/flight inspection for accuracy reasons.

NAT

(i) [NAT—North Atlantic Operations](#)

This entire chapter was reviewed and updated to be aligned with Part 2—Enroute (ENR), Section 7, *North Atlantic (NAT) Operations* in the [AIP Canada \(ICAO\)](#), published on the NAV CANADA website

RPA

(i) [RPA—Remotely Piloted Aircraft](#)

Some paragraphs were updated, reworded, relocated, and added to this chapter to clarify and support operational needs and also so that the chapter is fully aligned with regulations outlined in [CAR Part IX — Remotely Piloted Aircraft Systems](#).

(ii) [RPA 3.4.5 Operations at or in the Vicinity of an Airport or Heliport—Established Procedure](#)

This new section was added to outline the regulatory requirements as established in [CAR 901.73](#).

Table of Contents

GEN—GENERAL

1

1.0 GENERAL INFORMATION	1
1.1 Aeronautical Information.....	1
1.1.1 Aeronautical Authority.....	1
1.1.2 Aeronautical Information Management (AIM).....	2
1.1.3 Transport Canada Aeronautical Information Manual (TC AIM).....	2
1.1.4 Transport Canada Aeronautical Information Manual (TC AIM) Publication Information.....	2
1.1.5 NOTAM	3
1.1.6 Aerodromes.....	3
1.2 Summary of National Regulations.....	3
1.3 Differences with the International Civil Aviation Organization (ICAO) Standards, Recommended Practices and Procedures.....	3
1.3.1 International Civil Aviation Organization (ICAO)'s Procedures for Air Navigation Services—Aircraft Operations (PANS OPS).....	3
1.4 Units of Measurement.....	3
1.4.1 Other Units.....	3
1.4.2 Geographic Reference	4
1.5 Time System.....	4
1.5.1 Date-Time Group	4
1.5.2 Morning and Evening Twilight Charts	4
1.5.3 Time Zone	5
1.6 Nationality and Registration Marks	6
1.7 V-Speeds.....	6
1.7.1 Conversion Tables.....	6
1.7.2 RVR Comparative Scale—Feet to Metres	7
2.0 SAFETY.....	8
2.1 Aviation Occupational Health and Safety Program.....	8
2.1.1 General.....	8
2.1.2 Refusal to Work in Dangerous Situations.....	8
2.1.3 Delegated Labour Program Officials	8
2.2 Aviation Safety Analysis	8
2.2.1 General.....	8
2.2.2 Aviation Safety Research and Analysis	9
2.2.3 Minister's Observer and Technical Advisor Programs	9
2.2.4 Safety Promotion	9
3.0 TRANSPORTATION SAFETY BOARD OF CANADA (TSB).....	10
3.1 Aviation Safety Investigation	10
3.2 Definitions.....	10
3.3 Reporting an Aviation Occurrence.....	10
3.3.1 Accidents.....	10
3.3.2 Mandatory Reportable Incidents.....	10
3.3.3 Information to Report.....	11
3.3.4 Other Occurrences.....	11
3.3.5 Contacting the Transportation Safety Board of Canada (TSB)	12
3.4 Keeping and Preservation of Evidence	12
3.5 SECURITAS Program	12
3.5.1 How to Report to SECURITAS	12
3.5.2 What to Report to SECURITAS	12
3.5.3 Where to Submit a SECURITAS Report.....	13
3.6 Offices of the Transportation Safety Board of Canada (TSB).....	13
4.0 INDEX OF KEYWORDS.....	14
5.0 MISCELLANEOUS.....	31
5.1 Glossary of Aeronautical Terms	31
5.2 Abbreviations and Acronyms.....	42
5.3 Legislation Index	47
5.4 Canadian Aviation Regulation Advisory Council (CARAC).....	48
5.4.1 General.....	48
5.4.2 Governing Principles.....	48
5.4.3 Objective	48

5.4.4	Organizational Structure	49
5.4.4.1	Focus Group	49
5.4.4.2	Special Technical Committee	49
5.4.4.3	Canadian Aviation Regulation Advisory Council (CARAC) Plenary	49
5.4.4.4	Transport Canada Civil Aviation (TCCA) Management Team	49
5.4.4.5	Secretariat	49
5.4.5	Project Resources	49
5.4.6	Communication	49
5.4.7	Information	50
6.0	AVIATION OPERATIONS CENTRE (AOC)	50
6.1	Aviation Operations Centre (AOC)—Civil Aviation Accident, Occurrence and Incident Reporting	50
7.0	CIVIL AVIATION ISSUES REPORTING SYSTEM (CAIRS)	50

AGA—AERODROMES

51

1.0	GENERAL INFORMATION	51
1.1	General	51
1.1.1	Aerodrome Authority	51
1.1.2	International Civil Aviation Organization (ICAO) Documents	51
1.1.3	Canadian Runway Friction Index (CRFI)	51
1.1.4	Contaminated Runway Operations	51
1.1.4.1	Canadian Civil Aerodromes	51
1.1.4.2	Department of National Defence Aerodromes	51
1.1.5	Wildlife Hazard	51
1.2	International Airports	51
1.2.1	International Civil Aviation Organization (ICAO) Definitions	52
1.3	Aerodrome Directory	52
1.4	Aeronautical Ground Lights	52
2.0	AERODROMES AND AIRPORTS	52
2.1	General	52
2.1.1	Registration	52
2.1.2	Certification	53
2.2	Use of Aerodromes, Airports, and Heliports	53
2.3	Airport/Heliport/Water Airport Certification	53
2.3.1	General	53
2.3.2	Applicability of Airport Certification	53
2.3.3	Transport Canada's Responsibilities	53
2.3.4	Operator's Responsibilities	54
2.3.5	Airport Certification Process	54
2.3.6	Regulatory References for Aerodrome Certification (Airport/Heliport/Water Airport)	54
2.4	Airport/Heliport/Water Airport Certificate	54
2.4.1	Issue	54
2.4.2	Airport Certificate Validity and Amendments	54
3.0	RUNWAY CHARACTERISTICS	54
3.1	Runway Length and Width	54
3.2	Runway Strip	55
3.3	Runway Safety Area	55
3.4	Runway End Safety Area (RESA)	55
3.5	Runway Threshold Displacement	55
3.6	Runway Turn Pad	55
3.7	Blast Pad	55
3.8	Stopway	55
3.9	Clearway	55
3.10	Declared Distances	55
3.11	Rapid-Exit Taxiways	56
3.12	Runway and Taxiway Bearing Strength	56
3.12.1	Pavement Load Rating Charts	56
3.13	Heliports	56
3.13.1	Final Approach and Take-Off Area (FATO)	56
3.13.2	Heliport Classification	56
3.13.3	Heliport Operational Limitations	57

4.0	OBSTACLE RESTRICTIONS.....	57
4.1	General.....	57
4.2	Obstacle Limitation Surfaces (OLS).....	57
4.2.1	General.....	57
4.2.2	Heliports.....	57
4.3	Airport Zoning Regulations.....	57
4.3.1	General.....	57
4.3.2	Airports Where Zoning Regulations Are in Effect.....	58
5.0	MARKERS, MARKINGS, SIGNS, AND INDICATORS.....	58
5.1	Aircraft Take-off or Landing Area Boundary Markers.....	58
5.2	Air Taxiway Edge Markers.....	58
5.3	Seaplane Dock Markers.....	58
5.4	Runway Markings.....	59
5.4.1	Displaced Threshold Markings.....	59
5.4.2	Stopway Markings.....	59
5.4.3	Runway Holding Position Markings.....	60
5.5	Heliports.....	60
5.5.1	Heliprot Touchdown and Lift-Off Area (TLOF) Marking.....	60
5.5.2	Safety Area Markers.....	60
5.5.3	Heliprot Identification Markings.....	60
5.5.4	Final Approach and Take-Off Area (FATO) Markers.....	61
5.5.5	Helicopter Parking Position Markings.....	61
5.5.6	Approach and Take-Off Direction Indicator Markings.....	61
5.6	Closed Markings.....	61
5.7	Unserviceable Area Markers.....	62
5.8.1	General.....	62
5.8.2	Information Signs.....	62
5.8.3	Mandatory Instruction Signs.....	63
5.8.4	Illumination of Airside Signs.....	64
5.9	Wind Direction Indicators.....	64
6.0	OBSTRUCTION MARKING AND LIGHTING.....	64
6.1	General.....	64
6.2	Regulations.....	64
6.3	Aeronautical Evaluation.....	65
6.4	Marking.....	65
6.5	Lighting.....	65
6.5.1	Rotating Obstruction Light.....	65
6.5.2	Tower Configurations.....	65
6.6	Appurtenances.....	66
6.7	Suspended Cable Span Markings.....	66
6.8	Aircraft Detection Systems.....	67
7.0	AERODROME LIGHTING.....	67
7.1	General.....	67
7.2	Aerodrome Beacon.....	67
7.3	Minimum Night Lighting Requirements at Aerodromes.....	67
7.4	Unserviceable Area Lighting.....	68
7.5	Approach Lighting.....	68
7.5.1	Non-Precision Approach Runways.....	68
7.5.2	Precision Approach Runways.....	68
7.6	Visual Approach Slope Indicator Systems (VASIS).....	69
7.6.1	General.....	69
7.6.2	Visual Approach Slope Indicator (VASI) V1 and V2 and Abbreviated VASI (AVASI) AV.....	69
7.6.3	Precision Approach Path Indicator (PAPI) and Abbreviated PAPI (APAPI).....	70
7.6.4	Categories According to Eye-To-Wheel Height (EWH) in the Approach Configuration.....	70
7.6.4.1	General.....	70
7.6.4.2	Visual Approach Slope Indicator (VASI) Categories.....	70
7.6.4.3	Precision Approach Path Indicator (PAPI) Categories.....	70
7.6.5	Knowing the Eye-to-Wheel Height (EWH).....	71
7.6.6	Obstacle Protection Surface (OPS).....	71
7.7	Runway Identification Lighting.....	71
7.7.1	Runway Threshold Identification Lights (RTIL).....	71
7.7.2	Visual Alignment Guidance System (VAGS).....	71

7.8	Runway Lighting	72
7.8.1	Runway Edge Lights (REDL).....	72
7.8.2	Runway Threshold Lights and Runway End Lights (RENL).....	72
7.8.3	Displaced Threshold Lighting.....	72
7.8.4	Runway Centreline Lighting.....	73
7.8.5	Runway Touchdown Zone Lighting.....	73
7.9	Rapid-Exit Taxiway Indicator Lights (RETIL)	73
7.10	Taxiway Lighting	73
7.10.1	Taxiway Edge Lights.....	73
7.10.2	Taxiway Centreline Lights.....	73
7.10.3	Stop Bars.....	73
7.11	Runway Guard Lights	74
7.12	Heliport Lighting	74
7.12.1	Touchdown and Lift-Off Area (TLOF) Lighting.....	74
7.12.2	Final Approach and Take-Off (FATO) Lighting.....	74
7.12.3	Approach/Take-Off Direction Lights.....	75
7.13	Emergency Lighting	75
7.14	Aircraft Radio Control of Aerodrome Lighting (ARCAL)	75
7.15	Retroreflective Markers	75
8.0	AIRCRAFT RESCUE AND FIRE FIGHTING (ARFF)	76
8.1	General	76
8.2	Aircraft Rescue and Fire Fighting (ARFF) Hours of Availability	76
8.3	Classification System	76
8.4	Aircraft Rescue and Fire Fighting (ARFF) Standby Request	76
8.5	Aircraft Rescue and Fire Fighting (ARFF) Discreet Communication	77
9.0	AIRCRAFT ARRESTING SYSTEMS	77
9.1	Engineered Material Arresting Systems (EMAS)	77
9.1.1	System Description.....	77
9.1.2	System Depiction.....	77
9.1.3	Pilot Considerations for Engagement.....	77
9.2	Military Aircraft Arresting Systems	78
9.2.1	Background.....	78
9.2.2	Markings.....	78
9.2.3	Operations.....	78
9.2.4	Damage Hazards.....	78
9.2.5	Information for Pilots.....	78
10.0	AIRPORT COLLABORATIVE DECISION MAKING (A-CDM)	78
10.1	Introduction	78
10.2	Operational Concept	78
10.3	Terms	79
10.4	Scope of Applicability	79
10.5	Airport Collaborative Decision Making (A-CDM) Procedures	80
10.5.1	Commercial Air Transport Operations — Procedures for Operators and Handling Agents.....	80
10.5.1.1	Requirement for All Flights to Have a Current Target Off-Block Time (TOBT).....	80
10.5.1.2	Preferred Way of Providing the Target Off-Block Time (TOBT).....	80
10.5.1.3	Access to the Target Off-Block Time (TOBT).....	80
10.5.1.4	Pre-Departure Sequencing — Target Start-Up Approval Time (TSAT) Generation.....	80
10.5.1.5	Access to the Target Start-Up Approval Time (TSAT).....	80
10.5.1.6	Target Start-Up Approval Time (TSAT) Swapping.....	80
10.5.1.7	The Importance of Updating the Target Off-Block Time (TOBT).....	80
10.5.1.8	Target Off-Block Time (TOBT) Update Limitations.....	80
10.5.1.9	Methods for Updating the Target Off-Block Time (TOBT).....	81
10.5.2	Commercial Air Transport Operations — Flight Crew Procedures.....	81
10.5.2.1	Target Off-Block Time (TOBT) and Target Start-Up Approval Time (TSAT) Delivery Channels.....	81
10.5.2.2	Access to the Target Off-Block Time (TOBT).....	81
10.5.2.3	Access to the Target Start-Up Approval Time (TSAT).....	81
10.5.2.4	Information Related to Airport Collaborative Decision Making (A-CDM) on the Advanced Visual Docking Guidance System (AVDGS).....	81
10.5.2.5	Call Ready Procedure.....	81
10.5.2.6	Procedures for Extended Times Between Target Off-Block Time (TOBT) and Target Start-Up Approval Time (TSAT).....	81
10.5.2.7	Airport Collaborative Decision Making (A-CDM)-Imposed Waiting Time and On-Time Performance.....	81
10.5.2.8	Pushback / Start-Up Approval.....	81
10.5.2.9	Flight Crew Concerns About Meeting Constraints.....	82

10.5.2.10	De-icing Operations.....	82
10.5.3	General and Business Aviation Operations — Air Operator Procedures.....	82
10.5.3.1	Prior Permission to Operate Required (Reservation).....	82
10.5.3.2	Requirement to Provide the Target Off-Block Time (TOBT).....	82
10.5.3.3	Pre-Departure Sequencing — Target Start-Up Approval Time (TSAT) Generation.....	82
10.5.3.4	Access to the Target Start-Up Approval Time (TSAT).....	82
10.5.3.5	The Importance of Updating the Target Off-Block Time (TOBT).....	82
10.5.3.6	Target Off-Block Time (TOBT) Update Limitations.....	82
10.5.3.7	Method for Updating the Target Off-Block Time (TOBT).....	83
10.5.3.8	Target Off-Block Time (TOBT) and Target Start-Up Approval Time (TSAT) Delivery Channels.....	83
10.5.3.9	Access to the Target Off-Block Time (TOBT).....	83
10.5.3.10	Access to the Target Start-Up Approval Time (TSAT).....	83
10.5.3.11	Call Ready Procedure.....	83
10.5.3.12	Start-Up Procedures.....	83
10.5.3.13	Flight Crew Concerns About Meeting Constraints.....	83
10.5.3.14	De-icing Operations.....	83
10.6	Contingency Operations.....	83

COM—COMMUNICATIONS, NAVIGATION AND SURVEILLANCE

85

1.0	VOICE COMMUNICATIONS.....	85
1.1	General.....	85
1.2	Regulations.....	85
1.3	Language.....	85
1.4	Very High Frequency (VHF) Communication Frequencies—Channel Spacing.....	85
1.5	Use of Phonetics.....	85
1.6	Airways and Air Routes Designation.....	86
1.7	Distance Reporting.....	86
1.8	Use of Numbers.....	86
1.8.1	General.....	86
1.8.2	Altitude Above Sea Level and Flight Level.....	86
1.8.3	Aircraft Type, Wind Speed and Cloud Base.....	86
1.8.4	Time.....	86
1.8.5	Headings.....	86
1.8.6	Aerodrome Elevation.....	86
1.8.7	Transponder Codes.....	86
1.9	Call Signs.....	86
1.9.1	Civil Aircraft.....	86
1.9.1.1	Canadian and Foreign Air Carriers.....	87
1.9.1.2	Canadian Private Civil Aircraft and Canadian or Foreign Carriers Without an Assigned Radiotelephony Designator.....	87
1.9.1.3	Foreign Private Civil Aircraft.....	87
1.9.1.4	Medical Evacuation Flight (MEDEVAC).....	87
1.9.1.5	Formation Flights.....	87
1.9.1.6	Similar Sounding Call Signs.....	88
1.9.2	Ground Stations.....	88
1.9.3	Remote Communications Outlets (RCOs) and Dial-Up Remote Communications Outlets (DRCOs).....	88
1.10	Standard Radio Telephony.....	89
1.10.1	Message.....	89
1.10.2	Message Acknowledgement.....	89
1.11	Communications Checks.....	89
1.12	Emergency Communications.....	90
1.12.1	General.....	90
1.12.2	Emergency Frequency 121.5 MHz.....	90
1.13	Very High Frequency (VHF) Allocations.....	90
1.14	Use of Frequency 5 680 kHz.....	90
1.15	Phone Use During a Radio Communications Failure.....	90
1.16	Canadian Base Operators (CBO).....	91
1.17	Other Telecommunication System Operators.....	91
1.18	Satellite Voice Communications (SATVOICE).....	91
2.0	LOCATION INDICATORS.....	92
3.0	DATA LINK COMMUNICATION.....	92
3.1	Data Link Applications.....	92
3.2	Aircraft Communications Addressing and Reporting System (ACARS) and Future Air Navigation Systems (FANS) 1/A.....	92

3.3	Aeronautical Telecommunications Network (ATN).....	92
3.4	Data Link Service Providers	92
3.5	Data Link Networks	92
3.6	Aircraft Communications Addressing And Reporting System (ACARS) Initialization.....	93
3.7	Data Link Automatic Terminal Information Service (D-ATIS).....	93
3.8	Pre-Departure Clearance (PDC).....	93
3.9	Departure Clearance (DCL).....	93
3.10	Automatic Dependent Surveillance Contract (ADS-C).....	94
3.11	Controller-Pilot Data Link Communications (CPDLC).....	94
3.12	Air Traffic Services Facilities Notification (AFN).....	94
3.13	Current/Next Data Authorities	95
4.0	GROUND-BASED RADIO NAVIGATION AIDS.....	95
4.1	General.....	95
4.2	Accuracy, Availability and Integrity of Ground-Based Navigation Aids	95
4.3	Pilot Reporting of Abnormal Operation of Ground-Based Navigation Aids (NAVAIDS).....	96
4.4	Interference with Aircraft Navigational Equipment	96
4.5	VHF Omnidirectional Range (VOR)	96
4.5.1	VHF Omnidirectional Range (VOR) Receiver Checks.....	96
4.5.2	Airborne VHF Omnidirectional Range (VOR) Check.....	97
4.6	Non-Directional Beacon (NDB).....	97
4.7	Distance Measuring Equipment (DME)	97
4.8	Tactical Air Navigation (TACAN)	97
4.9	VHF Omnidirectional Range and Tactical Air Navigation Aid (VORTAC).....	98
4.10	Very High Frequency (VHF) Direction Finding Equipment.....	98
4.11	Instrument Landing System (ILS)	98
4.11.1	Localizer (LOC)	98
4.11.2	Glide Path (GP)	98
4.11.3	Non-Directional Beacon (NDB).....	99
4.11.4	Instrument Landing System (ILS)/Distance Measuring Equipment (DME).....	99
4.11.5	Instrument Landing System (ILS) Categories.....	99
4.11.6	Category II/III Instrument Landing System (ILS).....	99
4.11.7	Caution Regarding Use of Instrument Landing System (ILS).....	99
5.0	AREA NAVIGATION (RNAV).....	101
5.1	Global Navigation Satellite System (GNSS).....	101
5.2	Global Navigation Satellite System (GNSS) Constellations	101
5.2.1	Global Positioning System (GPS).....	101
5.2.2	Global Orbiting Navigation Satellite System (GLONASS)	102
5.2.3	Galileo Navigation Satellite System	102
5.2.4	BeiDou Navigation Satellite System.....	102
5.3	Augmentation Systems.....	102
5.3.1	Aircraft-Based Augmentation System (ABAS).....	102
5.3.2	Satellite-Based Augmentation System (SBAS).....	103
5.3.3	Ground-Based Augmentation System (GBAS).....	104
5.4	Domestic Instrument Flight Rules (IFR) Approval to Use Global Navigation Satellite System (GNSS) and Satellite-Based Augmentation System (SBAS).....	104
5.4.1	Domestic En Route and Terminal Operations	104
5.4.2	Global Navigation Satellite System (GNSS)-Based Area Navigation (RNAV) Approach Procedures.....	104
5.4.2.1	Area Navigation (RNAV) Approaches with Lateral Guidance Only	105
5.4.2.2	Global Navigation Satellite System (GNSS) Overlay Approaches	105
5.4.2.3	Vertical Guidance on Area Navigation (RNAV) Approaches	105
5.4.2.4	Area Navigation (RNAV) Approaches with Vertical Guidance Based on Barometric Vertical Navigation (Baro-VNAV)..	106
5.4.2.5	Area Navigation (RNAV) Approaches with Vertical Guidance Based on Wide Area Augmentation System (WAAS)	106
5.5	Flight Planning.....	107
5.5.1	Global Positioning System (GPS) NOTAM.....	107
5.5.2	Wide Area Augmentation System (WAAS) NOTAM.....	107
5.5.3	Negative W Notation	107
5.5.4	Space Weather.....	108
5.6	Instrument Flight Rules (IFR) Flight Plan Equipment Suffixes.....	108
5.7	Avionics Databases	108
5.8	Use of Global Navigation Satellite System (GNSS) in Lieu of Ground-based Aids.....	108
5.9	Area Navigation (RNAV) Approaches at Alternate Aerodromes.....	109
5.9.1	Global Navigation Satellite System (GNSS) Approaches—Global Positioning System (GPS) (TSO-C129/C129a) Avionics.....	109
5.9.2	Global Navigation Satellite System (GNSS) Approaches—Wide Area Augmentation System (WAAS) Avionics	109

5.10	Global Navigation Satellite System (GNSS) Vulnerability—Interference and Anomaly Reporting.....	109
5.11	Proper Use of Global Navigation Satellite System (GNSS)	110
5.12	VHF Omnidirectional Range (VOR)/Distance Measuring Equipment (DME) (RHO-THETA) System.....	110
5.13	Distance Measuring Equipment (DME-DME [RHO-RHO]) System.....	110
6.0	PERFORMANCE-BASED NAVIGATION (PBN).....	110
6.1	General.....	110
6.2	Key Elements of Performance-Based Navigation (PBN).....	111
6.2.1	Navigation Aid (NAVAID) Infrastructure.....	111
6.2.2	Navigation Specifications	111
6.2.3	Navigation Application	112
6.3	Navigation Specifications Expanded.....	112
6.3.1	Area Navigation (RNAV) 10.....	112
6.3.2	Area Navigation (RNAV) 5.....	112
6.3.3	Area Navigation (RNAV) 1 and RNAV 2.....	112
6.3.4	Required Navigation Performance (RNP) 4.....	112
6.3.5	Required Navigation Performance (RNP) 2.....	113
6.3.6	Required Navigation Performance (RNP) 1.....	113
6.3.7	Required Navigation Performance (RNP) 0.3.....	113
6.3.8	Advanced Required Navigation Performance (A-RNP).....	114
6.3.9	Required Navigation Performance Approach (RNP APCH).....	114
6.3.10	Required Navigation Performance Authorization Required Approach (RNP AR APCH).....	114
6.4	Fixed Radius Paths	114
6.4.1	Radius To Fix (RF) Path Terminator	114
6.4.2	Fixed Radius Transition (FRT)	115
6.5	International Civil Aviation Organization (ICAO) Flight Plan Completion.....	115
6.6	Navigation Error Components.....	115
7.0	SURVEILLANCE	115
7.1	Primary Surveillance Radar (PSR).....	115
7.2	Secondary Surveillance Radar (SSR)	116
7.2.1	Code Assignment.....	116
7.3	Automatic Dependent Surveillance - Broadcast (ADS-B).....	116
7.3.1	Aircraft Equipment.....	116
7.3.2	International Civil Aviation Organization (ICAO) Flight Plan Completion	117
7.3.3	Airworthiness Compliance Requirements.....	117
7.3.4	Surveillance Phraseology.....	117
7.4	Multilateration (MLAT).....	118
7.4.1	Code Assignment.....	118
8.0	TRANSPONDER OPERATION	118
8.1	General	118
8.2	Transponder Requirements	119
8.3	Instrument Flight Rules (IFR) Operations in Other Low-Level Airspace	119
8.4	Visual Flight Rules (VFR) Operations	120
8.5	Phraseology.....	120
8.6	Emergencies	120
8.7	Communication Failure	120
8.8	Unlawful Interference	120
9.0	TRAFFIC ALERT AND COLLISION AVOIDANCE SYSTEM (TCAS) AND AIRBORNE COLLISION AVOIDANCE SYSTEM (ACAS)	121
9.1	General	121
9.2	Transport Canada (TC) Regulations on Traffic Alert And Collision Avoidance System (TCAS)/Airborne Collision Avoidance System (ACAS).....	122
9.3	Use of the Traffic Alert and Collision Avoidance System (TCAS) Outside of Canada	123
9.4	Operational Approval	123
9.5	Aircraft Certification Approval	123
9.6	Operational Considerations	123
9.7	Pilot Action When Deviating From Clearances—Regulations and Information	124
9.8	Mode S Transponder Approval and Unique Codes	125
9.9	Pilot/Controller Actions.....	125
9.10	Pilot and Controller Phraseology	126

10.0	SATELLITE SYSTEMS	126
10.1	General	126
10.2	Satellite Service Providers	126

MET—METEOROLOGY**127**

1.0	GENERAL INFORMATION	127
1.1	General	127
1.1.1	Meteorological Responsibility	127
1.1.2	Meteorological Services Available	127
1.1.3	Aviation Weather Services	127
1.1.4	Weather Service Information	128
1.1.5	Weather Information from Air Traffic Service (ATS)	128
1.1.6	Pilot Reports	128
1.1.6.1	Pilot Weather Reports (PIREPs)	128
1.1.6.2	Air Reports (AIREPs)	128
1.1.7	Applicable International Civil Aviation Organization (ICAO) and World Meteorological Organization (WMO) Documents	128
1.1.8	Differences from International Civil Aviation Organization (ICAO) Annex 3	129
1.1.9	Pilot Responsibility	129
1.2	Meteorological Observation and Reports	129
1.2.1	Type and Frequency of Observations	129
1.2.2	Flight Weather Documentation	129
1.2.3	Weather Services Definitions in Flight Publications	129
1.2.4	Automated Weather Observation Systems (AWOS)	130
1.2.4.1	Overview	130
1.2.4.2	Visual Flight Rules (VFR) Weather Stations	130
1.2.5	Automatic Aerodrome Routine Meteorological Reports (METAR AUTO) and Limited Weather Information System (LWIS) Reports	130
1.2.5.1	Automatic Aerodrome Routine Meteorological Reports (METAR AUTO)	130
1.2.5.2	Limited Weather Information System (LWIS) Reports	131
1.2.6	Automatic (AUTO) Reports	131
1.2.7	Weather Services in Support of Approach Unicom (AU)	131
1.2.8	Runway Visibility Assessment	131
1.3	Meteorological Forecasts and Charts	131
1.3.1	Flight Information Centre (FIC) Hours of Service and Telephone Numbers	131
1.3.2	World Area Forecast System (WAFS) Charts	132
1.3.3	Aerodrome Forecasts (TAFs)	132
1.3.4	Aerodrome Advisory Forecasts	132
1.3.5	Coastal Weather	132
1.3.6	Graphic Area Forecasts (GFAs) and AIRMET	132
1.3.7	Upper Level Wind and Temperature Forecasts (FD)	132
1.3.8	Air Traffic Control (ATC) Weather Assistance	132
1.3.9	Supplementary Information	133
1.3.9.1	Weather Radar	133
1.3.9.2	ECCC/DND Weather Radar Network	134
1.4	In-Flight Meteorological Information (VOLMET)	134
2.0	PILOT WEATHER REPORTS (PIREPs)	134
2.1	General	134
2.1.1	Pilot Weather Report (PIREP) Example	135
2.2	Clear Air Turbulence (CAT)	135
2.2.1	General	135
2.2.2	Turbulence Reporting Criteria	136
2.3	Wind Shear (WS)	136
2.4	Airframe Icing	136
2.5	Volcanic Ash	137
2.6	Pilot Estimation of Surface Wind	137
3.0	CANADIAN WEATHER INFORMATION	139
3.1	Aviation Forecasts and Charts	139
3.2	Aviation Weather Reports	140
3.3	Weather Charts	141

4.0	GRAPHIC AREA FORECASTS (GFA)	141
4.1	General	141
4.2	Issue and Valid Times	141
4.3	Coverage Area	141
4.4	Units of Measure	142
4.5	Abbreviations and Symbols	142
4.6	Layout	142
4.7	Title Box	142
4.8	Legend Box	142
4.9	Comments Box.....	142
4.10	Weather Information	143
4.11	Clouds and Weather Chart.....	143
4.12	Icing, Turbulence and Freezing Level Chart.....	146
4.13	Graphic Area Forecast (GFA) Amendments	148
4.14	Graphic Area Forecast (GFA) Corrections	148
5.0	AIRMETs	148
5.1	Definition	148
5.2	Issuance Criteria	148
5.3	Coordinate Points	149
5.4	Rules for the Use of Letters.....	149
5.5	Rules for the Use of Numbers	149
5.6	Validity	150
5.7	Location of the Phenomenon	150
	5.7.1 Circle	150
	5.7.2 Line.....	150
	5.7.3 Polygon.....	150
5.8	Flight Level and Extent.....	150
5.9	Movement or Expected Movement	151
5.10	Change in Intensity.....	151
5.11	Remark	151
5.12	Updated AIRMET	151
5.13	Cancellation	151
5.14	Test AIRMET.....	151
5.15	AIRMET Identifiers.....	151
5.16	AIRMET Examples	152
6.0	SIGNIFICANT METEOROLOGICAL INFORMATION (SIGMET)	153
6.1	Definition	153
6.2	Issuance Criteria.....	153
6.3	Coordinate Points	153
6.4	Rules for the Use of Letters.....	154
6.5	Rules for the Use of Numbers	154
6.6	Validity	154
6.7	Location of the Phenomenon	154
	6.7.1 Circle	154
	6.7.2 Line.....	154
	6.7.3 Polygon.....	154
6.8	Flight Level and Extent.....	155
6.9	Movement or Expected Movement	155
6.10	Change in Intensity.....	155
6.11	Remark.....	155
6.12	Updated Significant Meteorological Information (SIGMET)	155
6.13	Cancellation	155
6.14	Test Significant Meteorological Information (SIGMET) Message	155
6.15	Significant Meteorological Information (SIGMET) Message Identifiers	156
6.16	Significant Meteorological Information (SIGMET) Message Examples.....	156
7.0	AERODROME FORECASTS (TAFs)	158
7.1	Aerodrome Forecast (TAF) Locations	158
7.2	General.....	159
7.3	National Variations.....	159
7.4	Sample Message	159

7.5	Aerodrome Forecasts (TAFs) from Automatic Aerodrome Routine Meteorological Reports (METAR AUTO)	162
7.6	Amended Aerodrome Forecast (TAF).....	162
8.0	AERODROME ROUTINE METEOROLOGICAL REPORTS (METARs)	163
8.1	The Aerodrome Routine Meteorological Report (METAR) Code	163
8.2	National Variations	163
8.3	Sample Message	163
8.4	Aerodrome Special Meteorological Reports (SPECI)	167
8.4.1	Criteria for Taking Aerodrome Special Meteorological Reports (SPECI)	167
8.4.2	Local Criteria	168
8.4.2.1	Observer's Initiative	168
8.4.2.2	Check Observations	168
8.5	Automatic Aerodrome Routine Meteorological Reports (METAR AUTO) and Limited Weather Information System (LWIS) Reports	168
8.5.1	Automatic Aerodrome Routine Meteorological Reports (METAR AUTO)	168
8.5.2	Limited Weather Information System (LWIS) Reports	169
8.5.3	Automated Weather Observation System (AWOS) and Limited Weather Information System (LWIS) Performance Characteristics	169
8.5.4	Automatic Aerodrome Routine Meteorological Reports (METAR AUTO) and Human Observation Comparison	170
8.6	Voice Generation Systems.....	172
9.0	UPPER LEVEL WINDS AND TEMPERATURES.....	173
9.1	Canadian Forecast Winds and Temperatures Aloft Network.....	173
9.2	Upper Level Wind and Temperature Forecasts (FDs)	173
10.0	SURFACE WEATHER MAPS	174
11.0	UPPER LEVEL CHARTS	175
11.1	Upper Level Analysis Charts.....	175
11.2	Upper Level Prognostic Charts	175
12.0	SIGNIFICANT WEATHER PROGNOSTIC CHARTS	176
12.1	Mid-Level Charts.....	176
12.2	High-Level Charts	177
13.0	VOLCANIC ASH PRODUCTS	179
14.0	SPACE WEATHER INFORMATION SERVICE	181
14.1	Introduction.....	181
14.2	Nature of the Disturbances.....	181
14.3	The ICAO Service Advisories.....	181
14.4	Response to Advisories.....	182
14.5	Space Weather Advisory Message	182
14.6	Examples of Space Weather Advisories	182
15.0	ABBREVIATIONS—AVIATION FORECASTS	183

RAC—RULES OF THE AIR AND AIR TRAFFIC SERVICES

187

1.0	GENERAL INFORMATION	187
1.1	Air Traffic Services	187
1.1.1	Air Traffic Control (ATC) and Information Services	187
1.1.2	Flight Advisory and Information Services	188
1.1.2.1	Flight Information Centres (FICs)	188
1.1.2.2	Flight Service Stations (FSSs).....	188
1.1.2.3	Flight Information Centres (FICs) and Flight Service Stations (FSSs).....	189
1.1.2.4	International Flight Service Station (IFSS).....	190
1.1.3	Arctic Territories	190
1.1.4	Military Flight Advisory Unit (MFAU)	190
1.2	Services Other Than Air Traffic Services (ATS)	190
1.2.1	Universal Communications (UNICOM).....	190
1.2.2	Airport Radio/Community Aerodrome Radio Station	190
1.2.3	Private Advisory Stations (PAS)—Controlled Airports	191
1.2.4	Apron Advisory Service	191

1.3	Automatic Terminal Information Service (ATIS)	191
1.4	Use of Term “Ceiling and Visibility OK (CAVOK)”	192
1.5	Radar Service	192
1.5.1	General	192
1.5.2	Procedures	192
1.5.3	Radar Traffic Information	193
1.5.4	Radar Navigation Assistance to Visual Flight Rules (VFR) Flights	194
1.5.5	Obstacle Clearance During Radar Vectors	194
1.5.6	Misuse of Radar Vectors	194
1.5.7	Canadian Forces Radar Assistance	195
1.5.8	The Use of Radar in the Provision of Aerodrome Advisory Service (AAS) and Remote Aerodrome Advisory Service (RAAS) by Flight Service Stations (FSS)	195
1.6	VHF Direction Finder (VDF) Service	195
1.6.1	Purpose.....	195
1.6.2	Equipment Operation	195
1.6.3	Provision of Service	195
1.6.4	Procedures	196
1.7	Air Traffic Control (ATC) Clearances, Instructions and Information	196
1.7.1	Inability to Issue Clearance.....	197
1.7.1.1	Examples.....	197
1.8	Air Traffic Control (ATC) Service Priority	199
1.8.1	Normal Conditions	199
1.8.2	Special Conditions	199
1.8.3	Minimum Fuel Advisory.....	199
1.9	Collision Avoidance—Right of Way (<i>Canadian Aviation Regulations</i> [CARs])	200
1.10	Aerobatic Flight (<i>Canadian Aviation Regulations</i> [CARs] 602.27 and 602.28)	201
1.11	Conservation	201
1.11.1	Fur and Poultry Farms	201
1.11.2	Protection of Wildlife	201
1.11.3	National, Provincial and Municipal Parks, Reserves and Refuges.....	202
2.0	AIRSPACE – REQUIREMENTS AND PROCEDURES	202
2.1	General	202
2.2	Canadian Domestic Airspace (CDA)	202
2.2.1	Northern Domestic Airspace (NDA)	202
2.3	High- and Low-Level Airspace	202
2.3.1	Cruising Altitudes and Flight Levels Appropriate to Aircraft Track	202
2.4	Flight Information Regions (FIRs)	203
2.5	Controlled Airspace	203
2.5.1	Use of Controlled Airspace by Visual Flight Rules (VFR) Flights	204
2.5.2	Aircraft Speed Limit Order	204
2.6	High-Level Controlled Airspace	204
2.7	Low-Level Controlled Airspace	205
2.7.1	Low-Level Airways	205
2.7.2	Control Area Extensions	205
2.7.3	Control Zones	206
2.7.4	Visual Flight Rules (VFR) Over-the-Top	207
2.7.5	Transition Areas	207
2.7.6	Terminal Control Areas	207
2.8	Airspace Classification	208
2.8.1	Class A Airspace	208
2.8.2	Class B Airspace	208
2.8.3	Class C Airspace	209
2.8.4	Class D Airspace	209
2.8.5	Class E Airspace.....	210
2.8.6	Class F Airspace	210
2.8.7	Class G Airspace	212
2.9	Other Airspace Divisions	212
2.9.1	Altitude Reservation	212
2.9.2	Temporary Flight Restrictions—Forest Fires	212
2.9.3	Flight Operations Over or in the Vicinity of Nuclear Power Plants	212
2.10	Altimeter Setting Region	212
2.11	Standard Pressure Region	213
2.12	Mountainous Regions	213
2.13	Emergency Communications and Security	214

3.0	FLIGHT PLANNING	214
3.1	General	214
3.2	Pilot Briefing Service	214
3.3	Aeronautical Information	215
3.4	Weight and Balance Control	215
3.4.1	Definitions	215
3.4.2	Weight Control	216
3.4.3	Balance	217
3.4.4	Operational Requirements	217
3.4.5	Computerized Systems	217
3.4.6	Segmented Weights	217
3.4.6.1	Derivation of Segmented Weights	217
3.4.7	Computation of Passenger and Baggage Weights	218
3.4.8	Fuel and Oil Weights	220
3.5	Flight Plans and Flight Itineraries	221
3.5.1	When Required	221
3.5.2	Filing (<i>Canadian Aviation Regulation</i> [RAC] 602.75)	221
3.5.3	Flight Plan Requirements—Flights Between Canada and a Foreign State	221
3.5.4	Opening a Visual Flight Rules (VFR) Flight Plan or Flight Itinerary	221
3.6	Changes To The Information In A Flight Plan Or Flight Itinerary	221
3.6.1	Visual Flight Rules (VFR) Flight Plan or Flight Itinerary	222
3.6.2	Instrument Flight Rules (IFR) Flight Plan or Flight Itinerary	222
3.7	Composite Flight Plan Or Flight Itinerary—Visual Flight Rules (VFR) And Instrument Flight Rules (IFR)	222
3.8	Defence Visual Flight Rules (VFR) Flight Plans and Defence Flight Itineraries (<i>Canadian Aviation Regulation</i> [CAR] 602.145)	222
3.9	Intermediate Stops	223
3.9.1	Consecutive Instrument Flight Rules (IFR) Flight Plans	223
3.10	Cross Country Instrument Training Flights	223
3.11	Closing a Flight Plan	224
3.11.1	Arrival Report	224
3.11.2	Closing of a Flight Plan or Flight Itinerary Prior to Landing	224
3.12	Fuel Requirements	224
3.12.1	Visual Flight Rules (VFR) Flight	225
3.12.2	Instrument Flight Rules (IFR) Flight	225
3.13	Requirements for Alternate Aerodrome — Instrument Flight Rules (IFR) Flight	225
3.13.1	Alternate Aerodrome Weather Minima Requirements	225
3.14	Completion of Canadian Flight Plans and Flight Itineraries and International Civil Aviation Organization (ICAO) Flight Plans	226
3.14.1	General	226
3.14.2	Canadian	227
3.14.3	International Civil Aviation Organization (ICAO)	227
3.14.4	Instructions for Completing the Form	227
3.14.4.1	General	227
3.14.4.2	Instructions for Insertion of ATS Data	227
3.15	Contents of a Flight Plan and Flight Itinerary	227
3.15.1	Item 7: Aircraft Identification (not exceeding seven alphanumeric characters and without hyphens or symbols)	227
3.15.2	Item 8: Flight Rules and Type of Flight	228
3.15.2.1	Flight Rules (one character) (Canadian and ICAO)	228
3.15.2.2	Type of Flight (up to two characters, as applicable)	228
3.15.3	Item 9: Number and Type of Aircraft and Wake Turbulence Category	228
3.15.3.1	Number of Aircraft (one or two characters)	228
3.15.3.2	Type of Aircraft (two to four characters)	228
3.15.3.3	International Civil Aviation Organization (ICAO) Wake Turbulence Category (one character)	229
3.15.4	Item 10: Equipment (Canadian and International Civil Aviation Organization (ICAO))	229
3.15.4.1	Radio Communication, Navigation and Approach Aid Equipment and Capabilities	229
3.15.4.2	Surveillance Equipment and Capabilities	230
3.15.5	Item 13: Departure Aerodrome and Time	230
3.15.5.1	Departure Aerodrome (maximum four characters)	230
3.15.5.2	Time (maximum four characters)	231
3.15.6	Item 15: Cruising Speed, Altitude/Level and Route	231
3.15.6.1	Flights Along Designated Air Traffic Service (ATS) Routes:	231
3.15.6.2	Flights Outside Designated Air Traffic Service (ATS) Routes:	232
3.15.7	Item 16: Destination Aerodrome, Total Estimated Elapse Time (EET), Search And Rescue (SAR) Time (for flights in Canada only) and Destination Alternate Aerodrome(s)	233
3.15.7.1	Destination Aerodrome and Total Estimated Elapse Time (EET) (maximum 10 characters)	233
3.15.7.2	Destination Alternate Aerodrome(s)	233
3.15.8	Item 18: Other Information	234

3.15.9	Item 19: Supplementary Information	236
3.15.9.1	Endurance	236
3.15.9.2	Persons On Board	236
3.15.9.3	Emergency and Survival Equipment	236
4.0	AIRPORT OPERATIONS	239
4.1	General	239
4.1.1	Wake Turbulence	239
4.1.2	Noise Abatement	241
4.1.3	Preferential Runway Assignments	241
4.1.4	Runway Protected Area	242
4.2	Departure Procedures — Controlled Airports	242
4.2.1	Automatic Terminal Information Service (ATIS) Broadcasts	242
4.2.2	Clearance Delivery	242
4.2.3	Radio Checks	242
4.2.4	Requests for Push-back or Power-back	242
4.2.5	Taxi Information	242
4.2.6	Taxi Holding Positions	243
4.2.7	Taxiway Holding Positions During Instrument Flight Rules (IFR) Operations	243
4.2.7.1	Glide Path Signal Protection Procedures	243
4.2.8	Take-off Clearance	244
4.2.8.1	Air Traffic Control (ATC) Phraseology When a Runway Is Temporarily Shortened Due to Construction	244
4.2.8.2	Clearance for Aborting a Takeoff	244
4.2.9	Release from Tower Frequency	244
4.2.10	Departure Procedures - No Radio (NORDO) Aircraft	245
4.2.11	Visual Signals	245
4.2.12	Departure Procedures – Receiver Only (RONLY) Aircraft	245
4.3	Traffic Circuits — Controlled Aerodromes	245
4.4	Arrival Procedures — Controlled Airports	246
4.4.1	Initial Contact	246
4.4.2	Initial Clearance	246
4.4.3	Landing Clearance	247
4.4.3.1	Air Traffic Control (ATC) Phraseology When a Runway Is Temporarily Shortened Due to Construction	247
4.4.4	Taxiing	248
4.4.5	Arrival Procedures – No Radio (NORDO) Aircraft	248
4.4.6	Arrival Procedures – Receiver Only (RONLY) Aircraft	248
4.4.7	Visual Signals	249
4.4.8	Communications Failure - Visual Flight Rules (VFR)	249
4.4.9	Operations on Intersecting Runways	249
4.4.10	High Intensity Runway Operations (HIRO).....	251
4.5	Aircraft Operations—Uncontrolled Aerodromes	252
4.5.1	General	252
4.5.2	Traffic Circuit Procedures — Uncontrolled Aerodromes	253
4.5.3	Helicopter Operations	254
4.5.4	Mandatory Frequency (MF)	254
4.5.5	Aerodrome Traffic Frequency (ATF)	254
4.5.6	Use of Mandatory Frequency (MF) and Aerodrome Traffic Frequency (ATF)	255
4.5.7	Visual Flight Rules (VFR) Communication Procedures at Uncontrolled Aerodromes with Mandatory Frequency (MF) and Aerodrome Traffic Frequency (ATF) Areas	255
4.5.8	Aircraft Without Two-Way Radio (No Radio [NORDO]/Receiver Only [RONLY]).....	256
4.5.8.1	Prior Arrangements	256
4.5.8.2	Traffic Circuits - No Radio [NORDO]/Receiver Only [RONLY]	256
4.5.8.3	Receiver Only (RONLY)	256
4.6	Helicopter Operations at Controlled Airports	256
5.0	VISUAL FLIGHT RULES (VFR)	
	EN ROUTE PROCEDURES	257
5.1	Monitoring, Broadcasting on 126.7 MHz and Position Reporting En Route.....	257
5.2	Acknowledgement of Clearances	257
5.3	Altitudes and Flight Levels — Visual Flight Rules (VFR)	257
5.4	Minimum Altitudes — Visual Flight Rules (VFR) (<i>Canadian Aviation Regulations</i> [CARs] 602.14 and 602.15)	257
5.5	Minimum Altitudes — Overflying Aerodromes [<i>Canadian Aviation Regulations</i> [CARs] 602.96(4)and(5)].....	258
5.6	Controlled Visual Flight Rules (CVFR) Procedures	258
5.7	En route Radar Surveillance	259
5.8	Visual Flight Rules (VFR) Operations Within Class C Airspace	259

6.0	INSTRUMENT FLIGHT RULES (IFR) — GENERAL	260
6.1	Air Traffic Control (ATC) Clearance	260
6.2	Instrument Flight Rules (IFR) Flights in Visual Meteorological Conditions (VMC)	260
6.2.1	Instrument Flight Rules (IFR) Clearance with Visual Flight Rules (VFR) Restrictions	260
6.2.2	Visual Flight Rules (VFR) Release of an Instrument Flight Rules (IFR) Aircraft	260
6.3	Emergencies and Equipment Failures — Instrument Flight Rules (IFR)	261
6.3.1	Declaration of Emergency	261
6.3.2	Two-Way Communications Failure	261
6.3.2.1	General	261
6.3.2.2	Instrument Flight Rules (IFR) Flight Plan	261
6.3.3	Reporting Malfunctions of Navigation and Communications Equipment	262
6.3.4	Fuel Dumping	263
6.4	Instrument Flight Rules (IFR) Separation	263
6.4.1	General	263
6.4.2	Vertical Separation — General	263
6.4.3	Vertical Separation Between Flight Levels and Altitudes Above Sea Level (ASL)	263
6.4.4	Longitudinal Separation—Distance-Based	263
6.4.5	Lateral Separation — General	263
6.4.6	Lateral Separation — Airways and Tracks	263
6.4.7	Lateral Separation — Instrument Approach Procedure	264
6.5	Visual Separation	264
6.5.1	General	264
6.5.2	Speed Control Instructions on Departure	264
6.5.3	Controller-Applied Visual Separation	264
6.5.4	Pilot-Applied Visual Separation	264
6.6	Development of Instrument Procedures	265
7.0	INSTRUMENT FLIGHT RULES – DEPARTURE PROCEDURES	265
7.1	Aerodrome Operations	265
7.2	Automatic Terminal Information Service (ATIS) Broadcasts	265
7.3	Initial Contact	265
7.4	Instrument Flight Rules (IFR) Clearances	265
7.5	Standard Instrument Departure (SID)	265
7.6	Noise Abatement Procedures — Departure	267
7.6.1	General	267
7.6.2	Noise Preferential Runways	267
7.6.3	Noise Abatement Departure Procedures (NADP)	268
7.7	Obstacle and Terrain Clearance	269
7.7.1	Visual Climb Over The Airport (VCOA)	270
7.7.2	Low, Close-in Obstacles	270
7.8	Release from Tower Frequency	271
7.9	Instrument Flight Rules (IFR) Departures from Uncontrolled Airports	271
7.10	Alerting Service Instrument Flight Rules (IFR) Departures from Uncontrolled Airports	271
8.0	INSTRUMENT FLIGHT RULES (IFR) – EN ROUTE PROCEDURES	271
8.1	Position Reports	271
8.2	Mach Number/True Airspeed—Clearances and Reports	272
8.2.1	Mach Number	272
8.2.2	True Airspeed (TAS)	272
8.3	Altitude Reports	272
8.4	Climb or Descent	273
8.4.1	General	273
8.4.2	Visual Climb and Descent	273
8.4.2.1	General	273
8.4.2.2	Visual Separation from Other Aircraft	273
8.5	Minimum Instrument Flight Rules (IFR) Altitudes	273
8.6	Air Traffic Control (ATC) Assignment of Altitudes	274
8.6.1	Minimum Instrument Flight Rules (IFR) Altitude	274
8.6.1.1	Distance Measuring Equipment (DME) Intersections on a Minimum En-Route Altitude (MEA)	275
8.6.2	Altitudes and Direction of Flight	275
8.7	“1 000-ft-on-Top” Instrument Flight Rules (IFR) Flight	275
8.8	Clearances—Leaving or Entering Controlled Airspace	276
8.9	Clearance Limit	276
8.10	Class G Airspace—Recommended Operating Procedures—En-Route	276

9.0	INSTRUMENT FLIGHT RULES (IFR)—ARRIVAL PROCEDURES	277
9.1	Automatic Terminal Information Service (ATIS) Broadcasts	277
9.2	Standard Terminal Arrival (STAR), Minimum Sector Altitude (MSA) and Terminal Arrival Area (TAA)	277
9.2.1	Minimum Sector Altitude (MSA)	277
9.2.2	Terminal Arrival Area (TAA)	277
9.2.3	Standard Terminal Arrival (STAR)	278
9.2.3.1	Conventional Standard Terminal Arrival (STAR)	278
9.2.3.2	Performance Based Navigation (PBN) Standard Terminal Arrival (STAR)	278
9.2.3.3	Flight Planning	278
9.2.3.4	Procedure Identification	278
9.2.3.5	Altitude Restrictions	279
9.2.3.6	Speed Restrictions	279
9.2.3.7	Operating Procedures	279
9.2.3.8	Top of Descent (TOD)	279
9.2.3.9	Descent Planning	280
9.2.3.10	Closed Standard Terminal Arrival (STAR) Procedures	280
9.2.3.11	Open Standard Terminal Arrival (STAR) Procedures	280
9.2.3.12	Transitioning from an Open Standard Terminal Arrival (STAR) to an Approach Procedure	280
9.2.3.13	Approach Clearances	281
9.2.3.14	Radar Vectors to Final	282
9.2.3.15	Amending Routes	282
9.2.3.16	Direct Routings to an Initial Approach Waypoint (IAWP)/Intermediate Waypoint (IWP)	282
9.2.3.17	Cancelling Standard Terminal Arrival (STAR) Procedures	282
9.2.3.18	Communication Failures on a Standard Terminal Arrival (STAR) Procedure	282
9.3	Approach Clearance	282
9.4	Descent Out of Controlled Airspace	283
9.5	Advance Notice of Intent in Minimum Weather Conditions	284
9.6	Contact and Visual Approaches	284
9.6.1	Contact Approach	284
9.6.2	Visual Approach	284
9.6.2.1	Missed Approach	285
9.7	Radar Arrivals	286
9.7.1	General	286
9.7.2	Radar Required	286
9.7.3	Speed Adjustment – Radar-Controlled Aircraft	286
9.7.4	Precision Radar Approaches	287
9.8	Initial Contact with Control Towers	287
9.9	Approach Position Reports— Controlled Airports	287
9.10	Control Transfer— Instrument Flight Rules (IFR) Units to Towers	287
9.11	Initial Contact with Air-Ground Facility at Uncontrolled Aerodromes	287
9.12	Instrument Flight Rules (IFR) Reporting Procedures at Uncontrolled Aerodromes	288
9.13	Instruments Flight Rules (IFR) Procedures at an Uncontrolled Aerodrome in Uncontrolled Airspace	288
9.14	Outbound Report	289
9.15	Straight-In Approach	289
9.16	Straight-In Approaches from an Intermediate Fix	289
9.17	Procedure Altitudes and Current Altimeter Setting	289
9.17.1	Corrections for Temperature	289
9.17.2	Remote Altimeter Setting	291
9.18	Departure, Approach and Alternate Minima	292
9.18.1	Category II Instrument Landing System (ILS) Approach Minima	292
9.19	Application of Minima	293
9.19.1	Takeoff Minima	293
9.19.2	Approach Ban	294
9.19.2.1	General Aviation—Non-Precision Approach (NPA), Approach Procedure with Vertical Guidance (APV), CAT I or CAT II Precision Approach	294
9.19.2.2	Approach Ban—General Aviation—CAT III Precision Approach	294
9.19.2.3	Approach Ban—Commercial Operators—General—Non-Precision Approach (NPA), Approach Procedure with Vertical Guidance (APV), or CAT I Precision Approach	295
9.19.2.4	Approach Ban—Commercial Operators—CAT II and CAT III Precision Approach	295
9.19.2.5	Approach Ban—Commercial Operators—Operations Specification—Non-Precision Approach (NPA), Approach Procedure with Vertical Guidance (APV), or CAT I Precision Approach	296
9.19.2.6	Runway Visibility	296
9.19.2.7	Localized Phenomenon	296
9.19.2.8	Effects of the High Intensity Approach Lighting (HIAL) System on <i>Canada Air Pilot</i> (CAP) Advisory Visibilities and Runway Certification	297
9.19.3	Landing Minima	297

9.20	Runway Visual Range (RVR)	298
9.20.1	Definitions	298
9.20.2	Operational Use of Runway Visual Range (RVR)	298
9.21	Aircraft Categories	299
9.22	Straight-In Landing Minima	299
9.23	Circling	300
9.23.1	Standard Circling Approach Radii	300
9.23.2	Expanded Circling Approach Radii	300
9.24	Circling Procedures	301
9.25	Missed Approach Procedure While Visually Manoeuvring in the Vicinity of the Aerodrome	301
9.26	Missed Approach Procedures	301
9.27	Simultaneous Precision Instrument Approaches - Parallel Runways	302
9.28	Simultaneous Precision Instrument Approaches - Converging Runways	302
10.0	INSTRUMENT FLIGHT RULES (IFR) — HOLDING PROCEDURES	303
10.1	General	303
10.2	Holding Clearance	303
10.3	Standard Holding Pattern	303
10.4	Non-Standard Holding Pattern	304
10.5	Entry Procedures	304
10.6	Timing	304
10.7	Speed Limitations	305
10.8	Distance Measuring Equipment (DME) Procedures	305
10.9	Shuttle Procedure	305
10.10	Holding Patterns Published on Enroute and Terminal Charts	305
11.0	AIR TRAFFIC CONTROL (ATC) SPECIAL PROCEDURES	306
11.1	Adherence to Mach Number	306
11.2	Parallel Offset Procedures	306
11.3	Structured Airspace	306
11.4	Canadian Domestic Routes	306
11.4.1	General	306
11.4.2	North American Route Program (NRP)	306
11.4.2.1	Introduction	306
11.4.2.2	Eligibility	306
11.4.2.3	Procedures	307
11.4.3	Mandatory Instrument Flight Rules (IFR) Routes	307
11.4.4	Fixed Area Navigation (RNAV) Routes	307
11.4.5	Northern Control Area (NCA) Random Routes	307
11.4.6	Arctic Control Area (ACA) Random Routes	307
11.4.7	Polar Routes	308
11.4.7.1	General	308
11.4.7.2	Flight Planning and Position Reporting	308
11.4.7.3	Altitude Assignment	308
11.5	Northern American Route (NAR) System	308
11.6	Security Control of Air Traffic	308
11.7	Reduced Vertical Separation Minimum (RVSM)	308
11.7.1	Definitions	308
11.7.2	Reduced Vertical Separation Minimum (RVSM) Airspace	308
11.7.3	Air Traffic Control (ATC) Procedures	309
11.7.4	In-Flight Procedures	309
11.7.5	Flight Planning Requirements	309
11.7.6	Operation of Non-Reduced Vertical Separation Minimum (Non-RVSM) Aircraft in RVSM Airspace	309
11.7.7	Delivery Flights for Aircraft that are Reduced Vertical Separation Minimum (RVSM)-Compliant on Delivery	310
11.7.8	Airworthiness and Operational Approval and Monitoring	310
11.7.9	Monitoring	310
11.7.10	North American Approvals Registry and Monitoring Organization (NAARMO)	311
11.7.11	Traffic Alert and Collision Avoidance System (TCAS) II/Airborne Collision Avoidance System (ACAS) II Reduced Vertical Separation Minimum (RVSM) Requirements	311
11.7.12	Mountain Wave Activity (MWA)	311
11.7.13	Wake Turbulence	311
11.7.14	In-Flight Contingencies	312
11.8	Minimum Safe Altitude Warning (MSAW)	313
11.8.1	General	313
11.8.2	Procedures	314
11.8.3	Pilot-Initiated Terrain Avoidance Procedure	314

11.8.4	Air Traffic Control (ATC)-Initiated Terrain Avoidance Procedure.....	314
11.8.5	Assistance to Aircraft in Distress	314

RAC ANNEX.....315

1.0	General	315
2.0	Canadian Aviation Regulations (CARs)	315
3.0	Transportation of Dangerous Goods (TDG) by Air	324

NAT—NORTH ATLANTIC (NAT) OPERATIONS 318

1.0 NORTH ATLANTIC (NAT) OPERATIONS318

1.1	Regulation, Reference Documents and Guidance Material	318
1.1.1	Regulation	318
1.1.2	North Atlantic (NAT) Documentation	318
1.2	General Aviation Aircraft	318
1.3	North American Routes (NAR)	318
1.4	Gander Oceanic Transition Area (GOTA)	318
1.5	North Atlantic (NAT) Organized Track System (OTS)	319
1.6	Flight Rules.....	319
1.7	Flight Planning Procedures	319
1.7.1	Routes	319
1.7.2	Airspeed	320
1.7.3	Altitude	320
1.7.4	Estimated Times	321
1.7.5	Aircraft Approval Status and Registration	321
1.7.6	Height Monitoring Unit (HMU).....	321
1.8	Preferred Route Message (PRM)	321
1.9	Clearances	321
1.9.1	Oceanic Clearances	321
1.9.2	Domestic Clearances—North Atlantic (NAT) Westbound Traffic	322
1.9.3	Oceanic Clearance Delivery	322
1.10	Position Reports	323
1.10.1	Requirements	323
1.10.2	Communications with air traffic control (ATC)	323
1.11	Minimum Navigation Performance Specifications (MNPS) for operations within the North Atlantic High-Level Airspace (NAT HLA).....	324
1.11.1	General	324
1.11.2	Aircraft without Minimum Navigation Performance Specifications (MNPS) for the North-Atlantic High-Level Airspace (NAT HLA) Operations	324
1.12	Reduced Vertical Separation Minimum (RVSM)—Minimum Aircraft System Performance Specifications (MASPS).....	324
1.13	Adherence to Mach Setting	324
1.14	Operation of Transponders	325
1.15	Meteorological Reports	325
1.16	Altitude Reports	325
1.17	Contingency and Emergency Procedures	325
1.17.1	In-Flight Contingencies	325
1.17.2	Contingency Procedures for Oceanic Traffic in the Event of an Evacuation of Gander Aera Control Centre (ACC)	326
1.18	Communications Failure—North Atlantic (NAT) Traffic	331
1.18.1	General	331
1.18.2	Communications Failure Prior to Entering the North Atlantic (NAT) Oceanic Airspace	331
1.18.3	Communications Failure Prior to Exiting the North Atlantic (NAT) Oceanic Airspace	331
1.19	North Atlantic High-Level Airspace (NAT HLA)	331
1.19.1	General	331
1.19.2	Time Keeping Procedures	332
1.19.3	Provisions for Partial Loss of Navigation Capability	332
1.19.4	Special Routes for Aircraft Fitted With a Single Long-Range Navigation System	332
1.19.5	Aircraft Without Minimum Navigation Performance Specifications (MNPS) Capability	333
1.19.6	Monitoring of Gross Navigation Errors	333
1.20	North Atlantic (NAT) Reduced Vertical Separation Minimum (RVSM)	333
1.20.1	Geographic Boundaries	333
1.20.2	Reduced Vertical Separation Minimum (RVSM) Details and Procedures	333
1.20.3	Flight Level Allocation Scheme (FLAS).....	333
1.20.3.1	Flight Level Allocation Scheme (FLAS) Procedures.....	334
1.20.3.2	Organized Track System (OTS).....	334
1.20.3.3	Organized Track System (OTS) Changeover Periods	334

1.20.3.4	Night Datum Line	335
1.20.3.5	North Datum Line.....	335
1.20.4	North Atlantic (NAT) Reduced Vertical Separation Minimum (RVSM) Aircraft Approvals	336
1.20.5	Central Monitoring Agency (CMA).....	336
1.20.6	Data Link Mandate (DLM) Airspace	336
1.20.6.1	General Information	336
1.20.6.2	Data Link Mandate (DLM) Flight Levels	336
1.20.6.3	Flights Permitted to Operate Within NAT DLM Airspace	336
1.20.6.4	Airspace Not Included in Gander's North Atlantic (NAT) Data Link Mandate (DLM) Airspace	337
1.20.6.5	Operational Policies	337
1.20.6.6	Equipment Failure of Either ADS-C or CPLDC Systems	337
1.20.7	Height Monitoring	337
1.20.8	Height Monitoring Unit (HMU).....	337
1.20.8.1	Pre-flight Procedures	337
1.20.8.2	In-flight Procedures	338
1.20.8.3	Post-flight Procedures	338
1.21	Strategic Lateral Offset Procedure (SLOP).....	338
2.0	INTERNATIONAL AIR-GROUND SERVICE.....	338
2.1	High Frequency (HF) Aeromobile Operations in the North Atlantic (NAT).....	338
2.2	High Frequency (HF) Operations—Anchorage Arctic	339
2.4	Selective Calling System (SELCAL).....	339
2.5	Use of General Purpose Very High Frequency (VHF) or Satellite Voice Communications (SATVOICE) in Lieu of International High Frequency (HF) Air-Ground Frequencies.....	340
2.5.1	North Atlantic (NAT) and Anchorage Arctic Regions—Satellite Voice Communications (SATVOICE) Use	340
2.5.2	North Atlantic (NAT) Region—Very High Frequency (VHF) Coverage	340
2.6	ARINC 424 Identifiers for Half-Degree Waypoints in the Gander Oceanic Control Area (OCA).....	341

SAR—SEARCH AND RESCUE

343

1.0	RESPONSIBLE AUTHORITY	343
1.1	General	343
1.2	Types of Service Available	343
1.3	Search and Rescue (SAR) Agreements	343
2.0	FLIGHT PLANNING	344
2.1	General	344
2.2	Request for Search and Rescue (SAR) Assistance	344
2.3	Missing Aircraft Notice (MANOT).....	344
2.4	Aiding Persons in Distress	345
3.0	EMERGENCY LOCATOR TRANSMITTER (ELT).....	346
3.1	General	346
3.2	Types of Emergency Locator Transmitter (ELT)	346
3.3	Installation and Maintenance Requirements	346
3.4	Emergency Locator Transmitter (ELT) Operating Instructions (Normal Use)	347
3.5	Emergency Locator Transmitter (ELT) Operating Instructions (Emergency Use)	347
3.6	Maximizing the Signal	348
3.7	Accidental Emergency Locator Transmitter (ELT) Transmissions	348
3.8	Testing Procedures	348
3.8.1	406 MHz Emergency Locator Transmitters (ELTs)	348
3.8.2	121.5/243 MHz Emergency Locator Transmitters (ELTs).....	348
3.9	Schedule of Requirements	349
4.0	AIRCRAFT EMERGENCY ASSISTANCE	350
4.1	Declaring an Emergency	350
4.2	Action by the Pilot During Emergency Conditions	350
4.3	Very High Frequency (VHF) Direction-Finding Assistance.....	350
4.4	Transponder Alerting	350
4.5	Radar Alerting Manoeuvres	350
4.6	Emergency Radio Frequency Capability.....	351
4.7	Interception Procedures (Canadian Aviation Regulation (CAR) 602.144)	351

4.8	Downed Aircraft Procedures	354
4.8.1	Ground-to-Air Signals	354
4.8.2	Survival	354
4.9	Canada Shipping Act, 2001 (2001, C. 26) EXTRACT—PART 5, SECTIONS 130–133	355

MAP—AERONAUTICAL CHARTS AND PUBLICATIONS 357

1.0	GENERAL INFORMATION	357
2.0	AERONAUTICAL PUBLICATIONS	357
2.1	AIP Canada (ICAO)	357
2.2	AIP Canada (ICAO) Supplements	357
2.3	AIP Canada (ICAO) Aeronautical Information Circulars	357
2.4	Aeronautical Information Regulation and Control (AIRAC) Canada	358
2.5	Visual Flight Rules (VFR) Aeronautical Information.....	358
2.5.1	VFR Navigation Chart (VNC)	358
2.5.2	VFR Terminal Area Chart (VTA).....	358
2.5.3	Canada Flight Supplement (CFS).....	358
2.5.4	Canada Water Aerodrome Supplement (CWAS).....	358
2.5.5	Aeronautical Charts	358
2.6	Instrument Flight Rules (IFR) Aeronautical Information.....	358
3.0	NOTAM	359
3.1	General	359
3.2	NOTAM Format	359
3.2.1	Format Description	359
3.2.2	Item Q Description	359
3.2.3	Items Description	360
3.2.3.1	NOTAM Number and Type.....	360
3.2.3.2	Item Q) Coded Line.....	360
3.2.3.3	Item A) Location Indicator(s).....	360
3.2.3.4	Items B) and C) Start and End Time.....	360
3.2.3.5	Item D) Schedule.....	360
3.2.3.6	Item E) NOTAM Text.....	361
3.2.3.7	Items F) and G) Lower and Upper Vertical Limits.....	361
3.3	NOTAM Types	361
3.4	NOTAM Issued Under a Flight Information Region (FIR) or an Aerodrome	361
3.5	NOTAM Distribution	361
3.6	Criteria for Issuing a NOTAM	362
3.7	Automatic Query/Response—Canadian NOTAM Database	363
3.8	Runway Surface Condition (RSC) / Canadian Runway Friction Index (CRFI) NOTAM (NOTAMJ)	363
3.8.1	Query/Response NOTAMJ (NOTAMQ)	363
4.0	PROCUREMENT OF AERONAUTICAL CHARTS AND PUBLICATIONS	364
4.1	General	364
4.2	NAV CANADA Publications.....	364
4.2.1	Individual Purchase	364
4.2.2	Subscriptions	364
5.0	CHARTS AND PUBLICATIONS FOR INTERNATIONAL FLIGHTS	365

LRA—LICENSING, REGISTRATION AND AIRWORTHINESS 367

1.0	FLIGHT CREW LICENSING	367
1.1	General.....	367
1.2	Aviation Document Booklet (ADB).....	367
1.3	Aviation Language Proficiency	367
1.4	Permits and Licences issued by Transport Canada Civil Aviation (TCCA).....	368
1.4.1	Permits	368
1.4.2	Licences	368
1.5	Definitions of Flight Experience	368

1.6	Summary of Requirements for Permits	369
1.6.1	Student Pilot Permits (SPP)	369
1.6.2	Pilot Permits	369
1.7	Summary of Requirements for Licences	370
1.7.1	Pilot Licence	370
1.7.2	Private Pilot Licence (PPL)	371
1.7.3	Commercial Pilot Licence (CPL)	371
1.7.4	Airline Transport Pilot Licence (ATPL)	372
1.7.5	Flight Engineer (FE) Licence	372
1.8	Differences Between the National Regulations and the International Civil Aviation Organization's (ICAO) Annex 1 Standards and Recommended Practices	372
1.9	Medical Fitness for Permits and Licences	372
1.9.1	Medical Validity Periods	373
1.9.2	Medical Fitness—Renewals for Category 1, 2 or 3 Medical Certificates (Assessed Fit)	374
1.9.3	Medical Fitness—Renewals for Category 4 Medical Certificate	374
1.9.4	Medical Fitness—Assessed Unfit	374
1.10	Refusal to Issue a Permit, Licence, Rating or Medical Certificate	374
1.11	Reinstatement of a Suspended Permit, Licence or Rating	374
1.12	Recency Requirements	374
1.13	Flight Crew Licensing Conversion Agreement Between Canada and the United States	375
1.14	Flight Crew Licensing Administration	376
1.14.1	Flight Crew Licensing Change of Address Request	376
1.14.2	Application for Re-Issue of Civil Aviation Licensing Document	376
1.14.3	Flight Crew Licensing Declaration of Name	376
1.14.4	Change of Citizenship	376
2.0	CIVIL AVIATION MEDICINE	376
2.1	Medical Assessment Process	376
2.1.1	Medical Examination Report	376
2.1.2	Category 4 Medical Declaration	376
2.2	Medical Examination Requirements	378
2.3	Periodic Medical Exam Categories 1, 2 and 3—Medically Fit	379
2.4	Aviation Medical Review Board	379
2.5	Unfit Assessment	379
2.6	Review by the Transportation Appeal Tribunal of Canada (TATC)	379
3.0	FLIGHT CREW EXAMINATIONS	380
3.1	Examination Offices	380
3.2	Cheating on an Exam	380
3.3	Use of Hand-Held Calculators or Computers	380
4.0	AIRCRAFT IDENTIFICATION, MARKING, REGISTRATION AND INSURANCE	381
4.1	General	381
4.2	Aircraft Identification	381
4.3	Nationality and Registration Marks	381
4.4	Change of Ownership—Canadian-Registered Aircraft	382
4.5	Initial Registration	382
4.6	Importation of Aircraft	382
4.7	Exportation of Aircraft	382
4.8	Liability Insurance	382
5.0	AIRCRAFT AIRWORTHINESS	383
5.1	General	383
5.2	Aircraft Design Requirements	383
5.2.1	General	383
5.2.2	Canadian Type Certificate	383
5.3	Flight Authority and Noise Compliance	383
5.3.1	General	383
5.3.2	Certificate of Airworthiness (C of A)	384
5.3.3	Special Certificate of Airworthiness (Special C of A)	384
5.3.4	Flight Permit	384
5.3.5	Noise Compliance	384
5.4	Maintenance Certification	385
5.4.1	General	385
5.4.2	Certification of Maintenance Performed Outside Canada	385

5.5	Annual Airworthiness Information Report (AAIR)	385
5.6	Maintenance Requirements for Canadian-Registered Aircraft	385
5.6.1	General	385
5.6.2	Maintenance Schedules	386
5.6.3	Maintenance Performance.....	386
5.6.4	Aircraft Technical Records	386
5.6.5	Service Difficulty Reporting Program	386
5.7	Airworthiness Directives (ADs)	386
5.7.1	General	386
5.7.2	Availability of Airworthiness Directives (ADs).....	387
5.7.3	Airworthiness Directive (AD) Schedule and Compliance Records.....	387
6.0	THE TRANSPORTATION APPEAL TRIBUNAL OF CANADA (TATC)	387
6.1	General	387
6.2	Refusal to Issue or Amend a Canadian Aviation Document	387
6.3	Suspension, Cancellation or Refusal to Renew a Canadian Aviation Document	388
6.4	Monetary Penalties	388
6.5	Appeals	388

AIR—AIRMANSHIP 389

1.0	GENERAL INFORMATION	389
1.1	General	389
1.2	Pilot Vital Action Checklists	389
1.3	Aviation Fuels	389
1.3.1	Fuel Grades	389
1.3.2	Aviation Fuel Handling	389
1.3.3	Fuel Anti-Icing Additives	389
1.3.4	Refuelling—Fires and Explosions	390
1.3.4.1	Understanding Flashpoint, Static and Auto-ignition.....	390
1.4	Aircraft Hand Fire Extinguishers	390
1.4.1	General	390
1.4.2	Classification of Fires	391
1.4.3	Types of Extinguishers	391
1.5	Pressure Altimeter	391
1.5.1	General	391
1.5.2	Calibration of the Pressure Altimeter	392
1.5.3	Incorrect Setting on the Subscale of the Altimeter	392
1.5.4	Non-Standard Temperatures	392
1.5.5	Standard Pressure Region	393
1.5.6	Effect of Mountains	393
1.5.7	Downdraft and Turbulence	393
1.5.8	Pressure Drop	393
1.5.9	Abnormally High Altimeter Settings	393
1.6	Canadian Runway Friction Index (CRFI)	394
1.6.1	General	394
1.6.2	Reduced Runway Coefficients of Friction and Aircraft Performance	394
1.6.3	Description of Canadian Runway Friction Index (CRFI) and Method of Measurement	394
1.6.4	Aircraft Movement Surface Condition Reports (AMSCR).....	394
1.6.5	Wet Runways	396
1.6.6	Canadian Runway Friction Index (CRFI) Application to Aircraft Performance	396
1.7	Jet and Propeller Blast Danger	400
1.8	Marshalling Signals	401
2.0	FLIGHT OPERATIONS	405
2.1	General	405
2.2	Crosswind Landing Limitations	405
2.3	Carburetor Icing	405
2.4	Low Flying	406
2.4.1	Flying Near Power Lines	406
2.4.2	Logging Operations	406
2.5	Flight Operations in Rain	407
2.6	Flight Operations in Volcanic Ash	407
2.7	Flight Operation Near Thunderstorms	407
2.7.1	General	407

2.7.2	Considerations	408
2.8	Low-Level Wind Shear (WS)	408
2.9	Wake Turbulence	409
2.9.1	Vortex Characteristics	410
2.9.2	Considerations	410
2.10	Clear Air Turbulence (CAT)	411
2.11	Flight Operations on Water	412
2.11.1	General	412
2.11.2	Ditching	412
2.11.3	Life-Saving Equipment For Aircraft Operating Over Water	413
2.11.4	Landing Seaplanes on Glassy Water	413
2.12	Flight Operations in Winter	413
2.12.1	General	413
2.12.1.1	Fan Blade Ice Shedding Procedure	413
2.12.2	Aircraft Contamination on the Ground – Frost, Ice or Snow	413
2.12.3	Aircraft Contamination in Flight – In-flight Airframe Icing	417
2.12.3.1	Types of Ice	417
2.12.3.2	Aerodynamic Effects of Airborne Icing	417
2.12.3.3	Roll Upset	417
2.12.3.4	Tail Plane Stall	418
2.12.3.5	Freezing Rain, Freezing Drizzle, and Large Super-Cooled Droplets	418
2.12.3.6	Detecting Large Super-Cooled Droplets Conditions in Flight	419
2.12.3.7	Flight Planning or Reporting	419
2.12.4	Landing Wheel-Equipped Light Aircraft on Snow Covered Surfaces	419
2.12.5	Use of Seaplanes on Snow Surfaces	420
2.12.6	Landing Seaplanes on Unbroken Snow Conditions	420
2.12.7	Whiteout	420
2.13	Flight Operations in Mountainous Areas	420
2.14	Flight Operations in Sparsely Settled Areas of Canada	421
2.14.1	Single-Engine Aircraft Operations in Northern Canada	421
2.15	Flight Operations at Night	421
2.16	Vertical Path Control on Non-Precision Approaches (NPAs)	421
2.16.1	Controlled Flight Into Terrain (CFIT).....	421
2.16.2	Stabilized Approach	421
2.16.3	Vertical Path Control Techniques.....	422
3.0	MEDICAL INFORMATION	423
3.1	General Health	423
3.1.1	Mandatory Medical Reporting	423
3.2	Specific Aeromedical Factors	423
3.2.1	Hypoxia.....	423
3.2.2	Carbon Monoxide	423
3.2.3	Hyperventilation.....	424
3.3	Decompression Sickness.....	424
3.4	Scuba Diving.....	424
3.5	Vision.....	424
3.6	Middle-Ear and Sinus Discomfort or Pain.....	425
3.7	Disorientation.....	425
3.8	Fatigue.....	425
3.9	Alcohol.....	426
3.10	Drugs	426
3.11	Anaesthetics.....	426
3.12	Blood Donation.....	426
3.13	Immunizations	426
3.14	Pregnancy	426
3.15	Positive and Negative G.....	427
3.15.1	What is G?	427
3.15.2	The Effects of G.....	427
3.15.3	G Straining Manoeuvres	428
3.15.4	Dealing with G.....	428
4.0	MISCELLANEOUS	428
4.1	Air Time and Flight Time	428
4.2	Conduct of Experimental Test Flights	428
4.3	Practice Spins	429
4.4	Cargo Restraint	429

- 4.4.1 General 429
- 4.4.2 Regulations 429
- 4.4.3 Guidelines 429
- 4.4.4 References 429
- 4.4.5 Approval 430
- 4.5 Collision Avoidance – Use of Landing Lights 430**
- 4.6 Use of Strobe Lights 430**
- 4.7 Manned Free Balloon Operations 430**
 - 4.7.1 Balloon Operations with Fare-Paying Passengers..... 430
- 4.8 Parachute Jumping/Skydiving 430**
- 4.9 Hang Glider and Paraglider Operations 431**
- 4.10 Ultra-light Aeroplane 431**
- 4.11 Circuit Breakers and Alerting Devices 431**
- 4.12 Design Eye Reference Point 432**
- 4.13 First Aid Kits on Privately Owned and Operated Aircraft 432**
- 4.14 Survival Advisory Information 432**
- 4.15 Potential Flight Hazards for Aircraft 432**
 - 4.15.1 Avoid Flight in the Vicinity of Exhaust Plumes..... 432
 - 4.15.2 Pilot Procedures When Exposed to Laser and Other Directed Bright Light Sources..... 433
 - 4.15.2.1 General..... 433
 - 4.15.2.2 Procedures..... 433
 - 4.15.2.2.1 Preventive Procedures 433
 - 4.15.2.2.2 Incident Procedures 434
 - 4.15.2.2.3 Medical Follow-up Procedures After an In-flight Illumination 434

RPA—REMOTELY PILOTED AIRCRAFT 437

- 1.0 GENERAL INFORMATION 437**
- 2.0 MICRO REMOTELY PILOTED AIRCRAFT SYSTEMS (mRPAS) — LESS THAN 250 G..... 437**
- 3.0 SMALL REMOTELY PILOTED AIRCRAFT SYSTEMS (sRPAS) — 250 G TO 25 KG 438**
 - 3.1 Registration 438**
 - 3.1.1 Modifying a Registration 438
 - 3.1.1.1 Cancelling a Registration 438
 - 3.1.1.2 Change of Name or Address..... 438
 - 3.2 General Operation and Flight Rules..... 438**
 - 3.2.1 Line-of-sight 438
 - 3.2.1.1 Visual line-of-sight (VLOS)..... 439
 - 3.2.1.2 Radio line-of-sight (RLOS)..... 439
 - 3.2.2 Emergency Security Perimeters 439
 - 3.2.3 Airspace 439
 - 3.2.3.1 Canadian Domestic Airspace..... 439
 - 3.2.3.2 Controlled Airspace..... 439
 - 3.2.3.3 Drone Site Selection Tool 441
 - 3.2.3.4 Inadvertent Entry Into Controlled Airspace..... 441
 - 3.2.4 Flight Safety 441
 - 3.2.5 Right of Way and Risk of Collision 441
 - 3.2.6 Detecting and Avoiding Traffic 442
 - 3.2.6.1 General 442
 - 3.2.6.2 Seeing Traffic 442
 - 3.2.6.3 Hearing Traffic..... 443
 - 3.2.6.4 Avoiding a Collision 443
 - 3.2.7 Fitness of Crew Members..... 443
 - 3.2.8 Visual Observers..... 444
 - 3.2.9 Compliance With Instructions 445
 - 3.2.10 Living Creatures 445
 - 3.2.11 Procedures..... 445
 - 3.2.11.1 Normal Operating Procedures 445
 - 3.2.11.2 Emergency Procedures..... 445
 - 3.2.12 Pre-flight Information 446
 - 3.2.12.1 Pre-flight Inspections 446
 - 3.2.12.2 Fuel and/or Energy..... 446
 - 3.2.13 Maximum Altitude..... 446
 - 3.2.13.1 Types of Altitudes..... 446

3.2.13.2	Measuring Altitude.....	447
3.2.14	Horizontal Distance.....	447
3.2.15	Site Survey.....	448
3.2.15.1	Understanding Your Area of Operation.....	448
3.2.15.2	Locating Local Aerodromes and Airports.....	448
3.2.15.3	Identifying Classes of Airspace.....	448
3.2.16	Other Pre-flight Requirements.....	449
3.2.17	Serviceability of the RPAS.....	449
3.2.17.1	Airframe (All Types).....	449
3.2.17.2	Landing Gear.....	449
3.2.17.3	Powerplant.....	449
3.2.17.4	Propellers.....	450
3.2.17.5	Battery—Lithium Polymer.....	450
3.2.17.6	RPAS Control Station/Receiver/Transmitters.....	450
3.2.18	Availability of RPAS Operating Manuals.....	450
3.2.19	Manufacturer’s Instructions.....	450
3.2.20	Control of RPAS.....	450
3.2.21	Takeoffs, Launches, Approaches, Landings, and Recovery.....	450
3.2.22	Minimum Weather Conditions.....	451
3.2.22.1	Sources of Weather Information.....	451
3.2.22.2	Micro vs. Macro Climate Environments.....	451
3.2.22.3	Wind.....	452
3.2.22.4	Visibility.....	452
3.2.22.5	Clouds.....	452
3.2.22.6	Precipitation.....	452
3.2.22.7	Fog.....	452
3.2.22.8	Temperature.....	452
3.2.22.9	Sun.....	453
3.2.23	Icing.....	453
3.2.24	Formation Flight.....	453
3.2.25	Operation of Moving Vehicles, Vessels, and Manned Aircraft.....	453
3.2.26	First-person View (FPV) Devices.....	454
3.2.27	Night Flight.....	454
3.2.27.1	Detecting Aircraft During Night Operations.....	454
3.2.27.2	Aircraft Lighting.....	454
3.2.27.3	Use of Lights.....	455
3.2.27.4	Night Vision Goggles.....	455
3.2.28	Multiple Remotely Piloted Aircraft (RPA).....	455
3.2.29	Special Events.....	455
3.2.29.1	Special Aviation Events.....	455
3.2.29.2	Advertised Events.....	455
3.2.30	Handovers.....	455
3.2.31	Payloads.....	455
3.2.32	Flight Termination Systems.....	456
3.2.33	Emergency Locator Transmitters (ELT).....	456
3.2.34	Transponders and Automatic Pressure-Altitude Reporting Equipment.....	456
3.2.34.1	Transponder-required Airspace.....	456
3.2.34.2	Transponder Requirements.....	456
3.2.35	Operations at or in the Vicinity of an Aerodrome, Airport, or Heliport.....	456
3.2.36	Records.....	457
3.2.37	Incidents and Accidents.....	457
3.2.38	Tethered Drone.....	458
3.3	Basic Operations.....	458
3.3.1	General.....	458
3.3.2	Pilot Requirements.....	459
3.3.2.1	Pilot Certificate.....	459
3.3.2.2	Recency Requirements.....	459
3.3.2.3	Access to Certificate and Proof of Currency.....	459
3.3.2.4	Examination Rules.....	459
3.3.3	Small Remote Pilot Aircraft (sRPA) Requirement.....	459
3.4	Advanced Operations.....	459
3.4.1	General.....	459
3.4.2	Pilot Requirements.....	459
3.4.2.1	Pilot Certificate.....	459
3.4.2.2	Recency Requirements.....	459
3.4.2.3	Access to Certificate and Proof of Currency.....	460
3.4.2.4	Examination Rules.....	460

3.4.3	Manufacturer Declaration	460
3.4.4	Operations in Controlled Airspace	460
3.4.5	Operations at or in the Vicinity of an Airport, Heliport, or Water Aerodrome — Established Procedure	460
3.4.6	Operations Near People	461
3.4.7	Operations Over People	461
3.5	Flight Reviewers.....	461
3.5.1	General	461
3.5.2	Pilot Requirements	461
3.5.2.1	Flight Reviewer Rating	461
3.5.2.2	Examination	462
3.5.3	Conduct of Flight Reviews	462
3.6	Special Flight Operations - RPAS	462
3.6.1	General	462
3.6.2	Application for a Special Flight Operations Certificate - RPAS (SFOC - RPAS)	462

GEN—GENERAL

1.0 GENERAL INFORMATION

1.1 AERONAUTICAL INFORMATION

1.1.1 Aeronautical Authority

Transport Canada is the responsible aeronautical authority in Canada.

Postal Address:

Assistant Deputy Minister
 Transport Canada, Safety and Security
 330 Sparks Street
 Ottawa ON K1A 0N8

Aeronautical Fixed Telecommunication
 Network (AFTN):CYHQYAYB

The Transport Canada, Aerodromes and Air Navigation Branch is responsible for the establishment and administration of the Regulations and Standards for the provision of AIS in Canada.

Enquiries relating to regulations and standards for AIS should be addressed to:

Postal Address:

Flight Standards (AARTA)
 Transport Canada Civil Aviation
 330 Sparks Street
 Ottawa ON K1A 0N8

Tel.: 1-800-305-2059
 Fax: 613-952-3298
 E-mail: TC.Flights.Standards-Normesdevol.TC@tc.gc.ca

TRANSPORT CANADA REGIONAL OFFICES

Transport Canada has five Regional Offices:

Pacific Region

Transport Canada Civil Aviation
 Suite 820
 800 Burrard Street
 Vancouver BC V6Z 2J8

Tel.: 1-800-305-2059
 Fax: 1-855-618-6288

Prairie and Northern Region

Transport Canada Civil Aviation
 344 Edmonton Street
 Winnipeg MB R3C 0P6

Tel.: 1-888-463-0521
 Fax: 1-800-824-4442

Ontario Region

Transport Canada Civil Aviation
 4900 Yonge Street, 4th Floor
 Toronto ON M2N 6A5

Tel.: 1-800-305-2059
 Fax: 1-877-822-2129

Quebec Region

Transport Canada Civil Aviation
 700 Leigh-Capreol Place
 Dorval QC H4Y 1G7

Tel.: 1-800-305-2059
 Fax: 1-855-633-3697

Atlantic Region

Transport Canada Civil Aviation
 95 Foundry Street
 PO Box 42
 Moncton NB E1C 8K6

Tel.: 1-800-305-2059
 Fax: 1-855-726-7495

Figure 1.1—Transport Canada Regions



1.1.2 Aeronautical Information Management (AIM)

NAV CANADA's AIM group is responsible for the collection, evaluation and dissemination of aeronautical information published in the state AIP and associated aeronautical charts. In addition, the AIM group assigns and controls Canadian location indicators and aircraft operating agency designators. (For information on the dissemination of aeronautical information and aeronautical products, see the MAP chapter.)

The AIM group postal address is:

NAV CANADA
Aeronautical Information Management
1601 Tom Roberts Avenue
PO BOX 9824 STN T CSC
Ottawa ON K1G 9Z9

Tel. (Toll free, North America only): 1-866-577-0247
Tel. (Outside North America): 1-613-248-4087
Fax: 1-613-248-4093
Email: aimdata@navcanada.ca

Comments on the Air Navigation System

Any errors, omissions, anomalies, suggestions or comments on the air navigation system can be submitted via any FIC.

To report any concerns about the safety or quality of services provided by NAV CANADA, please contact the local NAV CANADA Site Manager or our Customer Service Centre at:

NAV CANADA
Customer Service
77 Metcalfe Street
PO BOX 3411 STN T
Ottawa ON K1P 5L6

Tel. (Toll-free, North America only): 1-800-876-4693
Tel. (Outside North America): 1-613-563-5588
Fax (Toll-free, North America only): 1-877-663-6656
Fax (Outside North America): 1-613-563-3426
E-mail: service@navcanada.ca
Regular hours of operation: 08:00–18:00 EST/EDT

1.1.3 Transport Canada Aeronautical Information Manual (TC AIM)

The TC AIM provides flight crews with reference material useful for aircraft operation in Canadian airspace. It includes those sections of the CARs that are of interest to pilots.

The TC AIM supplements the rules of the air and procedures for aircraft operation in Canadian airspace found in *AIP Canada (ICAO)* (see MAP 2.1).

Throughout the TC AIM, the term “should” implies that TC encourages all pilots to conform with the applicable procedure. The term “shall” implies that the applicable procedure is mandatory because it is supported by regulations.

As much as possible, the rules of the air and ATC procedures have been incorporated into the TC AIM in plain language. Where this was not possible, the CARs have been incorporated verbatim. Editorial liberties have been taken in the deletion of definitions not considered essential to the understanding of the intent of the CARs. This has been done to enhance comprehension of the rules and procedures essential to the safety of flight. The inclusion of these rules and procedures in this format does not relieve persons concerned with aviation from their responsibilities to comply with the *Canadian Aviation Regulations (CARs)*, the *Aeronautics Act* and other regulations made under the Act. Where the subject matter of the TC AIM makes reference to the CARs, the relevant provisions are indicated.

Care has been taken to ensure that the information contained in the TC AIM is accurate and complete. Any correspondence concerning the content of the TC AIM is to be referred to:

TC AIM Co-ordinator (AARTT)
Transport Canada
330 Sparks Street
Ottawa ON K1A 0N8

Tel.: 613-993-4502
Fax: 613-952-3298
E-mail: TC.AeronauticalInformationManual-Manueldinformationaeronautique.TC@tc.gc.ca

1.1.4 Transport Canada Aeronautical Information Manual (TC AIM) Publication Information

Individual copies of the TC AIM may be purchased by logging onto the Transport Canada Publication Storefront Web site at <<https://www.tc.gc.ca/en/transport-canada/corporate/publications.html>>. All information with respect to purchases and subscriptions to the TC AIM will be available on this Web site, or by contacting the Order Desk.

This edition of the TC AIM is designed to be as inexpensive as possible since it is intended primarily for student pilots and foreign pilots for use over a short period of time.

The TC AIM is available on the TransportCanada Web site at: <<https://www.tc.gc.ca/en/services/aviation/publications/tc-aim.html>>.

Amendment Service

This document is intended to provide users of Canadian airspace with current information. A regular amendment service is established to advise individuals of changes to the airspace, regulations or procedures. New editions of the TC AIM are issued twice a year in phase with the ICAO AIRAC schedule. Future issue dates are as follows:

2021-1 – March 25, 2021

2021-2 – October 07, 2021

Each new edition of the TC AIM includes an explanation of changes section that highlights the most significant changes made to the TC AIM and may provide a reference to detailed information on the change.

Distribution

To ensure uninterrupted service, rectify any distribution problems or make a change of address, please contact the TC Publications Order Desk using one of the methods listed below.

Transport Canada Publications Order Desk
Operational Support Services (AAFBD)
2655 Lancaster Road
Ottawa ON K1B 4L5

Tel. (toll-free in North America): 1-888-830-4911
..... 613-991-4071
Fax: 613-991-1653
E-mail: publications@tc.gc.ca
Web site: www.tc.gc.ca/en/transport-canada/corporate/publications.html

1.1.5 NOTAM

NAV CANADA, International NOTAM Office (NOF), is responsible for the collection, evaluation and dissemination of NOTAMs. A complete description of the Canadian NOTAM system is located in MAP 3.0.

Postal Address

NAV CANADA
International NOTAM Office
Combined ANS Facility
1601 Tom Roberts Avenue
PO Box 9824 Stn. T
Ottawa ON K1G 6R2

Tel.: 613-248-4000
Fax: 613-248-4001
AFTN: CYHQYNYX

1.1.6 Aerodromes

Complete information for all Canadian aerodromes is published in the CFS. ICAO Type A Charts are available from NAV CANADA’s AIM group (see MAP 4.2.1 and *AIP Canada (ICAO) GEN 3.2*).

1.2 SUMMARY OF NATIONAL REGULATIONS

Civil aviation in Canada is regulated by the *Aeronautics Act* and the CARs. (See MAP 4.1 to find out where to find the CARs). A legislation index is located in GEN 5.3.

1.3 DIFFERENCES WITH THE INTERNATIONAL CIVIL AVIATION ORGANIZATION (ICAO) STANDARDS, RECOMMENDED PRACTICES AND PROCEDURES

Differences with ICAO Annexes, which comprise international standards, recommended practices and procedures, are listed in *AIP Canada (ICAO)*, GEN 1.7.

1.3.1 International Civil Aviation Organization (ICAO)'s Procedures for Air Navigation Services—Aircraft Operations (PANS OPS)

(See *AIP Canada (ICAO)* GEN 1.7)

1.4 UNITS OF MEASUREMENT

The imperial system of units is used for all information contained on aeronautical charts and publications.

1.4.1 Other Units

Other units are given in the following table and apply to specific situations.

Table 1.1—Other Units of Measurement Used in Aviation

MEASUREMENT	UNITS	SYMBOLS
Altimeter setting	inches of mercury	in. Hg
Altitudes, elevations and heights	feet	ft
Distance used in navigation	nautical miles	NM
Horizontal speed	knots	kt
Relatively short distances	feet	ft
Runway Visual Range (RVR)	feet	ft
Temperature	degrees Celsius	°C
Tire pressure	pounds per square inch megapascals	psi MPa
Vertical speed	feet per minute	ft/min
Visibility	statute miles	SM
Weight	pounds kilograms kilonewtons	lb kg kN
Wind direction, except for landing and takeoff	degrees true	°True
Wind direction observations for landing and takeoff *Degrees true in the NDA	degrees magnetic	°Mag
Wind speed	knots	kt

1.4.2 Geographic Reference

Geographic coordinates are determined using the North American Datum 1983 (NAD83). Canada has deemed NAD83 coordinates to be equivalent to the World Geodetic System 1984 (WGS-84) for aeronautical purposes.

1.5 TIME SYSTEM

Coordinated Universal Time, abbreviated UTC, Zulu (Z) or spoken Universal, is used in Canadian aviation operations and is given to the nearest minute. Time checks are given to the nearest 15 seconds. The day begins at 0000 hours and ends at 2359 hours.

1.5.1 Date-Time Group

(See *AIP Canada (ICAO) GEN 2.1*)

1.5.2 Morning and Evening Twilight Charts

In the morning, civil twilight begins when the centre of the sun's disc is 6° below the horizon and is ascending, and ends at sunrise, approximately 25 min later. In the evening, civil twilight begins at sunset, and ends when the centre of the sun's disc is 6° below the horizon and is descending, approximately 25 min later.

INSTRUCTIONS

1. Start at the top or bottom of the scale with the appropriate date and move vertically, up or down to the curve of the observer's latitude.
2. From the intersection move horizontally and read the local time.
3. To find the exact zone or standard time, ADD 4 minutes for each degree west of the standard meridian, or SUBTRACT 4 minutes for each degree east of the standard meridian.

The standard meridians in Canada are: AST-60W; EST-75W; CST-90W; MST-105W; PST-120W

Figure 1.2—Beginning of Morning Civil Twilight on Standard Meridian of Time Zone

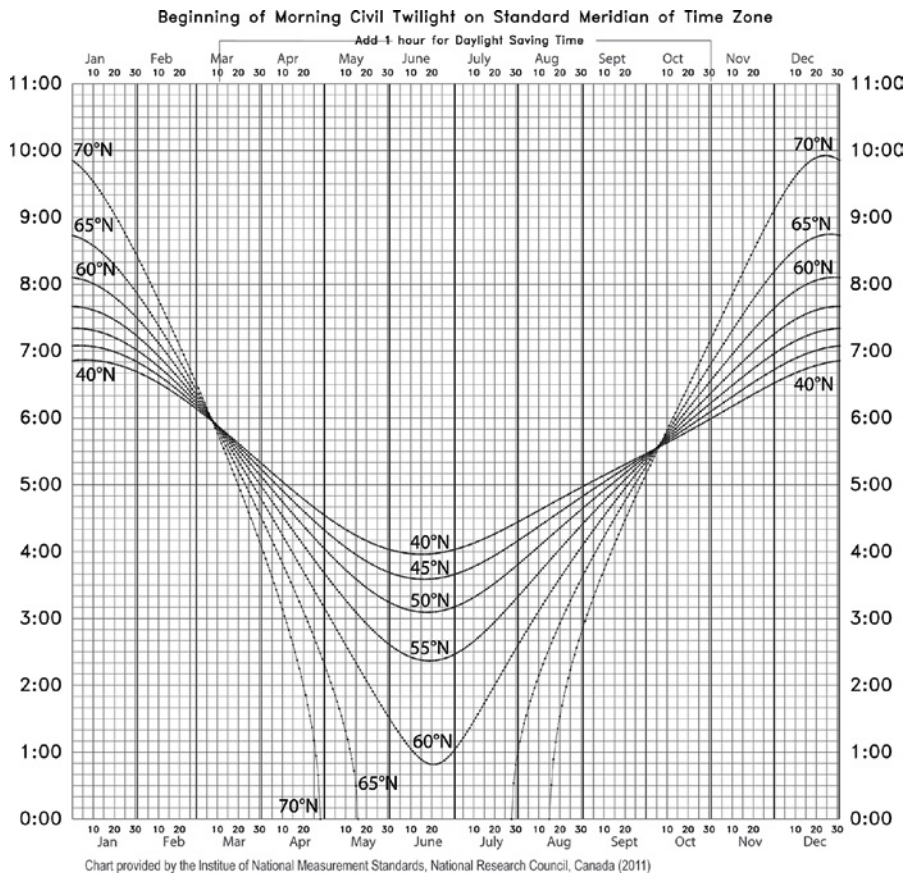
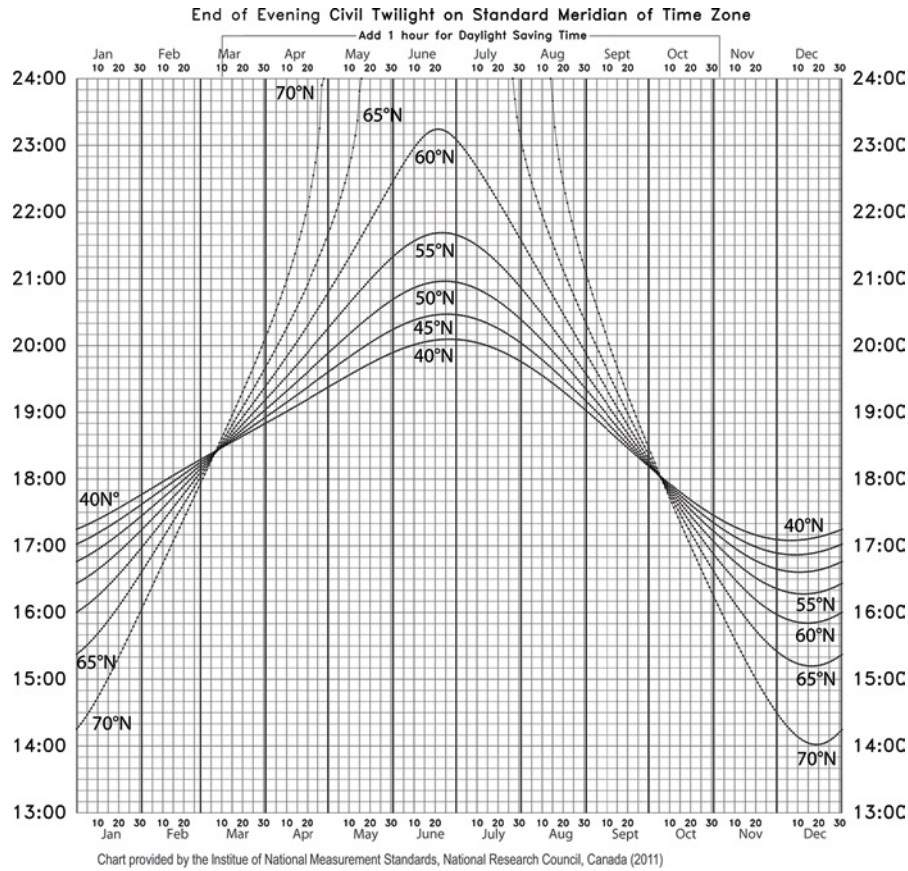




Figure 1.3—End of Evening Civil Twilight on Standard Meridian of Time Zone



1.5.3 Time Zone

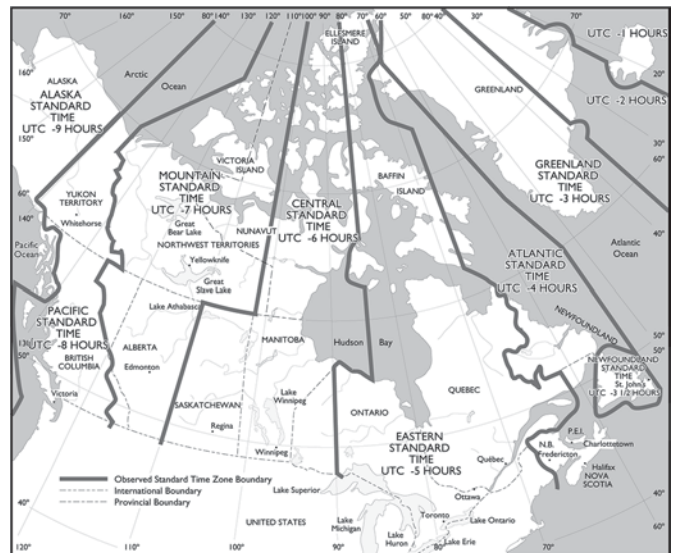
Where daylight saving time is observed in Canada, clocks are advanced one hour. Daylight saving time is in effect from 02:00 local time on the second Sunday in March to 02:00 local time on the first Sunday in November. Locations that observe daylight saving time are indicated in the CFS and the CWAS with the

abbreviation DT or the symbol “ $\frac{1}{2}$ ”, in the Aerodrome/Facility Directory, under the subheading REF (references).

Table 1.2—Time Zone Local Times

Time Zone	To Obtain Local Time
Newfoundland	UTC minus 3 1/2 hours (2 1/2 DT)
Atlantic	UTC minus 4 hours (3 DT)
Eastern	UTC minus 5 hours (4 DT)
Central	UTC minus 6 hours (5 DT)
Mountain	UTC minus 7 hours (6 DT)
Pacific	UTC minus 8 hours (7 DT)

Figure 1.4—Time Zone



1.6 NATIONALITY AND REGISTRATION MARKS

(See *AIP Canada (ICAO) GEN 2.1.5*)

1.7 V-SPEEDS

Table 1.3—V-Speeds

V_1	Critical engine failure recognition speed *
V_2	Takeoff safety speed
V_{2min}	Minimum takeoff safety speed
V_3	Flap retraction speed
V_a	Design safety speed
V_b	Speed for maximum gust intensity
V_c	Cruise speed
V_d	Diving speed
V_{df}/M_{df}	Demonstrated flight diving speed
V_f	Flap speed
V_{fe}	Maximum flap speed
V_h	Maximum level flight speed at maximum continuous power

V_{le}	Landing gear extended speed
V_{lo}	Maximum landing gear operation speed
V_{mc}	Minimum control speed with critical engine inoperative
V_{mo}/M_{mo}	Maximum operating limit speed
V_{mu}	Minimum unstick speed
V_{no}	Maximum structural cruising speed **
V_{nc}	Never exceed speed
V_r	Rotation speed
V_{ref}	Landing reference speed
V_s	Stalling speed or minimum steady controllable flight speed
V_{st}	Stalling speed or minimum steady flight speed obtained in a specific configuration
V_{so}	Stalling speed or minimum steady flight speed in the landing configuration
V_x	Speed for best angle of climb
V_y	Speed for best rate of climb

* This definition is not restrictive. An operator may adopt any other definition outlined in the aircraft flight manual (AFM) of TC type-approved aircraft as long as such definition does not compromise operational safety of the aircraft.

** For older transport category aircraft V_{no} means normal operating limit speed.

1.7.1 Conversion Tables

Table 1.4—Conversion of Millibars to Inches of Mercury

hPa/mb	0	1	2	3	4	5	6	7	8	9
	INCHES									
940	27.76	27.79	27.82	27.85	27.88	27.91	27.94	27.96	27.99	28.02
950	28.05	28.08	28.11	28.14	28.17	28.20	28.23	28.26	28.29	28.32
960	28.35	28.38	28.41	28.44	28.47	28.50	28.53	28.56	28.58	28.61
970	28.64	28.67	28.70	28.73	28.76	28.79	28.82	28.85	28.88	28.91
980	28.94	28.97	29.00	29.03	29.06	29.09	29.12	29.15	29.18	29.20
990	29.23	29.26	29.29	29.32	29.35	29.38	29.41	29.44	29.47	29.50
1000	29.53	29.56	29.59	29.62	29.65	29.68	29.71	29.74	29.77	29.80
1010	29.83	29.85	29.88	29.91	29.94	29.97	30.00	30.03	30.06	30.09
1020	30.12	30.15	30.18	30.21	30.24	30.27	30.30	30.33	30.36	30.39
1030	30.42	30.45	30.47	30.50	30.53	30.56	30.59	30.62	30.65	30.68
1040	30.71	30.74	30.77	30.80	30.83	30.86	30.89	30.92	30.95	30.98
1050	31.01	31.04	31.07	31.09	31.12	31.15	31.18	31.21	31.24	31.27

NOTE:

1 millibar (mb) = 1 hectopascal (hPa)

Table 1.5—Celsius and Fahrenheit Degrees Temperature Scales

°C	°F	°C	°F	°C	°F	°C	°F	°C	°F	°C	°F	°C	°F	°C	°F
-45	-49.0	-33	-27.4	-21	-5.8	-9	15.8	3	37.4	15	59.0	27	80.6	39	102.2
-44	-47.2	-32	-25.6	-20	-4.0	-8	17.6	4	39.2	16	60.8	28	82.4	40	104.0
-43	-45.4	-31	-23.8	-19	-2.2	-7	19.4	5	41.0	17	62.6	29	84.2	41	105.8
-42	-43.6	-30	-22.0	-18	-0.4	-6	21.2	6	42.8	18	64.4	30	86.0	42	107.6
-41	-41.8	-29	-20.2	-17	1.4	-5	23.0	7	44.6	19	66.2	31	87.8	43	109.4
-40	-40.0	-28	-18.4	-16	3.2	-4	24.8	8	46.4	20	68.0	32	89.6	44	111.2
-39	-38.2	-27	-16.6	-15	5.0	-3	26.6	9	48.2	21	69.8	33	91.4	45	113.0
-38	-36.4	-26	-14.8	-14	6.8	-2	28.4	10	50.0	22	71.6	34	93.2	46	114.8
-37	-34.6	-25	-13.0	-13	8.6	-1	30.2	11	51.8	23	73.4	35	95.0	47	116.6
-36	-32.8	-24	-11.2	-12	10.4	0	32.0	12	53.6	24	75.2	36	96.8	48	118.4
-35	-31.0	-23	-9.4	-11	12.2	1	33.8	13	55.4	25	77.0	37	98.6	49	120.2
-34	-29.2	-22	-7.6	-10	14.0	2	35.6	14	57.2	26	78.8	38	100.4	50	122.0

Table 1.6—Conversion Factors

To CONVERT	INTO	MULTIPLY BY
centimetres	inches	0.394
feet	metres	0.305
imperial gallon	U.S. gallon	1.201
imperial gallon	litres	4.546
inches	centimetres	2.540
inches of mercury	pounds per square inch	0.490
kilograms	pounds	2.205
kilograms per litre	pounds per imperial gallon	10.023
kilograms per litre	pounds per U.S. gallon	8.333
kilometres	nautical miles	0.540
kilometres	statute miles	0.621
litres	imperial gallon	0.220
litres	U.S. gallon	0.264
megapascals	pounds per square inch	145.14
metres	feet	3.281
nautical miles	kilometres	1.852
nautical miles	statute miles	1.152
newton	pounds	0.2248
pounds	kilograms	0.454
pounds	newtons	4.448

To CONVERT	INTO	MULTIPLY BY
pounds per imperial gallon	kilograms per litre	0.0998
pounds per square inch	inches of mercury	2.040
pounds per square inch	megapascals	0.00689
pounds per U.S. gallon	kilograms per litre	0.120
statute miles	kilometres	1.609
statute miles	nautical miles	0.868
U.S. gallon	imperial gallon	0.833
U.S. gallon	litres	3.785

1.7.2 RVR Comparative Scale—Feet to Metres

Table 1.7—RVR Comparative Scale: in Feet and Metres

RVR - FEET	RVR - METRES
500	150
600	175
700	200
1000	300
1200	350
1400	400
2600	800
4000	1200
5000	1500

2.0 SAFETY

2.1 AVIATION OCCUPATIONAL HEALTH AND SAFETY PROGRAM

Employers have a general obligation or duty to ensure that the health and safety of all persons they employ are protected while they are at work. Also, employers have specific duties in regard to each workplace they control and every work activity under their authority that occurs in a workplace that is beyond the employer's control.

No one knows a workplace better than the people who work in it, so Part II of the *Canada Labour Code* gives the workplace parties—employees and employers—a strong role in identifying and resolving health and safety concerns.

2.1.1 General

The TC Aviation Occupational Health and Safety Program began in 1987. Its primary objective is to ensure the health and safety of employees working on board aircraft in operation. This goal is accomplished through the administration, enforcement, and promotion of Part II of the *Canada Labour Code* (the Code) and the pursuant *Aviation Occupational Health and Safety Regulations*. The purpose of Part II of the Code is “to prevent accidents and injury to health arising out of, linked with or occurring in the course of employment to which this part applies”.

The Aviation Occupational Health and Safety Program operates as an extended jurisdiction from the Labour Program of Employment and Social Development Canada (ESDC) and is administered by TC, Safety and Security by virtue of a memorandum of understanding with Employment and Social Development Canada.

For additional information, see www.tc.gc.ca/eng/civilaviation/standards/commerce-ohs-menu-2059.htm.

2.1.2 Refusal to Work in Dangerous Situations

As outlined in subsection 128(1) of the Code, all employees have a legal right to refuse dangerous work and to refuse to work in a place if they have reasonable cause to believe that the use or operation of a machine or thing, the performance of an activity, or a condition existing in the workplace constitutes a danger to themselves or others. Pursuant to subsection 122(1) of the Code: “‘danger’ means any hazard, condition or activity that could reasonably be expected to be an imminent or serious threat to the life or health of a person exposed to it before the hazard or condition can be corrected or the activity altered”.

Due to the health and safety risk towards others, pilots are not permitted to refuse to work while in flight (see paragraph 128(2) (a) of the Code). However, pilots are permitted to refuse to work before or after the aircraft is in operation (e.g. at the gate or on the apron). Flight attendants and other on board employees must

report any in-flight refusal to work to the pilot-in-command who will in turn decide if the refusal is permitted while in the air. Regardless of whether the refusal is permitted in flight, it will be addressed as soon as the aircraft is on the ground at its next destination.

Once an employee has indicated that they are refusing to work, both they and their employer have specific roles and responsibilities that have been established to assist them in working together to find a solution. Sections 128 and 129 of the Code identify these employee and employer roles and responsibilities as well as the role and responsibility of the delegated labour program official, should their intervention become necessary.

To protect employees' rights, section 147 of the Code states that no employer shall take, or threaten to take, any disciplinary action against an employee who has refused to work in a dangerous situation. It should also be noted that subsection 147.1(1) states that after all the investigations and appeals have been exhausted by the employee who exercised their right to refuse dangerous work, the employer may take disciplinary action against that employee provided the employer can demonstrate that the employee has willfully abused their rights.

2.1.3 Delegated Labour Program Officials

The Aviation Occupational Health and Safety Program Headquarters provides guidance and assistance to regional delegated labour program officials who conduct inspections, investigations, and promotional visits to ensure that air operators are committed to the health and safety of their employees.

Delegated labour program officials may be reached during the day at their workplace by using the “How to Reach Us” page on the TC Aviation Occupational Health and Safety Web site: www.tc.gc.ca/eng/civilaviation/standards/commerce-ohs-reach-us-menu-2116.htm.

To ensure 24-hr service to the aviation community, in urgent situations or after working hours, a delegated labour program official may be reached through the Aviation Operations Centre (AVOPS) at: <https://www.tc.gc.ca/eng/civilaviation/opssvs/emergencies-incidentreporting-menu.htm>.

2.2 AVIATION SAFETY ANALYSIS

2.2.1 General

The Aviation Safety Analysis Division in the Policy and Regulatory Services Branch is responsible for monitoring and evaluating the level of safety within the National Civil Air Transportation System (NCATS) by:

- a) monitoring and evaluating all facets of the system;
- b) reviewing and analyzing accident and incident data, as well as other safety-related information;

- c) assessing risk and providing risk management advice; and
- d) preparing and coordinating emergency response to national or international emergencies affecting aviation.

For more information on the Policy and Regulatory Services Branch and its activities, visit its Web site at www.tc.gc.ca/eng/civilaviation/regserv/menu.htm.

2.2.2 Aviation Safety Research and Analysis

One of the objectives of the Aviation Safety Research and Analysis unit is to produce safety intelligence. This is information about hazards in the National Civil Air Transportation System (NCATS) that allows managers in Civil Aviation to understand the hazards and risks present in the elements of the system they oversee. Aviation safety hazards and trends are proactively identified, analyzed, and evaluated in order to produce a mix of special studies and routine standard products. This strategic analytical capability supports the development of mitigation and prevention strategies necessary for managing risks. These strategies feed into policy development, regulatory framework, and Civil Aviation operational areas.

2.2.3 Minister's Observer and Technical Advisor Programs

Key aspects of obtaining safety intelligence are the Minister's Observer and Technical Advisor Programs. While it is the TSB's mandate to advance transportation safety by conducting investigations into occurrences, the Minister's observer/technical advisor plays an essential role by:

- a) obtaining timely, factual information from an on-going investigation;
- b) advising the Minister of significant regulatory factors;
- c) identifying deficiencies that require immediate coordination of corrective actions;
- d) being TC's support to an aviation occurrence investigation; and
- e) providing safety intelligence to senior managers and the Minister to help support their decision making.

As a member of ICAO, Canada enjoys certain rights and accepts certain responsibilities in relation to accidents either occurring in another State, or where another State has an interest in an accident that occurs in Canada.

These responsibilities are detailed in Article 26 of ICAO's *Convention on International Civil Aviation*, which imposes an obligation on the State in which the aircraft accident occurs to institute an inquiry in accordance with ICAO procedures; and Article 37, which provides for the standards and recommended practices (SARPS) for aircraft accident investigation, which are detailed in Annex 13 to the Convention.

In the event of an accident that occurs outside Canada and involves a Canadian-registered aircraft, or an aircraft or significant component manufactured in Canada, Canada has the right to appoint an accredited representative. Under Annex 13, this duty falls to the TSB. TC and other Canadian interests may appoint technical advisors to support the accredited representative.

In the event of a domestic occurrence, the *Canadian Transportation Accident Investigation and Safety Board Act* (CTAISB Act) contains provisions that permit a party of direct interest to participate as an observer in a TSB investigation if the Board determines that it is appropriate.

If the TSB decides not to investigate, in accordance with subsection 14(2) of the CTAISB Act, TC can make a formal request to the TSB to investigate. Subsection 14(4) of the CTAISB Act also states:

“Nothing [...] prevents a department from commencing an investigation into or continuing to investigate a transportation occurrence for any purpose other than that of making findings as to its causes and contributing factors, or from investigating any matter that is related to the transportation occurrence and that is not being investigated by the Board[...].”

In the event of an occurrence involving a Canadian civil aviation certificate holder, Civil Aviation must determine, on behalf of the Minister, as quickly as possible, whether or not the certificate holder continues to meet the certificate's conditions of issue.

2.2.4 Safety Promotion

As part of Civil Aviation's wider risk mitigation strategy, TC communicates safety information to promote the adoption of practices known to be effective at mitigating risk and to educate the wider aviation community on current and emerging hazards.

Promotional and educational products are developed, as appropriate, to support Civil Aviation's programs and initiatives for the benefit of the Canadian aviation industry. These programs and initiatives aim to enhance aviation safety awareness and accident prevention. The *Aviation Safety Letter* (ASL), Civil Aviation's quarterly online newsletter, includes articles that address aviation safety from all perspectives, such as safety insight derived from accidents and incidents, regulatory updates, as well as safety information tailored to the needs of pilots, AMEs, certificate holders, and all other interested individuals within the aviation community. Readers can subscribe to the ASL e-Bulletin notification service to receive e-mails that announce the release of each new issue of the ASL and include a link to the ASL Web page. To register for this service, please go to www.tc.gc.ca/ASL and follow the appropriate steps. Those who prefer a printed copy can order a print-on-demand version (black and white) through TC's Publication Order Desk by calling 1-888-830-4911 or e-mailing MPSI@tc.gc.ca.

3.0 TRANSPORTATION SAFETY BOARD OF CANADA (TSB)

3.1 AVIATION SAFETY INVESTIGATION

The purpose of an aviation safety investigation into an aircraft accident or incident is to prevent a recurrence; it is not to determine or apportion blame or liability. The TSB, established under the *Canadian Transportation Accident Investigation and Safety Board Act* (CTAISB Act), is responsible for investigating all aviation occurrences in Canada involving civil aircraft registered both in Canada and abroad. A team of investigators is on 24-hr standby. The following text is mainly taken from the recently updated *Transportation Safety Board of Canada Regulations*. The complete text of both the CTAISB Act as well as the updated Regulations can be found on the Department of Justice Web site.

3.2 DEFINITIONS

Under the CTAISB Act, “*aviation occurrence*” means

- a) any accident or incident associated with the operation of an aircraft, and
- b) any situation or condition that the Board has reasonable grounds to believe could, if left unattended, induce an accident or incident described in paragraph (a).

The following definitions are taken from the *Transportation Safety Board of Canada Regulations*.

“*Collision*” means an impact, other than an impact associated with normal operating circumstances, between aircraft or between an aircraft and another object or terrain.

“*Dangerous goods*” has the same meaning as in section 2 of the *Transportation of Dangerous Goods Act, 1992*.

“*Operation*” means the activities for which an aircraft is used from the time any person boards the aircraft with the intention of flight until they disembark.

“*Risk of collision*” means a situation in which an aircraft comes so close to being involved in a collision that a threat to the safety of any person, property or the environment exists.

“*Serious injury*” means:

- a) a fracture of any bone, except simple fractures of fingers, toes or the nose;
- b) lacerations that cause severe hemorrhage or nerve, muscle or tendon damage;
- c) an injury to an internal organ;

- d) second or third degree burns, or any burns affecting more than 5% of the body surface;
- e) a verified exposure to infectious substances or injurious radiation; or
- f) an injury that is likely to require hospitalization.

3.3 REPORTING AN AVIATION OCCURRENCE

The owner, operator, pilot-in-command, any crew member of the aircraft and any person providing air traffic services that have direct knowledge of an occurrence must report the following aviation occurrences to the Board if they result directly from the operation of an aircraft.

3.3.1 Accidents

In the case of an accident,

1. a person is killed or sustains a serious injury as a result of:
 - a) being on board the aircraft,
 - b) coming into direct contact with any part of the aircraft, including parts that have become detached from the aircraft, or
 - c) being directly exposed to jet blast, rotor down wash or propeller wash, the aircraft sustains structural failure or damage that adversely affects the aircraft’s structural strength, performance or flight characteristics and would normally require major repair or replacement of any affected component, except for:
 - d) engine failure or damage, when the damage is limited to the engine, its cowlings or accessories, or
 - e) damage limited to propellers, wing tips, antennae, tires, brakes, fairings or small dents or puncture holes in the aircraft’s skin, or
2. the aircraft is missing or inaccessible.

3.3.2 Mandatory Reportable Incidents

In the case of an incident involving an aircraft having a maximum certificated take-off weight greater than 2 250 kg, or of an aircraft being operated under an air operator certificate issued under Part VII of the *Canadian Aviation Regulations*:

1. an engine fails or is shut down as a precautionary measure,
2. a power train transmission gearbox malfunction occurs,
3. smoke is detected or a fire occurs on board,

4. difficulties in controlling the aircraft are encountered owing to any aircraft system malfunction, weather phenomena, wake turbulence, uncontrolled vibrations or operations outside the flight envelope,
5. the aircraft fails to remain within the intended landing or take-off area, lands with all or part of the landing gear retracted or drags a wing tip, an engine pod or any other part of the aircraft,
6. a crew member whose duties are directly related to the safe operation of the aircraft is unable to perform their duties as a result of a physical incapacitation which poses a threat to the safety of persons, property or the environment,
7. depressurization of the aircraft occurs that requires an emergency descent,
8. a fuel shortage occurs that requires a diversion or requires approach and landing priority at the destination of the aircraft,
9. the aircraft is refuelled with the incorrect type of fuel or contaminated fuel,
10. a collision, a risk of collision or a loss of separation occurs,
11. a crew member declares an emergency or indicates an emergency that requires priority handling by air traffic services or the standing by of emergency response services,
12. a slung load is released unintentionally or as a precautionary or emergency measure from the aircraft, or
13. any dangerous goods are released in or from the aircraft.
8. a description of the occurrence and the extent of any resulting damage to the environment and to the aircraft and any other property;
9. a list of any dangerous goods carried on board or released from the aircraft, including the shipping name or UN number and consignor and consignee information;
10. if the aircraft is missing or inaccessible:
11. the last known position of the aircraft by reference to an easily defined geographical point, or by latitude and longitude, including the date and time that the aircraft was at that position, and
12. the actions taken or planned to locate or gain access to the aircraft;
13. a description of any action taken or planned to protect persons, property and the environment;
14. the name and title of the person making the report and the phone number and address at which they can be reached; and
15. any information specific to the occurrence that the Board requires.

The person making the report must send to the Board as soon as possible and by the quickest means available, all the information required that is available at the time of the occurrence; and the remainder of that information as soon as it becomes available within 30 days after the occurrence.

3.3.3 Information to Report

The report must contain the following information:

1. the type, model, nationality and registration marks of the aircraft;
2. the name of the owner, operator, pilot-in-command and, if applicable, hirer of the aircraft;
3. the last point of departure and the intended destination of the aircraft, including the date and time of the departure;
4. the date and time of the occurrence;
5. the name of the person providing air traffic services related to the occurrence;
6. the number of crew members, passengers and other persons involved in the occurrence and the number of those who were killed or sustained serious injuries as a result of the occurrence;
7. the location of the occurrence by reference to an easily defined geographical point, or by latitude and longitude;

3.3.4 Other Occurrences

Any other incident indicative of a deficiency or discrepancy in the Canadian air transportation system may be reported in writing to the TSB. Sufficient details concerning the incident should be provided to enable the identification of action required to remedy the deficiency or discrepancy.

3.3.5 Contacting the Transportation Safety Board of Canada (TSB)

Aviation occurrences are to be reported to a regional TSB office, using the telephone numbers listed in GEN 3.6.

For Canadian-registered aircraft operating outside of Canada, in addition to the reporting required by the state of occurrence, a report shall be made to the TSB regional office nearest to the company's headquarters or, for private aircraft, nearest to the aircraft's home base.

3.4 KEEPING AND PRESERVATION OF EVIDENCE

Every person having possession of or control over evidence relating to a transportation occurrence must keep and preserve the evidence unless the Board provides otherwise. This is not to be construed as preventing any person from taking the necessary measures to ensure the safety of any person, property or the environment. Any person who takes these measures must, to the extent possible in the circumstances and before taking those measures, record the evidence by the best means available and advise the Board of their actions.

3.5 SECURITAS PROGRAM

The SECURITAS program provides a means for individuals to report incidents and potentially unsafe acts or conditions relating to the Canadian transportation system that would not normally be reported through other channels. It should be noted that this multi-modal, confidential safety reporting system replaces the Confidential Aviation Safety Reporting Program (CASRP).

Each report is assessed by SECURITAS analysts. When a reported concern is validated as a safety deficiency, the TSB normally forwards the information, often with suggested corrective action, to the appropriate regulatory authority, or in some cases, the transportation company, organization or agency. No information will be released that could reasonably be expected to reveal the reporter's identity without the reporter's written consent.

3.5.1 How to Report to SECURITAS

SECURITAS is primarily concerned with unsafe acts and conditions relating to commercial and public transportation systems. When contacting SECURITAS, ensure the following is included in your message:

- your name, address and phone number
- your profession and experience
- your involvement in the unsafe situation being reported
- where else you may have reported this unsafe situation or safety concern

- complete identification of the aircraft or related facility/equipment
- the name of the owner/operator of the equipment

Also, please describe the unsafe act or safety concern.

For example:

- How was the unsafe act/condition discovered?
- If you are describing an event, tell SECURITAS
 - what happened;
 - where it happened;
 - when it happened (the date and the local time); and
 - why you think it happened.
- What actions/inactions resulted, or could have resulted?
- How do you think the situation could be corrected?

3.5.2 What to Report to SECURITAS

These are some examples of the types of situations that could affect air transportation safety and that your report might help correct.

Unsafe conditions:

- chronic lack of repair of aircraft, poor maintenance practices
- unsafe runway or aerodrome conditions
- inadequate or poor air traffic services in a particular area
- poor reception of navigation signals, weak radio coverage, inadequate weather services
- errors in aeronautical publications: unsafe procedures published in manuals of instructions for pilots, cabin crew, ground crew, aircraft maintenance or air traffic services

Unsafe procedures and practices:

- routinely descending below minimum en route altitude or approach in IMC
- non-compliance with airworthiness directives, minimum equipment list
- pilots flying in excess of regulatory flight-time limits
- unsafe aircraft circuit procedures and/or communications



- air traffic control practices that could jeopardize the safety of flight, e.g. use of non-standard phraseology, compromising separation criteria, inadequate manning and supervision
- unsafe cabin baggage stowage procedures, unsafe passenger seating or cargo securing arrangements
- aircraft maintenance procedures not completed correctly but signed off
- shortcuts in following checklist procedures
- crew scheduling problems: inadequate crew composition, unqualified crew, inadequate crew rest
- scheduling personnel who are not professionally or medically qualified for the assigned duties
- the use of unapproved parts, time-expired equipment

3.5.3 Where to Submit a SECURITAS Report

To submit a report, contact SECURITAS at:

SECURITAS
 PO Box 1996, Station B
 Gatineau QC J8X 3Z2
 Tel.: 1-800-567-6865
 Fax: 819-994-8065
 E-mail: securitas@tsb-bst.gc.ca

3.6 OFFICES OF THE TRANSPORTATION SAFETY BOARD OF CANADA (TSB)

HEADQUARTERS:

Place du Centre, 4th Floor
 200 Promenade du Portage
 Gatineau QC K1A 1K8
 Toll-free (within Canada): 1-800-387-3557
 Toll: 819-994-3741
 Fax:
 Toll-free (within Canada): 1-833-644-5149
 Toll: 819-997-2239
 TDD: 819-953-7287
 E-mail: airops@tsb-bst.gc.ca

REGIONAL OFFICES (AIR)

TSB—Pacific

Regional Office Administration, TSB-AIR
 4-3071 No 5 Road
 Richmond BC V6X 2T4
 Toll-free (within Canada): 1-800-387-3557
 Toll: 604-202-2400
 E-mail: airnotifications.vancouver@tsb-bst.gc.ca

TSB—Western

Regional Office Administration, TSB-AIR
 17803-106A Avenue
 Edmonton AB T5S 1V8
 Toll-free (within Canada): 1-800-387-3557
 E-mail: airnotifications.edmonton@tsb-bst.gc.ca

TSB—Central

Regional Office Administration, TSB-AIR
 335-550 Century Street
 Winnipeg MB R3H 0Y1
 Toll-free (within Canada): 1-800-387-3557
 Toll: 204-983-5991
 Fax: 204-983-8026
 E-mail: airnotifications.winnipeg@tsb-bst.gc.ca

TSB—Ontario

Regional Office Administration, TSB-AIR
 23 Wilmot Street East
 Richmond Hill ON L4B 1A3
 Toll-free (within Canada): 1-800-387-3557
 Toll: 905-771-7676
 E-mail: airnotifications.toronto@tsb-bst.gc.ca

TSB—Quebec (Dorval)

Regional Office Administration, TSB-AIR
 185 Dorval Avenue, Suite 403
 Dorval QC H9S 5J9
 Toll-free (within Canada): 1-800-387-3557
 Toll: 514-633-3246
 Fax: 514-633-2944
 E-mail: airnotifications.montreal@tsb-bst.gc.ca

TSB—Atlantic

Regional Office Administration, TSB-AIR
 150 Thorne Avenue
 Dartmouth NS B3B 1Z2
 Toll-free (within Canada): 1-800-387-3557
 Toll: 902-426-8563
 Fax: 902-426-5143
 E-mail: airnotifications.dartmouth@tsb-bst.gc.ca

4.0 INDEX OF KEYWORDS

- A**
- Abbreviations – Aviation Forecasts MET 15.0
 - Abbreviations and Acronyms GEN 5.2
 - Abnormal Operation of Navigation Aids, Pilot Reporting of COM 3.4
 - Abnormally High Altimeter Settings AIR 1.5.9
 - Aeronautical Fixed Service (AFS) ... MAP 3.1, 3.5, RAC 3.3
 - Calibration of RAC Fig. 9.1, AIR 1.5.2
 - Downdraft and Turbulence AIR 1.5.7
 - Effect of Mountains AIR 1.5.6
 - Incorrect Setting AIR 1.5.3
 - Major Errors of AIR 1.5.4
 - Pressure AIR 1.5
 - Pressure Drop AIR 1.5.8
 - Setting Region RAC 2.10, Fig. 2.10
 - Standard Pressure Region RAC 2.11, Fig. 2.10, AIR 1.5.5
 - Temperature Correction RAC Fig. 9.1, AIR 1.5.4
 - ACAS/TCAS COM 9.0
 - ACAS II and Transponder Equipage RAC 11.7.11
 - Accident reporting GEN 3.3
 - SECURITAS Program GEN 3.5
 - Accuracy, Availability and Integrity of Navigation Aids COM 4.2
 - Acknowledgement of Clearances – VFR RAC 5.2
 - Acronyms and Abbreviations GEN 5.2
 - ADIZ (Air Defence Identification Zone) RAC 2.13, 3.8
 - ADS-B COM 7.3
 - ADS-C COM 3.10
 - Advance Notice of Intent in Minimum Weather Conditions RAC 9.5
 - Advisory Airspace RAC 2.8.6
 - Advisory forecasts MET 7.2
 - Aerobatic Flight RAC 1.10
 - Aerodromes and airports AGA 2.0
 - ARCAL (Aircraft Radio Control of Aerodrome Lighting) AGA 7.14
 - ATF (Aerodrome Traffic Frequency) ... RAC 4.5.5, 4.5.6
 - Authority AGA 1.1.1
 - Beacon AGA 7.2
 - Certification AGA 2.3
 - Design Criteria, Runway AGA 3.1
 - Directory AGA 1.3
 - DND (Snow Removal and Ice Control) AGA 1.1.4
 - Lighting AGA 7.0
 - Maintenance
 - Transport Canada AGA 2.3.3
 - Obstacle Charts (ICAO Type A) MAP 4.2.1
 - Operator Responsibilities AGA 2.3.4
 - PNR (Prior Notice Required) AGA 2.2
 - PPR (Prior Permission Required) AGA 2.2
 - Private-use Certificate AGA 2.2
 - Public-use Certificate AGA 2.2
 - Registration AGA 2.1
 - Runway Characteristics AGA 3.0
 - TAF (Forecasts) MET 7.0
 - From AWOS Sites MET 7.5
 - National Variations MET 7.3
 - Uncontrolled Procedures (IFR) RAC 9.13
 - Use, International Flights AGA 1.2
 - Aeromedical Factors AIR 3.2
 - Aeronautical
 - Assessment AGA 6.3
 - Authority GEN 1.1.1
 - Charts for Visual Flight MAP 4.2.1
 - Ground Lights AGA 1.4
 - Aeronautical Information GEN 1.1
 - AIM (Aeronautical Information Management) GEN 1.1.2
 - AIRAC Canada MAP 2.4
 - Broadcast Service COM 1.9.3
 - Canada Flight Supplement MAP 2.5.3
 - Charts and Publications for International Flights MAP 5.0
 - Circular MAP 2.3
 - Collection MAP 1.0
 - ICAO Type A Charts MAP 4.2.1
 - IFR MAP 2.6
 - Manual (TC AIM) GEN 1.1.3
 - NOTAM MAP 3.0
 - Procurement of Charts and Publications MAP 4.0
 - Publication, Aeronautical Information
 - AIP Canada (ICAO) MAP 2.1
 - VFR MAP 2.5
 - Aeronautical Terms, Glossary GEN 5.1
 - Aeronautics Act and Canadian Air Regulations, Legislative Index GEN 5.3
 - Aiding Persons in Distress SAR 2.4
 - AIP Canada (ICAO) MAP 2.1
 - AIC (Aeronautical Information Circular) MAP 2.3
 - Supplements MAP 2.2
 - Airborne Collision Avoidance System (ACAS) COM 9.0
 - AIRAC Canada MAP 2.4
 - Air Routes and Airways Designation COM 5.5
 - Air Time and Flight Time AIR 4.1
 - Air Traffic and Advisory Services RAC 1.1
 - Air Traffic Services, Services Other Than RAC 1.2
 - Aircraft
 - Aviation Safety Investigation GEN 3.1
 - Aircraft Identification, Marking, Registration and Insurance LRA 4.0
 - Airworthiness LRA 5.0
 - Airworthiness ANNEX LRA 9.0
 - ARCAL (Radio Control of Aerodrome Lighting) AGA 7.14
 - Categories RAC 9.21
 - Change of Ownership – Canadian-Registered LRA 4.4
 - Contamination (Frost, Ice or Snow)
 - In Flight AIR 2.12.3
 - On ground AIR 2.12.2
 - Design Requirements LRA 5.2
 - Emergency Assistance SAR 4.0
 - First Aid Kits on Privately Owned

and Operated Aircraft	AIR 4.13	– Requirements and Procedures.....	RAC 2.0
– Identification.....	LRA 4.2	– Restricted.....	RAC 2.8.6
– Import/Export.....	LRA 4.6, 4.7	– Southern, Northern and Arctic Control Areas.....	RAC Fig. 2.4
– Liability Insurance	LRA 4.8	Airways and Air Routes Designation	COM 1.6
– Load rating.....	AGA 3.12	Airways, low-level – LF/MF, VHF/UHF	RAC 2.7.1
– Nationality and Registration Marks	GEN 1.6, LRA 4.3	Airworthiness	
– Navigational Equipment, Interference with.....	COM 4.4	– Aircraft	LRA 5.0
– Operations – Uncontrolled Aerodromes	RAC 4.5	– ANNEX.....	LRA 5.8
– Registration, Initial.....	LRA 4.5	– Annual Airworthiness Information Report.....	LRA 5.5
– Rescue and Fire Fighting (ARFF).....	AGA 8.0	– Flight Authority.....	LRA 5.3
– Speed Limit.....	RAC 2.5.2	Airworthiness Directives (ADs)	LRA 5.7
– Technical Records	LRA 5.6.3	– Availability of.....	LRA 5.7.2
Aircraft Contamination in Flight.....	AIR 2.12.3	– Schedule and Compliance Records	LRA 5.7.3
Aircraft Contamination on the Ground	AIR 2.12.2	AIS (Aeronautical Information Services).....	GEN 1.1.2
Aircraft Load Rating (ALR)	AGA 3.12	AIM (Aeronautical Information Management) ...	GEN 1.1.2
Aircraft Movement Surface Condition Report (AMSCR).....	AIR 1.6.4	Alcohol	AIR 3.9
Aircraft Parachute System	GEN 5.1	Alerting Devices and Circuit Breakers.....	AIR 4.11
Aircraft Rescue and Fire Fighting (ARFF).....	AGA 8.0	Alphabet, Phonetic	COM 1.5
– Hours of Availability	AGA 8.2	ALR (Aircraft Load Rating).....	AGA 3.12
– Classification System	AGA 8.3	Alternate Aerodrome, Requirements for IFR Flight.....	RAC 3.14
– ARFF Standby Request.....	AGA 8.4	Altimeter	
AIREP (Meteorological Report).....	MET 1.1.6, NAT 1.15	Altitude	
Airmanship.....	AIR 1.1	– And Direction of Flight	RAC 8.7.2
– Flight Operations.....	AIR 2.0	– Area Minimum Altitude (AMA).....	RAC 8.6.1
– Low Flying.....	AIR 2.4	– Correction Chart.....	RAC Fig. 9.1
AIRMET	MET 1.3.6, 5.0	– IFR Minimum.....	RAC 8.5, 8.6.1
Arrival Procedures – IFR.....	RAC 9.0	– Minimum Holding.....	RAC 10.7
Airport		– Report	NAT 1.16
– ASDE (Surface Detection Equipment).....	COM 7.1	Anti-icing Additives, Fuel.....	AIR 1.3.3
– Airport Radio (APRT RDO).....	RAC 1.2.2	Appeals – Transportation Appeal Tribunal of Canada (TATC).....	LRA 6.5
– Airside Signs.....	AGA 5.8	Approach	
– Bird Hazard.....	AGA 1.1.5	– Ban	RAC 9.19.2
– Certificate	AGA 2.4	– Contact.....	RAC 9.6.1
– Certification.....	AGA 2.3, 2.3.5, 2.3.6	– From an Intermediate Fix.....	RAC 9.16
– Collaborative Decision Making (A-CDM) ...	AGA 10.0	Lighting Systems	
– Information Signs	AGA 5.8.2	– ALSF-2, LIAL, ODALS, MALSF, MALS, MALSR, SSALR, SSALS.....	AGA 7.5.1, 7.5.2, RAC 9.19.2.8
– Operations.....	RAC 4.0	– Approach Lighting System with Sequenced Flashers - CAT II (ALSF - 2)	AGA 7.5.2, RAC 9.19.2.8
– Controlled Airports, Departure Procedures.....	COM 3.8	– PAPI.....	AGA 7.6.3
– Snow Removal and Ice Control.....	AGA 1.1.4	– PAR (Precision Radar)	COM 7.1, RAC 9.8.4
– Uncontrolled Aerodromes	RAC 4.5	– Position Reports – Controlled Airports	RAC 9.9
– Zoning Regulations	AGA 4.3	– Simplified Short Approach Lighting System (SSALS).....	AGA 7.5.1, RAC 9.19.2.8
– Airspace Classification.....	RAC 2.8	– Simplified Short Approach Lighting System with Runway Alignment Indicator Lights (SSALR)	AGA 7.5.2, RAC 9.19.2.8
– Advisory	RAC 2.8.6	– Straight-in	RAC 9.15
– Canadian Domestic/Northern and Southern Domestic	RAC 2.2, Fig. 2.1	– Visual.....	RAC 9.6.2
– Classification of.....	RAC 2.8	– Approach Procedures with Vertical Guidance (APV).....	COM 5.4.2
– High- and Low-Level	RAC 2.3	Apron Advisory Service	RAC 1.2.4
– High-Level Controlled.....	RAC 2.6		
– Joint Use.....	RAC 2.8.6		
– Low-Level Controlled	RAC 2.7		
– NAT MNPSA (North Atlantic Minimum Navigation Performance – Specifications) Between FL 285 and FL 420.....	RAC Fig.1.2,		
– Other Divisions.....	RAC 2.9		

ARCAL (Aircraft Radio Control of Aerodrome Lighting).....	AGA 7.14
Arctic Territories.....	RAC 1.1.3
Area Navigation (RNAV).....	COM 5.0
– Fixed RNAV Routes.....	RAC 11.4.4
– Mandatory IFR Routes (Including RNAV).....	RAC 11.4.3
Areas	
– Gander Oceanic Control.....	NAT Fig. 1.1
– Mountainous.....	RAC 2.12, Fig. 2.11
– RVSM Transition Area.....	RAC Fig. 12.3
– Southern, Northern and Arctic Control Areas.....	RAC Fig. 2.4
– Transition.....	RAC 2.7.5
Arresting Systems, Military Aircraft.....	AGA 9.1
Arrival	
– Procedures – Controlled Airports.....	RAC 4.4
– Traffic Circuit Procedures.....	
– Uncontrolled Aerodromes, VFR.....	RAC 4.5.2
– Report – Contents.....	RAC 3.12.1
ASDA (Accelerate Stop Distance Available).....	AGA 3.10
ATC (Air Traffic Control)	
– Assignment of Altitudes.....	RAC 8.6
– Clearances, Instructions and Information.....	RAC 1.7
– Flight Priority.....	RAC 1.8
ATIS (Automatic Terminal Information Service).....	RAC 1.3, 4.2.1
– Broadcasts.....	RAC 1.3, 7.2, 9.1
– METAR AUTO/SPECI AUTO Reports.....	MET 8.5
Automatic Flight Control Guidance System.....	COM 4.11.7
Automatic Landing (Autoland) Operations.....	COM 4.11.7
Aviation	
– Automated Reports – Other.....	MET 8.6
– Document Booklet.....	LRA 1.2
– Fuels.....	AIR 1.3
– Language Proficiency.....	LRA 1.3
– Medical Review Board.....	LRA 2.4
– METAR (Routine Weather Report).....	MET 5.14
– Occurrence, Reporting an.....	GEN 3.3
– Recreational.....	AIR 4.7 to 4.10
– Safety.....	GEN 2.0
– Weather Briefing Service (AWBS).....	MET 1.1.3
– Weather Information Service (AWWS).....	MET 1.1.3
– Weather Reports/Charts.....	MET 3.2.2, 3.2.3
AWOS (Automated Weather Observation Systems).....	MET 1.2.4, 8.5
– actual weather information/reports/charts...MET	1.2.4
– METAR SPECI/AUTO/LWIS Reports.....	MET 8.4, 8.5

B

Ballistic Parachute System.....	RAC 3.16.9
Balloon Operations, Manned Free.....	AIR 4.7
Bars	
– Stop.....	AGA 7.10.3
Beacons	
– Aerodrome.....	AGA 7.2
Bearing Strength, Runway and Taxiway.....	AGA 3.12
Beaufort Wind Scale.....	MET 2.6, Table 1

Bird Hazard Control, Airport.....	AGA 1.1.5
Blood Donation.....	AIR 3.14
BOTA.....	NAT 1.19.1
Brest Oceanic Transition Area (BOTA).....	NAT 1.19.1
Boundary Markers, Aerodromes.....	AGA 5.1

C

Cable Span Markings, Suspended.....	AGA 6.7
Call Signs.....	COM 1.9
– Air Carriers.....	COM 1.9.1
– Ground Stations.....	COM 1.9.2
– MEDEVAC.....	COM 1.9.1.4
– Private Civil Registration.....	COM 1.9.1.2
– RCO.....	COM 1.9.3
Canada	
– Flight Supplement.....	MAP 2.5.3
– Charts and Publications	
– Individual Purchases.....	MAP 4.2.1
– Subscriptions.....	MAP 4.2.2
– Shipping Act, extract from.....	SAR 4.9, AIR 2.11.1
Canadian Aviation Regulation Advisory Council (CARAC).....	GEN 5.4
RAC ANNEX 2.0, LRA ANNEX 5.8	
– Legislative Index.....	GEN 5.3
Canadian Domestic Airspace.....	RAC 2.2
Canadian Runway Friction Index (CRFI).....	AIR 1.6
– Coefficients.....	AIR 1.6.2
– Description and Method of Measurement...AIR	1.6.3
Canadian Type Certificate.....	LRA 5.2.2
Carbon Monoxide.....	AIR 3.2.3
Carburetor Icing.....	AIR 2.3
Cargo Restraint.....	AIR 4.4
Categories	
– VASI.....	AGA 7.6.4.2
– EWH (Eye-to-Wheel Height).....	AGA 7.6.4
CAVOK, Use of Term.....	RAC 1.4
Certificate	
– Airport.....	AGA 2.4
– Noise Compliance.....	LRA 5.3.5
Certificate of Airworthiness (C of A)	
– Special.....	LRA 5.3.2, 5.3.3
Certification	
– Of Airports.....	AGA 2.3
– Of Heliport.....	AGA 2.3
– Water Airport.....	AGA 2.3
Channel Spacing, VHF Communication Frequencies.....	COM 1.4
Charter Flight Airport Facilities Reservations	
– En Route, Low Altitude/High Altitude	
– Products.....	MAP 4.2.1
Charts	
– Aerodrome Obstacle – ICAO Type A.....	MAP 4.2.1
– Aeronautical, for Visual Flight.....	MAP 4.2.1
– En Route, Low Altitude/High Altitude	
– Prices.....	MAP 4.2.1
– Index of Aerodrome Obstacle Charts	
– ICAO Type A.....	MAP 4.2.1
– Index to Canadian Aeronautical.....	MAP 2.2



- Pavement Load Rating AGA 3.12.1
- Procurement
 - Individual and Subscription MAP 4.2.2
 - Publication Revision Cycles MAP 4.2.1
 - Publications – International Flights MAP 5.0
 - Procurement of Aeronautical MAP 4.2.1
 - Updating of Canadian Aeronautical MAP 2.3
 - Upper Level – Actual, Forecast (PROG) MET 11.0
- Checklists, Pilot Vital Action AIR 1.2
- Circling Minima and Procedures RAC 9.23, 9.24
- Circuit Breakers and Alerting Devices AIR 4.11
- Circuit
 - Controlled Aerodromes RAC 4.3
 - Uncontrolled Aerodromes RAC 4.5
- Circular, Aeronautical Information MAP 2.3
- Civil Aviation Complaint Filing Procedures GEN 7.0
- Civil Aviation Contingency Operations (CACO) ... GEN 6.0
 - Headquarters Operations GEN 6.2
 - Accident, Occurrence, or Incident Reporting ... GEN 6.3
- Civil Twilight, Morning and Evening GEN 1.5.2
- Class
 - A Airspace RAC 2.8.1
 - B Airspace RAC 2.8.2
 - C Airspace RAC 2.8.3, 5.8
 - D Airspace RAC 2.8.4
 - E Airspace RAC 2.8.5
 - F Airspace RAC 2.8.6
 - G Airspace RAC 2.8.7, 8.10
- Clean Aircraft Concept AIR 2.12.2
- Clear Air Turbulence (CAT),
 - Avoidance of MET 2.2, AIR 2.10
- Clearance(s)
 - Delivery RAC 4.2.2
 - “Hold/Hold Short” RAC 4.2.5
 - IFR RAC 7.4
 - Landing RAC 4.4.3
 - Limit RAC 8.9
 - Leaving or Entering Controlled Airspace RAC 8.8
 - Oceanic Clearance Delivery NAT 1.9.3
 - Resolution Advisory (TCAS/ACAS) RAC 1.7
 - Tower Frequency, Release from RAC 4.2.9
- Clearances Instructions and Information
 - from the ATC RAC 1.7, 6.1
- Clearway, Definition AGA 3.9
- Clock Position System (Radar Traffic Information)
 - RAC 1.5.3
- Closed Markings – Runway, Taxiway, Heliports AGA 5.6
- Cloud Heights MET 1.1.5, 3.13
- Code, Morse COM 1.5
- Collision Avoidance
 - Right of Way, Regulations RAC 1.9
 - Use of Landing Lights AIR 4.5
- Communications
 - Air-Ground Service, International NAT 2.0
 - Aviation Weather Information Service (AWIS)
 - MET 1.1.3
 - Checks COM 1.11

- Emergency Communications and Security
 - COM 1.12, RAC 2.13
 - Failure (VFR) RAC 4.4.8, 6.3.2.2
 - Frequency 5680 kHz, Use of COM 1.14
 - General Information COM 1.0
 - Initial Contact RAC 4.4.1, 9.9
 - Language COM 5.2
 - Location Indicators COM 2.0
 - Navigation Equipment, Reporting
 - Malfunction of RAC 6.3.3
 - Readability scale COM 1.11
 - Radiocommunication Regulations COM 1.10
 - Radio Navigation Aids COM 4.0
 - Responsible Authority COM 1.2
 - Satellite Systems COM 10.0
 - Satellite Voice COM 1.18
 - SATVOICE COM 1.18
 - Strength Scale COM 1.11
 - Summary of Services RAC 1.2.3
 - Use of MF and ATF RAC 4.5.6
 - VFR Procedures at Uncontrolled Aerodromes
 - with MF and ATF areas RAC 4.5.7
 - VHF Coverage in the NAT Region NAT 2.5.2
- Community Aerodrome Radio Stations
 - (CARS) RAC 1.2.2
- Confidential Incident Reporting
 - SECURITAS Program GEN 3.5
- Conservation RAC 1.11
- Contact and Visual Approaches RAC 9.6
- Contamination of Aircraft (Frost, Ice or Snow)
 - In Flight AIR 2.12.3
 - On Ground AIR 2.12.2
- Continuous Descent Final Approach (CDFA) AIR 2.17
- Control Transfer
 - IFR Units to Towers RAC 9.10
- Controlled Airports
 - Approach Position Reports RAC 9.9
 - Arrival Procedures RAC 4.4
 - Initial Clearance RAC 4.4.2
 - Landing Clearance RAC 4.4.3
 - Operations on Intersecting Runways RAC 4.4.9
 - Private Advisory Stations RAC 1.2.3
 - Sequential Operations RAC 4.4.9
 - Simultaneous Operations RAC 4.4.9
 - Traffic Circuits RAC 4.3
- Controlled Airspace RAC 2.5
 - Area Extensions RAC 2.7.2
 - Clearances
 - Leaving or Entering RAC 8.8
 - Control Zones RAC 2.7.3
 - High-Level RAC 2.6
 - Low-Level RAC 2.7
 - Low-Level Airways – LF/MF, VHF/UHF .. RAC 2.7.1
 - Transition Areas RAC 2.7.5
 - Use of Controlled Airspace by
 - VFR Flights RAC 2.5.1
- Controlled Flight Into Terrain (CFIT) AIR 2.17.1
- Controlled VFR (CVFR) Procedures RAC 5.6

Conversion Tables	GEN 1.7.2
CRFI	AGA 1.1.3, AIR 1.6
Cross Country Instrument Training Flights	RAC 3.11
Crosswind Landing Limitations	
– Light Aircraft	AIR 2.2
Cruising Altitudes and Flight Levels	RAC 2.3.1

D

Dangerous Goods	
– Transportation by Air	RAC ANNEX 3.0
Dangerous Situations	
– Refusal to Work	GEN 2.1.2
Date – Time Group	GEN 1.5.1
Day Markings of Obstructions	AGA 6.4
Declared Distances	AGA 3.10
Decompression Sickness	AIR 3.5
– Defence – ADIZ (Air Defence Identification Zone)	RAC 2.13, 3.9,
– Flight Plans	RAC 3.9
Departure(s)	
– Approach and Alternate Minima	RAC 9.18
– Non-radar	RAC 4.1.1
– Procedures – Controlled Airports	COM 3.8
– RONLY Aircraft	RAC 4.2.12
– Radar	RAC 4.1.1
Design Eye Reference Point	AIR 4.12
Designated Mountainous Regions	
in Canada	RAC Fig. 2.11
Dial-up RCO	RAC 1.1.4
Disorientation	AIR 3.7
Displaced	
– Threshold Lighting	AGA 7.8.3
– Thresholds	AGA 3.5
– Threshold Markings	AGA 5.4.1
Ditching	AIR 2.11.2
DME (Distance Measuring Equipment)	COM 4.7
– Intersections, Minimum En-Route	
– Altitude	RAC 8.6.1.1
– Procedures (Holding Patterns)	RAC 10.8
DME-DME (RHO-RHO) System	COM 5.14
Downed Aircraft Procedures	SAR 4.8
Downdraft and Turbulence	AIR 1.5.7
Drugs	AIR 3.10

E

ELT (Emergency Locator Transmitter)	SAR 3.0
– Accidental Transmissions	SAR 3.7
– Categories	SAR 3.2
– Downed Aircraft Procedures	SAR 4.8
– Flight Planning (Supplementary Information)	RAC 3.16.9
– Installation and Maintenance Requirements	SAR 3.3
– Operating Instructions (Emergency Use)	SAR 3.5
– Operating Instructions (Normal Use)	SAR 3.4
– Schedule of Requirements to Carry an ELT	SAR 3.9
– Signal, Maximizing the	SAR 3.6
– Testing Procedures	SAR 3.8

Emergency	
– Action by the Pilot during Emergency	
Conditions	SAR 4.2
– Assistance	SAR 4.0
– Communications and Security	COM 1.12, RAC 2.13
– Declaring an	RAC 6.3.1, SAR 4.1
– Lighting, Aerodrome	AGA 7.13
– Locator Transmitter	SAR 3.0
– Monitoring of Emergency Frequency	
121.5 MHz	COM 1.12.2
– Procedures, Downed Aircraft	SAR 4.8
– Procedures for Signaling Vessels	SAR 2.4
– Radio Frequency Capability	SAR 4.6
– Transponder Alerting	SAR 4.4
Emergency Equipment	
– Flight Planning (Supplementary Information)	
.....	RAC 3.16.9
– Operations Over Sparsely Settled Areas	AIR 2.14
– Operations Over Water	AIR 2.11.3
English, Use of in Communications	COM 1.3
En-Route Procedures – VFR	RAC 5.0
Equipment	
– COM/NAV	RAC 3.16.4
– RNAV	RAC 9.2.2
– Surveillance (SSR) (Canadian and ICAO)	RAC 3.16.4
Evaluation, Aeronautical	AGA 6.3
Examinations, Use of Hand-held Calculators	
or Computers for Written	LRA 3.3
Exhaust Plumes	AIR 4.16.1
Experimental Test Flights, Conduct of	AIR 4.2
Explosions and Fires	AIR 1.3.4
Export of Aircraft	LRA 4.7
Eye Reference Point, Design	AIR 4.12

F

Fan Blade Ice Shedding Procedure	AIR 2.12.1.1
FANS 1/A ADS WPR	COM 3.10
Fatigue	AIR 3.10
FD (Upper Level Wind	
and Temperature Forecasts)	MET 9.0
Final Approach Fix (FAF)	RAC 9.19.2
FIR (Flight Information Regions)	RAC Fig. 2.3, 2.4
Fire Extinguishers	
– For Use in Aircraft	AIR 1.4
– Types of	AIR 1.4.3
Fire Fighting, Aircraft Rescue and (ARFF)	AGA 8.0
– ARFF Hours of Availability	AGA 8.2
– Classification System	AGA 8.3
– ARFF Standby Request	AGA 8.4
– Discreet Communication	AGA 8.5
Fires and Explosions	AIR 1.3.4
Fires, Classification of	AIR 1.4.2
First Aid Kits on Privately Owned	
and Operated Aircraft	AIR 4.13
Fitness	
– Medically Fit	LRA 1.9.2
– Unfit Assessment	LRA 1.9.4
Flight Level Allocation Scheme (FLAS),	NAT 1.20.3

Flight(s)	
– Aerobatic.....	RAC 1.11
– Airmanship.....	AIR 1.0
– Authority.....	LRA 5.3
– Avoid flight in the vicinity of exhaust plumes	AIR 4.16.1
– Definitions flight experience	LRA 1.5
– Experimental Test.....	AIR 4.2
– Fuel Requirements.....	RAC 3.13
– Fuel, Sufficient Amount, IFR/VFR Flights	RAC 3.13.1, 3.13.2
– In Rain	AIR 2.5
– Information Regions (FIR).....	RAC Fig.2.3, RAC 2.4
– Information Service.....	RAC 1.1.1, 1.1.2
– Itineraries.....	RAC 3.6
– Itinerary form, Composite IFR/VFR/ IFR Sample	RAC Fig. 3.1
– Military Flight Advisory Unit (MFAU).....	RAC 1.1.6
– Mountainous Regions.....	RAC 2.12, AIR 2.13
– Operations – Airmanship.....	AIR 2.0
– Operations in Volcanic Ash.....	AIR 2.6
– Operations in Winter.....	AIR 2.12
– Operations – Mountainous Regions	RAC 2.12, AIR 2.13
– Operations on Water.....	AIR 2.11
– Other Information.....	RAC 3.16.8
– Permit.....	LRA 5.3.4
– Planning.....	RAC 3.0, 12.5.4, SAR 2.0
– Priority.....	RAC 1.8
– Temporary Restrictions – Forest Fires	RAC 2.9.2
– Time / Air Time	AIR 4.1
– Transoceanic, General Aviation Aircraft.....	NAT 1.2
Flight Plan/Itinerary	
– Aerodrome, Departure and Time	RAC 3.16.5
– Aerodrome, Destination, Total Estimated Elapsed Time, SAR Time (Canadian only) and Alternate Aerodrome(s).....	RAC 3.16.7
– Aircraft Identification	RAC 3.16.1
– Alternate Aerodrome for IFR Flight	RAC 3.14
– Canadian	RAC 3.15.2
– Changes to the Information.....	RAC 3.7
– Closing.....	RAC 3.12
– Closing of a Flight Plan or Flight Itinerary Prior to Landing.....	RAC 3.12.2
– Composite, VFR and IFR.....	RAC 3.8
– Contents	RAC 3.16
– Cross Country Instrument Training Flights.....	RAC 3.11
– Cruising Speed, Altitude/Level and Route	RAC 3.16.6
– Defence VFR (DVFR) and Defence Flight Itineraries	RAC 3.9
– Equipment (Canadian and ICAO).....	RAC 3.16.4
– Filing (CAR 602.75)	RAC 3.6.2
– Flight Rules and Type of Flight.....	RAC 3.16.2
– Flights Along or Outside Designated ATS Routes.....	RAC 3.16.6
– Forms, Completion of.....	RAC 3.15
– Fuel Requirements.....	RAC 3.13
– Fuel, Sufficient Amount, IFR/VFR Flights	RAC 3.13.1, 3.13.2
– ICAO	RAC 3.15.3, Fig. 3.2
– IFR	RAC 3.15
– IFR Flight Plan	RAC 3.7.2
– Intermediate Stops.....	RAC 3.10
– Number and Type of Aircraft and Wake Turbulence Category	RAC 3.16.3
– Other Information.....	RAC 3.16.8
– –.....	Opening a VFR Flight Plan or Flight Itinerary
– Requirements – Flights Between Canada and a Foreign State	RAC 3.6.3
Sample – Composite IFR/VFR/ IFR	
– Flight Itinerary.....	RAC Fig. 3.1
– IFR (ICAO).....	RAC Fig. 3.2
– VFR.....	RAC Fig. 3.3
– Type of Flight and Flight Rules.....	RAC 3.16.2
– VFR Flight Plan or Flight Itinerary	RAC 3.7.1
Flight Operations.....	AIR 2.0
– At night	AIR 2.16
Flight Planning.....	RAC 3.0
Flying Low, Hazards of.....	AIR 2.4
Forecast	
– Aerodrome Forecasts from AWOS Sites.....	MET 7.5
– Area (GFA).....	MET 4.0
– Aviation, Abbreviations.....	MET 15.0
– Charts (PROG)	MET 11.2
– Significant Weather Prognostic Charts	
– CMC.....	MET 12.1
– RAFC.....	MET 12.2
– TAF (Aerodrome)	MET 7.0
– Upper Level Charts – PROG.....	MET 11.0, 11.2
– Upper Level Wind and Temperature (FD)	MET 1.1.3, 9.0
– Winds and Temperatures Aloft Network, Canadian	MET 9.1
French, Use of in Communications.....	COM 1.3
Frequency	
– Mandatory (MF), Use of	RAC 4.5.4, 4.5.6
– Monitoring 126.7 MHz.....	RAC 5.1
– Release from Tower	RAC 4.2.9
FSS (Flight Service Stations).....	RAC 3.4.1
Fuels	
– Anti-icing Additives	AIR 1.3.3
– Aviation.....	AIR 1.3
– Dumping.....	RAC 6.3.4
– Fires and Explosions.....	AIR 1.3.4
– Grades.....	AIR 1.3.1
– Handling.....	AIR 1.3.2
– Minimum Fuel Advisory.....	RAC 1.8.2
– Requirements.....	RAC 3.13
– Sufficient Amount, IFR/VFR Flights	RAC 3.13.1, 3.13.2
Fuel and Oil Weights.....	RAC 3.5.2

- G**
- Gander Oceanic Transition Area (GOTA)..... NAT 1.4
 - Gander Radio..... NAT 2.5.1
 - Geographic Reference/Coordinates..... GEN 1.4.2
 - Glassy Water and Landing Seaplanes..... AIR 2.11.4
 - Global Navigation Satellite System (GNSS)....COM 5.1, 5.2
 - Approach Procedures..... COM 5.4.2
 - Approach Procedures with Barometric Vertical Navigation (baro-VNAV)..... COM 5.4.2.4
 - Approach Procedures with Vertical Guidance (APV)..... COM 5.4.2
 - Approaches at Alternate Aerodromes..... COM 5.9, 5.9.1, 5.9.2
 - Avionics Databases..... COM 3.15.8
 - Augmentation Systems (ABAS, SBAS, GBAS)..... COM 5.3
 - GNSS Vulnerability
 - Interference, Anomaly Reporting..... COM 5.10
 - NOTAMs..... COM 5.5.2
 - Proper use of..... COM 5.11
 - User Comments..... COM 5.12
 - Glossary of Aeronautical Terms..... GEN 5.1
 - GOTA..... NAT 1.4
 - Graphic Area Forecast (GFA)..... MET 4.0
 - Gross Navigation Errors, Monitoring of..... NAT 1.19.6
 - Ground-to-Air Signals..... SAR 4.8.1
- H**
- Hang Glider Operations..... AIR 4.15
 - Health and Safety Program, Transport Canada
 - Aviation Occupational (A-OH&S)..... GEN 2.1
 - Heaters, Portable Combustion – Danger of..... AIR 3.3
 - Helicopter Operations..... RAC 4.5.3, 4.6
 - At Controlled Airports..... RAC 4.6
 - Takeoff, Landing and Safety Areas..... AGA 3.12
 - Vortices..... AIR 2.9
 - Heliports..... AGA 5.5
 - Arrival and Departure Hover Area..... AGA 3.13
 - Final Approach and Take-Off Area (FATO)..... AGA 7.12.2
 - Lighting..... AGA 7.12
 - Markers and Markings..... AGA 5.5.1, 5.5.2, 5.5.3, 5.4, 5.5.5, 5.5.6, 5.6
 - Touchdown and Lift-Off Area (TLOF)..... AGA 7.12.1
 - High Altimeter Settings..... AIR 1.5.9
 - High Altitude Flight in Aircraft with Unpressurized Cabins..... AIR 3.4
 - High Intensity Approach Lighting (HIAL)..... RAC 9.19.2.8
 - High Intensity Runway Operations (HIRO)..... RAC 4.4.10
 - Hijack (Unlawful Interference)..... RAC 1.9.8
 - Holding
 - Clearance..... RAC 10.2
 - DME Procedures..... RAC 10.8
 - Pattern, Entry Procedures..... RAC 10.5
 - Pattern, Non-Standard..... RAC 10.4
 - Pattern, Speed Limitations, DME Procedures, Shuttle Procedure..... RAC 10.7, 10.8, 10.9
 - Pattern, Standard..... RAC 10.3
 - Pattern, Timing..... RAC 10.6
 - Patterns Depicted on En Route and Terminal Charts..... RAC 10.10
 - Positions, Taxi..... RAC 4.2.6
 - Procedures
 - IFR..... RAC 10.0
 - VFR..... RAC 4.4.2
 - Speed Limitations..... RAC 10.7
 - Hover
 - Approach and Take-Off Direction
 - Markings..... AGA 5.5.6
 - Taxi..... RAC 4.6
 - Hydroplaning..... AIR 1.6.5
 - Hyperventilation..... AIR 3.2.2
 - Hypothermia and Hyperthermia..... AIR 3.17
 - Hypoxia..... AIR 3.2.1
- I**
- ICAO
 - Applicable ICAO and WMO Documents..... MET 1.1.7
 - ICAO Flight Plan Form, Sample..... RAC Fig. 3.2
 - ICAO Type A Charts..... MAP 4.2.1
 - Ice Control and Snow Removal..... AGA 1.1.4
 - Ice
 - Aircraft Contamination on the Ground, and in Flight..... AIR 2.12.2, 2.12.3
 - Accumulation..... MET 2.4
 - Types of Ice..... AIR 2.12.3.1
 - Aerodynamic Effects of Airborne Icing..... AIR 2.12.3.2
 - Roll Upset..... AIR 2.12.3.3
 - IFR
 - Advance Notice of Intent..... RAC 9.5
 - Air Traffic Control Clearance..... RAC 6.1
 - Aircraft Categories..... RAC 9.21
 - Altitude Reports..... RAC 8.3
 - Application of Takeoff Minima..... RAC 9.19.1
 - Approach Ban..... RAC 9.19.2
 - Approach Clearance..... RAC 9.3
 - Approach Position Reports – Controlled Airports..... RAC 9.9
 - Arrival Procedures..... RAC 9.0
 - Uncontrolled Aerodromes/Airspace..... RAC 9.12, 9.13
 - ATC Assignment of Altitudes..... RAC 8.6
 - Circling..... RAC 9.23
 - Procedures..... RAC 9.24
 - Clearance with VFR Restrictions..... RAC 6.2.1
 - Clearances..... RAC 7.4
 - Clearances – Leaving or Entering Controlled Airspace..... RAC 8.8
 - Climb or Descent..... RAC 8.4
 - Contact and Visual Approaches..... RAC 9.6
 - Corrections for Temperature..... RAC 9.17.1, Fig. 9.1
 - Cross Country Training Flight..... RAC 3.11
 - Departure, Approach and Alternate Minima..... RAC 9.18
 - Departure Procedures..... RAC 7.0
 - Departure from Uncontrolled Aerodromes..... RAC 7.9
 - Descent Out of Controlled Airspace..... RAC 9.4
 - DME Holding Procedures..... RAC 10.8

– Emergencies and Equipment Failures	RAC 6.3	ILS (Instrument Landing Systems)	COM 4.11
– En Route Procedures	RAC 8.0	– Automatic Landing (Autoland) Operations	COM 4.11.7
– En Route – Uncontrolled Aerodromes (Class-“G” Airspace)	RAC 8.10	– Categories	COM 4.11.5
– Flight – Two-Way Communications Failure	RAC 6.3.2	– Glide Path	COM 4.11.2
– Flight Plan	RAC 3.7.2	– Glide Path Fluctuations	COM 4.11.7
– Flight Plan – Completion of	RAC 3.15	– Localizer	COM 4.11.1
– Flight, “1 000-Ft-on-Top”	RAC 8.7	– Minima, Category II	RAC 9.18.1
– Flights in VMC	RAC 6.2	Importation of	
– General	RAC 6.0	– Aircraft into Canada	LRA 4.6
– Holding Clearance	RAC 10.2	Index	
– Holding Entry Procedures	RAC 10.5	– Aerodrome Obstacle Charts	
– Holding Pattern, Speed Limitations	RAC 10.7	– ICAO Type A	MAP 4.2.1
– Holding Pattern, Timing	RAC 10.6	– Legislation – <i>Canadian Aviation Regulations</i>	GEN 5.3
– Holding Procedures	RAC 10.0	Information	
– ILS, Category II Minima	RAC 9.18.1	– Signs	AGA 5.8.2
– Initial Contact at Uncontrolled Aerodromes	RAC 9.11	– Survival Advisory	AIR ANNEX
– Initial Contact with Tower	RAC 7.3, 9.9	– Weather	MET 3.0
– Instrument Procedures, Development of	RAC 6.6	Initial Contact	RAC 4.4.1, 9.9
– Landing Minima	RAC 9.19.3	INMARSAT	COM 1.12.3
– Mach Number	RAC 8.3.1, 12.1, NAT 1.13	Interception – Procedures	SAR 4.7 SCHEDULE I
– Minimum Altitudes	RAC 8.5	– Visual Signals for Use in the Event of	SAR 4.7 SCHEDULE II
– Missed Approach Procedures	RAC 9.26	Intermediate Approach	RAC 9.16
– Missed Approach Procedures – Visual	RAC 9.25	Intermediate Stops	RAC 3.10
– Noise Abatement Procedures – Departure	RAC 7.6	International Civil Aviation Organization (ICAO)	
– Non-Standard Holding Pattern	RAC 10.4	– Definitions	AGA 1.2.1
– Obstacle and Terrain Clearance	RAC 7.7	– Documents	AGA 1.1.2
– Outbound Report	RAC 9.14	International Flights	
– PAR (Precision Radar Approaches)	COM 7.1, RAC 9.8.4	– Charts	MAP 5.0
– Position Reports	RAC 8.1	– HF Air-Ground Frequencies, Use of General Purpose VHF, in Lieu of	COM 1.4
– Mandatory Routes	RAC 3.16.6, 11.4.3	Internet address (Transport Canada Home Page)	LRA 5.7
– Mandatory IFR Routes (Including RNAV)	RAC 11.4.3	Instrument	
– Procedure Altitudes	RAC 9.17	– Flight Rules – General	RAC 6.0
– Procedures – Uncontrolled Aerodromes/Airspace	RAC 4.5.2, 9.14	– Flight Test (IFT)	COM 9.4
– Published Holding Patterns	RAC 10.10	– Rating Minima	RAC Fig. 9.2
– Radar Arrivals	RAC 9.7	Insurance	
– Release from Tower Frequency	RAC 7.8	– Liability	LRA 4.8
– Remote Altimeter Setting	RAC 9.17.2	Interference with Aircraft Navigational Equipment	COM 4.4
– Reporting of Equipment Malfunction	RAC 6.3.3	Intersecting Runways, Operations on	RAC 4.4.9
– Reporting Procedures		J	
– Uncontrolled Aerodrome	RAC 9.12	Jet and Propeller Blast Danger	AIR 1.7
– Required Visual Reference	RAC 9.19.3	L	
– Runway Visual Range (RVR)	RAC 9.20	Landing Distance Available (LDA)	AGA 3.10
– Separation	RAC 6.4	Landing Lights, Collision Avoidance	AIR 4.5
– Shuttle Procedure	RAC 10.9	Landing Minima	RAC 9.19.3
– Simultaneous Approaches	RAC 9.27	Legislative Index	
– Speed Adjustment – Radar Controlled Aircraft	RAC 9.8.3	– <i>Canadian Aviation Regulations</i>	GEN 5.3
– Standard Holding Pattern	RAC 10.3	Licences	
– Standard Instrument Departure (SID)	RAC 7.5	– Airline Transport	LRA 1.7.4
– Standard Terminal Arrival (STAR)	RAC 9.2, 9.2.3	– Commercial Pilot	LRA 1.7.3
– Straight-in Approach	RAC 9.15	– Differences with ICAO Standards	LRA 1.8
– Straight-in Landing Minima	RAC 9.22	– Flight Engineer	LRA 1.7.6
– True Airspeed (TAS)	RAC 8.2.2	– Medical Examination Requirements	LRA 2.2
– Uncontrolled Airspace	RAC 9.13		
– Visual Approach	RAC 9.6.2		

– Multi-crew	LRA 1.7.5
– Pilot	LRA 1.7.1
– Private Pilot	LRA 1.7.2
– Recency Requirements	LRA 1.7.2
– Reinstatement of Suspended Licence	LRA 1.11
Licensing	
– Flight Crew Licensing Administration	LRA 1.14
– Flight Crew Conversion Agreement between Canada and the United States	LRA 1.13
– Flight Crew Licensing	LRA 1.0
– Licensing and Registration of Aircraft	LRA 4.5
Life-Saving Equipment for Aircraft	
– Operating Over Water	AIR 2.11.3
Light Aircraft	
– Crosswind Landing Limitations	AIR 2.2
Lighting	
– Aerodrome	AGA 7.0
– Approach	AGA 7.5
– Approach/Take-Off Direction	AGA 7.12.3
– Displaced Threshold	AGA 7.8.3
– Emergency	AGA 7.13
– Heliport	AGA 7.12
– Low Intensity Approach (LIAL)	AGA 7.5.1
– Medium Intensity Approach Lighting	
– System (MALS)	AGA 7.5.1
– Medium Intensity Approach, System with Sequenced Flashing Lights (MALSF)	AGA 7.5.1
– Medium Intensity Approach Lighting and Runway	
– Alignment Indicator Lights (MALSR)	AGA 7.5.1
– Night	AGA 7.3
– Non-Precision Approach Runways	AGA 7.5.1
– Obstructions	AGA 6.0
– Omnidirectional Approach (ODALS)	AGA 7.5.1
– Rapid-Exit Taxiway Indicator Lights	AGA 7.9
– Runway	AGA 7.8
– Runway Centre Line	AGA 7.8.4
– Runway Touchdown Zone	AGA 7.8.5
– Simplified Short Approach Lighting System with Runway Alignment Indicator Lights (SSALR)	AGA 7.5.2
– Taxiway	AGA 7.10
– Unserviceable Area	AGA 7.4
Lights	
– Approach and Take-Off Direction Lights ...	AGA 7.12.3
– Rapid-Exit Taxiway Indicator Lights	AGA 7.9
– Runway Edge Lights	AGA 7.8.1
– Runway End Lights	AGA 7.8.2
– Runway Guard Lights	AGA 7.11
– Runway Threshold End Lights	AGA 7.8.2
– Taxiway Centreline Lights	AGA 7.10.2
– Taxiway Edge Lights	AGA 7.10.1
– Use of Landing Lights – Collision Avoidance ...	AIR 4.5
– Use of Strobe	AIR 4.6
Lights, Runway Threshold Identification (RTIL)	AGA 7.7.1
Limited Weather Information Systems (LWIS)	MET 1.1.5, 1.2.4
Localizer	COM 4.11.1
Logging Operations	AIR 2.4.2

Low	
– Level Controlled Airspace	RAC 2.7
– Level Wind Shear	AIR 2.8
– Flying	AIR 2.4
– Flying near power lines	AIR 2.4
– visibility operations plan (LVOP)	RAC 1.7

M

Mach Number	
– Clearances and Reports	RAC 8.2
– Adherence to	NAT 1.13
– True Airspeed (TAS)	NAT 1.7.2
Maintenance Requirements	
– For Canadian Registered Aircraft	LRA 5.6
– Aircraft used in Dual Role Operations	LRA 5.6.2
Maintenance Certificate	LRA 5.4
Major Errors in Altimeter	RAC Fig. 9.1, AIR 1.5.4
Mandatory Frequency (MF), Use of	RAC 4.5.4, 4.5.6
Mandatory Instruction Signs	AGA 5.8.3
Manned Free Balloon Operations	AIR 4.7
Manoeuvring Area, Visual	RAC 9.25
MANOT (Missing Aircraft Notice)	SAR 2.3
Markers	
– Aerodrome Boundary	AGA 5.1
– Retroflective	AGA 7.15
– Seaplane Dock	AGA 5.3
– Shore	AGA 6.7
– Takeoff or Landing Area Boundary	AGA 5.1
Markings	
– Aerodrome	AGA 5.1
– Approach and Take-Off	AGA 5.5.6
– Appurtenances	AGA 6.6
– Aeronautical Evaluation	AGA 6.3
– Arrows	AGA 5.4.1
– Cable Spans	AGA 6.2, 6.7
– Closed	AGA 5.6
– Day Marking	AGA 6.4
– Displaced Threshold	AGA 5.4.1
– Helicopter Safety Area Markers	AGA 5.5.2
– Heliports	AGA 5.5
– Heliport Identification	AGA 5.5.3
– Heliport Takeoff and Landing Area Marking	AGA 5.5.1
– Holding	AGA 5.4.3
– Hover Area	AGA 5.5.4
– Obstruction	AGA 6.0
– Power Line Crossings	AGA 6.7
– Preferred Approach and Departure Path	AGA 5.5.6
– Runway	AGA 5.4
– Standards	AGA 6.2
– Taxiway Exit and Holding	AGA 5.4.3
– Unserviceable Area	AGA 5.7
Marshalling Signals	AIR 1.8
Measurement, Units of	GEN 1.4
MEDEVAC – Call Signs	COM 1.9.1.4
Medical	
– Aeromedical Factors	AIR 3.2
– Assessment Process	LRA 2.1

– Aviation Medical Review Board	LRA 2.4	– Forecasts and Charts	MET 1.3
– Examination Requirements	LRA 2.2	– Ice Accumulation	MET 2.4
– Fitness for Permits and Licences	LRA 1.9	– Locations – Aerodrome Forecast	MET 7.1
– Periodic Medical Exam Categories 1, 2 3		– METAR (Aerodrome Routine Meteorological	
Medically Fit	LRA 2.3	Report)	MET 1.2.1, 3.2, 8.0
– Unfit Assessment	LRA 2.5	– Observations and Reports	MET 1.2
Medical Information	AIR 3.0	– Pilot Report (PIREP)	
– Alcohol	AIR 3.9	MET 1.1.3, 1.1.6, 2.0, 2.2.1, RAC1.1.3
– Anesthetics	AIR 3.13	– Report (AIREP)	MET 1.1.6, NAT 1.15
– Blood Donation	AIR 3.14	– Reports, Forecasts and Charts	MET 3.1, 3.2
– Carbon Monoxide	AIR 3.2.3	– Responsibility	MET 1.1.1
– Decompression Sickness	AIR 3.5	– Services Available	MET 1.1.2
– Disorientation	AIR 3.7	– SIGMET	MET 1.1.3, 6.0
– Drugs	AIR 3.10	– Space Weather	MET 14.0, COM 5.5.4
– Fatigue	AIR 3.10	– SPECI (Special Weather Reports)	
– follow-up procedures after an in-flight illumination		MET 1.2.1, 8.4, 8.5
.....	AIR 4.15.5	– Special VFR Weather Minima	RAC Fig. 2.8
– General Health	AIR 3.1	– Surface Weather Maps	MET 10.0
– High Altitude Flight in Aircraft with		– Symbols	
Unpressurized Cabin	AIR 3.4	– Significant Weather	MET 12.1
– Hyperventilation	AIR 3.2.2	– Surface Weather Maps	MET 10.0
– Hypothermia and Hyperthermia	AIR 3.17	– TAF (Aerodrome Forecast)	MET 1.1.3, 7.0
– Hypoxia	AIR 3.2.1	– Turbulence Reporting Criteria Table	MET 2.2.2
– Mandatory Medical Reporting	AIR 3.1.1	– Upper Level Charts, analysed (ANAL)	MET 11.1
– Middle Ear and Sinus Discomfort or Pain	AIR 3.8	– Upper Level Wind and Temperature	
– Portable Combustion Heaters, Potential		Forecasts	MET 1.3.7, 9.0
Hazard of	AIR 3.3	– VOLMET	NAT 2.2, MET 1.4
– Pregnancy	AIR 3.15	– Weather Charts	MET 3.3
– Scuba Diving	AIR 3.6	– Weather Observing Systems	MET 3.2, 3.3, 1.1.5
– Vision	AIR 3.7	– Weather Radar	COM 7.1, MET 1.3.9
Meteorological / Meteorology		– Wind Shear	MET 2.3
– Abbreviations, Significant Weather	MET 12.1	Middle Ear and Sinus Discomfort or Pain	AIR 3.8
– AIRMET	MET 1.1.3, 1.3.4, 1.3.6, 5.0	Military	
– Authority, Areas of Responsibility	MET 1.1.1	– Arrester Cables	AGA 9.2
– Automated Reports		– Flight Advisory Unit (MFAU)	RAC 1.1.6
– Other	MET 8.6	– Radar Assistance (Canadian Forces)	RAC 1.5.7
– Reports from Other Non-aviation Autostations		Minima	
.....	MET 8.6	– Application of	RAC 9.19
– Voice Generator Module (VGM)	MET 8.6	– Circling	RAC 9.23
– Aviation Forecasts, Abbreviations	MET 15.0	– Departure, Approach and Alternate	RAC 9.18
– Aviation Weather Briefing Service		– Straight-in Landing	RAC 9.22
(AWBS)	MET 1.1.3	Minimum	
– Aviation Weather Information Service		– Altitudes – Overflying Aerodromes	RAC 5.5
(AWWS)	MET 1.1.3	– Altitudes – VFR	RAC 5.4
– Aviation Weather Reports	MET 3.2, 8.0	– En-Route Altitudes (MEA)	RAC 8.6.1
– Aviation Weather Services	MET 1.1.3	– Fuel Advisory	RAC 1.8.2
– AWOS (Automated Weather Observation		– Holding Altitude (MHA)	RAC 10.7
System)	MET 8.5	– IFR Altitudes	RAC 8.6
– Canadian Forecast Winds and Temperatures		– Obstruction Clearance Altitude (MOCA)	
Aloft Network	MET 9.1	RAC 8.5, 8.6.1
– Canadian Meteorological Centre (CMC)	MET 12.1	– Sector Altitude (MSA)	RAC 9.2.1
– Canadian Weather Information	MET 1.3.5, 3.0	Minimum Navigation Performance Specifications	
– Charts and Forecasts	MET 1.3	(MNPS)	NAT 1.11
– Clear Air Turbulence (CAT), Avoidance of		NAT 1.7.5
.....	MET 2.2, AIR 2.10	– Certification	NAT 1.19
– Coastal Weather	MET 1.3.5	– High-Level Airspace (HLA)	NAT 1.11, NAT 1.19
– Differences with ICAO Annex-3	MET 1.1.8	– Navigation Errors, Monitoring of Gross	NAT 1.19.6
– GFA (Area Forecast)	MET 1.1.3, 1.3.6, 4.0	– North Atlantic (NAT) MNPS Operations	COM 3.15.11
		Missed Approach	

– From a Circling Procedure	RAC 9.25
– Procedures	RAC 9.26
Monitoring Emergency Frequency 121.5 MHz	COM 1.12.2
Morning and Evening Civil Twilight Charts	GEN 1.5.2
Morse Code and the Phonetic Alphabet	COM 1.5
Mountainous	
– Areas, Flight Operations in	AIR 2.13
– Regions	RAC 2.12, Fig. 2.12

N

NAR (North American Routes)	NAT 1.3
National Harbours Board Act	AIR 2.11.1
Nationality and Registration Marks	GEN 1.6, LRA 4.3
NAV CANADA	
– Regions – Addresses, Facsimile and Telephone Numbers	GEN 1.1.2
NAVAID	
– DME (Distance Measuring Equipment)	COM 4.7
– LOC (Localizer)	COM 4.11.1
– NDB (Non-Directional Beacon)	COM 4.11.3
– Radio Navigation Aids	COM 4.0
– TACAN (Tactical Air Navigation)	COM 4.8
– VDF (VHF Direction Finding System)	COM 4.10, RAC 1.6, SAR 4.3
– VOR (VHF Omnidirectional Range)	COM 4.5
– VORTAC (VOR and TACAN)	COM 4.9
Navigation Aids	
– Accuracy, Availability and Integrity of	COM 4.2
– Pilot Reporting of Abnormal Operation of ...	COM 4.3
Navigation System	
– GNSS (Global Navigation Satellite System)	COM 5.1, 5.2
– GPS (Global Positioning System)	COM 5.2.1
– NDB (Non-Directional Beacon)	COM 4.6
– VOR/DME (RHO-THETA)	COM 5.14
Night Lighting	AGA 7.3
Night, Flight Operations at	AIR 2.16
Noise	
– Abatement	RAC 4.1.2, 7.6
– Preferential Runways	RAC 4.1.3, 7.6.2
Non-Directional Beacon (NDB)	COM 4.11.3
NORDO/ONLY	RAC 4.2.10, 4.2.12, 4.4.5, 4.4.6, 4.5.7, 4.5.8
North American Routes (NAR)	NAT 1.3
North Atlantic	
– Clearances	NAT 1.9
– Data Link Mandate (DLM) Airspace	NAT 1.20.6
– Documents and Guidance Material	NAT 1.1.2
– Domestic Clearances	NAT 1.9.2
– Flight Planning Procedures	NAT 1.7
– Flight Rules	NAT 1.6
– In-flight Contingencies	NAT 1.17
– Oceanic Clearance Delivery	NAT 1.9.3
– Operations (NAT)	NAT 1.0
– Organized Track System	NAT 1.5, NAT 1.20.3
– Regulation	NAT 1.1.1
– Transponders, Operation of	NAT 1.14
Northern and Southern Domestic Airspace	RAC 2.2.1

Northern Canada, Single-Engine Aircraft Operations	AIR 2.14.1
NOTAM	MAP 3.0
– Collection, Evaluation and Dissemination	GEN 1.1.5
– Criteria for Issuance	MAP 3.1, 3.6
– Description	MAP 3.2.3
– Distribution – Canadian, International	MAP 3.5
– Format	MAP 3.2
– GPS Satellite Outages	COM 5.5.1
– Information for Flight Planning	RAC 3.3
– Schedule	MAP 3.2.3.5
– Service	COM 5.5.1, 5.5.2
– Types	MAP 3.3
Notice – PNR (Prior Notice Required)	AGA 2.2
Numbers, Use of	COM 1.8

O

Obstacle	
– And Terrain Clearance	RAC 7.7
– Clearance During Radar Vectors	RAC 1.5.5
– Clearance Limit	AGA 7.6.7
– Limitation Surfaces	AGA 4.2
– Protection Surface	AGA 7.6.6
– Restrictions	AGA 4.0
– Heliports	AGA 4.2.2
Obstruction	
– Aeronautical Evaluation	AGA 6.3
– Appurtenances	AGA 6.6
– Day Lighting	AGA 6.5
– Day Marking	AGA 6.4
– Markings	AGA 6.0
– Markings, Standards	AGA 6.2
– Suspended Cable Span Markings	AGA 6.7
Occupational Health and Safety Program, Aviation (A-OH&S)	GEN 2.1
– Civil Aviation Safety Inspectors	GEN 2.1.3
Occurrence – Reporting an Aviation	GEN 3.3
Oceanic Clearances	NAT 1.9.1
Oil and Fuel Weights	RAC 3.5.2
Operational Information Signs	AGA 5.8.2
Operations	
– On Intersecting Runways	RAC 4.4.9
– Sequential	RAC 4.4.9
– Simultaneous	RAC 4.4.9
Organized Track System (NAT)	NAT 1.5, NAT 1.20.3
Over-the-Top, VFR	RAC 2.7.4
Overflying Aerodromes, Minimum Altitudes	RAC 5.5

P

PAPI (Precision Approach Path Indicator)	AGA 7.6.3, 7.6.4.3
Parachute Jumping	AIR 4.8
Paraglider operations	AIR 4.9
Passenger(s) – Actual Weights	RAC 3.5.1
– Weight standards	RAC 3.5
Pavement Load Rating Charts	AGA 3.12.1
Permission – PPR (Prior Permission Required)	AGA 2.2
Permits	
– Medical Examination Requirements	LRA 2.2

- Reinstatement of a suspended LRA 1.11
- Student Pilot LRA.6.1
- Summary of Requirements LRA 1.6
- Phonetics, Use of COM 1.5
- Phone use During a Radio Communications
 - Failure COM 1.15
- Pilot
 - Permits LRA 1.4.1, 1.6.2
 - Procedures when exposed to laser or other
 - Directed Bright Light Sources AIR 4.15
 - Proficiency Check (PPC)..... COM 9.4
 - Reporting of Abnormal Operation of Navigation Aids..... COM 4.3
 - Vital Action Checklists AIR 1.2
 - Waivers – Wake Turbulence..... RAC 4.1.1
- PIREP (Pilot Report)..... MET 1.1.6, 2.0, 2.2.1
- PN (Prior Notice Required)..... AGA 2.2
- Position Reports NAT 1.10
 - IFR RAC 8.1
 - VFR..... RAC 5.1
 - Automatic Dependent Surveillance Waypoint Position Reporting (FANS 1/A ADS WPR)..... COM 3.10
- Positive and Negative G AIR 3.18
- Power-back / Push-back Requests..... RAC 4.2.4
- Power Line Crossing Markings..... AGA 6.7
- Practice Spins AIR 4.3
- Precision Approach Path Indicator (PAPI)
 - AGA 7.6.3, 7.6.4.3
- Preferential Runways
 - Assignments RAC 4.1.3
 - Noise RAC 7.6.2
- Preferred Routes Messages (PRM)..... NAT 1.8
- Pre-flight
 - Service, Single Source..... RAC 3.4
- Pregnancy AIR 3.15
- Pressure
 - Altimeter AIR 1.5
 - Drop AIR 1.5.8
 - Region, Standard AIR 1.5.5
- Prior Notice Required (PN) AGA 2.2
- Private
 - Advisory Stations – Controlled Airports..... RAC 1.2.3
- Procedure(s)
 - Air Traffic Control (ATC) Special RAC 11.0
 - Altitudes RAC 9.17
 - Downed Aircraft..... SAR 4.8
- Propeller and Jet Blast Danger..... AIR 1.7
- Publications and Charts, Procurement
 - of Aeronautical MAP 4.2.1
- Push-back / Power-back Requests..... RAC 4.2.4

R

- RADAR COM 7.0
 - Alerting Manoeuvres..... SAR 4.5
 - Arrivals RAC 9.7
 - ASDE (Airport Surface Detection Equipment) COM 7.1
 - Canadian Forces Radar Assistance RAC 1.5.7

- Navigation Assistance to VFR Flights RAC 1.5.4
- Obstacle Clearance During Radar Vectors RAC 1.5.5
- PAR (Precision Approach)..... COM 7.1
- Primary Surveillance Radar (PSR)..... COM 7.1
- Required..... RAC 9.8.2
- Secondary Surveillance Radar (SSR)..... COM 7.2
- Service RAC 1.5
- Procedures RAC 1.5.2
- Surveillance – VFR RAC 5.7
- Traffic Information (Clock System)..... RAC 1.5.3
- Use of Radar in the Provision of AAS by FSSs RAC 1.5.8
- Vectors, Misuse of Radar RAC 1.5.6
- Vectors, Obstacle Clearance During..... RAC 1.5.5
- Weather Radar COM 7.1 MET 1.3.9
- Radio
 - Checks..... COM 1.11, RAC 4.2.3
 - Navigation Aids, Ground Based..... COM 4.0
 - Radio Telephony Network Operations – North Atlantic Area (NAT)/Anchorage Arctic FIR..... NAT 2.2
 - Telephony, Standard..... COM 1.10
- Communications, Voice COM 1.0
 - Arctic RAC 1.1.3
 - Call Signs COM 1.9
 - Channel Spacing..... COM 1.4
 - Phonetic Alphabet/Morse Code..... COM 1.5
 - Phonetic Designation of Air Routes and Airways COM 1.6
 - Radiocommunication Regulations COM 1.2
 - Regulations – Operator’s Certificates and Station Licences..... COM 1.2
 - Time, Heading, Altimeter, Flight Level..... COM 1.8
- Rapid-Exit Taxiway Indicator Lights..... AGA 7.9
- Rapid-Exit Taxiways AGA 3.11
- Readability Scale – Communications Checks..... COM 1.11
- Recency Requirements – Pilot Licence
 - Privileges LRA 1.12
- Recreational Aviation..... AIR 4.7 to 4.10
- Reduced Lateral Separation, Arrangements for NAT 1.12
- Reduced Vertical Separation Minimum (RVSM)
 - North Atlantic RVSM..... RAC 1.21
 - NAT Height Monitoring NAT 1.20.7, 1.20.8
 - In-flight Contingencies..... NAT 1.17
 - Minimum Aircraft System Performance Specification NAT 1.12
- Reduced Visibility Operations Plan (RVOP)..... RAC 1.7
- Refuelling
 - Fires and Explosions AIR 1.3.4
- Refuges, Reserves and Parks (National, Provincial and Municipal)..... RAC 1.11.3
- Region(s)
 - Altimeter Setting RAC 2.11
 - Mountainous RAC 2.12, RAC Fig. 2.13
 - NAV CANADA GEN 1.1.2
 - Transport Canada..... GEN 1.1.1
- Registered Aerodrome AGA 2.0
- Registration Marks and Nationality..... GEN 1.6, LRA 4.3
- Regulations, Airport Zoning..... AGA 4.3

Reinstatement of Suspended Permit, Licence or Rating	LRA 1.11
Remote Altimeter Setting	RAC 9.17.2
Remote Communications Outlets (RCO)	RAC 1.1.4
– Dial-up RCOs.....	RAC 1.1.4
– Flight Information Service En Route (FISE)	COM 1.9.3, RAC 1.1.3, 1.1.4, 4.5.1
– Remote Aerodrome Advisory Service (RAAS)	COM 1.9.3, RAC 1.1.3, 1.1.4, 4.5.1
Remotely Piloted Aircraft (RPA)	
– Advanced Operations	RPA 3.4
– Basic Operations.....	RPA 3.3
– Fitness of Crew Members.....	RPA 3.2.7
– General Information	RPA 1.0
– General Operation and Flight Rules.....	RPA 3.2
– Maximum Altitude	RPA 3.2.13
– Micro Remotely Piloted Aircraft Systems (mRPAS).....	RPA 2.0
– Minimum Weather Conditions.....	RPA 3.2.22
– Night Flight.....	RPA 3.2.27
– Operations at or in the Vicinity of an Aerodrome, Airport or Heliport	RPA 3.2.35, 3.4.5
– Pilot Requirements	RPA 3.3.2, 3.4.2
– Pre-flight Information	RPA 3.2.12
– Records	RPA 3.2.36
– Registration.....	RPA 3.1
– Serviceability of the RPAS.....	RPA 3.2.17
– Small Remotely Piloted Aircraft Systems (sRPAS).....	RPA 3.0
Reports	
– Altitude	NAT 1.16
– ATS – Possible Contravention of the Air Regulations.....	RAC 1.1.4
– Automated Reports	
– Other	MET 8.6
– Limited Weather Information System (LWIS)	MET 8.5
– Voice Generator Module (VGM).....	MET 8.6
– AWOS – METAR AUTO or SPECI AUTO	MET 8.5
– CRFI.....	AGA 1.1.3, AIR 1.6
– Pilot (PIREP)	MET 2.0
– Pollution.....	RAC 1.12.5
Required Visual Reference	RAC 9.19.3
Resolution Advisories (TCAS/ACAS).....	RAC 1.7
Responsibilities	
– NAV CANADA	GEN 1.1.2
– Transport Canada.....	GEN 1.1.1, AGA 2.3.3
Restricted Airspace	RAC 2.8.6
Retroflective Markers	AGA 7.15
Right of Way – Collision Avoidance Regulations	RAC 1.10
RNAV (Area Navigation) Operations	COM 5.0
RONLY (Receiver Only)/NORDO (No Radio), Procedures	RAC 4.2.10, 4.2.12, 4.4.5, 4.4.6, 4.5.7, 4.5.8
Routes, Canadian Domestic	
– Mandatory IFR Routes (including RNAV)	RAC 3.16.6, 11.4.3
RSC and CRFI Reporting	AIR 1.6.4

RTIL (Runway Threshold Identification Lights).... AGA 7.7

Runway(s)	
– Centre Line Lighting	AGA 7.8.4
– Characteristics	AGA 3.0
– CRFI	AIR 1.6
– Declared Distances	AGA 3.10
– Dimensions	AGA 3.1
– End Lights	AGA 7.8.2
– Friction Calibration Method	AGA 1.1.4.1
– Guard Lights	AGA 7.11
– Heading	RAC 7.5
– Holding Position Markings	AGA 5.4.3
– Intersecting, Operations on	RAC 4.4.9
– Lighting	AGA 7.8
– Markings	AGA 5.4
– Non-Precision Approach	AGA 7.5.1
– Sequential Operations	RAC 4.4.9
– Simultaneous Operations	RAC 4.4.9
– Strip	AGA 3.2
– Taxiway Bearing Strength	AGA 3.12
– Threshold Identification Lights (RTIL)	AGA 7.7
– Touchdown Zone Lighting	AGA 7.8.5
– Wet	RAC 4.4.9, AIR 1.6.5
– Winter Condition NOTAM	AIR 1.6.4
Runway turn pad	AGA 3.6
Runway Visual Range (RVR)	RAC 9.20
– Comparative Scale – Feet to Meters	GEN 1.7.3
– Operational use of RVR	RAC 9.20.2
S	
Safety	GEN 2.0
– Alert Procedure and Phraseology	RAC 12.15
– Aviation Safety Analysis	GEN 2.2
– Aviation Safety Letter (ASL)	GEN 2.2.4
– Occupational	GEN 2.1
SAR (Search and Rescue)	SAR 1.1
– Agreements	SAR 1.3
– Aiding Persons in Distress	SAR 2.4
– Assistance, Request for	SAR 2.2
– Assistance to Aircraft With Emergencies	SAR 4.0
– Closing of a Flight Plan or Flight Itinerary Prior to Landing	RAC 3.12.2
– Declaring an Emergency	SAR 4.1
– Distress Signal Panel	SAR 2.4
– Downed Aircraft Procedures	SAR 4.8
– Emergency Locator Transmitter	SAR 3.0
– Flight Planning	SAR 2.0
– Ground-to-Air Signals	SAR 4.8.1
– Interception Procedures	SAR 4.7
– MANOT (Missing Aircraft Notice)	SAR 2.3
– Procedures for Signaling Vessels	SAR 2.4
– Regions (SRR)	SAR Fig. 1.1
– Rescue Co-ordination Centres (RCCs)	SAR 1.1
– Responsible Authority	SAR 1.0
– Services Available	SAR 1.2
– Survival	SAR 4.8.2
Satellite Navigation (SatNav)	COM 5.3.2
– Current Approvals	COM 5.4
– Required Navigation Performance	COM 6.0
Scheduled point	GEN 5.1
Scuba Diving	AIR 3.6
Seaplane Dock Markers	AGA 5.3
Seaplanes	
– Landing on Glassy Water	AIR 2.11.4
– Landing on Unbroken Snow Conditions	AIR 2.12.6
– Use on Snow Surfaces	AIR 2.12.5
Search and Rescue (see SAR)	SAR 1.1
SECURITAS Program	GEN 3.5
Security, Emergency Communications and	COM 1.12, RAC 2.13
– Distress Message from an Aircraft, example of a	COM 1.12.1
– Urgency Message Addressed to All Stations, example of a	COM 1.12.1
SELCAL (Selective Calling System)	NAT 2.4
Sequential Operations	RAC 4.4.9
Service Difficulty Reporting Program	LRA 2.6.4
Services	
– Aeronautical Fixed (AFS)	MAP 3.5, RAC 3.3
– Air Traffic	RAC 1.1.1
– Apron Advisory	RAC 1.2.4
– Arctic Territories	RAC 1.1.3
– Other Than Air Traffic Services	RAC 1.2
“Shall” and “Should” (Definitions)	GEN 1.1.3
Shannon Oceanic Transition Area (SOTA)	NAT 1.19.1
Shore Markers	AGA 6.7
“Should” and “Shall” (Definitions)	GEN 1.1.3
SIGMET (Significant Meteorological Report)	MET 1.1.3, 6.0
Signals	
– Ground-to-Air	SAR 4.8
– Intercepting and Intercepted Aircraft	SAR 4.7
– Marshalling for Aircraft and Helicopters	AIR 1.8
– Visual	RAC 4.2.11, 4.4.7
Significant Weather Prognostic Charts (RAFC)	MET 3.13
Signs	
– Airfield	AGA 5.8
– Illumination of Airfield	AGA 5.8.4
– Information	AGA 5.8.2
– Mandatory Instruction	AGA 5.8.3
– Simultaneous Operations	RAC 4.4.9
Simultaneous Precision Instrument Approaches	
– Converging Runways	RAC 9.28
– Parallel Runways	RAC 9.27
Single-engine Aircraft Operating in Northern Canada	AIR 2.14.1
– Transoceanic Flight	NAT 1.2
Single Side Band	NAT 2.3
Snow	
– Flight Operations in Winter	AIR 2.12
– Landing Seaplanes on Unbroken Snow Conditions	AIR 2.12.6
– Landing Wheel-Equipped Light Aircraft on Snow Covered Surfaces	AIR 2.12.4
– Removal and Ice Control	AGA 1.1.4
SOTA	NAT 1.19.1
Southern and Northern Domestic Airspace	RAC 2.2.1

Sparsely Settled Areas	
– Flight Operations	AIR 2.14
– Single-Engine Aircraft Operating in Northern Canada	AIR 2.14.1
Special VFR Weather Minima	RAC 2.7.3
Speed	
– Adjustment – Radar Controlled Aircraft	RAC 9.7.3
– Aircraft Speed Limit	RAC 2.5.2
Spins, Practice	AIR 4.3
Stabilized Approach	AIR 2.17.2
Standard	
– Instrument Departure (SID)	RAC 7.5
– Pressure Region	RAC 2.11
– Radio Telephony	COM 1.10
– Terminal Arrival (STAR)	RAC 9.2, 9.2.3
– Conventional STAR	RAC 9.2.3.1
– PBN STAR	RAC 9.2.3.2
Stop Bars	AGA 7.10.3
Stops, Intermediate	RAC 3.10
Stopway	
– Definition	AGA 3.8
Stopways	AGA 5.4.2
Straight-In Approach	RAC 9.15
Strength Scale – Communications Checks	COM 1.11
Strobe Lights, Use of	AIR 4.6
Sunrise/Sunset	GEN 1.5.2
Supplement, <i>AIP Canada (ICAO)</i>	MAP 2.2
Surface Condition Reports	
– Aircraft Movement (AMSCR)	AIR 1.6.4
Survival	SAR 4.8.2
– Advisory Information	AIR ANNEX

T

Tactical Air Navigation (TACAN)	COM 4.8
Takeoff Clearance	RAC 4.2.8
Takeoff Distance Available (TODA)	AGA 3.10
Takeoff Minima	RAC 9.19.1
Takeoff Run Available (TORA)	AGA 3.10
Taxi	
– Holding Positions	RAC 4.2.6
– Holding Positions During IFR Operations	RAC 4.2.7
– Information	RAC 4.2.5
Taxiing	RAC 4.4.4
Taxiway	
– Bearing Strength	AGA 3.12
– Lighting	AGA 7.10
– Rapid-Exit	AGA 3.11,
– Rapid-Exit Taxiway Indicator Lights	AGA 7.9
TC AIM	
– Amendments–Future dates	GEN 1.1.4
– Content	GEN 1.1.3
– Co-ordinator	GEN 1.1.3
– Distribution, address changes and information requests	GEN 1.1.4
– Obtaining the commercial edition	GEN 1.1.4
TCAS I/TCAS II	COM 9.0

TCAS/ACAS (Traffic Alert and Collision Avoidance Systems and Airborne Collision Avoidance Systems)	COM 9.0
– Airworthiness Approval	COM 9.5
– Mode S Transponder Approval and Unique Codes	COM 9.8
– Operational Approval	COM 9.4
– Pilot and Controller Interchange	COM 9.8
– Pilot/Controller Actions	COM 9.9
– Pilot Immunity from Enforcement Action for Deviating from Clearances	COM 9.7
– Transport Canada Policy	COM 9.2
– Use of	COM 9.3
Technical Records, Aircraft	LRA 2.6.3
Temperature Correction for Altimeter	RAC Fig. 9.1, AIR 1.5.2
Terminal Arrival Area (TAA)	RAC 9.2.2
Terminal Control Areas	RAC 2.7.6
Terminal Products	MAP 4.2.1, 4.2.2
Test Flights, Conduct of Experimental	AIR 4.2
Thresholds	
– Arrows	AGA 5.4.1
– Displaced Threshold Lighting	AGA 7.8.3
– Stopways	AGA 5.4.2
Thunderstorms	
– Flight Operations Near	AIR 2.7
Time	
– System	GEN 1.5
– Zone, UTC/Local	GEN 1.5.3
Traffic Circuit Procedures	
– Controlled Aerodromes	RAC 4.3
– NORDO/RONLY	RAC 4.5.8.2
– Uncontrolled Aerodromes	RAC 4.5.2
Transborder Flights	
– Flight Plan Requirements (Between Canada and a Foreign State)	RAC 3.6.3
Transfer – IFR Units to Towers	RAC 9.10
Transoceanic Flight – General Aviation Aircraft	NAT 1.2
Transition Areas	RAC 2.7.5
Transponder	
– Alerting	SAR 4.4
– Communication Failure	COM 8.7
– Emergencies	COM 8.6
– IFR Operations in Other Low-Level Airspace	COM 8.2
– Mode S, Approval and Unique Codes	COM 9.8
– Operation	COM 8.0
– Phraseology	COM 8.5
– Requirements	COM 8.2
– VFR Operations	COM 8.4
– Unlawful Interference (Hijack)	COM 8.8
– Regions – Addresses, Facsimile and Telephone Numbers	GEN 1.1.1
– Responsibilities	AGA 2.3.3
Transportation Appeal Tribunal of Canada (TATC)	LRA 6.0
– Refusal to issue or Amend a Canadian Aviation Document	LRA 6.2

- Suspension, Cancellation or Refusal to Renew LRA 6.3
- Monetary Penalties LRA 6.4
- Appeals LRA 6.5
- Transportation Safety Board of Canada (TSB)..... GEN 3.0
 - Addresses, Facsimile and Telephone Numbers GEN 3.6
- Tribunal – Transportation Appeal Tribunal of Canada (TATC) LRA 6.0
- True Airspeed (TAS).....RAC 8.3.2, NAT 1.7.2
- Turbulence MET 3.13
 - Clear Air (CAT) AIR 2.10
 - Reporting Criteria Table MET 2.2.2
 - Pilot Waivers RAC 4.1.1
 - Wake RAC 4.1.1, AIR 2.9
- Turbulence, Downdraft and AIR 1.5.7
- Turn pad, Runway AGA 3.6
- Twilight Charts, Morning and Evening GEN 1.5.2

U

- Ultra-light Aeroplane AIR 4.10
- Uncontrolled Aerodromes
 - Aircraft Operations RAC 4.5
 - Class “G” Airspace
 - Recommended Operating Procedures
 - En-Route RAC 8.11
 - Helicopter Operations RAC 4.5.3
 - Initial Contact with Air-Ground Facility RAC 9.11
 - Licensing, Registration and Airworthiness LRA 1.0
 - Reporting Procedures (IFR) RAC 9.12
 - Traffic Circuit Procedures RAC 4.5.2
- Uncontrolled Airspace – Procedures (IFR) RAC 9.13
- Underwater Diving AIR 3.6
- UNICOM (Universal Communications)..... RAC 1.2.1
 - Approach UNICOM (AU) RAC 1.2.1, MET 1.2.7
- Units of Measurement GEN 1.4
- Unlawful Interference COM 8.8, RAC 1.9.8
- Unmanned Air Vehicle (UAV) Systems AIR 4.15.3
- Unserviceable Area Markings AGA 5.7
- Upper Level
 - Charts (ANAL) MET 9.0
 - Wind and Temperature Forecasts (FD).....MET 1.3.8, 11.1
- Use of Numbers COM 1.8

V

- V Speeds GEN 1.7
- VASI (Visual Approach Slope Indicator) AGA 7.6.2, AGA 7.6.4.2
- VDF (VHF Direction Finder) COM 4.10, RAC 1.6, SAR 4.3
- Vertical Path Control on Non-Precision Approaches AIR 2.17
- Vertical Path Control Techniques AIR 2.17.3
- Vertigo AIR 3.7
- VFR
 - Acknowledgement of Clearances RAC 5.2
 - Aeronautical Information MAP 2.5

- Altitudes and Flight Levels RAC 5.3
- Controlled Airspace, Use of by VFR Flights RAC 2.5.1
- En Route Procedures RAC 5.0
- Flight Plan and Flight Itineraries ..RAC 3.6, RAC 3.7.1
- Holding Procedures RAC 4.4.2
- Minimum Altitudes RAC 5.4, 5.5
- Operations within Class “C” Airspace RAC 5.8
- Over-the-Top RAC 2.7.4
- Position Reporting RAC 5.1
- VFR Release of an IFR Aircraft..... RAC 6.2.2
- Weather Minima RAC 2.7.3, Fig. 2.7
- VGM (Voice Generated Module)..... RAC 4.5.1, RAC 9.12
- VHF
 - Channel Spacing COM 1.4
 - Direction Finding System (VDF) COM 4.10, RAC 1.6, SAR 4.3
 - In Lieu of International HF Air-Ground Frequencies COM 1.12.3
 - Omnidirectional Range and Tactical Air Navigation (VORTAC)..... COM 4.9
 - Omnidirectional Range (VOR) COM 4.5
- Visibility, Ground RAC 9.19.1
- Vision AIR 3.7
- Visual
 - Alignment Guidance System (VAGS)..... AGA 7.7.2
 - Approach Slope Indicator Systems (VASIS) AGA 7.6
 - Climb and Descent RAC 8.4.2
- Visual Climb Over the Airport RAC 7.7.1
- Visual Signals RAC 4.4.7
 - Ground RAC 4.3.11
 - Ground-to-Air SAR 4.8.1
 - Intercepting and Intercepted Aircraft SAR 4.7
 - Marshalling for Aircraft and Helicopters..... AIR 1.8
 - Tower to Aircraft RAC 4.2.11
- Voice Generated Module (VGM)..... RAC 4.5.1, 9.12 MET 8.6
- Volcanic Ash..... MET 2.5, 3.2.2, 13.0
 - Flight Operations in AIR 2.6
- VOLMET MET 1.4
- VOR/DME (RHO-THETA) System COM 5.13
- VORTAC (VHF Omnidirectional Range and Tactical Air Navigation) COM 4.9
- Vortex
 - Characteristics AIR 2.9.1
 - Strength AIR 2.9
- Vortices, Helicopter AIR 2.9
- VOR
 - Airborne VOR Check COM 4.5.3
 - Check Point COM 4.5.2
 - Receiver Checks COM 4.5.1

W

- Wake Turbulence RAC 4.1.1, AIR 2.9
- Water
 - Operations on AIR 2.11
 - Operations Over, Life-Saving Equipment..... AIR 2.11.3

Web, Transport Canada Site.....	GEN 1.1.4
Weather	
– ATC Weather Assistance.....	MET 1.3.8
– ATIS (Automatic Terminal Information Service).....	RAC 1.3, 4.2.1
– Automated Reports – Other.....	MET 8.6
– Voice Generator Module (VGM).....	MET 8.6
– Briefing, Flight Planning.....	RAC 3.2
– Charts, Reports.....	MET 3.2, 3.3
– Codes, significant.....	MET 8.3
– Flight Operation Near Thunderstorms.....	AIR 2.7
– Information.....	MET 3.0
– Minima Requirements, Alternate Aerodrome.....	RAC 3.14.1
– Minima, VFR.....	RAC 2.7.3, Fig. 2.7
– Observations, Surface.....	MET 8.0
– Pilot Report (PIREP).....	MET 1.1.6, 2.2.1
– Radar.....	MET 1.3.9
– Reporting of Cloud Bases.....	MET 1.1.5
– Reports, Charts.....	MET 3.2, 3.3
– METAR (Routine Report).....	MET 3.2, 8.0
– Special Reports (SPECI).....	MET 8.4
– Surface Maps.....	MET 10.0
– Surface Weather Observing Service.....	RAC 1.1.3
– Symbols, Significant.....	MET 10.0
– TAF (Aerodrome Forecast).....	MET 3.9
– Volcanic Ash.....	MET 2.5, 3.2, 13.0
– Flight Operations in.....	AIR 2.6
Weight and Balance Form.....	RAC 3.5
– Actual Weights.....	RAC 3.5.1
– Fuel and Oil Weights.....	RAC 3.5.2
– Passenger Standards.....	RAC 3.5
Wet Runways.....	RAC 4.4.9, AIR 1.6.5
Wheel-Equipped Light Aircraft on Snow-Covered Surfaces.....	
	AIR 2.12.4
Whiteout.....	AIR 2.12.7
Wind Direction Indicators (Wind Socks).....	AGA 5.9
Wind	
– Pilot Estimate of Surface Wind.....	MET 2.6
– Beaufort Wind Scale.....	MET 2.6, Table 1
Wind Shear.....	MET 2.3
– Low-Level.....	AIR 2.8
Winter Operations – Aircraft Contamination.....	AIR 2.12.2
World Meteorological Organization (WMO) and ICAO	
– Applicable Documents.....	MET 1.1.7
121.5 MHz, Monitoring of	
– Emergency Frequency.....	COM 1.12.2
126.7 MHz, Monitoring of.....	RAC 5.1

5.0 MISCELLANEOUS

5.1 GLOSSARY OF AERONAUTICAL TERMS

“Acknowledge”

An expression used in radiocommunication meaning “Let me know that you have received and understood this message.”

acts of unlawful interference

Acts or attempted acts such as to jeopardize the safety of civil aviation and air transport, i.e.:

- a) unlawful seizure of aircraft in flight;
- b) unlawful seizure of aircraft on the ground;
- c) hostage-taking on board aircraft or on aerodromes;
- d) forcible intrusion on board an aircraft, at an airport or on the premises of an aeronautical facility;
- e) introduction on board an aircraft or at an airport of a weapon or hazardous device or material intended for criminal purposes;
- f) communication of false information such as to jeopardize the safety of an aircraft in flight or on the ground, of passengers, crew, ground personnel or the general public, at an airport or on the premises of a civil aviation facility.

aerodrome

Any area of land, water (including the frozen surface thereof) or other supporting surface used, designed, prepared, equipped or set apart for use, either in whole or in part, for the arrival, departure, movement or servicing of aircraft. This includes any buildings, installations and equipment situated thereon or associated therewith.

aerodrome traffic frequency (ATF)

A very high frequency (VHF) designated to ensure that all radio-equipped aircraft operating at or in the vicinity of an aerodrome, or in a defined area where VFR traffic is high, are listening on a common frequency and following a common reporting procedure.

afterimage

A collection of light, dark, or coloured spots, perceived after exposure to bright light, that may be distracting and disruptive and may persist for several minutes.

- see also: **flash blindness, glare**

airborne collision avoidance system (ACAS)

An aircraft system based on secondary surveillance radar (SSR) transponder signals which operates independently of ground-based equipment to provide advice to the pilot on potential conflicting aircraft that are equipped with SSR transponders.

aircraft critical surface contamination (ACSC)

Presence of substances, including frost, ice and snow, on the critical surface of an aircraft that can have an adverse impact on the performance of an aircraft.

aircraft radio control of aerodrome lighting (ARCAL)

A system used by pilots to control some or all of the aerodrome lighting, aside from obstacle lights, via the aircraft VHF transmitter and the microphone on the appropriate frequency.

air defence identification zone (ADIZ)

An airspace of defined dimensions extending upwards from the surface of the earth within which certain rules for the security control of air traffic apply.

airport (APRT)

An aerodrome for which an airport certificate is in force.

airspace classification (see RAC 2.8).

The division of the Canadian Domestic Airspace (CDA) into seven classes, each identified by a single letter: A, B, C, D, E, F or G. The application of any classification to an airspace structure determines the operating rules, the level of ATC service provided within the structure and, in some instances, communications and equipment requirements. The horizontal and vertical limits of airspace are described in the *Designated Airspace Handbook* (DAH).

air traffic

All aircraft in flight or operating on the manoeuvring area of an aerodrome.

air traffic control clearance

An authorization issued by an ATC unit for an aircraft to proceed within controlled airspace in accordance with the conditions specified by that unit.

- also called: **air traffic clearance, ATC clearance and clearance**

air traffic control instruction

A directive issued by an ATC unit for ATC purposes.

air traffic control service

A service provided for the purposes of

- a) preventing collisions between
 - (i) aircraft;
 - (ii) aircraft and obstacles; and
 - (iii) aircraft and vehicles on the manoeuvring area; and
- b) expediting and maintaining an orderly flow of air traffic.

- also called: **ATC service**

air traffic control unit

As the circumstances require, this may be

- a) an area control centre (ACC) established to provide ATC service to aircraft; or
- b) an airport control tower unit established to provide ATC service to airport traffic.
 - also called: **ATC unit**

alternate aerodrome

An aerodrome to which an aircraft may proceed when it becomes either impossible or inadvisable to proceed to or land at the aerodrome of intended landing. Alternate aerodromes include the following:

- a) takeoff alternate aerodrome
- b) en-route alternate aerodrome
- c) destination alternate aerodrome

NOTE:

The aerodrome from which a flight departs may also be an en-route or a destination alternate aerodrome for that flight.

apron

That part of an aerodrome, other than the manoeuvring area, intended to accommodate the loading and unloading of passengers and cargo; the refuelling, servicing, maintenance and parking of aircraft; and any movement of aircraft, vehicles and pedestrians engaged in services for such purposes.

- also called: **flight line, ramp and tarmac**

arc

The track over the ground of an aircraft flying at a constant distance from a NAVAID by reference to distance measuring equipment (DME).

Arctic Control Area (ACA) (see RAC Figure 2.3)

A controlled airspace within the Northern Domestic Airspace (NDA) at FL 270 and above.

area minimum altitude (AMA)

The lowest altitude that may be used under instrument meteorological conditions (IMC) that will provide a minimum vertical clearance of 1000 ft or, in a designated mountainous region, 2000 ft, rounded up to the next 100-ft increment, under conditions of standard temperature and pressure, above all obstacles located in the area specified.

NOTE

This term replaced the term geographic area safe altitude (GASA) on April 18, 2002.

area navigation (RNAV)

A method of navigation which permits aircraft operation on any desired flight path within the coverage of ground- or space-based NAVAIDs or within the limits of the capability of self-contained aids, or a combination of these.

automatic dependent surveillance-broadcast (ADS-B)

A means by which aircraft, aerodrome vehicles and other objects can automatically transmit and/or receive data such as identification, position and additional data, as appropriate, in a broadcast mode via a data link.

ballistic parachute system

An aircraft parachute system that extracts/propels the parachute via an ignitable propellant (e.g. rocket motor or explosive charge).

barometric vertical navigation (baro-VNAV)

A function of certain RNAV systems that presents to the pilot computed vertical guidance referenced to a specified vertical path, based on barometric altitude information and typically computed as a geometric path between two waypoints or an angle based on a single waypoint.

- also called: lateral navigation/vertical navigation (LNAV/VNAV)

broadcast (BCST)

A transmission of information relating to air navigation that is not addressed to a specific station or stations.

Canadian Domestic Airspace (CDA)

As geographically delineated in the *Designated Airspace Handbook* (DAH), all airspace over the Canadian land mass, the Canadian Arctic and the Canadian archipelago, and over areas of the high seas.

ceiling

The lesser of:

- a) the height above ground or water of the base of the lowest layer of cloud covering more than half the sky; or
- b) the vertical visibility in a surface-based layer which completely obscures the sky.

clearance limit

The point to which an aircraft is granted an ATC clearance.

“Cleared for the option”

- a) For an arriving aircraft: An expression used to indicate ATC authorization for an aircraft to make a touch-and-go, low approach, missed approach (MA), stop-and-go, or full-stop landing, at the discretion of the pilot.
- b) For a departing aircraft: An expression used to indicate ATC authorization for an aircraft to execute manoeuvres other than a normal takeoff (e.g. an aborted takeoff). After such

a manoeuvre, the pilot is expected to exit the runway by the most expeditious way rather than backtrack the runway.

composite flight plan

A flight plan (FP) that specifies VFR operation for one portion of flight and IFR for another portion.

contact approach

An approach wherein an aircraft on an IFR flight plan (FP), having an ATC authorization and operating clear of clouds with at least 1 mi. flight visibility and a reasonable expectation of continuing to the destination airport in those conditions, may deviate from the instrument approach procedure (IAP) and proceed to the destination airport by visual reference to the surface of the earth.

continuous descent final approach (CDFA)

A technique, consistent with stabilized approach procedures, for flying the final approach segment of a non-precision instrument approach procedure as a continuous descent, without level-off, from an altitude/height at or above the FAF altitude/height to a point approximately 15 m (50 ft) above the landing runway threshold or the point where the flare manoeuvre should begin for the type of aircraft flown.

- also called: constant descent final approach

control area extension (CAE)

A controlled airspace of defined dimensions within the low-level airspace (LLA), extending upwards from 2 000 ft AGL unless otherwise specified.

controlled airspace

An airspace of defined dimensions within which ATC service is provided.

controlled flight into terrain (CFIT)

An occurrence in which an aircraft, under the control of the crew, is flown into terrain, water or an obstacle with no prior awareness on the part of the crew of the impending disaster.

controlled VFR flight (CVFR)

A flight conducted under VFR within Class B airspace and in accordance with an ATC clearance.

control zone (CZ)

A controlled airspace of defined dimensions extending upwards from the surface of the earth up to and including 3 000 ft AAE unless otherwise specified.

critical surface

Any stabilizing surface of an aircraft, including the wings, control surfaces, rotors, propellers, horizontal stabilizers, vertical stabilizers and, in the case of an aircraft that has rear-mounted engines, the upper surface of its fuselage.

cruise climb

A cruising technique resulting in a net increase in altitude as the aircraft mass decreases. A clearance or instruction to carry out a cruise climb allows the pilot the option of climbing at any given rate, as well as the option of levelling off at any intermediate altitude.

cruising altitude

The altitude, as shown by a constant altimeter indication in relation to a fixed and defined datum, maintained during a flight or portion thereof.

daylight

The period of time during any day that begins with the morning civil twilight and ends with the evening civil twilight.

dead reckoning navigation (DR)

The estimating or determining of position by advancing an earlier known position by the application of direction, time and speed data.

decision altitude (DA)

A specified altitude in the precision approach or approach with vertical guidance at which a missed approach must be initiated if the required visual reference to continue the approach to land has not been established.

NOTE:

Decision altitude (DA) is referenced to mean sea level (MSL) and decision height (DH) is referenced to the threshold elevation.

decision height (DH)

A specified height in the precision approach or approach with vertical guidance at which a missed approach must be initiated if the required visual reference to continue the approach to land has not been established.

NOTE:

Decision height (DH) is referenced to the threshold elevation and decision altitude (DA) is referenced to mean sea level (MSL).

defence visual flight rules (DVFR)

Rules applicable to flights within an air defence identification zone (ADIZ) conducted under VFR.

directed bright light source

Any directed light source that may create a hazard to aviation safety or cause damage to an aircraft or injury to persons on board.

NOTE:

Directed bright light sources include lasers, searchlights, spotlights, and image projectors.

downwind termination waypoint (DTW)

The waypoint located downwind to the landing runway abeam the final approach course fix (FACF) where an open RNAV STAR terminates.

engineered material arresting system (EMAS)

A soft ground arrestor system, located beyond the end of the runway and centred on the extended runway centreline, that deforms under the weight of an aircraft, bringing it to a safe stop in the event of an overrun without structural damage to the aircraft or injury to its occupants.

NOTE:

EMAS beds are made up of a grouping of blocks of crushable cellular concrete that will reliably deform under the weight of an aircraft.

evening civil twilight

Relative to the standard meridians of the time zones, the period of time that begins at sunset and ends at the time specified by the Institute of National Measurement Standards of the National Research Council of Canada.

NOTE:

Evening civil twilight ends in the evening when the centre of the sun's disc is 6° below the horizon.

expected approach time (EAT)

The time at which ATC expects that an arriving aircraft, following a delay, will leave the holding fix to complete its approach for landing.

expected further clearance time (EFC)

The time at which it is expected that further clearance will be issued to an aircraft.

expedite (to)

An expression used by ATC when prompt compliance is required to avoid the development of an imminent situation.

final approach area

The area within which the final approach portion of an instrument approach procedure (IAP) is carried out.

final approach course fix (FACF)

A fix and/or waypoint located on the final approach course of an instrument approach procedure (IAP)

- a) prior to the point of glide path (GP) intercept on a precision approach procedure;
- b) prior to the final approach fix (FAF) on a non-precision approach procedure that has a designated FAF;
- c) prior to any stepdown fixes on a non-precision approach procedure with designated fixes but no FAF; or
- d) at a point that would permit a normal landing approach on a non-precision approach procedure with no FAF or stepdown fixes.

final approach fix (FAF)

The fix of a non-precision instrument approach procedure (IAP) where the final approach segment commences.

final approach segment

That part of an instrument approach procedure (IAP) from the time that the aircraft

- a) completes the last procedure turn or base turn, where one is specified;
- b) intercepts the last track specified for the procedure;
- c) (for non-precision approaches) crosses the final approach fix (FAF), final approach waypoint (FAWP) or final approach point (FAP); or
- d) (for precision approaches) crosses the point where the vertical path or glide path intercepts the intermediate approach segment altitude until the aircraft reaches the missed approach point (MAP).

- also called: **final approach**

flash blindness

The temporary or permanent inability to see caused by bright light entering the eye and persisting after the illumination has ceased.

- see also: **afterimage, glare**

flight information centre (FIC)

A centralized ATS unit that provides services pertinent to pre-flight and the en-route phase of flight.

flight information region (FIR) (see RAC Figure 2.2)

An airspace of defined dimensions extending upwards from the surface of the earth within which flight information service (FIS) and alerting service are provided.

flight information service en route (FISE)

The provision and receipt by a FIC of information pertinent to the en route phase of flight.

flight level (FL)

The altitude expressed in hundreds of feet indicated on an altimeter set to 29.92 in. of mercury or 1013.2 mb.

flight management system (FMS)

An aircraft computer system that uses a large database to allow routes to be programmed and fed into the system by means of data loader. The system is constantly updated with regard to position accuracy by reference to conventional NAVAIDS.

flight service station (FSS)

An ATS unit that provides services pertinent to the arrival and departure phases of flight at uncontrolled aerodromes and for transit through a mandatory frequency (MF) area.

flight technical error (FTE)

The difference between estimated position and defined path. It relates to the ability of an air crew or autopilot to fly along a defined path. Any display errors, such as a CDI centering error, may cause FTE. FTE is usually the largest error component of the total system error (TSE).

flight visibility

The average range of forward visibility at any given time from the cockpit of an aircraft in flight.

flow control

Measures designed to adjust the flow of traffic into a given airspace, along a given route, or bound for a given aerodrome, so as to ensure the most effective utilization of the airspace.

fuel dumping

The intentional airborne release of usable fuel, excluding the dropping of fuel tanks.

- also called: fuel jettisoning

fuel remaining

The amount of fuel remaining on board until actual fuel exhaustion.

glare

A temporary disruption in vision caused by a bright light within an individual's field of vision and lasting only as long as the light is present within that field of vision.

NOTE:

Visible laser light can produce glare and interfere with vision even at low energies, including levels well below that which produce eye damage.

- see also: **afterimage, flash blindness**

“Go around”

An expression used in radiocommunications to instruct a pilot to abandon an approach or landing.

ground visibility

In respect of an aerodrome, the visibility at that aerodrome as contained in a weather observation reported by

- an ATC unit;
- an FSS or FIC;
- a community aerodrome radio station (CARS);
- an automated weather observation system (AWOS) used by the Department of Transport, the Department of National Defence or the Atmospheric Environment Service for the purpose of making aviation weather observations; or
- a radio station that is ground-based and operated by an air operator.

hang glider

A motorless heavier-than-air aircraft deriving its lift from surfaces that remain fixed in flight, designed to carry not more than two persons and having a launch weight of 45 kg (99.2 lb) or less.

“Have numbers”

An expression used by pilots to indicate that they have received runway, wind and altimeter information only.

heading (HDG)

The direction in which the longitudinal axis of an aircraft is pointed, usually expressed in degrees from north (true, magnetic, compass or grid north).

height above aerodrome (HAA)

The height in feet of the minimum descent altitude (MDA) above the published aerodrome elevation.

height above touchdown zone elevation

The height in feet of the decision height (DH) or the minimum descent altitude (MDA) above the touchdown zone elevation (TDZE).

- also called: **height above touchdown (HAT) and height above touchdown zone**

high-intensity runway operations (HIRO)

Operations, used at some airports, that consist of optimizing separation of aircraft on final approach in order to minimize runway occupancy time (ROT) for both arriving and departing aircraft so as to increase runway capacity.

high-level air route

In high-level airspace (HLA), a prescribed track between specified fixes.

NOTE:

On aeronautical charts, high-level air routes are indicated by letters such as “T” or “NAT.”

high-level airspace (HLA)

All airspace within the Canadian Domestic Airspace (CDA) at or above 18 000 ft ASL.

high-level airway

In controlled high-level airspace (HLA), a prescribed track between specified fixes.

NOTE:

On aeronautical charts, high-level airways are indicated by the letter “J” (e.g. J500).

initial approach segment

That part of an instrument approach procedure (IAP) between the initial approach fix (IAF) or waypoint and the intermediate approach fix (IF) or waypoint during which the aircraft departs the en route phase of flight and manoeuvres to enter the intermediate segment.

- also called: **initial approach**

instrument approach procedure (IAP)

A series of predetermined manoeuvres by reference to flight instruments with specified protection from obstacles from the initial approach fix (IAF), or where applicable, from the beginning of a defined arrival route to a point from which a landing can be completed and thereafter, if a landing is not completed, to a position at which holding or en route obstacle clearance criteria apply.

- also called: **instrument approach**

instrument meteorological conditions (IMC)

Meteorological conditions less than the minima specified in Subpart 602 of the *Canadian Aviation Regulations (CARs)* for visual meteorological conditions (VMC), expressed in terms of visibility and distance from cloud.

intermediate approach segment

That part of an instrument approach procedure (IAP) between the intermediate approach fix (IF) or waypoint and the final approach fix (FAF), waypoint or point, or between the end of a track reversal, racetrack or dead-reckoning track procedure and the FAF, waypoint or point, as appropriate. It is in this part of the procedure that aircraft configuration, speed and positioning adjustments are made for entry into the final approach segment.

- also called: **intermediate approach**

intersection (INTXN)

As the circumstances require, this may be

- a point on the surface of the earth over which two or more position lines intersect. The position lines may be true bearings from non-directional beacons (NDB) (magnetic bearings shown on chart for pilot usage); radials from VHF/UHF NAVAIDs; centrelines of airways, fixed RNAV routes or air routes; localizers; or DME distances; or
- the point where two runways, a runway and a taxiway, or two taxiways cross or meet.

Land and Hold Short Operations (LAHSO)

Operations that include simultaneous takeoffs and landings and/or simultaneous landings when a landing aircraft is able and is instructed by the controller to hold short of the intersecting runway/taxiway or designated hold-short point.

NOTE:

This term replaces the term *Simultaneous Intersecting Runway Operations (SIRO)*

laser

(or light amplification by stimulated emission of radiation)

A device that produces an intense, directional, coherent beam of light.

low approach

An approach over an airport or runway following an instrument approach procedure (IAP) or VFR approach, including the overshoot manoeuvre, where the pilot intentionally does not make contact with the runway.

low-level air route

Within low-level uncontrolled airspace, a route extending upwards from the surface of the earth and for which ATC service is not provided.

low-level airspace (LLA)

All airspace within the Canadian Domestic Airspace (CDA) below 18 000 ft ASL.

low-level airway

Within controlled low-level airspace (LLA), a route extending upwards from 2 200 ft above the surface of the earth and for which ATC service is provided.

low-visibility operations plan (LVOP)

A plan that calls for specific procedures established by the aerodrome operator and/or ATS when aerodrome visibility is below RVR 1 200 (¼ SM).

L-routes

L-routes are low-level uncontrolled fixed RNAV routes depicted on En Route Low Altitude charts using green dashed lines and require GNSS RNAV systems for use. The MOCA provides obstacle protection for only 6 NM either side of the track centreline and does not splay.

mandatory frequency (MF)

A very high frequency (VHF) specified in the *Canada Air Pilot (CAP)*, the *Canada Flight Supplement (CFS)* or the *Canada Water Aerodrome Supplement (CWAS)* for the use of radio-equipped aircraft operating within a mandatory frequency (MF) area.

manoeuvring area

The part of an aerodrome, other than an apron, that is intended to be used for the takeoff and landing of aircraft and for the movement of aircraft associated with takeoff and landing.

MEDEVAC

A term used to request ATS priority handling for a medical evacuation flight based on a medical emergency in the transport of patients, organ donors, organs or other urgently needed life-saving medical material.

NOTE:

This term is used on flight plans (FP) and in radiotelephony communications if a pilot determines that a priority is required and is suffixed to the aircraft identification.

military operations area (MOA)

An airspace of defined dimensions established to segregate certain military activities from IFR traffic and to identify, for

VFR traffic, where these activities are conducted.

military terminal control area (MTCA)

A controlled airspace of defined dimensions normally established in the vicinity of a military aerodrome and within which special procedures and exemptions exist for military aircraft. The terminology (Class B, C, D or E equivalent) used for the designations of MTCAs describes the equivalent level of service and operating rules for civilian aircraft operating within the MTCA and under military control.

minimum descent altitude (MDA)

The altitude above sea level (ASL) specified in the *Canada Air Pilot* (CAP) or the route and approach inventory for a non-precision approach, below which descent shall not be made until the required visual reference to continue the approach to land has been established.

minimum en route altitude (MEA)

The altitude above sea level (ASL) between specified fixes on airways or air routes that assures acceptable navigational signal coverage and that meets the IFR obstacle clearance requirements.

NOTE:

This altitude is published on aeronautical charts.

minimum fuel

An expression used to inform ATC that an aircraft's fuel supply has reached a state that is sufficient to reach destination, provided that unexpected delays are not encountered.

minimum IFR altitude

The lowest IFR altitude established for use in a specific airspace. Depending on the airspace concerned, the minimum IFR altitude may be a minimum obstacle clearance altitude (MOCA), a minimum en route altitude (MEA), a minimum sector altitude (MSA), a minimum vectoring altitude (MVA), a safe altitude within a radius of 100 NM, an area minimum altitude (AMA), a transition altitude or a missed approach altitude. The minimum IFR altitude provides obstacle clearance but may or may not be within controlled airspace.

minimum obstacle clearance altitude (MOCA)

The altitude above sea level (ASL) between specified fixes on airways or air routes that meets the IFR obstacle clearance requirements for the route segment in question.

NOTE:

This altitude is published on aeronautical charts.

minimum reception altitude (MRA)

When applied to a specific VHF/UHF intersection, the lowest altitude above sea level (ASL) at which acceptable navigational signal coverage is received to determine the intersection.

minimum sector altitude (MSA)

The lowest altitude that will provide a minimum clearance of 1000 ft, under conditions of standard temperature and pressure

above all objects located in an area contained within a sector of a circle with a 25 NM radius centred on a radio aid to navigation or a specified point.

minimum vectoring altitude (MVA)

The lowest altitude for vectoring aircraft by ATC that meets obstacle clearance and radio coverage requirements in the airspace specified.

missed approach point (MAP)

The point on the final approach course that signifies the termination of the final approach and the commencement of the missed approach segment. It may be

- a) the intersection of an electronic glide path (GP) with a decision height (DH);
- b) a NAVAID located on the aerodrome;
- c) a suitable fix (e.g. distance measuring equipment [DME]); or
- d) a specified distance beyond the NAVAID or final approach fix (FAF), not to exceed the distance from that NAVAID or fix to the nearest boundary of the aerodrome.

missed approach segment

That part of an instrument approach procedure (IAP) between the missed approach point (MAP), the missed approach waypoint (MAWP), or the point of arrival at decision height (DH), and the specified missed approach NAVAID, intersection, fix or waypoint, as appropriate, at the minimum IFR altitude. It is in this part of the approach procedure that the aircraft climbs and returns to the en route structure or is positioned for holding or a subsequent approach. The route of flight and altitudes are depicted on instrument approach charts.

- also called: **missed approach**

morning civil twilight

Relative to the standard meridians of the time zones, the period of time that begins at the time specified by the Institute for National Measurement Standards of the National Research Council of Canada and ends at sunrise.

NOTE:

Morning civil twilight begins in the morning when the centre of the sun's disc is 6° below the horizon.

mountainous region (see RAC Figure 2.10)

An area of defined lateral dimensions above which special rules concerning minimum en route altitudes (MEA) apply.

movement area

The part of an aerodrome that is intended to be used for the surface movement of aircraft and that includes the manoeuvring area and aprons.

multiple-touch and-gos

A procedure in which an aircraft makes more than one touch-and-go during a single pass along a runway.

- see also: **touch-and-go**

navigation aid (NAVAID)

Any visual or electronic device, airborne or on the surface of the earth, that provides point-to-point guidance information or position data to aircraft in flight.

- also called: **navigational aid**

navigation system error (NSE)

The difference between true and estimated position. The NSE is defined during navigation system certification.

night

The period of time during any day that starts at the end of evening civil twilight and ends at the start of morning civil twilight.

non-precision approach procedure

An instrument approach procedure (IAP) in which only electronic azimuth information is provided. No electronic glide path (GP) information is provided and obstacle assessment in the final segment is based on minimum descent altitude (MDA).

non-RVSM aircraft

An aircraft that does not meet reduced vertical separation minimum (RVSM) requirements for certification and/or for operator approval.

Northern Control Area (NCA) (see RAC Figure 2.3)

A controlled airspace within the Northern Domestic Airspace (NDA) at FL 230 and above.

Northern Domestic Airspace (NDA) (see RAC Figure 2.1)

As geographically delineated in the *Designated Airspace Handbook* (DAH), a subdivision of Canadian Domestic Airspace (CDA) commencing at the North Pole and extending southward to the northern limit of the Southern Domestic Airspace (SDA).

NOTAM

A notice distributed by means of telecommunication containing information concerning the establishment, condition or change in any aeronautical facility, service, procedure or hazard, the timely knowledge of which is essential to personnel concerned with flight operations.

obstacle (OBST)

All fixed (whether temporary or permanent) and mobile objects, or parts thereof, that are located on an area intended for the surface movement of aircraft or that extend above a defined surface intended to protect aircraft in flight.

- also called: **obstruction**

obstacle free zone (OFZ)

The airspace above the inner approach surface, inner transitional surfaces, and balked landing surface and that portion of the strip bounded by these surfaces, which is not penetrated by any fixed obstacle other than a low-mass and frangibly mounted one required for air navigation purposes.

obstruction

- also called: **obstacle**

pavement classification number (PCN)

Numbers expressing, in ICAO terminology, the bearing strength of a pavement for unrestricted operations in a similar fashion to Transport Canada's pavement load rating (PLR).

path definition error (PDE)

The difference between desired and defined paths which reflects errors in the navigation database, computational errors in the RNAV system and display errors. PDE is usually very small and often assumed to be negligible.

performance-based navigation (PBN)

Area navigation based on performance requirements for aircraft operating along an ATS route, on an instrument approach procedure or in a designated airspace.

NOTE:

Performance requirements are expressed in navigation specifications in terms of accuracy, integrity, continuity, availability and functionality needed for the proposed operation.

pilot briefing

The provision of, or consultation on, meteorological and aeronautical information to assist pilots in pre-flight planning.

- also called: **pre-flight pilot briefing**

precision approach radar (PAR)

A high-definition, short-range radar used as an approach aid. This system provides the controller with altitude, azimuth and range information of high accuracy for the purpose of assisting the pilot in executing an approach and landing. This form of navigation assistance is termed "precision radar approach".

pre-departure clearance (PDC)

An initial IFR clearance delivered electronically via air-ground data link (AGDL) to airline companies with an on-site computer capable of interfacing with ATC and the data link service provider.

NOTE:

Following initial delivery of the clearance to the air operator, the latter may subsequently relay the clearance by non-electronic means to the flight crew if the aircraft is not suitably equipped.

preferential runway

One or more runways designated and published by the airport operator whose selection directs aircraft away from noise-

sensitive areas during the initial departure and final approach phases of flight. Designation of preferential runways may be governed by time restrictions, weather, runway conditions, airport layout, aircraft routings or capacity maximization.

procedure turn (PT)

A manoeuvre in which a turn is made away from a designated track followed by a turn in the opposite direction to permit the aircraft to intercept and proceed along the reciprocal of the designated track.

procedure turn inbound

The point of a procedure turn manoeuvre where course reversal has been completed and an aircraft is established inbound on the intermediate approach or final approach course. A report of “procedure turn inbound” is normally used by ATC as a position report for separation purposes.

progressive taxi

Precise taxi instructions given to a pilot unfamiliar with the aerodrome or issued in stages as the aircraft proceeds along the taxi route.

Q-routes

Q-routes are high-level fixed RNAV routes depicted on En Route High Altitude charts using black dashed lines and require an RNAV system with performance capabilities currently only met by GNSS or distance measuring equipment/inertial reference unit (DME/DME/IRU) systems. DME/DME/IRU navigation may be limited in some parts of Canada owing to navigational facility coverage. In such cases, the routes will be annotated as “GNSS only” on the chart.

radar identification

The process of ascertaining that a particular target is the radar echo from a specific aircraft.

“Radar identified”

An expression used by ATC to inform the pilot of an aircraft when radar identification is established.

RADAR REQUIRED

Annotation used on an instrument approach chart to indicate that the procedure turn may have been eliminated and that the initial approach portion of the procedure is being provided by ATC vectors. Without ATC vectoring, the instrument approach procedure (IAP) may not have a published initial approach.

radial (R)

A magnetic bearing from a VHF omnidirectional range (VOR), tactical air navigation aid (TACAN), or VORTAC facility, except for facilities in the Northern Domestic Airspace (NDA), which may be oriented on true or grid north.

reduced vertical separation minimum (RVSM)

The application of 1 000-ft vertical separation at and above FL 290 between aircraft approved to operate in reduced vertical separation minimum airspace.

reduced-visibility operations plan (RVOP)

A plan that calls for specific procedures established by the aerodrome operator and/or ATC when aerodrome visibility is below RVR 2 600 (½ SM) down to and including RVR 1 200 (¼ SM).

remotely piloted aircraft (RPA)

A navigable aircraft, other than a balloon, rocket or kite, that is operated by a pilot who is not on board.

remotely piloted aircraft system (RPAS)

A set of configurable elements consisting of a remotely piloted aircraft, its control station, the command and control links and any other system elements required during flight operation.

required navigation performance (RNP)

A statement of the navigation performance accuracy necessary for operation within a defined airspace.

required visual reference

In respect of an aircraft on an approach to a runway, the section of the approach area of the runway or the visual aids that, when viewed by the pilot of the aircraft, enable the pilot to make an assessment of the aircraft position and the rate of change of position relative to the nominal flight path in order to continue the approach and complete the landing.

resolution advisory (RA)

An advisory issued by airborne collision avoidance system (ACAS)/traffic alert and collision avoidance system (TCAS) to alert pilots to potential conflicting air traffic and provide them with a suggested flight-path change in the vertical plane to reduce the possibility of collision.

restricted airspace

An airspace of defined dimensions above land areas or territorial waters within which the flight of aircraft is restricted in accordance with certain specified conditions.

- also called: **restricted area**

“Resume normal speed”

An expression used by ATC to advise a pilot that previously issued speed restrictions are cancelled, but that published speed restrictions are still applicable, unless otherwise stated by ATC.

runway edge lights (REDL)

Aeronautical ground lights located along the edges of the runway.

runway end safety area (RESA)

An area that extends from the end of the runway strip, primarily intended to reduce the risk of damage to an aeroplane undershooting or overrunning the runway.

runway heading

The magnetic or true direction that corresponds with the runway centreline rather than the painted runway numbers.

runway incursion

Any occurrence at an aerodrome involving the incorrect presence of an aircraft, vehicle, or person on the protected area of a surface designated for the landing and takeoff of aircraft.

runway in use

Any runway currently being used for takeoff or landing. When multiple runways are used, they are all considered runways in use.

runway lights

Aeronautical ground lights located on a runway, indicating its direction or boundaries, and including but not limited to runway centreline lights, runway edge lights, runway end lights, threshold lights and touchdown zone lights.

runway strip

A defined area, which includes the runway and stopway where provided, intended to protect aircraft flying over it during take-off or landing operations.

RVSM Aircraft

An aircraft that meets reduced vertical separation minimum (RVSM) requirements for certification and for operator approval.

safe altitude within a radius of 100 NM

The lowest altitude that may be used under instrument meteorological conditions (IMC) that will provide a minimum vertical clearance of 1000 ft or, in a designated mountainous region, 1500 or 2000 ft, as appropriate, rounded up to the next 100-ft increment, under conditions of standard temperature and pressure, above all obstacles located in an area contained within a radius of 100 NM of the aerodrome geometric centre.

secondary surveillance radar (SSR)

A radar system that requires complementary aircraft equipment (transponder). The transponder generates a coded reply signal in response to transmissions from the ground station (interrogator). Since this system relies on transponder-generated signals rather than signals reflected from the aircraft, as in primary surveillance radar, it offers significant operational advantages such as increased range and positive identification.

shuttle procedure

A manoeuvre involving a descent or climb in a pattern resembling a holding pattern.

Southern Control Area (SCA) (see RAC Figure 2.3)

A controlled airspace within the Southern Domestic Airspace (SDA) at 18 000 ft ASL and above.

Southern Domestic Airspace (SDA) (see RAC Figure 2.1)

As geographically delineated in the *Designated Airspace Handbook* (DAH), all airspace within the Canadian Domestic Airspace (CDA) commencing at the Canada-United States border and extending northward to the southern limit of the Northern Domestic Airspace (NDA).

“Squawk ident”

A request for a pilot to activate the aircraft transponder identification feature.

standard instrument departure (SID)

A preplanned IFR departure procedure requiring ATC clearance and published for pilot/controller use to provide obstacle clearance and a transition from an aerodrome to the appropriate en route structure.

NOTE:

IDs are published in the *Canada Air Pilot* (CAP) for pilot and controller use. SIDs may be either:

- a) pilot navigation SIDs: SIDs where the pilot is required to use the applicable SID chart as reference for navigation to the en route phase; or
- b) vector SIDs: SIDs established where ATC will provide radar navigational guidance to a filed or assigned route, or to a fix depicted on the applicable SID chart. Pilots are expected to use the SID chart as a reference for navigation until the vector is commenced.

standard terminal arrival (STAR)

An IFR ATC arrival procedure published in the *Canada Air Pilot* (CAP) for pilot and controller use.

stepdown fix

A fix permitting additional descent within a segment of an instrument approach procedure (IAP) by identifying the point at which a controlling obstacle has been safely overflown.

stop-and-go

A procedure in which an aircraft lands, makes a complete stop on the runway, and then commences a takeoff from that point.

straight-in approach

- a) A VFR approach in which the aircraft enters the aerodrome traffic circuit on the final leg without having executed any other part of the circuit.
- b) An IFR approach in which the aircraft begins the final approach without first having executed a procedure turn (PT).

terminal arrival area (TAA)

An area, bounded by tracks and distances to identified waypoints, depicted on select GNSS approach charts indicating altitudes that provide a minimum clearance of 1 000 ft above all obstacles.

terminal control area (TCA)

A controlled airspace of defined dimensions that is normally established in the vicinity of one or more major aerodromes and within which ATC service is provided based on the airspace classification.

threshold

The beginning of the portion of the runway usable for landing.

threshold crossing height (TCH)

The height of the glide path (GP) above the runway threshold.

total system error (TSE)

The difference between true position and desired position. This error is equal to the sum of the vectors of the PDE, FTE, and NSE.

touch-and-go

A procedure in which an aircraft lands and then takes off without stopping.

touchdown zone (TDZ)

The first 3 000 ft of the runway or the first third of the runway, whichever is less, measured from the threshold in the direction of landing.

touchdown zone elevation (TDZE)

The highest centreline elevation in the touchdown zone.

track

The projection on the earth's surface of the path of an aircraft, the direction of which path at any point is usually expressed in degrees from true, magnetic or grid north.

traffic advisory (TA)

An advisory issued by airborne collision avoidance system (ACAS)/traffic alert and collision avoidance system (TCAS) to alert pilots to other air traffic that may be in such proximity to the position or intended route of flight of their aircraft as to warrant their attention.

transition

- a) The general term that describes the change from one phase of flight or flight conditions to another, e.g. transition from en route flight to the approach or transition from instrument flight to visual flight.
- b) A published procedure used to connect the basic standard instrument departure (SID) to one or more en route airways or to connect one or more en route airways to the basic standard terminal arrival (STAR). More than one transition may be published in the associated SID or STAR.

- also called: **feeder route**

T-routes

T-routes are low-level controlled fixed RNAV routes depicted on En Route Low Altitude charts using black dashed lines and require GNSS RNAV systems for use. The airspace associated with T-routes extends upward from 2 200 ft AGL, 10 NM either side of the centreline, and does not splay. The MOCA provides obstacle protection for only 6 NM either side of the track centreline and does not splay.

unmanned air vehicle (UAV)

A power-driven aircraft, other than a model aircraft, that is designed to fly without a human operator on board.

vector

A heading given by a controller to a pilot on the basis of radar-derived information to provide navigational guidance.

- also called: **radar vectoring**

visual approach

An approach wherein an aircraft on an IFR flight plan (FP), operating in visual meteorological conditions (VMC) under the control of ATC and having ATC authorization, may proceed to the airport of destination.

visual meteorological conditions (VMC)

Meteorological conditions, expressed in terms of visibility and distance from cloud, equal to or greater than the minima specified in CAR 602.

visual separation

A means used by controllers to separate aircraft operating in visual meteorological conditions (VMC).

- a) VFR—The controller, having determined that a potential conflict exists, issues clearances, instructions and/or information as necessary to aid aircraft in establishing visual contact with each other or to assist aircraft in avoiding other aircraft.
- b) IFR or CVFR—Following a pilot's report that the traffic is in sight, the controller issues the clearance and instructs the pilot to provide his or her own separation by manoeuvring the aircraft as necessary to avoid or follow the traffic.

waypoint (WP)

A specified geographical location, defined by longitude and latitude, that is used in the definition of routes and terminal segments and for progress-reporting purposes.

“When ready...”

Authorization for an aircraft to comply with a clearance or instruction at some point in the future when convenient.

wind shear (WS)

A change in wind speed and/or wind direction in a short distance. It can exist in a horizontal or vertical direction and occasionally in both.

5.2 ABBREVIATIONS AND ACRONYMS

AAE.....	above aerodrome elevation	ARCAL.....	aircraft radio control of aerodrome lighting
AAIR.....	Annual Airworthiness Information Report	ARFF.....	Aircraft Rescue and Fire Fighting
AAS.....	aerodrome advisory service	ARP.....	aerodrome reference point
ABAS.....	aircraft-based augmentation system	ASDA.....	accelerate-stop distance available
AC.....	Advisory Circular	ASDE.....	airport surface detection equipment
ACA.....	Arctic Control Area	ASL.....	above sea level
ACARS.....	aircraft communications addressing and reporting system	ATA.....	actual time of arrival
ACAS.....	airborne collision avoidance system	ATC.....	air traffic control
ACC.....	area control centre	ATF.....	aerodrome traffic frequency
A-CDM.....	Airport Collaborative Decision Making	ATFM.....	air traffic flow management
ACSC.....	aircraft critical surface contamination	ATIS.....	automatic terminal information service
AD.....	Airworthiness Directive	ATM.....	air traffic management
ADB.....	aviation document booklet	ATN.....	aeronautical telecommunications network
ADCUS.....	“Advise customs”	ATPL.....	airline transport pilot licence
ADF.....	automatic direction finder	ATS.....	air traffic service
ADIZ.....	air defence identification zone	AU.....	approach UNICOM
ADS.....	automatic dependence surveillance	AVASI.....	abbreviated visual approach slope indicator
ADS-B.....	automatic dependent surveillance - broadcast	AVGAS.....	aviation gasoline
ADS-C.....	automatic dependent surveillance - contract	AVOPS.....	Aviation Operations Centre
ADS WPR.....	automatic dependent surveillance waypoint position report(ing)	AWOS.....	automated weather observation system
AFCGS.....	automatic flight control guidance system	AWWS.....	Aviation Weather Web Site
AFCS.....	automatic flight control system	baro-VNAV.....	barometric vertical navigation
AFM.....	aircraft flight manual	BCST.....	broadcast
AFN.....	air traffic services facilities notification	BOTA.....	Brest oceanic transition area
AFS.....	aeronautical fixed service	BPL.....	balloon pilot licence
AFTN.....	Aeronautical Fixed Telecommunications Network	BVLOS.....	beyond visual line-of-sight
AGL.....	above ground level	C.....	Celsius
AGN.....	aircraft group number	CADORS.....	Civil Aviation Daily Occurrence Reporting System
AIC.....	aeronautical information circular	CAE.....	control area extension
AIM.....	Aeronautical Information Management (NAV CANADA)	CAME.....	Civil Aviation Medical Examiner
AIP.....	Aeronautical Information Publication	CAP.....	<i>Canada Air Pilot</i>
AIRAC.....	Aeronautical Information Regulation and Control	CARs.....	<i>Canadian Aviation Regulations</i>
AIREP.....	air report	CARAC.....	Canadian Aviation Regulation Advisory Council
AIS.....	aeronautical information service	CARC.....	Civil Aviation Regulatory Committee
ALR.....	aircraft load rating	CARS.....	community aerodrome radio station
ALSF-2.....	approach lighting with sequenced flashers—CAT II	CASARA.....	Civil Air Search and Rescue Association
ALT.....	altitude	CAT.....	clear air turbulence
ALTRV.....	altitude reservation	CAT I, II, III.....	Category I, II, III
AM.....	amplitude modulation	CAVOK.....	ceiling and visibility OK
AMA.....	area minimum altitude	CDA.....	Canadian Domestic Airspace
AME.....	aircraft maintenance engineer	CDA.....	departure clearance readback (data link)
AMIS.....	aircraft movement information service	CDFA.....	constant descent final approach
AMSL.....	above mean sea level	CDI.....	course deviation indicator
ANS.....	air navigation system	CFB.....	Canadian Forces base
ANSP.....	air navigation service provider	CFS.....	<i>Canada Flight Supplement</i>
AOC.....	air operator certificate	CFIT.....	controlled flight into terrain
AOC.....	Aviation Operations Centre	CG.....	centre of gravity
AOE.....	airport of entry	CLD.....	departure clearance message (data link)
AOM.....	airport operations manual	CLDN.....	Canadian Lightning Detection Network
APAPI.....	abbreviated precision approach path indicator	CMA.....	Central Monitoring Agency
APREQ.....	approval request	CMAC.....	Canadian Meteorological Aviation Centre
APRT.....	airport	CMC.....	Canadian Meteorological Centre
APV.....	approach procedure with vertical guidance	CMNPS.....	Canadian minimum navigation performance specifications
		CMNPSA.....	Canadian minimum navigation performance specifications airspace
		CMU.....	communications management unit (data link)

CNS	communications, navigation, surveillance	FD	upper level wind and temperature forecast
CNOP	<i>Canadian NOTAM Operating Procedures</i>	FDE	fault detection and exclusion
CPDLC	controller-pilot data link communications	FE	flight engineer
C of A	certificate of airworthiness	FIC	flight information centre
C of R	certificate of registration	FIR	flight information region
CPL	commercial pilot licence	FISE	flight information service en route
C.R.C.	Consolidated Regulations of Canada	FL	flight level
CRFI	Canadian Runway Friction Index	FLAS	flight level allocation scheme
CTA	control area	FM	frequency modulation
CTAISB	Canadian Transportation Accident Investigation and Safety Board	FMC	flight management computer
CVFR	controlled VFR	FMS	flight management system
CWAS	<i>Canada Water Aerodrome Supplement</i>	FP	flight plan
CZ	control zone	fpm	flash per minute
DA	decision altitude	FPUI	flight plan unique identifier
DADS	digital altimeter display system	FPV	first-person view
DAH	<i>Designated Airspace Handbook (TP 1820E)</i>	FRT	fixed radius transition
D-ATIS	data link ATIS	FSM	flight system management (data link)
DCL	departure clearance (data link)	FSS	flight service station
DCPC	direct controller-pilot communications	FSTD	flight simulation training device
DF	direction finder	FTE	flight technical error
DH	decision height	GBAS	ground-based augmentation system
DLM	data link mandate	GEO	geostationary earth orbit (or geosynchronous equatorial orbit)
DME	distance measuring equipment	GEO	geosynchronous earth orbit
DND	Department of National Defence	GES	ground earth station
DR	dead reckoning navigation	GFA	graphic area forecast
DRCO	dial-up remote communications outlet	GHz	gigahertz
DT	daylight saving time	GLONASS	global orbiting navigation satellite system
DTW	downwind termination waypoint	GMU	GPS monitoring unit
DVFR	defence visual flight rules	GNSS	global navigation satellite system
D-VOLMET	data link VOLMET	GOTA	Gander oceanic transition area
E	east	GP	glide path
EAD	European AIS Database	GPL	glider pilot licence
EASA	European Aviation Safety Agency	GPS	global positioning system
EAT	expected approach time	GPWS	ground proximity warning system
ECAC	European Civil Aviation Conference	GS	glide slope
ECCC	Environment and Climate Change Canada	GYP	gyroplane pilot permit
EET	estimated elapsed time	HAA	height above aerodrome
EFC	expected further clearance time	HAT	height above touchdown
ELT	emergency locator transmitter	HDG	heading
EMAS	engineered material arresting system	HF	high frequency
EMI	electromagnetic interference	HFDL	HF data link
ERS	Emergency Response Service	Hg	mercury
ESCAT Plan	Emergency Security Control of Air Traffic Plan	HIAL	high intensity approach lighting
EST	Eastern Standard Time	HIRO	high-intensity runway operations
EST (NOTAM)	estimated time (NOTAM)	HLA	high-level airspace
ETA	estimated time of arrival	HMU	height monitoring unit
ETD	estimated time of departure	hPa	hectopascal
ETE	estimated time en route	HPL	horizontal protection limit
EWH	eye-to-wheel height	hr	hour
FAA	Federal Aviation Administration (USA)	HSI	horizontal situation indicator
FACF	final approach course fix	Hz	hertz
FAF	final approach fix	IAF	initial approach fix
FANS	future air navigation systems	IAP	instrument approach procedure
FARs	<i>Federal Aviation Regulations (USA)</i>	IAS	indicated airspeed
FATO	final approach and take-off area	IAWP	initial approach waypoint
FAWP	final approach waypoint	ICAO	International Civil Aviation Organization
		IF	intermediate fix

IFF	identification, friend or foe	MEHT	minimum eye height over threshold
IFR	instrument flight rules	MEL	minimum equipment list
IFSS	international flight service station	MEO	medium earth orbit
IFT	instrument flight test	METAR	aerodrome routine meteorological report
ILS	instrument landing system	MF	mandatory frequency
IMC	instrument meteorological conditions	MF	medium frequency
INF	inland navigation fix	MFAU	Military Flight Advisory Unit
INS	inertial navigation system	MHA	minimum holding altitude
INTXN	intersection	MHz	megahertz
IRS	inertial reference system	MLAT	multilateration
IRU	inertial reference unit	MLS	microwave landing system
ISA	International Standard Atmosphere	MM	middle marker
IWP	intermediate approach waypoint	MNPS	minimum navigation performance specifications
J or JET	high-level airway	MNPSA	minimum navigation performance specifications airspace
JRCC	joint rescue co-ordination centre	MOA	military operations area
kg	kilogram	MOC	minimum obstacle clearance
kHz	kilohertz	MOCA	minimum obstacle clearance altitude
KIAS	knots indicated airspeed	MPa	megapascal
kN	kilonewton	mph	miles per hour
kt	knot	MRA	minimum reception altitude
LAAS	local-area augmentation system	MRB	magnetic reference bearing
LAHSO	Land and Hold Short Operations	MSA	minimum sector altitude
lb	pound	MSL	Mean Sea Level
LDA	landing distance available	MTCA	military terminal control area
LED	light-emitting diode	MTOW	maximum take-off weight
LEO	low earth orbit	MTSAT	multifunctional transport satellite
LF	low frequency	MU	management unit (data link)
LIAL	low intensity approach lighting	MVA	minimum vectoring altitude
LIDAR	light detection and ranging	MVFR	marginal visual flight rules
LLA	low-level airspace	MWO	meteorological watch office
LOC	localizer	N	north
LNAV	lateral navigation	NAARMO	North American Approvals Registry and Monitoring Organization
LP	localizer performance without vertical guidance	NACp	navigation accuracy category—position
LPV	localizer performance with vertical guidance	NADP	noise abatement departure procedure
LRNS	long range navigation system	NAR	North American route
LVOP	low visibility operations plan	NASA	National Aeronautics and Space Administration (USA)
LWIS	limited weather information system	NAT	North Atlantic
MA	missed approach	NAT HLA	North Atlantic high-level airspace
MALS	medium intensity approach lighting system	NATO	North Atlantic Treaty Organization
MALSf	medium intensity approach lighting system with sequenced flashing lights	NAVAID	navigation aid
MALSR	medium intensity approach lighting system with runway alignment indicator lights	NCA	Northern Control Area
MANAB	<i>Manual of Word Abbreviations</i>	NCATS	National Civil Air Transportation System
MANAIR	<i>Manual of Standards and Procedures for Aviation Weather Forecasts</i>	NDA	Northern Domestic Airspace
MANOBS	<i>Manual of Surface Weather Observations</i>	NDB	non-directional beacon
MANOT	missing aircraft notice	NIC	navigation integrity category
MAP	missed approach point	NM	nautical mile
MASPS	minimum aircraft system performance specification	NOHD	Nominal Ocular Hazard Distance
MAWP	missed approach waypoint	NO PT	no procedure turn
mb	millibar	NORDO	no radio
MCDU	multipurpose control and display unit	NPA	non-precision approach
MCTOW	maximum certificated takeoff weight	NRP	North American Route Program
MDA	minimum descent altitude	NSE	navigation system error
MEA	minimum en route altitude	NUCp	navigation uncertainty category—position
MEDEVAC	medical evacuation flight	NVIS	night vision imaging system
		NWP	numerical weather prediction

OAC	oceanic area control centre	RETIL	rapid-exit taxiway indicator lights
OAT	outside air temperature	RF	radius to fix
OBST	obstacle	RLOS	radio line-of-sight
O/C	observer-communicator	RMI	radio magnetic indicator
OCA	oceanic control area	RNAV	area navigation
OCL	obstacle clearance limit	RNP	required navigation performance
OCL	oceanic clearance (data link)	RNP APCH	required navigation performance approach
OCS	obstacle clearance surface	RNP AR APCH	required navigation performance authorization required approach
ODALS	omnidirectional approach lighting system	RNPC	required navigation performance capability
ODL	opposite direction level	ROONLY	receiver only
ODP	obstacle departure procedure	RPA	remotely piloted aircraft
OEP	oceanic entry/exit point	RPAS	remotely piloted aircraft system
OFZ	obstacle free zone	RPP	recreational pilot permit
OIDS	operational information display system	RRTU	radio re-transmit unit
OKTA	one-eighth	RSC	runway surface condition
OLS	obstacle limitation surface	RTF	radiotelephony frequency
OPS	obstacle protection surface	RTIL	runway threshold identification lights
OTS	organized track system	RVOP	reduced visibility operations plan
OTT	over-the-top	RVR	runway visual range
PAC	Pacific	RVSM	reduced vertical separation minimum
PAL	peripheral station	RWS	reactive wind shear system
PAPI	precision approach path indicator	S	south
PAR	precision approach radar	SA	selective availability
PAS	private advisory station	SAR	search and rescue
PBN	performance-based navigation	SATCOM	satellite communications
PCN	pavement classification number (ICAO)	SATVOICE	satellite voice communications
PDC	pre-departure clearance (data link)	SBAS	satellite-based augmentation system
PDE	path definition error	SCA	Southern Control Area
PIC	pilot-in-command	SCDA	stabilized constant descent angle
PIREP	pilot weather report	SDA	Southern Domestic Airspace
PLR	pavement load rating	SELCAL	selective calling system
PN	prior notice required	SFOC	special flight operations certificate
PPC	pilot proficiency check	SID	standard instrument departure
PPL	private pilot licence	SIF	selective identification feature
PPR	prior permission required	SIGMET	significant meteorological information
PPS	present position symbol	SIL	source integrity level
PRM	preferred routes message	SLOP	strategic lateral offset procedure
PRN	pseudorandom noise	SM	statute mile
PSI	pounds per square inch	SNR	signal-to-noise ratio
PSR	primary surveillance radar	SOPs	standard operating procedures
PSTN	public switched telephone network	SOTA	Shannon oceanic transition area
PT	procedure turn	SPECI	aerodrome special meteorological report
PWS	predictive wind shear system	SPEC VIS	specified takeoff minimum visibility
R	radial	SPI	special position indicator
R	radius	SPP	student pilot permit
RA	resolution advisory	SSALR	simplified short approach lighting system with runway alignment indicator lights
RAAS	remote aerodrome advisory service	SSALS	simplified short approach lighting system
RAIM	receiver autonomous integrity monitoring	SSB	single sideband
RAMO	regional aviation medical officer	SSR	secondary surveillance radar
RASS	remote altimeter setting source	STAR	standard terminal arrival
Rc	radius of containment	STOL aircraft	short takeoff and landing aircraft
RCAP	<i>Restricted Canada Air Pilot</i>	SVFR	special VFR flight
RCD	departure clearance request (data link)	SVM	service volume model
RCMP	Royal Canadian Mounted Police	SVN	satellite vehicle number
RCO	remote communications outlet	T	true
REDL	runway edge lights	TA	traffic advisory
RENL	runway end lights		
RESA	runway end safety area		

TAA terminal arrival area
TAC terminal area chart
TACAN tactical air navigation aid
TAF aerodrome forecast
TAS true airspeed
TATC Transportation Appeal Tribunal of Canada
TAWS terrain awareness and warning system
TC Transport Canada
TC AIM *Transport Canada Aeronautical Information Manual*
TCCA Transport Canada Civil Aviation
TCA terminal control area
TCAS I/II traffic alert and collision avoidance system
TCH threshold crossing height
TCU terminal control unit
TDOA time difference of arrival
TDZ touchdown zone
TDZE touchdown zone elevation
TDZL touchdown zone lighting
TLOF touchdown and lift-off area
TMI track message identification
TOD top of descent
TODA take-off distance available
TORA take-off run available
TP Transport Canada publication
TRA tower radar area
TRB true reference bearings
TRP tower radar plan
TSB Transportation Safety Board of Canada
TSE total system error
TSO Technical Standard Order
TSR terminal surveillance radar
TWR control tower
UAS unmanned aircraft system
UAV unmanned air vehicle
ULP ultralight pilot permit
UHF ultrahigh frequency
UNICOM universal communications
USB upper sideband
UTC Coordinated Universal Time
VAA volcanic ash advisory
VAAC volcanic ash advisory centre
VAGS Visual Alignment Guidance System
VAS vehicle advisory service
VASI visual approach slope indicator
VASIS visual approach slope indicator system
(generic term)
VCOA visual climb over the airport
VCS vehicle control service
VDF VHF direction finder
VDI vertical deviation indicator
VDL VHF digital link
VDR VHF data radio
VFR visual flight rules
VGSS voice generator sub-system
VHF very high frequency
VLF very low frequency
VLOS visual line-of-sight

VMC visual meteorological conditions
VNAP vertical noise abatement procedure
VNAV vertical navigation
VNC VFR navigation chart
VOLMET in-flight meteorological information
VOR VHF omnidirectional range
VORTAC combination of VOR and TACAN
VPA vertical path angle
VTA VFR terminal area chart
VTOL aircraft vertical takeoff and landing aircraft
W west
WAAS wide area augmentation system
WAFC world area forecast centre
WAFS world area forecast system
WMO World Meteorological Organization
WP waypoint
WPR waypoint position report(ing)
WS wind shear
zulu (Z) Coordinated Universal Time

NOTES:

1. The Supplements contain additional abbreviations applicable to aeronautical charts and publications.
2. Abbreviations typical of meteorology are contained in MET 14.0.

5.3 LEGISLATION INDEX

This index provides a cross-reference between the CARs and corresponding TC AIM pages where relevant information can be found. Some administrative or enabling legislation has been omitted where it has been determined that knowledge of the rule is not required for aircraft operations.

The CARs section numbers contained throughout the text are those of the *Consolidated Regulations of Canada (CRC)*, Chapter 2, as contained in the CARs.

Table 5.1—Relevant Cross-References Between CARs and TC AIM

CARs Subpart No.	CAR Name	TC AIM Paragraph No.
Part I	General Provisions	
103	Administration and Compliance	LRA 6.4, 6.5
Part II	Aircraft Identification and Registration and Operation of a Leased Aircraft by a Non-registered Owner	LRA 4.1, 4.6, 4.7
201	Identification of Aircraft and Other Aeronautical Products	LRA 4.2
202	Aircraft Marking and Registration	LRA 4.3, 4.7, 5.7.2
Part III	Aerodromes, Airports and Heliports	
301	Aerodromes	AGA 2.1, 7.3
302	Airports	AGA 2.3.6
Part IV	Personnel Licensing and Training	
403	Aircraft Maintenance Engineer Licences and Ratings	LRA 5.4.2
406	Flight Training Units	LRA 5.6.1
421	Flight Crew Permits, Licences and Ratings	LRA 1.1, 1.5, 1.6, 1.7, 1.12, 1.14.4
424	Medical Requirements	LRA 1.1, 1.9, 2.1.1, 2.2
Part V	Airworthiness	
501	Annual Airworthiness Information Report	LRA 5.5
507	Flight Authority and Certificate of Noise Compliance	LRA 5.1, 5.3.1, 5.3.3, 5.3.4, 5.3.5
521	Approval of the Type Design or a Change to the Type Design of an Aeronautical Product	LRA 5.2.2
521 Division IX	Service Difficulty Reporting	LRA 5.6.5
571	Aircraft Maintenance Requirements	LRA 5.4.1, 5.6.3, 5.6.4
Part VI	General Operating and Flight Rules	
601	Airspace	RAC 3.1 RAC 2.8, 2.8.6, 2.9.2

CARs Subpart No.	CAR Name	TC AIM Paragraph No.
602	Operating and Flight Rules	COM 1.3, 9.7, MET 1.1.9, RAC 1.7, 1.9, 1.10, 2.3.1, 2.5.2, 2.7.3, 2.7.4, 2.9.3, 2.10, 2.11, 2.12, 2.13, 3.1, 3.6.1, 3.6.2, 3.7.1, 3.7.2, 3.9, 3.12, 3.12.1, 3.13, 3.14, 4.1, 4.1.2, 4.2.5, 4.3, 4.4.8, 4.5.2, 4.5.4, 4.5.7, 5.4, 5.5, 6.1, 8.1, 8.3, 8.4, 8.5, 9.6.1, 9.7.3, 9.11, 9.12, 9.18.1, 9.19.1, 9.19.2.1, 9.19.2.2, 9.19.2.3, 9.19.2.5, 9.19.2.6, 9.19.3, 10.7, 10.9, RAC Annex 2.0, NAT 1.1.1, 1.2, SAR 3.9, 4.7, 4.8.2, AIR 2.11.3, 2.17.3, 4.4.2, 4.8, 4.9, 4.13, 4.15, 4.15.3
603	Special Flight Operations	RAC 1.10, 2.5.2, AIR 4.7.1, 4.8
604	Private Operator Passenger Transportation	COM 5.4, 9.2, RAC 9.18, LRA 5.6.1
605	Aircraft Requirements	COM 8.2, RAC 2.7.4, RAC Annex 2.0, SAR 3.1, 3.3, 3.9, LRA 5.3.1, 5.4.1, 5.6.1, 5.6.2, 5.6.4, 5.7.1, 5.7.3
625	Aircraft Equipment and Maintenance Standard	LRA 5.4.1, 5.4.2, 5.6.2, 5.7.1
Part VII	Commercial Air Services	RAC 9.18, 9.19
703	Air Taxi Operations	COM 9.2, RAC 3.5.1, 3.5.7, AIR 4.4.2
704	Commuter Operations	COM 9.2, AIR 4.4.2
705	Airline Operations	COM 9.2, AIR 4.4.2
706	Aircraft Maintenance Requirements for Air Operators	LRA 5.6.1
Part VIII	Air Navigation Services	GEN 1.3.1, RAC 2.1, NAT 1.1.2

5.4 CANADIAN AVIATION REGULATION ADVISORY COUNCIL (CARAC)

CARAC's main governing principle is to maintain or improve upon Canada's high level of aviation safety.

5.4.1 General

This part outlines the TCCA regulatory consultation process. The TCCA advisory council is known as CARAC. The Director General, Civil Aviation is the sponsor of CARAC. The Council was established on July 1, 1993.

New proposals, including public interest issues, are judged on the safety and efficiency that would result from their implementation. Proposals are also assessed at an early stage to determine where the development and approval processes can be streamlined and where resources should be focused.

5.4.2 Governing Principles

The *Cabinet Directive on Regulatory Management* published by the Treasury Board of Canada requires TC (and other federal departments) to engage at all stages of the rulemaking process. TCCA engages stakeholders on regulatory initiatives through CARAC, and as such, CARAC is an important part of TC's rulemaking consultation process.

5.4.3 Objective

CARAC's prime objective of assessing and recommending potential regulatory changes through cooperative rulemaking activities is accomplished through:

- a) communicating and seeking industry input on TCCA's rulemaking and strategic priorities;

- b) identifying critical or contentious issues that indicate a need to examine and revise, where necessary, existing regulations, policies, standards or procedures to maintain or improve aviation safety in Canada;
- c) soliciting and identifying aviation industry needs for full consideration through direct involvement and consultation;
- d) developing and maintaining administrative tools in order to engage the aviation industry at various stages of the rulemaking process;
- e) eliminating, wherever possible, constraints to system safety and allowing for efficiency through regulations and standards to reduce complexity and increase the productivity of the overall aviation safety system;
- f) minimizing the regulatory burden where safety is not compromised;
- g) maximizing, to the extent practicable, the compatibility of the Canadian regulatory system with that of other regulatory authorities (e.g. ICAO standards and recommended practices, FAA, EASA) where safety or efficiency benefits can be derived; and
- h) transmitting comprehensive and accurate information to the aviation industry in a timely manner.

5.4.4 Organizational Structure

CARAC is a joint undertaking of government and the aviation community for formal consultations with aviation stakeholders on all aspects of rulemaking activities. The participation of a large number of organizations and individuals is sought to represent the overall viewpoint of the aviation community. Participants include management and labour organizations that represent air operators, manufacturers, and professional associations.

5.4.4.1 Focus Group

A focus group reviews technical or safety policy issues; provides technical expertise; conducts risk assessments; and develops possible solutions and recommendations within the scope of a defined terms of reference. Focus group members are comprised of selected subject matter experts from the industry and TC. A focus group is established based on the results of a preliminary issue and consultation assessment.

5.4.4.2 Special Technical Committee

A special technical committee provides advice and recommendations to TCCA's management team on regulatory issues and formal regulatory proposals. A special technical committee discusses policy objectives and supportive documentation. Membership is comprised of representatives from the aviation community, other interested parties and TC.

A special technical committee can be established based on the results of a preliminary issue and consultation assessment.

5.4.4.3 Canadian Aviation Regulation Advisory Council (CARAC) Plenary

The CARAC plenary provides an open forum for the aviation industry and TC to exchange on the content and execution of TCCA's rulemaking and strategic priorities in light of the operational and emerging technological needs of the aviation industry.

5.4.4.4 Transport Canada Civil Aviation (TCCA) Management Team

The TCCA management team has the responsibility to identify and prioritize regulatory issues and to consider, approve and direct the implementation of recommendations made by CARAC focus groups and special technical committees, as applicable.

The Director, Standards or the Director, Policy and Regulatory Services assesses proposals and supportive documentation before they are submitted to a focus group or special technical committee. The relevant director appoints the focus group leader and chairs the special technical committee meetings. They are responsible for reporting the outcome of a focus group or special technical committee meeting to the TCCA management team. The Director, Policy and Regulatory Services is responsible for managing the CARAC process and for ensuring that the aviation industry representatives are sufficiently diverse in order to gather a range of views and expertise.

5.4.4.5 Secretariat

The Secretariat establishes, implements and maintains all systems required to allow CARAC to properly function. The Secretariat is managed by Policy and Regulatory Services and serves as the focal point for consultations on civil aviation regulatory development issues within TC.

5.4.5 Project Resources

Apart from the full-time Secretariat, resource support is solicited from within TCCA and the aviation community, as required. Costs incurred by stakeholder organizations participating in a CARAC focus group, special technical committee or plenary are expected to be borne by those organizations. The CARAC Secretariat will provide, where available, meeting facilities and administrative support, such as decision records.

5.4.6 Communication

Comprehensive and timely communications are given top priority. The appropriate and timely participation of representatives from the aviation community and from within TC in the CARAC process is key to an effective consultation process with the aviation community.

The CARAC Activity Reporting System, accessible at <http://www.wapps.tc.gc.ca/Saf-Sec-Sur/2/NPA-APM/crs.aspx>, provides supportive documentation on any given issue that aviation stakeholders were consulted on. These documents include preliminary issue and consultation assessments, notice of proposed amendments, focus group reports, decision records and documents presented at the plenary.

5.4.7 Information

The information presented in this part is in the process of being published in greater detail in a revised *CARAC Management Charter and Procedures*. Those interested in becoming CARAC members or wishing to obtain more information about CARAC may contact the CARAC Secretariat by mail, telephone or e-mail at:

Transport Canada (AARBH)
CARAC Secretariat
330 Sparks Street
Ottawa ON K1A 0N8

Tel.: 613-990-1847

E-mail: carrac@tc.gc.ca

6.0 AVIATION OPERATIONS CENTRE (AOC)

6.1 AVIATION OPERATIONS CENTRE (AOC)— CIVIL AVIATION ACCIDENT, OCCURRENCE AND INCIDENT REPORTING

The Aviation Operations Centre (AOC) monitors the national civil air transportation system (NCATS) 24 hours a day, seven days a week and responds to NCATS emergencies that require the attention or coordination of concerned functional branches, including regional offices and other departments or agencies. The AOC is the initial point of contact for all aviation-related occurrences. It receives reports on accidents, occurrences and any incidents that occur within the NCATS from various sources, including NAV CANADA, airport authorities, Public Safety Canada, law enforcement agencies, other government departments, foreign governments, and the general public. These reports are continuously monitored and then distributed to the appropriate functional areas of Transport Canada Civil Aviation (TCCA) for review, trend analysis, investigation (if necessary), and final inclusion in the Civil Aviation Daily Occurrence Reporting System (CADORS).

Reports requiring a regional, modal, multi-modal, inter-departmental, or an outside agency's attention are immediately forwarded to that agency for further action. For more information about the AOC, please see *AIP Canada (ICAO) ENR 1.14* available on the NAV CANADA Web site.

To report an aircraft accident, occurrence or incident, contact the AOC 24 hours a day, seven days a week at:

Tel. (toll-free): 1-877-992-6853

Tel.: 613-992-6853

Fax (toll-free): 1-866-993-7768

Fax: 613-993-7768

http://www.wapps.tc.gc.ca/saf-sec-sur/2/IR-RI/av_i_r.aspx?lang=eng.

7.0 CIVIL AVIATION ISSUES REPORTING SYSTEM (CAIRS)

As of March 31, 2016, the Civil Aviation Issues Reporting System (CAIRS) is no longer in operation.

The aviation community and the public can report issues, concerns and hazards to the Civil Aviation Communications Centre.

In an effort to maintain confidentiality, steps have been taken by the communications centre to handle confidential enquiries; however, incoming submissions must be **clearly** marked, in title and body, as confidential.

Please send all enquiries to the Civil Aviation Communications Centre:

Civil Aviation Communications Centre (AARC)
Transport Canada
Place de Ville, Tower C, 5th floor
330 Sparks Street
Ottawa ON K1A 0N8

Tel.: 1-800-305-2059

Fax: 613-957-4208

E-mail: services@tc.gc.ca

AGA—AERODROMES

1.0 GENERAL INFORMATION

1.1 GENERAL

All flights into, from, or over the territory of Canada and all flights landing in such territory shall be carried out in accordance with Canada's civil aviation regulations. Aircraft arriving into or departing from the territory of Canada must first land at an aerodrome at which customs control facilities have been provided. For information about which aerodromes provide customs service, see the *Canada Flight Supplement (CFS)* or the *Canada Water Aerodrome Supplement (CWAS)*, Section B, "Aerodrome/Facility Directory." If the heading CUST (customs) appears in the left-hand column of an aerodrome table, the aerodrome is an airport of entry (AOE) with customs service.

The privileges extended to aircraft are subject to proper authorization of each flight and to whatever restrictions the Government of Canada may, from time to time, or in specific cases, deem to be warranted.

1.1.1 Aerodrome Authority

Transport Canada is responsible for the surveillance of all certified civil aerodromes in Canada. Contact information for Transport Canada's offices can be found in GEN 1.1.1.

1.1.2 International Civil Aviation Organization (ICAO) Documents

See *ICAO Annex 14*, Volumes I and II.

1.1.3 Canadian Runway Friction Index (CRFI)

Many airports throughout Canada are equipped with mechanical and electronic decelerometers which are used to obtain an average of the runway friction measurement. The average decelerometer reading of each runway is reported as the CRFI. Experience has shown that results obtained from the various types of decelerometers on water, slush, wet snow, and dry snow exceeding a 1-inch depth are inaccurate, and the CRFI will not be available when these conditions are present.

Aerodromes equipped with runway friction decelerometer capability are listed in the CFS under RWY DATA.

Operational data relating to the reported average CRFI and the methods to be used when applying these factors to aircraft performance are presented in AIR 1.6.

1.1.4 Contaminated Runway Operations

1.1.4.1 Canadian Civil Aerodromes

At Canadian aerodromes where snow removal and ice control

operations are conducted, assessment and mitigation procedures are carried out to the extent that is practicable in order to provide movement surfaces that will permit safe operational use.

Pilots who are confronted with conditions produced by the ever-changing Canadian climate must be familiar with and anticipate the overall effect of contaminated runways on aircraft handling characteristics in order to take any corrective actions considered necessary for flight safety.

In general terms, whenever a contaminant, such as water, snow, or ice, is present on the runway surface, the effective coefficient of friction between the aircraft tire and runway is reduced. However, the accelerate-stop distance, landing distance, and crosswind limitations contained in the AFM are demonstrated in accordance with specified performance criteria on bare and dry runways during the aircraft certification flight test program and are thus valid only when the runway is bare and dry.

As a result, the stop portion of the accelerate-stop distance will increase, the landing distance will increase, and a crosswind will present directional control difficulties.

It is therefore expected that pilots will take all necessary action, including the application of any appropriate adjustment factor to calculate stopping distances for their aircraft as may be required based on the RSC and CRFI information.

1.1.4.2 Department of National Defence Aerodromes

Snow removal and ice control policy and procedures at Canadian military aerodromes are similar to those of Canadian civil aerodromes; however, the military aerodrome operator might not use the same type of friction measuring equipment to obtain the average runway friction index.

1.1.5 Wildlife Hazard

Certified airports in Canada are required to have a plan to identify and control the hazards wildlife (birds and other animals) present to flight operations. The risk of wildlife strikes may increase during spring and autumn migrations; however, airports can be subject to hazardous wildlife year-round. Pilots should monitor ATIS for information concerning this hazard.

For more information on wildlife hazards, migratory birds, and wildlife-strike reporting, see *AIP Canada (ICAO)* ENR 5.6.

1.2 INTERNATIONAL AIRPORTS

Some airports are designated "international airport" by Transport Canada to support international commercial air transport. See *AIP Canada (ICAO)* GEN 1.2.2.1 for information on international commercial flights.

1.2.1 International Civil Aviation Organization (ICAO) Definitions

International Scheduled Air Transport, Regular Use (RS): An aerodrome which may be listed in the flight plan as an aerodrome of intended landing.

International Scheduled Air Transport, Alternate Use (AS): An aerodrome specified in the flight plan to which a flight may proceed when it becomes inadvisable to land at the aerodrome of intended landing.

International General Aviation, Regular Use (RG): All aircraft other than those operated on an international air service.

NOTE:

Any of the listed regular aerodromes may be used as a regular or alternate aerodrome.

Rules for operating an aerodrome are provided in Part III of the Canadian Aviation Regulations (CARs) under Subpart 301. The objective is to define the minimum safety standards that must be offered as well as to make provision for inspection by the Minister. Aerodrome operators are encouraged, in the interest of aviation safety, efficiency, and convenience, to improve their aerodromes beyond the basic regulatory requirements using, as guidelines, the standards and recommended practices applicable for the certification of aerodromes as airports, heliports, or water airports. Aerodrome users are, however, reminded that the improvement of aerodrome physical characteristics, visual aids, lighting, and markings beyond the basic regulatory requirements for aerodromes stated in CAR 301 is a matter of individual aerodrome operators' initiative. Such improvements do not require regulatory compliance, nor are those improvements inspected or certified in accordance with the standards and recommended practices applicable for the certification of aerodromes as airports, heliports, or water airports.

1.3 AERODROME DIRECTORY

Complete general data on Canadian aerodromes is listed in the *Canada Flight Supplement* (CFS). ICAO Type A Charts are available from NAV CANADA's Aeronautical Information Management (AIM) (see MAP 4.2.1 and www.navcanada.ca/EN/products-and-services/Pages/aeronautical-information-charts-ICAO-type-a-charts.aspx).

1.4 AERONAUTICAL GROUND LIGHTS

Information on aeronautical ground lights can be found in the *Canada Flight Supplement* (CFS) under the LIGHTING entry in the table of the aerodrome they serve or on visual flight rules (VFR) navigational charts.

2.0 AERODROMES AND AIRPORTS

2.1 GENERAL

An aerodrome is defined by the *Aeronautics Act* as:

Any area of land, water (including the frozen surface thereof) or other supporting surface used, designed, prepared, equipped or set apart for use either in whole or in part for the arrival, departure, movement or servicing of aircraft and includes any buildings, installations and equipment situated thereon or associated therewith.

This has a very broad application for Canada where there are no general restrictions preventing landings or takeoffs. There are defined exceptions, but, for the most part, all of Canada can be an aerodrome.

2.1.1 Registration

Subsection 301 also regulates the "Registration" process, which is used to publish and maintain information on an aerodrome in the CFS or the CWAS. The regulation specifies that an aerodrome operator can expect:

- a) to have their aerodrome registered in the appropriate publication when they provide the necessary information with respect to location, markings, lighting, use, and operation of the aerodrome;
- b) to have their aerodrome denied registration in the appropriate publication if they do not meet the aerodrome regulatory requirements for markers and markings, warning notices, wind direction indicator, and lighting;
- c) to assume responsibility of immediately notifying the Minister of any changes in the aerodrome's published information regarding its location, markings, lighting, use, or operation; and
- d) to have their aerodrome classed as a registered aerodrome when it is published in the CFS or CWAS.

NOTE:

No aerodrome operator is obliged by these regulations to have information published in the CFS or CWAS. The Minister may choose not to publish information for a site that is considered to be hazardous to aviation safety.

In addition to the initial inspection during the application for registration, other inspections are done on an as-required basis, once the aerodromes are registered, to verify their compliance with CARs and the accuracy of their information as it is published in the CFS or the CWAS. Such information, however, is only published for the convenience of the pilot and should be confirmed through contact with the aerodrome operator before the pilot uses a site.

2.1.2 Certification

Besides “aerodrome” and “registered aerodrome”, other terms include “airport”, “heliport”, and “water airport”. These are aerodromes for which a certificate has been issued under Subpart 302 of the CARs or Subpart 305 for heliports. The objective is to protect those, such as the fare-paying public and residents in the vicinity of an airport, who do not have the knowledge or ability to protect themselves and who could thus be affected by unsafe operations. This is achieved by ensuring sites are inspected periodically for compliance with Transport Canada standards for obstacle limitation surfaces, physical characteristics, marking, lighting, maintenance procedures, emergency response services, etc., which have been recorded in the Airport/Heliport Operations Manual. The current information is to be communicated to all interested aircraft operators through the CFS, the CAP, NOTAMs, and voice advisories, as applicable. See AGA 2.3 for more information about aerodrome certification.

2.2 USE OF AERODROMES, AIRPORTS, AND HELIPORTS

An aerodrome, airport, or heliport listed in the *Canada Flight Supplement* (CFS) or the *Canada Water Aerodrome Supplement* (CWAS) that does not require prior permission of the aerodrome or airport operator for aircraft operations is called a public-use aerodrome, airport, or heliport.

An aerodrome, airport, or heliport that can be listed in the CFS or CWAS but whose use can be limited is called a private-use aerodrome. This can include:

- a) Prior Permission Required (PPR): The aerodrome operator’s permission is required prior to use. All military aerodromes require PPR for Civilian aircraft.
- b) Prior Notice Required (PN): The aerodrome operator owner or operator is to be notified prior to use so that current information on the aerodrome may be provided.

NOTES:

1. Pilots and aerodrome operators are reminded that trespass restrictions are not applicable to aircraft in distress.
2. Pilots intending to use a non-certified aerodrome are advised to obtain current information from the aerodrome operator concerning operating conditions prior to using that aerodrome for aircraft operations.

2.3 AIRPORT/HELIPORT/WATER AIRPORT CERTIFICATION

2.3.1 General

Transport Canada is responsible for the regulatory development and compliance oversight in support of a safe national air

transportation system. Therefore, airports supporting commercial operations involving the carrying of passengers must meet accepted safety standards. The airport operator that holds an airport certificate testifies that the aerodrome meets such safety standards. Where variances from airport certification safety standards are required, studies will be undertaken to devise offsetting procedures, which will provide equivalent levels of safety.

2.3.2 Applicability of Airport Certification

The requirement for aerodrome certification applies to:

- a) any aerodrome that is located within the built-up area of a city or town;
- b) any land aerodrome that is used by an air operator for the purpose of a scheduled service for the transport of passengers; and
- c) any other aerodrome, where the Minister is of the opinion that it is in the public interest for that aerodrome to meet the requirements necessary for the issuance of an airport certificate because it would further the safe operation of the aerodrome.

Exemptions include:

- a) military aerodromes; and
- b) aerodromes for which the Minister has written an exemption and an equivalent level of safety is defined.

2.3.3 Transport Canada's Responsibilities

The responsibilities of Transport Canada include:

- a) developing safety standards, policies, and criteria for elements such as, but not limited to:
 - (i) physical characteristics of the manoeuvring area, including separations,
 - (ii) marking and lighting, and
 - (iii) obstacle limitation surfaces in the vicinity of airports, heliports and water airports;
- b) reviewing aeronautical studies where variances from airport certification safety standards are required;
- c) certifying and inspecting against the requirements and conditions of the respective operations manuals (for airports, heliports, or water airports); and
- d) verifying, amending, and relaying, as appropriate, pertinent airport/heliport/water airport information to be identified in the appropriate AIS publications.

2.3.4 Operator's Responsibilities

The responsibilities of the operator of an airport/heliport/water airport include, but are not limited to:

- a) complying with the applicable regulations and standards in Part III of CARs;
- b) completing and distributing an approved operations manual;
- c) maintaining the facility in accordance with the requirements specified in the airport/heliport/water airport operations manual; and
- d) advising Transport Canada and aircraft operators whenever services or facilities fall below requirements prescribed in the operations manual or differ from the information published in the aeronautical publications for their aerodrome.

2.3.5 Airport Certification Process

Airport certification is a process whereby Transport Canada certifies that an aerodrome meets airport certification safety standards and that aerodrome data, as provided by the owner or operator and as confirmed by Transport Canada inspectors at the time of certification, is correct and published in the appropriate aeronautical information publications. When these requirements are met, an airport certificate is issued. The airport certificate documentation includes:

- a) the airport certificate, which certifies that the airport meets required standards at the time of issuance; and
- b) the operations manual, which details the airport specifications, facilities, and services, and specifies the responsibilities of the operator for the maintenance of airport certification standards. The operations manual is a reference for airport operations and inspections, which ensures that variances from airport certification safety standards and the resulting conditions of airport certification are approved.

2.3.6 Regulatory References for Aerodrome Certification (Airport/Heliport/Water Airport)

The regulatory authority for airport, heliport, and water airport certification is Subpart 302 of the CARs. The regulatory authority for heliport certification can be found under Part III of the CARs, which includes reference to the respective compliance standards for aerodrome certification. Depending on the date on which the certificate was initially issued, some aerodrome operators may be complying with previous versions of the certification standards.

2.4 AIRPORT/HELIPORT/WATER AIRPORT CERTIFICATE

2.4.1 Issue

A certificate will be issued when an inspection confirms that all requirements for airport certification have been met, including the following:

- a) where variance from the certification standards exists, measures have been implemented to provide for an equivalent level of safety; and
- b) the operations manual has been approved by the Regional Director, Civil Aviation.

2.4.2 Airport Certificate Validity and Amendments

The airport certificate is a legal aviation document that remains valid as long as the airport is operated and maintained in accordance with the operations manual. Periodic inspections are conducted to verify continued conformity to the certification standards and conditions specified in the operations manual.

Transport Canada may make amendments to the conditions applicable to the issuing of an airport certificate when:

- a) an approved variance from certification standards and a change in the conditions of certification are required;
- b) there is a change in the use or operations of the airport; and
- c) it is requested by the holder of the airport certificate.

3.0 RUNWAY CHARACTERISTICS

3.1 RUNWAY LENGTH AND WIDTH

Runways are generally dimensioned to accommodate an aircraft considered to be the critical aircraft. Critical aircraft is defined in the fifth edition of the Transport Canada publication titled *Aerodrome Standards and Recommended Practices* (TP 312) as “the aircraft identified as having the most demanding operational requirements with respect to the determination of movement area dimensions, and other aerodrome physical characteristics at the aerodrome or part thereof”. To identify the critical aircraft, flight manual performance data of a variety of aircraft is examined. Once the critical aircraft has been determined, the longest distance determined after analyzing both take-off and landing performance is used as the basis for runway dimensions. Generally, the runway width can be increased by a maximum of 60 m as a function of length.

3.2 RUNWAY STRIP

Each runway is bounded by a runway strip on its sides and ends to protect aircraft that overfly the runway at very low altitudes during a balked approach for landing. This is achieved by restricting the presence of objects to only those that must be in proximity of the runway as part of normal operations and by prescribing frangibility requirements.

3.3 RUNWAY SAFETY AREA

Each runway is bounded by a prepared area on its sides and ends, within the dimensions of the runway strip. It is graded to prevent catastrophic damage to aircraft leaving the runway sides.

3.4 RUNWAY END SAFETY AREA (RESA)

On some runways there may be an area, at the end and beyond the runway strip, prepared to reduce the severity of damage to an aircraft overrunning or undershooting the runway.

3.5 RUNWAY THRESHOLD DISPLACEMENT

Occasionally, natural and human-made obstacles penetrate the obstacle limitation surfaces of the approach paths to runways.

To ensure that a safe clearance from these obstacles is maintained, it is necessary to displace the threshold upwind from the adjacent runway end where the approach slope cannot be raised. In the case of runways for which instrument approach procedures (IAP) are published in the *Canada Air Pilot (CAP)*, the usable runway distances for landings and takeoffs are specified as declared distances. The displacements are also depicted on the aerodrome or airport diagram in both the CAP and the *Canada Flight Supplement (CFS)*. For other runways that do not have approaches published in the CAP, the requisite data is given in the CFS. Where a threshold is displaced, it is marked as shown in AGA 5.4.1, Figure 5.5.

When the portion of the runway preceding the threshold is marked with arrows (see AGA 5.4.1), it is permissible to use that portion of the runway for taxiing, takeoff, and landing roll-out from the opposite direction. When taking off from the end opposite the threshold, pilots should be aware of the fact that there are obstacles present that have penetrated above the approach slope leading to the physical end of the runway and have resulted in the threshold being displaced. In some cases, this may result in the publication of a specified climb and/or visibility.

3.6 RUNWAY TURN PAD

Some runways have thresholds that are not served directly by taxiways. In such cases, there may be a runway turn pad, a widened area that can be used to facilitate turnaround. Pilots

are cautioned that these pads do not give sufficient clearance from the runway edge and thus cannot be used for holding while other aircraft are using the runway.

3.7 BLAST PAD

A blast pad is defined in the *Aerodrome Standards and Recommended Practices (TP 312)* as “an area before the threshold that is prepared to resist erosion arising from jet exhaust or propeller wash.” When over 60 m in length, this entire paved, non-load-bearing surface is marked with yellow chevrons, as shown in AGA 5.4.2, Figure 5.6.

3.8 STOPWAY

A stopway is defined in the *Aerodrome Standards and Recommended Practices (TP 312)* as “a rectangular area on the ground at the end of take-off run available prepared as a suitable area in which an aeroplane can be stopped in the case of a rejected takeoff”. Where paved, it is marked over its entire length with yellow chevrons (when its length exceeds 60 m) as shown in AGA 5.4.2, Figure 5.6, and is lit with red edge and end lights in the take-off direction. Its length is included in the accelerate-stop distance available (ASDA) declared for the runway.

3.9 CLEARWAY

A clearway is defined in the *Aerodrome Standards and Recommended Practices (TP 312)* as “a defined rectangular area over land or water under the control of the aerodrome operator, selected as a suitable area over which an aircraft may make a portion of its initial climb to a specified height”.

3.10 DECLARED DISTANCES

The *Canada Air Pilot (CAP)* provides information on declared distances, which are defined in the fifth edition of the *Aerodrome Standards and Recommended Practices (TP 312)* as follows:

“The distances that the aerodrome operator declares available for aircraft take-off run, take-off distance, accelerate stop distance, and landing distance requirements. The distances are categorized as follows:

- a) Take-off run available (TORA): The length of runway declared available and suitable for the ground run of an aircraft taking off.
- b) Take-off distance available (TODA): The length of the takeoff run available plus the length of the clearway, if provided.

- c) Accelerate-stop distance available (ASDA): The length of the takeoff run available plus the length of the stopway, if provided.
- d) Landing distance available (LDA): The length of the runway available and suitable for the ground run of an aircraft landing.”

3.11 RAPID-EXIT TAXIWAYS

To reduce the aircraft runway occupancy time, some aerodromes or airports provide rapid-exit taxiways, which are connected to the runway at an angle of approximately 30 degrees.

3.12 RUNWAY AND TAXIWAY BEARING STRENGTH

The bearing strength of some aerodrome or airport pavement surfaces (runways, taxiways, and aprons) that is required to withstand continuous use by aircraft of specific weights and tire pressures has been assessed at specific locations. The Transport Canada (TC) pavement load rating (PLR) and International Civil Aviation Organization (ICAO) pavement classification number (PCN) define the weight limits at or below which the aircraft may operate on pavements without prior approval of the aerodrome or airport authority. The tire pressure and aircraft load rating (ALR)/aircraft classification number (ACN) must be equal to or less than the PLR/PCN figures published for each aerodrome or airport. Aircraft exceeding the published load restrictions may be permitted for limited operations following an engineering evaluation by the airport operator. Requests to permit such operations should be forwarded to the airport operator and should include the aircraft type, operating weight, and tire pressure, as well as the frequency of the proposed operation and the pavement areas required at the aerodrome or airport.

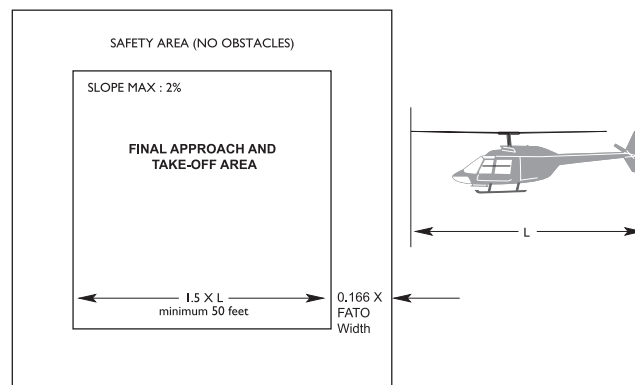
3.12.1 Pavement Load Rating Charts

Operators who require information about the aircraft weight limitations in effect at an aerodrome or airport can contact the aerodrome or airport operator.

3.13 HELIPORTS

Because of the unique operational characteristics of helicopters, a heliport's physical characteristics differ significantly from the physical characteristics of other aerodromes. For instance, a heliport does not require a runway, but instead requires a final approach and take-off area (FATO). The FATO is 1.5 times larger than the longest helicopter for which the heliport is certified and is surrounded by a safety area, which is to be kept free of obstacles, other than visual aids.

Figure 3.1—FATO/Safety Area



3.13.1 Final Approach and Take-Off Area (FATO)

Obstacle-free arrival and departure paths to and from a FATO are always required. In some cases, a FATO can be offset from the intended landing area. In this case, helicopter parking positions are established on an apron area and pilots will hover taxi to transition between the FATO and the parking position.

Figure 3.2—Heliport General Layout

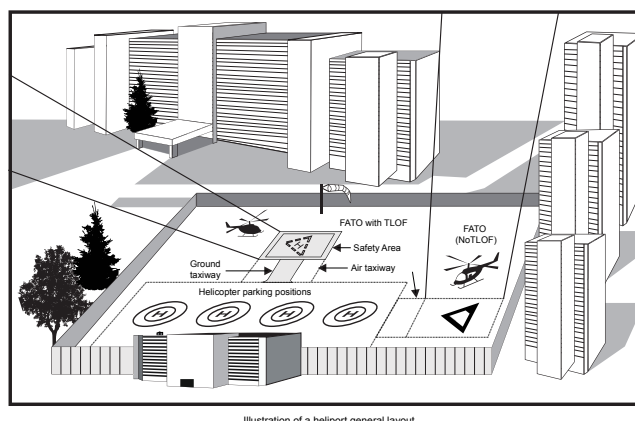


Illustration of a heliport general layout

3.13.2 Heliport Classification

Non-instrument heliports have three classifications: H1, H2, and H3.

H1 heliports have no suitable or available emergency landing areas within 625 m of the FATO. Their use is restricted to multi-engine helicopters capable of remaining 4.5 m above all obstacles within the defined approach/departure pathways when operating in accordance with their AFM with one engine inoperative.

H2 heliports do have suitable and available emergency landing areas within 625 m of the FATO; however, they may only be used by multi-engine helicopters because the associated approach slopes are higher due to high obstacles within the approach/departure pathways.

H3 heliports have suitable and available emergency landing areas within 625 m of the FATO and no obstacles that penetrate the OLSs; they may therefore be used by single- or multi-engine helicopters. Heliport classifications are specified in the CFS.

3.13.3 Heliport Operational Limitations

All heliports have three operational limitations. The limitations for each specific heliport are listed in the CFS.

The load-bearing strength shall be identified for each elevated or rooftop FATO or floating supporting structure. Surface-level heliports do not need to list a load-bearing strength.

The maximum helicopter overall length shall be identified for each FATO. This is calculated as the width or diameter of each FATO, divided by 1.5. This number represents the largest size of helicopter for which the FATO is certified.

The heliport category (instrument or non-instrument) and classification, as detailed in AGA 3.13.2, above, shall also be listed.

4.0 OBSTACLE RESTRICTIONS

4.1 GENERAL

The safe and efficient use of an aerodrome, airport, or heliport can be seriously compromised by the presence of obstacles within or close to the take-off or approach areas. The airspace in the vicinity of take-off or approach areas, which is to be maintained free from obstacles so as to facilitate the safe operation of aircraft, is defined for the purpose of:

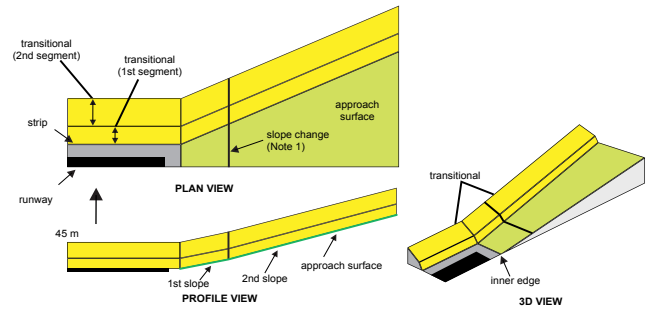
- a) regulating aircraft operations where obstacles exist;
- b) removing obstacles; or
- c) preventing the creation of obstacles.

4.2 OBSTACLE LIMITATION SURFACES (OLS)

4.2.1 General

An OLS establishes the limit to which objects may project into the airspace associated with an airport so that aircraft operations at the airport may be conducted safely. It includes an approach surface, a take-off surface, and a transitional surface.

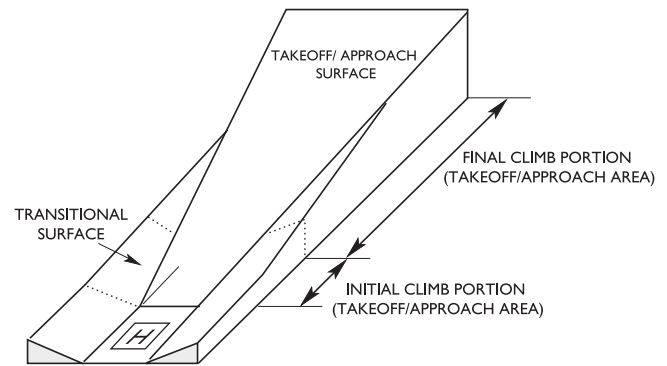
Figure 4.1—Example of OLSs



4.2.2 Heliports

Heliports are normally served by two approach and departure paths. In some instances, they only have one approach and departure path and will then require a transitional surface.

Figure 4.2—Heliport Take-off/ Approach Areas and Surfaces



4.3 AIRPORT ZONING REGULATIONS

4.3.1 General

An airport zoning regulation is a regulation applicable to a given airport pursuant to section 5.4(2) of the Aeronautics Act that imposes restrictions on land use, including vertical development, with the objective of protecting an airport’s current and future accessibility, usability, and viability by:

- a) preventing lands adjacent to or in the vicinity of a federal airport or an airport site from being used or developed in a manner that is, in the opinion of the Minister, incompatible with the operation of an airport;
- b) preventing lands adjacent to or in the vicinity of an airport or airport site from being used or developed in a manner that is, in the opinion of the Minister, incompatible with the safe operation of an airport or aircraft; and
- c) preventing lands adjacent to or in the vicinity of facilities used to provide services relating to aeronautics from being used or developed in a manner that would, in the opinion of the Minister, cause interference with signals or communications to and from aircraft or to and from those facilities.



NOTE:

An airport zoning regulation applies only to land outside the boundary of the airport it protects. Obstacles within an airport boundary must not penetrate an OLS for the runway(s) involved unless the obstacle is exempted as a result of an aeronautical study.

4.3.2 Airports Where Zoning Regulations Are in Effect

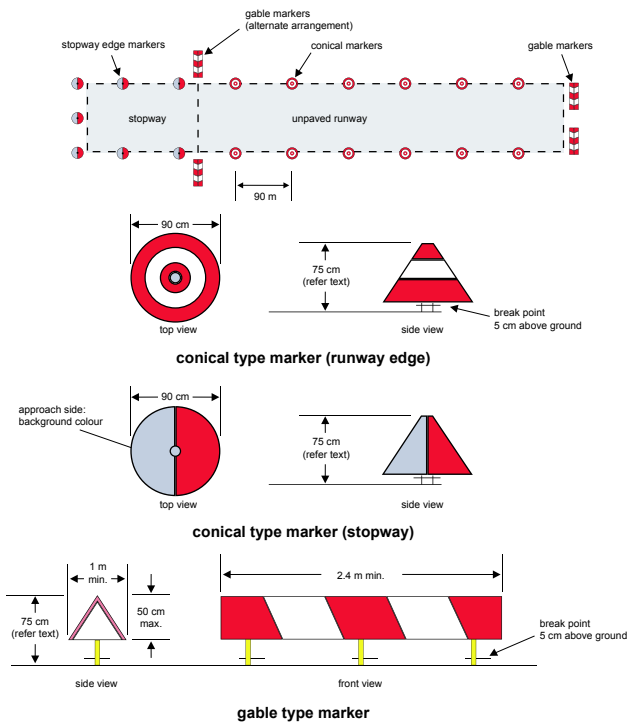
A list of airports where airport zoning regulations are in effect is maintained in the Regional Aerodrome Safety office and online on the Aeronautics Act page of the Department of Justice Web site, under the heading “Regulations made under this Act”.

5.0 MARKERS, MARKINGS, SIGNS, AND INDICATORS

5.1 AIRCRAFT TAKE-OFF OR LANDING AREA BOUNDARY MARKERS

The take-off or landing area boundaries of aerodromes without prepared runways are indicated by conical- or gable-type markers (highway-type cone markers are acceptable) or by evergreen trees in winter. No boundary markers are required if the entire movement area is clearly delineated from that of the surrounding ground. The markers are typically coloured international orange and white or solid international orange.

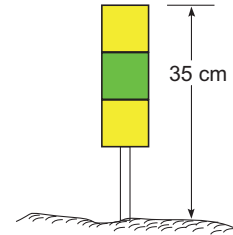
Figure 5.1—Examples of Conical and Gable Markers



5.2 AIR TAXIWAY EDGE MARKERS

The edges of the air taxiway route are indicated by markers 35 cm in height that consist of three horizontal bands of equal size arranged vertically. The top and bottom bands are yellow and the middle one is green.

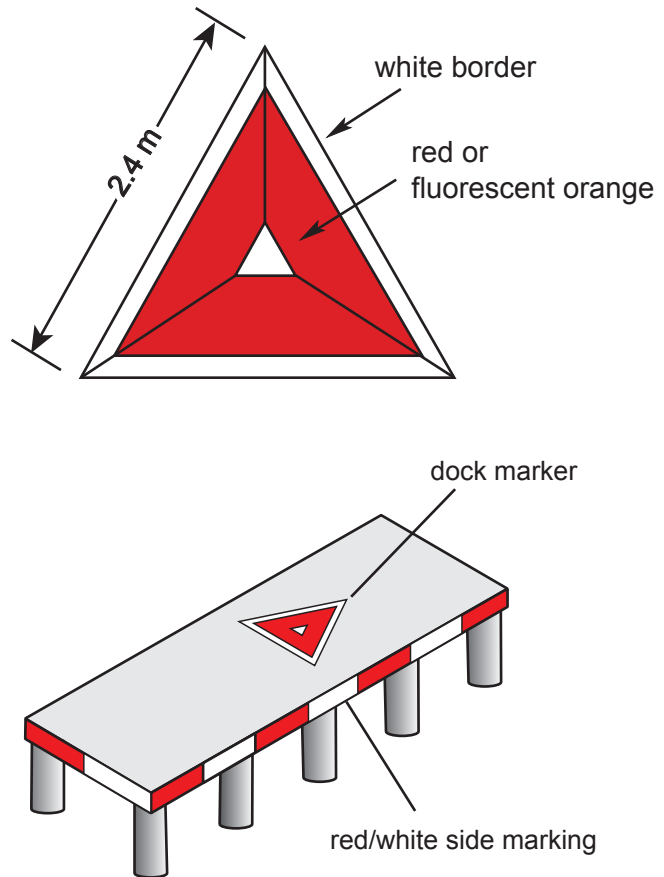
Figure 5.2—Air Taxiway Edge Marker



5.3 SEAPLANE DOCK MARKERS

Seaplane docks are marked to facilitate their identification. The dock is marked with an equilateral triangle measuring 2.4 m on each side. The dock to which this marker is affixed also has red and white side markings.

Figure 5.3—Seaplane Dock Markers



5.4 RUNWAY MARKINGS

Runway markings vary depending on the runway’s length, width, surface type, and, if available, aircraft group number (AGN). They are described in detail in Transport Canada’s *Aerodrome Standards and Recommended Practices* (TP 312).

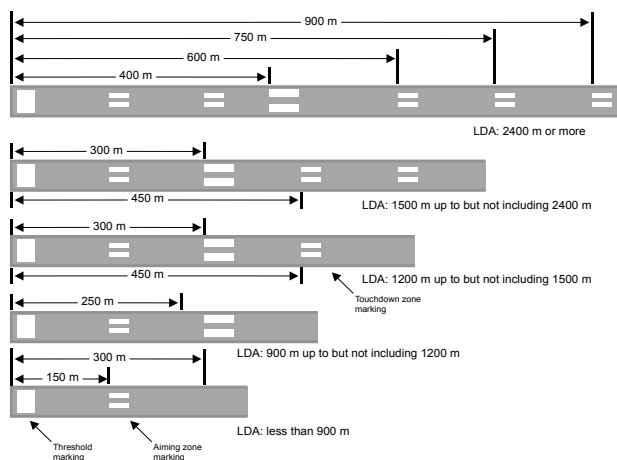
Where an aiming point marking is provided, it is white and located at a specific distance from the threshold per Table 5.1 below.

Table 5.1—Location of Aiming Point Marking

Declared landing distance available (LDA)	Location of aiming point marking distance from threshold (m)
less than 800 m	150
800 m up to but not including 1 200 m	250
1 200 m up to but not including 2 400 m	300
2 400 m or more	400

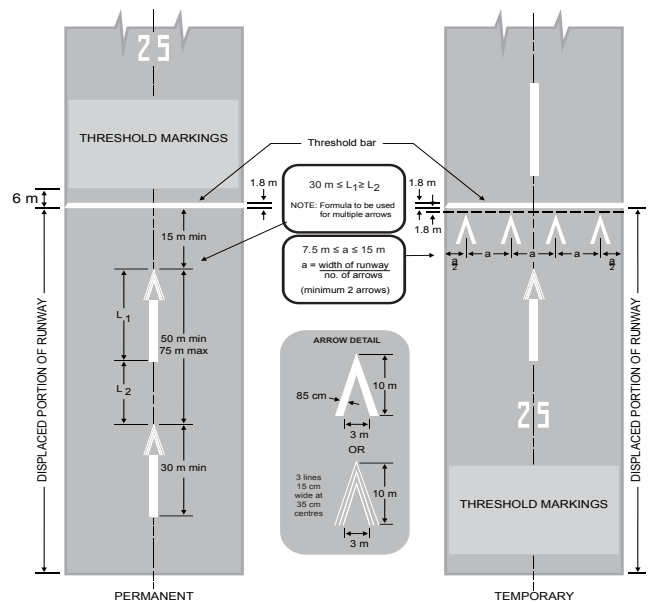
Where touchdown zone (TDZ) markings are provided, they are white and found in pairs in accordance with Table 5.2 and Figure 5.4 below. The location of pairs of TDZ markings is based on a horizontal spacing of 150 m. However, aiming point markings take precedence over TDZ markings; therefore, a pair of TDZ markings is omitted if it would otherwise fall within 50 m of the aiming point marking.

Figure 5.4—Aiming Point and TDZ Markings



5.4.1 Displaced Threshold Markings

Figure 5.5—Displaced Threshold Markings



NOTE:

When the threshold must be displaced for a relatively short period of time, painting a temporary threshold bar is impractical. Instead, flags, cones, or wing bar lights are installed to indicate the position of the displaced threshold. A NOTAM or voice advisory warning of the temporary displacement will contain a description of the markers and the expected duration of the displacement in addition to the length of the closed portion and the remaining usable runway.

5.4.2 Stopway Markings

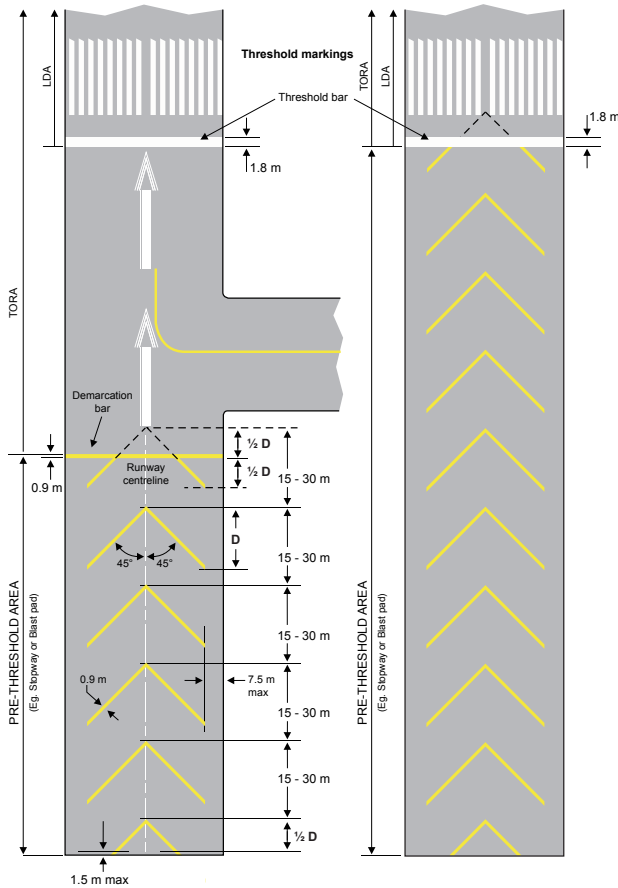
The paved area preceding a runway threshold prepared, maintained, and declared as a stopway is marked with yellow chevrons when its length exceeds 60 m. This area is not available for taxiing, the initial take-off roll, or the landing rollout. The chevron markings may also be used on blast pads.



Table 5.2—TDZ Marking Pairs

Distance between thresholds/declared LDA	Location of TDZ markings distance from threshold (m)	Location of aiming point marking distance from threshold (m)	Pairs of TDZ markings
less than 900 m	0	150	0
900 m up to but not including 1 200 m	150	250	1
1 200 m up to but not including 1 500 m	150 and 450	300	2
1 500 m up to but not including 2 400 m	150, 450 and 600	300	3
2 400 m or more	150, 300, 600, 750 and 900	400	5

Figure 5.6—Stopway Markings



Note: For information on marking tolerances, refer to the respective standards.

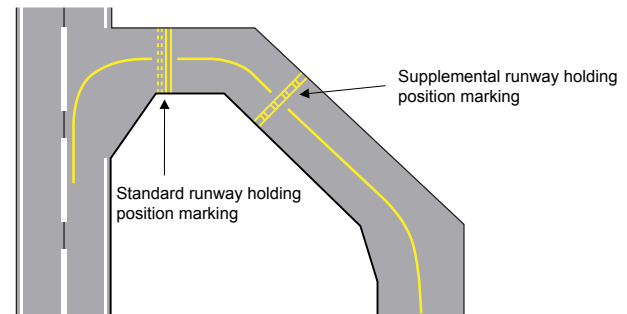
5.4.3 Runway Holding Position Markings

Runway holding position markings are provided near all runway/taxiway intersections and runway/runway intersections to protect the operational environment of the runway in use. They may also be established at other locations to protect the arrival and departure flight paths to a runway.

The standard runway holding position marking consists of two solid and two dashed lines as depicted in Figure 5.7.

Some airports may have multiple runway holding position markings on a given taxiway. These additional markings are commonly referred to as having a ladder-type pattern as depicted in Figure 5.7. It is important to note that in all cases, the runway holding position marking nearest to the runway will be the standard presentation.

Figure 5.7—Runway Holding Position Markings



5.5 HELIPORTS

5.5.1 Helicopter Touchdown and Lift-Off Area (TLOF) Marking

When the perimeter of the TLOF is not otherwise obvious, it will be marked by a solid white line.

5.5.2 Safety Area Markers

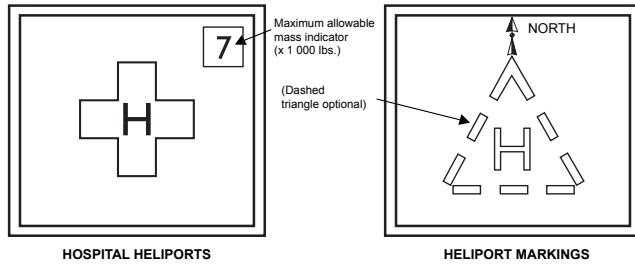
The safety area that surrounds the FATO may be indicated by gable, conical, or other types of suitable markers or markings.

5.5.3 Helicopter Identification Markings

Helicopters are identified by a white capital letter “H” centred within the TLOF. Where it is necessary to enhance the visibility of the letter “H”, it may be centred within a dashed triangle. Hospital heliports are identified by a red capital letter “H” centred within a white cross.

The letter “H” will be oriented with magnetic north, except in the area of compass unreliability, where it will be oriented with true north.

Figure 5.8—Heliport Identification Markings



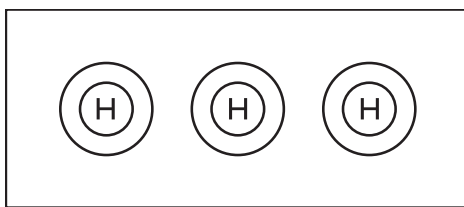
5.5.4 Final Approach and Take-Off Area (FATO) Markers

Where practicable, the boundary of the FATO will be indicated by gable, conical, or other types of suitable markers. The markers shall be frangible and shall not exceed a height of 25 cm. An aiming point marking will be provided and located in the centre of the FATO, where practicable. Where the direction of the helicopter parking position is not obvious, an indicator will show its direction.

5.5.5 Helicopter Parking Position Markings

Helicopter parking position markings consist of two concentric yellow circles. The diameter of the outer circle shall not be less than 1.2 times the overall length of the longest helicopter for which the helicopter parking position is certified. The diameter of the inner circle is one-third of the size of the outer circle. An “H” marking will be centred within the inner circle.

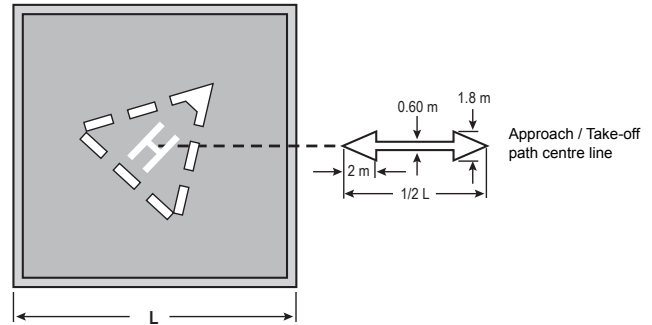
Figure 5.9—Helicopter Parking Position Markings



5.5.6 Approach and Take-Off Direction Indicator Markings

There may be heliports where, due to nearby obstacles or noise-sensitive areas, approach and take-off directions are designated. The direction of the approach and take-off paths is indicated by a double-headed arrow, showing their inbound and outbound directions. The arrows are located beyond the edge of the safety area or on the aiming point marking.

Figure 5.10—Approach and Take-Off Direction Marking



5.6 CLOSED MARKINGS

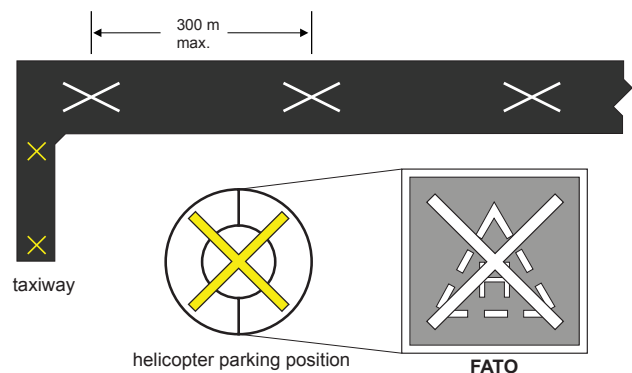
The closed portion of the runway may be shown on the aerodrome or airport diagram in the *Canada Flight Supplement (CFS)* and the *Canada Air Pilot (CAP)* for identification purposes; however, declared distances will only include runway length starting at the new threshold position.

Runways, taxiways, helicopter final approach and take-off areas (FATO), and other helicopter areas that are closed to operations are marked by “Xs”, as shown in Figure 5.11. Snow-covered areas may be marked by “Xs” using conspicuously coloured dye.

“Xs” applied to runways are white in colour and placed within a maximum spacing of 300 m of each other. For taxiways, the “Xs” are yellow in colour and placed at each end of the closed portion.

For helicopter FATOs, the “X” is white in colour. For other helicopter areas such as helicopter parking positions, the “X” is yellow in colour.

Figure 5.11—Closed Markings



A lighted “X” may also be used within 75 m of the threshold to mark a temporary full-length closure of a runway.

Figure 5.12—Lighted “X” Marking a Temporary Full-Length Runway Closure



5.7 UNSERVICEABLE AREA MARKERS

Unserviceable portions of the movement area other than runways and taxiways are delineated by markers such as marker boards, cones, or red flags and, where appropriate, a flag or suitable marker is placed near the centre of the unserviceable area. Red flags are used when the unserviceable portion of the movement area is sufficiently small for it to be by-passed by aircraft without affecting the safety of their operations.

5.8 AIRSIDE SIGNS

5.8.1 General

The primary purpose of airside signs is to ensure the safe and expeditious movement of aircraft on the aprons, taxiways, and runways by providing direction and information to pilots.

The two main categories of airside signs are information signs and mandatory instruction signs, differentiated by using black/yellow and red/white colour combinations, respectively.

5.8.2 Information Signs

Information signs identify a specific destination, location, frequency, or routing information to pilots. The inscriptions incorporate arrows, numbers, letters, or pictographs to convey instructions or to identify specific areas.

- a) *Location Sign*: A location sign has a yellow inscription on a black background and is used to identify the taxiway that the aircraft is on or entering. A location sign never contains arrows.
- b) *Direction Sign*: A direction sign has a black inscription on a yellow background and is used to identify the intersecting taxiways toward which an aircraft is approaching. The sign

is, whenever practicable, positioned on the left-hand side of the taxiway and prior to the intersection. A direction sign will always contain arrows to indicate the approximate angle of intercept. Direction signs are normally used in combination with location signs to provide the pilot with position information. The location sign will be in the centre or datum position. In this configuration, all left turn direction signs are located to the left of the location sign and all right turn direction signs are located to the right of the location sign.

The only exception to this rule is for a simple “T” intersection, where the information sign is located on the opposite side (the top of the “T”) of the intersection, facing the taxiway.

When a taxiway continues through the intersection and changes heading by more than 25° or changes its designation, a direction sign will indicate this fact.

- c) *Runway Exit Signs*: A runway exit sign has a black inscription on a yellow background and is used to identify a taxiway that exits a runway. The sign is positioned prior to the intersection on the same side of the runway as the exit. The sign will always contain an arrow and will indicate the approximate angle at which the taxiway intersects the runway. When a taxiway crosses a runway, a sign will be positioned on both sides of the runway. Runway exit signs may be omitted in cases where aircraft do not normally use the taxiway to exit or in cases of one-way taxiways.
- d) *Destination Signs*: A destination sign has a black inscription on a yellow background and is used to provide general guidance to points on the airfield. These signs will always contain arrows. The use of destination signs will be kept to a minimum. Airports with a good direction sign layout will have little need for destination signs.
- e) *Other Information Signs*: Other information signs have a black inscription on a yellow background and include information such as stand identification, parking areas and frequency.

Figure 5.13—Information Signs

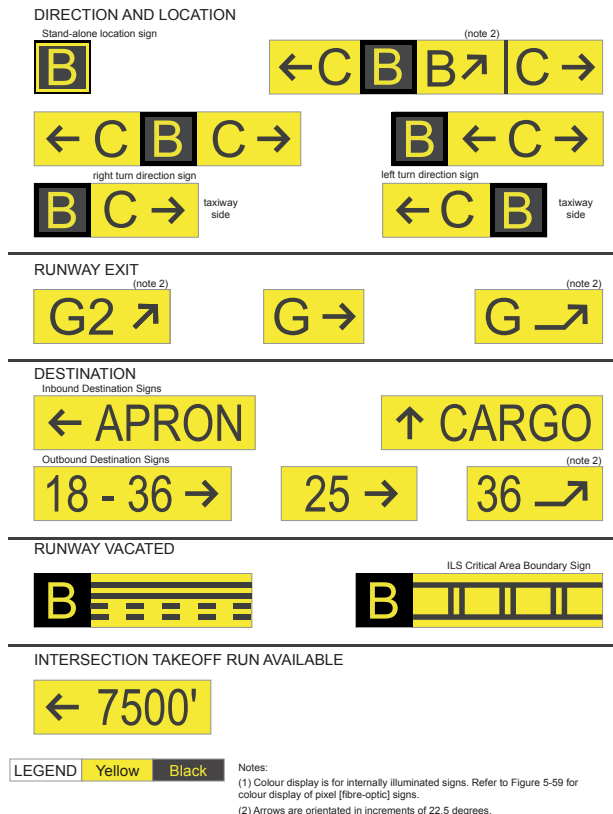
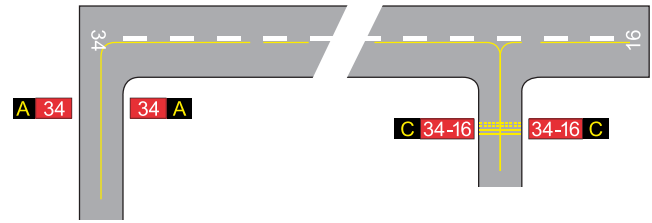


Figure 5.14—Examples of Runway Designation Signs



For airports located within the area of compass unreliability, the same rules apply, except that the sign shows the exact true azimuth of the runway(s) as a three-digit number.

Figure 5.15—Runway Designation Sign in Area of Compass Unreliability



- b) *Category I, Category II, and Category III holding position signs:* CAT I, CAT II, and CAT III holding position signs are installed to protect the ILS critical area during IFR precision operations. A sign is installed on each side of the taxiway in line with the CAT I/II/III hold position marking. The inscription will consist of the designator of the runway and the inscription CAT I, CAT II, CAT III, or a combination, as appropriate.

NOTE:

Where only one holding position is necessary for all categories of operation, a CAT I/II/III sign is not installed. In all cases, the last sign before entering a runway will be the runway designation sign.

- c) *NO-ENTRY sign:* A NO-ENTRY sign, as shown in Figure 5.16, will be located at the beginning and on both sides of the area to which entrance is prohibited.
- d) *APCH sign:* Located at a runway holding position that has been established for the protection of approach or departure paths. The airport configuration may be such that these holding positions are located on runways or taxiways.

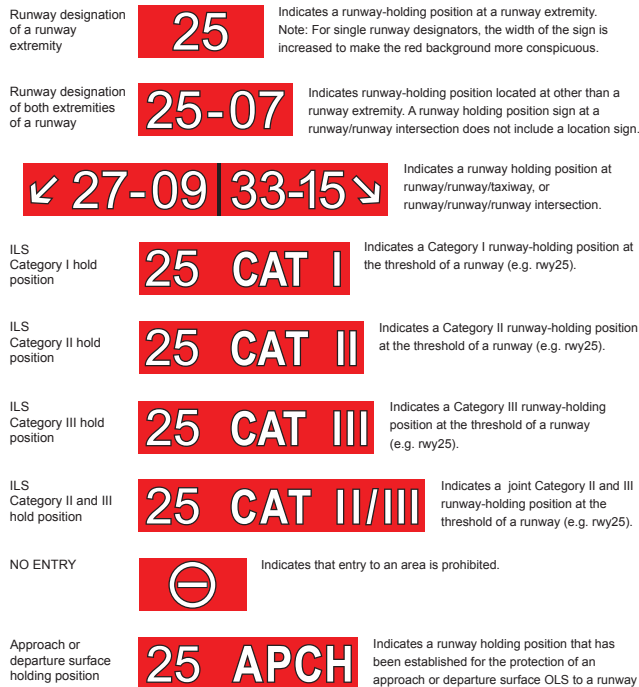
5.8.3 Mandatory Instruction Signs

Mandatory instruction signs are used to identify runway designations, holding positions, NO-ENTRY areas, and obstacle-free zones, where pilots must receive further ATC clearance to proceed. At uncontrolled aerodromes, pilots are required to hold at points marked by these signs until they have ascertained that there is no air traffic conflict. Mandatory instruction signs have white letters, numbers, or symbols against a red background and are installed on both sides of a taxiway or runway, unless it is physically impossible to do so and provided that an equivalent painted sign marking is provided on the taxiway or runway.

- a) *Runway Designation Sign:* A runway designation sign is installed at all taxiway/runway and runway/runway intersections at certified aerodromes. A runway designation sign is used for runways certified for VFR, IFR non-precision, and take-off operations. The sign, when installed at the runway end, shows the designator of the departure runway. Signs installed at locations other than the runway ends shall show the designator for both runways. A location sign is positioned in the outboard position beside the runway designator.

In the following examples, “A” shows that an aircraft is located on Taxiway “A” at the threshold of Runway 34. The second example has the aircraft on Taxiway “C” at the intersection of Runway 34/16. The threshold of Runway 34 is to the left and Runway 16 to the right.

Figure 5.16—Mandatory Instruction Signs



For night operations the wind direction indicator will be illuminated.

NOTE:

At aerodromes certified as airports, a dry standard wind direction indicator will react to wind speed as follows:

Table 5.3—Wind Indicator Angle Based on Wind Speed

Wind Speed	Wind Indicator Angle
15 kt or above	Horizontal
10 kt	5° below horizontal
6 kt	30° below horizontal

At aerodromes not certified as airports, non-standard wind indicator systems, which could react differently to wind speed, may be in use.

AGA

6.0 OBSTRUCTION MARKING AND LIGHTING

5.8.4 Illumination of Airside Signs

Airside signs are illuminated at airports that are used at night or in low visibility. Signs, which are illuminated internally, may be of two types. One type has a sign face constructed from material, such as plexiglass, which permits the entire sign face to be illuminated. The other type has a sign face that incorporates imbedded fibre optic bundles that illuminate the individual letters, numbers, and arrows, not the face of the sign. At night or in low visibility, pilots approaching a fibre optic sign will see RED illuminated characters on mandatory instruction signs, YELLOW characters on a location sign, and WHITE characters on all other information signs.

5.9 WIND DIRECTION INDICATORS

At aerodromes that do not have prepared runways, the wind direction indicator is usually mounted on or near some conspicuous building or in the vicinity of the general aircraft parking area.

Runways greater than 1 200 m in length will have a wind direction indicator for each end of the runway. It will be typically located adjacent to the touchdown zone, 60 m outward from the edge of the runway, and clear of the obstacle-free zone.

Runways 1 200 m in length and shorter will have a wind direction indicator located centrally on the aerodrome or near each end of the runway, typically positioned in proximity to the aiming point markings.

6.1 GENERAL

Where an object, regardless of its height, has been assessed as constituting an obstacle to air navigation as per subsection 601.23(1) of the *Canadian Aviation Regulation* (CARs), it requires marking and/or lighting in accordance with the standards specified in CAR Standard 621.

6.2 REGULATIONS

Sections 601.23–601.27 of the *Canadian Aviation Regulations* (CARs) provide regulations regarding marking and lighting of obstacles to air navigation. The following objects are marked and/or lighted in accordance with the standards specified in CAR Standard 621:

- a) any object penetrating an airport obstacle limitation surface (OLS) as specified in Chapter 4 of *Aerodrome Standards and Recommended Practices* (TP 312);
- b) any object greater than 90 m above ground level (AGL) within 6 km of the geographical centre of an aerodrome;
- c) any object greater than 90 m AGL within 3.7 km of the imaginary centreline of a recognized visual flight rules (VFR) route, including but not limited to a valley, a railroad, a transmission line, a pipeline, a river, or a highway;
- d) any permanent catenary wire crossing where any portion of the wires or supporting structures exceeds 90 m AGL;
- e) any object greater than 150 m AGL; and

- f) any other object, other than the above, deemed by the Minister to represent a likely hazard to aviation safety, in accordance with section 601.25 of the CARs.

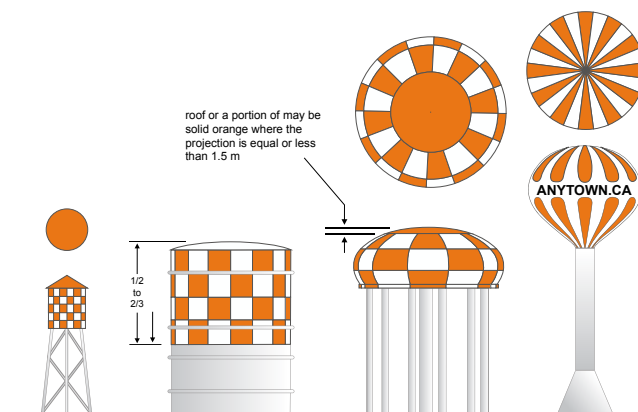
6.3 AERONAUTICAL EVALUATION

A person planning to erect or modify an obstacle, namely a building, structure, or object, including a moored balloon or kite, either permanently or temporarily, is required to contact the appropriate regional Transport Canada Civil Aviation office at least 90 days prior to erection and provide the information on the planned obstruction, using an *Aeronautical assessment form for obstruction marking and lighting* (Form 26-0427E is available in Transport Canada’s forms catalogue at <http://wwwapps.tc.gc.ca/Corp-Serv-Gen/5/Forms-Formulaire/search>).

6.4 MARKING

Day marking of obstructions that are 150 m above ground level (AGL) in height or less, such as poles, chimneys, antennas, and cable tower support structures, may consist of alternate bands of aviation orange and white paint. A checkerboard pattern may be used for water tanks, as shown in Figure 6.1. Where a structure is provided with medium or high-intensity white flashing strobe lighting systems that are operated during the day, paint marking of the structure may be omitted.

Figure 6.1—Storage Tank Marking



6.5 LIGHTING

Lighting is installed on obstructions in order to warn pilots of a potential collision.

The required intensity for this lighting is based upon an acquisition distance from which the pilot would recognize the lighting as identifying an obstruction, and be able to initiate evasive action to miss the obstruction by at least 600 m. For an aircraft operating at 165 knots indicated airspeed (KIAS), the acquisition distance is 1.90 km. For an aircraft operating between 165 and 250 KIAS, the acquisition distance is 2.4 km.

A variety of lighting systems are used on obstructions. Table 6.1 indicates the characteristics of light units according to their name or designation. Although these designations are similar to those of the Federal Aviation Administration (FAA), the photometric characteristics (intensity distribution) are not necessarily the same.

CL-810 lights are used primarily for night protection on smaller structures and for intermediate lighting on antennas of more than 45 m.

CL-856 lights are used primarily for high structures and day protection on towers where marking may be omitted.

CL-857 lights are used for lighting catenary crossings where marking can be omitted.

CL-864 lights are used for night protection of extensive obstacles, such as wind farms and towers, of more than 45 m.

For CL-865 lights, when operated 24hr/day on towers of less than 150m, paint marking may be omitted.

CL-866 lights are used for white catenary lighting.

CL-885 lights are used for red catenary lighting.

6.5.1 Rotating Obstruction Light

The majority of flashing obstruction light units are of a strobe (capacitor discharge) design. An exception is one type of CL-865 medium-intensity flashing light, which is of a rotating design, i.e. the light display is produced by rotating lenses. Since this particular light unit might otherwise be mistaken for an aerodrome beacon, colour coding is used to produce a sequenced display of white, white, red, white, white, and red.

Figure 6.2—Rotating Obstruction Light



The rotating type CL-865 also has the same 20 000 candela intensity for nighttime as for daytime operation. The absence of dimming is allowed for two reasons: (1) the specified intensities are minimum requirements; and (2) the rotating characteristic does not produce glare for the pilot.

6.5.2 Tower Configurations

Depending on the height of the towers and other factors, the installation of lights on towers and antennas may vary as shown in Figure 6.3.

Figure 6.3—Configurations of Lighting on Skeletal Structures

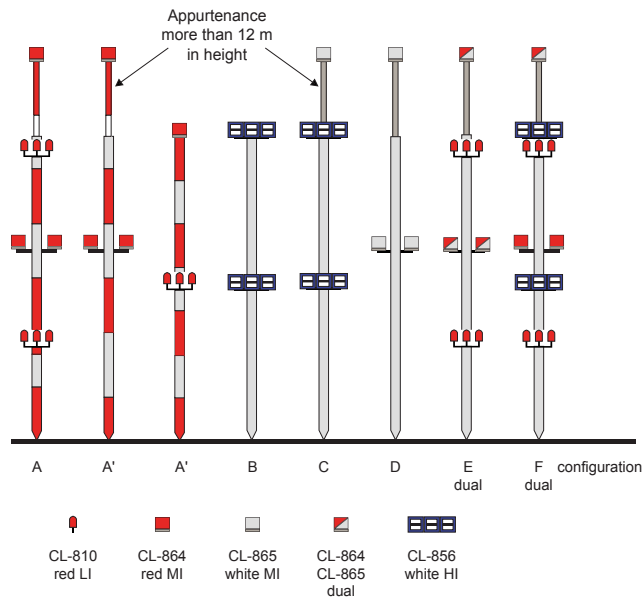


Table 6.1—Light Unit Characteristics

Name	Colour	Intensity	Intensity Value (candelas)	Signal Type	Flash Rate (flashes per min)
CL-810	red	low	32	steady burning	n/a
CL-856	white	high	200 000	flashing	40
CL-857	white	high	100 000	flashing	60
CL-864	red	medium	2 000	flashing	20–40
CL-865	white	medium	20 000	flashing	40
CL-866	white	medium	20 000	flashing	60
CL-885	red	medium	2 000	flashing	60

6.6 APPURTENANCES

Where an obstruction is provided with a red obstruction lighting system, any appurtenance 12 m in height will require an obstruction light at the base of the appurtenance. Where such an appurtenance is more than 12 m in height, the light must be installed on the top of the appurtenance. If the appurtenance is not capable of carrying the light unit, the light may be mounted on the top of an adjacent mast.

Where a high-intensity white flashing lighting system is required, appurtenances higher than 12 m in height will require a top-mounted medium-intensity white flashing omnidirectional light unit.

6.7 SUSPENDED CABLE SPAN MARKINGS

Suspended cable spans, such as power line crossings, assessed as being hazardous to air navigation are normally marked with

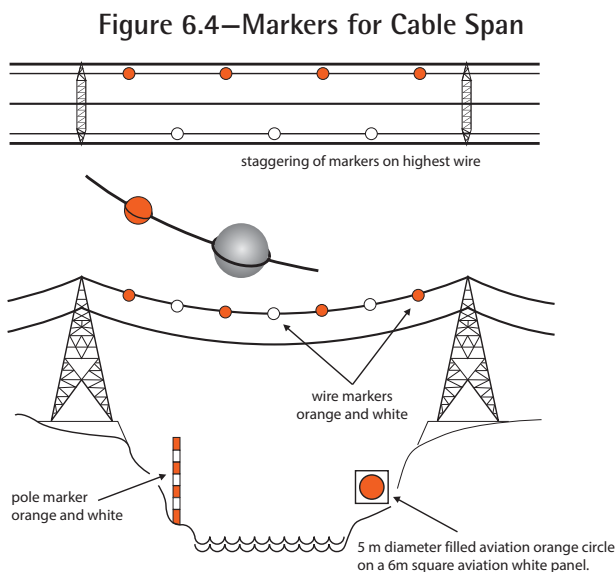
coloured balls suspended from a messenger cable between the tops of the support towers. The support towers are obstruction painted. When painting the support towers is not practical, or when additional warning is necessary, shore markers painted international orange and white will be displayed. In some cases, older marker panels that have not been updated are of a checkerboard design.

An alternative method of marking is to use strobe lights on shore-based cable support towers. Normally three levels of lights are installed as follows: one light unit at the top of the structures to provide 360° coverage; two light units on each structure at the lowest point of the arc of the lowest cable; and two light units at a point midway between the top and bottom levels with 180° coverage. The beams of the middle and lower lights are adjusted so that the signal will be seen from the approach direction on either side of the power line. The lights flash sequentially: middle lights followed by the top lights and then the bottom lights in order to display a “fly up” signal to the pilot. The middle light may be removed in the case of narrow power line sags; in this

case the bottom lights will flash first then the top lights will flash in order to display a “fly up” signal to the pilot. When deemed appropriate by an aeronautical study, medium-intensity white flashing omnidirectional lighting systems may be used on supporting structures of suspended cable spans lower than 150 m above ground level (AGL).

Obstruction markings on aerial cables (i.e. marker balls) that define aeronautical hazards are generally placed on the highest line for crossings where there is more than one cable. Obstruction markings can also be installed on crossings under the *Navigation Protection Act*. In this case, the marker balls are placed on the lowest power line and are displayed to water craft as a warning of low clearance between the water and an overhead cable.

In accordance with the foregoing, pilots operating at low levels may expect to find power line crossings marked as either an aeronautical hazard or a navigable water hazard. They may be unmarked if it has been determined by the applicable department or agency that they are neither an aeronautical nor a navigable waters hazard. Pilots operating at low altitudes must be aware of these hazards and exercise extreme caution.



6.8 AIRCRAFT DETECTION SYSTEMS

A technology has been developed so that obstacle lighting is activated only when required to alert pilots who are on a flight path that may lead to a collision with the obstacle. The system addresses public complaints regarding light pollution.

The system uses radar to detect and track aircraft. The potential for collision with an obstacle is determined by the aircraft's speed and angle of approach. If there is a risk of collision, the lighting turns on and an audio warning (if provided) is broadcast on the very high frequency (VHF) radio. The lighting does not turn on until it is needed by the detected aircraft. Since the system uses radar, its operation is independent of any equipment on board the aircraft (e.g. a transponder).

The obstacle lighting is turned on and the audio warning is emitted approximately 30 s before the aircraft reaches the obstacle. In the case of catenaries, the audio warning will state “POWER LINE, POWER LINE”. For other types of obstructions, a different message will be sent. In some cases, such as those involving wind farms near aerodromes, an audio signal might not be provided, in order to avoid confusing pilots making an approach to landing.

Any questions or comments may be directed to the Transport Canada Flight Standards office in Ottawa (see GEN 1.1.1 for contact information).

7.0 AERODROME LIGHTING

7.1 GENERAL

The lighting facilities available at an aerodrome or airport are described in the *Canada Flight Supplement* (CFS). Information concerning an aerodrome or airport's night lighting procedures is included as part of the description of lighting facilities, where routine night lighting procedures are in effect. Where night lighting procedures are not published for an aerodrome or airport, pilots should contact the aerodrome operator concerned and request that the appropriate lights be turned on to facilitate their intended night operations.

7.2 AERODROME BEACON

Many aerodromes are equipped with a flashing white beacon light to assist pilots in locating the aerodrome at night. The aerodrome beacon may be of the rotating or flashing type. The flash frequency of beacons at aerodromes or airports used by aeroplanes is 22 to 26 evenly spaced flashes per minute (fpm) for rotating beacons or 20 to 30 for flashing beacons.

The flash frequency of beacons at aerodromes and heliports used only by helicopters is sequenced to transmit the Morse code letter “H” (in groups of four quick flashes) at the rate of three to four groups per minute.

7.3 MINIMUM NIGHT LIGHTING REQUIREMENTS AT AERODROMES

Section 301.07 of the *Canadian Aviation Regulations* (CARs) requires that any area of land that is to be used as an aerodrome at night shall have fixed (steady) white lights to mark the runway, and fixed red lights to mark unserviceable (hazardous) areas.

Retroreflective markers may be substituted for lights to mark the runway at aerodromes, provided alignment lights are installed (see AGA 7.19). This alternative for night marking of runways, however, is not approved for certified sites.

7.4 UNSERVICEABLE AREA LIGHTING

Unserviceable areas within the manoeuvring area of an aerodrome being used at night are marked by steady burning red lights outlining the perimeter of the unserviceable area(s). Where it is considered necessary in the interest of safety, one or more flashing red lights may be used in addition to the steady red lights.

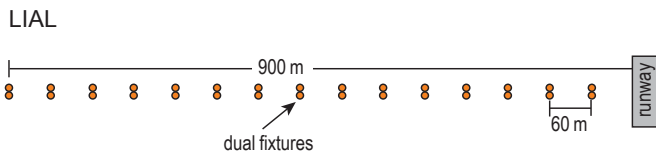
7.5 APPROACH LIGHTING

The approach lighting systems depicted in the *Canada Flight Supplement* (CFS) include the following:

7.5.1 Non-Precision Approach Runways

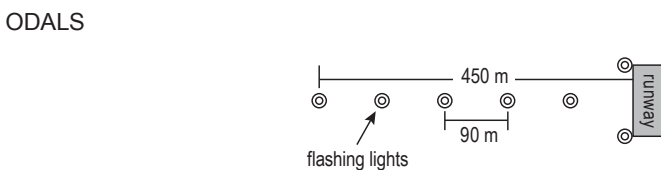
- a) *Low Intensity Approach Lighting System (LIAL)*: This system is provided on non-precision approach runways and consists of aviation yellow fixed-intensity twin light units spaced at 60-metre intervals commencing 60 m from the threshold and extending back for a total distance of 900 m (terrain permitting).

Figure 7.1—LIAL



- b) *Omnidirectional Approach Lighting System (ODALS)*: This system is a configuration of seven omnidirectional, variable-intensity, sequenced flashing lights. An ODALS provides circling, offset, and straight-in visual guidance for non-precision approach runways. There are five lights on the extended centreline commencing 90 m from the threshold and spaced 90 m apart over a total distance of 450 m. Two lights are positioned 12 m to the left and right of the threshold. The system flashes towards the threshold, then the two threshold lights flash in unison; the cycle repeats once per second.

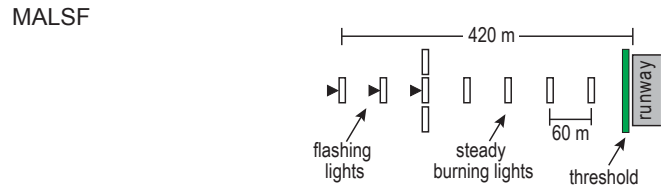
Figure 7.2—ODALS



- c) *Medium Intensity Approach Lighting System (MALS) or Medium Intensity Approach Lighting System with Sequenced Flashing Lights (MALSF)*: This system consists of seven barrettes of variable-intensity lights spaced 60 m apart, commencing 60 m from the threshold, over a distance of 420 m. In a MALSF, the three barrettes farthest away from the threshold contain a sequenced flashing light unit. These lights flash sequentially towards the threshold, repeating at

two cycles per second.

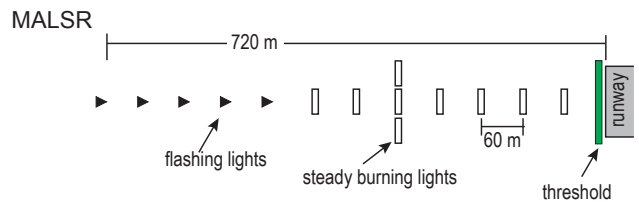
Figure 7.3—MALSF



- d) *Medium Intensity Approach Lighting System with Runway Alignment Indicator Lights (MALSR)*: This system consists of variable-intensity approach lights spaced 60 m apart, commencing at 60 m from the threshold, and extending 720 m. This system consists of the following:
 - (i) seven barrettes of light over a distance of 420 m;
 - (ii) one side barrette of light on each side of the centreline barrette at 300 m from the runway threshold; and
 - (iii) five sequenced flashing lights over the remaining distance of 300 m. These lights flash in sequence towards the threshold at a rate of two cycles per second.

The MALSR has the same configuration as the SSALR, but has lower intensity lights.

Figure 7.4—MALSR

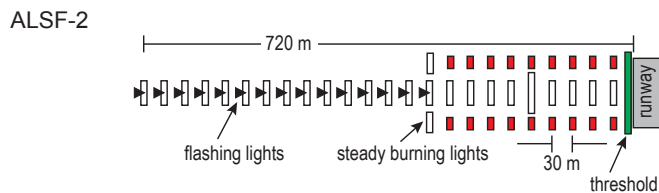


- e) *Simplified Short Approach Lighting System (SSALS)*: This system is the same as MALS (i.e. MALSF without the sequenced flashing lights) but high intensity lights are used instead. (See Figure 7.3 for the layout without the sequenced flashing lights.)

7.5.2 Precision Approach Runways

- a) *Simplified Short Approach Lighting System with Runway Alignment Indicator Lights (SSALR)*: This system is the same as the MALSR but high intensity lights are used instead. See Figure 7.4 for the layout.
- b) *Approach Lighting System with Sequenced Flashers—CAT II (ALSF-2)*: This system consists of rows of five white variable-intensity light units placed at longitudinal intervals of 30 m commencing 30 m from the threshold and extending for a total distance of 720 m. In view of the very low decision height associated with CAT II operations, the following additional lights are provided:
 - (i) runway threshold (green)
 - (ii) 150 m distance bar (white with red barrettes)
 - (iii) side barrettes (red)

Figure 7.5—ALSF-2



7.6 VISUAL APPROACH SLOPE INDICATOR SYSTEMS (VASIS)

7.6.1 General

VASIS is a generic term referring to different approach slope indicators. Types of VASIS are VASI (visual approach slope indicator), AVASI (abbreviated VASI), PAPI (precision approach path indicator), and APAPI (abbreviated PAPI).

A VASIS consists of a series of lights visible from approximately 4 NM and designed to provide visual indications of the desired approach slope to a runway (usually 3°). At a certified airport, aircraft following the on-slope signal are provided with safe obstruction clearance to a minimum of 6° on either side of the extended runway centreline out to 7.5 km (4.1 NM) from the runway threshold. Newly certified airports are commonly protected out to 8° on each side of the extended runway centreline. Exceptions will be noted in the CFS. Descent using VASIS should not be initiated until the aircraft is visually aligned with the runway centreline.

The vertical distance from a pilot’s eyes to the lowest portion of the aircraft in the landing configuration is called the eye-to-wheel height (EWH), and this distance varies from less than 10 ft (3 m) up to 45 ft (14 m) for some wide-bodied aircraft, such as the B-747. Consequently, approach slope indicator systems are related to the EWH for critical aircraft, and they provide safe wheel clearance over the threshold when the pilot is receiving the on-slope indication.

Pilots and/or air operators should ensure that the VASIS type to be used is appropriate to the given aircraft type, based on the EWH for that aircraft. If this information is not already available in the AFM or other authoritative aircraft manuals (e.g. the flight crew operating manual), the aircraft manufacturer should be contacted.

CAUTION:

Incompatibility between the EWH and the VASIS type could result in decreased terrain clearance margins and in some cases, even premature contact with terrain (e.g. a CFIT accident).

The Canadian civil aviation standard for VASIS is the PAPI. Some airports still have the older systems of VASI. The VASI and PAPI light units have the same purpose of descent indication with respect to an approach corridor but are arranged in a different pattern, as shown below.

The VASI and PAPI have lights normally situated on the left side of the runway only. When available strip widths preclude the use of a full system, an abbreviated approach slope indicator, AV or AP, consisting of only two light units, may be installed.

Where a PAPI or VASI is provided on a precision approach runway and has not been harmonized with a vertical guidance signal, it will be turned off in weather conditions involving a ceiling of less than 500 ft (150 m) and/or visibility less than 1 mi., unless specifically requested by the pilot. This is to avoid possible contradiction between the electronic precision approach vertical guidance and visual (VASI/PAPI) glide slope signal.

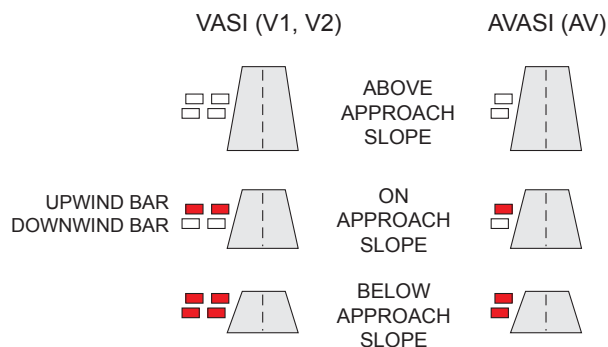
7.6.2 Visual Approach Slope Indicator (VASI) V1 and V2 and Abbreviated VASI (AVASI) AV

The VASI (V1 and V2) consists of four light units situated on the left side of the runway in the form of a pair of wing bars (two light units per wing bar), referred to as the upwind and downwind wing bars. Each light unit of a wing bar projects a beam of light. The upper part of the beam shows white while the lower part shows red. When the pilot is:

- a) above the approach slope, both upwind and downwind bars show white.
- b) on the approach slope, the upwind bar shows red and the downwind bar shows white.
- c) below the approach slope, both upwind and downwind bars show red.
- d) well below the approach slope, the lights of the two wing bars merge into one red signal.

The AVASI (AV) consists of two light units situated on the left side of the runway in the form of a pair of wing bars (one light unit per wing bar). The display is similar to that of a VASI and depends on the position of the pilot’s eyes.

Figure 7.6—VASI and AVASI Display



7.6.3 Precision Approach Path Indicator (PAPI) and Abbreviated PAPI (APAPI)

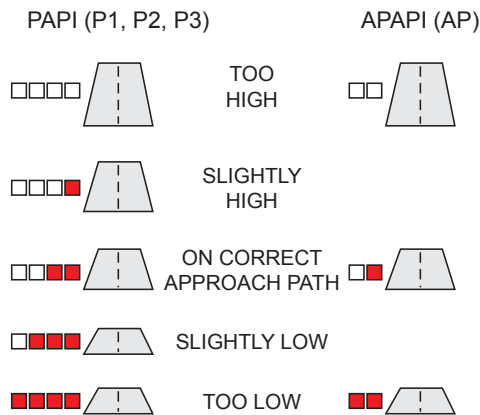
PAPI consists of four light units typically situated on the left side of the runway in the form of a wing bar. When the pilot is:

- a) well above the approach slope, all four units show white.
- b) slightly above the approach slope, the one unit nearest the runway edge shows red and the other three show white.
- c) on or close to the approach slope, the two units nearest the runway edge show red and the two units farthest from the runway edge show white.
- d) slightly below the approach slope, the three units nearest the runway edge show red and the other shows white.
- e) well below the approach slope, all four units show red.

APAPI consists of two light units situated on the left side of the runway in the form of a wing bar. When the pilot is:

- a) above the approach slope, both units show white.
- b) on or close to the approach slope, the unit nearer to the runway edge shows red and the unit farther from the runway edge shows white.
- c) below the approach slope, all units show red.

Figure 7.7—PAPI and APAPI Display



CAUTION:

Lens Contamination—The PAPI/APAPI light box is a sealed design with a front lens or cover glass. When the temperature of the PAPI/APAPI unit lens or cover glass descends below the dew point, frost or condensation may occur depending on the season. Frost or condensation contamination may produce a false signal by mixing the red and white colours of the beam. Under these conditions, the relative intensities of the red and white portions of the beam may cause the mixture to be perceived as predominantly white in colour for a period of time after the PAPI/APAPI is first turned on. Since the mixture may be

interpreted as a fly-down signal, the pilot should be aware of other cues (e.g. the runway perspective) so as to avoid descent below the OPS. When the PAPI/APAPI provides a true signal, it should display a crisp transition from white to red as the aircraft descends through the sectors. If contamination is suspected, flight crews are advised to disregard the PAPI/APAPI display.

7.6.4 Categories According to Eye-To-Wheel Height (EWH) in the Approach Configuration

7.6.4.1 General

VASIS are categorized according to the EWH in the approach configuration, as shown in Tables 7.1 and 7.2 below. Where a VASIS is given for a published category, it is intended to be useable by all aircraft within the stated EWH group unless otherwise stated.

NOTE:

The EWH is the vertical distance in-flight of the eye path to the wheel path, as shown in Figure 7.8, and is determined by the approach slope angle and the pitch angle for the maximum certified landing weight at V_{ref} . This should not be confused with the horizontal and vertical dimensions as may be measured when the aircraft is on the ground.

7.6.4.2 Visual Approach Slope Indicator (VASI) Categories

The VASI installations are designed according to aircraft height group categories AV, V1, and V2, as indicated in Table 7.1. The greater the value of the EWH in the approach configuration, the farther the VASI is installed upwind from the threshold to provide the appropriate MEHT.

Table 7.1—VASI Categories

Category	System	Aircraft height group EWH in the approach configuration
AV	AVASI	0 ft (0 m) ≤ EWH < 10 ft (3 m)
V1	VASI	0 ft (0 m) ≤ EWH < 10 ft (3 m)
V2	VASI	10 ft (3 m) ≤ EWH < 25 ft (7.5 m)

7.6.4.3 Precision Approach Path Indicator (PAPI) Categories

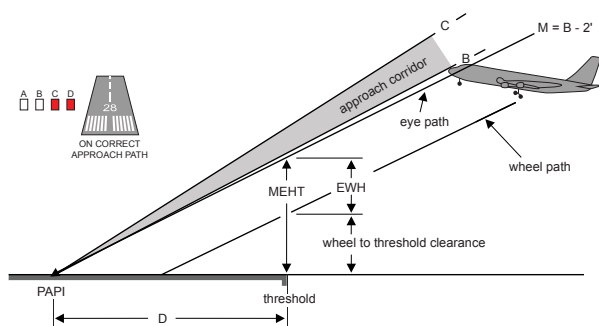
PAPI and APAPI installations are designed for aircraft height group categories AP, P1, P2, and P3, as indicated in Table 7.2. The greater the value of the EWH in the approach configuration, the farther the PAPI is installed upwind from the threshold to provide the appropriate MEHT.

Table 7.2—PAPI Categories

Category	System	Aircraft height group EWH in the approach configuration
AP	APAPI	0 ft (0 m) ≤ EWH < 10 ft (3 m)
P1	PAPI	0 ft (0 m) ≤ EWH < 10 ft (3 m)
P2	PAPI	10 ft (3 m) ≤ EWH < 25 ft (7.5 m)
P3	PAPI	25 ft (7.5 m) ≤ EWH < 45 ft (14 m)

The aircraft position with respect to the PAPI display is shown in Figure 7.8. The approach corridor is defined by the setting angles of light units C and B. The MEHT is defined by the angle M, which is 2 min of arc below the angle B. This accounts for the pilot’s difficulty in discerning when the transition from white to full red has occurred. The available MEHT is the sum of the EWH in the approach configuration and the prescribed wheel clearance. The distance D for the location of the PAPI from the threshold is calculated using the tangent of the angle M. In other words, $D = \text{MEHT}/\tan(M)$. For more information about wheel clearance, see *Aerodromes Standards and Recommended Practices* (TP 312).

Figure 7.8—PAPI: Pilot Eye Path to Wheel Path



7.6.5 Knowing the Eye-to-Wheel Height (EWH)

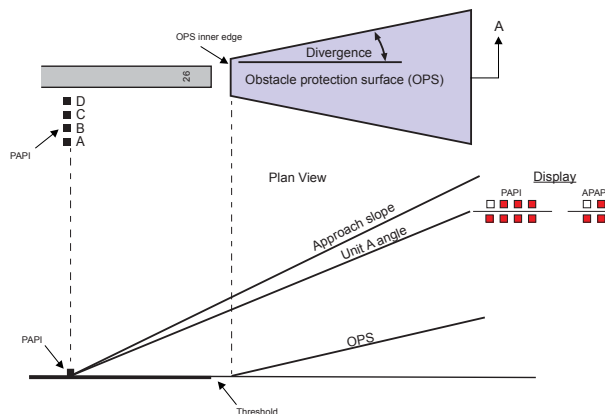
For a particular category of PAPI and aircraft group, there is an available wheel clearance. This is why knowing the EWH in the approach configuration is important. For example, if your aircraft belongs in the aircraft height group for a P3 PAPI, using a P2 PAPI means having much less wheel clearance at threshold crossing. Figure 7.8 also shows why flying below the approach corridor (with the lights showing three red and one white) is not recommended.

7.6.6 Obstacle Protection Surface (OPS)

For certified aerodromes, the installation of a PAPI or an APAPI requires the establishment of an obstacle protection surface (OPS). The OPS provides a buffer below unit angle A, which, for PAPI, is the transition from one white light and three red lights to four red lights, and for APAPI, is the transition from one white light and one red light to two red lights, as shown in Figure 7.9. Objects do not penetrate the OPS. Where an object or terrain protrudes above the OPS and beyond the length of the approach OLS, one of a number of possible measures may be taken such as raising the approach slope, moving the PAPI further upwind of the

threshold, or reducing the operational length of the OPS and marking/lighting the obstacle. At some aerodromes, particularly in mountainous regions, a limitation is established as a PAPI useable distance from the threshold and is published in the CFS. The PAPI signal is not to be used until the aircraft is within that specified distance. For more information about OPS dimensions, see *Aerodromes Standards and Recommended Practices* (TP 312).

Figure 7.9—PAPI/APAPI OPS



7.7 RUNWAY IDENTIFICATION LIGHTING

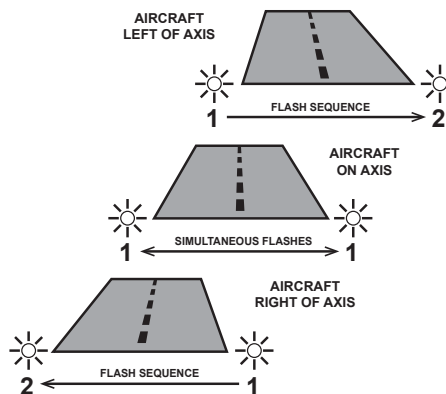
7.7.1 Runway Threshold Identification Lights (RTIL)

These are provided at aerodromes where terrain precludes the installation of approach lights, or where unrelated non-aeronautical lights or the lack of daytime contrast reduces the effects of approach lights. When an aerodrome is equipped with RTILs, it is indicated in the CFS by the notation “AS”.

7.7.2 Visual Alignment Guidance System (VAGS)

The VAGS consists of two lights similar to RTILs. However, by means of light beam rotation, the pilot is presented with a sequenced display, as shown in Figure 7.10 below. The display directs the pilot towards the runway/helipad axis, where he or she then sees the lights flash simultaneously.

Figure 7.10—VAGS



7.8 RUNWAY LIGHTING

A runway on an aerodrome that is used at night shall display two parallel lines of fixed white lights visible for at least 2 mi. to mark take-off and landing areas. These lights are arranged so that:

- the lines of lights or markers are parallel and of equal length and the transverse distance between the lines is equal to the runway width in use during the day;
- the distance between adjacent lights or markers in each line is the same and is not more than 60 m (200 ft);
- each line of lights or markers is not less than 420 m (1 377 ft) in length and contains no fewer than eight lights or markers; and
- each light or marker in a line of lights or markers is situated opposite to a light or marker in the line of lights or markers on the other side of the runway, so that a line connecting them forms a right angle to the centreline of the runway.

For a certified aerodrome, runway lighting may include centreline and touchdown zone lighting depending on runway visibility and approach category.

7.8.1 Runway Edge Lights (REDL)

These are variable-intensity white lights at the runway edges along the full length of the runway spaced at maximum intervals of 60 m, except at intersections with other runways. On some runways, a 600-m section of lights or the last third of the runway at the remote end—whichever is shorter—may show yellow. The units are light in weight and mounted in a frangible manner.

7.8.2 Runway Threshold Lights and Runway End Lights (RENL)

Runway threshold/end indication is provided by green and red light units respectively, in the form of a pair of bars along the threshold on each side of the runway centreline, where there is an ODALS or where no approach lighting is provided. Red shows in the direction of takeoff and green shows in the approach direction.

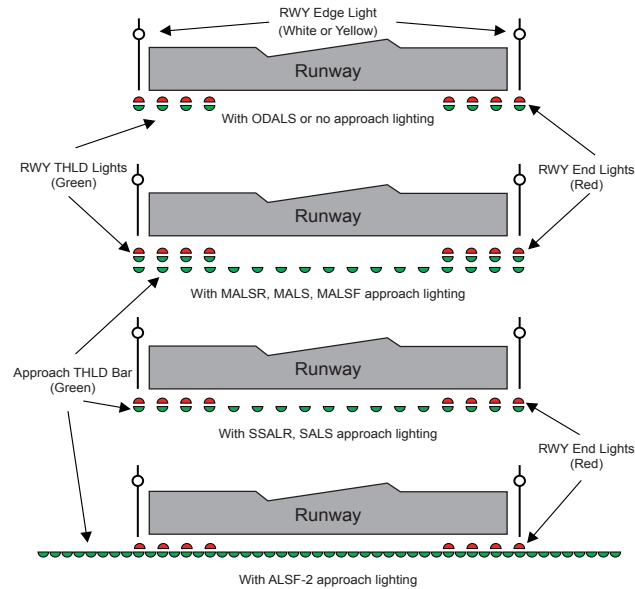
Where approach lighting other than ODALS is provided, an approach threshold bar that extends across the full width of the runway forms part of the approach lighting configuration. Figure 7.11 shows the different configurations of such lights. RENL are always provided. Runway threshold lights are independent from approach threshold bar lights and are only lit if the approach threshold bar is not lit.

Where MALSR, MALSF or MALS is provided, the green threshold lighting is physically separated from the approach threshold bar due to difference in light intensities and circuitry.

Where SSALR or SSALS is provided, the runway threshold lights form part of the approach threshold bar configuration (opposite the runway end lights).

Where an ALSF-2 is provided, the green threshold lighting is extended farther as wing bars to each side of the runway.

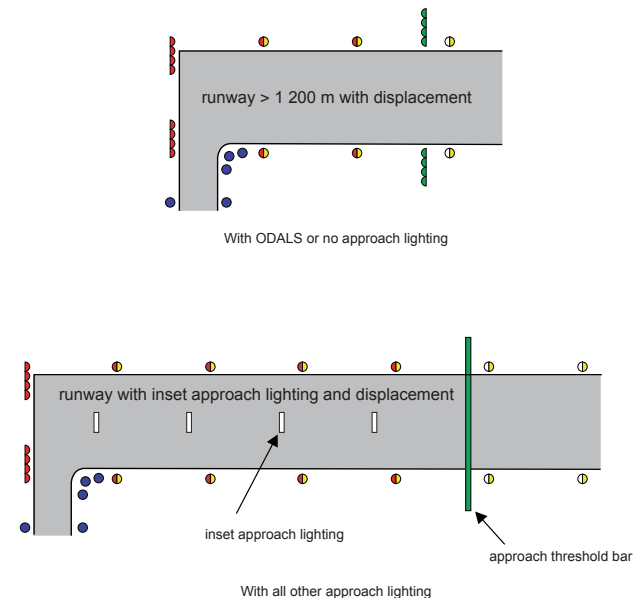
Figure 7.11—Runway Threshold and End Lights



7.8.3 Displaced Threshold Lighting

Where runway thresholds have been displaced from the beginning of the runway, the runway threshold lights and the approach threshold bar are displaced accordingly, using inset lights for approach threshold bars and wing bar lights for runway threshold lights, as follows:

Figure 7.12—Displaced Threshold Lighting



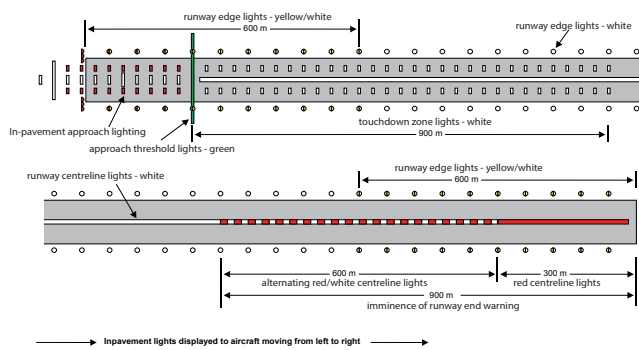
7.8.4 Runway Centreline Lighting

Runway centreline lighting is provided on CAT II and CAT III runways. It consists of lights installed on the runway surface spaced at intervals of 15 m. The lights leading in the take-off or landing direction are variable white from the threshold to 900 m from the runway end; alternate red and variable white from 900 m to 300 m from the runway end; and red from 300 m to the end of the runway.

7.8.5 Runway Touchdown Zone Lighting

Touchdown zone variable intensity white lights are provided on CAT II and CAT III instrument runways. They consist of barrettes of three inset lights disposed on either side of the runway centreline, spaced at 30-m intervals commencing 30 m from the threshold. They extend from the threshold for a distance of 900 m down the runway. The lights are unidirectional, showing in the direction of approach to landing.

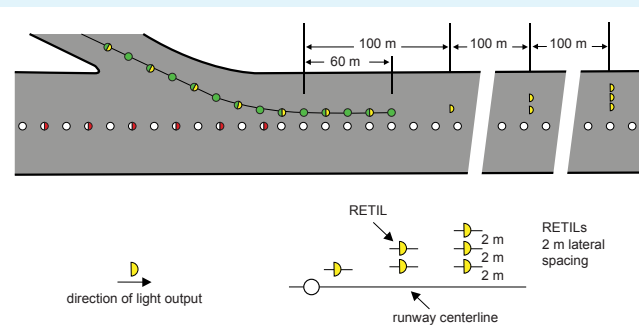
Figure 7.13—Runway Touchdown Zone Lighting



7.9 RAPID-EXIT TAXIWAY INDICATOR LIGHTS (RETIL)

Rapid-exit taxiway indicator lights (RETIL) provide pilots with distance-to-go information to the nearest rapid-exit taxiway on the runway. RETIL are fixed unidirectional yellow lights located on the runway on the same side of the runway centreline as the associated rapid-exit taxiway, in the configuration shown in Figure 7.14.

Figure 7.14—Rapid-Exit Taxiway Indicator Lights



7.10 TAXIWAY LIGHTING

7.10.1 Taxiway Edge Lights

Taxiway edge lights are blue in colour and are spaced at maximum intervals of 60 m. Where a taxiway intersects another taxiway or a runway, two adjacent blue lights are placed at each side of the taxiway where no fillet or curve is provided. To facilitate the identification of the taxiway entrance for an aircraft on departure and arriving from the apron, the intersection of an apron with a taxiway is indicated by two adjacent yellow lights at taxiway/apron corners.

7.10.2 Taxiway Centreline Lights

Taxiway centreline lights are green in colour and are installed on the taxiway surface. They are spaced at 15-m intervals with less spacing on taxiway curves. Taxiway centreline lights on an exit taxiway show alternate green and yellow from their beginning near the runway centreline to the outer perimeter of the ILS critical/sensitive area or the runway-holding position, whichever is farther from the runway; thereafter, all lights show green.

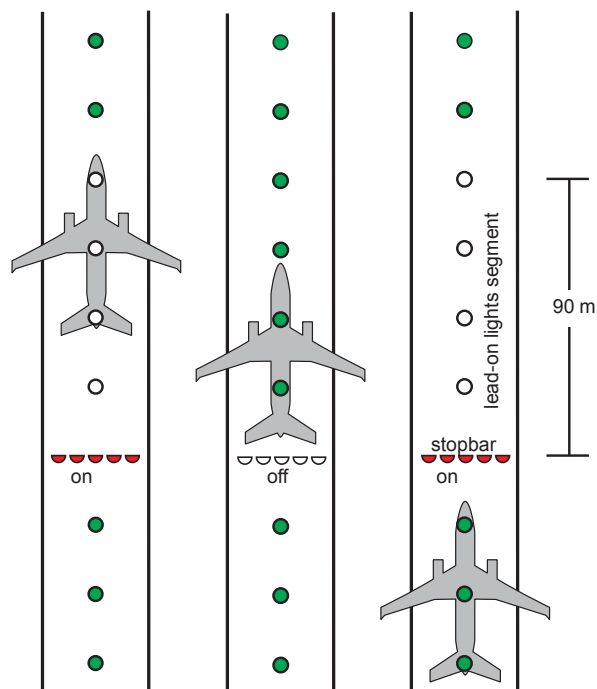
7.10.3 Stop Bars

A stop bar is provided at every runway-holding position serving a runway intended to be used in visibility conditions below RVR 1200 (¼ SM). Stop bars are located across the taxiway at the desired stopping point for traffic and consist of lights spaced at intervals of 3 m across the taxiway. They show red in the intended direction of approach to the intersection or runway-holding position.

Where the stop bar is co-located with taxiway centreline lighting, a 90-m segment of the taxiway centreline lighting beyond the stop bar is turned off when the stop bar is illuminated. The stop bar is illuminated again after a timed duration or by means of sensors installed on the taxiway.

An aircraft should never cross an illuminated stop bar, even with clearance from ATC.

Figure 7.15—Stop Bar Lighting



7.11 RUNWAY GUARD LIGHTS

Runway guard lights are provided at each taxiway/runway intersection to enhance the conspicuity of the holding position for taxiways supporting runway operations below a visibility value of runway visual range (RVR) 2600 ($\frac{1}{2}$ SM). They consist of yellow unidirectional lights that are visible to the pilot of an aircraft taxiing to the holding position, but their configuration may vary:

- They can consist of a series of lights spaced at intervals of 3 m across the taxiway. Where this is the case, the adjacent lights illuminate alternately and even lights illuminate alternately with odd lights.
- They can consist of two pairs of lights, one on each side of the taxiway adjacent to the hold line. Where this is the case, the lights in each unit illuminate alternately.

7.12 HELIPORT LIGHTING

7.12.1 Touchdown and Lift-Off Area (TLOF) Lighting

Where a heliport is used at night, the perimeter of the TLOF may be lighted by yellow perimeter lights or by floodlighting.

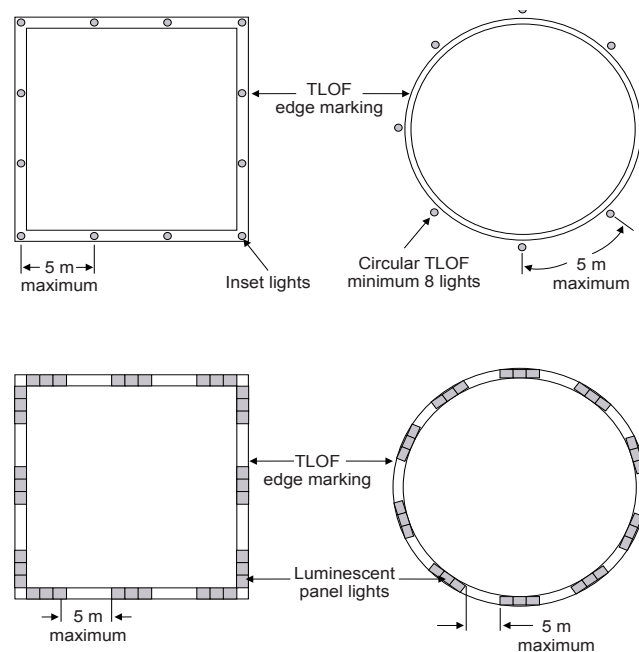
- Yellow perimeter lights:* Where the TLOF is circular, no fewer than eight yellow lights are used to mark the perimeter. In a rectangular layout, the perimeter is marked by a minimum of four yellow lights on each side, with a light at each corner.

- Floodlighting:* When provided, the floodlighting will illuminate the TLOF such that the perimeter marking of the TLOF is visible. Floodlight units will be located beyond the perimeter of the FATO.

NOTE:

Perimeter lighting or reflective tape may be used in addition to floodlighting.

Figure 7.16—Examples of TLOF Lighting



7.12.2 Final Approach and Take-Off (FATO) Lighting

A FATO perimeter is marked by white or green lights in the same configuration as TLOF perimeter lighting (see AGA 7.12.1). Where a TLOF is not located within a FATO, the aiming point will be defined by at least seven red aeronautical ground lights located on the triangular marking.

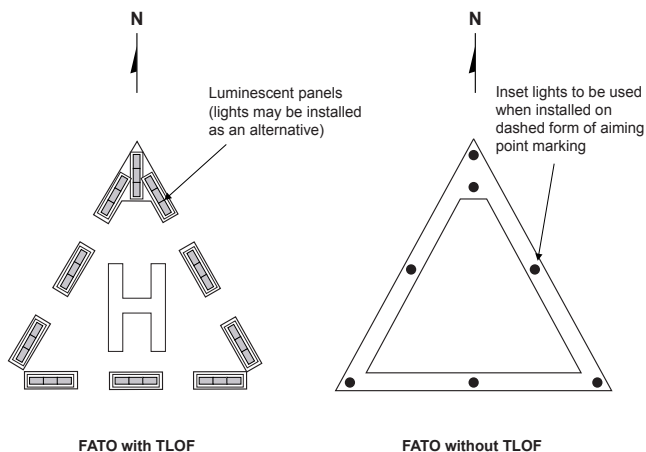
FATO or TLOF perimeter lights may be LEDs. Consult the CFS for verification of lighting type.

CAUTION:

Heliports using LED lighting systems may not be visible when certain NVIS equipment is employed. This is an operational limitation of the NVIS equipment, as the purpose of heliport lighting is to be viewed by the naked eye.

Candela values for heliport lighting systems are detailed in Figure 5-11 of ICAO Annex 14, Volume II.

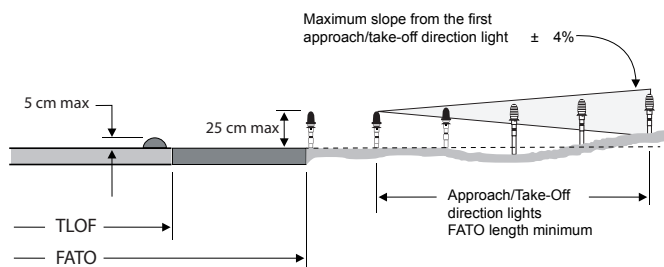
Figure 7.17—FATO and Aiming Point Lighting



7.12.3 Approach/Take-Off Direction Lights

At some heliports, where it is necessary to follow preferred approach and take-off paths to avoid obstructions or noise-sensitive areas, the direction of the preferred approach and take-off routes will be indicated by a row of five yellow fixed omnidirectional lights outside the FATO.

Figure 7.18—Maximum Mounting Height for TLOF, FATO, and Approach/Take-Off Direction Lights



7.13 EMERGENCY LIGHTING

Airports with Category (CAT) I, II, and III precision approaches in Canada are equipped with a secondary power system for visual aids lighting. This system is normally capable of assuming the electrical load within approximately 15 s for CAT I operations, and within 1 s for CAT II and III operations.

7.14 AIRCRAFT RADIO CONTROL OF AERODROME LIGHTING (ARCAL)

Aircraft radio control of aerodrome lighting (ARCAL) systems are becoming more prevalent as a means of conserving energy, especially at aerodromes not staffed on a continuous basis or at which it is not practicable to install a land line to a nearby flight service station (FSS). Aside from obstacle lights, some or all of the aerodrome lighting may be radio-controlled.

Control of the lights should be possible when aircraft are within 15 NM of the aerodrome. The frequency range is 118 to 136 MHz.

The system is activated via the aircraft very high frequency (VHF) transmitter and by pressing the push-to-talk button on the microphone a given number of times within a specified number of seconds. Each activation will start a timer to illuminate the lights for a period of approximately 15 min. The timing cycle may be restarted at any time by repeating the specified keying sequence. It should be noted that ARCAL Type K runway threshold identification lights (RTIL) (code AS) can be turned off by keying the microphone three times on the appropriate frequency. The code for the intensity and the lighting period varies for each installation. Consequently, the *Canada Flight Supplement (CFS)* must be consulted for each installation.

NOTE:

Pilots are advised to key the activating sequence when beginning their approach, even if the aerodrome or airport lighting is on. This will restart the timing cycle so that the full 15-min cycle is available for their approach.

7.15 RETROREFLECTIVE MARKERS

Some aerodromes may use retroreflective markers in place of lights to mark the edges of runways or helipads. These retroreflective markers are approved for use on runways at registered aerodromes only; however, they may be used as a substitute for edge lighting on taxiways or apron areas at some certified airports.

Retroreflective markers are to be positioned in the same manner as runway lighting described earlier in this chapter. Therefore, when the aircraft is lined up on final approach, retroreflective markers will provide the pilot with the same visual representation given by normal runway lighting. A fixed white light or strobe light shall be installed at each end of the runway to assist pilots in locating the aerodrome and aligning the aircraft with the runway. Similarly, retroreflective markers at heliports are to be positioned in the same pattern that is prescribed for helipad edge lighting.

The approved standard for retroreflective markers requires that they be capable of reflecting the aircraft landing lights so that they are visible from a distance of 2 NM. Pilots are cautioned that the reflective capabilities of retroreflective markers are greatly affected by the condition of the aircraft landing lights, the prevailing visibility, and other obscuring weather phenomena. Therefore, as part of pre-flight planning to an aerodrome that uses retroreflective markers, pilots should exercise extra caution in checking the serviceability of their aircraft landing lights and making provision for an alternate airport with lighting in case of an aircraft landing light failure.

8.0 AIRCRAFT RESCUE AND FIRE FIGHTING (ARFF)

8.1 GENERAL

Aircraft rescue and firefighting (ARFF) service is provided at some airports in accordance with the criteria stated in *Canadian Aviation Regulation (CAR) 303*. The primary responsibility of an ARFF service is to provide a fire-free egress route for the evacuation of passengers and crew following an aircraft accident.

8.2 AIRCRAFT RESCUE AND FIRE FIGHTING (ARFF) HOURS OF AVAILABILITY

Aerodromes or airports that provide aircraft rescue and firefighting (ARFF) publish the hours during which an ARFF service is operated in the *Canada Flight Supplement (CFS)* under the ARFF annotation. If there are no published hours next to the ARFF critical category number, this means 24-hour service is offered.

8.3 CLASSIFICATION SYSTEM

Table 8.1 identifies the critical category for firefighting as it relates to the aircraft size, the quantities of water and complementary extinguishing agents, the minimum number of aircraft rescue and firefighting (ARFF) vehicles, and the total discharge capacity. For ease of interpretation, the table is a combination of the two tables found under *Canadian Aviation Regulation (CAR) 303*.

Table 8.1—Classification for ARFF Purposes

Aircraft Category	Aircraft Overall Length	Maximum Fuselage Width (m)	Quantity of Water (L)	Quantity of Complementary Agents (kg)	Minimum Number of Aircraft Firefighting Vehicles	Total Discharge Capacity (L/min)
1	less than 9 m	2	230	45	1	230
2	at least 9 m but less than 12 m	2	670	90	1	550
3	at least 12 m but less than 18 m	3	1 200	135	1	900
4	at least 18 m but less than 24 m	4	2 400	135	1	1 800
5	at least 24 m but less than 28 m	4	5 400	180	1	3 000
6	at least 28 m but less than 39 m	5	7 900	225	2	4 000
7	at least 39 m but less than 49 m	5	12 100	225	2	5 300
8	at least 49 m but less than 61 m	7	18 200	450	3	7 200
9	at least 61 m but less than 76 m	7	24 300	450	3	9 000
10	at least 76 m	8	32 300	450	3	11 200

8.4 AIRCRAFT RESCUE AND FIRE FIGHTING (ARFF) STANDBY REQUEST

Local standby means the level of response when an aircraft has, or is suspected to have, an operational defect. The defect would normally cause serious difficulty for the aircraft to achieve a safe landing.

Full emergency standby means the level of response when an aircraft has, or is suspected to have, an operational defect that

affects normal flight operations to the extent that there is possibility of an accident.

When informed that an emergency has been declared by a pilot, the airport aircraft rescue and firefighting (ARFF) unit will take up emergency positions adjacent to the landing runway and stand by to provide assistance. Once response to an emergency situation has been initiated, the ARFF unit will remain at the increased state of alert until informed that the pilot-in-command

has terminated the emergency. After the landing, ARFF will intervene as necessary and, unless the pilot-in-command authorizes their release, escort the aircraft to the apron and remain in position until all engines are shut down.

For an adequate response on the part of the ARFF unit, a pilot request to “stand by in the fire hall” is not appropriate. Pilots are reminded, however, that the ARFF unit will terminate their state of alert when informed by the pilot that the emergency situation no longer exists.

8.5 AIRCRAFT RESCUE AND FIRE FIGHTING (ARFF) DISCREET COMMUNICATION

The capability to communicate on a discreet frequency is normally available at airports that provide aircraft rescue and firefighting (ARFF) services.

9.0 AIRCRAFT ARRESTING SYSTEMS

9.1 ENGINEERED MATERIAL ARRESTING SYSTEMS (EMAS)

The engineered material arresting system (EMAS) is an arresting system designed for transport category aeroplanes in the event of a runway overrun. An EMAS bed is designed to stop an overrunning aeroplane by exerting predictable deceleration forces on its landing gear as the EMAS material crushes.

9.1.1 System Description

The strength of the arrester bed is designed to reduce the aeroplane’s speed without leading to structural failure of the landing gear. The beds are made up of a grouping of crushable cellular concrete blocks that will reliably and predictably be crushed under the weight of an aeroplane.

To arrest an aeroplane overrunning a runway end, EMAS beds are placed beyond the end of a runway and in alignment with the extended runway centreline.

Figure 9.1—Photograph of an EMAS Installation

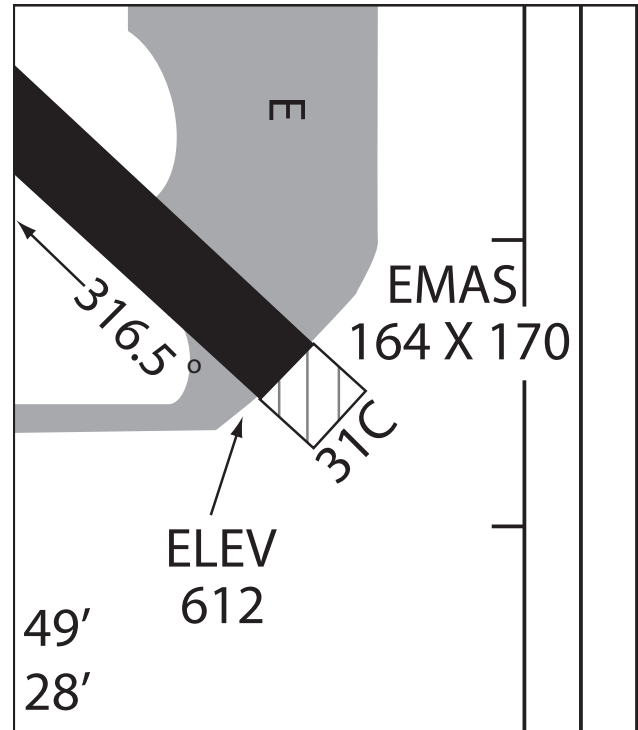


(The EMAS bed is the grey area under the yellow chevrons)

9.1.2 System Depiction

The aerodrome sketch will show the location and dimensions of the EMAS beds. In the example below, the EMAS bed is shown as an outlined box with diagonal lines running through it. The dimensions are provided in feet.

Figure 9.2—EMAS Depiction on an Aerodrome Sketch



9.1.3 Pilot Considerations for Engagement

Prior to using a runway, pilots should be aware of the presence of an EMAS bed. Pilots should review the aerodrome sketch and other aerodrome information to determine whether the runway that they will be using is equipped with an EMAS.

If, during the take-off or landing phase, a pilot determines that the aeroplane will overrun the runway end and enter the EMAS, the following procedure should be followed:

- a) *Continue to follow the rejected-takeoff procedures or, in the case of landing, the maximum-braking procedures outlined in the AFM, regardless of the aeroplane’s speed upon overrunning the runway.*
- b) *Continue straight ahead—do not veer left or right. The EMAS’s stopping capability is maximized when all of the aeroplane’s landing gears enter the bed. Veering to the side may result in the aeroplane missing the bed altogether or having only one set of wheels enter the bed with reduced effectiveness. The quality of deceleration will be best within the confines of the bed. The further the aeroplane travels into the bed, and into deeper concrete, the greater the deceleration.*

- c) *Do not take any action—the arrester bed is a passive system, similar to other traditional arresting systems such as cables, chains, and aircraft netting.*
- d) *Do not attempt to taxi or otherwise move the aeroplane once it has stopped.*
- e) *Use standard aircraft emergency ground egress procedures, should an emergency egress be required. Where the surface of the bed has been breached, the loose material will crumble underfoot. During egress, it is important to note that the two sides and the back of the arrester bed have built-in continuous steps built in to help provide easy access for ARFF vehicles and to enable passengers to step off the bed safely.*
- f) *Use slides or aircraft stairs to allow passengers to deplane after an EMAS arrestment, since the EMAS bed will not provide a stable base for the air stairs.*

cable at speeds in excess of 10 mph because a wave action may develop in the cable, which could damage the aircraft. This is particularly important for nose-wheel aircraft with wheel fairings or minimal propeller or undercarriage-door clearance. Tail-wheel aircraft may also sustain damage if the tail wheel engages the cable.

- b) **Runway edge sheaves:** The runway edge sheaves are above grade and located next to the runway edge, on the runway shoulder. The two sides perpendicular to the runway are sloped, but the other two sides, parallel to the runway, are vertical. The runway edge sheaves are not frangible and may cause damage to aeroplanes that contact or roll over them.
- c) **Energy absorbers:** The energy absorbers are normally located beside the graded area of the runway strip (at a distance greater than 61 m from the runway centreline). The energy absorbers are not frangible and will cause damage to aeroplanes that come into contact with them.

9.2 MILITARY AIRCRAFT ARRESTING SYSTEMS

9.2.1 Background

Some civil airports and military aerodromes are equipped with aircraft arresting systems. An aircraft arresting system usually consists of two sets of gear, called energy absorbers, with one located on each side of the runway, normally approximately 460 m from the threshold. These energy absorbers are interconnected by an arrester cable, which is attached to a nylon tape that is wound onto a tape storage drum (reel) on each energy absorber. To keep the energy absorbers away from the edge of the runway, runway edge sheaves are located next to the runway edge. The runway edge sheaves act as a guide (pulley) for the tape and have sloped sides to permit an aircraft to roll over them.

When the tailhook of a fighter aircraft engages the cable, the tape storage drums start to turn. The energy absorbers apply a braking force to the storage drums, which in turn slows the aircraft and brings it to a stop.

9.2.2 Markings

For identification, yellow circles are painted across the runway at the location of the aircraft arrester cable. A lighted sign with a yellow circle is located beside the runway to mark the location during darkness.

9.2.3 Operations

At civil airports, civil aviation operations will not be permitted while the arrester cable is deployed across the runway. At military aerodromes, civil aeroplane operations may be permitted with the arrester cable deployed across the runway.

9.2.4 Damage Hazards

- a) **Cables:** Pilots are advised to avoid crossing the aircraft arrester

9.2.5 Information for Pilots

Pilots will normally be advised of the status of the arrester cable through ATIS or by ATC. The presence of an aircraft arresting system should be included in the RWY DATA entry of the CFS for the aerodromes. The location of an aircraft arresting system should also be depicted on the aerodrome sketch.

10.0 AIRPORT COLLABORATIVE DECISION MAKING (A-CDM)

10.1 INTRODUCTION

Airport Collaborative Decision Making (A-CDM) is a method for improving the predictability of airport operations, resulting in the more efficient use of available resources and a better passenger experience. A-CDM has been in use for some years in various parts of the world and its benefits have been demonstrated.

A-CDM requires the partners involved in the operation of the airport to exchange certain information that meets prescribed levels of quality and timeliness. Furthermore, aircraft operations will be subject to defined A-CDM procedures. Adherence to these procedures is usually mandatory for most aircraft operators, unless a specific exemption applies.

10.2 OPERATIONAL CONCEPT

One of the objectives of Airport Collaborative Decision Making (A-CDM) is to make aircraft turnaround more predictable and create an efficient outbound flow of traffic. This is achieved by requiring a reliable and accurate Target Off-Block Time (TOBT) for each flight. This TOBT is then used to set up an optimal pushback and start-up sequence that considers all applicable

constraints, like de-icing and possible air traffic flow management restrictions.

Operators and their designated representatives are responsible for keeping the TOBT up to date by providing updates as necessary. The flight crew is responsible for operating the aircraft, taking the Target Start-Up Approval Time (TSAT) into account. Failure to comply with these responsibilities will usually result in an operational penalty.

More details about a typical A-CDM operation can be found in the *A-CDM Operations Manual – YYZ Edition*, available from the Greater Toronto Airports Authority at <http://torontopearson.com/acdm/>.

10.3 TERMS

The following terms and abbreviations are generally used with Airport Collaborative Decision Making (A-CDM):

Table 10.1—Terms and Abbreviations Used With A-CDM

Term	Definition
Appropriate radio frequency	The radio frequency that a flight crew must use to contact the Apron Management Unit (AMU) or other air traffic services (ATS) unit as part of an A CDM procedure.
Calculated take off time (CTOT)	The time calculated and issued by the air navigation service provider that indicates when an aircraft should be airborne if it is to meet the constraints arising from the applicable Traffic Management Initiatives (TMIs).
Commercial air transport operation	An aircraft operation involving the transport of passengers, cargo, or mail for remuneration or hire.
Designated representative	A person or organization authorized by an operator to act and perform tasks on its behalf within the constraints of their representation agreement.
Estimated off-block time (EOBT)	The estimated time at which the aircraft will start movement associated with departure. Note: This is the time shown in Item 13 of the flight plan.
Flight crew member	A licensed crew member charged with duties essential to the operation of an aircraft during a flight duty period.
Flight plan	Specified information provided to ATS units, relative to an intended flight or portion of a flight of an aircraft.

Term	Definition
General aviation (GA) operation	An aircraft operation other than a commercial air transport operation. GA operations include business aviation (BA) operations.
Ground handler	An organization offering the ground handling services that an aircraft needs for the period during which it is on the ground.
HMI	Human-Machine Interface
Minimum turnaround time (MTTT)	The minimum amount of time agreed upon with an operator or ground handler for a specified flight or aircraft type.
Operator	The person, organization, or enterprise engaged in or offering to engage in an aircraft operation.
Pilot-in-command (PIC)	The pilot designated by the operator, or, in the case of GA, the owner, as being in command and charged with the safe conduct of a flight.
Scheduled off-block time (SOBT)	The time that an aircraft is scheduled to depart from its parking position. Note: SOBT is the coordinated airport slot.
Target off-block time (TOBT)	The time at which an operator or ground handler estimates that an aircraft will be ready, with all doors closed, the boarding bridge removed, and a pushback vehicle available and ready to start up/push back immediately upon receiving clearance from the AMU. Note: TOBT is equivalent to estimated time of departure (ETD) as used by operators and ground handlers.
Target start-up approval time (TSAT)	The time at which an aircraft can expect to receive start-up/pushback approval. The TSAT may be equal to the TOBT.
Target take off time (TTOY)	The time at which an aircraft is expected to be airborne based on its TSAT and on the time it takes to taxi to the assigned runway.

10.4 SCOPE OF APPLICABILITY

Airport Collaborative Decision Making (A-CDM) procedures are normally mandatory for all flights operated as commercial air transport or general aviation (GA) operations. Depending on the airport, helicopters and flights identified by any one of the following designators in Item 18 of their flight plan, or by any other agreed-upon means that may be applicable, are sometimes exempt from adhering to A-CDM procedures:

Table 10.2—Operations Exempted From A-CDM Procedures

STS/FFR	Fire fighting
STS/HEAD	Flight with Head of State status
STS/HOSP	Flight on an actual medical mission
STS/MEDEVAC	Flight operated for life-critical medical emergency evacuation
STS/SAR	Flight engaged in a search and rescue mission
STS/STATE	Flight engaged in military, customs, or police services
STS/FLTCK	Aircraft performing NAVAID flight check

Any exemptions would be granted based on the type of mission an aircraft is engaged in and not on the identity of the operator.

10.5 AIRPORT COLLABORATIVE DECISION MAKING (A-CDM) PROCEDURES

Airport Collaborative Decision Making (A-CDM) procedures generally fall into the following three categories:

- a) Commercial Air Transport Operations—Procedures for Operators and Handling Agents
- b) Commercial Air Transport Operations—Flight Crew Procedures
- c) General and Business Aviation Operations—Air Operator Procedures

10.5.1 Commercial Air Transport Operations – Procedures for Operators and Handling Agents

10.5.1.1 Requirement for All Flights to Have a Current Target Off-Block Time (TOBT)

The TOBT is used to indicate when the aircraft will be ready to push back and start its engines. The initial TOBT is usually obtained by the A-CDM system from one of the following sources:

- a) Estimated time of departure (ETD) provided by an operator via the appropriate communications channel;
- b) EOBT from the flight plan; or
- c) SOBT from the airport coordinated schedule data held by the GTAA.

10.5.1.2 Preferred Way of Providing the Target Off-Block Time (TOBT)

Operators are reminded that using the SOBT may result in an inaccurate TOBT. It is therefore highly recommended that they explore options for providing the ETD via the appropriate

communications channel. This can be normally be done by contacting the Manager of Operations, Airport Flow, who typically serves as the single point of contact for all A-CDM-related matters.

10.5.1.3 Access to the Target Off-Block Time (TOBT)

The TOBT will be shown and accessible via the A-CDM application and the A-CDM HMI (such as a web portal) as soon as it is set in the A-CDM system.

10.5.1.4 Pre-Departure Sequencing – Target Start-Up Approval Time (TSAT) Generation

Based on the TOBT, a TSAT is generated by the A-CDM system for every flight. The TSAT is used to indicate the sequence in which aircraft can expect to receive pushback and start-up approval, ensuring an optimal flow of traffic to the assigned runways. An update to the TOBT will always result in the recalculation of the TSAT. However, this may not always result in a different TSAT or position in the sequence for the flight concerned.

Any applicable constraints, like the CTOT, resulting from TMIs, taxi times, and possible de-icing time are considered in the calculation of the TSAT to ensure that such constraints are always met.

10.5.1.5 Access to the Target Start-Up Approval Time (TSAT)

The TSAT will be shown in the A-CDM system via the A-CDM application and the A-CDM HMI as soon as stand and runway information are both available in the A-CDM system.

10.5.1.6 Target Start-Up Approval Time (TSAT) Swapping

An operator or handling agent (as applicable) may be able to swap the TSATs between flights of its own operator family if a given flight is delayed or if a reduction of the waiting time for a flight is desirable. Eligible flights are identified as such on the A-CDM system HMI.

10.5.1.7 The Importance of Updating the Target Off-Block Time (TOBT)

Operators and ground handlers (as appropriate) are responsible for updating the TOBT if there is a difference of +/- 5 minutes compared to the initial or previously updated TOBT. Failing to update the TOBT will result in a TSAT that is no longer operationally correct, and this, in turn, may cause the flight to be subject to unnecessary delay.

10.5.1.8 Target Off-Block Time (TOBT) Update Limitations

The TOBT can normally be updated as many times as necessary until 10 minutes prior to the TOBT. Thereafter, only two more updates are possible. Should a third update be necessary, the

operator or handling agent will likely need to contact the Manager of Operations, Airport Flow, for further instructions.

10.5.1.9 Methods for Updating the Target Off-Block Time (TOBT)

The TOBT may be updated via any of the available systems providing access to it.

10.5.2 Commercial Air Transport Operations – Flight Crew Procedures

10.5.2.1 Target Off-Block Time (TOBT) and Target Start-Up Approval Time (TSAT) Delivery Channels

Several channels are often provided for the delivery of the TOBT and TSAT to the flight crew. Operators are free to use any available channel. The following channels are examples:

- a) Advanced Visual Docking Guidance System (AVDGS), where available.
- b) Any specific means of communication that may exist between the operator or ground handler and the flight crew. This means of communication may be shared with other operational communications.
- c) An A-CDM web portal.

10.5.2.2 Access to the Target Off-Block Time (TOBT)

The TOBT will be displayed for the flight crew on all channels as soon as it is set in the A-CDM system.

10.5.2.3 Access to the Target Start-Up Approval Time (TSAT)

The TSAT will be displayed for the flight crew on all channels except the AVDGS as soon as it is set in the A-CDM system. It is expected that the TSAT will be displayed for the flight crew on the AVDGS as follows:

- a) 10 minutes before TOBT; or
- b) 20 minutes before TOBT if the TSAT is later than the TOBT by 20 minutes or more (as may be the case due to TMIs).

10.5.2.4 Information Related to Airport Collaborative Decision Making (A-CDM) on the Advanced Visual Docking Guidance System (AVDGS)

The information displayed on the AVDGS depends on the operating mode of the A-CDM system, such as:

- a) Traditional Ramp Information Display (e.g. ETD) = A-CDM is not running or A-CDM procedures have been suspended; or

- b) TOBT + time or TOBT + time and TSAT + time = A-CDM is running.

10.5.2.5 Call Ready Procedure

The flight crew usually must call the Apron Coordinator on the published radio frequency for the airport at TOBT +/- 5 minutes to confirm that the flight is ready as defined for the TOBT and state the location “gate.” Thereafter, the crew will need to change to the appropriate radio frequency and monitor it for pushback and start-up approval.

If the flight crew fails to call within the specified time window, it will be assumed that the TOBT is no longer valid and the corresponding TSAT will be removed from the sequence. The operator or ground handler will need to provide a new TOBT for a new TSAT to be generated. This may result in a substantial delay for the flight concerned.

10.5.2.6 Procedures for Extended Times Between Target Off-Block Time (TOBT) and Target Start-Up Approval Time (TSAT)

The time difference between the TOBT and the TSAT assigned to the flight may be substantial. Airports usually have a policy for aircraft to stay at the gate until the assigned TSAT time. In cases where the gate is required for another flight, or on the specific request of the operator or ground handler, the aircraft concerned could be relocated to a waiting area.

10.5.2.7 Airport Collaborative Decision Making (A-CDM)-Imposed Waiting Time and On-Time Performance

Traditionally, on-time performance (OTP) is measured by the point in time when the aircraft releases the brakes and is ready for movement associated with departure. If an aircraft waits at the stand for its TSAT, the time between TOBT and TSAT might be counted as a departure delay, adversely impacting the air operator’s OTP. It is recommended that air operators implement procedures whereby the time at which the flight crew makes the ready call is considered as the reference for OTP and any waiting time after the TOBT is met can be successfully ignored.

10.5.2.8 Pushback / Start-Up Approval

Depending on the airport, flight crews might expect pushback instructions and start-up approval to be issued on the appropriate radio frequency by the AMU at TSAT +/- 5 minutes without a need for the flight crew to make an additional call.

If the pushback and start-up process does not commence within 2 minutes of the time the approval was issued, the flight crew must call the AMU on the appropriate radio frequency, explain the situation, and request guidance on how to proceed. If this call is omitted, it will be assumed that the TSAT is no longer valid, and it will be removed from the sequence. The operator or ground handler will need to provide a new TOBT for a new TSAT to be generated. This may result in a substantial delay for the flight concerned.

If the pushback and start-up process is interrupted for any reason after the aircraft has cleared the stand area or if the start-up process is expected to take longer than normal, the flight crew must call the AMU on the appropriate radio frequency, explain the situation, and request guidance on how to proceed.

Flight crews are reminded that the actual order of pushback and start-up approval depends on the operational decisions of the AMU and hence, a difference may exist between the system-generated sequence and the sequence as established by the AMU. However, even after a manual intervention, any applicable constraints, like CTOT, would be met by the modified sequence.

10.5.2.9 Flight Crew Concerns About Meeting Constraints

All functions of an A-CDM system are designed to ensure that applicable constraints, most importantly those resulting from TMIs, are always fully met. For example, the TSAT is calculated taking all applicable constraints into account, and if duly observed by the flight crew, the runway slot (CTOT) allocated to the flight will not be missed.

Nevertheless, if flight crew members estimate that a TSAT assigned to them and their applicable CTOT are not compatible, they should contact their operator or ground handler to resolve the issue via the Manager of Operations, Airport Flow.

10.5.2.10 De-icing Operations

The need for de-icing has a substantial impact on standard A-CDM procedures, in particular the extended taxi times needed to account for the duration of the de-icing operation. To ensure that the de-icing needs of individual flights are properly considered, the following additional procedures are typically applicable during de-icing operations:

- a) A request for de-icing would normally be transmitted by the flight crew on the clearance delivery frequency.
- b) If the flight crew determines, following clearance delivery, that de-icing is required, they would contact the AMU on the applicable radio frequency and request de-icing.

10.5.3 General and Business Aviation Operations – Air Operator Procedures

10.5.3.1 Prior Permission to Operate Required (Reservation)

Operators or the designated representatives of general and business aviation aircraft typically obtain prior permission to operate (reservation) from the applicable airport authority using A-CDM procedures up to 72 hours before the EOBT, or a minimum of 60 minutes before the EOBT of the planned operation. Some airports have special arrangements with GA/BA Tenant Carriers allowing them to book up to 30 days prior to the EOBT.

Permission or reservation can normally be obtained by contacting the airport authority.

10.5.3.2 Requirement to Provide the Target Off-Block Time (TOBT)

Similar to Commercial Air Transport Operations, General and Business Aviation flights must also have a TOBT. Operators can typically obtain their TOBT using the airport's A-CDM web portal.

10.5.3.3 Pre-Departure Sequencing – Target Start-Up Approval Time (TSAT) Generation

Based on the TOBT, a TSAT is generated by the A-CDM system for every flight. The TSAT is used to indicate the sequence in which aircraft can expect to receive start-up approval, ensuring an optimal flow of traffic to the assigned runways. An update to the TOBT will always result in the recalculation of the TSAT; however, this may not always result in a different position in the sequence for the flight concerned.

Any applicable constraints, like the CTOT resulting from TMIs, taxi times, and possible de-icing time are considered in the calculation of the TSAT, ensuring that such constraints are always met.

10.5.3.4 Access to the Target Start-Up Approval Time (TSAT)

The TSAT will be shown in the A-CDM web portal as follows:

- a) 10 minutes before the TOBT; or
- b) 20 minutes before the TOBT if the TSAT is later than the TOBT by 20 minutes or more (as may be the case due to TMIs).

10.5.3.5 The Importance of Updating the Target Off-Block Time (TOBT)

Operators or their designated representatives are obliged to update the TOBT if there is a difference of +/- 5 minutes compared to the initial or previously updated TOBT. Failing to update the TOBT will result in a TSAT that is no longer operationally correct. This, in turn, may cause the flight to be subject to unnecessary delay.

10.5.3.6 Target Off-Block Time (TOBT) Update Limitations

The TOBT may normally be updated as many times as necessary until 10 minutes prior to the TOBT. Thereafter, only two more updates are usually possible. Should a third update be necessary, the operator or its designated representative should contact the Manager of Operations, Airport Flow, for further instructions.

10.5.3.7 Method for Updating the Target Off-Block Time (TOBT)

The TOBT must be updated either by updating the flight plan EOBT or via the airports A-CDM web portal.

10.5.3.8 Target Off-Block Time (TOBT) and Target Start-Up Approval Time (TSAT) Delivery Channels

Several channels are provided for the delivery of the TOBT and TSAT to the flight crew, such as:

- a) The A-CDM web portal;
- b) Any specific means of communication that may exist between the operator or its designated representative and the flight crew; or
- c) The AVGDS, where available.

10.5.3.9 Access to the Target Off-Block Time (TOBT)

The TOBT will be displayed for the flight crew on all channels as soon as it is set in the A-CDM system.

10.5.3.10 Access to the Target Start-Up Approval Time (TSAT)

The TSAT will usually be displayed for the flight crew on all channels as follows:

- a) 10 minutes before the TOBT; or
- b) 20 minutes before the TOBT if the TSAT is later than the TOBT by 20 minutes or more (as may be the case due to TMIs).

10.5.3.11 Call Ready Procedure

The flight crew should expect to call the AMU Apron Coordinator at TOBT +/- 5 minutes to confirm that the flight is ready as defined for the TOBT; they must state their location on the airport. The Apron Coordinator will advise the TSAT and then instruct the flight crew to change to the appropriate radio frequency. If the flight crew fails to call within the specified time window, it will be assumed that the TOBT is no longer valid and the corresponding TSAT will be removed from the sequence. The operator or its designated representative will need to provide a new TOBT for a new TSAT to be generated. This may result in a substantial delay for the flight concerned.

10.5.3.12 Start-Up Procedures

The start-up procedure typically commences at TSAT +/- 5 minutes without a need for the flight crew to make an additional call.

If the start-up process does not commence within 2 minutes of the TSAT time that was issued, the flight crew must call the AMU on the appropriate radio frequency, explain the situation, and request guidance on how to proceed. If this call is omitted, it will be assumed that the TSAT is no longer valid and it will

be removed from the sequence. The operator or its designated representative needs to provide a new TOBT via the A-CDM web portal or via the Manager of Operations, Airport Flow, for a new TSAT to be generated. This may result in a substantial delay for the flight concerned.

If the start-up process is interrupted for any reason or if the start-up process is expected to take longer than normal, the flight crew must call the AMU on the appropriate radio frequency, explain the situation, and request guidance on how to proceed.

Flight crew are reminded that the actual order of start-up approval depends on the operational decisions of the AMU. Hence, a difference may exist between the system-generated sequence and the sequence as established by the AMU. However, even after such manual intervention, the applicable constraints, like CTOT, would be met by the modified sequence.

10.5.3.13 Flight Crew Concerns About Meeting Constraints

All functions of the A-CDM system are designed to ensure that applicable constraints, most importantly those resulting from TMIs, are always fully met. For example, the TSAT is calculated to take all applicable constraints into account. If duly observed by the flight crew, the runway slot (CTOT) allocated to the flight would not be missed.

Nevertheless, if flight crew members estimate that a TSAT assigned to them and their applicable CTOT are not compatible, they should contact their operator or ground handler to resolve the issue via the Manager of Operations, Airport Flow.

10.5.3.14 De-icing Operations

The need for de-icing has a substantial impact on standard A-CDM procedures, especially the extended taxi times needed to account for the duration of the de-icing operation. To ensure that the de-icing needs of individual flights are properly considered, the following additional procedures are applicable during de-icing operations:

- a) A request for de-icing would normally be transmitted by the flight crew on the airport clearance delivery frequency.
- b) If members of the flight crew determine after clearance delivery that de-icing is required, they must contact the AMU and request de-icing.

10.6 CONTINGENCY OPERATIONS

If the Airport Collaborative Decision Making (A-CDM) system fails or becomes unreliable, the A-CDM procedures will be suspended. The suspension and eventual restarting of the procedures will be announced via the airport terminal information service (ATIS) broadcast and a NOTAM. During suspension of the A-CDM procedures, no target off-block time (TOBT) or target start-up approval time (TSAT) will be provided.



COM—COMMUNICATIONS, NAVIGATION AND SURVEILLANCE

1.0 VOICE COMMUNICATIONS

1.1 GENERAL

This subpart deals with mobile radio communications between aircraft and ground stations. Particular emphasis is placed on radiotelephony procedures that are intended to promote understanding of messages and reduce communication time.

The primary medium for aeronautical voice communications in Canada is VHF-AM in the frequency range of 118 to 137 MHz. For increased range in northern areas and the North Atlantic, HF-SSB is available in the frequency range of 2.8 to 22 MHz.

1.2 REGULATIONS

- a) *Operator’s certificates*—In accordance with section 33 of the *Radiocommunication Regulations*, a person may operate radio apparatus in the aeronautical service [...] only where the person holds [a Restricted Operator Certificate with Aeronautical Qualification, issued by Industry Canada]
- b) *Station licences*—All radio equipment used in aeronautical services is required to be licensed by Industry Canada.

For complete information on the requirements for communication in Canada, please consult the *Study Guide for the Restricted Operator Certificate with Aeronautical Qualification (ROC-A) (RIC-21)*. This study guide is available online by searching “RIC-21” on the Industry Canada Web site <www.canada.ca/en/innovation-science-economic-development.html>, from the nearest Industry Canada district office or by calling 1-877-604-7493.

1.3 LANGUAGE

The use of English and French for aeronautical radio communications in Canada is detailed in CARs 602.133, 602.134, and 602.135. For definitions of terminology and phraseology used in aviation in Canada, refer to the *Glossary for Pilots and Air Traffic Services Personnel (AC 100-001)*, which is available on TC’s Web site <www.tc.gc.ca/en/services/aviation/reference-centre/advisory-circulars/ac-100-001.html>.

1.4 VERY HIGH FREQUENCY (VHF) COMMUNICATION FREQUENCIES—CHANNEL SPACING

The standard very high frequency (VHF) air-ground channel spacing in Canada is 25 kHz. A 760-channel transceiver is necessary for operation of 25-kHz channels. This channel spacing means that some operators with 50-kHz capability will have their access to certain Canadian airspace and airports restricted, as 25-kHz channels are implemented for air traffic control (ATC) purposes. In some areas of Europe, channel spacing has been reduced to 8.33 kHz, which means that the same restrictions may apply.

Because the frequency selectors on some 25-kHz transceivers do not display the third decimal place, misunderstanding may exist in the selection of frequencies. With such transceivers, if the last digit displayed includes two and seven, then the equipment is capable of 25-kHz operations.

Example:

Toronto Centre: 132.475 (actual frequency)

ATC Assigned Frequency:..... 132.47 (digit 5 omitted)

Aircraft Radio Display:132.475 or 132.47

In either case, the aircraft radio is actually tuned to the proper frequency.

1.5 USE OF PHONETICS

Phonetic letter equivalents shall be used for single letters or to spell out groups of letters or words as much as practicable. The International Civil Aviation Organization (ICAO) phonetic alphabet should be used.

Table 1.1—Phonetic Alphabet and Morse Code

LETTER	CODE	WORD	PRONUNCIATION	LETTER	CODE	WORD	PRONUNCIATION
A	·-·	Alfa	AL fah	N	-·	November	no VEM ber
B	·-·-·	Bravo	BRAH VOH	O	-·-·	Oscar	OSS cah
C	·-·-·	Charlie	CHAR lee or SHAR lee	P	·-·-·	Papa	pah PAH
D	-·-·	Delta	DELL tah	Q	-·-·-	Quebec	keh BECK
E	·-·-·	Echo	ECK oh	R	·-·-	Romeo	ROW me oh
F	·-·-·	Foxtrot	FOKS trot	S	·-·-	Sierra	see AIR rah
G	-·-·	Golf	GOLF	T	-·-	Tango	TANG go
H	·-·-·	Hotel	hoh TELL	U	-·-·	Uniform	YOU nee form or OO nee form
I	·-·	India	IN dee ah	V	·-·-·	Victor	VIK tah
J	·-·-·	Juliett	JEW lee ETT	W	-·-·-	Whiskey	WISS key
K	-·-·	Kilo	KEY loh	X	-·-·-	X-ray	ECKS RAY
L	·-·-·	Lima	LEE mah	Y	-·-·-	Yankee	YANG key
M	-·-	Mike	MIKE	Z	-·-·-	Zulu	ZOO loo
NUMBER	CODE	WORD	PRONUNCIATION	NUMBER	CODE	WORD	PRONUNCIATION
0	-·-·-·	Zero	ZE RO	5	·-·-·	Five	FIFE
1	·-·-·	One	WUN	6	-·-·-	Six	SIX
2	·-·-·	Two	TOO	7	-·-·-	Seven	SEV en
3	·-·-·	Three	TREE	8	-·-·-	Eight	AIT
4	·-·-·	Four	FOW er	9	-·-·-	Nine	NIN er

When spoken, capitalized syllables are given equal stress, e.g. ECKS-RAY. When only one syllable is capitalized, that syllable is given primary stress, e.g. NINE-er.



1.6 AIRWAYS AND AIR ROUTES DESIGNATION

Phonetics are used with the designation of Canadian airways and air routes. All numbers are transmitted by pronouncing each digit separately.

Examples:

	<i>WRITTEN</i>	<i>SPOKEN</i>
AIRWAYS	G1	<i>GOLF ONE</i>
	A2	<i>ALFA TWO</i>
	J500	<i>JET FIVE ZERO ZERO</i>
AIR ROUTES	RR3	<i>ROMEO ROMEO THREE</i>
	BR4	<i>BRAVO ROMEO FOUR</i>

1.7 DISTANCE REPORTING

Distance reporting based on area navigation (RNAV) and global navigation satellite system (GNSS) will be provided in miles, e.g. 30 mi. from Someplace. When distance reports are based on DME, pilots will state DME, e.g. 30 DME from Someplace.

1.8 USE OF NUMBERS

1.8.1 General

All numbers except whole thousands should be transmitted by pronouncing each digit separately.

Examples:

572 *FIVE SEVEN TWO*

11000 *ONE ONE THOUSAND*

Decimal points are expressed in the appropriate sequence using the word “DECIMAL” except for VHF or UHF frequencies, in which case the decimal point may be omitted as long as the omission is not likely to cause any misunderstanding.

Examples:

118.1 *ONE ONE EIGHT DECIMAL ONE*

119.4 *ONE ONE NINE FOUR*

1.8.2 Altitude Above Sea Level and Flight Level

Altitude above sea level is expressed in thousands and hundreds of feet. Separate digits must be used to express flight levels.

Examples:

2700 *TWO THOUSAND SEVEN HUNDRED*

FL 260 *Flight Level TWO SIX ZERO*

1.8.3 Aircraft Type, Wind Speed and Cloud Base

Aircraft type numbers, wind speed and cloud base may be expressed in group form.

Examples:

DC10	<i>DC TEN</i>
Wind 270/10	<i>WIND TWO SEVEN ZERO AT TEN</i>
3400 broken	<i>THREE THOUSAND FOUR HUNDRED BROKEN</i>

1.8.4 Time

Time is provided according to the UTC system. Separate digits are used to express time, followed by “ZULU”, the spoken expression for UTC.

Examples:

0920Z	<i>ZERO NINE TWO ZERO ZULU</i>
09 minutes	<i>ZERO NINE (when the hour is understood)</i>

1.8.5 Headings

Aircraft headings are given in groups of three digits prefixed by the word “HEADING”. If operating within the SDA, degrees are expressed in magnetic. If operating within the NDA, degrees are expressed in true.

Example:

005 degrees *HEADING ZERO ZERO FIVE*

1.8.6 Aerodrome Elevation

Aerodrome elevations are expressed in feet, prefixed by the words “FIELD ELEVATION”.

Example:

150 *FIELD ELEVATION ONE FIVE ZERO*

1.8.7 Transponder Codes

Transponder codes are preceded by the word “SQUAWK”.

Example:

Code 1200 *SQUAWK ONE TWO ZERO ZERO*

1.9 CALL SIGNS

1.9.1 Civil Aircraft

In radio communications, always use phonetics if the call sign consists of the aircraft’s registration.

1.9.1.1 Canadian and Foreign Air Carriers

- a) *Initial contact*—Use the operator’s radiotelephony designator followed by the flight number, or the last four characters of the aircraft registration, and the word “HEAVY” if the aircraft is certified for a maximum take-off weight of 300 000 lb or more.

Examples:

Air Canada 149 Heavy *AIR CANADA ONE FOUR NINE HEAVY*

Air Canada FTHA Heavy *AIR CANADA FOXTROT TANGO HOTEL ALFA HEAVY*

Speedbird GABCD Heavy *SPEEDBIRD GOLF ALFA BRAVO CHARLIE DELTA HEAVY*

- b) *Subsequent communications*—After initial communication has been established, the word “HEAVY” may be omitted. Also, where the aircraft registration is used, it may be abbreviated to the operator’s radiotelephony designator and at least the last two characters of the aircraft registration, as long as this abbreviation is initiated by ATS.

Examples:

Air Canada HA *AIR CANADA HOTEL ALFA*

Speedbird CD *SPEEDBIRD CHARLIE DELTA*

1.9.1.2 Canadian Private Civil Aircraft and Canadian or Foreign Carriers Without an Assigned Radiotelephony Designator

- a) *Initial contact*—Use the manufacturer’s name or the type of aircraft, followed by the last four characters of the registration.

Examples:

Cessna GADT *CESSNA GOLF ALFA DELTA TANGO*
 Aztec FADT *AZTEC FOXTROT ALFA DELTA TANGO*

NOTE:

Helicopter, glider and ultralight pilots may prefix their call-sign with “HELICOPTER,” “GLIDER” or “ULTRALIGHT”. This practice fulfills the same purpose as stating the manufacturer’s name or type of aircraft and is an acceptable substitute.

- b) *Subsequent communications*—May be abbreviated to the last three characters of the registration, as long as this abbreviation is initiated by ATS.

Examples:

Cessna GADT becomes “ADT” *ALFA DELTA TANGO*

Aztec FADT becomes “ADT” *ALFA DELTA TANGO*

1.9.1.3 Foreign Private Civil Aircraft

- a) *Initial contact*—The manufacturer’s name or the type of aircraft, followed by the full aircraft registration.

Example:

Mooney N6920K *MOONEY NOVEMBER SIX NINE TWO ZERO KILO*

- b) *Subsequent communications*—May be abbreviated to the last three characters of the registration, as long as this abbreviation is initiated by ATS.

Example:

Mooney N6920K becomes 20K *TWO ZERO KILO*

1.9.1.4 Medical Evacuation Flight (MEDEVAC)

A MEDEVAC is a flight responding to a medical emergency for the transport of patients, organ donors, organs or other urgently needed life-saving medical material. This can also apply to certain medical flights, including helicopters, which may be designated as air ambulance flights.

- a) *Initial contact*—Use the manufacturer’s name or type of aircraft or operator’s radiotelephony designator, followed by the flight number and the word “MEDEVAC”, or the last four characters of the aircraft registration and the word “MEDEVAC”.

Examples:

Austin 101 MEDEVAC *AUSTIN ONE ZERO ONE MEDEVAC*

Cessna FABC MEDEVAC *CESSNA FOXTROT ALFA BRAVO CHARLIE MEDEVAC*

- b) *Subsequent communications*—May be abbreviated as per normal procedures, retaining the word “MEDEVAC”.

1.9.1.5 Formation Flights

- a) *Initial contact*—Use the aircraft call sign or the last four characters of the aircraft’s registration followed by “FLIGHT, FORMATION OF (number of aircraft)”.

Examples:

Griffin 11, Flight, Formation of 4 *GRIFFIN ONE ONE, FLIGHT, FORMATION OF FOUR*

FLVM, Flight, Formation of 2 *FOXTROT LIMA VICTOR MIKE, FLIGHT, FORMATION OF TWO*

- b) *Subsequent communications*—The number of aircraft may be omitted. All subsequent communications to and from the formation may be abbreviated per normal procedures, retaining the word “FLIGHT”.



Examples:

Griffin 11, Flight *GRIFFIN ONE ONE, FLIGHT*

FLVM, Flight *FOXTROT LIMA VICTOR MIKE, FLIGHT*

1.9.1.6 Similar Sounding Call Signs

If communicating with two or more aircraft that are using the same flight number or similar sounding identifications, ATS will advise each of the aircraft concerned of the other's presence.

In order to further minimize the chance for call sign confusion, ATS may take one of the following measures:

- a) Restate the operator's radiotelephony designator of the aircraft involved after the flight number, for emphasis.

Examples:

JAZZ EIGHT EIGHT ONE THREE JAZZ

TRANSPORT EIGHT ONE THREE TRANSPORT

- b) Add the type of aircraft to the identification.

Examples:

CHEROKEE ALFA BRAVO CHARLIE

- c) Instruct aircraft using the same flight number or similar sounding identification to use:
 - (i) the aircraft registration; or
 - (ii) the operator's radiotelephony designator, followed by at least the last two characters of the aircraft registration.

Example:

JAZZ NOVEMBER DELTA

CANJET ECHO PAPA ALFA

1.9.2 Ground Stations

The aerodrome name as published in the CFS is used to form the call sign to the associated ground stations. When the aerodrome name is different from the community (location) name, it will be published following the community (location) name and will be separated by a diagonal (/). Exceptions should be listed in the COMM section of the CFS.

Table 1.2—Example of Ground Station Name Different from Community Name per CFS

TORONTO/LESTER B. PEARSON INTL, ONT

COMM	TWR	Toronto	TORONTO TOWER

Table 1.3—Examples of Call Signs

	CFS	Call Sign
	COMM	—
Area Control Centre	CENTRE	MONTRÉAL CENTRE
Flight Service Station	RADIO	MONCTON RADIO
Terminal Control	TML	QUÉBEC TERMINAL
Arrival Control	ARR	VANCOUVER ARRIVAL
Departure Control	DEP	EDMONTON DEPARTURE
Clearance Delivery	CLNC DEL	OTTAWA CLEARANCE DELIVERY
Community Aerodrome	APRT RDO	REPULSE BAY AIRPORT RADIO
Radio Station Pilot to Forecaster	PMSV	COMOX METEO
Apron Advisory Service	APRON	MIRABEL APRON
Remote Communication Outlet	RCO	<i>Rouyn rdo</i> ROUYN RADIO
Mandatory Frequency	MF	<i>rdo</i> FREDERICTON RADIO
Aerodrome Traffic	ATF	MANIWAKI UNICOM
Frequency Peripheral Station	PAL	<i>Winnipeg Ctr</i> WINNIPEG CENTRE
VFR Advisory	VFR ADV	TORONTO TERMINAL

1.9.3 Remote Communications Outlets (RCOs) and Dial-Up Remote Communications Outlets (DRCOs)

RCOs are VHF transmitters/receivers installed at designated aerodromes to permit communications between aircraft and an FSS or FIC for the provision of FISE or RAAS. An RCO may also be installed at an off-aerodrome location to enhance en route communication coverage for the provision of FISE by FICs.

FISE RCOs use one of the following four frequencies: 123.275, 123.375, 123.475, or 123.55 MHz. At most of these outlets, 126.7 MHz is not active or monitored by a FIC. At these sites, as required, the FIC activates and transmits on 126.7 MHz to provide aeronautical broadcast services (broadcast of SIGMET or urgent PIREP) and to conduct communication searches for overdue aircraft. Further details on the use of RCOs can be found in the General section of the CFS.

A DRCO is a standard RCO with a dial-up unit installed to connect the pilot with an ATS unit (e.g. FIC) via a commercial telephone line. The line is only opened after communication has been initiated by the pilot or ATS. The radio range of the RCO is unaffected by the conversion.

Activation of the system by the pilot is accomplished via the aircraft radio transmitter by keying the microphone button four times with a deliberate and constant action on the published DRCO frequency. Procedures for establishing the link can be found in the General section of the CFS.

COMM

See the CFS for more information.

1.10 STANDARD RADIO TELEPHONY

Section 6 of the *Radiocommunication Regulations* specifies that aeronautical radio communications are restricted to communications relating to

- a) the safety and navigation of an aircraft;
- b) the general operation of the aircraft; and
- c) the exchange of messages on behalf of the public.

Pilots should:

- a) send radio messages clearly and concisely using standard phraseology whenever practical;
- b) plan the content of the message before transmitting; and
- c) listen out before transmitting to avoid interference with other transmissions.

1.10.1 Message

Radiotelephony traffic generally consists of four parts: the call-up, the reply, the message and the acknowledgement.

Example:

Pilot: *REGINA TOWER, (THIS IS) CESSNA FOXTROT BRAVO CHARLIE DELTA (OVER).*

Tower: *FOXTROT BRAVO CHARLIE DELTA, REGINA TOWER.*

Pilot: *REGINA TOWER, BRAVO CHARLIE DELTA, TEN SOUTH THREE THOUSAND FIVE HUNDRED FEET V-F-R LANDING INSTRUCTIONS*

Tower: *BRAVO CHARLIE DELTA, REGINA TOWER, RUNWAY TWO SIX, WIND TWO THREE ZERO AT TEN, ALTIMETER TWO NINE NINE TWO, CLEARED TO THE CIRCUIT.*

Pilot: *BRAVO CHARLIE DELTA.*

The terms “THIS IS” and “OVER” may be omitted, and if no likelihood of confusion exists, the call sign for the agency being called may be abbreviated as follows:

Pilot: *TOWER, BRAVO CHARLIE DELTA, CONFIRM RIGHT TURN.*

1.10.2 Message Acknowledgement

Pilots should acknowledge the receipt of all messages directed to them, including frequency changes. Such acknowledgement may take the form of a transmission of the aircraft call sign, a repeat of the clearance with the aircraft call sign or the call sign with an appropriate word(s).

Example:

Tower: *VICTOR LIMA CHARLIE, CLEARED TO LAND.*

Pilot: *VICTOR LIMA CHARLIE.*

Tower: *FOXTROT VICTOR LIMA CHARLIE, CONFIRM YOU ARE AT FIVE THOUSAND.*

Pilot: *FOXTROT VICTOR LIMA CHARLIE, AFFIRMATIVE.*

NOTE:

The clicking of the microphone button as a form of acknowledgement is not an acceptable radio procedure.

1.11 COMMUNICATIONS CHECKS

The readability scale from one to five has the following meaning:

1. unreadable;
2. readable now and then;
3. readable with difficulty;
4. readable; and
5. perfectly readable.

The strength scale from one to five used in high frequency (HF) communications has the following meaning:

1. bad;
2. poor;
3. fair;
4. good; and
5. excellent.

Communications checks are categorized as follows:

- a) *Signal check*—If the test is made while the aircraft is airborne.
- b) *Pre-flight check*—If the test is made prior to departure.
- c) *Maintenance check*—If the test is made by ground maintenance.

Example:

Pilot: *THOMPSON RADIO, CESSNA FOXTROT ALFA BRAVO CHARLIE, RADIO CHECK ON FIVE SIX EIGHT ZERO.*

Radio: *ALFA BRAVO CHARLIE, THOMPSON RADIO, READING YOU STRENGTH FIVE, OVER.*

1.12 EMERGENCY COMMUNICATIONS

1.12.1 General

An emergency situation is classified in one of the two following categories, in accordance with the degree of danger or hazard present:

- a) *Distress*—A condition of being threatened by serious and/or imminent danger and of requiring immediate assistance. The spoken word for distress is MAYDAY, and it is pronounced three times.
- b) *Urgency*—A condition concerning the safety of an aircraft or other vehicle, or of some person on board or within sight, but which does not require immediate assistance. The spoken word for urgency is PAN PAN, and it is pronounced three times.

The first transmission of the distress call and message by an aircraft should be on the air-ground frequency in use at the time. If the aircraft is unable to establish communication on the frequency in use, the distress call and message should be repeated on the HF general calling or distress frequency 3 023 kHz, 5 680 kHz, 121.5 MHz, 406.1 MHz, or other distress frequency available, such as 2 182 kHz, in an effort to establish communications with any ground station or the maritime service.

The distress call shall have absolute priority over all other transmissions. All stations hearing it shall immediately cease any transmission that may interfere with it and shall listen on the frequency used for the distress call.

Example of a distress message from an aircraft:

MAYDAY, MAYDAY, MAYDAY, THIS IS FOXTROT ZULU X-RAY YANKEE, FOXTROT ZULU X-RAY YANKEE, FOXTROT ZULU X-RAY YANKEE, FIVE ZERO MILES SOUTH OF YELLOWKNIFE AT ONE SEVEN TWO FIVE ZULU, FOUR THOUSAND, NORSEMAN, ICING, WILL ATTEMPT CRASH LANDING ON ICE, FOXTROT ZULU X-RAY YANKEE, OVER.

Example of an urgency message addressed to all stations:

PAN PAN, PAN PAN, PAN PAN, ALL STATIONS, ALL STATIONS, ALL STATIONS, THIS IS TIMMINS RADIO, TIMMINS RADIO, TIMMINS RADIO, EMERGENCY DESCENT AT TIMMINS AIRPORT, ATC INSTRUCTS ALL AIRCRAFT BELOW SIX THOUSAND FEET WITHIN RADIUS OF ONE ZERO MILES OF TIMMINS N-D-B LEAVE EAST AND NORTH COURSES IMMEDIATELY, THIS IS TIMMINS RADIO OUT.

Emergency procedures are contained in chapters RAC and SAR.

1.12.2 Emergency Frequency 121.5 MHz

Pilots should continuously monitor 121.5 MHz when operating within sparsely settled areas or when operating a Canadian

aircraft over water more than 50 NM from shore unless: essential cockpit duties or aircraft electronic equipment limitations do not permit simultaneous monitoring of two VHF frequencies; or the pilot is using other VHF frequencies.

Only control towers and FSSs have 121.5 MHz capability, and this emergency frequency is only monitored during these facilities' hours of operation. Remote communication facilities (PAL, RAAS RCO and FISE RCO) do not have 121.5 MHz capability.

During an emergency, a pilot has the following options for communicating with ATS:

- a) When within radio reception of a control tower or FSS during the facility's hours of operation, call ATS on the tower frequency/FSS MF or 121.5 MHz. It is recommended that pilots use the normal frequency or the frequency in use at the time.
- b) When within radio reception of a remote communications facility (FISE RCO, RAAS RCO or PAL), call ATS on the published frequency.

NOTE:

FISE RCOs and PALs operate 24 hr, while most RAAS RCOs operate part time.

- a) When out of range for VHF communications (for example at low altitude, along a highway corridor), pilots may use a cell phone if they have cell phone coverage.
- b) If beyond the radio reception of an ATS facility, or when outside the facility's hours of operation, broadcast on 121.5 MHz or 126.7 MHz, or both, for assistance from other pilots who may be monitoring the frequency.

1.13 VERY HIGH FREQUENCY (VHF) ALLOCATIONS

See *AIP Canada (ICAO) GEN 3.4*.

1.14 USE OF FREQUENCY 5 680 kHz

See *AIP Canada (ICAO) GEN 3.4*.

1.15 PHONE USE DURING A RADIO COMMUNICATIONS FAILURE

In the event of an in-flight radio communications failure, and only after normal communications failure procedures have been followed, the pilot-in-command may attempt to contact the appropriate NAV CANADA air traffic service (ATS) unit by means of a conventional cell or satellite phone. Before placing the call, transponder-equipped aircraft should squawk Code 7600.

Public switched telephone network (PSTN) numbers to be used in the event of a communication failure are published in the *Canada Flight Supplement (CFS)*.

In that case, the pilot can hear both ground parties at the same time and determine which is more important.

1.16 CANADIAN BASE OPERATORS (CBO)

See *AIP Canada (ICAO)* GEN 3.4.

1.17 OTHER TELECOMMUNICATION SYSTEM OPERATORS

See *AIP Canada (ICAO)* GEN 3.4.

1.18 SATELLITE VOICE COMMUNICATIONS (SATVOICE)

The aeronautical satellite voice communications (SATVOICE) system uses the public switched telephone network (PSTN) and/or dedicated networks to route calls between aircraft and the appropriate ground party. Dedicated network access switches locate the aircraft anywhere in the world, regardless of the satellite and ground earth station (GES) to which the aircraft is connected.

For ground-to-air calls, the ground party initiates the call using a network access number. Once connected to the network access switch, the ground party provides as a minimum the following information to the appropriate service provider in order to route the call to the aircraft:

- a) user identification (ID) [Required by Iridium. Inmarsat does not require a user ID, but does require that the telephone number be registered in their system as part of the validation process.];
- b) personal identification number (PIN);
- c) priority level; and
- d) aircraft address in octal format.

In addition to registration, every aircraft is assigned an aircraft address. An aircraft address can be defined in one of three formats: 24-bit format (24 binary characters), hexadecimal format (6 alpha-numeric characters) or octal format (8 characters).

The user ID and/or PIN are given by the service provider when access to the network is granted, and they are used to secure the call.

The priority level may be used by dedicated networks (and the aircraft systems) to end calls of a lower priority, if necessary, and allow incoming calls of a higher priority, although some systems may establish a 3-way call, so that the higher priority call can interrupt the ongoing conversation without ending it.

Table 1.4—Priority Levels for Satellite Voice Communications

Priority level	Use	Examples
1/EMG/Q15 Emergency Safety of Flight	Distress and urgency	Rapid descent Urgent weather deviation
2/HGH/Q12 Operational High Safety of Flight	Flight safety	Altitude request
3/LOW/Q10 Operational Low Safety of Flight	Regularity of flight, meteorological, administrative. Typically assigned to calls between aircraft operators and their aircraft	Flight information service Dispatch Maintenance
4/PUB/Q9 Non-operational Non-safety	Public correspondence	Public phone calls

Flight crews should only act on an air traffic control (ATC) clearance or instruction from a SATVOICE call with priority level 2. (Priority level 1/EMG/Q15 is reserved for outbound calls from aircraft.)

For air-to-ground calls, a telephone numbering plan has been developed that assigns short codes, as well as PSTN numbers, specific to each flight information region (FIR). When a GES receives the unique short code from the aircraft via satellite, it is converted and the call is routed to the appropriate air traffic services (ATS) unit.

Prior to using SATVOICE equipment for priority level 1, 2 or 3 calls, the aircraft operator should address flight crew training and qualification, maintenance, minimum equipment list (MEL), user modifiable software and service agreements with the commercial service provider. Installations would normally be approved by the state of registry or state of the operator, in accordance with Federal Aviation Administration (FAA) Advisory Circular (AC) 20-150A (or equivalent).

When using SATVOICE, pilots should apply the radiotelephony conventions and phraseology used for VHF/HF communications.

Operational procedures, along with SATVOICE short codes and PSTN numbers for aeronautical stations, are published in *AIP Canada (ICAO)* GEN 3.4.5, and on en route low altitude and en route high altitude charts.



2.0 LOCATION INDICATORS

Responsibility for Canadian location indicators rests with the Aeronautical Information Services Division of NAV CANADA. Location indicators are listed in the *Canada Flight Supplement (CFS)* and *Canada Water Aerodrome Supplement (CWAS)*.

3.0 DATA LINK COMMUNICATION

3.1 DATA LINK APPLICATIONS

The generic term “data link” encompasses different types of applications that can transfer data to and from an aircraft. In Canada, data link applications used by air traffic service (ATS) include data link automatic terminal information service (D-ATIS), pre-departure clearance (PDC) via the airline host, departure clearance (DCL), oceanic clearance (OCL), automatic dependent surveillance waypoint position reporting (ADS WPR) and controller-pilot data link communications (CPDLC). Operational information regarding Canadian applications can be found in *AIP Canada (ICAO) GEN 3.4*.

3.2 AIRCRAFT COMMUNICATIONS ADDRESSING AND REPORTING SYSTEM (ACARS) AND FUTURE AIR NAVIGATION SYSTEMS (FANS) 1/A

Many aircraft data link applications transfer data using the aircraft communications addressing and reporting system (ACARS). In the early 1990s, air traffic control (ATC) units in the United States began to use ACARS-based pre-departure clearance (PDC) applications to alleviate the problem of congestion on clearance delivery frequencies.

Seeing the benefits of this early type of application, airlines began to push for additional air traffic service (ATS) data link applications. Notwithstanding the reduced performance of ACARS networks that existed at the time, using ACARS-based applications was a valuable step towards early introduction of future air navigation systems (FANS). Based on this, various ATS applications operating on the ACARS network were developed. The original Boeing version of these applications was known as FANS 1, whereas the Airbus version was termed FANS A. Today, new FANS applications such as FANS 1/A+ and FANS B continue to be used in airspace not suited for traditional surveillance coverage.

3.3 AERONAUTICAL TELECOMMUNICATIONS NETWORK (ATN)

As reliance on data link increased, a new aeronautical telecommunications network (ATN) was implemented to enable greater data link performance. Compared to the original aircraft communications addressing and reporting system (ACARS)

network, the new ATN uses well-defined protocols, specifically designed to provide reliable communications service over dissimilar networks. Aircraft equipped for both ATN and future air navigation system (FANS) applications are said to be equipped with “dual-stack”.

3.4 DATA LINK SERVICE PROVIDERS

To operate data link, it is necessary to have a contract with at least one data link service provider. Major service providers include Rockwell Collins (formerly ARINC) and Société Internationale de Télécommunications Aéronautiques (SITA). These companies provide a variety of air-ground data links, operating in different frequency bands to ensure global coverage.

3.5 DATA LINK NETWORKS

Traditionally, analog very high frequency (VHF) was the most commonly used medium to transmit aircraft communications addressing and reporting system (ACARS) messages. This medium of ACARS transmission is known as plain old ACARS (POA). The low-speed characteristics of a POA data link require a number of frequencies to fully service all users. For example, almost a dozen VHF frequencies are required in North America in order to provide a reliable service. As the number of analog VHF data link transmissions continues to increase across busy areas, available channels in the aeronautical VHF band are approaching saturation.

New high speed digital data link systems transmitting in the VHF range are known as VHF digital link (VDL). Different forms of VDL (Mode 1 through 4) have been defined. This new digital architecture is called ACARS Over AVLC (AOA), where the term AVLC refers to aviation VHF link control, which is the protocol used over the VHF link for the relatively common VDL Mode 2 system.

To access VDL service, aircraft must be fitted with a communications management unit (CMU) that is equipped with a digital connection to a VHF data radio (VDR) transceiver. The CMU processes all the ACARS applications and can be upgraded to integrate both VDL and ATN functionality. The CMU automatically switches between AOA and POA according to service availability.

While VDL may provide faster message response times (two to eight seconds) than analog VHF, the system is still limited to line-of-sight coverage. When beyond line-of-sight of a VDL ground station, some aircraft may also have the capability for HF data link (HF DL) and/or communications through satellite data link (SATCOM).

Satellite data links provide greater coverage, although except for Iridium they are limited in the polar regions since most of the satellites are stationary over the equator. Satellite data links are also slower than VHF in response time (12–25 s). Service

providers with near-global coverage include Inmarsat (geostationary earth orbit [GEO] satellites) and Iridium (low earth orbit [LEO] satellites in polar orbits for worldwide coverage); others provide coverage in particular regions, such as the multifunctional transport satellite (MTSAT) over the Pacific Ocean.

HFDL provides near global coverage including over the polar regions, but message transit times (approximately 80 s) are much lengthier than other mediums.

3.6 AIRCRAFT COMMUNICATIONS ADDRESSING AND REPORTING SYSTEM (ACARS) INITIALIZATION

The core of the airborne data link system is called the aircraft communications addressing and reporting system (ACARS) management unit (MU) or communications management unit (CMU). At the initiation of a flight, one of the first flight crew actions is to perform the ACARS system initialization. This INIT REQUEST establishes a link with the airline ground system, and informs it that the aircraft is being prepared for departure.

3.7 DATA LINK AUTOMATIC TERMINAL INFORMATION SERVICE (D-ATIS)

Data link automatic terminal information service (D-ATIS) enables delivery to the cockpit of automatic terminal information service (ATIS) information in text format via data link. This results in a reduction of flight crew workload, eliminating the need to listen to the ATIS broadcast and hand transcribe the message during busy periods. Thanks to data link service provider coverage areas, D-ATIS can also be accessed well in advance of descent and approach. Flight crew flying aircraft communications addressing and reporting system (ACARS) equipped aircraft can send ATIS requests and receive ATIS information using their multipurpose control and display unit (MCDU).

D-ATIS implementation can vary in both avionics and ground systems. In Canada, D-ATIS is available on the Rockwell Collins (formerly ARINC) air traffic service (ATS) server.

3.8 PRE-DEPARTURE CLEARANCE (PDC)

Pre-departure clearance (PDC) via the airline host is a system that provides instrument flight rules (IFR) departure clearances (DCL) via data link to subscribing airlines at selected airports. The PDC message is sent from the tower to an airline's server. The airline then takes responsibility for delivery of the PDC via either the aircraft communications addressing and reporting system (ACARS) data link or, for non-ACARS-equipped aircraft, through some other means such as a gate printer.

Instead of a verbal readback of the entire clearance, air traffic control (ATC) primarily requires readback of the flight plan unique identifier (FPUI). This is a four-character (three numeric and one alphabetic) code included in the PDC message. See *AIP Canada (ICAO) GEN 3.4* for a list of airports offering PDC service along with registration instructions.

3.9 DEPARTURE CLEARANCE (DCL)

Another data link application similar to pre-departure clearance (PDC) is called DCL, which stands for departure clearance. The DCL message itself may contain the abbreviation PDC, however the delivery method is different for the DCL application. In DCL, the data link dialog is directly between the flight crew and the controller. The flight crew initiates DCL by sending a departure clearance request (RCD). That RCD is routed to the tower, where the controller can send the clearance to the aircraft directly via data link. When sending a RCD, the flight crew will immediately receive the following flight system message (FSM): RCD RECEIVED – REQUEST BEING PROCESSED – STANDBY.

If the RCD cannot be correlated to the flight plan or if the RCD was sent too late, the flight crew may receive one of the following FSMs: RCD REJECTED – FLIGHT PLAN NOT HELD – REVERT TO VOICE PROCEDURES or RCD REJECTED – ERROR IN MESSAGE – REVERT TO VOICE PROCEDURES – RCD TOO LATE.

When air traffic control (ATC) receives a valid RCD, it will respond by sending the departure clearance message (CLD) and, in turn, the flight crew will respond with a departure clearance readback (CDA). Upon successful reception of a matching CDA, the flight crew will receive a FSM that states: CDA RECEIVED – CLEARANCE CONFIRMED.

At any time during the clearance process, if the flight crew receives a FSM stating to REVERT TO VOICE, the data link clearance becomes void and the flight crew should contact ATC.

Other examples of FSM error messages include:

- a) RCD REJECTED – REQUEST ALREADY RECEIVED – STANDBY
- b) RCD REJECTED – ERROR IN MESSAGE – REVERT TO VOICE PROCEDURES
- c) CDA REJECTED – CLEARANCE CANCELLED – REVERT TO VOICE PROCEDURES

Unlike PDC, there is no registration requirement to use DCL; however, operators must be Rockwell Collins (formerly ARINC) or Société Internationale de Télécommunications Aéronautiques (SITA) data link subscribers. A list of airports offering DCL service can be found in *AIP Canada (ICAO) GEN 3.4*.

3.10 AUTOMATIC DEPENDENT SURVEILLANCE CONTRACT (ADS-C)

Position reporting is required in oceanic and remote airspace where there is no other means of surveillance. Automatic dependent surveillance - contract (ADS-C) waypoint position reporting (WPR) via data link can overcome issues with voice reporting. Automatic dependent surveillance (ADS) is a surveillance technique for use by air traffic services (ATS) in which aircraft automatically provide, via data link, information derived from on-board position-fixing and navigation systems. ADS allows controllers to obtain position data from future air navigation system (FANS) equipped aircraft in a timely manner, thereby facilitating route conformance monitoring in non-radar airspace.

An ADS-C is initiated by the ATS facility and it identifies the types of information and the conditions under which reports are to be sent by the aircraft. Some types of information are included in every report, while other types are provided only if specified in the ADS-C request. There are three types of ADS-C:

- a) periodic (a time interval at which the aircraft system sends an ADS-C report),
- b) demand (a single ADS-C periodic report), and
- c) event (triggered by a particular event such as a waypoint change event).

ADS-C are managed by ATS facilities based on their surveillance requirements, and ADS reports are sent automatically without notification to, or action required by, the flight crew. In the event that an ADS report is not received, air traffic control (ATC) would attempt to contact the flight crew to obtain the position report via voice. In the event of ADS service interruptions, aircraft equipment failures or loss of signal coverage, flight crews are expected to resume voice reporting. Flight crews should be aware of the limitations associated with available aircraft equipment and the signal coverage over the intended route.

Operational procedures for automatic dependent surveillance waypoint position reporting (ADS WPR) can be found in *AIP Canada (ICAO) GEN 3.4*.

3.11 CONTROLLER-PILOT DATA LINK COMMUNICATIONS (CPDLC)

Controller-pilot data link communications (CPDLC) is a data link application that supports the exchange of text-based messages between a controller and the flight crew. Text messages provide greater clarity than spoken very high frequency (VHF) or high frequency (HF) radio communications, so the risk of error is significantly decreased. Other advantages associated with CPDLC include:

- a) reducing voice channel congestion in busy airspace;
- b) providing direct controller-pilot communications (DCPC) in airspace where it was not previously available on voice channels;
- c) facilitating air traffic control (ATC) communications with flight crews whose first language is not English;
- d) reducing flight crew input errors, by allowing the loading of information from specific uplink messages into other aircraft systems, such as the flight management system (FMS) or aircraft radios;
- e) allowing the flight crew to request complex route clearances, which the controller can respond to without having to manually enter a long string of coordinates;
- f) reducing flight crew workload by supporting automatically transmitted reports when a specific event occurs, such as reaching the new flight level on an altitude change clearance; and
- g) reducing controller workload by providing automatic flight plan updates when specific downlink messages (and responses to some uplink messages) are received.

CPDLC messages consist of a set of message elements, most of which correspond to radiotelephone phraseology. CPDLC message elements that are sent to an aircraft are referred to as uplink messages or UM, whereas message elements that are sent by the aircraft are downlink messages or DM. There are two types of CPDLC implementations: future air navigation systems (FANS) 1/A and aeronautical telecommunications network (ATN) based CPDLC.

Operational procedures for CPDLC can be found in *AIP Canada (ICAO) GEN 3.4*.

3.12 AIR TRAFFIC SERVICES FACILITIES NOTIFICATION (AFN)

The first step for automatic dependent surveillance (ADS) or controller-pilot data link communications (CPDLC) is the air traffic services facilities notification (AFN), sometimes known as the air traffic control (ATC) logon process; it is typically initiated by the flight crew. The purpose of the AFN is to provide air traffic service (ATS) with the data link applications supported by the aircraft system and the unique identification of the aircraft. This allows ATS to correlate the logon information with the flight plan on file, ensure that messages are sent to the correct aircraft, and make certain that any subsequent reports and/or messages update the correct flight plan. This exchange of data link context is needed prior to any CPDLC or ADS connection.

An AFN is needed when the aircraft does not already have a connection, such as when the aircraft is preparing for departure,

or when the aircraft is planning to enter an area where ADS and CPDLC services are available after transiting an area where those services were not available.

To perform an initial logon request, the flight crew enters into the data link equipment:

- a) the four-character International Civil Aviation Organization (ICAO) facility identifier for the ATS unit that the logon request will be sent to;
- b) the aircraft identification (as entered in Item 7 of the ICAO flight plan);
- c) the aircraft registration and/or aircraft address (as entered in Item 18, preceded by REG and/or CODE, of the ICAO flight plan); and
- d) the departure and destination aerodromes, when required (as entered in Items 13 and 16 of the ICAO flight plan).

Canadian ATS facility identifiers can be found in *AIP Canada (ICAO) GEN 3.4*.

3.13 CURRENT/NEXT DATA AUTHORITIES

Aircraft can display two controller-pilot data link communications (CPDLC) air traffic service (ATS) facility connections at any time, but only one can be active. The ATS facility with which an aircraft has an active connection is the current data authority, sometimes displayed to the flight crew as CURRENT ATC. The ATS facility with the inactive connection is referred to as the next data authority. Under normal circumstances, the current data authority will initiate a transfer to an adjacent data link-capable ATS facility when the aircraft approaches the appropriate boundary. These transfers are normally automatic and no flight crew action is required.

4.0 GROUND-BASED RADIO NAVIGATION AIDS

4.1 GENERAL

Ground-based radio navigation systems available for use in Canada include: distance measuring equipment (DME), instrument landing system (ILS), localizer (LOC), non-directional beacon (NDB), precision approach radar (PAR), tactical air navigation aid (TACAN), VHF direction finder (VDF), VHF omnidirectional range (VOR), and a combination of VOR and TACAN (VORTAC).

4.2 ACCURACY, AVAILABILITY AND INTEGRITY OF GROUND-BASED NAVIGATION AIDS

Aviation navigation systems must meet stringent accuracy, availability and integrity requirements as specified in the International Civil Aviation Organization's (ICAO) Annex 10.

Measures to improve availability include:

- a) *Electronic means*—The provision of alternate or redundant circuitry for the electronic elements of the navigation aid (NAVAID).
- b) *Emergency back-up power*—All instrument landing system (ILS) and VHF omnidirectional range (VOR) facilities for which NAV CANADA has responsibility, as well as distance measuring equipment (DME) and tactical air navigation aid (TACAN) associated with these facilities, are provided with emergency power. Additionally, many non-directional beacons (NDBs) are provided with emergency power.

Measures to maintain accuracy and integrity of the navigation signals include:

- a) *Executive monitoring*—An electronic means in which the system checks its critical parameters. In the event of an out-of-tolerance condition, it either changes to an auxiliary back-up equipment or shuts the system down if there is no redundancy or if the redundant circuit has also failed. This monitoring is continuous.
- b) *Periodic maintenance*—NAVAIDs are periodically tested by qualified technologists.
- c) *Flight inspection*—In-flight inspections of ILS, VOR and DME are carried out by specially equipped aircraft on a regular basis to ensure that standards are met.

During periods of routine or emergency maintenance, or when a NAVAID is identified as not meeting the required performance standard, it is temporarily removed from service and a NOTAM is issued to advise pilots of the deficiency. The removal of the transmitted NAVAID identification can also warn pilots that the facility may be unreliable even though it may still transmit a navigation signal. Under these circumstances the facility should not be used. Similarly, prior to commissioning, a new facility (particularly VOR or ILS) may transmit with or without identification. In such cases, a NOTAM would identify that the facility is unavailable and not to be used for navigation.

The end result of these combined efforts is a safe and reliable air navigation system which meets the established standards. Nevertheless, prior to using any NAVAID, pilots should do the following:

- a) Check NOTAMs prior to flight for information on NAVAID outages. These may include scheduled outages for maintenance

or calibration. For remote aerodromes, or aerodromes with community aerodrome radio station (CARS), it is recommended that pilots contact the CARS observer-communicator (O/C) or the aerodrome operator prior to flight to determine the condition of the aerodrome, availability of services and the status of NAVAIDs.

- b) Ensure that on-board navigation receivers are properly tuned and that the NAVAID identifier is aurally confirmed.
- c) Visually confirm that the appropriate indicator displays are presented.

4.3 PILOT REPORTING OF ABNORMAL OPERATION OF GROUND-BASED NAVIGATION AIDS (NAVAIDs)

Pilots are responsible for reporting any navigation aid (NAVAID) failure or abnormality to the appropriate air traffic service (ATS) facility. If it is not practical to report while airborne, a report should be filed after landing.

Reports should contain the nature of the abnormal operation detected by the pilot and the approximate magnitude and direction of any course shift (if applicable). The magnitude may be either in miles or degrees from the published bearing. Reports should also include the approximate distance of the aircraft from the NAVAID when the observation was made and the time and date of the observation.

4.4 INTERFERENCE WITH AIRCRAFT NAVIGATIONAL EQUIPMENT

Some portable electronic devices can interfere with aircraft communications and radio navigation systems. The radiation produced by frequency modulation (FM) radio receivers and television broadcast receivers falls within the instrument landing system (ILS) localizer (LOC) and VHF omnidirectional range (VOR) frequency band, while the radiation produced by amplitude modulation (AM) radio receivers falls within the frequency range of automatic direction finder (ADF) receivers. This radiation could interfere with the correct operation of ILS, VOR and ADF equipment. Pilots are therefore cautioned against permitting the operation of any portable electronic device on board their aircraft during takeoff, approach and landing.

After extensive testing, Industry Canada has concluded that the switching on or use of handheld electronic calculators can cause interference to airborne ADF equipment in the 200 to 450 kHz frequency range when the calculator is held or positioned within 5 ft of the loop or sense antenna, or lead-in cable installation of the system. Pilots, especially of small aircraft and helicopters, are therefore cautioned against allowing the operation of calculators on board their aircraft while airborne.

4.5 VHF OMNIDIRECTIONAL RANGE (VOR)

The VHF omnidirectional range (VOR) is a ground-based, short-distance navigation aid (NAVAID) which provides continuous azimuth information in the form of 360 usable radials to or from a station. It is the basis for the very high frequency (VHF) airway structure. It is also used for VOR non-precision instrument approaches.

- a) *Frequency band*—VORs in Canada operate on assigned channels spaced at 0.05 MHz (50 kHz) increments within the frequency range 112.0 to 117.95 MHz.

The implication for users is that, in airspace serviced solely by VOR, aircraft equipped with older VOR receivers which cannot be tuned to two decimal places (e.g. 115.25 MHz) may not be able to operate under instrument flight rules (IFR). Of course, area navigation (RNAV), where approved for use, may enable operation under IFR.

Receivers with integrated distance measuring equipment (DME) (i.e. VOR/DME receivers) normally select the associated DME “Y” channel automatically, while stand-alone DME receivers display the “X” and “Y” channels separately.

- b) *Range*—VOR reception is subject to line-of-sight restrictions and range varies with aircraft altitude. Subject to shadow effect, reception at an altitude of 1 500 ft above ground level (AGL) is about 50 NM. Aircraft operating above 30 000 ft normally receive VOR at a distance of 150 NM or more.
- c) *Identification*—Identification is accomplished by means of a three-letter location indicator keyed in Morse code at regular intervals.
- d) *VOR courses*—Theoretically, an infinite number of courses (radials) are radiated from a VOR station; however, in actual practice, 360 radials are usable under optimum conditions.

The accuracy of course alignment for published VOR radials is $\pm 3^\circ$. Unpublished radials are not required to meet a particular standard of accuracy and may be affected by siting difficulties. Any significant anomalies in published radials sent out from VOR serving an aerodrome will be published in the *Canada Flight Supplement* (CFS).

4.5.1 VHF Omnidirectional Range (VOR) Receiver Checks

Where RNAV routes have not been published, VOR remains the primary NAVAID for use in Canada. It is important that the accuracy of the aircraft equipment be checked in accordance with principles of good airmanship and aviation safety.

While standard avionics maintenance practices are used for checking aircraft VOR receivers, dual VOR equipment may be

checked by tuning both sets to the same VOR facility and noting the indicated bearings sent to that station. A difference greater than 4° between the aircraft's two VOR receivers indicates that one of the aircraft's receivers may be beyond acceptable tolerance. In such circumstances, the cause of the error should be investigated and, if necessary, corrected before the equipment is used for an IFR flight.

4.5.2 Airborne VHF Omnidirectional Range (VOR) Check

Aircraft VOR equipment may also be checked while airborne by flying over a landmark located on a published radial and noting the indicated radial. Equipment which varies more than $\pm 6^\circ$ from the published radial should not be used for IFR navigation.

4.6 NON-DIRECTIONAL BEACON (NDB)

Non-directional beacons (NDBs) combine a transmitter with an antenna system providing a non-directional radiation pattern within the low frequency (LF) and medium frequency (MF) bands of 190–415 kHz and 510–535 kHz. NDBs are the basis of the LF/MF airway and air route system. In addition, they function as marker beacons for instrument landing system (ILS) as well as non-precision approach (NPA) aids for NDB instrument approaches.

- a) *Identification*—Identification consists of two or three letter or number indicators keyed in Morse code at regular intervals. (Private NDBs consist of a letter/number combination.)
- b) *Classification*—NDBs are classified by high, medium or low power output as follows:
 - (i) “H” power output is 2 000 W or more;
 - (ii) “M” power output is from 50 W to less than 2 000 W; and
 - (iii) “L” power output is less than 50 W.
- c) *Accuracy*—NDB systems are flight checked to an accuracy of at least $\pm 5^\circ$ for an approach and $\pm 10^\circ$ for en route. However, much larger errors are possible due to propagation disturbances caused by sunrise or sunset, reflected signals from high terrain, refraction of signals crossing shorelines at less than 30° and electrical storms.

4.7 DISTANCE MEASURING EQUIPMENT (DME)

Distance measuring equipment (DME) functions by means of two-way transmissions of signals between the aircraft and the DME site. Paired pulses at a specific spacing are sent out from the aircraft and are received by the ground station. The ground station then transmits paired pulses back to the aircraft on a different frequency. The time required for this signal exchange is measured in the airborne DME unit and is translated into distance (nautical mile [NM]) from the aircraft to the ground

station. Distance information received from DME is slant range distance and not actual horizontal distance. Accuracy of the DME system is within ± 0.5 NM or three percent of the distance, whichever is greater.

DME is collocated with most Canadian VHF omnidirectional range (VOR) installations (VOR/DME) and with many instrument landing system (ILS) and localizers (LOCs). In some cases, DME are also collocated with non-directional beacons (NDBs) to provide improved navigation capability. For collocated sites, a single keyer is used to key both the VOR/ILS/LOC and the DME with the three-letter location indicator. The VOR/ILS/LOC transmits three consecutive indicator codes in a medium pitch of 1 020 Hz followed by a single DME indicator code transmitted on the DME frequency (ultrahigh frequency [UHF]) and modulated at a slightly higher pitch of 1 350 Hz. In the event that synchronization from the VOR/ILS/LOC should fail, the DME identification will be transmitted independently.

The DME system is in the UHF band and therefore is limited to line-of-sight reception with a range similar to that of a VOR. Most DME “X” and “Y” channels are paired with VOR and LOC frequencies. As a result, the receiving equipment in most aircraft provide automatic DME selection through a coupled VOR/ILS receiver. Otherwise, the DME interrogator must be selected to the paired VOR or LOC frequency. Distance information from an independent tactical air navigation aid (TACAN) facility can be obtained by selecting the appropriate paired VOR frequency. (In that case, only DME information is being received; any apparent radial information must be ignored.) The DME paired frequency and channel number are published in the *Canada Flight Supplement* (CFS) and on instrument flight rules (IFR) en route charts in the navigation data box for all TACAN and DME installations.

By convention, those frequencies requiring only one decimal place (e.g. 110.3 MHz) are known as “X” channels and those associated with two decimal places are designated as “Y” channels (e.g. 112.45 MHz).

4.8 TACTICAL AIR NAVIGATION (TACAN)

Tactical air navigation aid (TACAN) is a navigation aid (NAVAID) used primarily by the military for en route, non-precision approaches (NPAs) and other military applications. It provides azimuth in the form of radials and slant distance in nautical miles (NM) from the ground station. The system operates in the ultrahigh frequency (UHF) range with the frequencies identified by channel number. There are 126 channels.

TACAN users may obtain distance information from a distance measuring equipment (DME) installation by selecting the TACAN channel that is paired with the VHF omnidirectional range (VOR) frequency. This TACAN paired channel number is published in the *Canada Flight Supplement* (CFS) for every VOR/DME facility.

CAUTION:

Only DME information is being received by the TACAN avionics. Any apparent radial information obtained through the TACAN avionics from a VOR/DME facility can only be false signals.

4.9 VHF OMNIDIRECTIONAL RANGE AND TACTICAL AIR NAVIGATION Aid (VORTAC)

A number of tactical air navigation aids (TACANs), supplied by the Department of National Defence (DND), are collocated with VHF omnidirectional ranges (VORs) to form facilities called VORTACs.

This facility provides VOR azimuth, TACAN azimuth and slant distance from the site. Components of a VORTAC operate simultaneously on paired frequencies so that aircraft distance measuring equipment (DME) avionics, when tuned using the paired VOR frequency, will obtain distance information from the DME component of the TACAN. An aircraft must be equipped with a VOR receiver to use VOR, appropriate equipment to use DME, or TACAN equipment to use TACAN (azimuth and DME).

4.10 VERY HIGH FREQUENCY (VHF) DIRECTION FINDING EQUIPMENT

VHF direction finders (VDF) are installed at a number of flight service stations (FSSs) and airport control towers. VDFs operate on pre-selected very high frequency (VHF) communication frequencies, which are listed in the *Canada Flight Supplement* (CFS) entry for the aerodrome where the equipment is installed. An airport controller or flight service specialist responsible for VDF operation has access to numerical readouts that provide a visual indication of an aircraft's bearing from a VDF site.

This information is based on the radio transmission received from the aircraft, thus giving the VDF operator a means of providing bearing or heading information to pilots requesting the service.

4.11 INSTRUMENT LANDING SYSTEM (ILS)

The instrument landing system (ILS) is designed to provide an aircraft with a precision final approach with horizontal and vertical guidance to the runway. The ground equipment consists of a localizer (LOC), a glide path transmitter, a non-directional beacon (NDB), and a distance measuring equipment (DME) fix or an area navigation (RNAV) fix to denote the final approach fix (FAF). See Figure 4.2 for a typical ILS installation.

4.11.1 Localizer (LOC)

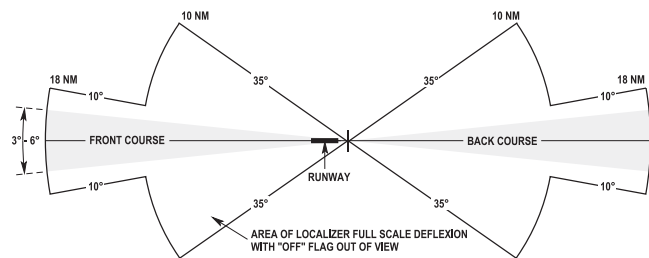
The LOC provides the pilot with course guidance to the runway centreline. When the LOC is used with the glide slope, it is called an ILS. The LOC is adjusted to provide an angular width typically between 3° and 6°, depending on runway length. The transmitter

antenna array is located at the far end of the runway away from the approach. LOCs operate in the 108.1–111.9 MHz frequency range. The LOC may be offset up to 3° from the runway heading and still publish as a straight-in procedure; however, the amount of offset will be published as a note on the approach plate. LOC alignment exceeding 3° of the runway heading will have an “X” as the first letter of the indicator, whereas LOCs and back courses with an alignment of 3° or less will have an “I” as the first letter.

At a few aerodromes, a LOC back course is also provided. This allows for an NPA in the opposite direction to a front course approach without glide path information. Note that not all ILS LOCs radiate a usable back course signal.

The normal, reliable coverage of ILS LOCs is 18 NM within 10° of either side of the course centreline and 10 NM within 35° of the course centreline for both front and back courses.

Figure 4.1—LOC Front and Back Course



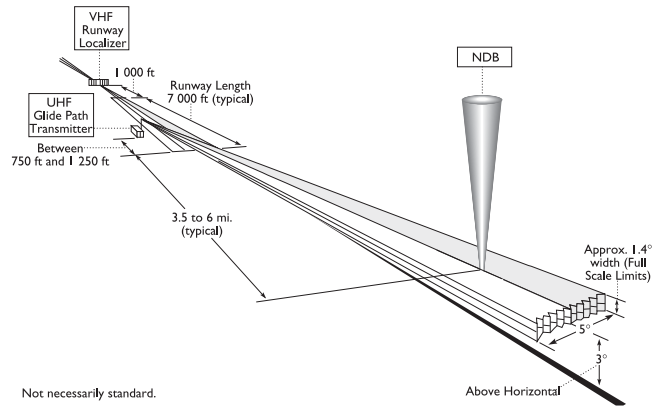
LOC and glide path identification is transmitted on the LOC frequency in the form of a two-letter or letter-number indicator preceded by the letter “I” (e.g. IOW).

4.11.2 Glide Path (GP)

The glide path transmitter operates within the frequency range of 329.3 to 335.0 MHz. The frequency is paired with the associated LOC frequency in accordance with ICAO standards. The glide path is adjusted to a published approach angle (typically 3°) and a beam width of 1.4°. There is no usable back course. The antenna array is located approximately 1 000 ft from the approach end of the runway and offset approximately 400 ft from the runway centreline. As the glide path is formed by reflecting the transmitted signal off the ground, the beam-forming area in front of the glide path antenna can be negatively affected by heavy snow buildup. Airports have snow-clearing plans in effect for this area as the snow must remain below the allowable design depth for proper glide path operation.

At some of the larger airports, an ILS is installed at each end of a runway. Consequently, a front course approach may be made to either end of the runway. The two systems are interlocked so that only one ILS can operate at any time.

Figure 4.2—Typical ILS Installation



4.11.3 Non-Directional Beacon (NDB)

Low-power NDB transmitters are sometimes located on the LOC (front and back course), 3.5 to 6 mi. from the runway threshold. If it is not possible to install an NDB, a DME fix or RNAV fix may be used instead to form the FAF. In some cases, an en route NDB is located on a LOC so that it may serve as a terminal as well as an en route facility. As a general rule, NDBs transmit a two- or three-letter indicator. The FAF provides a fix to which the pilot can navigate for the transition to the ILS.

4.11.4 Instrument Landing System (ILS)/Distance Measuring Equipment (DME)

At some locations, a DME paired with the ILS provides distance information to define the IAF and MAP. At other locations, VOR/DME, which are available either on the airport or aligned with the appropriate runway, will be used to provide distance information for the transition to the ILS.

4.11.5 Instrument Landing System (ILS) Categories

- Operational CAT I*—Operation down to a minima of 200 ft DH and an RVR of 2 600 ft with a high probability of success. (When RVR is not available, 1/2 SM ground visibility is substituted.)
- Operational CAT II*—Operation down to a minima below 200 ft DH and an RVR of 2 600 ft, to as low as 100 ft DH and an RVR of 1 200 ft, with a high probability of success.
- Operational CAT III*—CAT III minima will be prescribed in the carrier's operating specifications, in the operator's operations manual, or in the CAP.

4.11.6 Category II/III Instrument Landing System (ILS)

CAT II/III ILS enable pilots to conduct instrument approaches to lower weather minima by using special equipment and procedures in the aircraft and at the airport.

The following airport systems must be fully serviceable to meet CAT II/III standards:

- Airport lighting*—A lighting system which includes:
 - approach lights;
 - runway threshold lights;
 - touchdown zone lights;
 - centreline lights;
 - runway edge lights;
 - runway end lights;
 - all stop bars and lead-on lights;
 - essential taxiway lights.
- ILS components*—Including:
 - LOC;
 - glide path transmitter;
 - NDB, DME or RNAV fix.
- RVR equipment*—For CAT II operations, two RVRs: one located adjacent to the runway threshold (touchdown or RVR A), and one located adjacent to the runway mid-point (mid-point or RVR B). For CAT III operations, three RVRs: one located adjacent to the runway threshold (touchdown or RVR A), one located adjacent to the runway mid-point (mid-point or RVR B), and one located at the stop-end (rollout or RVR C) of the runway (ref. ICAO Annex 3, 4.6.3.4).
- Power source*—Airport emergency power (primary electrical source for all essential system elements), commercial power available within one second as backup.

4.11.7 Caution Regarding Use of Instrument Landing System (ILS)

- Low clearance indications*—Course interference is negligible with front and back courses when they are flown within 6° on either side of the course centreline. Acutal anomalies are typically noted on the applicable approach charts. However, failure of certain elements of some multi-element LOC antenna array systems can cause false courses or low clearances* beyond 6° from the front- or back-course centreline that are not detected by the LOC monitoring system. This could result in a premature cockpit indication of approaching or intercepting an on-course centreline. For this reason, a coupled approach should not be initiated until the aircraft is established within 6° of the LOC centreline. It is also essential to confirm the LOC on-course indication by reference to the aircraft's heading and other NAVAIDs (such as an ADF bearing or RNAV track) before commencing final descent. Any abnormal indications experienced within 35° of the published front- or back-course centreline of an ILS LOC should be reported immediately to the appropriate ATS facility.

*A low clearance occurs whenever there is less than full-scale deflection of the omnibearing selector or CDI at a position where a full-scale deflection should be displayed outside of 6° from the LOC centreline.

- b) *LOC false course*—False course captures may occur when the pilot prematurely selects APPROACH MODE from either HDG or LNAV MODE. Some ILS receivers produce lower than expected course deviation outputs in the presence of high modulation levels of the LOC-radiated signal. This can occur even when both the ground transmitter and the airborne receiver meet their respective performance requirements. The reduced course deviation can, in turn, trigger a false course capture in the AFCS. False course captures can occur at azimuths of anywhere from 6° to 35° but are most likely to occur in the vicinity of 6° to 10° azimuth from the published LOC course. A false capture is deemed to have occurred when the AFCGS allows the LOC to switch from ARMED to CAPTURED even though the omnibearing selector or CDI has not moved and is still at full-scale deflection.

In order to minimize the possibility of a false course capture during an ILS approach, pilots should use raw data sources to ensure that the aircraft is within 6° of the correct LOC course prior to initiating a coupled approach. The following cockpit procedures are recommended:

- (i) APPROACH MODE should not be selected until the aircraft is within 18 NM of the threshold and is positioned within 6° of the inbound ILS course.
 - (ii) In addition, pilots should:
 - (A) ensure that the ADF bearing (associated with the appropriate NDB site) or RNAV track for the runway is monitored for correct orientation;
 - (A) be aware when the raw data indicates that the aircraft is approaching and established on the correct course; and
 - (A) be aware that, should a false course capture occur, it will be necessary to deselect and re-arm APPROACH MODE in order to achieve a successful coupled approach on the correct LOC course.
- c) *EMI*—The effect of EMI, particularly on ILS LOC system integrity, is becoming increasingly significant. In built-up areas, power transformer stations, industrial activity, and broadcast transmitters have been known to generate interference that affects LOC receivers. The effect is difficult to quantify as the interference may be transitory, and certain LOC receivers are more susceptible than others to EMI. If the LOC goes off the air, the “off” flag may remain out of sight or the flag and CDI may give erratic or erroneous indications. It is even possible that normal on-course cockpit indications may continue. Under normal circumstances, ATS will advise pilots conducting an approach if there is equipment failure.
- d) *Automatic landing (autoland) operations*—The commissioning, periodic flight inspection, and maintenance of the ILS facility serving a CAT III runway include an analysis of the ILS LOC signal throughout the rollout to confirm that the ILS facility will support CAT III operations. The successful outcome of any ILS autoland depends on the performance of the aircraft’s AFCGS and the ILS LOC and

glide path signals. The course structure and the integrity of an ILS can be compromised when protection of the ILS critical areas is not assured. The LOC is particularly sensitive due to its larger signal volume in the aerodrome area. Surface and airborne traffic as well as vehicles that are crossing or parked in these critical areas can create a deflection in or a disturbance to the ILS signal. An ILS CAT III signal is only protected by ATC when low visibility procedures are in effect at that aerodrome.

It has been common practice for operators of appropriately equipped and certified aircraft to conduct AFCGS autoland operations at CAT I, II, or III facilities when weather conditions are above the appropriate minima to satisfy maintenance, training, or reliability program requirements. A portion of these autolands may also need to be conducted on CAT I ILS facilities, or on CAT II/III ILS facilities when low visibility procedures are not in force. In the case of a CAT I ILS facility, for example, the ILS should be of CAT II signal quality without necessarily meeting the associated CAT II reliability and availability criteria for backup equipment and automatic changeover of facility performance.

Some CAT I and II ILS facilities that have the signal characteristics to support AFCGS operations to CAT I and II minima, as applicable, may not have the requisite signal characteristics to support autoland operations. NAV CANADA maintains a list indicating which facilities are suitable for autoland practice. The list is available here: <https://www.navcanada.ca/EN/products-and-services/Pages/on-board-operational-initiatives-ils.aspx>.

Flight crews are reminded to exercise extreme caution whenever ILS signals are used beyond the minima specified in the approach procedure and when conducting autolands on any category of ILS when critical area protection is not assured by ATC. Pilots must be prepared to immediately disconnect the autopilot and take appropriate action should unsatisfactory AFCGS performance occur during these operations.

- e) *Glide path fluctuations*—While an aircraft is navigating on the ILS, fluctuations may occur when other aircraft or vehicles are moving through the glide path critical area, causing interference with the signal. In some cases, the aircraft automation/autopilot may follow momentary fluctuations, causing the aircraft to pitch or roll. ATS will protect the glidepath signal when:
- (i) The ceiling is less than 1 000 ft or visibility is less than 3 miles, or both; and
 - (ii) The arriving aircraft is inside the FAF on an ILS approach.

The ILS critical areas are not protected when aircraft are outside the FAF. Furthermore, except for CAT II/III operations, localizer signal protection is not applied when a preceding aircraft passes over or through the critical area while taking off, landing, or executing a missed approach on the same or

another runway. Pilots must be aware of ILS signal interference threats as well as flight display indications and autopilot functionality during manual or fully coupled ILS approaches.

In situations where protection of the ILS signal is not required but a pilot wishes to conduct autoland or practise low-visibility procedures, the pilot must advise the controller of these intentions early enough so that the controller can either protect the ILS critical area or advise the pilot that, due to traffic, ILS critical area protection is not possible. If ILS critical area protection is not possible, the controller will use the phrase “ILS CRITICAL AREA NOT PROTECTED”. It then becomes the pilot’s responsibility to continue the chosen approach mode.

Pilots should review Transport Canada’s *Manual of All Weather Operations* for an understanding of ILS critical and sensitive areas.

NOTE: At uncontrolled airports, aircraft manoeuvring on the ground may enter ILS critical areas during taxi, takeoff, or landing.

- f) *Glide path false course*—The normal antenna pattern of glide path installations produces a false glide path angle at two and three times the set angle (e.g. at 6° and 9° for a typical 3° published glide path angle).

ATC procedures in terminal areas are designed to maintain aircraft at an altitude that provides a normal rate of descent and a suitable position to capture the published glide path signal. Following the instrument procedures carefully will ensure both an approach with a stable rate of descent and the complete avoidance of a false glide path. Failure to adhere to instrument procedures (e.g. remaining at an altitude higher than published) could result in positioning the aircraft in a false glide path created by the radiated lobe.

In order to minimize the possibility of false glide path capture during an ILS approach, pilots should verify the rate of descent and the altitude at the FAF to ensure that the aircraft is on the published glide path.

5.0 AREA NAVIGATION (RNAV)

Area navigation (RNAV) is a method of navigation which permits aircraft operation on any desired flight path within the coverage of navigation aids (NAVAIDs) or within the limits of the capability of self-contained NAVAIDs, or a combination of these.

Existing navigation systems which provide an area navigation (RNAV) capability include the global navigation satellite system (GNSS), VHF omnidirectional range (VOR)/distance measuring equipment (DME) (RHO-THETA), DME-DME (RHO-RHO), inertial navigation system (INS) and inertial reference system (IRS).

5.1 GLOBAL NAVIGATION SATELLITE SYSTEM (GNSS)

The global navigation satellite system (GNSS) is a worldwide position and time determination system that includes one or more satellite constellations, aircraft receivers and system integrity monitoring, augmented as necessary to support the required navigation performance for the intended operation.

5.2 GLOBAL NAVIGATION SATELLITE SYSTEM (GNSS) CONSTELLATIONS

Currently, there are two complete navigation satellite constellations in orbit: the U.S. global positioning system (GPS) and the Russian global orbiting navigation satellite system (GLONASS). The U.S. and Russia have offered these systems as the basis of a GNSS that is free of direct user charges. Additional constellations are being developed by the European Union (Galileo), and by China (BeiDou). It is expected that all four GNSS constellations will be in service by 2020. Instrument flight rules (IFR) certified GNSS receivers manufactured in North America use only the GPS constellation, but plans are underway to expand that ability.

5.2.1 Global Positioning System (GPS)

The GPS constellation was developed by the U.S. military; but since 1996, it has been managed by an executive board, chaired jointly by the departments of Defense and Transportation, that is comprised of representatives from several other departments to ensure that civil users’ requirements are considered in the management of the system. Title 10 of the U.S. Code, Section 2281, assigns the Secretary of Defense statutory authority to sustain and operate GPS for military and civil purposes. This statute directs the Secretary of Defense to provide civil GPS service on a continuous, worldwide basis, free of direct user fees.

The design GPS constellation contains 24 GPS satellites, orbiting the earth twice a day at an altitude of 10 900 NM (20 200 km). They are arranged in six separate orbital planes, with four satellites in each; this gives complete global coverage. There are approximately 32 operational satellites; however, at any given time, one or more may be decommissioned or be out of service temporarily for maintenance.

All GPS orbits cross the equator at a 55° angle, so it is not possible to see a GPS satellite directly overhead when north of 55° N or south of 55° S latitude. This does not affect service in polar areas adversely; in fact, on average, more GPS satellites are visible at high latitudes since receivers can track satellites on the other side of the pole.

GPS positioning is based on precise timing. Each satellite has four atomic clocks on board, guaranteeing an accuracy of one billionth of one second, and broadcasts a digital PRN code that is repeated every millisecond. All GPS receivers start generating the same code at the same time. Code matching techniques

establish the time of arrival difference between the generation of the signal at the satellite and its arrival at the receiver. The speed of the signal is closely approximated by the speed of light, with variations resulting from ionospheric and atmospheric effects modeled or directly measured and applied. The time of arrival difference is converted to a distance, referred to as a pseudorange, by computing the product of the time of arrival difference and the average speed of the signal. The satellites also broadcast orbit information (ephemeris) to permit receivers to calculate the position of the satellites at any instant in time.

Normally, SVNs are sequential (i.e. SVN 68 was the sixty-eighth satellite launched), but PRN codes are assigned to a position in the constellation, and are numbered PRN 1 to 24 (with a maximum of 32).

A receiver normally needs four pseudoranges to calculate a three-dimensional position and to resolve the time difference between receiver and satellite clocks. In addition to position and time, GPS receivers can also calculate velocity—both speed and direction of motion.

GPS accuracy depends on transit time and signal propagation speed to compute pseudoranges. Therefore, accurate satellite clocks, broadcast orbits, and computation of delays as the signals pass through the ionosphere are critical. The ionosphere, which is a zone of charged particles several hundred kilometres above the Earth, causes signal delays that vary from day to night and by solar activity. Current receivers contain a model of the nominal day/night delay, but this model does not account for variable solar activity. For applications requiring high accuracy, GPS needs an augmentation system to correct the computed transit time to compensate for this delay.

Another key to GPS accuracy is the relative position of satellites in the sky, or satellite geometry. When satellites are widely spread, geometry and accuracy are better. If satellites are clustered in a small area of the sky, geometry and accuracy are worse. Currently, GPS horizontal and vertical positions are accurate to 6 m and 8 m, respectively, 95% of the time.

The GPS satellite constellation is operated by the U.S. Air Force from a control centre at Schriever Air Force Base in Colorado. A global network of monitor and uplink stations relays information about the satellites to the control centre and sends messages, when required, to the satellites.

If a problem is detected with a satellite, it is commanded to send an “unhealthy” status indication, causing receivers to drop it from the position solution. Since detection and resolution of a problem take time, and this delay is unacceptable in aviation operations, augmentation systems are used to provide the level of integrity required by aviation.

The GPS constellation status is available at <http://www.navcen.uscg.gov/?Do=constellationStatus>.

5.2.2 Global Orbiting Navigation Satellite System (GLONASS)

GLONASS is a global satellite constellation, operated by the Russian Aerospace Defence Forces, that provides real-time position and velocity determination for military and civilian users. The satellites are located at an altitude of 19 100 km and at an inclination of the orbital planes of 64.8° to the equator.

The GLONASS constellation status is available at www.glonass-iac.ru/en/.

5.2.3 Galileo Navigation Satellite System

Galileo is Europe’s GNSS constellation, which will provide a highly accurate, guaranteed global positioning service under civilian control. The fully deployed Galileo system will consist of 24 operational satellites plus six in-orbit spares, positioned in three circular medium Earth orbit (MEO) planes at an altitude of 23 222 km, and at an inclination of the orbital planes of 56° to the equator.

The Galileo system is scheduled to be completed in 2020.

The Galileo constellation status is available at <https://www.gsc-europa.eu/system-status/Constellation-Information>.

5.2.4 BeiDou Navigation Satellite System

BeiDou is the Chinese navigation satellite system. It consists of two separate satellite constellations—a limited test system that has been operating since 2000 and a full-scale global navigation system that is currently under construction. The BeiDou system is scheduled to be completed in 2020.

5.3 AUGMENTATION SYSTEMS

Augmentation of the global positioning system (GPS) constellation or the global orbiting navigation satellite system (GLONASS) constellation is required to meet the accuracy, integrity, continuity and availability requirements for aviation. There are currently three types of augmentation:

- a) aircraft-based augmentation system (ABAS);
- b) satellite-based augmentation system (SBAS); and
- c) ground-based augmentation system (GBAS).

5.3.1 Aircraft-Based Augmentation System (ABAS)

RAIM and FDE functions in current IFR-certified avionics are considered ABAS. RAIM can provide the integrity for the en route, terminal, and NPA phases of flight. FDE improves the continuity of operation in the event of a satellite failure and can support primary-means oceanic operations.

RAIM uses extra satellites in view to compare solutions and detect problems. It usually takes four satellites to compute a navigation solution, and a minimum of five for RAIM to function. The availability of RAIM is a function of the number of visible satellites and their geometry. It is complicated by the movement of satellites relative to a coverage area and temporary satellite outages resulting from scheduled maintenance or failures.

If the number of satellites in view and their geometry do not support the applicable alert limit (2 NM en route, 1 NM terminal and 0.3 NM NPA), RAIM is unable to guarantee the integrity of the position solution. (Note that this does not imply a satellite malfunction.) In this case, the RAIM function in the avionics will alert the pilot, but will continue providing a navigation solution. Except in cases of emergency, pilots must discontinue using GNSS for IFR navigation when such an alert occurs.

A second type of RAIM alert occurs when the avionics detects a satellite range error (typically caused by a satellite malfunction) that may cause an accuracy degradation that exceeds the alert limit for the current phase of flight. When this occurs, the avionics alerts the pilot and denies navigation guidance by displaying red flags on the HSI or CDI. Continued flight using GNSS is then not possible until the satellite is flagged as unhealthy by the control centre, or normal satellite operation is restored.

Some avionics go beyond basic RAIM by having an FDE feature that allows the avionics to detect which satellite is faulty, and then to exclude it from the navigation solution. FDE requires a minimum of six satellites with good geometry to function. It has the advantage of allowing continued navigation in the presence of a satellite malfunction.

Most first generation avionics do not have FDE and were designed when GPS had a feature called SA that deliberately degraded accuracy. SA has since been discontinued, and new generation SBAS-capable receivers (TSO-C145a/C146a) account for SA being terminated. These receivers experience a higher RAIM availability, even in the absence of SBAS messages, and also have FDE capability.

For avionics that cannot take advantage of SA being discontinued, average RAIM availability is 99.99% for en-route and 99.7% for NPA operations for a 24-satellite GPS constellation. FDE availability ranges from 99.8% for en route to 89.5% for NPA. Avionics that can take advantage of SA having been discontinued have virtually 100% availability of RAIM for en route and 99.998% for NPA; FDE availability ranges from 99.92% for en route to 99.1% for NPA. These figures have been computed for mid-latitudes, and are dependent on user position and also on which satellites are operational at any given time. RAIM and FDE availability is typically even better at high latitudes, since the receiver is able to track satellites on the other side of the North Pole.

The level of RAIM or FDE availability for a certain airspace at a certain time is determined by an analysis of satellite geometry, rather than signal measurement. This is why it can be predicted

by receivers or with PC-based computer software. The difference between the two methods is that the receivers use the current constellation in their calculations while the PC software can use a constellation definition that takes into account scheduled satellite outages.

Most TSO-C129a avionics also accept signals from an aircraft altitude encoder. This is called baro-aiding, and it essentially reduces the number of satellites required by one, thus further increasing the availability of RAIM and providing an additional measure of tolerance to satellite failures.

With proper integration, IRS and INS can augment/enhance GNSS navigation. This system allows “coasting” through periods of low availability.

5.3.2 Satellite-Based Augmentation System (SBAS)

SBAS uses a network of ground-based reference stations that monitor navigation satellite signals and relay data to master stations, which assess signal validity and compute error corrections. The master stations generate two primary types of messages: integrity, and range corrections. These are broadcast to SBAS-capable GNSS receivers via GEO satellites in fixed orbital positions over the equator. The SBAS GEO satellites also serve as additional sources of navigation ranging signals.

The integrity messages provide a direct validation of each navigation satellite’s signal. This function is similar to RAIM, except that the additional satellites required for RAIM are not necessary when SBAS integrity messages are used. The integrity messages are available wherever a GEO satellite signal can be received.

The range corrections contain estimates of the errors introduced into the range measurements as a result of ionospheric delays, and satellite ephemeris (orbit) and clock errors. Ionospheric delay terms are critical for correction messages, and are also the most challenging to characterize. First, each reference station measures the ionospheric delay for each visible satellite. These observations are sent to the master station, where they are combined, and used to generate a model of the ionosphere, which is then transmitted to the receivers via the GEO satellite. The accuracy of the model is dependent on the number and placement of the reference stations providing observations of ionospheric delays.

By compensating for these errors, SBAS-capable GNSS receivers can compute the position of the aircraft with the accuracy necessary to support flight operations with vertical guidance. Vertical guidance provides safer stabilized approaches and transition to visual for landing. This represents one of the principal benefits from SBAS service. The other is lower approach minima at certain airports, as a result of greater lateral accuracy.

The first SBAS, the U.S. FAA’s wide area augmentation system (WAAS), was commissioned in 2003. Europe has built a compatible system called EGNOS (European geostationary

navigation overlay service) which was approved for aviation use in August 2010. Japan and India also have similar systems to augment GNSS: MSAS (MTSAT satellite-based augmentation system) and GAGAN (GPS and GEO augmented navigation), respectively.

WAAS messages are currently being broadcast by three geostationary satellites located on the equator at 107.3°W, 116.8°W and 133°W.

5.3.3 Ground-Based Augmentation System (GBAS)

GBAS, also known as LAAS, sends corrections directly to GBAS-capable receivers from a ground station at an airport.

GPS receivers with antennas at surveyed surface locations provide measurements used to generate and broadcast pseudorange corrections. Aircraft receivers use the corrections for increased accuracy, while a monitor function in the ground station assures the integrity of the broadcast. GBAS provides service over a limited area, typically within 30 NM of the ground station.

GBAS is not yet available in Canada.

5.4 DOMESTIC INSTRUMENT FLIGHT RULES (IFR) APPROVAL TO USE GLOBAL NAVIGATION SATELLITE SYSTEM (GNSS) AND SATELLITE-BASED AUGMENTATION SYSTEM (SBAS)

The global navigation satellite system (GNSS) and satellite-based augmentation system (SBAS) approved for instrument flight rules (IFR) use in Canada are listed in *AIP Canada (ICAO)* ENR 4.3, Table 4.3.

GNSS capability may be provided by a panel-mount receiver or by a flight management system (FMS) that uses the appropriate sensor.

Avionics are required to meet appropriate equipment standards and, equally important, the avionics installation must be approved by Transport Canada (TC) to ensure proper avionics integration and display.

Handheld and other visual flight rules (VFR) receivers do not support integrity monitoring, nor do they comply with other certification requirements; therefore, they cannot be used for IFR operations.

Holders of air operator certificates (AOCs) issued under Part VII of the *Canadian Aviation Regulations* (CARs) and private operator certificates issued under CAR 604 are required to be authorized to conduct GNSS instrument approach operations in instrument meteorological conditions (IMC).

5.4.1 Domestic En Route and Terminal Operations

In practice, pilots can use GNSS for guidance most of the time. If an integrity alert occurs while en route, the pilot can then continue by using conventional aids, diverting if necessary from the direct routing, notifying ATS of any changes to the flight and obtaining a new clearance, as required.

When using GNSS to maintain a track in terminal operations, the avionics shall be in terminal mode and/or the CDI shall be set to terminal sensitivity. (Most avionics set the mode and sensitivity automatically within 30 NM of the destination airport, or when an arrival procedure is loaded.)

When using GNSS to navigate along VHF/UHF or LF/MF airways, ground-based NAVAID reception is not an issue. This means that pilots using GNSS for navigation can file or request an altitude below the MEA, but at or above the MOCA, to avoid icing, optimize cruise altitude, or in an emergency. However, an ATS clearance to fly at a below-MEA altitude could be dependent on issues such as radiocommunication reception and the base of controlled airspace. In the rare case of a RAIM alert while en route below the MEA, and out of range of the NAVAID, pilots should advise ATS and climb to continue the flight using alternate means of navigation.

GNSS avionics typically display the distance to the next waypoint. To ensure proper separation between aircraft, a controller may request the distance from a waypoint that is not the currently active waypoint in the avionics; it may even be behind the aircraft. Pilots must be able to obtain this information quickly from the avionics. Techniques vary by manufacturer, so pilots should ensure familiarity with this function.

At times outside radar coverage, pilots may be cleared by ATS to a position defined by a latitude and longitude. As these are usually outside the range of traditional NAVAIDs, there is no means to cross check that the coordinates have been entered accurately. Pilots must be particularly careful to verify that the coordinates are correct.

5.4.2 Global Navigation Satellite System (GNSS)-Based Area Navigation (RNAV) Approach Procedures

Prior to the advent of GNSS, only two types of approach and landing operations were defined: precision approach and NPA. Definitions have now been added for APV to cover approaches that use lateral and vertical guidance, but that do not meet the requirements established for precision approaches.

GNSS-based approaches are charted as “RNAV (GNSS) RWY XX.” The “(GNSS)” before the runway identification indicates that GNSS must be used for guidance. Pilots and controllers shall use the prefix “RNAV” in radio communications (e.g. “CLEARED TO THE VANCOUVER AIRPORT RNAV RUNWAY ZERO FOUR APPROACH”).

GNSS-based RNAV approaches are designed to take full advantage of GNSS capabilities. A series of waypoints in a “T” or “Y” pattern eliminates the need for a procedure turn. The accuracy of GNSS may result in lower minima and increased capacity at the airport. Because GNSS is not dependent on the location of a ground-based aid, straight-in approaches are possible for most runway ends at an airport.

In Canada, RNAV (GNSS) approach charts may depict up to five sets of minima:

- a) LPV;
- b) LP;
- c) LNAV/VNAV;
- d) LNAV; and
- e) CIRCLING.

The LP and LNAV minima indicate an NPA, while the LNAV/VNAV and LPV minima refer to APV approaches (RNAV approaches with vertical guidance). However, the actual terms “NPA” and “APV” do not appear on the charts because they are approach categories not related to specific procedure design criteria. In Canada, the depiction of the five sets of minima is similar to the way that an ILS approach may show landing minima for ILS, LOC and CIRCLING.

The approach chart may indicate a WAAS channel number. This is used for certain types of avionics and permits the approach to be loaded by entering the number shown.

All approaches must be retrieved from the avionics database, and that database must be current. While it is sometimes acceptable to use pilot-generated waypoints en route, this is not permitted for approach procedures.

5.4.2.1 Area Navigation (RNAV) Approaches with Lateral Guidance Only

Avionics for LNAV approaches do not define a vertical path through space; as such, each approach segment has a minimum altitude below which the pilot may not descend.

GPS (TSO-C129/C129a Class A1, B1, B3, C1 or C3) and WAAS (TSO-C145a/C146a, any class) avionics are both able to provide the lateral guidance required for these approaches.

Without vertical guidance, pilots are required to remain at or above the MDA unless a visual transition to landing can be accomplished, or to conduct a missed approach at the MAWP, typically located over the runway threshold.

WAAS and some GPS TSO-C129/C129a avionics may provide advisory vertical guidance when flying approaches without LNAV/VNAV or LPV minima. It is important to recognize that

this guidance is advisory only and the pilot is responsible for respecting the minimum altitude for each segment until a visual transition to land is commenced.

Pilots using TSO-C129/C129a avionics should use the RAIM prediction feature (including known satellite outages obtained by NOTAM at KGPS) to ensure that approach-level RAIM will be supported at the destination or alternate airport for the ETA (± 15 min). This should be done before takeoff, and again prior to commencing a GNSS-based approach. If approach-level RAIM is not expected to be available, pilots should advise ATS as soon as practicable and state their intentions (e.g. delay the approach, fly another type of approach, proceed to alternate).

5.4.2.2 Global Navigation Satellite System (GNSS) Overlay Approaches

GNSS overlay approaches are included on certain traditional VOR- or NDB-based approaches, that have been approved to be flown using the guidance of IFR approach-certified GNSS avionics. Because of approach design criteria, LOC-based approaches cannot be overlaid.

GNSS overlay approaches are identified in the CAP by including “(GNSS)” after the runway designation (e.g. NDB RWY 04 [GNSS]). When using GNSS guidance, the pilot benefits from improved accuracy and situational awareness through a moving map display (if available) and distance-to-go indication. Unless required by the AFM or AFM supplement, when conducting GNSS overlay approaches, the VOR, DME and/or NDB onboard navigation equipment does not need to be installed and/or functioning and the underlying approach navigation aid(s) do(es) not need to be functioning. Nevertheless, good airmanship dictates that all available sources of information be monitored.

Pilots shall request GNSS overlays as follows: “REQUEST GNSS OVERLAY RUNWAY ZERO FOUR”. ATS may ask the pilot to specify the underlying NAVAID if more than one overlay approach is published for the runway.

GNSS overlay approaches are intended to be a transition measure to allow immediate benefits while waiting for the commissioning of a GNSS stand-alone approach for a runway. For this reason, in most cases, the GNSS overlay approach will be discontinued when a GNSS stand-alone approach is published for a given runway.

When flying overlay approaches, pilots should use the RAIM prediction feature of TSO-C129/C129a avionics to ensure that approach-level RAIM will be supported, as described in the preceding subsection.

5.4.2.3 Vertical Guidance on Area Navigation (RNAV) Approaches

LNAV/VNAV and LPV describe approaches with vertical guidance. These deliver the safety benefits of a stabilized approach and, in many cases, improve airport accessibility.

Aircraft with TSO-C145a/C146a (WAAS Class 2 or 3) or TSO-C115b (multi-sensor FMS) avionics, may fly RNAV (GNSS) approaches to LNAV/VNAV minima with vertical guidance in a similar manner to the way they fly an ILS approach: with both a lateral CDI and a VDI. The lateral guidance must be based on GPS or WAAS. The vertical guidance may be based on WAAS, or on barometric inputs (baro-VNAV), depending on the approach and the aircraft equipment.

Aircraft with WAAS Class 3 avionics may fly RNAV (GNSS) approaches to LPV minima in a similar manner. In this case, both the lateral and vertical guidance are based on WAAS.

The nominal final approach course vertical flight path angle for LNAV/VNAV and LPV approaches is 3°, avoiding the step-down minimum altitudes associated with traditional NPAs.

The LNAV/VNAV and LPV minima depict a DA, which requires the pilot to initiate a missed approach at the DA if the visual reference to continue the approach has not been established.

5.4.2.4 Area Navigation (RNAV) Approaches with Vertical Guidance Based on Barometric Vertical Navigation (Baro-VNAV)

Multi-sensor FMSs that meet TSO-C115b have been certified since the late 1980s to provide guidance for a stabilized final approach segment during NPAs. The vertical guidance for these systems has been derived from a barometric altitude input; hence, these approaches are known as baro-VNAV approaches. This equipment has typically only been installed on transport category aeroplanes. The information provided by these systems is advisory only, and pilots are required to respect all minimum altitudes, including step-down altitudes, since NPAs are not specifically designed to take advantage of baro-VNAV capability.

With the publication in Canada of RNAV (GNSS) approaches with vertical guidance, suitably-equipped aircraft may fly baro-VNAV approaches to the LNAV/VNAV minima published on these approach plates. The standard for equipment is a multi-sensor FMS that meets TSO-C115b and is certified in accordance with FAA AC 20-138C or equivalent. The FMS must use GNSS sensor input, but does not require a WAAS-capable receiver to fly to LNAV/VNAV minima. Pilots must note that the vertical path defined by baro-VNAV is affected by altimeter setting errors. For this reason, baro-VNAV is not authorized unless a local field altimeter setting is available.

Non-standard atmospheric conditions, particularly temperature, also induce errors in the baro-VNAV vertical path. A nominal 3° glide path will be steeper at warmer temperatures and shallower at lower temperatures. To compensate for these temperature effects, some avionics allow input of the temperature at the airport and apply temperature compensation to the vertical path angle so that the baro-VNAV vertical path is not biased as a function of temperature. Unfortunately, not all systems have similar capabilities to compensate for temperature effects, and pilots need to understand their system's capabilities.

When temperature compensation is not or cannot be applied through the FMS, pilots shall refer to a temperature limit, referred to as TLim, published on the approach chart. This limiting temperature protects a baro-VNAV's final segment vertical path only (it does not protect any of the published minimum IFR altitudes on the chart). Below this temperature, the uncompensated vertical path generated by the FMS will not provide the required obstacle protection. Therefore, when the temperature is below the published TLim, an aircraft with an uncompensated baro-VNAV system shall not fly an RNAV approach to LNAV/VNAV minima. TLim will be a function of the reduced obstacle clearance resulting from flying an uncompensated VPA and will vary from approach to approach. For avionics systems that have the capability to correctly adjust the VPA for temperature deviations, the published TLim does not apply if the pilot enables the temperature compensation.

In short, regardless of whether or not the FMS (or other automated means) provides temperature compensation of the vertical path, and whether or not the actual reported airport temperature is within the temperature limit for the procedure, pilots are responsible for correcting the temperature of all minimum published IFR altitudes on the approach, including the DA.

5.4.2.5 Area Navigation (RNAV) Approaches with Vertical Guidance Based on Wide Area Augmentation System (WAAS)

RNAV (GNSS) approaches with vertical guidance based on WAAS require a Class 2 or 3 (for LNAV/VNAV minima) or Class 3 (for LPV minima) TSO-C145a WAAS receiver, or a TSO-C146a sensor interfaced to appropriate avionics.

RNAV (GNSS) approaches with vertical guidance based on WAAS are entirely dependent on the WAAS signal. WAAS meets essentially the same navigation performance requirements (accuracy, integrity and continuity) as ILS, and pilots can expect guidance to be similar to that provided by an ILS, with some improvement in signal stability over ILS.

WAAS avionics continuously calculate horizontal and vertical protection levels during an approach and will provide a message to the crew if alert limits for the procedure are exceeded, similar to the way in which ILS monitors shut down an ILS signal when its accuracy does not meet the required tolerances.

Although the WAAS integrity monitor is very reliable, good airmanship nevertheless dictates that pilots verify the FAWP crossing altitude depicted on approach plates with LNAV/VNAV and LPV minima, in the same way that the glide path check altitude is used when flying an ILS approach. Large altitude deviations could be an indication of a database error or otherwise undetectable incorrect signal.

5.5 FLIGHT PLANNING

NOTAM on ground-based navigation aid (NAVAID) outages are of direct use to pilots because if a NAVAID is not functioning, the related service is not available. With the global positioning system (GPS) and wide area augmentation system (WAAS), the knowledge of a satellite outage does not equate to a direct knowledge of service availability. The procedures for determining service availability are different for GPS (TSO-C129/C129a) and WAAS (TSO-C145a/C146a) avionics, and are explained in the next subsections.

5.5.1 Global Positioning System (GPS) NOTAM

NOTE:

This section applies only to operators using TSO-C129/C129a avionics.

Research has shown minor differences among avionics' computations of RAIM availability, making it impractical to develop a GPS RAIM NOTAM system that will work reliably for all receivers. Because of this, and since IFR GPS approval requires aircraft to be equipped with traditional avionics to be used when RAIM is unavailable, NOTAM information on GPS RAIM availability is not provided in Canada. Canadian FICs can supply NOTAM on GPS satellite outages by querying the international NOTAM identifier KGPS. (This information is also available at www.notams.faa.gov.) The availability of RAIM can then be computed from the satellite availability information by entering the expected outages into PC-based RAIM prediction software provided by some avionics manufacturers or through direct entry into the GNSS receiver or FMS computers that support this function.

GNSS avionics also contain such a model, and this allows pilots to determine if approach-level RAIM will be supported (available) upon arrival at destination or at an alternate. The calculation typically uses current information, broadcast by the satellites, identifying which satellites are in service at that time. However, unlike the software that is based on the NOTAM data, this prediction does not always take into account scheduled satellite outages.

Operators using TSO-C129/C129a avionics who wish to take advantage of an RNAV (GNSS) approach when specifying a destination or alternate airport must check KGPS NOTAM to verify the status of the constellation.

5.5.2 Wide Area Augmentation System (WAAS) NOTAM

NAV CANADA has implemented a NOTAM system for users of WAAS avionics (TSO C145a/C146a). When WAAS service is expected not to be available for a duration of more than 15 min, a NOTAM will be issued. This typically implies a WAAS GEO satellite failure.

Pilots should flight plan based on the assumption that the services referred to in a NOTAM will not be available. However, once they arrive at the aerodrome, they may discover that a service is in fact available, in which case they may use the approach safely if they so choose.

When LPV, LP and WAAS-based LNAV/VNAV are not available, pilots may fly the LNAV procedure to the published MDA as this will almost always be available to pilots using WAAS avionics. Since LNAV procedures will be used when LPV and LNAV/VNAV are not available, pilots should ensure that they maintain their skills in flying these approaches.

Examples of WAAS NOTAMs are listed below:

- a) LPV AND LP AND WAAS-BASED LNAV/VNAV APCH NOT AVBL (and a description of area such as: WEST OF A LINE FM WHITEHORSE TO CALGARY). This is issued as a national NOTAM and is used to communicate that a GEO satellite failure has occurred, potentially affecting all WAAS messages for the area covered by that satellite.
- b) LPV AND LP AND WAAS-BASED LNAV/VNAV APCH NOT AVBL. When issued as a national NOTAM, this indicates the complete loss of WAAS services.

NOTE:

LNAV will still likely be available for operators using WAAS avionics.

- c) WAAS UNMONITORED. Since pilots would not be alerted to disruptions of WAAS services, flight planning should be based on the assumption that LPV, LP and WAAS-based LNAV/VNAV may be unavailable.

NOTE:

WAAS NOTAM information is not applicable to users of TSO-C129a avionics.

5.5.3 Negative W Notation

Normally, WAAS-based approaches will only be designed and published where the nominal availability of the required service is greater than 99%.

However, there may be aerodromes on the fringe of WAAS coverage areas, for which an LPV, LP, or WAAS-based LNAV/VNAV approach is published because of local demand by operators. In the event that an approach is located in a region of marginal WAAS availability, pilots will be alerted to this fact by a negative "W" (white on a black background) on the approach plate.

Pilots should flight plan as though LPV, LP and WAAS-based LNAV/VNAV will not be available at these aerodromes; however, if the service is available, it may be used safely at the pilot's discretion.

5.5.4 Space Weather

The source of space weather is the sun, which releases streams of charged particles made up of energized electrons and protons.

Two types of solar phenomena can have a major impact on GNSS: coronal mass ejections (CMEs) and coronal holes. Coronal mass ejections are gigantic amounts of electrified gas or plasma launched into space that can have a major influence, typically reaching the Earth within 1–3 days. Coronal holes are regions of open magnetic field lines where high-speed streams of plasma can flow out from the sun. If conditions are right when these particles reach the Earth, geomagnetic storms can occur.

At the Earth's surface, geomagnetic storms are characterized by a K-level index that ranges from 0–9. Storms having little effect would range from 0–3, while those with moderate effects would be 4–7, and strong storms with a lot of impact would be > 7. The Canadian Space Weather Forecast Centre (CSWFC) monitors, analyzes and forecasts space weather. Based on solar observations, it can predict when the particles will reach the Earth, and forecast the expected geomagnetic activity that will result. More detailed measurements are made using space weather monitoring satellites, which provide information approximately 30 min before the particles reach the Earth.

Canada has three zones of geomagnetic activity: the polar cap, the auroral zone and the subauroral zone. The highest geomagnetic activity and greatest disturbances are observed in the auroral zone. Changes in electron density, due to space weather activity, can change the speed at which radio waves travel, introducing a “propagation delay” in the GNSS signal through the ionosphere. The propagation delay can vary from minute to minute, and these intervals of rapid change can sometimes last for several hours, especially in the polar and auroral regions. Changing propagation delays cause errors in the determination of the range.

ABAS, SBAS and GBAS use different techniques to correct for ionospheric delays. ABAS uses simple models implemented in the receiver software that are adequate for en route navigation through non-precision approach phases of flight, but are not adequate for any type of approach during which vertical guidance is provided. SBAS provides ionospheric delay corrections derived from measurements at a set of reference stations distributed over a wide area. GBAS provides corrections for the combined effects of various sources of ranging errors, including ionospheric delays. The corrections provided by SBAS and GBAS are much more accurate than those calculated by ABAS, because they are derived in real-time from actual measurements, and are therefore adequate for approach procedures with vertical guidance.

GNSS provides navigation either using unaugmented GNSS and RAIM or FDE, or using SBAS corrections. The availability and continuity of GNSS en route and NPA services are very robust against ionospheric delays caused by geomagnetic storms. This robustness is primarily due to the relatively wide alert limits associated with en route and non-precision approach operations.

SBAS augmentation makes APV possible by ensuring real-time monitoring of core constellation satellites and ionospheric delays. APV operations require accurate ionospheric corrections, as well as relatively narrow integrity bounds, and these bounds may be widened during periods when the ionosphere is severely disturbed, in order to account for the increased variability of ionospheric delays, while ensuring the integrity of the position solutions for all users. APV service is very robust in mid- and high-latitude regions, and losses of service due to ionospheric effects are expected to occur less than 1% of the time. Interruptions of APV service may occur during severe geomagnetic storms and affect portions of the service area for short periods of time. In rare cases, extremely severe geomagnetic storms may even cause temporary loss of APV service over large portions of the SBAS service area for several hours. During pre-flight planning, pilots can consult Canadian Space Weather Forecast Centre products to determine if APV service for their flight may be affected. See: <www.spaceweather.gc.ca/index-en.php>.

5.6 INSTRUMENT FLIGHT RULES (IFR) FLIGHT PLAN EQUIPMENT SUFFIXES

On an instrument flight rules (IFR) flight plan, the letter “G” in Item 10 (equipment and capabilities) indicates that the aircraft has IFR-approved global positioning system (GPS) or wide area augmentation system (WAAS) avionics, and can therefore be cleared by air traffic service (ATS) on direct routings while en route, in terminal areas, and for global navigation satellite system (GNSS) based approaches.

5.7 AVIONICS DATABASES

Global navigation satellite system (GNSS) avionics used for instrument flight rules (IFR) flight require an electronic database that can be updated, normally on 28- or 56-day cycles. The updating service is usually purchased under subscription from avionics manufacturers or database suppliers.

Database errors do occur, and should be reported to the avionics database supplier. It is good practice to verify that retrieved data is correct, and it is mandatory to do so for approach data. Verification can be accomplished either by checking waypoint coordinates or by checking bearings and distances between waypoints against charts.

5.8 USE OF GLOBAL NAVIGATION SATELLITE SYSTEM (GNSS) IN LIEU OF GROUND-BASED AIDS

See *AIP Canada (ICAO)* ENR 4.3.

5.9 AREA NAVIGATION (RNAV) APPROACHES AT ALTERNATE AERODROMES

Pilots may take credit for an area navigation (RNAV) approach at an alternate aerodrome as outlined in the *Canada Air Pilot (CAP)*.

Taking credit for RNAV approaches at an alternate aerodrome for instrument flight rules (IFR) flight plan filing purposes is possible because the availability of receiver autonomous integrity monitoring (RAIM) or wide area augmentation system (WAAS) integrity is normally very high. However, when satellites are out of service, availability could decrease. Consequently, it is necessary to determine satellite status to ensure that the necessary level of integrity will be available. The procedures for this are explained in the next two sections.

5.9.1 Global Navigation Satellite System (GNSS) Approaches—Global Positioning System (GPS) (TSO-C129/C129a) Avionics

The status of the GPS constellation may be obtained through the FAA by contacting a NAV CANADA FIC and requesting the international NOTAM file KGPS.

A procedure that meets the requirement to ensure that approach-level RAIM will be available for TSO-C129/C129a avionics is as follows.

- a) Determine the ETA at the proposed aerodrome.
- b) Check the GPS NOTAM file (KGPS) for a period of 60 min before and after the ETA. If not more than one satellite outage is predicted during that period, then this procedure is satisfied. If two or more satellites are anticipated to be unserviceable during the ETA ± 60 -min period, then it is necessary to determine if approach-level RAIM will be available, taking into account the reduced availability resulting from the outages. This may be accomplished by using commercially-available dispatch RAIM prediction software, acquiring a current almanac, and manually deselecting those satellites for the times described in the NOTAM.

The RAIM availability requirement is satisfied if the resulting prediction indicates that RAIM will be unavailable for a total of 15 min or less during the ETA ± 60 -min period.

It may be possible to change the alternate or adjust the departure time (and hence the ETA) and re-run the prediction to find a time for which the required RAIM availability is achieved, or simply to find a time when fewer than two satellite outages are predicted.

5.9.2 Global Navigation Satellite System (GNSS) Approaches—Wide Area Augmentation System (WAAS) Avionics

Operators using WAAS avionics (TSO-C145a/C146a) can verify that an approach is expected to be available by:

- a) checking the national (CYHQ) NOTAM files to ensure that no widespread WAAS outages have occurred, and then
- b) checking the WAAS horizontal and vertical service status, available at www.nstb.tc.faa.gov/index.htm, to predict if the desired approach line of minima is available given the current ionospheric conditions.

In the event of a widespread outage of WAAS, poor WAAS horizontal or vertical performance due to current ionospheric conditions, or an aerodrome outside the GEO coverage area, the pilot may need to determine if approach-level RAIM, as computed by a WAAS receiver, will be available. In this case, the pilot may use the procedure described in COM 5.9.1 for TSO-C129/C129a avionics. This will provide a safe, although conservative, indication of the availability of LNAV.

5.10 GLOBAL NAVIGATION SATELLITE SYSTEM (GNSS) VULNERABILITY—INTERFERENCE AND ANOMALY REPORTING

Global navigation satellite system (GNSS) is used in many applications: financial, security and tracking, transportation, agriculture, communications, weather prediction, scientific research, etc. Because it is used for such a wide range of civilian purposes, when somebody wishes to disable one GNSS-based system, their actions can also disrupt other, unrelated systems. Jamming, directed at non-aviation users, could affect aircraft operations. Over the past few years, Industry Canada has encountered several cases of illegal importation, manufacturing, distribution, offering for sale, possession and use of radiocommunication jamming devices, all of which are prohibited under the *Radiocommunication Act*. Many jamming devices are manufactured for the purpose of disrupting the functioning of GNSS receivers, cellular networks and low-power communication devices, such as cordless telephones and Wi-Fi networks. Of primary concern is the proliferation of radiocommunication jammers designed to defeat vehicle tracking and fee-collecting systems. Depending on signal strength, these jammers can also prevent communication related to 9-1-1 and emergency services, while inadvertently and unknowingly, in most cases, inhibiting aircraft in the vicinity overhead from receiving GNSS signals.

In the event of suspected interference or other problems with GNSS, pilots should advise air traffic service (ATS), and, if necessary, revert to using traditional aids for navigation. Pilots are also requested to complete a GNSS Anomaly Report Form, available at www.navcanada.ca/EN/products-and-services/Pages/Post-Flight-Reports.aspx, or equivalent, in order to assist in the identification and elimination of sources of interference or degradation of the navigation signal.

5.11 PROPER USE OF GLOBAL NAVIGATION SATELLITE SYSTEM (GNSS)

Global navigation satellite system (GNSS) offers a great opportunity to improve aviation safety and efficiency. Many pilots are benefiting from the advantages of GNSS as a principal navigation tool for instrument flight rules (IFR) flight or for visual flight rules (VFR) operations. To ensure safety, pilots must use GNSS properly. Here are some safety tips:

- a) use only IFR-certified avionics for IFR flights because hand-held and panel-mount VFR do not provide the integrity needed for IFR operations;
- b) for IFR flight, use a valid database for approach—a new one is required every 28 or 56 days;
- c) verify that all procedures that could be required are present in the database prior to flight to remote or small aerodromes—data storage limitations have resulted in some manufacturers omitting certain data from the avionics database;
- d) do not become an approach designer—approach designers require special training and specific tools, and there are many levels of validation before an approach is commissioned. Furthermore, the receiver autonomous integrity monitoring (RAIM) level and course deviation indicator (CDI) sensitivity will not be appropriate if an approach is not retrieved from the avionics database;
- e) never fly below published minimum altitudes while in instrument conditions. Accidents have resulted from pilots relying too much on the accuracy of GNSS;
- f) use VFR GNSS receivers only to supplement map reading in visual conditions, not as a replacement for current charts;
- g) position hand-held receivers and related cables carefully in the cockpit to avoid the potential for electromagnetic interference (EMI), and to avoid interfering with aircraft controls. Handheld units with valid databases could be useful in an emergency if IFR unit failed; and
- h) resist the urge to fly into marginal weather when navigating VFR. The risk of becoming lost is small when using GNSS, but the risk of controlled flight into terrain (CFIT) increases in low visibility. VFR charts must also be current and updated from applicable NOTAMs, and should be the primary reference for avoiding alert areas, etc. Some VFR receivers display these areas, but there is no guarantee that the presentation is correct, because there is no standard for such depictions.

5.12 VHF OMNIDIRECTIONAL RANGE (VOR)/DISTANCE MEASURING EQUIPMENT (DME) (RHO-THETA) SYSTEM

The capability of on-board area navigation (RNAV) computer systems which utilize VHF omnidirectional range (VOR)/distance measuring equipment (DME) signals varies considerably. The computer electronically offsets a VOR/DME station to any desired location within reception range. The relocated position is known as a waypoint and is defined by its bearing and distance from the station. Waypoints are used to define route segments and the computer provides steering guidance to and from waypoints.

5.13 DISTANCE MEASURING EQUIPMENT (DME-DME [RHO-RHO]) SYSTEM

DME-DME is a system which combines distance measuring equipment (DME) receivers with a microprocessor to provide an area navigation (RNAV) capability. The system has the location of the DME facilities in its database. Measuring the distance from two or more of these stations can provide a positional fix. The system provides a means of entering waypoints for a random route and displays navigation information such as bearing, distance, cross-track error and time-to-go between two points.

6.0 PERFORMANCE-BASED NAVIGATION (PBN)

6.1 GENERAL

Performance-based navigation (PBN) is not a stand-alone concept. Rather, along with communications, surveillance, and air traffic management (ATM), it is one of the four strategic enablers that support an overall airspace concept. An airspace concept may be described as a master plan or vision for a particular section of airspace, which aims to improve safety, increase capacity and efficiency, and mitigate negative environmental impacts.

PBN is intended to enable more repeatable, reliable and predictable flight tracks as well as smaller route containment areas to increase operational efficiency. In the simplest form, it is area navigation (RNAV) based on performance requirements for aircraft operating along an air traffic service (ATS) route, on an instrument approach procedure (IAP) or within designated airspace. Under the PBN concept, RNAV is defined as a method of navigation that permits aircraft operation on any desired flight path within the coverage of ground-based or space-based navigation aids (NAVAIDs) or within the limits of the capability of self-contained aids (inertial navigation). Area navigation systems can take two forms: RNAV, which is the basic definition above, or required navigation performance (RNP), which has an additional functional requirement for on-board performance monitoring and alerting. The RNP system relies upon the capability of the on-board navigation system to monitor, in real

time, the achieved navigation performance and to alert the flight crew when the specified minimum performance appropriate to a particular operation cannot be met. This additional functionality provided by RNP allows the flight crew to intervene and take appropriate mitigation actions if necessary. On-board performance monitoring and alerting allows RNP operations to provide an additional level of safety and capability over RNAV operations.

All future RNAV will identify performance requirements through the use of navigation specifications rather than defining required equipment of specific navigation sensors (VHF omnidirectional range [VOR], automatic direction finder [ADF], etc.). These navigation specifications are expressed in terms of accuracy, integrity, availability, continuity, and functionality needed for the proposed operation.

Accuracy: In the context of PBN, accuracy is the capability of the navigation system to maintain the computed position within a specified distance (lateral navigation accuracy) of the actual position 95 percent of the time.

Integrity: Integrity is the level of confidence that can be placed in the information received from the navigation system. Normally defined as a percentage probability to satisfy the assurance condition (i.e. 10^{-5}), it includes the ability of an RNP system to provide timely and valid warnings to users when the system must not be used for the intended operation or phase of flight.

Availability: Availability is stated as a percentage of time the navigation system can perform its function. It should provide reliable navigation information and present it to the crew, autopilot or other system managing flight of the aircraft.

Continuity: Continuity refers to the ability of a navigation system to provide its service without interruption. It should do so with the specified level of accuracy and integrity throughout the intended period of operation, assuming that it was available at the start of the operation.

Functionality: A set of functions or capabilities associated with PBN operations. Examples could include course deviation scaling and radius to fix (RF) capability.

6.2 KEY ELEMENTS OF PERFORMANCE-BASED NAVIGATION (PBN)

Performance-based navigation (PBN) consists of three main elements: navigation aid (NAVAID) infrastructure, navigation specifications and navigation applications. These elements, described in detail further on, must be present to have a fully incorporated PBN concept.

6.2.1 Navigation Aid (NAVAID) Infrastructure

The NAVAID infrastructure that contributes to an RNAV system may consist of ground-based, space-based or on-board NAVAIDs that support or provide positioning capabilities. System types are as follows:

- a) Ground infrastructure, which includes commissioned VORs and DMEs. (NDBs do not provide the specific range and azimuth information with accuracy necessary to be used in an RNAV system).
- b) Authorized GNSS space-based infrastructure (satellite constellations) such as: GPS, the European Union's Galileo, the Russian GLONASS, etc.
- c) SBASs that correct for variance in the GNSS satellite signals in order to provide greater accuracy and/or signal quality, e.g. WAAS.
- d) GNSS GBASs that provide navigation and precision approach service in the vicinity of the host airport, e.g. LAAS, GBAS landing system (GLS), etc.
- e) Certified INS or inertial reference units (IRU), which support on-board capability.

6.2.2 Navigation Specifications

A navigation specification is used as the basis for airworthiness and operational approval. It details the performance required of an RNAV or RNP system in terms of accuracy, integrity, availability, continuity, required navigation functionalities and NAVAIDs, and any requirements placed on the flight crew. Having a published navigation specification on Canadian routes and procedures will ensure compliance with common aircraft equipment and training that will result in assurance of track conformance. There are two main types of navigation specifications: RNAV and RNP.

An RNAV specification is based on an RNAV system and would be denoted by RNAV(X). An RNP navigation specification is based on an RNP system and is denoted by RNP(X).

In the examples above, "(X)" indicates the lateral navigation accuracy, in nautical miles, to be maintained 95 percent of the flight time by the population of aircraft operating within the airspace, route or procedure. For RNP specifications, it is also possible to have advanced RNP (A-RNP) and approach navigation specifications that cover all segments of an instrument approach. They are denoted as RNP APCH (RNP approach) or RNP AR APCH (RNP authorization required approach).

A navigation specification identifies not only a lateral accuracy figure but also functional and aircrew requirements. Therefore, certification for one type of navigation specification does not imply automatic qualification for a less stringent specification, and an RNP specification doesn't necessarily enable an RNAV specification.

ICAO has developed guidance on a range of navigation specifications. It is the responsibility of each State to determine which navigation specifications would be most applicable within their airspace concept with regards to current regulations and NAVAID infrastructure. For this reason it is important to note that what is needed to meet a navigation specification in one State may vary from that of another.

The following chart depicts all of the navigation specifications and their intended operational domain as outlined in ICAO's *Performance-based Navigation (PBN) Manual* (Doc 9613).

Table 6.1—Navigation Specification Designations

RNAV Specifications		RNP Specifications	
Oceanic and Remote Navigation Applications	En route and Terminal Navigation Applications	Oceanic and Remote Navigation Applications	En route and Terminal Navigation Applications
RNAV 10*	RNAV 5 RNAV 2 RNAV 1	RNP 4 RNP 2	RNP 2 RNP 1 A-RNP RNP APCH RNP AR APCH RNP 0.3
*Formerly referred to as RNP 10			

6.2.3 Navigation Application

Navigation application is the application of a navigation specification and supporting NAVAID infrastructure to specific routes, procedures and/or defined airspace volumes.

6.3 NAVIGATION SPECIFICATIONS EXPANDED

6.3.1 Area Navigation (RNAV) 10

RNAV 10 was historically designated as RNP 10. It requires aircraft be equipped with at least two independent long range navigation systems; any combination of INS/inertial reference unit (IRU) or GNSS meet the RNAV 10 requirements. During operations in airspace or on routes designated as RNAV 10, the lateral total system error must also be within ±10 NM for at least 95 percent of the total flight time. For normal operations, cross-track error/deviation should be limited to plus or minus one-half of the navigation accuracy associated with the route (i.e. 5 NM). Brief deviations from this standard (e.g. overshoots or undershoots) are allowable during and immediately after route turns, up to a maximum of one times the navigation (i.e. 10 NM).

Canadian RNAV 10 operations requirements are defined in AC 700-006—*Required Navigation Performance 4 (RNP 4) and Required Navigation Performance 10 (RNP 10) Airspace* and the associated Special Authorization RNP 10.

6.3.2 Area Navigation (RNAV) 5

RNAV 5 is an en route navigation specification and may also be used for initial STAR or ending SID segments, where the leg segments are beyond 30 NM from an aerodrome. RNAV 5 operations are based on the use of RNAV equipment that automatically determines aircraft position in the horizontal plane using inputs from one or a combination of the following types of position sensors:

- a) VOR/DME
- b) DME/DME
- c) INS or IRS
- d) GNSS

VOR/DME- and DME/DME-based RNAV 5 have limited opportunities in Canadian airspace because of the required numbers and geometry of ground-based aids to provide robust infrastructure. Introduction of RNAV 5 in Canadian airspace applications is of low value since current RNPC airspace requirements already require performance that exceeds RNAV 5 when conducting RNAV.

Operational requirements are defined in AC 700-015—*En Route Area Navigation Operations RNAV 5 (Formerly B-RNAV)* and the associated Special Authorization RNAV 5.

6.3.3 Area Navigation (RNAV) 1 and RNAV 2

RNAV 1 and RNAV 2 operations are based on the use of the same aircraft receivers as those required for RNAV 5. Additional aircraft functionality and NAVAID infrastructure requirements are needed to meet the more demanding performance of RNAV 1 and RNAV 2. This navigation specification is applicable to all routes, inside or outside of controlled airspace, SIDs and STARs. It also applies to IAP leg segments up to the FACP. RNAV 1 and RNAV 2 routes are expected to be conducted in a surveillance environment with DCPC. In Canada, RNAV 1 has some potential for terminal RNAV use for SIDs and STARs in areas where multiple DME pairs are available.

Operational requirements are defined in AC 700-019—*Terminal and En Route Area Navigation Operations (RNAV 1 and 2)* and the associated Special Authorization RNAV 1 and RNAV 2.

6.3.4 Required Navigation Performance (RNP) 4

RNP 4 is intended for oceanic or remote airspace where a robust ground-based navigation infrastructure is not available. Aircraft must have at least two fully serviceable independent long range

navigation systems (LRNS) listed in the flight manual; both must be operational at the point of entry into RNP 4 airspace. Position integrity bounding can currently only be met using certified GNSS receivers. The GNSS receivers may be part of a stand-alone navigation system or one of the sensors in a multi-sensor system. Where GNSS is an input as part of a multi-sensor system, the aircraft's position source must use GNSS positions exclusively during RNP 4 operations.

Canadian operational requirements are defined in AC 700-006—*Required Navigation Performance 4 (RNP 4) and Required Navigation Performance 10 (RNP 10) Airspace* and the associated Special Authorization RNP 4.

6.3.5 Required Navigation Performance (RNP) 2

RNP 2 is intended for en route application, primarily in areas where there is sparse or no ground NAVAID infrastructure, limited or no ATS surveillance, and low- to medium-density traffic. Use of RNP 2 in continental applications requires a lower continuity requirement than use in oceanic or remote applications. In oceanic or remote applications, the target traffic is primarily transport category aircraft operating at high altitude, whereas continental applications may include a significant percentage of other aircraft.

RNP 2 requires the use of certified GNSS receivers. Operators are required to have the means to predict the availability of GNSS fault detection (e.g. ABAS RAIM) to support operations along an RNP 2 route. The *AIP Canada (ICAO)* will indicate when a prediction capability is required and an acceptable means to satisfy that requirement.

Operational requirements for RNP 2 (Continental) are defined in AC 700-38—*Performance-based Navigation (PBN) — EnRoute* and the associated Special Authorization RNP 2 (Continental). RNP 2 (Oceanic/Remote) has additional requirements over those for RNP 2 Continental, but they have not yet been defined in a Canadian AC. A separate AC will be published when RNP 2 (Oceanic/Remote) operations are implemented in Canadian-controlled airspace.

6.3.6 Required Navigation Performance (RNP) 1

The RNP 1 navigation specification is intended to be applied on SIDs and STARs within 30 NM of the aerodrome where the surveillance services are limited or do not exist and/or a ground-based RNAV infrastructure is not practical. The STARs provide a means to connect the en route structure to a variety of approach procedures, including RNP approach (RNP APCH), RNP authorization required approach (RNP AR APCH) and ILS. Application of RNP 1 enables the use of RF leg segments in applications such as the STAR, transition to the approach or approach initial segments.

Position integrity bounding for RNP 1 can currently only be met using certified GNSS receivers. The GNSS receivers may be a part of a stand-alone navigation system or one of the sensors

in a multi-sensor system. Where GNSS is an input as part of a multi-sensor system, the aircraft's position source must use GNSS positions exclusively during RNP 1 operations. During operations in airspace or on routes designated as RNP 1, the lateral total system error must be within ± 1 NM for 95 percent of the total flight time. For normal operations, cross-track error/deviation should be limited to plus or minus one half of the navigation accuracy associated with the procedure. Brief deviations from this standard during and immediately after turns, up to a maximum of one times the navigation accuracy are allowable.

For RNP 1 routes, pilots must use a lateral deviation indicator, flight director, or autopilot in lateral navigation mode. Pilots of aircraft with a lateral deviation display must ensure that lateral deviation scaling is suitable for the navigation accuracy associated with the route/procedure.

Canadian RNP 1 operational requirements are defined in AC 700-025—*Required Navigation Performance 1 (RNP 1)* and the associated Special Authorization RNP 1.

6.3.7 Required Navigation Performance (RNP) 0.3

RNP 0.3 was developed in response to the helicopter community's desire for narrower IFR obstacle-free areas to allow operations in obstacle-rich environments and to allow simultaneous, non-interfering operations in dense terminal airspace. While this specification has been defined primarily for helicopter applications, it does not exclude the application to fixed-wing operations where demonstrated performance is sufficient to meet the functional and accuracy requirements of this specification for all phases of flight.

This specification requires the use of certified GNSS receivers; its implementation is not dependent on the availability of SBAS. DME/DME-based RNAV systems are not capable of consistently providing RNP 0.3 performance, and RNP 0.3 operations through application of DME/DME-based navigation is not currently viable. Operators are required to have the means to predict the availability of GNSS fault detection (e.g. RAIM) to support RNP 0.3 operations. The on-board RNP system, GNSS avionics, air navigation service provider (ANSP) or other entities may provide a prediction capability. The *AIP Canada (ICAO)* will indicate when a prediction capability is required and an acceptable means to satisfy that requirement. Owing to the high availability of RNP 0.3 performance available to SBAS receivers, prediction will not be required where the navigation equipment can make use of SBAS augmentation and the planned operation will be contained within the service volume of the SBAS signal.

Operational requirements are currently defined in ICAO's *Performance-based Navigation (PBN) Manual* (Doc 9613), Volume II, Part C, Chapter 7, but have not yet been defined in a Canadian AC; therefore, no Special Authorization is available.

6.3.8 Advanced Required Navigation Performance (A-RNP)

This is the only navigation specification that enables operations under other associated navigation specifications. When advanced RNP (A-RNP) is certified, the following other navigation accuracy and functional requirements are met in navigation specifications: RNAV 5, RNAV 2, RNAV 1, RNP 2, RNP 1, and RNP APCH. Some other functional elements are optional, such as RNP scalability, higher continuity, FRT, and baro-VNAV. However, RF leg capabilities are a requirement.

A-RNP has a very broad operational application; for operation in oceanic or remote airspace, on the continental en route structure, as well as on arrival and departure routes and approaches. Operations would rely solely on the integrity of the RNP system without a reversionary capability to conventional means of navigation since a conventional infrastructure may not be available. The advantage of utilizing a designation of A-RNP for a flight operation is the combined performance and functionality of a range of navigation specifications encompassing all phases of flight.

For further information on A-RNP, refer to ICAO's *Performance-based Navigation (PBN) Manual* (Doc 9613), Volume II, Part C, Chapter 4. Canadian operational approval of A-RNP is not currently in place; therefore, no AC or Special Authorization has been issued.

6.3.9 Required Navigation Performance Approach (RNP APCH)

RNP approach (RNP APCH) is the ICAO navigation specification designation for procedures currently published in Canada as "RNAV (GNSS)" and authorized under Special Authorization RNP APCH. They include approach operations with minima designated as "LNAV", "LNAV/VNAV", "LP" and "LPV".

Currently, integrity bounding for an RNP APCH can only be met using certified GNSS receivers. The GNSS receivers may be part of a stand-alone navigation system or one of the sensors in a multi-sensor system.

Canadian-specific RNP APCH requirements are published in [AC 700-023—Required Navigation Performance Approach \(RNP APCH\)](#) and the associated Special Authorization RNP APCH.

6.3.10 Required Navigation Performance Authorization Required Approach (RNP AR APCH)

RNP authorization required approach (RNP AR APCH) procedures can be built with various levels of RNP lateral containment values on the initial, intermediate, final and missed approach segments. There are increasingly demanding aircraft certifications and operational approvals required when RNP values lower than 0.3 NM are applied in any of the segments. These approaches will be published in pertinent publications as "RNAV (RNP)".

As with all the other RNP navigation specifications, RNP AR APCH position integrity bounding can only be met by utilizing certified GNSS receivers. There are numerous other aircraft equipment and functional requirements needed to meet the more demanding performance requirements. They can be found in AC 700-024—*Required Navigation Performance Authorization Required Approach (RNP AR APCH)* and Special Authorization RNP AR APCH.

6.4 FIXED RADIUS PATHS

Typically, with conventional navigation, turns had a large range of dispersion (some aircraft turned tight, others had wider turns) depending on aircraft speed, turn anticipation, bank angle and roll rate. Fixed radius paths standardize turns and provide a predictable, repeatable and accurate ground track throughout a turn. Using required navigation performance (RNP), aircraft can have a smaller area of containment throughout a turn, allowing greater flexibility to design procedures that avoid terrain, noise sensitive areas, restricted airspace or other arrival paths to nearby airports in a complex airspace structure. There are two types of fixed radius paths that may be used: radius to fix (RF) path terminator and fixed radius transitions (FRT).

While complex flight paths can now be designed and displayed as the active route, the aircraft must have the capability to accurately follow the defined path. Pilots are familiar with flying turns at a constant airspeed and angle of bank which enables a circular flight path to be flown with reference to the air mass and are trained to manually compensate for the presence of wind if necessary. Pilots now need to understand that the RNP system will fly an exact circular flight path over the ground. Groundspeed and the angle of bank must be adjusted throughout the turn by the automatic flight control system to maintain that circular flight path and in some cases these may be limiting factors for maintaining the specified turn radius.

6.4.1 Radius To Fix (RF) Path Terminator

The RF path terminator, referred to as an RF leg, is a specific fixed-radius curved path in a terminal or approach procedure. An RF leg is defined by a constant radius originating from the centre fix, the arc starting fix, the arc ending fix, and the turn direction. Only RNP systems are capable of flying RF legs, by providing precise and positive course guidance along a curved track, with the same containment value that would be achieved in a straight leg segment. In addition, the distance travelled from beginning to end of the turn will remain constant for every aircraft. This allows longitudinal separation to be maintained throughout the turn for aircraft travelling at the same speed.

Operational approval to use RF legs in conjunction with other RNP navigation specifications can be found in AC 700-027—*Radius to Fix (RF) Path Terminator* and Special Authorization RF Leg. Additional authorization is not required for RNP AR APCH or A-RNP as RF capability is already mandatory in these two Special Authorizations.

6.4.2 Fixed Radius Transition (FRT)

An FRT is used as an enabler to apply closer route spacing along turns in the en route structure. An FRT is intended to define the transition between airways where separation is required in the turns. Having smaller containment areas in turns allows for higher traffic density with closer spaced routes. The RNP system supporting FRT is capable of providing the same track-keeping accuracy in the turn as in the straight line segment. An RNP system seamlessly joins associated route segments.

Operational approval is not currently available in Canada. For further information on FRTs, refer to ICAO's *Performance-based Navigation (PBN) Manual* (Doc 9613), Volume II, Part C, Appendix 2.

6.5 INTERNATIONAL CIVIL AVIATION ORGANIZATION (ICAO) FLIGHT PLAN COMPLETION

Pilots should review the planned route of flight to determine that area navigation (RNAV)/required navigation performance (RNP) requirements, the aircraft, and the operator are approved for the desired route. Performance-based navigation (PBN) compliant aircraft should enter the appropriate equipment code in Item 10 of the International Civil Aviation Organization (ICAO) flight plan. A corresponding indication of RNAV and/or RNP capabilities must be entered in Item 18.

6.6 NAVIGATION ERROR COMPONENTS

The inability to achieve the required lateral navigation accuracy may be due to navigation errors related to aircraft tracking and positioning. These errors produce a path that is offset horizontally from the desired path. The following are sources of error for area navigation (RNAV) systems:

Where:

- Desired path is the path over the ground that the aircraft is expected to fly.
- Defined path is the reference path computed by the flight plan management function of the RNAV system.
- Estimated position is provided by the navigation function of the RNAV system.
- True position is the aircraft's actual position over the ground.

Path definition error (PDE): The difference between desired and defined paths which reflects errors in the navigation database, computational errors in the RNAV system and display errors. PDE is usually very small and often assumed to be negligible.

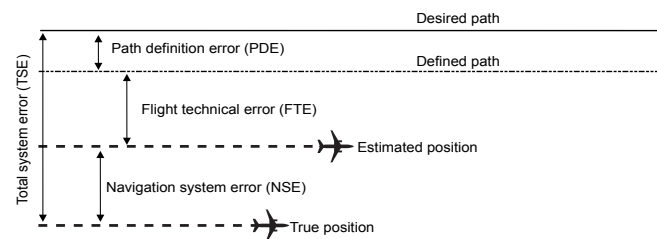
Flight technical error (FTE): The difference between estimated position and defined path. It relates to the ability of an air crew or autopilot to fly along a defined path. Any display errors, such as a course deviation indicator (CDI) centering error, may cause FTE. FTE is usually the largest error component of the total system error (TSE).

Navigation system error (NSE): The difference between true and estimated position. The NSE is defined during navigation system certification.

TSE: The difference between true position and desired position. This error is equal to the sum of the vectors of the PDE, FTE and NSE.

Any of the errors mentioned above would affect the ability of the aircraft to meet the required lateral navigation accuracy. If the on-board performance monitoring system cannot guarantee, with sufficient integrity, that the position meets the RNP defined in a navigation specification, an alert will be issued to the crew.

Figure 6.1—Lateral Navigation Errors



7.0 SURVEILLANCE

Surveillance enables air traffic control (ATC) to increase airspace use by allowing a reduction in aircraft-to-aircraft and aircraft-to-obstacle separation. In addition, surveillance permits an expansion of flight information services such as traffic information and navigation assistance. There are four types of surveillance systems currently used by ATC: primary surveillance radar (PSR), secondary surveillance radar (SSR), automatic dependent surveillance - broadcast (ADS-B) and multilateration (MLAT).

7.1 PRIMARY SURVEILLANCE RADAR (PSR)

Primary surveillance radar (PSR) computes target positions by determining the range and azimuth of transmitted and reflected radio frequency energy. It is a passive surveillance system and therefore does not rely on information transmitted from the aircraft.

Primary radar is used in the following applications:

- a) *Terminal surveillance radar (TSR)*—In general, a short-range PSR (80 NM) operating on 1 250 to 1 350 MHz complements secondary surveillance radar (SSR) for terminal operations.
- b) *Precision approach radar (PAR)*—A high-definition, short-range PSR operating on 9 000 to 9 180 MHz and is used as an approach aid. PAR provides the controller with altitude, azimuth and range information of high accuracy to assist pilots in executing approaches. While PAR is mainly a military system, it is available at some civilian airports and may be used by civilian pilots. Civil aircraft approach limits are published in the *Canada Air Pilot (CAP)* and the *Restricted Canada Air Pilot (RCAP)*.
- c) *Airport surface detection equipment (ASDE)*—Surveillance of surface traffic is provided at airports where traffic warrants it. ASDE is a high-definition PSR operating on 16 GHz. Tower controllers use ASDE to monitor the position of aircraft and vehicles on the manoeuvring areas of the airport (runways and taxiways), particularly during conditions of reduced visibility.
- d) *Weather radar*—Weather radar is a PSR used by the Meteorological Service of Canada to monitor for hazardous weather conditions.

For a map of PSR coverage in Canada, see *AIP Canada (ICAO)* ENR 1.6, Figure 1.6.1, Primary Radar Coverage.

7.2 SECONDARY SURVEILLANCE RADAR (SSR)

Secondary surveillance radar (SSR) determines aircraft range by measuring the interval between transmitting an interrogation to and receiving a reply from an airborne transponder.

SSR is a cooperative surveillance system and does not provide a position for an aircraft without an operating transponder. SSR offers significant operational advantages to air traffic control (ATC), such as increased range, positive identification and aircraft altitude, when the aircraft has an altitude-encoding transponder.

SSR is used in the following applications:

- a) *En route control*—SSR is a long-range radar with a range of 200 NM or more. It transmits on 1 030 MHz and receives the transponder reply on 1 090 MHz. SSR is the main source of en route (airway/area navigation [RNAV] route) surveillance and is not normally combined with primary surveillance radar (PSR).
- b) *Terminal control*—Terminal surveillance radar (TSR) uses long-range SSR equipment similar to en route control and may be used in conjunction with a short-range PSR.

For a map of SSR coverage in Canada, see *AIP Canada (ICAO)* ENR 1.6, Figure 1.6.2, Secondary Surveillance Radar Coverage.

7.2.1 Code Assignment

In the CFS and the CWAS, Section B, “Aerodrome/Facility Directory”, the table for an aerodrome may have a subheading PRO, which may contain information on special procedures for code assignment established at the aerodrome.

7.3 AUTOMATIC DEPENDENT SURVEILLANCE - BROADCAST (ADS-B)

Automatic dependent surveillance - broadcast (ADS-B) is a surveillance technology that gives controllers the opportunity to provide radar-like services. It uses aircraft avionics, satellites and/or ground infrastructure to relay a range of aircraft parameters to air traffic control (ATC). The system is automatic since no external stimulus is required for operation, and dependent because it relies on aircraft avionics to provide surveillance services through broadcast messages.

NAV CANADA’s ADS-B ground infrastructure consists of ground receiver stations, target processors and situation displays. The ground stations receive ADS-B signals and transfer the data via land line or satellite link to the target processors located within an area control centre (ACC). Target processors build a track profile based on the aircraft’s unique International Civil Aviation Organization (ICAO) 24-bit identifier. This profile is presented to ATC on a situation display to enable surveillance separation services.

For a map of ADS-B coverage in Canada, see *AIP Canada (ICAO)* ENR 1.6, Figure 1.6.3, Automatic Dependent Surveillance - Broadcast Coverage.

7.3.1 Aircraft Equipment

On-board aircraft equipment is responsible for gathering a range of flight parameters and compiling them into the ADS-B message, which is then transmitted through the Mode S transponder on a 1 090 MHz extended squitter (1 090ES). The full range of data is transmitted once per second, allowing ATC to access real-time aircraft position information.

At a minimum, the following aircraft parameters must be broadcast:

- a) *Airborne position*—Position data is generated by a GPS receiver compliant with TSO-C129, TSO-C145 or TSO-C146. A high degree of reliance is placed on the GPS data as it is the basis for reduced traffic separation. Therefore, it must be capable of producing a HPL.
- b) *Pressure altitude*—This is provided by the on-board encoding altimeter.

- c) *Aircraft identity*—Each Mode S transponder has a unique address assigned by the State of aircraft registry and known as the ICAO 24-bit aircraft identifier. It is entered into the transponder at the time of installation and cannot be modified by pilots from the flight deck. This address is used for aircraft identification and track processing.
- d) *Flight identification (Flight ID)*—A four- to seven-character alphanumeric parameter usually entered by the pilot into the transponder control panel (if present) or FMS. A flight ID that is an exact replica of the aircraft identification entered in Item 7 of the ICAO flight plan must be programmed into the transponder or FMS in order to receive ATS surveillance services. It is important that the flight crew verify that the flight ID is correct prior to departure as some avionics prevent a change to the flight ID once airborne. Airline aircraft will use the three-letter ICAO airline code.

The flight ID has a seven-character maximum and can be either:

- (i) the aircraft registration mark (CGSCX, N6891DE, 90HYT); or
- (ii) the ICAO airline designator followed by the flight number (ACA020, WJA229, JZA8249).

Errors and discrepancies can arise during flight ID entry due to confusion over the correct format. Common errors that arise when entering the flight ID include the use of leading zeros, hyphens, dashes, spaces or failure to use the correct airline designator. Zeros only appear when they are part of the ICAO flight plan number as in the example below:

Generic Airlines Flight 371
 Generic Airlines ICAO assigned registration: GNA
 Flight number: 371
 On the ICAO flight plan it is entered as: GNA0371

The flight ID pilot input would be: G N A 0 3 7 1, not G N A 3 7 1 or G N A 3 7 1 0

- e) *NUCp or NIC*—Numerical values that identify the quality of horizontal position data. The GNSS avionics is responsible for calculating either of these values by using the RAIM algorithm. These values equate to an Rc, which represents the uncertainty of the given position data in NM. Typical NUCp and NIC values range from 0–9 and 0–11 respectively. They are dynamic since the GPS constellation is constantly changing. Any detection of poor satellite geometry diminishes position data integrity, resulting in a reduction of NUCp or NIC values and a corresponding increase in Rc. NAV CANADA will accept position data contained in an ADS-B message with a NUCp value as low as 5 or a NIC as low as 6. Should the NUCp or NIC value fall below the minima, the target will not be passed through to ATC as a valid surveillance target.
- f) *NACp*—A position quality indicator used by surveillance services to determine if the reported horizontal position meets an acceptable level of accuracy for the intended operation.
- If an updated NACp has not been received within the past two seconds, the NACp value will be encoded as zero indicating “unknown accuracy” and will not be used for surveillance services.
- g) *SIL*—Indicates the probability of the reported horizontal position exceeding the containment radius defined by the NIC. Should NAV CANADA receive a SIL value below the pre-selected minima, the target will not be passed through to ATC as a valid surveillance target.
- h) *SPI*—A feature used to positively identify an aircraft. It is identical to the “Squawk Ident” feature on a basic transponder.
- i) *Emergency status*—Activation of an emergency transponder code (7500, 7600 or 7700) will result in a common emergency signal being sent as part of an ADS-B message. If an emergency transponder code is activated, ATS will receive a generic emergency (EMR) indication on their display and may request further information from the flight crew regarding the nature of the emergency.

NOTE:

Flight ID, SPI and emergency status are the only elements that can be modified by the flight crew.

7.3.2 International Civil Aviation Organization (ICAO) Flight Plan Completion

ADS-B capable aircraft should enter the appropriate equipment code in Item 10 of the ICAO flight plan.

7.3.3 Airworthiness Compliance Requirements

Any aircraft that emits position information using a 1 090 MHz extended squitter (1 090ES) may be provided surveillance separation services, if they meet the airworthiness compliance requirements defined in *AIP Canada (ICAO)* ENR 1.6.

7.3.4 Surveillance Phraseology

Flight through ADS-B airspace is very similar to radar surveillance airspace with regard to common radio communication phraseology. However, pilots will not be advised when transitioning between ADS-B surveillance airspace and a radar coverage area. Common radar and surveillance phrases are listed below.

Table 7.1—Surveillance Phraseology

Radar Phraseology	Surveillance Phraseology
RADAR SERVICE TERMINATED (non-radar routing if required).	SURVEILLANCE SERVICE TERMINATED (routing if required).
RADAR SERVICE TERMINATED DUE TO (reason).	SURVEILLANCE SERVICE TERMINATED DUE TO (reason).
SECONDARY RADAR OUT OF SERVICE.	ADS-B SURVEILLANCE OUT OF SERVICE DUE TO (reason).
MODE CHARLIE NOT VALIDATED.	PRESSURE ALTITUDE NOT VALIDATED.
MODE CHARLIE IS INVALID.	PRESSURE ALTITUDE IS INVALID.
RADAR SERVICE TERMINATED. RESUME POSITION REPORTS.	SURVEILLANCE SERVICE TERMINATED. RESUME POSITION REPORTS.
(aircraft ident) RADAR IDENTIFIED (position if required).	(aircraft ident) IDENTIFIED (position if required).
(aircraft ident) RADAR IDENTIFICATION LOST.	(aircraft ident) IDENTIFICATION LOST.
	IF ABLE, CHANGE YOUR FLIGHT ID TO (flight ID).
IF YOU READ (appropriate instructions), then – (action) OBSERVED. WILL CONTINUE RADAR CONTROL.	IF YOU READ (appropriate instructions), then – (action) OBSERVED. WILL CONTINUE SURVEILLANCE CONTROL.
	(aircraft ident) READING YOU ON SEVEN SEVEN ZERO ZERO.
	CONFIRM THE NATURE OF YOUR EMERGENCY.

7.4 MULTILATERATION (MLAT)

Multilateration (MLAT) increases air traffic service (ATS) situational awareness of aircraft and vehicles on the ground allowing them to safely manage ground movements, including in low visibility operations, by providing full surveillance coverage of runways, taxiways and terminal apron areas. MLAT uses a system of strategically placed ground stations to send interrogations and receive replies from Mode A, C or S transponders. It functions on a principle known as time difference of arrival (TDOA), where the system calculates the difference in transponder response time at multiple ground receivers and compares the results to determine a position. Usually three receiving units are required to obtain a horizontal position.

7.4.1 Code Assignment

In the CFS and the CWAS, Section B, “Aerodrome/Facility Directory”, the table for an aerodrome may have a subheading PRO, which may contain information on special procedures for code assignment established at the aerodrome.

Aircraft that have a technical limitation that might inhibit the transmission of a transponder code (such as weight on wheels switch deactivation) must report this condition to ATS and obtain an APREQ before commencing ground operations.

8.0 TRANSPONDER OPERATION

8.1 GENERAL

Transponders substantially increase the capability of radar to detect aircraft. The use of automatic pressure altitude reporting equipment (Mode C) enables controllers to quickly determine where potential conflicts could occur. Proper transponder operating procedures and techniques provide both visual flight rules (VFR) and instrument flight rules (IFR) aircraft with a higher degree of safety. In addition, proper use of transponders with Mode C capability results in reduced communications and more efficient service.

When pilots receive air traffic control (ATC) instructions concerning transponder operation, they shall operate transponders as directed until they receive further instructions or until the aircraft has landed, except in an emergency, communication failure or act of unlawful interference.

ATC radar units are equipped with alarm systems that respond when an aircraft is within radar coverage and the pilot selects the emergency, communication failure, or act of unlawful interference transponder code. It is possible to unintentionally select these codes momentarily when changing the transponder code. To prevent unnecessary alarm activation, pilots should

avoid inadvertent selection of 7500, 7600 or 7700 when changing the code if either of the first two digits to be selected is a seven. For example, when changing from Code 1700 to Code 7100, first change to Code 1100 (and NOT Code 7700) and then change to Code 7100. Do not select STANDBY while changing codes as this will cause the target to be lost on the ATC radar screen.

Pilots should adjust transponders to STANDBY while taxiing for takeoff, to ON (or NORMAL) as late as practicable before takeoff, and to STANDBY or OFF as soon as practicable after landing. In practice, transponders should be turned on only upon entering the active runway for departure and turned off as soon as the aircraft exits the runway after landing. Some airports have implemented surface surveillance services using multilateration (MLAT). MLAT relies on transponder returns; therefore, pilots of transponder-equipped aircraft should leave their transponders in the transmit mode at all times when on the airfield. Pilots should ensure that the transponder code issued by ATC is selected before switching the transponder out of STANDBY. In the event that no code has been issued by ATC, transponder Code 1000 should be selected.

In the event of a transponder or automatic pressure altitude reporting equipment (Mode C) failure during a flight when its use is mandatory, an aircraft may be operated to the next airport of intended landing; it may, thereafter, complete an itinerary or go to a repair base, if authorized by ATC.

ATC may, upon receiving a written request, authorize an aircraft not equipped with a functioning transponder or Mode C to operate in airspace where its use is mandatory. The purpose of this advanced request is to enable ATC to determine if the operation of the aircraft can be handled in the airspace at the time requested without compromising the safety of air traffic. Approval may be subject to conditions and limitations deemed necessary to preserve safety. Pilots must obtain approval before entering airspace where it is mandatory to be equipped with a functioning transponder and automatic pressure altitude reporting equipment. This includes aircraft proposing to take off from an airport located within that airspace.

8.2 TRANSPONDER REQUIREMENTS

CAR 605.35 outlines the transponder operating rule, as well as the circumstance in which operation with an unserviceable transponder is permitted. It also outlines the procedures to follow in order to operate an aircraft without a transponder and automatic pressure altitude reporting equipment within transponder airspace. CAR 601.03 states that “transponder airspace consists of:

- all Class A, B and C airspace as specified in the *Designated Airspace Handbook*; and
- any Class D or E airspace specified as transponder airspace in the *Designated Airspace Handbook*.”

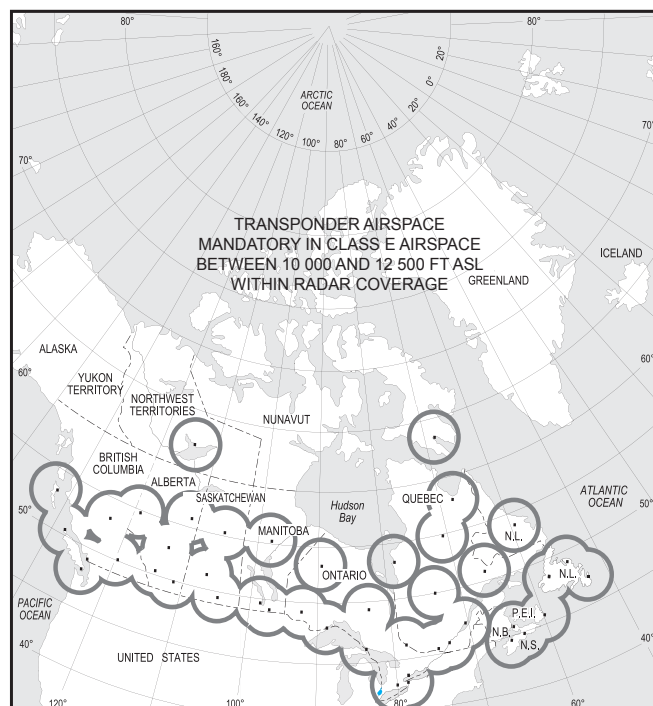
This includes all Class E airspace extending from 10 000 ft above sea level (ASL) up to and including 12 500 ft ASL within radar coverage, as shown in Figure 8.1.

Pilots of instrument flight rules (IFR) aircraft operating within controlled or uncontrolled high-level airspace should adjust their transponder to reply on Mode A, Code 2000 and on Mode C, unless otherwise instructed by air traffic control (ATC).

NOTE:

Pilots instructed to squawk a discrete code should not adjust their assigned transponder code when informed that radar or surveillance service is terminated. The termination of radar or surveillance service does not necessarily constitute direction to change to Code 2000.

Figure 8.1—Transponder Airspace



8.3 INSTRUMENT FLIGHT RULES (IFR) OPERATIONS IN OTHER LOW-LEVEL AIRSPACE

During instrument flight rules (IFR) flight in controlled low-level airspace other than that described earlier, adjust the transponder to reply on Mode A, Code 1000, and on Mode C (if available), unless otherwise instructed by air traffic control (ATC). If an IFR flight plan is cancelled or changed to a visual flight rules (VFR) flight plan, the transponder should be adjusted to reply on the appropriate VFR code, as specified in the following paragraphs, unless otherwise instructed by ATC.

To enhance the safety of IFR flight in uncontrolled low-level airspace, pilots are encouraged to adjust their transponders to reply on Mode A, Code 1000 and Mode C (if available), unless otherwise instructed by ATC.

8.4 VISUAL FLIGHT RULES (VFR) OPERATIONS

During visual flight rules (VFR) flight in low-level airspace, the pilot should adjust the transponder to reply on the following unless otherwise assigned by an air traffic services (ATS) unit:

- a) Mode A, Code 1200 for operation at or below 12 500 ft above sea level (ASL); or
- b) Mode A, Code 1400 for operation above 12 500 ft ASL.

Upon leaving the confines of an airspace for which a special code assignment has been received, the pilot is responsible for changing to the code shown in (a) or (b), unless they are assigned a new code by an ATS unit.

NOTES:

1. When climbing above 12 500 ft ASL, a VFR pilot should select Code 1200 until departure from 12 500 ft ASL at which point Code 1400 should be selected. When descending from above 12 500 ft ASL, a VFR pilot should select Code 1200 upon reaching 12 500 ft ASL. Pilots of aircraft equipped with a transponder capable of Mode C automatic altitude reporting should adjust their transponder to reply on Mode C when operating in Canadian airspace unless otherwise assigned by an ATS unit.
2. Pilots of gliders that are equipped with a transponder should adjust the transponder to reply on Mode A, Code 1202 at all times, unless otherwise directed by air traffic control (ATC). If their transponder is capable, pilots should use Mode C as well.

8.5 PHRASEOLOGY

Air traffic services (ATS) personnel will use the following phraseology when referring to transponder operation.

SQUAWK (code)—Operate transponder on designated code in Mode A.

SQUAWK IDENT—Engage the identification (IDENT) feature of the transponder.

NOTE:

A pilot should operate the IDENT feature only when requested by an ATS unit.

SQUAWK MODE CHARLIE—Activate Mode C with automatic altitude reporting.

STOP SQUAWK MODE CHARLIE—Turn off automatic altitude reporting function.

RESET TRANSPONDER—Reset the transponder and transmit the SQUAWK (code) currently assigned. This phraseology may be used if the target or identity tag data is not being displayed as expected.

REPORT YOUR ALTITUDE—This phraseology may be used when it is necessary to validate altitude readouts by comparing the readout value with the altitude reported by the aircraft. An altitude readout is considered valid if the readout value does not differ from the aircraft-reported altitude by more than 200 ft; it is considered invalid if the difference is 300 ft or more.

NOTE:

Readout values are displayed in 100-ft increments.

SQUAWK STANDBY – SQUAWK (code)—The present position symbol (PPS) disappears or changes to a primary surveillance radar (PSR) symbol after the aircraft is instructed to change its transponder to STANDBY; the PPS reappears or changes back to a secondary surveillance radar (SSR) symbol after the aircraft is requested to return the transponder to normal operation.

8.6 EMERGENCIES

In the event of an emergency and if unable to establish communication immediately with an air traffic control (ATC) unit, a pilot wishing to alert ATC to the emergency situation should adjust the transponder to reply on Code 7700. Thereafter, communication should be established with ATC as soon as possible and the transponder should be operated as directed by ATC.

8.7 COMMUNICATION FAILURE

In the event of a communication failure, the pilot should adjust the transponder to reply on Code 7600 to alert air traffic control (ATC) of the situation. This does not relieve the pilot of the requirement to comply with the appropriate communications failure procedures for instrument flight rules (IFR) flight.

8.8 UNLAWFUL INTERFERENCE

Canada, along with other nations, has adopted a special secondary surveillance radar (SSR) transponder code (7500) for use by pilots of aircraft subjected to an act of unlawful interference. Air traffic control (ATC) does not assign this code (7500) unless the pilot informs ATC of an act of unlawful interference in progress.

Selection of the code activates an alarm system and points out the aircraft on radar displays. If the controller doubts that an aircraft is the subject of an act of unlawful interference (as could occur when a code change was requested and the act of unlawful interference code appeared rather than the assigned code), the controller will say, “CONFIRM SQUAWK SEVEN FIVE ZERO ZERO”. If the pilot answers yes, the controller will alert the ATC system. If the pilot replies no, the controller will re-assign the proper code. If the pilot does not reply, the controller will take this as confirmation that the use of Code 7500 is intentional. If, after using Code 7500, an aircraft changes to Code 7700 or

transmits a message including the phrase “TRANSPONDER SEVEN SEVEN ZERO ZERO”, this indicates that the aircraft is threatened by grave and imminent danger and requires immediate assistance.

9.0 TRAFFIC ALERT AND COLLISION AVOIDANCE SYSTEM (TCAS) AND AIRBORNE COLLISION AVOIDANCE SYSTEM (ACAS)

9.1 GENERAL

The International Civil Aviation Organization (ICAO) uses the term airborne collision avoidance system (ACAS). The term traffic alert and collision avoidance system (TCAS) refers to the system developed in the United States by the Federal Aviation Administration (FAA). These terms are generally interchangeable. Care needs to be taken when comparing ICAO definitions of ACAS II with the North American definition of TCAS II. Specifically, the ICAO definition of a fully compliant ACAS II (see ICAO Annex 10, Volume 4, Chapter 4) is equivalent to TCAS II software version 7.1. Additional guidance and information on ACAS may be found in Transport Canada (TC) Advisory Circular (AC) 700-004.

NOTE:

For the purposes of the *Transport Canada Aeronautical Information Manual (TC AIM)*, the term TCAS will be used and, where necessary, a specific software version will be identified for clarity.

TCAS equipment alerts flight crews when the path of the aircraft is predicted to potentially collide with that of another aircraft. A TCAS-equipped aircraft interrogates other aircraft in order to determine their position. TCAS is designed to operate independently of air traffic control (ATC) and, depending on the type of TCAS, will display proximate traffic and provide traffic advisories (TAs) and resolution advisories (RAs).

- a) TAs provide information on proximate traffic and indicate the relative positions of intruding aircraft. TAs are intended to assist flight crew in visual acquisition of conflicting traffic and to prepare pilots for the possibility of an RA.
- b) RAs are divided into two categories: preventative advisories, which instruct the pilot to maintain or avoid certain vertical speeds; and corrective advisories, which instruct the pilot to deviate from the current flight path (e.g. “CLIMB” when the aircraft is in level flight).

There are two types of TCAS:

- a) TCAS I is a system, which includes a computer and pilot display(s), that provides a warning of proximate traffic (TA) to assist the pilot in the visual acquisition of intruder aircraft

and in the avoidance of potential collisions (it does not provide RAs).

- b) TCAS II is a system, which includes a computer, pilot display(s), and a Mode S transponder, that provides both TAs and vertical plane RAs. RAs include recommended escape manoeuvres, only in the vertical dimension, to either increase or maintain existing vertical separation between aircraft.

NOTE:

There is currently no TCAS equipment capable of providing RAs in the lateral direction.

The following paragraphs and table describe the TCAS levels of protection versus aircraft equipage.

- a) Intruder aircraft without transponders are invisible to TCAS-equipped aircraft and thus TAs or RAs are not provided.
- b) Intruder aircraft equipped with only a Mode A transponder are not tracked or detected by TCAS II, because TCAS II does not use Mode A interrogations. Mode A transponder aircraft are invisible to TCAS-equipped aircraft.
- c) Intruder aircraft equipped with a Mode C transponder without altitude input will be tracked as a non-altitude replying target. Neither a data tag nor a trend arrow will be shown with the traffic symbol. These aircraft are deemed to be at the same altitude as own aircraft.
- d) In an encounter between two TCAS II-equipped aircraft, their computers will communicate using the Mode S transponder data link, which has the capability to provide complementary RAs (e.g. one climbing and one descending).

Table 9.1—TCAS Levels of Protection

		Own Aircraft Equipment	
		TCAS I	TCAS II
Intruder Aircraft Equipage	Non-transponder-equipped or Mode A transponder only	Not tracked and not displayed	Not tracked and not displayed
	Mode C or Mode S transponder	TA	TA and vertical RA
	TCAS I	TA	TA and vertical RA
	TCAS II	TA	TA and coordinated vertical RA

COM

9.2 TRANSPORT CANADA (TC) REGULATIONS ON TRAFFIC ALERT AND COLLISION AVOIDANCE SYSTEM (TCAS)/AIRBORNE COLLISION AVOIDANCE SYSTEM (ACAS)

The Technical Standard Order (TSO) for TCAS I is TSO-C118 or CAN-TSO-C118.

The TSO for TCAS II/ACAS II is TSO-C119 or CAN-TSO-C119. The original release of TSO-C119 was associated with software version 6.0. Since then, the following updates to TSO-C119 have been released:

- a) *TSO-C119a (associated with software version 6.04a)*—Version 6.04a was released to address nuisance alerts which were occurring at low altitudes and during low-level manoeuvres, and to address a problem with the altitude crossing logic.

NOTE:

This version is the minimum requirement for operations in Canada when outside of reduced vertical separation minimum (RVSM) airspace.

- b) *TSO-C119b (associated with software version 7.0)*—Version 7.0 was released to address numerous enhancements to collision avoidance algorithms, aural annunciation, and resolution advisory (RA) displays as well as changes to reduce repetitive nuisance traffic advisories (TAs) on RVSM routes in slow closure situations.

NOTE:

Software version 7.0 is the minimum required for all CARs 702, 703, 704 and 705 aeroplanes when operating inside of RVSM airspace.

- c) *TSO-C119c (associated with software version 7.1)*—Version 7.1 was released to address reversal logic issues and flight crew misinterpretation of “ADJUST VERTICAL SPEED, ADJUST” aural annunciation. In International Civil Aviation Organization (ICAO) terminology, this is also referred to as ACAS II.

NOTES:

1. In Amendment 85 to ICAO Annex 10, Volume IV, Chapter 4, published in October 2010, ICAO has mandated that all new ACAS installations after January 1, 2014 be compliant with version 7.1 and that all ACAS units shall be compliant with version 7.1 after January 2017. Transport Canada (TC) has not initiated any rulemaking based on these ICAO requirements.
2. Be advised that if you operate in ICAO member countries after the abovementioned dates you will have to be equipped with software version 7.1.

Within some member states of the European Union and within European Civil Aviation Conference (ECAC) airspace, equipage with TCAS II software version 7.1 will be required earlier than the ICAO mandated dates.

The TSO for Mode S transponders is TSO-C112 or CAN-TSO-C112. The following table and associated notes summarize the TCAS/ACAS requirements for CAR Part VII air operators.

Table 9.2—TCAS/ACAS Requirements for CAR Part VII Air Operators

CAR	TCAS I*	TCAS II**
702.46	Not required	Required for turbine-powered aeroplanes of MCTOW exceeding 15 000 kg (33 069 lb). (See notes 1 and 2 below.)
703.70	Minimum required for aeroplanes of MCTOW exceeding 5 700 kg (12 566 lb) outside of RVSM airspace. (See note 1 below.)	Not required but acceptable outside of RVSM airspace. Required when operating in RVSM airspace. (See note 1 below.)
704.70	Minimum required for aeroplanes of MCTOW exceeding 5 700 kg (12 566 lb) outside of RVSM airspace. (See note 1 below.)	Required for turbine-powered aeroplanes of MCTOW exceeding 15 000 kg (33 069 lb). (See note 1 below.)
705.83	Minimum required for non-turbine-powered aeroplanes outside of RVSM airspace. (See note 1 below.)	Required for turbine-powered aeroplanes. (See note 1 below.)

* Equivalent to CAN-TSO-C118

** CAN-TSO-C119a (version 6.04a) outside of RVSM airspace or CAN-TSO-C119b (version 7.0) inside of RVSM airspace and Mode S transponder CAN-TSO-C112

NOTES:

1. TCAS II (CAN-TSO-C119b [software version 7.0] or more recent) and Mode S transponder (CAN-TSO-C112 or more recent) are required for operations in RVSM airspace.
2. Not required when engaged in or configured for firefighting, aerial spray services, or aerial survey and operated only in low-level airspace.

It is strongly recommended that foreign operators comply with TCAS equipage requirements as outlined above when operating within Canadian airspace.

There are currently no *Canadian Aviation Regulations* (CARs) requiring private operators (CAR 604) to be equipped with TCAS. However, private operators are advised that ICAO Annex 6, Part II, 3.6.9.2 requires that: “All turbine-engined aeroplanes of a maximum certificated take-off mass in excess of 15 000 kg, or authorized to carry more than 30 passengers, for which the individual airworthiness certificate is first issued after 1 January 2007, shall be equipped with an airborne collision avoidance system (ACAS II).” This means that affected private operators flying into ICAO member countries must be equipped with ACAS II.

9.3 USE OF THE TRAFFIC ALERT AND COLLISION AVOIDANCE SYSTEM (TCAS) OUTSIDE OF CANADA

Numerous countries have operational regulations which require certain aircraft to be equipped with a traffic alert and collision avoidance system (TCAS). If you are planning on operating your aircraft in a foreign country, consult that country’s regulations to determine TCAS equipage requirements.

Canadian air operators must meet the following TCAS requirements to operate in U.S. airspace (see Federal Aviation Administration [FAA] Federal Aviation Regulations [FAR] 129.18):

- a) TCAS I: Turbine-powered aeroplane with a passenger-seat configuration, excluding any pilot seat, of 10–30 seats.
- b) TCAS II: Turbine-powered aeroplane of more than 33 000 lb maximum certificated takeoff weight (MCTOW).

Canadian air operators planning operations in U.S. airspace are also advised to review FAA Advisory Circular (AC) 120-55C—*Air Carrier Operational Approval and Use of TCAS II* (as amended).

For Canadian air operators planning operations in Europe, details of European requirements are available at www.eurocontrol.int/acas/.

9.4 OPERATIONAL APPROVAL

For Canadian air operators, traffic alert and collision avoidance system (TCAS) operational approval is accomplished through Transport Canada (TC) approval of: pertinent training; checking and currency programs; checklists; standard operating procedure (SOP) operations or training manuals; maintenance programs; minimum equipment lists (MELs); or other pertinent documents.

When planning to equip with TCAS, Canadian air operators should consult their TC principle operations inspector early in their program to permit a timely response. Canadian air operators may address training, checking and currency individually or as part of an integrated program. For example, TCAS/ACAS qualification may be based on a specific aircraft (e.g. during A320 transition); may be addressed in conjunction with general flight crew qualification (e.g. during initial new hire indoctrination); or may be completed as dedicated TCAS/ACAS training and checking (e.g. completion of a standardized TCAS/ACAS curriculum in conjunction with a recurrent instrument flight test [IFT]/pilot proficiency check [PPC]).

Federal Aviation Administration (FAA) Advisory Circular (AC) 120-55C—*Air Carrier Operational Approval and Use of TCAS II* (as amended) provides information with respect to training, checking and currency in the use of TCAS. The material therein can be used by operators to assist in defining their implementation of TCAS.

EUROCONTROL has produced and published TCAS training material and information that are available at www.eurocontrol.int/acas/.

9.5 AIRCRAFT CERTIFICATION APPROVAL

An acceptable means of demonstrating compliance with the appropriate requirements in the *Airworthiness Manual*, Chapter 525 and of obtaining airworthiness approval is to follow the method specified in the Federal Aviation Administration’s (FAA) Advisory Circular (AC) 20-131A—*Airworthiness Approval of Traffic Alert and Collision Avoidance Systems (TCAS II) and Mode S Transponders* (as amended) for installation of Technical Standard Order TSO-C119a TCAS/ACAS. FAA AC 20-151B—*Airworthiness Approval of Traffic Alert and Collision Avoidance Systems (TCAS II), Versions 7.0 & 7.1 and Associated Mode S Transponders* should be followed for installations using TSO-C119b or TSO-C119c equipment.

9.6 OPERATIONAL CONSIDERATIONS

- a) Where required by regulations to be equipped with traffic alert and collision avoidance system (TCAS), flight crews must operate with their TCAS equipment on at all times, in so far as is consistent with the aircraft flight manual (AFM) and standard operating procedures (SOPs). This is true even when operating away from major, high traffic density airports. Although TCAS will never be a complete substitute for a good lookout, good situational awareness and proper radio procedures, it has proven to be a valuable tool that provides information on potential collision hazards. Hence, flight crews should not deprive themselves of this important asset, especially in areas of mixed instrument flight rules (IFR) and visual flight rules (VFR) traffic.

- b) For a TCAS-equipped aircraft to provide a flight crew with collision avoidance information, the TCAS unit and the transponder must be turned on and the transponder cannot be selected to STANDBY mode (i.e. powered but not transmitting data). If the transponder is not turned on and responding to interrogations, the aircraft's TCAS cannot display information about potentially conflicting aircraft nearby nor can it provide instructions to the crew to resolve impending collision threats. Failure of the TCAS computer unit itself can also occur; however, such a failure only affects the TCAS-equipped aircraft's ability to detect nearby aircraft. The aircraft containing the inoperative TCAS unit remains visible to other aircraft as long as its transponder remains operative. The consequences of a TCAS unit failure are magnified when the transponder is inoperative because not only is TCAS information lost to the affected aircraft, but the aircraft will not be visible to other airborne collision avoidance systems. Regardless of whether the transponder has failed or the TCAS has become inoperative, a flight crew's ability to mitigate the risk of collision is significantly degraded if the collision avoidance system becomes inoperative and the failure is not quickly and reliably brought to the crew's attention. Air operators are encouraged to inform pilots who use transponders or transponder/TCAS units that there may not be a conspicuous warning to indicate loss of collision protection resulting from a compromised transponder/TCAS unit. Air operators should require all pilots who use transponders or transponder/TCAS units to be familiar with the current annunciations used to indicate that these components have failed or are compromised.
- c) Flight crews are reminded to follow the resolution advisories (RAs) promptly and accurately, even though the RAs may change in strength and/or reverse. RA commands do not require large load factors when being followed. Any delay in responding to an RA could swiftly erode the ability to maintain or achieve adequate separation without resorting to strengthening RAs. For TCAS to provide safe vertical separation, initial vertical speed response is required within five seconds of the RA. Deviation from commands or second-guessing the commands should not occur. An RA prevails over any air traffic control (ATC) instruction or clearance.
- d) Flight crews may have to inhibit the RA function under certain circumstances per the AFM (e.g. during an engine failure).
- e) The TCAS system may inhibit RAs during certain flight phases, such as at low altitudes. Flight crews need to be aware of when TCAS will not provide a full range of RA commands.
- f) Flight crews should not attempt to manoeuvre solely on the basis of traffic advisory (TA) information. The TA should trigger a visual search for traffic and a request to ATC for help in determining whether a flight path change is required. In the case of a TCAS II TA, the flight crew should prepare for a possible RA, following the TA.

- g) TAs and RAs should be treated as genuine unless the intruder has been positively identified and assessed as constituting neither a threat nor a hazard.
- h) Flight crews should be aware that, in accordance with the *Canadian Transportation Accident Investigation and Safety Board Act*, an incident where a risk of collision or a loss of separation occurs is considered a reportable aviation incident. Responding to an RA is considered a reportable aviation incident. For more information on this topic, visit the following links:
- (i) [AC 700-004: Airborne Collision Avoidance System Advisory Material](#); and
 - (ii) www.tc.gc.ca/en/services/aviation/operating-airports-aerodromes/report-incident-airport-safety.html
- i) If a TCAS RA manoeuvre is contrary to other critical cockpit warnings, then those other warnings are respected per TCAS certification and training (i.e. responses to stall warning, wind shear and terrain awareness and warning systems [TAWSS] take precedence over a TCAS RA, especially when the aircraft is less than 2 500 ft above ground level [AGL]).
- j) Due to interference limiting algorithms, airborne collision avoidance system (ACAS) II may not display all proximate transponder-equipped aircraft in areas of high density traffic. Flight crews should not become complacent in their efforts to search the sky for other aircraft.

9.7 PILOT ACTION WHEN DEVIATING FROM CLEARANCES—REGULATIONS AND INFORMATION

Safety studies have confirmed that the significant safety benefit afforded by a traffic alert and collision avoidance system (TCAS) could be seriously degraded by a deficient response to resolution advisories (RAs). It has also been shown that the safety benefit of TCAS is eroded when pilots do not follow the flight path guidance provided during an RA.

In view of this safety hazard and to optimize the safety benefits of TCAS, the following regulatory provisions have been established:

CAR 602.31(3) states that:

“The pilot-in-command of an aircraft may deviate from an air traffic control clearance or an air traffic control instruction to the extent necessary to carry out a collision avoidance manoeuvre, if the manoeuvre is carried out

- (A) in accordance with a resolution advisory generated by an ACAS; or
- (A) in response to an alert from a TAWS or a Ground Proximity Warning System (GPWS).”

CAR 602.31(4) states that:

“The pilot-in-command of an aircraft shall

- (A) as soon as possible after initiating the collision avoidance manoeuvre referred to in subsection (3), inform the appropriate air traffic control unit of the deviation; and
- (A) immediately after completing the collision avoidance manoeuvre referred to in subsection (3), comply with the last air traffic control clearance received and accepted by, or the last air traffic control instruction received and acknowledged by, the pilot-in-command.”

NOTE:

By following the RA guidance precisely, the magnitude of the altitude deviation can be minimized. Pilots must ensure that the manoeuvre necessary to comply with the RA (climb or descent) is not maintained after the RA is terminated.

There is information available which highlights the importance of following RAs. EUROCONTROL has issued numerous airborne collision avoidance system (ACAS) II bulletins (see www.eurocontrol.int/articles/acas-ii-bulletins-and-safety-messages). ACAS II Bulletin Issue 1— Follow the RA, dated July 2002, describes several RA events and the consequences of the flight crew actions taken. The bulletin is informative and describes the advantages of TCAS/ACAS for collision avoidance when followed correctly. The bulletin also describes the limitations associated with the visual acquisition of traffic and those of air traffic control (ATC) radar displays.

Transport Canada (TC) recommends that operators disseminate this information to pilots for awareness and, where appropriate, establish suitable pilot training programs to ensure that flight crews follow RAs promptly and accurately, even when presented with conflicting avoidance instructions from ATC.

9.8 MODE S TRANSPONDER APPROVAL AND UNIQUE CODES

Along with performing all the functions of Mode A and C transponders, Mode S transponders also have a data link capability. Mode S transponders are an integral component of all TCAS II/ACAS II installations.

For aircraft that are not required to be equipped with TCAS/ACAS, there is no requirement to replace existing Mode A or C transponders with Mode S transponders until it becomes impossible to maintain presently installed Mode A or C transponders.

Airworthiness approval must be obtained by Canadian aircraft operators who install Mode S transponders. Federal Aviation Administration (FAA) Advisory Circular (AC) 20-131A— *Airworthiness Approval of Traffic Alert and Collision Avoidance Systems (TCAS II) and Mode S Transponders* (as amended)

should be used for guidance to obtain airworthiness approval. Canadian operators should contact their regional Transport Canada (TC) office for approval details.

At the time of registration, each Canadian aircraft with a Mode S transponder will receive a unique 24-bit Mode S code assignment, which must be uploaded to the transponder, usually by the installer.

9.9 PILOT/CONTROLLER ACTIONS

In order to use a traffic alert and collision avoidance system (TCAS) in the most effective and safest manner, the following pilot and controller actions are necessary:

- a) Pilots should not manoeuvre their aircraft in response to traffic advisories (TAs) only.
- b) In the event of a resolution advisory (RA) to alter the flight path, the alteration of the flight path should be limited to the minimum extent necessary to comply with the RA. Aggressive manoeuvring should not be required since TCAS RAs are predicted on ¼ G manoeuvre load factors.
- c) Pilots should notify, as soon as possible, the appropriate air traffic control (ATC) unit of the deviation and of when the deviation has ended.
- d) When a pilot reports a manoeuvre induced by an RA, the controller should not attempt to modify the aircraft flight path until the pilot reports returning to the terms of the existing ATC instruction or clearance. Instead, the controller should provide traffic information as appropriate.
- e) Pilots who deviate from an ATC instruction or clearance in response to an RA shall promptly return to the terms of that instruction or clearance when the conflict is resolved and advise ATC.

9.10 PILOT AND CONTROLLER PHRASEOLOGY

The current International Civil Aviation Organization (ICAO) traffic alert and collision avoidance system (TCAS) pilot/controller phraseology is detailed below (see also ICAO Doc 4444, 12.3.1.2). It should be noted that, for the purpose of phonetic clarity, the term TCAS is used.

Table 9.3—TCAS Pilot–Controller Phraseology

Circumstances	Pilot	Controller
After a flight starts to deviate from the ATC clearance or instructions to comply with a TCAS RA.	TCAS RA	ROGER
After the response to a TCAS RA is completed and a return to the ATC clearance or instruction is initiated.	CLEAR OF CONFLICT. RETURNING TO (assigned clearance).	ROGER (or alternative instruction)
After the response to a TCAS RA is completed and the assigned ATC clearance or instruction has been resumed.	CLEAR OF CONFLICT. (assigned clearance) RESUMED.	ROGER (or alternative instruction)
After an ATC clearance or instruction contradictory to the TCAS RA is received, the flight crew will follow the RA and inform ATC directly.	UNABLE, TCAS RA	ROGER

10.0 SATELLITE SYSTEMS

10.1 GENERAL

Satellite systems used for aviation are defined by different orbits: low earth orbit (LEO), medium earth orbit (MEO) and geosynchronous earth orbit (GEO). A special case of GEO is the geostationary earth orbit (or geosynchronous equatorial orbit), which is a circular geosynchronous orbit at zero inclination (that is, directly above the equator). The altitude of the orbit determines the surface area of the Earth that can be illuminated by the satellite signal: the higher the orbit, the larger the signal footprint. Propagation losses from satellites at higher orbits are offset by the increased complexity of the antenna systems, along with higher transmitter power. A LEO satellite’s footprint is smaller, which means that a higher number of satellites are required to provide seamless coverage, but the antennas are much simpler and have a reduced radio frequency power requirement on the user end.

10.2 SATELLITE SERVICE PROVIDERS

A number of providers offer telephone and data services to the aeronautical market via satellite. Iridium offers a low earth orbit (LEO) satellite system, while Inmarsat and the Japan Meteorological Agency operate geosynchronous earth orbit (GEO) satellite systems. These satellite systems use frequencies reserved for aeronautical safety services.

Iridium offers a constellation of 66 cross-linked satellites at an altitude of 780 km. Six orbital planes, with 11 satellites in each orbital plane, provide global coverage. Additionally, there are a number of spare satellites to replace any in-orbit failures. At that altitude, each satellite covers a circular area 4 500 km in diameter, and is in view for approximately nine minutes to anyone located on the ground.

The Inmarsat network uses geostationary earth satellites at an altitude of 35 786 km. At that altitude above Earth, each satellite’s footprint covers approximately 120° of longitude at the equator and stretches to approximately 82° north and 82° south latitude. The orbital period of each satellite is exactly the same as the rotation period of the Earth, so each satellite appears to remain in the same position.

Japan’s multifunctional transport satellite (MTSAT) functionality is equivalent to that of Inmarsat, except that the MTSAT constellation, centered over Japan, only provides a coverage footprint to Asia and the Pacific Ocean.

COM

MET—METEOROLOGY

1.0 GENERAL INFORMATION

1.1 GENERAL

The Minister of Transport is responsible for the development and regulation of aeronautics and the supervision of all matters connected with aeronautics.

The responsibility for the provision of aviation weather services in Canadian airspace, and any other airspace in which Canada accepts the responsibility for the provision of air traffic control (ATC) services, has been designated to NAV CANADA by the Minister of Transport.

NAV CANADA is responsible for a range of aviation weather services, some of which are provided to it under a contractual agreement with Environment and Climate Change Canada (ECCC). These services include most civilian aviation weather forecasts. NAV CANADA is responsible for determining the location and frequency of aviation weather observations and forecasts, and for the dissemination of this information for aviation purposes.

In addition to the aviation weather services provided by NAV CANADA, other aviation service providers may offer weather services in support of operations at local aerodromes that have light traffic, are private, and/or are used primarily in support of private industry, such as mining or other similar operations.

The Department of National Defence (DND) arranges for the provision of aviation weather services at military aerodromes.

1.1.1 Meteorological Responsibility

In accordance with CAR 804.01(1) the majority of standards for aviation weather services are found in: ICAO Annex 3, the *Manual of Standards and Procedures for Aviation Weather Forecasts* (MANAIR), and the *Manual of Surface Weather Observations* (MANOBS). The two manuals can be obtained from ECCC's Web site at <<https://www.canada.ca/en/environment-climate-change/services/weather-manuals-documentation.html>>, while Annex 3 can be obtained from ICAO. An updated eighth edition of MANOBS took effect in February 2019.

Enquiries relating to the provision of aviation weather services should be addressed to:

NAV CANADA
Aviation Weather Services
77 Metcalfe Street
Ottawa ON K1P 5L6

Tel. (toll-free in North America): 1-800-876-4693
Fax: 613-563-3426
Fax (toll-free in North America): 1-877-663-6656

E-mail: service@navcanada.ca

Enquiries relating to regulations and standards for aviation weather services should be addressed to:

Flight Standards (AARTA)
Transport Canada
Ottawa ON K1A 0N8

Tel.: 1-800-305-2059

Fax: 613-957-4208

E-mail: ... TC.Flights.Standards-Normesdevol.TC@tc.gc.ca

1.1.2 Meteorological Services Available

Aviation weather information is available from NAV CANADA FICs. Telephone numbers and hours of service are listed in the CFS and the CWAS.

1.1.3 Aviation Weather Services

- a) *Pilot briefing service*—The pilot briefing service is provided by NAV CANADA FICs to accommodate pilots at the pre-flight planning stage and for information updates while en route. Flight service specialists can access and display a full range of weather charts, imagery (e.g. satellite, lightning and radar) and aeronautical information (such as NOTAM, RSC and CRFI). They are qualified to provide briefings, consultation and advice, and to interpret meteorological information. (See RAC 3.2 for details).
- b) *Aviation weather web site (AWWS)*—NAV CANADA's aviation weather web site (AWWS), available at <<https://flightplanning.navcanada.ca/>>, and collaborative flight planning system, available at <https://plan.navcanada.ca>, offer aviation weather products, NOTAM and the ability to file flight plans. For more information, visit <www.navcanada.ca>. Pilots operating near the border should note that U.S. METAR, SPECI and TAF must be obtained through the Aviation Digital Data Service (ADDS), available at <www.aviationweather.gov/adds/>.
- c) *Other pilot weather services*—In accordance with an arrangement with the U.S. National Weather Service, digital upper level wind and temperature forecasts are available to operators in Canada for planning international flights. Digital forecasts are also available to the Gander OAC for planning transatlantic flights. Aviation weather flight documentation is provided, subject to prior notification, as determined by the local weather service outlet in consultation with the operator's local representative. Operators are responsible for notifying NAV CANADA's aviation weather services of new requirements. (See MET 1.1.1 for the address.) Where indicated in the CAP, altimeter settings in weather reports from U.S. aerodromes may be used as a RASS.

1.1.4 Weather Service Information

When planning a flight, pilots can obtain aviation weather and aeronautical information and file a flight plan through a NAV CANADA FIC. (See RAC 3.2 for details).

Radio communication should be established with a FIC on a FISE frequency if in-flight information is required to assist in making a decision or to terminate a flight, or to alter course before adverse weather conditions are encountered.

Pilot requests for initial pilot briefings while airborne are not encouraged because this practice leads to frequency congestion.

1.1.5 Weather Information from Air Traffic Service (ATS)

All aerodromes with operational ATS will provide, on initial contact or as soon as practicable, the current wind and altimeter information unless it is known that the aircraft already has this information. ATS procedures require that wind information be transmitted with landing and take-off clearance only when the wind speed is 15 kt or greater. Wind velocity (direction and speed) data is typically updated every five seconds using a running 2-min average. Variations to the wind speed (gusts) and/or wind direction are based on wind data from the previous 10 min.

At aerodromes with an operational ATIS, the full details of the most recent METAR or SPECI will be included in the recorded message. In rare circumstances, such as during rapidly changing weather conditions, this information will be provided directly by ATS. Where ATIS is not operational, updated current information about weather elements from METAR/SPECI is available on request.

RVR observations are obtained by transmissometers and forward-scatter sensors. Observations representative of the touchdown and, where available, midpoint and roll out visibility, averaged over 1 min and based on the light setting in use, are automatically displayed in digital form in the local ATS unit.

RVR is included in METARs and SPECIs when it is 6 000 ft or less for the runway in use and/or the visibility is 1 SM or less. The RVR is presented in ICAO format and is based on a 10-min average of the maximum runway light setting. Refer to the METAR example in MET 8.3 for further details.

1.1.6 Pilot Reports

1.1.6.1 Pilot Weather Reports (PIREPs)

Pilots are urged to volunteer reports of cloud tops, upper cloud layers, cruising level wind velocity, and other meteorological information which may be significant to safe or comfortable flight conditions. The information is also used by ECCC meteorologists to confirm or amend aviation weather forecasts. PIREPs less than one hour old that contain information about conditions considered to be a hazard to aviation are broadcast

immediately to aircraft in the affected area and will be included in subsequent scheduled weather broadcasts. PIREPs are also transmitted under the headings “UACN10” for normal PIREPs and “UACN01” or “UUA” for urgent PIREPs. A suggested format for PIREPs can be found on the back covers of the CFS and the CWAS. More information on PIREPs can be found in MET 2.0.

1.1.6.2 Air Reports (AIREPs)

AIREPs are appended to the routine position reports of some flights as follows:

- a) international air carrier aircraft transiting Canadian domestic FIRs north of 60°N and east of 80°W, and north of 55°N and west of 80°W should use the AIREP format and report routine meteorological observations to Gander Radio at each designated reporting point or line;
- b) all aircraft operating in the Gander OCA should use the AIREP format and report routine meteorological observations at each designated reporting point or line. The exception is that aircraft cleared on a designated NAT track will give these reports only if the phrase “SEND MET REPORTS” is included in their oceanic clearance.

There are no special requirements for transmitting AIREPs with appended meteorological information other than those specified in ICAO’s *Regional Supplementary Procedures* (Doc 7030).

1.1.7 Applicable International Civil Aviation Organization (ICAO) and World Meteorological Organization (WMO) Documents

Whereas ICAO determines the standards and recommended practices with respect to meteorological service for international air navigation, the WMO determines and reports the internationally agreed upon code formats for the reports and forecasts. ICAO and WMO documents applicable to aviation meteorology are as follows:

- a) ICAO Annex 3—*Meteorological Service for International Air Navigation*
- b) WMO Doc 306—*Manual on Codes*

WMO documents may be ordered directly from the WMO Secretariat in Geneva, Switzerland. ICAO documents may be purchased from ICAO Headquarters in Montréal. The two relevant addresses are listed below:

World Meteorological Organization (WMO)
Sales and Distribution of Publications
7bis, avenue de la Paix
P.O. Box 2300
CH-1211 Geneva 2, Switzerland

Tel.: +41-22-730-8111
Fax.: +41-22-730-8181
Web site: www.wmo.int

International Civil Aviation Organization (ICAO)
 Distribution Sales Unit
 Suite 305
 999 Robert-Bourassa Boulevard
 Montréal QC H3C 5H7

Tel.: 514-954-8022
 Web site: www.icao.int

Pilots flying outside of North America should consult the differences filed by other member states as outlined in WMO Doc 306 or in the AIP of each country.

1.1.8 Differences from International Civil Aviation Organization (ICAO) Annex 3

CAR 804.01(1)(a) incorporates standards contained in ICAO Annex 3. The current version of Annex 3 includes Amendment 78, which will be superseded by Amendment 79 on November 5, 2020. In accordance with CAR 800.01(2), the incorporation of Annex 3 as a standard “includes the differences notified to ICAO by the Government of Canada in respect of the standards specified in that annex”. The full details of these state differences are included in the *AIP Canada (ICAO)*, as published and disseminated by NAV CANADA.

1.1.9 Pilot Responsibility

Pilots must be aware of the requirements of CAR 602.72: “The pilot-in-command of an aircraft shall, before commencing a flight, be familiar with the available weather information that is appropriate to the intended flight.”

1.2 METEOROLOGICAL OBSERVATION AND REPORTS

1.2.1 Type and Frequency of Observations

METARs are coded weather observations that are taken every hour on the hour at over 200 aerodromes and other locations in Canada. In addition, SPECIs are issued whenever weather conditions cross specified criteria. For details on how to understand METARs, see MET 8.3. For details on SPECI criteria, see MET 8.4.

The location of transmissometers or forward scatter sensors used to determine RVR is specified on CAP aerodrome charts.

1.2.2 Flight Weather Documentation

Pilots must use the most recent weather information available when flight planning and be aware of scheduled weather information updates. Pilots must also remain vigilant for pertinent unscheduled weather updates or amendments.

Flight weather documentation should include, as appropriate: the relevant GFAs, AIRMETs, SIGMETs, TAFs, METARs, SPECIs, PIREPs, and upper wind and temperature forecasts.

There are two distinct methods of reporting cloud bases. It is vital for the pilot to be able to distinguish and recognize which method of reporting is in use. Heights in METARs and TAFs are always stated as height above ground level. On the other hand, heights in GFAs and PIREPs are normally stated as height above sea level, since terrain heights are variable over the larger area covered. If heights are not ASL in GFAs, this is always highlighted by statements such as “CIGS 2-4 AGL”.

1.2.3 Weather Services Definitions in Flight Publications

The terminology used in the CFS and the CAP to describe aviation weather services is as follows:

- a) *METAR*—METAR and SPECI weather observations taken by a qualified human observer.
- b) *METAR AUTO*—METAR and SPECI weather observations taken by a stand-alone AWOS with noted enhancements (see MET 8.5). AWOS located outside of the CLDN coverage area do not receive lightning data and therefore are unable to report thunderstorm or lightning activity.

Examples of METAR AUTO stations are the NAV CANADA AWOS and DND AWOS.

- c) *LWIS*—An automated weather system which produces an hourly LWIS report containing wind speed and direction; temperature; dew point; and altimeter setting only.
- d) *AUTO*—An automated weather system that does not meet requirements to produce a METAR AUTO, SPECI AUTO or LWIS report. These systems can report a variety of observed weather elements. Contact the aerodrome operator for further information on the specifics of the system. Some of these systems may have associated VHF transmissions of their reports as stated in the CAP or CFS.
- e) *WxCam*—Indicates that a NAV CANADA aviation weather camera is installed at the site. Still images are transmitted to the NAV CANADA AWWs at 10-min intervals.
- f) *Webcam*—Indicates that one or more cameras not belonging to NAV CANADA have been installed at this location. Contact the aerodrome operator for further information on the specifics of the camera system.
- g) *ALTIMETER*—Altimeter setting report observed from two aircraft altimeters. The private altimeter setting report is a weather service provided in support of an AU. Contact the aerodrome operator for further information on the service.
- h) *WIND*—Human assessment of wind speed and direction. The private wind speed and direction report is a weather service provided in support of an AU. Contact the aerodrome operator for further information on the service.

Observed weather information, observations, and forecasts originating from any non-NAV CANADA weather service, other than DND, are considered a private meteorological service.

Stand-alone METAR AUTO and LWIS reports are available during published hours through normal meteorological information systems. At some sites an automated voice broadcast of the latest observation is available via VHF transmitter. In these cases, the frequency is displayed in the COMM entry of the CFS Aerodrome/Facility Directory (e.g. COMM AWOS 124.7, COMM AUTO 122.025).

The hours of coverage for METAR, METAR AUTO, and LWIS reports are given (e.g. METAR 09-21Z). At sites where coverage is 24 hr/day, the coverage is listed as H24 (e.g. METAR H24, METAR AUTO H24, LWIS H24).

Sites that provide unspecified limited hours of coverage will be listed as ltd hrs (e.g. ALTIMETER ltd hrs). Contact the aerodrome operator for further information on the hours of operation.

1.2.4 Automated Weather Observation Systems (AWOS)

1.2.4.1 Overview

AWOS, LWIS and AUTO refer to automated equipment used as a means to provide an aviation weather service. The services that can be provided by these systems are either full METAR AUTO/SPECI AUTO or some subset thereof. LWIS provides a basic group of four elements and issues an hourly report. Operators of automated weather stations that are used to support instrument flight procedures are required to document the characteristics of their systems and to provide aircraft operators with suitable descriptions, upon request.

AWOS and LWIS operated by NAV CANADA have common performance characteristics across the country. A description of the performance characteristics of these systems can be found in MET 8.5.

The subset of weather elements provided by AUTO may vary from only one element to almost a full METAR AUTO/SPECI AUTO. Any automated system that is not capable of reporting all the elements required to generate METAR AUTO/SPECI AUTO reports and support any associated TAF should be referred to as AUTO or LWIS. Some local service providers may refer to their systems as AWOS, but if they do not support METAR AUTO/SPECI AUTO, then they will be listed as AUTO in the CFS.

NOTE:

The United States uses the term “automated surface observation system” (ASOS) as the equivalent to Canadian AWOS that provide METAR AUTO reports. Typically, usage of the term AWOS in the United States is equivalent to the Canadian LWIS but with several defined levels of observation capabilities. Further details regarding performance characteristics and reporting practices can be found in the FAA’s *Aeronautical Information Manual*.

1.2.4.2 Visual Flight Rules (VFR) Weather Stations

Some weather stations are intended exclusively for local use by VFR operators. These stations do not meet the requirements of a usable altimeter setting or of wind reports for IFR procedures. These stations are not permitted at aerodromes that have IAPs and they are not published in the CFS. Pilots making use of these stations do so at their discretion for VFR. If the reports from such stations are being broadcast as an advisory, the frequency will be mentioned in the COMM entry of the CFS Aerodrome/Facility Directory along with an annotation stating that the reports cannot be used for IFR. Pilots should contact the aerodrome operator if they require additional information.

1.2.5 Automatic Aerodrome Routine Meteorological Reports (METAR AUTO) and Limited Weather Information System (LWIS) Reports

1.2.5.1 Automatic Aerodrome Routine Meteorological Reports (METAR AUTO)

METAR AUTO reports are based on NAV CANADA or DND AWOS systems, which are comprised of a set of meteorological sensors, a data processing system, a communications system, and an optional VGSS and VHF transmitter. In addition, weather cameras are installed at most of these locations. METAR AUTO reports may be used to support a TAF at the associated aerodrome.

METAR AUTO reports depend on either a NAV CANADA- or DND-developed system or on a commercial system that complies with TC requirements for aviation use. Pending revisions to the CARs, the current standards for the operation of automatic weather stations for aviation use are contained in a global exemption to CAR 804.01. Full details on this exemption are available on the TC Web site or from TC regional offices.

Observations are distributed in the form of METAR AUTO reports and must be properly coded and supplemented by SPECI AUTO reports when SPECI thresholds are crossed. At a minimum, the following are observed and reported:

- a) wind (direction, speed and gusts);
- b) altimeter setting (these include multiple sensors as a fail-safe);
- c) air temperature;
- d) dew point;
- e) visibility;
- f) cloud height;
- g) sky coverage (of detected cloud);
- h) precipitation occurrence and type;

- i) fog, freezing fog, haze, blowing snow and mist;
- j) thunderstorm detection capability; and
- k) icing.

In addition, reports may include RVR when required.

For more information on METAR AUTO reports, refer to MET 8.5.

1.2.5.2 Limited Weather Information System (LWIS) Reports

A LWIS comprises automated meteorological sensors, a data processing system, a communication system, and an optional VGSS with a VHF transmitter. The LWIS collects limited meteorological data, produces LWIS reports, and transmits data to ATS facilities on the hour. The LWIS also transmits data updated every minute to the affiliated VGSS and VHF transmitter units.

These systems were developed to meet a defined level of service requirement for NAV CANADA.

Any LWIS used for civil aviation purposes must comply with TC requirements, including siting, maintenance, and quality control, and be equipped with sensors to report, at a minimum, the following:

- a) wind (direction, speed, and gusts);
- b) altimeter setting (these include multiple sensors as a fail-safe);
- c) air temperature; and
- d) dew point.

Wind direction is reported in degrees true except for the VGSS, which reports wind direction in degrees magnetic in SDA.

Except for the DND stations in the High Arctic that do not provide dew point information, any automated system that reports fewer elements than the standard four required for an LWIS should be referred to as an AUTO. For more information on LWIS, please refer to MET 8.5.

1.2.6 Automatic (AUTO) Reports

The term AUTO is used to describe all other automated aviation weather reports that have demonstrated compliance with TC requirements and are usable for IFR flight. However, they have a wide variety of performance characteristics and may be referred to locally by different labels, most often as AWOS. Contact the airport operator for more information on the characteristics of local systems.

1.2.7 Weather Services in Support of Approach Unicom (AU)

Weather information is not usable for instrument procedures unless it complies with the requirements of CAR 804 or a related national exemption.

AU is an air-ground communications service that can provide approach and landing information to IFR pilots. The altimeter setting and wind reports provided by an AU are usable in support of an instrument procedure. Pending revisions to the CARs, these services must be provided by qualified persons in accordance with one of the two national exemptions to CAR 804.01(1)(c) that are in effect for these services.

The first national exemption establishes how two aircraft altimeters can be used to observe and report a usable altimeter setting. The second establishes procedures to follow for the human assessment of wind speed and direction, usable for the selection of the most into-wind runway. More details regarding these exemptions can be found on the TC Web site or obtained from a TC regional office.

At a few AU locations, fully automated systems are used to measure atmospheric pressure. This data is used to determine the altimeter setting that is relayed to pilots. In these cases, the reported altimeter setting must comply with the same requirements applied to the altimeter component of METAR AUTO/SPECI AUTO.

Any weather information provided by a UNICOM, as opposed to an AU, is not usable for instrument procedures; alternative uses are entirely at the pilot's discretion.

1.2.8 Runway Visibility Assessment

At aerodromes where RVR is not provided, qualified persons may, in accordance with the runway visibility assessment standards referenced in CAR 804, provide an assessment of runway visibility. Instrument-rated pilots may also provide such assessments in accordance with CAR 602.131.

A runway visibility assessment is valid for only 20 min after it has been established.

1.3 METEOROLOGICAL FORECASTS AND CHARTS

1.3.1 Flight Information Centre (FIC) Hours of Service and Telephone Numbers

All FICs provide 24-hr service. FIC telephone numbers are provided in the CFS. Pilots dialing the common toll-free number 1-866-WXBRIEF (992-7433) will automatically be routed to the FIC serving the area from which the call is being made.

1.3.2 World Area Forecast System (WAFS) Charts

WAFS aviation weather charts are disseminated as required. These include prognostic significant weather charts for the North Pacific, the Caribbean and northern South America, the North Atlantic, Canada and the United States.

1.3.3 Aerodrome Forecasts (TAFs)

TAFs are prepared for approximately 200 aerodromes across Canada. TAFs are limited to aerodromes for which METAR and SPECI reports are available. The forecasts are generally prepared four times daily with periods of validity up to a maximum of 30 hr. See MET 7.0 for more information on TAFs, including where and when they are issued, their periods of validity and decoding instructions.

TAFs are issued in TAF code, with amendments as required.

1.3.4 Aerodrome Advisory Forecasts

Aerodrome advisories are forecasts that are issued in TAF format except that ADVISORY is added immediately after the period of validity group. They are issued in place of a TAF in the following circumstances:

- a) *Offsite*—the forecast is based on observations that have been taken off site, more than 1.6 NM from the aerodrome centre, and are not considered to be representative of weather conditions at the aerodrome;
- b) *Observation incomplete*—the forecast is based on observations which have regularly missing or incomplete data; or
- c) *No specials*—the forecast is based on observations from a station with a limited observing program that does not issue SPECIs.

In each case, after the period of validity group, the advisory forecast will be labelled with the word ADVISORY and the appropriate qualifier (OFFSITE, OBS INCOMPLETE, or NO SPECI).

1.3.5 Coastal Weather

Float plane operators can also obtain coastal marine weather on HF and VHF FM frequencies from some Canadian Coast Guard stations. Frequencies and time of broadcast are contained in two Canadian Coast Guard Publications: *Radio Aids to Marine Navigation (Pacific and Arctic)* and *Radio Aids to Marine Navigation (Atlantic, St. Lawrence, Great Lakes, Lake Winnipeg and Arctic)*. These two publications are published annually and are available on the Canadian Coast Guard Web site.

1.3.6 Graphic Area Forecasts (GFAs) and AIRMET

GFAs are issued as a series of temporally adjusted weather charts for CDA and distributed on a routine or on-request basis. These forecasts are prepared four times daily for seven regions across the country with a validity period of 12 hr and an IFR outlook for a further 12 hr. See MET 4.0 for issue, periods of validity and decoding instructions. Once issued, a SIGMET or AIRMET message automatically amends the current and relevant GFA. A full description of AIRMET can be found in MET 5.0.

1.3.7 Upper Level Wind and Temperature Forecasts (FD)

Alphanumeric upper level wind and temperature forecasts (FDs) are routinely prepared for 142 sites in Canada. FD forecasts are produced by a super-computer model of the atmosphere called a NWP model, which is run twice per day at 00Z and 12Z after collecting and analyzing weather observation data from around the world.

FD forecasts based on the 12Z NWP model run on the fifth day of the month would include the following text in front of the forecast data: “FCST BASED ON 051200 DATA”. The text “DATA VALID 060000” in the FD forecast indicates that the temperature and wind velocity data is forecast to be most representative of conditions at 00Z on the sixth day of the month. FD forecast data can be used for several hours before or after the stated valid time. This is indicated by the text “FOR USE” followed by the time range. For example, “FOR USE 21 – 06” means that this particular forecast may be used for a 9-hr period from 21Z to 06Z.

During flight planning, care must be exercised to ensure that the correct FD forecast is selected and the associated “FOR USE” coverage is appropriate for the time of the proposed flight.

Forecasts in digital form of the winds and temperatures aloft (FB), an improvement over FD forecasts, are now available over the phone. FB forecasts are updated four times per day. Over the next couple of years, FB forecasts will gradually replace FD forecasts for most flight planning purposes. Further information is available in the MANAIR, which can be found on ECCC’s Web site. Forecasts of upper winds and temperatures are also available in chart form.

1.3.8 Air Traffic Control (ATC) Weather Assistance

ATC will issue information on significant weather and assist pilots in avoiding weather areas when requested. However, for reasons of safety, an IFR flight must not deviate from an assigned course or altitude/flight level without a proper ATC clearance. When weather conditions encountered are so severe that an immediate deviation is determined to be necessary, and time will not permit approval by ATC, the pilot’s emergency authority may be exercised. However, when such action is taken, ATC should be advised of the flight alteration as soon as practicable.

When a pilot requests clearance for a route deviation or for an ATC radar vector and ATC operational boundaries have to be crossed, the controller must evaluate the air traffic situation in the affected area and coordinate with other controllers before replying to the request.

It should be remembered that the controller's primary function is to provide safe separation between aircraft. Any additional service, such as weather avoidance assistance, can only be provided to the extent that it does not detract from the primary function. Also note that the separation workload for the controller generally increases when weather disrupts the usual flow of traffic. ATC radar limitations and frequency congestion are also a factor in limiting the controller's capability to provide additional services.

It is important, therefore, that the request for a deviation or radar vector be forwarded to ATC as far in advance as possible. Delay in submitting it may delay or even preclude ATC approval or require that additional restrictions be placed on the clearance. Pilots should respond to a weather advisory by requesting: a deviation off course and stating the estimated number of miles and the direction of the requested deviation; a new route to avoid the affected area; a change of altitude; or radar vectors around the affected areas.

The following information should be given to ATC as early as possible when requesting clearance to detour around weather activity:

- a) proposed route and extent of detour (direction and distance);
- b) flight conditions (IMC or VMC); and
- c) whether or not the aircraft is equipped with a functioning cockpit weather radar.

The assistance that might be given by ATC will depend upon the weather information available to controllers. Owing to the often transitory nature of severe weather situations, the controller's weather information may be of only limited value if based on weather observed on radar only. Frequent updates by pilots, giving specific information as to the area affected, altitudes, intensity and nature of the severe weather, are of considerable value. Such PIREPs receive immediate and widespread dissemination to aircrew, dispatchers and aviation forecasters.

1.3.9 Supplementary Information

1.3.9.1 Weather Radar

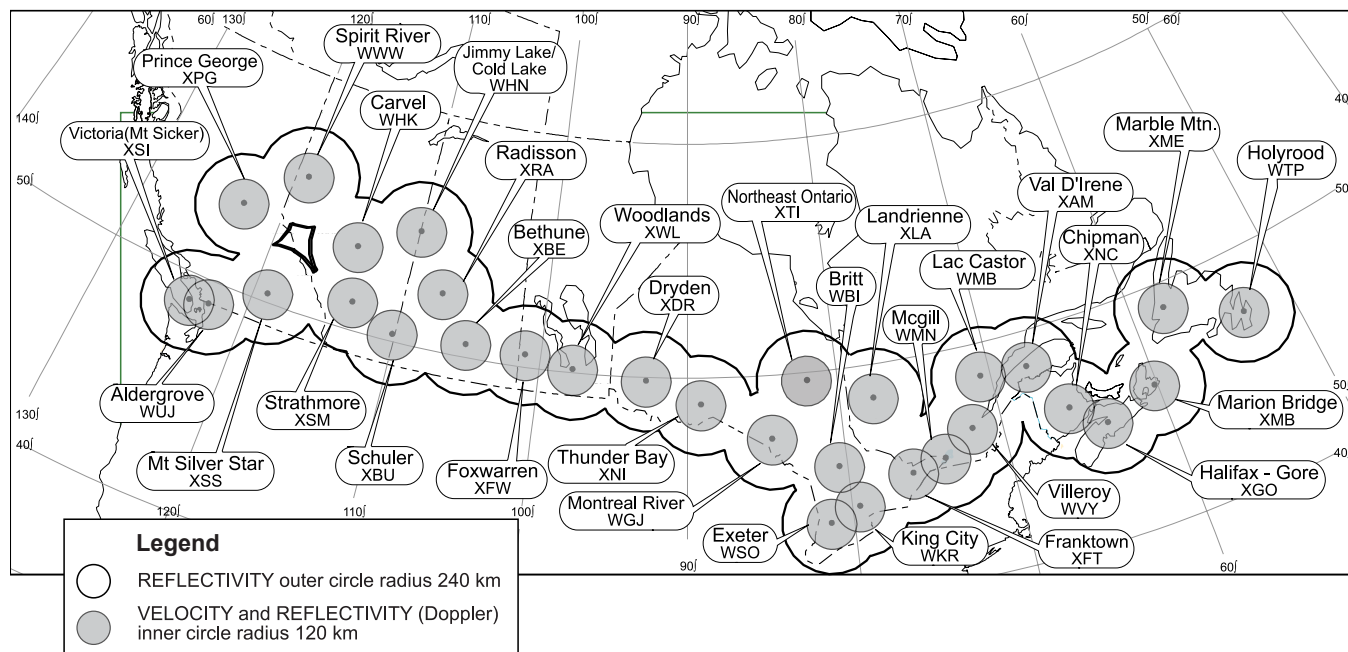
Weather radars typically present a display of precipitation within 150 NM of the facility site; storms of considerable height and intensity can be seen at greater ranges. However, it should be noted that these radars cannot detect turbulence. The turbulence associated with a very heavy rate of rainfall will generally be significantly more severe than that associated with light rainfall.

ECCC and DND operate a series of weather radars across Canada that provide frequent reports of precipitation echo tops and precipitation reflectivity. Radar images are updated approximately every 10 min for individual radars. A colour composite radar product, which depicts either echo tops or precipitation reflectivity, is also available on NAV CANADA's Aviation Weather Web Site (AWWS), from the Flight planning section at www.navcanada.ca/EN/products-and-services/Pages/flight-planning.aspx. Over the next few years, the weather radar network will be improved to offer better images and updates every 6 minutes. During the upgrades, radars will be unavailable and information from neighbouring radars will need to be used.

Detailed and real time information from the CLDN is available to the FICs and ACCs, which are both able to provide verbal descriptions to pilots.

1.3.9.2 ECCC/DND Weather Radar Network

Figure 1.1—ECCC/DND Weather Radar Network



1.4 IN-FLIGHT METEOROLOGICAL INFORMATION (VOLMET)

In-flight meteorological information (VOLMET) is meteorological information for aircraft in flight, particularly over the high seas. VOLMET contains aerodrome routine meteorological reports (METARs) and aerodrome forecasts (TAFs) for selected aerodromes and may be provided either by data link (D-VOLMET) or by voice broadcasts on designated frequencies, normally high frequency (HF).

Information on the content, issue times and transmitter frequencies for North Atlantic (NAT) VOLMET broadcasts is given in the *Canada Flight Supplement (CFS)*, Section D, Radio Navigation and Communications.

2.0 PILOT WEATHER REPORTS (PIREPs)

2.1 GENERAL

A pilot weather report (PIREP) is a report pertaining to current weather conditions encountered by aircraft in flight. A PIREP is extremely useful to other pilots, forecasters, dispatchers and weather briefers as it provides up-to-the-minute weather information to supplement what is received from meteorological observing stations. In addition, a PIREP is an invaluable data source for aviation meteorologists because it either confirms an existing forecast or highlights the requirement for an amendment. A PIREP may also be the only information available regarding areas between reporting stations, particularly those areas whose

topography may produce localized weather phenomena (e.g. hills or expanses of water). Urgent PIREPs are issued for atmospheric conditions that are an immediate hazard for all aviation users.

Pilots are encouraged to file brief reports of weather conditions when giving position reports, especially reports of any significant atmospheric phenomena. They are also encouraged to report conditions that differ significantly from those that were forecast. PIREPs that contain critical information on low clouds, reduced visibility, icing, and convective activities such as wind shear, squall line, turbulence, thunderstorms and cumulonimbus clouds are especially useful. PIREPs of hazardous conditions may trigger the issuance of significant meteorological information (SIGMET).

For timely distribution, PIREPs should be filed with a flight information centre (FIC) via an en route frequency or a toll-free call to a FIC after landing. PIREPs received by flight service personnel are immediately disseminated on meteorological communications circuits and provided to other air traffic service (ATS) units and the Canadian Meteorological Aviation Centres (CMAC).

Controllers, flight service specialists and community aerodrome radio station (CARS) observer/communicators (O/Cs) may request reports from pilots regarding specific weather conditions or weather conditions encountered during en route, climb-out or approach phases.

The *Canada Flight Supplement (CFS)* contains the toll-free FIC telephone numbers in the Flight Planning entry of each listed aerodrome. The recommended contents of a PIREP are listed

in the Planning section and on the exterior back cover of the CFS (hard copy).

2.1.1 Pilot Weather Report (PIREP) Example

Example:

UACN10 CYXU 032133 YZ UA /OV YXU 090010 /TM 2120 /FL080 /TP PA31 /SK 020BKN040 1100VC /TA -12 /WV 030045 /TB MDT BLO 040 /IC LGT RIME 020-040 /RM NIL TURB CYYZ-CYHM

Table 2.1—PIREP Example

PIREP EXAMPLE	DECODED EXAMPLE
UACN10	<i>Message Type:</i> Regular PIREP. Urgent PIREPs are encoded as UACN01 or UUA.
CYXU	<i>Issuing office:</i> London FIC.
032133	<i>Date/Time of Issue:</i> 3rd day of the month, at 2133Z.
YZ	<i>FIR:</i> Toronto. If the PIREP extends into an adjacent FIR, both FIRs will be indicated.
UA /OV YXU 090010	<i>Location:</i> London VOR 090° radial, 10 NM. PIREP location will be reported with reference to a NAVAID, airport or geographic coordinates (latitude/ longitude).
/TM 2120	<i>Time of PIREP:</i> 2120Z
/FL080	<i>Altitude:</i> 8 000 ft ASL. Altitude may also be reported as "DURD" (during descent), "DURC" (during climb) or "UNKN" (unknown).
/TP PA31	<i>Aircraft Type:</i> Piper Navajo (PA31).
/SK 020BKN 040 1100VC	<i>Sky Cover:</i> First layer of cloud based at 2 000 ft with tops at 4 000 ft ASL. Second layer of cloud based at 11 000 ft ASL.
/TA -12	<i>Air Temperature:</i> -12°C.
/WV 030045	<i>Wind Velocity:</i> Wind direction 030° true, wind speed 45 kt. Wind direction reported by pilots in degrees magnetic will subsequently be converted to degrees true for inclusion in PIREP.
/TB MDT BLO 040	<i>Turbulence:</i> Moderate turbulence below 4 000 ft ASL.
/IC LGT RIME 020-040	<i>Icing:</i> Light rime icing (in cloud) between 2 000 ft ASL and 4 000 ft ASL.
/RM NIL TURB CYYZ-CYHM	<i>Remarks:</i> No turbulence encountered between Toronto and Hamilton.

NOTE:

Supplementary information for any of the PIREP fields may be included in the remarks (RM) section of the PIREP.

2.2 CLEAR AIR TURBULENCE (CAT)

2.2.1 General

CAT remains a problem for flight operations, particularly above 15 000 ft. The best information available on this phenomenon is still obtained from PIREPs, since a CAT forecast is generalized and covers large areas. All pilots encountering CAT conditions are requested to urgently report the time, location, flight level and intensity (light, moderate, severe, or extreme) of the phenomena to the facility with which they are maintaining radio contact. (See the Turbulence Reporting Criteria Table, MET 2.2.2) A more complete description of CAT and recommended pilot actions can be found in AIR 2.10.



2.2.2 Turbulence Reporting Criteria

Table 2.2—Turbulence Reporting Criteria

INTENSITY	AIRCRAFT REACTION	REACTION INSIDE AIRCRAFT
LIGHT	Turbulence that momentarily causes slight, erratic changes in altitude and/or attitude (pitch, roll, yaw). Report as "light turbulence". OR Turbulence that causes slight, rapid and somewhat rhythmic bumpiness without appreciable changes in altitude or attitude. Report as "light chop".	Occupants may feel a slight strain against seat belts or shoulder straps. Unsecured objects may be displaced slightly. Food service may be conducted and little or no difficulty is encountered in walking.
MODERATE	Turbulence that is similar to light turbulence but of greater intensity. Changes in altitude and/or attitude occur but the aircraft remains in positive control at all times. It usually causes variations in indicated airspeed. Report as "moderate turbulence". OR Turbulence that is similar to light chop but of greater intensity. It causes rapid bumps or jolts without appreciable changes in aircraft altitude or attitude. Report as "moderate chop".	Occupants feel definite strains against seat belts or shoulder straps. Unsecured objects are dislodged. Food service and walking are difficult.
SEVERE	Turbulence that causes large, abrupt changes in altitude and/or attitude. It usually causes large variations in indicated airspeed. Aircraft may be momentarily out of control. Report as "severe turbulence".	Occupants are forced violently against seat belts or shoulder straps. Unsecured objects are tossed about. Food service and walking impossible.

The terms "occasional", "intermittent" and "continuous" are used to describe reported turbulence. Turbulence is considered occasional when it occurs less than 1/3 of the time, intermittent when it occurs 1/3 to 2/3 of the time and continuous when it occurs more than 2/3 of the time.

Pilots should report location(s), time (UTC), intensity, whether in or near clouds, altitude, type of aircraft and, when applicable, the duration of turbulence. Duration may be based on time between two locations or over a single location. All locations should be readily identifiable.

Examples:

1. Over REGINA 1232Z, moderate turbulence, in cloud FL310, B737.
2. From 50 NM EAST of WINNIPEG to 30 NM WEST of BRANDON 1210 to 1250Z occasional moderate chop, FL330, AIRBUS 320.

High-level turbulence (normally above 15 000 ft ASL) not associated with cumuliform clouds, including thunderstorms, should be reported as CAT preceded by the appropriate intensity or chop type.

2.3 WIND SHEAR (WS)

Intense down drafts, typically associated with thunderstorms, produce strong vertical and horizontal wind shear (WS) components that are a hazard to aircraft in the approach, landing, or take-off phase of flight (see AIR 2.8). Since ground-based instruments that measure WS have not been installed at Canadian

aerodromes, the presence of such conditions can normally be deduced only from pilot weather reports (PIREPs). Aircraft equipped with Reactive Wind Shear Systems (RWSS) can provide pilots with guidance to conduct a WS escape manoeuvre. Aircraft with Predictive Wind Shear Systems (PWSs) may allow pilots to avoid or minimize effects of WS (see RAC 6.1).

Aircrews capable of reporting the wind and altitude, both above and below the shear layer, from flight management systems (FMSs) are requested to do so. Pilots without this equipment should report WS by stating the loss or gain of airspeed and the altitude at which it was encountered. Pilots unable to report WS in terms of this specific information should do so in terms of its general effect on the aircraft.

2.4 AIRFRAME ICING

Report icing to air traffic service (ATS) and, if operating instrument flight rules (IFR), request a new routing or altitude if icing will be a hazard. Provide the aircraft identification, type, location, time (Coordinated Universal Time [UTC]), intensity of icing, type, altitude or flight level, and indicated airspeed. See the suggested format on the back cover of the *Canada Flight Supplement* (CFS).

The following describes icing and how to report icing conditions:

Table 2.3—Icing Intensity

INTENSITY	ICE ACCUMULATION
Trace	Ice becomes perceptible. The rate of accumulation is slightly greater than the rate of sublimation. It is not hazardous, even though de-icing or anti-icing equipment is not used, unless encountered for an extended period of time (over 1 hr).
Light	The rate of accumulation may create a problem if flight is prolonged in this environment (over 1 hr).
Moderate	The rate of accumulation is such that even short encounters become potentially hazardous, and use of de-icing or anti-icing equipment or diversion is necessary.
Severe	The rate of accumulation is such that de-icing or anti-icing equipment fails to reduce or control the hazard. Immediate diversion is necessary.

Table 2.4—Icing Types

Icing Types	
Rime ice	Rough, milky, opaque ice formed by the instantaneous freezing of small supercooled water droplets.
Clear ice	Glossy, clear, or translucent ice formed by the relatively slow freezing of large supercooled water droplets.
Mixed ice	Both rime and clear icing occurring at the same time.

2.5 VOLCANIC ASH

Flight operations in volcanic ash are hazardous (see AIR 2.6). Pilots may be the first line of volcanic eruption detection in more remote areas. Pilots may be able to provide valuable information about the spread of volcanic ash from an eruption; ash can rapidly rise to altitudes above 60 000 ft and exist at hazardous concentrations up to 1 000 NM from the source. Volcanic ash is not detectable on radar. If an eruption or ash cloud is detected, an urgent pilot weather report (PIREP) should be filed with the nearest air traffic service (ATS) unit.

A volcanic ash forecast chart is produced when required (see MET 13.0).

2.6 PILOT ESTIMATION OF SURFACE WIND

Surface wind direction and speed is information critical to effective pilot decision-making for takeoff and landing. Where neither wind measuring equipment nor a wind direction indicator (see AGA 5.9) is available, the wind direction and speed can be estimated by observing smoke, dust, flags or wind lines on bodies of water.

Pilots on the ground may estimate wind speed and direction by using anything that is free to be moved by the influence of the wind. The descriptions in the Beaufort Wind Scale found in Table 2.5 have been found to be particularly useful and are widely used.

Wind direction can also be estimated accurately by simply facing the wind. Such estimates should only be provided to the nearest eight points (i.e. north, northeast, east) of the compass. The best estimate is obtained by standing in an open area clear of obstructions. Should this not be possible, estimation errors may be so significant that pilots using the information should exercise caution. The direction and speed of low-lying clouds can be an indicator of surface winds but should also be used with caution because of the possibility of wind shear near the surface.

Pilots who relay reports of winds based on estimation should ensure that the intended user of the information is aware that it is based on estimation so that appropriate precautions can be taken.



Table 2.5—Beaufort Wind Scale

Descriptive Term	Beaufort Force	Speed Range (kt)	Average (kt)	Specification for estimating wind over land	Specification for estimating wind over sea (probable wave height in metres*)
Calm	0	Less than 1	—	Smoke rises vertically.	Sea is like a mirror (0).
Light Air	1	1–3	2	Direction of wind shown by smoke.	Ripples with the appearance of scales are formed, but without foam crest (0.1).
Light Breeze	2	4–6	5	Wind felt on face; leaves rustle; ordinary vane moved by wind.	Small wavelets, still short but more pronounced; crests have a glassy appearance and do not break (0.2 to 0.3).
Gentle Breeze	3	7–10	9	Leaves and small twigs in constant motion; wind extends light flag.	Large wavelets; crests begin to break; foam of glassy appearance; perhaps scattered white horses (0.6 to 1).
Moderate Breeze	4	11–16	14	Raises dust and loose paper; small branches are moved.	Small waves becoming longer; fairly frequent white horses (1 to 1.5).
Fresh Breeze	5	17–21	19	Small trees in leaf begin to sway; crested wavelets form on inland waters.	Moderate waves, taking a more pronounced long form; many white horses are formed, chance of some spray (2 to 2.5).
Strong Breeze	6	22–27	25	Large branches in motion; whistling heard in telephone wires; umbrellas used with difficulty.	Large waves begin to form; the white foam crests are more extensive everywhere, probably some spray (3 to 4).
Near Gale	7	28–33	31	Whole trees in motion; inconvenience felt in walking against wind.	Sea heaps up and white foam from breaking waves begins to be blown in streaks along the direction of the wind (4 to 5.5).
Gale	8	34–40	37	Breaks twigs off trees; generally impedes progress.	Moderately high waves of greater length; edges of crests begin to break into the spindrift; the foam is blown in well-marked streaks along the direction of the wind (5.5 to 7.5).
Strong Gale	9	41–47	44	Slight structural damage occurs to roofing shingles, TV antennae, etc.	High waves; dense streaks of foam along the direction of the wind; crests of waves begin to topple, tumble and roll over; spray may affect visibility (7 to 10).
Storm	10	48–55	52	Seldom experienced inland; trees uprooted; considerable structural damage.	Very high waves with long, overhanging crests; the resulting foam, in great patches, is blown in dense white streaks along the direction of the wind; on the whole, the surface of the sea takes on a white appearance; the tumbling of the sea becomes heavy and shock-like; visibility affected (9 to 12.5).
Violent Storm	11	56–63	60	Very rarely experienced; accompanied by widespread damage.	Exceptionally high waves (small- and medium-sized ships might be lost to the view behind the waves); the sea is completely covered with long white patches of foam lying along the direction of the wind; everywhere the edges of the wave crests are blown into froth; visibility affected (11.5 to 16).
Hurricane	12	Above 63			The air is filled with foam and spray; sea completely white with driving spray; visibility seriously affected (16+).

* Wave height is representative of conditions well away from shore and in deep water when winds of that strength have persisted for an extended period of time. The wave height figure does not give the maximum wave height nor does it take into account the effects of swell, air temperature or currents.

3.0 CANADIAN WEATHER INFORMATION

3.1 AVIATION FORECASTS AND CHARTS

Table 3.1—Aviation Forecasts and Charts

ITEM AND TYPE DESIGNATOR	TIME ISSUED	VALIDITY PERIODS	APPLICABLE LEVEL	REMARKS
GFA	Approximately 30 min before the beginning of the forecast period	0000Z, 0600Z, 1200Z, 1800Z. Each new set of GFA charts replaces the preceding one.	At or below 24 000 ft	Graphically depicts forecast weather elements affecting flight at a specific time over a particular area.
TAF	Approximately 20 min before the beginning of the validity period	Forecasts are generally issued every 6 hr with validity periods up to a maximum of 30 hr. Issue and update periods may vary—check the CFS. Next issue time is stated at the end of each TAF.	Surface (includes clouds at levels that can be seen from the surface)	The TAF is the forecaster's best judgment of the most probable weather conditions expected to occur at an aerodrome, together with their most probable time of occurrence. It is designed to meet the pre-flight and in-flight requirements of flight operations. TAFs are intended to relate to weather conditions for flight operations within 5 NM of the centre of the runway complex, depending on local terrain.
Amended Forecast	Forecasts will be amended when significant changes in ceiling or visibility occur, or when freezing precipitation begins, or is expected to occur, although it was not previously predicted. Amendments are also issued for significant changes in wind or present weather.			
SIGMET (WSCN, WCCN, WVCN)	A message issued by a MWO to advise pilots of the occurrence or expected occurrence of specified weather phenomena, which may affect the safety of aircraft operations, and the development of those phenomena in time and space.			
Upper Level Wind and Temperature Forecast (FD)	0330Z*	0500Z–0900Z	3 000 ft	Predicts upper winds and temperatures in numerical form at standard levels for a given time period and location.
	0330Z*	0900Z–1800Z	6 000 ft	
	0330Z*	1800Z–0500Z	9 000 ft	Upper level wind and temperature forecasts are issued by WAFCs.
	1530Z**	1700Z–2100Z	12 000 ft	
	1530Z**	2100Z–0600Z	18 000 ft	
	1530Z**	0600Z–1700Z		
	0200Z	0500Z–0900Z	24 000 ft	
	0200Z	0900Z–1800Z	30 000 ft	
	0200Z	1800Z–0500Z	34 000 ft	
	1400Z	1700Z–2100Z	39 000 ft	
	1400Z	2100Z–0600Z	45 000 ft	
	1400Z	0600Z–1700Z	53 000 ft	
	1400Z			
Upper Level Forecast Chart –PROG	12 hr before valid time	0000Z 0600Z 1200Z 1800Z	FL 240 FL 340 FL 390 FL 450	Depicts forecast wind and temperatures for the chart level.
Significant Weather Forecast Chart –PROG	12 hr before valid time	0000Z 0600Z 1200Z 1800Z	FL 100–FL 240 FL 250–FL 630	Charts are for a specific flight level range. They indicate surface positions of lows and highs and any significant weather, such as thunderstorms, turbulence and mountain waves, applicable to the chart.

* Based on upper atmosphere observations taken at 000Z.

** Based on upper atmosphere observations taken at 1200Z.

MET

Table 3.2—Upper Level Wind and Temperature Forecasts Issued as FB

OBSERVATION TIME (UTC)	APPROXIMATE ISSUE TIME (UTC)	VALID TIME (UTC)	PERIOD OF USE (UTC)
0000	0320	0600	0200–0900
0000	0330	1200	0900–1800
0000	0330	0000	1800–0600
0600	0920	1200	0800–1500
0600	0930	1800	1500–0000
0600	0930	0600	0000–1200
1200	1520	1800	1400–2100
1200	1530	0000	2100–0600
1200	1530	1200	0600–1800
1800	2120	0000	2000–0300
1800	2130	0600	0300–1200
1800	2130	1800	1200–0000

3.2 AVIATION WEATHER REPORTS

Table 3.3—Aviation Weather Reports

ITEM AND TYPE DESIGNATOR	TIME OBSERVED	REMARKS
METAR	Every hour on the hour	Describes actual weather at a specific location and at a specific time as observed from the ground. SPECIs are issued when required. METARs are not available 24 hr a day at all aerodromes; see CFS for observation program schedule.
PIREP/URGENT PIREP (UA/UUA)	As reported	Observations of actual conditions reported by pilots during flight.
Volcanic Ash Report (FV)	As required	Describes in graphical format the current and expected ash cloud dispersion and densities at various flight levels.

3.3 WEATHER CHARTS

The international practice is to label the levels in upper level weather charts in hectopascals (hPa) rather than millibars (mb) and this will be increasingly adopted in Canada. Note, however, that 1 mb equals 1 hPa.

Table 3.4—Weather Charts

ITEM AND TYPE DESIGNATOR	TIME OBSERVED	TIME ISSUED	REMARKS
Surface Weather Chart	0000Z 0600Z 1200Z 1800Z	2 or 3 hr after observation	Analysis of mean sea level pressure pattern, surface location of fronts, surface precipitation and obstructions to vision based on reports. Surface pressure patterns can be considered as representative of the atmosphere up to 3 000 ft. Weather visible from the surface at any level is included.
Upper Level Chart—ANAL	0000Z 1200Z	Over 3 hr after observation	Charts prepared for following levels: 850 hPa (1 500 m / 5 000 ft) 700 hPa (3 000 m / 10 000 ft) 500 hPa (5 500 m / 18 000 ft) 250 hPa (10 400 m / 34 000 ft) Charts show reported atmospheric conditions at the pressure levels, such as wind speed and direction, temperatures, and moisture content.

MET

4.0 GRAPHIC AREA FORECASTS (GFA)

4.1 GENERAL

The graphic area forecast (GFA) consists of a series of temporally adjusted weather charts, each depicting the most probable meteorological conditions expected to occur at or below 24 000 ft over a given area at a specified time. The GFA is primarily designed to meet general aviation and regional airline requirements for pre-flight planning in Canada.

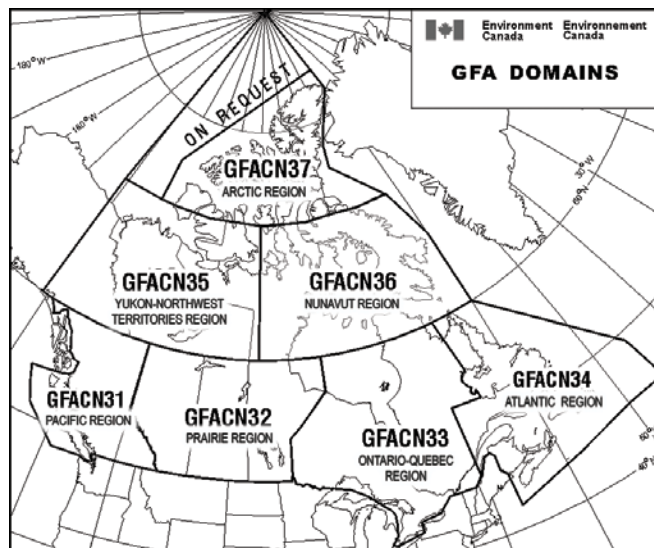
4.2 ISSUE AND VALID TIMES

Graphic area forecast (GFA) charts are issued four times daily, approximately 30 min before the beginning of the forecast period. The GFA is issued at approximately 2330, 0530, 1130 and 1730 UTC and is valid at 0000, 0600, 1200 and 1800 UTC respectively. Each issue of the GFA consists of six charts: two charts valid at the beginning of the forecast period; two charts valid six hours into the forecast period; and the final two charts valid twelve hours into the forecast period. Of the two charts valid at each of the three forecast periods, one chart depicts clouds and weather while the other chart depicts icing, turbulence and freezing level. An instrument flight rules (IFR) outlook for an additional 12-hr period is also included in the comments box of the final clouds and weather chart.

4.3 COVERAGE AREA

There are seven distinct graphic area forecast (GFA) areas, covering the entire Canadian domestic airspace (CDA), over which Canada is responsible for the provision of air traffic control (ATC) services. The following map illustrates the GFA coverage areas.

Figure 4.1—GFA Coverage Areas



4.4 UNITS OF MEASURE

Speeds in the graphic area forecast (GFA) are expressed in knots and heights in hundreds of feet. Horizontal visibility is measured in statute miles and all times are stated in Coordinated Universal Time. A nautical mile scale bar is included to assist in determining approximate distances on the chart. All heights are measured ASL unless otherwise noted.

4.5 ABBREVIATIONS AND SYMBOLS

Only standard meteorological abbreviations are used in the graphic area forecast (GFA). Symbols used in the GFA are consistent with those found on similar meteorological products described in this document such as significant weather prognostic charts (MET 12.0).

4.6 LAYOUT

Each graphic area forecast (GFA) chart is divided into four parts: title box; legend box; comments box; and weather information section.

Table 4.1—GFA Layout

Weather Information Section	Title Box
	Legend Box
	Comments Box

4.7 TITLE BOX

The title box includes the chart name; the issuing office four-letter identification; the name of the graphic area forecast (GFA) region; the chart type; the date and time of issue; and the valid date and time of the chart. The title box is found in the upper right corner of the GFA.

In the following example, the title box indicates the GFA name (GFACN33) and that it is issued by Canadian Meteorological Centre Network Operations in Montréal (CWAO). The GFA region for the sample chart is ONTARIO–QUÉBEC and the type of chart is clouds and weather. The next section indicates the date and time the GFA chart was issued, which was September 17, 2014, at 1130Z. The last section states the valid date and time for the GFA chart which, in this example, was September 18, 2014, at 0000Z.

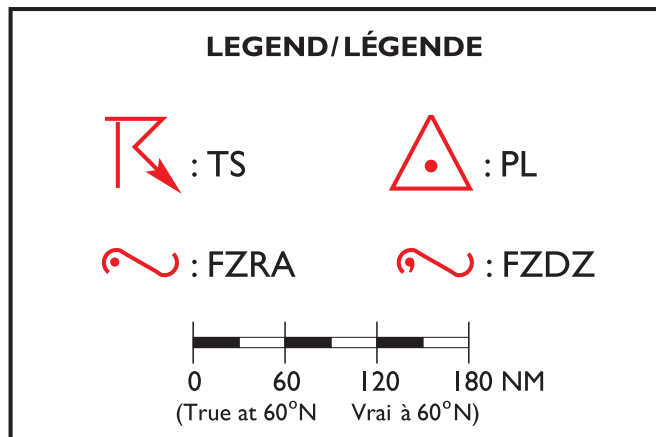
Table 4.2—GFA Title Box

GFACN33 CWAO REGION ONTARIO–QUÉBEC CLOUDS AND WEATHER NUAGES ET TEMPS	
ISSUED AT ÉMIS A	17/09/2014 1130Z
VLD	18/09/2014 0000Z

4.8 LEGEND BOX

The legend box includes weather symbols that may be used in the weather information part of the graphic area forecast (GFA) chart. It also includes a nautical mile scale bar to facilitate the determination of distances. Symbols used in the GFA are consistent with those used in a significant weather prognostic chart. In the following example, symbols for thunderstorm (TS), ice pellets (PL), freezing rain (FZRA) and freezing drizzle (FZDZ) are indicated in the legend box. These symbols are depicted in red when shown in colour.


Figure 4.2—GFA Legend Box



4.9 COMMENTS BOX

The comments box provides information that the weather forecaster considers important (e.g. formation or dissipation of fog, increasing or decreasing visibility). It is also used to describe elements that are difficult to render pictorially or, if added to the depiction, would cause the chart to become cluttered (e.g. light icing). The standard phrases “HGTS ASL UNLESS NOTED” and “CB TCU AND ACC IMPLY SIG TURBC AND ICG. CB IMPLIES LLWS” are also included in the comments box.

Figure 4.3—GFA Comments Box

COMMENTS/COMMENTAIRES	
1. FG/BR DS IPTG AFT 14Z	
2. CIGS BECMG SCT AFT 15Z	
HGTS ASL UNLESS NOTED CB TCU AND ACC IMPLY SIG TURBC AND ICG. CB IMPLIES LLWS	
 Environment Canada Environnement Canada	
IFR OTLK	
IFR CIGS/RA/BR S STLAWRC VLY. LCL IFR IN ONSHR/UPSPL NWLY FLO OFF JMSBA AND HSNBA.	

MET

In this example, the forecaster has added two comments. The first indicates that the fog/mist will dissipate after 1400 UTC. The second comment advises that ceilings will become scattered after 1500 UTC.

The comments box of the 12-hr clouds and weather graphic area forecast (GFA) chart also includes an instrument flight rules (IFR) outlook for an additional 12-hr period in the lower section of the box. The IFR outlook is always general in nature, indicating the main areas where IFR weather is expected, the cause for the IFR weather and any associated weather hazards. In the example given, IFR conditions caused by low ceilings (CIG), rain (RA) and mist (BR) south of the St. Lawrence Valley are forecast. Also, local IFR conditions are forecast because of an onshore (ONSHR) and upslope (UPSLP) northwesterly flow of air from James Bay (JAMSBA) and Hudson's Bay (HSNBA).

For meteorological purposes, the IFR outlook is based on the following.

Table 4.3—IFR Outlook Criteria

CATEGORY	CEILING	VISIBILITY
IFR	less than 1 000 ft AGL	and/or less than 3 SM
MVFR	between 1 000 ft and 3 000 ft AGL	and/or between 3 and 5 SM
VFR	more than 3 000 ft AGL	and more than 5 SM

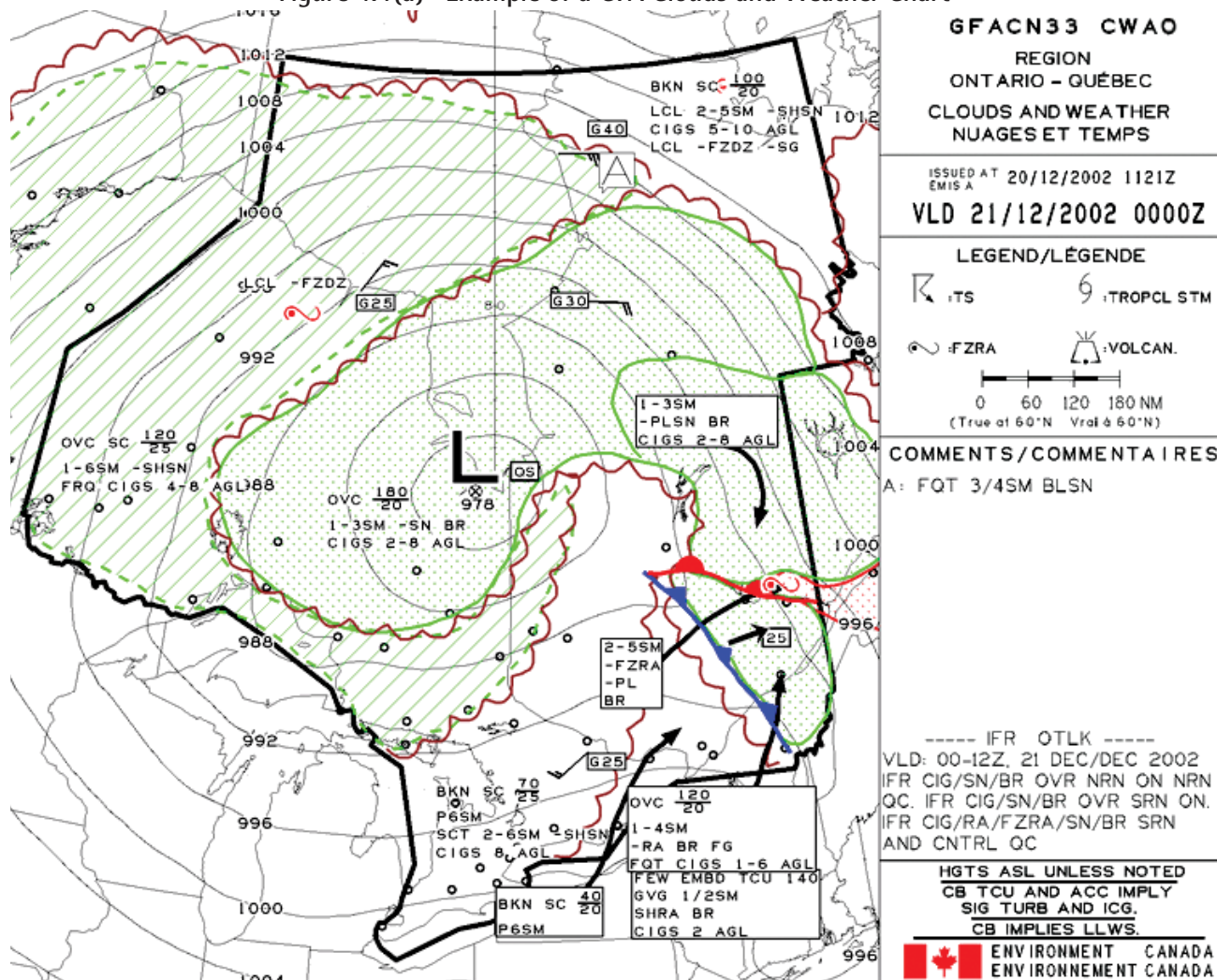
In the event that no organized IFR conditions are expected in the outlook period, NIL SIG WX is written in the comment box. Only IFR conditions are included in the IFR outlook of the GFA. Marginal visual flight rules (MVFR) conditions are defined in the table for reference only.

4.10 WEATHER INFORMATION

The weather information part of the chart depicts either a forecast of the clouds and weather conditions or a forecast of the icing, turbulence and freezing level conditions for a specified time.

4.11 CLOUDS AND WEATHER CHART

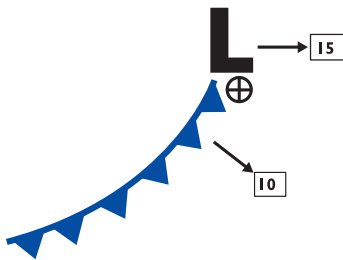
Figure 4.4(a)—Example of a GFA Clouds and Weather Chart



The graphic area forecast (GFA) clouds and weather chart provides a forecast of cloud layers and/or surface-based phenomena, visibility, weather and obstructions to vision at the valid time indicated. Lines joining points of equal surface pressure (isobars) are depicted at 4-hPa intervals. In addition, relevant synoptic features that are responsible for the portrayed weather are also depicted, with an indication of their speed and direction of movement at the valid time.

- a) *Synoptic features*—The motion of synoptic features when the speed of movement is forecast to be 5 kt or more will be indicated by an arrow and a speed value. For speeds less than 5 kt, the letters QS (quasi-stationary) are used. A low-pressure centre moving eastward at 15 kt with an associated cold front moving southeast at 10 kt would be indicated as follows:

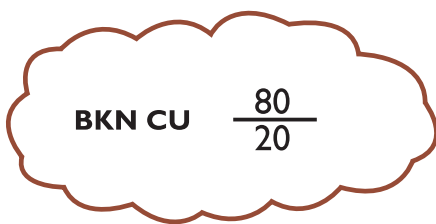
Figure 4.4(b)—Synoptic Features



- b) *Clouds*—The bases and tops of forecast clouds between the surface and 24 000 ft ASL will be indicated on the GFA clouds and weather chart. The tops of convective clouds (i.e. TCU, ACC, CB) are indicated, even if they extend above 24 000 ft ASL. Cirrus clouds are not depicted on the chart. The cloud type will be indicated if considered significant; however, convective clouds, such as CU, TCU, ACC and CB, will always be stated if forecast to be present.

A scalloped border, depicted in brown when shown in colour, encloses organized areas of clouds where the sky condition is either broken (BKN) or overcast (OVC). An organized area of broken cumulus clouds based at 2 000 ft ASL with tops at 8 000 ft ASL would be indicated as follows:

Figure 4.4(c)—Organized Area of Clouds (scalloped border)



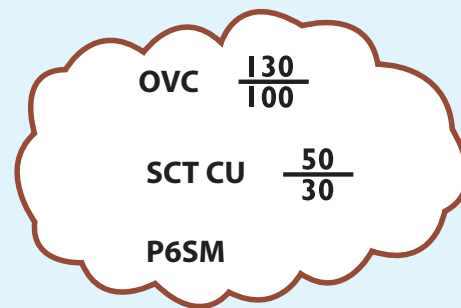
Where organized areas of clouds are not forecast and visibility is expected to be greater than 6 SM, a scalloped border is not used. In these areas, the sky condition is stated using the terms SKC, FEW or SCT. In the following example, unorganized scattered clouds are forecast based at 3 000 ft ASL with tops at 5 000 ft ASL:

Figure 4.4(d)—Unorganized Area of Clouds (no scalloped border)

SCT $\frac{50}{30}$

When a forecasted cloud deck contains more than one significant cloud layer, the cloud amount description depends on the space between the layers. When the separation is less than 2 000 ft, the descriptor represents the summation amount across all the layers, and the term LYRS is included immediately after it. When the separation is 2 000 ft or greater, each layer is stated, with its own descriptor that applies only to that layer. The bases and tops of each layer are indicated. For instance, a scattered layer of cumulus cloud based at 3 000 ft ASL with tops at 5 000 ft ASL and a higher overcast layer of cloud based at 10 000 ft ASL with tops at 13 000 ft ASL would be indicated as follows:

Figure 4.4(e)—Multiple Cloud Layers



All heights are indicated in hundreds of feet above sea level (2 means 200 ft, 45 means 4 500 ft, etc.) unless otherwise specified. Above ground level heights are indicated by the abbreviations CIG and AGL (e.g. CIGS 5–10 AGL). A note to this effect is included in the comments box in the lower right hand corner of the chart.

- c) *Surface-based layers*—The vertical visibility into surface-based layers is measured in hundreds of feet AGL. Local obscured ceilings with a vertical visibility of between 300 and 500 ft AGL would be indicated as follows:

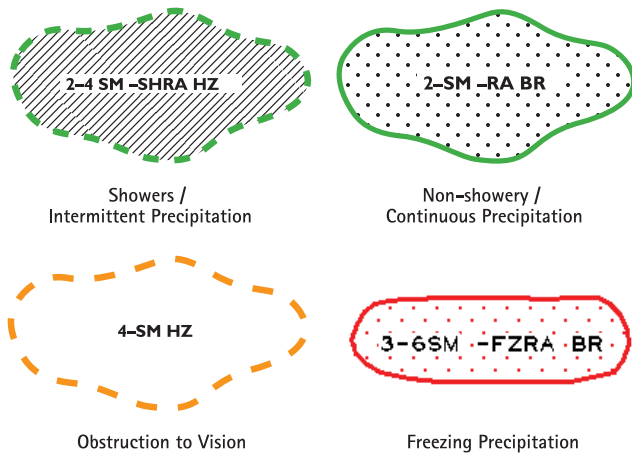
LCL CIGS 3–5 AGL

- d) *Visibility*—The forecast visibility is measured in statute miles. When the visibility is expected to be greater than 6 SM, it is indicated as P6SM. A forecast visibility that is expected to vary between 2 and 4 SM with light rain showers would be indicated as:

2–4SM -SHRA

e) *Weather and obstructions to vision*—Forecast weather is always included immediately after visibility. Obstructions to vision are only mentioned when visibility is forecast to be 6 SM or less (e.g. 2–4SM –RA BR). Only standard abbreviations are used to describe weather and obstructions to vision. Areas of showery or intermittent precipitation are shown as hatched areas enclosed by a dashed green line when colour is used. Areas of continuous precipitation are shown as stippled areas enclosed by a solid green line when colour is used. Areas of obstruction to vision not associated with precipitation, where visibility is 6 SM or less, are enclosed by a dashed orange line when colour is used. Areas of freezing precipitation are depicted in red and enclosed by a solid red line when colour is used.

Figure 4.4(f)—Weather and Obstructions to Vision



Weather and obstructions to vision in the GFA may include spatial qualifiers, which describe the coverage of the depicted meteorological phenomena.

Convective clouds and showers:

Table 4.4—Convective Clouds and Showers

Abbreviation	Description	Spatial Coverage
ISOLD	Isolated	25% or less
OCNL	Occasional	26–50%
FRQ	Frequent	Greater than 50%

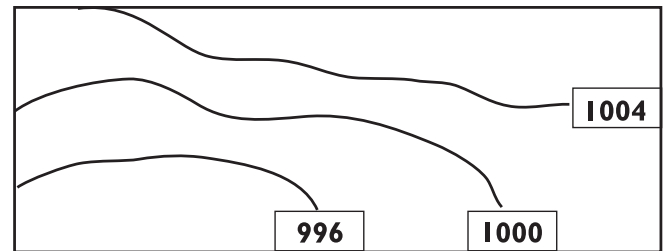
Non-convective clouds and precipitation, low stratus ceilings, precipitation ceilings, icing, turbulence, and restrictions to visibility:

Table 4.5—Non Convective Clouds and Precipitation

Abbreviation	Description	Spatial Coverage
LCL	Local	25% or less
PTCHY	Patchy	26–50%
XTNSV	Extensive	Greater than 50%

f) *Isobars*—These lines joining points of equal mean sea level pressure are depicted on the GFA clouds and weather chart. Isobars are drawn at 4-hPa intervals from a reference value of 1 000 hPa.

Figure 4.4(g)—Isobars



g) *Surface winds*—The speed and direction of forecast surface winds with a sustained speed of at least 20 kt are indicated by wind barbs and an associated wind-speed value. When accompanied by strong gusts, mean sustained winds of less than 20 kt may also be included, at the forecaster’s discretion, if moderate mechanical turbulence is expected to occur as a result of the wind gusts. Wind gusts are indicated by the letter “G,” followed by the peak gust speed in knots. In the following example, the surface wind is forecast to be from the west (270° true) with a speed of 25 kt and a peak gust speed of 35 kt.

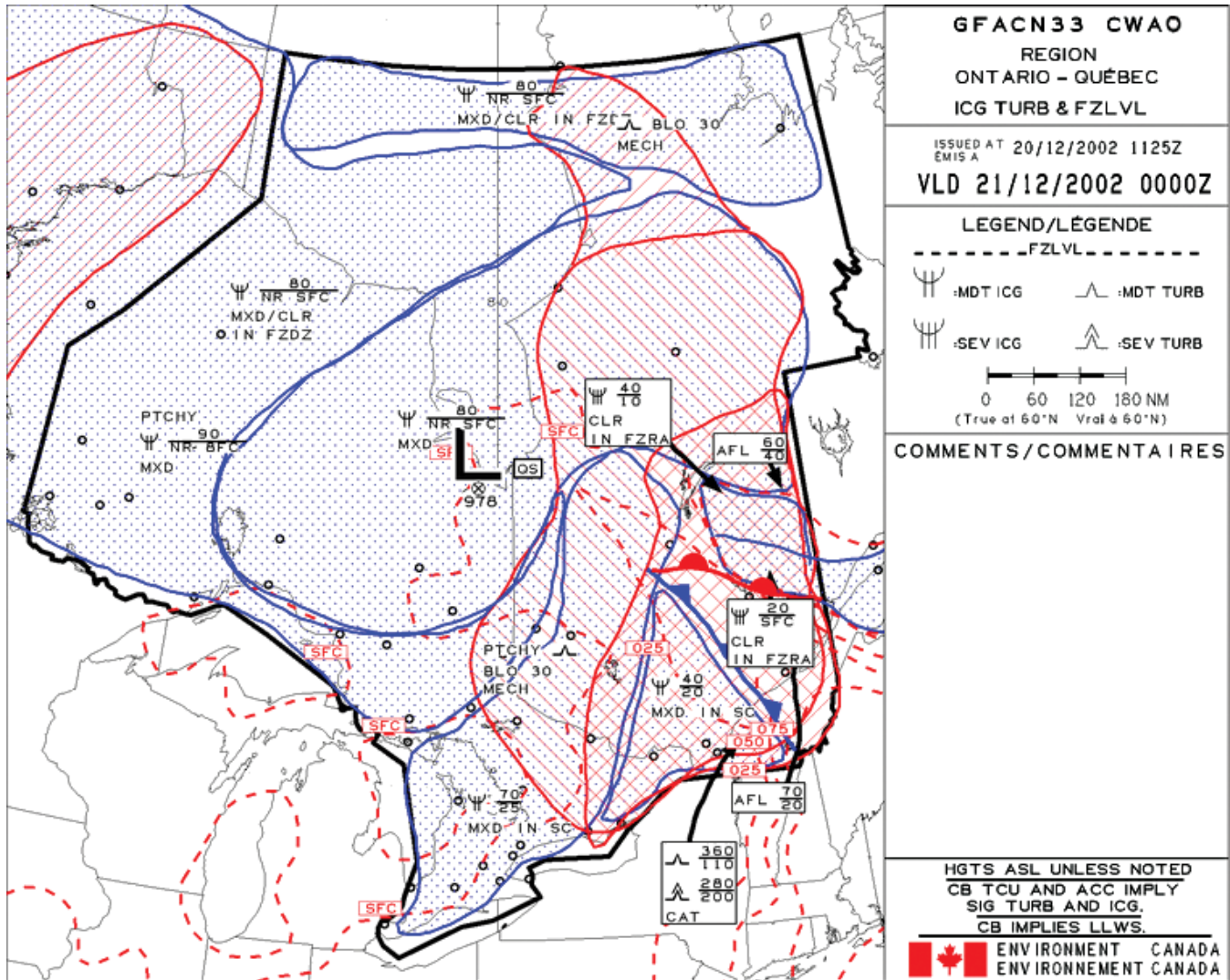
Figure 4.4(h)—Surface Winds



MET

4.12 ICING, TURBULENCE AND FREEZING LEVEL CHART

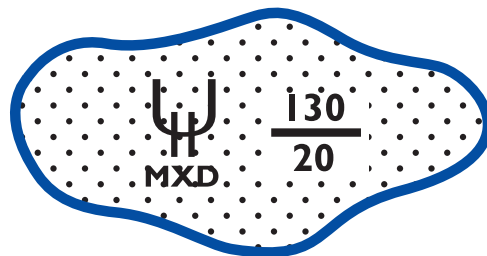
Figure 4.5(a)—Example of a GFA Icing Turbulence and Freezing Level Chart



The graphic area forecast (GFA) icing, turbulence and freezing level chart depicts forecast areas of icing and turbulence as well as the expected freezing level at a specific time. Included on the chart are the type, intensity, bases and tops of each icing and turbulence area. Surface synoptic features such as fronts and pressure centres are also shown. This chart is to be used in conjunction with the associated GFA clouds and weather chart issued for the same period of validity.

2 000 ft ASL with a top of 13 000 ft ASL would be indicated as follows:

Figure 4.5(b)—Icing

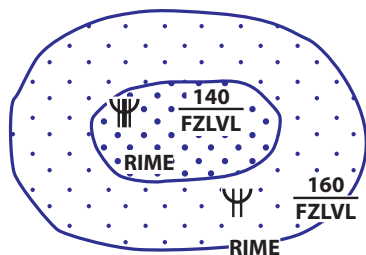


- a) *Icing*—Depicted in blue when shown in colour and indicated whenever moderate or severe icing is forecast for the coverage area. The bases and tops of each icing layer, measured in hundreds of feet above mean sea level, as well as the type of icing (e.g. “RIME”, “MXD” [mixed], “CLR” [clear]) will be indicated. Areas of light icing are described in the comments box. An area of moderate mixed icing based at

If icing is expected to be present during only part of the forecast period covered by the chart, the time of occurrence of the icing is indicated in the comments box.

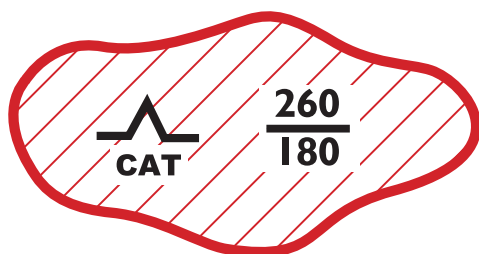
Areas of severe icing are indicated with a denser stippling. The following is an example of an area of severe icing contained within an area of moderate icing:

Figure 4.5(c)—Severe Icing



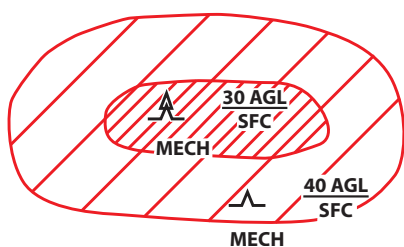
- b) **Turbulence**—Depicted in red when shown in colour and indicated whenever moderate or severe turbulence is forecast for the coverage area. The base and top of each turbulence layer is measured in hundreds of feet above sea level except for surface-based turbulence, which is measured in feet above ground level. An abbreviation indicating the cause of the turbulence will be included. Turbulence due to mechanical turbulence, low-level wind shear, lee/mountain waves, a significant low-level jet or in clear air will be indicated as MECH, LLWS, LEE WV, LLJ or CAT, respectively. The following example indicates an area of moderate clear air turbulence (CAT) based at 18 000 ft ASL with a top at 26 000 ft ASL.

Figure 4.5(d)—Turbulence



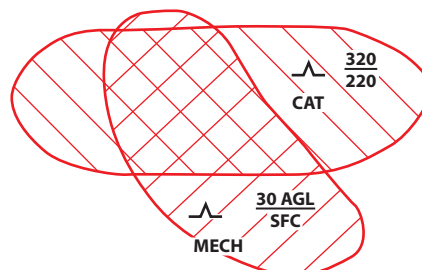
Severe turbulence is depicted with a higher density of hatching. The following example shows an area of severe turbulence surrounded by a larger area of moderate turbulence:

Figure 4.5(e)—Severe and Moderate Turbulence



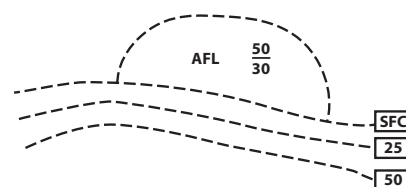
When separate areas of turbulence are occurring at different altitudes, the lower level is shown with hatching that slants upward to the right, while the higher level is depicted with hatching that slants downward to the right, as indicated below:

Figure 4.5(f)—Areas of Turbulence at Different Altitudes



- c) **Freezing level**—Freezing level contours are indicated on a GFA by dashed lines. The height of the freezing level is indicated to the nearest multiple of 2 500 ft using the standard heights in hundreds of feet above sea level (e.g. SFC, 25, 50, 75, 100, meaning surface, 2 500, 5 000, 7 500, 10 000). When more than one freezing level is forecast, only the lowest level needs to be indicated, unless meteorological conditions are expected to be relevant to aviation safety (e.g. freezing precipitation aloft). An above freezing layer (AFL) is indicated by a closed area as shown below:

Figure 4.5(g)—Freezing Level

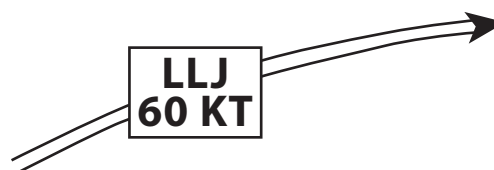


Temporal changes in the freezing level, when significant, are indicated in the comments box of the chart, as in the following example:

FZLVL 20 LWRG TO SFC AFT 03Z

- d) **Low-level jet (LLJ)**—Included on the GFA icing, turbulence and freezing level chart when it is expected to have a peak core speed of 50 kt or more. It may be included at speeds between 35 and 45 kt when significant associated turbulence or shear is expected. An LLJ is depicted as follows, with the wind being in the direction of the arrow and the speed shown being the maximum expected wind speed:

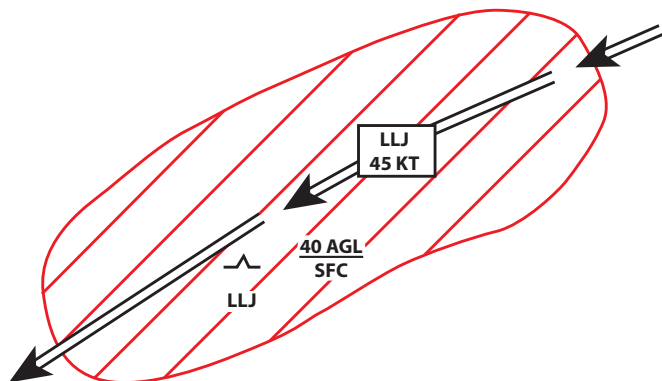
Figure 4.5(h)—LLJ



MET

In general, LLJs are not included if they are above 6 000 ft ASL, except as required over higher terrain. The height of the jet is not indicated. In many cases, there may be associated turbulence, as shown in the example below:

Figure 4.5(i)—LLJ and Turbulence



When reissued, the correction code “CCA” is added to the first line of the title box to indicate the first correction, “CCB” for the second, “CCC” for the third, etc.

Table 4.6—Example of Corrected GFA

GFACN33 CWAO CCA		
REGION		
ONTARIO-QUÉBEC		
CLOUDS AND WEATHER		
NUAGES ET TEMPS		
ISSUED AT	17/09/2014 1211Z	
ÉMIS A	17/09/2014 1200Z	
VLD	17/09/2014 1200Z	

4.13 GRAPHIC AREA FORECAST (GFA) AMENDMENTS

Once issued, a significant meteorological information (SIGMET) or AIRMET message automatically amends the current and relevant graphic area forecast (GFA). The remark (RMK) found in the national version of those messages indicates the GFA region(s) to which the SIGMET or AIRMET applies.

4.14 GRAPHIC AREA FORECAST (GFA) CORRECTIONS

A correction to a graphic area forecast (GFA) is issued for the following events:

- a) The occurrence of any unforecast weather phenomena that do not require an AIRMET (i.e. they are below the AIRMET criteria threshold) or any other unforecast weather phenomena that, according to the forecaster, should be depicted in the GFA.
- b) Forecast weather phenomena in the GFA fail to occur, in which case the weather phenomena that are no longer occurring or no longer expected to occur are removed.
- c) A significant error was made in a GFA chart. A significant error is one which, if uncorrected, would result in an erroneous interpretation of the GFA and create a potential hazard to aviation.

For detailed guidance on GFA correction, refer to Appendix C of the *Manual of Standards and Procedures for Aviation Weather Forecasts* (MANAIR). Information about the nature of the correction made to the chart is included in the comments box.

5.0 AIRMETs

5.1 DEFINITION

An information message issued by a meteorological watch office (MWO) to advise pilots of the occurrence or expected occurrence of weather phenomena, which may affect the safety of aircraft operations and which were not already included in the graphic area forecast (GFA). The message shall describe potentially hazardous weather conditions up to and including 24 000 ft (FL 240).

5.2 ISSUANCE CRITERIA

AIRMETs are issued when the following criteria occur or are expected to occur and were not forecast in the graphic area forecast (GFA) and a significant meteorological information (SIGMET) message is not warranted. The abbreviations shown in all capitals will be used as described below.

- a) *Surface wind speed*: Widespread mean surface wind speed above 30 kt is indicated by SFC WND SPD (along with details of the wind speed or wind speed range and units).
- b) *Surface visibility and/or cloud*:
 - (i) Widespread areas affected by reduced visibility of less than 3 SM (5 000 m), including weather phenomena causing reduced visibility indicated by SFC VIS (along with details of the visibility or visibility range and the weather phenomena or combinations thereof);
 - (ii) Widespread areas of broken or overcast cloud with height of base less than 1 000 ft (300 m) AGL indicated by BKN CLD or OVC CLD (along with details of the height or height range of the base, top and units).

MET

- c) *Thunderstorms and/or towering cumulus:*
 - (i) Isolated thunderstorms (ISOLD TS);
 - (ii) Occasional thunderstorms (OCNL TS);
 - (iii) Isolated thunderstorm with hail (ISOLD TSGR);
 - (iv) Occasional thunderstorms with hail (OCNL TSGR);
 - (v) Isolated towering cumulus (ISOLD TCU);
 - (vi) Occasional towering cumulus (OCNL TCU);
 - (vii) Frequent towering cumulus (FRQ TCU);
 - (viii) Occasional towering cumulus and isolated thunderstorms (OCNL TCU ISOLD TS);
 - (ix) Frequent towering cumulus and isolated thunderstorms (FRQ TCU ISOLD TS);
 - (x) Occasional towering cumulus and isolated thunderstorms with hail (OCNL TCU ISOLD TS GR);
 - (xi) Frequent towering cumulus and isolated thunderstorms with hail (FRQ TCU ISOLD TSGR).
- d) *Turbulence*—moderate turbulence (except for turbulence in convective clouds) (MDT TURB).
- e) *Icing*—moderate icing (except for icing in convective clouds) (MDT ICG).
- f) *Mountain wave*—moderate mountain wave (MDT MTW).

An AIRMET will be issued for only one of these criteria at any time. If more than one criterion occurs then more than one AIRMET will be issued.

An isolated (ISOLD) phenomenon consists of individual features which affect, or are forecast to affect, an area with a maximum spatial coverage of 25% or less of the area concerned (at a fixed time or during the period of validity).

An occasional (OCNL) phenomenon consists of well separated features which affect, or are forecast to affect, an area with a maximum spatial coverage of 26% to 50% of the area concerned (at a fixed time or during the period of validity).

Frequent (FRQ) coverage indicates an area of towering cumulus (TCU) within which there is little or no separation between adjacent clouds and with a maximum spatial coverage greater than 50% of the area affected, or forecast to be affected, by the phenomenon (at a fixed time or during the period of validity).

5.3 COORDINATE POINTS

The International Civil Aviation Organization (ICAO) AIRMET message describes a coordinate point using only latitude and longitude.

The national AIRMET message describes a coordinate point using latitude and longitude. In addition, an equivalent description is given in terms of direction and distance from an aviation reference site.

There are two exceptions to this rule for the national AIRMET:

- a) Any coordinate point located within Gander Oceanic flight information region (FIR) will be described in latitude and longitude only.
- b) Any coordinate point north of N72°00' will be described with respect to an aviation reference site only if it is within a 90-NM radius of that site. Otherwise, the coordinate point will be represented in latitude and longitude only. This is due to the sparse number of aviation reference sites in northern Canada.

The usable reference points are a subset of aerodromes listed in the *Canada Flight Supplement* (CFS). A complete list is included in the *Manual of Standards and Procedures for Aviation Weather Forecasts* (MANAIR).

5.4 RULES FOR THE USE OF LETTERS

All eight flight information regions (FIRs) share 25 letters of the alphabet (T is used only for tests).

The letter used cannot currently be in service in any other FIR and has to have been retired for a minimum of 24 hr. Otherwise the next letter is used. In addition, the same letter cannot be used for widely separated occurrences of the same phenomenon, even within a single FIR.

The letter Z will wrap back to A if necessary.

If all letters are unavailable, the letter that has had the longest retirement will be re-used.

The letter attributed to a bulletin will not change during its lifespan (updates and cancellation).

AIRMET messages do not share the same alphabet with WS (SIGMET). The letter A may be used simultaneously in both a WS (or WC or WV) and a WA.

5.5 RULES FOR THE USE OF NUMBERS

- a) Numbering of an event (as defined by the unique use of a letter in a flight information region (FIR) begins at 1 (i.e. B1).
- b) The number is incremented by 1 when updating a message, including cancellation.
- c) The sequence number shall correspond with the number of messages issued for an event within a FIR since 0000Z on the day concerned.
- d) The numbering is thus reset at 0000Z (messages are not updated at 0000Z for the sole purpose of resetting the number).

5.6 VALIDITY

The period of validity of an AIRMET is 4 hr and it may be issued up to 4 hr prior to the start of the validity period (i.e. expected time of occurrence of the phenomenon).

In the case of an AIRMET for an ongoing phenomenon, the date/time group indicating the start of the AIRMET period will be rounded back to 5 min from the filing time (date/time group in the World Meteorological Organization (WMO) heading).

In the case of an AIRMET for an expected phenomenon (forecast event), the beginning of the validity period will be the time of the expected commencement (occurrence) of the phenomenon.

An AIRMET for an expected phenomenon (forecast event) is issued only for the first appearance of that event in Canadian airspace (e.g. moving in from the USA or onset inside a Canadian flight information region (FIR). A phenomenon moving from one Canadian FIR to another is treated as an ongoing phenomenon. No forecast event AIRMET messages would be sent for the second FIR.

5.7 LOCATION OF THE PHENOMENON

The location of the phenomenon is depicted as an area using coordinate points. The description always begins with the abbreviation WTN (within) and the area can be described as a circle, a line or a polygon. Distances are in nautical miles and direction is to one of the eight points of compass (octants).

5.7.1 Circle

Example:

ICAO

WTN 45 NM OF N4643 W07345

National

WTN 45 NM OF /N4643 W07345/75 N CYUL

Plain language explanation of the national format: Within 45 NM of a point, with specified latitude and longitude, that is 75 NM north of Montréal/Pierre Elliott Trudeau International Airport.

5.7.2 Line

Example:

ICAO

WTN 45 NM OF LINE N4459 W07304 – N4855 W07253 – N5256 W06904

National

WTN 45 NM OF LINE /N4459 W07304/45 SE CYUL – /N4855 W07253/30 NW CYRJ – /N5256 W06904/75 W CYWK

Plain language explanation of the national format: Within 45 NM of a line from a point 45 NM southeast of Montréal/Pierre Elliott Trudeau International Airport to a point 30 NM northwest of Roberval Airport, followed by a point 75 NM west of Wabush Airport with the latitude and longitude of each point being specified.

5.7.3 Polygon

Example:

ICAO

WTN N4502 W07345 – N4907
W07331 – N5345 W06943 – N5256
W06758 – N4848 W07149 – N4508
W07206 – N4502 W07345

National

WTN /N4502 W07345/25 SW CYUL – /N4907 W07331/60 SE
CYMT – /N5345
W06943/150 E CYAH – /N5256 W06758/45 W CYWK – /
N4848 W07149/25 NE CYRJ – /N4508 W07206/25 SW
CYSC – /N4502 W07345/25 SW CYUL

Plain language explanation of the national format: Within an area bounded by points that are 25 NM southwest of Montréal/Pierre Elliott Trudeau International Airport; 60 NM southeast of Chibougamau/Chapais Airport; 150 NM east of La Grande-4 Airport; 45 NM west of Wabush Airport; 25 NM northeast of Roberval Airport and 25 NM southwest of Sherbrooke, then back to a point 25 NM southwest of Montréal/Pierre Elliott Trudeau International Airport. The latitude and longitude of each point being specified.

NOTE:

The polygon must be closed. The last coordinate is a repeat of the first one.

5.8 FLIGHT LEVEL AND EXTENT

The location and extent of the phenomenon in the vertical is given by one or more of the following:

- Reporting a layer (FL<nnn/nnn>), where the lower level is reported first; this is used particularly in reporting turbulence and icing.
- Reporting a layer with reference to one FL and the surface (SFC).
- Reporting the level of the tops of the thunderstorm (TS) and/or towering cumulus (TCU) clouds using the abbreviation TOP.

5.9 MOVEMENT OR EXPECTED MOVEMENT

Direction of movement is given with reference to one of the 16 points of compass (radials). Speed is given in knots. The abbreviation QS (quasi stationary) is used if no significant movement is expected.

5.10 CHANGE IN INTENSITY

The expected evolution of a phenomenon’s intensity is indicated by one of the following abbreviations:

- a) *INTSFYG*—intensifying;
- b) *WKNG*—weakening;
- c) *NC*—no change.

5.11 REMARK

The remark (RMK) is found only in the national AIRMET message. It begins on a new line. The purpose is to allow additional information of national interest to be conveyed in the AIRMET message. Items listed in the remark line will be separated by a forward slash (/).The remark always includes the graphic area forecast (GFA) region(s) to which the AIRMET applies (see Example 1 in MET 5.16). The remark may also include:

- a) Cross-references to AIRMET messages when a phenomenon straddles one or several flight information region (FIR) boundaries (see Example 1 in MET 5.16).
- b) For a phenomenon that has moved out of a flight information region (FIR), the cancelled AIRMET message will refer to the continuing AIRMET message in neighbouring FIR(s) within Canada’s area of responsibility.

5.15 AIRMET IDENTIFIERS

Table 5.1—AIRMET Identifiers

INDICATOR	FIR NAME	ICAO	NATIONAL
CZVR	VANCOUVER	WACN01 CWA0	WACN21 CWA0
CZEG	EDMONTON	WACN02 CWA0	WACN22 CWA0
CZWG	WINNIPEG	WACN03 CWA0	WACN23 CWA0
CZYZ	TORONTO	WACN04 CWA0	WACN24 CWA0
CZUL	MONTREAL	WACN05 CWA0	WACN25 CWA0
CZQM	MONCTON	WACN06 CWA0	WACN26 CWA0
CZQX	GANDER DOMESTIC	WACN07 CWA0	WACN27 CWA0
CZQX	GANDER OCEANIC	WANT01 CWA0	WANT21 CWA0

5.12 UPDATED AIRMET

An updated AIRMET, when issued, automatically replaces the previous AIRMET in the same series (i.e. the previous AIRMET with the same letter). An AIRMET must be updated every 4 hr (from date/time group in the World Meteorological Organization (WMO) heading).

However, a forecaster may update an AIRMET at any time if it is considered necessary.

5.13 CANCELLATION

An AIRMET must be cancelled when, during its validity period:

- a) the phenomenon for which the AIRMET had been issued is no longer occurring or no longer expected to occur (forecast AIRMET);
- b) the phenomenon for which the AIRMET had been issued strengthens such that significant meteorological information (SIGMET) is now required; or
- c) the new issue of the graphic area forecast (GFA) has been transmitted and now includes the phenomenon.

An AIRMET does not cancel itself automatically at the end of its validity period. A cancellation AIRMET with the abbreviation CNCL must be issued.

5.14 TEST AIRMET

There may be occasions when test AIRMET messages are transmitted by the meteorological watch office (MWO). The test AIRMET messages will be identifiable by the letter T in the alphanumeric sequence (see MET 5.4). Additionally, the statement “THIS IS A TEST” will be added at the beginning and end of the message.

5.16 AIRMET EXAMPLES

Example 1:

At 1305Z a pilot weather report (PIREP) from a Beechcraft 1900 (B190) indicated moderate turbulence. This was not forecast in GFACN32, leading the forecaster to issue the following AIRMET messages.

ICAO

WACN02 CWA0 251315
 CZEG AIRMET H1 VALID 251315/251715 CWEG-
 CZEG EDMONTON FIR MDT TURB OBS AT 1305Z WTN 45
 NM OF LINE
 N6228 W11427 – N6441 W10840 – N6453 W09605
 FL190/340 MOV NE 10KT NC=

National

WACN22 CWA0 251315
 CZEG AIRMET H1 VALID 251315/251715 CWEG-
 CZEG EDMONTON FIR MDT TURB OBS AT 1305Z WTN 45
 NM OF LINE
 /N6228 W11427/CYZF – /N6441 W10840/45 W CYOA – /
 N6453 W09605/30 W CYBK
 FL190/340 MOV NE 10KT NC
 RMK GFACN32=

Example 2:

Freezing drizzle (FZDZ) was observed at 0700Z at Churchill (CYYQ), Man. Icing was not forecast in GFACN32, leading the forecaster to issue the following AIRMET messages.

ICAO

WACN03 CWA0 250725
 CZWG AIRMET A1 VALID 250725/251125 CWEG-
 CZWG WINNIPEG FIR MDT ICG OBS AT 0700Z WTN 45NM
 OF LINE
 N5955 W09403 – N5845 W09404 – N5646 W08903 SFC/
 FL020 QS NC=

National

WACN23 CWA0 250725
 CZWG AIRMET A1 VALID 250725/251125 CWEG-
 CZWG WINNIPEG FIR MDT ICG OBS AT 0700Z WTN 45NM
 OF LINE
 /N5955 W09403/75 S CYEK – /N5845 W09404/CYYQ – /
 N5646 W08903/60 NW CYER
 SFC/FL020 QS NC
 RMK GFACN32=

Example 3:

Unforecast convective activity (CB) in the GFACN31 area required the issuance of the following AIRMET messages.

ICAO

WACN01 CWA0 301925
 CZVR AIRMET U1 VALID 301925/302325 CWEG-
 CZVR VANCOUVER FIR ISOLD TS OBS WTN N5138 W12321 –
 N4903 W11759 – N4900 W11546 – N5000 W11546 – N5123
 W11811 – N5138 W12321 TOP FL240 QS WKNG=

National

WACN21 CWA0 301925
 CZVR AIRMET U1 VALID 301925/302325 CWEG-
 CZVR VANCOUVER FIR ISOLD TS OBS WTN /N5138
 W12321/45 SE CYPY – /N4903
 W11759/20 SW CYCG – /N4900 W11546/30 S CYXC – /
 N5000 W11546/25 N CYXC –
 /N5123 W11811/25 N CYRV – /N5138 W12321/45 SE CYPY
 TOP FL240 QS WKNG
 RMK GFACN31=

Example 4:

Satellite pictures and surface observations indicate an area of stratus and fog along the Quebec Lower North Shore was not well represented in GFACN34 and required the issuance of AIRMET messages.

ICAO

WACN05 CWA0 301925
 CZUL AIRMET J1 VALID 301925/302325 CWEG-
 CZUL MONTREAL FIR SFC VIS 1/4-1SM FG/BR – OVC CLD
 100-500/1200FT
 OBS WTN N5013 W06536 – N5011 W06046 – N4906
 W06148 – N4932 W06444 – N5013 W06536 QS NC=

National

WACN25 CWA0 301925
 CZUL AIRMET J1 VALID 301925/302325 CWEG-
 CZUL MONTREAL FIR SFC VIS 1/4-1SM FG/BR – OVC CLD
 100-500/1200FT
 OBS WTN /N5013 W06536/25 E CYZV – /N5011
 W06046/45 E CYNA – /N4906
 W06148/60 SE CYNA – /N4932 W06444/25 SW CYPN – /
 N5013 W06536/25 E CYZV QS NC
 RMK GFACN34=

6.0 SIGNIFICANT METEOROLOGICAL INFORMATION (SIGMET)

6.1 DEFINITION

Information message issued by a meteorological watch office (MWO) to advise pilots of the occurrence or expected occurrence of specified weather phenomena, which may affect the safety of aircraft operations, and the development of those phenomena in time and space.

6.2 ISSUANCE CRITERIA

Significant meteorological information (SIGMET) is issued in response to the following criteria (the abbreviations are shown in all capital letters):

- a) Thunderstorms:
 - (i) Frequent (FRQ TS);
 - (ii) Frequent with hail (FRQ TSGR);
 - (iii) Frequent with hail and possible tornado/waterspout (FRQ TSGR PSBL +FC);
 - (iv) Frequent with hail and tornado/waterspout (FRQ TSGR +FC);
 - (v) Squall line (SQLN TS);
 - (vi) Squall line with hail (SQLN TSGR);
 - (vii) Squall line with possible tornado/waterspout (SQLN TSGR PSBL +FC);
 - (viii) Squall line with tornado/waterspout (SQLN TSGR +FC);
- b) Severe turbulence (SEV TURB);
- c) Severe icing (SEV ICG);
- d) Severe icing due to freezing rain (SEV ICG [FZRA]);
- e) Severe mountain wave (SEV MTW);
- f) Low-level wind shear (LLWS);
- g) Heavy dust storm (HVY DS);
- h) Heavy sandstorm (HVY SS);
- i) Radioactive cloud (RDOACT CLD);
- j) Volcanic ash (VA);
- k) Tropical cyclone (TC).

NOTES:

1. A squall line is defined as thunderstorms along a line with little or no space between the individual clouds.

2. Severe (SEV) turbulence (TURB) refers only to:
 - a) low-level turbulence associated with strong surface winds;
 - b) rotor streaming;
 - c) turbulence whether in cloud or not in cloud (i.e. CAT) near jet streams.

3. TS implies severe icing and turbulence; therefore separate SIGMET for these phenomenon are not issued in connection with convective clouds.
4. SIGMET will only be issued for one of these criteria at any time. If more than one criterion occurs then more than one SIGMET will be issued.
5. Frequent (FRQ) coverage indicates an area of thunderstorms within which there is little or no separation between adjacent thunderstorms and with a maximum spatial coverage greater than 50% of the area affected or forecast to be affected by the phenomenon (at a fixed time or during the period of validity).

6.3 COORDINATE POINTS

The International Civil Aviation Organization (ICAO) significant meteorological information (SIGMET) message describes a coordinate point using latitude and longitude only.

The national SIGMET message describes a coordinate point using latitude and longitude. However, in addition, an equivalent description is also given in terms of direction and distance from an aviation reference site.

There are two exceptions to the rule for the national SIGMET:

- a) Any coordinate point located within Gander Oceanic flight information region (FIR) will be described in latitude and longitude only.
- b) Any coordinate point north of N72°00' will be described with respect to an aviation reference site only if it is within a 90-NM radius of that site. Otherwise, the coordinate point will be represented in latitude and longitude only. This is due to the sparse number of aviation reference sites in northern Canada.

The usable reference sites are a subset of aerodromes listed in the *Canada Flight Supplement (CFS)* and the closest aerodrome(s) to the area of the phenomenon are used. A complete list is included in the *Manual of Standards and Procedures for Aviation Weather Forecasts (MANAIR)*.

6.4 RULES FOR THE USE OF LETTERS

All 8 flight information regions (FIRs) share 25 letters of the alphabet (T is used only for tests).

The letter used cannot currently be in service in any other FIR and has to have been retired for a minimum of 24 hr. Otherwise the next letter is used. In addition, the same letter cannot be used for widely separated occurrences of the same phenomenon, even within a single FIR.

The letter Z will wrap back to A if necessary.

If all letters are unavailable, the letter that has had the longest retirement will be re-used.

The letter attributed to a bulletin will not change during its lifespan (updates and cancellation).

Significant meteorological information (SIGMET) messages do not share the alphabet with WA (AIRMET). The letter A may be used simultaneously in both a WS (or WC or WV) and a WA.

6.5 RULES FOR THE USE OF NUMBERS

- a) Numbering of an event (as defined by the unique use of a letter in a flight information region [FIR]) begins at 1 (i.e. B1).
- b) Number incremented by 1 when updating a message, including cancellation.
- c) The sequence number shall correspond with the number of messages issued for an event within a FIR since 0000Z on the day concerned.
- d) The numbering is thus reset at 0000Z (messages are not updated at 0000Z for the sole purpose of resetting the number).

6.6 VALIDITY

The period of validity of a WS SIGMET is 4 hr and it may be issued up to 4 hr prior to the commencement of the phenomenon in the corresponding flight information region (FIR). There is an exception for volcanic ash and tropical storm SIGMETs which are valid for 6 hr and may be issued up to 12 hr before they enter the corresponding FIR.

In the case of a SIGMET for an ongoing phenomenon, the date/time group indicating the start of the SIGMET period will be rounded back to 5 min from the filing time (date/time group in the World Meteorological Organization [WMO] heading).

In the case of a SIGMET for an expected phenomenon (forecast event), the beginning of the validity period will be the time of the expected commencement (occurrence) of the phenomenon.

Any SIGMET for an expected phenomenon (forecast event) is issued only for the first appearance of an event in Canadian airspace (e.g. moving in from the U.S. or onset inside a Canadian FIR). A phenomenon moving from one Canadian FIR to another is treated as an ongoing phenomenon. No forecast event SIGMET messages would be sent for the second FIR.

6.7 LOCATION OF THE PHENOMENON

The location of the phenomenon is depicted as an area using coordinate points. The description always begins with the abbreviation WTN (within) and the area can be described as a circle, a line or a polygon. Distances are in nautical miles and direction is to one of the eight points of compass (octants). For plain language explanations of circle, line and polygon descriptions in the national format, see MET 5.7.

6.7.1 Circle

Example:

ICAO

WTN 45 NM OF N4643 W07345

National

WTN 45 NM OF /N4643 W07345/75 N CYUL

6.7.2 Line

Example:

ICAO

WTN 45 NM OF LINE N4459 W07304– N4855 W07253 – N5256 W06904

National

WTN 45 NM OF LINE /N4459 W07304/45 SE CYUL – / N4855 W07253/30 NW CYRJ –/N5256 W06904/75 W CYWK

6.7.3 Polygon

Example:

ICAO

WTN N4502 W07345 – N4907

W07331 – N5345 W06943 – N5256

W06758 – N4848 W07149 – N4508

W07206 – N4502 W07345

National

WTN /N4502 W07345/25 SW CYUL –/N4907 W07331/60 SE CYMT – /N5345

W06943/150 E CYAH – /N5256 W06758/45 W CYWK – /N4848 W07149/25 NE CYRJ – /N4508

W07206/25 SW CYSC – /N4502 W07345/25 SW CYUL

NOTE:

Tropical cyclone and volcanic ash SIGMETs also describe the affected location at the end of the forecast period.

The remark always includes the graphic area forecast (GFA) region(s) to which the SIGMET message applies (see Example 1a and 1b in MET 6.16). The remark may also include:

- a) Cross-references to SIGMET messages when a phenomenon straddles one or several flight information region (FIR) boundaries (see Example 1a and 1b in MET 6.16).
- b) For a phenomenon that has moved out of a FIR, the cancelled SIGMET message will refer to the continuing SIGMET message in neighbouring FIR(s) within Canada's area of responsibility (see Example 2 in MET 6.16).

6.8 FLIGHT LEVEL AND EXTENT

The location and extent of the phenomenon in the vertical is given by one or more of the following:

- a) Reporting a layer—FL<nnn/nnn>—where the lower level is reported first; this is used particularly in reporting turbulence and icing.
- b) Reporting a layer with reference to one FL and the surface (SFC).
- c) Reporting the level of the tops of the thunderstorms (TS) using the abbreviation TOP.

6.9 MOVEMENT OR EXPECTED MOVEMENT

Direction of movement is given with reference to one of the 16 points of compass (radials). Speed is given in knots. The abbreviation QS (quasi stationary) is used if no significant movement is expected.

6.10 CHANGE IN INTENSITY

The expected evolution of a phenomenon's intensity is indicated by one of the following abbreviations:

- a) *INTSFYG*—intensifying;
- b) *WKNG*—weakening;
- c) *NC*—no change.

6.11 REMARK

The remark (RMK) is found only in the national significant meteorological information (SIGMET) message. It begins on a new line. The purpose is to allow additional information of national interest to be conveyed in the SIGMET message. Items listed in the remark line will be separated by a forward slash (/).

6.12 UPDATED SIGNIFICANT METEOROLOGICAL INFORMATION (SIGMET)

An updated significant meteorological information (SIGMET) message, when issued, automatically replaces the previous SIGMET in the same series (i.e. the previous SIGMET with the same letter).

A WS SIGMET must be updated every 4 hr (from date/time group in the World Meteorological Organization (WMO) heading).

A WV and a WC SIGMET must be updated every 6 hr (from date/time group in the WMO heading).

However, a forecaster may update a SIGMET at any time if it is considered necessary.

6.13 CANCELLATION

If, during the validity period of a significant meteorological information (SIGMET) message, the phenomenon for which the SIGMET had been issued is no longer occurring or no longer expected to occur, this SIGMET should be cancelled by the issuing meteorological watch office (MWO). A cancellation SIGMET will be issued and will include the abbreviation CNCL.

6.14 TEST SIGNIFICANT METEOROLOGICAL INFORMATION (SIGMET) MESSAGE

There may be occasions when test significant meteorological information (SIGMET) messages are transmitted by the meteorological watch office (MWO). The test SIGMET messages will be identifiable by the letter T in the alphanumeric sequence. Additionally, the statement “**THIS IS A TEST**” will be added at the beginning and end of the message.

6.15 SIGNIFICANT METEOROLOGICAL INFORMATION (SIGMET) MESSAGE IDENTIFIERS

Table 6.1—SIGMET Message Identifiers

INDICATOR	FIR NAME	TYPE	ICAO	NATIONAL
CZVR	VANCOUVER	SIGMET SIGMET (TC) SIGMET(VA)	WSCN01 CWAO WCCN01 CWAO WVCN01 CWAO	WSCN21 CWAO WCCN21 CWAO WVCN21 CWAO
CZEG	EDMONTON	SIGMET SIGMET (TC) SIGMET(VA)	WSCN02 CWAO WCCN02 CWAO WVCN02 CWAO	WSCN22 CWAO WCCN22 CWAO WVCN22 CWAO
CZWG	WINNIPEG	SIGMET SIGMET (TC) SIGMET(VA)	WSCN03 CWAO WCCN03 CWAO WVCN03 CWA	WSCN23 CWAO WCCN23 CWAO WVCN23 CWAO
CZYZ	TORONTO	SIGMET SIGMET (TC) SIGMET(VA)	WSCN04 CWAO WCCN04 CWAO WVCN04 CWAO	WSCN24 CWAO WCCN24 CWAO WVCN24 CWAO
CZUL	MONTREAL	SIGMET SIGMET (TC) SIGMET(VA)	WSCN05 CWAO WCCN05 CWAO WVCN05 CWAO	WSCN25 CWAO WCCN25 CWAO WVCN25 CWAO
CZQM	MONCTON	SIGMET SIGMET (TC) SIGMET(VA)	WSCN06 CWAO WCCN06 CWAO WVCN06 CWAO	WSCN26 CWAO WCCN26 CWAO WVCN26 CWAO
CZQX	GANDER DOMESTIC	SIGMET SIGMET (TC) SIGMET(VA)	WSCN07 CWAO WCCN07 CWAO WVCN07 CWAO	WSCN27 CWAO WCCN27 CWAO WVCN27 CWAO
CZQX	GANDER OCEANIC	SIGMET SIGMET (TC) SIGMET(VA)	WSNT01 CWAO WCNT01 CWAO WVNT01 CWAO	WSNT21 CWAO WCNT21 CWAO WVNT21 CWAO

6.16 SIGNIFICANT METEOROLOGICAL INFORMATION (SIGMET) MESSAGE EXAMPLES

Example 1a:

An observed line of thunderstorms is over northwestern Ontario late in the day. This is the fourth significant meteorological information (SIGMET) message issued for this event.

ICAO

WSCN03 CWAO 162225
 CZWG SIGMET A4 VALID 162225/170225 CWEG-
 CZWG WINNIPEG FIR SQLN TS OBS WTN 20NM OF LINE
 N4929 W09449 -
 N5104 W09348 - N5209 W09120 TOP FL340 MOV E 15KT
 NC=

National

WSCN23 CWAO 162225
 CZWG SIGMET A4 VALID 162225/170225 CWEG-
 CZWG WINNIPEG FIR SQLN TS OBS WTN 20NM OF LINE /
 N4929 W09449/25 SW

CYQK - /N5104 W09348/CYRL - /N5209 W09120/60 NW
 CYPL TOP FL340 MOV E

15KT NC

RMK GFACN33=

Example 1b:

This SIGMET was updated after 000Z on the 17th, so the SIGMET number was reset while the letter remains the same.

ICAO

WSCN03 CWAO 170205
 CZWG SIGMET A1 VALID 170205/170605 CWEG-
 CZWG WINNIPEG FIR SQLN TS OBS WTN 20NM OF LINE
 N4915 W09332 - N5103
 W09212 - N5144 W08943 TOP FL310 MOV E 15KT WKNG=

National

WSCN23 CWAO 170205
 CZWG SIGMET A1 VALID 170205/170605 CWEG-
 CZWG WINNIPEG FIR SQLN TS OBS WTN 20NM OF LINE /
 N4915 W09332/45 SE

MET

CYQK – /N5103 W09212/60 E CYRL – /N5144 W08943/25
NE CYPL TOP FL310 MOV E 15KT WKNG

RMK GFACN33=

Example 2:

Severe mountain waves (lee waves) along the eastern side of the Rockies. The line falls entirely within the Edmonton flight information region (FIR) but covers two graphic area forecast (GFA) regions. The remark line in the national SIGMET message will mention the affected GFACNs.

ICAO

WSCN02 CWA0 161220

CZEG SIGMET L1 VALID 161220/161620 CWEG-

CZEG EDMONTON FIR SEV MTW FCST WTN 30NM OF LINE
N5614 W12155 – N5105 W11440 FL070/140 QS INTSFYG=

National

WSCN22 CWA0 161220

CZEG SIGMET L1 VALID 161220/161220 CWEG-

CZEG EDMONTON FIR SEV MTW FCST WTN 30NM OF LINE /
N5614 W12155/45 W CYXJ – /N5105 W11440/25 W CYYC
FL070/140 QS INTSFYG

RMK GFACN31/GFACN32=

Example 3:

Following an air report (AIREP) for severe turbulence encountered over the North Atlantic (NAT), the following SIGMET messages are issued. This event spans over Gander Domestic and Gander Oceanic FIRs as well as GFACN34.

ICAO

CZQX WSCN07 CWA0 161220

CZQX SIGMET E1 VALID 161220/161620 CWUL-

CZQX GANDER DOMESTIC FIR SEV TURB OBS AT 1155Z WTN
45NM OF LINE

N5319 W06025 – N5615 W05245 – N5930 W04715
FL280/350 MOV NE 20KT NC=

CZQX (Oceanic)

WSNT01 CWA0 161220

CZQX SIGMET U1 VALID 161220/161620 CWUL-

CZQX GANDER OCEANIC FIR SEV TURB OBS AT 1155Z WTN
45NM OF LINE N5319

W06025 – N5615 W05245 – N5930 W04715 FL280/350
MOV NE 20KT NC=

National

CZQX WSCN27 CWA0 161220

CZQX SIGMET E1 VALID 162225/170225 CWUL-

CZQX GANDER DOMESTIC FIR SEV TURB OBS AT 1155Z WTN
45NM OF LINE

/N5319 W06025/CYYR – /N5615 W05245/ – /N5930
W04715/ FL280/350 MOV NE 20KT NC

RMK GFACN34/CZQX GANDER OCEANIC FIR SIGMET U1=

CZQX (Oceanic)

WSNT21 CWA0 162225

CZQX SIGMET U1 VALID 162225/170225 CWUL-

CZQX GANDER OCEANIC FIR SEV TURB OBS AT 1155Z WTN
45NM OF LINE /N5319

W06025/CYYR – /N5615 W05245/ – /N5930 W04715/
FL280/350 MOV NE 20KT NC

RMK GFACN34/CZQX GANDER DOMESTIC FIR SIGMET E1=

NOTE:

Since this event spans over two FIRs, the remark line includes cross-references to the SIGMET messages. Note that only the first coordinate point relates to an aviation reference site. The other two coordinate points are in Gander Oceanic FIR and are defined only in latitudes and longitudes.

Example 4:

The centre of hurricane Maria is about to move across the Avalon Peninsula. The tropical cyclone SIGMET (WCCN) is updated and only covers the Gander Domestic FIR and GFACN34, since the CB activity is confined within a radius of 150 NM from the centre of the hurricane.

ICAO

WCCN07 CWA0 161220

CZQX SIGMET G3 VALID 1601800/170000 CWUL-

CZQX GANDER DOMESTIC FIR TC MARIA OBS AT 1800Z
N4720 W05430/ CB TOP

FL360 WTN 150NM OF CENTRE MOV NE 40KT WKNG FCST
0000Z TC CENTRE N5110 W05030 =

National

WCCN27 CWA0 161220

CZQX SIGMET G3 VALID 161800/170000 CWUL-

CZQX GANDER DOMESTIC FIR TC MARIA OBS AT 1800Z
N4720 W05430/75 SW

CYYT CB TOP FL360 WTN 150NM OF CENTRE MOV NE 40KT
WKNG FCST 0000Z

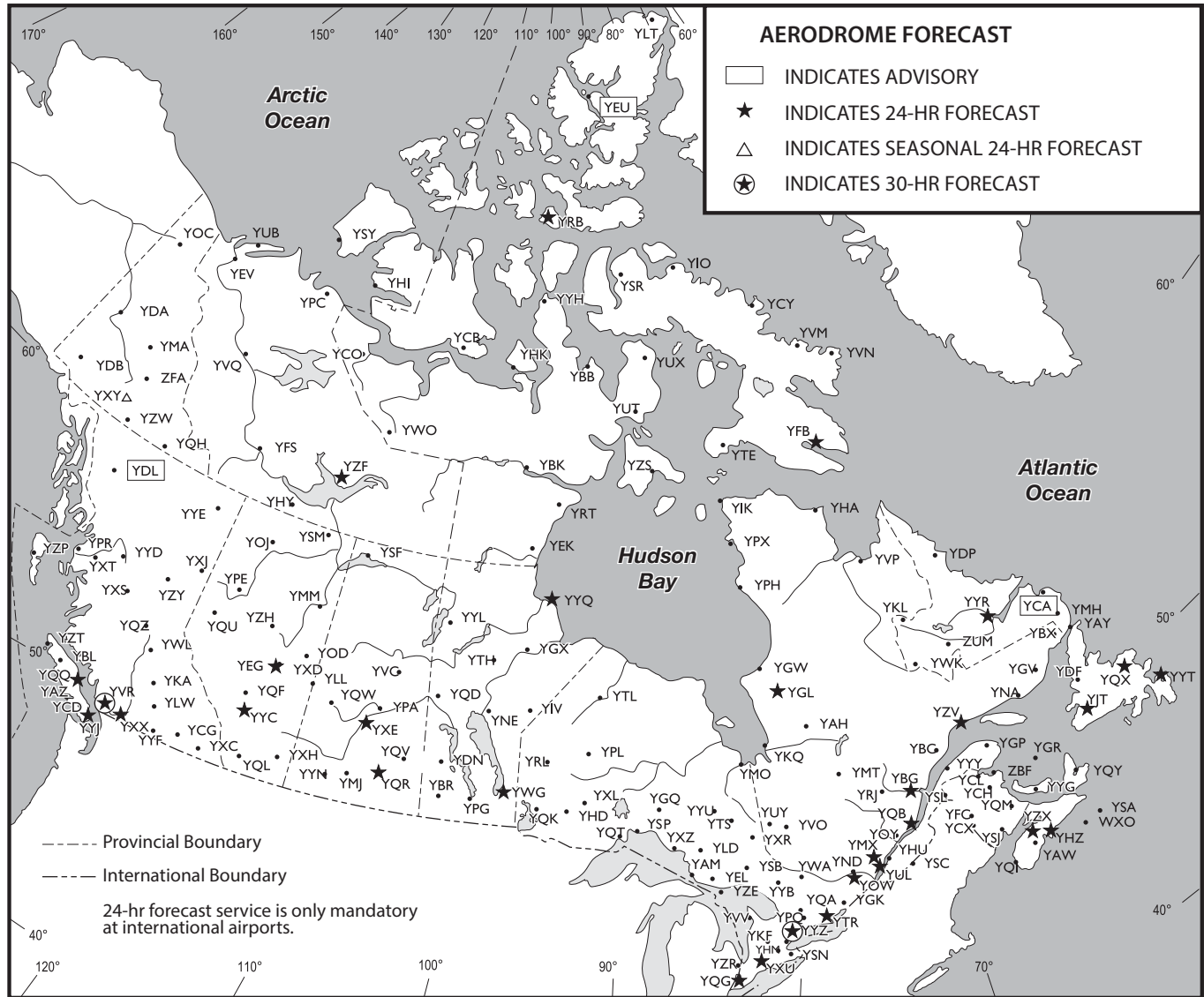
TC CENTRE N5110 W05030/180 NE CYYT

RMK GFACN34=

7.0 AERODROME FORECASTS (TAFs)

7.1 AERODROME FORECAST (TAF) LOCATIONS

Figure 7.1—TAF Locations



7.2 GENERAL

TAF is the international meteorological code for an aerodrome forecast, which is a description of the most probable weather conditions expected to occur at an aerodrome, together with their most probable time of occurrence. It is designed to meet the pre-flight and in-flight requirements of flight operations. The abbreviations of expected weather conditions follow the same form and order as those found in an aerodrome routine meteorological report (METAR) (see MET 8.0); they also have the same meaning.

In normal situations, an observation is considered representative of the specific weather conditions at the aerodrome if it is taken within 1.6 NM (3 km) of the geometric centre of the runway complex. TAFs are intended to relate to weather conditions for flight operations within 5 NM of the centre of the runway complex, depending on local terrain. Significant weather conditions, such as thunderstorms, within 5 to 10 NM of the aerodrome are also included. A regular and complete observation program that meets Transport Canada (TC) standards for METARs and aerodrome special meteorological reports (SPECI) is a prerequisite for the production of a TAF. Aerodrome advisories may be issued when this observation program prerequisite cannot be completely satisfied.

Aerodrome advisories are identified by the word “ADVISORY” appearing after the date/time group, followed by one of the qualifying reasons listed below. Advisories are formatted in the same manner as TAFs.

OFFSITE—The advisory is based on an observation that is not taken at or near the airport. “OFFSITE” is added after the word “ADVISORY,” followed by one space, if an observation is not considered representative. It is intended to indicate to the users that the observations do not necessarily reflect the actual conditions at the aerodrome.

OBS INCOMPLETE or *NO SPECI*—The advisory is based on incomplete data, either because the observations could not be completed, or because the aerodrome does not have an on-going weather watch in order to produce SPECIs. “OBS INCOMPLETE” or “NO SPECI” shall be added after the word “ADVISORY,” followed by one space.

7.3 NATIONAL VARIATIONS

As with the aerodrome routine meteorological report (METAR) code, even though aerodrome forecast (TAF) is an international code, there are national variations. For example, “CAVOK” is not authorized for use in Canadian TAFs, while “RMK” is used, but is not part of the international code. See MET 1.1.8 for more information on differences from the International Civil Aviation Organization (ICAO) Annex 3.

7.4 SAMPLE MESSAGE

TAF CYXE 281139Z 2812/2912 24010G25KT WS011/
27050KT 3SM -SN BKN010 OVC040 TEMPO 2818/2901
1 1/2SM -SN BLSN BKN008 PROB30 2820/2822 1/2SM
SN VV005 FM290130Z 28010KT 5SM -SN BKN020
BECMG 2906/2908 000000KT P6SM SKC RMK NXT FCST
BY 281800Z

- a) *Sample message decoded*—Aerodrome Forecast; Saskatoon, Saskatchewan; issued on the 28th day of the month at 1139Z; covers the period from the 28th day of the month at 1200Z to the 29th day of the month at 1200Z; surface wind 240° true at 10 kt, gusting to 25 kt; wind shear is forecast to exist in the layer from the surface to 1 100 ft AGL, with the wind at the shear height of 270° true at 50 kt; forecast prevailing visibility is 3 SM in light snow; forecast cloud layers are broken at 1 000 ft and overcast at 4 000 ft; between 1800Z on the 28th day and 0100Z on the 29th day there will be a temporary change to the prevailing visibility to 1 1/2 SM in light snow and blowing snow with a broken cloud layer at 800 ft; there is a 30% probability between 2000Z and 2200Z on the 28th day that the prevailing visibility will be 1/2 SM in moderate snow and create an obscuring phenomena, resulting in a vertical visibility of 500 ft; at 0130Z on the 29th day there will be a permanent change, the wind is forecast to be 280° true at 10 kt with a prevailing visibility of 5 SM in light snow and a broken cloud layer at 2 000 ft; between 0600Z and 0800Z on the 29th day there will be a gradual change in the weather to calm winds and a forecast visibility greater than 6 SM, and the sky will be clear of clouds;

Remarks: the next routine aerodrome forecast for this site will be issued by 1800Z on the 28th day.

- b) *Report type*—The code name “TAF” is given in the first line of text. It may be followed by “AMD” for amended or corrected forecasts.
- c) *Location indicator*—A four-letter International Civil Aviation Organization (ICAO) location indicator is used, as in aerodrome routine meteorological reports (METARs). See MET 8.3.
- d) *Date and time of origin*—As with the METAR format, the date (day of the month) and time (Coordinated Universal Time [UTC]) of origin are included in all forecasts. TAFs are issued approximately 20 min before the validity period. Some forecasts have update cycles as frequent as every three hours; however, the next issue time will always be indicated in the remarks section.

- e) *Period of validity*—The period of validity for the TAF is indicated by two four-digit date/time groups; the first four-digit group indicates the start date and time of the TAF, and the second four-digit group indicates the end date and time of the TAF. A TAF is considered to be valid from the moment it is issued (e.g. a TAF with an indicated period of validity from 1100Z to 2300Z that was issued at 1040Z is considered to be valid from 1040Z) until it is amended; until the next scheduled TAF for the same aerodrome is issued; or until the period of validity ends and no new TAF has been issued. The maximum period of validity for a TAF is 30 hr; however, some TAFs have staggered issue times and more frequent update cycles, which affects their periods of validity.
- f) *Wind*—This group forecasts the 2-min mean wind direction and speed to the nearest 10° true, and speed to the nearest whole knot. “KT” is used to indicate the speed units. If the maximum gust speed is forecast to exceed the mean speed by 10 kt or more, the letter G and the value of the gust speed, in knots, is added between the mean wind and the unit indicator (KT). “VRB” is normally coded for variable direction only if the wind speed is 3 kt or less; however, it may also be coded with higher speeds when it is impossible to forecast a single direction (e.g. when a thunderstorm passes). A north wind of 20 kt would be coded as 36020KT, while calm wind is coded as 00000KT.
- g) *Low-level wind shear*—This group is used if the forecaster has strong evidence to expect significant, non-convective wind shear that could adversely affect aircraft operation within 1 500 ft AGL over the aerodrome. The height of the top of the shear layer (in hundreds of feet above ground level) is given, followed by the forecast wind speed and direction at that height.

While the main effect of turbulence is related to erratic changes in altitude or attitude of the aircraft, or both, the main effect of wind shear is the rapid gain or, more critical, loss of airspeed. Therefore, for forecasting purposes, any cases of strong, non-convective low-level wind shear within 1 500 ft AGL will be labelled as “WS.”

To a great extent, wind shear is an element that, for the time being, cannot be satisfactorily observed from the ground. As a result, aircraft observations and radiosonde reports represent the only available evidence.

However, the following guidelines are used to establish whether significant non-convective wind shear hazardous to aircraft exists:

- (i) vector magnitude exceeding 25 kt within 500 ft AGL;
 - (ii) vector magnitude exceeding 40 kt within 1 000 ft AGL;
 - (iii) vector magnitude exceeding 50 kt within 1 500 ft AGL;
 - (iv) a pilot report of loss or gain of IAS of 20 kt or more within 1 500 ft AGL.
- h) *Prevailing visibility*—The horizontal prevailing visibility is indicated in statute miles and fractions up to 3 SM, then in

whole miles up to 6 SM. Visibilities greater than 6 SM are indicated as P6SM. The letters “SM” are added, without a space, to each forecast visibility, to identify the unit.

- i) *Significant weather*—Forecast significant weather may be decoded using the list of significant weather given in the WMO Code Table 4678 (Table 8.1) in MET 8.3. Intensity and proximity qualifiers, descriptors, precipitation, obscuration and other phenomena are included as required. A maximum of three significant weather groups is allowed per forecast period. If more than one group is used, they are considered one entity. When one of the significant weather groups is forecast to change, all the significant weather groups that will apply after the change are indicated following the change group. Details on the specific effects of change groups on significant weather will be addressed under the change group headings.

NOTE:

The meaning of the proximity qualifier, vicinity (VC), in the TAF code differs slightly from that in the METAR. In the METAR code, “VC” means elements observed within 5 SM., but not at the station. In the TAF code, “VC” means between 5 and 10 NM from the centre of the runway complex.

- j) *Sky condition*—Sky condition is decoded as in a METAR. Possible codes for sky cover amounts are SKC, FEW, SCT, BKN, OVC and VV. In case of a significant change in a cloud layer, as forecast using “BECMG” or “TEMPO”, the entire cloud group, including those cloud layers that are not expected to change, shall be repeated.

CB layers are the only forecast layers to have cloud type identified, e.g. “BKN040CB.”

- k) *Change groups*—For forecast purposes, all components of the following elements are grouped together:
- (1) sky condition,
 - (2) visibility, present weather and obstruction to vision.

Conditions listed after the change group represent new conditions.

In the following example, since wind is considered a group on its own and is not mentioned in the section after the “BECMG” change group, it is unchanged and will remain variable at 3 kt. However, changes have occurred to the sky condition and visibility, present weather and obstruction to vision. For the sky condition, the broken layer at 300 ft will no longer exist after 1400Z.

Example:

*TAF CYVP 301213Z 3012/3024 VRB03KT 1/4SM -RA FG
BKN003 OVC007*

BECMG 3012/3014 4SM -DZ BR OVC007

Plain language explanation of the forecast: TAF for Kuujuaq, Que., issued on the 30th day of the month at 1213Z,

valid from the 30th day of the month at 1200Z until the 30th day of the month at 2359Z. Wind variable at 3 kt, visibility 1/4 SM with light rain and fog; forecast cloud layers are broken at 300 ft and overcast at 700 ft. From 1200Z until 1400Z, conditions will become visibility 4 SM with light drizzle and mist; overcast cloud layer at 700 ft.

- (i) *Permanent change group (rapid)(FM)*—FM is the abbreviation for “from.” It is used for a permanent change to the forecast that will occur rapidly. All forecast conditions given before this group are superseded by the conditions indicated after the group. In other words, a complete forecast will follow and all elements must be indicated, including those for which no change is forecast. The time group represents hours and minutes in UTC.

Example:

“FM280930 would decode as the beginning of a new part period forecast from the 28th day of the month at 0930Z.

NOTE:

Where the permanent change group indicator (FM) indicates a change after the beginning of a whole hour, as in the example above, any subsequent use of a gradual change group (BECMG) or transitory change group (TEMPO) shall indicate changes after the time indicated in hours and minutes in the “from” (FM) indicator. Using the above example, if there was a subsequent use of “TEMPO 2809/2811,” the temporary change would be between 0930Z and 1100Z on the 28th day of the month.

- (ii) *Permanent change group (gradual) (BECMG)*—If a permanent change in a few weather elements is forecast to occur gradually, with conditions evolving over a period of time (normally one to two hours, but not more than four hours), the new conditions that differ from those immediately prior are indicated following “BECMG.” Normally only those elements for which a change is forecast to occur will follow “BECMG.” Any forecast weather element not indicated as part of the “BECMG” group remains the same as in the period prior to the onset of the change.

If a significant change in weather or visibility is forecast, all weather groups, as well as the visibility, are indicated following “BECMG,” including those that are unchanged. When the ending of significant weather is forecast, the abbreviation “NSW” (no significant weather) is used.

The start and stop time of the change period is indicated by two four-digit date/time groups following “BECMG.” The first two digits of each group indicate the date, while the last two digits of each group indicate the time in whole UTC hours.

As a general rule, to keep the forecast clear and unambiguous, the use of the “BECMG” change group is kept to a minimum, and confined to those cases where only one, or at most two, weather groups are expected to change while all the others stay the same.

In those cases where more than two groups are expected to change, the permanent change group “FM” will be used to start a new self-contained part period. For the purposes of flight planning, and specifically for the selection of IFR alternate aerodromes, if forecast conditions are improving, the new conditions will apply when the change period is complete, and if the conditions are deteriorating, the new conditions will apply at the beginning of the period.

Example:

“BECMG 2808/2809 OVC030” would decode as a change towards overcast sky conditions at 3 000 ft AGL occurring gradually between 0800Z and 0900Z on the 28th day of the month; and

- (A) if the previous sky condition forecast was for better than overcast conditions at 3 000 ft AGL, then the change would apply as of 0800Z; or
- (A) if the previous sky condition forecast was for worse than overcast conditions at 3 000 ft AGL, then the change would apply as of 0900Z.
- (ii) *Transitory change group (TEMPO)*—If a temporary fluctuation in some or all of the weather elements is forecast to occur during a specified period, the new conditions that differ from those immediately prior are indicated following “TEMPO.” In other words, when an element is not indicated after “TEMPO,” it shall be considered to be the same as that for the prior period. The time period, as with “BECMG,” is indicated by two four-digit date/time groups following “TEMPO.” The first two digits of each group indicate the date, while the last two digits of each group indicate the time in whole UTC hours.

Example:

FM281100 VRB03KT 3SM RA BR OVC020 TEMPO 2812/2815 1SM RA BR FM281500...

In this example, the cloud group “OVC020” is not repeated after “TEMPO” because it is forecast to remain unchanged. On the other hand, the weather group “RA BR” is repeated after “TEMPO” because a significant change in visibility is forecast.

When a significant change in weather or visibility is forecast, all weather groups are indicated following “TEMPO,” including those that are unchanged, and any weather element not indicated is forecast to remain the same as in the period prior to the temporary fluctuation. When the ending of significant weather is forecast, the abbreviation “NSW” (no significant weather) is used.

“TEMPO” is only used when the modified forecast condition is expected to last less than one hour in each instance, and if expected to recur, the total period of the modified condition will not cover more than half of the total forecast period. The total period of the modified condition is the time period during which the actual modified weather condition is expected to occur, and not the total time stated for the “TEMPO” time

period. When the modified forecast condition is expected to last more than one hour, either “FM” or “BECMG” must be used.

- (iii) *Probability group (PROB)*—In order to indicate the probability of occurrence of alternative values of forecast groups, PROB30 (a 30% probability) or PROB40 (a 40% probability) is placed directly before the change group’s validity period and alternative value(s) to indicate that different conditions will occur within the specified time period. The time period is given in whole UTC hour values. For example, “PROB30 2817/2821” would indicate that between 1700Z and 2100Z on the 28th day of the month there is a 30% probability that the indicated weather will occur. The weather elements used in the PROB group are restricted to hazards to aviation, which include, but are not limited to, the following:
- (A) thunderstorms;
 - (A) freezing precipitation;
 - (A) low-level wind shear at or below 1 500 ft AGL; or
 - (A) ceiling and visibility values important to aircraft operations (e.g. threshold such as alternate limits, lowest approach limits).

A probability of less than 30% of actual values deviating from those forecasts is not considered to justify the use of the PROB group. When the possibility of an alternative value is 50% or more, this shall be indicated by the use of BECMG, TEMPO or FM, as appropriate. The PROB group will not be used in combination with the TEMPO or BECMG groups.

- 1) *Remarks*—Remarks will appear in TAF from Canada, prefaced by “RMK.” Currently, the following remarks are allowed:
- (i) *FCST BASED ON AUTO OBS*—This remark indicates that the TAF is based on METAR AUTO observations.
 - (ii) *NXT FCST BY 290000Z*—This remark indicates the date and time (UTC) the next regular TAF will be issued, which will correspond to the beginning of its new period of validity. This remark will normally mark the end of the TAF.
 - (iii) *PARTIAL PROGRAM NOTICES*—For aerodromes with a partial observing program (e.g. no night-time observations are taken), a remark is included in the last regular TAF issued for the day to indicate when forecast coverage will resume, e.g. “NXT FCST WILL BE ISSUED AT 291045Z”. For military aerodromes, remarks may also be used and will take the form of either, “NO FCST COVERAGE 2820–2911Z,” or “NO FCST ISSUED UNTIL FURTHER NOTICE”.
 - (iv) *POSSIBLE DISCREPANCIES*—Forecasters will use remarks to explain possible discrepancies between an AWOS and a TAF if the forecasters have reason to believe that the AWOS observations are not representative of the actual weather at the aerodrome. For example, the remarks could

be “RMK AUTO OBS REPG NON-REPRESENTATIVE WND SPD” or “RMK AUTO OBS REPG NON-REPRESENTATIVE VIS.”

7.5 AERODROME FORECASTS (TAFs) FROM AUTOMATIC AERODROME ROUTINE METEOROLOGICAL REPORTS (METAR AUTO)

At some sites equipped with automated weather observation system (AWOS), forecasters will issue an aerodrome forecast (TAF) based in part on the METAR AUTO observations made by the AWOS at the aerodrome. The only visible distinction between this forecast and a TAF that is based on human observations is the comment at the end of the TAF “FCST BASED ON AUTO OBS”. The TAF based on automated observations, like the TAF based on human observations, provides a description of the most probable weather conditions expected to occur at an aerodrome, together with the most probable time of occurrence.

The abbreviated comment “FCST BASED ON AUTO OBS” at the end of the TAF is meant to inform pilots that the forecast has been developed from an automated weather observation. The pilot using this forecast should be familiar with the characteristics of METAR AUTO weather observations, and the comparison of automated and human observations contained in MET 8.5, e.g. the automated weather observation system (AWOS) cloud height sensor tends to under-read during precipitation events. The forecaster is also familiar with AWOS characteristics and has taken time to analyze not only AWOS data, but also additional information such as satellite and radar imagery, lightning data, remote video imagery, pilot reports, and observations from surrounding stations. Based on integration of this data, the forecaster may have inferred actual weather conditions that differ slightly from the METAR AUTO report. On those few occasions when there are differences between a METAR AUTO report and a TAF, it may not imply that the TAF is inaccurate, or that an amendment is required. In the event that an AWOS sensor is missing, inoperative, or functioning below standards, the forecaster will attempt to infer the value of the missing weather element from other available data and may include a remark in the TAF. If the forecaster is unable to infer the weather conditions, a decision may be made to cancel the TAF, pending correction of the problem. The decision to cancel will depend on the weather conditions prevailing at the time, and how critical the missing information is to the issuance of a credible TAF based on the automated data that is available.

7.6 AMENDED AERODROME FORECAST (TAF)

An aerodrome forecast (TAF) is amended when the forecast conditions are no longer representative of the current or expected conditions. An amendment is issued in response to a aerodrome routine meteorological report (METAR), aerodrome special meteorological report (SPECI) or pilot weather report (PIREP) indicating a significant change in weather relative to the conditions

forecast in the TAF or whenever, in the forecaster's judgment, the TAF is not representative of existing or expected weather conditions.

The amendment criteria include thresholds defined by changes in ceiling, visibility, present weather, wind speed and direction or the existence of low-level wind shear. TAF amendments are issued for weather that is better than previously forecast as well as for weather that is worse than previously forecast.

An amendment will also be issued to correct a TAF when typographical errors and/or forecast text omissions are such that the information content of the TAF is unclear.

An amended forecast covers the remaining period of the original forecast and is identified by TAF AMD in place of TAF prior to the aerodrome identifier in the first line of the forecast. In all cases, the issue time added to the body of the TAF will always indicate which TAF is the latest.

A TAF does not have to be amended for changes in ceiling and/or visibility when both the forecast and observed values are below the normal visual flight rules (VFR) minima or the lowest published instrument landing minima for an aerodrome (whichever is lower).

The VFR minima criteria for TAF amendment purposes are a ceiling of less than 1 000 ft and/or ground visibility of less than 3 SM.

8.0 AERODROME ROUTINE METEOROLOGICAL REPORTS (METARs)

8.1 THE AERODROME ROUTINE METEOROLOGICAL REPORT (METAR) CODE

An aerodrome routine meteorological report (METAR) describes the actual weather conditions at a specified location and at a specified time as observed from the ground. METAR is the name of the international meteorological code for an aerodrome routine meteorological report. METAR observations are normally taken and disseminated on the hour. An aerodrome special meteorological report (SPECI), the name of the code for an aerodrome special meteorological report, will be reported when weather changes of significance to aviation are observed (see MET 8.4).

In Canada, METARs and SPECIs are not encoded by the observer, but are generated by computer software, based on hourly or special observations taken at either staffed or automatic sites.

The code is composed of several groups which are always in the same relative position to one another. When a weather element or phenomenon does not occur, the corresponding group (or extension) is omitted. Certain groups may be repeated.

The large majority of METARs and SPECIs are provided by NAV CANADA; however, at Department of National Defence (DND) aerodromes they are provided by DND. If METARs and SPECIs are being provided by another source, they will be indicated as being "private" in the *Canada Flight Supplement* (CFS). For these sites, the aerodrome operator is the primary contact for further information.

8.2 NATIONAL VARIATIONS

Despite the fact that an aerodrome routine meteorological report (METAR) is an international code, there are some national variations. For example, wind speed may be reported in different units; however, the units are always appended to the values to avoid any misunderstanding. See MET 1.1.8 for more information on differences from the International Civil Aviation Organization (ICAO) Annex 3.

8.3 SAMPLE MESSAGE

```
METAR CYXE 292000Z CCA 09015G25KT 3/4SM
R09/4000FT/D -RA BR BKN008 OVC040 21/19 A2992
WS RWY 09 RMK SF5NS3 VIS NW 3/8 SLP134 DENSITY
ALTITUDE 2500FT
```

- Decoding of example*—Aerodrome routine meteorological report; Saskatoon, Sask., issued on the 29th day of the month at 2000 UTC; first correction to the original observation; wind 090° true, 15 kt with gusts to 25 kt; visibility 3/4 SM; RVR for Runway 09 is 4 000 ft and has had a downward tendency; present weather is light rain and mist; broken clouds at 800 ft AGL, and combined with the lower layer, overcast clouds at 4 000 ft; temperature 21°C; dew point 19°C; altimeter setting 29.92 in Hg; wind shear Runway 09; remarks: stratus fractus 5/8, nimbostratus 3/8, visibility to the northwest 3/8 SM, sea level pressure 1013.4 hPa, density altitude 2 500 ft.
- Report type*—The code name METAR (or SPECI) is given in the first line of text. An aerodrome special meteorological report (SPECI) is issued only when significant changes in weather conditions occur off the hour.
- Location indicator*—Canadian aviation weather reporting stations are assigned four-character International Civil Aviation Organization (ICAO) indicators commencing with C and followed by W, Y or Z. These stations are normally located within 1.6 NM (3 km) of the geometric centre of the runway complex. Aviation weather reporting sites are listed in the *Canada Flight Supplement* (CFS).
- Date/time of observation*—The date (day of the month) and time (Coordinated Universal Time [UTC]) of the observation are included in all reports. The official time of the observation (on the hour) is used for all aerodrome routine meteorological reports (METARs) that do not deviate from the official time by more than 10 min. In SPECIs, the time refers to the time

of occurrence (hours and minutes) of the change(s) which required the issue of the report.

e) *Report modifier*—This field may contain two possible codes: “AUTO” or “CCA”. Both codes may appear simultaneously, i.e. “AUTO CCA”. “AUTO” is used when data for the primary report is gathered by an automated weather observation system (AWOS). See MET 8.5 for more information about AWOS reports. “CCA” is used to indicate corrected reports. The first correction is indicated as CCA, the second as CCB, etc.

f) *Wind*—This group reports the 2-min mean wind direction and speed, along with gusts. Wind direction is always three digits, given in degrees (true) but rounded off to the nearest 10° (the third digit is always a “0”). Wind speeds are two digits (or three digits, if required) and in knots. Calm is encoded as “0000KT”. In Canada, the unit for wind speed is knots (nautical miles per hour) and is indicated by including “KT” at the end of the wind group. Other countries may use kilometres per hour (KMH), or metres per second (MPS).

(i) *Wind gusts*—Gust information will be included if gust speeds, averaged over a 5-second period, exceed the average wind speed by 5 kt or more in the 10-min period preceding the observation and the peak gust reaches a maximum speed of 15 kt or more. “G” indicates gusts and the peak gust is reported, using two or three digits as required.

(ii) *Variations in wind direction*—This group reports variations in wind direction. It is only included if, during the 10-min period preceding the observation, the direction varies by 60° or more and less than 180°, and the mean speed exceeds 3 kt. The two extreme directions are encoded in clockwise order. In the example below, the wind is varying from 260° true to 340° true.

Example:

METAR CYWG 172000Z 30015G25KT 260V340

In the case of variable wind direction, wind direction in tens of degrees (ddd) shall be coded as VRB when the wind speed is less than 3 kt. A variable wind at higher speeds shall be reported only when the variation in wind direction is 180° or more or when it is impossible to determine a single wind direction.

Example:

METAR CYQB 041500Z VRB02KT

(iii) When wind sensors are not functioning at a human METAR site, the wind speed and direction will be estimated and a remark will be added to the report (“WND ESTD”).

g) *Prevailing visibility*—The prevailing visibility is reported in statute miles and fractions. There is no maximum visibility value reported. Lower sector visibilities which are half or less of the prevailing visibility are reported as remarks at the end of the report.

h) *RVR*—The runway visual range (RVR) for the touchdown zone of up to four available landing runways is reported as a 10-min average, based on the maximum runway light settings at the time of the report. It is included if the prevailing visibility is 1 SM or less, and/or the RVR is 6 000 ft or less. “R”, the group indicator, is followed by the runway designator (e.g. 06), to which may be appended the letters “L”, “C”, or “R” (left, centre, or right) if there are two or more parallel runways. The RVR value is then reported in hundreds of feet, using three or four digits. FT indicates the units for RVR are feet. “M” preceding the lowest measurable value (or “P” preceding the highest) indicates the value is beyond the instrument range. The RVR trend is then indicated if there is a distinct upward or downward trend from the first to the second 5-min part-period such that the RVR changes by 300 ft or more (encoded “/U” or “/D” for upward or downward) or if no distinct change is observed, the trend “/N” is encoded. If it is not possible to determine the trend, the field will be left blank.

i) *Variations in RVR*—Two RVR values may be reported, the minimum and maximum 1-min mean RVR values during the 10-min period preceding the observation, if they vary from the 10-min mean by at least 20% (and by 150 ft).

Example:

“R06L/1000V2400FT/U” decodes as the minimum RVR for Runway 06 Left is 1 000 ft; the maximum RVR is 2 400 ft; and the trend is upward.

j) *Present weather*—The present weather is coded in accordance with the WMO Code Table 4678, which follows. As many groups as necessary are included, with each group containing from two to nine characters.

Present weather is comprised of weather phenomena, which may be one or more forms of precipitation, obscuration, or other phenomena. Weather phenomena are preceded by one or two qualifiers; one of which describes either the intensity or proximity to the station of the phenomena, the other of which describes the phenomena in some other manner.

**Table 8.1—Significant Present Weather Codes
(WMO Code Table 4678, incorporating Canadian differences)**

QUALIFIER			WEATHER PHENOMENA					
INTENSITY or PROXIMITY	DESCRIPTOR		PRECIPITATION		OBSCURATION		OTHER	
NOTE: Precipitation intensity refers to all forms combined.	MI	Shallow	DZ	Drizzle	BR	Mist (Vis ≥ 5/8 SM)	PO	Dust/sand Whirls (Dust Devils)
	BC	Patches	RA	Rain				
	PR	Partial	SN	Snow	FG	Fog (Vis < 5/8 SM)	SQ	Squalls
	DR	Drifting	SG	Snow Grains	FU	Smoke (Vis ≤ 6 SM)	+FC	Tornado or Waterspout
– Light	BL	Blowing	IC	Ice Crystals (Vis ≤ 6 SM)	DU	Dust (Vis ≤ 6 SM)	FC	Funnel Cloud
	SH	Shower(s)						
Moderate (no qualifier)	TS	Thunderstorm	PL	Ice Pellets	SA	Sand (Vis ≤ 6 SM)	SS	Sandstorm (Vis < 5/8 SM) (+SS Vis < 5/16 SM)
			GR	Hail				
+Heavy	FZ	Freezing	GS	Snow Pellets	HZ	Haze (Vis ≤ 6 SM)	DS	Dust storm (Vis < 5/8 SM) (+DS Vis < 5/16 SM)
VC In the vicinity			UP	Unknown precipitation (AWOS only)	VA	Volcanic Ash (with any visibility)		

(i) *Qualifiers*

(A) *Intensity: (–) light (no sign) moderate (+) heavy*

If the intensity of the phenomena being reported in a group is either light or heavy, this is indicated by the appropriate sign. No sign is included if the intensity is moderate, or when intensity is not relevant. If more than one type of precipitation is reported together in a group, the predominant type is given first; however, the reported intensity represents the overall intensity of the combined types of precipitation.

(B) *Proximity: The proximity, qualifier “VC”, is used in conjunction with the following phenomena:*

- SH (showers)
- FG (fog)
- FC (funnel cloud)
- +FC (tornado or waterspout)
- TS (thunderstorm)
- BLSN (blowing snow)
- BLDU (blowing dust)
- BLSA (blowing sand)
- PO (dust/sand whirls)
- DS (dust storm)
- SS (sandstorm)

VC is used if these phenomena are observed within 5 SM, but not at the station. When VC is associated with SH, the type and intensity of precipitation are not specified because they cannot be determined.

(C) *Descriptor: No present weather group has more than one descriptor. The descriptors MI (shallow), BC (patches) and PR (partial) are used only in combination with the abbreviation FG (fog), e.g. MIFG.*

The descriptors DR (drifting) and BL (blowing) are used only in combination with SN (snow), DU (dust) and SA (sand). Drifting is used if the snow, dust or sand is raised less than 2 m above ground; if 2 m or more, blowing is used. If blowing snow (BLSN) and snow (SN) are occurring together, both are reported but in separate present weather groups, e.g. “SN BLSN”.

SH (shower) is used only in combination with precipitation types RA (rain), SN (snow), PL (ice pellets), GR (hail) and GS (snow pellets) if occurring at the time of observation, e.g. “SHPL” or “–SHRAGR”. SHGS refers to either snow pellet showers or small hail (less than 5 mm diameter). When it is used for small hail, the diameter of the hail is included in remarks and CB are usually present.

TS (thunderstorm) is either reported alone or in combination with one or more of the precipitation types. The end of a thunderstorm is the time at which the last thunder was heard, followed by a 15-min period with no further thunder.

TS and SH are not used together, since present weather groups can have only one descriptor.

FZ (freezing) is used only in combination with the weather types DZ (drizzle), RA (rain) and FG (fog).

MET

- (ii) Weather phenomena—Different forms of precipitation are combined in one group, the predominant form being reported first. The intensity qualifier selected represents the overall intensity of the entire group, not just one component of the group. The one exception is freezing precipitation (FZRA or FZDZ), which is always reported in a separate present weather group. Obstructions to vision are generally reported if the prevailing visibility is 6 SM or less, with some exceptions. Any obscuration occurring simultaneously with one or more forms of precipitation is reported in a separate present weather group. Other phenomena are also reported in separate groups, and, when funnel clouds, tornados or waterspouts are observed, they will be coded in the present weather section, as well as being written out in their entirety in remarks.
- k) Sky conditions—This group reports the sky condition for layers aloft. A vertical visibility (VV) is reported in hundreds of feet when the sky is obscured. All cloud layers are reported based on the summation of the layer amounts as observed from the surface up, reported as a height above the station elevation in increments of 100 ft to a height of 10 000 ft, and thereafter in increments of 1 000 ft. The layer amounts are reported in eighths (oktas) of sky coverage as follows:

Table 8.2—Sky Conditions for METARs

SKC	"sky clear"	no cloud present
FEW	"few"	less than 1/8 to 2/8 summation amount
SCT	"scattered"	3/8 to 4/8 summation amount
BKN	"broken"	5/8 to less than 8/8 summation amount
OVC	"overcast"	8/8 summation amount
CLR	"clear"	clear below 25 000 ft as interpreted by an AWOS

Significant convective clouds (cumulonimbus or towering cumulus only), if observed, are identified by the abbreviations CB (cumulonimbus) or TCU (towering cumulus), which are appended to the cloud group without a space, e.g. "SCT025TCU".

When observed, CB and TCU of any amount are always reported in the remarks of the aerodrome routine meteorological report (METAR) or aerodrome special meteorological report (SPECI), even if they are only embedded or distant.

When either CB or TCU is the predominant cloud type in a layer reported in the cloud group of the METAR/SPECI, the applicable cloud type (CB or TCU) is included within the cloud group. When an individual layer of cloud is composed of CB and TCU with a common cloud base, the type shall be reported as CB only.

The automated weather observation system (AWOS) cannot report cloud types. AWOS cloud layers are limited to four, and it will report clear (CLR) when no layers are detected below a base of 25 000 ft (some private AWOS are limited to cloud bases of 10 000 ft).

A ceiling is the lesser of the following: the height above ground or water of the base of the lowest layer of cloud covering more than half of the sky, or the vertical visibility in a surface-based layer which completely obscures the whole sky. Therefore, a ceiling exists at the height of the first layer for which a coverage symbol of BKN or OVC is reported. The existence of a vertical visibility constitutes an obscured ceiling.

- l) *Temperature and dew point*—This group reports the air temperature and the dew point temperature, rounded to the nearest whole Celsius degree (e.g. +2.5°C would be rounded to +3°C). Negative values are preceded by the letter M, and values with a tenths digit equal to precisely 5 are rounded to the warmer whole degree. For example, 2.5, -0.5, -1.5, and -12.5 would be reported as 03, M00, M01 and M12, respectively.
- m) *Altimeter setting*—This group reports the altimeter setting. A is the group indicator, followed by the altimeter setting indicated by a group of four figures representing tens, units, tenths and hundredths of inches of mercury. To decode, place a decimal point after the second digit (e.g. A3006 becomes 30.06).
- n) *Wind shear*—This group contains reports of low-level wind shear (within 1 500 ft AGL) along the take-off or approach path of the designated runway. The two-digit runway identifier is used, to which the letters "L", "C", or "R" may be appended. If the existence of wind shear applies to all runways, "WS ALL RWY" is used.
- o) *Remarks*—Remarks will appear in reports from Canada, prefaced by RMK. Remarks will include, where observed, layer type and cloud or obscuring phenomena (in eighths of sky covered or oktas), general weather remarks, and sea level pressure, as required. The sea level pressure, prefixed by "SLP" and indicated in hectopascals, will be the last mandatory field in the METAR. Density altitude will be indicated after sea level pressure when the density altitude is 200 ft or more than the aerodrome elevation.

Abbreviations for cloud types:

- | | |
|------------------------|-------------------------------|
| CI = cirrus | NS = nimbostratus |
| CS = cirrostratus | ST = stratus |
| CC = cirrocumulus | SF = stratus fractus |
| AS = altostratus | SC = stratocumulus |
| AC = altocumulus | ACC = altocumulus castellanus |
| CU = cumulus | CF = cumulus fractus |
| TCU = towering cumulus | CB = cumulonimbus |

8.4 AERODROME SPECIAL METEOROLOGICAL REPORTS (SPECI)

8.4.1 Criteria for Taking Aerodrome Special Meteorological Reports (SPECI)

Special observations will be taken promptly to report changes that occur between scheduled transmission times whenever one or more of the following elements have changed in the amount specified. The amount of change is measured with reference to the preceding routine or special observation.

- a) *Ceiling*—The ceiling decreases to less than the following values, or it increases to equal to or greater than these values:
- (i) 1 500 ft
 - (ii) 1 000 ft
 - (iii) 500 ft
 - (iv) 400 ft*
 - (v) 300 ft
 - (vi) 200 ft*
 - (vii) 100 ft*
 - (viii) the lowest published minimum

Criteria marked with an asterisk (*) are applicable only at aerodromes with precision approaches, and only down to and including the lowest published minima for those aerodromes.

- b) *Sky condition*—A layer aloft is observed below:
- (i) 1 000 ft and no layer aloft was reported below this height in the report immediately previous; or
 - (ii) the highest minimum for IFR straight-in landing or takeoff, and no layer was reported below this height in the report immediately previous.
- c) *Visibility*—Prevailing visibility decreases to less than, or increases to equal to or greater than:
- (i) 3 SM
 - (ii) 1 1/2 SM
 - (iii) 1 SM
 - (iv) 3/4 SM*
 - (v) 1/2 SM
 - (vi) 1/4 SM*
 - (vii) the lowest published minimum

Criteria marked with an asterisk (*) are applicable only at aerodromes with precision approaches, and only down to and including the lowest published minima for these aerodromes.

- d) *Tornado, waterspout or funnel cloud*—If one or more of these phenomena:
- (i) is observed;
 - (ii) disappears from sight; or
 - (iii) is reported by the public (from reliable sources) to have occurred within the preceding six hours and not previously reported by another station.

- e) *Thunderstorm*—When storm activity:
- (i) begins;
 - (ii) increases in intensity to become “heavy”; or
 - (iii) ends (a SPECI shall be issued when 15 min have elapsed without the occurrence of thunderstorm activity).
- f) *Precipitation*—When any of the following begins, ends or changes intensity:
- (i) freezing rain
 - (ii) freezing drizzle
 - (iii) ice pellets (showery and non-showery)
 - (iv) rain
 - (v) rain showers
 - (vi) drizzle
 - (vii) snow
 - (viii) snow showers
 - (ix) snow grains
 - (x) hail
 - (xi) snow pellets
 - (xii) ice crystals begin or end

SPECIs shall be taken as required to report the beginning and end of each individual type of precipitation, regardless of simultaneous occurrences of other types. A leeway of up to 15 min is allowed after the ending of precipitation before a SPECI is mandatory.

Example:

–RA to –SHRA; SPECI not required.

- g) *Obstruction to vision*—A SPECI shall be taken to report the beginning or end of freezing fog.
- h) *Wind*—A SPECI shall be taken to report when the wind:
- (i) speed (2 min mean) increases suddenly to at least double the previously reported value and exceeds 30 kt;
 - (ii) direction changes sufficiently to fulfill criteria required for a “wind shift.”
- i) *Temperature*—A SPECI shall be taken to report when the temperature
- (i) increases by 5°C or more from the previous reported value and the previous reported value was 20°C or higher; or
 - (ii) decreases to a reported value of 2°C or lower.

The following airports have been identified for SPECI criteria for significant temperature changes between hourly reports:

- (i) Calgary Intl, Alta.
- (ii) Edmonton Intl, Alta.
- (iii) Gander Intl, N.L.
- (iv) Moncton/Greater Moncton Intl, N.B.
- (v) Montréal/Pierre Elliott Trudeau Intl, Que.
- (vi) Montréal/Mirabel Intl, Que.
- (vii) Ottawa/Macdonald-Cartier Intl, Ont.
- (viii) St. John’s Intl, N.L.
- (ix) Toronto/Lester B. Pearson Intl, Ont.
- (x) Vancouver Intl, B.C.

- (xi) Victoria Intl, B.C.
- (xii) Halifax Intl, N.S.
- (xiii) London, Ont.
- (xiv) Québec/Jean Lesage Intl, Que.
- (xv) Whitehorse Intl, Y.T.
- (xvi) Winnipeg Intl, Man.
- (xvii) Yellowknife, N.W.T.
- (xviii) Charlottetown, P.E.I.
- (xix) Fredericton, N.B.
- (xx) Prince George, B.C.
- (xxi) Regina Intl, Sask.
- (xxii) Saint John, N.B.
- (xxiii) Saskatoon/John G. Diefenbaker Intl, Sask.
- (xxiv) Thunder Bay, Ont.

- j) *Volcanic eruption*—A SPECI shall be issued when a volcano erupts.

8.4.2 Local Criteria

Additional criteria may be established to meet local requirements.

8.4.2.1 Observer's Initiative

The criteria specified in the preceding paragraphs shall be regarded as the minimum requirements for taking special observations. In addition, any weather condition that, in the opinion of the observer, is important for the safety and efficiency of aircraft operations, or otherwise significant, shall be reported by a special observation.

8.4.2.2 Check Observations

Check observations are taken between regular hourly observations to ensure that significant changes in weather do not remain unreported. If such an observation does not reveal a significant change, it is designated as a “check observation.” If a significant change has occurred, the report is treated as a “special observation.”

A check observation shall be taken whenever a PIREP is received from an aircraft within 1 1/2 SM of the boundary of an airfield, and the PIREP indicates that weather conditions, as observed by the pilot, differ significantly from those reported by the current observation (i.e. the PIREP indicated that a special report may be required). This check observation should result in one of the following:

- a) transmission of a special observation over regular communications channels; or
- b) if no special observation is warranted, transmission of the check observation, together with the PIREP, to local airport agencies.

8.5 AUTOMATIC AERODROME ROUTINE METEOROLOGICAL REPORTS (METAR AUTO) AND LIMITED WEATHER INFORMATION SYSTEM (LWIS) REPORTS

8.5.1 Automatic Aerodrome Routine Meteorological Reports (METAR AUTO)

Automated aviation weather observations are an integral component of the aviation weather reporting system in Canada, and there are currently more than 80 in operation in all regions of the country. They were developed to provide an alternative method of collecting and disseminating weather observations from sites where human observation programs could not be supported. Automation provides accurate and reliable data, but it does have limitations and characteristics that are important to understand when using the information.

NAV CANADA AWOS that produces METAR AUTO reports incorporates sensors capable of measuring cloud base height (up to 25 000 ft AGL); sky cover; visibility; temperature; dew point; wind velocity; altimeter setting; precipitation occurrence, type, amount and intensity; and the occurrence of icing. METARs and SPECIs based on automated weather observations include the word “AUTO”. METAR AUTO observations are reported on the hour and SPECI AUTO observations are issued to report significant changes in cloud ceiling, visibility and wind velocity, as well as the onset and cessation of thunderstorms, precipitation or icing. AWOS operated by NAV CANADA and DND issue METAR AUTO reports and, when appropriate, SPECI AUTO reports.

AWOS is based on sensors that sample the atmosphere and prepare a data message every minute. If the observed weather conditions have changed significantly enough to meet the SPECI criteria, subject to the various processing algorithms, a SPECI AUTO will be issued. Human observers view the entire celestial dome and horizon; this results in a naturally smoothed and more representative value for ceiling and visibility. Because of the precise measurement, continuous sampling and unidirectional views of the sensors, NAV CANADA AWOS normally produces more SPECI observations than human observation sites (five to six percent of the time SPECI AUTO counts exceed six per hour). In cases where there are several reports issued over a short period of time, it is important to summarize the observations to gain an appreciation of the weather trend. One report in a series should not be expected to represent the prevailing condition.

For more information about METAR AUTO reports, please refer to MET 1.2.6.1.

8.5.2 Limited Weather Information System (LWIS) Reports

LWIS is an automated weather system which produces an hourly report containing wind speed and direction; temperature; dew point; and altimeter setting. LWIS is designed for use at aerodromes where provision of METAR AUTO and SPECI AUTO reports is not justified, but support for a CAP approach is required. For more information about LWIS reports, see MET 1.2.6.2.

Example:

LWIS CYXP 221700Z AUTO 25010G15KT 03/M02 A3017=

8.5.3 Automated Weather Observation System (AWOS) and Limited Weather Information System (LWIS) Performance Characteristics

All AWOS and LWIS systems operated by NAV CANADA have the following performance characteristics.

- a) Thunderstorm reporting (AWOS) at sites within the domain of the CLDN. Thunderstorm activity, based on the proximity of the lightning strike(s) to the site, will be reported as:
 - (i) TS—Thunderstorm (at site), if lightning detected at 6 SM or less;
 - (ii) VCTS—Thunderstorm in vicinity, if lightning detected from > 6 to 10 SM;
 - (iii) LTNG DIST (direction)—If lightning detected from > 10 to 30 SM, lightning distant with octant compass cardinal direction shall be reported in remarks, e.g. LTNG DIST NE, S, SW; and
 - (iv) LTNG DIST ALL QUADS—Lightning distant all quadrants will be reported in remarks if lightning is detected in four or more octants.
- b) Ice-resistant anemometer (AWOS and LWIS)—New ice-resistant technology essentially eliminates anemometer performance degradation due to freezing precipitation, freezing fog or snow contamination.
- c) Freezing drizzle and drizzle are not reported. When drizzle is occurring, the AWOS will usually report either rain or unknown precipitation. When freezing drizzle is occurring, the AWOS will usually report either freezing rain or freezing precipitation of an unknown type.
- d) Density altitude reporting capability (AWOS and LWIS)—Density altitude is the altitude in ISA at which the air density would be equal to the air density at field elevation at the current temperature. This remark is only added when the density altitude, rounded to the nearest 100 ft, is 200 ft or higher than the aerodrome elevation. A rough value of density altitude can be approximated by adding 118.8 ft to the aerodrome pressure altitude for every degree Celsius the temperature is above ISA. Density altitude can also be less than aerodrome elevation and can be estimated by subtracting 118.8 ft from the aerodrome pressure altitude for every degree Celsius colder than ISA, but it is not reported.
- e) Visibility (AWOS)—Visibility will be reported in daytime and at night in a manner similar to human assessment.
- f) Ceilometer—AWOS is capable of reporting cloud bases up to 25 000 ft.
- g) “Obstructions to vision” reporting capability—AWOS is able to report haze (HZ); mist (BR); fog (FG); freezing fog (FZFG); and blowing snow (BLSN).
- h) VGSS—Text-to-voice technology at many sites for local VHF transmission of weather report to pilots.
- i) Icing—The occurrence of icing at the time of observation or during the past hour will be noted in remarks.
- j) RVR reporting (AWOS) at sites where RVR sensors are installed.
- k) Digital aviation weather cameras (WxCam) are installed at stand-alone locations as well as at many AWOS and LWIS sites.

All regulated observations of wind speed, direction, and character, as well as temperature, dew point, and altimeter setting must meet the same performance specifications regardless of the means of assessment (either human or automated). Among these requirements is one that stipulates that all reports of altimeter setting must be based upon a fail-safe design that utilizes two or more independently operating pressure sensors that must agree within established tolerances before they can be included in a report.

8.5.4 Automatic Aerodrome Routine Meteorological Reports (METAR AUTO) and Human Observation Comparison

METAR AUTO provided by NAV CANADA AWOS and METAR issued by human are compared in the following table.

Table 8.3—METAR Observation Comparison

WX Report Parameter	Human Observation	NAV CANADA METAR AUTO	
Report type	METAR or SPECI	METAR or SPECI	
Location indicator	Four-letter indicator (e.g. CYQM, CYVR).	No difference.	
	At stations where the observer is not at the aerodrome, (beyond 1.6 NM [3 km] of the geometric centre of the runway complex) the Wx report indicator differs from the aerodrome indicator, e.g. Cartwright aerodrome is CYCA; the Wx report is identified as CWCA.	No difference.	
Report time	Date and time in UTC, followed by a "Z", e.g. 091200Z.	No difference.	
Type indicator		AUTO	
Corrections indicator	Corrections can be issued, e.g. "CCA", the "A" indicates the first correction.	Not applicable.	
Wind	A 2-min average direction in degrees true; speed in kt; "G" represents a gust, e.g. 12015G25KT.	No difference.	
	Human observers shall provide an estimate of wind speed and direction in the event of wind sensor failure.	No difference. NOTE: When a VGSS is installed, the wind direction will be broadcast in degrees magnetic if the AWOS is located in SDA; elsewhere, it will be broadcast in degrees true. If wind information is missing, five forward slashes (/) are placed in the wind field, e.g. /////.	
Variable wind group	Wind direction variation of 60° or greater.	No difference.	
Visibility	Reported in SM up to 15 mi. After 15 mi., it is reported as 15+, e.g. 10 SM.	Reported in SM up to 9 mi.	
	Fractional visibilities are reported.	No difference.	
	Visibility is prevailing visibility, i.e. common to at least half the horizon circle.	Visibility is measured using fixed, unidirectional, forward scatter techniques.	Reported visibilities tend to be comparable to (especially with visibility less than 1 SM) or higher than human observations in precipitation.
		Reported visibilities at night are the same as the day and tend to be comparable to or higher than human observations.	
RVR	Runway direction, followed by the visual range in feet, followed by a trend. RVR will be reported where equipment is available.	No difference.	

WX Report Parameter	Human Observation	NAV CANADA METAR AUTO
Weather group	See the WMO Code Table 4678 (Table 8.1) in MET 8.3 for the symbols used for obstructions to visibility (e.g. smoke, haze).	AWOS are capable of reporting FG, FZFG, BR, BLSN and HZ.
	See the table WMO Code Table 4678 (Table 8.1) in MET 8.3 for the symbols used for the description of weather.	AWOS will report weather phenomena using the following symbols: RA—rain, FZRA—freezing rain, SN—snow, UP—unknown precipitation type. AWOS reports thunderstorms (TS) and includes remarks on location of lightning. Drizzle (DZ) or freezing drizzle (FZDZ) are not reported and will usually be reported as rain (RA or FZRA) or unknown precipitation type (UP or FZUP).
	"+" or "-" is used to indicate weather intensity.	No difference. Squalls are not reported. AWOS does not report "in the vicinity" phenomena other than TS and lightning. AWOS may sporadically report freezing precipitation at temperatures above 0°C and below +3°C, during periods of wet snow, rain, drizzle or fog.
Cloud amount and sky conditions	Observer views entire celestial dome and determines cloud-base height, layer amounts and opacity, and cumulative amount and opacity.	Laser ceilometer views one point directly over the station. It measures the cloud-base height and then uses time integration to determine layer amounts.
	SKC or height of cloud base plus FEW, SCT, BKN, OVC.	Height of cloud base plus FEW, SCT, BKN, OVC. "CLR" is reported if no cloud below 25 000 ft AGL is detected.
	Surface-based layers are prefaced by "VV" and a three-figure vertical visibility.	No difference.
	The cloud layer amounts are cumulative.	No difference.
		Multiple overcast layers can be detected and reported.
		Ceilometer may occasionally detect ice crystals, smoke aloft or strong temperature inversion aloft and report them as cloud layers.
Reported cloud layers in precipitation are comparable to or lower than human observations.		
Check GFA and TAF for further information.		
Temperature and dew point	Temperature then dew point expressed as a two-digit number in degrees Celsius, separated by a forward slash (/) and preceded by an "M" for below freezing temperatures, e.g. 03/M05.	No difference.
Altimeter setting	An "A" followed by a four-digit number in inches of mercury. e.g. A2997.	No difference.
Wind shear	Existence in the lower layers shall be reported when known to the observer.	Not reported.

WX Report Parameter	Human Observation	NAV CANADA METAR AUTO
Supplementary information (Remarks)	See the WMO Code Table 4678 (Table 8.1) in MET 8.3 for the symbols used to describe clouds and obscuring phenomena.	Clouds and obscuring phenomena are not described in METAR AUTO or SPECI AUTO reports.
	Significant weather or variation not reported elsewhere in the report.	Currently, remarks are limited. When visibility is variable, the remark VIS VRB followed by the limits will appear, e.g. VIS VRB 1-2. When icing is detected, ICG, ICG INTMT or ICG PAST HR will appear. Remarks on precipitation amount, rapid changes in pressure and the location of lightning may also appear.
Barometric pressure	The last remark in the METAR or SPECI is the mean sea level pressure in hectopascals, e.g. SLP127 (1012.7 hPa).	No difference.
Density altitude	Density altitude for heights 200 ft above aerodrome elevation. The dry air density altitude will be included in the remarks.	No difference.

Example of METAR issued by human observation:

METAR CYEG 151200Z CCA 12012G23KT 3/4SM R12/4000FT/D -RA BR FEW008 SCT014 BKN022 OVC035 10/09 A2984 RMK SF1SC2SC4SC1 VIS W2 SLP012=

Example of METAR AUTO issued by NAV CANADA’s AWOS system:

METAR CZVL 151200Z AUTO 12012G23KT 3/4SM -RA FEW008 SCT014 BKN022 OVC035 10/09 A2984 RMK SLP012=

NOTE:

If an AWOS sensor is malfunctioning or has shut down, that parameter will be missing from the report.

8.6 VOICE GENERATION SYSTEMS

Where a voice generator sub-system (VGSS), very high frequency (VHF) radio and/or telephone are connected to the automated weather observation system (AWOS) or limited weather information system (LWIS), the most recent data gathered once each minute will be broadcast to pilots on the VHF frequency and/or via the telephone number published in the *Canada Flight Supplement* (CFS). A pilot with a VHF receiver should be able to receive the VGSS transmission at a range of 75 NM from the site at an altitude of 10 000 ft AGL. Weather data will be broadcast in the same sequence as that used for aerodrome routine meteorological reports (METARs) and aerodrome special meteorological reports (SPECIs).

A human observed METAR/SPECI or a METAR AUTO/SPECI AUTO shall take priority over an automated voice generated report (minutely reports). During the hours when a human

observation program is operating and there is no direct VHF communication between the pilot and the weather observer, the VGSS VHF transmitter will normally be off. This eliminates the risk of a pilot possibly receiving two contradictory and confusing weather reports.

In variable weather conditions, there may be significant differences between broadcasts only a few minutes apart. It is very important during these conditions to obtain several broadcasts of the minutely data for comparison to develop an accurate picture of the actual conditions to be expected at the location.

Below is the typical format of an NAV CANADA AWOS voice message:

“(site name) AUTOMATED WEATHER OBSERVATION SYSTEM—OBSERVATION TAKEN AT (time) — WIND (direction) (MAGNETIC/TRUE) AT (speed) KNOTS — VISIBILITY (visibility data) — (present weather data) — (sky condition/cloud data) — TEMPERATURE (temperature data)— DEW POINT (dew point data)— ALTIMETER (altimeter data)”

Below is an example of the LWIS voice message:

“(site name) LIMITED WEATHER INFORMATION SYSTEM—CURRENT OBSERVATION TAKEN AT (time) — WIND (direction) (MAGNETIC/TRUE) (speed) KNOTS — TEMPERATURE (temperature data) — DEW POINT (dew point data) — ALTIMETER (altimeter data)”

NOTE:

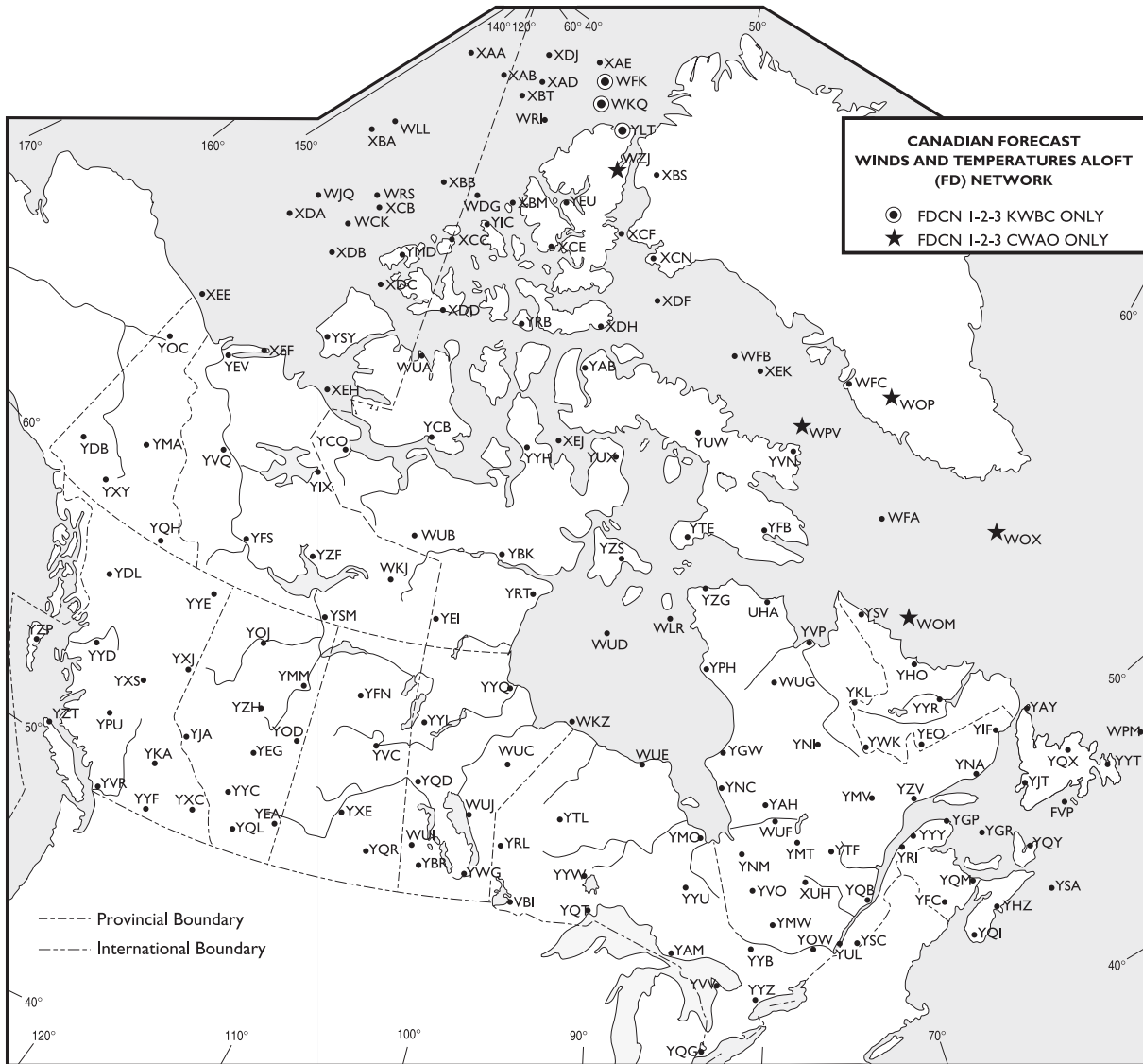
Missing data or data that has been suppressed is transmitted as “MISSING”.

METAR

9.0 UPPER LEVEL WINDS AND TEMPERATURES

9.1 CANADIAN FORECAST WINDS AND TEMPERATURES ALOFT NETWORK

Figure 9.1—Canadian Forecast Winds and Temperatures Aloft Network



MET

9.2 UPPER LEVEL WIND AND TEMPERATURE FORECASTS (FDs)

Upper level wind and temperature forecasts (FDs) are upper level forecasts of wind velocity, expressed in knots and to the nearest 10° true, and temperature, expressed in degrees Celsius. Temperatures are not forecast for 3 000 ft; in addition, this level is omitted if the terrain elevation is greater than 1 500 ft. All forecast temperatures for altitudes over 24 000 ft are negative.

measurements of pressure, temperature, relative humidity and wind velocity, taken at 32 sites twice daily (at 0000Z and 1200Z). Following the computer run of a subsequent numeric weather model, FD forecasts are available at the valid times indicated in MET 3.1.

Data for the production of FD forecasts are derived from a variety of atmospheric data sources, including upper air sounding

Table 9.1—FD Example 1

FDCN01 CWA0 071530 FCST BASED ON 071200 DATA VALID 080000 FOR USE 21-06					
Airport / FT	3 000	6 000	9 000	12 000	18 000
YVR	9900	2415-07	2430-10	2434-10	2542-26
YYF	2523	2432-04	2338-08	2342-13	2448-24
YXC		2431-02	2330-06	2344-11	2352-22
YYC		2426-03	2435-06	2430-12	2342-22
YQL		2527-01	2437-05	2442-10	2450-21

Table 9.2—FD Example 2

FDCN1 KWBC 080440DATA BASED ON 080000Z VALID 091200Z FOR USE 0900-1800Z. TEMPS NEG ABV 24 000				
Airport / FT	24 000	30 000	34 000	39 000
YVR	2973-24	293040	283450	273763
YYF	3031-24	314041	304551	204763
YXC	3040-27	315143	316754	306761
YYC	3058-29	317246	317855	306358
YQL	2955-28	306845	307455	791159

When the forecast speed is less than 5 kt, the code group is “9900,” which reads “light and variable.”

Encoded wind speeds from 100 to 199 kt have 50 added to the direction code and 100 subtracted from the speed. Wind speeds that have had 50 added to the direction can be recognized when figures from 51 to 86 appear in the code. Since no such directions exist (i.e. 510° to 860°), obviously they represent directions from 010° to 360°.

Should the forecast wind speed be 200 kt or greater, the wind group is coded as 199 kt, that is, 7799 is decoded as 270° at 199 kt or greater.

Examples of decoding FD winds and temperatures are as follows (the third and fourth examples are both for altitudes above 24 000 ft):



















Table 9.3—Example of Code Used in FDs

EXAMPLE	DECODED
9900 + 00	Wind light and variable, temperature 0°C
2523	250° true at 23 kt
791159	290° true (79 - 50 = 29) at 111 kt (11 + 100 = 111), temperature - 59°C
859950	350° true (85 - 50 = 35) at 199 kt or greater, temperature -50°C

Forecasts in digital form of the winds and the temperatures aloft (FB) are currently available over the phone. They have a similar format to FD forecasts but are updated four times a day and include other improvements. FD forecasts will continue to be available but will gradually be replaced by FB forecasts.

10.0 SURFACE WEATHER MAPS

Figure 10.1—Surface Weather Maps Legend

COLOUR	SYMBOL	DESCRIPTION
BLUE		High pressure centre
RED		Low pressure centre
BLUE		Cold front
BLUE		Cold front aloft
RED		Warm front
RED		Warm front aloft
RED / BLUE		Stationary front
PURPLE		Occluded front
BLUE		Cold frontogenesis
RED		Warm frontogenesis
RED / BLUE		Stationary frontogenesis
BLUE		Cold frontolysis
RED		Warm frontolysis
RED / BLUE		Stationary frontolysis
PURPLE		Occluded frontolysis
PURPLE		Squall line
PURPLE		Trough
BLUE / RED		Trowal

The following is a list of things to keep in mind when reading surface weather maps:

1. Check the time of the map to make sure that it is the latest one available.
2. Always remember that weather moves. A map provides a static picture of weather conditions over a large area at a specific time. Always use a map along with the latest reports and forecasts.
3. The curving lines on the map, which form patterns like giant thumbprints, are called isobars. Joining points of equal sea level pressure, isobars outline the areas of high and low pressure, marked H and L, respectively.
4. The winds at 2 000 ft AGL blow roughly parallel to the isobars—in a clockwise direction around highs and counter-clockwise around lows. Wind speeds vary with the distance between isobars. Where the lines are close together, moderate to strong winds can be expected; where they are far apart, light variable winds are expected.
5. The red and blue lines are called fronts. These lines indicate the zones of contact between large air masses with differing physical properties—cold vs. warm, dry vs. moist, etc. Blue lines are for cold fronts—cold air advancing. Red lines are for warm fronts—warm air advancing. Alternate red and blue lines are for quasi-stationary fronts—neither warm air nor cold air advancing. Hook marks in red and blue are for trowals—troughs of warm air aloft. A purple line is called an occluded front—where a cold front has overtaken a warm front. Solid coloured lines are fronts which produce air mass changes at the ground level as well as in the upper air.

MET

Dashed coloured lines represent “upper air” fronts—they also are important. Along all active fronts, one usually encounters clouds and precipitation.

- When colours cannot be used to distinguish the various kinds of fronts, monochromatic symbols are used.

isotachs are analyzed by a computer and are drawn at 30-kt intervals starting at 60 kt.

NOTE:

Computer analyzed charts have the analyzed parameters smoothed to some extent.

11.0 UPPER LEVEL CHARTS

Upper level charts depict two forms of data: actual and forecast. Actual measured conditions are represented on analyzed charts (ANAL). These charts show conditions as they were at a specific time in the past. Prognostic charts (PROG) show forecast conditions for a specific time in the future. Always check the map label for the type, date and valid time of a chart.

11.1 UPPER LEVEL ANALYSIS CHARTS

Meteorological parameters in the upper atmosphere are measured twice a day (0000Z and 1200Z). The data are plotted and analyzed on constant pressure level charts. These charts always indicate past conditions. The 850 hPa (5 000 ft), 700 hPa (10 000 ft), 500 hPa (18 000 ft) and 250 hPa (34 000 ft) analyzed charts are available in Canada and are generally in weather offices and on NAV CANADA’s aviation weather web site (AWWS) about three hours after the data are recorded.

The maps include the following useful information:

- Height**—The solid lines (contours) on all the charts represent the approximate height of the pressure level indicated by the map. The contours are labelled in decametres (10s of metres) such that on a 500 hPa map, 540 means 5 400 m and on a 250 hPa map, 1020 means 10 200 m. Contours are spaced 60 m (6 decametres) apart except at 250 hPa, where the spacing is 120 m.
- Temperature**—Temperature is analyzed on the 850 hPa and 700 hPa charts only. Dashed lines are drawn at 5°C intervals and are labelled 5, 0, -5, etc. Temperatures at 500 hPa and 250 hPa are obtained by reading the number in the upper left corner of each of the station plots.
- Wind direction**—Wind direction may be determined at any point by using the height contours. The wind generally blows parallel to the contours and the direction is determined by keeping the “wind at your back with low heights to the left”. The plotted wind arrows also provide the actual wind direction at the stations.
- Wind speed**—Wind speed is inversely proportional to the spacing of the height contours. If the contours are close together, the winds are strong; if far apart, the winds are light. The plotted wind arrows also provide the wind speed.

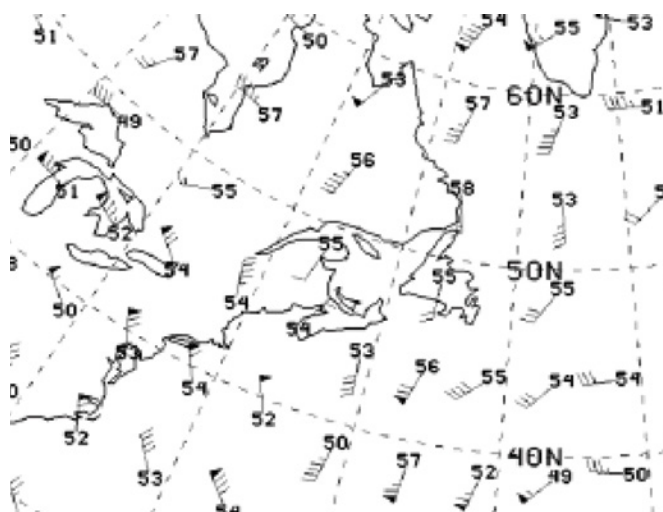
On the 250 hPa chart, wind speeds are analyzed using dashed lines for points with the same wind speed (isotachs). The

11.2 UPPER LEVEL PROGNOSTIC CHARTS

Upper level wind and temperature charts are issued by a world area forecast centre (WAFC), through the U.S. National Oceanic and Atmospheric Administration’s National Weather Service in Washington, D.C. Winds are depicted for FL 240, FL 340, FL 390 and FL 450 using arrow shafts with pennants (50 kt each), full feathers (10 kt each) and half feathers (5 kt each). The orientation of the shaft indicates wind direction (degree true). Temperatures (°C) are presented in bold type at fixed grid points for the flight level. All temperatures are negative unless otherwise noted.

Wind and temperature information from these charts, in conjunction with the upper level wind and temperature forecast (FD) and significant weather charts (SIGWX), can be used to determine wind shear and other salient information such as the probability of clear air turbulence (CAT) over given points. Remember, the wind speed is normally highest at the tropopause and decreases above and below at a relatively constant rate.

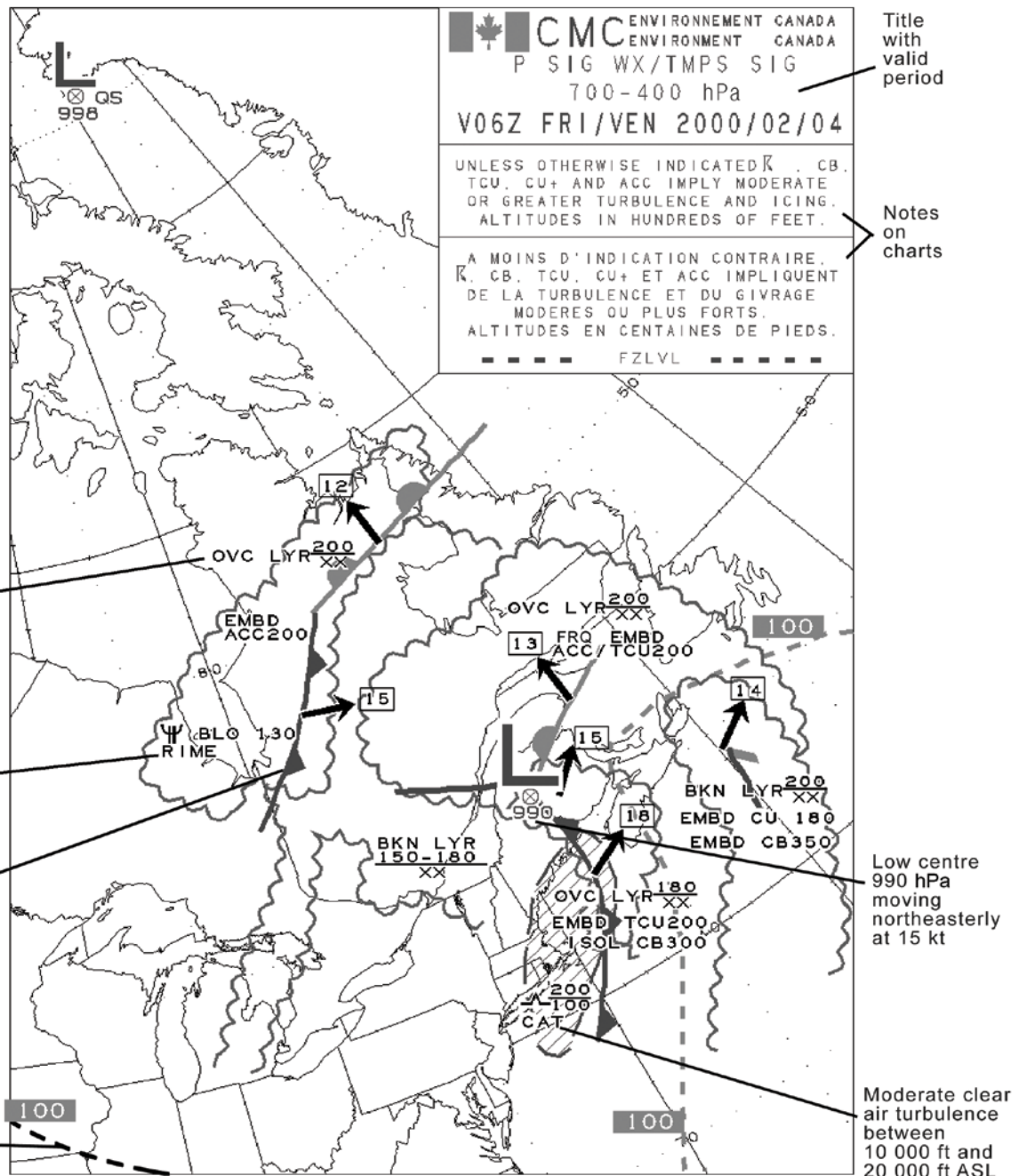
Figure 11.1—Section of an Upper Level Wind and Temperature Chart



12.0 SIGNIFICANT WEATHER PROGNOSTIC CHARTS

12.1 MID-LEVEL CHARTS

Figure 12.1(a)—Example of a Mid-Level Significant Weather Chart



The Canadian Meteorological Aviation Centres (CMACs) issue a series of significant weather prognostic charts for the mid-levels from 700 to 400 hPa (FL 100 to FL 240). They use the same criteria as the significant weather prognostic high-level charts plus the following:

- a) moderate to severe icing (light icing is not depicted);
- b) cloud layers of significance;

- c) marked mountain waves;
- d) freezing level line (0°C) at 5 000-ft intervals, and labeled in hundreds of feet; and/or
- e) surface positions and direction of motion (in knots) of highs, lows, and other significant features (front, trough).

Symbols used on the Significant Weather Prognostic Charts by the CMAC:

Figure 12.1(b)—Significant Weather Symbols

	Boundary of an Area of Significant Cloud		Boundary of an Area of Turbulence
	Moderate Turbulence*		Thunderstorm
	Severe Turbulence*		Severe Line Squall
	Light Icing*		Hurricane
	Moderate Icing*		Tropical Storm
	Severe Icing*		Dust or Sand Storm

* an abbreviation for the type of turbulence, or icing is placed below the symbol (for e.g. CAT for clear air turbulence or MXD for mixed icing).

CLOUD		
Cloud types are represented by the conventional abbreviation, cloud amounts are indicated as BKN or OVC and the height of the base and the tops are indicated by the following convention:	BKN AC 240	Alto cumulus, base below chart level, tops 24 000 ft.
	XX	

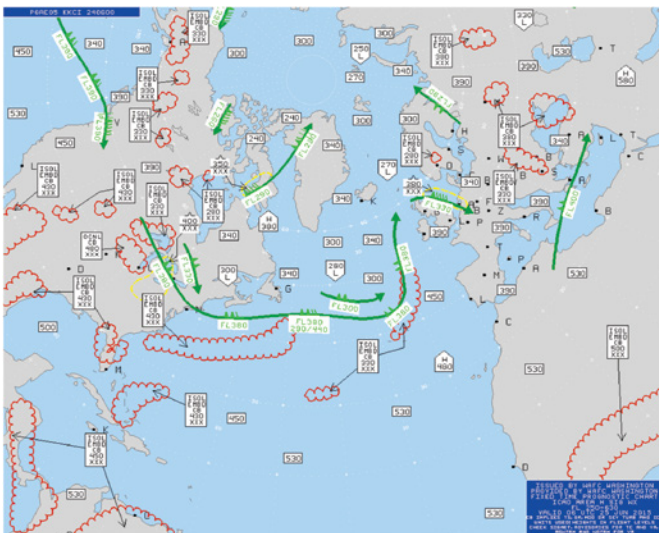
*** ABBREVIATIONS**

CAT	– clear air turbulence
ISOLD	– isolated
FRQ	– frequent
LYR	– layers
MXD	– mixed
OCNL	– occasional
LEE WV	– lee/mountain waves
CLR	– clear
FZLVL	– freezing level

Figure 12.1(c)—Fronts and Other Conventions

	Warm front		Occlusion		Trough of warm air aloft
	Cold front		Quasistationary front		Upper trough
	Mean sea level isobars, pressure in millibars		0°C Isotherm height in hundreds of feet		Trough line

12.2 HIGH-LEVEL CHARTS



These charts, produced for the mid and high levels, show occurring or forecast weather conditions considered to be of concern to aircraft operations. A world area forecast

centre (WAFC), through the U.S. National Oceanic and Atmospheric Administration’s National Weather Service, issues a chart depicting forecast weather conditions between FL 250 and FL 630. Each chart includes a background that depicts the major bodies of land and water for the related region along with a few letters that correspond to the first letters of the names of cities located at the adjacent black dot. The meteorological conditions depicted and the symbols used are:

- a) *Active thunderstorms*—The cumulonimbus (CB) symbol is used when thunderstorms occur, or are forecast to occur, over a widespread area, along a line, embedded in other cloud layers, or when concealed by a hazard. The amounts and the spatial coverage (in brackets) are indicated as:
 - (i) *ISOL (isolated)*—for individual CBs (less than 50%)
 - (ii) *OCNL (occasional)*—for well-separated CBs (50–75% inclusive)
 - (iii) *FRQ (frequent)*—for CBs with little or no separation (greater than 75%)

NOTE:

The definitions of the above terms, as used in the International Civil Aviation Organization (ICAO) charts, differ from those used for national significant meteorological information (SIGMET), AIRMET and graphic area forecast (GFA). The ICAO definitions involve 25% greater coverage in all cases. Some charts may include SCT which refers to 25–50% area coverage. In addition, ISOL is used by ICAO while ISOLD is used in national forecasts.

Embedded CBs may or may not be protruding from the cloud or haze layer. The following abbreviations are used to indicate the presence of CBs: ISOL embedded CB, OCNL embedded CB, FRQ embedded CB and FRQ CB. All other clouds are depicted using OKTA amounts, followed by the cloud type. In certain cases the abbreviation LYR (layer or layered) is used to indicate cloud structure.

- b) *Cloud heights*—When cloud tops or bases exceed the upper or lower limits of a significant weather prognostic chart, an XXX symbol is used on the appropriate side of the dividing line. Consider, for example, the significant weather prognostic chart that extends from FL 250 to FL 630. If well-separated embedded CBs based below FL 250 and topped at FL 450 were present, this would be depicted as follows:

Figure 12.2(b)—Clouds Heights



MET

The scalloped line indicates the area in which the conditions written inside apply.

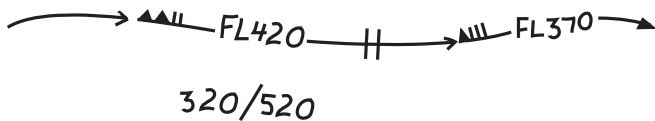
- c) *Tropopause heights*—Tropopause heights are depicted as flight levels, except when defining areas of very flat slope, and are enclosed in a rectangular box. The centre of the box represents the grid point being forecast.

Figure 12.2(c)—Tropopause Heights

450 : meaning FL450

- d) *Jet streams*—The height and speed of jet streams having a core speed of 80 kt or more are shown oriented to true north using arrows with pennants and feathers for speed and spaced sufficiently close to give a good indication of speed and height changes. A double-hatched line across the jet stream core indicates a speed increase or decrease of 20 kt or greater at a jet stream speed of 100 kt or higher. For example, a 120 kt jet stream initially at FL 420 dropping to 80 kt at FL 370 would be depicted as

Figure 12.2(d)—Jet Streams



The vertical depth of the jet stream is depicted by two numbers, indicating the base and top of the 80-kt isotach in hundreds of feet above sea level. In the above example, the 80-kt isotach is forecast to be based at FL 320 and topped at FL 520. Only jet streams with a speed of 120 kt or more will contain vertical depth information.

- e) *Turbulence*—Areas of moderate or severe turbulence in cloud or clear air are depicted using heavy dashed lines, height symbols, a for moderate turbulence and a for severe. Wind shear and mountain wave turbulence are included; convective turbulence is not. For example, an area of moderate turbulence between FL 280 and FL 360 would be shown as:

Figure 12.2(e)—Turbulence



- f) *Severe squall lines*—Severe squall lines are depicted using the symbol and are oriented to true north with a representative length. An area of frequent CBs associated with a squall line would be shown as:

Figure 12.2(f)—Severe Squall Lines

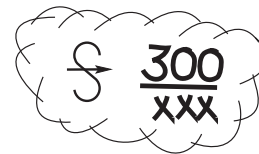


- g) *Icing and hail*—Icing and hail are not specifically noted, but rather, the following statement is included in the label on each chart:

SYMBOL CB IMPLIES HAIL, MODERATE OR GREATER TURBULENCE AND ICING

- h) *Widespread sandstorms or dust storms*—Areas of these conditions are shown using a scalloped line, height symbol and a . For example:

Figure 12.2(g)—Widespread Sandstorms or Dust Storms



- i) *Tropical cyclones*—The symbol is used to depict tropical

cyclones and, if any of the previous criteria are met, these will be included. For example, an area of frequent CBs between 10 000 ft and 50 000 ft with an associated tropical storm named “William” would be shown as:

Figure 12.2(h)—Tropical Cyclones



Significant weather prognostic charts depicting the tropical cyclone symbol will have a statement to the effect that the latest tropical cyclone advisory, rather than the tropical cyclone’s prognostic position on the chart, is to be given public dissemination.

MET

- j) *Volcanic eruptions*—Information on the location of volcanic eruptions that are producing ash clouds of significance to aircraft operations is shown as follows: the volcanic eruption symbol is shown at the location of the volcano; on the side of the chart, a box is shown containing the volcano eruption symbol, the name and international number of the volcano (if known), the latitude/longitude, and date and time of the first eruption (if known). Check SIGMET and NOTAM or ASHTAM for volcanic ash. The symbol is as follows, and may be depicted in red on colour charts:

Figure 12.2(i)—Volcanic Eruptions



- k) *Radioactive material in the atmosphere*—Information on the location of a release of radioactive materials into the atmosphere that is of significance to aircraft operations is shown as follows: the radioactivity symbol at the site of the accident; on the side of the chart, in a box containing the radioactivity symbol, latitude/longitude of the site of the accident, date and time of the release and a reminder to users to check NOTAM for the area concerned. The symbol, in black on a yellow circular background when depicted in colour, is as follows:

Figure 12.2(j)—Radioactive Material in the Atmosphere



13.0 VOLCANIC ASH PRODUCTS

- a) *ICAO products*—The Montréal volcanic ash advisory centre (VAAC), a unit of ECCC, is an International Civil Aviation Organization (ICAO) designated centre responsible for issuing specialized advisories when volcanic ash is present in Canadian-controlled airspace. VAAC Montréal issues volcanic ash advisories (VAA) on the horizontal and vertical extent of volcanic clouds, their altitude, and expected movements. These advisories are based on satellite observations, pilot reports, and weather forecast and dispersion models. VAA are issued as both text and graphic products and are available via the VAAC Montréal Web site at https://weather.gc.ca/eer/vaac/index_e.html.

Model simulations of volcanic ash—In addition to the official VAA described in the previous paragraph, results from simulations of the volcanic ash dispersion model, known as MLDPn (an abbreviation that stands for *modèle langrangien de dispersion de particules d'ordre n*), are also available at https://weather.gc.ca/eer/vaac/index_e.html. Forecasts of

concentrations of ash and the expected paths of volcanic clouds are generated when volcanic ash threatens Canadian-controlled airspace.

Such simulations are also performed for active volcanos whose eventual eruption could affect Canadian-controlled airspace. These MLDPn outputs are produced automatically using hypothetical eruption start times that are three hours apart. Forecast ash concentrations are presented as prognostic charts composed of four panels. Figure 13.1 shows the average concentration for three layers expressed in terms of flight levels (in hundreds of feet) as well as the ash mass loading for the whole atmospheric column: surface to FL200 (upper left-hand panel), FL200–FL350 (upper right-hand panel), FL350–FL600 (lower left-hand panel), and ash mass loading (lower right-hand panel).

The time at which the run starts is indicated in the legend box in the lower, left-hand portion of the image. The date and time of forecast validity are indicated on the clock in the lower, right-hand portion of the image. The results are based on the execution of the last global numerical weather prediction (NWP) model using either 0000 or 1200 UTC data.

The volcano of interest is at the centre of the image. The average volcanic ash concentration in the atmospheric layer is depicted as very low, low, moderate, or high. The isolines are for 1, 10, 100 and 1 000 $\mu\text{g}/\text{m}^3$ (micrograms per cubic metre). The areas between the isolines are enhanced as follows:

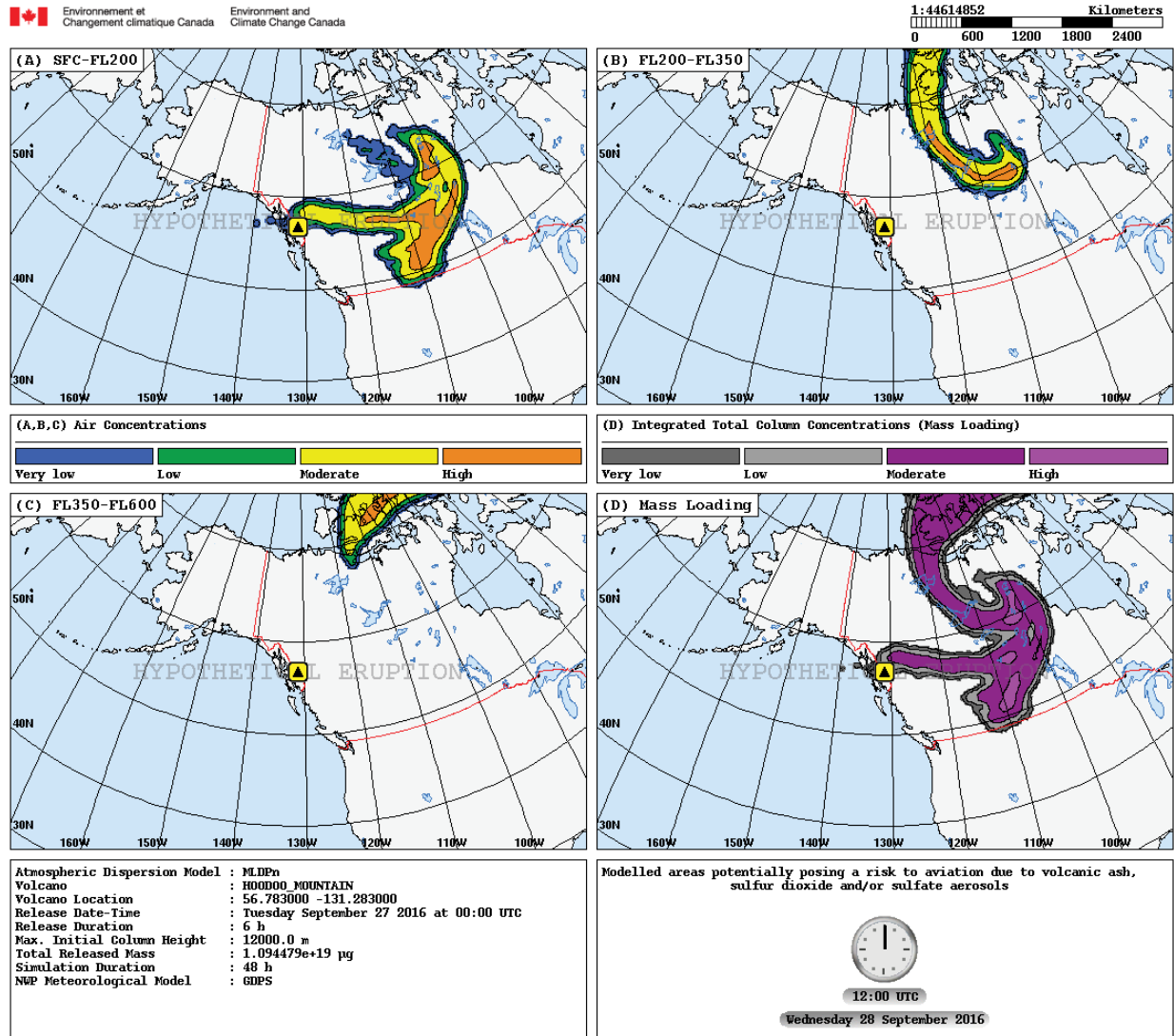
- 1–10 $\mu\text{g}/\text{m}^3$ is indicated by blue stippling;
- 10–100 $\mu\text{g}/\text{m}^3$ is indicated by green stippling;
- 100–1 000 $\mu\text{g}/\text{m}^3$ is indicated by yellow stippling; and
- > 1 000 $\mu\text{g}/\text{m}^3$ is indicated by orange stippling.

The total ash mass loading is also depicted as very low, low, moderate, or high, with isolines for 0.01; 0.1; 1 and 10 g/m^2 .

CAUTION:

Users are reminded to consult the latest significant meteorological information (SIGMET) and official ICAO products for updates on the position and vertical extent of the volcanic ash warning area. Even light (LGT) concentrations constitute a potential danger to aviation. Turbine engine flameouts have been attributed to light volcanic ash clouds located up to 1 000 NM from the source (see AIR 2.6).

Figure 13.1—Example of Volcanic Ash Forecast Caused by a Hypothetical Eruption



MET

14.0 SPACE WEATHER INFORMATION SERVICE

14.1 INTRODUCTION

Civil aviation may be affected by space weather phenomena, notably with respect to:

- a) high-frequency (HF) radio communications;
- b) global navigation satellite system-based (GNSS-based) navigation and surveillance;
- c) satellite communications; and
- d) increased exposure to radiation aboard aircraft.

ICAO has therefore organized a space weather information service, whereby advisories will be disseminated through the aeronautical fixed service (AFS), including the aeronautical fixed telecommunications network (AFTN) and the Air Traffic Services Message Handling System (AMHS), in cases of moderate or severe impacts on the four domains identified above.

14.2 NATURE OF THE DISTURBANCES

Space weather events are caused by solar flares and particles ejected from the sun. The electromagnetic radiation from solar flares causes a shortwave fadeout (i.e. an increased absorption of HF radio waves on the dayside of the earth that lasts for up to an hour). The particles arriving from the sun are guided to high latitudes, where they produce polar cap absorption and auroral absorption, which cause a loss of HF radio communications that can last for many hours and recur for several days. In addition, ionospheric disturbances at mid-latitudes can reduce the maximum useable frequency for HF radio communications.

Ionospheric disturbances can also interfere with the radio signals used for global navigation satellite system (GNSS) positioning and navigation. Increases in the total electron content (TEC) of the ionosphere lead to an increase in the transit time of the GNSS signal, producing position errors in GNSS receivers. Scintillation (rapid variations in amplitude or phase) of the radio signals can cause GNSS receivers to “lose lock” on the radio signals and give false information or no information at all. Satellite communications (SATCOM) signals also pass through the ionosphere and can be affected by scintillation.

High-energy particles from the sun are guided by the earth’s magnetic field and enter the atmosphere in polar regions. The latitudes affected depend on the energy of the particles. Most solar particles are absorbed by the atmosphere, but the high-energy particles that interact with atmospheric particles trigger secondary ionising particle cascades, which increase radiation aboard aircraft. The dose from these particles is greatest at the highest aviation altitudes and decreases with reduced altitude.

14.3 THE ICAO SERVICE ADVISORIES

Space weather service providers will issue an advisory when conditions exceed thresholds for moderate (MOD) or severe (SEV) events. The parameters and thresholds used to define MOD and SEV events are listed in the first edition (2019) of the *ICAO Manual on Space Weather Information in Support of International Air Navigation* (Doc 10100).

The space weather advisories will contain information about current conditions, as well as forecast levels for 6 hours, 12 hours, 18 hours, and 24 hours ahead.

Separate advisories will be issued for each of the following three phenomena:

- a) HF radio communications (HF COM)
- b) GNSS-based navigation (GNSS)
- c) Radiation at aircraft altitudes (RADIATION)

Advisories for satellite communications (SATCOM) will not be provided by any space weather centres as further work is required to establish operationally relevant thresholds for aviation SATCOM.

Affected geographic areas are referenced by their latitudes and longitudes, and above flight levels (ABV FL) for radiation. Abbreviations are also used:

- a) High latitudes northern hemisphere (N9000 – N6000): HNH
- b) Mid-latitudes northern hemisphere (N6000 – N3000): MNH
- c) Equatorial latitudes northern hemisphere (N3000 – N0000): EQN
- d) Equatorial latitudes southern hemisphere (S0000 – S3000): EQS
- e) Mid-latitudes southern hemisphere (S3000 – S6000): MSH
- f) High latitudes southern hemisphere (S6000 – S9000): HSH

NOTE:

Some advisories may be for the whole daylight side of Earth (daylight side).

Advisories will be issued as soon as an increase above the MOD or SEV thresholds are detected. Advisories are updated as often as necessary, but at least every 6 hours, until such time as the elevated space weather levels are no longer detected or no longer expected. At that time, an advisory will be issued stating that the event is finished, with the message that no elevated space weather is expected (NO SWX EXP).

Test or exercise advisories may be issued.

Space weather advisory information relevant to the whole route

should be supplied to operators and flight crew members as part of meteorological information.

14.4 RESPONSE TO ADVISORIES

The ICAO service does not define the operational responses to space weather events. Such responses are the responsibility of aircraft operators, who may choose to have operational procedures in place to be ready in case of space weather events. Guidance on the use of space weather advisory information is provided in Chapter 4 of the *ICAO Manual on Space Weather Information in Support of International Air Navigation* (Doc 10100, 2019).

14.5 SPACE WEATHER ADVISORY MESSAGE

A space weather advisory message has the following format:

Table 14.1—Space Weather Advisory Message Format

(1)	WMO Header (FNXX01, WMO location indicator, UTC date-time of issue of the message)
(2)	SWX ADVISORY (message type)
(3)	STATUS (either test (TEST) or exercise (EXER) if required)
(4)	DTG (Time of Origin – Year/month/date/time in UTC)
(5)	SWXC (name of Space Weather Centre)
(6)	ADVISORY NR (advisory number; unique sequence for each space weather effect: HF COM, GNSS, RADIATION, SATCOM)
(7)	NR RPLC (number of the previously issued advisory being replaced)
(8)	SWX EFFECT (effect and intensity of space weather phenomenon)
(9)	OBS (or FCST) SWX (Date and time [in UTC] and description of spatial extent of observed or forecast space weather phenomenon)
(10)	FCST SWX +6HR (Date-time [in UTC] of forecast spatial extent of space weather event)
(11)	FCST SWX +12HR (as above)
(12)	FCST SWX +18HR (as above)
(13)	FCST SWX +24HR (as above)
(14)	RMK (NIL or free text)
(15)	NXT ADVISORY (Year/month/date/time [in UTC] or NO FURTHER ADVISORIES)

14.6 EXAMPLES OF SPACE WEATHER ADVISORIES

Table 14.2—Advisories: Example #1

FNXX01 YMMC 020100	
SWX ADVISORY	
DTG:	20190502/0054Z
SWXC:	ACFJ
ADVISORY NR	2019/319
SWX EFFECT:	HF COM MOD
OBS SWX:	02/0054Z DAYLIGHT SIDE
FCST SWX + 6 HR:	02/0700Z DAYLIGHT SIDE
FCST SWX + 12 HR:	02/1300Z DAYLIGHT SIDE
FCST SWX + 18 HR:	02/1900Z NOT AVBL
FCST SWX + 24 HR:	03/0100Z NOT AVBL
RMK:	SOLAR FLARE EVENT IN PROGRESS IMPACTING HF COM ON DAYLIGHT SIDE. PERIODIC LOSS OF HF COM ON DAYLIGHT SIDE POSSIBLE NXT 12HRS.
NXT ADVISORY:	WILL BE ISSUED BY 20190502/0654Z=

Table 14.3—Advisories: Example #2

FNXX01 EFKL 190300	
SWX ADVISORY	
DTG:	20190219/0300Z
SWXC:	PECASUS
ADVISORY NR:	2019/20
SWX EFFECT:	RADIATION MOD
OBS SWX:	19/0300Z HNH HSH E18000-W18000 ABV FL370
FCST SWX + 6 HR:	19/0900Z NO SWX EXP
FCST SWX + 12 HR:	19/1500Z NO SWX EXP
FCST SWX + 18 HR:	19/2100Z NO SWX EXP
FCST SWX + 24 HR:	20/0300Z NO SWX EXP
RMK:	RADIATION AT AIRCRAFT ALTITUDES ELEVATED BY SMALL ENHANCEMENT JUST ABOVE PRESCRIBED THRESHOLD. DURATION TO BE SHORT-LIVED
NXT ADVISORY:	NO FURTHER ADVISORIES=

Table 14.4—Advisories: Example #3

FNXX01 KWNP 020100	
SWX ADVISORY	
DTG:	20190502/0100Z
SWXC:	SWPC
ADVISORY NR:	2019/59
SWX EFFECT:	GNSS MOD
OBS SWX	02/0100Z HNH HSH E18000-W18000
FCST SWX + 6 HR:	02/0700Z HNH HSH E18000-W18000
FCST SWX + 12 HR:	02/1300Z HNH HSH E18000-W18000
FCST SWX + 18 HR:	02/1900Z NO SWX EXP
FCST SWX + 24 HR:	03/0100Z NO SWX EXP
RMK:	IONOSPHERIC STORM CONTINUES TO CAUSE LOSS-OF-LOCK OF GNSS IN AURORAL ZONE. THIS ACTIVITY IS EXPECTED TO SUBSIDE IN THE FORECAST PERIOD
NXT ADVISORY:	20190502/0700Z=

15.0 ABBREVIATIONS—AVIATION FORECASTS

The following list of commonly used abbreviations is not exhaustive. For a complete list of abbreviations, please consult the *Manual of Word Abbreviations (MANAB)* on the ECCC Web site.

Table 15.1—Aviation Forecast Abbreviations

CONTRACTION	PLAIN LANGUAGE
ABV	above
ACC	altocumulus castellanus
ACRS	across
ACSL	standing lenticular altocumulus
AFL	above freezing layer
AHD	ahead
ALG	along
APCH	approach
ASL	above sea level
BECMG	becoming
BGNG	beginning
BKN	broken
BL	blowing
BLO	below
BR	mist
BRF	brief

CONTRACTION	PLAIN LANGUAGE
BRFLY	briefly
BRKS	breaks
BTN	between
CAT	clear air turbulence
CAVOK	ceiling and visibility OK
CB	cumulonimbus
CIG	ceiling
CLD	cloud
CLR	clear
CNTR	centre
CST	coast
CU	cumulus
DCRG	decreasing
DEG	degree
DNSLP	downslope
DP	deep
DPNG	deepening
DRFT	drifting
DURG	during
DVLPG	developing
DZ	drizzle
E	east
ELSW	elsewhere
EMBD	embedded
ENDG	ending
ERLY	easterly
EXC	except
FCST	forecast
FEW	Few
FG	fog
FM	from
FNT	front
FRQ	frequent
FT	foot
FU	smoke
FZ	freezing
FZLVL	freezing level
HGT	height
HI	high
HR	hour
HVY	heavy

MET

CONTRACTION	PLAIN LANGUAGE
ICG	icing
ICGIC	icing in cloud
ICGIP	icing in precipitation
INSTBY	instability
INTMT	intermittent
INTS	intense
INTSFY	intensify
ISOL	isolate
ISOLD	isolated
KT	knot
LCL	local
LFTG	lifting
LGT	light
LK	lake
LLJ	low-level jet stream
LLWS	low-level wind shear
LN	line
LO	low
LTL	little
LTNG	lightning
LVL	level
LWR	lower
LWRG	lowering
LYR	layer
MDT	moderate
MOVG	moving
MTS	mountains
MXD	mixed
N	north
NE	northeast
NELY	northeasterly
NGT	night
NLY	northerly
NM	nautical mile
NMRS	numerous
NR	near
NRLY	nearly
NSW	no significant weather
NW	northwest
NWLY	northwesterly
OBSC	obscure

CONTRACTION	PLAIN LANGUAGE
OBSCD	obscured
OCNL	occasional
OCNLY	occasionally
OFSHR	offshore
ONSHR	onshore
OTLK	outlook
OTWZ	otherwise
OVC	overcast
OVR	over
PCPN	precipitation
PD	period
PL	ice pellets
PROB	probability
PROG	prognostic, prognosis
PRSTG	persisting
PTCHY	patchy
PTLY	partly
QS	quasi-stationary
RA	rain
RDG	ridge
REP	report
REPS	reports
RGN	region
RPDLY	rapidly
S	south
SCT	scattered
SE	southeast
SELY	southeasterly
SEV	severe
SFC	surface
SH	shower
SHLW	shallow
SIGWX	significant weather
SKC	sky clear
SLY	southerly
SM	statute mile
SN	snow
SPECI	special meteorological report
SQ	squall
STG	strong
SVRL	several

CONTRACTION	PLAIN LANGUAGE
SW	southwest
SWLY	southwesterly
TCU	towering cumulus
TEMPO	temporary
TROF	trough
TROWAL	trough of warm air aloft
TRRN	terrain
TS	thunderstorm
TURB	turbulence
UPR	upper
UPSLP	upslope
UTC	coordinated universal time
VC	vicinity
VIS	visibility
VLY	valley
VRB	variable
VV	vertical visibility
W	west
WDLY	widely
WK	weak
WLY	westerly
WND	wind
WRM	warm
WS	wind shear
WV	wave
XTNSV	extensive
XTRM	extreme
Z	ZULU (or UTC)

MEET

RAC—RULES OF THE AIR AND AIR TRAFFIC SERVICES

1.0 GENERAL INFORMATION

1.1 AIR TRAFFIC SERVICES

The following is a list of control, advisory and information services that are available to pilots.

1.1.1 Air Traffic Control (ATC) and Information Services

The following air traffic control and information services are provided by ACCs and TWRs.

- a) Airport control service is provided by airport TWRs to aircraft and vehicles on the manoeuvring area of an airport and to aircraft operating in the vicinity of an airport.
- b) Area control service is provided by ACCs to IFR and CVFR flights operating within specified control areas.
- c) Terminal control service is provided by ACCs to IFR and CVFR flights operating within specified control areas.
- d) Terminal radar service is an additional service provided by IFR units to VFR aircraft operating within Class C airspace.
- e) Alerting service notifies appropriate organizations regarding aircraft in need of search and rescue services, or alerts crash equipment, ambulances, doctors and any other safety services.
- f) Altitude reservation service includes the service of the altitude reservation East (Gander) and altitude reservation West (Edmonton) in co-ordination with ACCs in providing reserved altitude for specified air operations in controlled airspace, and in providing information concerning these reservations and military activity areas in controlled and uncontrolled airspace.
- g) AMIS is provided by ACCs for the collection, processing and dissemination of aircraft movement information for use by air defence units relative to flights operating into or within Canadian ADIZ.
 - (i) Flight information service is provided by ATC units to assist pilots by supplying information concerning known hazardous flight conditions. This information will include data concerning unfavourable flight conditions and other known hazards; which may not have been available to the pilot prior to takeoff or which may have developed along the route of flight.

The ATC service has been established primarily for the prevention of collisions and the expediting of traffic. The provision of such service will take precedence over the provision of flight information service, but every effort will be made to provide flight information and assistance.

Flight information will be made available, whenever practicable, to any aircraft in communication with an ATC unit, prior to takeoff or when in flight, except where such service is provided by the aircraft operator. Many factors (such as volume of traffic, controller workload, communications frequency congestion and limitations of radar equipment) may prevent a controller from providing this service.

VFR flights will be provided with information concerning:

- a) severe weather conditions along the proposed route of flight;
- b) changes in the serviceability of navigation aids;
- c) conditions of airports and associated facilities;
- d) other items considered pertinent to safety of flight.

IFR flights will be provided with information concerning:

- a) severe weather conditions;
- b) weather conditions reported or forecast at destination or alternate aerodromes;
- c) changes in the serviceability of navigation aids;
- d) condition of airports and associated facilities; and
- e) other items considered pertinent to the safety of flight.

Flight information messages are intended as information only. If a specific action is suggested, the message will be prefixed by the term “ATC SUGGESTS...” or “SUGGEST YOU...” and the pilot will be informed of the purpose of the suggested action. The pilot is responsible for making the final decision concerning any suggestion.

Surveillance radar equipment is frequently used in the provision of information concerning hazards, such as chaff drops, bird activity and possible traffic conflicts. Due to limitations inherent in all radar systems, aircraft, chaff, etc., cannot be detected in all cases.

Whenever practicable, ATC will provide flights with severe weather information pertinent to the area concerned. Pilots may assist ATC by providing pilot reports of severe weather conditions they encounter. ATC will endeavour to suggest alternate routes available in order to avoid areas experiencing severe weather.

ATC will provide pilots intending to operate through chaff areas with all available information relating to proposed or actual chaff drops:

- a) location of chaff drop area;
- b) time of drop;
- c) estimated speed and direction of drift;
- d) altitudes likely to be affected; and
- e) relative intensity of chaff.

Information concerning bird activity, obtained through controller's observations or pilot reports, will be provided to aircraft operating in the area concerned. In addition, pilots may be warned of possible bird hazards if radar observation indicates the possibility of bird activity. Information will be provided concerning:

- a) size or species of bird, if known;
- b) location;
- c) direction of flight; and
- d) altitude, if known.

Radar traffic information and radar navigation assistance to VFR flights are contained in RAC 1.5.

1.1.2 Flight Advisory and Information Services

The following flight advisory and information services are provided by FICs and FSSs.

1.1.2.1 Flight Information Centres (FICs)

- a) *Pilot briefing service*: the provision of, or consultation on, meteorological and aeronautical information to assist pilots in pre-flight planning for the safe and efficient conduct of flight. The flight service specialist adapts meteorological information, including satellite and radar imagery, to fit the needs of flight crew members and operations personnel, and provides consultation and advice on special weather problems. Flight service specialists accept flight plan information during a briefing.
- b) *FISE*: the exchange on the FISE frequency of information pertinent to the en-route phase of flight. Air traffic information is not provided. Upon request from an aircraft, a FIC provides:
 - (i) meteorological information: SIGMET, AIRMET, PIREP, aerodrome routine meteorological report (METAR), aviation selected special weather report (SPECI), aerodrome forecast (TAF), altimeter setting, weather radar, lightning information and briefing update;
 - (ii) aeronautical information: NOTAM, RSC, CRFI,

MANOT and other information of interest for flight safety; and

- (iii) relay of communications with ATC: IFR clearance and SVFR authorization.

En-route aircraft may submit to a FIC: PIREPs, IFR and VFR position reports (including arrival and departure times), revised flight plan or flight itinerary information and other reports, such as vital intelligence sightings (CIRVIS) and pollution reports. Fuel dumping information may also be submitted for coordination with the appropriate ACC and for aeronautical broadcast needs.

- c) *Aeronautical broadcast service*: the broadcast on the FISE frequency, and on 126.7 MHz, of SIGMET, urgent PIREP and information concerning fuel dumping operations.
- d) *VFR flight plan alerting service*: the notification of RCCs and provision of communications searches when an aircraft on a VFR flight plan or flight itinerary becomes overdue and needs SAR aid.
- e) *Flight regularity message service*: the relay by FICs of messages between an aircraft in flight and the aircraft operating agency, and vice versa, when an agency with AFTN access subscribes to the service for an annual cost. Agencies interested in subscribing to this service should contact the NAV CANADA Customer Service Centre.

1.1.2.2 Flight Service Stations (FSSs)

- a) *AAS*: the provision of information pertinent to the arrival and departure phases of flight at uncontrolled aerodromes and for transit through an MF area. AAS is provided on the MF and is normally in conjunction with VCS.

The elements of information listed below are provided, if appropriate, by the flight service specialist during initial aerodrome advisory communications with an aircraft:

- (i) runway;
- (ii) wind direction and speed;
- (iii) air traffic that warrants attention;
- (iv) vehicle traffic;
- (v) wake turbulence cautionary;
- (vi) aerodrome conditions;
- (vii) weather conditions;
- (viii) additional information of interest for the safety of flight.

The flight service specialist updates this information, when appropriate, after the initial advisory. Pilots are encouraged to indicate in initial transmissions to the FSS that information has been obtained from the ATIS or from an AWOS (or LWIS) broadcast, or use the phrase “HAVE NUMBERS” if runway, wind and altimeter information from the previous aerodrome advisory have been received, so that the flight service specialist does not repeat the information.

Mandatory reports by aircraft on the MF are critical for the FSS to be able to provide effective air traffic information. At certain FSS locations, air traffic information may also be based on a radar display. A pilot remains responsible for avoidance of traffic in Class E airspace.

Communications regarding TCAS events and displayed information should be limited to that required to inform the flight service specialist that the aircraft is responding to an RA. Discretion should be used in using the TCAS traffic display to ask questions regarding traffic in the vicinity of an aircraft. As would be expected, aircraft shown on a TCAS display may not match the traffic information provided by the flight service specialist.

NOTAM, RSC and CRFI are included in advisories for a period of 12 hr for domestic traffic, and 24 hr for international traffic, after dissemination by means of telecommunication. Aerodrome conditions published prior to these time limits should have been received in the pilot briefing or can be obtained on request.

Aerodrome lighting is operated by the FSS, unless otherwise indicated in the CFS. The flight service specialist relays ATC clearances, SVFR authorizations, and routinely informs the ACC of all IFR arrival times. The specialist also relays a VFR arrival report to a FIC upon request from an aircraft.

Pilots should be aware that a flight service specialist will alert the appropriate agencies for any aircraft that has received a landing advisory for an aerodrome that lies within an MF area and within radio communication range, if it fails to arrive within 5 min of its latest ETA, and communication cannot be re-established with the aircraft.

b) *VCS*: the provision, at locations where AAS is provided, of instructions to control the movements of vehicles, equipment and pedestrians on manoeuvring areas of uncontrolled aerodromes. Flight service specialists will normally instruct vehicle traffic to leave the intended runway at least 5 min prior to the estimated time of landing or before a departing aircraft enters the manoeuvring area. The specialist will coordinate with the pilot prior to authorizing traffic to operate on the intended runway within less than 5 min of the estimated time of landing or the time an aircraft is ready for takeoff.

c) *VDF service*: the provision of VDF navigation assistance to VFR aircraft. This service includes provision of the aircraft’s bearing and a reciprocal heading, but is not intended as a substitute for normal VFR navigation.

1.1.2.3 Flight Information Centres (FICs) and Flight Service Stations (FSSs)

a) *RAAS*: the provision, via RCO, of information pertinent to the arrival and departure phases of flight and for transit through an MF area.

RAAS consists in the issuance of the same type of information as in AAS, except that it is provided from a remote location. It is emphasized that the flight service specialist cannot observe the runways, taxiways, airspace or weather conditions in the vicinity of the aerodrome. Wind, altimeter and other weather information is usually extracted from the latest METAR or SPECI, and may not always be as representative of actual conditions as in AAS.

b) *VAS*: the provision, via RCO, of information and advisories concerning the movements of vehicles, equipment and pedestrians on manoeuvring areas at designated uncontrolled aerodromes. VAS is provided at locations where RAAS is also provided. The flight service specialist will request vehicle traffic to leave the intended runway at least 5 min prior to the estimated time of landing, but cannot ascertain visually if the traffic has actually vacated the runway.

c) *Alerting service*: the notification of appropriate organizations regarding aircraft in need of SAR services or alerts of crash equipment, ambulances, doctors and any other safety services. Alerting of a responsible authority, if experiencing unlawful interference, bomb threat or inability to communicate in the clear, is also included in this service.

d) *Emergency assistance service*: the provision of aid to a pilot when in an emergency, or potential emergency situation, such as being lost, encountering adverse weather conditions or experiencing aircraft-related emergencies or equipment failure. At some locations, emergency navigational assistance is provided to a pilot who is lost or experiencing IMC, through the use of VDF equipment or by transferring the pilot to ATC for radar service.

e) *NOTAM information service*: the collection and dissemination of NOTAM, RSC, and CRFI information by the flight service specialist. A pilot may report to a FIC or to an FSS any hazards to the air navigation system that may need NOTAM distribution. The flight service specialist will distribute the information if it meets the criteria established in the *Canadian NOTAM Operating Procedures (CNOP)*.

- f) *Weather observation service*: the observation, recording and dissemination of surface weather information for aviation purposes.
- b) UNICOM operators meet the training requirements stipulated under CAR 804.01(1)(c) or the applicable exemption.

1.1.2.4 International Flight Service Station (IFSS)

An aeronautical station that provides a communications service for international air operators. Gander is the only IFSS in Canada.

1.1.3 Arctic Territories

Arctic territories are serviced by the Edmonton (Alta.), Winnipeg (Man.), and Quebec (Que.) FICs, which provide FISE and emergency communication to aircraft operating in the Northwest Territories and Nunavut and in the vicinity of the ADIZ.

1.1.4 Military Flight Advisory Unit (MFAU)

DND operates Military Flight Advisory Unit (MFAU) which provide flight information services that enhance flight safety and efficiency. These services are available by calling the appropriate station followed by “Advisory”, i.e. “Namaso Advisory”. MFAU provide en route flight information, airport advisory, ground control, field condition reports, flight planning, alerting service, navigation assistance, NOTAM, PIREPs, and weather reports. An MFAU may be used to accept and relay VFR and IFR position reports and ATC clearances.

1.2 SERVICES OTHER THAN AIR TRAFFIC SERVICES (ATS)

1.2.1 Universal Communications (UNICOM)

A UNICOM is an air-ground communications facility operated by a private agency to provide PAS service at uncontrolled aerodromes. At these locations the choice of frequencies are 122.7, 122.8, 123.0, 123.3, 123.5, 122.35, 122.95, 123.35, 122.725, 122.775, and 122.825 MHz.

The use of all information received from a UNICOM station is entirely at the discretion of the pilot. The frequencies are published in aeronautical information publications as a service to pilots, but TC takes no responsibility for the use made of a UNICOM frequency.

An AU is an air-ground communications service that can provide approach and landing information to IFR pilots. The service provider is required to ensure that:

- a) meteorological instruments used to provide the approach and landing information meet the requirements stipulated under CAR 804.01(1)(c) or the applicable exemption; and

Where the above standards are met, the AU operator may provide a station altimeter setting for an instrument procedure. The wind speed and direction for a straight-in landing from an instrument approach may or may not be provided.

Operators providing AU services may also advise pilots of runway conditions and of vehicle or aircraft positions on the manoeuvring area.

An AU is indicated as “UNICOM (AU)” in the CAP and the CFS.

1.2.2 Airport Radio/Community Aerodrome Radio Station

Airport radio (APRT RDO), in most cases, is provided by a community aerodrome radio station (CARS) and has been established to provide aviation weather and communication services to enhance aircraft access to certain aerodromes.

APRT RDO/CARS service is provided by observer-communicators (O/C) who are certified to conduct aviation weather observations and radio communications to facilitate aircraft arrivals and departures.

Hours of operation are listed in the *Canada Flight Supplement (CFS) Aerodrome/ Facility Directory* under the subheadings COM/APRT RDO.

Services provided by APRT RDO/CARS include the following:

- a) *Emergency Service*: The O/C will respond to all emergency calls (distress, urgency and ELT signals), incidents or accidents by alerting a designated NAV CANADA FIC and appropriate local authorities.
- b) *Communication Service*: The O/C will provide pilots with information in support of aircraft arrivals and departures, including wind, altimeter, runway and aerodrome status (including vehicle intentions and runway condition), current weather conditions, PIREPs and known aircraft traffic.

NOTES:

- O/Cs are authorized to provide an altimeter setting for an instrument approach.
- O/Cs provide limited traffic information. APRT RDOs/CARS are located at uncontrolled aerodromes within MF areas. Pilots must communicate on the MF as per uncontrolled aerodrome procedures.
- O/Cs do not provide ATC services. At aerodromes within controlled airspace served by APRT RDO/CARS, pilots must contact ATS via the RCO, PAL or telephone to obtain special VFR authorization or IFR clearances.

- c) *Weather Observation Service*: The O/C will monitor, observe, record and relay surface weather data for aviation purposes (METARs or SPECIs) in accordance with CAR 804 standards. The O/C may request PIREPs from pilots to confirm weather conditions, such as height of cloud bases.
- d) *Flight Plan/Flight Information Service*: If necessary, at most APRT RDOs/CARS, O/Cs will accept flight plans/ itineraries; however, pilots are encouraged to obtain a full pre-flight briefing and then file their flight plan/itinerary with a FIC.

NOTE

Pilots should be aware that O/Cs are only authorized to provide NOTAMs and weather information (METARs or SPECIs) for their own aerodrome. Information for other areas/aerodromes should be obtained from a FIC.

- e) At APRT RDO/CARS sites colocated with an RCO, pilots should open and close flight plans/itineraries, pass position reports and obtain FISE directly from the FIC via the RCO. At sites with no RCO, when requested by the pilot, the APRT RDO/CARS O/C will relay messages to open and close flight plans/ itineraries and position reports (IFR, VFR, DVFR) to a FIC.
- f) *Monitoring of Equipment/NAVAIDs*: During the APRT RDO/CARS hours of operation, O/Cs will monitor the status of equipment related to aerodrome lighting, weather, communications, etc. Malfunctions will be reported to the designated NAV CANADA facility, and a NOTAM will be issued as required. For site-specific NAVAID monitoring by APRT RDO/CARS, refer to the CFS and Enroute Low Altitude and Enroute High Altitude charts.

1.2.3 Private Advisory Stations (PAS)—Controlled Airports

Aeronautical operators may establish their own private facilities at controlled airports for use in connection with company business, such as servicing of aircraft, availability of fuel, and lodging. The use of PAS at controlled aerodromes shall not include information relative to ATC, weather reports, condition of landing strips, or any other communication normally provided by ATC units.

1.2.4 Apron Advisory Service

Apron advisory service at most controlled airports is provided by ATS. However, some large airports are providing advisory service on aprons through a separate apron management unit staffed by airport or terminal operator personnel. This service normally includes gate assignment, push-back instructions, and advisories on other aircraft and vehicles on the apron. Aircraft entering the apron will normally be instructed by the ground controller to contact apron prior to or at the designated change-over point. Aircraft leaving the apron shall contact ground on the appropriate frequency to obtain taxi clearance before exiting the apron and before entering the manoeuvring area.

1.3 AUTOMATIC TERMINAL INFORMATION SERVICE (ATIS)

ATIS is the continuous broadcasting of recorded information for arriving and departing aircraft on a discrete VHF/UHF frequency. Its purpose is to improve controller and flight service specialist effectiveness and to relieve frequency congestion by automating the repetitive transmission of essential but routine information.

ATIS messages are recorded in a standard format and contain such information as:

- a) airport name and message code letter;
- b) weather information, including:
 - (i) time,
 - (ii) surface wind, including gusts,
 - (iii) visibility,
 - (iv) weather and obstructions to vision,
 - (v) ceiling,
 - (vi) sky condition,
 - (vii) temperature,
 - (viii) dew point,
 - (ix) altimeter setting,
 - (x) pertinent SIGMETs, AIRMETs and PIREPs, and
 - (xi) other pertinent remarks;
- c) type of instrument approach in use, including information on parallel or simultaneous converging runway operations;
- d) landing runway, both IFR and VFR, including information on hold short operations and the stopping distance available;
- e) departure runway, both IFR and VFR;
- f) a NOTAM or an excerpt from a NOTAM, pertinent information regarding the serviceability of a NAVAID, or field conditions applicable to arriving or departing aircraft. These may be deleted from an ATIS message after a broadcast period of 12 hr at domestic airports or 24 hr at international airports;
- g) instruction that aircraft are to acknowledge receipt of the ATIS broadcast on initial contact with ATC/FSS.

Each recording will be identified by a phonetic alphabet code letter, beginning with ALFA. Succeeding letters will be used for each subsequent message.

Example of an ATIS Message:

*TORONTO INTERNATIONAL INFORMATION BRAVO.
WEATHER AT ONE FOUR ZERO ZERO ZULU: WIND ZERO FIVE
ZERO AT TWO ZERO, VISIBILITY FIVE HAZE, CEILING THREE
THOUSAND OVERCAST, TEMPERATURE ONE EIGHT, DEW
POINT ONE SIX, ALTIMETER TWO NINER FOUR SIX,
PARALLEL ILS APPROACHES ARE IN PROGRESS. IFR
LANDING ZERO SIX RIGHT, ZERO SIX LEFT. VFR LANDING
ZERO SIX LEFT. DEPARTURE ZERO SIX LEFT. NOTAM: GLIDE
PATH ILS RUNWAY ONE FIVE OUT OF SERVICE. INFORM ATC
YOU HAVE INFORMATION BRAVO.*

NOTE:

Current time and RVR measurements will not be included in the ATIS message, but will be issued in accordance with current practices. Temperature and dew point information is derived only from the scheduled hourly weather observations.

Pilots hearing the broadcast should inform the ATC/FSS unit on initial contact that they have received the information, by repeating the code letter that identifies the message, thus obviating the need for the controller/specialist to issue information.

Example:

...WITH BRAVO.

During periods of rapidly changing conditions that would create difficulties in keeping the ATIS message current, the following message will be recorded and broadcasted:

*BECAUSE OF RAPIDLY CHANGING WEATHER/AIRPORT CONDITIONS,
CONTACT ATC/FSS FOR CURRENT INFORMATION.*

The success and effectiveness of ATIS is largely dependent upon the co-operation and participation of airspace users; therefore, pilots are strongly urged to take full advantage of this service.

1.4 USE OF TERM "CEILING AND VISIBILITY OK (CAVOK)"

The term "CAVOK" (KAV-OH-KAY) may be used in air-ground communications when transmitting meteorological information to arriving aircraft.

CAVOK refers to the simultaneous occurrence of the following meteorological conditions at an airport:

- a) no cloud below 5 000 feet, or below the highest minimum sector altitude, whichever is higher, and no cumulonimbus;
- b) a visibility of 6 SM or more;
- c) no precipitation, thunderstorms, shallow fog, or low drifting snow.

This term, coupled with other elements of meteorological information, such as wind direction and speed, altimeter setting and pertinent remarks, will be used in transmissions directed to arriving aircraft and, where applicable, in the composition of ATIS messages. A pilot, on receipt of CAVOK, may request that detailed information be provided.

CAVOK does not apply to the provision of meteorological information to en route aircraft and, therefore, will not be used when such information is transmitted to aircraft engaged in that particular phase of flight.

1.5 RADAR SERVICE

1.5.1 General

The use of radar increases airspace utilization by allowing ATC to reduce the separation interval between aircraft. In addition, radar permits an expansion of flight information services, such as traffic information, radar navigation assistance and information on chaff drops and bird activity. Due to limitations inherent in all radar systems, it may not always be possible to detect aircraft, weather disturbances, etc. Where radar information is derived from secondary surveillance radar (SSR) only (i.e. without associated primary radar coverage), it is not possible to provide traffic information on aircraft that are not transponder-equipped or to provide some of the other flight information (See *AIP Canada (ICAO) ENR 1.6*).

1.5.2 Procedures

Before providing radar service, ATC will establish identification of the aircraft concerned either through the use of position reports, identifying turns, or transponders. Pilots will be notified whenever radar identification is established or lost.

Examples:

IDENTIFIED; or IDENTIFICATION LOST.

Pilots are cautioned that radar identification of their flight does not relieve them of the responsibility for collision avoidance or terrain (obstacle) clearance. ATC will normally provide radar-identified IFR and CVFR flights with information on observed radar targets. At locations where an SSR is used without collocated primary radar equipment, ATC cannot provide traffic information on aircraft without a functioning transponder.

ATC assumes responsibility for terrain (obstacle) clearance when vectoring en route IFR and CVFR flights and for IFR aircraft being vectored for arrival until the aircraft resumes normal navigation.

Vectors are used when necessary for separation purposes, when required by noise abatement procedures, when requested by the pilot, or whenever vectors will offer operational advantages to the pilot or the controller. When vectors are initiated, the pilot will be informed of the location to which the aircraft is being vectored.

Example:

VECTORS TO VICTOR THREE ZERO ZERO, TURN LEFT HEADING ZERO FIVE ZERO. VECTORS TO THE VANCOUVER V-O-R ZERO FIVE THREE RADIAL, FLY HEADING ZERO TWO ZERO. VECTORS TO FINAL APPROACH COURSE, DEPART KLEINBURG BEACON ON HEADING TWO FOUR ZERO.

Pilots will be informed when vectors are terminated, except when an arriving aircraft is vectored to the final approach course or to the traffic circuit.

Example:

RESUME NORMAL NAVIGATION.

When an aircraft is vectored to final approach or to the traffic circuit, the issuance of approach clearance indicates that normal navigation should be resumed.

Normally radar service will be continued until an aircraft leaves the area of radar coverage, enters uncontrolled airspace, or is transferred to an ATC unit not equipped with radar. When radar service is terminated the pilot will be informed accordingly.

Example:

RADAR SERVICE TERMINATED.

1.5.3 Radar Traffic Information

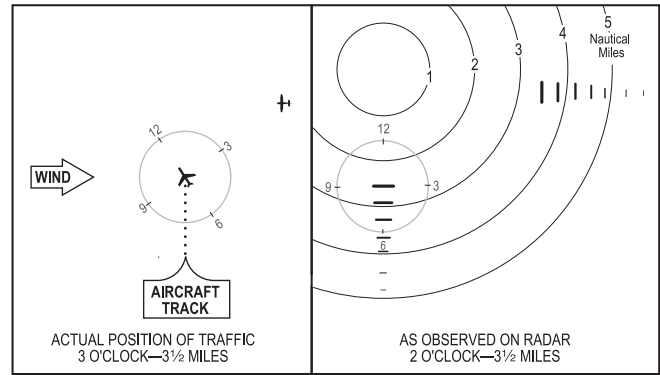
Traffic (or workload) permitting, ATC will provide IFR and CVFR flights with information on observed radar targets whenever the traffic is likely to be of concern to the pilot, unless the pilot states that the information is not wanted. This information may be provided to VFR aircraft when requested by the pilot.

If requested by the pilot, ATC will attempt to provide radar separation between identified IFR aircraft and the unknown observed aircraft.

When issuing radar information, ATS units will frequently define the relative location of the traffic, weather areas, etc., by referring to the clock position. In this system, the 12 o'clock position is based on the observed radar track rather than the actual nose of the aircraft. In conditions of strong crosswind, this can lead to a discrepancy between the position as reported by the controller and the position as observed by the pilot.

The following diagram illustrates the clock positions.

Figure 1.1—Clock Positions Diagram



Issue traffic information to radar-identified aircraft as follows:

- a) Position of the traffic in relation to the aircraft’s observed track.
- b) Direction of flight.
- c) Type of aircraft, if known, or the relative speed and the altitude, if known.

NOTE:

Direction of flight may be expressed as OPPOSITE DIRECTION or SAME DIRECTION, while the altitude may be expressed as a number of feet above or below the aircraft receiving the traffic information.

Example:

TRAFFIC, TWO O’CLOCK, THREE AND A HALF MILES, WESTBOUND, B747, ONE THOUSAND FEET ABOVE YOUR ALTITUDE.

Issue traffic information to non-radar-identified aircraft as follows:

- a) Position of the traffic in relation to a fix.
- b) Direction of flight.
- c) Type of aircraft, if known, or the relative speed and the altitude, if known.

NOTE:

Direction of flight may be expressed as OPPOSITE DIRECTION or SAME DIRECTION, while the altitude may be expressed as a number of feet above or below the aircraft receiving the traffic information.

Example:

TRAFFIC, SEVEN MILES SOUTH OF RESOLUTE BAY VOR, NORTHBOUND, B737, FL300.

1.5.4 Radar Navigation Assistance to Visual Flight Rules (VFR) Flights

When requested by pilots, radar-equipped ATC units will provide assistance to navigation in the form of position information, vectors or track, and ground speed checks. Flights requesting this assistance must be operating within areas of radar and communication coverage, and be radar-identified.

VFR flights may be provided with this service:

- a) at the request of a pilot, when traffic conditions permit;
- b) when the controller suggests and the pilot agrees; or
- c) in the interest of flight safety.

The pilot is responsible for avoiding other traffic and avoiding weather below VFR minima while on a VFR flight on radar vectors.

If a radar vector will lead a VFR flight into IFR weather conditions, the pilot must inform the controller and take the following action:

- a) if practicable, obtain a vector which will allow the flight to remain in VFR weather conditions; or
- b) if an alternative vector is not practicable, revert to navigation without radar assistance; or
- c) if the pilot has an IFR rating and the aircraft is equipped for IFR flight, the pilot may file an IFR flight plan, and request an IFR clearance.

Emergency radar assistance will be given to VFR flights which are able to maintain two-way radio communication with the unit, are within radar coverage, and can be radar identified.

Pilots requiring radar assistance during emergency conditions should contact the nearest ATC unit and provide the following information:

- a) Declaration of emergency (state nature of difficulty and type of assistance required).
- b) Position of aircraft and weather conditions within which the flight is operating.
- c) Type of aircraft, altitude, and whether equipped for IFR flight.
- d) Whether pilot has an IFR Rating.

Pilots unable to contact radar but in need of emergency assistance may alert radar by flying a triangular pattern.

1.5.5 Obstacle Clearance During Radar Vectors

a) *IFR Flights*

The pilot of an IFR flight is responsible for ensuring that the aircraft is operated with adequate clearance from obstacles and terrain; however, when the flight is being radar-vectorred, ATC will ensure that the appropriate obstacle clearance is provided.

Minimum radar vectoring altitudes (lowest altitude at which an aircraft may be vectored and still meet obstacle clearance criteria), which may be lower than minimum altitudes shown on navigation and approach charts, have been established at a number of locations to facilitate transitions to instrument approach aids. When an IFR flight is cleared to descend to the lower altitude, ATC will provide terrain and obstacle clearance until the aircraft is in a position from which an approved instrument approach or a visual approach can be commenced.

If a communication failure occurs while a flight is being vectored at an altitude below the minimum IFR altitudes shown in the instrument approach chart, the pilot should climb immediately to the appropriate published minimum altitude, unless the flight is able to continue in Visual Meteorological Conditions (VMC).

b) *VFR Flights*

The pilot of a VFR aircraft remains responsible for maintaining adequate clearance from obstacles and terrain when the flight is being radar-vectorred by ATC.

If adequate obstacle or terrain clearance cannot be maintained on a vector, the pilot must inform the controller and take the following action:

- (i) if practicable, obtain a heading that will enable adequate clearance to be maintained, or climb to a suitable altitude, or
- (ii) revert to navigation without radar assistance.

1.5.6 Misuse of Radar Vectors

Pilots have, on occasion, for practice purposes, followed radar instructions issued to other pilots without realizing the potential hazard that accompanies such action.

ATC may require aircraft to make turns for radar identification; however, when more than one aircraft target is observed making a turn, identification becomes difficult or impossible. Should misidentification be the result of more than one aircraft following the instructions issued by ATC, it could be hazardous to the aircraft involved.

Any pilot wishing to obtain radar practice, however, needs only to contact the appropriate ACC or TCU and request practice radar vectors. Practice vectors will be issued to the extent that air traffic conditions permit.

1.5.7 Canadian Forces Radar Assistance

The Canadian Forces can provide assistance in an emergency to civil aircraft operating within the ADIZ.

No responsibility for the direct control of aircraft is accepted and radar assistance does not absolve the captain of the responsibility of complying with ATC clearances or other required procedures. Assistance consists of:

- a) track and ground speed checks—speeds in kt;
- b) position of the aircraft in geographic reference, or by bearing and distance from the station—distances are in NM and bearings in degrees True; and
- c) position of heavy cloud in relation to the aircraft.

To obtain assistance in the North Warning System area, call “Radar Assistance” on 126.7 MHz; or when circumstances require a MAYDAY call, use 121.5 MHz, giving all the necessary details. When assistance is required in ADIZ areas contact will have to be made on the 121.5 MHz frequency or on the UHF frequencies 243.0 or 364.2 MHz. Initial contact should be made at the highest practicable altitude. If air defence commitments preclude the granting of radar assistance, the ground station will transmit the word “UNABLE” and no further explanation will be given.

1.5.8 The Use of Radar in the Provision of Aerodrome Advisory Service (AAS) and Remote Aerodrome Advisory Service (RAAS) by Flight Service Stations (FSS)

Certain FSSs are equipped with a radar display to aid the flight service specialist in monitoring the aircraft traffic situation and to enhance the accuracy of traffic information provided in AAS or RAAS.

An FSS equipped with a radar display:

- a) may instruct an aircraft to “SQUAWK IDENT” or assign a specific SSR code to the aircraft;
- b) will acknowledge the squawk transmission or SSR code change by stating the phrase “ROGER IDENT”;
- c) will issue the reminder “NO CONTROL SERVICE AVAILABLE, THIS IS AN ADVISORY SERVICE,” if deemed appropriate;
- d) may issue radar-observed traffic information with reference to the 12-hr clock position or geographical locations.

It is important for pilots to keep in mind that:

- a) flight service specialists may stop monitoring the radar display at any time without prior notice to aircraft;
- b) FSSs do not inform aircraft when radar identification is lost;
- c) FSSs do not provide control services such as vectors and conflict resolution;
- d) pilots are responsible for maintaining a visual lookout outside the cockpit at all times for the purpose of avoiding a collision with other aircraft, terrain and obstacles.

1.6 VHF DIRECTION FINDER (VDF) SERVICE

VDF equipment is available at selected airports across Canada (additional details in the COM chapter).

1.6.1 Purpose

The purpose of the VDF is to provide navigation assistance to VFR aircraft. This equipment is not intended as a substitute for normal VFR navigation, but rather as an aid in times of difficulty.

A VFR aircraft encountering IMC is not normally given VDF headings; rather, on request, it is provided with position information relevant to the VDF site or some other location. However, should a VFR aircraft encountering IMC declare an emergency, navigation assistance to the VDF site will be provided, if appropriate.

1.6.2 Equipment Operation

VDF information is electronically derived from radio signals transmitted from the aircraft. Since VHF transmissions are restricted to line-of-sight, the altitude and location of the aircraft may limit the provision of the service. As in radio communication, the power of the transmitted signal will affect reception distance. Information may be obtained from either a modulated signal (speech transmission) or an un-modulated signal (microphone button pressed—no speech). The length of the transmission is not critical since information can be obtained from a very short transmission (2 s).

1.6.3 Provision of Service

VDF navigation assistance is provided when requested by the pilot or when suggested by the VDF operator (either an airport controller or a flight service specialist) and accepted by the pilot.

VDF navigation assistance consists of the aircraft’s bearing in relation to the VDF site and the reciprocal heading to this site.

The VDF operator will provide the pilot with heading and bearing information relevant to the VDF site. Pilots planning to use the direction indicator as a heading reference during VDF navigation assistance should reset the direction indicator to the magnetic

compass before requesting VDF navigation assistance. Thereafter, the direction indicator should not be reset without advising the VDF operator.

1.6.4 Procedures

Pilots requesting VDF navigation assistance will be asked to provide the VDF operator with the following information:

- a) the position of aircraft, if known; and
- b) the altitude.

In order to derive VDF information from the radio signals transmitted from the aircraft, when asked to “transmit for bearing” pilots should transmit the aircraft call-sign, hold the microphone button for a few seconds, and repeat their call-sign.

Pilots receiving VDF navigation assistance retain their responsibility to see and avoid other traffic, to maintain appropriate terrain and obstacle clearance, and to remain in VFR weather conditions.

Example:

Pilot: KINGSTON RADIO. THIS IS PIPER GOLF HOTEL GOLF BRAVO. REQUEST VDF NAVIGATION ASSISTANCE. APPROXIMATELY TWENTY MILES NORTHEAST OF KINGSTON, AT FIVE THOUSAND.

Based on the aircraft’s VDF bearing indication, the VDF operator will provide the pilot with the aircraft’s reciprocal heading to the VDF site.

VDF operator: *GOLF HOTEL GOLF BRAVO, KINGSTON RADIO, TRANSMIT FOR BEARING.*

VDF operator: *GOLF HOTEL GOLF BRAVO, YOUR HEADING TO THE AIRPORT* IS TWO-TWO ZERO.*

***NOTE:**

In instances where the VDF site is located more than one mile from the airport, the VDF operator will transmit to the pilot: “YOUR HEADING TO THE VDF SITE IS...”

1.7 AIR TRAFFIC CONTROL (ATC) CLEARANCES, INSTRUCTIONS AND INFORMATION

Whenever pilots receive and accept an ATC clearance, they shall comply with the clearance. If unable to comply with the clearance, pilots should immediately inform ATC since the controller will understand the acknowledgement of the clearance as indicating acceptance. For example, upon receiving a clearance for takeoff, pilots should acknowledge the clearance and take off without undue delay or, if not ready to take off at that particular time, inform ATC of their intentions, in which case the clearance may be changed or cancelled.

A clearance will be identified by the use of some form of the word “clear” in its contents. An instruction will always be worded in such a manner as to be readily identified, although the word “instruct” will seldom be included. Pilots shall comply with and acknowledge receipt of all ATC instructions directed to and received by them, provided the safety of the aircraft is not jeopardized (CAR 602.31).

CAR 602.31 permits pilots to deviate from an ATC instruction or clearance in order to follow TCAS or ACAS RAs. Pilots responding to an RA shall advise the appropriate ATC unit of the deviation as soon as possible and shall expeditiously return to the last ATC clearance received and accepted, or the last ATC instruction received and acknowledged prior to the RA manoeuvre. Aircraft manoeuvres conducted during an RA should be kept to the minimum necessary to satisfy the resolution advisory. For more information on TCAS and ACAS, see the COM chapter.

ATC is not responsible for the provision of IFR separation to an IFR aircraft which carries out a TCAS or ACAS RA manoeuvre until one of the following conditions exist:

- a) the aircraft has returned to the last ATC clearance received and accepted, or last ATC instruction received and acknowledged prior to the RA; or
- b) an alternate ATC clearance or instruction has been issued.

TCAS and ACAS do not alter or diminish the pilot-in-command’s responsibility to ensure safe flight. Since TCAS and ACAS do not respond to aircraft which are not transponder-equipped or to aircraft with a transponder failure, TCAS and ACAS alone do not ensure safe operation in every case. The services provided by ATC units are not predicated upon the availability of TCAS or ACAS equipment in an aircraft.

It should be remembered that air traffic control is predicated on known air traffic only and, when complying with clearances or instructions, pilots are not relieved of the responsibility of practicing good airmanship.

NOTE:

A clearance or instruction is only valid while in controlled airspace. Pilots crossing between controlled and uncontrolled airspace should pay close attention to the terrain and obstacle clearance requirements.

ATS personnel routinely inform pilots of conditions, observed by others or by themselves, which may affect flight safety and are beyond their control. Examples of such conditions are observed airframe icing and bird activity. These are meant solely as assistance or reminders to pilots and are not intended in any way to absolve the pilot of the responsibility for the safety of the flight.

1.7.1 Inability to Issue Clearance

ATC clearances are based on known traffic conditions and aerodrome limitations which affect the safety of aircraft operations. This encompasses aircraft in flight and on the manoeuvring area, vehicles, and other potential obstructions. ATC is not authorized to issue ATC clearances when traffic conditions are unknown, when any part of the aerodrome is partially or fully closed, or when the aerodrome or runway operating minima are not met.

There are two distinct phrases used when unable to issue ATC clearances:

- a) *AT YOUR DISCRETION*—Used to approve aircraft movement on any surface not visible from the control tower due to a physical obstruction other than weather phenomena, or on the non-manoeuving area. Pilots are responsible for manoeuvring safely with respect to traffic or hazards encountered during the operation. ATC will provide information on known traffic or obstructions when possible.
- b) *UNABLE TO ISSUE CLEARANCE*—Used when controllers are not authorized to issue an ATC clearance. Pilots who continue without a clearance in these circumstances may be subject to regulatory action by TC. ATC will provide pertinent taxi, take-off or landing information and then file an aviation occurrence report. Pilots are responsible for manoeuvring safely with respect to traffic or other hazards encountered during the operation.

1.7.1.1 Examples

The following are scenarios in which ATC may not be able to provide a clearance, followed by ensuing ATC actions, and examples of phraseology that will be used.

- a) *ATIS message*—ATC will include the following information in an ATIS message, as applicable, upon restriction or suspension of landings or takeoffs. These restrictions or suspensions may be due to the implementation of RVOP or LVOP, direction from the airport operator, obstructed runway protected area, or other reasons.

NOTE:

When conditions are rapidly changing, this information may be issued by ATC, rather than via the ATIS.

Examples:

LOW VISIBILITY PROCEDURES IN EFFECT. RUNWAY ZERO FOUR NOT AUTHORIZED FOR LANDING.

REDUCED VISIBILITY PROCEDURES IN EFFECT. RUNWAY TWO TWO NOT AVAILABLE.

RUNWAY ONE THREE NOT AVAILABLE DUE TO RUNWAY PROTECTED AREA OBSTRUCTION.

- b) *Operations on a surface other than a runway*

- (i) If the pilot of a fixed-wing aircraft requests landing or takeoff from a surface other than a runway or area approved and designated for that purpose, ATC will provide traffic and obstruction information; control instructions, if necessary; and inform the pilot that landing or takeoff will be at the pilot's discretion.

NOTE:

Examples of surfaces other than a runway may include areas at or adjacent to the airport, areas in the control zone but not at the airport, a water aerodrome, or a temporary landing area in the control zone.

Example:

GOLF JULIETT ALFA LIMA, WIND THREE ZERO ZERO AT FIFTEEN, TAKE OFF AT YOUR DISCRETION.

- (i) Workload permitting, ATC will provide traffic and obstruction information to aircraft taxiing on a non-manoeuving area.

Example:

GOLF LIMA BRAVO JULIETT, TAXI AT YOUR DISCRETION.

- (i) If necessary, ATC will inform a taxiing aircraft that a portion of the manoeuvring area is not visible from the tower and, if possible, provide traffic and obstruction information.

NOTE:

Restricted visibility of the manoeuvring area may be the result of a structure, but excludes situations due to weather.

Example:

FOXTROT ALFA BRAVO CHARLIE, TAXIWAY NOT VISIBLE, TAXI AT YOUR DISCRETION ON TAXIWAY ALFA.

- c) *RVOP and LVOP*—The following procedures will be used by ATC when implementation of RVOP or LVOP results in manoeuvring area restrictions or closures. RVOP and LVOP procedures vary across Canada, depending on airport operating limits.

- (i) If a pilot requests taxi clearance, ATC will inform the pilot that taxi clearance cannot be issued, and provide the reason. Pilots shall make the request prior to commencing push-back with the intent of taking off; commencing push-back with the intent of taxiing to the de-icing bay; or commencing taxiing on the manoeuvring area under the aircraft's own power with the intent of taking off.

Example:

FOXTROT BRAVO WHISKY DELTA, UNABLE TAXI CLEARANCE ON TAXIWAY CHARLIE, LOW VISIBILITY PROCEDURES IN EFFECT.

- (i) If a pilot is taxiing for takeoff, ATC will inform the pilot that clearance cannot be issued on the intended runway; provide the reason; determine if another runway is available for takeoff; inform the pilot of the alternate runway; and request the pilot's intentions.

Example:

GOLF JULIETT ALFA LIMA, UNABLE CLEARANCE. REDUCED VISIBILITY PROCEDURES IN EFFECT. RUNWAY THREE TWO CLOSED.

Then, if appropriate:

- (ii) *GOLF JULIETT ALFA LIMA, RUNWAY TWO FIVE AVAILABLE, ADVISE INTENTIONS.*

NOTE:

If no alternate runway is available ATC will request the pilot's intentions.

Example:

FOXTROT ALFA BRAVO CHARLIE, UNABLE CLEARANCE. LOW VISIBILITY PROCEDURES IN EFFECT. ALL RUNWAYS CLOSED. ADVISE INTENTIONS.

- (i) If a pilot requests taxi after landing, ATC will provide taxi clearance.

Example:

FOXTROT BRAVO WHISKY DELTA, TAXI VIA ECHO.

- (i) If a pilot requests landing or takeoff, ATC will inform the pilot that a clearance cannot be issued; provide the reason; and request the pilot's intentions.

Example:

GOLF JULIETT ALFA LIMA, UNABLE CLEARANCE RUNWAY ONE EIGHT, LANDING NOT AUTHORIZED. ADVISE INTENTIONS.

- (i) If the pilot chooses to land or take off anyway, and traffic permits, ATC will acknowledge the pilot's intentions; provide landing or take-off information as well as any special information required; notify the airport operator; and complete an aviation occurrence report.

NOTE:

Special information may include traffic, hazards, obstructions, runway exits, runway surface conditions, or other pertinent information.

Example:

GOLF LIMA BRAVO JULIETT, ROGER.

- d) *Denial of clearance*—The following procedures will be used when ATC refuses a clearance request because the airport or part of the airport is closed by the operator; or ATC is directed to deny taxi clearance by NAV CANADA or other authority.
 - (i) If the pilot requests a landing, takeoff or other manoeuvre, ATC will inform the pilot that a clearance cannot be issued; provide the reason; provide pertinent NOTAM(s) or airport condition directive(s); and request the pilot's intentions.

Example:

WESTJET THREE SEVEN ONE, UNABLE CLEARANCE. RUNWAY ZERO SEVEN IS CLOSED FOR MAINTENANCE

UNTIL ONE NINE ZERO ZERO ZULU AS PER NOTAM. ADVISE INTENTIONS.

- (i) If the pilot chooses to land, take off or manoeuvre anyway, and traffic permits, ATC will acknowledge the pilot's intentions; provide landing, take-off or manoeuvring information as well as any special information required; notify the airport operator; and complete an aviation occurrence report.

NOTE:

Special information may include traffic, hazards, obstructions, runway exit, runway surface conditions, or other pertinent information.

Example:

AIR CANADA THREE FIVE SIX, ROGER.

- e) *Taxi authorization*—If a pilot requests a push-back from a loading position on the apron, ATC will inform the pilot that the push-back is at pilot's discretion and provide traffic information, if possible.

Example:

NOVEMBER ONE THREE SIX TWO ALFA, PUSH BACK AT YOUR DISCRETION.

- f) *Helicopters*—If a helicopter pilot intends to land or take off from a non-manoeuving area approved for that purpose, ATC will provide traffic and obstruction information; control instructions, if necessary; and inform the pilot that landing or takeoff will be at the pilot's discretion.

Example:

GOLF JULIETT ALFA DELTA, TRAFFIC CHEROKEE DEPARTING RUNWAY THREE ONE, WIND THREE ZERO ZERO AT TEN. TAKE OFF AT YOUR DISCRETION FROM APRON FOUR.

- g) *Taxiing aircraft and ground traffic*—The following procedures will be used when ATC is unable to determine that the runway or runway protected area is or will be free of obstacles before either an arrival crosses the threshold or a departure starts its take-off roll.

NOTE

Obstacles include taxiing aircraft and ground traffic.

- (i) If the pilot requests a landing or takeoff, ATC will inform the pilot that a clearance cannot be issued; provide the reason; and request the pilot's intentions.

Example:

GOLF ZULU YANKEY ZULU, UNABLE LANDING CLEARANCE RUNWAY ONE FOUR, VEHICLE INSIDE THE RUNWAY PROTECTED AREA AT ALFA. ADVISE INTENTIONS.

- (ii) If the pilot chooses to land or take off anyway, and traffic permits, ATC will acknowledge the pilot's intentions; provide landing or take-off information as

well as any special information required; notify the airport operator; and complete an aviation occurrence report.

NOTE:

Special information may include traffic, hazards, obstructions, runway exit, runway surface conditions or other pertinent information.

Example:

JAZZ SIX EIGHT EIGHT, ROGER.

- (iii) If a landing or take-off clearance has been issued and ATC is unable to determine that the runway or runway protected area is or will be free of obstacles before an arrival crosses the threshold, or a departure starts its take-off roll, ATC will cancel the clearance.

NOTE:

Controllers will use their best judgement if cancelling the clearance may result in a hazardous situation.

Example:

GOLF ALFA DELTA ALFA, TAKE-OFF CLEARANCE CANCELLED, AIRCRAFT INSIDE THE RUNWAY PROTECTED AREA AT CHARLIE, ADVISE INTENTIONS.

1.8 AIR TRAFFIC CONTROL (ATC) SERVICE PRIORITY

1.8.1 Normal Conditions

Normally, ATC provides control service on a first-come, first-served basis. However, controllers may adjust the arrival or departure sequence in order to facilitate the maximum number of aircraft movements with the least average delay. Altitude assignment may also be adjusted in order to accommodate the maximum number of aircraft at their preferred altitudes, or to comply with ATFM requirements.

1.8.2 Special Conditions

Flight priority is provided to:

- a) an aircraft that is known or believed to be in a state of emergency;

NOTE:

This category includes aircraft subjected to unlawful interference or other distress or urgency conditions that may compel the aircraft to land or require flight priority.

- b) a MEDEVAC flight;
- c) military or civilian aircraft participating in SAR missions and identified by the radiotelephony call sign “RESCUE” and the designator “RSCU,” followed by an appropriate flight number;

- d) military aircraft that are departing on:
 - (i) operational air defence flights,
 - (ii) planned and coordinated air defence training exercises, and
 - (iii) exercises to an altitude reservation; or
- e) an aircraft carrying Her Majesty the Queen, the Governor General, the Prime Minister, heads of state, or foreign heads of government.

1.8.3 Minimum Fuel Advisory

Pilots may experience situations where traffic, weather or other delays result in concern about the aircraft’s fuel state. The term MINIMUM FUEL describes a situation where the aircraft’s fuel supply has reached a state where the flight is committed to land at a specific aerodrome and no additional delay can be accepted. The pilot should advise ATC as soon as possible that a MINIMUM FUEL condition exists. This is not an emergency situation, but merely an advisory that indicates an emergency is possible should any undue delay occur.

A minimum fuel advisory does not imply an ATC traffic priority; however, ATC special flight handling procedures are as follows:

- a) Be alert for any occurrence or situation that might delay the aircraft;
- b) Respond to the declaration and keep the pilot informed of any anticipated delay as soon as you become aware, using the following phraseology:
 - ROGER or*
 - ROGER NO DELAY EXPECTED or*
 - ROGER EXPECT (delay information).*
- c) Inform the next sector or unit of the minimum fuel status of the aircraft and
- d) Record the information in the unit log, reduce unnecessary radio transmissions and ensure appropriate responses; use of internationally recognized fuel-related phraseology among pilots and controllers is essential.

Traffic priority is given to a pilot who declares an emergency for fuel by broadcasting MAYDAY MAYDAY MAYDAY FUEL. Use of standardized pilot phraseology distinguishes minimum fuel from a fuel emergency, assuring pilot intent without further verification

1.9 COLLISION AVOIDANCE—RIGHT OF WAY (CANADIAN AVIATION REGULATIONS [CARs])

Reckless or Negligent Operation of Aircraft

602.01

No person shall operate an aircraft in such a reckless or negligent manner as to endanger or be likely to endanger the life or property of any person.

Right-of-Way – General

602.19

- a) Notwithstanding any other provision of this section,
 - (i) the pilot-in-command of an aircraft that has the right-of-way shall, if there is any risk of collision, take such action as is necessary to avoid collision; and
 - (ii) where the pilot-in-command of an aircraft is aware that another aircraft is in an emergency situation, the pilot-in-command shall give way to that other aircraft.
- b) When two aircraft are converging at approximately the same altitude, the pilot-in-command of the aircraft that has the other on its right shall give way, except as follows:
 - (i) a power-driven, heavier-than-air aircraft shall give way to airships, gliders and balloons;
 - (ii) an airship shall give way to gliders and balloons;
 - (iii) a glider shall give way to balloons; and
 - (iv) a power-driven aircraft shall give way to aircraft that are seen to be towing gliders or other objects or carrying a slung load.
- c) When two balloons operating at different altitudes are converging, the pilot-in-command of the balloon at the higher altitude shall give way to the balloon at the lower altitude.
- d) Where an aircraft is required to give way to another aircraft, the pilot-in-command of the first-mentioned aircraft shall not pass over or under, or cross ahead of, the other aircraft unless passing or crossing at such a distance as will not create any risk of collision.
- e) Where two aircraft are approaching head-on or approximately so and there is a risk of collision, the pilot-in-command of each aircraft shall alter its heading to the right.
- f) An aircraft that is being overtaken has the right-of-way and the pilot-in-command of the overtaking aircraft, whether climbing, descending or in level flight, shall give way to the other aircraft by altering the heading of the overtaking aircraft to the right, and no subsequent change in the relative positions of the two aircraft shall absolve the pilot-in-command of the overtaking aircraft from this obligation until that aircraft has entirely passed and is clear of the other aircraft.

- g) Where an aircraft is in flight or manoeuvring on the surface, the pilot-in-command of the aircraft shall give way to an aircraft that is landing or about to land.
- h) The pilot-in-command of an aircraft that is approaching an aerodrome for the purpose of landing shall give way to any aircraft at a lower altitude that is also approaching the aerodrome for the purpose of landing.
- i) The pilot-in-command of an aircraft at a lower altitude, as described in subsection (8), shall not overtake or cut in front of an aircraft at a higher altitude that is in the final stages of an approach to land.
- j) No person shall conduct or attempt to conduct a takeoff or landing in an aircraft until there is no apparent risk of collision with any aircraft, person, vessel, vehicle or structure in the takeoff or landing path.

Right-of-Way – Aircraft Manoeuvring on Water

602.20

- a) Where an aircraft on the water has another aircraft or a vessel on its right, the pilot-in-command of the first-mentioned aircraft shall give way.
- b) Where an aircraft on the water is approaching another aircraft or a vessel head-on, or approximately so, the pilot-in-command of the first-mentioned aircraft shall alter its heading to the right.
- c) The pilot-in-command of an aircraft that is overtaking another aircraft or a vessel on the water shall alter its heading to keep well clear of the other aircraft or the vessel.

Avoidance of Collision

602.21

No person shall operate an aircraft in such proximity to another aircraft as to create a risk of collision.

Formation Flight

602.24

No person shall operate an aircraft in formation with other aircraft except by pre-arrangement between.

- a) the pilots-in-command of the aircraft; or
- b) where the flight is conducted within a control zone, the pilots-in-command and the appropriate air traffic control unit.

1.10 AEROBATIC FLIGHT (*CANADIAN AVIATION REGULATIONS [CARs] 602.27 AND 602.28*)

Aerobatic Manoeuvres – Prohibited Areas and Flight conditions

602.27

No person operating an aircraft shall conduct aerobatic manoeuvres

- a) over a built-up area or an open-air assembly of persons;
- b) in controlled airspace, except in accordance with a special flight operations certificate issued pursuant to Section 603.67;
- c) when flight visibility is less than three miles; or
- d) below 2 000 feet AGL, except in accordance with a special flight operations certificate issued pursuant to Section 603.02 or 603.67.

Aerobatic Manoeuvres with Passengers

602.28

No person operating an aircraft with a passenger on board shall conduct aerobatic manoeuvres unless the pilot-in-command of the aircraft has engaged in

- a) at least 10 hours dual flight instruction in the conducting of aerobatic manoeuvres or 20 hours conducting aerobatic manoeuvres; and
- b) at least one hour of conducting aerobatic manoeuvres in the preceding six months.

1.11 CONSERVATION

1.11.1 Fur and Poultry Farms

Experience has shown that aviation noise caused by rotary wing and fixed wing aircraft flying at low altitudes can cause serious economic losses to the farming industry. The classes of livestock particularly sensitive are poultry (including ostriches and emus), because of the crowding syndrome and stampeding behaviour they exhibit when irritated and frightened, and foxes who, when excited, will eat or abandon their young. Avoid overflying these farms below 2 000 ft AGL.

Fur farms may be marked with chrome yellow and black stripes painted on pylons or roofs. In addition, a red flag may be flown during whelping season (February–May).

Pilots are therefore warned that any locations so marked should be avoided, and special vigilance should be maintained during the months of February, March, April and May.

1.11.2 Protection of Wildlife

It is vital that all pilots understand the importance of wildlife conservation. They are urged to become familiar with the game laws in force in the various provinces and territories, and encouraged to co-operate with all game officers to ensure that violations of game laws do not occur. The *Migratory Birds Regulations* prohibit the intentional killing of migratory birds through the use of an aircraft.

Pilots should be aware that flying low over herds of wild animals such as reindeer, caribou, moose or muskoxen may result in reducing the animal population. Accidents resulting in broken bones may increase. Exhausted and disorganized animals are more susceptible to be attacked by wolves. Feeding is interrupted, and normal herd movement and reproductive functions may be seriously disrupted.

Serious damage can also be done to migratory birds by low flying aircraft. Geese in particular have a great fear of aircraft, and their movements may be seriously disorganized by such interference. As well, many bird species in Canada are in decline, and it is felt that every effort should be made to protect them.

In the interest of conserving wildlife, pilots must not fly at an altitude of less than 2 000 ft AGL when in the vicinity of herds of wildlife animals or above wildlife refuges/bird sanctuaries, depicted on affected aeronautical charts.

The landing or takeoff of aircraft in areas designated as bird sanctuaries may require a permit. Contact information for bird sanctuaries can be found at Environment and Climate Change Canada's Web site: <<https://www.canada.ca/en/environment-climate-change/services/migratory-bird-sanctuaries.html>>.

Contact information for provincial and territorial game officers, and information concerning the preservation of wildlife within the various provinces and territories in Canada, can be found in the *AIP Canada (ICAO)* on the NAV CANADA Web site at: <www.navcanada.ca/EN/products-and-services/Pages/AIP-part-2-current.aspx>.

Information pertaining to the *Migratory Bird Regulations* may be obtained at <http://laws-lois.justice.gc.ca/eng/regulations/C.R.C.,_c._1035/index.html> or by contacting:

Assistant Deputy Minister
Canadian Wildlife Service
Environment and Climate Change Canada
Ottawa ON K1A 0H3

Tel.: 1-800-668-6767

E-mail: ec.enviroinfo.ec@canada.ca

1.11.3 National, Provincial and Municipal Parks, Reserves and Refuges

To preserve the natural environment of parks, reserves and refuges, and to minimize the disturbance to the natural habitat, overflights should not be conducted below 2 000 ft AGL. To assist pilots in observing this, boundaries are depicted on the affected aeronautical charts.

The landing or takeoff of aircraft in national parks and national park reserves may only take place at prescribed locations. Contact information for each location can be found on the Parks Canada Web site at: <www.pc.gc.ca/>.

Additional details can be found in the *National Parks of Canada Aircraft Access Regulations* available at: <<http://laws-lois.justice.gc.ca/eng/regulations/SOR-97-150/page-1.html>>.

2.0 AIRSPACE – REQUIREMENTS AND PROCEDURES

2.1 GENERAL

Canadian airspace is divided into a number of categories, which in turn are subdivided into a number of areas and zones. The various rules are simplified by the classification of all Canadian airspace. This section describes all of the above in detail, as well as the regulations and procedures specific to each. The official designation of all airspace is published in the DAH. Canadian airspace is managed by NAV CANADA in accordance with the terms established for the transfer of the air navigation system (ANS) from government operation to NAV CANADA, and with the rights granted to the corporation pursuant to the *Civil Air Navigation Services Commercialization Act*.

2.2 CANADIAN DOMESTIC AIRSPACE (CDA)

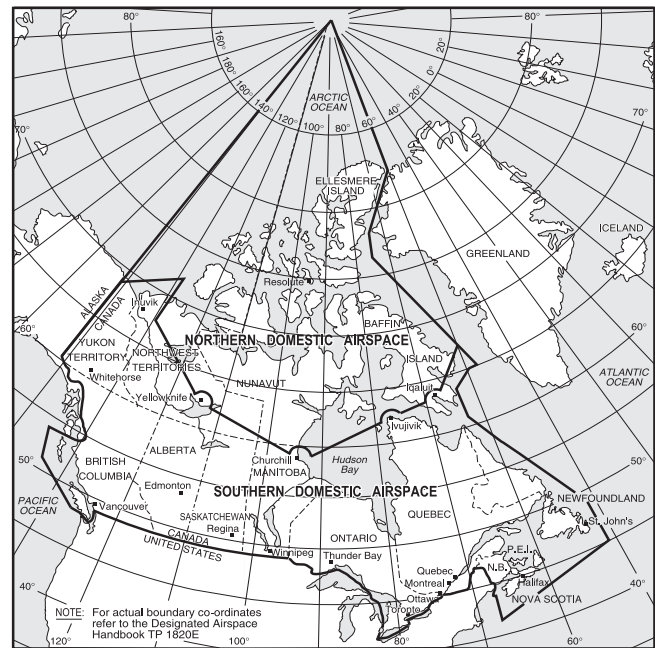
Canadian Domestic Airspace (CDA) includes all airspace over the Canadian land mass, the Canadian Arctic, Canadian Archipelago and those areas of the high seas within the airspace boundaries. These boundaries are depicted on the Enroute Charts.

2.2.1 Northern Domestic Airspace (NDA)

Canadian Domestic Airspace is geographically divided into the Southern Domestic Airspace and the Northern Domestic Airspace as indicated in Figure 2.1. In the Southern Domestic Airspace, magnetic track is used to determine cruising altitude for direction of flight.

The Magnetic North Pole is located near the centre of the Northern Domestic Airspace, therefore magnetic compass indications may be erratic. Thus, in this airspace, runway heading is given in true and true track is used to determine cruising altitude for direction of flight in lieu of magnetic track.

Figure 2.1—Boundaries of Canadian Domestic Airspace, Northern Domestic Airspace and Southern Domestic Airspace



2.3 HIGH- AND LOW-LEVEL AIRSPACE

The CDA is further divided vertically into low-level airspace, which consists of all of the airspace below 18 000 ft ASL; and high-level airspace which consists of all airspace from 18 000 ft ASL and above.

2.3.1 Cruising Altitudes and Flight Levels Appropriate to Aircraft Track

General Provisions

- a) The appropriate altitude or flight level for aircraft in level cruising flight is determined in accordance with:
 - (i) the magnetic track, in SDA; and
 - (ii) the true track, in NDA.
- b) When an aircraft is operated in level cruising flight:
 - (i) at more than 3 000 ft AGL, in accordance with VFR;
 - (ii) in accordance with IFR; or
 - (iii) during a CVFR flight;

the pilot-in-command of an aircraft shall ensure that the aircraft is operated at an altitude or flight level appropriate to the track, unless he/she is assigned an altitude or flight level by an ATC unit or by written authority from the Minister.

- c) RVSM cruising flight levels appropriate to aircraft track are applicable in designated RVSM airspace.

d) The pilot-in-command of an aircraft operating within controlled airspace between 18 000 ft ASL and FL 600, inclusive, shall ensure that the aircraft is operated in accordance with IFR unless otherwise authorized in writing by the Minister. (CAR 602.34).

NOTE:

As per the table in CAR 602.34(2), a vertical separation of 2 000 ft is required from FL 290 to FL 410 inclusive.

Table 2.1—Aircraft Tracks at Various Altitudes and Flight Levels

ALTITUDES OR FLIGHT LEVELS	AIRCRAFT TRACK	
	000° - 179°	180° - 359°
ABOVE FLIGHT LEVEL 290: FLY 4 000 FT INTERVALS	BEGINNING AT FLIGHT LEVEL 290 (FL 290, 330, 370, 410, 450)	BEGINNING AT FLIGHT LEVEL 310 (FL 310, 350, 390, 430, 470)
RVSM	FL 290, 310, 330, 350, 370, 390, 410	FL 300, 320, 340, 360, 380, 400
AT OR ABOVE 18 000 ASL BUT BELOW FL 290: FLY 2 000 FT INTERVALS	ODD FLIGHT LEVELS (FL 190, 210, 230, etc.)	EVEN FLIGHT LEVELS (FL 180, 200, 220, etc.)
BELOW 18 000 ASL: (FLY CORRESPONDING FLIGHT LEVELS IN STANDARD PRESSURE REGION) FLY 2 000 FT INTERVALS	IFR and CVFR	IFR and CVFR
	ODD THOUSANDS ASL (1 000, 3 000, 5 000, etc.)	EVEN THOUSANDS ASL (2 000, 4 000, 6 000, etc.)
	VFR	VFR
	ODD THOUSANDS plus 500 FT ASL (3 500, 5 500, 7 500, etc.)	EVEN THOUSANDS plus 500 FT ASL (4 500, 6 500, 8 500, etc.)

2.4 FLIGHT INFORMATION REGIONS (FIRs)

A Flight Information Region (FIR) is an airspace of defined dimensions extending upwards from the surface of the earth, within which flight information service and alerting services are provided. The Canadian Domestic Airspace is divided into the Vancouver, Edmonton, Winnipeg, Toronto, Montréal, Moncton and Gander Domestic Flight Information Regions. Gander Oceanic is an additional FIR allocated to Canada by ICAO for the provision of flight information and alerting services over the high seas.

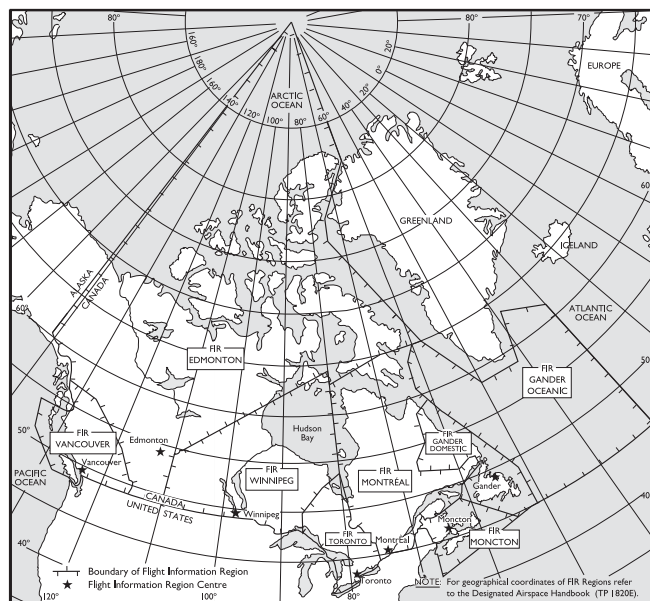
Canadian Flight Information Regions are described in the *Designated Airspace Handbook* (TP 1820E), and are depicted on the Enroute Charts and illustrated in Figure 2.2.

Agreements have been effected between Canada and the United States to permit reciprocal air traffic control services outside of

the designate national FIR boundaries. An example is V300 and J500 between SSM and YQT. The control of aircraft in US airspace delegated to a Canadian ATC unit is effected by applying the Canadian rules, procedures and separation minima with the following exceptions:

- a) aircraft will not be cleared to maintain “1 000 feet on top”;
- b) ATC vertical separation will not be discontinued on the basis of visual reports from the aircraft; and
- c) Canadian protected airspace criteria for track separation will not be used.

Figure 2.2—Flight Information Regions



2.5 CONTROLLED AIRSPACE

Controlled airspace is the airspace within which air traffic control service is provided and within which some or all aircraft may be subject to air traffic control. Types of controlled airspace are:

- a) in the High-Level Airspace:
 - the Southern, Northern and Arctic Control Areas.

NOTE:

Encompassed within the above are high-level airways, the upper portions of some military terminal control areas and terminal control areas.

RAC

- b) in the Low-Level Airspace:
 - low-level airways,
 - terminal control areas,
 - control area extensions,
 - control zones,
 - transition areas,
 - military terminal control areas.

2.5.1 Use of Controlled Airspace by Visual Flight Rules (VFR) Flights

Due to the speeds of modern aircraft, the difficulty in visually observing other aircraft at high altitudes and the density of air traffic at certain locations and altitudes, the “see and be seen” principle of VFR separation cannot always provide positive separation. Accordingly, in certain airspace and at certain altitudes VFR flight is either prohibited or subject to specific restrictions prior to entry and during flight.

2.5.2 Aircraft Speed Limit Order

According to CAR 602.32, no person shall operate an aircraft in Canada:

- a) below 10 000 ft ASL at more than 250 KIAS; or
- b) below 3 000 ft AGL within 10 NM of a controlled airport and at more than 200 KIAS, unless authorized to do so in an air traffic control clearance.

Exceptions

- a) A person may operate an aircraft at an indicated airspeed greater than the airspeeds referred to in (a) and (b) above where the aircraft is being operated in accordance with a special flight operations certificate – special aviation event issued under CAR 603.
- b) If the minimum safe speed, given the aircraft configuration, is greater than the speed referred to in (a) or (b) above, the aircraft shall be operated at the minimum safe speed.

Notifying ATC

On departure, when intending to operate at speeds exceeding 250 KIAS below 10 000 ft ASL, pilots must, on initial contact, notify the departure controller of the reason for this action.

ATC requires this information for the following reasons:

- for operational considerations regarding other traffic, particularly in potential overtake situations; and
- so that ATC will know that the request or notification of intent to operate above the speed limit is for “*minimum safe speed*” requirements and will therefore not file an Aviation Occurrence Report.

The phraseology of “*minimum safe speed XXX kt*” is encouraged and ATC will acknowledge.

Example: *Montreal Centre, ACA123, minimum safe speed 270 kt*

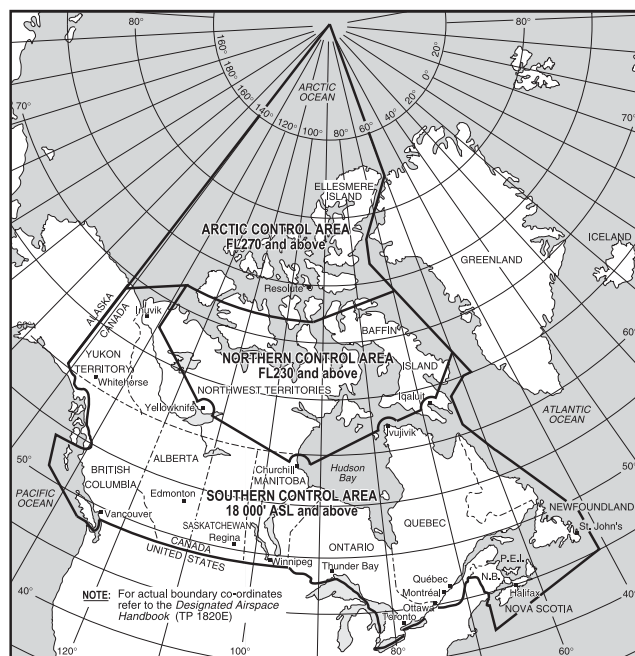
As ATC is not authorized to approve a speed greater than 250 KIAS below 10 000 ft ASL, the phraseology “request high-speed climb” should not be used.

2.6 HIGH-LEVEL CONTROLLED AIRSPACE

Controlled airspace within the High-Level Airspace is divided into three separate areas. They are the Southern Control Area (SCA), the Northern Control Area (NCA) and the Arctic Control Area (ACA). Their lateral dimensions are illustrated in Figure 2.3. Figure 2.4 illustrates their vertical dimensions which are: SCA, 18 000 ft ASL and above; NCA, FL 230 and above; ACA, FL 270 and above. The volume and concentration of international air traffic transiting the NCA and ACA on random tracks can create en route penalties to users by preventing maximum utilization of the airspace. To ensure the flow of traffic is accommodated efficiently, a track system has been established which interacts with the established airway system in the SCA and Alaska. Use of these tracks is mandatory at certain periods of the year.

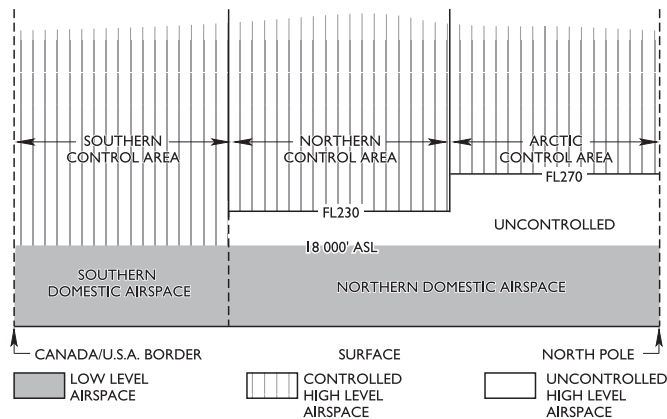
Pilots are reminded that both the NCA and the ACA are within the Northern Domestic Airspace; therefore, compass indications may be erratic, and true tracks are used in determining the flight level at which to fly. In addition, the airspace from FL 330 to FL 410 within the lateral dimensions of the NCA, the ACA and the northern part of the SCA has been designated CMNPS airspace. (See *AIP Canada (ICAO) ENR 2.2*)

Figure 2.3—Southern, Northern and Arctic Control Areas



RAC

Figure 2.4—Vertical Dimensions of Southern, Northern and Arctic Control Areas



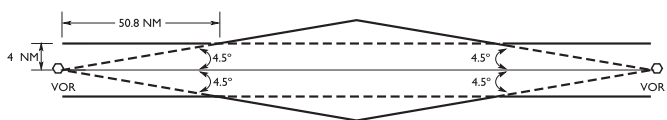
2.7 LOW-LEVEL CONTROLLED AIRSPACE

2.7.1 Low-Level Airways

Controlled low-level airspace extends upward from 2 200 ft AGL up to, but not including, 18 000 ft ASL, within the following specified boundaries:

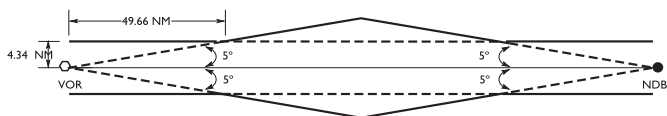
- a) *VHF/UHF Airways:* The basic VHF/UHF airway width is 4 NM on each side of the centreline prescribed for such an airway. Where applicable, the airway width shall be increased between the points where lines, diverging 4.5° on each side of the centreline from the designated facility, intersect the basic width boundary; and where they meet, similar lines projected from the adjacent facility.

Figure 2.5(a)—VHF/UHF Airway Dimensions



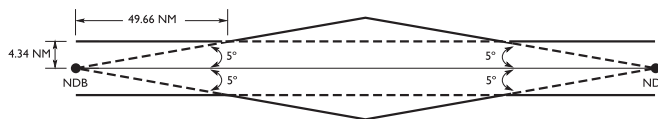
Where a Victor airway is established based on a VOR/VORTAC and NDB, the boundaries of that airway will be those of an LF/MF airway [see Figure 2.5(b)].

Figure 2.5(b)—VHF/UHF Airway Based on VOR and NDB



- b) *LF/MF Airways:* The basic LF/MF airway width is 4.34 NM on each side of the centreline prescribed for such an airway. Where applicable, the airway width shall be increased between the points where lines, diverging 5° on each side of the centreline from the designated facility, intersect the basic width boundary; and where they meet, similar lines projected from the adjacent facility.

Figure 2.6—LF/MF Airway Dimensions



- c) *T-Routes:* Low-level controlled fixed RNAV routes have dimensions of 4 NM of primary obstacle protection area, plus 2 NM of secondary obstacle protection area on each side of the centreline. The airspace associated with RNAV T-routes is 10 NM on each side of the centreline. RNAV T-route airspace and protection areas do not splay.

Figure 2.7(a)—Fixed RNAV Route

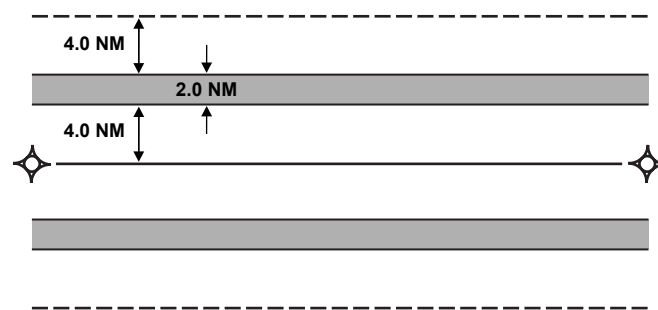
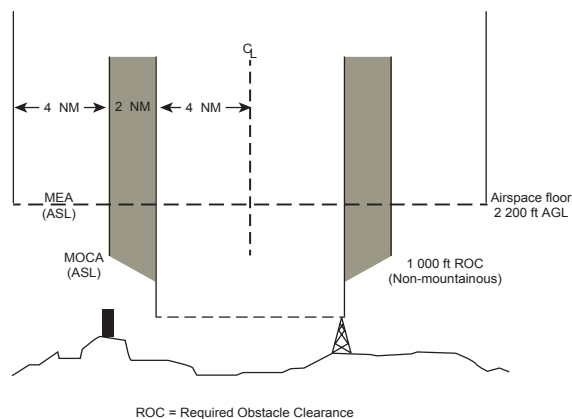


Figure 2.7(b)—Fixed RNAV Route Cross Section



2.7.2 Control Area Extensions

Control area extensions are designated around aerodromes where the controlled airspace provided is insufficient to permit the required separation between IFR arrivals and departures and to contain IFR aircraft within controlled airspace. A control area extension provides:

- a) additional controlled airspace around busy aerodromes for IFR control. The controlled airspace contained within the associated control zone and airway(s) width is not always sufficient to permit the manoeuvring required to separate IFR arrivals and departures; or

- b) connecting controlled airspace, e.g. a control area extension is used to connect a control zone with the en route structure.

Control area extensions are based at 2 200 ft AGL unless otherwise specified and extend up to, but not including 18 000 ft ASL. Some control area extensions, such as those which extend to the oceanic controlled airspace, may be based at other altitudes such as 2 000, 5 500 or 6 000 ft ASL. The outer portions of some other control area extensions may be based at higher levels. Even if described with an ASL floor, the base of a Control Area Extension shall not extend lower than 700 ft AGL.

2.7.3 Control Zones

Control zones are designated around certain aerodromes to keep IFR aircraft within controlled airspace during approaches and to facilitate the control of VFR and IFR traffic.

Control zones having a civil control tower within a terminal control area normally have a 7-NM radius. Others have a 5-NM

radius, with the exception of a few which have a 3-NM radius. Control zones are capped at 3 000 ft AAE unless otherwise specified. Military control zones usually have a 10-NM radius and are capped at 6 000 ft AAE. All control zones are depicted on VFR aeronautical charts and the Enroute Low Altitude Charts. Control zones will be classified as “B”, “C”, “D” or “E” depending on the classification of the surrounding airspace.

The VFR weather minima for control zones are outlined in Table 2.2. When weather conditions are below VFR minima, a pilot operating VFR may request special VFR (SVFR) authorization in order to enter the control zone. This authorization is normally obtained through the local tower or FSS, and must be obtained before SVFR is attempted within a control zone. ATC will issue an SVFR authorization, traffic and weather conditions permitting, only upon a request for SVFR from a pilot. SVFR will not be initiated by ATS. Once having received SVFR authorization, the pilot continues to remain responsible for avoiding other aircraft and weather conditions beyond the pilot’s own flight capabilities and the capabilities of the aircraft.

Table 2.2—VFR Weather Minima*

AIRSPACE		FLIGHT VISIBILITY	DISTANCE FROM CLOUD	DISTANCE AGL
Control Zones		not less than 3 mi.**	horizontally: 1 mi. vertically: 500 ft	vertically: 500 ft
Other Controlled Airspace		not less than 3 mi.	horizontally: 1 mi. vertically: 500 ft	—
Uncontrolled Airspace	1 000 ft AGL or above	not less than 1 mi. (day) 3 mi. (night)	horizontally: 2 000 ft vertically: 500 ft	—
	below 1 000 ft AGL – all aircraft except helicopters	not less than 2 mi. (day) 3 mi. (night) (see Note 1)	clear of cloud	—
	below 1 000 ft AGL – helicopter	not less than 1 mi. (day) 3 mi. (night) (see Note 2)	clear of cloud	—

* See CAR 602, Division VI – Visual Flight Rules

** Ground visibility when reported

NOTES:

1. Notwithstanding CAR 602.115, an aircraft other than an helicopter may be operated in visibilities less than 2 miles during the day, when authorized to do so in an air operator certificate or in a private operator certificate.
2. Notwithstanding CAR 602.115, a helicopter may be operated in visibilities less than 1 mile during the day, when authorized to do so in an air operator certificate or in a flight training unit operator certificate helicopter.

Special VFR weather minimum and requirements applicable within control zones are found in CAR 602.117, and are summarized as follows:

Where authorization is obtained from the appropriate ATC unit, a pilot-in-command may operate an aircraft within a control

zone, in IFR weather conditions without compliance with the IFR, where flight visibility and, when reported, ground visibility are not less than:

- a) 1 mile for aircraft other than helicopters; and
- b) 1/2 mile for helicopters.

NOTES:

1. All aircraft, including helicopters, must be equipped with a radio capable of communicating with the ATC unit and must comply with all conditions issued by the ATC unit as part of the SVFR authorization.
2. Aircraft must operate clear of cloud and within sight of the ground at all times.
3. Helicopters should operate at such reduced airspeeds so as

to give the pilot-in-command adequate opportunity to see other air traffic or obstructions in time to avoid a collision.

4. When the aircraft is not a helicopter and is being operated at night, ATC will only authorize special VFR where the authorization is for the purpose of allowing the aircraft to land at the destination aerodrome.

Table 2.3—Special VFR Weather Minima (control zones only)

	Flight Visibility (Ground when reported)	Distance from cloud
Aircraft other than Helicopter	1 mile	Clear of cloud
Helicopter	1/2 mile	

2.7.4 Visual Flight Rules (VFR) Over-the-Top

A person may operate an aircraft VFR over-the-top (VFR OTT), provided certain conditions are met. Those conditions include weather minima, aircraft equipment and pilot qualifications. Pilots should indicate that the flight is VFR OTT during communications with ATS units. Deviations from the intended route of flight may be necessary when transiting CZs or TCAs. Pilots should take into consideration the additional fuel requirements this may cause.

CAR 602.116 specifies the weather minima for VFR OTT. A summary of the minima follows:

- a) VFR OTT is allowed during the day only, and during the cruise portion of the flight only.
- b) The aircraft must be operated at a vertical distance from cloud of at least 1 000 ft.
- c) Where the aircraft is operated between two cloud layers, those layers must be at least 5 000 ft apart.
- d) The flight visibility at the cruising altitude of the aircraft must be at least 5 mi.
- e) The weather at the destination aerodrome must have a sky condition of scattered cloud or clear, and a ground visibility of 5 mi. or more, with no forecast of precipitation, fog, thunderstorms, or blowing snow, and these conditions must be forecast to exist
 - (i) in the case of an aerodrome forecast (TAF), for the period from 1 hr before to 2 hr after the ETA; and
 - (ii) in the case of an area forecast (GFA) because a TAF is not available, for the period from 1 hr before to 3 hr after the ETA.

CARs 605.14 and 605.15 outline the aircraft equipment requirements for VFR OTT. In part, the equipment requirements are the same as for VFR flight, with extra requirements for VFR OTT.

Pilot qualifications for VFR OTT flight are specified in CARs Part IV—*Personnel Licensing and Training*.

2.7.5 Transition Areas

Transition areas are established when it is considered advantageous or necessary to provide additional controlled airspace for the containment of IFR operations.

Transition areas are of defined dimensions, based at 700 ft AGL unless otherwise specified, and extend upwards to the base of overlying controlled airspace. The area provided around an aerodrome will normally be 15 NM radius of the aerodrome coordinates, but shall be of sufficient size to contain all of the aerodrome published instrument approach procedures. Even if described with an ASL floor, the base of a transition area shall not extend lower than 700 ft AGL.

2.7.6 Terminal Control Areas

Terminal control areas are established at high volume traffic airports to provide an IFR control service to arriving, departing and en route aircraft. Aircraft operating in the TCA are subject to certain operating rules and equipment requirements. The TCA operating rules are established by the classification of the airspace within the TCA. These rules will be based on the level of ATC service that is appropriate for the number and type of aircraft using the airspace as well as the nature of the operations being conducted.

A TCA is similar to a control area extension except that:

- a TCA may extend up into the high-level airspace;
- IFR traffic is normally controlled by a terminal control unit. The ACC will control a TCA during periods when a TCU is not in operation; and
- TCA airspace will normally be designed in a circular configuration, centred on the geographic coordinates of the primary aerodrome. The outer limit of the TCA should be at 45 NM radius from the aerodrome geographic coordinates based at 9 500 ft AGL, with an intermediate circle at 35 NM based at 2 200 ft AGL and an inner circle at 12 NM radius based at 1 200 ft AGL. Where an operational advantage may be gained, the area may be sectorized. For publication purposes the altitudes may be rounded to the nearest appropriate increment and published as heights ASL. The floor of a TCA shall not extend lower than 700 ft AGL.

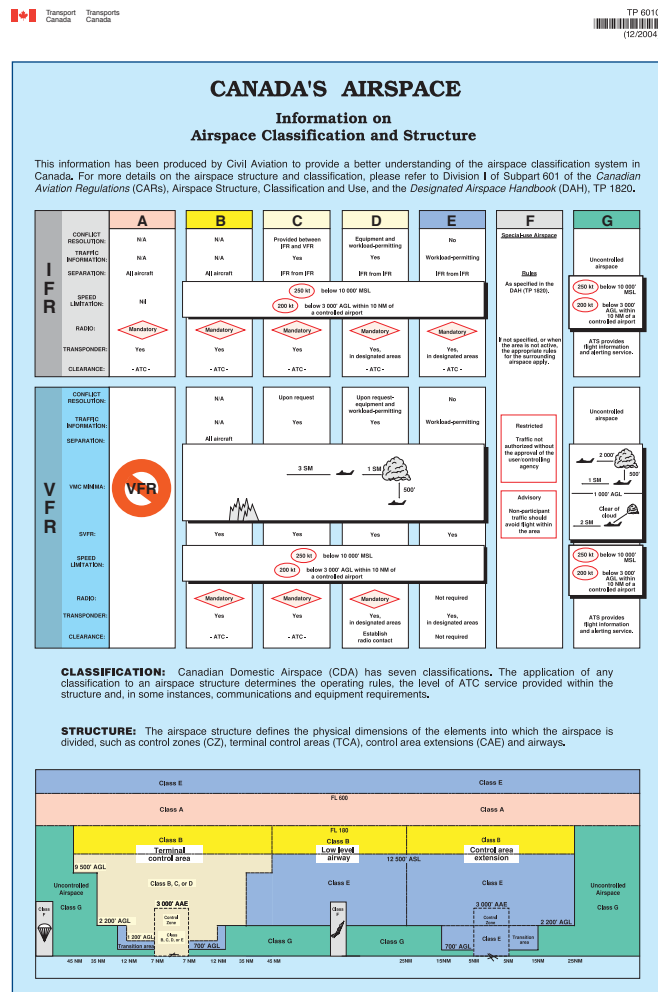
A military terminal control area is the same as a TCA, except that special provisions prevail for military aircraft while operating within the MTCA. MTCAs may be designated at selected military aerodromes where the control service will be provided by a military TCU, or by ATC, through agreement with DND.

2.8 AIRSPACE CLASSIFICATION

CDA is divided into seven classes, each identified by a single letter—A, B, C, D, E, F or G. Flight within each class is governed by specific rules applicable to that class and are contained in CAR 601—*Division I, Airspace Structure, Classification and Use*. CAR 601 can be found at <<https://laws-lois.justice.gc.ca/eng/regulations/SOR-96-433/page-80.html#h-720>>.

The rules for operating within a particular portion of airspace depend on the classification of that airspace and not on the name by which it is commonly known. Thus, the rules for flight within a high-level airway, a TCA or a CZ depend on the class of airspace within all or part of the defined area. Weather minima are specified for controlled or uncontrolled airspace, not for each class of airspace. For more information on Canada's airspace classification and structure, please see Figure 2.8. A bilingual, printable copy of Figure 2.8 is available at <www.tc.gc.ca/Publications/BIL/TP6010/PDF/HR/TP6010B.PDF>.

Figure 2.8—Canada's Airspace (TP 6010)



2.8.1 Class A Airspace

Class A airspace is designated where an operational need exists to exclude VFR aircraft.

All operations must be conducted under Instrument Flight Rules and are subject to ATC clearances and instructions. ATC separation is provided to all aircraft.

All aircraft operating in Class A airspace must be equipped with a transponder and automatic pressure altitude reporting equipment.

Class A airspace will be designated from the base of all high-level controlled airspace, or from 700 ft AGL, whichever is higher, up to and including FL 600.

2.8.2 Class B Airspace

Class B airspace is designated where an operational need exists to provide air traffic control service to IFR and to control VFR aircraft.

Operations may be conducted under IFR or VFR. All aircraft are subject to ATC clearances and instructions. ATC separation is provided to all aircraft.

All low-level controlled airspace above 12 500 feet ASL or at and above the MEA, whichever is higher, up to but not including 18 000 feet ASL will be Class B airspace.

Control zones and associated terminal control areas may also be classified as Class B airspace.

NOTES:

1. No person shall operate an aircraft in Class B controlled airspace in VFR flight unless:
 - a) the aircraft is equipped with:
 - (i) radio communication equipment capable of two-way communication with the appropriate ATS facility, and
 - (ii) radio navigation equipment capable of using navigation facilities to enable the aircraft to be operated in accordance with the flight plan, and
 - (iii) a transponder and automatic pressure altitude reporting equipment;
 - b) a continuous listening watch is maintained by a flight crew member on a radio frequency assigned by ATC;
 - c) except as otherwise authorized by ATC, when the aircraft is over a reporting point a position report is transmitted to the appropriate unit or, when so directed by ATC, to an FSS; and
 - d) the aircraft is operated in VMC at all times.

2. A person operating an aircraft on a VFR flight in Class B airspace shall operate the aircraft in VMC at all times. When it becomes evident that flight in VMC will not be possible at the altitude or along the route specified, the pilot shall:

- a) request an ATC clearance which will enable the aircraft to be operated in VMC to the filed destination, or to another aerodrome;
- b) where the person is the holder of a valid instrument rating, request an IFR clearance for flight under the instrument flight rules; or
- c) where the Class B airspace is a control zone, request an authorization for special VFR flight.

3. A person operating an aircraft in Class B controlled airspace in VFR flight who is unable to comply with the requirements of the preceding paragraphs shall ensure that:

- a) the aircraft is operated in VMC at all times;
- b) the aircraft leaves Class B controlled airspace:
 - (i) by the safest and shortest route, either exiting horizontally or descending, or
 - (ii) when that airspace is a control zone, by landing at the aerodrome on which the control zone is based, and
- c) an ATC unit is informed as soon as possible of the actions taken pursuant to paragraph (b).

2.8.3 Class C Airspace

Class C airspace is a controlled airspace within which both IFR and VFR flights are permitted, but VFR flights require a clearance from ATC to enter. ATC separation is provided between all aircraft operating under IFR and, as necessary to resolve possible conflicts, between VFR and IFR aircraft. Aircraft will be provided with traffic information. Conflict resolution will be provided, upon request, after VFR aircraft is provided with traffic information.

Traffic information is issued to advise pilots of known or observed air traffic which may be in proximity to their aircraft's position or intended route of flight warranting their attention. Conflict resolution is defined as the resolution of potential conflicts between IFR/VFR and VFR/VFR aircraft that are radar identified and in communication with ATC.

Airspace classified as Class C becomes Class E airspace when the appropriate ATC unit is not in operation.

Terminal control areas and associated control zones may be classified as Class C airspace.

A person operating an aircraft in VFR flight in Class C airspace shall ensure that:

- a) the aircraft is equipped with
 - (i) radio communication equipment capable of two-way communication with the appropriate ATC unit, and
 - (ii) a transponder and automatic pressure altitude reporting equipment; and
- b) a continuous listening watch is maintained by a flight crew member on a radio frequency assigned by ATC.

A person wishing to operate an aircraft that is not equipped with functioning communication and transponder equipment for VFR flight in Class C airspace may, during daylight hours and in VMC, enter Class C airspace provided that permission to enter and to operate within the airspace is obtained from ATC prior to the operation being conducted.

2.8.4 Class D Airspace

Class D airspace is a controlled airspace within which both IFR and VFR flights are permitted, but VFR flights must establish two-way communication with the appropriate ATC agency prior to entering the airspace. ATC separation is provided only to IFR aircraft. Aircraft will be provided with traffic information. Equipment and workload permitting, conflict resolution will be provided between VFR and IFR aircraft, and upon request between VFR aircraft.

Airspace classified as Class D becomes Class E airspace when the appropriate ATC unit is not in operation.

A terminal control area and associated control zone could be classified as Class D airspace.

A person operating an aircraft in VFR flight in Class D airspace shall ensure that:

- a) the aircraft is equipped with
 - (i) radio communication equipment capable of two-way communication with the appropriate ATC unit, and
 - (ii) where the Class D airspace is specified as Transponder Airspace, a transponder and automatic pressure altitude reporting equipment; and
- b) a continuous listening watch is maintained by a flight crew member on a radio frequency assigned by ATC.

A person operating an aircraft in VFR flight that is not equipped with the required radio communication equipment may, during daylight hours in VMC, enter Class D airspace provided that permission to enter is obtained from the appropriate ATC unit prior to operating within the airspace.

2.8.5 Class E Airspace

Class E airspace is designated where an operational need exists for controlled airspace but does not meet the requirements for Class A, B, C, or D.

Operations may be conducted under IFR or VFR. ATC separation is provided only to aircraft operating under IFR. There are no special requirements for VFR.

Aircraft are required to be equipped with a transponder and automatic pressure altitude equipment to operate in Class E airspace that is specified as transponder airspace.

Low-level airways, control area extensions, transition areas, or control zones established without an operating control tower may be classified as Class E airspace.

2.8.6 Class F Airspace

Class F airspace is airspace of defined dimensions within which activities must be confined because of their nature, and within which limitations may be imposed upon aircraft operations that are not a part of those activities.

Special-use airspace may be classified as Class F advisory or as Class F restricted, and can be controlled airspace, uncontrolled airspace, or a combination of both. An advisory area, for example, may have the floor in uncontrolled airspace and the ceiling in controlled airspace. The significance, in this instance, is that the weather minima would be different in the controlled and uncontrolled portions.

Unless otherwise specified, the rules for the appropriate airspace apply in areas of Class F airspace, no matter if they are active or inactive.

Class F airspace shall be designated in the DAH (TP 1820E) in accordance with the airspace regulations, and shall be published on the appropriate aeronautical charts.

Charting of Class F Airspace

All designated Class F restricted and advisory airspace is published on HI or LO charts, as applicable, and on VFR aeronautical charts.

Each restricted and advisory area within Canada has been assigned an identification code group, which consists of the four following parts:

- Part (a) the nationality letters CY;
- Part (b) the letter R for restricted area (the letter D for danger area if the restricted area is established over international waters) or the letter A for advisory area;

Part (c) a three-digit number that will identify the area. This number will indicate the Canadian region within which the area lies as follows:

- 101 to 199 – British Columbia
- 201 to 299 – Alberta
- 301 to 399 – Saskatchewan
- 401 to 499 – Manitoba
- 501 to 599 – Ontario
- 601 to 699 – Quebec
- 701 to 799 – New Brunswick,
Nova Scotia,
Prince Edward Island,
Newfoundland
- 801 to 899 – Yukon Territory
- 901 to 999 – Northwest Territories
and Nunavut (including the Arctic
Islands)

Part (d) in the case of advisory areas, the letter A, F, H, M, P, S or T in parentheses after the three-digit number that will indicate the type of activity within the area as follows:

- A – acrobatic
- F – aircraft test
- H – hang gliding
- M – military operations
- P – parachuting
- S – soaring
- T – training

Example:

The identification code group CYA113(A) means the following:

- CY – indicates Canada
- A – indicates advisory
- 113 – indicates the number of an area
in British Columbia
- (A) – indicates acrobatic activity
takes place within the area.

All altitudes will be inclusive, unless otherwise indicated (e.g. 5 000 to 10 000 ft). To indicate when either the bottom or upper altitude is not included, the words below and above will be placed before the appropriate altitude (e.g. above 5 000 to 10 000 ft, or 5 000 to below 10 000 ft).

Danger Area (International Waters)

Any restricted area that may be established over international waters, but controlled by Canadian ATC, will be indicated as a “danger area” in accordance with ICAO requirements. ICAO defines a danger area as airspace of defined dimensions within which activities dangerous to the flight of aircraft may exist at specified times.

Advisory Airspace

Airspace may be classified as Class F advisory airspace if it is airspace within which an activity occurs that, for flight safety purposes, non-participating pilots should be aware of, such as training, parachuting, hang gliding, military operations, etc.

There are no specific restrictions that apply to the use of advisory airspace. VFR aircraft are, however, encouraged to avoid flight in advisory airspace unless participating in the activity taking place therein. If necessary, pilots of non-participating flights may enter advisory areas at their own discretion; however, due to the nature of the aerial activity, extra vigilance is recommended. Pilots of participating aircraft, as well as pilots flying through the area, are equally responsible for collision avoidance.

ATC will not clear IFR aircraft through Class F airspace, except if:

- a) the pilot states that permission has been obtained from the user agency to enter the airspace;
- b) the aircraft is operating on an altitude reservation approval (ALTRV APVL); or
- c) the aircraft has been cleared for a contact or visual approach.

IFR aircraft shall be provided 500 ft vertical separation from an active Class F advisory airspace, unless wake turbulence minima is applicable, in which case 1 000 ft vertical separation shall be applied.

Pilots intending to fly in Class F advisory airspace are encouraged to monitor an appropriate frequency, to broadcast their intentions when entering and leaving the area, and to communicate, as necessary, with other users to ensure flight safety in the airspace. In a Class F advisory uncontrolled airspace area, 126.7 MHz would be an appropriate frequency.

NOTE:

Military operations in Class F airspace may be UHF only.

Restricted Airspace

A restricted area is airspace of defined dimensions above the land areas or territorial waters within which the flight of aircraft is restricted in accordance with certain specified conditions. Restricted airspace is designated for safety purposes when the level or type of aerial activity, the surface activity, or the protection of a ground installation requires the application of restrictions within that airspace.

No person may conduct aerial activities within active Class F restricted airspace, unless permission has been obtained from the user agency. In some instances, the user agency may delegate the appropriate controlling agency the authority to approve access. IFR flights will not be cleared through active restricted areas, unless the pilot states that permission has been obtained.

The user agency is the civil or military agency or organization responsible for the activity for which the Class F airspace has been provided. It has the jurisdiction to authorize access to the airspace when it is classified restricted. The user agency must be identified for Class F restricted airspace, and where possible, it should be identified for Class F advisory airspace.

Special-use areas will be designated restricted areas and identified by the prefix CYR, followed by a three-digit number that identifies the location of the area.

Elements of existing airspace structure may also be designated as restricted airspace if it would facilitate the efficient flow of air traffic.

There are two additional methods of restricting airspace.

- a) CAR 601.16—Issuance of NOTAM for Forest Fire Aircraft Operating Restrictions, is designed to allow the Minister to issue a NOTAM to restrict flight around and over forest fire areas or areas where forest fire control operations are being conducted. The provisions of this section can be invoked quickly via NOTAM by Transport Canada.
- b) Section 5.1 of the *Aeronautics Act* allows the Minister to restrict flight in any airspace, for any purpose, by NOTAM. This authority is delegated by the Minister to cover specific situations, such as well fires, disaster areas, etc., for the purpose of ensuring safety of flight for air operations in support of the occurrence.

It should be noted that airspace that is restricted by invoking CAR 601.16 or section 5.1 of the *Aeronautics Act* is not Class F restricted airspace; the airspace has not been classified in accordance with the airspace regulations. This distinction is important to those who are charged with the responsibility for restricting airspace, since their actions are governed by the provisions of the *Statutory Instruments Act*.

Joint-Use Airspace

Joint-use airspace is Class F airspace within which operations may be authorized by the controlling agency when it is not being utilized by the user agency.

Class F restricted airspace should be available for use by non-participating aircraft when all or part of the airspace is not required for its designated purpose.

To ensure maximum utilization of restricted airspace, user agencies should be encouraged to make restricted airspace available for the conduct of operations or training of other agencies or commands on a joint-use basis.

The ATC agency may be designated to provide air traffic control or information service within the Class F airspace involved. A controlling agency will normally be assigned when there is joint use of the airspace.

NOTAM

It is permissible to designate Class F restricted airspace by NOTAM, if the following prerequisites are met:

- a) the area of restricted airspace is required for a specified period of time of relative short duration (i.e. several hours or days); and
- b) the appropriate NOTAM is issued at least 24 hr in advance of the area's activation.

2.8.7 Class G Airspace

Class G airspace is airspace that has not been designated Class A, B, C, D, E or F, and within which ATC has neither the authority nor the responsibility to exercise control over air traffic.

However, ATS units do provide flight information and alerting services. The alerting service will automatically alert SAR authorities once an aircraft becomes overdue, which is normally determined from data contained in the flight plan or flight itinerary.

In effect, Class G is all uncontrolled domestic airspace.

Low-level air routes are contained within Class G airspace. They are basically the same as a low-level airway, except that they extend upwards from the surface of the earth and are not controlled. The lateral dimensions are identical to those of a low-level airway.

2.9 OTHER AIRSPACE DIVISIONS

Additional airspace divisions have been designated in order to increase safety or make allowances for the remote or mountainous regions within Canada. These divisions (or regions) are: altimeter setting region, standard pressure region and designated mountainous region.

2.9.1 Altitude Reservation

An altitude reservation is airspace of defined dimensions within controlled airspace reserved for the use of a civil or military agency during a specified period. An altitude reservation may be confined to a fixed area (stationary) or moving in relation to the aircraft that operates within it (moving). Information on the description of each altitude reservation is normally published by NOTAM. Civil altitude reservations are normally for a single aircraft, while those for military use are normally for more than one aircraft.

Pilots should plan to avoid known altitude reservations. ATC will not clear an unauthorized flight into an active reservation. IFR and CVFR flights are provided with standard separation from altitude reservations.

2.9.2 Temporary Flight Restrictions—Forest Fires

In the interest of safe and efficient fire fighting operations, the Minister may issue a NOTAM restricting flights over a forest fire area to those operating at the request of the appropriate fire control authority (i.e. water bombers), or to those with written permission from the Minister.

The NOTAM would identify the following:

- a) the location and dimensions of the forest fire area;
- b) any airspace in which forest fire control operations are being conducted; and
- c) the length of time during which flights are restricted in the airspace.

No person shall operate an aircraft in the airspace below 3 000 ft AGL within 5 NM of the limits of a forest fire area, or as described in a NOTAM (CARs 601.15, 601.16, and 601.17).

2.9.3 Flight Operations Over or in the Vicinity of Nuclear Power Plants

Pilots are reminded that overflights of nuclear power plants shall be carried out in accordance with the provisions of CAR 602.14(2) (see RAC 5.4).

Pilots should also be aware that loitering in the vicinity of, or circling, nuclear power plants should be avoided. Aircraft observed operating in this manner in the vicinity of nuclear power plants could be intercepted by government or law-enforcement aircraft, and escorted away from the facility to the nearest suitable aerodrome to be interviewed by police authorities.

2.10 ALTIMETER SETTING REGION

The altimeter setting region is an airspace of defined dimensions below 18 000 feet ASL (see CAR 602.35 and Figure 2.9) within which the following altimeter setting procedures apply:

Departure – Prior to takeoff, the pilot shall set the aircraft altimeter to the current altimeter setting of that aerodrome or, if that altimeter setting is not available, to the elevation of the aerodrome.

En route – During flight the altimeter shall be set to the current altimeter setting of the nearest station along the route of flight or, where such stations are separated by more than 150 NM, the nearest station to the route of flight.

Arrival – When approaching the aerodrome of intended landing the altimeter shall be set to the current aerodrome altimeter setting, if available.

2.11 STANDARD PRESSURE REGION

The standard pressure region includes all airspace over Canada at or above 18 000 feet ASL (the high-level airspace), and all low-level airspace that is outside of the lateral limit of the altimeter setting region (see Figure 2.11 and CAR 602.36). Within the standard pressure region the following flight procedures apply;

General – Except as otherwise indicated below, no person shall operate an aircraft within the standard pressure region unless the aircraft altimeter is set to standard pressure, which is 29.92 inches of mercury or 1013.2 mbs. (See Note).

Departure – Prior to takeoff the pilot shall set the aircraft altimeter to the current altimeter setting of that aerodrome or, if the altimeter setting is not available, to the elevation of that aerodrome. Immediately prior to reaching the flight level at which flight is to be conducted, the altimeter shall be set to standard pressure (29.92 inches of mercury or 1013.2 mbs). If the planned cruising flight level is above FL 180, resetting the altimeter to 29.92 inches of mercury or 1013.2 mbs at 18 000 ft ASL is acceptable and meets the requirement of CAR 602.36.

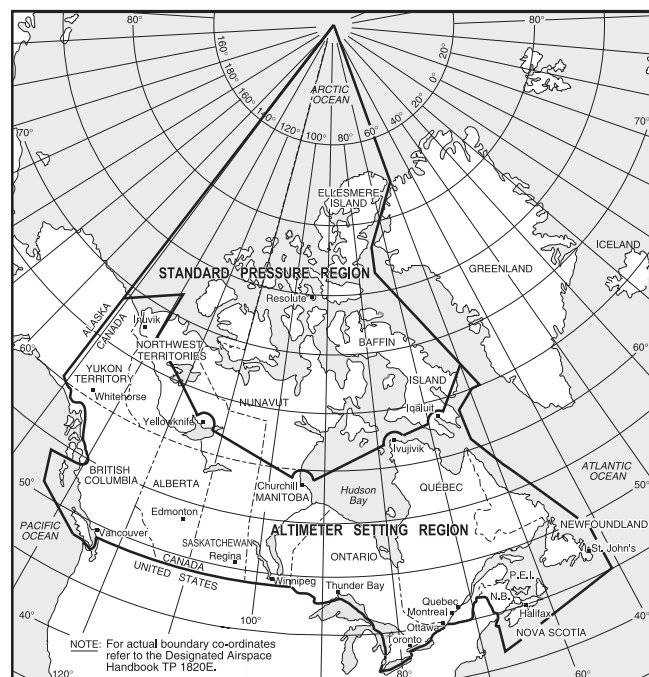
Arrival – Prior to commencing descent with the intention to land, the altimeter shall be set to the current altimeter setting of the aerodrome of intended landing, if available. However, if a holding procedure is conducted, the altimeter shall not be set to the current aerodrome altimeter setting until immediately prior to descending below the lowest flight level at which the holding procedure is conducted. Pilots of aircraft descending from cruising flight levels above FL 180 may reset altimeters to the current altimeter setting of the aerodrome of intended landing when approaching FL 180 provided no holding or cruise level flight below FL 180 is to be made or anticipated.

Transition – CAR 602.37 – *Altimeter Setting and Operating Procedures in Transition between Regions*, specifies that except as otherwise authorized by ATC, aircraft progressing from one region to another shall make the change in the altimeter setting while within the standard pressure region prior to entering, or after leaving, the altimeter setting region. If the transition is to be made into the altimeter setting region while in level cruising flight, the pilot should obtain the current altimeter setting from the nearest station along the route of flight as far as practical before reaching the point at which the transition is to be made. When climbing from the altimeter setting region into the standard pressure region, pilots shall set their altimeters to standard pressure (29.92 inches of mercury or 1013.2 mbs) immediately after entering the standard pressure region. When descending into the altimeter setting region, pilots shall set their altimeters to the appropriate station altimeter setting immediately prior to descending into the altimeter setting region. Normally, the pilot will receive the appropriate altimeter setting as part of the ATC clearance prior to descent. If it is not incorporated in the clearance, it should be requested by the pilot.

NOTE:

When an aircraft is operating in the standard pressure region with standard pressure set on the altimeter subscale, the term “flight level” is used in lieu of “altitude” to express its height. Flight level is always expressed in hundreds of feet. For example FL 250 represents an altimeter indication of 25 000 ft; FL 50, an indication of 5 000 ft.

Figure 2.9—Altimeter Setting and Standard Pressure Regions



2.12 MOUNTAINOUS REGIONS

Designated mountainous regions are areas of defined lateral dimensions, specified in the *Designated Airspace Handbook*, above which special rules concerning minimum IFR altitudes to ensure obstacle clearance (CAR 602.124) apply.

An aircraft, when operated in accordance with IFR within designated mountainous regions, but outside of areas for which minimum altitudes for IFR operations have been established (including minimum radar vectoring altitudes, MOCAs, transition altitudes, 100NM safe altitudes, MSAs and AMAs), shall be flown at an altitude of at least 2000 feet above the highest obstacle within 5NM of the aircraft in flight when in areas 1 and 5, and at least 1500 feet above the highest obstacle within 5NM when in areas 2, 3 and 4. (See Figure 2.10.)

As minimum en route IFR altitudes have been established for designated airways and air routes, such minimum altitudes shall be applied when flying in accordance with IFR along airways or air routes within designated mountainous regions, except that aircraft should be operated at an altitude which is at least 1000 feet higher than the minimum en route IFR altitude, when there are large variations in temperature and/or pressure. (See RAC 8.6)

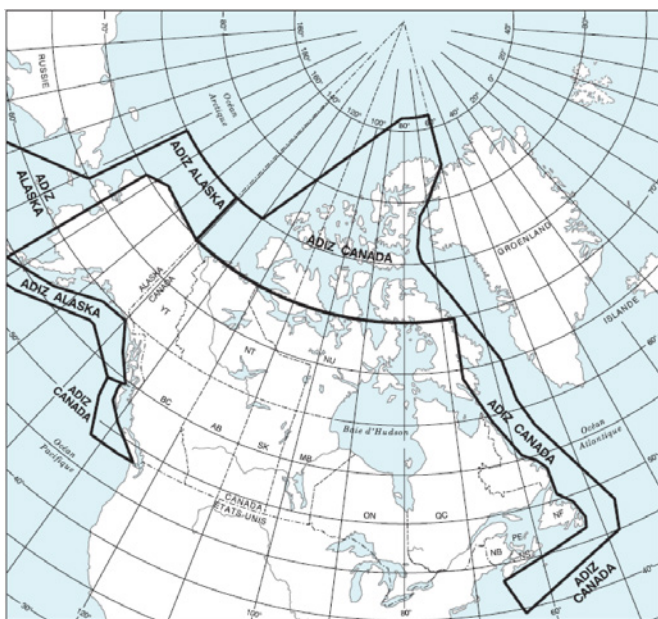
Figure 2.10—Designated Mountainous Regions in Canada



2.13 EMERGENCY COMMUNICATIONS AND SECURITY

The rules for operating within the Air Defence Identification Zone (ADIZ) are specified in CAR 602.145 – ADIZ, and are repeated in RAC 3.9.

Figure 2.11—Air Defence Identification Zone (ADIZ)



RAC

3.0 FLIGHT PLANNING

3.1 GENERAL

The flight planning requirements contained in this Section are based, in part, on the CAR, Part VI, General Operating and Flight Rules.

The pilot-in-command of an aircraft shall, before commencing a flight, be familiar with the available information that is appropriate to the intended flight (CAR 602.71).

The pilot-in-command of an aircraft shall, before commencing a flight, be familiar with the available weather information that is appropriate to the intended flight (CAR 602.72). Pilots should refer to the MET Section for aviation weather information.

3.2 PILOT BRIEFING SERVICE

The pilot briefing service is provided by FICs to assist pilots at the pre-flight planning stage and for information updates while en route. Pilot requests for initial briefings while airborne are not encouraged because this practice leads to frequency congestion.

The telephone numbers of NAV CANADA FICs are found in the General and Aerodrome/Facility Directory sections of the CFS or CWAS. Long distance phone calls can be made to a FIC toll-free at 1-866-WXBRIEF (1-866-992-7433). A call to this number is routed to the FIC that serves the area from which the call originates. A call to 1-866-GOMÉTÉO (1-866-466-3836) is routed to the Québec FIC for the provision of bilingual service. A specific FIC may be contacted at the number shown in the CFS or CWAS, General section, Flight Planning (FLT PLN) sub-section. Collect calls from pilots are accepted at all FICs.

When requesting a briefing, identify yourself as a pilot; provide the aircraft identification and the following:

- a) type of flight (VFR, IFR, CVFR, composite) planned;
- b) type of aircraft;
- c) aerodrome of departure and estimated time of departure (ETD);
- d) destination aerodrome and estimated elapsed time (EET);
- e) planned cruising level(s) or altitude(s);
- f) route to be flown and estimated times of arrival at, and departure from, any intermediate aerodrome(s);
- g) alternate aerodrome, if appropriate;
- h) type of meteorological information requested, i.e. whether a briefing or consultation; and
- i) information already on hand, if any.

The flight service specialist requires this information to tailor the briefing to the planned flight and the needs of the pilot. The flight service specialist may omit information normally provided in a briefing if the pilot has indicated having the data on hand or requested the briefing be limited to specific information. The flight service specialist will terminate the briefing by soliciting flight plan information not already obtained at the beginning of the briefing and PIREP, if appropriate.

3.3 AERONAUTICAL INFORMATION

Aeronautical information (NOTAM, RSC, CRFI, flow control, etc.) is available at ATS units and at certain operations offices. Aeronautical information is routinely provided by FICs during a pilot briefing and upon request in FISE. Telephone numbers and RCO frequencies for all FICs are listed in the CFS and the CWAS.

Canadian domestic NOTAMs are disseminated via the aeronautical fixed service (AFS) and stored electronically in accordance with a NOTAM series concept. NOTAMs are further divided as aerodrome NOTAM and flight information region (FIR) NOTAM in accordance with the subject and impact. Before commencing a flight, pilots must ensure that each pertinent NOTAM series and type has been reviewed, so that they are familiar with all appropriate NOTAMs for the intended flight.

All Canadian NOTAMs, with the exception of NOTAMJ, are composed and disseminated in the International Civil Aviation Organization (ICAO) format. Canadian NOTAM series have different distribution lists and dissemination categories. For more details on series, NOTAM regions, and dissemination categories, refer to *AIP Canada (ICAO)* section GEN 3.1.3.

3.4 WEIGHT AND BALANCE CONTROL

3.4.1 Definitions

The following definitions and abbreviations are used in weight and balance control:

- a) **Actual weight** is the weight, when referenced to passenger weight, derived by the weighing of each passenger just prior to flight boarding, and then adding the allowances for personal clothing and carry-on baggage. Infants shall be weighed along with their accompanying adult. Where weighing scales are not available or serviceable, or the passenger refuses to be weighed, the following weights may be used in lieu of actual weight.
 - (i) **Volunteered weight** is the weight obtained by asking the passenger for their weight, adding 4.5 kg (10 lb) to the disclosed weight, and then adding the allowances for personal clothing and carry-on baggage.
 - (ii) **Estimated weight** is the reasonable estimate of the passenger's weight made by the operator, where actual weight is not available and volunteered weight is either

not provided or is deemed to be understated, to which allowances are then added for personal clothing and carry-on baggage.

NOTE:

Personnel who board passengers should, with a reasonable degree of accuracy, be able to assess the validity of a passenger's volunteered weight, or estimate the weight, and shall include allowances for personal clothing and carry-on baggage. Where necessary, the volunteered weight should be appropriately increased so as to avoid gross inaccuracies.

- b) **Air operator segmented weights** are the approved segmented weights derived by the air operator from statistically meaningful data using a methodology that is acceptable to the Minister. They may be used in lieu of TCCA published segmented weights and are applicable only to that air operator. Furthermore, the weights may be used only in circumstances consistent with those under which the survey was conducted.
- c) **Air operator standard weights** are the approved standard weights derived by the air operator from statistically computed data in accordance with procedures that are acceptable to the Minister. They may be used in lieu of the standard weights published by TCCA and are applicable only to that air operator. Furthermore, the weights may be used only in circumstances consistent with those under which the survey was conducted.
- d) **Basic empty weight** is the basic weight of the aircraft as determined in accordance with the aircraft flight manual (AFM).
- e) **Carry-on baggage** is the baggage that a passenger may carry on board. Based on the particular aircraft stowage limitations, the operator may limit the number, size, shape and weight of the carry-on baggage to enable it to be stowed under the passenger seat or in the storage compartment. Otherwise, the standard allowance is 5.9 kg (13 lb) of carry-on baggage per passenger and this remains constant throughout the year. Carry-on baggage weight shall be included in the weight of the passenger for the purpose of weight and balance calculation.

NOTE:

The only circumstance under which the weight of the carry-on baggage may not be added to the weight of each passenger is when no carry-on baggage is permitted on the flight.

- f) **Checked baggage** is baggage that is individually checked in, weighed and placed in the cargo compartment of the aircraft. This includes baggage that is too large to be placed in the cabin of the aircraft and baggage that must be carried in the cargo compartment by regulation, security program, or company policy. For baggage checked plane-side, see the definition for plane-side loaded bag.
- g) **Empty weight** is the total weight of the following parts or contents, which are part of, or carried on board, the aircraft:
- the airframe, including the rotor of a helicopter or gyroplane;
 - the power plant;
 - the fixed ballast;
 - the unusable fuel;
 - the maximum amount of normal operating fluids, including oil, power-plant coolant, hydraulic fluid, de-icing fluid and anti-icing fluid, but not including potable water, lavatory pre-charge fluid or fluid intended for injection into the engines; and
 - all of the installed equipment.
- h) **Large aeroplane** is an aeroplane with an maximum certificated take-off weight (MCTOW) of over 5 700 kg (12 566 lb).
- i) **Maximum certificated take-off weight (MCTOW)** is weight identified as such in an aircraft type certificate.
- j) **Maximum permissible take-off weight or maximum take-off weight (MTOW)** is the maximum take-off weight for an aircraft as authorized by the aircraft's state of registry or as provided for in the aircraft type certificate.
- k) **On board weight and balance system** is a system that weighs the aircraft and its payload and then calculates the centre of gravity (CG) using equipment on board the aircraft.
- l) **Operational empty weight** is the actual weight of the aircraft before loading for dispatch. The operational empty weight may include removable equipment, flight crew members and crew members (including baggage), oil, unusable fuel, as well as emergency equipment, and should be defined by the air operator. It does not include usable fuel and payload.
- m) **Operations personnel** is the personnel whose duties and responsibilities involve maintenance, loading, unloading, dispatching, servicing, weight and balance, passenger escort, scheduling, de-icing, or working on the ramp. This also includes members of the flight crew and cabin crew, as well as anyone involved in the aircraft's operation.
- n) **Passenger** is a person, other than a crew member, who is carried on board an aircraft and who, for weight and balance control, is categorized as a(n):
- Adult**—a person, regardless of sex, who is aged 12 years or older and who may be subcategorized as male or female;
 - Child**—a person (male or female) who is between two to less than 12 years of age; or
 - Infant**—a baby who is less than two years of age.
- o) **Personal clothing allowance** is the weight of personal clothing that a passenger carries on board the aircraft, which is standardized as 3.6 kg (8 lb) for summer and 6.4 kg (14 lb) for winter and must be added to the passenger's weight for the purpose of weight and balance calculation.
- p) **Plane-side loaded bag** is any bag or item that is placed at the door or steps of an aircraft because it cannot be accommodated as carry-on baggage and that is subsequently placed in the aircraft cargo compartment or cargo bin.
- q) **Segmented weights** are the statistically derived average adult (male or female) passenger weights modified by appropriate standard deviations so as to be representative of small passenger groups and provide a predetermined degree of confidence and accuracy (tolerance) that the actual weight of the passenger group will not exceed the weight calculated by using segmented weight values. The segmented weight table identifies weight values that are modified to cater for variations in aircraft passenger seating capacity and include personal clothing and carry-on baggage allowances. In the Canadian context, segmented weights are applicable only for aeroplanes that are certificated for passenger seating capacity of five or more and are being operated under Subpart 703 of the CARs.

NOTE:

Segmented weights should be used where actual weights, volunteered weights or estimated weights are not available or cannot be used.

- r) **Small aircraft** is an aircraft with a maximum permissible take-off weight of 5 700 kg (12 566 lb) or less, or a helicopter with a maximum permissible take-off weight of 2 730 kg (6 018 lb) or less.
- s) **Standard weights** are the weights published by TCCA as standard average passenger weights, including personal clothing and carry-on baggage allowances, for use in weight and balance calculations that do not involve actual weighing.

3.4.2 Weight Control

Pilots must recognize the effect of weight and balance on the performance and handling of aircraft, particularly in combination with performance-reducing factors, such as contaminated runways, aircraft icing, degraded engine performance, severe or uncoordinated manoeuvres, turbulence, high ambient temperatures and emergency situations.

It is mandatory to calculate weight and balance accurately for every flight and ensure that they are within the aircraft's permissible limits in order to comply with the aircraft airworthiness certificate and conform to the regulations. Before the aircraft takes off, it is important that the PIC of the aircraft ensure that the load carried by the aircraft is of an appropriate weight; the weight must be distributed and secured so that it may be carried

safely on the intended flight. If weight and CG (balance) limitations are not observed, then the pilot has failed to comply with a legal condition for the operation of the aircraft and the airworthiness certificate is nullified.

It must be recognized that with many four- and six-seat aircraft, it is not possible to fill all the seats, use the maximum baggage allowance, fill all the fuel tanks and still remain within the approved weight and CG limitations.

Estimating baggage weight can result in gross inaccuracies. If it is possible that the aircraft is operating close to its MTOW, the baggage must be weighed. Even a pocket-sized spring balance can be used as a handy standby if weighing scales are not available. This reduces the risk involved in guesswork. Note that on some aircraft, restrictions are placed on rear-seat occupancy if the maximum baggage allowance is used. When the aircraft is carrying freight, check for discrepancies with the declared weight. Ensure that the weight per unit area limitation on the baggage compartment floor is not exceeded. It is critical to ensure that the baggage/freight is properly stowed, cannot move during flight, and does not obstruct exits or access to emergency equipment. If the aircraft is suspected to be operating anywhere close to its maximum weight, passengers must be weighed. The risk of embarrassment is not a reason for risking safety or crossing weight limits. It is important to remember that a passenger's weight is not his or her stripped weight, but must include personal clothing and carry-on baggage allowances.

Fuel is supplied in pounds, kilograms, litres or gallons. Pilots should note which unit is being used and calculate the fuel weight accordingly. Incorrect conversion could be hazardous in terms of endurance and fuel weight estimation.

3.4.3 Balance

Balance refers to the location of the CG along the longitudinal axis of the aircraft. There are forward and aft limits established during certification flight testing; they are the maximum CG positions at which the longitudinal stability requirements can be met. If an aircraft is being operated outside these limits, its handling is either unsatisfactory or has not been investigated. The limits for each aircraft are contained in the pilot operating handbook and the AFM. The aircraft must not be flown outside these limits.

In many aircraft, there is significant CG movement as fuel is being consumed; pilots should familiarize themselves with how this affects their aircraft.

3.4.4 Operational Requirements

It is the responsibility of the PIC of the aircraft to ensure that the weight and balance report of the flight accurately represents the actual load and that the actual load does not exceed the maximum allowable weight limits specified in the AFM for any phase of the flight.

The report may be prepared by the crew, another qualified person authorized by the company or by the operator of the aircraft.

Companies and operators may establish specific procedures with respect to preparing and retaining weight and balance documentation in order to meet regulatory requirements.

3.4.5 Computerized Systems

When a company or operator generates load data from a computerized weight and balance system, the integrity of the output data must be checked at regular intervals (preferably not greater than six months). The length of the intervals must be specified in the company operations manual.

There must be a means in place to identify the person inputting the data for the preparation of every load manifest. Moreover, the identity of that person must be verified and authenticated by the system and retained as required.

3.4.6 Segmented Weights

In practice, it was found that the use of standard passenger weights, regardless of aircraft size, increases the probability of overloading the aircraft when its passenger-carrying capacity decreases and vice versa. For example, when the standard passenger weight is used for an aircraft certificated for 12 passengers, like the Twin Otter, the statistical probability of overloading the aircraft is as high as 25%, whereas when it is used for large passenger aircraft, like the Boeing 747, this probability diminishes to 0.0014%.

Furthermore, a single weight cannot account for the weight differences between men and women or for variations in aircraft seating capacity. To minimize the probability of overloading the aircraft, an alternative to standard passenger weights, called segmented weights, was implemented. Segmented weights are based on aircraft seating capacity and account for weight differences between men and women as well as for summer and winter variations.

Segmented weights are designed to guarantee a 95% confidence level that the actual total weight of passengers will not exceed the total weight of passengers obtained by using segmented weights by more than one percent. This is the benchmark of segmented weights for accuracy and reliability.

3.4.6.1 Derivation of Segmented Weights

A specific methodology was used to calculate the precise values published in the segmented weight tables. TCCA's segmented weight tables are based on the Canadian Community Health Survey, Cycle 2.1 (2003), which obtained large-scale weight data by interviewing some 130 000 Canadians. In addition, standard deviations of 16.8 kg (37 lb) for males and 14.6 kg (32.2 lb) for females were applied to obtain a revised average weight for each sex. These weights were further modified to account for specific aircraft seating capacity ranges so as to be representative of the

highest average weight amongst all sample sizes for that range. A constant value of 5.9 kg (13 lb) for carry-on baggage was then added to the average adult (male/female) passenger weight and finally, two values were developed to account for seasonal variations in personal clothing—3.6 kg (8 lb) for summer clothing and 6.4 kg (14 lb) for winter clothing. See Table 3.2 for finalized weight values.

3.4.7 Computation of Passenger and Baggage Weights

To compute passenger weight, the following methods are used: actual weights, standard weights and segmented weights.

NOTE:

For aircraft with a passenger seating capacity of less than five, the use of actual weights provides the greatest accuracy in calculating the weight and balance of the aircraft, therefore the use of standard or segmented passenger weights is not recommended.

- a) *Using Actual Weights*—In determining the actual weight, an air operator must weigh each passenger and must ensure that personal clothing and carry-on baggage are also weighed. The total of the person's weight, personal clothing and carry-on baggage would then be treated as the passenger's weight. Weighing should be conducted just before boarding (to minimize the chances of the passenger acquiring additional load just before boarding the aircraft); alternatively, the allowances for personal clothing and carry-on baggage can be added to a passenger's weight and the result can be used as the passenger's actual weight.

When a passenger refuses to be weighed, the air operator should ask the passenger to volunteer their weight (**volunteered weight**). If they refuse, the air operator should estimate the passenger's weight (**estimated weight**), ensuring in both cases that the allowances for personal clothing and carry-on baggage are included in the passenger's weight.

Personnel boarding passengers based on volunteered weights should be able to assess the validity of the disclosed weight. If a volunteered weight is deemed to be significantly inaccurate, personnel should use good judgment to make a reasonably accurate estimate. Similarly, estimating passenger weight must be done with a reasonable degree of accuracy. Due diligence should be exercised to ensure that passenger weights used to calculate the passenger and baggage load accurately reflect the actual weight to be carried on any given flight.

- b) *Using Standard Weights*—The weight of each passenger is calculated using standard weights published by TCCA or established by the air operator. The standard weights include the standardized allowances for personal clothing and carry-on baggage. See Tables 3.1 and 3.3 for standard weights.

- c) *Using Segmented Weights*—Segmented weights should be used only when actual weights, volunteered weights, and estimated weights are not available or cannot be implemented. Air operators are prohibited from using standard weights for aeroplanes operated under Subpart 703 of the CARs that also have a certificated passenger seating capacity of five or more passengers. Instead, it is recommended that they use either actual weights or the segmented weights that are published by TCCA or established by the air operator.

When using the segmented weight table (Table 3.2), an air operator must follow these steps:

- (i) Step 1: Under the column titled Maximum Certificated Passenger Seating Capacity, select the row that represents the certificated seating capacity of the intended aircraft.
- (ii) Step 2: Under the column that represents the season, select winter or summer.
- (iii) Step 3: Depending on the aircraft capacity and seasons selected in steps 1 and 2, use the weight values identified in the intersecting cells for the weights of males and females. When changing the aircraft, steps 1 to 3 have to be repeated.
- (iv) Step 4: Multiply the individual male/female weight identified in step 3 by the number of male/female passengers on board, and the total of these weights will be the weight of the passenger load for that particular flight.

NOTES:

1. Actual weights should be used on any flight identified as carrying a significant number of passengers whose weight or number of carry-on baggage is deemed to be in excess of those specified in the segmented weights published by TCCA or established by the air operator.
2. The only circumstance under which the weight of carry-on baggage may not be added to the weight of each passenger is when no carry-on baggage is permitted on the flight.

- d) *Weight of Children and Infants*—Each child should be weighed, or their weight should be included at the standard rate. Infants should be weighed with the accompanying adult. When an infant's weight is over 10% of the adult passenger's weight, the infant's weight should be included separately at the rate of 13.6 kg (30 lbs) per infant. Infants occupying separate seats should be treated as children for the purpose of weight and balance calculation, and their weight should be included at the standard rate per child. See Table 3.3 for standard weights of children and infants.

- e) *Checked Baggage and Cargo*—The air operator must use the actual weight of checked baggage and cargo.

Table 3.1—Standard Weights of Passengers Aged 12 Years or Older

Summer		Winter
206 lb or 93.4 kg	Males (12 years and up)	212 lb or 96.2 kg
172 lb or 78.1 kg	Females (12 years and up)	178 lb or 80.7 kg
206 lb or 93.4 kg	Gender X	212 lb or 96.2 kg

Table 3.2—Segmented Weights of Passengers Aged 12 Years or Older (in Pounds)

Maximum Certificated Passenger Seating Capacity	Winter			Summer		
	Male	Female	Gender X	Male	Female	Gender X
1–4	Use actual weights, volunteered weights or estimated weights.					
5	249	210	249	243	204	243
6–8	244	206	244	238	200	238
9–11	236	199	236	230	193	230
12–16	233	196	233	227	190	227
17–25	229	193	229	223	187	223

Table 3.3—Standard Weights of Children and Infants

Summer		Winter
75 lb or 34 kg	Children 2–11 years	75 lb or 34 kg
30 lb or 13.6 kg	*Infants 0 to less than 2 years	30 lb or 13.6 kg

3.4.8 Fuel and Oil Weights

Fuel and oil weights were obtained from the Canadian Government Standards Bureau specifications. It should be remembered that the capacity of tanks is often expressed in US gallons. The standard weights of fuel and oil are provided in Tables 3.4, 3.5 and 3.6.

NOTE:

The weights shown are for the maximum density at the various temperatures. The actual fuel weight for specific conditions can usually be obtained from the dealer supplying the fuel. Conversion factors for litres to imperial gallons and kilograms to pounds are found in GEN 1.7.1.

Table 3.4—Fuel Weight Based on Temperature

Temperature	-40°C			-20°C			0°C			15°C			30°C		
Fuel	lb per			lb per			lb per			lb per			lb per		
	litre	UK gal.	US gal.	litre	UK gal.	US gal.	litre	UK gal.	US gal.	litre	UK gal.	US gal.	litre	UK gal.	US gal.
Aviation Kerosene CAN 2-3, 23-M81 (JET A, JET A-1, JET A-2) and Arctic Diesel	1.93	8.80	7.32	1.90	8.65	7.19	1.87	8.50	7.09	1.85	8.39	7.00	1.83	8.27	6.91
Aviation Wide Cut Fuel CAN 2-3, 23-M80 (F-40 [JP4] and JET B)	1.85	8.38	6.99	1.82	8.24	6.88	1.79	8.11	6.78	1.77	8.01	6.68	1.74	7.92	6.60
Aviation Gasoline All Grades CAN 2-3, 25-M82 (AV GAS)	1.69	7.68	6.41	1.65	7.50	6.26	1.62	7.33	6.12	1.59	7.20	6.01	1.56	7.07	5.90

Table 3.5—Lubricating Oil Weight Based on Temperature

Temperature	-10°C			0°C			10°C			20°C			30°C		
Lubricating oil	lb per			lb per			lb per			lb per			lb per		
	litre	UK gal.	US gal.	litre	UK gal.	US gal.	litre	UK gal.	US gal.	litre	UK gal.	US gal.	litre	UK gal.	US gal.
Piston Engine 65 Grade	1.98	8.98	7.46	1.97	8.92	7.46	1.95	8.85	7.38	1.94	8.78	7.33	1.92	8.71	7.28
120 Grade	2.01	9.10	7.59	1.99	9.03	7.54	1.97	8.96	7.46	1.96	8.88	7.41	1.94	8.82	7.35

Table 3.6—Turbine Engine Lubricating Oil Weight at a 15°C Temperature

Type of lubricating oil	lb/litre	lb/UK gal.	lb/US gal.
3cS	2.09	9.4	7.92
5cS	2.15	10.1	8.14

3.5 FLIGHT PLANS AND FLIGHT ITINERARIES

3.5.1 When Required

CAR 602.73 states that no pilot-in-command shall operate an aircraft in VFR flight unless a VFR flight plan or a VFR flight itinerary has been filed, except where the flight is conducted within 25 NM of the departure aerodrome.

No pilot-in-command shall operate an aircraft in IFR flight unless an IFR flight plan has been filed. A pilot-in-command may file an IFR flight itinerary instead of an IFR flight plan where:

- a) the flight is conducted, in part or in whole, outside controlled airspace; or
- b) facilities are inadequate to permit the communication of flight plan information to an ATC unit, an FSS or a CARS.

Notwithstanding any of the requirements mentioned above, pilots are required to file a flight plan when operating between Canada and a foreign state.

3.5.2 Filing (*Canadian Aviation Regulation [RAC] 602.75*)

602.75

1. A flight plan shall be filed with an air traffic control unit, a flight service station or a community aerodrome radio station.
2. A flight itinerary shall be filed with a responsible person, an air traffic control unit, a flight service station or a community aerodrome radio station.
3. A flight plan or flight itinerary, shall be filed by
 - a) sending, delivering or otherwise communicating the flight plan or flight itinerary or the information contained therein; and
 - b) receiving acknowledgement that the flight plan or flight itinerary or the information contained therein has been received.

A “responsible person” means an individual who has agreed with the person who has filed a flight itinerary to ensure that, if the aircraft is overdue, the following are notified in the manner prescribed in this Section:

- a) an ATC unit, an FSS or a CARS; or
- b) an RCC.

NOTES:

1. The notification requires the flight itinerary information.
2. The expression flight service station used in the regulation includes a FIC. Flight plan information should be filed with a FIC, where complete briefing information is available. An IFR flight plan should be submitted to the flight planning section of an ACC.

The timely filing of IFR flight plans or flight itineraries is essential to allow ATC personnel time to extract and record the relevant content, correlate these new data with available information on other traffic under control, coordinate as necessary, and determine how the flight may best be integrated with the other traffic.

Accordingly, in order to assist ATS in improving the service provided and to allow sufficient time for input into the ATS data processing system, pilots are encouraged to file IFR flight plans or flight itineraries as early as practicable, preferably at least 30 min prior to their proposed departure time. Pilots are expected to depart in accordance with the flight plan ETD. Some delay could be experienced if an IFR clearance is required less than 30 min after filing. It is also important that ATS be informed of the circumstances if commencement of an IFR flight is to be delayed. IFR flight itineraries are limited to one departure from and one entry into controlled airspace; multiple exits and entries into controlled airspace will not be accepted by ATS.

3.5.3 Flight Plan Requirements—Flights Between Canada and a Foreign State

A VFR or IFR flight plan must be filed prior to conducting any flight between Canada and a foreign state. If the flight is to any country other than the U.S., an ICAO flight plan must be filed. ATS must not accept flight itineraries, composite flight plans, or CVFR flight plans for flights between Canada and the U.S.

ADCUS notification is no longer accepted on flight plans for transborder flights departing from Canada to the U.S. or from the U.S. to Canada. Pilots are required to file a flight plan to an acceptable customs destination in the U.S. and are also required to contact U.S. Customs and Border Protection (CBP) to make customs arrangements prior to their flight. Failure to do so may subject the pilot to a penalty.

3.5.4 Opening a Visual Flight Rules (VFR) Flight Plan or Flight Itinerary

A VFR flight plan or flight itinerary should normally be opened with a TWR, an FSS, a FIC or a CARS upon departure to activate the alerting service. The pilot is responsible for extending or cancelling the flight plan or flight itinerary if the flight is delayed or cancelled. If an extension or cancellation is not received by the proposed departure time, the responsible ATS unit will activate the flight plan or flight itinerary, using the ETD as the actual time of departure (ATD).

3.6 CHANGES TO THE INFORMATION IN A FLIGHT PLAN OR FLIGHT ITINERARY

Since control and alerting services are based primarily on information provided by the pilot, it is essential that modifications to flight plans and flight itineraries be communicated to an ATC unit, a FIC, a CARS or, as applicable, a responsible person concerned, as soon as practicable.

3.6.1 Visual Flight Rules (VFR) Flight Plan or Flight Itinerary

CAR 602.76(3) and (4) specify that a pilot “shall notify as soon as practicable an air traffic control unit, a flight service station, a community aerodrome radio station or the responsible person,” of any change to:

- a) the route of flight,
- b) the duration of the flight; or
- c) the destination aerodrome.

3.6.2 Instrument Flight Rules (IFR) Flight Plan or Flight Itinerary

CAR 602.76(1) and (2) specify that a pilot shall notify as soon as practicable an air traffic control unit, a flight service station, a community aerodrome radio station or a responsible person, as the case may be, of any change to:

- a) the cruising altitude or cruising flight level;
- b) the route of flight;
- c) the destination aerodrome;
- d) when in controlled airspace:
 - (i) the true airspeed at the cruising altitude or cruising level where the change intended is 5% or more of the TAS specified in the IFR flight plan; or
 - (ii) the Mach number, where the change intended is 0.01 or more of the Mach number that has been included in the ATC clearance.

Where the flight is being conducted in controlled airspace, the pilot shall receive ATC clearance before making the intended change.

3.7 COMPOSITE FLIGHT PLAN OR FLIGHT ITINERARY—VISUAL FLIGHT RULES (VFR) AND INSTRUMENT FLIGHT RULES (IFR)

A composite flight plan or flight itinerary may be filed that describes part(s) of the route as operating under VFR and part(s) of the route as operating under IFR. All rules governing VFR or IFR apply to that portion of the route of flight. A composite flight plan or flight itinerary shall not be filed for an aircraft that will enter airspace controlled by the FAA, including CDA delegated to the FAA, as composite data cannot be correctly processed between NAV CANADA and FAA systems.

A pilot who files IFR for the first part of a flight and VFR for the next part will be cleared by ATC to the point within controlled airspace at which the IFR part of the flight ends. A pilot who files VFR for the first part of a flight and IFR for the next part is expected to contact the appropriate ATC unit for clearance

prior to approaching the point where the IFR portion of the flight commences. If direct contact with an ATC unit is not possible, the pilot may request ATC clearance through a FIC. It is important that the flight continue under VFR conditions until appropriate IFR clearance within controlled airspace is issued by ATC and acknowledged by the pilot.

3.8 DEFENCE VISUAL FLIGHT RULES (VFR) FLIGHT PLANS AND DEFENCE FLIGHT ITINERARIES (*CANADIAN AVIATION REGULATION [CAR] 602.145*)

CAR 602.145 outlines the requirements when operating into or within the Air Defence Identification Zone (ADIZ). In order to ensure that the Air Traffic System (ATS) is aware that VFR flights will be operating into or within the ADIZ, ATS requires that pilots file a Defence Flight Plan or Flight Itinerary.

CAR 602.145 ADIZ states:

602.145 ADIZ

1. This Section applies in respect of aircraft before entering into and while operating within the ADIZ, the dimensions of which are specified in the *Designated Airspace Handbook*.
2. Every flight plan or flight itinerary required to be filed pursuant to this Section shall be filed with an air traffic control unit, a flight service station or a community aerodrome radio station.
3. The pilot-in-command of an aircraft whose point of departure within the ADIZ or last point of departure before entering the ADIZ has facilities for the transmission of flight plan or flight itinerary information shall:
 - a) before takeoff, file a defence flight plan or defence flight itinerary;
 - b) in the case of a VFR aircraft where the point of departure is outside the ADIZ,
 - (i) indicate in the flight plan or flight itinerary the estimated time and point of ADIZ entry, and
 - (ii) as soon as possible after takeoff, communicate by radio to an air traffic control unit, a flight service station or a community aerodrome radio station a position report of the aircraft's location, altitude, aerodrome of departure and estimated time and point of ADIZ entry; and
 - c) in the case of a VFR aircraft where the point of departure is within the ADIZ, as soon as possible after takeoff, communicate by radio to an air traffic control unit, a flight service station or a community aerodrome radio station a position report of the aircraft's location, altitude and aerodrome of departure.
4. The pilot-in-command of an aircraft whose point of departure within the ADIZ or last point of departure before entering the ADIZ does not have facilities for the transmission of

flight plan or flight itinerary information shall:

- (i) as soon as possible after takeoff, file by radio communication a flight plan or flight itinerary; and
 - (ii) in the case of a VFR aircraft, indicate in the flight plan or flight itinerary the estimated time and point of ADIZ entry, if applicable.
3. The pilot-in-command of a VFR aircraft shall revise the estimated time and point of ADIZ entry and inform an air traffic control unit, a flight service station or a community aerodrome radio station, when the aircraft is not expected to arrive:
- a) within plus or minus five minutes of the estimated time at:
 - (i) a reporting point,
 - (ii) the point of ADIZ entry, or
 - (iii) the point of destination within the ADIZ; or
 - b) within 20 nautical miles of:
 - (i) the estimated point of ADIZ entry, or
 - (ii) the centreline of the route of flight indicated in the flight plan or flight itinerary.

3.9 INTERMEDIATE STOPS

Intermediate stops may not be included in a single instrument flight rules (IFR) flight plan. A single visual flight rules (VFR) flight plan or an IFR or VFR flight itinerary including one or more intermediate stops en route may be filed provided that:

- a) for VFR flight plans, the stop will be of short duration (for purposes such as boarding passengers, and refuelling);
- b) for IFR flight itineraries, the stop will be in uncontrolled airspace; and
- c) each intermediate stop is indicated by repeating the name of the stopping point and its duration in the “Route” section of the flight plan or flight itinerary. Record the duration of the stopover in hours and minutes with four consecutive digits. Example: CYXU 0045 CYXU. You may include a phone number for the stopover in the “Other Information” section of the flight plan or flight itinerary, if available, as this may be useful in case of search and rescue (SAR).

When intermediate stops are planned, the “Estimated Elapsed Time” must be calculated as the total time to the final destination, including the duration of the intermediate stops. It should be noted that SAR action would only be initiated at the specified SAR time or, in the event that a SAR time is not indicated, 60 minutes for a flight plan and 24 hours for a flight itinerary after the estimated time of arrival (ETA) at the final destination. Pilots who wish to have SAR action based on every leg of a flight should file one flight plan or flight itinerary for each stop.

3.9.1 Consecutive Instrument Flight Rules (IFR) Flight Plans

Consecutive IFR flight plans may be filed at the initial point of departure providing the following points are adhered to:

- a) initial point of departure and en route stops must be in Canada except that one flight plan will be accepted for a departure point within United States controlled airspace;
- b) the sequence of stops will fall within one 24-hour period;
- c) the flight planning unit must be provided with at least the following items of information for each stage of the flight:
 - (i) point of departure,
 - (ii) altitude,
 - (iii) route,
 - (iv) destination,
 - (v) proposed time of departure,
 - (vi) estimated elapsed time,
 - (vii) alternate,
 - (viii) fuel on board, and, if required,
 - (A) TAS,
 - (A) number of persons on board, and
 - (A) where an arrival report will be filed.

3.10 CROSS COUNTRY INSTRUMENT TRAINING FLIGHTS

A cross country instrument training flight is one in which there are no intermediate stops and one or more instrument approaches are made en route. For example, an aircraft departs Airport A, completes a practice approach at Airport B and either lands at destination Airport C or returns to land at Airport A.

The following apply:

- a) A single flight plan is filed.
- b) Those en route locations at which instrument approaches and overshoots are requested shall be listed in the “Other Information” portion of the flight plan form, together with the estimated period of time to carry out each approach (i.e. REQ NDB RWY 32 AT B-15 MIN.).
- c) The estimated elapsed time (EET) of the flight plan form is NOT to include the estimated time to carry out approaches at the en route locations.
- d) ATC will normally clear the aircraft to final destination.
- e) If it is not practicable to clear the aircraft to final destination or to assign an operationally suitable altitude with the initial clearance, a time or specific location for the aircraft to expect further clearance to the destination or to a higher altitude will be issued with the initial clearance.

- f) When an en route approach clearance is requested, a missed approach clearance will be issued to the aircraft prior to the commencement of the approach.
- g) If traffic does not permit an approach, holding instructions will be issued to the aircraft if requested by the pilot.

3.11 CLOSING A FLIGHT PLAN

In order to comply with CAR 602.77, an arrival report for a flight plan shall be submitted to an ATC unit, an FSS (or a FIC) or a CARS as soon as practicable after landing but not later than:

- a) the SAR time specified in the flight plan; or
- b) where no SAR time is specified in the flight plan, one hour after the last reported ETA.

A pilot who terminates a flight itinerary shall ensure that an arrival report is filed with an ATC unit, an FSS (or a FIC), a CARS or, where the flight itinerary was filed with a responsible person, the responsible person as soon as practicable after landing but not later than:

- a) the SAR time specified in the flight itinerary; or
- b) where no SAR time was specified in the flight itinerary, 24 hours after the last reported ETA.

A pilot who terminates an IFR flight at an aerodrome where there is an operating ATC unit, FSS or where RAAS is provided, is not required to file an arrival report unless requested to do so by the appropriate ATC unit or FSS.

When submitting an arrival report, the pilot should clearly indicate that he/she was operating on a flight plan or flight itinerary and wishes it to be closed. Failure to close a flight plan or flight itinerary will initiate SAR action. It should not be assumed that ATS personnel will automatically file arrival reports for VFR flights at locations served by control towers and FSSs or an RCO. Toll-free calls, as outlined in the CFS, may be made to an ATS facility for this purpose.

3.11.1 Arrival Report

CAR 602.78 specifies that the contents of an arrival report for a flight plan or flight itinerary, which are listed in the CFS, shall include:

- a) the aircraft registration mark, flight number or radio call sign;
- b) the type of flight plan or flight itinerary;
- c) the departure aerodrome;
- d) the arrival aerodrome, and
- e) the date and time of arrival.

3.11.2 Closing of a Flight Plan or Flight Itinerary Prior to Landing

A pilot, who conducts a flight in respect of which a flight plan or flight itinerary has been filed with an ATC unit, FIC, FSS, or CARS, has the option of closing the flight plan or flight itinerary with any of these agencies prior to landing.

The closing of a flight plan or flight itinerary prior to landing is considered as filing an arrival report, and as such, it will result in the termination of all alerting services with respect to SAR notification.

When flying IFR in airspace under the jurisdiction of Canadian ATC, use of the phrase “Cancelling IFR” results in ATC discontinuing the provision of IFR separation, but it does not automatically close the flight plan or itinerary. Therefore, alerting service with regard to SAR notification is still active and is based on the information submitted in the original flight plan or itinerary. Because the pilot is now flying in accordance with VFR, the flight plan or itinerary must either be closed prior to landing, or an arrival report filed after landing, with an ATC unit, a FIC, a FSS or a CARS. When flying IFR in the U.S.A. or landing at a Canadian airport that underlies airspace delegated to the control of the FAA, use of the phrase “Cancelling IFR” results in ATC discontinuing the provision of IFR separation and also closes the flight plan or itinerary. Therefore, alerting service with regard to SAR notification is also terminated, unless the pilot files and activates a VFR flight plan.

3.12 FUEL REQUIREMENTS

The fuel requirements contained in this Section do not apply to gliders, balloons or ultra-light aeroplanes. (CAR 602.88)

In addition to VFR and IFR fuel requirements, every aircraft shall carry an amount of fuel that is sufficient to provide for

- a) taxiing and foreseeable delays prior to takeoff;
- b) meteorological conditions;
- c) foreseeable air traffic routings and traffic delays;
- d) landing at a suitable aerodrome in the event of loss of cabin pressurization or, in the case of a multi-engined aircraft, failure of any engine, at the most critical point during the flight; and
- e) any other foreseeable conditions that could delay the landing of the aircraft.

3.12.1 Visual Flight Rules (VFR) Flight

An aircraft operated in VFR flight shall carry an amount of fuel that is sufficient to allow the aircraft

- a) in the case of an aircraft other than a helicopter,
 - (i) when operated during the day, to fly to the destination aerodrome and then to fly for 30 minutes at normal cruising speed, or
 - (ii) when operated at night, to fly to the destination aerodrome and then to fly for 45 minutes at normal cruising speed, or
- b) in the case of a helicopter, to fly to the destination aerodrome and then to fly for 20 min. at normal cruising speed.

3.12.2 Instrument Flight Rules (IFR) Flight

An aircraft operated in IFR flight shall carry an amount of fuel that is sufficient to allow the aircraft

- a) in the case of a propeller-driven aeroplane,
 - (i) where an alternate aerodrome is specified in the flight plan or flight itinerary, to fly to and execute an approach and a missed approach at the destination aerodrome, to fly to and land at the alternate aerodrome, and then to fly for a period of 45 minutes, or
 - (ii) where an alternate aerodrome is not specified in the flight plan or flight itinerary, to fly to and execute an approach and a missed approach at the destination aerodrome and then to fly for a period of 45 minutes; or
- b) in the case of a turbojet powered aeroplane or a helicopter,
 - (i) where an alternate aerodrome is specified in the flight plan or flight itinerary, to fly to and execute an approach and a missed approach at the destination aerodrome, to fly to and land at the alternate aerodrome, and then to fly for a period of 30 minutes, or
 - (ii) where an alternate aerodrome is not specified in the flight plan or flight itinerary, to fly to and execute an approach and a missed approach at the destination aerodrome and then to fly for a period of 30 minutes.

3.13 REQUIREMENTS FOR ALTERNATE AERODROME — INSTRUMENT FLIGHT RULES (IFR) FLIGHT

Except as otherwise authorized by the Minister in an air operator certificate (AOC) or in a private operator certificate, no pilot-in-command shall operate an aircraft in IFR flight unless the IFR flight plan or IFR flight itinerary that has been filed for the flight includes an alternate aerodrome having a landing area suitable for use by that aircraft. No pilot-in-command of an aircraft shall include an alternate aerodrome in an IFR flight plan or IFR flight itinerary unless available weather information indicates that the ceiling and ground visibility at the alternate aerodrome will, at the expected time of arrival, be at or above

the alternate aerodrome weather minima criteria specified in the CAP. (CARs 602.122 and 602.123)

Aerodrome forecasts (TAF) that contain the terms BECMG, TEMPO or PROB may be used to determine the weather suitability of an aerodrome as an alternate, provided that:

- a) where conditions are forecast to improve, the forecast BECMG condition shall be considered to be applicable as of the end of the BECMG time period, and these conditions shall not be below the published alternate minima requirements for that aerodrome;
- b) where conditions are forecast to deteriorate, the forecast BECMG condition shall be considered to be applicable as of the start of the BECMG time period, and these conditions shall not be below the published alternate minima requirements for that aerodrome;
- c) the forecast TEMPO condition shall not be below the published alternate minima requirements for that aerodrome; and
- d) the forecast PROB condition shall not be below the appropriate landing minima for that aerodrome.

3.13.1 Alternate Aerodrome Weather Minima Requirements

Authorized weather minima for alternate aerodromes are to be determined using the information presented in the tables below. The “Alternate Weather Minima Requirements” table presented in the CAP GEN (reproduced below) applies to all approach charts, except where use as an alternate is not authorized on the chart. The minima derived for an alternate aerodrome shall be consistent with aircraft performance, navigation-equipment limitations, functioning NAVAIDs, type of weather forecast and runway to be used.

Pilots may take credit for RNAV approaches at alternate aerodromes in accordance with the criteria outlined in the “Alternate Aerodrome Weather Minima Requirements” section of the CAP GEN.

Table 3.7—Alternate Aerodrome Weather Minima Requirements

FACILITIES AVAILABLE AT SUITABLE ALTERNATE	WEATHER REQUIREMENTS
TWO OR MORE USABLE PRECISION APPROACHES, each providing straight-in minima to separate suitable runways	400-1 or 200-1/2 above lowest usable HAT and visibility, whichever is greater.
ONE USABLE PRECISION APPROACH	600-2* or 300-1 above the lowest usable HAT and visibility, whichever is greater.

FACILITIES AVAILABLE AT SUITABLE ALTERNATE	WEATHER REQUIREMENTS
NON-PRECISION ONLY AVAILABLE	800-2* or 300-1 above the lowest usable HAT/HAA and visibility, whichever is greater.
NO IFR APPROACH AVAILABLE	Forecast weather must be no lower than 500 ft above a minimum IFR altitude that will permit a VFR approach and landing.
FOR HELICOPTERS, where instrument approach procedures are available	Ceiling 200 ft above the minima for the approach to be flown, and visibility at least 1 SM, but never less than the minimum visibility for the approach to be flown.

*600-2 and 800-2, as appropriate, are considered to be STANDARD ALTERNATE MINIMA.

Should the selected alternate weather requirements meet the standard minima, then the following minima are also authorized:

Table 3.8—Other Authorized Minima

STANDARD ALTERNATE MINIMA		IF STANDARD IS APPLICABLE, THEN THE FOLLOWING MINIMA ARE ALSO AUTHORIZED	
CEILING	VISIBILITY	CEILING	VISIBILITY
600	2	700	1 1/2
		800	1
800	2	900	1 1/2
		1000	1

NOTES:

1. These requirements are predicated upon the aerodrome having a TAF available.
2. Aerodromes served with an AERODROME ADVISORY forecast may qualify as an alternate, provided the forecast weather is no lower than 500 ft above the lowest usable HAT/HAA and the visibility is not less than 3 mi.
3. Aerodromes served with a GRAPHIC AREA FORECAST (GFA) may qualify as an alternate, provided the forecast weather contains:
 - a) no cloud lower than 1 000 ft above the lowest usable HAT/HAA;
 - b) no cumulonimbus; and
 - c) a visibility that is not less than 3 mi.

4. Ceiling minima are calculated by reference to the procedure HAA or HAT. Ceiling values in aviation forecasts are established in 100–ft increments. Up to 20 ft, use the lower 100–ft increment; above 20 ft, use the next higher 100–ft increment:

Examples:

- HAA 620 ft = ceiling value of 600 ft;
- HAA 621 ft = ceiling value of 700 ft;
- HAT 420 ft = ceiling value of 400 ft;
- HAT 421 ft = ceiling value of 500 ft.

5. Calculated visibilities should not exceed 3 mi.

CAUTION:

All heights specified in a GFA are ASL, unless otherwise indicated.

The emphasis of these criteria is placed upon the availability of the lowest usable landing HAT/HAA and visibility for an aerodrome. In determining the lowest usable landing HAT/HAA and visibility, the pilot should consider:

- a) the operational availability of the ground navigational equipment by consulting NOTAM;
- b) the compatibility of the aircraft equipment with the ground navigational equipment;
- c) the forecast surface wind conditions could dictate the landing runway and associated approach minima;
- d) the operational applicability of terms BECMG, TEMPO and PROB within the forecast;
- e) all heights mentioned within a GFA are ASL heights, unless otherwise indicated, and the terrain elevation must be applied in order to determine the lowest forecast ceiling at a particular location; and
- f) alternate minima values determined from a previous flight operation may not be applicable to a subsequent flight operation.

3.14 COMPLETION OF CANADIAN FLIGHT PLANS AND FLIGHT ITINERARIES AND INTERNATIONAL CIVIL AVIATION ORGANIZATION (ICAO) FLIGHT PLANS

3.14.1 General

The flight plan form is to be used for Canadian flight plans or flight itineraries and ICAO flight plans. Completion of the form is simply a matter of inserting the requested information in the appropriate boxes. The white boxes relate to required information for Canadian flight plans and for flight itineraries and for ICAO flight plans. The shaded boxes indicate the information which

is applicable only to Canadian flight plans and flight itineraries.

NOTE:

A Canadian flight plan is used for flights from Canada to the United States.

3.14.2 Canadian

A Canadian flight plan or flight itinerary shall contain such information as is specified in the CFS, including:

- aircraft identification
- flight rules
- type of flight
- number of aircraft (if more than one)
- type of aircraft
- wake turbulence category
- equipment
- departure aerodrome
- time of departure (UTC)—proposed/actual
- cruising speed
- altitude/level
- route
- destination aerodrome
- EET en-route
- SAR time*
- destination alternate aerodrome(s)
- other information
- endurance (flight time in hours and minutes)
- total number of persons on board
- type of ELT*
- survival equipment (type, jackets, dinghies)
- aircraft colour and markings
- remarks (regarding other survival equipment)
- arrival report—where it will be filed*
- name and number or address of person or company to be notified if SAR action is initiated*
- pilot's name
- pilot's licence number (Canadian pilot licence only)*

* Not required for an ICAO flight plan

3.14.3 International Civil Aviation Organization (ICAO)

Flight plans for international flights originating in, or entering, Canada shall be filed in the ICAO format, as specified in ICAO Doc 4444—*Operations 5-2 PANS-RAC* (DOC 4444-RAC/501 Mil GPH 204 DOC FLIGHT INFO PUBLICATION).

For the purpose of flight planning, flights between Canada and the continental United States are not classed as “international flights”.

3.14.4 Instructions for Completing the Form

3.14.4.1 General

Adhere closely to the prescribed formats and manner of specifying data.

Commence inserting data in the first space provided. Where excess space is available, leave unused spaces blank.

All times should be indicated in UTC, using four digits.

Indicate all EETs using four digits (hours and minutes) for flight plans.

NOTE:

Because EETs on a flight itinerary may include days as well as hours and minutes, insert the EET using six digits, if required.

The shaded area preceding Item 3 is to be completed by ATS and COM services, unless the responsibility for originating flight plan messages has been delegated.

NOTE:

The term “aerodrome,” where used in the flight plan, is intended to also cover sites other than aerodromes that may be used by certain types of aircraft, e.g. helicopters or balloons.

3.14.4.2 Instructions for Insertion of ATS Data

Complete Items 7 to 18 as indicated hereunder.

Complete Item 19 as well to facilitate alerting of SAR services.

NOTE:

Item numbers on the form are not consecutive as they correspond to Field Type numbers in ATS messages.

Use location indicators listed in Canadian AIPs (defined in CAR 300.01), in ICAO Doc 7910—*Location Indicators*, and in FAA Order 7350.7—*Location Identifiers*.

3.15 CONTENTS OF A FLIGHT PLAN AND FLIGHT ITINERARY

3.15.1 Item 7: Aircraft Identification (not exceeding seven alphanumeric characters and without hyphens or symbols)

Canadian:

Normally, this consists of the aircraft registration letters or the company designator followed by the flight number.

Examples:

- a) Aircraft registration: N123B, CGABC, 4XGUC
- b) Operating agency and flight number: ACA123, KLM672
- c) Tactical call sign: BRUNO12, SWIFT45, RED1

ICAO:

- a) the ICAO designator for the aircraft operating agency followed by the flight identification (e.g. KLM511, NGA213, JTR25) when in radiotelephony the call sign to be used by the aircraft will consist of the ICAO telephony designator for the operating agency followed by the flight identification (e.g. KLM511, NIGERIA213, JESTER25); OR
- b) the nationality or common mark and registration mark of the aircraft (e.g. E1AKO, 4XBCD, N2567GA), when:
- in radiotelephony, the call sign to be used by the aircraft will consist of this identification alone (e.g. CGAJS), or will be preceded by the ICAO telephony designator for the aircraft operating agency (e.g. BLIZZARD CGAJS); or
 - the aircraft is not equipped with radio.

NOTES:

- Standards for nationality, common and registration marks to be used are contained in ICAO Annex 7, Chapter 2.
- Provisions for the use of radiotelephony call signs are contained in ICAO Annex 10, Volume II, Chapter 5. ICAO designators and telephony designators for aircraft operating agencies are contained in ICAO Doc 8585—*Designators for Aircraft Operating Agencies, Aeronautical Authorities and Services*.

3.15.2 Item 8: Flight Rules and Type of Flight**3.15.2.1 Flight Rules (one character) (Canadian and ICAO)**

INSERT one of the following letters to denote the category of flight rules with which the pilot intends to comply:

- I if it is intended that the entire flight will be operated under IFR;
- V if it is intended that the entire flight will be operated under VFR;
- Y if the flight initially will be operated under IFR, followed by one or more subsequent changes of flight rules; or
- Z if the flight initially will be operated under VFR, followed by one or more subsequent changes of flight rules.

If “Y” or “Z” is filed, specify, in the Route section of the flight plan (Item 15), the point(s) where a change in flight rules is planned. Similarly, where there is more than one change in the type of flight rules, the code to be used is to reflect the first rule, i.e. use “Z” for VFR/IFR/VFR.

3.15.2.2 Type of Flight (up to two characters, as applicable)

INSERT up to two of the following letters to denote the type of flight when so required by the appropriate ATS authority:

First character (Canadian only, as applicable):

- C for controlled VFR;
- D for defence flight plan;
- E for defence flight itinerary;
- F for flight itinerary.

Second character (ICAO, as applicable):

- S for scheduled air service;
- N for non-scheduled air transport operation;
- G for general aviation;
- M for military;
- X for other than the preceding categories.

Specify the status of a flight following the indicator “STS” in Item 18, or when necessary to denote other reasons for specific handling by ATS, indicate the reason following the indicator “RMK/” in Item 18.

3.15.3 Item 9: Number and Type of Aircraft and Wake Turbulence Category**3.15.3.1 Number of Aircraft (one or two characters)**

INSERT the number of aircraft, if more than one.

3.15.3.2 Type of Aircraft (two to four characters)

INSERT the appropriate ICAO aircraft type designator. If no such designator has been assigned, or in the case of formation flights comprising more than one type, insert “ZZZZ” and specify in Item 18 the number(s) and type(s) of aircraft preceded by “TYP/”.

3.15.3.3 International Civil Aviation Organization (ICAO) Wake Turbulence Category (one character)

INSERT one of the following letters to indicate the wake turbulence category of the aircraft:

H (HEAVY) to indicate an aircraft type with a maximum certificated take-off mass of 136 000 kg (300 000 lbs) or more.

M (MEDIUM) to indicate an aircraft type with a maximum certificated take-off mass of less than 136 000 kg (300 000 lbs) but more than 7 000 kg (15 500 lbs).

L (LIGHT) to indicate an aircraft type with a maximum certificated take-off mass of 7 000 kg (15 500 lbs) or less.

3.15.4 Item 10: Equipment (Canadian and International Civil Aviation Organization (ICAO))

Capabilities comprise the following elements:

- a) presence of relevant serviceable equipment on board the aircraft;
- b) equipment and capabilities commensurate with flight crew qualifications; and
- c) where applicable, authorization from the appropriate authority.

The communication (COM), navigation (NAV), approach aid and SSR equipment on board and its serviceability must be inserted by adding the appropriate suffixes. The first suffixes will denote the COM, NAV and approach aid equipment, followed by an oblique stroke, and another suffix to denote the SSR equipment.

3.15.4.1 Radio Communication, Navigation and Approach Aid Equipment and Capabilities

INSERT one letter as follows:

“N” if no COM, NAV or approach aid equipment for the route to be flown is carried, or the equipment is unserviceable;
OR

“S” if standard COM, NAV and approach aid equipment for the route to be flown is carried and available (see NOTE 1)

Information on navigation capability is provided to ATC for clearance and routing purposes.

AND/OR INSERT one or more of the following letters to indicate the serviceable COM, NAV and approach aid equipment and capabilities available.

Table 3.9—Alphanumeric Characters to Be Indicated in Flight Plan Item 10: Equipment

A	GBAS landing system	K	MLS
B	LPV (APV with SBAS)	L	ILS
C	LORAN C	M1	ATC SATVOICE (INMARSAT)
D	DME	M2	ATC SATVOICE (MTSAT)
E1	FMC WPR ACARS	M3	ATC SATVOICE (Iridium)
E2	D-FIS ACARS	O	VOR
E3	PDC ACARS	P1	CPDLC RCP 400
F	ADF	P2	CPDLC RCP 240
G	GNSS (see NOTE 2)	P3	SATVOICE RCP 400
H	HF RTF	P4–P9	Reserved for RCP
I	Inertial Navigation	R	PBN approved (see NOTE 4)
J1	CPDLC ATN VDL Mode 2 (see NOTE 3)	T	TACAN
J2	CPDLC FANS 1/A HFDL	U	UHF RTF
J3	CPDLC FANS 1/A VDL mode A	V	VHF RTF
J4	CPDLC FANS 1/A VDL mode 2	W	RVSM approved
J5	CPDLC FANS 1/A SATCOM (INMARSAT)	X	MNPS approved
J6	CPDLC FANS 1/A SATCOM (MTSAT)	Y	VHF with 8.33 kHz channel spacing capability
J7	CPDLC FANS 1/A SATCOM (Iridium)	Z	Other equipment carried or other capabilities (see NOTE 5)

Any alphanumeric characters not indicated above are reserved.

NOTES:

1. If the letter “S” is used, standard equipment is considered to be VHF RTF, VOR and ILS, unless another combination is prescribed by the appropriate ATS authority.
2. ICAO: If the letter “G” is used, the types of external GNSS augmentation, if any, are specified in Item 18 following the indicator “NAV/” and separated by a space.
3. Canadian: When using the letter “G” on an IFR flight plan, the GNSS receiver must be approved in accordance with the requirements specified in *AIP Canada (ICAO)* ENR 4.3. IFR-certified receivers are not mandatory for VFR flights. Pilots are encouraged to use the letter “G” on VFR flight plans when using any type of GNSS to assist VFR navigation.
4. See *RTCA/EUROCAE Interoperability Requirements Standard For ATN Baseline 1* (ATN BI INTEROP Standard—DO-280B/ED-110B) for data link services, ATC clearance and information, ATC communications management, and ATC microphone check.
5. If the letter “R” is used, the performance-based navigation levels that can be met are specified in Item 18 following the indicator “PBN/”. Guidance material on the application of performance-based navigation to a specific route segment, route or area is contained in the *Performance-Based Navigation Manual* (ICAO Doc 9613).
6. If the letter “Z” is used, specify in Item 18 the other equipment carried, or other capabilities, preceded by “COM/”, “NAV/” and/or “DAT/”, as appropriate.

3.15.4.2 Surveillance Equipment and Capabilities

INSERT “N” if no surveillance equipment for the route to be flown is carried, or the equipment is unserviceable, OR INSERT one or more of the following descriptors, to a maximum of 20 characters, to describe the serviceable surveillance equipment and/or capabilities on board:

SSR Modes A and C

- A Transponder—Mode A (four digits—4096 codes);
- C Transponder—Mode A (four digits—4096 codes) and Mode C

SSR Mode S

- E Transponder—Mode S, including aircraft identification, pressure-altitude and extended squitter (ADS-B) capability;
- H Transponder—Mode S, including aircraft identification, pressure-altitude and enhanced surveillance capability;
- I Transponder—Mode S, including aircraft identification, but no pressure-altitude capability;
- L Transponder—Mode S, including aircraft identification, pressure-altitude, extended squitter (ADS-B) and enhanced surveillance capability;

P Transponder—Mode S, including pressure-altitude transmission, but no aircraft identification capability;

S Transponder—Mode S, including both pressure-altitude and aircraft identification capability;

X Transponder—Mode S with neither aircraft identification nor pressure-altitude capability.

NOTE:

Enhanced surveillance capability is the ability of the aircraft to down-link aircraft-derived data via a Mode S transponder.

ADS-B

B1 ADS-B with dedicated 1090 MHz ADS-B “out” capability;

B2 ADS-B with dedicated 1090 MHz ADS-B “out” and “in” capability;

U1 ADS-B “out” capability using UAT;

U2 ADS-B “out” and “in” capability using UAT;

V1 ADS-B “out” capability using VDL Mode 4;

V2 ADS-B “out” and “in” capability using VDL Mode 4.

ADS-C

D1 ADS-C with FANS 1/A capabilities;

G1 ADS-C with ATN capabilities.

Alphanumeric characters not indicated above are reserved.

Example:

ADE3RV/HB2U2V2G1

NOTE:

Additional surveillance application should be listed in Item 18 following the indicator “SUR/”.

3.15.5 Item 13: Departure Aerodrome and Time**3.15.5.1 Departure Aerodrome (maximum four characters)****ICAO:**

INSERT the ICAO four-letter location indicator of the departure aerodrome as specified in ICAO Doc 7910—*Location Indicators*;
OR

Canadian:

INSERT the four-character location indicator of the departure aerodrome; OR

Canadian and ICAO:

If no location indicator has been assigned:

INSERT “ZZZZ” and specify in Item 18 the name and location of the aerodrome preceded by “DEP”; OR

INSERT the first point of the route or the marker radio beacon preceded by “DEP”, if the aircraft has not taken off from the aerodrome.

3.15.5.2 Time (maximum four characters)

Indicate the hour and minutes in UTC.

NOTE:

Pilots may file a flight plan or flight itinerary up to 24 hr in advance of the departure time.

3.15.6 Item 15: Cruising Speed, Altitude/Level and Route**Canadian:****NOTES:**

1. On designated airways and air routes, IFR flights may be operated at the published MEA/MOCA, except that in winter, when air temperatures may be much lower than those of the ICAO Standard Atmosphere (ISA), aircraft should be operated at an altitude which is at least 1 000 ft higher than the published MEA/MOCA.
2. Mandatory IFR routes, published in the CFS—Planning section, have been established to aid in the efficient and orderly management of air traffic between selected aerodromes. Pilots are required to file these routes.

Canadian and ICAO:

INSERT

- the first cruising speed as described in (a),
- the first cruising level as described in (b), and
- the route description as described in (c).

a) Cruising speed (maximum five characters)

INSERT the true airspeed for the first or the whole cruising portion of the flight, in terms of:

- Kilometres per hour (ICAO only), expressed as “K” followed by four figures (e.g. K0830); OR
- Knots, expressed as “N” followed by four figures (e.g. N0485); OR
- True Mach number, when so prescribed by the appropriate ATS authority, to the nearest hundredth of unit Mach,

expressed as “M” followed by three figures (e.g. M082).

b) Cruising level (maximum five characters)

INSERT the planned cruising level for the first or the whole portion of the route to be flown, in terms of:

- Flight level, expressed as “F” followed by three figures (e.g. F085, F330); OR
- Standard metric level in tens of metres (ICAO only), expressed as “S” followed by four figures (e.g. S1130), when so prescribed by the appropriate ATS authorities; OR
- Altitude in hundreds of feet, expressed as “A” followed by three figures (e.g. A045, A100); OR
- Altitude in tens of metres (ICAO only), expressed as “M” followed by four figures (e.g. M0840); OR
- For uncontrolled VFR flights, the letters “VFR” (ICAO only).

c) Route (including changes of speed, level and/or flight rules)**3.15.6.1 Flights Along Designated Air Traffic Service (ATS) Routes:**

INSERT

- if the departure aerodrome is located on, or connected to, the ATS route:
 - the designator of the first ATS route (e.g. if the departure aerodrome is Carp: T614 TUKIR, etc.); OR
- if the departure aerodrome is not located on, or connected to, the ATS route:
 - (ICAO only) the letters “DCT”, followed by the joining point of the first ATS route, followed by the designator of the ATS route (e.g. if the departure aerodrome is Ottawa: DCT IKLAX T634, etc.);
 - (Canadian only) the joining point of the first ATS route, followed by the designator of the ATS route (e.g. if the departure aerodrome is Ottawa: YOW T616, etc.).

INSERT each point at which a change of speed or level is planned to commence, or a change of ATS route, or a change of flight rules is planned (e.g. AGLUK/N0200A170 IFR).

NOTE:

When a transition is planned between a lower and an upper ATS route and the routes are oriented in the same direction, the point of transition need not be inserted.

FOLLOWED IN EACH CASE BY

- the designator of the next ATS route segment, even if it is the same as the previous one (e.g. if the departure aerodrome is Québec: DICEN T680 LETAK T616, etc.); OR
- if the flight to the next point is outside a designated route:
 - (ICAO only) the letters “DCT”, unless both points are defined by geographical coordinates (e.g. if the departure aerodrome is Québec: DCT YQB DCT FLEUR DCT YYY, etc.);
 - (Canadian only) the next point (e.g. if the departure aerodrome is Québec: YQB FLEUR YYY etc.). The absence of “DCT” between points on a Canadian flight plan or flight itinerary indicates direct flight.

3.15.6.2 Flights Outside Designated Air Traffic Service (ATS) Routes:

ICAO:

INSERT points normally not more than 30 min flying time or 370 km (200 NM) apart, including each point at which a change of speed or level, a change of track, or a change of flight rules is planned; OR

When required by appropriate ATS authority(ies),

DEFINE the track of flights operating predominantly in an east-west direction between 70°N and 70°S by reference to significant points formed by the intersections of half or whole degrees of latitude with meridians spaced at intervals of 10° of longitude. For flights operating in areas outside those latitudes, the tracks shall be defined by significant points formed by the intersection of parallels of latitude with meridians normally spaced at 20° of longitude. The distance between significant points shall, as far as possible, not exceed one hour's flight time. Additional significant points shall be established as deemed necessary.

For flights operating predominantly in a north-south direction, define tracks by reference to significant points formed by the intersection of whole degrees of longitude with specified parallels of latitude which are spaced at 5°.

INSERT “DCT” between successive points unless both points are defined by geographical coordinates or by bearing and distance.

Canadian:

INSERT points at which a change of speed or level, a change of track, or a change of flight rules is planned. Absence of “DCT” between points on a Canadian flight plan or itinerary indicates direct flight; OR

When required by appropriate ATS authority(ies),

Canadian and ICAO:

USE the conventions in (1) to (5), below, and SEPARATE each sub-item by a space.

1. ATS route (two to seven characters):

The coded designator assigned to the route or route segment including, where appropriate, the coded designator assigned to the standard departure or arrival route (e.g. BCN1, B1, R14, UB10, KODAP2A).

NOTE:

Provisions for the application of route designators are contained in ICAO Annex 11, Appendix 1.

2. Significant point (two to eleven characters):

The coded designator (two to five characters) assigned to the point (e.g. LN, MAY, HADDY), OR

If no coded designator has been assigned, one of the following ways:

- (i) Degrees only (seven characters):

Two figures describing latitude in degrees, followed by “N” (North) or “S” (South), followed by three figures describing longitude in degrees, followed by “E” (East) or “W” (West). Make up the correct number of figures, where necessary, by insertion of zeros, e.g. 46N078W.

- (ii) Degrees and minutes (11 characters):

Four figures describing latitude in degrees, and tens and units of minutes followed by “N” (North) or “S” (South), followed by five figures describing longitude in degrees and tens and units of minutes, followed by “E” (East) or “W” (West). Make up the correct number of figures, where necessary, by insertion of zeros, e.g. 4620N07805W.

- (iii) Bearing and distance from a significant point: The identification of the significant point followed by the bearing from the point in the form of three figures giving degrees magnetic followed by the distance from the point in the form of three figures expressing nautical miles. In areas of high latitude where it is determined by the appropriate authority that reference to degrees magnetic is impractical, degrees true may be used. Make up the correct number of figures, where necessary, by insertion of zeros, e.g. a point 180° magnetic at a distance of 40 NM from VOR “DUB” should be expressed as DUB180040.

3. Change of speed or level (maximum 21 characters):

The point at which a change of speed (5 percent TAS or 0.01 Mach or more) or a change of level is planned to commence, expressed exactly as in (2), above, followed by an oblique stroke and both the cruising speed and the cruising level, expressed exactly as in (a) and (b), above, without a space between them, even when only one of these quantities will be changed.

Examples:

LN/N0284A045
 MAY/N0305F180
 HADDY/N0420F330
 4602N07805W/N0500F350
 46N078W/M082F330
 DUB180040/N0350M0840

4. Change of flight rules (maximum three characters):

The point at which the change of flight rules is planned, expressed exactly as in (2) or (3), above, as appropriate, followed by a space and one of the following:

VFR if from IFR to VFR

IFR if from VFR to IFR

Examples:

LN VFR
 LN/N0284A050 IFR

5. Cruise climb (maximum 28 characters):

The letter “C” followed by an oblique stroke; THEN the point at which cruise climb is planned to start, expressed exactly as in (2), above, followed by an oblique stroke; THEN the speed to be maintained during cruise climb, expressed exactly as in (a), above, followed by the two levels defining the layer to be occupied during cruise climb, each level expressed exactly as in (b), above, or the level above which cruise climb is planned followed by the letters “PLUS”, without a space between them.

Examples:

C/48N050W/M082F290F350
 C/48N050W/M082F290PLUS
 C/52N050W/M220F580F620

3.15.7 Item 16: Destination Aerodrome, Total Estimated Elapse Time (EET), Search And Rescue (SAR) Time (for flights in Canada only) and Destination Alternate Aerodrome(s)

3.15.7.1 Destination Aerodrome and Total Estimated Elapse Time (EET) (maximum 10 characters)

ICAO:

INSERT the ICAO four-letter location indicator of the destination aerodrome as specified in ICAO Doc 7910—*Location Indicators*; OR

Canadian:

INSERT the four-character location indicator of the destination aerodrome; OR

NOTE:

In the case of a Canadian flight itinerary, as applicable, the EET may also include the number of days. The total duration of the flight itinerary shall not exceed 30 days.

Canadian and ICAO:

If no location indicator has been assigned,

INSERT “ZZZZ” and specify in Item 18 the name and location of the aerodrome, preceded by “DEST”.

THEN, without a space, INSERT the total EET.

NOTE:

For a flight plan received from an aircraft in flight, the total EET is the estimated time from the first point of the route to which the flight plan applies to the termination point of the flight plan.

INSERT SAR time (four digits) (maximum of 24 hr)

3.15.7.2 Destination Alternate Aerodrome(s)

ICAO:

INSERT the ICAO four-letter location indicator(s) of not more than two destination alternate aerodromes, as specified in ICAO Doc 7910—*Location Indicators*, separated by a space; OR

Canadian:

INSERT the four-character location indicator of not more than two destination alternate aerodromes, separated by a space; OR

Canadian and ICAO:

If no location indicator has been assigned to the destination alternate aerodrome(s),

INSERT “ZZZZ” and specify in Item 18 the name and location of the destination alternate aerodrome(s), preceded by “ALTN”.

NOTES:

1. If departure alternate required insert ZZZZ for second alternate aerodrome and SPECIFY in Item 18 the departure alternate, i.e.: DEP ALTN/CYOW.
2. No alternate is required on a VFR flight plan or itinerary.

3.15.8 Item 18: Other Information

NOTE:

Use of indicators not included under this item may result in data being rejected, processed incorrectly or lost.

Hyphens or oblique strokes should only be used as prescribed below.

INSERT “0” (zero) if no other information; OR

Any other necessary information in the sequence shown hereunder, in the form of the appropriate indicator selected from those defined hereunder, followed by an oblique stroke and the information to be recorded.

STS/ Reason for special handling by ATS, e.g. a SAR mission, as follows:

ALTRV: for a flight operated in accordance with an altitude reservation;

ATFMX: for a flight approved for exemption from ATFM measures by the appropriate ATS authority;

FFR: for fire-fighting;

FLTCK: for a flight check for calibration of NAVAIDs;

HAZMAT: for a flight carrying hazardous material;

HEAD: for a flight with Head of State status;

HOSP: for a medical flight declared by medical authorities;

HUM: for a flight operating on a humanitarian mission;

MARSA: for a flight for which a military entity assumes responsibility for separation of military aircraft;

MEDEVAC: for a life critical medical emergency evacuation;

NONRVSM: for a non-RVSM capable flight intending to operate in RVSM airspace;

SAR: for a flight engaged in a search and rescue mission; and

STATE: for a flight engaged in military, customs or police services.

Other reasons for special handling by ATS shall be denoted under the designator “RMK/”.

PBN/ Indication of RNAV and/or RNP capabilities: Include as many of the descriptors below as possible that apply to the flight, up to a maximum of eight entries, i.e. no more than 16 characters.

Table 3.10—RNAV Specifications to Be Indicated in Flight Plan Item 18: Other Information

A1	RNAV 10 (RNP 10)
B1	RNAV 5 all permitted sensors
B2	RNAV 5 GNSS
B3	RNAV 5 DME/DME
B4	RNAV 5 VOR/DME
B5	RNAV 5 INS or IRS
B6	RNAV 5 LORAN C
C1	RNAV 2 all permitted sensors
C2	RNAV 2 GNSS
C3	RNAV 2 DME/DME
C4	RNAV 2 DME/DME/IRU
D1	RNAV 1 all permitted sensors
D2	RNAV 1 GNSS
D3	RNAV 1 DME/DME
D4	RNAV 1 DME/DME/IRU

Table 3.11—RNP Specifications to Be Indicated in Flight Plan Item 18: Other Information

L1	RNP 4
O1	Basic RNP 1 all permitted sensors
O2	Basic RNP 1 GNSS
O3	Basic RNP 1 DME/DME
O4	Basic RNP 1 DME/DME/IRU
S1	RNP APCH
S2	RNP APCH with baro-VNAV
T1	RNP AR APCH with RF (special authorization required)
T2	RNP AR APCH without RF (special authorization required)

Combinations of alphanumeric characters not indicated above are reserved.

ICAO has not yet allocated a two-digit alphanumeric character to describe RNP 2 under the PBN/ indicator. For an RNP 2 capable flight, enter a Z in item 10 and spell out “RNP2” after NAV/ in item 18: NAV/RNP2.

NAV/ Significant data related to navigation equipment other than that specified in PBN/, as required by the appropriate ATS authority. Indicate GNSS augmentation under this indicator, with a space between two or more methods of augmentation, e.g. NAV/GBAS SBAS.

COM/ Indicate communications applications or capabilities not specified in Item 10(a).

DAT/ Indicate data applications or capabilities not specified in 10(a).

SUR/ Include surveillance applications or capabilities not specified in Item 10(b).

DEP/ Name and location of departure aerodrome, if “ZZZZ” is inserted in Item 13, or the ATS unit from which supplementary flight plan data can be obtained, if “AFIL” (airfile) is inserted in Item 13. For aerodromes not listed in the relevant AIP, indicate location as follows:

With four figures describing latitude in degrees and tens and units of minutes followed by “N” (North) or “S” (South), followed by five figures describing longitude in degrees and tens and units of minutes, followed by “E” (East) or “W” (West). Make up the correct number of figures, where necessary, by insertion of zeros, e.g. 4620N07805W (11 characters); OR

Bearing and distance from the nearest significant point, as follows:

The identification of the significant point followed by the bearing from the point in the form of three figures giving degrees magnetic, followed by the distance from the point in the form of three figures expressing nautical miles. In areas of high latitude where it is determined by the appropriate authority that reference to degrees magnetic is impractical, degrees true may be used. Make up the correct number of figures, where necessary, by insertion of zeros, e.g. a point of 180° magnetic at a distance of 40 NM from VOR “DUB” should be expressed as DUB180040; OR

The first point of the route (name or LAT/LONG) or the marker radio beacon, if the aircraft has not taken off from an aerodrome.

DEST/ Name and location of the destination aerodrome, if “ZZZZ” is inserted in Item 16. For aerodromes not listed in the relevant AIP, indicate location in LAT/LONG or bearing and distance from the nearest significant point, as described under DEP/, above.

DOF/ The date of flight departure in a six-figure format (YYMMDD, where YY equals the year, MM equals the month and DD equals the day).

REG/ The nationality or common mark and registration mark of the aircraft, if different from the aircraft identification in Item 7.

EET/ Significant points or FIR boundary designators and accumulated EETs from takeoff to such points or FIR boundaries, when so prescribed on the basis of regional air navigation agreements, or by the appropriate ATS authority.

Examples:

EET/CAP0745 XYZ0830/

EET/EINN0204

SEL/ SELCAL Code, for aircraft so equipped.

TYP/ Type(s) of aircraft, preceded if necessary without a space by number(s) of aircraft and separated by one space, if “ZZZZ” is inserted in Item 9.

Example:

TYP/2F15 5F5 3B2

DLE/ En-route delay or holding, insert the significant point(s) on the route where a delay is planned to occur, followed by the length of delay using four-figure time in hours and minutes (hhmm).

Example:

DLE/MDG0030

OPR/ ICAO designator or name of the aircraft operating agency, if different from the aircraft identification in Item 7.

ORGN/ The originator’s eight-letter AFTN address or other appropriate contact details, in cases where the originator of the flight plan may not be readily identified, as required by the appropriate ATS authority.

NOTE:

In some areas, flight plan reception centres may insert the “ORGN/” identifier and originator’s AFTN address automatically.

PER/ Aircraft performance data, indicated by a single letter as specified in the *Procedures for Air Navigation Services—Aircraft Operations* (PANS-OPS, ICAO Doc 8168), *Volume I—Flight Procedures*, if so prescribed by the appropriate ATS authority.

ALTN/ Name of destination alternate aerodrome(s), if “ZZZZ” is inserted in Item 16. For aerodromes not listed in the relevant AIP, indicate location in LAT/LONG or bearing and distance from the nearest significant point, as described in DEP/, above.

RALT/ ICAO four-letter indicator(s) for en-route alternate(s), as specified in ICAO Doc 7910—*Location Indicators*, or name(s) of en-route alternate aerodrome(s), if no indicator is allocated. For aerodromes not listed in the relevant AIP, indicate location in LAT/LONG or bearing and distance from the nearest significant point, as described in DEP/, above.

TALT/ ICAO four-letter indicator(s) for takeoff alternate, as specified in ICAO Doc 7910—*Location Indicators*, or name of takeoff alternate aerodrome, if no indicator is allocated. For aerodromes not listed in the relevant AIP, indicate location in LAT/LONG or bearing and distance from the nearest significant point, as described in DEP/, above.

RIF/ The route details to the revised destination aerodrome, following by the ICAO four-letter location indicator of the aerodrome. The revised route is subject to reclearance in flight.

Examples:

RIF/DTA HEC KLAX

RIF/ESP G94 CLA YPPH

RMK/ Any other plain-language remarks when required by the appropriate ATS authority or deemed necessary, e.g. TCAS-equipped—ICAO only.

3.15.9 Item 19: Supplementary Information

3.15.9.1 Endurance

AFTER “E/”

INSERT a four-figure group giving the fuel endurance in hours and minutes.

3.15.9.2 Persons On Board

AFTER “P/”

INSERT the total number of persons (passengers and crew) on board, when required by the appropriate ATS authority. INSERT “TBN” (to be notified) if the total number of persons is not known at the time of filing.

3.15.9.3 Emergency and Survival Equipment

R/(RADIO)

CROSS OUT indicator “U” if UHF on frequency 243.0 MHz is not available. CROSS OUT indicator “V” if VHF on frequency 121.5 MHz is not available. CROSS OUT indicator

“E” if an ELT is not available. Canadian use only: ELT categories should be entered in the “ELT TYPE” box on the flight plan and flight itinerary forms.

S/(SURVIVAL EQUIPMENT)

CROSS OUT all indicators if survival equipment is not carried. CROSS OUT indicator “P” if polar survival equipment is not carried. CROSS OUT indicator “D” if desert survival equipment is not carried. CROSS OUT indicator “M” if maritime survival equipment is not carried. CROSS OUT indicator “J” if jungle survival equipment is not carried.

J/(JACKETS)

CROSS OUT all indicators if life jackets are not carried. CROSS OUT indicator “L” if life jackets are not equipped with lights. CROSS OUT indicator “F” if life jackets are not equipped with fluorescein. CROSS OUT indicator “U” or “V” or both (as in R/, above) to indicate radio capability of jackets, if any.

D/(DINGHIES) (NUMBER)

CROSS OUT indicators “D” and “C” if no dinghies are carried, or INSERT number of dinghies carried; and

(CAPACITY)

INSERT total capacity, in persons, of all dinghies carried; and

(COVER)

CROSS OUT indicator “C” if dinghies are not covered; and

(COLOUR)

INSERT colour of dinghies, if carried.

A/(AIRCRAFT COLOUR AND MARKINGS)

INSERT colour of aircraft and significant markings. Canadian use only: Tick appropriate box for wheels, skis, etc.

N/(REMARKS)

CROSS OUT indicator “N” if no remarks, or INDICATE any other survival equipment carried and any other remarks regarding survival equipment. INDICATE if aircraft is equipped with a ballistic parachute system.

ARRIVAL REPORT

Canadian use only: Fill in the required information.

AIRCRAFT

Canadian use only: Indicate the aircraft owner, person(s) or company to be notified if SAR action is initiated.

C/(PILOT)

INSERT name of pilot-in-command.

Canadian use only: INSERT pilot's licence number.

Figure 3.1—Composite IFR/VFR/IFR Flight Itinerary

NAV CANADA		CANADIAN FLIGHT PLAN / ITINÉRAIRE PLAN DE VOL / ITINÉRAIRE DE VOL CANADIEN		ICAO FLIGHT PLAN PLAN DE VOL OACI	
PRIORITY / PRIORITE FF		ADDRESSES / DESTINATAIRES			
FILING TIME / HEURE DE DÉPÔT		ORIGINATOR / EXPÉDITEUR			
SPECIFIC IDENTIFICATION OF ADDRESSES AND/OR ORIGINATOR / IDENTIFICATION PRÉCISE DU(DES) DESTINATAIRE(S) ET/OU DE L'EXPÉDITEUR					
3 MESSAGE TYPE / TYPE DE MESSAGE FPL		7 AIRCRAFT IDENTIFICATION / IDENTIFICATION DE L'AVION C.F.A.B.C.		8 FLIGHT RULES / RÉGLES DE VOL Y	
9 NUMBER / NOMBRE B.E.10		10 EQUIPMENT / ÉQUIPEMENT SD/C		11 DEPARTURE AERODROME / AERODROME DE DÉPART C.Y.X.E.	
12 CRUISING SPEED / VITESSE EN CRUIZÈRE N.O.170		13 ALTITUDE / LEVEL / NIVEAU A.O.5000		14 ROUTE / ROUTE V306 VLN VFR Q3 (5200) Q3 VLN/N0170 A060 IFR V306 YXE	
15 DESTINATION AERODROME / AERODROME DE DESTINATION C.Y.X.E.		16 DURATION / DURÉE 02 06 00		17 OTHER INFORMATION / RENSEIGNEMENTS DIVERS	
19 ENDURANCE / AUTONOMIE E / 05 00 00		20 SURVIVAL EQUIPMENT / ÉQUIPE DE SURVIE S / P		21 EMERGENCY RADIO / RADIO DE SECOURS R / V / E / A / P	
22 AIRCRAFT COLOUR AND MARKINGS / COULEUR ET MARQUES DE L'AVION A / RED ON WHITE		23 WHEELS / ROUES X		24 SEAPLANE / HYDROAVION V	
25 REMARKS / REMARQUES SASKATOON TOWER G. RENNICK 306-878-4373		26 PILOT-IN-COMMAND / PILOTE COMMANDANT DE BORD C / S. RENNICK		27 PILOT'S LICENCE No./N° DE LICENCE DU PILOTE 123456	

Explanation of Figure 3.1—Composite IFR/VFR/IFR Flight Itinerary

Item 7:

Aircraft identification

Item 8:

“Y” indicates that the flight will be initially operated under the IFR, followed by one or more subsequent changes of flight rules.

“F” indicates that it is a flight itinerary.

Item 9:

Aircraft is a Beechcraft 100.

Item 10:

“S” indicates standard COM/NAV equipment of VHF, RTF, VOR and ILS.

“D” indicates DME equipped.

“C” indicates transponder Mode A (four digits—4096 codes) and Mode C.

Item 13:

Departure aerodrome is Saskatoon at 0900 UTC.

Item 15:

Speed is 170 kt.

Altitude is 5 000 ft.

Route is V306 to the Lumsden VOR.

“VFR” indicates a change in flight rules to VFR at Lumsden.

“JQ3” indicates direct flight from Lumsden to the aerodrome at Carlyle.

“(5200)” indicates a stopover at Carlyle in hours and minutes.

Second “JQ3” indicates there will be a stopover at Carlyle.

“VLN” indicates direct flight from Carlyle to the Lumsden VOR.

“N0170A060IFR” indicates that the altitude is changed to 6 000 ft and the next leg will be IFR (although the speed did not change; if there is a change to either speed or altitude, both have to be indicated).

Route is V306 from Lumsden to the Saskatoon VOR.

Item 16:

Destination aerodrome is Saskatoon.

EET from takeoff to landing at Saskatoon is 2 days and 6 hours (this includes the flight time and the stopover time at Carlyle).

SAR time of 6 hours indicates the pilot's desire to have SAR action initiated at 6 hours after the total EET of the trip; in other words, 2 days and 12 hours after takeoff from Saskatoon (if there is no entry in this block the SAR activation time would be 24 hours after the EET).

Alternate aerodrome is Prince Albert.

Item 18:

Although no other information is provided in this example, this section is for listing any other information as previously described.

Item 19:

Flying time endurance is 5 hr. There are two people in the aircraft (including crew).

“X” over “U” indicates there is no UHF emergency radio.

Unaltered “V” indicates there is VHF emergency radio.

Unaltered “E” under ELT indicates there is an emergency locator transmitter.

“AP” under ELT TYPE indicates an automatic portable ELT.

Unaltered “P” under POLAR indicates polar equipment is carried.

Unaltered “J” and “L” indicates that life jackets with lights are carried.

“Xs” on “D” and “C” indicate there are no dinghies.

Aircraft colour and markings are self explanatory.

“X” on “N” indicates there are no additional remarks on survival gear.

Example indicates closure with Saskatoon tower.

Contact name and number is self explanatory.

Pilot’s licence number assists SAR specialists in their search.

Figure 3.3—VFR Flight Plan

NAV CANADA CANADIAN FLIGHT PLAN / ITINÉRAIRE PLAN DE VOL / ITINÉRAIRE DE VOL CANADIEN ICAO FLIGHT PLAN PLAN DE VOL OACI

PRIORITY / PRIORITÉ: FF ADDRESS(ES) / DESTINATAIRE(S)

FLYING TIME / HEURE DE DÉPART: ORIGINATOR / EXPÉDITEUR

3 MESSAGE TYPE / TYPE DE MESSAGE: (FPL) 7 AIRCRAFT IDENTIFICATION / IDENTIFICATION DE L'AÉRONEF: C, F, A, B, C 8 FLIGHT RULES / RÈGLES DE VOL: V TYPE OF FLIGHT / TYPE DE VOL

9 NUMBER / NOMBRE: C, 1, 7, 2 TYPE OF AIRCRAFT / TYPE D'AÉRONEF: WAKE TURBULENCE CAT. / CAT. DE TURBULENCE DE SILLAGE: 10 EQUIPMENT / ÉQUIPEMENT: S/C

13 DEPARTURE AERODROME / AERODROME DE DÉPART: C, Y, O, W TIME / HEURE: 0, 9, 0, 0

15 CRUISING SPEED / VITESSE DE CRUISE: M, 0, 1, 2, 0 ALTITUDE / LEVEL / NIVEAU: Y, S, H ROUTE / ROUTE

16 DESTINATION AERODROME TOTAL EET / DURÉE TOTALE ESTIMÉE: C, Y, O, W AERODROME DE DESTINATION: 0, 0, 3, 2 ALT. AERODROME / AERODROME DE DÉGAGEMENT: 2ND ALT. AERODROME / AERODROME DE DÉGAGEMENT

18 OTHER INFORMATION / RENSEIGNEMENTS DIVERS

19 ENDURANCE / AUTONOMIE: E / 0, 3, 0, 0 PERSONS ON BOARD / PERSONNES À BORD: P / 0, 2 EMERGENCY RADIO / RADIO DE SECOURS: R / U, V, E, A, F

SURVIVAL EQUIPMENT / ÉQUIPEMENT DE SURVIE: POLAR, DESERT, MARITIME, JUNGLE, LIGHT, FLUORESC, UHF, VHF, ELT

DINGHIES / CANOTS: S / X, D / X, C / X, COULEUR: A / RED ON WHITE

REMARKS / REMARQUES: N /

AN ARRIVAL REPORT WILL BE FILED WITH - UN COMPTE RENDU D'ARRIVÉE SERA NOTIFIÉ A: KINGSTON FSS

NAME AND PHONE NUMBER OR ADDRESS OF PERSON(S) OR COMPANY TO BE NOTIFIED IF SEARCH AND RESCUE ACTION INITIATED: S. RENNICK 613-878-4373

PILOT-IN-COMMAND / PILOTE COMMANDANT DE BORD: S. RENNICK PILOT'S LICENCE No./N° DE LICENCE DU PILOTE: 123456

FILED BY / DÉPOSÉ PAR: SPACE RESERVED FOR ADDITIONAL REQUIREMENTS / ESPACE RÉSERVÉ À DES FINS SUPPLÉMENTAIRES

Figure 3.2—IFR Flight Plan (ICAO)

NAV CANADA CANADIAN FLIGHT PLAN / ITINÉRAIRE PLAN DE VOL / ITINÉRAIRE DE VOL CANADIEN ICAO FLIGHT PLAN PLAN DE VOL OACI

PRIORITY / PRIORITÉ: FF ADDRESS(ES) / DESTINATAIRE(S)

FLYING TIME / HEURE DE DÉPART: ORIGINATOR / EXPÉDITEUR

3 MESSAGE TYPE / TYPE DE MESSAGE: (FPL) 7 AIRCRAFT IDENTIFICATION / IDENTIFICATION DE L'AÉRONEF: A, C, A, 8, 5, 6, 8 FLIGHT RULES / RÈGLES DE VOL: I TYPE OF FLIGHT / TYPE DE VOL: S

9 NUMBER / NOMBRE: B, 7, 4, 7 TYPE OF AIRCRAFT / TYPE D'AÉRONEF: WAKE TURBULENCE CAT. / CAT. DE TURBULENCE DE SILLAGE: H 10 EQUIPMENT / ÉQUIPEMENT: S X/S

13 DEPARTURE AERODROME / AERODROME DE DÉPART: C, Y, U, L TIME / HEURE: 0, 0, 5, 2

15 CRUISING SPEED / VITESSE DE CRUISE: M, 0, 4, 3, 8 ALTITUDE / LEVEL / NIVEAU: F, 3, 3, 0, 0 ROUTE / ROUTE: NA231 YVR/M084 DCT SCOD DCT 56N 050W/M084 F370 57N 040W 57N 030W 57N 020W 56N 010W DCT BEL/M0475 F370 UR3 WAL UB3 HON DCT WCO DCT BMM DCT

16 DESTINATION AERODROME TOTAL EET / DURÉE TOTALE ESTIMÉE: E, G, L, L AERODROME DE DESTINATION: 0, 6, 1, 0 ALT. AERODROME / AERODROME DE DÉGAGEMENT: L, F, P, S 2ND ALT. AERODROME / AERODROME DE DÉGAGEMENT

18 OTHER INFORMATION / RENSEIGNEMENTS DIVERS: EET/YE 00137 YYR015 SCOD 0 0 0 50W 0234 40W 0312 EEGX 0350 20W 0426 10W 306 BEL 0526 REG/CGACA SEL/EHFK

19 ENDURANCE / AUTONOMIE: E / 0, 9, 0, 0 PERSONS ON BOARD / PERSONNES À BORD: P / 3, 4, 5 EMERGENCY RADIO / RADIO DE SECOURS: R / U, V, E, A, F

SURVIVAL EQUIPMENT / ÉQUIPEMENT DE SURVIE: POLAR, DESERT, MARITIME, JUNGLE, LIGHT, FLUORESC, UHF, VHF, ELT

DINGHIES / CANOTS: S / X, D / X, C / X, COULEUR: D / 1, 2, 3, 6, 0, C / YELLOW

REMARKS / REMARQUES: A / WHITE

AN ARRIVAL REPORT WILL BE FILED WITH - UN COMPTE RENDU D'ARRIVÉE SERA NOTIFIÉ A:

NAME AND PHONE NUMBER OR ADDRESS OF PERSON(S) OR COMPANY TO BE NOTIFIED IF SEARCH AND RESCUE ACTION INITIATED:

PILOT-IN-COMMAND / PILOTE COMMANDANT DE BORD: S. RENNICK PILOT'S LICENCE No./N° DE LICENCE DU PILOTE:

FILED BY / DÉPOSÉ PAR: SPACE RESERVED FOR ADDITIONAL REQUIREMENTS / ESPACE RÉSERVÉ À DES FINS SUPPLÉMENTAIRES

RAC

4.0 AIRPORT OPERATIONS

4.1 GENERAL

Pilots must be particularly alert when operating in the vicinity of an airport. Increased traffic congestion, aircraft in climb and descent attitudes, and pilots preoccupied with cockpit duties are some of the factors that increase the accident potential near airports. The situation is further compounded when the weather only just meets VFR requirements.

Several operators have, for some time, been using their landing lights when flying at lower altitudes and within terminal areas, both during daylight hours and at night. Pilot comment has confirmed that the use of landing lights greatly increases the probability of the aircraft being seen. An important side benefit for improved safety is that birds appear to see aircraft showing lights in time to take avoiding action. In view of this, it is recommended that, when so equipped, all aircraft use landing lights during the takeoff and landing phases and when flying below 2 000 ft AGL within terminal areas and aerodrome traffic patterns.

ATC towers equipped with radar have the capability of providing an increased level of service to the aviation community. The class of airspace determines the controller's responsibilities vis-à-vis separation between IFR and VFR aircraft, and between VFR and VFR aircraft. Control staff in certain towers will be able to assist aircraft in establishing visual separation through the provision of radar vectors, radar monitoring and altitude assignments. Use of the radar will also result in more efficient control of VFR aircraft.

While aircraft shall not be operated at speeds greater than 200 KIAS below 3 000 ft AGL and within 10 NM of a controlled aerodrome (CAR 602.32), there is no mandatory speed restriction when operating in the vicinity of an uncontrolled aerodrome. As traffic levels at some of these aerodromes may be high from time to time, the risk of a possible mid-air collision is somewhat elevated during these periods. For this reason, it is recommended that pilots reduce their aircraft speed to the maximum extent possible when operating below 3 000 ft AGL and within 10 NM of an uncontrolled aerodrome.

Incidents have occurred when aircraft are being operated VFR within control zones, when the flight visibility is less than three miles due to local smoke, haze, rain, snow, fog or other condition. CAR 602.114 requires a minimum of three miles ground visibility for VFR flight within a control zone. This visibility is, of course, taken by a person on the ground and does not preclude the possibility that the visibility aloft may be less. Good airmanship requires that a pilot encountering less than three miles flight visibility within a control zone will either:

- a) take action to avoid the area of reduced visibility; or
- b) remain clear of the area of reduced visibility and request a special VFR clearance from ATC.

Pilots shall maintain a listening watch on the appropriate tower frequency while under control of the tower. Whenever possible, requests for radio checks and taxi instructions should be made on the appropriate ground control frequency. After establishing initial contact with the control tower, pilots will be advised of any frequency changes required.

4.1.1 Wake Turbulence

Wake turbulence has its greatest impact on departure and arrival procedures; however, pilots should not assume that it will only be encountered in the vicinity of aerodromes. Caution should be exercised whenever a flight is conducted anywhere behind and at less than 1 000 ft below a large aircraft.

Radar Vectoring

Controllers apply the following wake turbulence radar separation minima between a preceding IFR/VFR aircraft and an aircraft vectored directly behind it and at less than 1 000 ft during any phase of flight.

Categories, weight limits, aircraft examples and separation criteria are indicated in the table below.

Table 4.1—Separation per Aircraft Category for Wake Turbulence Purposes

Category	Limits	Examples	Separation (NM)
SUPER HEAVY (S)	This category currently only applies to Airbus A380 aircraft with a maximum takeoff mass of 560 000 kg.	A380-800	Super Heavy behind a Super Heavy - 4 mi.
HEAVY (H)	Aircraft types weighing less than 560 000 kg but more than 136 000 kg	B747/B777/B767 A340A330/MD11	Heavy behind a Super Heavy - 6 mi. Heavy behind a Heavy - 4 mi.
MEDIUM (M)	Aircraft types weighing less than 136 000 kg but more than 7 000 kg	B757/B737/A320 ERJ145/TU154	Medium behind a Super Heavy - 7 mi. Medium behind a Heavy - 5 mi.
LIGHT (L)	Aircraft types weighing 7 000 kg or less	C150/C152 C172/ C182/PA38/PA2	Light behind a Super Heavy - 8 mi.
			Light behind a Heavy - 6 mi.
			Light behind a Medium - 4 mi.

Non-Radar Departures

Controllers will apply a two-minute separation interval to any aircraft that takes off into the wake of a known heavy aircraft if:

- the aircraft concerned commences the takeoff from the threshold of the same runway; or
- any following aircraft departs from the threshold of a parallel runway that is located less than 2 500 ft away from the runway used by the preceding heavy aircraft.

NOTE:

ATC does not apply this two-minute spacing interval between a light following a medium aircraft in the above circumstances, but will issue wake turbulence advisories to light aircraft. Controllers will apply a three-minute separation interval to any aircraft that takes off into the wake of a known heavy aircraft, or a light aircraft that takes off into the wake of a known medium aircraft if:

- the following aircraft starts its takeoff roll from an intersection or from a point further along the runway than the preceding aircraft; or
- the controller has reason to believe that the following aircraft will require more runway length for takeoff than the preceding aircraft.

ATC will also apply separation intervals of up to three minutes when the projected flight paths of any following aircraft will cross that of a preceding heavy aircraft.

In spite of these measures, ATC cannot guarantee that wake turbulence will not be encountered.

Pilot Waivers

ATC tower controllers are required to advise pilots whenever a requested take-off clearance is denied solely because of wake turbulence requirements. The intention of this advisory is to make pilots aware of the reason for the clearance denial so that they may consider waiving the wake turbulence requirement. To aid in the pilot's decision, the tower controller will advise the type and position of the wake-creating aircraft. The following phraseologies will be used by the controller in response to a request for take-off clearance when wake turbulence is a consideration:

Tower: *NEGATIVE, HOLD SHORT WAKE TURBULENCE. HEAVY BOEING 747, ROTATING AT 6 000 FT;* or

Tower: *LINE UP AND WAIT, WAKE TURBULENCE, HEAVY DC10 AIRBORNE AT 2 MI.*

Pilots are reminded that there are some circumstances where wake turbulence separation cannot be waived.

There may be departure situations, such as with a steady crosswind component, where the full wake turbulence separation minima is not required. The pilot is in the best position to make an assessment of the need for wake turbulence separation. Although controllers are not permitted to initiate waivers to

wake turbulence separation minima, they will issue takeoff clearance to pilots who have waived wake turbulence requirements on their own initiative, with the following exceptions:

- a) a light or medium aircraft taking off behind a heavy aircraft and takeoff is started from an intersection or a point significantly further along the runway, in the direction of takeoff; or
- b) a light or medium aircraft departing after a heavy aircraft takes off or makes a low or missed approach in the opposite direction on the same runway; or
- c) a light or medium aircraft departing after a heavy aircraft makes a low or missed approach in the same direction on the same runway.

A pilot-initiated waiver for a VFR departure indicates to the controller that the pilot accepts responsibility for wake turbulence separation. The controller will still issue a wake turbulence cautionary with the takeoff clearance. Controllers are responsible for ensuring wake turbulence minima are met for IFR departures. More information on wake turbulence can be found in the AIR section of this manual.

4.1.2 Noise Abatement

Pilots and operators must conform to the applicable provisions of CAR 602.105—*Noise Operating Criteria*, and CAR 602.106—*Noise Restricted Runways* (see RAC Annex) and the applicable noise abatement procedures published in the CAP.

Noise operating restrictions may be applied at any aerodrome where there is an identified requirement. When applied at an aerodrome, the procedures and restrictions will be set out in the CFS, and shall include procedures and requirements relating to:

- a) preferential runways;
- b) minimum noise routes;
- c) hours when aircraft operations are prohibited or restricted;
- d) arrival procedures;
- e) departure procedures;
- f) duration of flights;
- g) the prohibition or restriction of training flights;
- h) VFR or visual approaches;
- i) simulated approach procedures; and
- j) the minimum altitude for the operation of aircraft in the vicinity of the aerodrome.

Transport Canada recognizes the need for analysis and consultation in the implementation of proposed new or amended noise abatement procedures or restrictions at airports and aerodromes. A process has been developed that includes consultation with all concerned parties before new or amended noise abatement procedures or restrictions can be published in the CAP or the CFS. When the following checklist has been completed for the proposed noise abatement procedures or restrictions, and the resulting analysis has been completed and approved by Transport Canada, the noise abatement procedure or restriction will be published in the appropriate aeronautical publication.

- (i) Description of the problem
- (ii) Proposed solution (including possible exceptions)
- (iii) Alternatives (such as alternative procedures or land uses in the community)
- (iv) Costs (such as revenue impact, direct and indirect costs to the community, airport operator and airport users)
- (v) Noise impacts of the proposed solution
- (vi) Effects on aircraft emissions
- (vii) Effect on current and future airport capacity
- (viii) Implications of not proceeding with the proposal
- (ix) Implementation issues (e.g. aircraft technology, availability of replacement aircraft, ground facilities)
- (x) Impact on the aviation system
- (xi) Safety implications
- (xii) Air traffic management
- (xiii) Fleet impact

A complete description of the process involved is available on the Internet at: <www.tc.gc.ca/eng/civilaviation/opssvs/management-services-referencecentre-ac3-300-302-002-469.htm>

4.1.3 Preferential Runway Assignments

At controlled airports, when selecting preferential runways for noise abatement or for other reasons, air traffic controllers consider the runway condition, the effective crosswind component and the effective tailwind component.

The maximum effective crosswind component considered in determining runway selection is 25 kt for arrivals and departures on DRY runways, and 15 kt on WET runways. The maximum effective tailwind component is 5 kt.

During consultation between NAV CANADA, aviation stakeholders and Transport Canada, it was decided that operations on the preferential runway should be allowed to continue when more than 25 percent of the runway is covered with a TRACE contaminant, provided:

- a) the airport operator has issued an Aircraft Movement *Surface Condition Report (AMSCR)* with a reported *CRFI* value in all segments of the runway greater than .40 or, if no AMSCR is received, an aircraft reports the braking action as being “good”; and

- b) the maximum crosswind component, including gusts, is 15 kt or less.

In conditions where more than 25 percent of the preferential runway is covered with a TRACE contaminant, the runway most nearly aligned into the wind must be selected if:

- a) the reported CRFI value in any segment of the runway is .40 or lower;
- b) the crosswind component rises above 15 kt; or
- c) a less than “good” braking action report is received from a pilot.

Although air traffic controllers may select a preferential runway in accordance with the foregoing criteria, pilots are not obligated to accept the runway for taking off or landing. It remains the pilot’s responsibility to decide if the assigned runway is operationally acceptable.

4.1.4 Runway Protected Area

Runway protected area procedures aim to ensure the runway protected area will be free of objects, which will provide a safe environment during aircraft operations in the event of a runway excursion, arrival undershoot, or departure overrun by an aircraft.

ATC and FSS will hold vehicles and pedestrians and ATC will hold taxiing aircraft at published holding positions or at least 200 ft from the runway edge until an aircraft taking off or landing has passed the holding traffic.

The airport operator may designate an alternate holding position at a distance from the runway edge that ensures no hazard is created for arriving or departing aircraft. The airport operator may also permit pedestrians to operate within the runway protected area when an aircraft is taking off or landing.

Controlled Airports

ATC will not clear an aircraft to take off or land if a holding position is transgressed. If a holding position is transgressed after a takeoff or landing clearance has been issued, ATC will cancel the clearance, unless doing so would create a hazardous situation for the aircraft.

Uncontrolled Airports

FSS will inform pilots of aircraft taking off or landing of runway protected area transgressions and seek the pilots’ intentions.

4.2 DEPARTURE PROCEDURES — CONTROLLED AIRPORTS

The following departure procedures are based on those applicable for an aerodrome that have all available services, and are listed in the order that they would be used. At smaller, less equipped airports, some services will be combined, e.g. the IFR clearance would be obtained from ground control where there is no separate

clearance delivery frequency. Procedures solely applicable to IFR flight are briefly introduced here to establish their sequence. An elaboration thereof may be found in RAC 7.0, Instrument Flight Rules –Departure Procedures.

4.2.1 Automatic Terminal Information Service (ATIS) Broadcasts

If ATIS is available, a pilot should obtain the ATIS information prior to contacting either the ground control or tower. See RAC 1.3 for information on ATIS broadcasts.

4.2.2 Clearance Delivery

At locations where a “clearance delivery” frequency is listed, IFR departures should call on this frequency, prior to requesting taxi authorization, normally no more than 5 minutes prior to engine start. Where a clearance delivery frequency is not listed, the IFR clearance will normally be given after taxi authorization has been received. At several major aerodromes, departing VFR aircraft are required to contact “clearance delivery” before taxiing. These frequencies, where applicable, are found in the COMM Section of the CFS, for the appropriate aerodrome.

4.2.3 Radio Checks

If required, radio checks should, wherever possible, be requested on frequencies other than ATC frequencies (see COM 1.11 for readability scale). Normally, the establishment of two-way contact with an agency is sufficient to confirm that the radios are functioning properly.

4.2.4 Requests for Push-back or Power-back

Since controllers may not be in a position to see all obstructions an aircraft may encounter during push-back or power-back, clearance for this manoeuvre will not be issued by the tower. Pilots are cautioned that it is their responsibility to ensure that push-back or power-back can be accomplished safely prior to initiating aircraft movement.

4.2.5 Taxi Information

Taxi authorization should be requested on the ground control frequency. At locations where a “Clearance Delivery” frequency is listed, pilots should obtain their IFR clearance or a VFR code where applicable on this frequency prior to contacting ground control. Where no “Clearance Delivery” frequency is listed, the IFR clearance will normally be relayed by ground control before or after taxi authorization has been issued. If no flight plan has been filed, the pilot should inform the tower “Clearance Delivery”, where available, or ground control of the nature of the flight on initial contact, such as “local VFR” or “proceeding VFR to (destination)”.

Pilot: WINNIPEG GROUND, AZTEC GOLF JULIETT VICTOR HOTEL AT HANGAR NUMBER THREE, REQUEST TAXI-IFR EDMONTON EIGHT THOUSAND.

Ground control: AZTEC GOLF JULIETT VICTOR HOTEL, WINNIPEG GROUND, RUNWAY (number), WIND (in magnetic degrees and knots), ALTIMETER (four-digit group giving the altimeter in inches of mercury), TAXI VIA (runway or other specific point, route), (other information, such as traffic, airport conditions), (CRFI, RSC, or RVR when applicable), CLEARANCE ON REQUEST.

Pilot: GOLF JULIETT VICTOR HOTEL.

Under no circumstances may a taxiing aircraft, whether proceeding to or from the active runway, taxi onto an active runway unless specifically authorized to do so.

Upon receipt of a normal taxi authorization, a pilot is expected to proceed to the taxi-holding position for the runway assigned for takeoff. If a pilot is required to cross any runway while taxiing towards the departure runway, the ground or airport controller will issue a specific instruction to cross or hold short. If a specific authorization to cross was not received, pilots should hold short and request authorization to cross the runway. Pilots may be instructed to monitor the tower frequency while taxiing or until a specific point, or they may be advised to “contact tower holding short.” The term “holding short,” when used during the communications transfer, is considered as a location and does not require a readback.

To emphasize the protection of active runways and to enhance the prevention of runway incursions, ATC is required to obtain a readback of runway “hold” instructions. As a good operating practice, taxi authorizations that contain the instructions “hold” or “hold short” should be acknowledged by the pilot by providing a readback or repeating the hold point.

Examples of “hold” instructions that should be read back:

HOLD or HOLD ON (runway number or taxiway);

HOLD (direction) OF (runway number); or

HOLD SHORT OF (runway number, or taxiway).

Reminder: In order to reduce frequency congestion, readback of ATC taxi instructions, other than those listed above, is not required in accordance with CAR 602.31(1)(a); such instructions are simply acknowledged. With the increased simultaneous use of more than one runway, however, instructions to enter, cross, backtrack or line up on any runway should also, as a good operating practice, be acknowledged by a readback.

Example:

An aircraft is authorized to backtrack a runway to the holding bay and to report clear when in the holding bay.

Pilot: CHARLIE FOXTROT ALFA BACKTRACKING RUNWAY TWO FIVE AND WILL REPORT IN THE HOLDING BAY.

NOTE:

To avoid causing clutter on controllers’ radar displays, pilots should adjust their transponders to “STANDBY” while taxiing and should not switch them to “ON” (or “NORMAL”) until immediately before takeoff.

The tower may instruct aircraft to “line up and wait.” Controllers will issue the name of the runway intersection or taxiway with the authorization if the line-up position is not at the threshold of the departing runway. When more than one entry point for the same runway is in use, ATC will also specify the runway entry point with the instruction to line up at the threshold.

4.2.6 Taxi Holding Positions

Authorization must be obtained before leaving a taxi holding position, or where a holding position marking is not visible or has not been established, before proceeding closer than 200 feet from the edge of the runway in use. At airports where it is not possible to comply with this provision, taxiing aircraft are to remain at a sufficient distance from the runway in use to ensure that a hazard is not created to arriving or departing aircraft.

4.2.7 Taxiway Holding Positions During Instrument Flight Rules (IFR) Operations

It is imperative that aircraft do not proceed beyond taxiway holding signs at controlled airports until cleared by ATC. Aircraft proceeding beyond the taxiway holding position signs may enter electronically sensitive areas and cause dangerous interference to the glide path or localizer signals. In Canada, holding position signs and holding position markings normally indicate the boundaries of electronically sensitive areas, and provide safe obstruction clearance distances from landing runways.

When a controlled airport is operating under CAT II/III weather conditions, or its CAT II/III operations plan is in effect, pilots are to observe CAT II or III mandatory holding position signs. When a controlled airport is not operating under CAT II/III weather conditions, or its LVOP is not in effect, pilots need not abide by the CAT II or III taxiway holding positions and are expected to taxi to the normal taxiway holding position markings, unless advised otherwise by ATC.

At uncontrolled aerodromes, pilots awaiting takeoff should not proceed beyond the holding position signs or holding position markings until there is no risk of collision with landing, taxiing or departing aircraft.

4.2.7.1 Glide Path Signal Protection Procedures

The ILS signal will only be protected under the conditions described below.

A controller will protect the glide path signal when:

- a) The ceiling is less than 1 000 ft or visibility is less than three miles, or both; and
- b) The arriving aircraft is inside the FAF on an ILS approach.

NOTE:

At uncontrolled aerodromes, aircraft manoeuvring on the ground may enter ILS critical areas during taxi, takeoff or landing.

4.2.8 Take-off Clearance

When ready for takeoff, the pilot shall request a take-off clearance and should include the runway number. Upon receipt of the take-off clearance, the pilot shall acknowledge it and take off without delay, or inform ATC if unable to do so.

Example:

Pilot: *TOWER, JULIETT GOLF TANGO READY FOR DEPARTURE, RUNWAY THREE SIX.*

Tower: *JULIETT GOLF TANGO, (any special information such as hazards, obstructions, turn after takeoff, wind information if required, etc.), CLEARED FOR TAKEOFF RUNWAY THREE SIX (or JULIETT GOLF TANGO, FROM GOLF, CLEARED FOR TAKEOFF RUNWAY THREE SIX).*

Pilot: *JULIETT GOLF TANGO.*

Pilots may request to use the full length of the runway for takeoff at any time. If the runway is to be entered at an intersection and back tracking is required, pilots should indicate their intentions and obtain a clearance for the manoeuvre before entering the runway.

Pilots may request, or the controller may suggest, takeoff using only part of a runway. The pilot's request will be approved, provided noise abatement procedures, traffic, and other conditions permit. If suggested by the controller, the available length of the runway will be stated. It is the pilot's responsibility to ensure that the portion of the runway to be used will be adequate for the take-off run.

To expedite movement of airport traffic and achieve spacing between arriving and departing aircraft, take-off clearance may include the word "immediate." In such cases, "immediate" is used for the purpose of air traffic separation. On acceptance of the clearance, the aircraft shall taxi onto the runway and take off in one continuous movement. If, in the pilot's opinion, compliance would adversely affect their operations, the pilot should refuse the clearance. Pilots planning a static takeoff (i.e. a full stop after "lined up" on the runway), or a delay in takeoff, should indicate this when requesting take-off clearance. ATC will specify the name of the taxiway or intersection with the clearance for takeoff from a taxiway or runway intersection.

When more than one entry point for the same runway is in use, ATC will also specify the threshold as the point from which the take-off run will commence for those aircraft departing from the threshold. A controller may not issue a clearance that would result in a deviation from established noise abatement procedures or wake turbulence separation minima.

4.2.8.1 Air Traffic Control (ATC) Phraseology When a Runway Is Temporarily Shortened Due to Construction

Whenever the length of a runway has been temporarily shortened due to construction, tower controllers will use the word "shortened" immediately following the runway number for all line-up and take-off clearances.

NOTE:

These changes do not transfer pilot responsibility to the controller, but they do ensure that changes in runway length due to construction are communicated as an additional layer of safety.

Example:

Tower Line up Clearance: *GOLF JULIETT ECHO TANGO LINE UP RUNWAY ONE - SIX SHORTENED*

4.2.8.2 Clearance for Aborting a Takeoff

Aborting a takeoff is an emergency procedure used by a pilot when continuing the takeoff would present a grave hazard to the aircraft. A controller-initiated aborted takeoff is an extreme measure used only where no clear alternative exists.

Example:

Tower: *ALPHA BRAVO CHARLIE, ABORT ABORT. ALPHA BRAVO CHARLIE, ABORT ABORT (reason)*

4.2.9 Release from Tower Frequency

Unless otherwise advised by ATC, pilots do not require permission to change from tower frequency once clear of the control zone and should not request release from this frequency or report clear of the zone when there is considerable frequency congestion. When practicable, it is recommended that a pilot of a departing aircraft monitor tower frequency until 10 NM from the control zone.

VFR flights will not normally be released from tower frequency while operating within the control zone. Once outside control zones, or when departing from an uncontrolled aerodrome where an MF has been assigned, beyond the range within which MF procedures apply, pilots should monitor frequency 126.7 MHz.

4.2.10 Departure Procedures – No Radio (NORDO) Aircraft

Before proceeding to any portion of the manoeuvring area of a controlled airport, it is the pilot’s responsibility to inform the control tower of his/her intentions and make appropriate arrangements for visual signals.

NOTE:

Before operating within a control zone with Class C airspace, a clearance shall be obtained from the control tower.

A pilot should remain continuously alert for visual signals from the control tower.

An aircraft should remain at least 200 ft from the edge of any runway where holding position markings or signs are not visible or have not been established unless a clearance for takeoff or to cross the runway has been received.

When stopped by a red light, a pilot must wait for a further clearance before proceeding.

When ready for takeoff by day, the pilot may attract the attention of the airport controller by turning the aircraft toward the tower.

Acknowledgement of Visual Signals – pilot shall, where practical, acknowledge all clearances and instructions received by visual signals by day, by full movement of rudder or ailerons, whichever can be seen most easily (such movement should be repeated at least three times in succession), or by taxiing the aircraft to the authorized position.

4.2.11 Visual Signals

Visual signals used by the tower and their meanings are as follows:

Table 4.2–Visuals Signals to Aircraft on the Ground

1	SERIES OF GREEN FLASHES	Cleared to taxi.
2	STEADY GREEN LIGHT	Cleared for takeoff.
3	SERIES OF RED FLASHES	Taxi clear of landing area in use.
4	STEADY RED LIGHT	Stop.
5	FLASHING WHITE LIGHT	Return to starting point on airport.
6	BLINKING RUNWAY LIGHTS	Advises vehicles and pedestrians to vacate runways immediately.

4.2.12 Departure Procedures – Receiver Only (RONLY) Aircraft

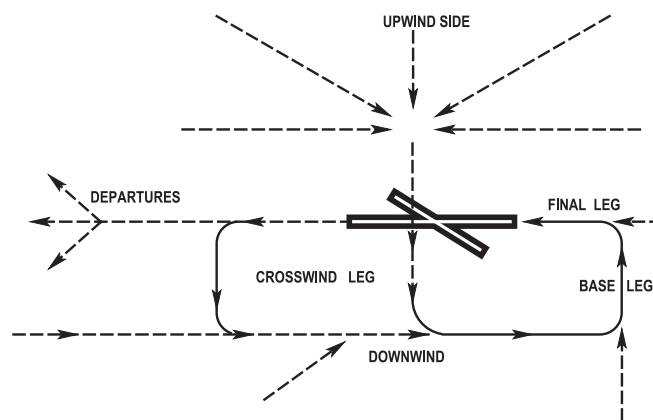
The procedures which apply to aircraft without radio also apply to aircraft equipped with receiver only, except that an airport controller may request the pilot to acknowledge a transmission in a specific manner. After the initial acknowledgement, no further acknowledgement, other than compliance with clearances and instructions, is necessary, unless otherwise requested by the controller.

4.3 TRAFFIC CIRCUITS – CONTROLLED AERODROMES

The following procedures apply to all aerodromes at which a control tower is in operation.

The traffic circuit consists of the crosswind leg, downwind leg, base leg and final approach leg.

Figure 4.1–Standard Left-Hand Traffic Circuit



NOTES:

1. Circuit normally flown at 1 000 ft AAE.
2. Where a right-hand circuit is required in accordance with CAR 602.96, the opposite of this diagram is applicable.

Entry to the circuit shall be made in such a manner so as to avoid cutting off other aircraft, conforming as closely as possible to the altitude (normally 1 000 ft AAE), speed and size of the circuit being flown by other traffic.

In order to increase safety by reducing the possibility of conflicting with departing traffic, aircraft approaching the active runway from the upwind side are to join the downwind leg abeam a point approximately midway between each end of the runway, taking into account aircraft performance, wind and/or runway length.

Pilots of NORDO and RONLY aircraft, who have made specific arrangements to operate within the control zone (RAC 4.4.5 and RAC 4.4.6), should approach the circuit from the upwind side, join crosswind at circuit height and, taking due account of other traffic, join the circuit on the downwind leg. Pilots are cautioned to remain clear of the approach and/or departure path of the



active runway when joining the circuit (see Figure 4.1). Flights which are not in communication with the tower shall, at all times, be on the alert for visual signals. Pilots are reminded that below 3 000 ft AGL and within 10 NM of a controlled aerodrome, aircraft shall not be operated at speeds greater than 200 KIAS. However, where the minimum safe speed of the aircraft is greater than 200 KIAS, the aircraft may be operated at the minimum safe speed (CAR 602.32).

4.4 ARRIVAL PROCEDURES — CONTROLLED AIRPORTS

If ATIS is available, all arrivals shall monitor this frequency to obtain the basic aerodrome information prior to contacting the tower. (See RAC 1.3 for ATIS information and refer to RAC 5.8 for arrival procedures in Class C airspace, other than a control zone.)

4.4.1 Initial Contact

Pilots must establish and maintain radio communications with the appropriate control tower prior to operating within any control zone served by an operational control tower. Also, if the control zone is Class B or C airspace, the appropriate clearance must be received from the controlling agency prior to entry.

When practical, it is recommended that the pilot make initial contact at least 5 minutes prior to requiring clearance or entering the zone.

4.4.2 Initial Clearance

On initial contact with the tower, unless the pilot advises receipt of ATIS, the airport controller will inform the pilot of runway in use, wind direction and speed, altimeter setting and any other pertinent information. Following this, the pilot will receive clearance to proceed, including any necessary restrictions. The shortest routing to the runway may be expected if traffic permits. Pilots of VFR aircraft should check the CFS (or a VTA chart if applicable) for special procedures at the time of flight planning.

When a pilot is given a clearance “to the circuit” by ATC, it is expected that the aircraft will join the circuit on the downwind leg at circuit height. Depending on the direction of approach to the airport and the runway in use, it may be necessary to proceed crosswind prior to joining the circuit on the downwind leg.

The ATC phraseology “cleared to the circuit” authorizes a pilot to make a right turn in order to join crosswind, or partial right turn to join a left-hand circuit provided that the right turn or partial right turn can be carried out safely.

A straight-in approach is an approach where an aircraft joins the traffic circuit on the final leg without having executed any other portion of the circuit.

When an aircraft is cleared for a right-hand approach while a left-hand circuit is in effect, it shall be flown so as to join the circuit on the right-hand downwind leg, or join directly into the right-hand base leg, as cleared by the airport controller.

Pilot: KELOWNA TOWER, CESSNA FOXTROT ALFA BRAVO CHARLIE, ONE FIVE MILES NORTH, SIX THOUSAND FIVE HUNDRED FEET VFR, REQUEST LANDING INSTRUCTIONS.

Tower: CESSNA FOXTROT ALFA BRAVO CHARLIE, KELOWNA TOWER, RUNWAY (number), WIND (direction in degrees magnetic, speed in knots), ALTIMETER (4-digit group in inches), (other pertinent instructions or information if deemed necessary), CLEARED TO THE CIRCUIT or CLEARED TO LEFT BASE LEG or CLEARED STRAIGHT-IN APPROACH.

Pilot: ALFA BRAVO CHARLIE.

When a pilot has received current landing information from the tower or the ATIS broadcast, initial clearance may be requested as follows:

Pilot: VICTORIA TOWER, CESSNA FOXTROT ALFA BRAVO CHARLIE (aircraft position), ALTITUDE, CHECK LANDING INFORMATION (or) WITH INFORMATION (ATIS code). REQUEST CLEARANCE TO THE CIRCUIT (or other type of approach).

Once established in the circuit as cleared, the pilot is to advise the tower accordingly.

Pilot: TOWER, ALFA BRAVO CHARLIE DOWNWIND.

Tower: ALFA BRAVO CHARLIE NUMBER (approach sequence number). If not Number 1, the tower will give the type, position and colour if significant, of aircraft to follow and other instructions or information.

Pilot: ALFA BRAVO CHARLIE.

Common ATC Phraseologies:

FOLLOW (aircraft type) NOW ON BASE LEG.

EXTEND DOWNWIND.

WIDEN APPROACH.

VFR Holding Procedures

When it is required by traffic, VFR flights may be asked to ORBIT visually over a geographic location, VFR checkpoint or call-up point (when these are published in the CFS or VTA charts) until they can be cleared to the airport. If the request is not acceptable, pilots should inform ATC and state their intentions.

Pilot: TORONTO TOWER, CESSNA FOXTROT ALFA BRAVO CHARLIE, OVER PORT CREDIT AT THREE THOUSAND FIVE HUNDRED FEET WITH INFORMATION ROMEO.

Tower: CESSNA FOXTROT ALFA BRAVO CHARLIE, TORONTO TOWER, ORBIT THE FOUR STACKS, ANTICIPATE A FIVE MINUTE DELAY, TRAFFIC IS A CESSNA ONE SEVEN TWO OVER THE FOUR STACKS, LAST REPORTED AT TWO THOUSAND FEET.

The pilot is expected to proceed to the FOUR STACKS, orbit within visual contact of the checkpoint and be prepared to proceed to the airport immediately upon receipt of a further clearance. Left turns are recommended as terrain and collision avoidance are the pilot's responsibilities.

Tower: ALFA BRAVO CHARLIE, REPORT LEFT BASE FOR RUNWAY TWO FOUR LEFT. CLEARED TO THE CIRCUIT.

Pilot: ALFA BRAVO CHARLIE DEPARTING THE FOUR STACKS AT THIS TIME, WILL REPORT LEFT BASE TO RUNWAY TWO FOUR LEFT; or

Pilot: ALFA BRAVO CHARLIE

4.4.3 Landing Clearance

At controlled airports, a pilot must obtain landing clearance prior to landing. Normally, the airport controller will initiate landing clearance without having first received the request from the aircraft; however, should this not occur, the onus remains upon the pilot to request such clearance in sufficient time to accommodate the operating characteristics of the aircraft being flown. NORDO and RONLY aircraft should be considered as intending to land when they join and conform to the traffic circuit. Landing clearance will normally be given when an aircraft is on final approach. If landing clearance is not received, the pilot should, except in case of emergency, pull up and make another circuit.

Pilot: TOWER, ALFA BRAVO CHARLIE LANDING CLEARANCE RUNWAY TWO SIX.

Tower: ALFA BRAVO CHARLIE, CLEARED TO LAND RUNWAY TWO SIX.

Pilot: ALFA BRAVO CHARLIE.

Controllers may, on occasion, authorize ground traffic to cross the landing runway after a landing clearance has been issued. Any such authorization by ATC is given with the assurance that the runway will be clear of conflicting traffic at the time the arriving aircraft crosses the landing threshold. When it appears that the runway may not be clear for landing, the pilot will be advised to "CONTINUE APPROACH, POSSIBLE PULL-UP."

When a "pull-up" is necessary (before or after the landing clearance has been issued), the pilot shall abandon the approach and make another circuit.

Tower: ALFA BRAVO CHARLIE, TRAFFIC STILL ON RUNWAY, PULL UP AND GO AROUND.

Common ATC Phraseologies:

CAUTION, POSSIBLE TURBULENCE FROM LANDING (aircraft type and position).

MAKE LEFT/RIGHT THREE SIX ZERO.

MAKE FULL-STOP LANDING.

CONTACT TOWER/GROUND ON (frequency) WHEN OFF RUNWAY/ NOW.

The "cleared for the option" procedure has been introduced to give a pilot the option to make touch-and-gos, low approach, missed approach, stop-and-go, or a full stop landing. This procedure will normally be used during light traffic conditions.

Pilot: TOWER, ALFA BRAVO CHARLIE, DOWNWIND RUNWAY TWO SEVEN, REQUEST THE OPTION.

Tower: ALFA BRAVO CHARLIE, CLEARED FOR THE OPTION RUNWAY TWO SEVEN.

A clearance for multiple touch-and-gos permits the pilot to perform more than one touch-and-go during a single pass along the runway without stopping. The procedure is intended for student pilots training with an instructor and will only be authorized during light traffic conditions.

Pilot: TOWER, ALFA BRAVO CHARLIE, DOWNWIND RUNWAY TWO SEVEN, REQUEST MULTIPLE TOUCH-AND-GOS.

Tower: ALFA BRAVO CHARLIE, CLEARED MULTIPLE TOUCH-AND-GOS, RUNWAY TWO SEVEN.

4.4.3.1 Air Traffic Control (ATC) Phraseology When a Runway Is Temporarily Shortened Due to Construction

Whenever the length of a runway has been temporarily shortened due to construction, tower controllers will use the word "shortened" immediately after the runway number on initial contact with arrivals and for all landing clearances.

NOTES:

1. These changes do not transfer pilot responsibility to the controller, but they do ensure that changes in runway length due to construction are communicated as an additional layer of safety.
2. For repetitive operations (ex. circuits), ATC will use the term

“shortened” only for the first arrival/departure clearance.

Example:

Tower landing clearance: *GOLF JULIET ECHO TANGO
CLEARED TO LAND RUNWAY
ONE-SIX SHORTENED*

4.4.4 Taxiing

A pilot must obtain an ATC authorization to taxi on the manoeuvring area at a controlled airport. Unless otherwise instructed by the airport controller, aircraft are expected to continue in the landing direction to the nearest suitable taxiway, exit the runway without delay and obtain further authorization to taxi. No aircraft shall exit a runway onto another runway unless instructed or authorized to do so by ATC. When required, ATC will provide the pilot with instructions for leaving the runway. These instructions will normally be given to the pilot prior to landing or during the landing roll. When an aircraft is instructed to exit onto another runway, the pilot must:

- a) obtain further authorization to taxi; and
- b) remain on tower frequency until clear of that runway or until communication is transferred to ground control.

After landing on a dead-end runway, the pilot will normally be given instructions to backtrack. In all cases, after leaving the runway, unless otherwise instructed by ATC, pilots should continue to taxi forward across the taxi holding position lines or to a point at least 200 ft from the edge of the runway where a taxi holding position line is not available. The aircraft is not considered clear of the runway until all parts of the aircraft are past the taxi holding position line or the 200-ft point. When clearing landing runways onto taxiways or other runways, pilots should exercise good airmanship by continuing to taxi well clear of the hold position while contacting ground control to obtain taxi clearance. This is to prevent aircraft from blocking a runway exit to following aircraft. If unable to establish contact with ground control, pilots should stop and not cross any runway without receiving ATC authorization.

Tower: *ALFA BRAVO CHARLIE (instructions for leaving runway),
CONTACT GROUND (specific frequency).*

Towers will normally provide the aircraft down time only when requested by the pilot.

Normally, aircraft will not be changed to ground control until off the active runway or runways.

Tower: *ALFA BRAVO CHARLIE, TAXI TO (apron or parking area)(any special instructions such as routing, traffic, cautionary or warning regarding construction or repair on the manoeuvring areas).*

4.4.5 Arrival Procedures – No Radio (NORDO) Aircraft

Before operating into a controlled aerodrome, pilots shall contact the control tower, inform the tower of their intentions and make arrangements for clearance through visual signals.

NOTE:

Before operating within a control zone with Class C airspace, a clearance shall be obtained from the control tower.

Pilots should remain continuously alert for visual signals from the control tower.

Traffic Circuit – The pilot should approach the traffic circuit from the upwind side of the runway, join crosswind at circuit height abeam a point approximately midway between each end of the runway and join the circuit on the downwind leg. While within the circuit the pilot should conform to the speed and size of the circuit, maintaining a separation from aircraft ahead so that a landing can be made without overtaking it. If it is necessary for a flight to cross the airport prior to joining crosswind, this should be done at least 500 feet above circuit height, and descent to circuit height should be made in the upwind area of the active runway.

Final Approach – Before turning on final approach, a pilot shall check for any aircraft on a straight-in approach.

Landing Clearance – Landing clearance will be given on final approach. If landing clearance is not received, the pilot shall, except in case of emergency, pull up and make another circuit. (Landing clearance may be withheld by the tower when there are preceding aircraft which have not landed or if the runway is occupied.)

Taxiing – No taxi clearance is required after landing, except to cross any runway or to taxi back to a turn-off point. When an aircraft's landing run carries it past the last available turn-off point, it should proceed to the end of the runway and taxi to one side, waiting there until instruction is received to taxi back to the nearest turn-off point.

4.4.6 Arrival Procedures – Receiver Only (RONLY) Aircraft

The procedures which apply to aircraft without radio also apply to aircraft equipped with receiver only, except that an airport controller may request the pilot to acknowledge a transmission in a specified manner. After initial acknowledgement, no further acknowledgement other than compliance with clearances and instructions is necessary, unless otherwise requested by the controller.

4.4.7 Visual Signals

Visual signals used by the tower and their meanings are as follows:

Table 4.3—Visuals Signals to Aircraft in Flight

1	STEADY GREEN LIGHT	Cleared to land.
2	STEADY RED LIGHT	Give way to other aircraft and continue circling.
3	SERIES OF GREEN FLASHES	Return for landing. (This shall be followed at the proper time by a steady green light.)
4	SERIES OF RED FLASHES	Airport unsafe; do not land.
5	THE FIRING OF A RED PYROTECHNICAL LIGHT (see NOTE)	Whether by day or night and notwithstanding previous instructions, means do not land for the time being.

NOTE:

Military control towers only.

Acknowledgement of Visual Signals – A pilot shall, where practicable, acknowledge all clearances and instructions received. Signals may be acknowledged as follows:

- a) distinct rocking of aircraft in flight;
- b) at night, by a single flash of a landing light.

4.4.8 Communications Failure – Visual Flight Rules (VFR)

- a) CAR 602.138 specifies that where there is a two-way radio communication failure between the controlling air traffic control unit and a VFR aircraft while operating in Class B, Class C or Class D airspace, the pilot-in-command shall:
 - (i) leave the airspace
 - (A) where the airspace is a control zone, by landing at the aerodrome for which the control zone is established, and
 - (A) in any other case, by the shortest route;
 - (ii) where the aircraft is equipped with a transponder, set the transponder to Code 7600; and
 - (iii) inform an air traffic control unit as soon as possible of the actions taken pursuant to (i).
- b) Should the communications failure occur while operating outside of Class B, C, or D airspace precluding the pilot from obtaining the appropriate clearance to enter or establishing radio contact, and if no nearby suitable aerodrome is available, the pilot may enter the Class B, C or D airspace, continue under VFR, and shall carry out the remaining procedures listed in (a).

Should the communications failure occur and there is a suitable aerodrome nearby at which the pilot wishes to land, it is recommended that the pilot comply with the established NORDDO arrival procedure outlined in RAC 4.4.5.

Pilots operating VFR in either Class E or G airspace may follow the procedures in (a) even though there is no intention to enter Class B, C, or D airspace.

4.4.9 Operations on Intersecting Runways

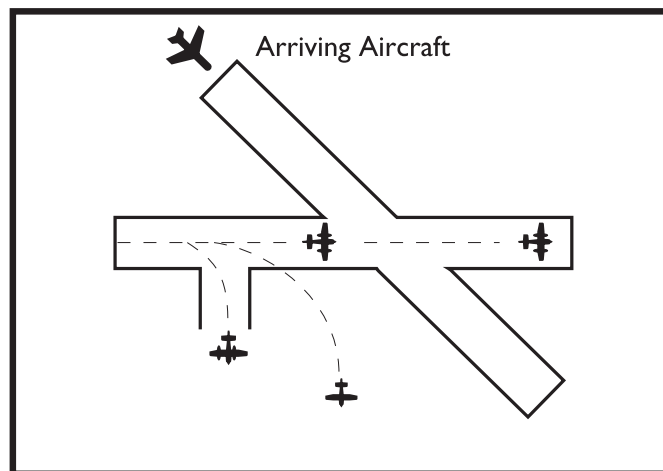
ATC procedures allow for sequential and/or simultaneous operations on intersecting runways. Their intent is to increase airport traffic capacity, thus reducing delays and saving fuel. These operations differ only in the controllers' application of ATC procedures; ATC advisories will specify the type of operation(s) in progress.

- a) *Sequential Operations:* Sequential operations do not permit controllers to allow either an arriving aircraft to cross the arrival threshold or a departing aircraft to commence its takeoff roll until certain conditions are met.

For an arriving aircraft (Figure 4.2) the conditions are as follows:

- (i) the preceding departing aircraft has:
 - (A) passed the intersection, or
 - (A) is airborne and has turned to avoid any conflict;
- (ii) the preceding arriving aircraft has:
 - (A) passed the intersection, or
 - (A) completed its landing roll and will hold short of the intersection (i.e. stopped or at taxi speed), or
 - (A) completed its landing roll and turned off the runway.

Figure 4.2—Arriving Aircraft

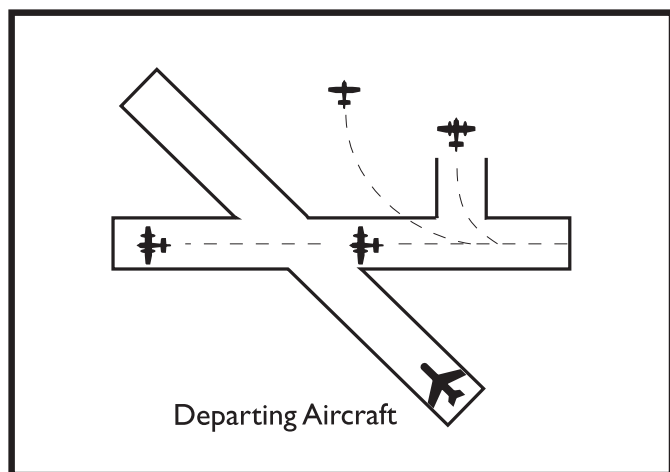


RAC

For a departing aircraft (Figure 4.3) the sequential conditions are listed below:

- (iii) the preceding departing aircraft
 - (A) has passed the intersection; or
 - (A) is airborne and has turned to avoid any conflict.
- (iv) the preceding arriving aircraft has
 - (A) passed the intersection;
 - (A) completed its landing roll and will hold short of the intersection (i.e. is stopped or at taxi speed); or
 - (A) completed its landing roll and turned off the runway.

Figure 4.3—Departing Aircraft



- b) *Simultaneous Operations*: Simultaneous operations differ from sequential operations in the application of ATC procedures. The procedures for simultaneous use of intersecting runways are applied only between two arrivals or an arrival and a departure. Air traffic controllers will permit an arriving aircraft to cross the runway threshold or a departing aircraft to begin its takeoff roll provided one of the aircraft has accepted a clearance to land and hold short of the intersecting runways (Figure 4.4). These operations are known as land and hold short operations (LAHSO).

General

LAHSO may be carried out under the following conditions:

- (i) the LDA, measured from the threshold or displaced threshold to 200 ft short of the nearest edge of the runway being intersected must be published in the CAP and in the CFS. ATC shall also broadcast LAHSO advisories, including LDAs, through an ATIS or voice advisory, well in advance of the final approach descent;
- (ii) the weather minima of a 1 000-ft ceiling and visibility of three statute miles are required. In specific cases, these criteria may be reduced by the Regional Director, Civil Aviation, but only with a written agreement between ATC and the operator;
- (iii) the reported braking action must be not less than good. The runway must be bare. (No snow, slush, ice, frost, or standing water is visible from the tower or reported

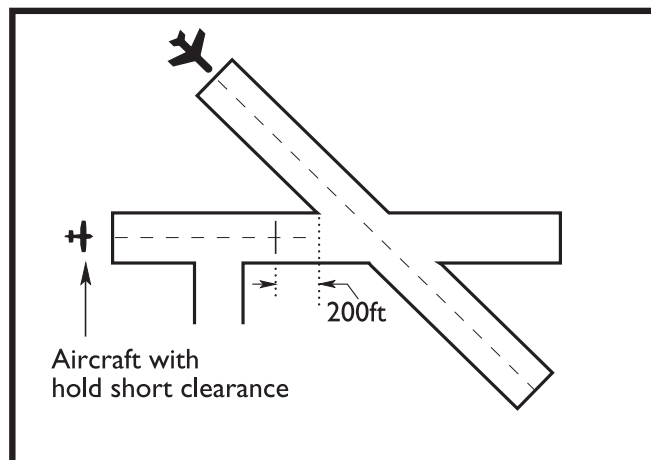
by a competent person. In order to accommodate small accumulations of ice or snow at the runway edge during winter operations, only the centre 100 ft of the runway must be bare.);

- (iv) a tailwind of less than five knots is acceptable for normal LAHSO on both dry and wet runway operations. The maximum allowable crosswind component for dry runways is 25 kt and 15 kt for LAHSO. Controllers will not initiate or approve a request for LAHSO on any runway when crosswinds on that runway exceed the maximum; ATC must include specific directions to hold short of an intersecting runway (e.g. “cleared to land Runway 27, hold short of Runway 36”). Pilots, in accepting the clearance, must read back “cleared to land Runway 27, hold short of Runway 36.” Having accepted the hold-short clearance, pilots are obligated to remain 200 ft short of the closest edge of the runway being intersected. If, for any reason, a pilot is unsure of being able to comply with a hold-short clearance, the pilot must advise ATC immediately of non-acceptance of the clearance; it is far better to be safe than sorry;
- (v) the lines are the same as taxiway exit and holding markings. These lines shall be located on the runway 90° to the hold-short runway centreline, 200 ft short of the nearest edge of the runway being intersected. Red and white mandatory instruction signs, illuminated for night LAHSO, shall be located at either end of the lines. More details on lines can be found in *Aerodrome Standards and Recommended Practices (TP 312E)*; and
- (vi) for tactical ATC reasons, controllers may offer or approve a pilot request for the use of a dry runway for landing with a tailwind not exceeding ten knots. LAHSO will not be authorized on wet runways if the tailwinds are five knots or more.

NOTE:

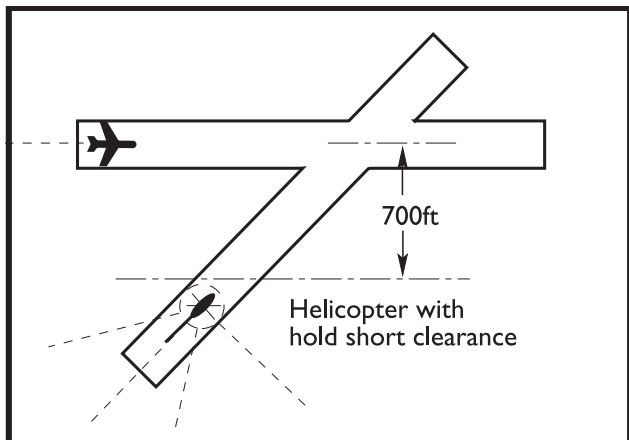
LAHSO are not authorized if thunderstorms, turbulence, wind shear or other conditions exist that would adversely affect the restricted aircraft’s ability to hold short after landing.

Figure 4.4—Aircraft with Hold-short Clearance



For simultaneous operations involving helicopters (Figure 4.5), if the arriving helicopter has a hold-short clearance, its point of landing is at least 700 ft from the centreline of the other runway.

Figure 4.5—Helicopter with Hold-short Clearance



Wet Runways

The following conditions are applicable for wet runway operations:

- (i) no Group 6 aircraft shall be instructed to hold short of an intersecting runway;
- (ii) stopping distances for Group 1, 2 and 3 aircraft are increased by 15% (see Note); and
- (iii) the coefficient of friction on LAHSO runways must meet a minimum standard. The coefficient of friction will be measured in accordance with *Airport Pavement Evaluation—Surface Friction* (AK-68-35-000/TP 3716); only those runways with average coefficients of friction above 0.6 will be approved for wet runway LAHSO.

NOTE:

Aircraft are categorized into groups requiring the following stopping distances:

Table 4.4—Stopping Distances on Dry and Wet Runways per Aircraft Group

—	Dry Runway	Wet Runway
Group 1	1 650 ft	1 900 ft
Group 2	3 000 ft	3 500 ft
Group 3	4 500 ft	5 200 ft
Group 4	6 000 ft	6 000 ft
Group 5	8 000 ft	8 000 ft
Group 6	8 400 ft	8 400 ft

These stopping distances are based on ISA conditions for sea-level runways. For higher airport elevations, the distances are adjusted for pressure altitude. An aircraft’s grouping is such that its normal stopping distance is approximately 50% of the available

stopping distance.

General Provisions

- (i) All pilots will be advised that simultaneous LAHSO are in progress.
- (ii) Controllers will issue appropriate traffic information.
- (iii) Acceptance of a hold-short landing clearance indicates to the controller that a pilot is able to comply with the clearance. If for any reason a pilot elects to use the full length of a runway, or a different runway, the pilot should inform ATC on or before receipt of the hold-short landing clearance.

NOTE:

During sequential and/or simultaneous operations, ATC procedures and pilot compliance with clearance conditions will ensure aircraft separation (i.e. spacing between aircraft). Notwithstanding this, conflicts between aircraft may occur, particularly at runway intersections, if a pilot does not comply with a clearance or is unable to comply as a result of unforeseen circumstances, such as missed approaches, misjudged landings, balked landings or brake failures. In these circumstances, ATC will endeavour to provide traffic advisories and/or instructions to assist pilots with collision avoidance.

4.4.10 High Intensity Runway Operations (HIRO)

Several of Canada’s airports rank among North America’s busiest in total aircraft movements. HIRO, as a concept, have evolved from procedures developed by high density terminals in North America and Europe. It is intended to increase operational efficiency and maximize the capacity at those airports where it is employed through the use of disciplined procedures applied by both pilots and air traffic controllers. HIRO is intended to minimize the occurrence of overshoots that result from slow-rolling and/or slow-clearing aircraft and offers the prospective of reducing delays overall, both on the ground and in the air. In its fullest application, HIRO enables ATC to apply minimum spacing to aircraft on final approach to achieve maximum runway utilization.

The tactical objective of HIRO is to minimize runway occupancy times (ROT) for both arriving and departing aircraft, consistent with both safety and passenger comfort. Effective participation in HIRO results when the pilot of an arriving aircraft exits the runway expeditiously, allowing the following arriving aircraft to cross the threshold with a minimum time interval. In the case of an arrival and a subsequent departure, the arriving pilot clears the runway in a minimum ROT, permitting a departure before the next arrival crosses the threshold. The air traffic controller’s objective in HIRO is to optimize approach spacing. This can be best achieved when pilots reach and adhere to assigned speeds as soon as practicable.

Effective participation in HIRO is achieved by satisfying the following key elements.

RAC

Key elements for arrivals:

- The pilot's objective should be to achieve minimum ROT, within the normally accepted landing and braking performance of the aircraft, by targeting the earliest suitable exit point and applying the right deceleration rate so that the aircraft leaves the runway as expeditiously as possible at the nominated exit.
- The expected runway exit point to achieve minimum ROT should be nominated during approach briefing. It is better, in terms of ROT, to select an exit you know you can make, rather than choose an earlier one, miss it, and then roll slowly to the next available exit.
- Upon landing, pilots should exit the runway without delay.
- High-speed exits have specific maximum design speeds. These speeds may be available through the appropriate airport authority.

Key elements for departures:

- On receipt of a line-up clearance, pilots should ensure that they are able to line up on the runway as soon as the preceding aircraft has commenced its takeoff roll.
- ATC will expect aircraft to enter the runway at a suitable angle to quickly line-up on the centreline and, when possible, continue in to a rolling takeoff when cleared. Pilots should ensure that they are able to commence the takeoff roll immediately when a takeoff clearance is issued.
- Aircraft that need to enter the runway at right angles, to backtrack, or to use the full length of the runway will require extra time on the runway. Therefore, pilots should notify ATC before arriving at the holding area so that the controller can re-sequence departures to provide the extra time.
- Cockpit checks should be completed prior to line-up, and any checks requiring completion on the runway should be kept to a minimum. If extra time is required on the runway, ATC should be informed before the aircraft arrives at the holding area so that the controller can re-sequence departures to provide the extra time.

4.5 AIRCRAFT OPERATIONS— UNCONTROLLED AERODROMES

4.5.1 General

An uncontrolled aerodrome is an aerodrome without a control tower, or one where the tower is not in operation. There is no substitute for alertness while in the vicinity of an uncontrolled aerodrome. It is essential that pilots be aware of, and look out for, other traffic, and exchange traffic information when approaching or departing from an uncontrolled aerodrome, particularly since some aircraft may not have communication capability. To achieve the greatest degree of safety, it is essential that all radio-equipped aircraft monitor a common designated

frequency, such as the published MF or ATF, and follow the reporting procedures specified for use in an MF area, while operating on the manoeuvring area or flying within an MF area surrounding an uncontrolled aerodrome.

- *MF area* means an area in the vicinity of an uncontrolled aerodrome for which an MF has been designated. The area within which MF procedures apply at a particular aerodrome is defined in the Aerodrome/Facility Directory Section of the CFS, under the heading COMM. Normally, the MF area is a circle with a 5-NM radius capped at 3 000 ft AAE.

At uncontrolled aerodromes without a published MF or ATF, the common frequency for the broadcast of aircraft position and the intentions of pilots flying in the vicinity of that aerodrome is 123.2 MHz.

At aerodromes within an MF area, traffic information may be exchanged by communicating with an FSS, CARS, UNICOM operator, vehicle operator, or by a broadcast transmission. The VCS in conjunction with AAS is normally provided at aerodromes served by an FSS. Some uncontrolled aerodromes are indirectly served by an FSS through an RCO and may provide RAAS. As flight service specialists may be located some distance from an aerodrome, it is essential that they be kept fully informed of both aircraft and vehicle activity.

Other aerodromes are designated as having an ATF. At some aerodromes with a control tower or FSS, an ATF is designated for use when the air traffic facility is closed. If a radio-equipped vehicle is present at ATF aerodromes, pilots can contact the vehicle operator directly on the ATF to ascertain that no vehicle-aircraft conflict exists. Operators of such radio-equipped vehicles will also provide pilots with any other available information on runway status and presence of other aircraft or vehicles on the runway.

There are some remote airports where a voice generator module (VGM) connected to an AWOS (or LWIS) continuously broadcasts weather information. An AWOS (or LWIS) broadcasts weather information that may differ from the aerodrome routine meteorological report (METAR) or aviation selected special weather report (SPECI) issued for the location. There may also be significant differences between broadcasts only a few minutes apart. Transport Canada recognizes that for any given site at any given time there can be only one official weather observation (METAR or SPECI), whether from a human observer or an automated station. As a result, it has been determined that although an AWOS (or LWIS) broadcast constitutes an additional source of accurate, up-to-the-minute weather information, it does not constitute an official weather observation (METAR or SPECI).

The wind and altimeter data obtained from an AWOS (or LWIS) via a VGM broadcast can be used to conduct an instrument approach. Therefore, at aerodromes where RAAS is provided and where AWOS (or LWIS) weather information is also available

via a VGM broadcast, the wind and altimeter data may be omitted from the RAAS if the pilot indicates in the initial call to the FSS that the weather information has already been obtained from the VGM broadcast. To avoid unnecessary frequency changes and to assist in reducing frequency congestion, it is desirable that pilots acquire this weather information prior to entering either the MF or ATF area and inform the flight service specialist that they have the wind and altimeter information. On start-up at such an aerodrome, it would be desirable to listen to the VGM broadcast prior to taxiing.

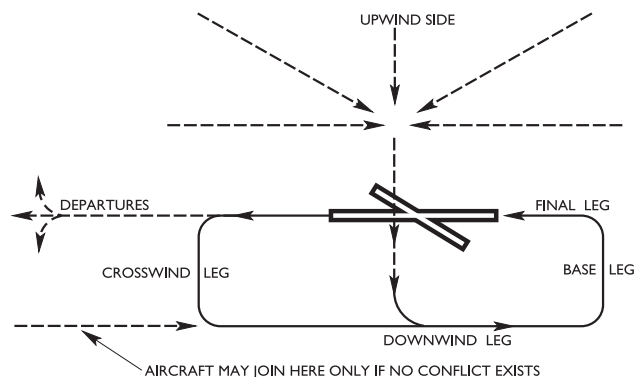
The flight service specialist will advise pilots of below-minima conditions reported in the current official METAR or SPECI. This will ensure a common reference for pilots and ATS personnel since IFR or SVFR authorization would then be required to operate within the control zone. Pilots will also be advised of any other significant weather conditions reported in current METAR, SPECI, SIGMET, AIRMET or PIREP, as appropriate, which may affect the safety of the flight. The flight service specialist will provide, upon request, the complete current METAR or SPECI for the location.

4.5.2 Traffic Circuit Procedures – Uncontrolled Aerodromes

The following procedures apply to all aircraft operating at aerodromes where airport control service is not provided except those aircraft following a standard instrument approach procedure. For procedures that apply to aircraft on a standard instrument approach, refer to RAC 9.0. Prior to joining a traffic circuit, all pilots should announce their intentions (see RAC 4.5.6). All turns shall be to the left while operating in the circuit, unless a right-hand circuit has been specified in the CFS.

Pilots operating aircraft under IFR or VFR are expected to approach and land on the active runway. The active runway is a runway that other aircraft are using or are intending to use for the purpose of landing or taking off. Should it be necessary for aircraft to approach to, land on, or take off from a runway other than the active runway, it is expected that the appropriate communication between pilots and the ground station will take place to ensure there is no conflict with other traffic. Some pilots operating under VFR at many sites prefer to give commercial IFR and larger type of aircraft priority. This practice, however, is a personal airmanship courtesy, and it should be noted that these aircraft do not establish any priority over other aircraft operating VFR at that aerodrome.

Figure 4.6—Standard Left-Hand Circuit Pattern



NOTES:

1. The circuit is normally flown at 1 000 ft AAE.
2. If a right-hand circuit is required in accordance with CAR 602.96, the opposite of this diagram is applicable.

a) Joining the Circuit

- (i) Landing and takeoff should be accomplished on the runway pointing as directly into the wind as possible, or on a runway parallel to it. However, the pilot has the final authority and is responsible for the safe operation of the aircraft, and another runway may be used if it is determined to be necessary in the interest of safety.
- (ii) Unless otherwise specified or required by the applicable distance-from-cloud criteria, aircraft should approach the traffic circuit from the upwind side. Alternatively, once the pilot has ascertained without any doubt that there will be no conflict with other traffic entering the circuit or established within it, the pilot may also join the circuit on the downwind leg (Figure 4.6). When joining from the upwind side, the pilot should plan the descent to cross the runway in level flight at 1 000 ft AAE or at the published circuit altitude and maintain that altitude until further descent is required for landing.
- (iii) If it is necessary for an aircraft to cross the airport before joining the circuit, it is recommended that the crossover be accomplished at least 500 ft above the circuit altitude.
- (iv) All descents should be made on the upwind side or well clear of the circuit pattern.
- (v) For aerodromes not within an MF area: Where no MF procedures are in effect, aircraft should approach the traffic circuit from the upwind side. Alternatively, once the pilot has ascertained without any doubt that there will be no conflict with other traffic entering the circuit or established within it, the pilot may join the circuit on the downwind leg (Figure 4.6).
- (vi) For aerodromes within an MF area when airport advisory information is available: Aircraft may join the circuit pattern straight-in or at a 45° angle to the downwind leg or straight-in to the base or final legs (Figure 4.1). Pilots should be alert both to other

VFR traffic entering the circuit at these positions and to IFR straight-in or circling approaches.

- (vii) For aerodromes within an MF area when airport advisory information is not available: Aircraft should normally approach the traffic circuit from the upwind side. Alternatively, once the pilot has ascertained without any doubt that there will be no conflict with other traffic entering the circuit or established within it, the pilot may join the circuit on the downwind leg (Figure 4.6), or as in subparagraph (vi) above.

NOTE:

When an uncontrolled aerodrome lies within an MF area, the pilot must follow the MF reporting procedures set out in CAR 602.97 to 602.103, inclusive. (See RAC 4.5.4 and 4.5.7.)

- b) *Continuous Circuits:* Aircraft performing a series of circuits and landings should, after each takeoff, reach circuit altitude before joining the downwind leg.
- c) *Departing the Circuit or Airport:* Aircraft departing the circuit or airport should climb straight ahead on the runway heading up to the circuit traffic altitude before commencing a turn in any direction to an en route heading. A turn back toward the circuit or airport should not be initiated until the aircraft is at least 500 ft above the circuit altitude.

4.5.3 Helicopter Operations

Pilots of helicopters at uncontrolled aerodromes are urged to avoid air taxiing or low flying across runways and taxiway areas where risk of collision with unseen aircraft or vehicles exists.

In addition to maintaining a sharp look-out and practising good airmanship, generally, pilots should avoid ground or air taxiing and hovering where blown dust, sand or gravel could prove hazardous to other aircraft, or when debris could be blown onto paved surfaces.

4.5.4 Mandatory Frequency (MF)

Transport Canada has designated a Mandatory Frequency (MF) for use at selected uncontrolled aerodromes, or aerodromes that are uncontrolled between certain hours. Aircraft operating within the area in which the MF is applicable (MF area), on the ground or in the air, shall be equipped with a functioning radio capable of maintaining two-way communication. Reporting procedures shall be followed, as specified in CARs 602.97 to 602.103 inclusive.

An MF area will be established at an aerodrome if the traffic volume and mix of aircraft traffic at that aerodrome is such that there would be a safety benefit derived from implementing MF procedures. There may or may not be a ground station in operation at the aerodrome for which the MF area has been established. When a ground station is in operation, for example, an FSS, an RCO through which RAAS is provided, a CARS, or an Approach UNICOM, then all aircraft reports that are required for operating

within, and prior to entering an MF area, shall be directed to the ground station. However, when the ground station is not in operation, then all aircraft reports that are required for operating within and prior to entering an MF area shall be broadcast. The MF will normally be the frequency of the ground station which provides the air traffic advisory services for the aerodrome. For the aerodromes with an MF, the specific frequency, distance and altitude within which MF procedures apply will be published in the CFS.

Examples:

MF—rdo 122.2 5 NM 3100 ASL

MF—UNICOM (AU) ltd hrs O/T tfc 122.75 5 NM 3100 ASL

4.5.5 Aerodrome Traffic Frequency (ATF)

An Aerodrome Traffic Frequency (ATF) is normally designated for active uncontrolled aerodromes that do not meet the criteria listed in RAC 4.5.4 for an MF. The ATF is established to ensure that all radio-equipped aircraft operating on the ground or within the area are listening on a common frequency and following common reporting procedures. The ATF will normally be the frequency of the UNICOM where one exists or 123.2 MHz where a UNICOM does not exist. Trained vehicle operators who possess a valid radiotelephone licence and authorized to do so, can communicate with pilots using two-way communication on the ATF and provide information such as:

- a) position of vehicles on the manoeuvring area;
- b) position of other aircraft on the manoeuvring area; and
- c) runway condition, if known.

The specific frequency, distance and altitude within which use of the ATF is required will be published in the CFS.

Example:

ATF – tfc 123.2 5 NM 5500 ASL

Personnel providing Approach UNICOM service, can also advise pilots on the ATF of the runway condition and position of vehicles or aircraft on the manoeuvring area.

NOTE:

Pilots may be able to communicate with either the UNICOM or the vehicle operator if radio-equipped, and coordinate their arrival or departure while using normal vigilance to ensure safe operations. When communications cannot be established (no reply or NORDO) or the status of the runway is unknown, it is the pilot's responsibility to visually ascertain the runway condition before landing or taking off.

The designation of an ATF is not limited to aerodromes only. An ATF may also be designated for use in certain areas—other than the area immediately surrounding an aerodrome—where VFR traffic activity is high, and there is a safety benefit to

ensuring that all traffic monitor the same frequency. For example, an ATF area could be established along a frequently flown corridor between two uncontrolled aerodromes. All aircraft operating within the area, below a certain altitude, would be requested to monitor and report intentions on one frequency. When such an area is designated, it will be specified in an *AIP Canada (ICAO) Supplement* or in the CFS.

4.5.6 Use of Mandatory Frequency (MF) and Aerodrome Traffic Frequency (ATF)

When operating in accordance with VFR, or in accordance with IFR but in VMC, pilots have sole responsibility for seeing and avoiding other aircraft. Aural and visual alertness are required to enhance safety of flight in the vicinity of uncontrolled aerodromes. At uncontrolled aerodromes for which an MF or ATF has been designated, certain reports shall be made by all radio-equipped aircraft.

NOTE:

Pilots operating VFR en route in uncontrolled airspace or VFR on an airway should continuously monitor 126.7 MHz when not communicating on the MF or ATF.

Reports on either the MF or ATF have three formats:

- a) a directed transmission made to a ground station;
- b) a directed transmission made to a vehicle operator on the ATF; or
- c) a broadcast transmission that is not directed to any particular receiving station.

Whenever the CFS indicates that reports are to be made to a ground station, the initial transmission should be made to the station. To assist in reducing frequency congestion, pilots are encouraged to use the phrase “HAVE NUMBERS” on the initial call to a ground station (arrival or departure) to indicate that they have received runway, wind and altimeter information from the previous aerodrome advisory. When operating outside an MF area, and when frequency congestion prevents pilots from making their mandatory calls, it is their responsibility to remain clear of the MF area until contact can be established with the FSS. If operating inside an MF area, the pilot should continue as stated in previous radio transmissions.

Pilot: *FREDERICTON RADIO, PIPER FOXTROT X-RAY YANKEE ZULU. WE HAVE THE NUMBERS, SIX MILES SOUTHWEST AT THREE THOUSAND FIVE HUNDRED VFR. INBOUND FOR LANDING.*

Should there be no acknowledgement of a directed transmission to a ground station or a vehicle operator, reports shall be made in the broadcast format unless the ground station or vehicle operator subsequently establishes two-way contact, in which case pilots shall resume communicating by directed transmission.

Examples:

Directed: *FREDERICTON RADIO, THIS IS PIPER FOXTROT X-RAY YANKEE ZULU BEACON INBOUND LANDING RUNWAY EIGHTEEN.*

or,

FREDERICTON VEHICLES, THIS IS PIPER FOXTROT X-RAY YANKEE ZULU...

Broadcast: *FREDERICTON TRAFFIC, THIS IS PIPER FOXTROT X-RAY YANKEE ZULU...*

4.5.7 Visual Flight Rules (VFR) Communication Procedures at Uncontrolled Aerodromes with Mandatory Frequency (MF) and Aerodrome Traffic Frequency (ATF) Areas

- a) *Radio-equipped Aircraft:* The following reporting procedures shall be followed by the pilot-in-command of radio-equipped aircraft at uncontrolled aerodromes within an MF area and should also be followed by the pilot-in-command at aerodromes with an ATF:
 - (i) *Listening Watch and Local Flying* [CAR 602.97 (2)]
Maintain a listening watch on the mandatory frequency specified for use in the MF area. This should apply to ATF areas as well.
 - (ii) *Before Entering Manoeuvring Area* [(CAR 602.99)]
Report the pilot-in-command's intentions before entering the manoeuvring area.
 - (iii) *Departure* (CAR 602.100)
 - (A) Before moving onto the take-off surface, report the pilot-in-command's departure intentions on the MF or ATF frequency. If a delay is encountered, broadcast intentions and expected length of delay, then rebroadcast departure intentions prior to moving onto the take-off surface;
 - (A) Before takeoff, ascertain by radio on the MF or ATF frequency and by visual observation that there is no likelihood of collision with another aircraft or a vehicle during takeoff; and,
 - (A) After takeoff, report departing from the aerodrome traffic circuit, and maintain a listening watch on the MF or ATF frequency until clear of the area.
 - (ii) *Arrival* (CAR 602.101)
 - (A) Report before entering the MF area and, where circumstances permit, shall do so at least five minutes before entering the area, giving the aircraft's position, altitude and estimated time of landing and the pilot-in-command's arrival procedure intentions;
 - (A) Report when joining the aerodrome traffic circuit, giving the aircraft's position in the circuit;
 - (A) Report when on downwind leg, if applicable;
 - (A) Report when on final approach; and, Report when clear of the surface on which the aircraft has landed.

- (ii) *Continuous Circuits* (CAR 602.102)
 - (A) Report when joining the downwind leg of the circuit;
 - (A) Report when on final approach; stating the pilot-in-command's intentions; and,
 - (A) Report when clear of the surface on which the aircraft has landed.
- (vi) *Flying Through an MF Area* (CAR 602.103)
 - (A) Report before entering the MF or ATF area and, where circumstances permit, shall do so at least five minutes before entering the area, giving the aircraft's position and altitude and the pilot-in-command's intentions; and,
 - (A) Report when clear of the MF or ATF area.

NOTE:

In the interest of minimizing possible conflict with local traffic and minimizing radio congestion on the MF or ATF, pilots of en-route VFR aircraft should avoid passing through MF or ATF areas.

- b) *NORDO*: NORDO aircraft will only be included as traffic to other aircraft and ground traffic as follows:
 - (i) *Arrival*: from five minutes before the ETA until ten minutes after the ETA, and
 - (ii) *Departure*: from just prior to the aircraft departing until ten minutes after the departure, or until the aircraft is observed/reported clear of the MF area.

4.5.8 Aircraft Without Two-Way Radio (No Radio [NORDO]/Receiver Only [RONLY])

4.5.8.1 Prior Arrangements

Aircraft without a functioning two-way radio may operate on the manoeuvring area or within the MF area associated with an uncontrolled aerodrome, provided:

- a) an FSS, a CARS, or an RCO through which RAAS is provided, is located at the aerodrome and is operating at the time proposed for the operation; and
- b) prior arrangements have been made, by telephone or in person, with the appropriate agency, FSS, CARS, or in the case of a RAAS, the FSS.

NOTES:

Prior arrangements for an AAS location: phone the "emergency only" number listed in the CFS under COMM / RADIO for the FSS serving the AAS location.

1. Prior arrangements for a RAAS location: the FSS or FIC serving a RAAS location is shown in the CFS under COMM / RCO for the RAAS location.
 - a) If an FSS serves the RAAS location: phone the "emergency only" number listed in the CFS under COMM / RADIO for the FSS serving the RAAS location; or

- b) If a FIC serves the RAAS location: phone the number listed in the CFS under FLT PLAN / FIC for the RAAS location.

When a pilot-in-command intends to operate at an uncontrolled aerodrome for which an MF has been designated, the pilot-in-command shall ascertain by visual observations that no other aircraft or vehicle is likely to come into conflict with the aircraft during takeoff or landing.

Pilots of NORDO/ONLY aircraft must be extremely vigilant when operating at either controlled or uncontrolled aerodromes and ensure through prior arrangements that other aircraft and vehicles will be informed of their presence within the area.

4.5.8.2 Traffic Circuits – No Radio [NORDO]/Receiver Only [RONLY]

When approaching an aerodrome, pilots of NORDO/ONLY aircraft shall enter the circuit as illustrated in Figure 4.6 and ensure that the aircraft completes at least two sides of a rectangular circuit before turning on to the final approach path.

4.5.8.3 Receiver Only (RONLY)

When operating an aircraft equipped with a VHF receiver capable of receiving transmissions on the MF, pilots shall maintain a listening watch on the MF when operating on the manoeuvring area or within the MF area.

4.6 HELICOPTER OPERATIONS AT CONTROLLED AIRPORTS

Two modes of helicopter airborne taxiing operations have been defined to accommodate the movement of helicopters at controlled airports; these are HOVER TAXI and AIR TAXI.

Hover taxi is the movement of a helicopter above the surface of an aerodrome, in ground effect, and at airspeeds less than approximately 20 KIAS. The actual height may vary; some helicopters require hover taxi above 25 ft AGL to reduce ground effect turbulence or provide clearance for cargo slingloads.

Air taxi is the movement of a helicopter above the surface of an aerodrome normally below 100 ft AGL. The pilot is solely responsible for selecting an appropriate height and airspeed for the operation being conducted and consistent with existing traffic and weather conditions. Pilots are cautioned of the possibility of the loss of visual references when conducting air taxi operations. Because of the greater operating flexibility, an air taxi clearance is to be expected unless traffic conditions will not permit this mode of operation.

When a helicopter is wheel-equipped and the pilot wishes to taxi on the ground, ATC should be informed when the clearance is requested.

NOTE:

Helicopter pilots are reminded that aircraft, vehicle and personnel movements are not controlled on airport aprons, and that caution must be exercised at all times during any surface movement, hover or air taxiing.

5.0 VISUAL FLIGHT RULES (VFR) EN ROUTE PROCEDURES

5.1 MONITORING, BROADCASTING ON 126.7 MHZ AND POSITION REPORTING EN ROUTE

Pilots operating VFR en route in uncontrolled airspace when not communicating on an MF, or an ATF, or VFR on an airway should continuously monitor 126.7 MHz and whenever practicable, broadcast their identification, position, altitude and intentions on this frequency to alert other VFR or IFR aircraft that may be in the vicinity. Although it is not mandatory to monitor 126.7 MHz and broadcast reports during VFR or VFR-OTT flights, pilots are encouraged to do so for their own protection. Pilots are encouraged to make position reports on the appropriate FISE frequency to a FIC where they are recorded by the flight service specialist and are immediately available in the event of SAR action. The following reporting format is recommended:

- | | |
|-------------------|------------------|
| 1. Identification | 4. Altitude |
| 2. Position | 5. VFR / VFR-OTT |
| 3. Time over | 6. Destination |

Example:

Pilot: *QUEBEC RADIO, THIS IS CESSNA GOLF INDIA GOLF BRAVO ON THE GATINEAU R-C-O, VFR (or VFR OVER-THE-TOP) POSITION REPORT.*

Radio: *CESSNA GOLF INDIA GOLF BRAVO, QUEBEC RADIO, GO AHEAD.*

Pilot: *QUEBEC RADIO, GOLF INDIA GOLF BRAVO, BY OTTAWA AT FIVE EIGHT, FOUR THOUSAND FIVE HUNDRED, VFR (or VFR OVER-THE-TOP), DESTINATION SUDBURY.*

NOTES:

- As shown in the example, it is important on initial contact that the pilot alerts the FIC to the fact that it is a VFR or VFR-OTT position report and indicates the name of the location of the RCO followed by the letters R-C-O in a non-phonetic form.
- The ETA destination or next reporting point may be included.
- Under certain conditions position reports are required prior to entering the ADIZ when operating on a DVFR flight plan or a defence flight itinerary.

5.2 ACKNOWLEDGEMENT OF CLEARANCES

Pilots of VFR flights shall read back the text of an ATC clearance when requested by an ATC unit.

5.3 ALTITUDES AND FLIGHT LEVELS — VISUAL FLIGHT RULES (VFR)

Aircraft shall be operated at altitudes or flight levels appropriate to the direction of flight when in level cruising flight above 3 000 feet AGL.

5.4 MINIMUM ALTITUDES — VISUAL FLIGHT RULES (VFR) (CANADIAN AVIATION REGULATIONS [CARs] 602.14 AND 602.15)

Minimum Altitudes and Distances

602.14

- This subsection was repealed on 2003/03/01.
- Except where conducting a takeoff, approach or landing or where permitted under Section 602.15, no person shall operate an aircraft
 - over a built-up area or over an open-air assembly of persons unless the aircraft is operated at an altitude from which, in the event of an emergency necessitating an immediate landing, it would be possible to land the aircraft without creating a hazard to persons or property on the surface, and, in any case, at an altitude that is not lower than
 - for aeroplanes, 1,000 feet above the highest obstacle located within a horizontal distance of 2,000 feet from the aeroplane,
 - for balloons, 500 feet above the highest obstacle located within a horizontal distance of 500 feet from the balloon, or
 - for an aircraft other than an aeroplane or a balloon, 1,000 feet above the highest obstacle located within a horizontal distance of 500 feet from the aircraft; and
 - in circumstances other than those referred to in paragraph (a), at a distance less than 500 feet from any person, vessel, vehicle or structure.



Permissible Low Altitude Flight**602.15**

1. A person may operate an aircraft at altitudes and distances less than those specified in subsection 602.14(2) where the aircraft is operated at altitudes and distances that are no less than necessary for the purposes of the operation in which the aircraft is engaged, the aircraft is operated without creating a hazard to persons or property on the surface and the aircraft is operated
 - a) for the purpose of a police operation that is conducted in the service of a police authority;
 - b) for the purpose of saving human life;
 - c) for fire-fighting or air ambulance operations;
 - d) for the purpose of the administration of the Fisheries Act or the Coastal Fisheries Protection Act;
 - e) for the purpose of the administration of the national or provincial parks; or
 - f) for the purpose of flight inspection.
2. A person may operate an aircraft, to the extent necessary for the purpose of the operation in which the aircraft is engaged, at altitudes and distances less than those set out in
 - a) paragraph 602.14(2)(a), where operation of the aircraft is authorized under Subpart 3 or Section 702.22; or
 - b) paragraph 602.14(2)(b), where the aircraft is operated without creating a hazard to persons or property on the surface and the aircraft is operated for the purpose of
 - (i) aerial application or aerial inspection,
 - (ii) aerial photography conducted by the holder of an air operator certificate,
 - (iii) helicopter external load operations, or
 - (iv) flight training conducted by or under the supervision of a qualified flight instructor.

NOTES:

The hazards of low flying cannot be over-emphasized. In addition to the normal hazards of low flying, such as impact with the ground, two issues regarding man-made structures should be stressed.

1. All obstructions extending 300 ft AGL or higher, or lower if deemed hazardous by TC, will be charted on VNCs and VTAs.

New obstructions, correctly reported by the owner to TC and NAV CANADA, will be NOTAMed and inserted in the CFS and eventually (next edition) charted on the applicable VNC and VTA. (Pilots noting obstructions not depicted are asked to alert TC).

2. Wire-strikes account for a significant number of low flying accidents. A number of these accidents occur over level terrain, in good weather and at very low altitudes.

The regulations governing low-level flight are located in several areas of the CARs. It is the responsibility of the pilots and the companies they work for to ensure that all regulations are strictly adhered to.

5.5 MINIMUM ALTITUDES — OVERFLYING AERODROMES [CANADIAN AVIATION REGULATIONS [CARs] 602.96(4) AND(5)]

602.96

4. Unless otherwise authorized by the appropriate air traffic control unit, no pilot-in-command shall operate an aircraft at a height of less than 2 000 feet over an aerodrome except for the purpose of landing or taking off or if the aircraft is operated pursuant to subsection (5).

602.96

5. Where it is necessary for the purposes of the operation in which the aircraft is engaged, a pilot-in-command may operate an aircraft at less than 2 000 feet over an aerodrome, where it is being operated
 - a) in the service of a police authority;
 - b) for the purpose of saving human life;
 - c) for fire-fighting or air ambulance operations;
 - d) for the purpose of the administration of the *Fisheries Act or the Fisheries Protection Act*;
 - e) for the purpose of the administration of the national or provincial parks;
 - f) for the purpose of flight inspection;
 - g) for the purpose of aerial application or aerial inspection;
 - h) for the purpose of highway or city traffic patrol;
 - i) for the purpose of aerial photography conducted by the holder of an air operator certificate;
 - j) for the purpose of helicopter external load operations; or
 - k) for the purpose of flight training conducted by the holder of a flight training unit operator certificate.

5.6 CONTROLLED VISUAL FLIGHT RULES (CVFR) PROCEDURES

Pilots intending to fly CVFR shall file a flight plan and obtain

an ATC clearance prior to entering Class B airspace. The ATC clearance will not normally be issued prior to takeoff unless the airspace within a control zone is Class B. The ATC clearance will normally be issued upon receipt of a position report filed by the pilot upon reaching the last 1 000 feet altitude below the base of Class B or before entering laterally. This procedure is intended to ensure that the radio equipment is operating and to remind the pilots that, while outside of Class B airspace, ATC separation is not provided and that they must maintain a vigilant watch for other traffic. The ATC clearance will contain the phrase “MAINTAIN (altitude) VFR”.

CVFR flights must be conducted in accordance with procedures designed for use by IFR flights, except when IFR weather conditions are encountered, the pilot of a CVFR flight must avoid such weather conditions. This should be accomplished by:

- a) requesting an amended ATC clearance which will enable the aircraft to remain in VFR weather conditions
- b) requesting an IFR clearance if the pilot has a valid instrument rating and the aircraft is equipped for IFR flight.
- c) request special VFR if within a control zone.

If unable to comply with the preceding, ensure that the aircraft is in VFR weather conditions at all times and leave Class B airspace horizontally or by descending. If the airspace is a control zone, land, at the aerodrome on which the control zone is based. In both cases, inform ATC as soon as possible of the action taken.

5.7 EN ROUTE RADAR SURVEILLANCE

When operating in areas where radar coverage exists, VFR flights with transponder equipped aircraft may request radar traffic information. ATC will provide this information, traffic (or workload) permitting.

The service is provided by the ACC or TCU responsible for IFR control service in the area(s) concerned. The appropriate frequency for the controlling ATC unit may be found in the CFS (nearest controlled airport), en route (IFR) charts or by request to a FIC.

Phraseology: “*REQUEST RADAR SURVEILLANCE*”

Example:

“EDMONTON ADVISORY, CESSNA SKYLANE FOXTROT ALFA BRAVO CHARLIE, TEN NORTHEAST OF CAMROSE AT 6500 VFR SQUAWKING 1200 EN ROUTE TO VILLENEUVE; REQUEST RADAR SURVEILLANCE.”

5.8 VISUAL FLIGHT RULES (VFR) OPERATIONS WITHIN CLASS C AIRSPACE

The following are the basic procedures for entry into, and for operation within Class C airspace. Pilots should consult the applicable VTA chart for any additional procedures that may be required for that particular Class C airspace.

- a) *Pilot Procedures*
 - (i) Obtain ATIS information (when available) prior to contacting ATC.
 - (ii) Contact ATC on VFR advisory frequency (depicted on VTA charts) prior to entry into Class C airspace and provide the following information:
 - aircraft type and identification,
 - position (preferably over a call-up point depicted on the VTA chart or a bearing and distance from it, otherwise another prominent reporting point or a VOR radial or VOR/DME fix),
 - altitude,
 - destination and route, and
 - transponder code (if transponder equipped), and ATIS (code) received.
 - (iii) Comply with ATC instructions received. Any ATC instruction issued to VFR flights is based on the firm understanding that a pilot will advise ATC immediately if compliance with the instructions would result in not being able to maintain adequate terrain or obstacle clearance, or to maintain flight in accordance with VFR. If so advised, ATC will issue alternate instructions.
- b) *ATC Procedures*
 - (i) Identify the aircraft with radar. (Pilots may be required to report over additional fixes, or squawk ident on their transponder.) The provision of an effective radar service is dependent upon communications equipment capabilities and the adequacy of the radar-displayed information. In the latter case, it may be difficult to maintain radar identification of aircraft which are not operating on specific tracks or routes (i.e. sightseeing, local training flights, etc.), and pilots will be advised when radar service cannot be provided.
 - (ii) Issue landing information on initial contact or shortly thereafter unless the pilot states that the appropriate ATIS information has been received.
 - (iii) Provide the aircraft with routing instructions or radar vectors whenever necessary. The pilot will be informed when vectoring is discontinued except when transferred to a tower. Occasionally, an aircraft may be held at established fixes within Class C airspace to await a position in the landing sequence.
 - (iv) Issue traffic information when two or more aircraft are held at the same fix, or whenever in the controller’s

judgement a radar-observed target might constitute a hazard to the aircraft concerned.

- (v) When required, conflict resolution will be provided between IFR and VFR aircraft, and upon request, between VFR aircraft.
- (vi) Visual separation may be effected when the pilot reports sighting a preceding aircraft and is instructed to follow it.
- (vii) Inform the pilot when radar service is terminated, except when the aircraft has been transferred to a tower.

6.0 INSTRUMENT FLIGHT RULES (IFR) – GENERAL

6.1 AIR TRAFFIC CONTROL (ATC) CLEARANCE

Air traffic control (ATC) clearance shall be obtained before takeoff from any point within controlled airspace or before entering controlled airspace for flight under instrument flight rules (IFR) or during instrument meteorological conditions (IMC).

According to *Canadian Aviation Regulation (CAR) 602.31*, clearance received by a pilot must be read back to the controller, except in certain circumstances. When clearance is received on the ground before departure from a controlled aerodrome and a standard instrument departure (SID) is included in the clearance, the pilot only needs to acknowledge receipt of the clearance by repeating the aircraft call sign and the transponder code that was assigned. If there is an amendment to the altitude contained in the SID, that altitude shall also be read back. Whenever the controller requests a full readback, the pilot shall comply. Also, the pilot may, at any time, read back a clearance in full to seek clarification.

Whenever clearance is received and accepted by the pilot, the pilot shall comply with it. If the clearance cannot be accepted, the pilot shall immediately notify ATC because simple acknowledgement of the clearance will be interpreted by the controller as acceptance.

Pilots shall not deviate from a clearance except in an emergency that necessitates immediate action, or in order to respond to an airborne collision avoidance system/traffic alert and collision avoidance system (ACAS/TCAS) resolution advisory (RA), a warning from a ground proximity warning system (GPWS), or a warning from an aircraft wind shear (WS) detection and warning system (see MET 2.3). In these cases, the pilot shall inform ATC as soon as possible and obtain an amended clearance (as per CAR 602.31).

6.2 INSTRUMENT FLIGHT RULES (IFR) FLIGHTS IN VISUAL METEOROLOGICAL CONDITIONS (VMC)

A pilot may elect to conduct a flight in accordance with IFR in VMC. Flights operating in accordance with IFR shall continue

in accordance with IFR, regardless of weather conditions. An IFR clearance provides separation between IFR aircraft in controlled airspace only. Pilots operating IFR must be aware of the need to provide their own visual separation from VFR aircraft when operating in VMC and from any other aircraft when operating in uncontrolled airspace.

A pilot may cancel IFR, or close the IFR flight plan, provided the aircraft is operating in VMC, is outside Class A or B airspace, and it is expected that the flight will not return to IMC. If the pilot closes the IFR flight plan or cancels IFR, ATC will discontinue the provision of IFR control service.

Refer to RAC Closing a Flight Plan, for information on the requirement to submit an arrival report and on the provision of alerting service upon closure or cancellation of IFR. Provided the destination remains the same, a pilot may change an IFR flight plan to a VFR flight plan without having to file a new flight plan. ATS will, however, confirm the aircraft's destination and ETA and obtain a search and rescue time from the pilot.

6.2.1 Instrument Flight Rules (IFR) Clearance with Visual Flight Rules (VFR) Restrictions

ATC may issue an IFR clearance for an aircraft to depart, climb or descend VFR until a specified time, altitude, or location provided

- a) the pilot requests it;
- b) the aircraft is outside Class A airspace;
- c) the aircraft is within Class B airspace at or below 12 500 ft ASL or within Class C, D or E airspace; and
- d) the weather conditions permit.

Pilots are reminded that during such a VFR restriction they must provide their own separation, including wake turbulence separation, from other IFR aircraft as well as from the VFR traffic. Controllers normally issue traffic information concerning other IFR aircraft, particularly in marginal weather conditions. If compliance with the restriction is not possible, the pilot should immediately advise ATC and request an amended clearance.

6.2.2 Visual Flight Rules (VFR) Release of an Instrument Flight Rules (IFR) Aircraft

When a delay is experienced in receiving an IFR departure clearance, a pilot may request approval to depart and maintain VFR until an IFR clearance can be received. The conditions in the sub-section above also apply in this situation. If the request for a VFR departure is approved, the pilot will be given a time, altitude or location at which to contact ATC for an IFR clearance. Depending upon the reasons for the IFR departure clearance delay, a VFR departure of an IFR flight may not be approved by the IFR unit. In situations such as these, it may be desirable for the pilot to wait for the IFR departure clearance.

6.3 EMERGENCIES AND EQUIPMENT FAILURES — INSTRUMENT FLIGHT RULES (IFR)

6.3.1 Declaration of Emergency

Whenever pilots are faced with an emergency situation, ATC expects the pilot to take whatever action is considered necessary. ATC will assist pilots in any way possible whenever an emergency is declared. Pilots are requested to advise ATC of any deviations from IFR altitudes or routes necessitated by an emergency situation as soon as it is practicable in order that every effort can be made to minimize conflicts with other aircraft.

Pilots of transponder-equipped aircraft, when experiencing an emergency and unable to establish communications immediately with an ATC unit, may indicate “Emergency” to ATC by adjusting the transponder to reply to Mode A/3 Code 7700. Thereafter, radio communications should be established with ATC as soon as possible.

It should be pointed out, however, that when Code 7700 is used, the signal may not be detected because the aircraft may not be within the range of SSR coverage.

6.3.2 Two-Way Communications Failure

It is impossible to provide regulations and procedures applicable to all possible situations associated with a two-way communications failure. During a communications failure, when confronted by a situation not covered in the regulations, pilots are expected to exercise good judgment in whatever action they elect to take. The following procedures are the standard communications failure procedures; however, they may be superseded by specific procedures that take precedence. For example, some missed approach and SID procedures may have specific published communications failure procedures.

6.3.2.1 General

Unless otherwise authorized by ATC, the pilot-in-command of an aircraft that experiences a two-way communications failure when operating in or cleared to enter controlled airspace under IFR, or when operating in or cleared to enter Class B or C airspace under VFR shall:

- a) select the transponder to reply to Mode A/3 Code 7600 interrogations, if the aircraft is transponder-equipped;
- b) maintain a listening watch on appropriate frequencies for control messages or further clearances; acknowledge receipt of any such messages by any means available, including the use of approved satellite voice equipment or the selective use of the normal/standby functions of transponders;
- c) attempt to contact any ATC facility or another aircraft, inform them of the difficulty, and request they relay the information to the ATC facility with whom communications are intended;

- d) comply with the procedures specified by the Minister in the CAP and the CFS, except where specific instructions to cover an anticipated communications failure have been received from an ATC unit; and
- e) attempt to contact the appropriate NAV CANADA ATS unit by means of a conventional cell or satellite phone, when all of the above attempts have failed.

NOTE:

Approved SATCOM voice equipment refers to on-board embedded equipment. Permanent satellite voice equipment is installed and tested in accordance with appropriate certification and airworthiness standards.

6.3.2.2 Instrument Flight Rules (IFR) Flight Plan

- a) *Visual Meteorological Conditions (VMC)*: If the failure occurs in VMC, or if VMC are encountered after the failure, the pilot-in-command shall continue the flight under VFR and land as soon as practicable.

NOTE:

This procedure applies in any class of airspace. The primary purpose is to preclude extended IFR operation in controlled airspace in VMC. However, it is not intended that the requirement to “land as soon as practicable” be construed to mean “land as soon as possible.” The pilot retains the prerogative of exercising his/her best judgment and is not required to land at an unauthorized airport, at an airport unsuitable for the type of aircraft flown, or to land only minutes short of destination.

- b) *Instrument Meteorological Conditions (IMC)*: If the failure occurs in IMC, or if the flight cannot be continued under VMC, the pilot-in-command shall continue the flight according to the following:
 - (i) *Route*
 - (A) by the route assigned in the last ATC clearance received and acknowledged;
 - (A) if being radar-vector, by the direct route from the point of communications failure to the fix, route, or airway specified in the vector clearance;
 - (A) in the absence of an assigned route, by the route that ATC has advised may be expected in a further clearance; or
 - (A) in the absence of an assigned route or route that ATC has advised may be expected in a further clearance, by the route filed in the flight plan.
 - (ii) *Altitude*: At the highest of the following altitudes or FLs for *the route segment being flown*:
 - (A) the altitude(s) or FLs assigned in the last ATC clearance received and acknowledged;
 - (A) the minimum IFR altitude; or
 - (A) the altitude or FL ATC has advised may be expected in a further clearance. (The pilot shall commence climb to this altitude/FL at the time or point specified by ATC to expect further clearance/ altitude change.)

NOTES:

1. The intent of this is that an aircraft that has experienced a communications failure will, during any segment of a flight, be flown at an altitude that provides the required obstacle clearance.
2. If the failure occurs while being vectored at a radar vectoring altitude that is lower than a published IFR altitude, the pilot shall immediately climb to and maintain the appropriate minimum IFR altitude until arrival at the fix, route or airway specified in the clearance.

(iii) *Descent for Approach:* Maintain en route altitude to the navigation facility or the approach fix to be used for the IAP selected and commence an appropriate descent procedure at whichever of the following times is the most recent:

- (A) the ETA (ETA as calculated from take-off time plus the estimated time en route filed or amended [with ATC]);
- (A) the ETA last notified to and acknowledged by ATC; or
- (A) the EAT last received and acknowledged.

If failure occurs after you have received and acknowledged a holding instruction, hold as directed and commence an instrument approach at the EAT or expected further clearance time (EFC), whichever has been issued.

NOTES:

1. If the holding fix is not a fix from which an approach begins, leave the fix at the expected further clearance time if one has been received. If none has been received, proceed to a fix from which an approach begins upon arrival over the clearance limit. Commence descent and/or approach as close as possible to the ETA as calculated from the filed estimated time en route or as amended with ATC.
2. If cleared for a STAR, maintain the appropriate altitude described above and proceed to the final approach fix (FAF):
 - a) via the published routing;
 - b) via the published routing to the segment where radar vectors are depicted to commence, then direct to the facility or fix serving the runway advised by ATIS or specified in the ATC clearance, for a straight-in approach, if able, or for the full procedure if one is published;
 - c) for a CLOSED RNAV STAR, by flying the arrival as published, including any vertical and speed restraints depicted in the procedure, and intercepting the final approach course for a straight-in approach; or
 - d) for an OPEN RNAV STAR, by flying the arrival as published, including any vertical and speed restraints depicted in the procedure. The pilot is expected to delete the heading leg at the DTW, to initiate an auto-turn at the DTW and FACF and to intercept the final approach course for a straight-in approach.

For flights to the United States, communications failure procedures are essentially the same, but it is the pilot's responsibility to consult the appropriate American publications. Some instrument procedures do not include a procedure turn but include the statement "RADAR OR RNAV REQUIRED" as part of the procedure. The initial approach segment of these instrument procedures is being provided by ATC radar vectors. Without ATC radar vectoring, the instrument procedure may not have a published initial approach segment.

Should an aircraft communications failure occur while the aircraft is being vectored on one of these approaches, separately or as part of a STAR, the pilot is expected to comply with the communications failure procedure by selecting the transponder to Mode A/3 Code 7600 immediately. Pilots should always be aware of the traffic situation. For example, ATC may have indicated that your aircraft was second for an approach to Runway 06L; under these circumstances, the flight should be continued along the route that normally would have been expected under radar vectoring. In some cases of communications failure, pilots may need to revert to dead reckoning navigation (DR) to the final approach course. It is important to other aircraft and ATC for the aircraft experiencing a communications failure to continue the flight along a route that would permit the aircraft to conduct a straight-in approach and landing without unexpected manoeuvring. Pilots are expected to exercise good judgment in these cases. Unexpected manoeuvres, such as turns away from the final approach course, may cause traffic disruptions and conflicts.

If the communications failure occurs while being vectored at a radar vectoring altitude that is lower than a published IFR altitude (e.g. minimum sector altitude 25 NM), the pilot shall immediately climb to and maintain the appropriate minimum IFR altitude until arrival at a fix associated with the instrument procedure.

Modern technology has introduced new on-board communications capabilities, such as airborne telephone communications. Pilots who are confronted with an aircraft communications failure may, if circumstances permit, use this new on-board technology to establish communications with the appropriate ATC units. NAV CANADA publishes the phone numbers of ACCs, control towers, FICs and FSSs in the CFS.

6.3.3 Reporting Malfunctions of Navigation and Communications Equipment

The pilot-in-command of an aircraft in IFR flight within controlled airspace should report immediately to the appropriate ATC unit any malfunction of navigation or air-ground communications equipment.

Examples:

- Loss of VOR, ADF or low frequency navigation capability.
- Complete or partial loss of ILS capability.
- Impairment of air-ground communications capability.
- Impairment of transponder serviceability.

Having received this information, ATC will take into account any limitations in navigation or air-ground communications equipment in further clearances to the aircraft.

6.3.4 Fuel Dumping

Whenever it is necessary to jettison fuel, the pilot should immediately notify ATC and provide information such as the course to be flown, the period of time and weather conditions. To allow for adequate vaporization, fuel dumping should be carried out at least 2 000 feet above the highest obstacle within 5 NM of the track to be flown. ATC may suggest an alternate area where fuel should be dumped; aircraft will be encouraged to dump fuel on a constant heading over unpopulated areas and clear of heavy traffic. When necessary information has been obtained, ATC will broadcast on appropriate frequencies a “fuel dumping” advisory. Pilots should advise ATC immediately when fuel dumping has been completed.

6.4 INSTRUMENT FLIGHT RULES (IFR) SEPARATION

6.4.1 General

The following information is intended to acquaint pilots with some of the basic non-radar separation standards applied by ATC and so facilitate flight planning and understanding of ATC techniques.

6.4.2 Vertical Separation – General

The standard vertical separation minima is as follows:

- FL 290 and below – 1 000 ft;
- above FL 290 – 2 000 ft.

6.4.3 Vertical Separation Between Flight Levels and Altitudes Above Sea Level (ASL)

When the altimeter setting is less than 29.92 in. Hg, there will be less than 1 000 ft vertical separation between an aircraft flying at 17 000 ft ASL with that altimeter setting and an aircraft flying at FL 180, (with altimeter set at 29.92 in. Hg); therefore, the lowest usable flight level will be assigned or approved in accordance with the following table:

Altimeter Setting	Lowest Usable Flight Level
29.92 in. or higher	FL 180
29.91 in. to 28.92 in.	FL 190
28.91 in. to 27.92 in.	FL 200

6.4.4 Longitudinal Separation—Distance—Based

Longitudinal separation of IFR flights based on distance is established by ATC on the basis of position reports, expressed

in units of distance, from the concerned aircraft determined in relation to a common point. To account for the effect of slant range, controllers must know when distance reports are derived from DME when establishing longitudinal separation between a mix of RNAV/GNSS- and DME-equipped aircraft.

To this end, pilots should report distances based on RNAV and GNSS in miles, e.g. 30 mi. from “Someplace.” When distance reports are based on DME, pilots should state DME, e.g. 30 DME from “Someplace.”

NOTE:

RNAV position reports derived from DME-DME computations are not affected by slant range.

6.4.5 Lateral Separation – General

Lateral separation of IFR flights is provided by ATC in the form of “airspace to be protected” in relation to a holding procedure, instrument approach procedure or the approved track. The dimensions of protected airspace for a particular track take into account the accuracy of navigation that can be reasonably expected. For track segments within signal coverage of NDB, VOR or TACAN stations and along bearings/courses/radials of such facilities, protected airspace takes into account the accuracy of available track guidance, accuracy of airborne receiver and indicator equipment, and a small pilotage tolerance. Separation is considered to exist provided the airspaces protected for each aircraft do not overlap. It is essential, therefore, that accuracy capability of navigation equipment be maintained.

Pilots of IFR or controlled VFR flights must adhere as closely as practicable to the centreline of their approved airway or track. If the aircraft inadvertently deviates from the approved track, immediate action must be taken to regain the centreline as soon as practicable. Pilots realizing that they are outside the airspace protected for their approved track must notify the appropriate ATC unit immediately.

6.4.6 Lateral Separation – Airways and Tracks

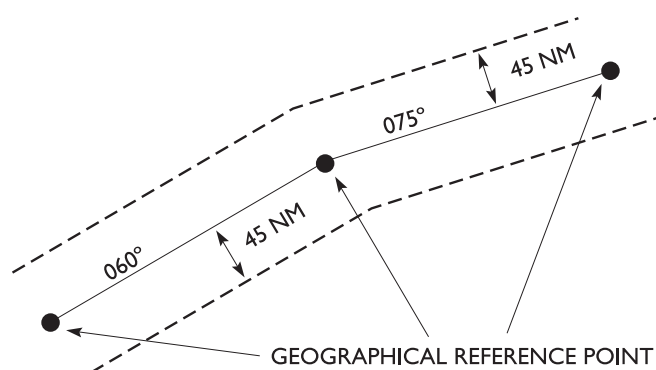
In the low-level airspace, the airspace to be protected is the full width of the airway as illustrated in RAC Low-Level Airways.

In the high-level airspace, all airspace is controlled within the Southern, Northern, and Arctic Control Areas. As a result, a high-level airway is “a prescribed track between specified radio aids to navigation” and, thus, has no defined lateral dimensions. Therefore, the airspace to be protected for airways and/or tracks in the high-level airspace is the same as that for low-level airways.

Along off-airway tracks the “airspace to be protected” is 45 NM each side of that portion of the track which is beyond navigational and signal coverage range.

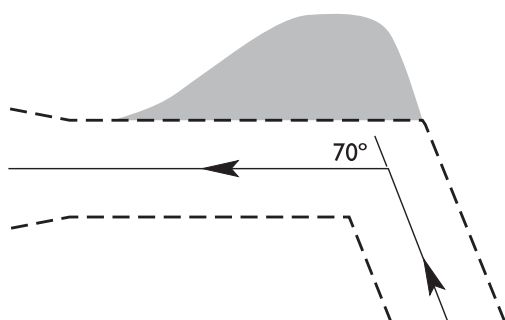


Figure 6.1—Airspace to be Protected Along Off-Airway Tracks



Additional airspace will be protected at and above FL 180 on the manoeuvring side of tracks that change direction by more than 15° overhead navigation aids or intersections. It is expected that pilots of aircraft operating below FL 180 will make turns so as to remain within the normal width of airways or airspace protected for off-airway tracks.

Figure 6.2—Additional Airspace to be Protected for Turns



Normally, the airspace to be protected for an approved track will be based on the premise that the changeover from one navigation reference to another will take place approximately midway between facilities. Where this is not possible due to a difference in the signal coverage provided by two adjacent navigation aids, the equal signal point on an airway segment will be shown.

To remain clear of restricted areas, active danger or alert areas, or active areas such as the Churchill Rocket Range, pilots should file a flight plan so that the airspace-to-be-protected for the intended track do not overlap the area of concern.

6.4.7 Lateral Separation — Instrument Approach Procedure

Air traffic controllers have been authorized to consider the basic horizontal dimensions of intermediate approach areas, final approach areas and missed approach areas, for obstacle clearance purposes, as the airspace-to-be-protected for aircraft conducting standard instrument approach procedures. Adequate horizontal separation is then deemed to exist when the airspace-to-be-protected for such aircraft do not overlap the airspace-to-be-protected

for aircraft en route, holding or conducting simultaneous adjacent instrument approaches. As with other separation standards based on the airspace-to-be-protected concept, it will be the pilot's responsibility to remain within the limits of airspace-to-be-protected. This can be accomplished by following the procedures published in CAP or approved for company use. If a pilot who is operating in controlled airspace anticipates being unable to conduct the approach as published, the pilot should inform ATC so that separation from other aircraft concerned can be increased as necessary.

6.5 VISUAL SEPARATION

6.5.1 General

Visual separation is a means of separating IFR aircraft using visual observation and is performed by an airport controller or by a pilot, when a pilot is assigned responsibility for separation. Visual separation may be applied in a CZ or TCA at 12 500 ft ASL and below.

6.5.2 Speed Control Instructions on Departure

Visual departure separation procedures require airport controllers to consider aircraft performance, wake turbulence, closure rate, routes of flight and known weather conditions. Airport controllers do not issue speed control instructions coincident with takeoff clearances. In addition, there is no increase in the incidence of speed control instructions issued by the departure controller.

6.5.3 Controller-Applied Visual Separation

The airport controller ensures separation through visual observation of the aircraft involved. This type of visual separation cannot be applied if departure routes or aircraft performance preclude maintaining separation. ATC does not use visual separation between successive departing IFR aircraft if wake turbulence separation is required. Controller-applied visual separation is normally seamless to pilots.

6.5.4 Pilot-Applied Visual Separation

Pilot-applied visual departure separation procedures require a pilot to see the other aircraft involved and, upon instructions from the controller, maintain visual separation from the other aircraft.

Pilots who accept responsibility for visual separation must maintain constant visual contact, without referring to an airborne surveillance system, with the other aircraft involved until visual separation is discontinued. This responsibility does not eliminate the pilot's regulatory responsibility to see and avoid other aircraft; meet noise abatement requirements; or meet obstacle clearance requirements and is not intended to restrict pilots from completing other necessary tasks.

ATC does not use pilot-applied visual separation between successive departing IFR aircraft if wake turbulence separation

is required. If, for any reason, the pilot refuses pilot-applied visual separation, ATC will separate departures using another form of IFR separation.

Example phraseology for pilot-applied visual departure separation:

Tower: AIRLINE ONE TWO THREE, TRAFFIC [position, type of aircraft, intentions, etc.] CONFIRM TRAFFIC IN SIGHT?

Pilot: AIRLINE ONE TWO THREE, TRAFFIC IN SIGHT.

Tower: AIRLINE ONE TWO THREE, MAINTAIN VISUAL SEPARATION [other information or instructions, as required] CLEARED FOR TAKE-OFF.

Pilot: AIRLINE ONE TWO THREE, MAINTAINING VISUAL SEPARATION [read back additional instructions, as appropriate].

Visual separation is discontinued when either aircraft is observed on a diverging heading, unless otherwise advised by ATC.

Pilots must notify ATC as soon as possible if:

- a) they anticipate losing sight of the other aircraft;
- b) course deviations are required to maintain visual separation with preceding traffic; or
- c) they suspect they will be unable to maintain visual separation for any reason.

In these cases, another form of IFR separation will be applied by ATC.

6.6 DEVELOPMENT OF INSTRUMENT PROCEDURES

Instrument procedure development worldwide follows one of two existing standards: *ICAO Procedures for Air Navigation Services—Aircraft Operations*, Volume II—*Construction of Visual and Instrument Flight Procedures* (Doc 8168); or the *United States Standard for Terminal Instrument Procedures* (TERPS). Instrument procedures in CDA are developed in accordance with a document entitled *Criteria for the Development of Instrument Procedures* (TP 308). This document is a joint TC/DND publication and prescribes standardized methods for use in designing both civil and military instrument flight procedures.

In order to achieve ICAO regional commonality, the instrument procedure design standards and criteria contained in TP 308 are modeled after the standards and criteria contained in the TERPS.

Strict adherence by pilots to the published instrument procedures will ensure an acceptable level of safety in flight operations.

7.0 INSTRUMENT FLIGHT RULES – DEPARTURE PROCEDURES

7.1 AERODROME OPERATIONS

Pilots should read the sub-sections above, in conjunction with the IFR departure procedures listed in this section.

7.2 AUTOMATIC TERMINAL INFORMATION SERVICE (ATIS) BROADCASTS

If available, the basic aerodrome information should be obtained from ATIS prior to requesting taxi clearance.

7.3 INITIAL CONTACT

On initial contact with ATC (clearance delivery or ground control), a pilot departing IFR should state the destination and planned initial cruising altitude.

7.4 INSTRUMENT FLIGHT RULES (IFR) CLEARANCES

At locations where a “Clearance Delivery” frequency is listed, pilots should obtain their IFR clearance on this frequency prior to contacting ground control. Where no clearance delivery frequency is listed, the IFR clearance will normally be relayed by ground control after taxi authorization has been issued. However, due to high fuel consumption during ground running time, some pilots of turbojet aircraft may wish to obtain their IFR clearance prior to starting engines. Pilots using this procedure should call ATC, using a phrase such as READY TO START NOW or READY TO START AT (TIME). Normally this request should be made within 5 minutes of the planned engine start time.

7.5 STANDARD INSTRUMENT DEPARTURE (SID)

At certain airports, an instrument flight rules (IFR) departure clearance may include departure instructions known as a standard instrument departure (SID). A SID is a planned IFR air traffic control (ATC) departure procedure, published in the *Canada Air Pilot* (CAP), for pilot and controller use in graphic and textual form. SIDs provide a transition from the terminal to the appropriate en route structure, and may be either:

- a) *pilot navigation SIDs*—established where the pilot is required to use the chart as reference for navigation to the en route phase; or
- b) *vector SIDs*—established where ATC will provide radar navigational guidance to a filed/assigned route or to a fix depicted on the chart. Pilots are expected to use the SID chart as reference for navigation until radar vectoring has commenced.

SIDs incorporate obstacle and terrain clearance within the procedure. Pilots should note, however, that SIDs for military aerodromes that are only available in textual form do not incorporate obstacle and terrain clearance. At these aerodromes, it is the pilot's responsibility to ensure appropriate obstacle and terrain clearance on departure.

Pilots of aircraft operating at airports for which SIDs have been published will normally be issued a SID clearance by ATC. No pilot is required to accept a SID clearance. If any doubt exists as to the meaning of such a clearance, the pilot should request a detailed clearance.

Routings contained in SIDs will normally be composed of two segments:

- a) an initial segment from the departure end of the runway to the position where the aircraft will first turn from the initial departure heading; and
- b) a second segment, either via radar vectors or by pilot navigation, from the first turning point to the SID termination point.

When instructed to fly on the runway heading, or when flying a SID for which no specific heading is published, pilots are expected to fly or maintain the heading that corresponds with the extended centreline of the departure runway until otherwise instructed by ATC. Drift correction must not be applied, e.g. Runway 04, if the actual magnetic heading of the runway centreline is 044°, then fly a heading of 044°M.

When flying a SID for which a specific heading is published, the pilot is expected to steer the published SID heading until radar vectoring commences. This is because initial separation is based on divergence between assigned headings until radar separation is established.

When assigning SIDs, ATC will include the following:

- a) the name of SID;
- b) the SID termination fix, if appropriate;
- c) the transition, if necessary; and
- d) the time or location for the aircraft to expect a climb to an operationally suitable altitude or flight level, if necessary. (**NOTE:** An "expect further clearance" statement may be included in the SID chart.)

Example:

CLEARED TO THE CALGARY AIRPORT, TORONTO ONE DEPARTURE, FLIGHT PLANNED ROUTE.

NOTE:

A SID termination fix may be a NAVAID, intersection, or DME and is normally located on an established airway where the SID terminates and the en route phase of flight commences. The SID, as published, contains an altitude to climb to after departure; however, ATC may assign an altitude different from the altitude specified in the SID, provided the altitude is stated and a readback is obtained from the pilot prior to departure. In addition, where vector SIDs are used, ATC may assign a different initial departure heading. However, an ATC revision to any item of a SID does not cancel the SID.

Example:

CLEARED TO THE CALGARY AIRPORT, TORONTO ONE DEPARTURE, FLIGHT PLANNED ROUTE, CLIMB TO AMENDED ALTITUDE, SEVEN THOUSAND...

If an aircraft is issued a vector SID, radar vectors will be used, as traffic permits, to provide navigational guidance to the filed/assigned route and over the SID termination fix. However, if the controller or the aircraft will gain an operational advantage, the aircraft may be vectored on a route that will not take the aircraft over the SID termination fix.

In this case, if ATC had previously specified a SID termination fix as the location for the aircraft to expect to climb to an operationally suitable altitude or flight level, the controller shall cancel the SID. If, with the change of clearance, it is not practicable for the controller to assign an operationally suitable altitude or flight level, the controller will specify another location or time to expect the higher altitude.

Example:

SID CANCELLED, VECTORS TO (fix or airway) (heading). EXPECT FLIGHT LEVEL THREE FIVE ZERO AT FOUR FIVE D-M-E WEST OF EDMONTON VORTAC.

It is impossible to precisely define "operationally suitable altitudes" to meet requirements in all circumstances.

The following are considered operationally suitable altitudes or flight levels:

- a) *piston aircraft*—flight planned altitude or lower; and
- b) *other aircraft*—flight planned altitude or altitude as near as possible to the flight planned altitude, taking into consideration the aircraft's route of flight. As a guideline, an altitude not more than 4 000 ft below the flight planned flight level in the high-level structure will be considered as operationally suitable in most cases.

If it is not practicable for the controller to assign the flight planned altitude and if the pilot has not been informed as to when they

may expect a clearance to another altitude, it is the pilot's responsibility to advise ATC if the currently assigned altitude is not satisfactory to permit the aircraft to proceed to the destination airport, should a communications failure occur.

The controller will then be required to issue an appropriate "expect further clearance" statement or issue alternative instructions.

Controllers are required to issue a clearance to the altitude or flight level the pilot was told to expect prior to the time or location specified in an "expect further clearance" statement. The pilot must ensure that further clearance is received because the "altitude to be expected" included in the clearance is not applicable:

- a) once the aircraft has proceeded beyond the fix specified in the "expect further clearance" statement; or
- b) once the time designated in the "expect further clearance" statement has expired.

SIDs may include specific communications failure procedures. These specific procedures supersede the standard communication failure procedures.

SIDs, as published, will not contravene noise abatement procedures. ATC-assigned vectors will not normally contravene noise abatement procedures; however, for flight safety reasons, ATC may be required to issue a vector contrary to noise abatement requirements.

ATC-assigned vectors shall be followed in a timely manner even if they conflict with the published noise abatement procedures.

The initial call to departure control should contain at least:

- a) the aircraft call sign;
- b) the departure runway;
- c) the present vacating altitude (to the nearest 100-ft increment); and
- d) the assigned (SID) altitude.

Example:

*OTTAWA DEPARTURE, BEECH GOLF ALFA BRAVO TANGO,
OFF RUNWAY 25, HEADING 250, LEAVING 1 900 FOR
4 000.*

NOTE:

An altitude readout is valid if the readout value does not differ from the aircraft reported altitude by more than 200 ft. Pilot altitude reports should be made to the nearest 100-ft increment.

7.6 NOISE ABATEMENT PROCEDURES — DEPARTURE

7.6.1 General

These aeroplane operating procedures for the takeoff and climb have been developed so as to ensure that the necessary safety of flight operations is maintained whilst minimizing exposure to noise on the ground. One of the two procedures listed in the sub-sections below should be applied routinely for all takeoffs where noise abatement procedures are in effect.

Nothing in these procedures shall prevent the pilot-in-command from exercising his/ her authority for the safe operation of the aeroplane, except that when a climb gradient is published, it must be maintained, or alternate procedures must be adopted.

The procedures herein describe the methods for noise abatement when a noise problem is evident. They can comprise any one or more of the following:

- a) use of noise preferential runways to direct the initial and final flight paths of aeroplanes away from noise-sensitive areas;
- b) use of noise preferential routes to assist aeroplanes in avoiding noise-sensitive areas on departure and arrival, including the use of turns to direct aeroplanes away from noise-sensitive areas located under or adjacent to the usual takeoff and approach flight paths; and
- c) use of noise abatement takeoff or approach procedures, designed to minimize the overall exposure to noise on the ground and, at the same time, maintain the required levels of flight safety.

7.6.2 Noise Preferential Runways

Preferred runway directions for takeoff are designated for noise abatement purposes; the objective being to use, whenever possible, those runways that permit aeroplanes to avoid noise-sensitive areas during the initial departure and final approach phases of flight.

Noise abatement is not the determining factor in runway designation under the following circumstances:

- a) if the runway is not clear and dry, i.e. it is adversely affected by snow, slush, ice, water, mud, rubber, oil or other substances;
- b) when the crosswind component, including gusts, exceeds 25 KIAS; and
- c) when the tail wind component, including gusts, exceeds 5 kt.

NOTE:

Although ATS personnel may select a preferential runway in accordance with the foregoing criteria, pilots are not obligated to accept the runway for taking off or landing. It remains the pilot's responsibility to decide if the assigned runway is

operationally acceptable.

7.6.3 Noise Abatement Departure Procedures (NADP)

NADP are designed to minimize the environmental impact of departing aircraft without compromising safety. Typically, operators require two procedures: one to minimize close-in noise (NADP1), the other to minimize noise over a more distant noise-sensitive area (NADP2).

Under the NADP concept, airport operators identify their noise and emission control needs and may identify specific noise-sensitive areas. Aircraft operators choose the departure method that safely meets the airport operator's objectives.

When deciding on a noise abatement strategy, it is important to keep in mind that each procedure minimizes noise in its target area at the expense of relatively increased noise elsewhere. NADP1 reduces noise immediately after takeoff, but results in higher downrange noise than NADP2, and vice versa. For each aircraft type, powerplant and set of takeoff conditions, there is a distance at which the NADP1 and NADP2 noise contours cross over. The area from the takeoff to the crossover point defines the 'close-in' zone of NADP1, while the area beyond the crossover point is the effective range of NADP2.

When developing a noise abatement strategy, airports and air operators should consider the following:

- a noise abatement departure shall not invalidate an engine failure strategy;
- aircraft limitations, including maximum body angle limits, shall be respected at all times;
- where possible, each aircraft type should base its standard departure procedure on the noise abatement strategy that minimizes its overall noise impact;
- operators serving certain noise-sensitive airports may need to follow specific, non-standard departure procedures. Crew training and departure information shall address identification and procedural differences associated with alternate noise abatement procedures; and
- where applicable, air traffic control agencies should be involved in the development of noise abatement procedures, especially regarding take-off flight path in the event of an engine failure.
- In addition to the above general requirements, the following operational limitations apply: NADPs requiring reduced take-off thrust settings may only be flown when reduced thrust is permitted by the aircraft flight manual or aircraft operating manual;

- noise abatement procedures shall not be executed below 800 ft AAE;
- noise abatement procedures are not to be used when wind shear warnings exist, or the presence of wind shear or downburst activity is suspected; and
- conduct of noise abatement procedures is secondary to the satisfaction of obstacle requirements.

NADPs start at or above 800 ft and initiate the final stage at or below 3 000 ft AAE, allowing operators to develop specific procedures to suit their local situations.

Operators transitioning from VNAP to NADP will note that the NADP1 envelope includes the former VNAP A procedure, while NADP2 includes the former VNAP B procedure.

To illustrate the NADP concept, two examples of compliant procedures appear below. Operators are free to design other procedures that fit within the NADP envelopes.

NADP 1 (criteria for a close-in noise abatement procedure):

This procedure involves a power reduction at or above the prescribed minimum altitude (no less than 800 ft) AAE and delaying flap/slat retraction until the prescribed maximum altitude (3 000 ft) AAE is attained. At the prescribed maximum altitude, accelerate and retract flaps/slats on schedule, while maintaining a positive rate of climb, and complete the transition to normal en-route climb speed. The initial climbing speed to the noise abatement initiation point is no less than $V_2 + 10$ KIAS.

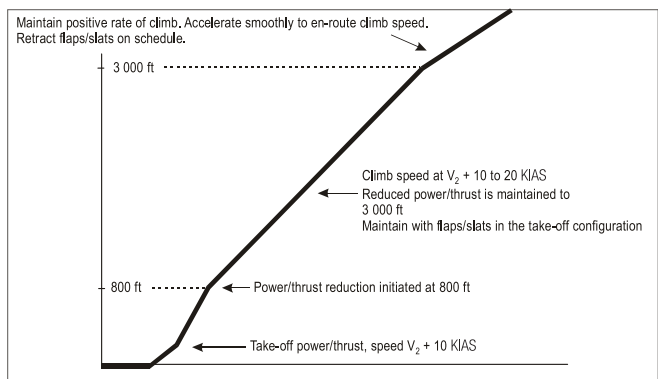
Specific example of NADP 1:

- Initial climb to 800 ft AAE with take-off thrust and $V_2 + 10$ to 20 KIAS.
- Upon reaching an altitude of 800 ft AAE, adjust and maintain engine thrust in accordance with the noise abatement thrust schedule provided in the aircraft operating manual. Maintain a climb speed of $V_2 + 10$ to 20 KIAS with flaps and slats in the take-off configuration.
- At 3 000 ft AAE, while maintaining a positive rate of climb, accelerate and retract flaps/slats on schedule.
- At 3 000 ft AAE, accelerate to normal en-route climb speed.

NOTE:

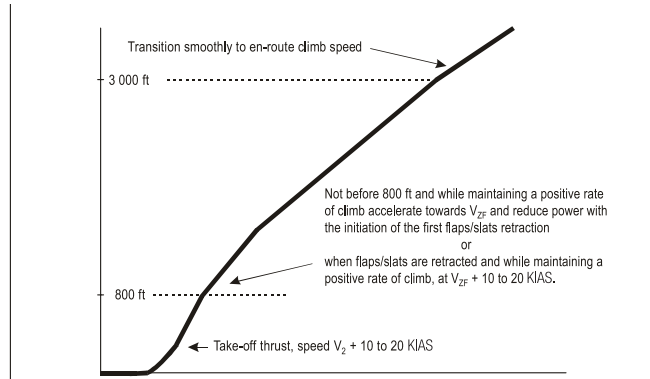
To assist in planning departure spacing, pilots intending to use NADP 1 at Canadian airports are to notify ATC Clearance Delivery or Ground Control. At airports where NADP 1 is the only procedure to follow, ATC does not need to be notified.

Figure 7.1—Noise Abatement Departure Procedures (NADP 1)



Noise abatement take-off climb — Example of a procedure alleviating noise close to the aerodrome (NADP 1)

Figure 7.2—Noise Abatement Departure Procedures (NADP 2)



Noise abatement take-off climb — Example of a procedure alleviating noise distant from the aerodrome (NADP 2)

NADP 2 (criteria for distant noise abatement procedure):

This procedure involves the initiation of flap/slat retraction at or above the prescribed minimum altitude (800 ft) AAE but before reaching the prescribed maximum altitude (3 000 ft) AAE. The flaps/slats are to be retracted on schedule, while maintaining a positive rate of climb. The thrust reduction is to be performed with the initiation of the first flaps/slats retraction or when the zero flaps/slats configuration is attained. At the prescribed maximum altitude, complete the transition to normal en-route climb procedures. The initial climbing speed to the noise abatement initiation point is no less than $V_2 + 10$ KIAS and the noise abatement procedure is not to be initiated at less than 800 ft AAE.

Specific example of NADP 2:

- Initial climb to 800 ft AAE with take-off thrust and $V_2 + 10$ to 20 KIAS.
- Upon reaching an altitude equivalent to 800 ft AAE, decrease aircraft body angle while maintaining a positive rate of climb, accelerate towards V_{ZF} speed and reduce thrust after flaps/slats retraction.
- Maintain a positive rate of climb and accelerate to and maintain a climb speed of $V_{ZF} + 10$ to 20 KIAS until 3 000 ft AAE.
- At 3000 ft AAE, accelerate to normal en-route climb speed.

The use of this guidance material should be limited to acquiring general insight into NADPs. In applying this guidance, users should seek expert noise and emissions advice.

7.7 OBSTACLE AND TERRAIN CLEARANCE

Aerodromes that have an instrument approach procedure (IAP) published in the *Canada Air Pilot* (CAP) also have an instrument flight rules (IFR) departure procedure.

There are two types of IFR departure procedures: the standard instrument departure (SID) and the obstacle departure procedure (ODP). SIDs are developed to establish a traffic flow (see RAC 7.5) while ODPs are pilot initiated. Both types meet obstacle and terrain clearance requirements.

IFR departure procedures are expressed in the form of take-off minima on an aerodrome chart. These procedures are based on the premise that, on departure, an aircraft will

- a) cross at least 35 ft above the departure end of the runway;
- b) climb straight ahead to 400 ft above aerodrome elevation (AAE) before turning; and
- c) maintain a climb gradient of at least 200 ft/NM throughout the climb to a minimum IFR altitude for en route operations.

Climb gradients greater than 200 ft/NM may be published. In this case, the aircraft is expected to achieve and maintain the published gradient to the specified altitude or fix, then continue climbing at a minimum of 200 ft/NM until reaching a minimum IFR altitude for en route operations.

For flight planning purposes, IFR departure procedures assume normal aircraft performance in all cases.

ODPs in the take-off minima box are shown as either:

- a) 1/2—This indicates that IFR departures from the specified runway(s) will be assured of obstacle and terrain clearance in any direction, if the aircraft meets the previously stated departure premise. Pilots may consider this procedure as “takeoff, climb on course.” The minimum visibility (unless otherwise approved by the appropriate authority) for takeoff

RAC

in these circumstances is 1/2 SM. IFR takeoffs for rotorcraft are permitted when the take-off visibility is reduced to half the CAP value, but no less than 1/4 SM.

- b) *(asterisk)*—The asterisk (*) following all or specific runways refers the pilot to the applicable minimum take-off visibility (1/2 or SPEC VIS) and the corresponding procedures which, if followed, will ensure obstacle and terrain clearance. Procedures may include specific climb gradients, routings, visual climb requirements, locations of close-in obstacles (see RAC 7.7.2), or combinations thereof. Where a visual climb is stated in the departure procedure, pilots are expected to comply with the specified takeoff minimum visibility (SPEC VIS) corresponding to the appropriate aircraft category listed in the following table:

Table 7.1—Aircraft Categories and the Associated SPEC VIS

Aircraft Category	A	B	C	D
SPEC VIS in SM	1	1 1/2	2	2

NOTE

No reductions in SPEC VIS are permitted for rotorcraft. For further information on SPEC VIS, see RAC 7.7.1.

- (c) *NOT ASSESSED*—IFR departures have not been assessed for obstacles. Pilots-in-command (PICs) are responsible for determining minimum climb gradients and/or routings for obstacle and terrain avoidance.

In the absence of a published visibility for a particular runway, a pilot may depart IFR only if take-off visibility will allow avoidance of obstacles and terrain on departure. In no case should the take-off visibility be less than 1/2 SM (1/4 SM for rotorcraft).

Where aircraft limitations or other factors preclude the pilot from following the published procedure, it is the PIC’s responsibility to determine alternative procedures that take into account obstacle and terrain avoidance.

Air traffic control (ATC) terms such as “on departure, right turn climb on course” or “on departure, left turn on course” are not to be considered specific departure instructions. It remains the pilot’s responsibility to ensure that terrain and obstacle clearance has been achieved by conforming to the IFR departure procedures.

7.7.1 Visual Climb Over The Airport (VCOA)

VCOA—sometimes referred to as “climb visual” or “visual climb” in the CAP—was developed to provide an alternate IFR departure procedure for aircraft that cannot meet the greater-than-standard climb gradient specified in the primary instrument departure procedure.

NOTE:

Occasionally, VCOA may be the only available departure procedure developed for an aerodrome.

VCOA differs from other instrument departure procedures in that the pilot must maintain certain visual references with the ground and obstacles until reaching a given altitude over the aerodrome.

NOTE:

Even though the aircraft is being operated with visual references to the ground, it is still departing on an IFR clearance.

The VCOA text includes a SPEC VIS and a climb-to altitude in feet above sea level. The SPEC VIS is the minimum visibility in statute miles that a pilot requires to manoeuvre the aircraft while climbing. The climb-to altitude is the minimum altitude above the aerodrome that the aircraft must reach before departing en route.

It is the pilot’s responsibility to see and avoid obstacles while climbing visually. The pilot should be familiar with the local terrain and the obstacles that surround the aerodrome and plan the climb appropriately. Taking local traffic and obstacles into consideration, it is advisable that the pilot keep the aerodrome in sight while climbing. The visual climb segment ends when the aircraft crosses the aerodrome at or above the required minimum altitude. From this point on, obstacles will be cleared if the aircraft maintains a minimum climb gradient of 200 ft/NM to the en-route structure.

The PIC should ensure that the reported ceiling is above the climb-to altitude and that the local prevailing visibility is equal to or greater than that required in the procedure. Additionally, before taxiing for departure, the PIC should inform ATC of the intention to perform a VCOA so that the appropriate coordination can be ensured. If ATC services are not available, then intentions should be broadcast on the ATF (see RAC 7.9).

7.7.2 Low, Close-in Obstacles

Obstacles that penetrate the standard OCS require the publication of a climb gradient. However, certain close-in obstacles may be exempt from this requirement. Instead, a note is published on the departure procedure and/or on the aerodrome chart. The note alerts the pilot to the nature of the close-in obstacle and gives its height and location so that it may be avoided. An obstacle is determined to be “close-in” if it is within 1 NM of the departure end of the runway, or within 1 NM from the end of the clearway, if a clearway exists. Either way, the charted distance to the obstacle will be noted as being from the departure end of the runway.

If the obstacle(s) cannot be visually acquired during departure, pre-flight planning should take into account the turns or other manoeuvres that may be necessary immediately after takeoff to avoid the obstacle(s). These obstacles are especially critical to aircraft that do not lift off until close to the departure end of the runway or that climb at the minimum rate.

7.8 RELEASE FROM TOWER FREQUENCY

If the departure airport is located within a terminal control area, the departing IFR flight will be cleared by the tower to contact a specific control unit on a specified frequency once clear of conflicting airport traffic. At certain locations, flights will be advised prior to takeoff to change to a specified departure frequency. In this case, the change should be made as soon as practicable after takeoff.

If the departure airport is not located within a terminal control area, the pilot, when requesting release from tower frequency, should advise the tower of the agency or frequency to which he/she will change unless directions for the change were included in the ATC clearance.

7.9 INSTRUMENT FLIGHT RULES (IFR) DEPARTURES FROM UNCONTROLLED AIRPORTS

Where a pilot-in-command intends to take off from an uncontrolled aerodrome, the pilot shall:

- a) obtain an ATC clearance if in controlled airspace;
- b) report their departure procedure and intentions on the appropriate frequency before moving on to the runway or before aligning the aircraft on the take off path; and
- c) ascertain by radio on the appropriate frequency and by visual observation that no other aircraft or vehicle is likely to come into conflict with the aircraft during takeoff.

The pilot-in-command shall maintain a listening watch:

- a) during takeoff from an uncontrolled aerodrome; and
- b) after takeoff from an uncontrolled aerodrome for which a MF has been designated, until the aircraft is beyond the distance or above the altitude associated with that frequency.

As soon as possible after reaching the distance or altitude associated with the MF, the pilot-in-command shall communicate with the appropriate ATC unit or a ground station on the appropriate en-route frequency.

Where IFR departures are required to contact an IFR control unit or ground station after takeoff, it is recommended that, if the aircraft is equipped with two radios, the pilot should also monitor the MF during the departure.

If the aerodrome is located in uncontrolled airspace, these procedures shall be followed except that an ATC clearance is not required. In addition to maintaining a listening watch, it is recommended that the pilot-in-command communicate with the appropriate ATC unit, FIC, or other ground station on the appropriate en-route frequency.

NOTE:

It is recommended that pilots inform ATC if a flight will not commence within 60 min of the proposed departure time stipulated in an IFR flight plan. Failure to do so will result in activating the SAR process.

At an uncontrolled aerodrome, the initial IFR clearance may contain a time or an event-based departure restriction or clearance cancellation.

Examples:

ATC CLEARS AIRLINE123 (IFR clearance) DO NOT DEPART UNTIL 1340; CLEARANCE CANCELLED IF NOT AIRBORNE BEFORE 1349.

or

ATC CLEARS AIRLINE123 (IFR clearance) DO NOT DEPART UNTIL CESSNA ABC HAS LANDED; CLEARANCE CANCELLED IF NOT AIRBORNE BEFORE 1349.

In the first example, the clearance is valid the moment the time turns 1340, and in both examples, the clearance is cancelled the moment the time turns 1349.

7.10 ALERTING SERVICE INSTRUMENT FLIGHT RULES (IFR) DEPARTURES FROM UNCONTROLLED AIRPORTS

At locations where communication with ATS is difficult, pilots may elect to depart VFR and obtain their IFR clearance once airborne. In Canada, if IFR clearance is not received prior to departure, SAR alerting service is activated based on the ETD filed in the flight plan. However, if departing from a Canadian airport that underlies airspace delegated to FAA control, then responsibility for SAR alerting service is transferred to the FAA and FAA procedures apply. In such cases, alerting service is not activated until the aircraft contacts ATS for IFR clearance. Therefore, if the aircraft departs before obtaining its IFR clearance, alerting service is not provided until contact is established with ATS.

8.0 INSTRUMENT FLIGHT RULES (IFR) – EN ROUTE PROCEDURES

8.1 POSITION REPORTS

Pilots of instrument flight rules (IFR) and controlled VFR (CVFR) flights are required to make position reports over compulsory reporting points specified on IFR charts, and over any other reporting points specified by air traffic control (ATC).

As specified in *Canadian Aviation Regulation (CAR) 602.125*, the position report shall include the information in the sequence set out on page C2 of the *Canada Flight Supplement (CFS)*, that is:

- a) the identification;
- b) the position;
- c) the time over the reporting point in coordinated universal time (UTC);
- d) the altitude or flight level;
- e) the type of flight plan or flight itinerary filed;
- f) the name of the next designated reporting point and estimated time of arrival (ETA) over that point in UTC;
- g) the name only of the next reporting point along the route of flight (see NOTE); and
- h) any additional information requested by ATC or deemed necessary by the pilot.

NOTE:

Reporting points are indicated by a symbol on the appropriate charts. The “designated compulsory” reporting point is a solid triangle and the “on request” reporting point symbol is an open triangle. Position reports over an “on request” reporting point are only necessary when requested by ATC. Therefore, no mention of an “on request” reporting point needs to be made in any position report unless it has been requested by ATC.

En route IFR and CVFR flights should establish direct controller-pilot communications (DCPC) wherever possible. Peripheral stations (PAL) have been established at a number of locations to extend the communications coverage. Some PAL locations also employ a radio re-transmit unit (RRTU). The purpose of the RRTU is to transmit a pilot’s broadcast from one PAL location over another frequency at a different PAL location. This allows the pilot to know when the controller is working communications traffic on a different PAL frequency. Controllers at an area control centre (ACC) can disable this equipment when necessary due to the communications workload. However, it must be remembered that, while DCPC provides direct contact with the IFR unit at locations where there is no VFR control and aerodrome advisory service (AAS) or remote aerodrome advisory service (RAAS) is provided, pilots must also communicate with the flight service station (FSS) or flight information centre (FIC) for local traffic information. Whenever DCPC cannot be established, or whenever ATC has instructed a pilot to contact a FIC, position reports shall be made through the assigned FIC or the nearest communications agency en route.

When the pilot-in-command of an IFR aircraft is informed that the aircraft has been IDENTIFIED, position reports over compulsory reporting points are no longer required. Pilots will

be informed when to resume normal position reporting.

In order that flight information and alerting service may be provided to all IFR flights outside controlled airspace, pilots should make position reports over all navigation aids (NAVAID) along the route of flight to the nearest station with air-ground communications capability.

If the time estimate for the next applicable reporting point differs from the previously reported estimate by 3 min or more, a revised estimated time should be reported to the appropriate air traffic service (ATS) unit as soon as possible.

8.2 MACH NUMBER/TRUE AIRSPEED—CLEARANCES AND REPORTS

8.2.1 Mach Number

Clearances to turbojet aircraft equipped with a Machmeter may include an appropriate Mach number. If the Mach number cannot be adhered to, ATC is to be so informed when the clearance is issued. Once accepted, the Mach number shall be adhered to within .01 Mach, unless ATC approval is obtained to make a change. If an immediate temporary change in Mach number is necessary (e.g. because of turbulence), ATC must be notified as soon as possible. When a Mach number is included in a clearance, the flight concerned should transmit its current Mach number with each position report.

8.2.2 True Airspeed (TAS)

ATC is to be notified as soon as practicable of an intended change to the TAS at the cruising altitude or flight level, where the change intended is five percent or more of the TAS specified in the IFR flight plan or flight itinerary.

8.3 ALTITUDE REPORTS

Although the CARs do not specifically direct pilots to report altitude information to ATC, pilots, if not operating in radar airspace (i.e. radar-identified by ATC), should report reaching the altitude to which the flight has been initially cleared. When climbing or descending en route, pilots should report when leaving a previously-assigned altitude and when reaching the assigned altitude.

On initial contact with ATC, or when changing from one ATC frequency to another, when operating in radar or non-radar airspace, pilots of IFR and CVFR flights should state the assigned cruising altitude and, when applicable, the altitude through which the aircraft is climbing or descending.

In order for ATC to use Mode C altitude information for separation purposes, the aircraft Mode C altitude readout must be verified. The Mode C altitude is considered valid if the readout value does not differ from the aircraft reported altitude by more than

200 ft. The readout is considered invalid if the difference is 300 ft or more. Therefore, it is expected that pilot altitude reports, especially during climbs and descents, will be made to the nearest 100-ft increment.

Example:

EDMONTON CENTRE, AIR CANADA EIGHT ZERO ONE HEAVY, LEAVING EIGHT THOUSAND THREE HUNDRED FEET, CLIMBING TO FLIGHT LEVEL THREE FIVE ZERO.

If the phrase “report reaching”, “report leaving” or “report passing” is used by ATC, the pilot shall comply (CAR 602.31—*Compliance with Air Traffic Control Instructions and Clearances*).

8.4 CLIMB OR DESCENT

8.4.1 General

During any phase of flight, pilots should adhere to the following procedures:

- a) When an altitude clearance is issued, the pilot should begin the climb or descent promptly on acknowledgement of the clearance. The climb or descent should be made at an optimum rate consistent with the operating characteristics of the aircraft. If the above is not the case, or if it becomes necessary to stop the climb or descent, the pilot should advise ATC of the interruption or the delay in vacating an altitude.
- b) If the phrase “when ready” is used in conjunction with an altitude clearance or instruction, the change of altitude may be initiated whenever the pilot wishes. The climb or descent should be made at an optimum rate consistent with the operating characteristics of the aircraft. When not informed that the aircraft has been IDENTIFIED, pilots are expected to advise ATC when the altitude change is initiated. Compliance with assigned or published altitude crossing restrictions and speeds is mandatory (CAR 602.31), unless specifically cancelled by ATC. (MEAs are not considered restrictions; however, pilots are expected to remain at or above MEAs.)

NOTE:

When an aircraft reports vacating an altitude, ATC may assign the altitude to another aircraft. Control will be based on the pilot following these procedures and on the normal operating characteristics of the aircraft.

- c) If a descending aircraft must level off at 10 000 ft ASL to comply with CAR 602.32 while cleared to a lower level, the pilot should advise ATC of the descent interruption.
- d) ATC may authorize aircraft to employ cruise climb techniques either between two levels or above a specified level. A clearance or instruction to cruise climb authorizes climb at any given rate as well as temporarily levelling at intermediate

altitudes. Pilots are expected to advise ATC of the altitude they temporarily level off at to the nearest 100 ft. Once the aircraft has vacated an altitude during a cruise climb, it may not return to that altitude. ATC will use the following phraseology:

CRUISE CLIMB TO (altitude)

or

CLIMB TO (altitude) CRUISE CLIMB BETWEEN (levels) (or ABOVE [level])

8.4.2 Visual Climb and Descent

8.4.2.1 General

Application of visual climbs and descents in VMC, under certain circumstances, provides both controllers and pilots with an operational advantage in the conduct of safe and orderly flow of air traffic.

8.4.2.2 Visual Separation from Other Aircraft

ATC may authorize the pilot of an IFR aircraft to conduct a visual climb or descent while maintaining visual separation with the appropriate traffic only if a pilot requests it. Controllers will not initiate or suggest a visual climb/descent in this application. During this altitude change in VMC, pilots must provide their own separation, including wake turbulence separation, from all other aircraft. This application may be exercised in both radar and non-radar environments.

IFR separation is required for all altitude changes in Class A and B airspace. Accordingly, visual climbs or descents will not be approved for aircraft operating in these classes of airspace.

8.5 MINIMUM INSTRUMENT FLIGHT RULES (IFR) ALTITUDES

Except when taking off or landing, aircraft in IFR flight shall be operated at least 1 000 ft above the highest obstacle within a horizontal radius of 5 NM of the aircraft (CAR 602.124). Exceptions to this are flights within designated mountainous regions, but outside areas for which minimum altitudes for IFR operations have been established (see RAC 2.12 and RAC Figure 2.10).

NOTE:

The established MOCA for IFR operations provides obstacle clearance above the highest obstacle within the following areas:

- a) 1 000 ft:
 - (i) airways and air routes outside of designated mountainous areas;
 - (ii) certain airway and air route segments within designated mountainous areas, which are used in the arrival or departure phase of flight;

- (iii) Safe Altitude 100 NM outside of designated mountainous areas; all MSA;
 - (iv) instrument approach transitions (including DME arcs);
 - (v) radar vectoring areas [except as in (c)(iii)]; and
 - (vi) AMA outside of designated mountainous areas as shown on the Enroute and Terminal Area Charts.
- b) 1 500 ft:
- (i) airways and air routes within designated mountainous areas 2, 3, and 4; or
 - (ii) Safe Altitude 100 NM within designated mountainous areas 2, 3, and 4.
- c) 2 000 ft:
- (i) airways and air routes within designated mountainous areas 1 and 5 with the exception of those segments described in (a)(ii);
 - (ii) Safe Altitude 100 NM within designated mountainous areas 1 and 5;
 - (iii) certain radar vectoring areas within designated mountainous areas; and
 - (iv) AMA within designated mountainous areas as shown on the Enroute and Terminal Area Charts.

MEAs have been established for all designated low-level airways and air routes in Canada. An MEA is defined as the published altitude ASL between specified fixes on airways or air routes, which assures acceptable navigational signal coverage, and which meets IFR obstacle clearance requirements.

The minimum flight plan altitude shall be the nearest altitude or flight level consistent with the direction of flight (CAR 602.34). This altitude should be at or above the MEA. Unless the MEA is one which is consistent with the direction of flight, it is not to be used in the flight plan or flight itinerary.

As different MEAs may be established for adjoining segments of airways or air routes, aircraft are, in all cases, to cross the specified fix at which a change in the MEA takes place, at the higher MEA.

To ensure adequate signal coverage, many of the MEAs on low-level airways are established at altitudes which are higher than those required for obstacle clearance. When this occurs, a MOCA is also published to provide the pilot with the minimum IFR altitude for obstacle clearance. A MOCA is defined as the altitude between radio fixes on low-level airways and air routes, which meets the IFR Air routes clearance requirements for the route segment. Where the MOCA is lower than the MEA, the MOCA is published in addition to the MEA on the Enroute Charts. Where the MEA and MOCA are the same, only the MEA is published.

The MOCA, or the MEA when the MOCA is not published, is the lowest altitude for the airway or air route segment at which an IFR flight may be conducted under any circumstances. These altitudes are provided so that pilots will be readily aware of the

lowest safe altitude that may be used in an emergency, such as a malfunctioning engine or icing conditions. Under ISA conditions, they provide a minimum of 1 000 ft of clearance above all obstacles lying within the lateral limits of all airways and air routes and 1500/2000 ft in designated mountainous regions.

Pressure altimeters are calibrated to indicate true altitude under ISA conditions, and any deviation from ISA will result in an erroneous altimeter reading. When temperatures are extremely cold, true altitudes will be significantly lower than indicated altitudes. Although pilots may fly IFR at the published MEA/MOCA, in the winter, when air temperatures are much lower than ISA, they should operate at altitudes of at least 1 000 ft above the MEA/MOCA.

NOTE:

When flying at a flight level in an area of low pressure, the true altitude will always be lower than the corresponding flight level. For example, this “pressure error,” in combination with a temperature error, can produce errors of up to 2 000 ft while flying in the standard pressure region at FL 100. Further, mountain waves in combination with extremely low temperatures may result in an altimeter over-reading by as much as 3 000 ft. For further details, see AIR 1.5.

8.6 AIR TRAFFIC CONTROL (ATC) ASSIGNMENT OF ALTITUDES

8.6.1 Minimum Instrument Flight Rules (IFR) Altitude

Within controlled airspace, ATC is not permitted to approve or assign any IFR altitude below the minimum IFR altitude. To ATC, the minimum IFR altitude is the lowest IFR altitude established for use in specific airspace and, depending on the airspace concerned, this may be:

- a) a minimum en route altitude (MEA);
- b) a minimum obstacle clearance altitude (MOCA);
- c) a minimum sector altitude (MSA);
- d) a safe altitude within a radius of 100 NM;
- e) an area minimum altitude (AMA); or
- f) a minimum vectoring altitude (MVA).

When a direct route is given, ATC is responsible for obstacle clearance. Provided that the altitude is at or above the minimum IFR altitude for the controlled airspace where the pilot intends to operate, ATC may use “direct” in a route clearance. ATC may clear aircraft that are traversing airways or air routes below the MEA, but not below the applicable minimum IFR altitude.

Within ATS surveillance coverage, it is common for controllers to issue the MVA when issuing direct routes. An MVA can be lower than a published minimum IFR altitude (MSA, MOCA, MEA, or AMA).

All ATC-assigned altitudes provide obstacle clearance.

A controller is not permitted to clear an aircraft flying on an airway at an altitude below the MEA. However, flight below the MEA, but not below the MOCA, may be approved when specifically requested by the pilot in the interest of flight safety (e.g. icing/turbulence), to conduct a flight check, for MEDEVAC, or when navigating using GNSS.

Navigational signal coverage is not guaranteed below the MEA; when navigating using NAVAIDS, the pilot should ensure that the aircraft is within, and will remain within, the lateral limits of the airway before requesting approval to fly below the MEA. It should also be noted that flight below the MEA does not guarantee the aircraft will remain in controlled airspace.

8.6.1.1 Distance Measuring Equipment (DME) Intersections on a Minimum En-Route Altitude (MEA)

The purpose of these fixes is to develop an airway segment where lower MEAs may be applied, thus reducing the high descent rates that otherwise are required when the aircraft is on initial approach to destination.

Pilots without DME normally will not be able to use these lower MEAs and may conceivably experience delays in receiving approach and departure clearances due to other traffic operating below the conventional MEA (i.e. the MEA required for non-DME-equipped aircraft). However, in a radar environment, the non-DME-equipped aircraft may be cleared at the lower MEA where it will be provided with radar service while operating below the conventional MEA.

8.6.2 Altitudes and Direction of Flight

Pilots will normally file flight plans and be assigned altitudes appropriate to the airway, air route or direction of flight. There are exceptions, and the following information is intended to familiarize pilots with the circumstances of those exceptions.

ATC may assign an altitude that is not appropriate to the airway, air route or direction of flight if:

- a) a pilot requests it because of icing, turbulence, or fuel considerations, provided:
 - (i) the pilot informs ATC of the time or location at which an appropriate altitude can be accepted, and
 - (ii) the altitude has been approved by affected units/sectors; or
- b) an aircraft is:
 - (i) holding, arriving or departing;

- (ii) conducting a flight inspection of a NAVAID;
- (iii) operating within an altitude reservation;
- (iv) engaged in an aerial survey, mapping flight or test flight;
- (v) operating on a polar route; or

- c) no alternative separation minima can be applied, provided:
 - (i) the altitude has been approved by affected units/sectors, and
 - (ii) the aircraft is cleared to an appropriate altitude as soon as possible;
- d) the airspace is structured for a one-way traffic flow.

NOTES:

1. In situation (a), the pilot, when able to accept an appropriate altitude, will be requested to advise ATC. In situation (c), the aircraft will be re-cleared to an appropriate altitude as soon as operationally feasible. Due to safety implications, use of altitudes inappropriate for the direction of flight must be limited, and requests must not be made solely for fuel efficiency reasons. Pilots should make requests only to avoid a fuel situation that might cause an otherwise unnecessary refuelling stop short of the flight-planned destination. ATC will not ask the pilot to substantiate a request; if ATC is unable to approve the request, the controller will state the reason and request the pilot's intention.
2. In the application of (a) or (c) in high-level radar-controlled airspace, aircraft at an altitude not appropriate for the direction of flight will be issued radar vectors or offset tracks to establish the aircraft at least 5 NM from the centreline of an airway or published track displayed on the radar.

Phraseology:

VECTORS TO (direction) OF (airway, track) TURN (left/right) TO HEADING (degrees).

ADVISE IF ABLE TO PROCEED PARALLEL OFFSET.

PROCEED OFFSET (number) MILES (right/left) OF CENTRELINE (track/route) AT (significant point/time) UNTIL (significant point/time). CANCEL OFFSET.

8.7 "1 000-FT-ON-TOP" INSTRUMENT FLIGHT RULES (IFR) FLIGHT

1 000-ft-on-top IFR flight may be conducted provided that

- a) the flight is made at least 1 000 ft above all cloud, haze, smoke, or other formation;
- b) the flight visibility above the formation is at least three miles;
- c) the top of the formation is well defined;
- d) the altitude appropriate to the direction of flight is maintained when cruising in level flight;

- e) the “1 000-ft-on-top” flight has been authorized by the appropriate ATC unit; and
- f) the aircraft will operate within Class B airspace at or below 12 500 ft ASL, Class C, D, or E airspace.

NOTE:

ATC does not apply separation to aircraft operating 1 000-ft-on-top except in the following conditions:

1. at night, separation is applied between an aircraft operating 1 000-ft-on-top and other aircraft if any of the aircraft are holding; and
2. between aircraft operating 1 000-ft-on-top and an aircraft operating on an altitude reservation approval.

8.8 CLEARANCES—LEAVING OR ENTERING CONTROLLED AIRSPACE

ATC will use the phrase “while in controlled airspace” in conjunction with the altitude if an aircraft will be entering or leaving controlled airspace. In addition, ATC will specify the lateral point and altitude at which an aircraft is to leave or enter controlled airspace if the instruction is required for separation purposes (see Note).

Example:

LEAVE/ENTER CONTROLLED AIRSPACE (number) MILES (direction) OF (fix) AT (altitude).

LEAVE/ENTER CONTROLLED AIRSPACE AT (altitude).

NOTE:

The altitude assigned by ATC need only reflect the minimum safe IFR altitude within controlled airspace. A pilot should be alert to the possibility of a higher minimum safe IFR altitude outside of controlled airspace. If uncertain (or unable to determine) when to enter or leave the area where the higher minima is applied, a request for clearance to maintain an altitude that will accommodate the higher minimum IFR altitude should be made.

8.9 CLEARANCE LIMIT

The clearance limit, as specified in an ATC clearance, is the point to which an aircraft is cleared. Further clearance is delivered to a flight prior to arrival at the clearance limit. However, occasions may arise when this may not be possible. In the event that further clearance is not received, the pilot is to hold at the clearance limit, maintain the last assigned altitude and request further clearance. If communications cannot be established with ATC, the pilot should then proceed in accordance with communications failure procedures as described in RAC 6.3.2.

The responsibility rests with the pilot to determine whether or not a received clearance can be complied with in the event of a communications failure. Under such circumstances, a clearance may be refused, but such refusal should specify acceptable alternatives.

8.10 CLASS G AIRSPACE—RECOMMENDED OPERATING PROCEDURES—EN-ROUTE

When aircraft are manoeuvring in the vicinity of uncontrolled aerodromes or cruising in Class G airspace, the lack of information on the movements of other aircraft operating in close proximity may occasion a potential hazard to all concerned. To alleviate this situation, all pilots are advised that:

- a) when operating in Class G airspace, they should continuously monitor frequency 126.7 MHz whenever practicable;
- b) position reports should be made over all NAVAIDs along the route of flight to the nearest station having air-ground communications capability. These reports should be made on frequency 126.7 MHz whenever practicable. If it is necessary to use another frequency to establish communications with the ground station, the report should also be broadcast on 126.7 MHz for information of other aircraft in the area. The report should contain present position, track, altitude, altimeter setting in use, next position and ETA;
- c) immediately before changing altitude, commencing an instrument approach or departing IFR, pilots should broadcast their intentions on 126.7 MHz whenever practicable. Such broadcasts should contain adequate information to enable other pilots to be fully aware of the position and intentions so that they can determine if there will be any conflict with their flight paths;
- d) at aerodromes where an MF has been designated, arriving pilots shall first broadcast their intentions on 126.7 MHz before changing to the MF. If conflicting IFR traffic becomes evident, this change should be delayed until the conflict is resolved. Pilots departing IFR should broadcast their intentions on 126.7 MHz, in addition to the MF, prior to takeoff; and
- e) the preceding reporting requirements are considered as the minimum necessary. Pilots are encouraged to make additional reports whenever the possibility of conflicting IFR traffic is suspected. An example would be reporting prior to overflying a facility where cross traffic is probable or where there is a published instrument approach procedure.

NOTE:

There is no frequency comparable to 126.7 MHz for use by aircraft equipped only with UHF; however, pertinent UHF traffic information will be relayed on the MF by the flight service specialist.

9.0 INSTRUMENT FLIGHT RULES (IFR)—ARRIVAL PROCEDURES

9.1 AUTOMATIC TERMINAL INFORMATION SERVICE (ATIS) BROADCASTS

If ATIS is available, all pilots should use it to obtain the basic arrival or departure and aerodrome information as soon as it is practicable.

9.2 STANDARD TERMINAL ARRIVAL (STAR), MINIMUM SECTOR ALTITUDE (MSA) AND TERMINAL ARRIVAL AREA (TAA)

The objective of the standard terminal arrival (STAR), the minimum sector altitude (MSA) and the terminal arrival area (TAA) depictions is to provide arriving aircraft with a seamless transition from the en route structure to the terminal environment.

Unlike the MSAs and TAAs, the STARs are developed to simplify clearance procedures at higher density airports and are individually depicted in the *Canada Air Pilot* (CAP). The MSA and TAA depictions are also in the CAP, but are found in the plan view of the associated approach chart.

A STAR requires the pilot to follow a predetermined route, whereas the MSA and the TAA are less prescriptive and simply offer safe altitudes to which the pilot can descend before commencing the approach. Pilots are to review each STAR issued and to follow the procedure as published. If there is any doubt as to what is required, clarification should be obtained from air traffic control (ATC). Pilots are not required to accept a STAR clearance, and, if they are unable to follow it, they should request alternate instructions.

9.2.1 Minimum Sector Altitude (MSA)

The MSA, as depicted on the approach chart (see the CAP), provides a minimum of 1 000 ft clearance above all obstacles within a sector of a circle having a radius of at least 25 NM centred on a radio aid to navigation or on a waypoint located near the aerodrome. Where required, the depiction may be divided into several pie-shaped sectors of varying minimum altitudes. Pilots can locate their sector by superimposing their track to the selected NAVAID onto the MSA depiction.

Unlike TAA depictions, MSA depictions do not allow the sectors to be further partitioned into step-down arcs of varying distances.

NOTE:

MSAs are not flight-inspected. Therefore, MSAs based on conventional NAVAIDs may not necessarily assure acceptable navigational signal coverage throughout the 25-NM radius area.

RNAV approaches may use either an MSA or a TAA depiction. RNAV approaches that use the MSA shall depict the common minimum altitude only.

9.2.2 Terminal Arrival Area (TAA)

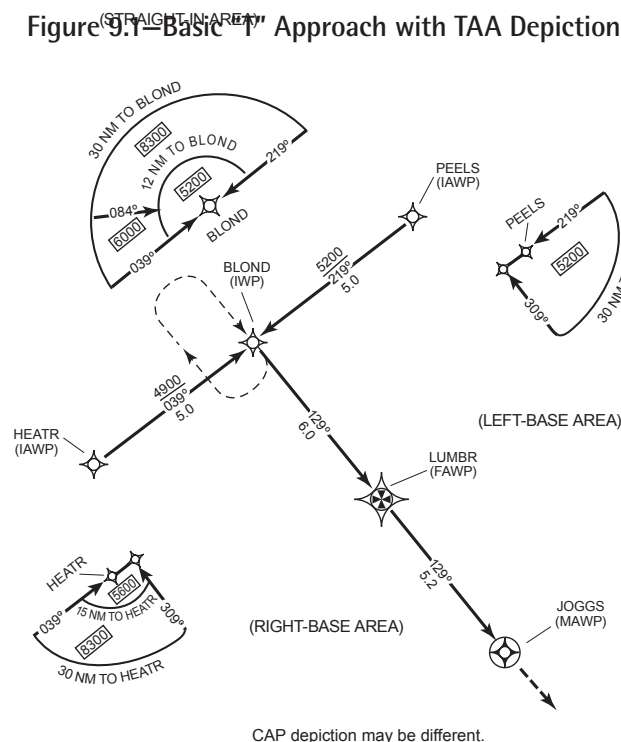
TAAs are developed for aircraft equipped with an FMS and/or a GNSS.

When a TAA is published, it replaces the MSA depiction on the approach chart (see the CAP).

The main advantage of the TAA over the MSA is that it can allow step-down arcs, based on RNAV distances, within its divided areas. This allows the aircraft to descend to lower minimum altitudes while still providing a minimum clearance of 1 000 ft above all obstacles.

The standard TAA consists of three areas which are defined by the extension of the initial and intermediate approach segments. These are called the straight-in, left-base, and right-base areas.

Figure 9.1—Basic “T” Approach with TAA Depiction



CAP depiction may be different.

NOTE:

The standard “T” design of the approach courses may be modified by the procedure designer where required by terrain or for ATC considerations. For instance, the “T” design may appear more like a regularly or irregularly shaped “Y”, or may even have one or both outboard IAWP eliminated, resulting in an upside down “L” or an “I” configuration.



Prior to arriving at the TAA boundary, the pilot should determine which area of the TAA the aircraft will enter by selecting the IWP to determine the magnetic bearing TO the waypoint. That bearing should then be compared with the published bearings that define the lateral boundaries of the TAA areas.

CAUTION:

When taking such a bearing, using the left or right IAWP (instead of the IWP) may give a false indication of which area the aircraft will enter. This is critical when approaching the TAA near the extended boundary between the left- and right-base areas, especially where these areas contain different minimum altitude requirements.

A standard racetrack holding pattern may be provided at the center IWP/IAWP and, if present, may be necessary for course reversal and for altitude adjustment for entry into the procedure. In the latter case, the pattern provides an extended distance for the descent required by the procedure.

9.2.3 Standard Terminal Arrival (STAR)

A STAR is an ATC IFR arrival procedure published in the CAP for use by aircraft with the appropriate navigation capabilities and is coded in many GNSS and FMS databases.

STARs provide the following benefits:

- a) *Predictability for flight crews:* As opposed to radar vectors, STARs allow pilots to be aware in advance of arrival routings and plan more optimum descent profiles.
- b) *Facilitation of clearances and radiotelephony exchanges:* Published STARs reduce the need to communicate detailed descent, speed, and track instructions.
- c) *Increased predictability for ATC:* Controllers observe more consistent aircraft track-keeping and turn performance on STARs due to published speed and altitude restrictions.

9.2.3.1 Conventional Standard Terminal Arrival (STAR)

A conventional STAR can be flown using ground-based NAVAIDs and/or charted headings and traditionally ends with ATC providing radar vectors. Pilots who request a conventional STAR are expected to have sufficient navigation equipment to fly the procedure. Canadian conventional STARs are gradually being replaced with PBN STARs.

9.2.3.2 Performance Based Navigation (PBN) Standard Terminal Arrival (STAR)

With the widespread deployment of PBN, even greater benefits are now possible in STAR design. PBN STARs thus permit an increase in flight safety as well as potential fuel savings. When used by qualified aircraft and operators, a PBN STAR can result in greater reliability, repeatability, and predictability of aircraft flight paths.

A PBN STAR is titled “STAR (RNAV)” and is a performance-based operation in which the performance requirements are specified by the publication of a navigation specification (such as RNAV 1 or RNP 1) on the chart in the PBN requirements box. Detailed explanations of navigation specifications can be found in COM 6.0, or in the NAV CANADA PBN Operations Plan available at <www.navcanada.ca/en/products-and-services/pages/on-board-operational-initiatives-pbn-rnav.aspx>.

In cases where a navigation specification has not yet been assigned to a PBN STAR, the following equipment would be required:

- a) at least one RNAV system or FMS certified for terminal use that meets either of the following standards:
 - (i) AC 20-130 (or later approved) *Airworthiness Approval of Navigation or Flight Management Systems Integrating Multiple Navigation Sensors*; or
 - (ii) AC 20-138 (or later approved) *Airworthiness Approval of Global Positioning System (GPS) Navigation Equipment for use as a VFR and IFR Supplemental Navigation System*, and
 - (iii) TSO C129a, *Airborne Supplemental Navigation Equipment Using the Global Positioning System (GPS)*;
- b) at least one automatic radio-updated IRU, if the RNAV system or FMS does not use a GPS sensor;
- c) a current database containing the waypoints, for the STAR to be flown, that can be automatically loaded into the RNAV system or FMS active flight plan;
- d) a system capable of following the RNAV system or FMS lateral flight path and limiting the cross-track error deviation to $\pm 1/2$ the navigation accuracy associated with the procedure or route; and
- e) an electronic map display.

9.2.3.3 Flight Planning

Authorized aircraft and air operators who meet the appropriate navigation specification (or the equipment list shown above for STARs without a navigation specification) may file STARs in their flight plan. Operators not authorized to flight plan PBN STARs are expected to file plans that include waypoints from the expected STAR procedure (or plans that are as close to the waypoints as possible), and include the remark in field 18 of the flight plan: RMK/NO RNAV STAR.

When included in a flight plan, the STAR will form part of the flight-planned route in the ATC clearance.

NOTE:

Mandatory IFR Routes may include a STAR. See RAC 11.4.3.

9.2.3.4 Procedure Identification

A STAR can designate multiple lateral routes, dependent on the runway in use, for an aircraft to fly from various points along the en route phase of flight to the approach phase with little or

no ATC intervention. These lateral routes (referred to as transitions) are listed on the STAR chart and may include instructions for management of the vertical profile. The procedure identification on a STAR chart includes the primary procedure identification and the en route transition identification.

The primary procedure identification consists of the following three elements:

- Procedure type
- Plain-language designator
- Coded designator

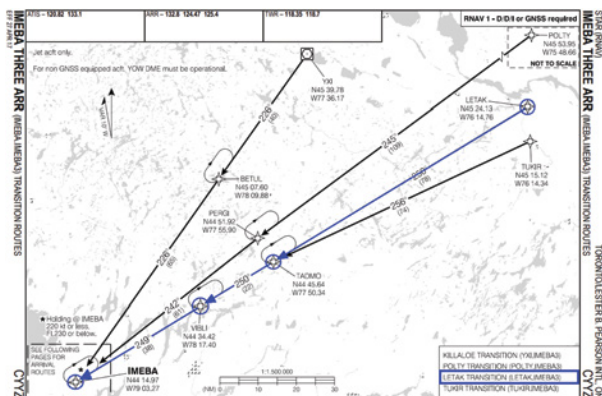
The procedure type is shown as one of the following:

- STAR: identifies the procedure as a conventional STAR
- STAR (RNAV): identifies the procedure as a PBN STAR

The plain-language designator is the spoken identification for the STAR procedure. It consists of a basic indicator, a validity number, and the term “ARR”. The validity number is a number between one and nine assigned sequentially after a qualifying procedure amendment. Example: UDNOX ONE ARR. A qualifying procedure amendment is a change in a procedure track or another significant change affecting the database coding of the procedure.

When a STAR procedure includes transitions from the en route airspace structure, the en route transitions are identified in similar fashion to the main STAR procedure. The en route transition identification includes a plain-language designator and a coded designator. The plain-language designator is the spoken identification for the en route transition and, while not always, it is usually derived from the name of the first point of the en route transition. The coded designator is the database/flight planning identification for the en route transition and is derived from both the en route transition plain-language designator and the primary procedure identification. For example, the LETAK TRANSITION (LETAK.IMEBA3) on the IMEBA THREE ARR into CYYZ is highlighted on the chart below.

Figure 9.2—Example of an En route Transition on the IMEBA THREE ARR into CYYZ



9.2.3.5 Altitude Restrictions

Altitude restrictions may be included in the STAR. Although an aircraft is expected to follow the charted lateral track of the cleared STAR without further ATC clearance, as per the flight-planned/cleared route, such is not the case with the STAR vertical profile; ATC has to issue descent clearance, and when a lower altitude is issued, pilots shall descend on the STAR profile to the ATC-assigned altitude. Unless specially cancelled by ATC, all charted restrictions above the assigned altitude on the STAR remain mandatory.

9.2.3.6 Speed Restrictions

Pilots must follow charted speed restrictions on a STAR. An ATC-assigned speed restriction supersedes any STAR-charted speed restrictions and must be followed until CAR 602.32 prohibits the pilot from flying at that speed.

9.2.3.7 Operating Procedures

When included in a flight plan, the STAR forms part of the flight-planned route received in the initial ATC clearance. When a flight plan that includes a STAR has been filed, or when the pilot receives and acknowledges a clearance that includes a STAR, the pilot is expected to fly the charted lateral track without further clearance. However, descent clearance must be obtained from ATC before commencing the vertical profile.

9.2.3.8 Top of Descent (TOD)

Sophisticated FMSs have the ability to determine precisely where to begin a descent from cruise altitude in order to minimize fuel usage, pollution, and noise by having the engines at their minimum thrust setting (idle) from cruise altitude to the final approach fix. This point is known as TOD. The most recent Canadian STAR procedures are carefully designed to allow the greatest benefits from idle descents while meeting the most common ATC requirements.

In order to maintain safety and airspace capacity, ATC may have to issue tactical instructions such as interim altitudes, speed control, radar vectors, or direct routes. Tactical instructions impact the TOD planning carried out by the FMS. For instance, delaying the planned descent, reducing the speed, or shortcutting STAR intermediate waypoints translate into a steeper descent angle, requiring the use of speed brakes and/or a longer flying distance. A premature descent clearance will translate into a shallower descent angle, requiring the use of engine thrust. To help mitigate the impact of these tactical instructions, ATC will endeavour to cancel or assign altitude and speed restrictions as far in advance as possible to help the flight crew re-optimize the descent.

In some terminal areas, the en route controller may issue initial descent instructions at TOD, but it may be an arrival controller who could ultimately be responsible for sequencing aircraft to the final approach course. Pilots should always state their requested approach when making initial contact with the

controller who will be responsible for sequencing the aircraft to the final approach course, even if the initial descent clearance was issued by another controller.

9.2.3.9 Descent Planning

Some PBN instrument approach procedures require fewer track miles to be flown, necessitating STAR vertical profiles significantly lower than those required for other approaches.

There are two main classifications of PBN approach procedures (see COM 6.0):

- Required navigation performance approach (RNP APCH) procedures, bearing the chart title “RNAV (GNSS)”
- Required navigation performance authorization required approach (RNP AR APCH) procedures, bearing the chart title “RNAV (RNP)”

Altitude constraints specific to RNP AR APCH are built into STAR procedures in order to enhance RNP AR APCH connectivity. While these constraints are a benefit for aircraft planning an RNP AR APCH, they are a drawback for aircraft planning other approach types, as they force them below an optimum vertical profile and may require a longer final approach segment. For maintaining the flight efficiencies of aircraft not planning an RNP AR APCH, some STAR procedures may offer guidance for descent planning.

9.2.3.10 Closed Standard Terminal Arrival (STAR) Procedures

A closed STAR procedure provides a continuous path from the en route structure and automatically joins up with the final approach course. A closed STAR terminates at the FACP. On a closed STAR, when an approach clearance is received, the pilot will continue to comply with all published altitude and speed restrictions, fly the charted track to the FACP, intercept the final approach course, and fly the straight-in approach. A closed STAR procedure is normally used when the inbound track is within plus or minus 90° of the final approach course to the runway.

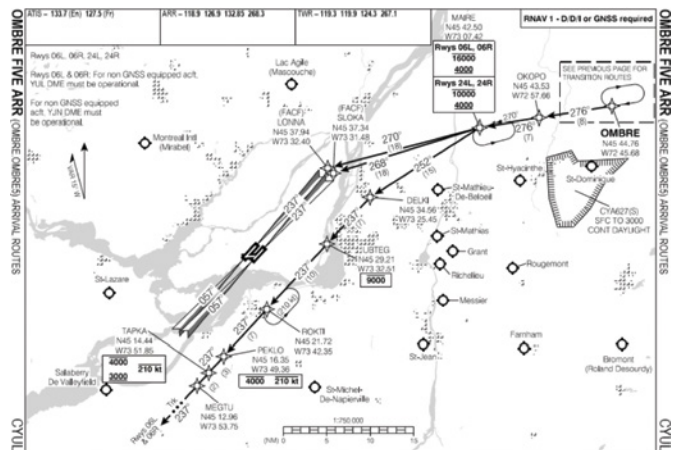
ATC always strives to issue approach clearances before aircraft reach the end of closed STARs, but in very rare cases (such as a distress call in progress on the frequency, frequency congestion, or high ATC workload), this may not always be possible. In order to assure obstacle clearance throughout the STAR and the approach lateral tracks, if an aircraft were to reach the end of a closed STAR prior to the issuance of an approach clearance, the pilot would be expected to safely intercept the final approach course and fly inbound maintaining the last assigned altitude. In the extremely remote case in which the aircraft reaches the end of the final approach track and further clearance has still not been obtained, the pilot would be expected to track the lateral position of the missed approach procedure for what would have been the anticipated approach, and maintain the last assigned

altitude or climb to the anticipated missed approach altitude if the missed approach altitude is higher.

9.2.3.11 Open Standard Terminal Arrival (STAR) Procedures

Similar to a closed STAR, an open STAR procedure also provides a continuous path from the en route structure but does not automatically join up with the final approach course. Open STARs are charted with an expectation of radar vectors and essentially place aircraft in a downwind to simplify approach sequencing. A STAR can be linked to an approach once ATC has issued an approach clearance. Unless ATC issues an approach clearance, aircraft must continue on the STAR procedure while awaiting ATC instructions. Once an approach clearance is issued, the pilot is expected to comply with any remaining STAR charted altitude and speed restrictions, intercept the final approach course using the assigned transition (or the assigned radar vectors), and conduct a straight-in approach. If an approach clearance is not received prior to the transition that is expected by the pilot, the aircraft will maintain the STAR as charted, and ATC will provide vectors to a point from which the aircraft can fly the straight-in approach.

Figure 9.3 – Example of a Closed STAR for Rwsy 24L and 24R and an Open STAR for Rwsy 06L and 06R



9.2.3.12 Transitioning from an Open Standard Terminal Arrival (STAR) to an Approach Procedure

The open STAR procedure normally offers the pilot an option to link the lateral profile of the STAR procedure to the lateral profile of the approach procedure through the use of a variety of approach transitions. A STAR can connect to some ILS approach procedures by using “GNSS REQUIRED” transitions published on the approach procedure. A STAR can connect to some RNP APCH (bearing the chart title “RNAV (GNSS)”) when the approach IAWP is also published on the STAR. Similarly, a STAR can connect to an RNP AR APCH (bearing the chart title “RNAV (RNP)”) when the approach IAWPs are published on the STAR. When a waypoint is published on both a STAR and an approach, it is referred to as a STAR/approach interface waypoint.

NOTE:

While it may still exist at a few airports, the connection between STAR DTW and FACP is gradually being phased out.

Figure 9.4 – CYHZ ILS RWY 23 with “GNSS REQUIRED” Left and Right IAWP to IF Transitions

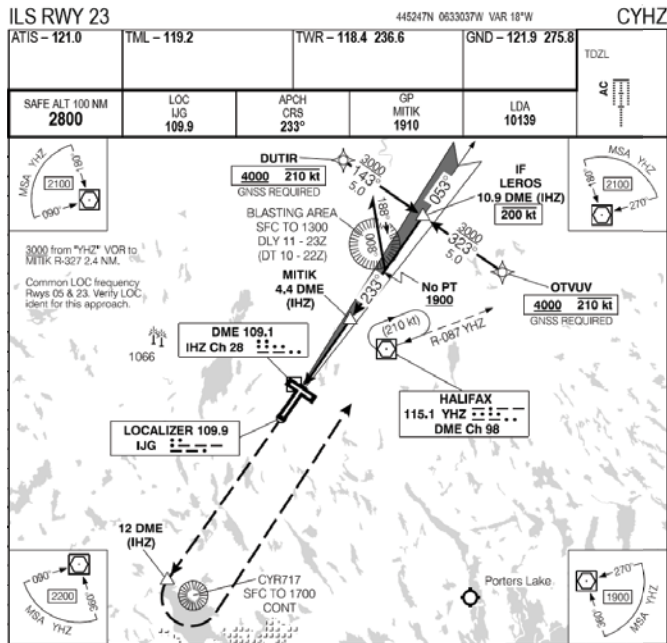


Figure 9.5 – CYHZ RNAV (GNSS) Z RWY 23 with Left and Right IAWP to IWP Transitions

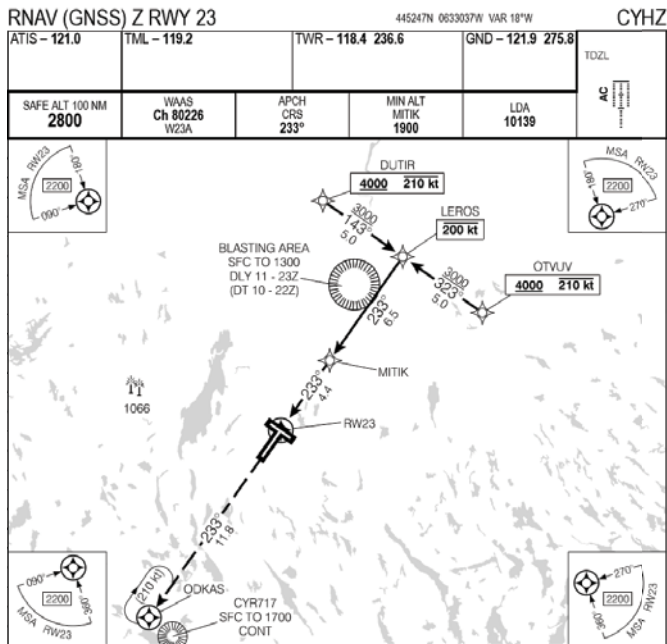
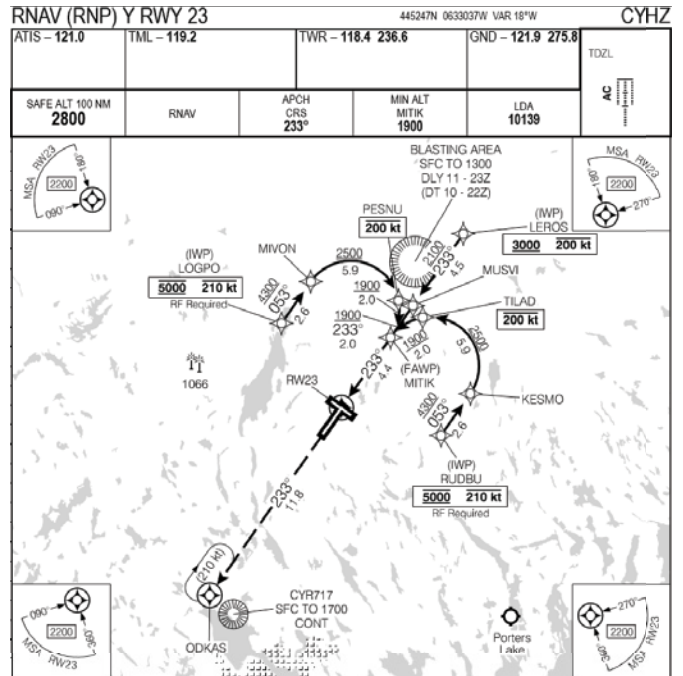


Figure 9.6 – CYHZ RNAV (RNP) Y RWY 23 with Left and Right “RF REQUIRED” IWP to FAWP Transitions



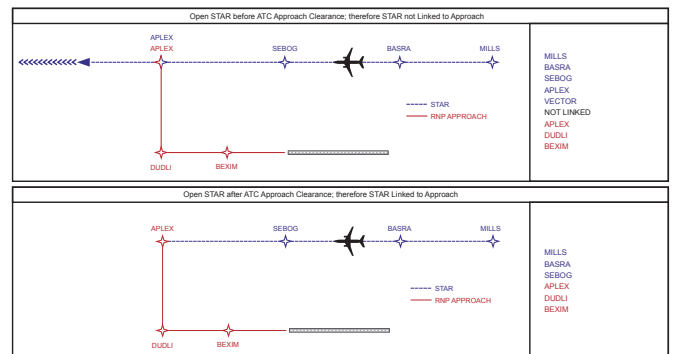
9.2.3.13 Approach Clearances

An approach clearance needs to be received prior to commencing an approach procedure; otherwise, aircraft are expected to continue flying the STAR procedure while awaiting further instructions. ATC always strives to provide transitions and early approach clearances, but sometimes traffic conditions necessitate vectors to intercept the final approach course.

Below are examples of typical FMS displays when a STAR/approach interface waypoint is used to link a STAR to an approach, both before and after an approach clearance has been issued. In both examples, before the approach clearance has been received, a discontinuity appears in the FMS waypoint list, since linking the STAR to the approach has not yet been permitted.

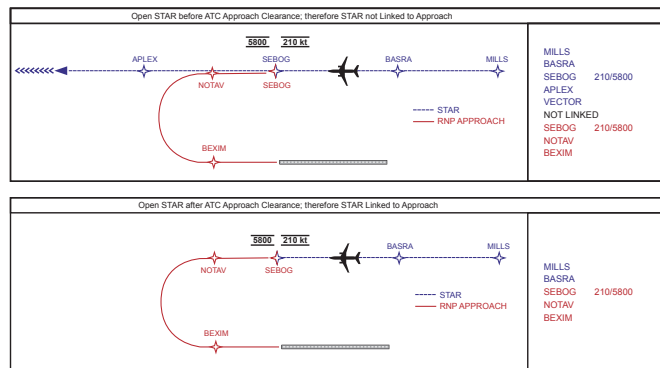
Linking the STAR to the approach without ATC clearance could result in a loss of separation.

Figure 9.7 – Open STAR to RNP APPROACH



RAC

Figure 9.8 – Open STAR to RNP AR APPROACH



Once the aircraft is cleared for an approach with a specified transition, if the FMS does not link the STAR to the approach before the STAR/approach interface waypoint, or if the aircraft is unable to execute the procedure, the pilot must advise ATC immediately upon recognizing the missed transition and wait for alternate instructions.

9.2.3.14 Radar Vectors to Final

Sometimes, depending on traffic and options for ATC to sequence aircraft, the published transition may not be available, and radar vectors will be provided to join the final approach course. If this occurs, and a clearance for the transition is not possible, pilots will not be expected to re-configure for a new transition or for another approach. ATC will state that they are unable to provide a particular transition and that the aircraft should expect radar vectors.

9.2.3.15 Amending Routes

ATC may amend STAR routes by clearing the aircraft direct to a waypoint depicted within the STAR. ATC will confirm what to expect if they intend for the aircraft to rejoin the STAR procedure when initiating radar vectors. When an aircraft is cleared direct to a STAR/approach interface waypoint, unless it is cleared for an approach, the pilot shall proceed direct to the STAR waypoint, and not to the approach waypoint, to re-intercept the STAR profile.

9.2.3.16 Direct Routings to an Initial Approach Waypoint (IAWP)/Intermediate Waypoint (IWP)

An RNP AR APCH (bearing the chart title “RNAV (RNP)”) normally offers RF leg segments to intercept the final approach course. Obstacle protection areas on these RF legs are designed with the consideration that the aircraft be established at the published speed and altitude, on the track centreline, and with the wings level prior to the beginning of the RF leg. The straight segment prior to these RF legs provides adequate time for aircraft to stabilize in this configuration. Direct routings to the beginning of RF leg segments are not permitted. An RNP AR APCH must not begin inside of the IWP.

9.2.3.17 Cancelling Standard Terminal Arrival (STAR) Procedures

Accepting a visual approach clearance automatically cancels the STAR procedure. A STAR may also be cancelled by ATC if required. If ATC cancels a STAR, the pilot should expect alternate instructions (either radar vectors to the final approach course, or a new route clearance). A STAR that has been cancelled may be reinstated by ATC.

9.2.3.18 Communication Failures on a Standard Terminal Arrival (STAR) Procedure

See the CFS, section F (Emergency), under Two-Way Communications Failure—IFR Flight Plan

9.3 APPROACH CLEARANCE

When using direct controller pilot communications, ATC normally advises pilots of the ceiling, visibility, wind, runway, altimeter setting, approach aid in use, and pertinent aerodrome conditions (CRFI, RSC, etc.) immediately prior to or shortly after descent clearance. Upon acknowledging receipt of the current ATIS broadcast, the pilot is advised by ATC of the current airport conditions only if they are changing rapidly.

Aircraft destined to airports which underlie controlled low-level airspace and for which there is a published instrument approach procedure, will be cleared out of controlled airspace (vertically) via the published instrument approach procedure.

Example:

ATC CLEARS (aircraft identification) OUT OF CONTROLLED AIRSPACE VIA (name, type) APPROACH.

Aircraft destined to airports which underlie controlled low-level airspace and for which there is not a published instrument approach procedure will be cleared to descend out of controlled airspace and informed of the appropriate minimum IFR altitude.

Example:

ATC CLEARS (aircraft identification) TO DESCEND OUT OF CONTROLLED AIRSPACE VICINITY OF (aerodrome name). THE (minimum IFR altitude) IS (number) feet.

The pilot may elect to cancel IFR as soon as visual conditions permit the continuation of the flight under VFR, or remain on the IFR flight plan until the aircraft has landed and the pilot files an arrival report. Should the pilot anticipate that visual conditions to permit continued flight under VFR may not be achieved, the pilot may arrange with ATC to have the MEA protected.

Aircraft destined to airports which underlie controlled high-level airspace and where there is no minimum IFR altitude established that would prohibit such a manoeuvre will be cleared out of controlled high-level airspace.

Example:

ATC CLEARS (aircraft identification) OUT OF (type of airspace).

When an approach clearance is issued, the published name of the approach is used to designate the type of approach if adherence to a particular procedure is required. If visual reference to the ground is established before completion of a specified approach, the aircraft should continue with the entire procedure unless further clearance is obtained.

Example:

CLEARED TO THE OTTAWA AIRPORT, STRAIGHT-IN ILS RUNWAY ZERO SEVEN APPROACH.

CLEARED TO THE TORONTO AIRPORT, ILS RUNWAY ZERO SIX LEFT APPROACH.

The number of the runway on which the aircraft will land is included in the approach clearance when a landing will be made on a runway other than that aligned with the instrument approach aid being used.

Example:

CLEARED TO THE OTTAWA AIRPORT, STRAIGHT-IN ILS RUNWAY ZERO SEVEN APPROACH/CIRCLING PROCEDURE SOUTH FOR RUNWAY THREE TWO.

NOTE:

If the pilot begins a missed approach during a circling procedure, the published missed approach procedure as shown for the instrument approach just completed shall be flown. The pilot does not use the procedure for the runway on which the landing was planned.

At some locations during periods of light traffic, controllers may issue clearances that do not specify the type of approach.

Example:

CLEARED TO THE LETHBRIDGE AIRPORT FOR AN APPROACH.

When such a clearance is issued by ATC and accepted by the pilot, the pilot has the option of conducting any published instrument approach procedure. In addition, the pilot also has the option of proceeding by the route so cleared by ATC in a previous clearance, by any published transition or feeder route associated with the selected procedure, or by a route present position direct to a fix associated with the selected instrument approach procedure. Pilots who choose to proceed to the instrument procedure fix via a route that is off an airway, air route or transition are responsible for maintaining the appropriate obstacle clearance, complying with noise abatement procedures and remaining clear of Class F airspace. As soon as practicable after receipt of this type of clearance, it is the pilot's responsibility to advise ATC of the type of published instrument approach procedure that will be carried out, the landing runway and the intended route to be flown.

This clearance does not constitute authority for the pilot to execute a contact or visual approach. Should the pilot prefer to conduct a visual approach (published or non-published) or a contact approach, the pilot must specifically communicate that request to the controller.

Upon changing to the tower or FSS frequency, pilots should advise the agency of the intended route and published instrument approach procedure being carried out.

The pilot should not deviate from the stated instrument approach procedure or route without the concurrence of ATC because such an act could cause dangerous conflict with another aircraft or a vehicle on a runway.

A clearance for an approach may not include any intermediate altitude restrictions. The pilot may receive this clearance while the aircraft is still a considerable distance from the airport, in either a radar or non-radar environment. In these cases, the pilot may descend, at his/her convenience, to whichever is the lowest of the following IFR altitudes applicable to the position of the aircraft:

- a) minimum en route altitude (MEA);
- b) published transition or feeder route altitude;
- c) minimum sector altitude (MSA) specified on the appropriate instrument approach chart;
- d) safe altitude 100 NM specified on the appropriate instrument approach chart; or
- e) when in airspace for which the Minister has not specified a higher minimum, an altitude of at least 1 000 ft above the highest obstacle within a horizontal radius of 5 NM (1 500 ft or 2 000 ft within designated mountainous regions, depending on the zone) from the established position of the aircraft.

NOTE:

When a pilot receives and accepts an ATC clearance which authorizes descent to MSA or a safe altitude 100 NM during normal IFR operations, descent below the MEA for the preceding en route phase should not commence until the pilot can positively establish the aircraft's position by means of a bearing, radial, DME, radar or visual means.

CAUTION:

Pilots are cautioned that descents to MSA or Safe Altitude 100 NM may, under certain conditions, exit controlled airspace. ATC provides IFR separation within controlled airspace only.

9.4 DESCENT OUT OF CONTROLLED AIRSPACE

ATC may not clear an aircraft to operate below the MEA of an airway, nor below the minimum IFR altitude in other controlled low-level airspace. The pilot, however, may operate at the MOCA, and ATC will approve flight at the MOCA at the pilot's request.

If unable to cancel IFR at the MEA, the pilot may advise that he/she intends to descend to the MOCA. By prior arrangement with ATC, the MEA will be protected in the event that the pilot does not encounter visual conditions at the MOCA. Under this arrangement, the MEA will be protected:

- a) until the pilot files an arrival report;
- b) for 30 min; to allow descent to the MOCA and return to the MEA when communication is restored with ATC; or
- c) if ATC does not hear from the pilot under (a) or (b), until the aircraft is estimated to have arrived at the filed alternate plus 30 min.

9.5 ADVANCE NOTICE OF INTENT IN MINIMUM WEATHER CONDITIONS

ATC can handle missed approaches more efficiently if the controller knows the pilot's intentions in advance. They can use the extra time to plan for the possibility of a missed approach and thus provide better service in the event of an actual missed approach.

Pilots should adopt the following procedures as the occasion arises.

On receipt of approach clearance, when the ceiling and visibility reported at the destination airport is such that a missed approach is probable, the pilot should advise the controller as follows:

IN THE EVENT OF MISSED APPROACH REQUEST (altitude or level) VIA (route) TO (airport).

Implementation of this procedure increases the amount of communications, but the increase can be minimized if pilots employ it only when there is a reasonable chance that a missed approach may occur.

9.6 CONTACT AND VISUAL APPROACHES

9.6.1 Contact Approach

A contact approach is an approach wherein an aircraft on an IFR flight plan or flight itinerary having an ATC clearance, operating clear of clouds with at least 1 NM flight visibility and a reasonable expectation of continuing to the destination airport in those conditions, may deviate from the IAP and proceed to the destination airport by visual reference to the surface of the earth. In accordance with CAR 602.124, the aircraft shall be flown at an altitude of at least 1 000 ft above the highest obstacle located within a horizontal radius of 5 NM from the estimated position of the aircraft in flight until the required visual reference is acquired in order to conduct a normal landing. Pilots are cautioned that conducting a contact approach in minimum visibility conditions introduces hazards to flight not experienced when flying IFR procedures. Familiarity with the aerodrome

environment, including local area obstacles, terrain, noise sensitive areas, Class F airspace and aerodrome layout, is paramount for a successful contact approach in minimum visibility conditions. Pilots are responsible for the adherence to published noise abatement procedures and compliance with any restrictions that may apply to Class F airspace when conducting a contact approach.

NOTE:

This type of approach will only be authorized by ATC when:

1. the pilot requests it; and
2. there is an approved functioning instrument approach, a published GNSS or a GNSS overlay approach for the airport.

An aircraft that requests a contact approach to an airport served only by a GNSS approach is indicating to ATS that the pilot understands that no ground based approach is available and is confirming that it is able to conduct a GNSS approach.

ATC will ensure IFR separation from other IFR flights and will issue specific missed approach instructions if there is any doubt that a landing will be accomplished. Pilots are cautioned that when any missed approach is initiated while conducting a contact approach, obstacle and terrain avoidance is the pilot's responsibility even though specific missed approach instructions may have been issued by ATC. ATC only ensures appropriate IFR separation from other IFR aircraft during contact approaches.

NOTE:

ATC will not issue an IFR approach clearance that includes clearance for a contact approach unless there is a published and functioning IAP or a restricted instrument approach procedure (RIAP) authorized by TC for the airport. Where a GNSS or GNSS overlay approach is the only available IAP or RIAP, this fulfils the requirement for a "functioning instrument approach."

9.6.2 Visual Approach

A visual approach is an approach wherein an aircraft on an IFR flight plan, operating in VMC under the control of ATC and having ATC authorization, may proceed to the destination airport. It permits aircraft to manage their lateral and vertical flight profiles according to the runway.

To gain operational advantages in a surveillance environment, the pilot may request a visual approach, or ATC may initiate one, provided that:

- a) the reported ceiling at the destination airport is 500 ft or more above the minimum IFR altitude and the ground visibility is 3 statute miles or more;
- b) at a controlled or uncontrolled airport, the pilot reports sighting the airport; and
- c) at a controlled airport,
 - (i) the pilot reports sighting the preceding aircraft and is instructed by ATC to follow that aircraft; or

- (ii) the pilot reports sighting the airport but not the preceding aircraft, in which case ATC will ensure separation from the preceding aircraft until:
 - (A) the preceding aircraft has landed; or
 - (A) the pilot has sighted the preceding aircraft and has been instructed to follow or maintain visual separation from it.

ATC considers acceptance of a visual approach clearance as acknowledgement that the pilot should be responsible for:

- a) maintaining visual separation from the preceding aircraft that the pilot has been instructed to follow;
- b) maintaining adequate wake turbulence separation from the preceding aircraft that the pilot has been instructed to follow;
- c) navigating to the final approach course;
- d) adhering to published noise abatement procedures and avoiding Class F airspace; and
- e) at uncontrolled airports, maintaining appropriate separation from VFR traffic that, in many cases, will not be known to ATC.

ATC will issue a visual approach clearance and, as required, supplement it with additional instructions such as:

1. Heading assignment:
 - To ensure the aircraft stays separated from preceding or succeeding traffic. ATC will consider the aircraft's altitude and remaining distance to the airport when using this method; and
 - To comply with parallel runway operation rules that require a 30-degree intercept heading to final prior to issuing the visual approach clearance.
2. Distance to intercept the final approach course and/or altitude to establish separation from traffic under the control tower's responsibility using references to:
 - published NAVAIDs, fixes, or waypoints;
 - the distance from the runway; and
 - a prominent landmark on the final approach course.

ATC may anticipate that pilots will navigate to the final approach course using the following methods depending on the aircraft's altitude and distance from the airport:

1. Flying the shortest distance to the airport while complying with ATC and noise abatement restrictions; or

2. Using the on-board navigation guidance to follow a lateral profile reflecting any remaining portion of the STAR and the previously planned published instrument approach procedure. This provides the following benefits:

- enhanced aircraft energy management;
- predictability;
- reduced flight deck workload;
- flexibility in meeting stabilized approach criteria; and
- adherence to altitude restrictions during nighttime conditions.

As both methods differ in terms of flying distance, it is good airmanship for pilots to advise ATC of the planned flight path, especially if it is likely to be unexpected or unpredictable, such as cases involving the widening of the base leg or the inability to shorten the flying distance as anticipated by ATC.

9.6.2.1 Missed Approach

A visual approach is not an IAP, and except for published visual approach procedures in the CAP, there are no procedures associated with a missed visual approach; visual approaches therefore have no missed approach segment. If a go-around is necessary for any reason, aircraft operating at controlled airports will be issued an appropriate advisory/clearance/instruction by the tower to ensure that separation from other airport traffic is maintained.

NOTE:

It is understood that the execution of a missed approach manoeuvre involves critical internal flight deck communications and high pilot workload. If these instructions are required for planning, pilots may request them before the approach clearance or at any time prior to initiating the missed approach.

ATC instructions will guide the pilot to:

- (i) continue flying the issued IFR clearance; or
- (ii) integrate into the airport VFR circuit.

a) Controlled Airports

At controlled airports, until missed approach instructions are issued, ATC should anticipate that pilots conducting a go-around from a visual approach will:

- (i) initially fly the runway heading;
- (ii) follow the published missed approach instructions for the IAP requested by the pilots and acknowledged by ATC; or
- (iii) follow the published missed approach instructions for the IAP advertised on the ATIS.

b) Uncontrolled Airports

At uncontrolled airports, aircraft crews are required to remain clear of clouds and are expected to complete a landing as soon as possible. If a landing cannot be accomplished, the aircraft crew is required to:

- (i) remain clear of clouds; and
- (ii) maintain separation from other airport traffic.

The crew is also expected to contact ATC as soon as possible for further clearance.

ATC separation from other IFR aircraft is only assured once further ATC clearance has been received and acknowledged by the aircraft crew.

9.7 RADAR ARRIVALS

9.7.1 General

Radar separation is applied to arriving aircraft in order to establish and maintain the most desirable arrival sequence to avoid unnecessary “stacking”. In the approach phase, radar vectoring is carried out to establish the aircraft on an approach aid. The initial instruction is normally a turn to a heading for radar vectors to a final approach to the runway in use. Should a communications failure occur after this point, the pilot should continue and carry out a straight-in approach if able, or carry out a procedure turn and land as soon as possible. Aircraft are vectored so as to intercept the final approach course approximately 2 NM from the point at which final descent will begin.

Example:

JULIETT WHISKEY CHARLIE, TURN LEFT HEADING ONE SEVEN ZERO TO INTERCEPT FINAL APPROACH COURSE. SEVEN MILES FROM AIRPORT. CLEARED FOR STRAIGHT-IN ILS RUNWAY ONE FIVE LEFT APPROACH. CONTACT TORONTO TOWER ON ONE ONE EIGHT DECIMAL SEVEN NOW.

9.7.2 Radar Required

Traditionally, instrument approach procedures have been developed to include a procedure turn initial approach segment. Procedure turns permitted the pilot to “self navigate” the aircraft within the procedure in order to place the aircraft in a position to conduct a normal landing. Introducing DME and other feeder routes or transitions permitted the pilot to conduct a straight-in procedure without conducting the procedure turn. Most instrument procedures today are accomplished without conducting a procedure turn.

Instrument approaches at Canada’s major airports are conducted by radar vectors to the final approach course. While procedure turns are depicted on the instrument approach procedures at these airports, procedure turns are never flown. ATC route and space all aircraft within the terminal area in order to provide a systematic flow of the air traffic. An aircraft conducting a procedure turn manoeuvre at these major centres would cause serious traffic disruptions which may lead to losses of separation or possibly a mid-air collision.

Instrument procedures are being introduced eliminating the procedure turn as well as including a statement “RADAR

REQUIRED” as part of the procedure. The initial approach segment of these instrument procedures is being provided by ATC radar vectors. Without ATC radar vectoring, the instrument procedure may not have a published initial approach segment.

Should an aircraft communication failure occur while being vectored for one of these approaches, refer to the communications failure procedures detailed in RAC Two-Way Communication Failure.

9.7.3 Speed Adjustment – Radar-Controlled Aircraft

NOTE:

This section is for information only. It describes directives to controllers and in no way alters the applications of CAR 602.32, which prescribes the following maximum speeds for all aircraft:

1. below 10 000 ft ASL, 250 KIAS; and
2. below 3 000 ft AGL and within 10 NM of controlled airports, 200 KIAS.

To assist with radar vectoring, it is sometimes necessary to issue speed adjustments. While ATC will take every precaution not to request speeds beyond the capability of the aircraft, it is the pilot’s responsibility to ensure that the aircraft is not operated at an unsafe speed. If ATC issues a speed reduction that is inconsistent with safe operation, the pilot must inform ATC when unable to comply.

Speed adjustment will be expressed in units of 10 KIAS or multiples of 10 KIAS. Pilots complying with a speed adjustment are expected to maintain a speed within 10 KIAS of the specified speed.

Pilots may be asked to:

- a) maintain present speed; or
- b) increase or reduce speed to a specified speed or by a specified amount.

Unless prior concurrence in the use of a lower speed is obtained from the pilot, the following minimum speeds will be applied to:

- a) aircraft operating 20 NM or more from destination airport:
 - (i) at or above 10 000 ft ASL: 250 KIAS; and
 - (ii) below 10 000 ft ASL: 210 KIAS;
- b) turbojet aircraft operating less than 20 NM from destination airport: 160 KIAS; and
- c) propeller-driven aircraft operating less than 20 NM from destination airport: 120 KIAS.

Pilots of aircraft that cannot attain speeds as high as the minimum speeds specified may be requested to:

- a) maintain a specified speed equivalent to that of a preceding or succeeding aircraft; or
- b) increase or decrease speed by a specified amount.

The issuance of an approach clearance normally cancels a speed adjustment; however, if the controller requires that a pilot maintain a speed adjustment after the issuance of the approach clearance, the controller will restate it. Otherwise, ATC may use the phrase “resume normal speed” to advise a pilot that previously issued speed restrictions are cancelled. Unless specifically stated by ATC, an instruction to “resume normal speed” does not cancel speed restrictions that are applicable to published procedures of upcoming segments of flight.

9.7.4 Precision Radar Approaches

- a) Precision Radar Approaches (PARs) are provided at aerodromes with military PAR units. The aircraft is vectored by surveillance radar to a predetermined position, at which point control is transferred to the PAR controller for the approach.

Example:

JULIETT WHISKEY CHARLIE, EIGHT MILES FROM AIRPORT, TURN LEFT HEADING TWO SEVEN ZERO FOR FINAL APPROACH. CLEARED FOR PRECISION RADAR APPROACH RUNWAY TWO FOUR. CONTACT TRENTON PRECISION ON ONE TWO EIGHT DECIMAL SEVEN NOW.

- b) In an emergency, where surveillance radar coverage permits it, air traffic controllers will provide a surveillance radar approach if no alternative method of approach is available and the pilot declares an emergency and requests a radar approach.

NOTE:

NAV CANADA radars are not flight-checked or commissioned for surveillance approaches, nor are NAV CANADA controllers specifically trained to provide them.

9.8 INITIAL CONTACT WITH CONTROL TOWERS

Pilots should establish contact with the control tower as follows:

- a) If in direct communication with an ACC or a TCU, the IFR controller shall advise the pilot when contact is to be made with the tower. Unless on radar vectors to final approach, pilots should give the tower their ETA to the facility for the approach they intend to fly.
- b) If the conditions above do not apply, pilots should establish communication with the tower when approximately 25 NM from the airport, give their ETA, obtain an ATC approach

clearance (if not already received), advise approach intentions and remain on tower frequency.

NOTE:

Whenever an ETA is passed, the pilot should specify the point, fix or facility to which the ETA applies.

9.9 APPROACH POSITION REPORTS— CONTROLLED AIRPORTS

Pilots conducting an instrument approach to, or landing at, a controlled airport should only make position reports that are requested by the appropriate ATC unit. As an example, pilots may expect ATC to request a report by the Final Approach Fix (FAF) or a specified distance on final. Position reports made under these circumstances are expected to be stated by reporting the position only.

9.10 CONTROL TRANSFER— INSTRUMENT FLIGHT RULES (IFR) UNITS TO TOWERS

Tower controllers may accept responsibility for control of an arriving IFR flight within the CZ if VMC exist at an airport, and the aircraft has been sighted and will remain in sight. The transfer of control to the tower does not cancel the IFR flight plan, but rather indicates that the aircraft is now receiving airport control service. In such instances, IFR separation minima may not continue to be applied. The tower controller may use visual separation procedures, or issue clearances and instructions as necessary to maintain a safe, orderly and expeditious flow of airport traffic. Occasionally the tower controller may issue instructions that supersede previous instructions and clearances that the pilot had received from the IFR unit. Acknowledgement of these instructions indicates to the tower that the pilot shall comply with them. A pilot must not assume that the control tower has radar equipment or that radar service is being provided.

9.11 INITIAL CONTACT WITH AIR-GROUND FACILITY AT UNCONTROLLED AERODROMES

Pilots shall establish communications with the air-ground facility (FSS, RCO, CARS or UNICOM) on the appropriate frequency if in direct communication with an ACC or a TCU, when directed to do so by the ACC or TCU.

Notwithstanding this, in accordance with CAR 602.104, pilots shall establish communication with the facility on the appropriate frequency no later than five minutes prior to the estimated time of commencing the approach procedure. If the ATC approach clearance has not already been received, it should be obtained from the agency listed on CAP approach charts, unless otherwise directed by ATC.

NOTES:

1. If a pilot is instructed to remain on the ATC frequency rather than being transferred to the appropriate frequency for the uncontrolled aerodrome, it remains the pilot's responsibility to notify the associated destination aerodrome ground station, or to broadcast where no ground station exists, and report in accordance with the following subsection. This may be accomplished by taking one of the following actions:

- a) if the aircraft is equipped with more than one two-way communication radio, the pilot is expected to make the report on the appropriate frequency with the secondary radio, while monitoring the ATC frequency on the primary radio; or
- b) if the aircraft is equipped with a single two-way communication radio, the pilot must first request and receive permission to leave the ATC frequency in order to transmit this directed or broadcast report and then return to the ATC frequency; or, if this is not possible, the pilot should specifically request ATC to notify the associated ground station of their approach intentions and estimated time of landing.

2. At aerodromes where RAAS is provided via an RCO and where AWOS (or LWIS) weather information is also broadcast via a voice generator module (VGM), it is recommended that pilots listen to the broadcast prior to contacting the air-ground facility, and upon contact, advise that they have the wind and altimeter information.

Because a VGM weather broadcast contains up-to-the-minute weather, it will be more current and may differ slightly from the most recently disseminated aerodrome routine meteorological report (METAR) or aviation selected special weather report (SPECI). The latest METAR or SPECI for the remote aerodrome will be provided, upon request, from the ATS unit controlling the RCO.

9.12 INSTRUMENT FLIGHT RULES (IFR) REPORTING PROCEDURES AT UNCONTROLLED AERODROMES

Subsection 1 of CAR 602.104—Reporting Procedures for IFR Aircraft When Approaching or Landing at an Uncontrolled Aerodrome “applies to persons operating IFR aircraft when approaching or landing at an uncontrolled aerodrome, whether or not the aerodrome lies within an MF area.”

Subsection 2 of CAR 602.104 states:

The pilot-in-command of an IFR aircraft who intends to conduct an approach to or a landing at an uncontrolled aerodrome shall report

- a) the pilot-in-command's intentions regarding the operation of the aircraft
 - (i) five minutes before the estimated time of commencing

the approach procedure, stating the estimated time of landing,

- (ii) when commencing a circling manoeuvre, and
- (iii) as soon as practicable after initiating a missed approach procedure; and

b) the aircraft's position

- (i) when passing the fix outbound, where the pilot-in-command intends to conduct a procedure turn or, if no procedure turn is intended, when the aircraft first intercepts the final approach course,
- (ii) when passing the final approach fix or three minutes before the estimated time of landing where no final approach fix exists, and
- (iii) on final approach.

In addition to these requirements, pilots operating aircraft under IFR into an uncontrolled aerodrome, when the weather conditions at the aerodrome could permit VFR circuit operations, are expected to approach and land on the active runway that may be established by the aircraft operating in the VFR circuit. Pilots operating aircraft under IFR at an uncontrolled aerodrome do not establish any priority over aircraft operating under VFR at that aerodrome. Should it be necessary for the IFR aircraft to approach and/or land on a runway contrary to the established VFR operation, it is expected that appropriate communications, between pilots or between pilots and the air-ground facility, will be effected in order to ensure there is no traffic conflict.

9.13 INSTRUMENTS FLIGHT RULES (IFR) PROCEDURES AT AN UNCONTROLLED AERODROME IN UNCONTROLLED AIRSPACE

Pilots operating under IFR in uncontrolled airspace should, whenever practical, monitor 126.7 MHz and broadcast their intentions on this frequency immediately prior to changing altitude or commencing an approach. Therefore, when arriving at an aerodrome where another frequency is designated as the MF, descent and approach intentions should be broadcast on 126.7 MHz before changing to the MF. If conflicting IFR traffic becomes evident, this change should be delayed until the conflict is resolved. Once established on the MF, the pilot shall make the reports listed in the sub-section above.

A straight-in landing from an IFR approach should not be used at an uncontrolled aerodrome where air-ground advisory is not available to provide the wind direction and speed and runway condition reports required to conduct a safe landing. The pilot should determine the wind and verify that the runway is unobstructed before landing. Where pilots lack any necessary information, they are expected to ensure that a visual inspection of the runway is completed prior to landing. In some cases, this can only be accomplished by conducting a circling approach using the appropriate circling MDA.

Pilots operating aircraft under IFR into an uncontrolled aerodrome in uncontrolled airspace when the weather conditions at the

aerodrome could permit VFR circuit operations are expected to approach and land on the active runway that may be established by the aircraft operating in the VFR circuit. Pilots operating aircraft under IFR at an uncontrolled aerodrome in uncontrolled airspace do not establish any priority over aircraft operating under VFR at that aerodrome. Should it be necessary for the IFR aircraft to approach to, land, or take off on a runway contrary to the established VFR operation, it is expected that appropriate communications between the pilots, or pilots and the air-ground facility, will be effected in order to ensure that there is no conflict of traffic.

9.14 OUTBOUND REPORT

To apply the prescribed separation minima between aircraft intending to make a complete instrument approach procedure and other aircraft, ATC must often establish the position and direction of arriving aircraft with respect to the approach facility. When reporting “outbound”, pilots should make these reports only after they are over or abeam the approach facility and proceeding in a direction away from the airport.

9.15 STRAIGHT-IN APPROACH

ATC uses the term “straight-in approach” to indicate an instrument approach conducted so as to position the aircraft on final approach without performing a procedure turn.

9.16 STRAIGHT-IN APPROACHES FROM AN INTERMEDIATE FIX

Published transitions normally are designated from an en route navigation aid to the primary approach aid upon which the procedure turn is based. However, to accommodate aircraft with modern avionics equipment and to improve fuel economy, transitions at some locations direct the pilot to an intermediate fix (IF) on the final approach course. Subject to ATC requirements and local traffic conditions, a straight-in approach may be made from this fix.

Intermediate fixes are usually located on the final approach track at the procedure turn distance specified in the profile view. This distance, which is normally 10 NM, is the distance within which the procedure turn should be executed. Accordingly, after passing the fix and manoeuvring the aircraft onto the proper inbound track, descent may be made to the appropriate published altitude that would apply as if a procedure turn had been completed.

The abbreviation “NO PT” is used to denote that no procedure turn is necessary from the point indicated and will normally be shown adjacent to the IF. However, if the minimum altitude IF to the final approach fix (FAF) is not readily apparent, the “NO PT” abbreviation may be shown at some point between the fix and FAF, along with an altitude applicable for this segment.

Where more than one transition intersects the final approach track at different points, only the furthest intersection is designated as the IF. Pilots may begin a straight-in approach from any depicted transition that intersects the final approach track inside the designated IF provided that ATC is aware of their intentions and subsequent manoeuvring is within the capabilities of the aircraft.

If the aircraft is badly positioned, laterally or vertically, after being cleared by ATC for the straight-in approach, pilots should climb to the procedure turn altitude, or the minimum altitude at the facility if one is depicted, and proceed to the FAF requesting clearance for a procedure turn.

NOTE:

If the FAF is behind the aircraft, the pilot must conduct a missed approach and request further clearance from ATC.

The depiction of radials on a DME arc transition to an IF are normally limited to the radial forming the IAF at the beginning of the arc, the lead radial (if required) to indicate where the turn to the final approach track should be commenced, and radials forming step-down fixes if descent to lower altitudes can be approved. However, the arc may be joined from any radial that intercepts the depicted arc.

9.17 PROCEDURE ALTITUDES AND CURRENT ALTIMETER SETTING

All altitudes published in the CAP are minimum altitudes that meet obstacle clearance requirements when International Standard Atmosphere (ISA) conditions exist and the aircraft altimeter is set to the current altimeter setting for that aerodrome. The altimeter setting may be a local or a remote setting when so authorized on the instrument approach chart. A current altimeter setting is one provided by approved direct reading or remote equipment or by the most recent routine hourly weather report. These readings are considered current up to 90 min from the time of observation. Care should be exercised when using altimeter settings older than 60 min or when pressure has been reported as falling rapidly. In these instances, a value may be added to the published DH/MDA in order to compensate for falling pressure tendency (0.01 inches of mercury = 10-ft correction). When an authorized remote altimeter setting is used, the altitude correction shall be applied as indicated.

9.17.1 Corrections for Temperature

Pressure altimeters are calibrated to indicate true altitude under ISA conditions. Any deviation from ISA will result in an erroneous reading on the altimeter. In a case when the temperature is higher than the ISA, the true altitude will be higher than the figure indicated by the altimeter, and the true altitude will be lower when the temperature is lower than the ISA. The altimeter error may be significant, and becomes extremely important when considering obstacle clearances in cold temperatures.

The published minimum IFR altitudes (i.e. the MSA/TAA and the initial/intermediate/final and missed approach segments, including the MDA/DA) must be adjusted when the ambient temperature on the surface is much lower than that predicted by the standard atmosphere. As a general rule this is considered to be 0°C or, when MDAs/DAs are 1 000 ft HAA or higher, it begins at 10°C.

NOTE:

Should the pilot feel that the above rules do not adequately adjust the published minimum IFR altitudes in the procedures to compensate for low temperatures, it is at the pilot’s discretion to apply temperature correction whenever the aerodrome temperature is below the ISA.

Corrections may be obtained from the “Altitude Correction Chart” in the CAP (which is reproduced as Table 9.1 in RAC). This chart is calculated for an aerodrome at sea level. It is, therefore, conservative when applied to aerodromes at higher altitudes. To calculate the corrections (reduced altitudes) for specific aerodromes or altimeter setting sources above sea level, or for values not tabulated, refer to the following paragraphs.

With respect to altitude corrections, the following procedures apply:

1. IFR assigned altitudes may be either accepted or refused.

Refusal in this case is based upon the pilot’s assessment of temperature effect on obstacle clearance. IFR assigned altitudes accepted by a pilot should not be adjusted to compensate for cold temperatures, i.e. if a pilot accepts “maintain 3 000”, an altitude correction should not be applied to 3 000 ft.

2. Vectoring altitudes assigned by ATC are temperature corrected and require no temperature compensation by pilots.
3. When altitude corrections are applied to a published mandatory altitude or missed approach holding altitude, pilots should advise ATC of the temperature-corrected altitude prior to crossing the associated waypoint.

The “Altitude Correction Chart” was calculated assuming a linear variation of temperature with height. It is based on the following equation, which may be used with the appropriate value of t_o , H , L_o and H_{ss} to calculate temperature corrections for specific conditions. This equation produces results that are within five percent of the accurate correction for altimeter setting sources up to 10 000 ft and with minimum heights up to 5 000 ft above that source. Unless otherwise specified, the destination aerodrome elevation is used as the elevation of the altimeter source.

Table 9.1—Altitude Corrections Based on Aerodrome Cold Temperatures

Aerodrome Temperature °C	Height above the elevation of the altimeter setting sources (feet)													
	200	300	400	500	600	700	800	900	1 000	1 500	2 000	3 000	4 000	5 000
+10									20	30	40	60	80	100
0	20	20	30	30	40	40	50	50	60	90	120	170	230	290
-10	20	30	40	50	60	70	80	90	100	150	200	290	390	490
-20	30	50	60	70	90	100	120	130	140	210	280	430	570	710
-30	40	60	80	100	120	130	150	170	190	280	380	570	760	950
-40	50	80	100	120	150	170	190	220	240	360	480	720	970	1 210
-50	60	90	120	150	180	210	240	270	300	450	600	890	1 190	1 500

NOTES:

1. The corrections have been rounded up to the next 10-ft increment.
2. Values should be added to published minimum IFR altitudes.
3. Temperature values from the reporting station nearest to the position of the aircraft should be used. This is normally the aerodrome.

RAC

Table 9.2—Example of Corrections for an Aerodrome at an Elevation of 2 262 ft with a Temperature of -50°C

	ALTITUDE	HAA	CORRECTION	INDICATED ALTITUDE
Procedure Turn	4 000 ft	1 738 ft	+521.4 ft ¹	4 600 ft ²
FAF	3 300 ft	1 038 ft	+311.4 ft	3 700 ft
MDA Straight-in	2 840 ft	578 ft	+173.4 ft	3 020 ft
Circling MDA	2 840 ft	578 ft	+173.4 ft	3 020 ft

¹ CORRECTION derived as follows:
 (2 000 ft at -50° error) 600 - (1 500 ft at -50° error) 450 = 150
 Altitude difference of above (2 000 - 1 500) = 500
 Error per foot difference (150/500) = 0.3HAA = 1 738
 Error at 1 738 = (1 738 - 1 500) * 0.3 = 71.4 + 450 (error -50° at 1 500) = 521.4

² INDICATED ALTITUDE derived as follows:
 Calculated error at 1 738 from above = 521.4
 Procedure-turn altitude (4 000) + error (521.4) = 4 521.4
 INDICATED ALTITUDE rounded next higher 100-ft increment = 4 600

Figure 9.9—Correction for Cold Temperatures: Equation

$$\text{Correction} = H \times \left(\frac{15 - t_0}{273 + t_0 - 0.5 \times L_0 \times (H + H_{ss})} \right)$$

where:

- H = minimum height above the altimeter setting source (setting source is normally the aerodrome unless otherwise specified)
- t_0 = $t_{\text{aerodrome}} + L_0 \times h_{\text{aerodrome}}$ aerodrome (or specified temperature reporting point) temperature adjusted to sea level
- L_0 = 0.0065°C per metre or 0.00198°C per foot
- H_{ss} = altimeter setting source elevation
- $t_{\text{aerodrome}}$ = aerodrome (or specified temperature reporting point) temperature
- $h_{\text{aerodrome}}$ = aerodrome (or specified temperature reporting point) elevation

For occasions when a more accurate temperature correction is required, this may be obtained from the following equation, which assumes an off-standard atmosphere.

Figure 9.10—Correction for Cold Temperatures: Equation 2

$$\frac{-\Delta t_{\text{std}}}{L_0} \ln \left(\frac{1 + L_0 \times \Delta h_{\text{PAirplane}}}{t_0 + L_0 \times \Delta h_{\text{PAerodrome}}} \right)$$

where:

- $\Delta h_{\text{PAirplane}}$ = aircraft height above aerodrome (pressure)
- $\Delta h_{\text{GAirplane}}$ = aircraft height above aerodrome (geopotential)
- ΔT_{std} = temperature deviation from the ISA temperature
- L_0 = standard temperature lapse rate with pressure altitude in the first layer (sea level to tropopause) of the ISA.
- T_0 = standard temperature at sea level

The above equation cannot be solved directly in terms of $\Delta h_{\text{GAirplane}}$ and an iterative solution is required. This can be done with a simple computer or spreadsheet program.

NOTE:

Geopotential height includes a correction to account for the variation of g (average 9.8067 m sec²) with height. However, the effect is negligible at the minimum altitudes considered for obstacle clearance: the difference between geometric height and geopotential height increases from zero at mean sea level to -59 ft at 36 000 ft.

Both the preceding equations assume a constant off-standard temperature lapse rate. The actual lapse rate may vary considerably from the assumed standard, depending on latitude and time of year. However, the corrections derived from the linear approximation can be taken as a satisfactory estimate for general application at levels up to 10 000 ft. The correction from the accurate calculation is valid up to 36 000 ft.

NOTES:

1. Where accurate corrections are required for non-standard (as opposed to off-standard) atmospheres, appropriate methods are given in Engineering Sciences Data Unit (ESDU) Item 78012 “Height relationships for non-standard atmospheres.” This allows for non-standard temperature lapse rates and lapse rates defined in terms of either geopotential height or pressure height.
2. Temperature values are those at the altimeter setting source (normally the aerodrome). When en route, the setting source nearest to the position of the aircraft should be used.

9.17.2 Remote Altimeter Setting

Normally, approaches shall be flown using the current altimeter setting only for the destination aerodrome. However, at certain aerodromes where a local pressure setting is not available, approaches may be flown using a current altimeter setting for a nearby aerodrome. Such an altimeter setting is considered a remote altimeter setting, and authorization for its use is published in the RASS box, located at the bottom left-hand corner of the approach chart, adjacent to the minima box, below the profile view.

RAC

If the use of a remote altimeter setting is required for limited hours only, an altitude correction will be included with the authorization. When the remote altimeter setting is used, the altitude correction shall be applied as indicated. If the use of a remote altimeter setting is required at all times, then the correction is incorporated into the procedure at the time it is developed.

Examples:

1. RASS: When using CYYY add 200’.

(When using the Mont-Joli altimeter setting, add 200 ft to the intermediate, final and missed approach segment minimum altitudes.)

2. RASS: Use CYXU.

(Use London altimeter setting.)

If the altitude correction results in the calculated rate of descent exceeding design parameters, the words “circling minima apply” will be added to the RASS box. The intent of this note is to draw the pilot’s attention to the fact that he/she cannot use straight-in minima when using the remote altimeter source. However, this does not prohibit the pilot from landing straight in if he/she has adequate visual reference in applying circling minima and the aircraft is suitably positioned to land straight in.

Example:

RASS: When using CYHU add 120’. Circling minima apply.
(When using St-Hubert altimeter, add 120 ft to the intermediate, final and missed approach segment minimum altitudes; circling minima apply.)

9.18 DEPARTURE, APPROACH AND ALTERNATE MINIMA

The civil minima published in the CAP shall, unless otherwise authorized, be observed by all pilots in accordance with their instrument rating as outlined in RAC Figure 9.2. Authorization to operate to special limits may be obtained by air operators in accordance with Part VII of the CARs or by private operators in accordance with subpart 604 of the CARs

9.18.1 Category II Instrument Landing System (ILS) Approach Minima

Category II operations are precision approaches in weather minima as low as 100 ft DH and RVR 1 200 ft. These minima are restricted to aircraft and pilots specifically approved for such operations by TC and to runways specially equipped for the category of operation. Details on Category II requirements are contained in CAR 602.128, *Landing Minima*, and the *Manual of All Weather Operations (Categories II and III)* (TP 1490E).

Table 9.3—Instrument Rating Weather Minima for CAT II ILS Approach

	AIRCRAFT	ROTORCRAFT
TAKEOFF VISIBILITY	CAP	1/2 CAP but not less than 1/4 SM.
LANDING DH or MDA	CAP	CAP
ALTERNATE WEATHER MINIMA REQUIREMENTS – CAP GEN		
FACILITIES AVAILABLE AT SUITABLE ALTERNATE	WEATHER REQUIREMENTS	
TWO OR MORE USABLE PRECISION APPROACHES Each providing straight-in minima to separate suitable runways.	400 - 1 or 200 - 1/2 above the lowest usable HAT and visibility, whichever is greater.	N/A
ONE USABLE PRECISION APPROACH	600 - 2* or 300-1 above the lowest usable HAT and visibility, whichever is greater.	N/A
NON-PRECISION ONLY AVAILABLE	800 - 2* or 300-1 above the lowest usable HAT/HAA and visibility, whichever is greater.	N/A
NO IFR APPROACH AVAILABLE	Forecast weather must be no lower than 500 ft above a minimum IFR altitude that will permit a VFR approach and landing.	N/A
FOR ROTORCRAFT Where instrument approach procedures are available.	N/A	Ceiling 200 ft above the minima for the approach to be flown, and visibility at least 1 SM but never less than the minimum visibility for the approach to be flown.

RAC

9.19 APPLICATION OF MINIMA

9.19.1 Takeoff Minima

CAR 701.20—Take-off Minima states that:

For the purposes of section 602.126, a person may conduct a take-off in an aircraft where weather conditions are below the take-off minima specified in the *Canada Air Pilot* if:

- c) in the case of a foreign air operator, the foreign air operator is authorized to do so in its Canadian foreign air operator certificate and complies with the Commercial Air Service Standards; or
- d) in the case of a person who operates a foreign state aircraft, the person is authorized to do so in a flight authorization and complies with the Commercial Air Service Standards.

Subsection (1) of CAR 602.126—Take-off Minima states that:

No pilot-in-command of an aircraft shall conduct a take-off if the take-off visibility, as determined in accordance with subsection (2), is below the minimum take-off visibility specified in:

- a) the air operator certificate where the aircraft is operated in accordance with Part VII;
- b) the private operator certificate where the aircraft is operated in accordance with Subpart 4; or
- c) the *Canada Air Pilot* in any case other than a case described in paragraph (a) or (b).

Subsection (2) of CAR 602.126 states that:

For the purposes of subsection (1), the take-off visibility is:

- a) the RVR of the runway, if the RVR is reported to be at or above the minimum take-off visibility specified in a document or the manual referred to in subsection (1);
- b) the ground visibility of the aerodrome for the runway, if the RVR
 - (i) is reported to be less than the minimum take-off visibility specified in a document or the manual referred to in subsection (1),
 - (ii) is reported to vary between distances less than and greater than the minimum take-off visibility specified in the *Canada Air Pilot* or a certificate referred to in subsection (1), or
 - (iii) is not reported; or
- c) the runway visibility as observed by the pilot-in-command, if
 - (i) the RVR is not reported, and
 - (ii) the ground visibility of the aerodrome is not reported.

- (iii) With respect to takeoff visibility, pilots will be advised of the ground visibility by the appropriate ATS unit. In the following example, explanations are provided to illustrate whether takeoff is authorized in a variety of visibility conditions.

Example:

A takeoff is to be conducted from Runway 27; the pilot is authorized a takeoff minimum of RVR 2600 (1/2 SM).

1. ATC/FSS reports "... RVR Runway 27 is 2000, variable 1600-2800, visibility 1/2 mile".

Although the RVR variation may be below minimum, a takeoff is authorized because the reported ground visibility of 1/2 mi. is governing.

2. ATC/FSS reports "... RVR Runway 27 is 2200, visibility observed on-the-hour 1/4 mile, visibility now 1/2 mile".

Although the RVR is below minimum, a takeoff is authorized because the reported ground visibility of 1/2 mi. is governing.

3. ATC/FSS reports "... RVR 2600, visibility 1/4 mile".

A takeoff is authorized since the lowest reported RVR is at or above minimum.

4. ATC/FSS reports "... RVR Runway 27 is 2000, variable 1600-2800, visibility 1/4 mile".

A takeoff is not authorized since both the lowest RVR and the reported ground visibility are below minimum.

5. ATC/FSS reports "... RVR Runway 27 is 2000 ...".

A takeoff is not authorized because the reported RVR is below minimum.

6. ATC/FSS/CARS reports only "... visibility observed on-the-hour 1/4 mile".

A takeoff is not authorized because reported visibility is below minimum.

In summary, a takeoff is authorized when:

- (a) the lowest reported RVR for the runway is at or above the minimum takeoff visibility, regardless of reported ground visibility;
- (b) the reported ground visibility for the aerodrome is at or above the minimum takeoff visibility, regardless of the reported RVR for the runway; or (c) in the absence of a reported RVR or reported ground visibility, the runway visibility as observed by the pilot in command is at or above minimum takeoff visibility.

9.19.2 Approach Ban

9.19.2.1 General Aviation—Non-Precision Approach (NPA), Approach Procedure with Vertical Guidance (APV), CAT I or CAT II Precision Approach

CAR 602.129 specifies that instrument approaches by general aviation aircraft are governed by RVR values only. With certain exceptions, pilots of aircraft are prohibited from completing an instrument approach past the FAF (or where there is no FAF, the point where the final approach course is intercepted) to a runway served by an RVR, if the RVR values as measured for that runway are below the following minima:

Table 9.4—Minimum RVR for Airplanes and Helicopters (General Aviation)

MEASURED RVR*	AEROPLANES	HELICOPTERS
RVR "A" only	1 200	1 200
RVR "A" and "B"	1 200/600	1 200/0
RVR "B" only	1 200	1 200

* RVR "A" located adjacent to the runway threshold.
RVR "B" located adjacent to the runway mid-point.

The following exceptions to the above prohibitions apply to all aircraft when:

- a) the below-minima RVR report is received, the aircraft is inbound on approach and has passed the FAF, or where there is no FAF, the point where the final approach course is intercepted;
- b) the pilot-in-command has informed the appropriate ATC unit that the aircraft is on a training flight and that the pilot-in-command intends to initiate a missed approach procedure at or above the DH or the MDA, as appropriate;
- c) the RVR is varying between distances less than and greater than the minimum RVR;
- d) the RVR is less than the minimum RVR, and the ground visibility at the aerodrome where the runway is located is reported to be at least one-quarter statute mile; or
- e) the pilot-in-command is conducting a precision approach to CAT III minima.

With respect to approach restrictions, in the case of a localized phenomenon or any fluctuations that affect RVR validity, where the ground visibility is reported by ATC or FSS to be at or above one-quarter statute mile, an approach may be completed.

Example:

An ILS approach is to be conducted to Runway 27; RVR sensors are located at positions A and B; the pilot is flying an aeroplane.

1. ATC/FSS reports "...RVR "A" 800, RVR "B" 800, observed visibility one-quarter statute mile."

An approach to DH/MDA is authorized because the reported ground visibility of one-quarter statute mile is governing.

2. ATC/FSS reports "...RVR "A" not available, RVR "B" 1 000."

An approach to DH/MDA is not authorized since RVR "B" is governing and is below 1 200 ft.

If, after commencing an approach (but before reaching the FAF, or where there is no FAF, the point where the final approach course is intercepted), a pilot must discontinue an approach because the RVR has gone below minima, the pilot shall continue as cleared, advise ATC of their intentions and request further clearance. If further clearance is not received by the time the aircraft reaches the FAF, or where there is no FAF, the point where the final approach course is intercepted, the pilot shall execute a missed approach and proceed via the missed approach procedure to the specified missed approach clearance limit.

In summary, an approach is authorized whenever:

- a) the lowest reported RVR for the runway is at or above minima (CAR 602.129), regardless of reported ground visibility;
- b) the RVR is reported to be varying between distances less than and greater than the minimum RVR;
- c) the RVR is below the minimum, and the ground visibility is reported to be at least one-quarter statute mile;
- d) the RVR for the runway is unavailable or not reported; or
- e) ATS is informed that an aircraft is on a training flight and will conduct a planned missed approach.

No pilot shall commence an NPA, an APV, or a CAT I or CAT II precision approach to an airport where low-visibility procedures are in effect. Low-visibility procedures are associated with CAT III operations. They are specified for an airport (for example, CYVR or CYYZ) in the CAP and restrict aircraft and vehicle operations on the movement area of the airport when the RVR is less than 1 200 ft.

9.19.2.2 Approach Ban—General Aviation—CAT III Precision Approach

CAR 602.130 specifies the general aviation CAT III precision approach ban. No pilot shall continue a CAT III precision approach in an IFR aircraft beyond the FAF inbound, or where there is no FAF, the point where the final approach course is intercepted, unless the RVR reported is equal to or greater than the minimum RVR specified in the CAP in respect of the runway or surface of intended approach for the IAP conducted.

Table 9.5—Minimum RVR for Aircraft CAT III Approaches (General Aviation)

MEASURED RVR*	CAT IIIA	CAT IIIB	CAT IIIC
RVR "A", "B" and "C"	600/600/600	Not Authorized	Not Authorized

*RVR "A" located adjacent to the runway threshold.
 RVR "B" located adjacent to the runway mid-point.
 RVR "C" located adjacent to the runway end.

9.19.2.3 Approach Ban—Commercial Operators—General—Non-Precision Approach (NPA), Approach Procedure with Vertical Guidance (APV), or CAT I Precision Approach

CAR 700.10 specifies the NPA, APV and precision approach ban that generally applies to commercial operators. With certain exceptions, pilots of commercial aircraft are prohibited from completing an NPA, an APV, or a CAT I precision approach past the FAF inbound, or where there is no FAF, the point where the final approach course is intercepted, if the visibility report is below the value corresponding to the CAP advisory visibility for the approach conducted.

Table 9.6—Minimum Visibility for Airplanes (Commercial Operators)

CAP ADVISORY VISIBILITY (SM, RVR x 100 ft)	VISIBILITY REPORT (Grnd Vis SM, RVR "A" or Rwy Vis ft)
1/2 RVR 26	3/8, RVR or Rwy Vis 1 600
3/4 RVR 40	5/8, RVR or Rwy Vis 3 000
1 RVR 50	3/4, RVR or Rwy Vis 4 000
1 1/4	1, RVR or Rwy Vis 5 000
1 1/2	1 1/4, RVR or Rwy Vis 6 000
1 3/4	1 1/2, RVR or Rwy Vis > 6 000
2	1 1/2, RVR or Rwy Vis > 6 000
2 1/4	1 3/4, RVR or Rwy Vis > 6 000
2 1/2	2, RVR or Rwy Vis > 6 000
2 3/4	2 1/4, RVR or Rwy Vis > 6 000
3	2 1/4, RVR or Rwy Vis > 6 000

Table 9.7—Minimum Visibility for Helicopters (Commercial Operators)

MEASURED RVR	HELICOPTERS
RVR "A" only	1 200
RVR "A" and "B"	1 200/0
RVR "B" only	1 200

An RVR report takes precedence over a runway visibility report or a ground visibility report, and a runway visibility report takes precedence over a ground visibility report. Ground visibility will only impose an approach ban at aerodromes south of 60°N latitude. If no RVR, runway visibility, or ground visibility is

reported, there are no criteria to impose an approach ban. (This concept is similar to the present CAR 602 approach ban, where if there is no RVR reported, there is no criterion to impose an approach ban.)

The following exceptions to the above prohibitions apply to all aircraft when:

- a) the visibility report is below the required value, and the aircraft has passed the FAF inbound, or where there is no FAF, the point where the final approach course is intercepted;
- b) the pilot-in-command has informed the appropriate ATC unit that the aircraft is on a training flight and that the pilot-in-command intends to initiate a missed approach procedure at or above the decision altitude (height) [DA(H)] or the MDA, as appropriate;
- c) the RVR is varying between distances less than and greater than the minimum RVR;
- d) the ground visibility is varying between distances less than and greater than the minimum visibility;
- e) a localized meteorological phenomenon is affecting the ground visibility to the extent that the visibility on the approach to the runway of intended approach and along that runway, as observed by the pilot in flight and reported immediately to ATS, if available, is equal to or greater than the visibility specified in the CAP for the IAP conducted; or
- f) the approach is conducted in accordance with an Operations Specification issued in accordance with CAR 703, 704 or 705.

No pilot shall commence an NPA, an APV, or a CAT I precision approach to an airport where low-visibility procedures are in effect. Low-visibility procedures are associated with CAT III operations. They are specified for an airport (for example, CYVR or CYYZ) in the CAP and restrict aircraft and vehicle operations on the movement area of the airport when the RVR is less than 1 200 ft.

9.19.2.4 Approach Ban—Commercial Operators—CAT II and CAT III Precision Approach

CAR 700.11 specifies the CAT II and CAT III precision approach ban that applies to commercial operators. No pilot shall continue a CAT II or CAT III precision approach in an IFR aircraft beyond the FAF inbound, or where there is no FAF, the point where the final approach course is intercepted, unless the RVR reported is equal to or greater than the minimum RVR specified in the CAP in respect of the runway or surface of intended approach for the IAP conducted.



Table 9.8— Minimum RVR for Airplane and Helicopter CAT II Approaches (Commercial Operators)

MEASURED RVR*	AEROPLANES	HELICOPTERS
RVR "A" and "B"	1 200/600	1 200/0

Table 9.9— Minimum RVR for Aircraft CAT III Approaches (Commercial Operators)

MEASURED RVR *	CAT IIIA	CAT IIIB	CAT IIIC
RVR "A", "B" and "C"	600/600/600	Not Authorized	Not Authorized

*RVR "A" located adjacent to the runway threshold.
 RVR "B" located adjacent to the runway mid-point.
 RVR "C" located adjacent to the runway end.

9.19.2.5 Approach Ban—Commercial Operators— Operations Specification—Non-Precision Approach (NPA), Approach Procedure with Vertical Guidance (APV), or CAT I Precision Approach

CARs 703.41, 704.37, and 705.48 specify the NPA, APV and precision approach ban that applies to commercial operators through an Operations Specification. CAR 703, 704 and 705 operators authorized through Operations Specification 019, 303 or 503 and who meet all the conditions related to the approach procedure, are permitted to conduct an approach at a visibility value less than those specified in the CAR 700 approach ban. With certain exceptions, pilots of commercial aircraft are prohibited from completing an NPA, an APV, or a CAT I precision approach past the FAF inbound, or where there is no FAF, the point where the final approach course is intercepted, if the visibility report is below the value corresponding to the CAP advisory visibility for the approach conducted.

Table 9.10— Minimum Visibility for Airplanes (CARs 703/704/705 Operations)

CAP ADVISORY VISIBILITY (SM, RVR x 100 ft)	VISIBILITY REPORT (Grnd Vis SM, RVR "A" or Rwy Vis ft)
1/2 RVR 26	1/4, RVR or Rwy Vis 1 200
3/4 RVR 40	3/8, RVR or Rwy Vis 2 000
1 RVR 50	1/2, RVR or Rwy Vis 2 600
1 1/4	5/8, RVR or Rwy Vis 3 400
1 1/2	3/4, RVR or Rwy Vis 4 000
1 3/4	1, RVR or Rwy Vis 5 000
2	1, RVR or Rwy Vis 5 000
2 1/4	1 1/4, RVR or Rwy Vis 6 000
2 1/2	1 1/4, RVR or Rwy Vis > 6 000
2 3/4	1 1/2, RVR or Rwy Vis > 6 000
3	1 1/2, RVR or Rwy Vis > 6 000

An RVR report takes precedence over a runway visibility report or a ground visibility report, and a runway visibility report takes precedence over a ground visibility report. Ground visibility will only impose an approach ban at aerodromes south of 60°N

latitude. If no RVR, runway visibility, or ground visibility is reported there are no criteria to impose an approach ban. (This concept is similar to the present CAR 602 approach ban, where if there is no RVR reported, there is no criterion to impose an approach ban.)

The following exceptions to the above prohibitions apply to aeroplanes when:

- a) the visibility report is below the required value and the aircraft has passed the FAF inbound, or where there is no FAF, the point where the final approach course is intercepted; or
- b) the RVR is varying between distances less than and greater than the minimum RVR.

9.19.2.6 Runway Visibility

CAR 602.131 specifies the concept of runway visibility as defined in CAR 101.01(1). The purpose of runway visibility is to determine and report a visibility at the TDZ of a runway that is not equipped with or is not reporting an RVR. An instrument-rated pilot or a qualified person (under CAR 804) can assess runway visibility when RVR sensor detection equipment is not available. In effect, a person is permitted to assess runway visibility from approximately the same position as an RVR "A" sensor installation. CAR Standard 622.131 (for pilots) and CAR Standard 824.25 (for qualified persons) describe how to assess and report runway visibility.

Runway visibility is assessed at or adjacent to the runway threshold, in the direction of the runway, based on runway lights or landmarks that can be seen and recognized. The assessment is made in feet based on a 200-ft runway edge light spacing, or using landmarks found on the applicable CAP aerodrome chart. A report of runway visibility should be reported immediately to ATS in the following format:

"RUNWAY VISIBILITY, RUNWAY [runway number] ASSESSED AS [distance assessed] FEET AT [time] UTC," to the nearest 100-ft increment.

A runway visibility report is valid for a period of 20 min after it is assessed. If the runway visibility varies during the assessment, the lowest value is reported. The lowest value that is reported is 200 ft, with lower values reported as "... LESS THAN 200 FEET..." The highest value that is reported is 6 000 ft, with higher values reported as "...GREATER THAN 6 000 FEET..."

9.19.2.7 Localized Phenomenon

CAR 700.10 recognizes that certain localized meteorological conditions can reduce the reported ground visibility, thus imposing an approach ban when the flight visibility appears to be much greater. An example would be a localized fog bank that is covering the ground observer's observation point, resulting in a reported ground visibility of one-quarter statute mile at an aerodrome south of 60°N latitude, while the flight visibility along the approach to the runway and on the runway itself (as

RAC

observed by the pilot-in-command), is greater than 15 SM. In this case, the pilot can declare a localized phenomenon, and override an approach ban imposed by a ground visibility report. A pilot cannot use localized phenomena to override an RVR or a runway visibility report that imposes an approach ban. To legally continue the approach past the FAF inbound, the flight visibility on the approach path and along the runway must be equal to or greater than the advisory visibility published in the CAP, for the procedure flown, and the pilot-in-command must immediately report the conditions observed to ATS.

CAUTION:

Pilots are reminded of the insidious hazard that thin ground-based layers, such as shallow fog, ice fog, or blowing snow can present. Such conditions may allow a pilot-in-command to override an approach ban based on what appears to be a localized phenomenon, when in fact extensive and very poor visibility will be encountered at low altitude during the later stages of the approach, landing and roll-out. The pilot-in-command should take all possible information into account before overriding an approach ban, based on what appears to be a localized phenomenon, in order to avoid conducting an approach during these hazardous conditions.

9.19.2.8 Effects of the High Intensity Approach Lighting (HIAL) System on *Canada Air Pilot* (CAP) Advisory Visibilities and Runway Certification

Instrument approach procedures developed for runways with HIAL systems receive a credit against their CAP advisory visibility (by up to ½ SM). When these lighting systems are inoperative, adjustments to the approach minima must be made by the pilot as indicated in the tables below. These adjustments may determine whether or not the pilot is prohibited from completing an instrument approach past the FAF (see RAC 9.19.2).

HIAL systems in Canada include SSALR (“AN” in the CAP), ALSF-2 (“AL” in the CAP), and SSALS (“AW” in the CAP). Also included are the following older type systems: *CAT I High Intensity* (also known as ALSF-1 or as “AE” in the CAP) and *CAT II High Intensity* (“AC” in the CAP). All of these systems, except for SSALS, are used to certify a precision approach runway.

When the HIAL system is inoperative, a certified precision runway is downgraded to a non-precision runway. For this reason, an approach procedure with straight-in minima below a DH of 250 ft and below an advisory visibility of 1 SM (RVR 50) must have its minima increased to 250 ft DH and 1 SM (RVR 50) visibility when the HIAL is inoperative. For example:

Table 9.11—Straight-in minima corrections for a DH below 250 ft

HIAL Operational (published)		HIAL Inoperative	
DH (ft)	Advisory Visibility (SM)	DH (ft)	Advisory Visibility (SM)
200 - 249	½ (RVR 26)	250	1 (RVR 50)

For approach procedures with straight-in minima of 250 ft DH / HAT or greater, the advisory visibility must be increased if any of the HIAL systems become inoperative, as indicated in the following table. No increase to the DH / HAT

itself is required.

No adjustment to circling minima is required based on the operating condition of the HIAL systems.

Table 9.12—Advisory visibility corrections for a DH equal to or greater than 250 ft

DH / HAT (ft)	Advisory Visibility when HIAL is Operational (published) (SM)	Advisory Visibility when HIAL is Inoperative (SM)
250 - 347	1	1
348 - 434	1	1 ¼
435 - 521	1	1 ½
522 - 608	1 ¼	1 ¾
609 - 695	1 ½	2
696 - 782	1 ¾	2 ¼
783 - 869	2	2 ½
870 - 956	2 ¼	2 ¾
957 and above	2 ½	3

9.19.3 Landing Minima

CAR 602.128 specifies that landings are governed by published DH/MDAs. Pilots of aircraft on instrument approaches are prohibited from continuing the final approach descent below DH or descending below MDA, as applicable, unless the required

visual reference has been established and maintained in order to complete a safe landing. When the required visual reference is not established or maintained, a missed approach must be initiated. Pilots must be cautioned that the missed approach segment that provides for obstacle clearance originates at the

published MAP. The published MAP on a precision approach is coincidental with the DH. Obstacle clearance will not be assured for missed approaches initiated beyond the MAP.

NOTE:

Certain published approaches that contain multiple lines of minima may have step-down altitudes that are lower than a published line of minima. Pilots should not descend to a step-down altitude that is lower than the altitude on their selected line of minima.

The visual references required by the pilot to continue the approach to a safe landing should include at least one of the following references for the intended runway, and should be distinctly visible and identifiable to the pilot by:

- (i) the runway or runway markings;
- (ii) the runway threshold or threshold markings;
- (iii) the touchdown zone or touchdown zone markings;
- (iv) the approach lights;
- (v) the approach slope indicator system;
- (vi) the runway identification lights;
- (vii) the threshold and runway end lights;
- (viii) the touchdown zone light;
- (ix) the parallel runway edge lights; or
- (x) the runway centreline lights.

Aerodromes that have instrument approaches may not have all of the above items, therefore pilots should consult the appropriate charts and current NOTAM to ascertain the available aids.

Published landing visibilities associated with all instrument approach procedures are advisory only. Their values are indicative of visibilities which, if prevailing at the time of approach, should result in required visual reference being established. (See GEN 5.1 for the definition.) They are not limiting and are intended to be used by pilots only to judge the probability of a successful landing when compared against available visibility reports at the aerodrome to which an instrument approach is being carried out.

9.20 RUNWAY VISUAL RANGE (RVR)

9.20.1 Definitions

Prevailing Visibility: The maximum visibility value common to sectors comprising one-half or more of the horizontal circle.

NOTE:

Prevailing visibility is determined by human observations.

Runway Visual Range (RVR): in respect of a runway, means the maximum horizontal distance, as measured by an automated visual landing distance system and reported by an ATC unit or an FSS for the direction of takeoff or landing, at which the runway, or the lights or markers delineating it, can be seen from a point above its centreline at a height corresponding to the average eye level of pilots at touchdown.

To compute RVR, three factors must be known. The first is the transmissivity of the atmosphere as provided by a visibility sensor. The second is the brightness of the runway lights which is controlled on request by the ATC controller. The third factor is whether it is day or night, since the eye can detect lights easier at night than during the day. There is a period during twilight where there is a problem similar to that with prevailing visibility when neither day, nor night conditions prevail.

RVR is measured by a visibility sensor such as a RVR sensor located near the runway threshold. For CAT II landing systems, a second sensor is provided about the mid-point of the runway. The RVR sensor near the threshold is identified as “A” and the second one as “B”. Their locations are important for the assessment of visibility, and so their positions are indicated on the aerodrome diagrams in CAP.

A light emitted from a source is attenuated in the atmosphere due to snow, fog, rain, and so forth. The amount of this attenuation, or the transmissivity of the atmosphere, can be obtained by measuring the amount of light reaching a detector after being transmitted by a projector. The visibility sensor samples the atmosphere at a height that best represents the slant transmittance from the pilot’s eye at cockpit level to the runway.

9.20.2 Operational Use of Runway Visual Range (RVR)

RVR information is available at the ATC IFR arrival control position, the PAR position, the control tower and the FSS.

When applicable, RVR information is given to the pilot as a matter of routine and can be used in the determination or application of visibility minima only if the active runway is served by the visibility sensor. RVR information, found in the Remarks section of surface weather reports, is not to be used for operational purposes and is superseded by any RVR information from ATS personnel.

NOTE:

RVR reports are intended to provide an indication of how far the pilot can expect to see along the runway in the touchdown zone; however, the actual visibility at other points along the runway may differ due to differing weather conditions. This should be taken into account when decisions must be made based on reported RVR.

A pertinent phenomenon that occurs fairly often during periods of low visibility is large fluctuations that occur over extremely short time intervals. As per ICAO recommendations, the RVR computer automatically averages the readings over the last minute.

The controller will provide the RVR if it is less than 6 000 ft, or upon request. The RVR will be provided in 100-ft increments from 300 ft to 1 199 ft, in 200-ft increments from 1 200 ft to 2 999 ft, and in 500-ft increments from 3 000 ft to 6 000 ft. The RVR remains constant for runway light settings of 1, 2 and 3, but it can increase for settings of 4 and 5. If the latter settings

are used, the pilot will be provided with both the RVR and the light setting.

NOTE:

At aerodromes equipped with ARCAL, the light settings may not be known to ATS personnel.

In daytime, even a high intensity setting can fade into background brightness. For example, the pilot may be provided with an RVR of 4 000 ft while making an approach when shallow fog is occurring over a snow surface in bright sunlight. Because of the glare, runway lights will be difficult to see; therefore, visibility will be much less than the reported RVR. In situations such as this, the use of prevailing visibility would be more appropriate.

RVR may be used instead of prevailing visibility for landing and take-off minima, but only for runways equipped with an RVR system. In such cases, the following table can be used.

Table 9.13—RVR to Be Used Instead of Prevailing Visibility for Landing and Take-Off Minima on Equipped Runways

GROUND VISIBILITY	RVR
1 mile	5 000 feet
3/4 mile	4 000 feet
1/2 mile	2 600 feet
1/4 mile	1 400 feet
See Note 2	under 1 200 feet

NOTES:

1. A comparative scale converting RVR-feet into RVR-metres is shown in the GEN section.
2. Ground visibility does not apply to operators with a takeoff limit below 1 200 feet.

ATS phraseology applicable to the foregoing is as follows:

- a) Runway (number) visual range/ RVR three thousand five hundred feet.
- b) Runway (number) visual range/ RVR less than three hundred feet.
- c) Runway (number) visual range/ RVR more than six thousand feet.
- d) Runway (number) visual range/ RVR (number) feet, fluctuating (number) to (number) feet, visibility (fraction) mile.
- e) Runway (number) visual range/ RVR (number) feet, runway lights at setting four/five.
- f) Runway (number) visual range/ RVR ALFA (number) feet, BRAVO (number) feet, CHARLIE (number) feet.

9.21 AIRCRAFT CATEGORIES

Aircraft performance differences have an effect on the airspace and visibility needed to perform certain manoeuvres. In order that the appropriate obstacle clearance areas and landing and departure minima can be established, five different aircraft categories have been identified. Aircraft that are manoeuvred within these category speed ranges are to use the appropriate instrument approach minima for that category. For example, an aircraft that is flown on a straight-in approach at 135 KIAS is to use the Category C approach minima. However, if that same aircraft is required to manoeuvre on a circling approach at 143 KIAS, then the Category D circling minima applies. The category speed groupings are:

Table 9.14—Aircraft Categories

CATEGORY	A	B	C	D	E
SPEEDS	up to 90 KIAS (includes all rotorcraft)	91 to 120 KIAS	121 to 140 KIAS	141 to 165 KIAS	above 165 KIAS

NOTE:

Category E Minima are not provided for on civil instrument approach procedure charts.

9.22 STRAIGHT-IN LANDING MINIMA

Minima for a straight-in landing are published when a normal rate of descent can be made from the final approach fix (FAF) to the runway threshold and when the final approach track intersects the extended runway centre-line within 30° and within a prescribed distance from the threshold. When either the normal rate of descent or the runway alignment exceeds the criteria, straight-in landing minima are not published and only circling minima apply. The fact that only circling minima are published does not preclude a pilot from landing straight-in if the required visual reference is available in sufficient time to make a normal approach and landing.

NOTE:

The term straight-in used in connection with landing should not be confused with its use in straight-in approach minima. An ATC clearance for a straight-in approach merely clears the aircraft for an approach without first completing a procedure turn. The minima that will subsequently be used will be based on considerations such as the runway in use, published minima, aircraft category, etc.

The use of straight-in landing minima is predicated upon the pilot having the wind direction and speed and runway condition reports required to conduct a safe landing. At an uncontrolled aerodrome where the pilot may lack the necessary information, the pilot is expected to verify that the runway is unobstructed prior to landing. In some cases, this can only be accomplished

by conducting a circling approach using the appropriate circling minima.

At an uncontrolled aerodrome, runway conditions (including any temporary obstructions such as vehicles) may be determined by the pilot by:

- a) contacting the appropriate FSS or UNICOM at the destination;
- b) a pre-flight telephone call to the destination to arrange for making the necessary information available when required for landing;
- c) a visual inspection;
- d) a NOTAM issued by the aerodrome operator; or
- e) any other means available to the pilot, such as message relay from preceding aircraft at the destination.

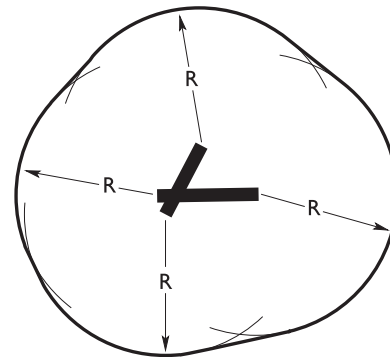
9.23 CIRCLING

Circling is the term used to describe an IFR procedure that is conducted by visually manoeuvring an aircraft, after completing an instrument approach, into position for landing on a runway which is not suitably located for a straight-in landing (not usually applicable to rotorcraft).

The visual manoeuvring area for a circling approach is determined by drawing arcs centred on each runway threshold and joining those arcs with tangent lines. The radius of the arcs is related to the aircraft category and may be based on either standard circling approach radii or expanded circling approach radii (see sections 9.23.1 and 9.23.2 below). The circling minimum descent altitude (MDA) provides a minimum of 300 feet above all

obstacles within the visual manoeuvring area for each category.

Figure 9.11—Visual Manoeuvring (Circling) Area



If it is necessary to manoeuvre an aircraft at a speed in excess of the upper limit of the speed range for its approach category, the circling minima for the next higher category should be used in order to ensure appropriate protection from obstacles.

Circling restrictions are published at some locations to prevent circling manoeuvres in certain sectors or directions where higher terrain or prominent obstacles exist. This practice allows the publication of lower minima than would otherwise be possible. In such cases, the circling MDA DOES NOT PROVIDE OBSTACLE CLEARANCE WITHIN THE RESTRICTED SECTOR.

9.23.1 Standard Circling Approach Radii

Circling approach protected areas developed prior to 2020 used the radius distances shown in the following table. Approaches using standard circling approach areas can be identified by the **absence** of the **C** symbol on the circling line of minima.

Table 9.15 – Standard Circling Approach Radii

Circling MDA in feet AMSL	Approach Category and Circling Radius (NM)				
	CAT A	CAT B	CAT C	CAT D	CAT E*
All altitudes	1.3	1.5	1.7	2.3	4.5

*Category E circling minima are published at DND aerodromes only.

9.23.2 Expanded Circling Approach Radii

Circling approach protected areas developed in 2020 or later use a radius distance based on the aircraft category as well as the altitude of the circling MDA, which accounts for increases to true airspeed with altitude. The following table provides radius

values for each aircraft category within five altitude bands. Approaches using expanded circling approach areas can be identified by the **presence** of the **C** symbol on the circling line of minima.

Table 9.16 – Expanded Circling Approach Radii

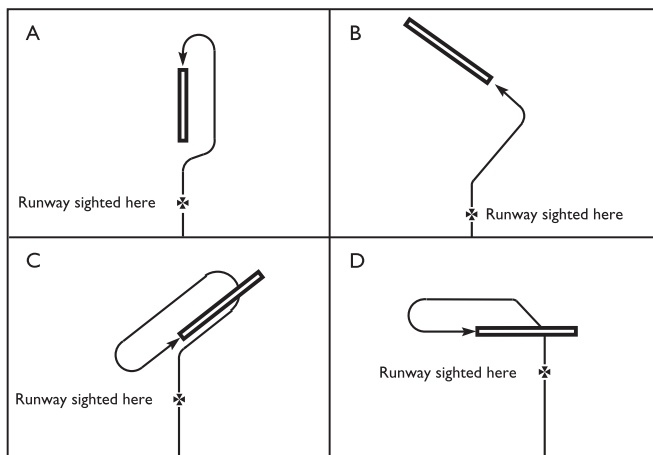
Circling MDA in feet AMSL	Approach Category and Circling Radius (NM)				
	CAT A	CAT B	CAT C	CAT D	CAT E*
1000 or less	1.3	1.7	2.7	3.6	4.5
1001 – 3000	1.3	1.8	2.8	3.7	4.6
3001 – 5000	1.3	1.8	2.9	3.8	4.8
5001 – 7000	1.3	1.9	3.0	4.0	5.0
7001 – 9000	1.4	2.0	3.2	4.2	5.3

*Category E circling minima are published at DND aerodromes only.

9.24 CIRCLING PROCEDURES

An air traffic controller may specify manoeuvring in a certain direction or area due to traffic considerations; however, the selection of the procedure required to remain within the protected area and to accomplish a safe landing rests with the pilot. There can be no single procedure for conducting a circling approach due to variables such as runway layout, final approach track, wind velocity and weather conditions. The basic requirements are to keep the runway in sight after initial visual contact, and remain at the circling MDA until a normal landing is assured. Examples of various circling approach situations are illustrated in Figure 9.12.

Figure 9.12—Typical Circling Manoeuvres



9.25 MISSED APPROACH PROCEDURE WHILE VISUALLY MANOEUVRING IN THE VICINITY OF THE AERODROME

The pilot may have to conduct a missed approach after starting visual manoeuvres. There are no standard procedures in this situation. Thus, unless the pilot is familiar with the terrain, it is recommended that:

- a) a climb be initiated;
- b) the aircraft be turned towards the centre of the aerodrome; and

- c) the aircraft be established, as closely as possible, in the missed approach procedure published for the instrument approach procedure just completed.

With the runway in sight at circling MDA, the pilot should execute the missed approach if there is any doubt that the ceiling and visibility are inadequate for manoeuvring safely to the point of touchdown.

9.26 MISSED APPROACH PROCEDURES

Whenever a pilot conducts a published missed approach from an instrument approach procedure, the aircraft must continue along the published final approach course to the published Missed Approach Point (MAP) and follow the published missed approach instructions. The pilot may climb immediately to the altitude specified in the missed approach procedure or assigned by ATC. In the event of a missed approach when no missed approach clearance has been received, the pilot will follow the published missed approach instructions. Should the pilot arrive at the missed approach holding fix prior to receiving further clearance, the pilot will:

- a) hold in a standard holding pattern on the inbound track used to arrive at the fix;
- b) if there is a published missed approach track to the fix, hold in a standard holding pattern inbound to the fix on this track;
- c) if there is a published shuttle or holding pattern at the fix, hold in this pattern regardless of the missed approach track to the fix; or
- d) if there are published missed approach holding instructions, hold in accordance with these.

If a clearance to another destination has been received, the pilot shall, in the absence of other instructions, carry out the published missed approach instructions until at an altitude which will ensure adequate obstacle clearance before proceeding on course.

If specific missed approach instructions have been received and acknowledged, the pilot is required to comply with the new

RAC

missed approach instructions before proceeding on course, e.g. “on missed approach, climb runway heading to 3 000 feet; right turn, climb on course” or “on missed approach, climb straight ahead to the BRAVO NDB before proceeding on course”.

Civil and military air traffic control procedures do not require the air traffic controller to provide terrain and obstacle clearance in their missed approach instructions. Terms such as “on missed approach, right turn climb on course” or “on missed approach, left turn on course” are not to be considered specific missed approach instructions. It remains the pilot’s responsibility to ensure terrain and obstacle avoidance and clearance.

The terrain and obstacle environment in the missed approach segment may require a climb gradient greater than the standard 200 ft/NM (or 400 ft/NM for helicopter-only procedures). The pilot must plan in advance to ensure that the aircraft can meet the climb gradient required by the procedure in the event of a missed approach and must also be aware that flying at a ground speed higher than anticipated will increase the climb rate requirement (feet per minute). Where aircraft limitations or other factors preclude the pilot from following the published climb gradient, it is the responsibility of the pilot-in-command (PIC) to determine alternative procedures that will take into account obstacle and terrain clearance.

9.27 SIMULTANEOUS PRECISION INSTRUMENT APPROACHES – PARALLEL RUNWAYS

When simultaneous precision instrument approaches are in progress, ATC will vector arriving aircraft to one or the other of the parallel localizers for a straight-in final approach. (When cleared for a straight-in approach, a procedure turn is not permitted.) Each of the parallel approaches has a “high side” and a “low side” for vectoring and to allow for vertical separation until both aircraft are established inbound on their respective parallel localizer (LOC).

The pilot will be instructed to change and report on the tower frequency prior to reaching the final approach fix (FAF) inbound. If an aircraft is observed to overshoot the localizer during the final turn, the pilot will be instructed to return to the correct localizer course immediately. After an aircraft is established on the localizer, the controller monitoring the final approach will issue control instructions only if an aircraft deviates or is expected to deviate by 1 500 ft from the localizer centreline. Information or instructions issued by the monitoring controller will be aimed at returning the aircraft to the localizer course. If the aircraft fails to take corrective action, the aircraft on the adjacent localizer may be issued appropriate control instructions. Monitoring of the approach is terminated without notification to the pilot when the aircraft is 1 NM from the runway threshold. If considered necessary, appropriate missed approach instructions will be issued.

THE APPROACH CLEARANCE WILL INCLUDE AN ALTITUDE THAT MUST BE MAINTAINED UNTIL INTERCEPTING THE GLIDE PATH. If the glide path is inoperative, the pilot will be cleared to maintain an altitude to a specified distance measuring equipment (DME) distance before commencing the descent.

When informed by automatic terminal information service (ATIS) or by the arrival controller that simultaneous precision instrument approaches are in progress, pilots should advise the arrival controller immediately of any avionics unserviceabilities having an impact on their capabilities to accept this procedure.

9.28 SIMULTANEOUS PRECISION INSTRUMENT APPROACHES – CONVERGING RUNWAYS

ATC may clear pilots for precision instrument approaches simultaneously to converging runways at airports where this procedure has been approved.

Aircraft will be informed through ATIS or by the arrival controller as soon as feasible after initial contact when simultaneous precision instrument approaches to converging runways are in progress. When simultaneous approaches are in progress, ATC will vector arriving aircraft to the appropriate runway localizer for a straight-in final approach. Pilots should advise the arrival controller immediately of any malfunctioning or inoperative equipment making this procedure undesirable.

These are the restrictions for simultaneous precision approaches to converging runways:

- Converging runways (defined as an included angle between 15° and 100°).
- Radar available.
- Precision instrument approach systems (ILS/MLS) operating on each runway.
- Non-intersecting final approach courses.
- Missed approach points at least 3 NM apart.
- Non-overlapping primary missed approach protected airspace.
- Separate instrument approach charts denoting the procedures.
- If runways intersect, tower controllers must be able to apply visual separation as well as intersecting runway separation criteria.
- Only straight-in approaches and landing are authorized.

To emphasize the protection of active runways and to aid in preventing runway incursions, landing instructions which include the words “HOLD SHORT” should be acknowledged by a readback of the hold point by the pilot.

10.0 INSTRUMENT FLIGHT RULES (IFR) — HOLDING PROCEDURES

10.1 GENERAL

Pilots are expected to adhere to the aircraft entry and holding manoeuvres, as described in RAC 10.5, since ATC provides lateral separation in the form of airspace to be protected in relation to the holding procedure.

10.2 HOLDING CLEARANCE

A holding clearance issued by ATC includes at least

- a clearance to the holding fix;
- the direction to hold from the holding fix;
- a specified radial, course, or inbound track;
- if DME is used, the DME distances at which the fix end and outbound end turns are to be commenced (e.g. hold between [number of miles] and [number of miles]);

NOTE:

In the absence of an outbound DME being issued by ATC, pilots are expected to time the holding pattern in accordance with sub-sections below.

- the altitude or FL to be maintained; and
- the time to expect further clearance or an approach clearance; or
- the time to leave the fix in the event of a communications failure.

NOTE:

An expect-further-clearance time is usually followed by further en route clearance, which is followed by an expect-approach-clearance time when traffic conditions permit.

During entry and holding, pilots manually flying the aircraft are expected to make all turns to achieve an average bank angle of at least 25° or a rate of turn of 3° per second, whichever requires the lesser bank. Unless the ATC clearance contains instructions to the contrary, or a non-standard holding pattern is published at the holding fix, pilots are expected to make all turns to the right after initial entry into the holding pattern.

Occasionally, a pilot may reach a clearance limit before obtaining further clearance from ATC. In this event, where a holding pattern is published at the clearance limit, the pilot is to hold as published. Where no holding pattern is published, the pilot is to hold in a standard pattern on the inbound track to such clearance limit and request further clearance.

If communication cannot be established with ATC, the pilot should then proceed in accordance with communication failure procedures.

Examples

- A westbound flight on R77, cleared to Greely NDB (YRR) reaches Ottawa before obtaining further clearance. The pilot is to hold at YRR on an inbound track of 287° and request further clearance.
- The published missed approach procedure for an ILS RWY 23 approach at Halifax is the following: *"CLIMB TO 2 200 ON TRACK OF 234° TO "ZHZ" NDB."*

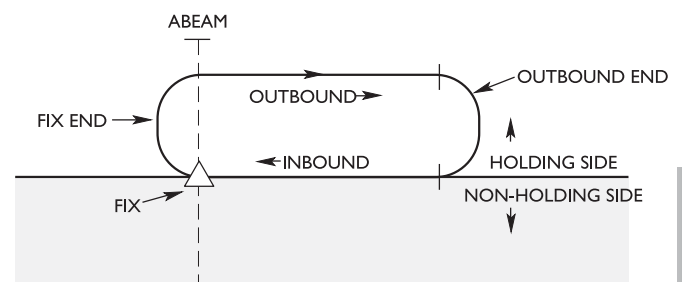
A pilot missing an ILS approach to RWY 23 and not in receipt of further clearance is to proceed directly to the "ZHZ" NDB, make a right turn and hold at the "ZHZ" beacon on an inbound track of 234° and request further clearance.

If for any reason a pilot is unable to conform to these procedures, ATC should be advised as early as possible.

10.3 STANDARD HOLDING PATTERN

A standard holding pattern is depicted in Figure 10.1 in terms of still air conditions.

Figure 10.1—Standard Holding Pattern



- Having entered the holding pattern, on the second and subsequent arrivals over the fix, the pilot executes a right turn to fly an outbound track that positions the aircraft most appropriately for the turn onto the inbound track. When holding at a VOR, the pilot should begin the turn to the outbound leg at the time of station passage as indicated on the TO-FROM indicator.
- Continue outbound for one minute if at or below 14 000 ft ASL, or one and a half minutes if above 14 000 ft ASL. (ATC specifies distance, not time, where a DME fix is to be used for holding.)
- Turn right to realign the aircraft on the inbound track.

10.4 NON-STANDARD HOLDING PATTERN

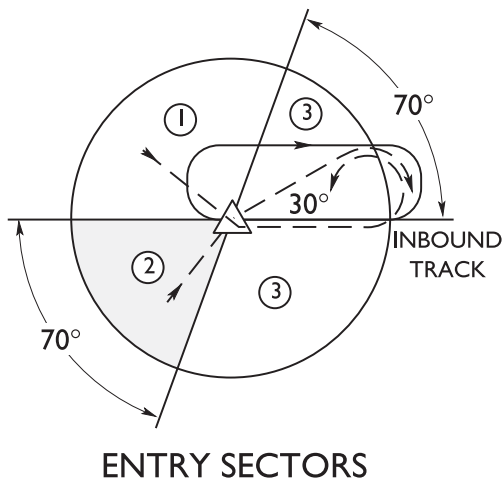
A non-standard holding pattern is one in which

- the fix end and outbound end turns are to the left; and/or
- the planned time along the inbound track is other than the standard one-minute or one-and-a-half minute leg appropriate for the altitude flown.

10.5 ENTRY PROCEDURES

The pilot is expected to enter a holding pattern according to the aircraft's heading in relation to the three sectors shown in Figure 10.2, recognizing a zone of flexibility of five degrees on either side of the sector boundaries. For holding on VOR intersections or VOR/DME/TACAN (VHF omnidirectional range/distance measuring equipment/tactical air navigation aid) fixes, entries are limited to the radials or DME arcs forming the fix, as appropriate.

Figure 10.2—Entry Sectors



ENTRY SECTORS

Sector 1 procedures (parallel entry) are:

- Upon reaching the fix, turn onto the outbound heading of the holding pattern for the appropriate period of time.
- Turn left to intercept the inbound track or to return directly to the fix.
- On the second arrival over the fix, turn right and follow the holding pattern.

Sector 2 procedures (offset entry) are:

- Upon reaching the fix, turn to a heading that results in a track having an angle of 30° or less from the inbound track reciprocal on the holding side.

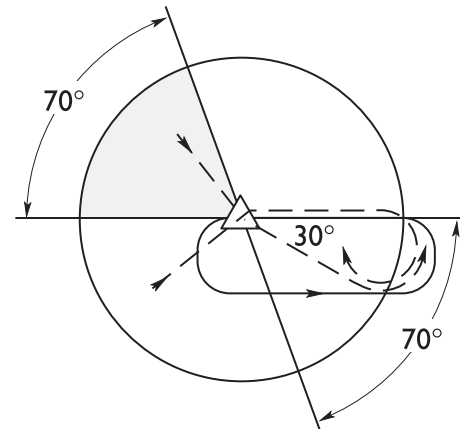
- continue for the appropriate period of time, then turn right to intercept the inbound track and follow the holding pattern.

Sector 3 procedure (direct entry) is:

- Upon reaching the fix, turn right and follow the holding pattern.

Entry procedures to a non-standard pattern requiring left turns are oriented in relation to the 70° line on the holding side (Figure 10.3), just as in the standard pattern.

Figure 10.3—Left Hand Pattern Entry



LEFT HAND ENTRY PATTERN

When crossing the fix to enter a holding pattern, the appropriate ATC unit should be advised. ATC may also request that the pilot report “established in the hold”. The pilot is to report “established” when crossing the fix after having completed the entry procedure.

10.6 TIMING

The still air time for flying the outbound leg of a holding pattern should not exceed 1 min if at or below 14 000 ft ASL, or 1 1/2 min if above 14 000 ft ASL; however, the pilot should make due allowance in both heading and timing to compensate for wind effect.

After the initial circuit of the pattern, timing should begin abeam the fix or on attaining the outbound heading, whichever occurs later. The pilot should increase or decrease outbound times, in recognition of winds, to effect 1 or 1 1/2 min (appropriate to altitude) inbound to the fix.

When the pilot receives ATC clearance specifying the time of departure from the holding fix, adjustments should be made to the flight pattern within the limits of the established holding pattern to leave the fix as close as possible to the time specified.

10.7 SPEED LIMITATIONS

The size of the protected airspace for a holding pattern is based on aircraft speed. Unless otherwise noted on the charts or when a shuttle procedure is specified (see RAC 10.9), holding patterns must be entered and flown at or below the airspeeds listed in Table 10.1 below:

Table 10.1—Maximum Holding Airspeeds

Altitude (ASL)	Maximum Holding Airspeed (KIAS)
At or below 6 000 ft	200
Above 6 000 ft up to and including 14 000 ft	230
Above 14 000 ft	265

NOTES:

- At Canadian military airfields, the size of the protected airspace is for a maximum of 310 KIAS, unless otherwise noted.
- For helicopter procedures (COPTER), the maximum holding airspeed is 90 KIAS, unless otherwise noted.

Pilots are to advise ATC immediately if airspeeds in excess of those specified above become necessary for any reason, including turbulence, or if they are unable to accomplish any part of the holding procedure.

After departing a holding fix, pilots should resume normal speed subject to other requirements, such as speed limitations in the vicinity of controlled airports, specific ATC requests, etc.

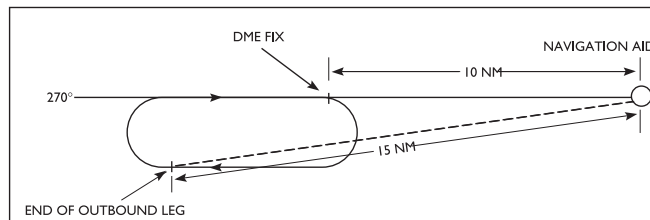
NOTE:

In areas where turbulence is known to exist, holding patterns may be designed for speeds of 280 KIAS.

10.8 DISTANCE MEASURING EQUIPMENT (DME) PROCEDURES

DME holding is subject to the same entry and holding procedures previously described except that distances, in NM are used in lieu of time values. In describing the direction from the fix on which to hold and the limits of a DME holding pattern, an ATC clearance will specify the DME distance from the navigation aid at which the inbound and outbound legs are to be terminated. The end of each leg is determined by the DME indications.

Figure 10.4—DME Hold



Example:

An aircraft cleared to the 270° RADIAL 10 mile DME FIX, to HOLD BETWEEN 10 AND 15 miles, will hold inbound on the 270° radial, commence turn to the outbound leg when the DME indicates 10 NM and commence turn to inbound leg when the DME indicates 15 NM.

10.9 SHUTTLE PROCEDURE

A shuttle procedure is defined as a manoeuvre involving a descent or climb in a pattern resembling a holding pattern. Shuttles are generally prescribed on instrument procedure charts located in mountainous areas. In the approach phase, it is normally prescribed where a descent of more than 2 000 ft is required during the initial or intermediate approach segments. It can also be required when flying a missed approach or departure procedure from certain airports in the vicinity of mountain ranges. A shuttle procedure shall be executed in the pattern as published unless instructions contained in an ATC clearance direct otherwise.

To ensure that the aircraft does not exceed the obstacle clearance protected airspace during a shuttle descent or climb, the aircraft must not exceed:

- the airspeed limit published on instrument procedure charts or, if no airspeed limit is published, the following limits:
 - For climbs, the maximum airspeed is 310 KIAS.
 - For descents, the maximum airspeeds from Table 10.1 apply;
- the outbound/inbound still air time restrictions;
- the DME holding restrictions.

NOTE:

All shuttle climb airspeeds are subject to CAR 602.32.

10.10 HOLDING PATTERNS PUBLISHED ON ENROUTE AND TERMINAL CHARTS

At some high traffic density areas, holding patterns are depicted on IFR Terminal Area and Enroute charts. When pilots are cleared to hold at a fix where a holding pattern is published, or if clearance beyond the fix has not yet been received, pilots are to hold according to the depicted pattern using normal entry



procedures and timing in the hold as described above. ATC will use the following phraseology when clearing an aircraft holding at a fix that has a published holding pattern;

*CLEARED TO THE (fix), HOLD (direction) AS PUBLISHED
EXPECT FURTHER CLEARANCE AT (time)*

NOTE:

The holding direction means the area in which the hold is to be completed in relation to the holding fix, e.g. east, northwest, etc. If a pattern is required that is different than that published, detailed holding instructions will be issued by ATC.

If a pilot is instructed to depart a fix that has a published hold, at a specified time, the pilot has the option to:

- a) proceed to the fix, then hold until the “depart fix” time specified;
- b) reduce speed to make good his “depart fix” time; or
- c) a combination of (a) and (b).

11.0 AIR TRAFFIC CONTROL (ATC) SPECIAL PROCEDURES

11.1 ADHERENCE TO MACH NUMBER

- a) Within CDA, aircraft shall adhere to the Mach number assigned by ATC, to within 0.01 Mach, unless approval is obtained from ATC to make a change or until the pilot receives the initial descent clearance approaching destination. If it is necessary to make an immediate temporary change in the Mach number (e.g. because of turbulence), ATC shall be notified as soon as possible that such a change has been made.
- b) If it is not possible to maintain the last assigned Mach number during en route climbs and descents because of aircraft performance, pilots shall advise ATC at the time of the climb/descent request.

11.2 PARALLEL OFFSET PROCEDURES

- a) ATC may request that an aircraft fly a parallel offset from an assigned route. This manoeuvre and subsequent navigation is the responsibility of the pilot. When requested to offset or regain the assigned route, the pilot should change heading by 30° to 45° and report when the offset or assigned route is attained.
- b) In a radar environment, ATC will provide radar monitoring and the required separation.
- c) In a non-radar environment, ATC will apply parallel offsets to RNPC-certified aircraft operating within high-level RNPC

airspace in order to accomplish an altitude change with respect to same direction aircraft.

- d) The following phraseology is normally used for parallel offset procedures:

*PROCEED OFFSET (number) MILES (right/left) OF
CENTRELINE (track/route) AT (significant point/time)
UNTIL (significant point/time).*

11.3 STRUCTURED AIRSPACE

During specific periods, certain portions of domestic high-level airspace may be structured for one-way traffic in which cruising flight levels inappropriate to the direction of the aircraft track may be assigned by ATC. Aircraft operating in a direction contrary to the traffic flow will be assigned those cruising flight levels appropriate to the direction of track except in specific instances, such as turbulence. When the airspace is not structured for one-way traffic, appropriate cruising flight levels will be used. ATC will transition aircraft to the appropriate cruising flight level for the direction of track before aircraft exit the defined areas or before termination of the indicated times.

11.4 CANADIAN DOMESTIC ROUTES

11.4.1 General

Within North American Airspace, various route and track systems exist in order to provide effective management of airspace and traffic. Under specified conditions, random routes may be included in a flight plan or requested.

11.4.2 North American Route Program (NRP)

11.4.2.1 Introduction

The North American Route Program (NRP) is a joint FAA and NAV CANADA program that allows air operators to select operationally advantageous routings. The objective of the NRP is to harmonize and adopt common procedures, to the extent possible, applicable to random route flight operations at and above FL 290 within the conterminous U.S. and Canada.

The NRP will be implemented through various phases with the end goal of allowing all international and domestic flight operations to participate in the NRP throughout the conterminous U.S. and Canada.

11.4.2.2 Eligibility

Flights may participate in the NRP under specific guidelines and filing requirements:

- a) provided the flight originates and terminates within conterminous U.S. and Canada; or

- b) for North Atlantic international flights, provided that they are operating within the North American Route (NAR) System.

11.4.2.3 Procedures

NRP common procedures and specific NAV CANADA requirements are contained in the “Planning” section of the CFS.

11.4.3 Mandatory Instrument Flight Rules (IFR) Routes

Air traffic controllers and ATS automated systems rely on certain set routes in order to plan systematic air traffic flows, a process that is critical for reducing delays. Mandatory IFR routes provide guidance in planning routes, minimize route changes, and allow for efficient departure, en route, and arrival ATS while also reducing communication and the potential for readback and FMS input errors.

Procedures for and descriptions of mandatory routes are published in the “Planning” section of the CFS.

11.4.4 Fixed Area Navigation (RNAV) Routes

Published fixed RNAV routes can be flight planned for use by aircraft with RNAV capability, subject to any limitations or requirements noted on the en route charts, in applicable advisory circulars, or by NOTAM.

- a) Q-routes are high-level fixed RNAV routes depicted on En Route High Altitude charts using black dashed lines and require an RNAV system with performance capabilities currently only met by GNSS or distance measuring equipment/inertial reference unit (DME/DME/IRU) systems. DME/DME/IRU navigation may be limited in some parts of Canada owing to navigational facility coverage. In such cases, the routes will be annotated as “GNSS only” on the chart.
- b) T-routes are low-level controlled fixed RNAV routes depicted on En Route Low Altitude charts using black dashed lines and require GNSS RNAV systems for use. The airspace associated with T-routes extends upward from 2 200 ft AGL, 10 NM either side of the centreline, and does not splay. The MOCA provides obstacle protection for only 6 NM either side of the track centreline and does not splay.
- c) L-routes are low-level uncontrolled fixed RNAV routes depicted on En Route Low Altitude charts using green dashed lines and require GNSS RNAV systems for use. The MOCA provides obstacle protection for only 6 NM either side of the track centreline and does not splay.

Magnetic reference bearing (MRB) is the published bearing between two waypoints on a fixed RNAV route and will be published within the SDA. The MRB is calculated by applying magnetic variation at the waypoint to the calculated true course between two waypoints. Pilots should use this bearing as a

reference only, because RNAV systems will fly the true course between the waypoints. True reference bearings (TRB) will be published along fixed RNAV routes located in the NDA and shall be notated with the suffix “T.”

11.4.5 Northern Control Area (NCA) Random Routes

Within the Northern Control Area (NCA), flights operating on random routes shall flight plan and make positions reports as follows:

- a) flights operating on predominately north or south tracks (315°T clockwise through 045°T or the reciprocals) shall report over reporting line points formed by the intersection of parallels of latitude spaced at 5° intervals expressed in latitude by whole degrees and meridians of longitude expressed in either whole degrees or whole and half degrees;
- b) south of 75°N latitude, flights operating on predominately east or west tracks (046°T clockwise through 134°T or the reciprocals) shall report over reporting line points formed by the intersection of either whole degrees or whole and half degrees of latitude coincident with each 10° of longitude. For flights operating north of 75°N latitude, where 20° of longitude is traversed in less than 60 min, reporting line points are to be defined by parallels of latitude expressed in degrees and minutes coincident with meridians of longitude at 20° intervals;
- c) as requested by ATS.

11.4.6 Arctic Control Area (ACA) Random Routes

Within the Arctic Control Area (ACA), flights operating on random routes shall flight plan and make positions reports as follows:

- a) at the reporting lines coincident with 141°W, 115°W and 60°W meridians. If the route of flight is north of 87°N latitude, the 115°W report is not required;
- b) westbound flights which do not cross the 60°W meridian on entry or prior to entry into the ACA shall report at the point of entry into the ACA;
- c) westbound flights which do not cross the 141°W meridian prior to exiting the ACA shall report at the point of exit from the ACA;
- d) eastbound flights which do not cross the 141°W meridian on entry into the ACA shall report at the point of entry;
- e) eastbound flights which do not cross the 60°W meridian on or after exiting the ACA shall report the point of exit;
- f) northbound or southbound flights which do not cross significant reporting lines shall report at the entry and exit points of the ACA; and
- g) as requested by ATS.

11.4.7 Polar Routes

11.4.7.1 General

With the advent of aircraft capable of long-range flight, circumventing the globe via the North Pole has become routine. Polar routes are flight paths to or from the Americas and Eurasia via Russian polar airspace. Polar flights must file designated polar fixes on the Anchorage/Russian border but are otherwise random in Canadian airspace.

11.4.7.2 Flight Planning and Position Reporting

Polar routes can be flight planned by aircraft with CMNPS certification. Flight plan routing should be filed with a fix every 5° of latitude. Random points should be expressed in whole degrees of latitude and either whole degrees or whole and half degrees of longitude.

11.4.7.3 Altitude Assignment

Current cruising altitude for direction of flight requirements are based on east-west traffic flows. A shift in flight track (from east to west or vice versa) requires the assignment of a new flight level. Flights on north-south routes may shift track, from easterly to westerly or vice versa, depending on route segment. This shifting makes altitude assignment based on current regulations less than optimal.

In order to accommodate polar route flights, aircraft operating on polar routes within the Edmonton, Winnipeg and Montréal FIRs may be assigned altitudes inappropriate to the direction of flight. Altitude assignment is based on traffic management requirements for the movement of aircraft in a safe, orderly and expeditious manner.

11.5 NORTHERN AMERICAN ROUTE (NAR) SYSTEM

- a) The NAR System provides an interface between NAT oceanic and domestic airspaces. Operating conditions and description of the NAR are contained in RAC 11.4 and the CFS, “Planning” section.
- b) For a detailed description of the NAR System, refer to the CFS NORTH AMERICAN ROUTES (NARs) for NORTH ATLANTIC TRAFFIC Section 7(a), which outlines the requirements to flight plan and operate using the NAR system.

11.6 SECURITY CONTROL OF AIR TRAFFIC

(see CFS, Emergency Section)

11.7 REDUCED VERTICAL SEPARATION MINIMUM (RVSM)

11.7.1 Definitions

RVSM: The application of 1000-ft vertical separation at and above FL 290 between aircraft approved to operate in reduced vertical separation minimum airspace.

Non-RVSM Aircraft: An aircraft that does not meet reduced vertical separation minimum (RVSM) requirements for certification and/or for operator approval.

RVSM Aircraft: An aircraft that meets reduced vertical separation minimum (RVSM) requirements for certification and for operator approval.

11.7.2 Reduced Vertical Separation Minimum (RVSM) Airspace

- a) RVSM airspace is all airspace within CDA from FL 290 to FL 410 inclusive as defined in the DAH (TP 1820) and depicted in Figure 12.3.

Figure 11.1—RVSM Airspace and RVSM Transition Airspace



11.7.3 Air Traffic Control (ATC) Procedures

- a) Within RVSM airspace ATC:
- (i) will, within non-radar airspace, endeavour to establish 2 000 ft separation or applicable lateral or longitudinal separation minimum if an aircraft reports greater-than-moderate turbulence, and/or mountain wave activity that is of sufficient magnitude to significantly affect altitude-keeping, and is within 5 min of another aircraft at 1 000 ft separation;
 - (ii) will, within radar airspace, vector aircraft to establish radar separation or establish 2 000 ft separation if an aircraft reports greater-than-moderate turbulence, or encountering mountain wave activity that is of sufficient magnitude to significantly affect altitude-keeping, if 1 000 ft vertical separation exists between two aircraft, and targets appear likely to merge;
 - (iii) may structure portions of the airspace for specific periods of time for one-way traffic in which inappropriate flight levels to the direction of flight may be assigned; and
 - (iv) may, within non-radar airspace, temporarily suspend RVSM within selected areas and/or altitudes due to adverse weather conditions, e.g. pilot reports greater-than-moderate turbulence. When RVSM is suspended, the vertical separation minimum between all aircraft will be 2 000 ft.
- b) Pilots may be requested by ATC to confirm that they are approved for RVSM operations. Pilots/operators unable to provide such confirmation will be issued a clearance to operate outside RVSM airspace:

Phraseology: *"Affirm RVSM" or "Negative RVSM (supplementary information, e.g. monitoring flight)." See phraseology depicted in Figure 12.4*

11.7.4 In-Flight Procedures

- a) Before entering RVSM airspace, the status of required equipment should be reviewed. The following equipment should be operating normally:
- (i) two independent altitude measurement systems;
 - (ii) one automatic altitude control system; and
 - (iii) one altitude alert system.
- b) The pilot must notify ATC whenever the aircraft:
- (i) is no longer RVSM-compliant due to equipment failure;
 - (ii) experiences loss of redundancy of altimetry systems; or
 - (iii) encounters turbulence or mountain wave activity that affects the capability to maintain the cleared flight level.
- c) In the event that any of the required equipment fails prior to entering RVSM airspace, a new clearance should be requested in order to avoid RVSM airspace.
- d) In level cruise, it is essential that the aircraft maintains the cleared flight level. Except in contingency situations, aircraft

should not deviate from the cleared flight level without an ATC clearance. If the pilot is notified by ATC of an assigned altitude deviation (AAD) error of 300 ft or greater, the pilot should return to the cleared flight level as soon as possible.

- e) **TRANSITION BETWEEN FLs:** During cleared transition between flight levels, the aircraft should not overshoot or undershoot the assigned level by more than 150 ft.

11.7.5 Flight Planning Requirements

- a) Unless an aircraft can be accommodated in RVSM airspace as detailed in paragraph 12.17.6, RVSM approval is required for the aircraft to operate within RVSM airspace. The operator must determine that the aircraft has been approved by the appropriate State authority and will meet the RVSM requirements for the filed route of flight and any planned alternate routes. The letter "W" shall be inserted in Item 10 (Equipment) of the flight plan to indicate that the aircraft is RVSM-compliant and the operator is RVSM-approved. The "W" designator is not to be used unless both conditions are met. If the aircraft registration is not used in Item 7, the registration is to be entered in Item 18 (RAC 3.16.8 "REG/").
- b) ATC will use the equipment block information to either issue or deny clearance into RVSM airspace and to apply either 1 000 ft or 2 000 ft vertical separation minimum.
- c) Non-RVSM aircraft requesting permission to operate in RVSM airspace shall include "STS/NONRVSM" in Item 18 of the flight plan to indicate the reason for special handling by ATS.

11.7.6 Operation of Non-Reduced Vertical Separation Minimum (Non-RVSM) Aircraft in RVSM Airspace

- a) **FLIGHT PRIORITY:**
- RVSM aircraft will be given priority for level allocation over non-RVSM aircraft. Non-RVSM aircraft may be accommodated on a traffic- and workload-permitting basis.
- b) **VERTICAL SEPARATION:**
- The vertical separation minimum between non-RVSM aircraft operating in RVSM airspace and all other aircraft is 2 000 ft.
- c) **CONTINUOUS CLIMB OR DESCENT THROUGH RVSM AIRSPACE:**
- Non-RVSM aircraft may be cleared to climb to and operate above FL 410 or descend to and operate below FL 290, provided the aircraft is capable of:
- (i) a continuous climb or descent and does not need to level off at an intermediate altitude for any operational considerations; and
 - (ii) climb or descent at the normal rate for the aircraft.

d) STATE AIRCRAFT:

For the purposes of RVSM operations, State aircraft are those aircraft used in military, customs and police services.

State aircraft are exempt from the requirement to be RVSM-approved to operate in RVSM airspace.

e) NON-RVSM AIRCRAFT IN RVSM AIRSPACE:

Non-RVSM aircraft may flight plan to operate within RVSM airspace, provided the aircraft:

- (i) is being delivered to the State of Registry or Operator;
- (ii) was formerly RVSM-approved, but has experienced an equipment failure and is being flown to a maintenance facility for repair in order to meet RVSM requirements and/or obtain approval;
- (iii) is being utilized for mercy or humanitarian purposes;
- (iv) is a photographic survey flight (CDA only). This approval is not applicable for that portion of flight transiting to and from the area(s) of surveying or mapping operations;
- (v) is conducting flight checks of a NAVAID. This approval is not applicable for that portion of flight transiting to and from the area(s) of flight check operations; or
- (vi) is conducting a monitoring, certification or developmental flight.

f) PHRASEOLOGY:

Pilots of non-RVSM flights should include the phraseology “negative RVSM” in all initial calls on ATC frequencies, requests for flight level changes, readbacks of flight level clearances within RVSM airspace and readbacks of climb or descent clearances through RVSM airspace. See Figure 12.4.

appropriate, to conduct RVSM operations. For the purposes of RVSM, the following terminology has been adopted:

- (i) RVSM Airworthiness Approval: The approval that is issued by the appropriate State authority to indicate that an aircraft has been modified in accordance with the relevant approval documentation, e.g. service bulletin, supplemental type certificate, and is therefore eligible for monitoring. The date of issue of such an approval should coincide with the date when the modification was certified by the operator as being complete.
 - (ii) RVSM (Operational) Approval: The approval that is issued by the appropriate State authority once an operator has achieved the following:
 - (A) RVSM airworthiness approval; and
 - (A) State approval of Operations Manual (where applicable) and on-going maintenance procedures.
- b) Operators of Canadian-registered aircraft intending to operate in RVSM airspace will be required to show that they meet all the applicable standards in accordance with CARs Parts VI and VII. Information on RVSM approval may be obtained from:

Airworthiness Approvals:

Transport Canada
 Safety and Security Director,
 Aircraft Certification (AARD)
 Ottawa ON K2G 5X4
 Tel: 1-800-305-2059
 Fax: 613-996-9178

Operating Standards Commercial Air Carriers and Private Operators:

Transport Canada Safety and Security,
 Commercial and Business Aviation (AARTF)
 Ottawa ON K1A 0N8
 Tel.: 1-800-305-2059
 Fax: 613-954-1602

RVSM Maintenance Programs: (AARTM)
 Transport Canada Safety and Security,
 Ottawa ON K1A 0N8
 Tel.: 1-800-305-2059
 Fax: 613-952-3298

11.7.7 Delivery Flights for Aircraft that are Reduced Vertical Separation Minimum (RVSM)-Compliant on Delivery

- a) An aircraft that is RVSM-compliant on delivery may operate in Canadian Domestic RVSM airspace provided that the crew is trained on RVSM policies and procedures applicable in the airspace and the responsible State issues the operator a letter of authorization approving the operation.
- b) State notification to the NAARMO should be in the form of a letter, e-mail or fax documenting the one-time flight indicating:
 - (i) planned date of the flight;
 - (ii) flight identification;
 - (iii) registration number; and
 - (iv) aircraft type/series.

11.7.8 Airworthiness and Operational Approval and Monitoring

- a) Operators must obtain airworthiness and operational approval from the State of Registry or State of the Operator, as

11.7.9 Monitoring

- a) All operators that operate or intend to operate in airspace where RVSM is applied are required to participate in the RVSM monitoring program. Monitoring prior to the issuance of RVSM operational approval is not a requirement. However, operators should submit monitoring plans to the responsible civil aviation authority to show that they intend to meet the North American RVSM Minimum Monitoring Requirements.
- b) Ground-based and GPS-based monitoring systems are available to support RVSM operations. Monitoring is a quality control program that enables Transport Canada and other



civil aviation authorities to assess the in-service altitude-keeping performance of aircraft and operators.

- c) Ground-based height monitoring systems are located in the vicinity of Ottawa, Ont., and Lethbridge, Alta. Over-flight of ground-based height monitoring systems is transparent to the pilot. Aircraft height-keeping performance monitoring flights using ground-based monitoring systems should be flight planned to route within a 30 NM radius of the Ottawa VORTAC, or a 30 NM radius of the Lethbridge VOR/DME.
- d) GPS monitoring unit (GMU) services to conduct a height-keeping performance monitoring flight may be obtained from the following agencies:

CSSI, Inc.
 Washington, DC
 Tel: 202-863-2175
 E-mail: monitor@cssiinc.com
 Web site: ...www.cssiinc.com/industries/aviation/reduced-vertical-separation-minimum-rvsm/

ARINC
 Annapolis, MD
 RVSM Operations Coordinator
 Tel: 410-266-4707
 E-mail: rvsmops@arinc.com
 Web site: www.rockwellcollins.com

11.7.10 North American Approvals Registry and Monitoring Organization (NAARMO)

- a) The Regional Monitoring Agency for CDA is the NAARMO, located in Atlantic City, NJ, and may be contacted as follows:
 William J. Hughes Technical Center NAS & International Airspace Analysis Branch (ACT-520)
 Atlantic City International Airport Atlantic City, NJ
 08405 USA
 Fax: 609-485-5117
 AFTN: N/A
- b) Information on the responsibilities and procedures applicable to the NAARMO may be found on the Web site:

<www.faa.gov/air_traffic/separation_standards/naarmo/>.

11.7.11 Traffic Alert and Collision Avoidance System (TCAS) II/Airborne Collision Avoidance System (ACAS) II Reduced Vertical Separation Minimum (RVSM) Requirements

Aeroplanes operating in accordance with CAR 702, 703, 704 and 705 in RVSM airspace must be equipped with TCAS II/ACAS II. The TCAS II/ACAS II must be TSO to TSO-C-119b or later revision (TCAS II software version 7.0). All other TCAS/ACAS-equipped aircraft operating in RVSM airspace should be equipped with software version 7.

11.7.12 Mountain Wave Activity (MWA)

- a) Significant MWA occurs both below and above FL 290, which is the floor of RVSM airspace. It often occurs in western Canada and western USA in the vicinity of mountain ranges. It may occur when strong winds blow perpendicular to mountain ranges, resulting in up and down or wave motions in the atmosphere. Wave action can produce altitude excursions and airspeed fluctuations accompanied by only light turbulence. With sufficient amplitude, however, wave action can induce altitude and airspeed fluctuations accompanied by severe turbulence. MWA is difficult to forecast and can be highly localized and short-lived
- b) Wave activity is not necessarily limited to the vicinity of mountain ranges. Pilots experiencing wave activity anywhere that significantly affects altitude-keeping can follow the guidance provided below.
- c) In-flight indications that the aircraft is being subjected to MWA are:
 - (i) altitude excursions and airspeed fluctuations with or without associated turbulence;
 - (ii) pitch and trim changes required to maintain altitude with accompanying airspeed fluctuations; and
 - (iii) light to severe turbulence depending on the magnitude of the MWA.
- d) *TCAS Sensitivity*—For both MWA and greater-than-moderate turbulence encounters in RVSM airspace, an additional concern is the sensitivity of collision avoidance systems when one or both aircraft operating in close proximity receive TCAS advisories in response to disruptions in altitude hold capability.
- e) *Pre-flight tools*—Sources of observed and forecast information that can help the pilot ascertain the possibility of MWA or severe turbulence are: Forecast Winds and Temperatures Aloft (FD), Area Forecast (FA), SIGMETS and PIREPS.

11.7.13 Wake Turbulence

- a) Pilots should be aware of the potential for wake turbulence encounters following Southern Domestic RVSM (SDRVSM) implementation. Experience gained since 1997, however, has shown that such encounters in RVSM airspace are generally moderate or less in magnitude.
- b) It is anticipated that, in SDRVSM airspace, wake turbulence experience will mirror European RVSM experience gained since January 2002. European authorities have found that reports of wake turbulence encounters had not increased significantly since RVSM implementation (eight versus seven reports in a ten-month period). In addition, they found that reported wake turbulence was generally similar to moderate clear air turbulence.

RAC

- c) Pilots should be alert for wake turbulence when operating:
 - (i) in the vicinity of aircraft climbing or descending through their altitude;
 - (ii) approximately 12–15 mi. after passing 1 000 ft below opposite direction traffic; and
 - (iii) approximately 12–15 mi. behind and 1 000 ft below same direction traffic.

Table 11.1—Pilot/Controller Standard Phraseology for RVSM Operations

Message	Phraseology
For a controller to ascertain the RVSM approval status of an aircraft	(call sign) confirm RVSM approved
Pilot indication that flight is RVSM-approved	Affirm RVSM
Pilot will report lack of RVSM approval (Non-RVSM status): <ul style="list-style-type: none"> a. On the initial call on any frequency in the RVSM airspace; and b. In all requests for flight level changes pertaining to flight levels within the RVSM airspace; and c. In all read-backs to flight level clearances pertaining to flight levels within the RVSM airspace; and d. In read-back of flight level clearances involving climb and descent through RVSM airspace (FL 290–410) 	Negative RVSM (supplementary information, e.g. "monitoring flight")
Pilot report of one of the following after entry into RVSM airspace: all primary altimeters, automatic altitude control systems or altitude alerters have failed (This phrase is to be used to convey both the initial indication of RVSM aircraft system failure and on initial contact on all frequencies in RVSM airspace until the problem ceases to exist or the aircraft has exited RVSM airspace)	Unable RVSM Due Equipment
ATC denial of clearance into RVSM airspace	Unable issue clearance into RVSM airspace, maintain FL___.
Pilot reporting inability to maintain cleared flight level due to weather encounters.	Unable RVSM due (state reason) (e.g. turbulence, mountain wave)
ATC requesting pilot to confirm that an aircraft has regained RVSM-approved status or a pilot is ready to resume RVSM	Confirm able to resume RVSM
Pilot ready to resume RVSM after aircraft system or weather contingency	Ready to resume RVSM

11.7.14 In-Flight Contingencies

- a) The following general procedures are intended as guidance only. Although all possible contingencies cannot be covered, they provide for cases of inability to maintain assigned level due to:
 - (i) weather;
 - (ii) aircraft performance; and
 - (iii) pressurization failure.

The pilot’s judgment should determine the sequence of actions to be taken, taking into account specific circumstances, and ATC shall render all possible assistance.

- b) If an aircraft is unable to continue flight in accordance with its ATC clearance, a revised clearance shall, whenever possible, be obtained prior to initiating any action, using a distress or urgency signal if appropriate. If prior clearance cannot be obtained, an ATC clearance shall be obtained at the earliest possible time. The pilot should take the following actions until a revised ATC clearance is received:
 - (i) establish communications with and alert nearby aircraft by broadcasting, at suitable intervals: flight identification, flight level, aircraft position, (including the ATS route designator or the track code) and intentions on the frequency in use, as well as on frequency 121.5 MHz (or, as a back-up, the inter-pilot air-to-air frequency 123.45 MHz);
 - (ii) initiate such action as necessary to ensure safety. If the pilot determines that there is another aircraft at or near the same flight level, which might conflict, the pilot is expected to adjust the path of the aircraft, as necessary, to avoid conflict.

Figure 12.5 provides pilot guidance on actions to take under certain conditions of aircraft system failure and weather encounters. It also describes the ATC controller actions in these situations. It is recognized that the pilot and controller will use judgement to determine the action most appropriate to any given situation.

Table 11.2(a)—Contingency Pilot Actions: Initial Actions

<p>Initial pilot actions when unable to maintain flight level or unsure of aircraft altitude—keeping capability</p> <ul style="list-style-type: none"> • Notify ATC and request assistance as detailed below; • Maintain cleared flight level, if possible, while evaluating the situation; • Watch for conflicting traffic, both visually and with reference to ACAS/TCAS, if equipped; and • Alert nearby aircraft by illuminating exterior lights, broadcasting position, flight level and intentions on 121.5 MHz (or as back-up, the inter-pilot air-to-air frequency, 123.45 MHz).

Table 11.2(b)—Contingency Pilot Actions: Inability to Maintain Cleared Flight Level Due to Weather

Pilot should:	ATC may be expected to:
<ul style="list-style-type: none"> Contact ATC and advise Unable RVSM Due (state reason)" (e.g. turbulence, mountain wave) 	<ul style="list-style-type: none"> In radar airspace, where 1 000 ft vertical separation exists between two aircraft, and targets appear likely to merge, vector one or both aircraft to establish radar separation until the pilot reports clear of the turbulence
<ul style="list-style-type: none"> If not initiated by the controller, and if in radar airspace, request vector clear of traffic at adjacent flight levels 	<ul style="list-style-type: none"> Provide lateral or longitudinal separation from traffic at adjacent flight levels, traffic-permitting
<ul style="list-style-type: none"> Request flight level change or re-route, if desired 	<ul style="list-style-type: none"> Advise pilot of conflicting traffic Issue flight level change or re-route, traffic-permitting

Table 11.2(c)—Contingency Pilot Actions: Report of Mountain Wave Activity

Pilot should:	ATC may be expected to:
<ul style="list-style-type: none"> Contact ATC and report experiencing MWA 	<ul style="list-style-type: none"> Advise pilot of conflicting traffic
<ul style="list-style-type: none"> If advised of conflicting traffic at adjacent flight levels and the aircraft is experiencing MWA that significantly affects altitude-keeping, request vector to acquire horizontal separation If so desired, request a flight level change or re-route 	<ul style="list-style-type: none"> If pilot requests, vector aircraft to achieve horizontal separation, traffic-permitting In radar airspace, where 1 000 ft vertical separation exists between two aircraft, and targets appear likely to merge, vector one or both aircraft to establish radar separation until the pilot reports clear of MWA Issue flight level change or re-route, traffic-permitting
<ul style="list-style-type: none"> Report location and magnitude of MWA to ATC 	<ul style="list-style-type: none"> Issue PIREP to other aircraft concerned

Table 11.2(d)—Contingency Pilot Actions: Wake Turbulence Encounter

Pilot should:	ATC may be expected to:
<ul style="list-style-type: none"> Contact ATC and request vector lateral offset or flight level change 	<ul style="list-style-type: none"> Issue vector, lateral offset or flight level change, traffic-permitting

Table 11.2(e)—Contingency Pilot Actions: Failure of Automatic Altitude Control System, Altitude Alerter or All Primary Altimeters

Pilot will:	ATC will:
<ul style="list-style-type: none"> Contact ATC and advise "Unable RVSM Due Equipment" Request Clearance out of RVSM unless operational situation dictates otherwise 	<ul style="list-style-type: none"> Provide 2 000 ft vertical separation or appropriate horizontal separation Clear aircraft out of RVSM airspace

Table 11.2(f)—Contingency Pilot Actions: One Operational Primary Altimeter

Pilot will:	ATC will:
<ul style="list-style-type: none"> Cross-check stand-by altimeter Notify ATC of loss of redundancy, operation with single primary altimeter If unable to confirm primary altimeter accuracy, follow action for failure of all primary altimeters 	<ul style="list-style-type: none"> Acknowledge operation with single primary altimeter and monitor progress

11.8 MINIMUM SAFE ALTITUDE WARNING (MSAW)

11.8.1 General

Minimum safe altitude warning (MSAW) is a radar display feature designed to alert controllers to the existence of aircraft operating or predicted to operate at altitudes where separation from terrain cannot be assured. It is used to assist controllers in detecting altitude deviations that could result in controlled flight into terrain (CFIT).

MSAW service is only available in the Vancouver FIR to IFR and CVFR aircraft operating in en route controlled airspace that receive radar service and are in direct communication with the controller. There is a service exclusion zone within a 100-NM radius of CYVR. In addition, MSAW service is not available in control zones and approach/departure corridors.

11.8.2 Procedures

In the event an MSAW is generated, the controller will provide the following information:

1. TERRAIN WARNING
2. IMMEDIATE SAFE ALTITUDE [VALUE]
3. ALTIMETER [VALUE]

11.8.3 Pilot-Initiated Terrain Avoidance Procedure

If the aircraft is equipped with GPWS or TAWS, the flight crew is expected to carry out the appropriate terrain avoidance procedures in response to an on-board alarm. The pilot of a GPWS/TAWS-equipped aircraft should acknowledge receipt of the altimeter and immediate safe altitude information from the controller. The pilot should also advise the controller of the terrain avoidance action being taken when beginning the manoeuvre or as soon as workload permits.

Example:

*Pilot: ROGER, INITIATING GPWS/TAWS CLIMB or
ROGER, GPWS/TAWS EQUIPPED*

The controller at this point will provide the aircraft with additional terrain-related information, as appropriate.

Example:

*ATC: [higher/lower] TERRAIN AHEAD, TO YOUR [left/right]
IMMEDIATE SAFE ALTITUDE NOW [altitude]*

11.8.4 Air Traffic Control (ATC)-Initiated Terrain Avoidance Procedure

After issuing the altimeter and immediate safe altitude information the controller will, if appropriate, provide direction based on the MSAW information received.

Example:

ATC: EXPEDITE CLIMB TO SEVEN THOUSAND

In the event that the aircraft is not GPWS/TAWS-equipped or the pilot has not yet received a warning from his/her on-board system, the pilot should request vectors for terrain avoidance assistance as required.

Example:

*Pilot: REQUEST VECTORS FOR TERRAIN AVOIDANCE or
REQUEST TERRAIN AVOIDANCE INSTRUCTION*

Although the prime responsibility to initiate terrain avoidance rests with the pilot, if, in the judgment of the controller, it becomes apparent that the aircraft is in danger of colliding with terrain, the controller may initiate terrain avoidance intervention.

Example:

*ATC: TURN [left/right] [number of] DEGREES IMMEDIATELY
or CLIMB [altitude] IMMEDIATELY*

Once terrain avoidance has been initiated, the pilot will be provided with all additional terrain-related information available.

Example:

*ATC: [higher/lower] TERRAIN AHEAD, TO YOUR [left/right]
IMMEDIATE SAFE ALTITUDE NOW [value]*

If, at any time during the procedure, the pilot regains sight of the terrain, visual terrain avoidance should resume and the controller should be advised as soon as practicable.

11.8.5 Assistance to Aircraft in Distress

The digitized terrain contour map component of the MSAW system can be used by the controller independently of the warning function to provide navigational assistance to any aircraft in need. Such aircraft could include radar-identified aircraft that are lost or have encountered icing in mountainous terrain.

Vectoring for terrain avoidance can be provided to aircraft in distress or experiencing an emergency, provided the pilot requests it or the controller suggests it and the pilot concurs.

RAC ANNEX**1.0 GENERAL**

This annex contains those *Canadian Aviation Regulations (CARs)* that relate to the subject matter of this chapter, but may not have been incorporated, in full or in part, in the chapter text.

2.0 CANADIAN AVIATION REGULATIONS (CARs)***Reckless or Negligent Operation of Aircraft*****602.01**

No person shall operate an aircraft in such a reckless or negligent manner as to endanger or be likely to endanger the life or property of any person.

Fitness of Flight Crew Members**602.02**

An operator of an aircraft shall not require any person to act as a flight crew member or to carry out a preflight duty, and a person shall not act as a flight crew member or carry out that duty, if the operator or the person has reason to believe that the person is not, or is not likely to be, fit for duty.

Alcohol or Drugs – Crew Members**602.03**

No person shall act as a crew member of an aircraft

- a) within 12 hours after consuming an alcoholic beverage;
- b) while under the influence of alcohol; or
- c) while using any drug that impairs the person's faculties to the extent that the safety of the aircraft or of persons on board the aircraft is endangered in any way.

Alcohol or Drugs – Passengers**602.04**

1. In this Section, "intoxicating liquor" means a beverage that contains more than 2.5 percent proof spirits.
2. No person shall consume on board an aircraft an intoxicating liquor unless the intoxicating liquor
 - a) has been served to that person by the operator of the aircraft;
 - b) where no flight attendant is on board, has been provided by the operator of the aircraft.

3. No operator of an aircraft shall provide or serve any intoxicating liquor to a person on board the aircraft, where there are reasonable grounds to believe that the person's faculties are impaired by alcohol or a drug to an extent that may present a hazard to the aircraft or to persons on board the aircraft.
4. Subject to subsection (5), no operator of an aircraft shall allow a person to board the aircraft, where there are reasonable grounds to believe that the person's faculties are impaired by alcohol or a drug to an extent that may present a hazard to the aircraft or to persons on board the aircraft.
5. The operator of an aircraft may allow a person whose faculties are impaired by a drug to board an aircraft, where the drug was administered in accordance with a medical authorization and the person is under the supervision of an attendant.

Compliance with Instructions**602.05**

1. Every passenger on board an aircraft shall comply with instructions given by any crew member respecting the safety of the aircraft or of persons on board the aircraft.
2. Every crew member on board an aircraft shall, during flight time, comply with the instructions of the pilot-in-command or of any person whom the pilot-in-command has authorized to act on behalf of the pilot-in-command.

Smoking**602.06**

1. No person shall smoke on board an aircraft during takeoff or landing or when directed not to smoke by the pilot-in-command.
2. No person shall smoke in an aircraft lavatory.
3. No person shall tamper with or disable a smoke detector installed in an aircraft lavatory without permission from a crew member or the operator of the aircraft.

Aircraft Operating Limitations**602.07**

No person shall operate an aircraft unless it is operated in accordance with the operating limitations

- a) set out in the aircraft flight manual, where an aircraft flight manual is required by the applicable standards of airworthiness;
- b) set out in a document other than the aircraft flight manual, where use of that document is authorized pursuant to Part VII;
- c) indicated by markings or placards required pursuant to

Section 605.05; or

- d) prescribed by the competent authority of the state of registry of the aircraft.

Portable Electronic Devices

602.08

1. No operator of an aircraft shall permit the use of a portable electronic device on board an aircraft, where the device may impair the functioning of the aircraft's systems or equipment.
2. No person shall use a portable electronic device on board an aircraft except with the permission of the operator of the aircraft.

Carry-on Baggage, Equipment and Cargo

602.86

1. No person shall operate an aircraft with carry-on baggage, equipment or cargo on board, unless the carry-on baggage, equipment and cargo are
 - a) stowed in a bin, compartment, rack or other location that is certified in accordance with the aircraft type certificate in respect of the stowage of carry-on baggage, equipment or cargo; or
 - b) restrained so as to prevent them from shifting during movement of the aircraft on the surface and during takeoff, landing and in-flight turbulence.
2. No person shall operate an aircraft with carry-on baggage, equipment or cargo on board unless
 - a) the safety equipment, the normal and emergency exits that are accessible to passengers and the aisles between the flight deck and a passenger compartment are not wholly or partially blocked by carry-on baggage, equipment or cargo;
 - b) all of the equipment and cargo that are stowed in a passenger compartment are packaged or covered to avoid possible injury to persons on board;
 - c) where the aircraft is type-certificated to carry 10 or more passengers and passengers are carried on board,
 - (i) no passenger's view of any "seat belt" sign, "no smoking" sign or exit sign is obscured by carry-on baggage, equipment or cargo except if an auxiliary sign is visible to the passenger or another means of notification of the passenger is available,
 - (ii) all of the passenger service carts and trolleys are securely restrained during movement of the

aircraft on the surface, takeoff and landing, and during in-flight turbulence where the pilot-in-command or in-charge flight attendant has directed that the cabin be secured pursuant to subsection 605.25(3) or (4), and

- (iii) all of the video monitors that are suspended from the ceiling of the aircraft and extend into an aisle are stowed and securely restrained during takeoff and landing; and

- d) all of the cargo that is stowed in a compartment to which crew members have access is stowed in such a manner as to allow a crew member to effectively reach all parts of the compartment with a hand-held fire extinguisher.

Crew Member Instructions

602.87

The pilot-in-command of an aircraft shall ensure that each crew member, before acting as a crew member on board the aircraft, has been instructed with respect to

- a) the duties that the crew member is to perform; and
- b) the location and use of all of the normal and emergency exits and of all of the emergency equipment that is carried on board the aircraft.

Passenger Briefings

602.89

1. The pilot-in-command of an aircraft shall ensure that all of the passengers on board the aircraft are briefed before takeoff with respect to the following, where applicable:
 - a) the location and means of operation of emergency and normal exits;
 - b) the location and means of operation of safety belts, shoulder harnesses and restraint devices;
 - c) the positioning of seats and the securing of seat backs and chair tables;
 - d) the stowage of carry-on baggage;
 - e) where the aircraft is unpressurized and it is possible that the flight will require the use of oxygen by the passengers, the location and means of operation of oxygen equipment; and
 - f) any prohibition against smoking.

2. The pilot-in-command of an aircraft shall ensure that all of the passengers on board the aircraft are briefed

- a) in the case of an over-water flight where the carriage of life preservers, individual flotation devices or personal flotation devices is required pursuant to Section 602.62, before commencement of the over-water portion of the flight, with respect to the location and use of those items; and
- b) in the case of a pressurized aircraft that is to be operated at an altitude above FL 250, before the aircraft reaches FL 250, with respect to the location and means of operation of oxygen equipment.

3. The pilot-in-command of an aircraft shall, before takeoff, ensure that all of the passengers on board the aircraft are provided with information respecting the location and use of

- a) first aid kits and survival equipment;
- b) where the aircraft is a helicopter or a small aircraft that is an aeroplane, any ELT that is required to be carried on board pursuant to Section 605.38; and
- c) any life raft that is required to be carried on board pursuant to Section 602.63.

Noise Operating Criteria

602.105

No person shall operate an aircraft at or in the vicinity of an aerodrome except in accordance with the applicable noise abatement procedures and noise control requirements specified by the Minister in the *Canada Air Pilot* or *Canada Flight Supplement*, including the procedures and requirements relating to

- a) preferential runways;
- b) minimum noise routes;
- c) hours when aircraft operations are prohibited or restricted;
- d) arrival procedures;
- e) departure procedures;
- f) duration of flights;
- g) the prohibition or restriction of training flights;
- h) VFR or visual approaches;
- i) simulated approach procedures; and
- j) the minimum altitude for the operation of aircraft in the vicinity of the aerodrome.

Noise-Restricted Runways

602.106

- a) Subject to subsection (2), no person shall operate a subsonic turbo-jet aeroplane that has a maximum certificated take-off weight of more than 34 000 kg (74,956 pounds) on take-off at a noise-restricted runway set out in column II of an item of the table to this section at an aerodrome set out in column I of that item, unless there is on board
 - (i) a certificate of airworthiness indicating that the aeroplane meets the applicable noise emission standards;
 - (ii) a certificate of noise compliance issued in respect of the aeroplane; or
 - (iii) where the aeroplane is not a Canadian aircraft, a document issued by the state of registry that specifies that the aeroplane meets the applicable noise emission requirements of that state.
- b) Subsection (1) does not apply
 - (iv) to the extent that it is inconsistent with any obligation assumed by Canada in respect of a foreign state in a treaty, convention or agreement;
 - (v) where the pilot-in-command of an aircraft has declared an emergency; or
 - (vi) where an aircraft is operated on
 - (i) an air evacuation operation,
 - (ii) any other emergency air operation, or
 - (iii) a departure from an aerodrome at which it was required to land because of an emergency.

Table 1 RAC Annex—Noise Restricted Runways for Takeoff

Item	Column I	Column II
	Aerodrome	Noise Restricted Runways for Takeoff
1.	Vancouver International Airport	08L, 08R, 12, 26R
2.	Calgary International Airport	07, 10, 16, 25, 28
3.	Edmonton City Centre (Blatchford Field) Airport	All runways
4.	Edmonton International Airport	12
5.	Winnipeg/James Armstrong Richardson International Airport	13, 18
6.	Hamilton Airport	06
7.	Toronto/Lester B. Pearson International Airport	05, 06L, 06R, 15L, 15R
8.	Ottawa/Macdonald-Cartier International Airport	32
9.	Montréal/Pierre Elliott Trudeau International Airport	All runways

Power-driven Aircraft – day VFR**605.14**

No person shall conduct a takeoff in a power-driven aircraft for the purpose of day VFR flight unless it is equipped with

- a) where the aircraft is operated in uncontrolled airspace, an altimeter;
- b) where the aircraft is operated in controlled airspace, a sensitive altimeter adjustable for barometric pressure;
- c) an airspeed indicator;
- d) a magnetic compass or a magnetic direction indicator that operates independently of the aircraft electrical generating system;
- e) a tachometer for each engine and for each propeller or rotor that has limiting speeds established by the manufacturer;
- f) an oil pressure indicator for each engine employing an oil pressure system;
- g) a coolant temperature indicator for each liquid-cooled engine;
- h) an oil temperature indicator for each air-cooled engine having a separate oil system;

- i) a manifold pressure gauge for each
 - (i) reciprocating engine equipped with a variable-pitch propeller,
 - (ii) reciprocating engine used to power a helicopter,
 - (iii) supercharged engine, and
 - (iv) turbocharged engine;
- j) a means for the flight crew, when seated at the flight controls to determine
 - (i) the fuel quantity in each main fuel tank, and
 - (ii) if the aircraft employs retractable landing gear, the position of the landing gear;
- k) subject to subsections 601.08(2) and 601.09(2), a radiocommunication system adequate to permit two-way communication on the appropriate frequency when the aircraft is operated within
 - (i) Class B, Class C or Class D airspace,
 - (ii) an MF area, unless the aircraft is operated pursuant to subsection 602.97(3), or
 - (iii) the ADIZ;
- l) where the aircraft is operated under Subpart 4 of this Part, or under Subpart 3, 4 or 5 of Part VII, radiocommunication equipment adequate to permit two-way communication on the appropriate frequency;
- m) where the aircraft is operated in Class B airspace, radio navigation equipment that will enable it to be operated in accordance with a flight plan; and
- n) where the aircraft is operated under Subpart 4 of this Part or under Subpart 5 of Part VII, radio navigation equipment that is adequate to receive radio signals from a transmitting facility.

Power-driven Aircraft – VFR OTT**605.15**

1. No person shall conduct a takeoff in a power-driven aircraft for the purpose of VFR OTT flight unless it is equipped with
 - a) the equipment referred to in paragraphs 605.14(c) to (j);
 - b) a sensitive altimeter adjustable for barometric pressure;
 - c) a means of preventing malfunction caused by icing for each airspeed indicating system;
 - d) a gyroscopic direction indicator or a stabilized magnetic direction indicator;
 - e) an attitude indicator;
 - f) subject to subsection (2), a turn and slip indicator or turn coordinator;

- g) where the aircraft is to be operated within the Northern Domestic Airspace, a means of establishing direction that is not dependent on a magnetic source;
 - h) radiocommunication equipment adequate to permit two-way communication on the appropriate frequency; and
 - i) radio navigation equipment adequate to permit the aircraft to be navigated safely.
2. Where the aircraft is equipped with a third attitude indicator that is usable through flight attitudes of 360° of pitch and roll for an aeroplane, or ± 80° of pitch and ± 120° of roll for a helicopter, the aircraft may be equipped with a slip-skid indicator in lieu of a turn and slip indicator or turn coordinator.

Power-driven Aircraft – Night VFR

605.16

1. No person shall conduct a takeoff in a power-driven aircraft for the purpose of night VFR flight, unless it is equipped with
 - a) the equipment referred to in paragraphs 605.14(c) to (n);
 - b) a sensitive altimeter adjustable for barometric pressure;
 - c) subject to subsection (2), a turn and slip indicator or turn coordinator;
 - d) an adequate source of electrical energy for all of the electrical and radio equipment;
 - e) in respect of every set of fuses of a particular rating that is installed on the aircraft and accessible to the pilot-in-command during flight, a number of spare fuses that is equal to at least 50 percent of the total number of installed fuses of that rating;
 - f) where the aircraft is operated so that an aerodrome is not visible from the aircraft, a stabilized magnetic direction indicator or a gyroscopic direction indicator;
 - g) where the aircraft is to be operated within the Northern Domestic Airspace, a means of establishing direction that is not dependent on a magnetic source;
 - h) where the aircraft is an airship operated within controlled airspace, radar reflectors attached in such a manner as to be capable of a 360-degree reflection;
 - i) a means of illumination for all of the instruments used to operate the aircraft;
 - j) when carrying passengers, a landing light; and
 - k) position and anti-collision lights that conform to the Aircraft Equipment and Maintenance Standards.
2. Where the aircraft is equipped with a third attitude indicator that is usable through flight attitudes of 360° of pitch and roll for an aeroplane, or ± 80° of pitch and ± 120° of roll for a helicopter, the aircraft may be equipped with a slip-skid indicator in lieu of a turn and slip indicator or turn coordinator.
 3. No person shall operate an aircraft that is equipped with any light that may be mistaken for, or downgrade the conspicuity of, a light in the navigation light system, unless the aircraft is being operated for the purpose of aerial advertising.
 4. In addition to the equipment requirements specified in subsection (1), no person shall operate an aircraft in night VFR flight under Subpart 4 of this Part or Subparts 2 to 5 of Part VII, unless the aircraft is equipped with
 - a) an attitude indicator;
 - b) a vertical speed indicator;
 - c) a means of preventing malfunction caused by icing for each airspeed indicating system; and
 - d) an outside air temperature gauge.

Use of Position and Anti-collision Lights

605.17

1. Subject to subsection (2), no person shall operate an aircraft in the air or on the ground at night, or on water between sunset and sunrise, unless the aircraft position lights and anti-collision lights are turned on.
2. Anti-collision lights may be turned off where the pilot-in-command determines that, because of operating conditions, doing so would be in the interests of aviation safety.

Power-driven Aircraft – IFR

605.18

No person shall conduct a takeoff in a power-driven aircraft for the purpose of IFR flight unless it is equipped with

- a) when it is operated by day, the equipment required pursuant to paragraphs 605.16(1)(a) to (h);
- b) when it is operated by night, the equipment required pursuant to paragraphs 605.16(1)(a) to (k);
- c) an attitude indicator;
- d) a vertical speed indicator;

- e) an outside air temperature gauge;
- f) a means of preventing malfunction caused by icing for each airspeed indicating system;
- g) a power failure warning device or vacuum indicator that shows the power available to gyroscopic instruments from each power source;
- h) an alternative source of static pressure for the altimeter, airspeed indicator and vertical speed indicator;
- i) sufficient radiocommunication equipment to permit the pilot to conduct two-way communications on the appropriate frequency; and
- j) sufficient radio navigation equipment to permit the pilot, in the event of the failure at any stage of the flight of any Item of that equipment, including any associated flight instrument display,
 - (i) to proceed to the destination aerodrome or proceed to another aerodrome that is suitable for landing, and
 - (ii) where the aircraft is operated in IMC, to complete an instrument approach and, if necessary, conduct a missed approach procedure.

Balloons – Day VFR

605.19

No person shall conduct a takeoff in a balloon for the purpose of day VFR flight unless it is equipped with

- a) an altimeter;
- b) a vertical speed indicator;
- c) in the case of a hot air balloon,
 - (i) a fuel quantity gauge, and
 - (ii) an envelope temperature indicator;
- d) in the case of a captive gas balloon, a magnetic direction indicator; and
- e) subject to subsections 601.08(2) and 601.09(2), a radio communication system adequate to permit two-way communication on the appropriate frequency when the balloon is operated within
 - (i) Class C or Class D airspace,
 - (ii) an MF area, unless the aircraft is operated pursuant to subsection 602.97(3), or
 - (iii) the ADIZ.

Balloons – Night VFR

605.20

No person shall conduct a takeoff in a balloon for the purpose of night VFR flight unless it is equipped with

- a) equipment required pursuant to Section 605.19;
- b) position lights;
- c) a means of illuminating all of the instruments used by the flight crew, including a flashlight; and
- d) in the case of a hot air balloon, two independent fuel systems.

Gliders – Day VFR

605.21

No person shall operate a glider in day VFR flight unless it is equipped with

- a) an altimeter;
- b) an airspeed indicator;
- c) a magnetic compass or a magnetic direction indicator; and
- d) subject to subsections 601.08(2) and 601.09(2), a radiocommunication system adequate to permit two-way communication on the appropriate frequency when the glider is operated within
 - (i) Class C or Class D airspace,
 - (ii) an MF area, unless the aircraft is operated pursuant to subsection 602.97(3), or
 - (iii) the ADIZ.

Seat and Safety Belt Requirements

605.22

1. Subject to subsection 605.23, no person shall operate an aircraft other than a balloon unless it is equipped with a seat and safety belt for each person on board the aircraft other than an infant.
2. Subsection (1) does not apply to a person operating an aircraft that was type-certificated with a safety belt designed for two persons.
3. A safety belt referred to in subsection (1) shall include a latching device of the metal-to-metal type.

Restraint System Requirements**605.23**

An aircraft may be operated without being equipped in accordance with Section 605.22 in respect of the following persons if a restraint system that is secured to the primary structure of the aircraft is provided for each person who is

- a) carried on a stretcher or in an incubator or other similar device;
- b) carried for the purpose of parachuting from the aircraft; or
- c) required to work in the vicinity of an opening in the aircraft structure.

Shoulder Harness Requirements**605.24**

1. No person shall operate an aeroplane, other than a small aeroplane manufactured before July 18, 1978, unless each front seat or, if the aeroplane has a flight deck, each seat on the flight deck is equipped with a safety belt that includes a shoulder harness.
2. Except as provided in Section 705.75, no person shall operate a transport category aeroplane unless each flight attendant seat is equipped with a safety belt that includes a shoulder harness.
3. No person shall operate a small aeroplane manufactured after December 12, 1986, the initial type certificate of which provides for not more than nine passenger seats, excluding any pilot seats, unless each forward- or aft-facing seat is equipped with a safety belt that includes a shoulder harness.
4. No person shall operate a helicopter manufactured after September 16, 1992, the initial type certificate of which specifies that the helicopter is certified as belonging to the normal or transport category, unless each seat is equipped with a safety belt that includes a shoulder harness.
5. No person operating an aircraft shall conduct any of the following flight operations unless the aircraft is equipped with a seat and a safety belt that includes a shoulder harness for each person on board the aircraft:
 - a) aerobatic manoeuvres;
 - b) Class B, C or D external load operations conducted by a helicopter; and
 - c) aerial application, or aerial inspection other than flight inspection for the purpose of calibrating electronic navigation aids, conducted at altitudes below 500 feet AGL.

General Use of Safety Belts and Restraint Systems**605.25**

1. The pilot-in-command of an aircraft shall direct all of the persons on board the aircraft to fasten safety belts
 - a) during movement of the aircraft on the surface;
 - b) during takeoff and landing; and
 - c) at any time during flight that the pilot-in-command considers it necessary that safety belts be fastened.
2. The directions referred to in subsection (1) also apply to the use of the following restraint systems:
 - a) a child restraint system;
 - b) a restraint system used by a person who is engaged in parachute descents; and
 - c) a restraint system used by a person when working in the vicinity of an opening in the aircraft structure.
3. Where an aircraft crew includes flight attendants and the pilot-in-command anticipates that the level of turbulence will exceed light turbulence, the pilot-in-command shall immediately direct each flight attendant to
 - a) discontinue duties relating to service;
 - b) secure the cabin; and
 - c) occupy a seat and fasten the safety belt provided.
4. Where an aircraft is experiencing turbulence and the in-charge flight attendant considers it necessary, the in-charge flight attendant shall
 - a) direct all of the passengers to fasten their safety belts; and
 - b) direct all flight attendants to discontinue duties relating to service, to secure the cabin, to occupy the assigned seats and to fasten the safety belts provided and to do so oneself.
5. Where the in-charge flight attendant has given directions in accordance with subsection (4), the in-charge flight attendant shall so inform the pilot-in-command.

Use of Passenger Safety Belts and Restraint Systems**605.26**

1. Where the pilot-in-command or the in-charge flight attendant directs that safety belts be fastened, every passenger who is not an infant shall
 - a) ensure that the passenger's safety belt or restraint system is properly adjusted and securely fastened;
 - b) if responsible for an infant for which no child restraint system is provided, hold the infant securely in the passenger's arms; and
 - c) if responsible for a person who is using a child restraint system, ensure that the person is properly secured.
2. No passenger shall be responsible for more than one infant.

Use of Crew Member Safety Belts**605.27**

1. Subject to subsection (2), the crew members on an aircraft shall be seated at their stations with their safety belts fastened
 - a) during takeoff and landing;
 - b) at any time that the pilot-in-command directs; and
 - c) in the case of crew members who are flight attendants, at any time that the in-charge flight attendant so directs pursuant to paragraph 605.25(4)(b).
2. Where the pilot-in-command directs that safety belts be fastened by illuminating the safety belt sign, a crew member is not required to comply with paragraph (1)(b)
 - a) during movement of the aircraft on the surface or during flight, if the crew member is performing duties relating to the safety of the aircraft or of the passengers on board;
 - b) where the aircraft is experiencing light turbulence, if the crew member is a flight attendant and is performing duties relating to the passengers on board; or
 - c) if the crew member is occupying a crew rest facility during cruise flight and the restraint system for that facility is properly adjusted and securely fastened.
3. The pilot-in-command shall ensure that at least one pilot is seated at the flight controls with safety belt fastened during flight time.

Child Restraint System**605.28**

1. No operator of an aircraft shall permit the use of a child restraint system on board the aircraft unless
 - a) the person using the child restraint system is accompanied by a parent or guardian who will attend to the safety of the person during the flight;
 - b) the weight and height of the person using the child restraint system are within the range specified by the manufacturer;
 - c) the child restraint system bears a legible label indicating the applicable design standards and date of manufacture;
 - d) the child restraint system is properly secured by the safety belt of a forward-facing seat that is not located in an emergency exit row and does not block access to an aisle; and
 - e) the tether strap is used according to the manufacturer's instructions or, where subsection (2) applies, secured so as not to pose a hazard to the person using the child restraint system or to any other person.
2. Where a seat incorporates design features to reduce occupant loads, such as the crushing or separation of certain components, and the seat is in compliance with the applicable design standards, no person shall use the tether strap on the child restraint system to secure the system.
3. Every passenger who is responsible for a person who is using a child restraint system on board an aircraft shall be
 - a) seated in a seat adjacent to the seat to which the child restraint system is secured;
 - b) familiar with the manufacturer's installation instructions for the child restraint system; and
 - c) familiar with the method of securing the person in the child restraint system and of releasing the person from it.

Flight Control Locks**605.29**

- No operator of an aircraft shall permit the use of a flight control lock in respect of the aircraft unless
- a) the flight control lock is incapable of becoming engaged when the aircraft is being operated; and
 - b) an unmistakable warning is provided to the person operating the aircraft whenever the flight control lock is engaged.

De-icing or Anti-icing Equipment

605.30

No person shall conduct a takeoff or continue a flight in an aircraft where icing conditions are reported to exist or are forecast to be encountered along the route of flight unless

- a) the pilot-in-command determines that the aircraft is adequately equipped to operate in icing conditions in accordance with the standards of airworthiness under which the type certificate for that aircraft was issued; or
- b) current weather reports or pilot reports indicate that icing conditions no longer exist.

Oxygen Equipment and Supply

605.31

- 1. No person shall operate an unpressurized aircraft unless it is equipped with sufficient oxygen dispensing units and oxygen supply to comply with the requirements set out in the table to this subsection.

Table 2 RAC Annex—Oxygen Requirements for Unpressurized Aircraft

Item	Column I	Column II
	Persons For Whom Oxygen Supply Must Be Available	Period Of Flight And Cabin-Pressure-Altitude
1.	All crew members and 10 percent of passengers and, in any case, no less than one passenger	Entire period of flight exceeding 30 minutes at cabin-pressure-altitudes above 10 000 feet ASL but not exceeding 13 000 feet ASL
2.	All persons on board the aircraft	(a) Entire period of flight at cabin-pressure-altitudes above 13 000 feet ASL (b) For aircraft operated in an air transport service under the conditions referred to in paragraph(a), a period of flight of not less than one hour.

- 2. No person shall operate a pressurized aircraft unless it is equipped with sufficient oxygen dispensing units and oxygen supply to provide, in the event of cabin pressurization failure at the most critical point during the flight, sufficient oxygen to continue the flight to an aerodrome suitable for landing while complying with the requirements of the table to this subsection.

Table 3 RAC Annex—Minimum Oxygen Requirements for Pressurized Aircraft Following Emergency Descent

Item	Column I	Column II
	Persons For Whom Oxygen Supply Must Be Available	Period Of Flight And Cabin-Pressure-Altitude
1.	All crew members and 10 percent of passengers and, in any case, no less than one passenger	a) Entire period of flight exceeding 30 minutes at cabin-pressure-altitudes above 10 000 feet ASL but not exceeding 13 000 feet ASL b) Entire period of flight at cabin-pressure-altitudes above 13 000 feet ASL c) For aircraft operated in an air transport service under the conditions referred to in paragraph (a) or (b), a period of flight of not less than (i) 30 minutes (Note 2), and (ii) for flight crew members, two hours for aircraft the type certificate of which authorizes flight at altitudes exceeding FL 250 (Note 3)
2.	All passengers	a) Entire period of flight at cabin-pressure-altitudes exceeding 13 000 feet ASL b) For aircraft operated in an air transport service under the conditions referred to in paragraph (a), a period of flight of not less than 10 minutes

NOTES:

- 1. In determining the available supply, the cabin pressure altitude descent profile for the routes concerned must be taken into account.
- 2. The minimum supply is that quantity of oxygen necessary for a constant rate of descent from the aircraft’s maximum operating altitude authorized in the type certificate to 10 000 ft ASL in 10 minutes, followed by 20 minutes at 10 000 feet ASL.
- 3. The minimum supply is that quantity of oxygen necessary for a constant rate of descent from the aircraft’s maximum operating altitude authorized in the type certificate to 10 000 ft ASL in 10 minutes, followed by 110 minutes at 10 000 feet ASL.



Use of Oxygen

605.32

1. Where an aircraft is operated at cabin-pressure-altitudes above 10 000 ft ASL, but not exceeding 13 000 ft ASL, each crew member shall wear an oxygen mask and use supplemental oxygen for any part of the flight at those altitudes that is more than 30 min in duration.
2. Where an aircraft is operated at cabin-pressure-altitudes above 13 000 ft ASL, each person on board the aircraft shall wear an oxygen mask and use supplemental oxygen for the duration of the flight at those altitudes.
3. The pilot at the flight controls of an aircraft shall use an oxygen mask if
 - a) the aircraft is not equipped with quick-donning oxygen masks and is operated at or above FL 250; or
 - b) the aircraft is equipped with quick-donning oxygen masks and is operated above FL 410.

3.0 TRANSPORTATION OF DANGEROUS GOODS (TDG) BY AIR

Dangerous goods refers to a product, substance or organism included by its nature or by the regulations in any of the classes listed in the schedule to the *Transportation of Dangerous Goods Act, 1992*. There are nine classes of dangerous goods:

- | | |
|----------|---|
| Class 1: | Explosives; |
| Class 2: | Gases; |
| Class 3: | Flammable liquids; |
| Class 4: | Flammable solids; substances liable to spontaneous combustion;

substances that on contact with water emit flammable gases; |
| Class 5: | Oxidizing substances and organic peroxides; |
| Class 6: | Toxic and infectious substances; |
| Class 7: | Radioactive materials; |
| Class 8: | Corrosives; and |
| Class 9: | Miscellaneous products, substances or organisms. |

Dangerous goods shall not be carried on board any Canadian aircraft, or in any foreign aircraft when operated in Canada,

unless in compliance with the *Transportation of Dangerous Goods Act, 1992*, (TDG Act, 1992) and the *Transportation of Dangerous Goods Regulations* (TDG Regulations).

Sections 12.1 to 12.3 of the TDG Regulations regulate the domestic and international transport of dangerous goods by air, and adopt by reference the *ICAO Technical Instructions for the Safe Transport of Dangerous Goods by Air* (ICAO TIs).

Sections 12.4 to 12.17 of the TDG Regulations provide alternative domestic provisions for dangerous goods in air transport, which address the unique characteristics of the Canadian aviation industry and geographical environment.

NOTE:

Activities related to the handling, offering for transport or transporting of dangerous goods by air, which are not consistent with the TDG Act, 1992 or the TDG Regulations, require an equivalency certificate issued under section 31 of the TDG Act, 1992, and section 14.1 of the TDG Regulations.

Canadian Air Operators are required to submit procedures for the carriage of dangerous goods and corresponding TDG Training Program to TC for review and approval. TC published *Advisory Circular (AC) 700-001-Procedures for the Carriage of Dangerous Goods to the Company Operations Manual* and *AC 700-008 – Development of a Dangerous Goods Training Program* to assist air operators in the development of dangerous goods procedures and training program. The ACs are found on the Transport Canada Civil Aviation (TCCA) documentation website: <www.tc.gc.ca/eng/civilaviation/opssvs/management-services-reference-centre-ac-700-menu-511.htm>.

NOTE:

Consultants may provide assistance in developing dangerous goods procedures and training programs; however, generic procedures and training programs may need to be amended to reflect air operators' activities.

Anyone handling, offering for transport, transporting or importing dangerous goods in Canada must be trained and hold a valid training certificate in compliance with Part 6, Training, of the TDG Regulations. An air operator can delegate some of its responsibilities to third parties; however, the air operator remains accountable. Therefore, an air operator is responsible for training employees (and third party staff) who handle, offer for transport, or transport dangerous goods based on the approved dangerous goods procedures and TDG training program. Employees (and third party staff) can also perform TDG duties if in the presence and under the direct supervision of a person who is trained and who holds a TDG training certificate. A TDG training certificate expires 24 months after its date of issuance.

Guidance material and additional information can be obtained from one of the following TCCA TDG regional offices:

Headquarters—National Capital Region AARXE

Place de Ville, Tower C
330 Sparks Street, 4th Floor
Ottawa ON K1A 0N8
Tel:613-990-1060
Fax:613-954-1602

Quebec Region—NAXD

Commercial and Business Aviation
700 Leigh Capreol Place
Pierre Elliott Trudeau International Airport
Dorval QC H4Y 1G7
Tel:514-633-2838
Fax:514-633-3697

Atlantic Region—MAXD

Commercial and Business Aviation
PO Box 42,
Heritage Court
Moncton NB E1C 8K6
Tel:506-851-7247
Fax:506-851-7190

Pacific Region—TAXD

Commercial and Business Aviation
800 Burrard Street, Suite 620
Vancouver BC V6Z 2J8
Tel:604-666-5655
Fax:604-666-0682

Ontario Region—PAXD—PIA

Commercial and Business Aviation
5431 Flightline Drive
Pearson International Airport
Mississauga ON L5P 1B2
General Information:416-952-0000
Fax:905-405-3305

Prairie and Northern Region—RAEX

Commercial and Business Aviation
1100 Jasper Place
9700 Jasper Avenue
Edmonton AB T5J 4E6
Tel:780-495-5278
Fax:780-495-4622

Winnipeg Office

Tel:204-495-1424
Fax:204-495-1734

National Operations—NAROA

700 Leigh Capreol Place, Suite 2093
Pierre Elliott Trudeau International Airport
Dorval QC H4Y 1G7
Tel:514-633-3116
Fax:514-633-3717

NAT—NORTH ATLANTIC (NAT) OPERATIONS

NOTE: Refer to the [AIP CANADA \(ICAO\) Part 2 Enroute \(ENR\)](#) for the most up-to-date navigation data and coordinates.

1.0 NORTH ATLANTIC (NAT) OPERATIONS

1.1 REGULATION, REFERENCE DOCUMENTS AND GUIDANCE MATERIAL

1.1.1 Regulation

CAR 602.38 requires pilots of Canadian aircraft, when flying over the high seas, to comply with the applicable rules set out in ICAO Annex 2, *Rules of the Air*, and with the applicable regional supplementary procedures set out in ICAO Doc 7030.

1.1.2 North Atlantic (NAT) Documentation

The following documents are applicable to operations in the NAT region:

- a) ICAO Annex 2—*Rules of the Air*;
- b) ICAO Annex 11—*Air Traffic Services*;
- c) ICAO Doc 4444—*Procedures for Air Navigation Services—Air Traffic Management*;
- d) ICAO Doc 7030—*Regional Supplementary Procedures*;
- e) ICAO NAT Doc 001—*NAT SPG Handbook*;
- f) ICAO NAT Doc 006—*Air Traffic Management Operational Contingency Plan—North Atlantic Region*;
- g) ICAO NAT Doc 007—*North Atlantic Operations and Airspace Manual*; and
- h) *Gander Data Link Oceanic Clearance Delivery (OCD) Crew Procedures*.

1.2 GENERAL AVIATION AIRCRAFT

Canadian Aviation Regulation (CAR) 602.39 specifies the following:

"No pilot-in-command of a single-engined aircraft, or of a multi-engined aircraft that would be unable to maintain flight in the event of the failure of any engine, shall commence a flight that

will leave Canadian Domestic Airspace and enter airspace over the high seas unless:

- a) the pilot-in-command holds a pilot licence endorsed with an instrument rating;
- b) the aircraft is equipped with
 - (i) the equipment referred to in section 605.18,
 - (ii) a high frequency radio capable of transmitting and receiving on a minimum of two appropriate international air-ground general purpose frequencies, and
 - (iii) hypothermia protection for each person on board; and
- c) the aircraft carries sufficient fuel to meet the requirements of section 602.88 and, in addition, carries contingency fuel equal to at least 10 percent of the fuel required pursuant to section 602.88 to complete the flight to the aerodrome of destination."

1.3 NORTH AMERICAN ROUTES (NAR)

The North American route (NAR) system interfaces with North Atlantic (NAT) oceanic, the oceanic transition area, and domestic airspace and is used by air traffic transiting the NAT. NARs consist of a series of pre-planned routes to and from established oceanic entry/exit points (OEP) and major identified airports throughout Canada and the United States.

NARs and their associated procedures are published in the Planning section of the *Canada Flight Supplement (CFS)* and in the Federal Aviation Administration's (FAA) *Airport Facility/Directory—Northeast*.

1.4 GANDER OCEANIC TRANSITION AREA (GOTA)

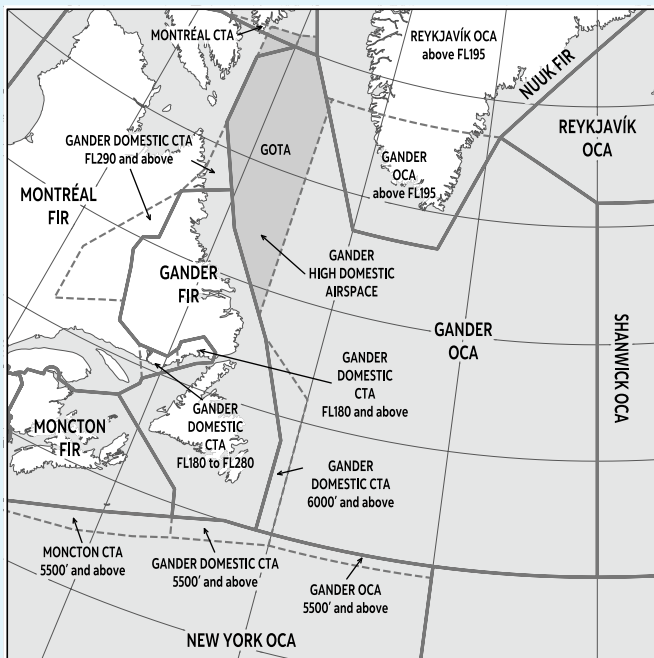
The implementation of additional surveillance and communication sites along the north-east coast of Canada allowed for the provision of enhanced services and led to the creation of the Gander oceanic transition area (GOTA).

The lower limit of the GOTA is FL 290; the upper limit is FL 600. The GOTA is Class A controlled airspace.

The GOTA consists of airspace FL 290 and above, from 6530N 060W, east to the Reykjavik area control centre (ACC) boundary, south to 6330N 055W, south along 055W to the Gander domestic boundary, north along the Gander/Montreal domestic boundaries, north to the Edmonton boundary, and then back to the point of origin (see Figure 1.1).

Surveillance services are provided by Gander ACC. The automatic dependence surveillance - contract/controller-pilot data link communications (ADS-C/CPDLC) log on address for aircraft in GOTA airspace is CDQX.

Figure 1.1—Gander OCA



1.5 NORTH ATLANTIC (NAT) ORGANIZED TRACK SYSTEM (OTS)

Organized tracks are formulated and published in a North Atlantic (NAT) track message via the Aeronautical Fixed Telecommunications Network (AFTN) and sent to all interested operators. The daytime structure is published by Shanwick area control centre (ACC) and the night-time structure is published by Gander ACC.

Flight levels are allocated for use within the organized track system (OTS), and in most cases, details of domestic entry and exit routings associated with individual tracks are provided in the NAT track message.

To permit an orderly changeover between successive OTSs, a period of several hours is interposed between the termination of one system and the commencement of the next. During these periods, operators are expected to file random routes or use the coordinates of a track in the system that is about to come into effect.

Eastbound traffic crossing 030°W at 1030 UTC or later and westbound traffic crossing 030°W at 0000 UTC or later should plan to avoid the OTS at the published levels.

Further information on available flight level profiles can be found in NAT 1.20.3.

1.6 FLIGHT RULES

Over the high seas, the lower limit of all North Atlantic (NAT) oceanic control areas (OCA) is FL 055; there is no upper limit. Throughout the NAT region, airspace at and above FL 055 is Class A controlled airspace, and below FL 055 is Class G

uncontrolled airspace.

At or above FL 060, flights shall be conducted under instrument flight rules (IFR) even when aircraft are not operating in instrument meteorological conditions (IMC).

Air traffic control (ATC) clearances to climb or descend while maintaining one's own separation and remaining in visual meteorological conditions (VMC) shall not be issued to aircraft.

1.7 FLIGHT PLANNING PROCEDURES

1.7.1 Routes

For eastbound and westbound traffic:

- South of 70°N, the planned tracks shall be defined by significant points formed by the intersection of half or whole degrees of latitude at each 10° of longitude (060°W, 050°W, 040°W). For flights operating north of 70°N, significant points are defined by the parallels of latitude expressed in degrees and minutes with longitudes at 20° intervals; the distance between significant points shall, as far as possible, not exceed one hour of flight time. Additional significant points should be established when required because of aircraft speed or the angle at which meridians are crossed. When the flight time between successive significant points is less than 30 min, one of the points may be omitted.
- Oceanic traffic transitioning through the GOTA from FL 290 to FL 600 shall flight plan an oceanic entry/exit point (OEP), a 050°W coordinate, and a 040°W coordinate.
- The following OEPs are limited to flights conducted from FL 290 and above: AVPUT, CLAVY, EMBOK, KETLA, LIBOR, MAXAR, NIFTY, PIDSO, RADUN, SAVRY, TOXIT, URTAK, VESMI, AVUTI, BOKTO, CUDDY, DORYY, and ENNSO.
- The following OEPs shall be flight planned by all aircraft entering or exiting Gander oceanic airspace, regardless of altitude: HOIST, IRLOK, JANJO, KODIK, LOMSI, MELDI, NEEKO, PELTU, RIKAL, SAXAN, TUDEP, UMESI, ALLRY, BUDAR, ELSIR, IBERG, JOOPY, MUSAK, NICSO, OMSAT, PORTI, RELIC, SUPRY, and RAFIN.

For northbound and southbound traffic, the planned tracks shall be defined by significant points formed by the intersection of whole degrees of longitude with parallels of latitude spaced at 5° (65°N, 60°N, 55°N).

For aircraft planning to fly within the OTS from the oceanic entry point to the oceanic exit point as detailed in the daily NAT track message, the track shall be defined in Item 15 of the flight plan by the abbreviation "NAT" followed by the code letter assigned to the track. Refer to subsection 1.20.3.2 for more details on the OTS.

NAT

For eastbound NAT flights planning to operate on the OTS, the second and third route options should be indicated at the end of Item 18 of the flight plan. Those operators who do not have the capability to provide this information in Item 18 of the flight plan should send the information by a separate AFTN message to Gander ACC (CYQXZQZX).

Examples:

RMKS/ ... O2.X370 O3.V350 (Option 2 is Track X at FL 370; option 3 is Track V at FL 350).

RMKS/ ... O2.RS390 O3.Z370 (Option 2 is random track south at FL 390; option 3 is Track Z at FL 370).

NOTE:

In the preceding examples, options 2 and 3 are indicated by the letter “O” and not by the number zero.

ATS requires flights entering or exiting the Gander OCA to flight plan in accordance with the published NAT OTS or, if exiting by way of 58°N 050°W and south thereof, via the following OEPs (compulsory reporting points) and associated 050°W coordinates (see Table 1.1).

Table 1.1—OEPs and Associated Coordinates

OEP	Coordinates	OEP	Coordinates
CUDDY or DORYY	5800N 05000W	UMESI	5130N 05000W
ENNSO	5730N 05000W	ALLRY	5100N 05000W
HOIST	5700N 05000W	BUDAR	5030N 05000W
IRLOK	5630N 05000W	ELSIR	5000N 05000W
JANJO	5600N 05000W	IBERG	4930N 05000W
KODIK	5530N 05000W	JOOPY	4900N 05000W
LOMSI	5500N 05000W	MUSAK	4830N 05000W
MELDI	5430N 05000W	NICSO	4800N 05000W
NEEKO	5400N 05000W	OMSAT	4730N 05000W
PELTU	5330N 05000W	PORTI	4700N 05000W
RIKAL	5300N 05000W	RELIC	4630N 05000W
SAXAN	5230N 05000W	SUPRY	4600N 05000W
TUDEP	5200N 05000W	RAFIN	4500N 05000W

ATS requires flights entering or exiting the New York OCA through CDA to flight plan over one of the following compulsory reporting points: NOVOK, JEBBY, BOBTU, or TALGO; or via ELERI or MUSPO, for flights arriving at or departing from Halifax airport (CYHZ). Eastbound flights that exit the New York OCA via CDA and subsequently enter the Gander OCA are required to flight plan in accordance with the published NAT OTS or over an oceanic entry point and a 050°W coordinate.

Flights exiting the New York OCA via BOBTU should contact Gander ACC five minutes prior to BOBTU on frequency 134.7 MHz. Operators should be aware that if the NAT OTS includes tracks that are at or south of SUPRY 46°N 050°W (or 46°N 050°W SUPRY), optimal flight levels and routes may not be available.

To facilitate effective coordination for flights entering or exiting the Gander domestic CTA and the New York OCA via 44°N 050°W or south thereof:

- a) Eastbound flights exiting the Gander domestic CTA directly into the New York OCA are required to flight plan via LOMPI direct JAROM direct TALGO direct 44°N 050°W or south thereof.
- b) Eastbound flights exiting the New York OCA directly into the Gander domestic CTA are required to flight plan via BOBTU.
 - (i) When the eastbound OTSs are anchored at RAFIN and/or TALGO, BOBTU will be unavailable for eastbound NAT traffic flight planning between FL 300 and FL 400, inclusive.
- c) Westbound flights exiting the New York OCA directly into the Gander domestic CTA are required to flight plan via BOBTU direct JAROM direct LOMPI.

NOTE:

TALGO is not to be used for westbound flights.

ATS system parameters require all westbound flights transiting from the Gander OCA or the GOTA to the Montréal FIR/CTA to flight plan via 060°W below FL 290 and via an oceanic entry point if operating from FL 290 up to and including FL 600, followed by both a boundary reporting point and then one of the following inland reporting points: LAKES, LOPVI, RODBO, JELCO, FEDDY, TEFFO, DUTUM, or BEZED. KENKI and IRBIM are not to be used as boundary reporting points. Flights operating from FL 290 and above may flight plan a NAR to or from an oceanic entry point.

1.7.2 Airspeed

The TAS or Mach number is to be entered in Item 15 of the flight plan.

1.7.3 Altitude

The planned cruising level(s) for the oceanic portion of the flight should be included in Item 15 of the flight plan.

NOTE:

Pilots planning to conduct a flight wholly or partly outside the OTS should indicate, in a flight plan, cruising level(s) appropriate to the direction of flight and in accordance with the flight levels as described in the NAT FLAS. Refer to section 1.20.3 for more details on FLAS.



Requests for a suitable alternative flight level may be indicated in Item 18 of the flight plan.

1.7.4 Estimated Times

For flights conducted on the OTS, the accumulated elapsed time only to the first oceanic FIR boundary (Gander accepts elapsed time to OEPs) is to be entered in Item 18 of the flight plan.

For flights conducted wholly or partly on the OTS, accumulated estimated times to significant points en route are to be entered in Item 18 of the flight plan.

1.7.5 Aircraft Approval Status and Registration

For an aircraft certified as being in compliance with operations within the NAT HLA, the approval status (MNPS) shall be indicated in Item 10 by entering the letter “X”. It is the pilot’s responsibility to ensure that specific approval has been given for the NAT HLA operations. Refer to subpart 1.11 for more information on MNPS in the NAT HLA.

For an aircraft certified as being in compliance with RVSM MASPS, RVSM approval shall be indicated in Item 10 by entering the letter “W”. It is the pilot’s responsibility to ensure that specific approval has been given for RVSM operations. Refer to subpart 1.12 for more information on RVSM MASPS.

If the aircraft registration is not included in Item 7, it shall be indicated in Item 18.

1.7.6 Height Monitoring Unit (HMU)

An aircraft that requires HMU monitoring shall include in Item 18 of the flight plan the remarks “RMK/HMU FLT STU”.

1.7.7 Filing

NAT operators shall forward all flight plans for eastbound NAT flights to the Canadian ACCs whose FIR or CTA the flights will traverse. These flight plans shall include the EET for each CTA boundary in Item 18 of the flight plan. The AFTN addresses for Canadian ACCs are listed in Table 1.2.

Table 1.2—AFTN Addresses for Canadian ACCs

AFTN Addresses	Canadian ACCs	AFTN Addresses	Canadian ACCs
CZQXZQZX	Gander	CZWGZQZX	Winnipeg
CZQMZQZX	Moncton	CZEGZQZX	Edmonton
CZULZQZX	Montréal	CZVRZQZX	Vancouver
CZYZZQZX	Toronto	—	—

Where possible, operators are to file eastbound NAT flight plans at least four hours prior to the ETA at the oceanic entry point specified in the flight plan.

1.8 PREFERRED ROUTE MESSAGE (PRM)

North Atlantic (NAT) operators shall send preferred route messages (PRMs) for eastbound flights to the following Gander Aeronautical Fixed Telecommunication Network (AFTN) addresses:

- a) CZQXZQZX (Gander ACC)
- b) CZULZQZX (Montreal ACC)

The following format is to be used for eastbound PRMs:

[PRIORITY] [DEST ADDRESS] [DEST ADDRESS] – [DATE TIME OF ORIGIN] [ORIGIN ADDRESS] [MESSAGE TYPE]- [COMPANY]-[EB]-[YYMMDD AT 030°W]- [(DEP/DEST) (INLAND FIX) (OEP) (OCA RPS) (LANDFALL) (LAST UK POINT) (NUMBER OF FLT 01-99)]

Example:

```
FF CZQXZQZX
130502 KJFKSWRW
PRM-SWR-E-200113
CYUL/LSZH JOOPY 49/50 49/40 49/30 49/20 BEDRA
NASBA 02
KJFK/LSZH PORTI 47/50 48/40 49/30 50/20 SOMAX ATSUR
03
```

NOTES:

1. If there is no inland navigation fix (INF), the latitude crossing 080°W is to be used.
2. PRMs for eastbound flights are to be sent no later than 1000 Coordinated Universal Time (UTC).

1.9 CLEARANCES

1.9.1 Oceanic Clearances

Pilots intending to operate aircraft in the Gander OCA should note the following:

- a) Clearances for VFR climb or descent will not be granted.
- b) The Mach number to be maintained will be specified.
- c) ATC will specify the full route details for aircraft cleared on a route other than an organized track or flight planned route. The pilot is to read back the full details of the clearance including the cleared track or details of the flight planned route.

- d) ATC will issue an abbreviated oceanic clearance to aircraft that will be operated along one of the NAT organized tracks. The abbreviated clearance will include the track letter, the flight level, and the Mach number or speed in knots to be maintained. The pilot is to read back the clearance including the TMI number. ATC will confirm the accuracy of the readback and the TMI number.

NOTE:

The OTS is identified by a TMI number, which is determined by using the Julian calendar for the day on which the tracks are effective. (Refer to subsection 1.20.3.2 for more information on OTS.) The TMI number is contained in the Remarks section on the NAT track message. Amendments to tracks that are already published are indicated by appending a letter to the Julian date, e.g. TMI 320A. A revised TMI will be issued for changes to:

- (i) any track coordinate(s), including named points;
- (ii) published track levels; or
- (iii) named points within European routes west.

A TMI revision will not be issued for changes to other items such as NARs.

- e) Whether received via data link or voice, the oceanic clearance to enter the Gander OCA has the following meaning:
- (i) the clearance is valid only within oceanic airspace, and details the route, altitude and speed at which the flight is to enter oceanic airspace;
 - (ii) the flight crew is not immediately authorized to change the route, altitude or speed in order to comply with the oceanic clearance;
 - (iii) the flight crew is required to obtain a subsequent clearance in order to comply with the oceanic clearance; and
 - (iv) if unable to obtain a subsequent clearance, the flight crew should revert to the procedures for radio communications failure detailed in the CFS and in the NAT section of ICAO's *Regional Supplementary Procedures* (Doc 7030) in order to manoeuvre as necessary to comply with the oceanic clearance.
- f) If the aircraft is designated to report meteorological information, the pilot will be advised by the inclusion of the phrase "SEND MET REPORTS" in the clearance.

1.9.2 Domestic Clearances—North Atlantic (NAT) Westbound Traffic

Pilots proceeding westbound across the NAT and entering CDA within the Gander, Moncton and Montréal FIRs should comply with the following procedures:

- a) Flights whose oceanic clearance contains their flight planned oceanic exit point will not be issued en route clearances upon entering the airspace and are to follow the flight planned route as cleared. Domestic en route clearances will be issued:
 - (i) for flights that have been rerouted and exit oceanic airspace at a point other than the flight planned exit fix; or

- (ii) at a pilot's request for another routing; or
- (iii) if a flight plan has not been received by the ACC.

- b) Flights that have been rerouted from the flight planned route and enter CDA within 120 NM of the flight planned oceanic exit point can anticipate a clearance to regain the flight planned route by the INF unless the pilot requests a different routing. For flights entering CDA more than 120 NM from the flight planned oceanic exit point, a clearance will be issued following consultation with the pilot.
- c) ATC will use the latest flight plan received before a flight departs. Subsequent changes to the flight plan route, including any changes received by the pilot from flight operations or dispatch, must be requested directly by the pilot on initial contact with the appropriate domestic ACC. Direct requests from flight operations or dispatch to ATC to re-clear aircraft will only be considered under exceptional circumstances and are not an acceptable alternative to a pilot-initiated request for a re-clearance.
- d) Domestic re-clearances by ATC may contain either the route specified in full detail or a NAR.

If an aircraft enters CDA via the Edmonton FIR, the onward domestic routing will have been established in coordination between the Reykjavik and Edmonton ACCs, and additional domestic clearance is not required. If there has been a change in route from the filed flight plan, clarification of the onward routing may be obtained from Edmonton ACC on request.

Westbound aircraft that have proceeded across the NAT and have entered the GOTA or CDA shall maintain the last oceanic Mach setting assigned by ATC:

- a) unless approval is obtained from ATC to make a change; or
- b) until the pilot receives an initial descent clearance approaching destination.

NOTE:

Pilots should request changes to their oceanic Mach setting once communication has been established within the GOTA or CDA.

1.9.3 Oceanic Clearance Delivery

Unless otherwise advised by ATC, the following oceanic clearance delivery procedures are in effect daily between 2330 and 0730 UTC (DST 2230 and 0630 UTC) for all eastbound oceanic flights that transit the Gander domestic FIR/CTA:

- a) Clearance delivery frequencies are published daily in the Remarks section on the eastbound NAT track message. During published clearance delivery hours, pilots are to contact Gander Clearance Delivery on the frequency designated for their oceanic entry point. Pilots should contact Clearance Delivery when they are within 200 NM of the specified clearance delivery frequency location. In the event that contact cannot be established, pilots are to advise ATC on the assigned

control frequency. The following frequencies and frequency locations will normally be used:

Table 1.3—Oceanic Clearance Delivery Frequencies

Frequency Locations	Frequencies
Natashquan (YNA) (50°11'N 061°47'W)	135.45 MHz
Allan's Island (46°50'N 055°47'W)	128.45 MHz
Churchill Falls (UM) (53°35'N 064°14'W)	128.7 MHz
Stephenville (YJT) (48°34'N 058°40'W)	135.05 MHz
Sydney (YQY) (46°09'N 060°03'W)	119.42 MHz
Brevoort (63°20'N 064°08'W)	132.025 MHz
Kuujuaq (YVP) (58°05'N 068°25'W)	134.2 MHz

- b) Operators who do not receive the NAT track message are to contact Gander Clearance Delivery when they are within 200 NM of the frequency location. In the event that contact cannot be established, pilots are to advise ATC on the assigned control frequency.

Pilots are to maintain a continuous listening watch on the assigned control frequency while obtaining the oceanic clearance.

Flights that are equipped to request and receive solicited electronic oceanic clearances are not required to contact Clearance Delivery if an electronic clearance is received and confirmed successfully. Confirmation is the receipt of the following message: CLA RECEIVED CLEARANCE CONFIRMED END OF MESSAGE.

If the above message is not received, data link oceanic clearances must be verified, either with Gander Clearance Delivery, during published hours, or on the control frequency, outside of published hours.

ATC will not normally advise pilots to contact Gander Clearance Delivery. There is no requirement for pilots to confirm receipt of an oceanic clearance (including a data link oceanic clearance) from Gander Clearance Delivery with the assigned control frequency. Due to frequency congestion on both the clearance delivery and control frequencies, pilots should refrain from unnecessary lengthy discussions with respect to oceanic clearances and procedures. Constructive comments and complaints should be processed post-flight through company operations.

Procedures and further information for flights intending to receive oceanic clearances via data link are published in *Gander Data Link Oceanic Clearance Delivery (OCD) Crew Procedures*.

1.10 POSITION REPORTS

1.10.1 Requirements

Unless otherwise requested by ATC, flights shall make position reports at all points contained in their oceanic clearance.

Position reports shall include the reported position, including the time it is reached, the current flight level (or passing flight level and final level if the aircraft is either climbing or descending), the next reporting point and estimated time, and the succeeding reporting point per the cleared route. If the estimated time over the next reporting point is found to be in error by three minutes or more, a revised estimated time shall be transmitted as soon as possible to the appropriate ATC unit. Revisions to forward estimates are not required for flights with established ADS-C contracts.

When making position reports, all times shall be expressed in hours and minutes UTC.

If an aircraft in the Gander OCA is unable to communicate with Gander oceanic, the pilot shall endeavour to relay position reports through:

- another oceanic control centre with which communication has been established;
- another aircraft in the NAT region (when out of range of VHF ground stations, aircraft may use 123.45 MHz for air-to-air communications, including the relaying of position reports); or
- another aircraft on emergency frequencies 121.5 or 243.0 MHz, if no other means is available.

1.10.2 Communications With Air Traffic Control (ATC)

All aircraft operating in the Gander OCA must be capable of conducting two-way radio communication with ATC. The radio communication equipment shall consist of at least one HF and one other long-range communication system (HF, CPDLC, or SATVOICE). Carrying HF radio and the additional long-range communication system is mandatory, except for operations on routes covered by VHF facilities. (Refer to Planning Section C in the CFS for a list of VHF facilities.)

See CARs 602.38 and 602.39 for Canadian-registered aircraft or for aircraft entering the NAT via CDA.

For more details on equipment requirements in the NAT HLA, refer to ICAO Annex 2 *Rules of the Air* and to North Atlantic (NAT) Regional Supplementary Procedures in ICAO Doc 7030 *Regional Supplementary Procedures*, as well as national AIPs for the states concerned.

All flights operating in the Gander OCA should check in on international air-ground frequencies.

1.11 MINIMUM NAVIGATION PERFORMANCE SPECIFICATIONS (MNPS) FOR OPERATIONS WITHIN THE NORTH ATLANTIC HIGH-LEVEL AIRSPACE (NAT HLA)

1.11.1 General

All operators are to ensure that aircraft used to conduct flights within the NAT HLA have the minimum navigation equipment. For detailed requirements, refer to the following documents:

- a) ICAO Doc 7030—*Regional Supplementary Procedures*;
- b) ICAO NAT Doc 001—*NAT SPG Handbook*;
- c) ICAO NAT Doc 007—*North Atlantic Operations and Airspace Manual*; and
- d) Parts VI and VII of the CARs.

Eastbound aircraft requesting an oceanic clearance from Gander ACC to enter the NAT HLA may be asked by ATC to confirm that they are approved for MNPS operations. Pilots/operators unable to provide such confirmation will be issued an oceanic clearance to operate their aircraft outside the NAT HLA (below FL 285 or above FL 420).

1.11.2 Aircraft Without Minimum Navigation Performance Specifications (MNPS) for the North-Atlantic High-Level Airspace (NAT HLA) Operations

An aircraft that does not meet the NAT HLA requirements may be allowed to operate in the NAT HLA if the following conditions are satisfied:

- a) The aircraft is being provided with ATS surveillance services;
- b) Direct controller-pilot VHF communication is maintained; and
- c) The aircraft has a certified installation of equipment providing it with the ability to navigate along the cleared track.

NOTE:

Pilots operating aircraft in the NAT HLA under these provisions should familiarize themselves with NAT HLA operations and procedures. They should also have a current copy of the OTS message that is in effect for the time of their flight for situational awareness.

Aircraft that are not approved to operate in the NAT HLA and do not meet the above provisions may be cleared to climb or descend through the NAT HLA, traffic permitting.

1.12 REDUCED VERTICAL SEPARATION MINIMUM (RVSM)—MINIMUM AIRCRAFT SYSTEM PERFORMANCE SPECIFICATIONS (MASPS)

All operators of aircraft used to conduct flights within the North Atlantic high-level airspace (NAT HLA) where reduced vertical separation minimum (RVSM) is applied are to ensure that they meet the minimum aircraft system performance specifications (MASPS). For detailed requirements, refer to the following publications:

- a) International Civil Aviation Organization (ICAO) Doc 7030—*Regional Supplementary Procedures*;
- b) ICAO NAT Doc 001—*NAT SPG Handbook*;
- c) ICAO NAT Doc 007—*North Atlantic Operations and Airspace Manual*; and
- d) Parts VI and VII of the *Canadian Aviation Regulations* (CARs).

Eastbound aircraft requesting an oceanic clearance from Gander area control centre (ACC) to enter the NAT HLA at designated RVSM altitudes may be asked by air traffic control (ATC) to confirm that they are approved for minimum navigation performance specifications (MNPS) and/or RVSM operations. Pilots/operators unable to provide such confirmation will be issued an oceanic clearance to operate their aircraft outside designated RVSM altitudes.

1.13 ADHERENCE TO MACH SETTING

While operating in the Gander oceanic control area (OCA) and Canadian Domestic Airspace (CDA), aircraft shall adhere to the Mach setting assigned by air traffic control (ATC) unless approval is obtained from ATC to make a change or until the pilot receives an initial descent clearance approaching destination. If it is essential to make an immediate temporary change in Mach setting (e.g. as a result of turbulence), ATC shall be notified as soon as possible that such a change has been made.

When adherence to an assigned “MACH” setting is no longer required, pilots will receive a controller-pilot data link communications (CPDLC) message to “RESUME NORMAL SPEED”, at which point the flight crew can continue at their cost index. Refer to aeronautical information circular (AIC) 1/20 *Operations Without an Assigned Fixed Speed (OWAFS) in the North Atlantic* for more details.

Pilots shall advise ATC at the time of the climb/descent request if it is not possible to maintain the last assigned Mach setting during en route climbs and descents because of aircraft performance.

1.14 OPERATION OF TRANSPONDERS

Transponders must be operated at all times on Mode A or Mode C on Code 2000 while the aircraft is operated in the North Atlantic (NAT) region. However, the last air traffic control (ATC) assigned code must be retained for a period of 30 min after entry into NAT airspace unless the pilot is otherwise directed by ATC.

NOTE:

This procedure does not affect the use of the special purpose codes 7500, 7600, and 7700.

1.15 METEOROLOGICAL REPORTS

Aircraft must make, record, and report meteorological observations at each designated reporting point on a routine basis. However, aircraft cleared on an organized track should be required to make, record, and report meteorological observations only upon a specific request by air traffic control (ATC). Such requests will be included in the oceanic clearance using the phrase “SEND MET REPORTS”. The International Civil Aviation Organization (ICAO) air report (AIREP) form, as contained in Appendix 1 of the *Procedures for Air Navigation Services—Air Traffic Management* (Doc 4444), should be used for this purpose.

1.16 ALTITUDE REPORTS

Aircraft cleared for climb or descent should report their level to the nearest 100 ft.

For all altitude changes, whether they are climbs or descents, pilots should report reaching the new level/cruising altitude to air traffic control (ATC).

1.17 CONTINGENCY AND EMERGENCY PROCEDURES

1.17.1 In-Flight Contingencies

All pilots transiting the NAT should be thoroughly familiar with the in-flight contingency procedures for situations of rapid descent, turnback, diversion, and reduction of navigation capability.

In-flight contingency procedures are published in the following documents:

- a) ICAO Doc 4444—*Procedures for Air Navigation Services—Air Traffic Management*;
- b) ICAO Doc 7030—*Regional Supplementary Procedures*;
- c) ICAO NAT Doc 001—*NAT SPG Handbook*;
- d) ICAO NAT Doc 007—*North Atlantic Operations and Airspace Manual*; and
- e) NAT OPS Bulletins.

1.17.2 Contingency Procedures for Oceanic Traffic in the Event of an Evacuation of Gander Aera Control Centre (ACC)

1.17.2.1 AIRCRAFT PROCEDURES – Westbound								
a) Aircraft that do not receive an oceanic clearance								
i)	In the event that Gander ACC must be evacuated, only aircraft with received and acknowledged oceanic clearances will be permitted to transit the Gander OCA.							
ii)	If unable to obtain or acknowledge an oceanic clearance, flights should plan to re-route around the Gander OCA or land at an appropriate aerodrome. Request the appropriate reclearance on the current frequency. Frequency congestion is likely.							
b) Aircraft that receive an acknowledged oceanic clearance								
i)	Aircraft operating with a received and acknowledged oceanic clearance should proceed in accordance with the clearance. Flights should not request changes in altitude, speed, or route except for reasons of flight safety.							
ii)	Any flights involved in level changes should complete the manoeuvre as soon as possible in accordance with any restrictions provided with the clearance.							
c) Contact Procedures								
i)	Upon receipt of an emergency evacuation message, pilots are requested to broadcast to other flights on 121.5, 243.0, and 123.45. A listening watch on these frequencies and the current frequency should be maintained until the flight exits the Gander OCA and FIR.							
ii)	All flights within the Gander OCA should transmit position reports on any available HF or VHF frequency to Shanwick Radio either directly or through another agency or flight.							
iii)	Flights should establish communication with the next agency at the earliest opportunity, stating their current position, cleared flight level, next position and estimate, and subsequent position. This also applies to flights using automated position reports (ADS/FMC) because those reports may not have been received by the next agency.							
iv)	Flights within the Gander OCA should initially establish contact with Shanwick Radio. Flights within the Gander FIR should contact Montreal Centre or Moncton Centre, depending on their oceanic exit point as described in subparagraph vii) below. Flights about to exit the Gander OCA into the New York OCA, the Reykjavik Oceanic CTA, the Santa Maria OCA, or the Nuuk FIR should contact New York ARINC, Iceland Radio, Santa Maria Radio, or Nuuk Radio as appropriate.							
v)	If unable to establish radio contact, flights may use SATVOICE voice or satellite telephone to provide position reports.							
	<table border="1"> <thead> <tr> <th>Oceanic Centre</th> <th>Public Switched Telephone Network (PTSN) Number</th> <th>Short Code</th> </tr> </thead> <tbody> <tr> <td>Gander Shift Manager</td> <td>001-709-651-5207</td> <td>N/A</td> </tr> </tbody> </table>	Oceanic Centre	Public Switched Telephone Network (PTSN) Number	Short Code	Gander Shift Manager	001-709-651-5207	N/A	
Oceanic Centre	Public Switched Telephone Network (PTSN) Number	Short Code						
Gander Shift Manager	001-709-651-5207	N/A						
vi)	Aircraft may request that their flight dispatch offices forward position reports, if these aircraft are sending position reports to multiple ATS Units or if they are otherwise unable to forward position reports.							

1.17.2.1 AIRCRAFT PROCEDURES – Westbound

- vii) Based on where they exit oceanic airspace, flights shall proceed in accordance with the following table until communication is established with the next agency and this agency issues a reclearance.
For flights operating at FL290 and above:

Flight is routed over:	The flight shall proceed to:	Next control agency and frequency:
AVPUT	NALDI DUTUM	Montreal ACC 134.85
CLAVY	KAGLY TEFFO	Montreal ACC 134.85
EMBOK	IKMAN FEDDY	Montreal ACC 134.85
KETLA	GRIBS JELCO	Montreal ACC 134.800
MAXAR	MIBNO RODBO	Montreal ACC 134.800
PIDSO	PEPKI LOPVI	Montreal ACC 135.800
SAVRY	LAKES MCKEE	Montreal ACC 132.450
URTAK	TEALS VANSI	Montreal ACC 132.450
AVUTI	YKL ROUND	Montreal ACC 132.450
CUDDY	YWK MT	Montreal ACC 132.90 @ 63W
DORYY	YBC ANCER	Moncton ACC 132.95
HOIST	YRI	Moncton ACC 118.875
IRLOK	5031N 06500W	Moncton ACC 118.875
JANJO	CEFOU	Moncton ACC 118.875
KODIK	4941N 06500W	Moncton ACC 132.52
LOMSI	QUBIS	Moncton ACC 132.52
MELDI	4853N 06500W	Moncton ACC 132.52
NEEKO	TAFFY	Moncton ACC 124.975
PELTU	4813N 06500W	Moncton ACC 135.77
RIKAL	MIILS	Moncton ACC 135.77
SAXAN	4718N 06500W	Moncton ACC 133.55
TUDEP	TOPPS	Moncton ACC 133.55
UMESI	4618N 06500W	Moncton ACC 133.55
ALLRY	EBONY	Moncton ACC 132.8
BUDAR	4536N 06500W	Moncton ACC 132.8
ELSIR	ALLEX	Moncton ACC 132.8
IBERG	4451N 06500W	Moncton ACC 132.75
JOOPY	TUSKY	Moncton ACC 132.75
MUSAK	4409N 06500W	Moncton ACC 132.75
NICSO	BRADD	Moncton ACC 132.75
OMSAT	4336N 06500W	Moncton ACC 133.3
PORTI	KANNI	Moncton ACC 133.3
RELIC	4303N 06500W	Moncton ACC 133.7
SUPRY	WHALE	Moncton ACC 133.7
VODOR	NANSO VITOL	Moncton ACC 125.25
BOBTU	JAROM GAYBL	Moncton ACC 125.25

1.17.2.1 AIRCRAFT PROCEDURES – Westbound

For flights operating at FL280 and below:

NOTE: Routes HOIST and south are the same as for flights operating at FL290 and above.

Flight is routed over:	The flight shall proceed to:	Next control agency and frequency:
NALDI	DUTUM	Montreal ACC 134.55
KAGLY	TEFFO	Montreal ACC 134.55
IKMAN	FEDDY	Montreal ACC 134.55
GRIBS	JELCO	Montreal ACC 128.25
MIBNO	RODBO	Montreal ACC 128.25
PEPKI	LOPVI	Montreal ACC 135.1
5900N 06000W	LAKES MCKEE	Montreal ACC 135.1
MOATT	LOMTA TEALS VANSI	Montreal ACC 132.9
PRAWN	YDP YKL ROUND	Montreal ACC 132.25@65W
PORGY	HO YWK MT	Montreal ACC 132.25@ 63W

1.17.2.2 AIRCRAFT PROCEDURES – Eastbound

a) Aircraft that do **not** receive an oceanic clearance

- i) In the event that Gander ACC must be evacuated, only aircraft with received and acknowledged oceanic clearances will be permitted to transit the Gander OCA.
- ii) If unable to obtain or acknowledge an oceanic clearance, flights should plan to re-route around the Gander OCA or land at an appropriate aerodrome. Flights may be required to re-route around the Gander FIR as well. Flights should request the appropriate re-clearance from Montreal or Moncton Centre. Frequency congestion is likely.

b) Aircraft that receive an acknowledged oceanic clearance

- i) Aircraft operating with a received and acknowledged oceanic clearance should proceed in accordance with the clearance. Flights should not request changes in altitude, speed, or route except for reasons of flight safety or to comply with the oceanic clearance.
- ii) Flights west of 50 west longitude should contact either Montreal or Moncton Centre, depending on which of the two was the previous agency, using the previous assigned frequency.

1.17.2.2 AIRCRAFT PROCEDURES – Eastbound

- iii) The Eastbound Organized Track System will be extended to begin at fixes on or near the western boundary between the Gander FIR and the Moncton and Montreal FIRs as follows:

INLAND CONTINGENCY FIX	INTERMEDIATE FIX	OCEANIC ENTRY POINT
KENKI		AVPUT
MUSVA		CLAVY
BERUS		EMBOK
GRIBS		KETLA
6101N 06241W		LIBOR
MIBNO		MAXAR
MUSLO		NIFTY
PEPKI		PIDSO
SINGA		RADUN
LAKES	5900N 06000W	SAVRY
UDMAR		TOXIT
YKL	LOMTA	URTAL
ALSOP		VESMI
YWK	YDP	AVUTI
DUVBI	VOKET	BOKTO
MUNBO	HO	CUDDY
BORUB		DORYY
TEXUN		ENNSO
TASTI	YYR	HOIST
5222N 06106W		IRLOK
SERBO		JANJO
KONCH		KODIK
VERTU		LOMSI
5111N 05929W		MELDI
PIKNA		NEEKO
5052N 05859W		PELTU
NAPLO	YAY	RIKAL
4950N 05828W		SAXAN
MIGLI		TUDEP
4904N 05754W		UMESI
LOPRO		ALLRY
4818N 05730W		BUDAR
VINSI	YQX	ELSIR
4734N 05712W		IBERG
TAGRA		JOOPY
4649N 05654W		MUSAK
SUTKO	YYT	NICSO
4610N 05639W		OMSAT
RUBDA		PORTI
4521N 05621W		RELIC
PEPRA		SUPRY

1.17.2.2 AIRCRAFT PROCEDURES – Eastbound

	INLAND CONTINGENCY FIX	INTERMEDIATE FIX	OCEANIC ENTRY POINT
	NANSO		RAFIN
	LOMPI	JAROM	
iv)	<p>Flights at or east of 50 west longitude should initially contact Shanwick Radio. Flights about to exit the Gander OCA should contact New York ARINC, Santa Maria Radio, Iceland Radio, or Nuuk Radio as appropriate. The following information should be provided:</p> <p>(A) call sign; (B) current position; (C) current flight level and cleared oceanic flight level (if different from the current level); (D) assigned Mach or speed; (E) next waypoint and estimate; and (F) subsequent waypoint.</p>		
v)	<p>If a level change is required to comply with the oceanic clearance, the flight should request clearance from Montreal or Moncton Centre. If unable to obtain an ATC clearance, the aircraft should climb or descend so as to cross the oceanic entry point at the cleared oceanic flight level.</p>		
vi)	<p>The following communications procedures have been developed in accordance with the Traffic Information Broadcast by Aircraft (TIBA) procedures recommended by ICAO Annex 11 – <i>Air Traffic Services</i>, Attachment C. Unless otherwise instructed by Moncton or Montreal Centre, aircraft should apply these procedures when completing an altitude change to comply with the oceanic clearance.</p> <p>At least 3 minutes prior to initiating a climb or descent, the flight should broadcast the following on the last assigned frequency, 121.5, 243.0, or 123.45:</p> <p>ALL STATIONS (call sign) (direction) DIRECT FROM (landfall fix) TO (oceanic entry point) LEAVING FLIGHT LEVEL (number) FOR FLIGHT LEVEL (number) AT (distance)(direction) FROM (oceanic entry point) AT (time)</p> <p>When the level change begins, the flight should make the following broadcast:</p> <p>ALL STATIONS (call sign) (direction) DIRECT FROM (landfall fix) TO (oceanic entry point) LEAVING FLIGHT LEVEL (number) NOW FOR FLIGHT LEVEL (number)</p> <p>When level, the flight should make the following broadcast:</p> <p>ALL STATIONS (call sign) MAINTAINING FLIGHT LEVEL (number)</p>		
vii)	<p>When ADS-equipped flights are notified of a Gander evacuation, they must revert to voice position reporting until they are either clear of Gander OCA or notified otherwise. Pilots should note that they may be asked to log on to EGGX when within the Gander OCA; they should not initiate this action until instructed to do so.</p>		

1.18 COMMUNICATIONS FAILURE—NORTH ATLANTIC (NAT) TRAFFIC

The following procedures are intended to provide general guidance for North Atlantic (NAT) aircraft experiencing a communications failure. It is impossible to provide guidance for all possible situations associated with a communications failure.

1.18.1 General

If the aircraft is so equipped, a pilot experiencing a two-way radio communications failure shall operate the transponder in Mode C and squawk Code 7600.

The pilot shall attempt to contact any ATC facility, inform controllers of the difficulty, and request that information be relayed to the intended ATC facility.

1.18.2 Communications Failure Prior to Entering the North Atlantic (NAT) Oceanic Airspace

If operating with a received and acknowledged oceanic clearance, the pilot should enter oceanic airspace at the cleared oceanic entry point, flight level, and speed, and proceed in accordance with the received and acknowledged oceanic clearance. Any flight level or speed changes required to comply with the oceanic clearance should be completed within the vicinity of the oceanic entry point. The cleared oceanic flight level is the flight level contained in the oceanic clearance.

If operating without a received and acknowledged oceanic clearance, the pilot should enter oceanic airspace at the first oceanic entry point, flight level, and speed contained in the filed flight plan, and proceed via the filed flight plan route to landfall. The first oceanic flight level and speed should be maintained to landfall.

1.18.3 Communications Failure Prior to Exiting the North Atlantic (NAT) Oceanic Airspace

If the oceanic clearance includes the flight planned oceanic exit point, the pilot should proceed in accordance with the last received and acknowledged oceanic clearance, including flight level and speed, to the last specified oceanic exit point. The pilot should continue on the flight plan route and, after passing the last specified oceanic exit point, conform to the relevant state procedures and regulations.

If cleared on a route that contains an oceanic exit point other than the one contained in the flight plan, the pilot should proceed in accordance with the last received and acknowledged oceanic clearance, including flight level and speed, to the last specified oceanic route point. After passing this point, the pilot should conform to the relevant state procedures and regulations, rejoining the filed flight plan route by proceeding, via published ATS routes where possible, to the next significant point west of the last oceanic route point contained in the filed flight plan.

1.19 NORTH ATLANTIC HIGH-LEVEL AIRSPACE (NAT HLA)

1.19.1 General

The MNPS shall be applicable in that volume of airspace between FL 285 and FL 420 within the OCAs of Bodo Oceanic, Gander Oceanic, New York Oceanic East, Reykjavik, Santa Maria, and Shanwick excluding the Brest Oceanic Transition Area (BOTA) and the Shannon Oceanic Transition Area (SOTA).

Operators of Canadian-registered aircraft intending to fly in the NAT HLA will be required to show that they meet all the applicable standards. Information on the measures necessary to gain approval may be obtained from the following:

Equipment Installation Approval:

Transport Canada Civil Aviation
Regional Airworthiness Engineer
(See GEN 1.0 for the appropriate regional office.)

Commercial Flight Standards:

Transport Canada Civil Aviation
330 Sparks Street
Ottawa ON K1A 0N8

Tel.: 1-800-305-2059
Fax: 613-990-6215

Figure 1.2—NAT HLA Between FL 285 and FL 420



1.19.2 Time Keeping Procedures

Prior to entry into the NAT HLA, the time reference system(s) to be used during the flight for calculation of waypoint ETAs and waypoint ATAs should be synchronized to UTC. All ETAs and ATAs passed to ATC should be based on a time reference that has been synchronized to UTC or equivalent. Acceptable sources of UTC include the following:

- a) The United States National Institute of Standards and Technology (NIST) HF radio station near Fort Collins, Colo., (call sign WWV), which operates 24 hr a day on 2 500, 5 000, 10 000, 15 000, and 20 000 kHz (AM/SSB) and announces UTC time at the top of each minute.
- b) Approved (TSO-C129) GPS equipment on board (corrected to UTC) that allows pilots to access UTC time 24 hr a day.
- c) The National Research Council of Canada HF radio station in Ottawa (call sign CHU), which is available 24 hr a day on 3 330, 7 850, and 14 670 kHz (SSB). In the final ten-second period of each minute, it makes a bilingual station identification and time announcement in UTC.
- d) The British Broadcasting Corporation (BBC), which transmits the Greenwich time signal once every hour on a number of domestic and worldwide frequencies.
- e) Any other source shown to the state of registry or state of the operator (as appropriate) to be an equivalent source of UTC.

1.19.3 Provisions for Partial Loss of Navigation Capability

If an aircraft suffers partial loss of navigation capability (in which only one long-range navigation system is serviceable) prior to entry into oceanic airspace, the following routes should be considered:

- a) STN – 6000N 01000W (ATSIX) – 6100N 01234W – ALDAN KJV
- b) BEN – 6100N 01000W (RATSU) – ALDAN – KJV
- c) MAC – BEL – GOW – SHA – 5700N 01000W (GOMUP) – 6000N 01500W – 6100N 01630W BREKI KJV
- d) KJV – SOPEN – DA – SF – YFB
- e) KJV – EPENI – 6300N 03000W – 6100N 04000W – OZN
- f) OZN – 5900N 05000W – AVUTI (FL 290-FL 600) – PRAWN – YDP;
- g) OZN – 5900N 05000W – CUDDY (FL 290-FL 600) – PORGY – HO;
- h) OZN – 5800N 05000W – HOIST – YYR;

- i) SF – 6700N 06000W (DARUB) – YXP;
- j) KU – 6600N 06000W (EPMAN) – YXP;
- k) KU – 6400N 06000W – 6400N 06300W (MUSVA) – YFB
- l) RE – 6930N 02240W – CP

These routes are subject to the following conditions:

- a) sufficient navigation capability remains to meet the MNPS, and the requirements in ICAO Annex 6, Part I, Section 7.3 and ICAO Annex 6, Part II, Section 3.7.2 can be met by relying on the use of short-range NAVAIDS;
- b) a revised flight plan is filed with the appropriate ATS unit; and
- c) an ATC clearance is obtained.

NOTES:

1. A revised oceanic clearance will be issued after coordination between all oceanic ACCs concerned.
2. If the OTS extends to the northern part of the NAT region, the aircraft concerned may be required to accept a lower than optimum flight level in the revised oceanic clearance, especially during peak traffic periods.
3. This guidance material does not relieve the pilot from the requirement to take the best possible course of action in light of the prevailing circumstances.

1.19.4 Special Routes for Aircraft Fitted With a Single Long-Range Navigation System

In order to be considered capable of meeting the MNPS while operating along the routes listed below, aircraft must have state approval to operate in the NAT HLA, be equipped with normal short-range navigation equipment (VOR/DME, ADF), and have at least one fully operational set of one of the following navigation equipment:

- a) DOPPLER with computer;
- b) INS;
- c) GPS approved in accordance with the requirements specified in TSO C-129 (Class A1, A2, B1, B2, C1, or C2); or
- d) FMS or IRS.

The aforementioned routes are known as Blue Spruce routes and are as follows:

- a) STN or BEN – 60N 010W (ATSIX) – 61N 01234W – ALDAN – KJV (HF required on this route);

- b) STN or BEN – 61N 010W (RATSU) – ALDAN – KFV (VHF coverage exists and, subject to prior coordination with Scottish Airways and Prestwick [Shanwick OAC], this route may be used by non-HF equipped aircraft);
- c) MAC, BEL, GOW, SGA – 57N 010W (GOMUP) – 60N 015W – 61N 01630W – BREKI KFV (HF required on this route)
- d) Tango Nine (T9) – 483554N 0090000W (LASNO) – 45N 009W (BEGAS) – STG (HF required on this route);
- e) Tango Sixteen (T16) – 485020N 0120000W (OMOKO) – 4500N 01600W (GONAN) – 4000N 01600W – NAVIX (HF required on this route);
- f) Tango Two One Three (T213) – 484343N 0102950W (TAMEL) – 4500N 01300W (BERUX) (HF required on this route);
- g) KFV – SOPEN – DA – SF – YFB;
- h) KFV – EPENI – 6300N 03000W – 6100N 04000W – OZN;
- i) OZN – 5900N 05000W – AVUTI (FL 290-FL 600) – PRAWN – YDP;
- j) OZN – 5900N 05000W – CUDDY (FL 290-FL 600) – PORGY – HO;
- k) OZN – 5800N 05000W – HOIST – YZR;
- l) SF – 6700N 06000W (DARUB) – YXP;
- m) KU – 6600N 06000W (EPMAN) – YXP;
- n) KU – 6400N 06000W – 6400N 06300W (MUSVA) – YFB;
- o) RE – 6930N 02240W – CP;
- p) Funchal/Porto Santo – Santa Maria/Ponta Delgada; and
- q) Lisboa Porto Faro – Ponta Delgada/Santa Maria/Lajes.

1.19.5 Aircraft Without Minimum Navigation Performance Specifications (MNPS) Capability

An aircraft that does not meet the NAT HLA requirements may be allowed to operate in the NAT HLA if the following conditions are satisfied:

- a) The aircraft is being provided with ATS surveillance services;
- b) Direct controller-pilot VHF communication is maintained; and
- c) The aircraft has a certified installation of equipment providing it with the ability to navigate along the cleared track.

NOTE:

Pilots operating aircraft in the NAT HLA under these provisions should familiarize themselves with NAT HLA operations and procedures. They should also have a current copy of the OTS message that is in effect for the time of their flight for situational awareness.

Aircraft that are not approved to operate in the NAT HLA and do not meet the above provisions may be cleared to climb or descend through the NAT HLA, traffic permitting.

1.19.6 Monitoring of Gross Navigation Errors

In order to ensure that the required navigation standards are being observed within the NAT HLA, a continuous monitoring of the navigation accuracy of aircraft in this airspace takes place using surveillance systems in Canada, Ireland, France, Iceland, and the United Kingdom. In cases of a gross navigation error, the pilot will normally be notified by the ATC unit observing the error. The subsequent investigation to determine the error will involve the ATC unit, the operator, and the state of registry.

If there is a serious increase in the number of large errors, it may become necessary to increase separation standards until remedial action has been determined. Alternatively, if rapid corrective action cannot be achieved, it may be necessary for the state of registry or the state of the operator to temporarily exclude offending aircraft types or operators from the NAT HLA.

1.20 NORTH ATLANTIC (NAT) REDUCED VERTICAL SEPARATION MINIMUM (RVSM)

1.20.1 Geographic Boundaries

In the NAT, RVSM airspace is airspace within the geographic extent of the NAT region from FL 290 to FL 410 inclusive.

1.20.2 Reduced Vertical Separation Minimum (RVSM) Details and Procedures

For RVSM details and procedures applicable to both the NAT and CDA, see RAC 11.7.

1.20.3 Flight Level Allocation Scheme (FLAS)

As with procedures in CDA, aircraft flight planning in oceanic airspace should normally plan for a flight level appropriate to the direction of flight, particularly when they are operating outside of the OTS structure and valid times.

In an effort to provide efficient and economic profiles, NAT ANSPs, through consultation, have designed the FLAS.

The FLAS standardizes flight levels available for traffic routing on and outside of the OTS as well as during transition times (times between valid OTS).

Aircraft operators are advised to flight plan using the flight levels specified in this document, relative to their particular flight(s).

1.20.3.1 Flight Level Allocation Scheme (FLAS) Procedures

FLAS procedures entail:

- a) the establishment of flight level profiles normally available during OTS valid times;
- b) the establishment of flight level profiles during OTS changeover periods;
- c) the establishment of a night datum line, with the area south of the line reserved principally for traffic originating in New York/Santa Maria; and
- d) the establishment of a north datum line, with the area on or north of the line reserved for late-running westbound traffic from Reykjavik to Gander.

1.20.3.2 Organized Track System (OTS)

- a) Westbound
 - (i) The westbound OTS message is designed and published by Shanwick daily.
 - (ii) The most northerly track of a day OTS is designated as NAT Track Alpha; the adjacent track to the south, as NAT Track Bravo; and so on.
 - (iii) The valid times are 1130 to 1900 UTC at 30°W.
 - (iv) The flight level profiles normally published are FL 310 to FL 390 inclusive
 - (v) Tracks that landfall at or north of CUDDY FL 340 will not be published.
 - (A) FL 340 is omitted from these tracks to allow profiles for aircraft originating in the Reykjavik OCA.
- b) Eastbound
 - (i) The eastbound OTS message is designed and published by Gander daily.
 - (ii) The most southerly track is designated as Track Zulu; the adjacent track to the north, as Track Yankee; and so on.
 - (iii) The valid times are 0100 to 0800 UTC at 30°W.
 - (iv) The flight level profiles normally published are FL 310 to FL 400 inclusive.
 - (A) FL 310 is available on New York tracks only.
 - (v) Eastbound traffic routing, south of both the night datum line and the main OTS, should flight plan using FL 310, FL 340, FL 360, or FL 380.
 - (vi) New York Tracks entering Shanwick OCA that cross, or route south of, the night datum line may be any combination of FL 310, FL 340, FL 360, or FL 380, or as otherwise agreed between Santa Maria and New York. Additional levels will be allocated to New York Tracks if the core OTS is located in that area.

NOTE:

For this procedure “New York Tracks” are any eastbound OTS Tracks that originate in the New York area and enter Gander or Shanwick OCAs.

1.20.3.3 Organized Track System (OTS) Changeover Periods

- a) Basic Principles:
 - (i) The time period between the expiration of one OTS and the commencement of another set is known as the OTS changeover period.
 - (ii) All times relate to 030°W.
 - (iii) OTS changeover rules apply from 0801 to 1129 UTC and from 1901 to 0059 UTC.
 - (iv) During these times, flight levels shall be applied in accordance with the direction of flight except as stated below.
- b) Guidelines
 - (i) Westbound traffic crossing 030°W from 2230 to 0059 UTC:
 - (A) Remain clear of the incoming OTS; and
 - (B) Do not plan delegated ODLs (FL 340 and FL 380).
 - (I) After 2230 UTC, the published OTS flight levels and ODLs are released to Gander for the use of eastbound traffic.
 - (ii) Eastbound traffic crossing 030°W from 1000 to 1129 UTC:
 - (A) Remain clear of the incoming OTS at FL 350; and
 - (B) Do not plan the delegated ODL (FL 330).
 - (I) After 1000 UTC, the OTS (at FL 330 and FL 350) and ODL (FL 330) are released to Shanwick for the use of westbound traffic.
 - (iii) Eastbound traffic crossing 30°W from 1030 to 1129 UTC at FL 370 and FL 390:
 - (A) Remain clear of the incoming OTS.
 - (I) After 1030 UTC, the OTS (at FL 370 and FL 390) is released to Shanwick for the use of westbound traffic.
 - (iv) At the end of westbound (daytime) OTS:
 - (A) Westbound aircraft crossing 030°W until 1900 UTC at the ODL (FL 330) or on the OTS shall have priority over eastbound aircraft.
 - (I) During the westbound OTS hours of validity, Gander delegates FL 330 to Shanwick for use by westbound traffic.
 - (v) At the end of eastbound (night-time) OTS:
 - (A) Eastbound aircraft crossing 030°W until 0800 UTC at the ODLs (FL 340 and FL 380) or on the OTS shall have priority over westbound aircraft.

The table below provides a summary:

Table 1.4—OTS Changeover Periods

Level	Time (UTC)	Direction
FL 430	24 hr	Westbound. May be flight planned as eastbound by non-RVSM aircraft.
FL 410	24 hr	Eastbound.
FL 400	0801–2229 2230–0059 0100–0800	Westbound. Westbound (avoiding OTS). Eastbound OTS(subject to westbounds). Westbound (avoiding OTS). Eastbound (OTS).
FL 390	1901–1029 1030–1129 1130–1900	Eastbound. Eastbound (avoiding OTS). Westbound OTS (subject to eastbounds). Eastbound (avoiding OTS). Westbound (OTS).
FL 380	0300–0700 0801–2229 2230–0059 0100–0800	Westbound (ODL, on and to the North of the North datum line). Westbound. Eastbound (subject to westbounds). Eastbound (OTS and ODL).
FL 370	1901–1029 1030–1129 1130–1900	Eastbound. Eastbound (avoiding OTS). Westbound OTS (subject to eastbounds). Eastbound (avoiding OTS). Westbound (OTS).
FL 360	0801–2229 2230–0059 0100–0800	Westbound. Westbound (avoiding OTS). Eastbound OTS (subject to westbounds). Westbound (avoiding OTS). Eastbound (OTS).
FL 350	1901–0959 1000–1129 1130–2000	Eastbound. Eastbound (avoiding OTS). Westbound OTS (subject to eastbounds). Eastbound (avoiding OTS). Westbound (OTS).
FL 340	0801–2229 2230–0059 0100–0800	Westbound. Eastbound (subject to westbounds). Eastbound OTS (subject to westbounds). Eastbound (OTS and ODL).
FL 330	1901–0959 1000–1129 1130–1900	Eastbound. Westbound (subject to eastbounds). Westbound (OTS and ODL).
FL 320	0801–2229 2230–0059 0100–0800	Westbound. Westbound (avoiding OTS). Eastbound OTS (subject to westbounds). Westbound (avoiding OTS). Eastbound (OTS).
FL 310	24 hr	Westbound (ODL).
FL 300	24 hr	Westbound.
FL 290	24 hr	Eastbound.

1.20.3.4 Night Datum Line

During the eastbound OTS hours of validity, a static datum line, known as the night datum line, is established with the following coordinates:

45°N 030°W – 49°N 020°W – SOMAX – ATSUR

FL 340 and FL 380 are delegated to Gander for eastbound traffic on and to the north of the night datum line.

FL 340 will not be used for Gander eastbound traffic to the south of the night datum line.

FL 380 will not be used for Gander eastbound traffic to the south of either the night datum line or the eastbound OTS, whichever is further south.

Figure 1.3—Night Datum Line



1.20.3.5 North Datum Line

Between 0300 and 0700 UTC, a static datum line, known as the north datum line, is established with the following coordinates:

LOMTA – URTAK – 60°N 050°W – 62°N 040°W – 63°N 030°W

On and to the north of the north datum line, FL 380 is delegated to Reykjavik for use by westbound traffic.

In the event of a high volume of north random flights or OTS tracks, the north datum line may be suspended to accommodate the anticipated eastbound traffic.

Figure 1.4—North Datum Line



1.2.0.4 North Atlantic (NAT) Reduced Vertical Separation Minimum (RVSM) Aircraft Approvals

Operators of Canadian-registered aircraft intending to fly in NAT MNPS/RVSM airspace will be required to show that they meet all of the applicable standards. Further information on the measures necessary to gain approval may be obtained from the following:

Airworthiness Approvals

RVSM Maintenance Programs
 Director, Standards (AART)
 Transport Canada Civil Aviation
 330 Sparks Street
 Ottawa ON K1A 0N8

Tel.: 1-800-305-2059
 Fax: 613-952-3298

Commercial Flight Standards (AARTF)

Transport Canada Civil Aviation
 330 Sparks Street
 Ottawa ON K1A 0N8

Tel.: 1-800-305-2059
 Fax: 613-990-6215

RVSM Maintenance Programs

Director, Standards (AART)
 Transport Canada Civil Aviation
 330 Sparks Street
 Ottawa ON K1A 0N8

Tel.: 1-800-305-2059
 Fax: 613-952-3298

1.2.0.5 Central Monitoring Agency (CMA)

The Regional Monitoring Agency for the NAT is the CMA located in Prestwick, UK, and it may be contacted at the following address:

North Atlantic Central Monitoring Agency
 c/o National Air Traffic Services
 Room G41
 Scottish & Oceanic Area Control Centre
 Sherwood Road
 Prestwick, Ayrshire KA9 2NR
 United Kingdom

Tel.: +44 1292 692412
 Strumble HMU status
 (recorded message)..... +44 1292 692760
 Fax: +44 1292 692754
 E-mail: natcma@nats.co.uk

Information on the responsibilities of the CMA and the procedures applicable to it are contained in ICAO NAT Doc 001—*NAT SPG Handbook*, available at the following address: <www.icao.int/EURNAT/Pages/EUR-and-NAT-Document.aspx>.

1.2.0.6 Data Link Mandate (DLM) Airspace

1.2.0.6.1 General Information

The objectives of the NAT Data Link Mandate are to enhance communication, surveillance, and ATC intervention capabilities in the NAT region. ADS-C provides conformance monitoring of aircraft adherence to cleared routes and flight levels, significantly enhancing safety. ADS-C also facilitates SAR operations, including the capability to locate the site of an accident in oceanic airspace. CPDLC substantially improves air-ground communications capability, and therefore, controller intervention capability.

1.2.0.6.2 Data Link Mandate (DLM) Flight Levels

DLM airspace encompasses FL 290 to FL 410, inclusive, throughout the NAT region.

1.2.0.6.3 Flights Permitted to Operate Within NAT DLM Airspace

The following flights are permitted in NAT DLM airspace:

- a) Flights equipped with and prepared to operate FANS 1/A (or equivalent) CPDLC and ADS-C data link systems (see ICAO Doc 7030 3.3.2 and 5.4.2);
 - (i) The appropriate equipage to be indicated in Item 10 of the ICAO flight plan is:
 - (A) D1; and
 - (B) One of the following: J2, J5, or J7.
- b) Non-equipped flights that file STS/FFR, HOSP, HUM, MEDEVAC, SAR, or STATE in item 18 of the flight plan.

NOTE: Such flights may not receive an ATC clearance that matches flight-planned requests, depending on tactical situations.

1.20.6.4 Airspace Not Included in Gander's North Atlantic (NAT) Data Link Mandate (DLM) Airspace

Outside Gander oceanic's DLM airspace is the area where ATS surveillance service is provided by ADS-B coupled with VHF communications.

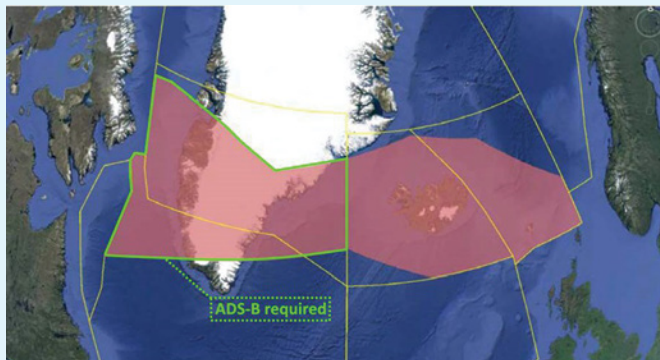
The boundaries are as follows (refer to Figure 1.5 ADS-B Required Airspace):

NORTHERN BOUNDARY: 64N000W – 68N010W – 69N020W – 68N030W – 67N040W – 69N050W – 69N060W – BOPUT

SOUTHERN BOUNDARY: 61N000W – 61N007W – 6040N010W – 61N010W – 61N020W – 63N030W – 62N040W – 61N050W – SAVRY

Non-equipped flights may flight plan to operate in the above described area at DLM levels provided that the aircraft is equipped with a transponder/ADS-B extended squitter transmitter.

Figure 1.5—ADS-B Required Airspace



1.20.6.5 Operational Policies

Non-equipped aircraft may request to climb or descend through NAT DLM airspace. Such requests will be considered on a tactical basis.

Altitude reservation requests will be considered on a case-by-case basis irrespective of the equipment status of the requesting aircraft.

1.20.6.6 Equipment Failure of Either ADS-C or CPLDC Systems

- a) Prior to departure:
 - (i) Resubmit the flight plan to remain clear of NAT DLM airspace.
- b) After departure but prior to entering DLM airspace:
 - (i) Notify ATC prior to entering DLM airspace.
 - (ii) Requests to operate in DLM airspace will be considered on a tactical basis.

- c) After entering NAT DLM airspace:
 - (i) Notify ATC immediately.
 - (ii) Tactical consideration will be given to allow the flight to continue in NAT DLM airspace. Flights may be required to exit NAT DLM airspace if this is warranted due to traffic.

1.20.7 Height Monitoring

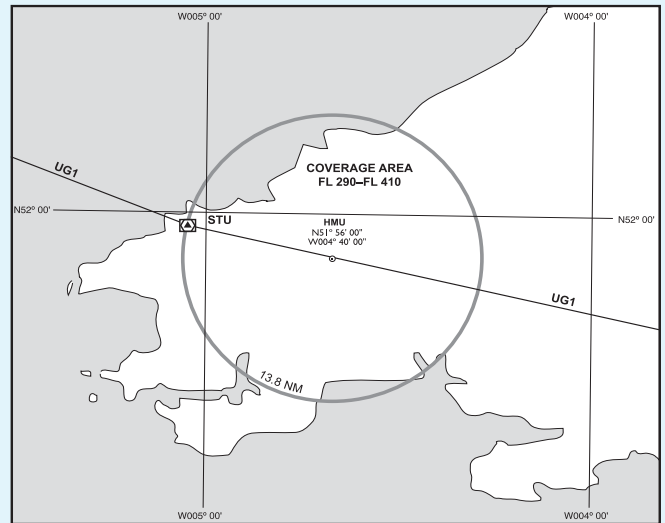
For the NAT, height monitoring is carried out using a hybrid system composed of a fixed ground-based HMU and a GPS-based monitoring system that consists of portable GMUs.

1.20.8 Height Monitoring Unit (HMU)

The HMU site is located at Strumble, UK, 15 NM east of the Strumble VOR/DME (STU), beneath upper ATS UG1, at coordinates 51°56'00"N 004°40'00"W (see Figure 1.6).

The coverage area for the Strumble HMU is a 13.8-NM radius circle from FL 290 to FL 410, inclusive.

Figure 1.6—Strumble HMU



1.20.8.1 Pre-flight Procedures

Operators proposing to divert from an optimum route in order to fly over the Strumble HMU should check the HMU status at +44 1292 692760 (UK) for serviceability information. Every effort will be made to ensure that the promulgated information is accurate, but operators should note that the equipment may become unserviceable on short notice.

Pilots of aircraft that must be monitored should flight plan their route over STU. Item 18 of the flight plan must include both the aircraft registration (if not included in Item 7) and the remarks "RMK/HMU FLT STU".

1.20.8.2 In-flight Procedures

Prior to an overflight of the Strumble HMU, pilots are requested to transmit “for HMU flight” to London Control on initial contact and, if they are not RVSM approved, a request for a level between FL2 90 and FL 410 (inclusive) should be made. The controller will endeavour to allow the aircraft to route through the HMU coverage area in straight and level flight, if operational requirements so permit.

1.20.8.3 Post-flight Procedures

ATC is not aware of whether an aircraft has been successfully monitored by the HMU. Operators wishing to ascertain this information may send a fax to the NAT CMA or complete and submit the HMU request form, which is available at <http://natcma.com/height-monitoring-2/strumble-hmu/>. Please note that operators are encouraged to use the NAT CMA Web site.

Operator queries for specific overflights may be made to the NAT CMA. Such queries should include the Mode S or A codes and approximate time of overflight.

1.21 STRATEGIC LATERAL OFFSET PROCEDURE (SLOP)

The strategic lateral offset procedure (SLOP) is now a standard operating procedure (SOP) throughout the North Atlantic (NAT) region. This procedure mitigates collision risk and wake turbulence encounters. Pilots conducting oceanic flights within the NAT region with automatic offset programming capability are recommended to fly lateral offsets up to 2 NM right of centreline.

The introduction of very accurate aircraft navigation systems, along with sophisticated flight management systems (FMS), has drastically reduced the number of risk-bearing lateral navigation (LNAV) errors reported in NAT airspace.

Paradoxically, the capability of aircraft to navigate to such a high level of accuracy has led to a situation in which aircraft on the same track, but at different levels, are increasingly likely to be in lateral overlap. This results in an increased risk of collision if an aircraft departs from its cleared level for any reason.

SLOP reduces risk by distributing aircraft laterally. It is applicable within the New York oceanic, Gander oceanic, Shanwick oceanic, Santa Maria oceanic, Nuuk, and Reykjavik flight information regions (FIRs), and within the Bodø oceanic FIR when flights are conducted more than 185 km (100 NM) seaward from the shoreline.

SLOP conforms to direction in the International Civil Aviation Organization’s (ICAO) *Procedures for Air Navigation Services—Air Traffic Management* (Doc 4444) and is subject to the following guidelines:

- a) Aircraft without automatic offset programming capability must fly the route centreline.
- b) Operators capable of programming automatic offsets may fly the centreline or an offset up to a maximum of 2 NM right of centreline.
- c) Offsets to the left of centreline are not permitted.
- d) An aircraft overtaking another aircraft should offset within the confines of this procedure, if capable, so as to minimize the amount of wake turbulence for the aircraft being overtaken. The pilot should take into account wind, estimated wake vortex drift, and time to descend. (Nominal descent rates for wakes are 300-600 ft/min.)
- e) Pilots should use whatever means are available (e.g. traffic alert and collision avoidance system [TCAS], communications, visual acquisition) to determine the best flight path to fly. Pilots may contact other aircraft on frequency 123.45 MHz, as necessary, to coordinate the best wake turbulence offset option.
- f) Pilots may apply an offset outbound after the oceanic entry point and must return to the centreline before the oceanic exit point. Position reports transmitted via voice should be based on the waypoints of the current air traffic control (ATC) clearance and not on the offset positions.
- g) There is no ATC clearance required for this procedure, and it is not necessary that ATC be advised.

2.0 INTERNATIONAL AIR-GROUND SERVICE

Gander international flight service station (IFSS) is the only Canadian aeronautical station that provides international aeronautical telecommunication services.

2.1 HIGH FREQUENCY (HF) AEROMOBILE OPERATIONS IN THE NORTH ATLANTIC (NAT)

All North Atlantic (NAT) high frequencies (HF) are organized into groups, known as families. The families are identified as NAT family A, B, C, D, E, and F. Initial contact with Gander international flight service station (IFSS) on HF radio should be made on families B, C, D or F. When an aircraft fails to establish contact with Gander IFSS on the designated frequency, it shall attempt to establish contact on another frequency appropriate to the route.

Table 2.1—Families of NAT HF Frequencies Monitored by Gander IFSS

NAT Family	Frequencies
A*	3 016 kHz
B	2 899 kHz
	5 616 kHz
	8 864 kHz
	13 291 kHz
C	2 872 kHz
	5 649 kHz
	8 879 kHz
	11 336 kHz
	13 306 kHz
D	2 971 kHz
	4 675 kHz
	8 891 kHz
	11 279 kHz
	13 291 kHz
F	3 476 kHz
	6 622 kHz
	8 831 kHz
	13 291 kHz

*Note: The NAT Family A of frequencies is not routinely monitored by Gander IFSS; however, they are available for use in unusual circumstances such as an adjacent ATS Unit evacuation or loss communications.

For information about hours of service, refer to the AIP GEN section 3.4 *Communication Services* under 3.4.3 *Types of Service: HF*. For further details regarding Gander Radio Station Information, refer to the International Civil Aviation Organization (ICAO) NAT Doc 003, *High Frequency Management Guidance Material for the North Atlantic Region*, Appendix B-2.

In the event that the overloading of a family occurs or is anticipated, aircraft of one or more operators may be offloaded from that family to another appropriate family for the expected duration of the condition. The offloading may be requested by any station, but Shannon and Gander will be responsible for making a decision after coordination with all NAT stations concerned.

2.2 HIGH FREQUENCY (HF) OPERATIONS—ANCHORAGE ARCTIC

Aircraft operating in the Anchorage Arctic control area (CTA)/flight information region (FIR) beyond the line-of-sight range of remote control very high frequency (VHF) air-ground facilities operated from the Anchorage area control centre (ACC) shall maintain communications with Gander Radio and a listening or selective calling system (SELCAL) watch on North Atlantic Delta (NAT D) network high frequencies (HF) 2 971 kHz, 4 675 kHz, 8 891 kHz, and 11 279 kHz. Primary daytime

frequency is 11 279 kHz with a primary nighttime frequency of 8 891 kHz. Additionally, and in view of reported marginal reception of Honolulu Pacific in-flight meteorological information (VOLMET) broadcast in and adjacent to Canadian airspace, Gander Radio can provide, on request, Anchorage and Fairbanks surface observations and aerodrome forecasts to flight crews.

2.3 AVAILABILITY OF SINGLE SIDEBAND (SSB)

All international high frequency (HF) equipment is operated on single sideband (SSB) J3E emission. In all cases, the upper sideband (USB) is employed.

2.4 SELECTIVE CALLING SYSTEM (SELCAL)

The selective calling system (SELCAL) is installed on all international frequencies at Gander Radio. SELCAL provides an automatic and selective method of calling any aircraft. Voice calling is replaced by the transmission of code tones to the aircraft over the international radiotelephone channels. A single selective call consists of a combination of four pre-selected audio tones requiring approximately two seconds of transmission time. The tones are generated in the ground station coder and are received by a decoder connected to the audio output of the airborne receiver. Receipt of the assigned tone code (SELCAL code) activates a light or chime signal in the cockpit of the aircraft.

It is the responsibility of the flight crew to ensure that Gander Radio is informed of the SELCAL code available based on the airborne equipment, if they intend to communicate with Gander Radio. This may be done in connection with the off-ground report or when they are transferring in flight from one network to another.

SELCAL standards and procedures are found in the International Civil Aviation Organization's (ICAO) Annex 10, Volume II. The worldwide administration of SELCAL code assignments has been delegated to Aviation Spectrum Resources, Inc. SELCAL code application forms may be obtained at: www.asri.aero/selcal.

2.5 USE OF GENERAL PURPOSE VERY HIGH FREQUENCY (VHF) OR SATELLITE VOICE COMMUNICATIONS (SATVOICE) IN LIEU OF INTERNATIONAL HIGH FREQUENCY (HF) AIR-GROUND FREQUENCIES

2.5.1 North Atlantic (NAT) and Anchorage Arctic Regions—Satellite Voice Communications (SATVOICE) Use

SATVOICE may be used to contact Gander Radio for non-routine flight safety calls or during periods of poor HF propagation. Gander Radio may be contacted at 1-709-651-5328 or using Inmarsat short code 431613.

2.5.2 North Atlantic (NAT) Region—Very High Frequency (VHF) Coverage

Table 2.2—NAT Region VHF Frequencies

VHF FREQUENCIES	COORDINATES/NAMED FIXES
122.375	45N 050W – 54N 050W
135.35	45N 050W – 48N 050W
126.9	48N 050W – 51N 050W
127.1	48N 050W – 51N 050W
119.85	51N 050W – 54N 050W
120.55	LOMSI – AVUIT
123.75	PIDSO – BOKTO
124.82	NIFTY – AVPUT
134.47	58N 050W – 65N 050W
134.95	57N 040W – 63N 040W
127.9	57N 040W – 63N 040W – 61N 050W – 57N 050W
126.9 (CYFB)	61N 070W – 67N 070W

NOTE:

SELCAL is used on all air-ground frequencies.

General purpose VHF communications facilities have been provided by Canada, Denmark and Iceland in order to supplement HF radio coverage in the NAT region. General purpose VHF coverage is shown on the following charts. It should be noted that:

- a) charts depict approximate coverage areas only;
- b) coverage at lower altitudes will be less than depicted; and
- c) the minimum altitude for continuous VHF coverage across the NAT is considered to be 30 000 ft (see the following charts).

Figure 2.1—NAT VHF Coverage at 10 000 ft

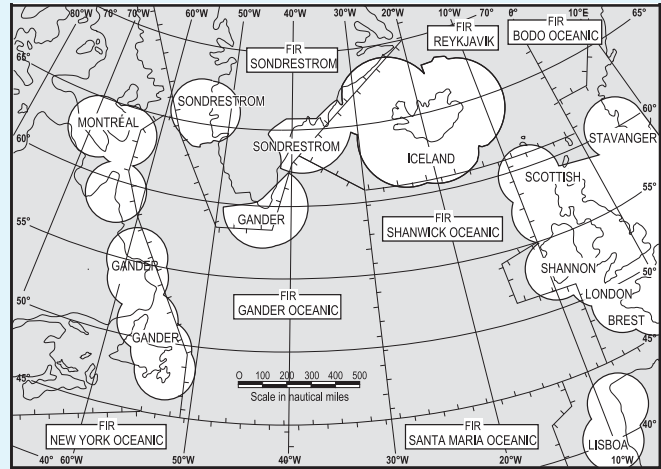


Figure 2.2—NAT VHF Coverage at 20 000 ft

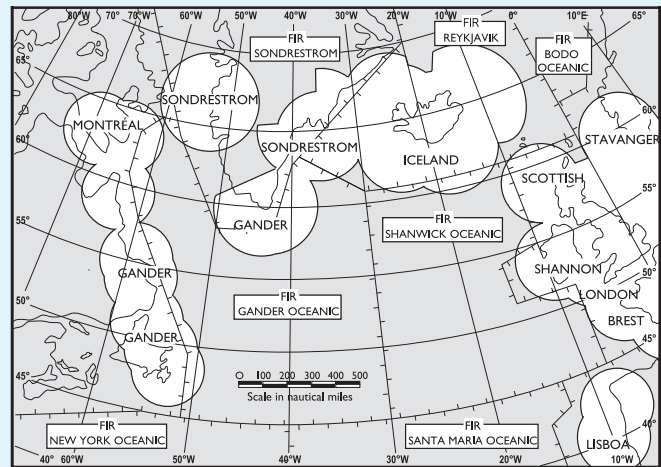
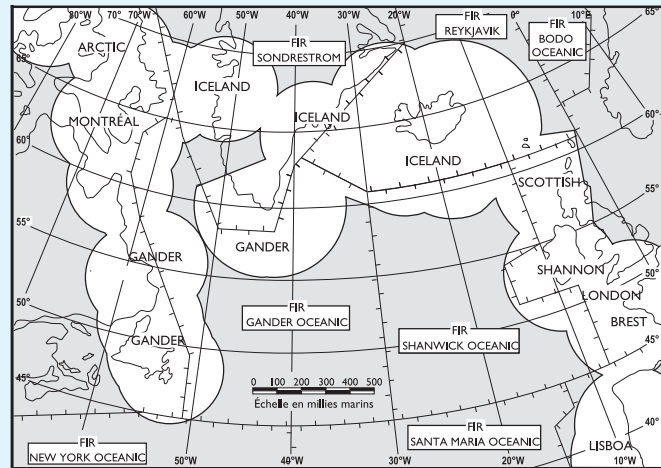


Figure 2.3—NAT VHF Coverage at 30 000 ft



NOTE : Minimum altitude for continuous VHF coverage across the North Atlantic is considered to be 30 000 feet.

Several attempts to establish communication may be necessary upon entry into the fringe area of reception. Aircraft should maintain SELCAL watch on HF when in fringe areas of VHF coverage. Upon exiting, communication should be re-established on HF channels, preferably before flying beyond normal VHF coverage. Because VHF coverage is limited, aircraft must be equipped with an approved and serviceable HF radio capable of two-way radio communication with ATS from any point along the route of flight.

NOTE:

Because of VHF coverage, aircraft may proceed across the Atlantic without HF radio subject to the following restrictions:

- a) below FL 195, routing YFB – SF – KFV; and
- b) FL 250 or above, routing YYR – OZN (or NA) – KFV.

2.6 ARINC 424 IDENTIFIERS FOR HALF-DEGREE WAYPOINTS IN THE GANDER OCEANIC CONTROL AREA (OCA)

The manual entry of latitude/longitude waypoints using short codes derived from the *ARINC Specification 424*, paragraph 7.2.5 (“Reporting Positions Defined by Coordinates”) standard (5050N = 50°N/50°W, N5050 = 50°30’N/50°W) has been directly identified as a causal factor in many of the occurrences of gross navigation errors within the North Atlantic (NAT) region.

The use of the entire latitude/longitude coordinates to enter waypoints, using procedures that provide for adequate mitigation of display ambiguity, is strongly advocated to avoid flight management computer (FMC) insertion errors.

If full latitude and longitude coordinates are not used to enter waypoints:

- a) Aircraft navigation databases should NOT contain waypoints in the Gander oceanic control area (OCA) in the format of “Nxxxx”, according to ARINC-424 paragraph 7.2.5.
- b) If an aircraft operator or flight planning service has an operational need to populate databases with half-degree waypoints in the Gander OCA, they are advised to use an alternate format, such as “Hxxxx”.

Flight crew procedures should require each pilot to independently display and verify the DEGREES and MINUTES loaded into the FMC for the latitude/longitude waypoints defining the route contained in the NAT oceanic clearance.



SAR—SEARCH AND RESCUE

1.0 RESPONSIBLE AUTHORITY

1.1 GENERAL

Search and rescue (SAR) service in Canada was established in accordance with the provisions of the International Civil Aviation Organization's (ICAO) Annex 12. The Canadian Forces are responsible for conducting SAR operations for aeronautical incidents in Canada.

Aeronautical SAR service is provided through three joint rescue coordination centres (JRCC), located at Victoria, B.C., Trenton, Ont., and Halifax, N.S. The JRCCs control all rescue units in their region through an extensive civil/military communications network. The addresses of the JRCCs are:

VICTORIA

(serving British Columbia and the Yukon)

Joint Rescue Coordination Centre Victoria
P.O. Box 17000 Station Forces
Victoria BC V9A 7N2

Tel. (toll-free within region): 1-800-567-5111
Tel.: 250-413-8933
Tel. (toll-free cellular): #SAR or #727

TRENTON

(serving Alberta, Manitoba, Northwest Territories, western Nunavut, Ontario, western Quebec, Saskatchewan)

Joint Rescue Coordination Centre Trenton
P.O. Box 1000 Station Forces
Astra ON K0K 3W1

Tel. (toll-free): 1-800-267-7270
Tel.: 613-965-3870

HALIFAX

(serving New Brunswick, Newfoundland and Labrador, Nova Scotia, eastern Nunavut, Prince Edward Island, eastern Quebec)

Joint Rescue Coordination Centre Halifax
P.O. Box 99000 Station Forces
Halifax NS B3K 5X5

Tel. (toll-free): 1-800-565-1582
Tel.: 902-427-8200

NOTE:

All JRCCs will accept collect telephone calls dealing with missing or overdue aircraft.

1.2 TYPES OF SERVICE AVAILABLE

Aeronautical search and rescue (SAR) service is available continuously throughout Canada and the Canadian territorial coastal water areas of the Atlantic, Pacific and Arctic oceans. Canadian Forces SAR units are equipped with helicopters and fixed-wing aircraft to conduct searches and provide rescue services, including rescue specialists (search and rescue technicians) who are capable of parachuting into remote locations. These rescue personnel can render initial medical aid and provide emergency supplies and survival support. The Civil Air Search and Rescue Association (CASARA), a nationwide volunteer organization, assists the Canadian Forces with aeronautical SAR cases.

Workload permitting, joint rescue coordination centre (JRCC) personnel are prepared to present briefings on SAR services and techniques to the public and aviation groups on request. Visits to JRCCs are encouraged, as long as prior notice is provided.

Other major SAR providers in Canada include:

- The Canadian Coast Guard, which has primary responsibility for marine incidents along Canada's ocean coasts, in all waterways in the Arctic, and in the waters of the Great Lakes St. Lawrence Seaway System;
- Provincial and territorial governments, which, through their police service, respond to SAR incidents involving persons on land, or on inland waterways;
- Parks Canada's warden service, which is responsible for ground or inland water SAR within National Parks;
- Trained volunteers across Canada who also play a key role in providing SAR services to the public.

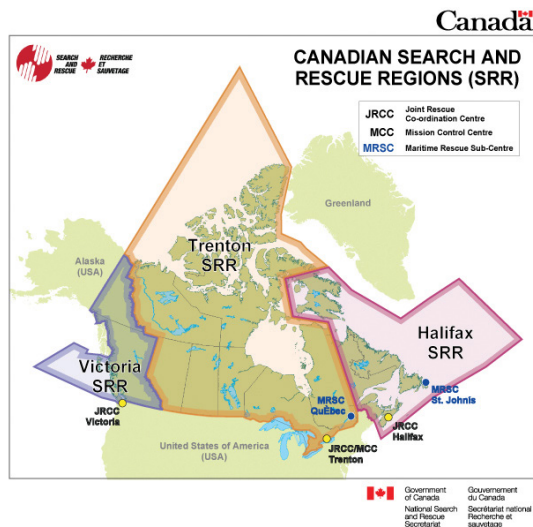
As mutual aid is one of the strengths of Canada's SAR system, the JRCCs may call upon any of these other providers, as well as the private sector, to assist with an aeronautical SAR case.

1.3 SEARCH AND RESCUE (SAR) AGREEMENTS

Two bilateral agreements relating to aeronautical search and rescue (SAR) exist between Canada and the United States. The first permits public aircraft of either country that are engaged in aeronautical SAR operations to enter or leave the other country without being subject to normal immigration or customs formalities. The second agreement permits vessels and wrecking appliances of either country to render aid and assistance on specified border waters and on the shores and in the waters of the other country along the Atlantic and Pacific coasts within a distance of 30 NM from the international boundary on those coasts.

In situations not covered by the agreements above, requests from the United States for aircraft of their own registry to participate in a SAR operation within Canada may be addressed to the nearest joint rescue coordination centre (JRCC). The JRCC would reply and issue appropriate instructions.

Figure 1.1—Search and Rescue Regions (SRR)



2.0 FLIGHT PLANNING

2.1 GENERAL

In addition to signals from emergency locator transmitters (ELTs), the flight plan and flight itinerary are the primary sources of information for search and rescue (SAR) operations. Therefore, proper flight planning procedures must be followed and the filed routes adhered to in order to ensure early detection and rescue.

In Canada, the area covered in a visual search will typically extend to a maximum of 15 NM on either side of the flight-planned route, starting from the aircraft's last known position and extending to its destination. In mountainous regions, search areas will be defined to best suit the terrain and the planned route of flight. It is therefore critical to the safety of pilots that they maintain their route as planned, and advise air traffic service (ATS) of any en route change or deviation as soon as practicable.

Refer to RAC 3.0 for details relating to filing and closing various plans or itineraries.

2.2 REQUEST FOR SEARCH AND RESCUE (SAR) ASSISTANCE

As soon as information is received that an aircraft is overdue, operators or owners should immediately alert the nearest joint rescue coordination centre (JRCC) or any air traffic service (ATS) unit, giving all known details. The alerting call

should not be delayed until after a small-scale private search has taken place. Such a delay could deprive those in need of urgent assistance at a time when it is most needed.

2.3 MISSING AIRCRAFT NOTICE (MANOT)

When an aircraft is reported missing, the appropriate joint rescue coordination centre (JRCC) will issue a missing aircraft notice (MANOT) to the air traffic service (ATS) units that are providing services in or near the search area. MANOTs will be communicated to pilots planning to overfly the search area by notices posted on flight information boards, orally during the filing of flight plans, or by radiocommunication.

Pilots receiving MANOTs are requested to maintain a thorough visual lookout and, insofar as it is practicable, a radio watch on 121.5 MHz when operating in the vicinity of the track the missing aircraft had planned to follow.

Once a MANOT has been issued, a major search effort will be initiated. Such an operation will be published in a NOTAM, and will involve a large number of military and civilian aircraft flying in a relatively confined area. Aircraft that are not participating in the search will be requested to keep a sharp lookout for other traffic, report any probable crash sightings to a flight information centre (FIC) or JRCC, and remain clear of active search areas, if possible.

On termination of the search, another MANOT will be issued and designated as final.

Table 2.1—Initial MANOT Message Required Information

Required Information			Example	
A.	MANOT number Type of MANOT	- SAR operation - JRCC responsible	A.	MANOT SIX SAR-FSOX Initial-JRCC Victoria
B.	Type of Aircraft	- Registration - Colour	B.	Cessna 180 C-FSOX red with white wings and black lettering
C.	Number of crew and/or passengers		C.	Pilot, plus 3
D.	Route		D.	Fort St. John to Abbotsford
E.	Departure date/time (local)		E.	1 May—10:00 PST
F.	Last known position (LKP) date/time (local)		F.	Prince George 1 May—11:31 PST
G.	Fuel exhaust time		G.	Fuel exhaust time 1 May—15:00 PST
H.	Frequency of ELT		H.	121.5 MHz and 243 MHz

SAR

2.4 AIDING PERSONS IN DISTRESS

When a pilot observes an aircraft, ship or vessel in distress, the pilot shall, if possible:

- a) keep the craft in sight until his presence is no longer necessary;
- b) report the following information to the joint rescue coordination centre (JRCC) or air traffic service (ATS) unit:
 - (i) time of observation,
 - (ii) position of craft,
 - (iii) general description of scene, and
 - (iv) apparent physical condition of survivor(s).

NOTE:

See SAR 4.9 concerning the obligations of an aircraft to render assistance to ships or vessels in distress.

Pilots should be familiar with the distress signal that may be used by small craft. It consists of a rectangular, fluorescent orange-red cloth panel on which a black square and disc are displayed.

Figure 2.1—Distress Signal Panel

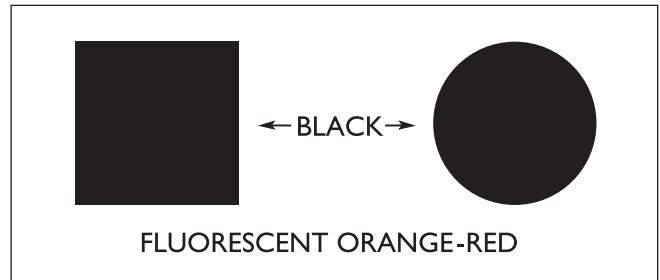
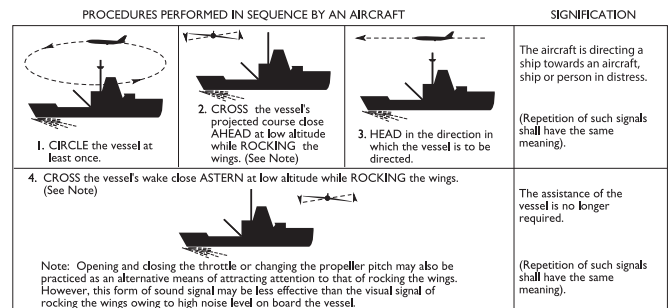


Figure 2.2—Procedures for Signaling Vessels



3.0 EMERGENCY LOCATOR TRANSMITTER (ELT)

3.1 GENERAL

Emergency locator transmitters (ELTs) are required for most general aviation aircraft (see CAR 605.38). They operate on a primary frequency of 121.5, 243, or 406 MHz, and help search crews locate downed aircraft to rescue survivors.

Pilots are strongly encouraged to switch from old analog 121.5 MHz ELTs to the newer 406 MHz digital ELTs since position information from a 406 MHz ELT is calculated and relayed to the appropriate joint rescue coordination centre (JRCC) for action. The 406 MHz beacon is associated with a unique user; therefore, identification is rapid and resolution of a false alarm may only require a few phone calls. In addition, activation of a 406 MHz ELT is detected by satellites, whereas, a 121.5 MHz signal relies on the aircraft being within the range of an air traffic service (ATS) facility or on another aircraft passing by at high altitude. Search and rescue (SAR) response could be delayed for several hours when a 121.5 MHz ELT is activated. Survivability decreases with time and, on numerous occasions, lives have been saved as a result of the early detection possible with a 406 MHz beacon. The 121.5 MHz signal common to all ELTs also produces a distinctive siren-like tone that can be heard on a radio receiver tuned to this frequency. This signal helps incoming SAR responders pinpoint an aircraft's position. During routine operations, hearing a 121.5 MHz signal may also alert pilots to the inadvertent activation of their ELT. Therefore, pilots should briefly monitor the frequency after each flight to ensure their ELT is not emitting a signal.

Properly maintained ELTs with serviceable batteries should provide continuous operation for a minimum of 24 hr at a wide range of temperatures. Batteries that remain in service beyond their recommended life may not provide sufficient power to produce a usable signal. ELTs that contain outdated batteries are not considered to be serviceable.

All ELTs currently operating on 406 MHz can be detected by COSPAS-SARSAT satellites. It is vital to note that effective February 1, 2009, COSPAS-SARSAT satellites will only detect 406 MHz ELT signals. A 406 MHz ELT is now required to ensure that the COSPAS-SARSAT system is automatically notified in the event of an aircraft crash. However, 121.5 MHz signals are still used for short-range location during SAR operations.

3.2 TYPES OF EMERGENCY LOCATOR TRANSMITTER (ELT)

There are five types of emergency locator transmitter (ELT):

- a) *TYPE A or AD (automatic ejectable or automatically deployable)*—This type automatically ejects from the aircraft and is set in operation by inertia sensors when the aircraft is subjected to a crash deceleration force acting through the aircraft's flight axis. This type is expensive and is seldom used in general aviation.
- b) *TYPE F or AF (fixed [not ejectable] or automatic fixed)*—This type is automatically set in operation by an inertia switch when the aircraft is subjected to crash deceleration forces acting in the aircraft's flight axis. The transmitter can be manually activated or deactivated, and in some cases, may be remotely controlled from the cockpit. Provision may also be made for recharging the batteries from the aircraft's electrical supply. An additional antenna may be provided for portable use of the ELT. Most general aviation aircraft use this ELT type, which must have the function switch placed to the "ARM" position for the unit to function automatically in a crash.
- c) *TYPE AP (automatic portable)*—This type is similar to Type F or AF, except that the antenna is integral to the unit for portable operation.
- d) *TYPE P (personal)*—This type has no fixed mounting and does not transmit automatically. A manual switch is used to start or stop the transmitter.
- e) *TYPE W or S (water-activated or survival)*—This type transmits automatically when immersed in water. It is waterproof, floats, and operates on the surface of the water. It has no fixed mounting. It should be tethered to survivors or life rafts.

3.3 INSTALLATION AND MAINTENANCE REQUIREMENTS

Installation of an emergency locator transmitter (ELT), as required by CAR 605.38, must comply with Chapter 551 of the *Airworthiness Manual*.

For maintenance, inspection, and test procedures, refer to CAR 605 and CAR 571.

3.4 EMERGENCY LOCATOR TRANSMITTER (ELT) OPERATING INSTRUCTIONS (NORMAL USE)

Pre-flight

(Where practicable):

- inspect the emergency locator transmitter (ELT) to ensure that it is secure, free of external corrosion, and that antenna connections are secure;
- ensure that the ELT function switch is in the “ARM” position;
- ensure that ELT batteries have not reached their expiry date; and
- listen to 121.5 MHz to ensure the ELT is not transmitting.

In-flight

Monitor 121.5 MHz when practicable. If an ELT signal is heard, notify the nearest ATS unit of:

- position, altitude and time when signal was first heard;
- ELT signal strength;
- position, altitude and time when contact was lost; and
- whether the ELT signal ceased suddenly or faded.

Pilots should not attempt a search and rescue (SAR) operation. If unable to contact anyone, pilots should continue attempts to gain radio contact with an air traffic service (ATS) unit, or land at the nearest suitable aerodrome where a telephone is located.

NOTE:

If the signal remains constant, it may be your ELT.

Post-flight

Listen to 121.5 MHz. If an ELT is detected, and your ELT has not been switched to “OFF”, deactivate it. For those ELT models that do not have an “OFF” switch, disconnect and re-set the unit per the manufacturer’s instructions. Notify the nearest ATS unit or joint rescue coordination centre (JRCC) of the time the signal was first heard, the actions you have taken and whether the signal has ceased or is on-going. If you still hear an ELT on 121.5 MHz after you have deactivated your ELT, it may not be yours. Notify the nearest ATS unit or JRCC.

3.5 EMERGENCY LOCATOR TRANSMITTER (ELT) OPERATING INSTRUCTIONS (EMERGENCY USE)

Emergency locator transmitters (ELTs) in general aviation aircraft contain a crash activation sensor, or G-switch, which is designed to detect the deceleration characteristics of a crash and automatically activate the transmitter. However, it is always safest to place the ELT function switch to “ON” as soon as possible after the crash, if practicable.

Geostationary satellites will detect an unobstructed 406 MHz ELT within minutes of activation; there are no satellite-based means of detecting a 121.5 MHz signal. In addition to geostationary satellites, polar orbiting low altitude satellites continually overfly Canada and will also detect a 406 MHz beacon within 90 min of activation, producing a position report.

Some military and commercial aircraft also monitor 121.5 or 243 MHz and will notify air traffic service (ATS) or search and rescue (SAR) agencies of any ELT transmissions they hear.

In case of emergency, do not delay ELT activation until flight-planned times expire, as such delays will only delay rescue. Do not cycle the ELT through “OFF” and “ON” positions to preserve battery life, as irregular operation reduces localization accuracy and will hamper homing efforts. Once your ELT has been switched to “ON”, do not switch it to “OFF” until you have been positively located, and the SAR forces have directed you to turn it off.

If you have landed to wait out bad weather, or for some other non-emergency reason, and no emergency exists, do not activate your ELT. However, your aircraft will be reported overdue, and a search will begin if the delay will extend beyond:

- 1 hr past the estimated time of arrival (ETA) filed on a flight plan; or
- the SAR time specified, 24 hr after the duration of the flight, or the ETA specified on a flight itinerary.

To avoid an unnecessary search, notify the nearest ATS unit of your changed flight plan or itinerary. If you cannot contact an ATS unit, attempt to contact another aircraft on one of the following frequencies in order to have that aircraft relay the information to ATS:

- 126.7 MHz;
- local visual flight rules (VFR) common frequency;
- local area control centre (ACC) instrument flight rules (IFR) frequency listed in the *Canada Flight Supplement* (CFS);
- 121.5 MHz; or
- high frequency (HF) 5 680 kHz, if so equipped.

If you cannot contact anyone, a search will begin at the times mentioned above. At the appropriate time, switch your ELT to “ON”, and leave it on until search crews locate you. Once located, use your aircraft radio on 121.5 MHz (turn the ELT off if there is interference) to advise the SAR crew of your condition and intentions.

ELTs and the COSPAS-SARSAT system work together to speed rescue. The ELT “calls for help”; COSPAS-SARSAT hears that call and promptly notifies SAR authorities, who then dispatch help.

NOTE:

Delays in activating your ELT will delay your rescue.

3.6 MAXIMIZING THE SIGNAL

If the emergency locator transmitter (ELT) is a portable model with its own auxiliary antenna, and can be safely removed from the aircraft, it should be placed as high as possible on a level surface to reduce obstructions between it and the horizon. Raising an ELT from ground level to 2.44 m (8 ft) may increase the range by 20 to 40 percent. The antenna should be vertical to ensure optimum radiation of the signal. Placing the transmitter on a piece of metal, or even the wing of the aircraft, if it is level, will provide the reflectivity to extend transmission range. Holding the transmitter close to the body in cold weather will not significantly increase battery power output. In addition, as the body will absorb most of the signal energy, such action could reduce the effective range of the transmission.

If the ELT is permanently mounted in the aircraft, ensure that it has not been damaged and is still connected to the antenna. If it is safe to do so (i.e. no spilled fuel or fuel vapours), confirm the ELT’s operation by selecting 121.5 MHz on the aircraft radio and listening for the audible siren-like tone.

NOTE:

Since aircraft are easier to see than people are, the search will be conducted to locate the aircraft first. If the aircraft lands in an uninhabited area, stay with the aircraft and the ELT. If possible, have smoke, flares or signal fires ready to attract the attention of search crews who are homing to the ELT. Smoke, flares and signal fires should be sited with due regard for any spilled fuel resulting from the crash.

3.7 ACCIDENTAL EMERGENCY LOCATOR TRANSMITTER (ELT) TRANSMISSIONS

To forestall unnecessary search and rescue (UN SAR) missions, all accidental emergency locator transmitter (ELT) activations shall be reported to the nearest air traffic service (ATS) unit, or the nearest joint rescue coordination centre (JRCC), giving the location of the transmitter, and the time and duration of the accidental transmission and the ELT shall be switched off. ELT alarms trigger considerable activity within ATS and SAR units.

Although some accidental ELT transmissions can be resolved without launching SAR or Civil Air Search and Rescue Association (CASARA) aircraft, such as a properly-registered 406 MHz beacon, the JRCCs will adopt the safe course. Promptly notifying ATS or a JRCC of an accidental ELT transmission may prevent the unnecessary launch of a search aircraft. If promptly reported, there is no charge or penalty associated with the accidental triggering of an ELT.

3.8 TESTING PROCEDURES

When originally installed in an aircraft, and when parts of the emergency locator transmitter (ELT) system are moved or changed, an ELT will be tested in accordance with CAR 571. Every few months, or as recommended by the manufacturer, pilots should test their ELT. Testing procedures for ELTs will vary depending upon the type.

3.8.1 406 MHz Emergency Locator Transmitters (ELTs)

Since the digital emergency signals from 406 MHz ELTs are detected almost immediately by COSPAS-SARSAT satellites, the transmitters should never be activated in their operational mode except in an emergency.

406 MHz ELTs should only be tested in accordance with the manufacturer’s instructions. Most 406 MHz ELTs are equipped with an integral self-test function. The manufacturer’s instructions describe how to carry out this self-test and interpret its results. The instructions should be followed closely to avoid false alerts. Activation of the self-test will transmit a 406-MHz, digitally-altered test signal to the Canadian Beacon Registry. If the ELT is appropriately registered, the test signal will cause an e-mail to be sent to the address on file. This will confirm both a successful self-test as well as the status of the registration. The self-test function may also transmit a 121.5 MHz test signal. In this case, ensure that the test is conducted at the top of the hour (UTC) within the first five minutes.

3.8.2 121.5/243 MHz Emergency Locator Transmitters (ELTs)

Any testing of an ELT that operates only on 121.5 MHz or 243 MHz shall only be conducted during the first 5 min of any UTC hour, and restricted in duration to not more than 5 s.

Such tests can be done between two stations separated by at least half a kilometre, or by a single aircraft, using its own radio receiver.

- a) Two-station 121.5/243 MHz ELT test:
 - (i) position the aircraft about one-half kilometre from the tower, FSS or other aircraft that will monitor 121.5 MHz. Ensure the listening station is clearly visible from the aircraft, as ELT transmissions are line-of-sight. Intervening obstacles, such as hills, buildings, or other

- aircraft, may prevent the listening station from detecting the ELT transmission.
- (ii) using the aircraft radio or other pre-arranged signals, establish contact with the listening station. When the listening station confirms that it is ready, switch the 121.5/243 MHz ELT function to “ON”. After no more than 5 s, turn the ELT function switch to “OFF”. The listening station should confirm that the ELT was heard.
- (iii) reset the ELT function switch to “ARM”.
- (iv) tune the aircraft radios to 121.5 MHz to confirm that the ELT stopped transmitting.
- (v) if the listening station did not hear the ELT, investigate further before flying the aircraft.

When conducting the two-station test at a busy airport, take due regard of tower or FSS workload. Keep the voice radio transmissions to a minimum. If the “listening” station does not hear the ELT transmission, it may be necessary to move the aircraft to another location on the airfield to conduct the test.

It will often be impractical to coordinate a 121.5/243 MHz ELT test with a tower, FSS, or other aircraft. In such circumstances, pilots can use the following procedures to test their ELTs. Such tests are to be conducted in the first 5 min of any UTC hour, and test transmissions must be limited to 5 s or less.

- b) Single-station ELT test:
 - (i) tune the aircraft radio receiver to 121.5 MHz.
 - (ii) switch the ELT to “ON” just long enough to hear the tone, and immediately return the function switch to “ARM”.

NOTES:

1. It is best to have another person in the cockpit to ensure the minimum “on-air” test period.
2. Do not exceed the 5 s “on-air” time.
 - (i) recheck 121.5 MHz on the aircraft receiver to ensure that the ELT stopped transmitting.

When conducting a single-aircraft test, it is possible that the aircraft radios will hear the ELT output, even though the ELT power transistor is defective, and will not be detected by a receiver half a kilometre away. However, this test will uncover a totally unserviceable ELT, and is better than no test.

NOTE:

While all 406 MHz ELTs also transmit a 121.5 MHz homing signal, testing of 406 MHz ELTs must follow the manufacturer’s instructions provided with the unit.

3.9 SCHEDULE OF REQUIREMENTS

The following schedule outlines the requirement to carry an emergency locator transmitter (ELT). Gliders, balloons, airships, ultralight aeroplanes and gyroplanes are exempt, as are aircraft operated by the holder of a flight training unit operating certificate that are engaged in flight training, and operated within 25 NM of the departure aerodrome. Additional exemptions are contained in CAR 605.38.

Table 3.1—ELT Requirements

Column I	Column II	Column III
Aircraft	Area of Operation	Minimum Equipment
1. All aircraft except those exempted.	Over land	One ELT of type AD, AF, AP, A, or F.
2. Large multi-engine turbo-jet aeroplanes engaged in an air transport service carrying passengers.	Over water at a distance from land that requires the carriage of life raft pursuant to CAR 602.63.	Two ELTs of type W or S, or one of each.
3. All aircraft that require an ELT other than those set out in item 2.	Over water at a distance from land that requires the carriage of life raft pursuant to CAR 602.63.	One ELT of type W or S.

If an ELT becomes unserviceable, the aircraft may be operated according to the operator’s approved minimum equipment list (MEL). Where no MEL has been approved, the aircraft may be operated for up to 30 days, provided:

- a) the ELT is removed at the first aerodrome at which repairs or removal can be accomplished;
- b) the ELT is promptly sent to a maintenance facility;
- c) and a placard is displayed in the cockpit stating that the ELT has been removed, and the date of removal (see CAR 605.39).

Despite these exemptions, all pilots are reminded of the rugged, inhospitable terrain that covers much of Canada.

CAUTION:

Although some flights without ELTs may be legal, they are not advisable.

ELTs are designed to speed rescue to survivable crashes, and they should function automatically. However, if you are aware of their capabilities and limitations, you can improve the performance of your ELT, and thus assist search and rescue (SAR).



4.0 AIRCRAFT EMERGENCY ASSISTANCE

4.1 DECLARING AN EMERGENCY

An emergency condition is classified in accordance with the degree of danger or hazard being experienced, as follows:

- a) *Distress*—A condition of being threatened by serious and/or imminent danger and requiring immediate assistance.
- b) *Urgency*—A condition concerning the safety of an aircraft or other vehicle, or of some person on board or within sight, which does not require immediate assistance.

The radiotelephone distress signal, MAYDAY, and the radiotelephone urgency signal, PAN PAN, must be used at the beginning of the first distress or urgency communication, respectively, and, if considered necessary, at the beginning of any subsequent communication.

4.2 ACTION BY THE PILOT DURING EMERGENCY CONDITIONS

Pilots should:

- a) precede the distress or urgency message by the appropriate radiotelephone signal, preferably spoken 3 times;
- b) transmit on the air-ground frequency in use at the time;
- c) include in the distress or urgency message as many as possible of the following elements:
 - (i) the name of the station addressed (time and circumstances permitting),
 - (ii) the identification of the aircraft,
 - (iii) the nature of the distress or urgency condition,
 - (iv) the intention of the person in command, and
 - (v) the present position, altitude or flight level, and heading.

NOTES:

1. The above procedures do not preclude the possibility of the following courses of action:
 - (a) the pilot making use of any available frequency, or of broadcasting the message;
 - (b) the pilot using any means at his/her disposal to attract attention and make known his/her conditions;
 - (c) any person taking any means at his/her disposal to assist the emergency aircraft.
2. The station addressed will normally be that station communicating with the aircraft.
3. International emergency frequencies are 121.5 and 243.0 MHz. In Canada, 126.7 MHz should, whenever practicable, be continuously monitored in uncontrolled airspace. When aircraft are equipped with dual very high frequency (VHF)

equipment, it is strongly recommended that frequency 121.5 MHz be monitored at all times.

4. 121.5 MHz may also be used to establish communications when the aircraft is not equipped with the published frequencies or when equipment failure precludes the use of normal channels. See COM 1.12 for information about communicating with air traffic service (ATS) on 121.5 MHz.

4.3 VERY HIGH FREQUENCY (VHF) DIRECTION-FINDING ASSISTANCE

The VHF direction-finder (VDF) system is covered in COM 4.10. VDF operating instructions are outlined in RAC 1.6.

4.4 TRANSPONDER ALERTING

If unable to establish communication immediately with an air traffic control (ATC) unit, a pilot wishing to alert ATC to an emergency situation should adjust the transponder to reply on Mode A/3, Code 7700. Communication with ATC should be established as soon as possible thereafter.

In the event of a communication failure, the transponder should be adjusted to reply on Mode A/3, Code 7600, to alert ATC to the situation. This action does not relieve the pilot of the requirement to comply with CAR 602.137.

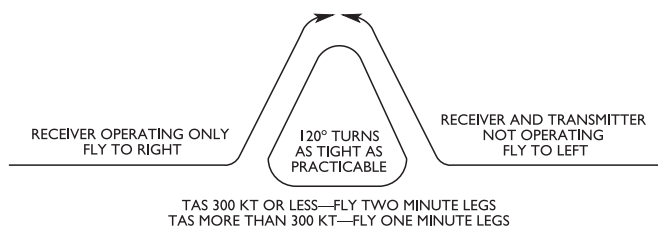
In the event of unlawful interference, the transponder should be adjusted to reply to Mode A/3, Code 7500, to alert ATC to the situation (see RAC 1.9.8).

4.5 RADAR ALERTING MANOEUVRES

RAC 1.5.7 describes the radar assistance that is available through Canadian Forces facilities; however, when lost or in distress and unable to make radio contact, a pilot should attempt to alert *all available radar systems as follows*:

- a) activate the identification, friend or foe (IFF) system and selective identification feature (SIF) to EMERGENCY;
- b) guard emergency frequencies;
- c) fly two triangular patterns as depicted, resume course and repeat at 5-min intervals.

Figure 4.1—Radar Alerting Manoeuvres



Since the greater the altitude of the aircraft, the better its chance of being detected, low-flying aircraft should attempt to climb. Also, if flying in limited visibility or at night, landing lights and navigation lights should be turned on to assist the interceptor.

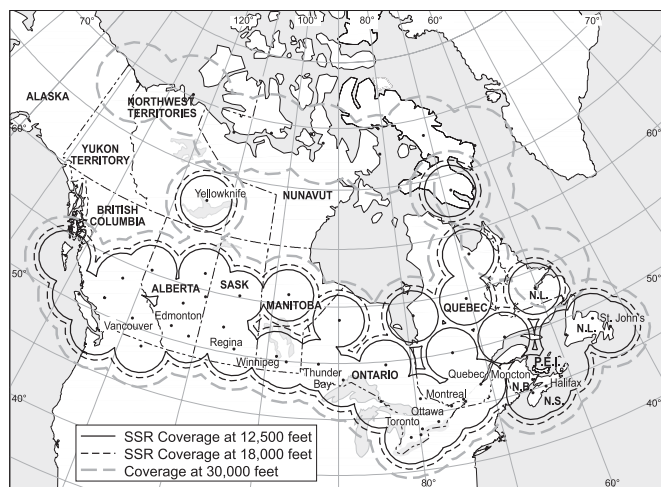
Once radar contact is established, and if it is possible to do so, a rescue aircraft will be dispatched to intercept. Upon successful interception, the interceptor and distressed aircraft should attempt radio contact. If this is not possible, use the visual interception signals (see SAR 4.7). If, in a particular case, it is not possible for the Canadian Forces to send out an intercepting aircraft, flying the triangular pattern will serve to position the distressed aircraft and thus narrow any search area.

NOTE:

The opportunity for an aircraft to be detected by radar increases with altitude.

Figure 4.1 shows the area of radar coverage in Canada provided by both Department of National Defence (DND) and NAV CANADA installations. Pilots should be aware that if they are flying in an area outside of radar coverage, flying a triangular pattern for alerting purposes would not be a valid manoeuvre.

Figure 4.2—Canadian Radar Coverage Provided by NAV CANADA and DND



4.6 EMERGENCY RADIO FREQUENCY CAPABILITY

Where an aircraft is required by the laws of Canada to install two-way very high frequency (VHF) radiocommunication equipment, no person shall operate that aircraft unless the

radiocommunication equipment is capable of providing communication on VHF aeronautical emergency frequency 121.5 MHz.

A person operating an aircraft within a sparsely settled area, or a Canadian aircraft over water at a horizontal distance of more than 50 NM from the nearest shoreline, should continuously monitor the VHF aeronautical emergency frequency 121.5 MHz unless:

- a) that person is carrying out communications on other VHF aeronautical frequencies; or
- b) aircraft electronic equipment limitations or essential cockpit duties do not permit simultaneous monitoring of the two VHF aeronautical frequencies.

4.7 INTERCEPTION PROCEDURES (CANADIAN AVIATION REGULATION (CAR) 602.144)

1. No person shall give an interception signal or an instruction to land except
 - a) a peace officer, an officer of a police authority or an officer of the Canadian Forces acting within the scope of their duties; or
 - b) a person authorized to do so by the Minister pursuant to subsection (2).
2. The Minister may authorize a person to give an interception signal or an instruction to land if such authorization is in the public interest and is not likely to affect aviation safety.
3. The pilot-in-command of an aircraft who receives an instruction to land from a person referred to in subsection (1) shall, subject to any direction received from an air traffic control unit, comply with the instruction.
4. The pilot-in-command of an intercepting aircraft and the pilot-in command of an intercepted aircraft shall comply with the rules of interception set out in the *Canada Flight Supplement* [and repeated in Schedules I and II].

SCHEDULE I

PROCEDURES TO BE FOLLOWED IN THE EVENT OF INTERCEPTION

An aircraft which is intercepted by another aircraft shall immediately:

- a) follow the instructions given by the intercepting aircraft, interpreting and responding to visual signals [in accordance with Schedule II];
- b) notify, if possible, the appropriate air traffic services unit;
- c) attempt to establish radio communication with the intercepting aircraft or with the appropriate intercept control unit by making a general call on aeronautical emergency frequency

SAR

121.5 MHz and repeating this call on emergency frequency 243.0 MHz, if practicable giving the identity and position of the aircraft and the nature of the flight; and

- d) if equipped with a transponder, select Mode A Code 7700, unless otherwise instructed by the appropriate air traffic services unit.

with those given by the intercepting aircraft by visual or radio signals, the intercepted aircraft shall request immediate clarification while continuing to comply with the instructions given by the intercepting aircraft.

SCHEDULE II

SIGNALS FOR USE IN THE EVENT OF INTERCEPTION

If any instructions received by radio from any sources conflict

Table 4.1(a)– Signals Initiated by Intercepting Aircraft and Response by Intercepted Aircraft

Series	Intercepting Aircraft Signal	Meaning	Intercepted Aircraft Response	Meaning
1.	<p>DAY—Rocking wings from a position in front and, normally, to the left of the intercepted aircraft, and after acknowledgement, a slow level turn, normally to the left, on to the desired heading.</p> <p>NIGHT—Same and, in addition, flashing navigational lights at irregular intervals.</p> <p>DAY or NIGHT—Flares dispensed in immediate vicinity.</p> <p>NOTES:</p> <p>1. Meteorological conditions or terrain may require the intercepting aircraft to take up a position in front and to the right of the intercepted aircraft, and to make the subsequent turn to the right.</p> <p>2. If the intercepted aircraft is not able to keep pace with the intercepting aircraft, the latter is expected to fly a series of racetrack patterns and to rock its wings each time it passes the intercepted aircraft.</p>	You have been intercepted. Follow me.	<p>AEROPLANES: DAY—Rocking wings and following.</p> <p>NIGHT—Same and, in addition, flashing navigational lights at irregular intervals.</p> <p>HELICOPTERS: DAY or NIGHT—Rocking aircraft, flashing navigational lights at irregular intervals, and following.</p> <p>NOTE: Additional action by intercepted aircraft is prescribed in SAR 4.7, Schedule 1.</p>	Understood; will comply.
2.	DAY or NIGHT—An abrupt breakaway manoeuvre from the intercepted aircraft, consisting of a climbing turn of 90 degrees or more, without crossing the line of flight of the intercepted aircraft.	You may proceed.	<p>AEROPLANES: DAY or NIGHT—Rocking wings.</p> <p>HELICOPTERS: DAY or NIGHT—Rocking aircraft.</p>	Understood; will comply.
3.	<p>DAY—Circling aerodrome, lowering landing gear, and overflying runway in direction of landing or, if the intercepted aircraft is a helicopter, overflying the helicopter landing area.</p> <p>NIGHT—Same, and in addition, showing steady landing lights.</p>	Land at this aerodrome.	<p>AEROPLANES: DAY—Lowering landing gear, following the intercepting aircraft, and if, after overflying the runway, landing is considered safe, proceeding to land.</p> <p>NIGHT—Same, and in addition, showing steady landing lights (if carried).</p> <p>HELICOPTERS: DAY or NIGHT— Following the intercepting aircraft and proceeding to land, showing a steady landing light (if carried).</p>	Understood; will comply.

Table 4.1(b)—Signals Initiated by Intercepted Aircraft and Response by Intercepting Aircraft

Series	Intercepted Aircraft Signal	Meaning	Intercepting Aircraft Response	Meaning
4.	<p>AEROPLANES: DAY—Raising landing gear while passing over landing runway at a height exceeding 300 m (1 000 ft) but not exceeding 600 m (2 000 ft) above the aerodrome level, and continuing to circle the aerodrome. NIGHT—Flashing landing lights while passing over landing runway at a height exceeding 300 m (1 000 ft) but not exceeding 600 m (2 000 ft) above the aerodrome level, and continuing to circle the aerodrome. If unable to flash landing lights, flash any other lights available.</p>	Aerodrome you have designated is inadequate.	<p>DAY or NIGHT—If it is desired that the intercepted aircraft follow the intercepting aircraft to an alternate aerodrome, the intercepting aircraft raises its landing gear and uses the Series 1 signals prescribed for intercepting aircraft. If it is decided to release the intercepted aircraft, the intercepting aircraft uses the Series 2 signals prescribed for intercepting aircraft.</p>	Understood, follow me.
				Understood, you may proceed.
5.	<p>AEROPLANES: DAY or NIGHT—Regular switching on and off of all available lights but in such a manner as to be distinct from flashing lights.</p>	Cannot comply.	DAY or NIGHT—Use Series 2 signals prescribed for intercepting aircraft.	Understood.
6.	<p>AEROPLANES: DAY or NIGHT—Irregular flashing of all available lights. HELICOPTERS: DAY or NIGHT—Irregular flashing of all available lights.</p>	In distress.	DAY or NIGHT—Use Series 2 signals prescribed for intercepting aircraft.	Understood.

4.8 DOWNED AIRCRAFT PROCEDURES

4.8.1 Ground-to-Air Signals

Even if no ELT or distress signal has been received, a visual search will commence at the time indicated in the flight plan or flight itinerary. The search in Canada will typically extend up to 15 NM on either side of the flight-planned route, starting from the aircraft's last known position and concluding just beyond its destination. In mountainous regions, the search area will be defined to best suit the terrain and route of flight.

Some searches may last at least 24 hr before rescue is accomplished. Make the accident site as conspicuous as possible. Searchers will be looking for anything out of the ordinary, and their eyes will be drawn to any unnatural feature on the ground. The aircraft has the best chance of being spotted if large portions of its wings and tail are painted in vivid colours. Keep the aircraft cleared of snow.

As soon as possible after landing, and with due concern for spilled fuel or vapours, build a campfire. Collect a large pile of green material (e.g. tree boughs, fresh leaves, grasses) to quickly place on the fire, should an aircraft be seen or heard. Three signal fires forming a triangle is the standard distress signal, but even one large smoky fire should attract the attention of searchers.

One of the best high-visibility items now available on the market is a cloth panel of brilliant fluorescent colour, often referred to as a "conspicuity panel." It is staked to the ground during the day and used as a highly effective ground signal. It can also be used as a lean-to shelter and can supply some warmth as a blanket. Other means of attracting attention are reflecting sunlight using signal mirrors or shiny pieces of metal during daylight; or using flashlights, headlamps, strobes, or even camera flashes during hours of darkness.

The following symbols are to be used to communicate with aircraft when an emergency exists. Symbols 1 to 5 are internationally accepted; 6 to 9 are for use in Canada only.

Table 4.2—Ground-to-Air Visual Signals to Be Used in Case of Emergency

NO.	MESSAGE	CORE SYMBOL
1.	REQUIRE ASSISTANCE	V
2.	REQUIRE MEDICAL ASSISTANCE	X
3.	NO or NEGATIVE	N
4.	YES or AFFIRMATIVE	Y
5.	PROCEEDING IN THE DIRECTION	↑
6.	ALL IS WELL	LL
7.	REQUIRE FOOD AND WATER	F
8.	REQUIRE FUEL AND OIL	L
9.	NEED REPAIRS	W

NOTES:

1. Use strips of fabric or parachutes, pieces of wood, stones or any other available material to make the symbols.
2. Endeavour to provide as big a colour contrast as possible between the material used for the symbols and the background against which the symbols are exposed.
3. Symbols should be at least 8 ft in length or longer, if possible. Care should be taken to lay out symbols exactly as depicted to avoid confusion with other symbols.
4. A space of 10 ft should separate the elements of symbol 6.

4.8.2 Survival

Ability to assist the search can depend on the success of survival efforts. The emergency equipment detailed in CARs 602.61, 602.62 and 602.63 emphasizes being prepared for the geographical location and anticipated seasonal climatic variations.

If the aircraft lands in an uninhabited area, stay near the aircraft; the search is to locate the aircraft. Past experience has demonstrated that persons with a knowledge of survival techniques have saved their own and others' lives. Similarly, survivors invariably comment that a better knowledge of how to stay alive would have been invaluable.

There are several good books on survival skills widely available from bookstores and through the Internet.

The Emergency section of the CFS contains procedures to follow when sighting a downed aircraft, a ship in distress or when receiving an ELT signal.

4.9 CANADA SHIPPING ACT, 2001 (2001, C. 26) EXTRACT—PART 5, SECTIONS 130–133

SEARCH AND RESCUE

Designation of rescue coordinators

130. (1) The Minister may designate persons as rescue coordinators to organize search and rescue operations.

Power of rescue coordinators

(2) On being informed that a person, a vessel or an aircraft is in distress or is missing in Canadian waters or on the high seas off any of the coasts of Canada under circumstances that indicate that they may be in distress, a rescue coordinator may

- (a) direct all vessels within an area that the rescue coordinator specifies to report their positions;
- (b) direct any vessel to take part in a search for that person, vessel or aircraft or to otherwise render assistance;
- (c) give any other directions that the rescue coordinator considers necessary to carry out search and rescue operations for that person, vessel or aircraft; and
- (d) use any lands if it is necessary to do so for the purpose of saving the life of a shipwrecked person.

Duty to comply

(3) Every vessel or person on board a vessel in Canadian waters and every vessel or person on board a vessel in any waters that has a master who is a qualified person shall comply with a direction given to it or them under subsection (2).

Answering distress signal

131. (1) Subject to this section, the master of a vessel in Canadian waters and every qualified person who is the master of a vessel in any waters, on receiving a signal from any source that a person, a vessel or an aircraft is in distress, shall proceed with all speed to render assistance and shall, if possible, inform the persons in distress or the sender of the signal.

Distress signal—no assistance

(2) If the master is unable or, in the special circumstances of the case, considers it unreasonable or unnecessary to proceed to the assistance of a person, a vessel or an aircraft in distress, the master is not required to proceed to their assistance and is to enter the reason in the official log book of the vessel.

Ships requisitioned

(3) The master of any vessel in distress may requisition one or more of any vessels that answer the distress call to render assistance. The master of a requisitioned vessel in Canadian waters and every qualified person who is the master of a requisitioned vessel in any waters shall continue to proceed with all speed to render assistance to the vessel in distress.

Release from obligation

(4) The master of a vessel shall be released from the obligation imposed by subsection (1) when the master learns that another vessel is complying with a requisition referred to in subsection (3).

Further release

(5) The master of a vessel shall be released from an obligation imposed by subsection (1) or (3) if the master is informed by the persons in distress or by the master of another vessel that has reached those persons that assistance is no longer necessary.

Assistance

132. The master of a vessel in Canadian waters and every qualified person who is the master of a vessel in any waters shall render assistance to every person who is found at sea and in danger of being lost.

Aircraft treated as if vessel

133. Sections 130 to 132 apply in respect of aircraft on or over Canadian waters as they apply in respect of vessels in Canadian waters, with any modifications that the circumstances require.

SAR

MAP—AERONAUTICAL CHARTS AND PUBLICATIONS

1.0 GENERAL INFORMATION

The Minister of Transport is responsible for the development and regulation of aeronautics and the supervision of all matters connected with aeronautics.

The responsibility for the collection, evaluation and dissemination of aeronautical information published in the *AIP Canada (ICAO)*, the *Canada Flight Supplement (CFS)*, the *Canada Water Aerodrome Supplement (CWAS)*, the *Canada Air Pilot (CAP)* and in aeronautical charts has been delegated by the Minister of Transport to NAV CANADA.

2.0 AERONAUTICAL PUBLICATIONS

2.1 AIP CANADA (ICAO)

The *AIP Canada (ICAO)* is published and disseminated by NAV CANADA; it is an International Civil Aviation Organization (ICAO) compliant publication intended primarily to satisfy international requirements for the exchange of aeronautical information of a lasting nature. It constitutes the basic information source for permanent and long-duration temporary Canadian aeronautical information.

AIP Canada (ICAO) consists of Part 1—General (GEN), Part 2—En Route (ENR), and Part 3—Aerodromes (AD). Each part is divided into sections, which are further divided into subsections; the publication contains information relevant to aircraft operation in Canadian airspace. Amendments to *AIP Canada (ICAO)* are published every 56 days. *AIP Canada (ICAO)* also consists of *AIP Canada (ICAO)* Supplements, aeronautical information circulars and NOTAMs.

Additional *AIP Canada (ICAO)* information is provided in the following documents and charts:

- a) *Canada Flight Supplement (CFS)*;
- b) *Canada Water Aerodrome Supplement (CWAS)*;
- c) *Canada Air Pilot (CAP)* [seven volumes];
- d) en route low altitude charts (LO charts);
- e) en route high altitude charts (HI charts);
- f) terminal area charts (TAC);

- g) ICAO Type A charts (aerodrome obstacles);
- h) aeronautical charts for visual navigation (VNC and VTA); and
- i) *Designated Airspace Handbook (DAH)* [TP 1820].

These documents and charts are designated supplements and form an integral part of the *AIP Canada (ICAO)* in that they provide the pre-flight and in-flight information necessary for the safe and efficient movement of aircraft in Canadian airspace.

Any correspondence concerning the content of the *AIP Canada (ICAO)* is to be referred to:

AIP Canada (ICAO) Co-ordinator
NAV CANADA
1601 Tom Roberts Avenue
Ottawa ON K1V 1E5

Tel.: 613-248-4157
Fax: 613-248-4093
E-mail: aipcoord@navcanada.ca

2.2 AIP CANADA (ICAO) SUPPLEMENTS

While permanent changes are published in the *Transport Canada Aeronautical Information Manual (TC AIM)* and *AIP Canada (ICAO)*, temporary operational changes of long duration (three months or longer), as well as information of short duration that contains extensive text and/or graphics, are published in an *AIP Canada (ICAO)* Supplement in accordance with the International Civil Aviation Organization's (ICAO) Annex 15.

2.3 AIP CANADA (ICAO) AERONAUTICAL INFORMATION CIRCULARS

Aeronautical information circulars (AICs) provide advance notification of major changes to legislation, regulations, procedures or purely administrative matters where the text is not part of the *Transport Canada Aeronautical Information Manual (TC AIM)* or *AIP Canada (ICAO)*.

In accordance with the International Civil Aviation Organization's (ICAO) Annex 15, an AIC shall be issued whenever it is desirable to promulgate:

- a) a long-term forecast of any major change in legislation, regulations, procedures or facilities;
- b) information of a purely explanatory or advisory nature liable to affect flight safety;
- c) information or notification of an explanatory or advisory nature concerning technical, legislative or purely administrative matters.

2.4 AERONAUTICAL INFORMATION REGULATION AND CONTROL (AIRAC) CANADA

The Aeronautical Information Regulation and Control (AIRAC) Canada notice is issued weekly by NAV CANADA, Aeronautical Information Management, to provide advance notification to chart makers and producers of aeronautical information concerning changes within Canadian domestic airspace (CDA). This notice ensures that all users of Canadian airspace have the same information on the same date.

2.5 VISUAL FLIGHT RULES (VFR) AERONAUTICAL INFORMATION

Visual flight rules (VFR) aeronautical information is found in the *Transport Canada Aeronautical Information Manual* (TC AIM), *AIP Canada (ICAO)*, VFR navigation charts (VNC), VFR terminal charts (VTA) and the *Canada Flight Supplement (CFS)* or *Canada Water Aerodrome Supplement (CWAS)*.

2.5.1 VFR Navigation Chart (VNC)

Information specific to the en route portion of the flight is printed on the aeronautical charts. This includes:

- a) topography;
- b) hydrography;
- c) aerodromes;
- d) NAVAIDs;
- e) airways and other controlled airspace;
- f) en route hazards, such as:
 - (i) advisory areas
 - (ii) restricted areas
 - (iii) obstructions.

Complete coverage of Canada is available in the VNC (1:500 000 scale).

2.5.2 VFR Terminal Area Chart (VTA)

To satisfy special operational requirements at certain high density traffic airports with complex airspace structures, VTA are available (1:250 000 scale). VTA are produced for Vancouver, Edmonton, Calgary, Winnipeg, Toronto, Ottawa and Montréal.

2.5.3 Canada Flight Supplement (CFS)

Other aeronautical information required for VFR flight, but not suitable for depiction on visual aeronautical charts, is published in the CFS. The CFS supports and complements the visual charts for all of Canada and some NAT destinations and includes:

- a) a complete list of NAVAIDs associated with airports;
- b) the current status of individual airports;
- c) the availability of facilities and services at airports;
- d) the telephone numbers for flight planning services;
- e) general procedural information; and
- f) aerodrome sketches.

2.5.4 Canada Water Aerodrome Supplement (CWAS)

The CWAS provides tabulated data and graphical information in support of Canadian VFR charts. It contains an aerodrome/facilities directory of all water aerodromes shown on Canadian VFR charts and lists communications station data, radio aids and other supplemental data.

2.5.5 Aeronautical Charts

AIP Canada (ICAO) GEN 3.2 details the aeronautical chart series available.

2.6 INSTRUMENT FLIGHT RULES (IFR) AERONAUTICAL INFORMATION

Instrument flight rules (IFR) aeronautical information consists of two parts: firstly, en route information which is published on the en route low altitude charts (LO charts) and the en route high altitude charts (HI charts); and secondly, arrival and departure information which is published in the *Canada Air Pilot (CAP)* (seven volumes). All operational information specifically pertinent to the conduct of the en route portion of flight is found on the en route charts (airports, navigation aids [NAVAIDs], air routes, airways, minimum en route altitudes [MEAs], etc.). Aeronautical information specifically pertinent to the conduct of the arrival or departure portion of flight (instrument approach procedures [IAPs], standard instrument departure [SID] procedures, and noise abatement procedures) is published in the CAP.

In addition, terminal area charts (TAC) are available, depicting the terminal areas at the larger national airports. TAC are intended to assist in the transition from the en route portion of flight to the arrival portion, or from the departure portion to the en route portion, at those terminals where the airspace structure is sufficiently complex. TAC do not depict any aeronautical information that is not already depicted on the en route charts,

the IAP or departure procedure charts.

The en route charts and CAP are supported and complemented by the *Canada Flight Supplement* (CFS). It contains an aerodrome/facilities directory of all IFR airports, detailing the facilities and services available at these airports; it also provides information on communications, navigational facilities, radar, and special notices and procedures. The CFS contains the IFR information required for use in flight, but that is not suitable for depiction on the en route charts or for inclusion in the CAP.

AIP Canada (ICAO) GEN 3.2 details the aeronautical chart series available.

3.0 NOTAM

3.1 GENERAL

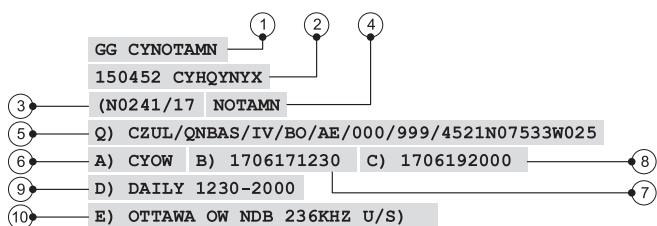
A NOTAM is a notice that contains information concerning the establishment or condition of, or any changes in, any aeronautical facility, service, procedure, or hazard, the timely knowledge of which is essential to personnel involved in flight operations. A NOTAM is originated and issued promptly whenever the information to be distributed is of a temporary nature and of short duration, or when operationally significant permanent changes or temporary changes of long duration are made at short notice, except for extensive text and/or graphics (see MAP 2.2). NOTAMs are distributed by teletype on the aeronautical fixed service (AFS) or by voice advisory using radio communications. NOTAMs can be used to advertise changes to the information on aeronautical charts or in aeronautical information publications.

3.2 NOTAM FORMAT

All Canadian NOTAMs, with the exception of the runway surface condition NOTAM (NOTAMJ), are presented in the internationally recognized format prescribed by Annex 15 to the Convention on International Civil Aviation. This format bases its dissemination on series and comprises “items” (fields) that are used for parsing based on user requirements. Not all items are mandatory or permissible.

3.2.1 Format Description

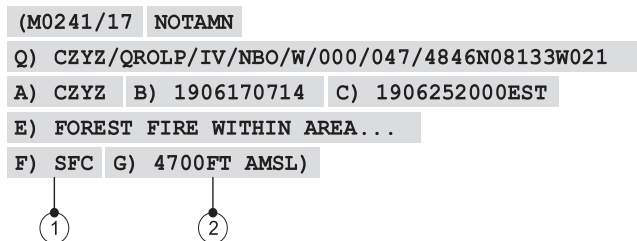
Figure 3.1—NOTAM Format: Example 1



1. Aeronautical fixed service (AFS) message priority and addressing (recipients)

2. Date and time (DDHHMM) and addressing (originator)
3. NOTAM Series, number, and year of issuance
4. NOTAM type (New, Replacement, Cancellation)
5. Item Q): Coded line for custom briefings
6. Item A): Location indicator(s)
7. Item B): Start date and time
8. Item C): End date and time
9. Item D): Schedule
10. Item E): NOTAM text

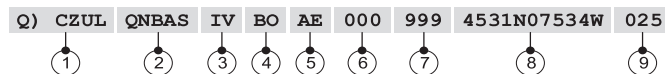
Figure 3.2—NOTAM Format: Example 2



1. Item F): Lower vertical limit
2. Item G): Upper vertical limit

3.2.2 Item Q Description

Figure 3.3—NOTAM: Item Q



1. FIR within which the event is occurring
2. NOTAM Code (always starts with “Q”), subject, and condition of the subject
3. Type of traffic affected: IFR (I), VFR (V), or IFR and VFR (IV)
4. Briefing purpose: Notify users immediately (N), include in briefings (B), concerns flight operations (O), or miscellaneous (M)
5. Scope of impact: Aerodrome (A), Enroute (E), Aerodrome and Enroute (AE), Navigation warning (W)
6. Lower vertical limit expressed in flight level
7. Upper vertical limit expressed in flight level
8. Latitude and longitude of subject in degrees and minutes
9. Subject radius of area of influence in nautical miles



3.2.3 Items Description

3.2.3.1 NOTAM Number and Type

The NOTAM number starts with the NOTAM series letter, followed by 4 digits (NOTAM number), a stroke, and the year. For example: F0002/19 means the 2nd NOTAM issued in 2019 in series “F”.

3.2.3.2 Item Q) Coded Line

This mandatory line is intended to be used by flight planning system users and developers for parsing and tailored briefings. For a detailed explanation on the use of item Q, consult the *Canadian NOTAM Operating Procedures (CNOP)*.

3.2.3.3 Item A) Location Indicator(s)

Item A) is mandatory and must contain a four-letter location indicator of either an aerodrome (based on the NOTAM subject) or one or more FIR. Since the item only accepts letters, CXXX is entered in item A) for aerodromes location indicators that contain 3 letters and 1 number (for example, CEB5). When this occurs, the location indicator and name of the aerodrome appear in item E) NOTAM text.

3.2.3.4 Items B) and C) Start and End Time

Item B) is mandatory and always contains a 10-digit date-time group expressed as YYMMDDHHMM. All dates and times are always in UTC. For example: 1910021300 means October 2, 2019, at 1300Z.

Item C) is mandatory and can be presented in 3 forms:

- C) YYMMDDHHMM – should be used when the end time is known precisely. The NOTAM will expire without human intervention when the time is reached.
- C) YYMMDDHHMMEST – should be used when the end time is not known with certainty (for example, in the case of equipment outages). EST means estimated or approximate. When the end time is reached, if there is no human intervention, the NOTAM will remain intact. Therefore, the NOTAM must be revised (NOTAMR) or cancelled (NOTAMC) before the time is reached.
- C) PERM – used when the NOTAM promulgates a permanent change to aeronautical information. Human intervention is required to remove the NOTAM. Therefore, the NOTAM must be revised (NOTAMR) or cancelled (NOTAMC) when the NOTAM is no longer needed.

3.2.3.5 Item D) Schedule

Item D) is optional, and it is inserted only when the information contained in a NOTAM occurs during more than one period within the overall “in force” period. All dates and times are always in UTC. The start of the first time period corresponds

to the start date-time group (item B) and the end of the last period corresponds to the end date-time group (item C), unless days are used and the NOTAM is in force for more than a week. The periods are in chronological order. A date appears only once. The hyphen “-” is used to express a range and means “to”. A space between schedule elements means “and”.

Example 1:

B) 1912241700 C) 1912262230
E) RWY 03/21 CLSD

Example 2:

D) DAILY 1700-2230
B) 1912241700 C) 1912262230
E) RWY 03/21 CLSD

Example 3:

B) 1905142200 C) 1905170900
D) 2200-0900 DLY
E) RWY 03/21 CLSD

Example 4:

B) 1901141200 C) 1901191300
D) JAN 14 1200-16 1730
JAN 17 0100-19 1300

Example 5:

D) JAN 14-16 1200-1730
JAN 17-19 0100-1300

Example 6:

D) UG 14 1200-1730
AUG 16 0700-1200 1630-2200
AUG 18 1200-1730

Example 7:

D) AUG 15-18 1000-1900
AUG 19-21 0800-1400

Example 8:

B) 1908112030 C) 1908170430
D) AUG 11 2030-0300
AUG 12 2000-0200
AUG 13-16 2100-0430
E) RWY 03/21 CLSD

Example 9:

DEC 08 10 11 13 1200-2200

Example 10:

FEB 20-24 1200-1900
FEB 26-28 1300-1900
MAR 02-05 1000-1300

Example 11:

B) 1912080000 C) 1912172359
D) DEC 08-12, 14-17 H24
E) RWY 12/30 CLSD

Example 12(a):

- B) 1907010000 C) 1907211700
 D) MON WED FRI H24
 SAT SUN 0600-1700
 E) RWY 12/30 CLSD

Example 12(b):

- B) 1906290600 C) 1907192359
 D) MON WED FRI H24
 SAT SUN 0600-1700
 E) RWY 12/30 CLSD

NOTE:

In examples 12(a) and (b), the schedule is the same but the start date-time group and end date-time group differ based on the start day and end day.

Example 13:

1. SR-SS*
2. SR MINUS25 MIN-SS
3. SR MINUS25 MIN-1600
4. 0800-SS
5. 0800-SS PLUS25 MIN

*SR means sunrise and SS means sunset.

3.2.3.6 Item E) NOTAM Text

Item E) is mandatory and contains the subject and condition of the subject, completed where necessary with ICAO-approved abbreviations, indicators, identifiers, call signs, frequencies, numbers, and plain language.

3.2.3.7 Items F) and G) Lower and Upper Vertical Limits

Items F) and G) are mandatory if the NOTAM is a navigation warning. Item F) lower vertical limit can be expressed as “SFC” (surface), in feet above ground level (AGL), in feet above mean sea level (AMSL), or as flight level (FL). Item G) upper vertical limit can be expressed as “UNL” (unlimited), in feet AGL, in feet AMSL, or as flight level (FL).

3.3 NOTAM TYPES

NOTAM can be issued as a new NOTAM (NOTAMN), a replacing NOTAM (NOTAMR), or a cancelling NOTAM (NOTAMC). Replacements and cancellations must occur within the same NOTAM series:

N0241/19 NOTAMN

F0344/19 NOTAMR F0213/19

H0007/19 NOTAMC H7004/18

3.4 NOTAM ISSUED UNDER A FLIGHT INFORMATION REGION (FIR) OR AN AERODROME

If a NOTAM subject affects an aerodrome directly or is 5 NM or less from an aerodrome, item A) contains the location indicator of an aerodrome or CXXX (see MAP 3.2.3.3). If a NOTAM subject affects multiple aerodromes, if it is beyond 5 NM from any aerodrome, if it affects airspace, or if it is a navigation warning, item A) contains one or more flight information regions (FIR) (up to 7). More details on the application of an aerodrome or FIR in item A) can be found in the *Canadian NOTAM Operating Procedures (CNOP)* and in the *AIP Canada* (ICAO).

It is necessary that all airspace users review both pertinent aerodrome and FIR NOTAMs.

3.5 NOTAM DISTRIBUTION

Canadian NOTAMs are distributed to flight information centres (FIC), flight service stations (FSS), and aircraft operators on the aeronautical fixed service (AFS). The distribution is tailored to specific user requirements. (For details, see Table 3.1 in this chapter). NOTAMs can also be found on the NAV CANADA website.

Series are assigned in accordance with NOTAM regions, dissemination categories, and subject categories. There are 18 series letters used in Canada: C, D, E, F, G, H, I, J, K, L, M, N, O, P, Q, R, U, V.

There are three NOTAM regions:

- The Western Region consists of the Vancouver and Edmonton flight information regions (FIR).
- The Central Region consists of the Winnipeg and Toronto FIRs except for three locations where services are available in English and French: CNC9-Perth (Great War Mem Hosp) (Heli), CTA4-St-Bruno-de-Guigues, and CSR8-La Sarre.
- The Eastern Region consists of Montreal, Moncton, and Gander FIRs in addition to the three locations in the Toronto FIR where services are available in English and French: CNC9-Perth (Great War Mem Hosp) (Heli), CTA4-St-Bruno-de-Guigues, and CSR8-La Sarre.

There are three dissemination categories, each containing six series:

- International: disseminated to international stakeholders, to the USA, and within Canada;
- International – USA: disseminated to the USA and within Canada; and
- National: disseminated within Canada only.

Details on NOTAM regions, dissemination categories, and series can be found in *AIP Canada (ICAO)* paragraph GEN 3.1.3.

A monthly numerical checklist of current Canadian NOTAMs series is generated automatically on the first day of each month and contains all the valid NOTAM numbers within a series, in addition to the valid *AIP Canada (ICAO)* amendments, AIP supplements, and AIC numbers.

3.6 CRITERIA FOR ISSUING A NOTAM

A NOTAM should be published with sufficient lead time for the affected parties to take any required action, except in the cases of unplanned unserviceability, volcanic activity, the release of

radioactive material or toxic chemicals, and other events that cannot be foreseen. The lead time is at the discretion of the originator but does not exceed 14 days. Whenever possible, at least 24 hours' advance notice is desirable, to permit timely completion of the notification process and to facilitate airspace utilization planning. For planned events, outages, and activities, no less than 6 hours' lead time is provided.

A NOTAM shall be originated and issued promptly whenever the information to be distributed is of a temporary nature and of short duration, or when operationally significant permanent changes or temporary changes of long duration are made at short notice, except in the case of extensive text and/or graphics.

A NOTAM will be originated and issued in the following cases:

Table 3.1—NOTAM Dissemination Categories

Western Region		Central Region		Eastern Region	
INTL	C, F	INTL	D, G	INTL	E, H
INTL-USA	I, L	INTL-USA	J, M	INTL-USA	K, N
NATIONAL	O, R	NATIONAL	P, U	NATIONAL	Q, V

- a) establishment, closure, or significant changes in operation of aerodrome(s) or runways;
- b) establishment, withdrawal, or significant changes in operation of aeronautical services (AGA, AIS, ATS, COM, MET, SAR, etc.);
- c) establishment, withdrawal, or significant changes in operational capability of radio navigation and air/ground communication services. This includes: an interruption or return to operation, a change of frequencies, a change in notified hours of service, a change of identification, a change of orientation (directional aids), a change of monitoring capability or location of any radio navigation and air/ground communication services, or limitations of relay stations including operational impact, affected service, frequency, and area;
- d) unavailability of back-up and secondary systems, having a direct operational impact;
- e) establishment or withdrawal of or significant changes made to visual aids;
- f) interruption of or return to operation of major components of aerodrome lighting systems;
- g) establishment or withdrawal of or significant changes made to procedures for air navigation services;
- h) occurrence or correction of major defects or impediments in the manoeuvring area;
- i) changes to and limitations on the availability of fuel, oil, and oxygen;
- j) major changes to search and rescue (SAR) facilities and services available;
- k) establishment, withdrawal, or return to operation of hazard beacons marking obstacles to air navigation;
- l) changes in regulations requiring immediate action, for example, *Designated Airspace Handbook (DAH)* (TP 1820) amendments;
- m) presence of hazards that affect air navigation (including obstacles, military exercises, displays, fireworks, rocket debris, races, and major parachuting events outside promulgated sites);
- n) planned laser emissions, laser displays, and search lights if pilots' night vision is likely to be impaired;
- o) erection or removal of or changes to obstacles to air navigation in the takeoff/climb, missed approach, and approach areas, and on the runway strips;
- p) establishment or discontinuance (including activation or deactivation), as applicable, or changes in the status of restricted, danger, or advisory areas;
- q) establishment or discontinuance of areas or routes or portions thereof where the possibility of interception exists and where the maintenance of guard on the emergency very high frequency (VHF) 121.5 MHz is required;
- r) allocation, cancellation, or change of location indicators;
- s) changes in the aerodrome/heliport rescue and fire fighting category provided;

- t) outbreaks of epidemics necessitating changes in notified requirements for inoculations and quarantine measures;
- u) observations or forecasts of space weather phenomena, the date and time of their occurrence, the flight levels where provided, and portions of the airspace that may be affected by the phenomena;
- v) an operationally significant change in volcanic activity; the location, date, and time of volcanic eruptions; and/or the horizontal and vertical extent of volcanic ash cloud, including direction of movement, flight levels, and routes or portions of routes that could be affected;
- w) release into the atmosphere of radioactive materials or toxic chemicals following a nuclear or chemical incident; the location, date, and time of the incident; the flight levels and routes or portions thereof which could be affected; and the direction of movement;
- x) establishment of operations of humanitarian relief missions, such as those undertaken under the auspices of the United Nations, together with procedures and/or limitations that affect air navigation;
- y) implementation of short-term contingency measures in cases of disruption, or partial disruption, of air traffic services and related supporting services;
- z) unavailability of meteorological data; or
- aa) other operationally significant circumstances.

Example 2:

GG CYHQYNYX

281530 LFFAYNYX

RQN CYHQ C0400/19 C0410/19 C0421/19 C0470/19-C0499/19

3.7 AUTOMATIC QUERY/RESPONSE—CANADIAN NOTAM DATABASE

Canadian NOTAMs in all 18 series are available by automatic query/response via the aeronautical fixed service (AFS) to Canadian and international users. Foreign NOTAMs are not stored in the Canadian NOTAM database but are available by automatic query/response via the AFS through the European AIS Database (EAD). Details for query/response messages can be found in *AIP Canada (ICAO)* paragraph GEN 3.1.3.

Example 1:

GG CYHQYNYX.....Message priority and recipient of the query

160830 LFFAYNYX.....Date and time of query (ddhhmm) and sender of query (France NOF)

RQN CYHQ C0123/19.....Query designator, NOTAM nationality, subject of query (number 0123 of year 2019 in NOTAM Series C).

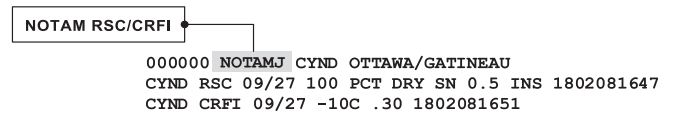
3.8 RUNWAY SURFACE CONDITION (RSC) / CANADIAN RUNWAY FRICTION INDEX (CRFI) NOTAM (NOTAMJ)

NOTAMs concerning runway surface conditions (RSC) and the Canadian Runway Friction Index (CRFI) are presented in the NOTAMJ format. This format relies on NOTAM files and is issued only for aerodromes.

Approximately 210 NOTAM files (four-letter Canadian location indicators) are resident in the domestic NOTAM database. The NOTAM files are found in the *Canada Flight Supplement (CFS)*, Section B, Subsection FLT PLN.

The four letters following “NOTAMJ” identify the NOTAM file whereas the first four characters of the next line (NOTAM text) identify the aerodrome.

Figure 3.4—Example of a RSC/CRFI NOTAM (NOTAMJ)



3.8.1 Query/Response NOTAMJ (NOTAMQ)

Requests for NOTAMJ must be sent to CYZZQQNI. Note that the query identifies the NOTAM file and will return all aerodromes within the NOTAM file.

Example:

GG CYZZQQNI

261855 EGGNYNYX

NOTAMQ CYYZ

To obtain the French version, where issued:

GG CYZZQQNI

DDHHMM CYZVYFYX

NOTAMQ CYYFF

MAP

Figure 3.5—Example of a Query/
Response NOTAMJ (NOTAMQ)



4.0 PROCUREMENT OF AERONAUTICAL CHARTS AND PUBLICATIONS

4.1 GENERAL

The following is a list of links to aviation-related resources and publications:

- a) The *Forms Catalogue*, available at <<http://wwwapps.tc.gc.ca/Corp-Serv-Gen/5/Forms-Formulaire/English.aspx>>, provides access to a number of Transport Canada (TC) forms. To search specifically for aviation forms, go to the Forms Search page and, under Transportation Mode, select Air in the dropdown menu.
- b) The *Aviation Safety Letter* [TP 185] is available at <www.tc.gc.ca/eng/civilaviation/publications/tp185-menu-5395.htm>.
- c) The *Designated Airspace Handbook* (DAH) [TP 1820] is available on the NAV CANADA Web site at <www.navcanada.ca/EN/products-and-services/Pages/aeronautical-information-products-designated-airspace-handbook.aspx>.
- d) The *Canadian Aviation Regulations* (CARs) are available on the Department of Justice (DOJ) Web site at <<http://laws-lois.justice.gc.ca/eng/regulations/sor-96-433/>>.

TC priced publications, CDs, DVDs and forms are available from the TC Publications Order Desk. Contact the Order Desk for information about ordering; change of address; the TCCA e-Bulletin service; and print-on-demand options and pricing. Print-on-demand copies of the *Transport Canada Aeronautical Information Manual* (TC AIM) [TP 14371] and *Aviation Safety Letter* (TP 185) are available for order.

TC Publications Order Desk

Tel. (toll-free in North America): 1-888-830-4911
 613-991-4071

Chief, Operational Support Services
 Transport Canada (AAFB)
 2655 Lancaster Road
 Ottawa ON K1B 4L5

Fax: 613-991-1653

E-mail: publications@tc.gc.ca

Web site: www.tc.gc.ca/eng/civilaviation/publications/menu.htm

4.2 NAV CANADA PUBLICATIONS

Fit for Purpose: A Guide to Using NAV CANADA Aeronautical Publications is a NAV CANADA publication that describes the intended use of and limitations to their publications. *Fit for Purpose* can be accessed on the NAV CANADA Web site by selecting “Aeronautical Information Products” and clicking on “Aeronautical Publications Guide” under “Related Links”.

See MAP 4.2.1 and MAP 4.2.2 for the lists of NAV CANADA publications available for individual purchase or by subscription.

4.2.1 Individual Purchase

The following publications are available for individual purchase:

- a) VFR Navigation Charts (VNC)
- b) VFR Terminal Area Charts (VTA)
- c) Terminal Area Charts (TAC)
- d) En Route Low Altitude Charts (LO charts)
- e) En Route High Altitude Charts (HI charts)
- f) ICAO Type A Charts*
- g) *Canada Air Pilot* (CAP)*
- h) *Restricted Canada Air Pilot* (RCAP)*
- i) *Canada Flight Supplement* (CFS)
- j) *Canada Water Aerodrome Supplement* (CWAS)*

*This publication is available in electronic form. See the NAV CANADA online store for details.

Individual aeronautical charts and publications can be obtained from authorized distributors or from NAV CANADA’s online store. Authorized distributors can be found by clicking on “Aeronautical Information Products” and then selecting “Purchase Information” at <www.navcanada.ca> and in Section C of the CFS. You can also call AEROPUBS at 1-866-731-PUBS (7827) for the distributor nearest you. Distributors may offer products at different prices.

4.2.2 Subscriptions

The following charts and publications are revised regularly in accordance with the AIRAC cycle. Please see the NAV CANADA online store for more details.

- a) En Route Low Altitude Charts (LO charts)
- b) En Route High Altitude Charts (HI charts)

- c) Terminal Area Charts (TAC)
- d) *Canada Air Pilot (CAP)**
- e) *Restricted Canada Air Pilot (RCAP)**
- f) *Canada Flight Supplement (CFS)**
- g) *AIP Canada (ICAO)**

*This publication is available in electronic form. See the NAV CANADA online store for details.

Subscriptions are available from NAV CANADA's online store or through the Aeronautical Publications Sales and Distribution Unit (AEROPUBS).

NAV CANADA
 Aeronautical Publications Sales and Distribution Unit
 P.O. Box 9840 Station T
 Ottawa ON K1G 6S8

Tel. (toll-free): 1-866-731-PUBS (7827)
 Fax (toll-free):..... 1-866-740-9992
 Fax:..... 613-563-4049
 E-mail:..... aeropubs@navcanada.ca
 Web site:..... www.navcanada.ca
 Online store:.....<http://products.navcanada.ca>

Payment Methods and Shipping and Handling:

For up-to-date information about payment methods and shipping and handling fees, please visit the NAV CANADA online store or contact the NAV CANADA Aeronautical Publication Sales and Distribution Unit using one of the methods listed above. All sales are final. For more information, see the FAQ page at the NAV CANADA online store.

5.0 CHARTS AND PUBLICATIONS FOR INTERNATIONAL FLIGHTS

Foreign air rules, procedures and customs requirements may be different from those applicable in Canada. Failure to comply with foreign customs requirements may cause unnecessary delay and embarrassment. Failure to comply with foreign air rules and procedures may cause a near miss or an accident. Therefore, pilots who are planning flights to other countries must ensure they obtain the required current aeronautical information for each country to be visited.

Most countries publish a State aeronautical information publication (AIP) as well as aeronautical charts and publications similar to those used in Canada. For the address from which aeronautical information for foreign states may be obtained, refer to *Aeronautical Information Services Provided By States* (ICAO Doc 7383). To obtain this document, you may contact:

Document Sales Unit
 International Civil Aviation Organization
 999 Robert-Bourassa Boulevard
 Montréal QC H3C 5H7

Tel.: 514-954-8022
 Fax:.....514-954-6769
 E-mail: sales@icao.int



MAP

LRA—LICENSING, REGISTRATION AND AIRWORTHINESS

1.0 FLIGHT CREW LICENSING

1.1 GENERAL

The *Aeronautics Act* and *Canadian Aviation Regulations* (CARs) contain Canadian aeronautics legislation, regulations and standards for flight crew licensing.

NOTES:

1. The information provided in this chapter is intended only as a guide. Contact a Transport Canada (TC) regional licensing office for specific concerns.
2. In the event of a discrepancy between the information found in this chapter and the CARs, the CARs shall take precedence.

The CARs or any bilateral flight crew licensing agreement with an International Civil Aviation Organization (ICAO) contracting state, contain(s) complete licensing requirements and specific details for individual permits, licences, ratings and medical requirements. Flight crew licensing regulations and standards are found in:

- a) CAR 401 and CAR Standard 421;
- b) CAR 404 and CAR Standard 424; or
- c) bilateral flight crew licensing agreements.

An aviation document booklet (ADB), designed to hold aviation-related documents, is evidence that a flight crew member is qualified for certain permits, licences, certificates and ratings. The permits, licences and medical certificates are attached as labels to the ADB. The ADB includes the holder's photograph and other security features for positive authentication.

Licences in the ADB conform to the standards set forth in ICAO Annex 1. All Canadian differences to ICAO standards are published in *AIP Canada (ICAO)* GEN 1.7. Permits do not conform to ICAO standards and are valid only in Canadian airspace, unless authorized by the country in which the flight is conducted.

Permit and licence holders must hold a Restricted Operator Certificate with an Aeronautical Qualification in accordance with the requirements of Industry Canada, if they are going to operate radiotelephone equipment on board an aircraft.

1.2 AVIATION DOCUMENT BOOKLET (ADB)

Canadian permit and licence holders must hold an *aviation document booklet* (ADB).

A first-time Canadian permit or licence applicant must also apply for an ADB at the same time. A passport-style photograph must be submitted with the Application for an Aviation Document Booklet Form (Form 26-0726).

The 24-page ADB is divided into different sections and includes the holder's licensing information, as well as ADB-associated legal text and abbreviations. Three sections clearly show the holder's licence(s) and permit(s), competency records, and medical certificate(s).

The ADB allows for multiple permits, licences, rating renewals and medical certificates throughout its validity period.

Transport Canada (TC) has started issuing ADBs that are valid for 10 years. Since licence holders with operational language proficiency must be retested every five years, they will continue to be issued ADBs valid for up to five years. The *Canadian Aviation Regulations* (CARs) will be amended to reflect this change.

More information on the booklet can be found on the following Transport Canada Civil Aviation (TCCA) Web page: <<https://www.tc.gc.ca/en/services/aviation/licensing-pilots-personnel/applying-aviation-document-booklet.html>>.

1.3 AVIATION LANGUAGE PROFICIENCY

All flight crew licences are required by the International Civil Aviation Organization (ICAO) to be annotated with a language proficiency rating.

ICAO language proficiency requirements apply to any language used for radiotelephony communications in international operations; therefore, pilots on international flights shall demonstrate an acceptable level of language proficiency in either English or the language used by the station on the ground.

Transport Canada Civil Aviation (TCCA) annotates flight crew licences to indicate English, French or both to show that the holder has met the requirements for aviation language proficiency, provided that the holder has been assessed at an expert or operational level.

- a) Expert level corresponds to ICAO level 6. The expert level does not expire, and requires no further testing for the licence holder.
- b) Operational level corresponds to ICAO levels 4 and 5. The operational level is the minimum required proficiency level for radiotelephony communication; a licence holder with an operational level of language proficiency must be retested every five years.
- c) Those persons assessed at below operational level (ICAO levels 1-3) do not qualify for a Canadian flight crew licence.

1.4 PERMITS AND LICENCES ISSUED BY TRANSPORT CANADA CIVIL AVIATION (TCCA)

1.4.1 Permits

- a) Student Pilot Permit
- b) Gyroplane Pilot Permit
- c) Ultralight Aeroplane Pilot Permit
- d) Recreational—Aeroplane Pilot Permit

1.4.2 Licences

- a) Glider Pilot Licence
- b) Balloon Licence
- c) Private Pilot Licence—Aeroplane
- d) Private Pilot Licence—Helicopter
- e) Commercial Pilot Licence—Aeroplane
- f) Commercial Pilot Licence—Helicopter
- g) Airline Transport Pilot Licence—Aeroplane
- h) Airline Transport Pilot Licence—Helicopter
- i) Flight Engineer Licence

NOTE:

The qualifications relating to AMEs and air traffic controllers are outlined in:

- a) CAR Subpart 402 and CAR Standard 422
- b) CAR Part V *Airworthiness Manual* Chapter 566

1.5 DEFINITIONS OF FLIGHT EXPERIENCE

For the purposes of flight training or flight proficiency to meet the *Canadian Aviation Regulations* (CARs) requirements, the following definitions apply.

- a) **Dual instruction flight time** is the flight time during which a person is receiving flight instruction from a person qualified in accordance with the CARs.

- (i) Pilot flying time is flight time during which a licensed pilot, for proficiency purposes, shows the required pilot-in-command (PIC) skills while carrying out duties as if they were the PIC of the aircraft.
- (ii) Pilot monitoring/pilot-not-flying time is flight time during which a licensed pilot, for proficiency purposes, shows the required co-pilot or second-in-command skills while carrying out duties as if they were the co-pilot of the aircraft.

- b) **Solo flight time** is the flight time necessary to acquire a flight permit, licence or rating.

- (i) For a pilot, the flight time during which the pilot is the sole flight crew member.
- (ii) For a student pilot permit holder, the flight time during which the permit holder is the sole occupant of an aircraft while under the direction and supervision of a qualified flight instructor for the appropriate category of aircraft.

- c) **Instrument flight time** is any flight time in an aircraft while piloting the aircraft by sole reference to the flight instruments. This flight time can be accumulated while operating under instrument flight rules (IFR) in instrument meteorological conditions (IMC), or in visual meteorological conditions (VMC) during flight training by means which limit a pilot's ability to see outside the cockpit environment such as while under a hood or wearing limited vision goggles.

- d) **Instrument ground time** is instrument time in a flight simulation training device (FSTD) approved by Transport Canada Civil Aviation (TCCA) for flight training purposes while controlling the simulator by sole reference to the flight instruments.

- e) **Pilot-in-command (PIC) flight time** is flight time in an aircraft as the pilot with responsibility and authority for the operation and safety of the aircraft.

- f) **PIC under supervision flight time** is flight time, other than for receiving flight instruction, acquired by a co-pilot under a TCCA approved pilot training program while acting as PIC under supervision of a PIC. PIC under supervision flight time can only be credited if it is obtained in accordance with CAR Standard 421.11, see <www.tc.gc.ca/eng/civilaviation/regserv/cars/part4-standards-421-1086.htm#421_11> .

- g) **Co-pilot flight time** is flight time as a co-pilot in an aircraft certified as requiring a co-pilot, as specified in the flight manual or by the air operator certificate (AOC), or flight time in an aircraft that must be operated with a minimum of two crew (as certified by TCCA).

NOTE:

Every holder of or applicant for a flight crew permit, licence or rating shall maintain a personal log in accordance with CAR 401.08, see <<http://laws-lois.justice.gc.ca/eng/regulations/SOR-96-433/FullText.html#s-401.08>>.

1.6 SUMMARY OF REQUIREMENTS FOR PERMITS

The following tables summarize the licensing and medical fitness requirements for all flight crew permits. For more information, refer to CAR Standard 421

1.6.1 Student Pilot Permits (SPP)

NOTES:

1. SPP holders must hold a valid and appropriate medical certificate to exercise the privileges of their permit.
2. Medical certificates associated with a permit have a validity period per CAR 404.04. In order to continue exercising permit privileges, a holder must renew the relevant medical certificate(s) before the end of the validity period.
3. When the Category 4 Medical Declaration is used for the Student Pilot Permit—Aeroplane, the declaration must be signed by a physician licensed to practice in Canada.

Table 1.1—SPP Requirements

SPP CATEGORY	AGE	MEDICAL CATEGORY	KNOWLEDGE AND EXAMINATION	EXPERIENCE	SKILL
Gyroplane	14	1 or 3	PSTAR* 90%	Per skill	Certified for solo
Ultralight Aeroplane	14	1, 3 or 4	CAR 421.19(2)(d)(i)	Per skill	Certified for solo
Glider	14	1, 3 or 4	CAR 421.19(2)(d)(ii)	Per skill	Certified for solo
Balloon	14	1 or 3	PSTAR 90%	Per skill	Certified for solo
Aeroplane	14	1, 3 or 4	PSTAR 90%	Per skill	Certified for solo
Helicopter	14	1 or 3	PSTAR 90%	Per skill	Certified for solo

*PSTAR is the computer code for the Student Pilot Permit or Private Pilot Licence for Foreign and Military Applicants, Aviation Regulations written examination.

1.6.2 Pilot Permits

NOTES:

1. Permit holders must hold a valid and appropriate medical certificate to exercise the privileges of their permit.
2. Medical certificates associated with a permit have a validity period per CAR 404.04. In order to continue exercising permit privileges, a holder must renew the relevant medical certificate(s) before the end of the validity period.
3. When the Category 4 Medical Declaration is used for the Recreational Pilot Permit—Aeroplane, the declaration must be signed by a physician licensed to practice in Canada.

Table 1.2—Pilot Permit Requirements

PERMIT CATEGORY	AGE	MEDICAL CATEGORY	KNOWLEDGE AND EXAMINATION	EXPERIENCE (Minimum instruction flight time)	SKILL
Gyroplane (GYP)	17	1 or 3	40 hr ground school and GYROP* 60%	Total - 45 hr including: Dual - 12 hr Solo - 12 hr	Flight demonstration and letter from instructor
Ultralight Aeroplane (ULP-A)	16	1, 3 or 4	20 hr ground school and ULTRA* 60%	Total - 10 hr including: Dual - 5 hr Solo - 2 hr	Flight demonstration and letter from instructor
Recreational-Aeroplane (RPP-A)	16	1, 3 or 4	RPPAE* or PPAER* 60%	Total - 25 hr including: Dual - 15 hr Solo - 5 hr	Flight test

*GYROP is the computer code for the Pilot Permit—Gyroplane written examination.

ULTRA is the computer code for the Pilot Permit—Ultralight Aeroplane written examination.

RPPAE is the computer code for the Pilot Permit—Recreational Aeroplane written examination.

PPAER is the computer code for the Private Pilot Licence—Aeroplane written examination.

1.7 SUMMARY OF REQUIREMENTS FOR LICENCES

1.7.1 Pilot Licence

The following tables summarize the licensing and medical fitness requirements for all flight crew licences. For more information, refer to CAR Standard 421.

NOTES:

1. Licence holders must hold a valid and appropriate medical certificate to exercise the privileges of their licence.
2. Medical certificates associated with a licence have a validity period per CAR 404.04. In order to continue exercising licence privileges, a holder must renew the relevant medical certificate(s) before the end of the validity period.

Table 1.3—Glider and Balloon Licence Requirements

LICENCE CATEGORY	AGE	MEDICAL CATEGORY	KNOWLEDGE AND EXAMINATION	EXPERIENCE (Minimum instruction flight time)	SKILL
Glider (GPL)	16	1, 3 or 4	15 hr ground school and GLIDE* 60%	Total - 6 hr including: Dual - 1 hr Solo - 2 hr	Flight demonstration and letter from instructor
Balloon (BPL)	17	1 or 3	10 hr ground school and PIBAL* 60%	Total - 16 hr including: Untethered - 11 hr including a minimum of: Dual - 3 hr Solo - 1 hr	Flight demonstration and letter from instructor

*GLIDE is the computer code for Pilot Licence—Glide written examination.

PIBAL is the computer code for the Pilot Licence—Balloon written examination.

1.7.2 Private Pilot Licence (PPL)

Table 1.4—PPL Requirements

LICENCE CATEGORY	AGE	MEDICAL CATEGORY	KNOWLEDGE AND EXAMINATION	EXPERIENCE (Minimum instruction flight time)	SKILL
Aeroplane (PPL-A)	17	1 or 3	40 hr ground school and PPAER* 60%	Total - 45 hr including: Dual - 17 hr Solo - 12 hr	Flight test
Helicopter (PPL-H)	17	1 or 3	40 hr ground school and PPHL* 60%	Total - 45 hr including Dual - 17 hr Solo - 12 hr	Flight test

*PPAER is the computer code for the Private Pilot Licence—Aeroplane written examination.
PPHEL is the computer code for the Private Pilot Licence—Helicopter written examination.

1.7.3 Commercial Pilot Licence (CPL)

Table 1.5—CPL Requirements

LICENCE CATEGORY	AGE	MEDICAL CATEGORY	KNOWLEDGE AND EXAMINATION	EXPERIENCE (Minimum instruction flight time)	SKILL
Aeroplane (CPL-A) If a PPL-A is held.	18	1	80 hr ground school and CPAER* 60%	Total - 200 hr including: PIC - 100 hr AND Commercial flight training - 65 hr consisting of: Dual - 35 hr Solo - 30 hr	Flight test
Aeroplane (CPL-A) For graduates from an approved integrated course.	18	1	A course completion certificate in lieu of these requirements	A course completion certificate in lieu of these requirements	Flight test
Helicopter (CPL-H) If a PPL-H is held.	18	1	40 hr ground school and CPHEL* 60%	Total - 100 hr including: PIC - 35 hr AND Commercial flight training - 60 hr consisting of: Dual - 37 hr Solo - 23 hr	Flight test
Helicopter (CPL-H) If a PPL-H is not held.	18	1	80 hr ground school and CPHEL 60%	Total - 100 hr including: PIC - 35 hr AND Commercial flight training - 100 hr including: Dual - 55 hr Solo - 35 hr	Flight test

*CPAER is the computer code for the Commercial Pilot Licence—Aeroplane written examination.
CPHEL is the computer code for the Commercial Pilot Licence—Helicopter written examination.

1.7.4 Airline Transport Pilot Licence (ATPL)

Table 1.6—ATPL Requirements

LICENCE CATEGORY	AGE	MEDICAL CATEGORY	KNOWLEDGE AND EXAMINATION	EXPERIENCE (Minimum instruction flight time)	SKILL
Aeroplane (ATPL-A)	21	1	SAMRA* 70%, SARON* 70% and INRAT* 70%	Total - 1 500 hr including: Aeroplane - 900 hr PIC - 250 hr	Flight test for a Group 1 Instrument Rating
Helicopter (ATPL-H)	21	1	HAMRA* 70% and HARON* 70%	Total - 1 000 hr including: Helicopter - 600 hr PIC - 250 hr	Flight test as PIC on a two- crew helicopter

*SAMRA is the computer code for the Airline Transport Pilot Licence (Aeroplane)—Meteorology, Radio Aids to Navigation and Flight Planning written examination.

SARON is the computer code for the Airline Transport Pilot Licence (Aeroplane)—Air Law, Aeroplane Operation and Navigation General written examination.

INRAT is the computer code for the Instrument Rating.

HAMRA is the computer code for the Airline Transport Pilot Licence (Helicopter)—Meteorology, Radio Aids to Navigation and Flight Planning written examination.

HARON is the computer code for the Airline Transport Pilot Licence (Helicopter)— Air Law, Helicopter Operation and

Navigation General written examination.

1.7.5 Flight Engineer (FE) Licence

Table 1.7—FE Requirements

LICENCE CATEGORY	AGE	MEDICAL CATEGORY	KNOWLEDGE (Examination)	EXPERIENCE (Minimum Hours)	SKILL
Flight Engineer (FE)	18	1	FLENG* 60%	Total - 100 hr	Flight demonstration and letter from instructor
Flight Engineer (FE) If a CPL-A is held.	18	1	FLENG 60%	Approved training program Total - 50 hr	Flight demonstration and letter from instructor

*FLENG is the computer code for the Flight Engineer Licence written examination.

1.8 DIFFERENCES BETWEEN THE NATIONAL REGULATIONS AND THE INTERNATIONAL CIVIL AVIATION ORGANIZATION'S (ICAO) ANNEX 1 STANDARDS AND RECOMMENDED PRACTICES

Licences conform to the standards set forth in the International Civil Aviation Organization's (ICAO) Annex 1. All Canadian differences to ICAO Standards are published in *AIP Canada (ICAO) GEN 1.7* (see <www.navcanada.ca/EN/products-and-services/Pages/AIP-current.aspx>).

1.9 MEDICAL FITNESS FOR PERMITS AND LICENCES

The medical standards for civil aviation flight crew licences have been established in accordance with the International Civil Aviation Organization's (ICAO) standards and recommended practices and are outlined in CAR Standard 424. A medical assessment is required to allow permit or licence holders to exercise their privileges.

NOTE:

A Category 4 Medical Certificate is issued for certain permits and licences for use in Canadian airspace only.

Medical fitness for a Category 1, 2 or 3 Medical Certificate is established by a medical examination conducted by a Canadian Civil Aviation Medical Examiner (CAME) or an Aviation Medical Examiner designated by the licensing authority of an ICAO contracting state.

If the medical examination is conducted by an Aviation Medical Examiner designated by the licensing authority of an ICAO contracting state, the completed medical examination report shall be forwarded to the following TCCA Medicine Branch address for review and assessment:

Civil Aviation Medicine Branch
 Transport Canada
 330 Sparks Street
 Place de Ville, Tower C, Room 617
 Ottawa ON K1A 0N8

Medical fitness for a Category 4 Medical Certificate is established by completing the Medical Declaration for Licences and Permits Requiring a Category 4 Medical Standard Form (Form 26-0297), available at <www.tc.gc.ca/wwwdocs/Forms/26-0297_0712-06_BO.pdf>.

The age of the applicant and the type of permit or licence applied

for determine the frequency of the medical examinations needed to meet the medical fitness requirements.

The validity period of a medical certificate is calculated from the first day of the month following the date of the medical examination or declaration.

1.9.1 Medical Validity Periods

The following table is an abridged list of the medical validity periods provided in the CARs for the following permits, licences and ratings.

Table 1.8—Medical Validity Periods

PERMIT, LICENCE or RATING HELD	FLIGHT CREW UNDER 40 YEARS OF AGE	FLIGHT CREW 40 YEARS OF AGE or OLDER
Student Pilot Permit	Dependent on the medical certificate held (See CAR 404.04)	Dependent on the medical certificate held (See CAR 404.04)
Gyroplane Pilot Permit	60 months	24 months
Ultralight Pilot Permit—Aeroplane	60 months	60 months
Passenger Carrying Ultralight—Aeroplane	60 months	24 months
Recreational Pilot Permit—Aeroplane	60 months	24 months
Glider Pilot Licence	60 months	60 months
Balloon Pilot Licence	60 months	24 months
Private Pilot Licence—Aeroplane and Helicopter	60 months	24 months
Commercial Pilot Licence—Aeroplane and Helicopter	12 months	12 months*
Airline Transport Pilot Licence—Aeroplane and Helicopter	12 months	12 months*
Flight Engineer Licence	12 months	12 months
Flight Instructor Rating—Glider	60 months	60 months
Flight Instructor Rating—Ultralight Aeroplane	60 months	60 months

*For the holder of a commercial pilot licence or an airline transport pilot licence, the validity period of a medical certificate is reduced to 6 months if the holder is: 40 years of age or older and engaged in a single-pilot operation with passengers on board; or 60 years of age or older.

NOTE:

The holder of a commercial or airline transport pilot licence may exercise the privileges of a private pilot licence until the end of the validity period for private pilot licences as specified in the table above.

1.9.2 Medical Fitness—Renewals for Category 1, 2 or 3 Medical Certificates (Assessed Fit)

Category 1, 2 or 3 Medical Certificate renewals may be conducted by a Canadian CAME or an Aviation Medical Examiner designated by the licensing authority of an ICAO contracting state.

If the holder is assessed medically fit for that permit or licence by a CAME, the examiner will renew the medical certificate for the full validity period by placing a date and signature stamp on the applicable page of the ADB.

If the medical examination is conducted by an Aviation Medical Examiner designated by the licensing authority of an ICAO contracting state, the completed medical examination report shall be forwarded to the following TCCA Medicine Branch address for review and assessment:

Civil Aviation Medicine Branch
Transport Canada
330 Sparks Street
Place de Ville, Tower C, Room 617
Ottawa ON K1A 0N8

If the holder is assessed medically fit for the permit or licence by the TCCA Medicine Branch, a new medical certificate will be issued. See LRA 2.3 for more information.

1.9.3 Medical Fitness—Renewals for Category 4 Medical Certificate

A pilot wishing to maintain a Category 4 Medical Certificate shall complete the *Medical Declaration for Licences and Permits Requiring a Category 4 Medical Standard* Form (Form 26-0297) 60 days before the expiry date of their medical certificate. This will allow TC licensing personnel enough time to issue a new Category 4 Medical Certificate before the original medical certificate expires.

1.9.4 Medical Fitness—Assessed Unfit

The underlying goal of medical assessments is to allow permit or licence holders to exercise their privileges. Some medical certificate applicants may be assessed as unfit and will not be issued a medical certificate.

In an unfit assessment where the applicant is on the borderline of a medical standard, the applicant's medical information will be reviewed by the Aviation Medical Review Board.

In this situation, flexibility may be applied to the medical standard to allow the applicant to exercise the privileges of their permit or licence provided that aviation safety is not compromised. See LRA 2.4 and LRA 2.5 for more information.

1.10 REFUSAL TO ISSUE A PERMIT, LICENCE, RATING OR MEDICAL CERTIFICATE

The Minister's power to refuse to issue or amend a permit, licence, rating or medical certificate is set out in the *Aeronautics Act*.

Grounds for refusing to issue are as follows:

- a) the applicant is incompetent per section 6.71 of the Act;
- b) the applicant fails to meet the qualifications or fulfill the conditions necessary for the issuance or amendment of the document per section 6.71 of the Act;
- c) public interest reasons per section 6.71 of the Act; and
- d) the applicant fails to pay monetary penalties per section 7.21 of the Act.

Transport Canada Civil Aviation (TCCA) takes care to determine whether an application is merely incomplete or whether the applicant does not meet the requirements set out in the *Canadian Aviation Regulations* (CARs).

- a) If an applicant has not submitted all of the required material, licensing personnel shall advise the applicant that the application cannot be processed until the specified additional documentation or information is provided.
- b) When all options are exhausted and the information provided by the applicant demonstrates that the applicant is not qualified for the requested document, licensing personnel shall advise the applicant of the decision not to issue the document.

Where the Minister decides to refuse to issue or amend a permit, licence, rating or medical certificate in accordance with the *Aeronautics Act*, the Minister will forward a Notice of Refusal to Issue or Amend a Canadian Aviation Document Letter to the applicant. The letter states the grounds and specific reasons for the decision.

1.11 REINSTATEMENT OF A SUSPENDED PERMIT, LICENCE OR RATING

To reinstate a flight crew permit, licence or rating that has been suspended under subsection 7.1(1) of the *Aeronautics Act*, the applicant shall provide proof that they have satisfied the conditions for reinstatement.

1.12 RECENCY REQUIREMENTS

In addition to a valid medical certificate, flight crew must meet the *Canadian Aviation Regulations* (CARs) requirements for recency in order to exercise the privileges of their permit, licence or rating in accordance with CAR 401.05 and CAR 421.05.

The recency requirements address three time periods: five years, two years, and six months. If a pilot wishes to act as pilot-in-command (PIC) or co-pilot of an aircraft, they must meet both the five-year and the two-year recency requirements. If they wish to carry passengers, they must also meet the six-month requirement.

For five-year recency, the pilot must have either:

- a) flown as pilot-in-command (PIC) or co-pilot within the previous five years; or
- b) completed a flight review with an instructor and written and passed the Student Pilot Permit or Private Pilot Licence for Foreign and Military Applicants, Aviation Regulation Examination, commonly known as PSTAR, within the previous 12 months.

For the 24-month recurrent training program, the pilot must have successfully completed a recurrent training program within the previous 24 months, and therefore meet one of the following seven conditions:

- a) complete a flight review with an instructor;
- b) attend a safety seminar conducted by Transport Canada Civil Aviation (TCCA);
- c) participate in a TCCA-approved recurrent training program;
- d) complete a self-paced study program;
- e) complete a training program or pilot proficiency check (PPC) as required by CARs Part IV, VI or VII;
- f) complete the requirements for the issue or renewal of a licence, permit or rating; or
- g) complete the written exam for a licence, permit or rating.

Flight crew must also meet specific recency requirements for other aircraft categories, instrument ratings and passenger carrying operations. Refer to CAR 401.05 and CAR 421.05 for more information.

1.13 FLIGHT CREW LICENSING CONVERSION AGREEMENT BETWEEN CANADA AND THE UNITED STATES

In June 2000, the United States and Canada signed a bilateral aviation safety agreement to coordinate various aspects of their respective aviation safety oversight systems for the benefit of users in both countries. In the agreement, the two countries developed technical annexes called implementation procedures that address specific aviation safety activity areas.

The technical annex addressing pilot licensing is called *Implementation Procedures for Licensing*. It authorizes pilots holding certain licences or certificates from one country to obtain a licence or certificate from the other country when certain requirements are met.

In order to facilitate the certificate or licence conversion, the Federal Aviation Administration (FAA) and Transport Canada Civil Aviation (TCCA) agreed to provide each other with a verification of pilot licence or certificate authenticity and the associated medical certificate(s) prior to starting the conversion. TCCA considers that a FAA Airman Certificate holder, who has complied with the respective TCCA licence conditions for conversion set forth in the *Implementation Procedures for Licensing*, shall be eligible for a TCCA licence.

NOTES:

1. It is intended that applicants following these implementation procedures do not also need to meet the requirements of the relevant CAR standards.
2. Licences or certificates that are endorsed “issued on the basis of a foreign licence” are **NOT** eligible for this conversion process.

The following FAA Airman Certificates may be converted using the applicable implementation procedures:

- a) Private Pilot – Aeroplane or Rotorcraft
- b) Commercial Pilot – Aeroplane or Rotorcraft
- c) Airline Transport Pilot – Aeroplane or Rotorcraft

When an application is made to convert any of the above listed certificates, the ratings or qualifications already endorsed may also be transferred. The following ratings or qualifications may be converted using the applicable implementation procedures:

- a) instrument rating,
- b) applicable aircraft class or type ratings, and
- c) night rating or qualification.

After the conversion of any of the above airman certificates and the issuance of the TCCA equivalent licence, a provision is made in the implementation procedure for instrument rating renewal.

No flight test is required for applicants who go through this conversion process.

More information on application guidelines for aeroplane or rotorcraft licence conversion can be found on the following TCCA Web page: <<https://www.tc.gc.ca/en/services/aviation/licensing-pilots-personnel/flight-crew-licenses-permits-ratings/convert-us-canadian-pilot-licence.html>>.

TCCA applicants are required to fill out FAA Form AC 8060-71, Verification of Authenticity of Foreign License Rating and Medical Certification, and comply with other eligibility requirements listed in FAA Advisory Circular (AC) 61-135A, see <www.faa.gov/regulations_policies/advisory_circulars/index.cfm/go/document.information/documentID/1027574>.

1.14 FLIGHT CREW LICENSING ADMINISTRATION

1.14.1 Flight Crew Licensing Change of Address Request

TCCA shall be advised of any change of mailing address within seven days following the change in accordance with CAR 400.07. A completed Flight Crew Licensing Change of Address Request Form (Form 26-0760) should be submitted to the closest TCCA regional licensing office. A PDF copy of this form is available at <http://www.wapps.tc.gc.ca/Corp-Serv-Gen/5/forms-formulaires/download/26-0760_BO_PD>.

1.14.2 Application for Re-Issue of Civil Aviation Licensing Document

If a permit or licence is not received in the mail, or is lost, stolen, destroyed or rendered illegible, a completed Application for Re-Issue of a Civil Aviation Licensing Document Form (Form 26-0738) should be submitted to the closest TCCA regional licensing office. A PDF copy of this form is available at <http://www.wapps.tc.gc.ca/wwwdocs/Forms/26-0738E_1405-03_E.pdf>.

1.14.3 Flight Crew Licensing Declaration of Name

TCCA shall be advised of any change in your given name or surname. A completed Flight Crew Licensing Declaration of Name Form (Form 26-0759) should be submitted to the closest TCCA regional licensing office. A PDF copy of this form is available at <www.tc.gc.ca/wwwdocs/Forms/26-0759_1001-01_BO.pdf>.

1.14.4 Change of Citizenship

TCCA shall be advised of any change in your citizenship. A letter should be sent to the closest TCCA regional licensing office notifying them of the change. The letter must be accompanied by proof of new citizenship in accordance with CAR Standard 421.06.

to determine their medical fitness to exercise the privileges of their permit or licence. This medical examination will normally be carried out by a designated CAME. The frequency of the medical examinations depends on the age of the applicant and the type of permit or licence applied for. For some examinations, supplementary tests, such as an audiogram or an electrocardiogram, may be required. The schedule for periodic examinations can be found in CAR 404.04(6) at <<http://laws-lois.justice.gc.ca/eng/regulations/SOR-96-433/page-50.html#h-404>>.

There are approximately 700 physicians who are designated by TC as CAMEs. They are strategically located across the country and overseas.

If the examination is performed in a contracting ICAO state, it must be completed by a medical examiner designated by Canada or by that state. The resulting medical examination must meet the Canadian physical and mental requirements. See CAR Standard 424 at <www.tc.gc.ca/civilaviation/regserv/cars/part4-standards-t42402-1412.htm>.

Only designated Canadian CAMEs may validate a renewal examination with the official CAME stamp and by signing the medical certification section in the ADB.

Local flying organizations usually have a list of examiners in their immediate area. Examiner lists are also available from the regional office of Civil Aviation Medicine or on the TCCA Web site: <<http://www.wapps.tc.gc.ca/saf-sec-sur/2/came-meac/1.aspx?lang=eng>>.

2.1.2 Category 4 Medical Declaration

When applying for the issuance or revalidation of any of the Canadian aviation documents listed below, the applicant may apply to obtain a Category 4 Medical Certificate by completing the Medical Declaration for Licences and Permits Requiring a Category 4 Medical Standard Form (Form 26-0297) at <http://www.wapps.tc.gc.ca/wwwdocs/Forms/26-0297E_1308-07_E.pdf>

- a) Student Pilot Permit—Aeroplane;
- b) Pilot Permit—Recreational;
- c) Pilot Permit—Ultralight Aeroplane;
- d) Student Pilot Permit—Glider; and
- e) Pilot Licence—Glider.

This medical declaration may be used to determine the applicant's medical fitness to exercise the privileges of their permit or licence. The medical declaration may be completed unless the applicant has ever suffered from any of the conditions listed in Part B of the declaration form, in which case they must undergo a medical examination with a CAME.

2.0 CIVIL AVIATION MEDICINE

2.1 MEDICAL ASSESSMENT PROCESS

2.1.1 Medical Examination Report

All holders of Canadian pilot licences or permits or air traffic controller licences must undergo a periodic medical examination

The Medical Declaration for Licences and Permits Requiring a Category 4 Medical Standard Form (Form 26-0297) is composed of three parts.

- a) *Part A*—All applicants must complete this part of the form. Part A requires the applicant to fill in their name, current address and other personal information.
- b) *Part B*—All ultralight and glider pilot applicants are required to complete, sign and date Part B of the medical declaration and have it signed by a witness. Applicants for a Student Pilot Permit—Aeroplane and a Pilot Permit—Recreational are also required to complete, sign, and date Part B of the medical declaration, but a witness signature is not required.

NOTE:

If the applicant has ever suffered from any of the conditions listed in Part B, they must undergo a medical examination with a CAME. Failure to disclose a medical issue is a federal offence under the *Aeronautics Act*.

- c) *Part C (applies only to Student Pilot Permit—Aeroplane or Pilot Permit—Recreational)*—In addition to completing Part B, Student Pilot Permit—Aeroplane and Pilot Permit—Recreational holders need to have Part C of the medical declaration completed by a physician licensed in Canada or by a CAME. A witness signature is not required.

All Pilot Permit—Recreational applicants need to undergo a resting 12-lead electrocardiogram after the age of 40, as well as on the first medical examination after the age of 50, and then every four years thereafter. The electrocardiogram tracing does not need to be submitted with the medical declaration form, but must be acknowledged as having been completed and read by the signing physician.

When a Category 4 Medical Declaration is completed in full, the candidate must submit the above-mentioned form to a TC regional licensing office, where a medical certificate will be issued.

An applicant who has completed the Category 4 Medical Declaration may not act as a flight crew member unless they can produce the appropriate, valid medical certificate. Please refer to CAR 401.03 for more details.

A pilot renewing a Category 4 Medical Declaration should complete the declaration form 60 days before the expiry date of the medical certificate. This will allow TC licensing personnel enough time to issue a new Category 4 Medical Certificate or label for the ADB before the original medical certificate expires.

An applicant holding a Category 4 Medical Certificate may exercise the privileges of the appropriate permit or licence while flying in Canadian airspace only.

NOTE:

If an applicant wishes to obtain a private pilot licence or higher or intends to pursue a career in aviation, it is advisable to forego a Category 4 application and apply directly for a Category 3 or 1 Medical Certificate in order to save time and money.

2.2 MEDICAL EXAMINATION REQUIREMENTS

Table 2.1—Medical Categories and Requirements by Age

Licence or Permit Type	Medical Category	Medical Report		Audiogram	Electrocardiogram	
		Age	Requirement		Age	Requirement
Airline Transport Senior Commercial Commercial (Validates all other categories)	1	Under 40	Within 12 months of issue or revalidation	At first examination then at 55 years old	Under 30	At first examination
		Over 40	Within 6 months of issue or revalidation		30-40	At first examination and every 2 years thereafter
					Over 40	At first examination and every year thereafter
NOTE: The holder of Medical Category 1 shall be considered fit for any permit or licence for its respective duration of validity unless otherwise specified.						
Flight Navigator/ Flight Engineer Air Traffic Controller	2	Under 40	Within 2 years of issue or revalidation	At first examination then at 55 years old	Under 30	At first examination
		Over 40	Within 12 months of issue or revalidation		30-40	At first examination and every 2 years thereafter
					Over 40	At first examination and every year thereafter
Student Pilot Private Pilot Gyroplane Pilot Balloon Pilot	3	Under 40	Within five years of issue or revalidation	(If clinically indicated)	Under 40	N.A.
		Over 40	Within two years of issue or revalidation		Over 40	At first examination and every four years thereafter
Ultralight Instructor Glider Instructor	4	All	Within five years of issue or revalidation	(If clinically indicated)	Under 40	N.A.
					Over 40	At first examination and every five years thereafter
Glider Pilot Ultralight Pilot	4	All	Medical Declaration (Full medical examination report only if clinically indicated)	(If clinically indicated)		N.A.
Recreational Pilot Student Pilot	4	All	Medical Declaration or Form 26-0297 counter-signed by a physician	(If clinically indicated)	Under 40	N.A.
					40-50	At first examination
					Over 50	At first examination and every four years thereafter

These requirements can be found in the table entitled “Physical and Mental Requirement” in CAR Standard 424 at www.tc.gc.ca/en/transport-canada/corporate/acts-regulations/regulations/sor-96-433/part4-standards-t42402-1412.htm.

2.3 PERIODIC MEDICAL EXAM CATEGORIES 1, 2 AND 3—MEDICALLY FIT

When the examination has been completed, the examiner will make a recommendation of fitness and will forward the medical examination report to the regional aviation medical officer (RAMO) at the appropriate regional office for review. If the person is already the holder of a Canadian pilot permit or licence or air traffic controller licence and is, in the opinion of the examiner, medically fit, the examiner will extend the medical validity of the holder’s permit or licence for the full validity period by signing and stamping the aviation document booklet (ADB) in the medical certification section.

The ADB is valid for five years.

2.4 AVIATION MEDICAL REVIEW BOARD

A small percentage of applicants will have medical issues that place them outside the medical standard. In those cases, their medical information may be reviewed by the Aviation Medical Review Board. The Review Board—a group of specialists in neurology, cardiology, psychiatry, ophthalmology, internal medicine, otolaryngology and aviation medicine—meets regularly in Ottawa to review complex cases and make recommendations to the regional aviation medical officer (RAMO).

2.5 UNFIT ASSESSMENT

Less than one percent of all applicants are assessed as unfit, a decision that is not made lightly. The underlying goal of the medical assessment is to allow permit/licence holders to maintain their privileges within the bounds of aviation safety. Flexibility may be applied to the medical standard if there is a counterbalancing safety restriction and/or a change in periodicity of medical surveillance that could be applied to a holder’s permit or licence, which would compensate for the deviation from the standard. For example, a pilot with certain medical conditions may be restricted to flying with or as an accompanying pilot.

If an applicant is assessed as unfit, they will be informed by the regional aviation medical officer (RAMO) in writing, and by the Regional Technical Team Lead, Flight Operations at Transport Canada Civil Aviation (TCCA). If it is an initial application, a medical certificate will not be issued. If the applicant holds a medical certificate, it will either be suspended or cancelled. If a medical certificate was previously held, a letter refusing to renew the document will be issued to the applicant.

If a medical certificate is refused, suspended, cancelled or not renewed, the applicant or permit/licence holder may wish to

discuss and review their medical assessment with the RAMO. Via teleconference and/or at a meeting, the RAMO will review, with the applicant or permit/licence holder, the medical information relevant to the assessment. As a general rule, the applicant or permit/licence holder may see these documents in the presence of the RAMO and ask questions concerning the content of the documents relative to the medical standards. In the case of sensitive or complicated medical information, the RAMO may elect to refer questions of a more clinical nature to the applicant or permit/licence holder’s personal physician, who can better explain the implications. In such cases, the applicant or permit/licence holder will be asked to sign a Consent to Release Form to designate a physician who will receive these reports.

In addition, the applicant or licence/permit holder may invoke the provisions outlined in the *Canadian Aviation Regulations* (CARs) regarding reconsideration of assessment.

CAR 404.12 states that:

“(1) An applicant for the renewal of a medical certificate who is assessed by the Minister as not meeting the requirements referred to in subsection 404.11(1) may, within 30 days after the date that the applicant receives the notification referred to in subsection 404.11(2),

- a) request the Minister to reconsider the assessment; and
- b) submit additional information to the Minister regarding the medical fitness of the applicant in support of the request.

(2) Where the Minister is requested to reconsider an assessment pursuant to subsection (1), the Minister shall

- a) take into consideration any additional information regarding the medical fitness of the applicant; and
- b) immediately notify the applicant in writing of the result of the reconsideration of the assessment.”

2.6 REVIEW BY THE TRANSPORTATION APPEAL TRIBUNAL OF CANADA (TATC)

After the steps outlined above, if the applicant or permit/licence holder wishes for the Transportation Appeal Tribunal of Canada (TATC) to review the medical certification decision, they must file a request by the date specified in the notice of suspension, cancellation or non-renewal. The TATC will acknowledge their request for review and subsequently set a hearing date. Any questions on hearing procedures should be directed to the TATC, which is independent from Transport Canada (TC)

If the applicant or permit/licence holder has new or additional medical information, it is strongly suggested that they share it with the regional aviation medical officer (RAMO) before the

hearing; this information may be sufficient for the RAMO to recommend reinstatement of the medical certificate and spare the applicant or permit/licence holder the inconvenience of a hearing before the TATC. Whether the applicant or permit/licence holder elects to disclose this evidence or not, the right to a hearing before the TATC is not affected, but the Tribunal will decline to make a determination of the case if the new evidence has not been reviewed by Civil Aviation Medicine.

If the applicant or permit/licence holder does decide to proceed with a review by the TATC, the following are the procedural steps.

The review will normally be heard by a single medical professional, a member of the TATC. The TATC member considers the medical evidence against the regulatory medical standards promulgated by the International Civil Aviation Organization (ICAO), the *Canadian Aviation Regulations* (CARs) and appropriate Civil Aviation Medicine guidelines. The member can either uphold the Minister's decision or request that the Minister reconsider their decision. The TATC does not have the power to require the Minister to issue a valid medical certificate to the applicant or permit/licence holder.

If the TATC member does not decide in the applicant or permit/licence holder's favour, this decision may be appealed to a three-member board of the TATC. This board can only review the evidence that was presented at the review hearing. No new evidence can be considered at the appeal level. If the three-member board of the TATC decides in the applicant or permit/licence holder's favour, the determination will be that the Minister reconsider their decision. If the three-member board does not decide in the applicant or permit/licence holder's favour, there is no further avenue of appeal to the TATC.

If either the single-member TATC or the three-member TATC decides that the Minister reconsider their decision, TC does not have the right of appeal. The merits of the case, based only on the evidence available at the time of the original review, will be reconsidered by the Minister. As part of the reconsideration process, the Director, Standards will ask the Director, Civil Aviation Medicine to review the case and provide them with a recommendation regarding the applicant or permit/licence holder's medical fitness. The Director, Civil Aviation Medicine does not normally participate in the medical review by the RAMO or in the Aviation Medical Review Board recommendations and is thus able to formulate an unbiased opinion after an independent review of all of the medical evidence available at the time of the original decision. If the Director of Civil Aviation Medicine has been involved, the case will be referred outside the department for a second opinion.

A copy of this recommendation will then be sent to the applicant or permit/licence holder who will have ten working days to provide the Director, Standards with any comments they may wish to make regarding the recommendation of the Director, Civil Aviation Medicine.

After that time, a final decision will be made by the Director, Standards regarding the medical assessment, and the applicant or permit/licence holder will be notified.

3.0 FLIGHT CREW EXAMINATIONS

3.1 EXAMINATION OFFICES

Flight crew written examinations for recreational-level pilot licences can be written at certain flight training units. Most Transport Canada Civil Aviation (TCCA) regional offices and centres offer a written examination service. Visit the following Transport Canada (TC) Web page <<https://www.tc.gc.ca/en/services/aviation/licensing-pilots-personnel/flight-crew-licenses-permits-ratings/flight-crew-examinations/transport-canada-centres-authorized-examination-invigilators.html>> for contact information.

There are no TC examination facilities outside of Canada.

3.2 CHEATING ON AN EXAM

CAR 400.02 states that:

- “(1) Except as authorized by an invigilator, no person shall, or shall attempt to, in respect of a written examination,
- a) copy or remove from any place all or any portion of the text of the examination;
 - b) give to or accept from any person a copy of all or any portion of the text of the examination;
 - c) give help to or accept help from any person during the examination;
 - d) complete all or any portion of the examination on behalf of any other person; or
 - e) use any aid or written material during the examination.
- (2) A person who commits an act prohibited under subsection (1) fails the examination and may not take any other examination for a period of one year.”

3.3 USE OF HAND-HELD CALCULATORS OR COMPUTERS

The following is a list of rules regarding the use of hand-held calculators or electronic computers during written examinations:

- a) An applicant may use a hand-held calculator for problem solving, including those with a tape printout, if it has no memory system.

- b) An applicant may use a hand-held electronic computer that has been specifically designed for flight operations, including a self-prompting type, provided it has been approved by Transport Canada (TC) for examination purposes and the computer memory bank is cleared before and after the examination, in the presence of the examination invigilator.
- c) Requests for hand-held electronic computer approval—along with a functioning sample computer, all available software, and, if applicable, instructions on how to completely clear all memory without affecting any programming—should be forwarded by the manufacturer to:

Transport Canada
 Commercial Flight Standards (AARTF)
 330 Sparks Street
 Ottawa ON K1A 0N8

The memory bank clearing instructions and the process shall be simple enough to be completed with minimum distraction to invigilators.

NOTES:

- 1. No computer capable of being used to type and store a significant quantity of language text will be approved.
- 2. No device capable of accessing other applications or networks will be approved.
- d) The Jeppesen/Sanderson PROSTAR and AVSTAR, the Jeppesen TECHSTAR and TECHSTAR PRO, the ASA CX-1a Pathfinder, the ASA CX-2 Pathfinder, the ASA CX-3, the Cessna Sky/Comp, the NAV-GEM, and the Sporty's E6B electronic flight computers have been approved for use with all flight crew personnel licensing written examinations requiring numerical computations.
- e) An applicant may not use an instructional handbook or a user's manual when writing a TC examination.
- f) Upon completion of a written examination, all printout material shall be given to the invigilator.

4.0 AIRCRAFT IDENTIFICATION, MARKING, REGISTRATION AND INSURANCE

4.1 GENERAL

No civil aircraft, other than hang gliders or model aircraft, shall be flown in Canada unless they are registered in accordance with Part II of the *Canadian Aviation Regulations* (CARs), the laws of an International Civil Aviation Organization (ICAO) member state, or a state that has a bilateral agreement with Canada concerning interstate flying

To be eligible for registration in Canada, an aircraft must be of a type that has been approved in Canada for issuance of a certificate of airworthiness (C of A), special C of A or a flight

permit (except ultralight aeroplanes), and the owner must be qualified to be the registered owner of a Canadian aircraft in accordance with the Part II of the CARs.

4.2 AIRCRAFT IDENTIFICATION

Under CAR 201.01, Canadian-registered aircraft are required to have an aircraft identification plate attached to the aircraft. The fireproof plate bears information relating to the aircraft manufacturer, model designation, type certificate number and serial number. A photograph of the identification plate, clearly reproducing the information it contains, is required when applying for a certificate of registration (C of R).

4.3 NATIONALITY AND REGISTRATION MARKS

No person shall operate a registered aircraft in Canada unless its nationality and registration marks are clean, visible and displayed in accordance with the *Canadian Aviation Regulations* (CARs) or with the laws of the state of registry.

Canadian nationality and registration marks for new or imported aircraft are issued, on request, by the appropriate Transport Canada (TC) regional office. Should an applicant request a specific mark that is not the next available mark, it is deemed to be a special mark and may be obtained, if available, upon payment of a fee. Marks may be reserved for a one-year period without being assigned to a specific aircraft, also upon payment of a fee.

Aircraft registration marks are composed of a nationality mark and a registration mark. The Canadian nationality marks are the capital letters "C" or "CF". "CF" may only be issued for vintage (heritage) aircraft manufactured prior to January 1, 1957. If the nationality mark is "CF", the registration mark is a combination of three capital letters. If the nationality mark consists only of the capital letter "C", the registration mark is a combination of four capital letters beginning with "F" or "G" for regular aircraft (including amateur-built aircraft). The nationality mark shall precede the registration mark and be separated from it by a hyphen.

In the case of basic and advanced ultralight aeroplanes, the registration mark is a combination of four capital letters beginning with "I".

Aircraft manufactured before January 1, 1957, are considered to be vintage aircraft and are eligible to display either the "C" or "CF" nationality mark. Aircraft manufactured after December 31, 1956, will be issued only "C" nationality marks. Aircraft manufactured after December 31, 1956, that now display the "CF" nationality mark may continue to do so until such time as the aircraft is next painted, after which the aircraft shall display the "C" nationality mark (e.g. *CF-XXX* becomes *C-FXXX*). The TC regional office shall be notified, in writing, of any changes to the mark.

The specifications for Canadian nationality and registration marks are contained in CAR 202.01 and are in accordance with CAR Standard 222. For details on the placement and size of aircraft marks, see CAR 222.01.

CAR 202.04(1) provides for marks to be changed after an aircraft has been registered. The aircraft may be removed from the register if it is destroyed, permanently withdrawn from service or exported. It is the responsibility of the owner to notify TC immediately if any of these events occur. The owner shall also notify TC, in writing, within seven days of a change to the owner's name or permanent address.

4.4 CHANGE OF OWNERSHIP—CANADIAN-REGISTERED AIRCRAFT

When the ownership of a Canadian-registered aircraft changes, the registration is cancelled and the registered owner must notify Transport Canada (TC) in writing no more than seven days after the change. A pre-addressed postcard-type notice is provided with the certificate of registration (C of R) for this purpose. The C of R contains the forms and instructions necessary to apply for registration in the new owner's name.

4.5 INITIAL REGISTRATION

To obtain an application for registration, the new owner should contact the applicable Transport Canada (TC) regional office. The applicant can also access the forms (Form 26-0522 or Form 26-0521) online at www.tc.gc.ca/eng/civilaviation/standards/maintenance-regdocs-form-2943.htm. No person shall operate an aircraft in Canada unless it is registered.

4.6 IMPORTATION OF AIRCRAFT

The International Civil Aviation Organization's (ICAO) *Convention on International Civil Aviation* (Doc 7300) and the Canadian Aviation Regulations (CARs) state that an aircraft cannot be registered in more than one state at the same time. Therefore, persons proposing to import an aircraft into Canada and to have it registered should ascertain whether the aircraft is eligible for import and registration prior to making any commitments. Inquiries relating to importation and registration can be addressed to the nearest Transport Canada Civil Aviation (TCCA) regional office, TC Centre or Minister's Delegate—Maintenance.

4.7 EXPORTATION OF AIRCRAFT

When a Canadian-registered aircraft is sold or leased to a person who is not qualified to be the owner of a Canadian aircraft and the aircraft is not in Canada at the time of the sale or lease, or it is understood by the vendor or lessor that the aircraft is to be exported, the vendor shall ensure that the requirements of CAR 202.38 are satisfied. The vendor or lessor shall:

- a) remove the Canadian marks from the aircraft and, if applicable, the aircraft address from the Mode S transponder and from the other avionics equipment of the aircraft;
- b) notify the Minister in writing, within seven days after the sale or lease, of the date of:
 - (i) the sale or lease;
 - (ii) the exportation, if applicable;
 - (iii) the removal of the Canadian marks; and
 - (iv) the removal of the aircraft address from the Mode S transponder and from the other avionics equipment of the aircraft, if applicable;
- c) provide the Minister with a copy of all of the agreements that relate to the transfer of any part of the legal custody and control of the aircraft resulting from the sale or lease; and
- d) return the certificate of registration (C of R) of the aircraft to the Minister.

Transport Canada (TC) will remove the aircraft from the *Canadian Civil Aircraft Register* and forward a Canadian registration cancellation notification to the national aviation authority of the country that is importing the aircraft upon receipt of a request from the registered owner and only after the foregoing conditions have been met.

4.8 LIABILITY INSURANCE

Canadian and foreign aircraft operated in Canada or Canadian aircraft operated in a foreign country are required to have public liability insurance. In the case of most air operators (those operating under CAR 703, CAR 704 and CAR 705), the specific requirement can be found in section 7 of the *Air Transportation Regulations*; for other air operators, the requirement is outlined in CAR 606.02. Public liability insurance protects the owner and operator of the aircraft if the aircraft causes damage to persons or property.

Similarly, passenger liability insurance is required in certain circumstances, as indicated in section 7 of the *Air Transportation Regulations*. Passenger liability insurance is required by operators operating under the authority of an air operator certificate (AOC), a flight training unit operator certificate, or a special flight operations certificate (SFOC) for balloons with fare-paying passengers. Certain privately operated aircraft require both public and passenger liability insurance (see CAR 606.02(4) and CAR 606.02(8)). Passenger liability insurance protects the owner and operator of the aircraft if a passenger on board the aircraft suffers from injury or death.

Passenger liability insurance is not mandatory for aerial work operators certified under CAR 702 as they do not carry passengers.

Details on the specific amounts of public liability insurance required and how to calculate passenger liability insurance can be found in CAR 606.02.

5.0 AIRCRAFT AIRWORTHINESS

5.1 GENERAL

This subpart provides an explanation of the means by which Transport Canada (TC) exercises regulatory oversight to ensure the continuing airworthiness of Canadian-registered aircraft. It focuses on the general intent of the regulatory process rather than dealing with the applicable airworthiness requirements and procedures in detail. Readers should consult the applicable *Canadian Aviation Regulations (CARs)* that are mentioned in this section if a more detailed understanding of the current airworthiness requirements and procedures is required.

It is the responsibility of the owner or pilot to ensure that Canadian-registered aircraft are fit and safe for flight prior to being flown. The primary regulatory control for meeting this objective is achieved by making it unlawful for any person to fly or attempt to fly an aircraft, other than a hang glider or an ultralight aeroplane, unless flight authority in the form of a valid certificate of airworthiness (C of A), special C of A, or flight permit—whichever is applicable—has been issued for that aircraft (see CAR 507.02, CAR 507.03, and CAR 507.04).

5.2 AIRCRAFT DESIGN REQUIREMENTS

5.2.1 General

ICAO's *Convention on International Civil Aviation* (Doc 7300), signed in Chicago in 1944, mandates that every aircraft of a contracting state engaged in international aerial navigation be provided with a C of A issued or rendered valid by the state in which it is registered. This agreement has the following effects:

- a) to promote the idea of mutually acceptable aircraft design standards between contracting states;
- b) to provide all contracting states with the assurance that the aircraft of any other contracting state flying over their territories is certificated to a common minimum acceptable level of airworthiness; and
- c) to achieve minimum acceptable standards in matters related to the aircraft's continuing airworthiness.

The ultimate objective of this agreement is to protect other aircraft, third parties, and people on the ground from any hazards associated with overflying aircraft.

5.2.2 Canadian Type Certificate

CAR 521 establishes the rules that govern the application for and the issuance of a design approval document. The regulation also enables the use of the *Airworthiness Manual* chapters that establish the design standards for various categories of aircraft. The standards may be defined as statements of the minimum acceptable properties and characteristics of the configuration,

material, performance and physical properties of an aircraft.

Applicants are issued a design approval document once they have demonstrated that the type design of the aeronautical product conforms to the applicable airworthiness and noise and engine emission standards that are in force for the product. The design approval document certifies that the type design of the product meets the applicable standards and includes the conditions and limitations prescribed by the airworthiness authority as well as how the product meets the standards.

NOTE:

A design approval document is defined in CAR 521.01 as “a type certificate, a supplemental type certificate, a repair design approval, a part design approval or a Canadian Technical Standard Order (CAN-TSO) design approval.”

All information concerning the approval of a type design or a change to the type design of an aeronautical product can be found in CAR 521 at <http://laws-lois.justice.gc.ca/eng/regulations/SOR-96-433/FullText.html#s-521.01>. Guidance material supporting this regulation can be found at <https://www.tc.gc.ca/en/services/aviation/reference-centre/advisory-circulars.html#500-series>.

5.3 FLIGHT AUTHORITY AND NOISE COMPLIANCE

5.3.1 General

CAR 605.03 prescribes that:

“(1) “No person shall operate an aircraft in flight unless:

- a) a flight authority is in effect in respect of the aircraft;
- b) the aircraft is operated in accordance with the conditions set out in the flight authority; and
- c) subject to subsections (2) and (3), the flight authority is carried on board the aircraft.

(2) Where a specific-purpose flight permit has been issued pursuant to Section 507.04, an aircraft may be operated without the flight authority carried on board where:

- a) the flight is conducted in Canadian airspace; and
- b) an entry is made into the journey log indicating:
 - (i) that the aircraft is operating under a specific-purpose flight permit, and
 - (ii) where applicable, any operational conditions that pertain to flight operations under the specific-purpose flight permit.

(3) A balloon may be operated without the flight authority carried on board where the flight authority is immediately available to the pilot-in-command:

- a) prior to commencing a flight; and
- b) upon completion of that flight.”

A flight authority may be issued in the form of a C of A, a special C of A or a flight permit. The specific requirements and procedures for each are detailed in CAR 507 and its related standard.

5.3.2 Certificate of Airworthiness (C of A)

The C of A is issued for aircraft that fully comply with all standards of airworthiness for:

- a) aeroplanes in the normal, utility, aerobatic, commuter and transport categories;
- b) rotorcraft in the normal and transport categories; and
- c) gliders, powered gliders, airships, and manned free balloons.

The C of A is transferable with the aircraft when sold or leased, provided the aircraft remains registered in Canada. The C of A may provide an indication of the aircraft’s compliance status with respect to the noise limitations specified in chapter 516 of the *Airworthiness Manual*. When applying for a C of A, it is advisable for the owner to have or obtain a copy of the applicable type certificate data sheets. A copy of the data sheets can be obtained from the type certificate holder. The data sheets may also be found online at <http://www.wapts.tc.gc.ca/saf-sec-sur/2/nico-celn/>.

Nothing in the CARs or their associated standards relieves the operator of a Canadian aircraft from the requirement to comply with local regulations when operating outside Canada. An aircraft for which the Minister has issued a C of A is considered to be fully compliant with article 31 of ICAO’s *Convention on International Civil Aviation* (Doc 7300), thereby meeting the code established by ICAO in Annex 8. Regarding airworthiness, aircraft meeting this code can be flown without further approval in the airspace of any ICAO contracting state.

5.3.3 Special Certificate of Airworthiness (Special C of A)

A special C of A may be issued for an aircraft in one of the following classifications: restricted, amateur-built, limited or owner-maintenance. The requirements and procedures for each classification are specified in CAR 507 and its related standard.

An aircraft for which a special C of A is issued by the Minister is not considered to be in compliance with all requirements of the code in ICAO’s Annex 8 and cannot be flown in the airspace of another country without special authorization by the civil aviation authority of that other country.

CAR Standard 507, Appendix H lists aircraft types and models that are eligible for a special C of A—owner-maintenance. This special C of A allows owners to perform and certify maintenance on their aircraft, provided the relevant requirements of the CARs and the associated standards are met.

Aircraft owners who apply for a C of A for an aircraft for which the last permanent flight authority issued was a special C of A—owner-maintenance must meet the additional relevant requirements set out in CAR Standard 507.02(3).

5.3.4 Flight Permit

CAR Standard 507.04 prescribes that:

1. “Flight permits shall only be issued on a temporary (12 months or less) basis where the aircraft in respect of which an application is made does not conform to the conditions of issue for a C of A or a Special C of A. A flight permit is issued in one of the following classifications: [...]

2. Flight Permit—Experimental

An experimental flight permit is issued for any aircraft, excluding aircraft that are operated under a special certificate of airworthiness in the owner-maintenance or amateur-built classification, which is manufactured for, or engaged in, aeronautical research and development, or for showing compliance with airworthiness standards.

3. Flight Permit—Specific Purpose

A specific purpose flight permit is issued for an aircraft which does not conform to applicable airworthiness standards, but is capable of safe flight. It provides flight authority in circumstances when a certificate of airworthiness is invalidated, or there is no other certificate or permit in force.

Information Note: Specific purpose flight permits may be issued for:

- a) Ferry-flights to a base for repairs or maintenance;
- b) Importation or exportation flights;
- c) Demonstration, market survey or crew training flights;
- d) Test purposes following repair, modification or maintenance; or
- e) Other temporary purposes.”

5.3.5 Noise Compliance

CAR 507.20 to CAR 507.23 set out the requirements with respect to the application for, as well as the issuance and suspension of, certificates of noise compliance and validation of foreign certificates of noise compliance. Further, CAR Standard 507.20(a) states:

“In the case of a Canadian aircraft, the C of A shall be annotated to indicate that:

- (i) the aircraft complies with the applicable noise emission standards and what those standards are; or
- (ii) the noise compliance requirements are not applicable to the aircraft.”

5.4 MAINTENANCE CERTIFICATION

5.4.1 General

CAR 605.85 stipulates, in part, that “no person shall conduct a take-off in an aircraft, or permit a take-off to be conducted in an aircraft that is in the legal custody and control of the person, where that aircraft has undergone maintenance, unless the maintenance has been certified by the signing of a maintenance release pursuant to section 571.10.” Details of the maintenance activities performed or any outstanding work must also be entered in the technical log.

Specific qualifications for personnel who can sign a maintenance release are indicated in CAR 571 and its associated standard. The owner of an amateur-built or owner-maintained aircraft can perform the work and sign the maintenance release for their own aircraft.

It is the owner’s responsibility to ensure that only personnel meeting those qualifications sign a maintenance release for their aircraft, engine, propeller or other installed component. The standards and procedures applicable to a maintenance release are contained in CAR Standard 571 at www.tc.gc.ca/eng/civilaviation/regserv/cars/part5-standards-standard571-1971.htm.

Elementary work does not require a maintenance release to be signed by an AME. However, pursuant to CAR 571.03, any elementary work performed on an aircraft must be detailed in the technical record and accompanied by the signature of the person who performed the work. The tasks and conditions associated with elementary work are listed in CAR Standard 625, Appendix A, see www.tc.gc.ca/eng/civilaviation/regserv/cars/part6-standards-standard625-514.htm.

5.4.2 Certification of Maintenance Performed Outside Canada

In the case of maintenance performed outside Canada (except for the annual inspection portion of the maintenance schedule outlined in CAR Standard 625, Appendix B, Part I or II), a maintenance release may be signed by a person who is authorized under the laws of a state that is party to an agreement or a technical arrangement with Canada if the agreement or arrangement provides for such certification.

In the case of certifying of the 100-hr inspection performed annually on the basis of the maintenance schedule outlined in CAR Standard 625, Appendix B, a maintenance release can only

be signed by the holder of an appropriately-rated AME licence issued pursuant to CAR 403.

5.5 ANNUAL AIRWORTHINESS INFORMATION REPORT (AAIR)

CAR 501.01 requires that the owner of a Canadian aircraft, other than an ultralight aeroplane, submit an Annual Airworthiness Information Report (AAIR). This report can be submitted online through the Continuing Airworthiness Web Information System (CAWIS) at <https://www.wapps.tc.gc.ca/saf-sec-sur/2/cawis-swimn/i.aspx?lang=eng> or by filling out the Annual Airworthiness Information Report Form (Form 24-0059), as specified in Chapter 501 of the *Airworthiness Manual*.

An AAIR notice is sent to each registered aircraft owner several weeks before the due date. The aircraft owner shall complete the annual report by entering all required data and signing to certify that the information supplied is correct.

Failure to receive an AAIR notice does not relieve the owner from the requirement to submit a report. The owner should therefore notify the appropriate Transport Canada (TC) regional office or TC Centre if the form, or its online equivalent, has not been received two weeks before the anticipated due date.

An alternate due date may be granted in accordance with CAR 501.03.

The owner of an aircraft that will be out of service for one or more reporting periods (calendar years) is not required to submit an AAIR for those periods, provided the appropriate section of Form 24-0059, or its online equivalent, is completed and indicates the date the aircraft is expected to return to service.

5.6 MAINTENANCE REQUIREMENTS FOR CANADIAN-REGISTERED AIRCRAFT

5.6.1 General

Under CAR 605, it is the responsibility of the owner or operator (defined in CAR 101 as the person who has legal custody and control of the aircraft) of aircraft other than ultralight aeroplanes or hang gliders to ensure that their aircraft is properly equipped for its intended uses and maintained in accordance with an approved maintenance schedule; that the defects are recorded and properly rectified or the repairs are deferred; and that any applicable ADs have been addressed.

It is also the responsibility of owners or operators to ensure that the person intending to take off in the aircraft has the information required to establish whether or not the aircraft is airworthy for the intended flight.

It is the responsibility of the pilot to be familiar with the available information and to make an informed decision regarding the aircraft and the intended flight.

CAR 605.94 requires the pilot-in-command to enter the particulars of any abnormal occurrence to which the aircraft has been subjected, as well as the particulars of any defect in any part of the aircraft or its equipment that becomes apparent during flight, in the journey log as set out in CAR 605, Schedule I.

In addition to the general rules in CAR 605, private operators must respect the maintenance requirements in CAR 604 and its associated standard. Commercial air operators must respect the requirements in CAR 706 and flight training units must respect those in CAR 406.

5.6.2 Maintenance Schedules

CAR 605.86 prescribes, in part, that all Canadian aircraft except ultralight aeroplanes or hang gliders shall be maintained in accordance with a maintenance schedule that has been approved by the Minister and that conforms to CAR Standard 625.

Appendices B, C and D to CAR Standard 625 are applicable to the development of maintenance schedules.

Owners of non-commercially operated small aircraft and balloons may choose to comply with Part I or II of Appendix B, as applicable, and Appendix C to CAR Standard 625. They need not submit any documents to the Minister for formal approval. The maintenance schedule is considered to be approved for their use by the Minister. Owners need only make an entry in the aircraft technical records indicating that the aircraft is maintained pursuant to the maintenance schedule. Owners should periodically review the maintenance schedule to ensure that it meets the requirements.

Operators of large aircraft, turbine-powered pressurized aeroplanes, airships, any aeroplane or helicopter operated by a flight training unit, or any commercially operated aircraft must submit an application for approval of their maintenance schedule to the Minister through the TC regional office with jurisdiction over the area in which the applicant is located. The maintenance schedule shall address the requirements of CAR Standard 625, Appendices C and D.

5.6.3 Maintenance Performance

CAR 571 is applicable to the performance of maintenance or elementary work. It addresses how work should be done, as opposed to what work should be done.

5.6.4 Aircraft Technical Records

CAR 605 and its related standard prescribe and set out the requirements and procedures for keeping aircraft technical records. Pursuant to CAR 605.92(1), every owner of an aircraft shall keep the following technical records regarding the aircraft:

- a) a journey log;
- b) a separate technical record for the airframe, each installed engine and each variable-pitch propeller; and
- c) an empty weight and balance report that meets the applicable standards set out in CAR Standard 571.

The technical records may consist of separate technical records for each component installed in the airframe, engine or propeller. In the case of a balloon or a glider, or an aircraft operated under a special C of A in the owner-maintenance or amateur-built classification, all technical record entries, referred to above, may be kept in the journey log.

5.6.5 Service Difficulty Reporting Program

By means of the service difficulty reporting program, reported service difficulties are collected, analyzed and used to identify and rectify, as required, deficiencies of a design, manufacturing, maintenance or operational nature, which might affect aircraft airworthiness.

TC utilizes a user-reporting system to collect service difficulty data.

The service difficulty reporting program provides a means for AMEs and private aircraft owners or operators to report service difficulties on a voluntary basis. Commercial or corporate air operators, Canadian holders of design approval documents, and approved organizations engaged in the manufacture, maintenance, repair or overhaul of aeronautical products are subject to the mandatory service difficulty reporting prescribed in CAR 521, Division IX.

Service difficulties encountered in the field that have caused or may cause a safety hazard may be reported to the Minister using either a Service Difficulty Report Form (Form 24-0038) or the Internet-based TC Web Service Difficulty Reporting System application at <https://www.wapps.tc.gc.ca/Saf-Sec-Sur/2/cawis-swimn/wsdrrs_h.aspx>.

The data collected by the service difficulty reporting program is available to interested parties from TC headquarters and regional offices and from the TC Web Service Difficulty Reporting System application.

5.7 AIRWORTHINESS DIRECTIVES (ADs)

5.7.1 General

Compliance with ADs is essential to airworthiness. Pursuant to CAR 605.84, aircraft owners are responsible for ensuring that their aircraft are not flown unless they meet the requirements of any ADs relevant to the aircraft or to its engines, propellers or equipment. Refer to CAR Standard 625, Appendix H, for further details.

When an AD is not complied with, the flight authority is not in effect and the aircraft is not considered to be airworthy.

Exemptions to AD compliance or the authorization of an alternative means of compliance may be requested by an owner pursuant to CAR 605.84(4). General information about exemptions and alternative means of compliance is given in Appendix H, subsection 3. Applications should be made to the nearest TC regional office or TC Centre in accordance with the procedure detailed in CAR Standard 625, Appendix H, subsection 4.

5.7.2 Availability of Airworthiness Directives (ADs)

TC endeavours to notify owners of Canadian registered aircraft of the issuance of any applicable AD or mandatory service bulletin as outlined below. To this end, the owner must advise the nearest TCCA office of any change of address in accordance with CAR 202.51. However, TC cannot guarantee that it will receive all foreign ADs. Aircraft owners are responsible for obtaining the relevant continuing airworthiness information applicable to the type and model of aircraft—including installed equipment, engine, propeller(s) (if any)—that they own.

Aircraft owners who wish to ascertain which ADs, if any, apply in Canada for a particular type of aircraft, engine, propeller or other item of equipment may do so by checking this Web site: https://www.wapps.tc.gc.ca/Saf-Sec-Sur/2/cawis-swimm/AD_h.aspx?lang=eng.

5.7.3 Airworthiness Directive (AD) Schedule and Compliance Records

Details of the scheduling provisions and compliance with any applicable ADs shall be entered in the aircraft technical record, in accordance with CAR 605, by persons authorized to do so.

6.0 THE TRANSPORTATION APPEAL TRIBUNAL OF CANADA (TATC)

6.1 GENERAL

The process for enforcement of Canada's *Aeronautics Act* came into force in 1986. This process includes powers of suspension, an administrative monetary penalty system and an independent tribunal to review the decisions made by the Minister of Transport.

This process was expanded on June 30, 2003, when the *Transportation Appeal Tribunal of Canada Act* and consequential amendments to the *Aeronautics Act* were proclaimed in force.

The Transportation Appeal Tribunal of Canada (TATC) consequently replaced the Civil Aviation Tribunal and has expanded jurisdiction and authority. The Appeal Tribunal has the authority to review the Minister's decisions with respect to Canadian aviation documents and the assessment of monetary penalties.

The Tribunal process applies to five types of administrative actions. One type of action is the refusal to issue or amend a Canadian aviation document. There are also three types of actions that are related to the powers of suspension or cancellation of a Canadian aviation document. The fifth type of action is the Minister's power to assess monetary penalties for the contravention of certain regulatory provisions. Decisions made by the Minister of Transport to take any of these administrative actions may be reviewed by a single member of the Tribunal and may be followed by an appeal to a three-member panel.

The purpose of this scheme is to provide those affected by administrative decisions with an opportunity for a fair hearing before an independent body. The TATC is not a Transport Canada (TC) agency. It is composed of individuals with experience in many different aspects of the transportation industry. Its members, who have aviation industry experience, will hear aviation cases as the need arises.

6.2 REFUSAL TO ISSUE OR AMEND A CANADIAN AVIATION DOCUMENT

The Minister's power to refuse to issue or amend a Canadian aviation document is set out in the amended *Aeronautics Act*. The four distinct grounds for those powers are as follows:

- a) incompetence of the applicant for the document or amendment;
- b) failure to meet the qualifications or fulfill the conditions necessary for the issuance or amendment of the document;
- c) public interest reasons; and
- d) failure by the applicant to pay monetary penalties for which the Tribunal has issued a certificate.

Where the Minister decides to refuse to issue or amend a Canadian aviation document, they must notify the applicant of the decision, the grounds for the decision and the specific reasons those grounds apply. The applicant has the right to request a review of the Minister's decision. The Notice of Refusal to Issue or Amend a Canadian Aviation Document Letter must inform the applicant of the steps they must follow to obtain a review.

At the review, the Tribunal will consider whether or not the Minister's decision is justified, based on the facts of the case. Both the applicant and the Minister will be given full opportunity to present evidence and make representations with respect to the decision under review. The applicant may call their own witnesses and cross-examine those called by the Minister. They may also be represented by counsel or have another person appear on their behalf.

In making its determination at the review, the Tribunal may confirm the Minister's decision or, if it finds the decision is unjustified, it may refer the matter to the Minister for reconsideration.

6.3 SUSPENSION, CANCELLATION OR REFUSAL TO RENEW A CANADIAN AVIATION DOCUMENT

The powers to suspend, cancel or refuse to renew a Canadian aviation document are set out in the amended *Aeronautics Act*. The Minister has the power to:

- a) suspend or cancel a document for contravention of any provision in Part I of the Act or the regulations made under the Act (e.g. the *Canadian Aviation Regulations* [CARs]);
- b) suspend a document on the grounds that an immediate threat to aviation safety exists or is likely to occur;
- c) suspend, cancel or refuse to renew a document on the grounds of:
 - (i) incompetence,
 - (ii) ceasing to meet the qualifications or fulfill the conditions under which the document was issued (this includes medical grounds), or
 - (iii) public interest reasons; and
- d) suspend or refuse to renew a document for failure to pay monetary penalties for which the Tribunal has issued a certificate of nonpayment.

Where the Minister decides to suspend, cancel or refuse to renew a Canadian aviation document, they must notify the document holder. The notice must include the decision, the grounds for the decision and the specific reasons for those grounds. The document holder has the right to request a review of the Minister’s decision. The notice must also inform the applicant of the steps they must follow to obtain a review.

The review process and the Tribunal’s authority are the same as what is outlined in LRA 6.2 regarding the refusal to issue or amend a Canadian aviation document. The only difference is that in the case of a suspension or cancellation of a Canadian aviation document on the grounds that the holder of the document has contravened a provision of the Act or regulations, the Tribunal may confirm the Minister’s decision or may substitute its own decision for that of the Minister.

6.4 MONETARY PENALTIES

The power to assess a monetary penalty applies only to those regulations referred to as designated provisions. These offences, generally of a regulatory nature, are designated and listed in CAR 103, Schedule II. Where a person contravenes a designated provision, the Minister may assess an appropriate fine to be paid as a penalty for the contravention. A notice of assessment of monetary penalty is then sent to inform the person that full payment of the penalty will end the matter. The notice must also inform the person of the steps they must follow to obtain a review.

In the event that full payment is not received within 30 days and no request for a review is filed with the Tribunal, the person will be deemed to have committed the contravention and must pay the penalty assessed.

If the alleged offender requests a review hearing, the process of the hearing is the same as that set out in LRA 6.2 and LRA 6.3. The Tribunal has the authority to confirm the Minister’s decision to impose a penalty and its amount, or it may substitute its own decision for the Minister’s. If a contravention is confirmed, the Tribunal will inform both the Minister and the alleged offender of the decision and the amount of the penalty payable with respect to the contravention.

6.5 APPEALS

If a party fails to appear or be represented at a review hearing without sufficient reason to justify their absence, that party is not entitled to request an appeal of the determination.

A person affected by the Tribunal’s review determination may request an appeal of the determination. The Minister may also request an appeal of the Tribunal’s review determination with respect to a suspension or cancellation of a Canadian aviation document on the grounds of contravention of a provision of the Act; contravention of the regulations; or with respect to a monetary penalty. In all cases, the request for an appeal must be made within 30 days after the Tribunal’s review determination.

The appeal is based on the merits of the decision and the appeal panel is limited to considering the record of the evidence introduced at the review hearing, other evidence that was not available at the review hearing and oral arguments by the parties. The appeal panel may allow the appeal or dismiss it. If the Tribunal allows the appeal, it may send the matter back to the Minister for reconsideration or, in the case of an alleged contravention or monetary penalty, the Tribunal may substitute its own decision for the review determination.

Further information regarding procedures before the Transportation Appeal Tribunal of Canada (TATC) may be obtained by consulting the *Transportation Appeal Tribunal of Canada Act*, the *Aeronautics Act* (sections 6.6 to 7.21 and sections 7.6 to 8.2), the Tribunal rules and CAR 103.

The TATC may be contacted at:

Transportation Appeal Tribunal of Canada
 333 Laurier Avenue West
 Room 1201
 Ottawa ON K1A 0N5

Tel.: 613-990-6906
 Fax: 613-990-9153
 E-mail:.....info@tatc.gc.ca

LRA

AIR—AIRMANSHIP

1.0 GENERAL INFORMATION

1.1 GENERAL

Airmanship is the application of flying knowledge, skill and experience which fosters safe and efficient flying operations. Airmanship is acquired through experience and knowledge. This section contains information and advice on various topics which help to increase knowledge.

1.2 PILOT VITAL ACTION CHECKLISTS

A number of aircraft accidents have been directly attributed to the lack of proper vital action checks by the pilots concerned. It is essential that pretakeoff, prelanding and other necessary vital action checks be performed with care.

While Transport Canada does not prescribe standard checks to be performed by pilots, it is strongly recommended that owners equip their aircraft with the manufacturer’s recommended checklists. For any specific type of aircraft, only relevant items should be included in the checklists which should be arranged in an orderly sequence having regard to the cockpit layout.

1.3 AVIATION FUELS

1.3.1 Fuel Grades

The use of aviation fuel other than specified is contrary to a condition of the Certificate of Airworthiness and, therefore, a contravention of regulations. A fuel which does not meet the specifications recommended for the aircraft may seriously damage the engine and result in an in-flight failure. In Canada, fuels are controlled by government specifications. Aviation fuel can usually be identified by its colour.

Table 1.1—Fuel Grades and Colours

FUEL	COLOUR
AVGAS 80/87	red
AVGAS 100/130	green
100 LL	blue
Aviation Turbine Fuels	straw-coloured or
MOGAS P 87-90 (see NOTE 2)	undyed
MOGAS R 84-87 (see NOTE 2)	green
	undyed

NOTES:

1. Good airmanship ensures that positive identification of the type and grade of aviation fuel is established before fuelling.
2. Transport Canada now approves the use of automotive gasoline for certain aircraft types under specific conditions. For additional information, refer to TP 10737E—*Use of Automotive Gasoline (MOGAS) for General Aviation Aircraft*, available from your TC Airworthiness Regional office. (See GEN 1.1.2 for addresses.)

1.3.2 Aviation Fuel Handling

A company supplying aviation fuel for use in civil aircraft is responsible for the quality and specifications of its products up to the point of actual delivery. Following delivery, the operator is responsible for the correct storage, handling, and usage of aviation fuel. A fuel dispensing system must have an approved filter, water separator or monitor to prevent water or sediment from entering aircraft fuel tanks. The use of temporary fuelling facilities such as drums or cans is discouraged. However, if such facilities are necessary, always filter aviation fuel using a proper filter and water separator with a portable pump bonded to the drum before bungs are removed.

The aircraft and fuelling equipment through which fuel passes all require bonding. The hose nozzle must be bonded to the aircraft before the tank cap is removed in over-wing fuelling. All funnels or filters used in fuelling are to be bonded together with the aircraft. Bonding prevents sparks by equalizing or draining the electric potentials.

During the pre-flight check, a reasonable quantity of fuel should be drawn from the lowest point in the fuel system into a clear glass jar. A “clear and bright” visual test should be made to establish that the fuel is completely free of visible solid contamination and water (including any resting on the bottom or sides of the container), and that the fuel possesses an inherent brilliance and sparkle in the presence of light. Cloudy or hazy fuel is usually caused by free and dispersed water, but can also occur because of finely divided dirt particles. Free water may also be detected by the use of water-finding paste available from oil companies. If there is any suspicion that water exists in an aircraft’s fuel system detailed checking of the entire system should be carried out until it is proven clear of contamination. Analysis by an approved laboratory is the only way to ensure positive proof of compliance if doubt exists.

1.3.3 Fuel Anti-Icing Additives

All aviation fuels absorb moisture from the air and contain water in both suspended particles and liquid form. The amount of suspended particles varies with the temperature of the fuel. When the temperature of the fuel is decreased, some of the suspended particles are drawn out of the solution and slowly fall to the bottom on the tank. When the temperature of the fuel increases, water particles from the atmosphere are absorbed to maintain a saturated solution.

AIR

As stated in AIR 1.3.2, water should be drained from aircraft fuel systems before flight. However, even with this precaution water particles in suspension will remain in the fuel. While this is not normally a problem it becomes so when fuel cools to the freezing level of water and the water particles change to ice crystals. These may accumulate in fuel filters, bends in fuel lines, and in some fuel-selectors and eventually may block the fuel line causing an engine stoppage. Fuel anti-icing additives will inhibit ice crystal formation. Manufacturer approved additives, such as ethylene-glycol-monomethyl-ether (EGME), used in the prescribed manner have proven quite successful. The aircraft manufacturer’s instructions for the use of anti-icing fuel additives should therefore be consulted and carefully followed.

1.3.4 Refuelling—Fires and Explosions

Pound for pound, aviation fuel is more explosive than dynamite. It has different properties than automotive fuel so the rules you follow when filling your car at the pump are not enough to keep you safe when fuelling your aircraft. AVGAS used in piston engines is also very different from jet fuel.

1.3.4.1 Understanding Flashpoint, Static and Auto-ignition

The flashpoint of a volatile material is the lowest temperature at which it can vaporize to form an ignitable mixture in air. The flashpoint of AVGAS is well below freezing, making it extremely flammable. To be explosive, the mixture must contain one to six percent fuel vapour by volume when combined with air. Mixtures below this range are too lean and those above are too rich to ignite. The mixture in the space above the fuel in a gas-tight compartment is usually too rich for combustion; but in extremely cold conditions, the mixture may be lean enough to be explosive. Regardless of the temperature or type of fuel, it is essential that aircraft be properly bonded to the refuelling equipment and grounded to avoid the risk of a spark igniting the fuel vapour when the fuel nozzle nears the fuel tank. All other possible sources of ignition—smoking, portable electronics—should also be controlled. Do not refuel when thunderstorms are in the vicinity.

For very light aircraft that may be refuelled using portable tanks, it is also important to understand that plastic jerry cans cannot be easily grounded, and that fuel vapours remaining in empty tanks can be highly flammable.

The flashpoint of jet fuel is 38°C, so flammable fuel vapours are present only at high ambient temperatures. It is less flammable than AVGAS but has other characteristics critical to refuelling operations. All fuels generate static charges from agitation during fuelling as well as from movement through fuel pumps, filters and lines. Jet fuel accumulates more static charges than AVGAS. Jet fuel, particularly Jet A-1, has low electrical conductivity and requires time at rest to dissipate accumulated static charges. Anti-static additives make jet fuel more conductive. The additives do not reduce the generation of static charges, but allow the

charges to be dissipated faster. Proper bonding/grounding does not eliminate the static charges accumulated in jet fuel.

Jet A-1 also has a low auto-ignition temperature (220°C), which is the lowest temperature at which it will spontaneously ignite in a normal atmosphere without an external source of ignition (such as a flame or spark). Jet A-1 fuel spills onto hot surfaces such as exhaust pipes or brakes can result in spontaneous ignition.

NOTES:

1. Incidents of fuelling in enclosed spaces and/or with inadequate bonding have resulted in death or injury. At low temperature and humidity, a blower heater could cause statically charged dust particles to build up and combine with fuel vapours leading to catastrophic results.
2. Plastic fuel containers cannot be properly bonded or grounded, which increases the chance of explosion and fire.

1.4 AIRCRAFT HAND FIRE EXTINGUISHERS

1.4.1 General

When selecting a hand fire extinguisher for use in aircraft, consider the most appropriate extinguishing agent for the type and location of fires likely to be encountered. Take account of the agent’s toxicity, extinguishing ability, corrosive properties, freezing point, etc.

The toxicity ratings listed by the Underwriters’ Laboratories for some of the commonly known fire extinguisher chemicals are as follows:

Bromotrifluoromethane (Halon 1301)	– Group 6
Bromochlorodifluoromethane (Halon 1211)	– Group 5a
Carbon dioxide.....	– Group 5a
Common Dry Chemicals	– Group 5a
Dibromodifluoromethane (Halon 1202).....	– Group 4*
Bromochloromethane (Halon 1011).....	– Group 4*
Carbon Tetrachloride (Halon 104).....	– Group 3*
Methyl bromide (Halon 1001).....	– Group 2*

**Should not be installed in an aircraft*

It is generally realized that virtually any fire extinguishing agent is a compromise between the hazards of fire, smoke, fumes and a possible increase in hazard due to the toxicity of the extinguishing agent used. Hand fire extinguishers using agents having a rating in toxicity Groups 2 to 4 inclusive should not be installed in aircraft. Extinguishers in some of the older types of aircraft do not meet this standard and for such aircraft it is recommended that hand fire extinguishers employing agents in toxicity Group 5 or above be installed when renewing or replacing units and that they be of a type and group approved by the Underwriters’ Laboratories. It is further recommended that instruction in the proper use, care and cautions to be followed be obtained from the manufacturer and the local fire protection agency.

1.4.2 Classification of Fires

Table 1.2—Fire Classification

<i>Class A fires:</i>	Fires in ordinary combustible materials. On these, water or solutions containing large percentages of water are most effective.
<i>Class B fires:</i>	Fires in flammable liquids, greases, etc. On these a blanketing effect is essential.
<i>Class C fires:</i>	Fires in electrical equipment. On these the use of a nonconducting extinguishing agent is of first importance.

1.4.3 Types of Extinguishers

1. *Carbon Dioxide Extinguishers:* Carbon dioxide extinguishers are acceptable when the principal hazard is a Class B or Class C fire. Carbon dioxide portable installations should not exceed five pounds of agent per unit to ensure extinguisher portability and to minimize crew compartment CO₂ concentrations.
2. *Water Extinguishers:* Water extinguishers are acceptable when the principal hazard is a Class A fire and where a fire might smolder if attacked solely by such agents as carbon dioxide or dry chemical. If water extinguishers will be subject to temperatures below freezing, the water extinguisher must be winterized by addition of a suitable anti-freeze.
3. *Vaporizing Liquid Extinguishers:* Vaporizing liquid type fire extinguishers are acceptable when the principal hazard is a Class B or Class C fire.
4. *Dry Chemical Extinguishers:* Dry chemical extinguishers using a bi-carbonate of sodium extinguishing agent or potassium bi-carbonate powder are acceptable where the principal hazard is a Class B or Class C fire.

Dry chemical extinguishers using a so-called All Purpose Monoammonium Phosphate are acceptable where the hazard includes a Class A fire as well as Class B and Class C.

The size of the dry chemical extinguisher should not be less than two lbs. Only an extinguisher with a nozzle that can be operated either intermittently or totally by the operator should be installed.

Some abrasion or corrosion of the insulation on electrical instruments, contacts or wiring may take place as a result of using this extinguisher. Cleaning and inspection of components should be carried out as soon as possible.

Care should be taken when using this extinguisher in crew compartments because the chemical can interfere with visibility while it is being used and because the nonconductive powders may be deposited on electrical contacts not involved in the fire. This can cause equipment failure.

5. *Halon Extinguishers:* Halon 1211 is a colourless liquefied gas which evaporates rapidly, does not freeze or cause cold burn, does not stain fabrics nor cause corrosive damage. It is equally effective on an A, B or C class fire and has proven to be the most effective extinguishant on gasoline based upholstery fires. The size of a Halon 1211 extinguisher for a given cubic space should not result in a concentration of more than 5%. Halon 1211 is at least twice as effective as CO₂ and is heavier than air (so it “sinks”). Decomposed Halon 1211 “stinks” so it is not likely to be breathed unknowingly.

Halon 1301 is less toxic than Halon 1211 but it is also less effective and is excellent for B or C class fires. A short-coming appears to be the lack of a visible “stream” on discharge; Halon 1301 turns into an invisible gas as it discharges.

1.5 PRESSURE ALTIMETER

1.5.1 General

The pressure altimeter used in aircraft is a relatively accurate instrument for measuring flight level pressure but the altitude information indicated by an altimeter, although technically “correct” as a measure of pressure, may differ greatly from the actual height of the aircraft above mean sea level or above ground. In instances of aircraft flying high above the earth’s surface, knowledge of the actual distance between the aircraft and the earth’s surface is of little immediate value to the pilot except, perhaps, when navigating by pressure pattern techniques. In instances of aircraft operating close to the ground or above the highest obstacle en route, especially when on instruments, knowledge of actual ground separation or of “error” in the altimeter indication, is of prime importance if such separation is less than what would be assumed from the indicated altitude.

An aircraft altimeter which has the current altimeter setting applied to the subscale should not have an error of more than ± 50 feet when compared on the ground against a known aerodrome or runway elevation. If the error is more than ± 50 feet, the altimeter should be checked by maintenance as referenced in AIR 1.5.2.

1.5.2 Calibration of the Pressure Altimeter

Pressure altimeters are calibrated to indicate the “true” altitude in the ICAO Standard Atmosphere. The maximum allowable tolerance is ± 20 feet at sea level for a calibrated altimeter. This tolerance increases with altitude.

The ICAO Standard Atmosphere conditions are:

- a) air is a perfectly dry gas;
- b) mean sea level pressure of 29.92 inches of mercury;
- c) mean sea level temperature of 15°C; and
- d) rate of decrease of temperature with height is 1.98°C per 1 000 feet to the height at which the temperature becomes -56.5°C and then remains constant.

1.5.3 Incorrect Setting on the Subscale of the Altimeter

Although altimeters are calibrated using the Standard Atmosphere sea level pressure of 29.92 inches of mercury, the actual sea level pressure varies hour to hour, and place to place. To enable the “zero” reference to be correctly set for sea level at any pressure within a range of 28.0 to 31.0 inches of mercury, altimeters incorporate a controllable device and subscale. Whether a pilot inadvertently sets an incorrect pressure on the altimeter subscale or sets the correct pressure for one area and then, without altering the setting, flies to an area where the pressure differs, the result is the same – the “zero” reference to the altimeter will not be where it should be but will be “displaced” by an amount proportional to 1 000 feet indicated altitude per 1 inch of mercury that the subscale setting is in error. As pressure decreases with altitude, a subscale setting that is higher than it should be will “start” the altimeter at a lower level, therefore, A TOO HIGH SUBSCALE SETTING MEANS A TOO HIGH ALTIMETER READING, that is the aircraft would be at a level lower than the altimeter indicates; A TOO LOW SUBSCALE SETTING MEANS A TOO LOW ALTIMETER READING, that is the aircraft would be at a level higher than the altimeter indicates. As the first instance is the more dangerous, an example follows:

A pilot at Airport A, 500 feet ASL, sets the altimeter to the airport’s altimeter setting of 29.80 inches of mercury prior to departure for Airport B, 1 000 feet ASL, some 400 NM away. A flight altitude of 6 000 feet is selected for the westbound flight so as to clear a 4 800-foot mountain ridge lying across track about 40 NM from B. The pilot does not change the altimeter subscale reading until he makes radio contact with B when 25 NM out and receives an altimeter setting of 29.20 inches of mercury. Ignoring other possible errors (see below), when the aircraft crossed the mountain ridge the actual ground clearance was only 600 feet, not 1 200 feet as expected by the pilot. This illustrates the importance of having the altimeter setting of the nearest airport along the route set on the instrument.

1.5.4 Non-Standard Temperatures

- a) The only time that an altimeter will indicate the “true” altitude of an aircraft at all levels is when ICAO Standard Atmosphere conditions exist.
- b) When the current altimeter setting of an airport is set on the subscale of an altimeter, the only time a pilot can be certain that the altimeter indicates the “true” altitude is when the aircraft is on the ground at that airport.
- c) When 29.92 inches of mercury is set on the subscale of an altimeter within the Standard Pressure Setting Region, the altimeter will indicate “true” altitude if ICAO Standard Atmosphere conditions exist or if the aircraft is flying at that particular level for which 29.92 inches of mercury would be the altimeter setting.

In general, it can be assumed that the altitude indication of an altimeter is always in error due to temperature when an aircraft is in flight.

The amount of error will be approximately 4% of the indicated altitude for every 11°C that the average temperature of the air column between the aircraft and the “ground” differs from the average temperature of the Standard Atmosphere for the same air column. In practice, the average temperature of the air column is not known and “true” altitude is arrived at from knowledge of the outside air temperature (OAT) at flight level and use of a computer. The “true” altitude found by this method will be reasonably accurate when the actual lapse rate is, or is near, that of the Standard Atmosphere, i.e. 2°C per 1 000 feet. During the winter when “strong” inversions in the lower levels are likely and altimeters “habitually” over-read, in any situation where ground separation is marginal, a pilot would be well advised to increase the altimeter error found using flight level temperature by 50%. Consider the aircraft in the above example; assume that the OAT at flight level in the vicinity of the mountain ridge was -20°C; what was the likely “true” altitude of the aircraft over the mountain ridge?

To calculate “true” altitude using a computer, the pressure altitude is required. In this case, the altimeter indicates 6 000 feet with 29.80 inches of mercury set on the subscale, therefore, if the pilot altered the subscale to 29.92 inches of mercury momentarily, the pilot would read a pressure altitude of 6 120 feet. Although the indicated altitude is 6 000 feet, if the altimeter setting of the nearest airport (B) was set, the indicated altitude would be 5 400 feet. With 29.20 inches of mercury set on the altimeter subscale if the aircraft was on the ground at B, the altimeter would indicate the “true” altitude of 1 000 feet; assuming no pressure difference, it can be taken that the altimeter set to 29.20 inches of mercury would indicate the 1 000-foot level at the mountain with no error due to temperature, therefore temperature error will occur only between the 1 000-foot level and the 5 400-foot level, i.e. 4 400 feet of airspace.

- a) Set pressure altitude, 6 120 feet, against OAT, -20°C, in the appropriate computer window.

- b) Opposite 4 400 feet (44) on the inner scale read 4 020 feet (40.2) on the outer scale.
- c) Add the 1 000 feet previously deducted as being errorless and find the “true” altitude of 4 020 feet + 1 000 feet = 5 020 feet ASL. The margin of safety is now just over 200 feet, but this does not take into account variables which may prevail as outlined immediately above and due to mountain effect as explained below.

1.5.5 Standard Pressure Region

When flying within this region, the altimeter must be reset, momentarily, to the altimeter setting of the nearest airport along the route to obtain indicated altitude, or indicated altitude calculated from the altimeter setting, and the steps given above followed, or, when over large expanses of water or barren lands where there are no airports, the forecast mean sea level pressure for the time and place must be used to get indicated altitude. In the other instance, “airport” level would be zero, therefore subtraction and addition of airport elevation would not be done. The “true” altitude determined in such a case would be “true” only if the forecast pressure used approximates the actual sea level pressure. (If sea level pressure is not known and pressure altitude is used also as indicated altitude, the resultant “true” altitude will be the “true” altitude above the 29.92 level, wherever it may be in relation to actual mean sea level).

1.5.6 Effect of Mountains

Winds which are deflected around large single mountain peaks or through the valleys of mountain ranges tend to increase speed which results in a local decrease in pressure (Bernoulli’s Principle). A pressure altimeter within such an airflow would be subject to an increased error in altitude indication by reason of this decrease in pressure. This error will be present until the airflow returns to “normal” speed some distance away from the mountain or mountain range.

Winds blowing over a mountain range at speeds in excess of about 50 kt and in a direction perpendicular (within 30°) to the main axis of the mountain range often create the phenomena known as “Mountain” or “Standing Wave”. The effect of a mountain wave often extends as far as 100 NM downwind of the mountains and to altitudes many times higher than the mountain elevation. Although most likely to occur in the vicinity of high mountain ranges such as the Rockies, mountain waves have occurred in the Appalachians, elevation about 4 500 feet ASL (the height of the ridge of our example).

Aware and the *Air Command Weather Manual* (TP 9352E) cover the mountain wave phenomena in some detail; however, aspects directly affecting aircraft “altitude” follow.

1.5.7 Downdraft and Turbulence

Downdrafts are most severe near a mountain and at about the same height as the top of the summit. These downdrafts may

reach an intensity of about 83 ft/s (5 000 ft/min) to the lee of high mountain ranges, such as the Rockies. Although mountain waves often generate severe turbulence, at times flight through waves may be remarkably “smooth” even when the intensity of downdrafts and updrafts is considerable. As these smooth conditions may occur at night, or when an overcast exists, or when no distinctive cloud has formed, the danger to aircraft is enhanced by the lack of warning of the unusual flight conditions.

Consider the circumstances of an aircraft flying parallel to a mountain ridge on the downwind side and entering a smooth downdraft. Although the aircraft starts descending because of the downdraft, as a result of the local drop in pressure associated with the wave, both the rate of climb indicator and the altimeter will not indicate a descent until the aircraft actually descends through a layer equal to the altimeter error caused by the mountain wave, and, in fact, both instruments may actually indicate a “climb” for part of this descent; thus the fact that the aircraft is in a downdraft may not be recognized until after the aircraft passes through the original flight pressure level which, in the downdraft, is closer to the ground than previous to entering the wave.

1.5.8 Pressure Drop

The “drop” in pressure associated with the increase in wind speeds extends throughout the mountain wave, that is downwind and to “heights” well above the mountains. Isolating the altimeter error caused solely by the mountain wave from error caused by non-standard temperatures would be of little value to a pilot. Of main importance is that the combination of mountain waves and non-standard temperature may result IN AN ALTIMETER OVERREADING BY AS MUCH AS 3 000 FT. If the aircraft in our example had been flying upwind on a windy day, the actual ground separation on passing over the crest of the ridge may well have been very small.

1.5.9 Abnormally High Altimeter Settings

Cold dry air masses can produce barometric pressures in excess of 31.00 in. of mercury. Because barometric readings of 31.00 in. of mercury or higher rarely occur, most standard altimeters do not permit setting of barometric pressures above that level and are not calibrated to indicate accurate aircraft altitude above 31.00 in. of mercury. As a result, most aircraft altimeters cannot be set to provide accurate altitude readouts to the pilot in these situations.

When aircraft operate in areas where the altimeter setting is in excess of 31.00 in. of mercury and the aircraft altimeter cannot be set above 31.00 in. of mercury, the true altitude of the aircraft will be HIGHER than the indicated altitude.

Procedures for conducting flight operations in areas of abnormally high altimeter settings are detailed in *AIP Canada (ICAO) ENR 1.7*.

1.6 CANADIAN RUNWAY FRICTION INDEX (CRFI)

1.6.1 General

The following paragraphs discuss the slippery runway problem and suggest methods of applying runway coefficient of friction information to aircraft flight manual (AFM) data.

1.6.2 Reduced Runway Coefficients of Friction and Aircraft Performance

The accelerate-stop distance, landing distance and crosswind limitations (if applicable) contained in the aircraft flight manual (AFM) are demonstrated in accordance with specified performance criteria on runways that are bare, dry, and that have high surface friction characteristics. Unless some factor has been applied, these distances are only valid under similar runway conditions. Whenever a contaminant—such as water, snow or ice—is introduced to the runway surface, the effective coefficient of friction between the aircraft tire and runway is substantially reduced. The stop portion of the accelerate-stop distance will increase, the landing distance will increase and a crosswind may present directional control difficulties. The problem has been to identify, with some accuracy, the effect that the contaminant has had on reducing the runway coefficient of friction and to provide meaningful information to the pilot, e.g. how much more runway is needed to stop and what maximum crosswind can be accepted.

1.6.3 Description of Canadian Runway Friction Index (CRFI) and Method of Measurement

The decelerometer is an instrument mounted in a test vehicle that measures the decelerating forces acting on the vehicle when the brakes are applied. The instrument is graduated in increments from 0 to 1, the highest number being equivalent to the theoretical maximum decelerating capability of the vehicle on a dry surface. These numbers are referred to as the CRFI. It is evident that small numbers represent low braking coefficients of friction while numbers on the order of 0.8 and above indicate the braking coefficients to be expected on bare and dry runways.

The brakes are applied on the test vehicle at 300-m (1 000-ft) intervals along the runway within a distance of 10 m (30 ft) from each side of the runway centreline at that distance from the centreline where the majority of aircraft operations take place at each given site. The readings taken are averaged and reported as the CRFI number.

1.6.4 Aircraft Movement Surface Condition Reports (AMSCR)

AMSCRs are issued to alert pilots of natural surface contaminants—such as snow, ice or slush—that could affect aircraft braking performance. The RSC section of the report provides information about runway condition in plain language, while the CRFI section describes braking action quantitatively using the numerical format described in AIR 1.6.3.

Because of mechanical and operational limitations, the runway friction readings produced by decelerometer devices may be inaccurate under certain surface conditions. As a result, runway friction readings will not be taken and a CRFI will not be provided to ATS or to pilots when any of the following conditions are present.

- a) the runway surface is wet and no other type of contamination is present;
- b) there is a layer of slush on the runway surface and no other type of contamination is present;
- c) there is wet snow on the runway surface; or
- d) there is dry snow on the runway surface exceeding 2.5 cm (1 in.) in depth.

An RSC report must be provided when:

- a) there is frost, snow, slush or ice on a runway;
- b) there are snow banks, drifts or windrows on or adjacent to a runway;
- c) sand, aggregate material, anti-icing or de-icing chemicals are applied to a runway;
- d) the cleared runway width falls below the published width;
- e) the runway lights are obscured or partially obscured by contaminants;
- f) there is a significant change in runway surface conditions including a return to bare and dry conditions; or
- g) as per the required minimum inspection frequency.

The following changes relating to runway conditions are considered significant:

- a) a change of 0.05 or more in the coefficient of friction;
- b) changes in depth of deposit greater than 20 mm (0.79 in.) for dry snow, 10 mm (0.4 in.) for wet snow, 3 mm (0.13 in.) for slush;
- c) a change in the cleared width of a runway of 10 percent or more;
- d) any change in the type of deposit or extent of coverage, including a return to bare and dry conditions;
- e) any change in the height of snow banks or their distance from the centreline on one or both sides of the runway;
- f) any change in the visibility of runway lighting because the lights are obscured by contaminants; and

- g) any other conditions that are, in the opinion of the aerodrome authority, considered to be significant.

When available, a CRFI reading will be issued along with the RSC in order to provide an overall descriptive picture of the runway condition and to quantify braking action. The CRFI is to be reported whenever:

- a) there is ice or frost on the runway;
- b) there is wet ice on the runway;
- c) there is slush over the ice on the runway;
- d) sand, aggregate material, anti-icing or de-icing chemicals are applied to the runway;
- e) there is a chemical solution on the ice on the runway;
- f) there is compacted snow on the runway; or
- g) there is dry snow not exceeding a depth of 2.5 cm (1 in.) on the runway.

When a deposit is present but the depth is not measurable, the word “TRACE” shall be used. Otherwise, the depth is expressed in inches or feet or both. When the depth is above 2 in, whole values are used. When the depth is less than 2 in, the decimal system is used. The accepted decimal values are 0.13, 0.25, 0.5, 0.75 and 1.5; however, caution has to be exercised as these values could be confused with CRFI measurements.

When clearing is not underway or expected to begin within the next 30 min, a notation such as “Clearing expected to start at (time in UTC)” will be added to the RSC report. When the meteorological conditions cause runway surface conditions to change frequently, the NOTAMJ will include the agency and telephone number to contact for the current runway conditions.

The full range of RSC/CRFI information will be available as a voice advisory from the control tower at controlled aerodromes and from the FSS at uncontrolled aerodromes.

Each new NOTAMJ (AMSCR report) issued supersedes the previous report for that aerodrome. A NOTAMJ is valid for 24 hr, based on the most recent observation of either the RSC or CRFI, after which time it is removed from the database by way of cancellation. A NOTAMJ may also be cancelled if the reporting requirements are no longer met or the NOTAMJ was issued in error.

NOTE:

The absence of a NOTAMJ in no way indicates that runway conditions are acceptable for operations.

The format of the CRFI portion of the report is as follows: location indicator, title (CRFI), runway number, temperature (in degrees Celsius), runway average CRFI reading, and time (UTC) when readings were taken (using a ten-digit time group in the year-month-day-hour-minute [YYMMDDHHMM] format).

Examples of RSC and CRFI reports for paved runways:

- a) CYND RSC 09/27 100 PCT DRY SN 4 INS 1101190630
RMK: CLEARING EXP TO START AT 1101191000
- b) CYFB RSC 17/35 100 PCT DRY SN ON ICE 0.5 INS 1101190630
CYFB CRFI 17/35 -22C .34 1101190630
- c) CYFB RSC 17/35 10 PCT SN DRIFTS 2 INS, 90 PCT BARE AND DRY 1101191050
CYFB CRFI 17/35 -10C .30 1101191055
- d) CYHZ RSC 05/23 160 FT CL 40 PCT COMPACTED SN, 60 PCT FROST. REMAINING WID 80 PCT COMPACTED SN, 20 PERCENT FROST. RMK: SANDED 100 FT CL. 1102131240
CYHZ CRFI 05/23 0C .22 1102131234
CYHZ RSC 14/32 160 FT CL 20 PCT COMPACTED SN, 80 PCT FROST.
REMAINING WID 80 PCT COMPACTED SN, 20 PCT FROST. RMK: SANDED 100 FT CL 1102131240
CYHZ CRFI 14/32 0C .29 1102131210
- e) CYFB RSC CANCELLED
- f) CYND RSC RWY COND CHANGING RAPIDLY. CTC OPR (555) 555-5555 1102131240

Examples of RSC and CRFI reports for gravel runways:

- a) CYBK RSC 16/34 100 PCT 0.5 INS DRY SN ON COMPACTED SN 1112190640
CYBK CRFI 16/34 -22C .30 0112190645
- b) CYGX RSC 05/23 100 PCT COMPACTED SN GRVL MIX 1112210740
CYGX CRFI 05/23 -8C .39 1112210745
- c) CYGW RSC 04/22 100 PCT 0.5 INS WET SN ON ICE 1112220630
CYGW CRFI 04/22 -14C .18 1112220635

A NOTAMJ is issued based on reporting requirements rather than on dissemination criteria. Therefore, conditions such as “100 percent bare and dry”, “bare and damp”, or “bare and wet” will be disseminated if reported.

Information on taxiways and aprons, although not mandatory, can be disseminated in a NOTAMJ if deemed to have an impact on safe operations.

1.6.5 Wet Runways

Runway friction values are currently not provided during the summer and when it is raining. Consequently, some discussion of wet runways is in order to assist pilots in developing handling procedures when these conditions are encountered.

A packed-snow or ice condition at a fixed temperature presents a relatively constant coefficient of friction with speed, but this is not the case for a liquid (water or slush) state. This is because water cannot be completely squeezed out from between the tire and the runway and, as a result, there is only partial tire-to-runway contact. As the aircraft speed is increased, the time in contact is reduced further, thus braking friction coefficients on wet surfaces fall as the speed increases, i.e. the conditions in effect become relatively more slippery, but will improve again as the aircraft slows down. The situation is further complicated by the susceptibility of aircraft tires to hydroplane on wet runways.

Hydroplaning is a function of the water depth, tire pressure and speed. Moreover, the minimum speed at which a non-rotating tire will begin to hydroplane is lower than the speed at which a rotating tire will begin to hydroplane because a build up of water under the non-rotating tire increases the hydroplaning effect. Pilots should therefore be aware of this since it will result in a substantial difference between the take-off and landing roll aircraft performance under the same runway conditions. The minimum speed, in knots, at which hydroplaning will commence can be calculated by multiplying the square root of the tire pressure (PSI) by 7.7 for a non-rotating tire, or by 9 for a rotating tire.

This equation gives an approximation of the minimum speed necessary to hydroplane on a smooth, wet surface with tires that are bald or have no tread. For example, the minimum hydroplaning speeds for an aircraft with tires inflated to 49 PSI are calculated as:

Non-rotating tire: $7.7 \times \sqrt{49} = 54$ kt; or

Rotating tire: $9 \times \sqrt{49} = 63$ kt

When hydroplaning occurs, the aircraft's tires are completely separated from the actual runway surface by a thin water film and they will continue to hydroplane until a reduction in speed permits the tires to regain contact with the runway. This speed will be considerably lower than the speed at which hydroplaning commences. Under these conditions, the tire traction drops to almost negligible values, and in some cases, the wheel will stop rotating entirely. The tires will provide no braking capability and will not contribute to the directional control of the aircraft. The resultant increase in stopping distance is impossible to predict accurately, but it has been estimated to increase as much as 700 percent. Further, it is known that a 10-kt crosswind will drift an aircraft off the side of a 200-ft wide runway in approximately 7 sec under hydroplaning conditions.

Notwithstanding the fact that friction values cannot be given for a wet runway and that hydroplaning can cause pilots serious difficulties, it has been found that, under light or moderate rain conditions, well-drained runways seldom accumulate sufficient standing water for hydroplaning to occur.

1.6.6 Canadian Runway Friction Index (CRFI) Application to Aircraft Performance

The information contained in Tables 1 and 2 has been compiled and is considered to be the best data available at this time because it is based upon extensive field test performance data of aircraft braking on winter-contaminated surfaces. The information should provide a useful guide to pilots when estimating aircraft performance under adverse runway conditions. The onus for the production of information, guidance or advice on the operation of aircraft on a wet and/or contaminated runway rests with the aircraft manufacturer. The information published in the TC AIM does not change, create any additional, authorize changes in, or permit deviations from regulatory requirements. These Tables are intended to be used at the pilot's discretion.

Because of the many variables associated with computing accelerate-stop distances and balanced field lengths, it has not been possible to reduce the available data to the point where CRFI corrections can be provided, which would be applicable to all types of operations. Consequently, only corrections for landing distances and crosswinds are included pending further study of the take-off problem.

It should be noted that in all cases the Tables are based on corrections to aircraft flight manual (AFM) dry runway data and that the certification criteria does not allow consideration of the extra decelerating forces provided by reverse thrust or propeller reversing. On dry runways, thrust reversers provide only a small portion of the total decelerating forces when compared to wheel braking. However, as wheel braking becomes less effective, the portion of the stopping distance attributable to thrust reversing becomes greater. For this reason, if reversing is employed when a low CRFI is reported, a comparison of the actual stopping distance with that shown in Table 1 will make the estimates appear overly conservative. Nevertheless, there are circumstances—such as crosswind conditions, engine out situations or reverser malfunctions—that may preclude their use.

Landing distances recommended in Table 1 are intended to be used for aeroplanes with no discing and/or reverse thrust capability and are based on statistical variation measured during actual flight tests.

Notwithstanding the above comments on the use of discing and/or reverse thrust, Table 2 may be used for aeroplanes with discing and/or reverse thrust capability and is based on the landing distances recommended in Table 1 with additional calculations that give credit for discing and/or reverse thrust. In calculating the distances in Table 2, the air distance from the screen height of 50 ft to touchdown and the delay distance from touchdown to the application of full braking remain unchanged from Table 1.

The effects of discing and/or reverse thrust were used only to reduce the stopping distance from the application of full braking to a complete stop.

The recommended landing distances stated in Table 2 take into account the reduction in landing distances obtained with the use of discing and/or reverse thrust capability for a turboprop-powered aeroplane and with the use of reverse thrust for a turbojet-powered aeroplane. Representative low values of discing and/or reverse thrust effect have been assumed and, therefore, the data may be conservative for properly executed landings by some aeroplanes with highly effective discing and/or thrust reversing systems.

The crosswind limits for CRFI shown in Table 3 contain a slightly different display range of runway friction index values from those listed in Tables 1 and 2. However, the CRFI values used for Table 3 are exactly the same as those used for Tables 1 and 2 and are appropriate for the index value increments indicated for the index value increments indicated.

Table 1.3—CRFI Recommended Landing Distances (No Discing/Reverse Thrust)

Reported Canadian Runway Friction Index (CRFI)														
Landing Distance (Feet) Bare and Dry	0.60	0.55	0.50	0.45	0.40	0.35	0.30	0.27	0.25	0.22	0.20	0.18	Landing Field Length (Feet) Bare and Dry	Landing Field Length (Feet) Bare and Dry
Unfactored	Recommended Landing Distances (no Discing/Reverse Thrust)												60% Factor	70% Factor
1 800	3 120	3 200	3 300	3 410	3 540	3 700	3 900	4 040	4 150	4 330	4 470	4 620	3 000	2 571
2 000	3 480	3 580	3 690	3 830	3 980	4 170	4 410	4 570	4 700	4 910	5 070	5 250	3 333	2 857
2 200	3 720	3 830	3 960	4 110	4 280	4 500	4 750	4 940	5 080	5 310	5 490	5 700	3 667	3 143
2 400	4 100	4 230	4 370	4 540	4 740	4 980	5 260	5 470	5 620	5 880	6 080	6 300	4 000	3 429
2 600	4 450	4 590	4 750	4 940	5 160	5 420	5 740	5 960	6 130	6 410	6 630	6 870	4 333	3 714
2 800	4 760	4 910	5 090	5 290	5 530	5 810	6 150	6 390	6 570	6 880	7 110	7 360	4 667	4 000
3 000	5 070	5 240	5 430	5 650	5 910	6 220	6 590	6 860	7 060	7 390	7 640	7 920	5 000	4 286
3 200	5 450	5 630	5 840	6 090	6 370	6 720	7 130	7 420	7 640	8 010	8 290	8 600	5 333	4 571
3 400	5 740	5 940	6 170	6 430	6 740	7 110	7 550	7 870	8 100	8 500	8 800	9 130	5 667	4 857
3 600	6 050	6 260	6 500	6 780	7 120	7 510	7 990	8 330	8 580	9 000	9 320	9 680	6 000	5 143
3 800	6 340	6 570	6 830	7 130	7 480	7 900	8 410	8 770	9 040	9 490	9 840	10 220	6 333	5 429
4 000	6 550	6 780	7 050	7 370	7 730	8 170	8 700	9 080	9 360	9 830	10 180	10 580	6 667	5 714

Application of the CRFI

1. The recommended landing distances in Table 1 are based on a 95 percent level of confidence. A 95 percent level of confidence means that in more than 19 landings out of 20, the stated distance in Table 1 will be conservative for properly executed landings with all systems serviceable on runway surfaces with the reported CRFI.
2. Table 1 will also be conservative for turbojet- and turboprop-powered aeroplanes with reverse thrust, and additionally, in the case of turboprop-powered aeroplanes, with the effect obtained from discing.
3. The recommended landing distances in CRFI Table 1 are based on standard pilot techniques for the minimum distance landings from 50 ft, including a stabilized approach at V_{Ref}

4. using a glide slope of 3° to 50 ft or lower, a firm touchdown, minimum delay to nose lowering, minimum delay time to deployment of ground lift dump devices and application of brakes, and sustained maximum antiskid braking until stopped.
4. Landing field length is the landing distance divided by 0.6 (turbojets) or 0.7 (turboprops). If the aircraft flight manual (AFM) expresses landing performance in terms of landing distance, enter the Table from the left-hand column. However, if the AFM expresses landing performance in terms of landing field length, enter the Table from one of the right-hand columns, after first verifying which factor has been used in the AFM.

AIR

Table 1.4—CRFI Recommended Landing Distances (Discing/Reverse Thrust)

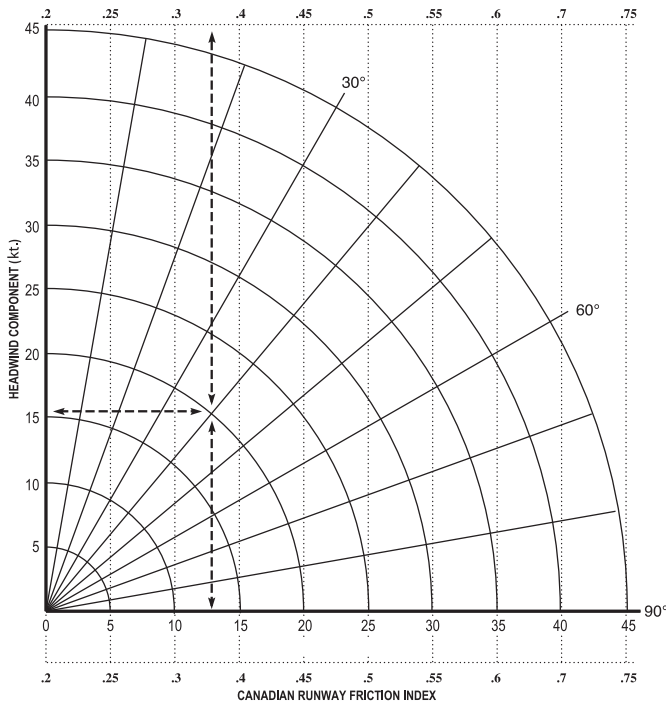
Reported Canadian Runway Friction Index (CRFI)														
Landing Distance (Feet) Bare and Dry	0.60	0.55	0.50	0.45	0.40	0.35	0.30	0.27	0.25	0.22	0.20	0.18	Landing Field Length (Feet) Bare and Dry	Landing Field Length (Feet) Bare and Dry
Unfactored	Recommended Landing Distances (Discing/Reverse Thrust)												60% Factor	70% Factor
1 200	2 000	2 040	2 080	2 120	2 170	2 220	2 280	2 340	2 380	2 440	2 490	2 540	2 000	1 714
1 400	2 340	2 390	2 440	2 500	2 580	2 660	2 750	2 820	2 870	2 950	3 010	3 080	2 333	2 000
1 600	2 670	2 730	2 800	2 880	2 970	3 070	3 190	3 280	3 360	3 460	3 540	3 630	2 667	2 286
1 800	3 010	3 080	3 160	3 250	3 350	3 480	3 630	3 730	3 810	3 930	4 030	4 130	3 000	2 571
2 000	3 340	3 420	3 520	3 620	3 740	3 880	4 050	4 170	4 260	4 400	4 510	4 630	3 333	2 857
2 200	3 570	3 660	3 760	3 880	4 020	4 170	4 360	4 490	4 590	4 750	4 870	5 000	3 667	3 143
2 400	3 900	4 000	4 110	4 230	4 380	4 550	4 750	4 880	4 980	5 150	5 270	5 410	4 000	3 429
2 600	4 200	4 300	4 420	4 560	4 710	4 890	5 100	5 240	5 350	5 520	5 650	5 790	4 333	3 714
2 800	4 460	4 570	4 700	4 840	5 000	5 190	5 410	5 560	5 670	5 850	5 980	6 130	4 667	4 000
3 000	4 740	4 860	5 000	5 160	5 340	5 550	5 790	5 950	6 070	6 270	6 420	6 580	5 000	4 286
3 200	5 080	5 220	5 370	5 550	5 740	5 970	6 240	6 420	6 560	6 770	6 940	7 110	5 333	4 571
3 400	5 350	5 500	5 660	5 850	6 060	6 310	6 590	6 790	6 930	7 170	7 340	7 530	5 667	4 857
3 600	5 620	5 780	5 960	6 160	6 390	6 650	6 960	7 170	7 320	7 570	7 750	7 950	6 000	5 143
3 800	5 890	6 060	6 250	6 460	6 700	6 980	7 310	7 540	7 700	7 970	8 160	8 380	6 333	5 429
4 000	6 070	6 250	6 440	6 660	6 910	7 210	7 540	7 780	7 950	8 220	8 430	8 650	6 667	5 714

Application of the CRFI

1. The recommended landing distances in Table 2 are based on a 95 percent level of confidence. A 95 percent level of confidence means that in more than 19 landings out of 20, the stated distance in Table 2 will be conservative for properly executed landings with all systems serviceable on runway surfaces with the reported CRFI.
2. The recommended landing distances in Table 2 take into account the reduction in landing distances obtained with the use of discing and/or reverse thrust capability for a turboprop-powered aeroplane and with the use of reverse thrust for a turbojet-powered aeroplane. Table 2 is based on the landing distances recommended in Table 1 with additional calculations that give credit for discing and/or reverse thrust. Representative low values of discing and/or reverse thrust effect have been assumed, hence the data will be conservative for properly executed landings by some aeroplanes with highly effective discing and/or thrust reversing systems.

3. The recommended landing distances in CRFI Table 2 are based on standard pilot techniques for the minimum distance landings from 50 ft, including a stabilized approach at V_{Ref} using a glide slope of 3° to 50 ft or lower, a firm touchdown, minimum delay to nose lowering, minimum delay time to deployment of ground lift dump devices and application of brakes and discing and/or reverse thrust, and sustained maximum antiskid braking until stopped. In Table 2, the air distance from the screen height of 50 ft to touchdown and the delay distance from touchdown to the application of full braking remain unchanged from Table 1. The effects of discing/reverse thrust were used only to reduce the stopping distance from the application of full braking to a complete stop.
4. Landing field length is the landing distance divided by 0.6 (turbojets) or 0.7 (turboprops). If the AFM expresses landing performance in terms of landing distance, enter the Table from the left-hand column. However, if the AFM expresses landing performance in terms of landing field length, enter the Table from one of the right-hand columns, after first verifying which factor has been used in the AFM.

Figure 1.1—Crosswind Limits for CRFI



The wind is 40° off the runway heading and produces a headwind component of 15 kt and a crosswind component of 13 kt. The recommended minimum CRFI for a 13-kt crosswind component is .35. A takeoff or landing with a CRFI of .3 could result in uncontrollable drifting and yawing.

The CRFI depends on the surface type, as shown in Table 4a. It should be noted that:

- a) the CRFI values given in Table 4a are applicable to all temperatures. Extensive measurements have shown that there is no correlation between the CRFI and the surface temperature. The case where the surface temperature is just at the melting point (i.e. about 0°C) may be an exception, as a water film may form from surface melting, which could induce slippery conditions with CRFIs less than those in Table 4a.
- b) the CRFI may span a range of values for various reasons, such as variations in texture among surfaces within a given surface class. The expected maximum and minimum CRFIs for various surfaces are listed in Table 4b. Note that these values are based on a combination of analyses of extensive measurements and sound engineering judgment.

This chart provides information for calculating headwind and crosswind components. The vertical lines indicate the recommended maximum crosswind component for reported CRFI.

Example:

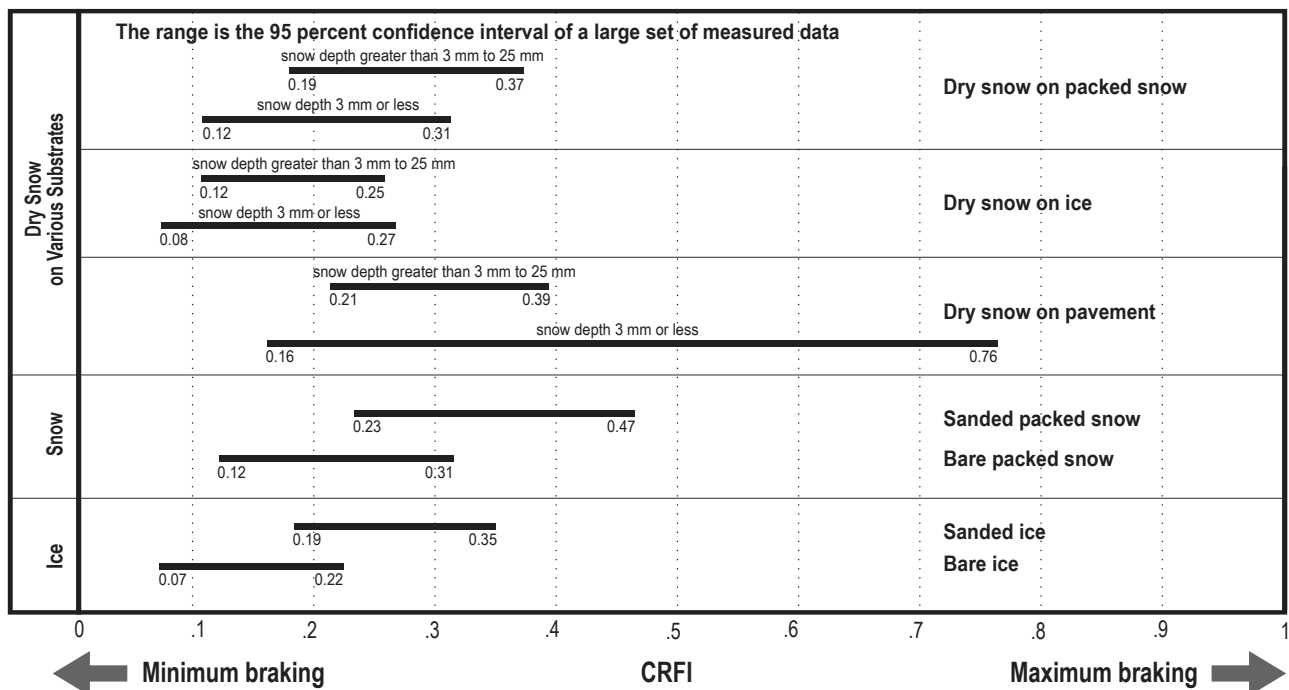
CYOW CRFI 07/25 -4C .30 1201191200

Tower Wind 110° 20 kt.

- c) the largest range in CRFI is to be expected for a thin layer (3 mm or less in thickness) of dry snow on pavement (Table 4a). This variation may occur due to:
 - (i) non-uniform snow coverage; and/or
 - (ii) the tires breaking through the thin layer.

In either case, the surface presented to the aircraft may range from snow to pavement.

Table 1.5(a)—Expected Range of CRFI by Surface Type



AIR

Table 1.5(b)—Minimum and Maximum CRFI for Various Surfaces

SURFACE	LOWER CRFI LIMIT	UPPER CRFI LIMIT
Bare Ice	No Limit	0.3
Bare Packed Snow	0.1	0.4
Sanded Ice	0.1	0.4
Sanded Packed Snow	0.1	0.5
Dry Snow on Ice (depth 3 mm or less)	No Limit	0.4
Dry Snow on Ice (depth 3 to 25 mm)	No Limit	0.4
Dry Snow on Packed Snow (depth 3 mm or less)	0.1	0.4
Dry Snow on Packed Snow (depth 3 to 25 mm)	0.1	0.4
Dry Snow on Pavement (depth 3 mm or less)	0.1	Dry Pavement
Dry Snow on Pavement (depth 3 mm to 25 mm)	0.1	Dry Pavement

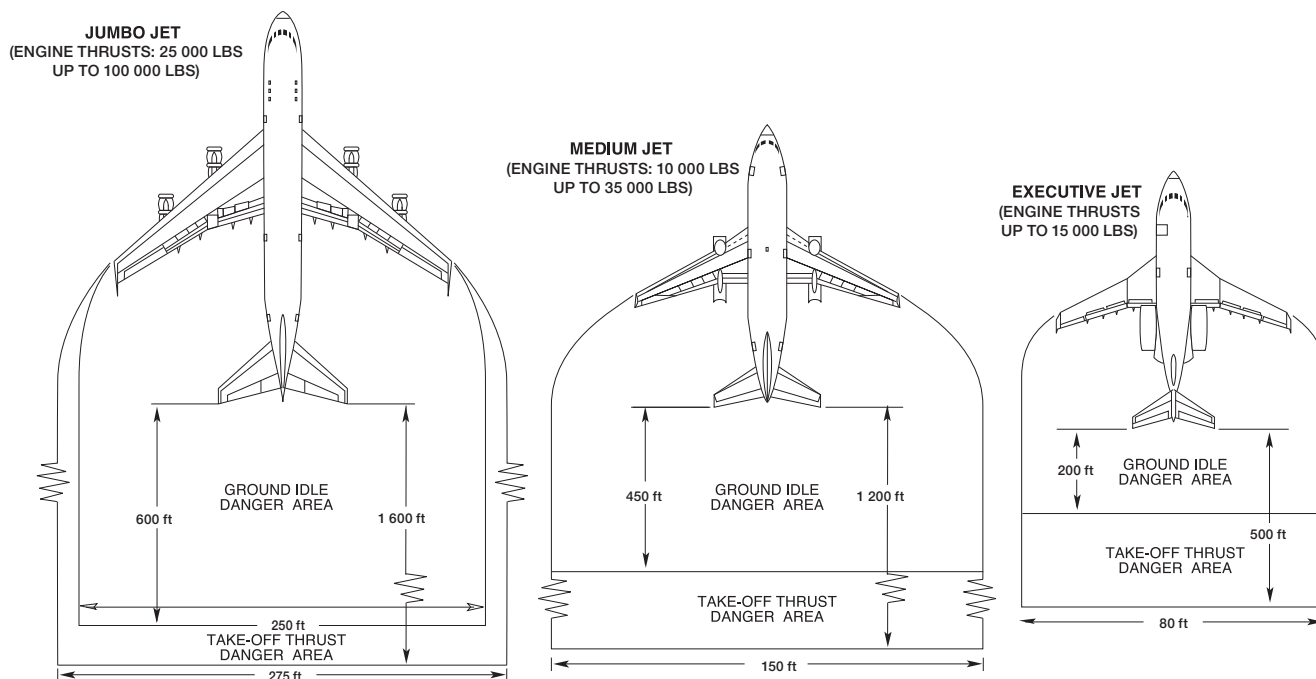
1.7 JET AND PROPELLER BLAST DANGER

Jet aircraft are classified into three categories according to engine size. The danger areas are similar to those shown in Figure 1.1 and are used by ground control personnel and pilots. The danger areas have been determined for ground idle and take-off thrust settings associated with each category.

As newer aircraft are designed to handle more weight, larger engines are being used. Executive jets may have thrusts of up to 15 000 lbs; medium jets may have thrusts of up to 35 000 lbs; and some jumbo jets now have thrusts in excess of 100 000 lbs. Therefore, caution should be used when interpreting the danger

areas for ground idle and take-off thrust settings, as some of the distances shown in Figure 1.1 may need to be increased significantly. Pilots should exercise caution when operating near active runways and taxiways. With the use of intersecting runways, there is an increased possibility of jet blast or propeller wash affecting other aircraft at the aerodrome. This can occur while both aircraft are on the ground or about to take off or land. Pilots taxiing in close proximity to active runways should be careful when their jet blast or propeller wash is directed towards an active runway. Pilots operating behind a large aircraft, whether on the ground or in the take-off or landing phase, should be aware of the possibility of encountering localized high wind velocities.

Figure 1.2—Jet Blast Danger Areas (Not To Scale)



No information is available for supersonic transport aircraft or for military jet aircraft. Many of these aircraft are pure-jet aircraft with high exhaust velocities for their size, and may or may not use afterburner during the take-off phase. Thus, great caution should be used when operating near these aircraft.

Lastly, it should be noted that light aircraft with high wings and narrow-track undercarriages are more susceptible to jet blast and propeller wash related hazards than heavier aircraft with low wings and wide-track undercarriages.

The following is a Table showing the expected speed of the blast created by large turbo-prop aeroplanes:

Table 1.6—Expected Large Turbo-Prop Blast Speed

DISTANCE BEHIND PROPELLERS	LEAVING PARKED AREA	TAXIING	TAKING OFF
ft	kt	kt	kt
60	59	45	–
80	47	36	60–70
100	47	36	50–60
120	36	28	40–50
140	36	28	35–45
180	–	–	20–30


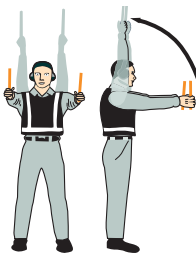



1.8 MARSHALLING SIGNALS

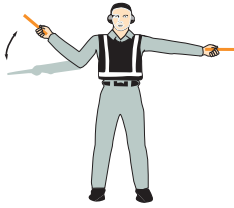
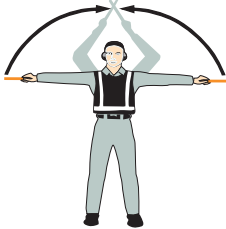




Marshalling signals for the guidance of aircraft on the ground are set out in section 5 of ICAO Annex 2. These signals should be used in order to standardize signalling between ground and flight personnel when required for aircraft entering, departing or manoeuvring within the movement area of an aerodrome.


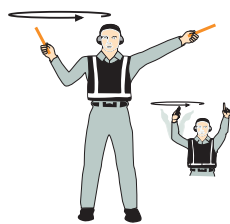
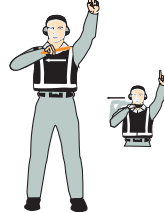

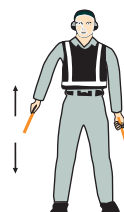

NOTES:



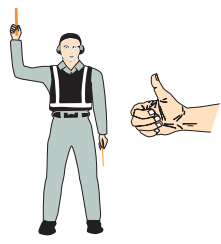
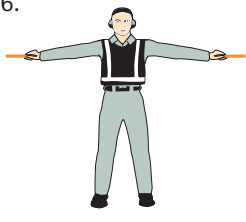
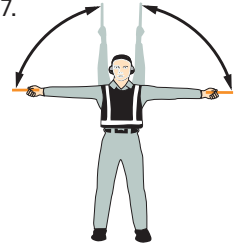
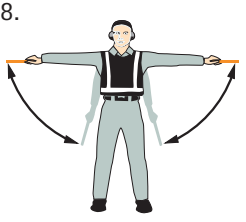
1. Marshalling signals are designed for use by the marshaller, with hands illuminated as necessary to facilitate observation by the pilot, and facing the aircraft in a position:
 - a) for fixed-wing aircraft, on the left side of the aircraft, where best seen by the pilot; and
 - b) for helicopters, where the marshaller can best be seen by the pilot.
2. The aircraft engines are numbered from left to right, with the No. 1 engine being the left outer engine. That is right to left for a marshaller facing the aircraft.
3. Signals marked with an asterisk (*) are designed for use with hovering helicopters.

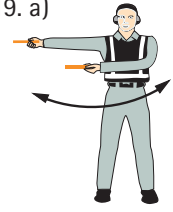


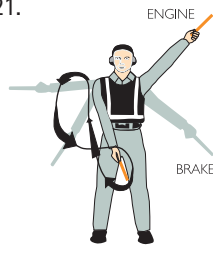


Marshalling Signals Diagram


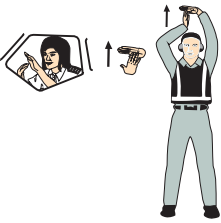

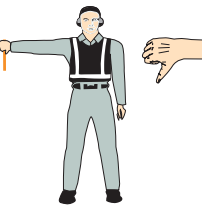
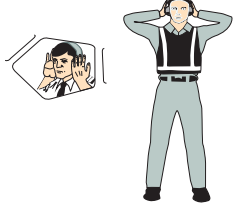
Signal	Description
1. 	Wingwalker/guide Raise right hand above head level with wand pointing up; move left-hand wand pointing down toward body. NOTE: This signal provides an indication by a person positioned at the aircraft wing tip, to the pilot/ marshaller/ push-back operator, that the aircraft movement on/off a parking position would be unobstructed.
2. 	Identify gate Raise fully extended arms straight above head with wands pointing up.
3. 	Proceed to next marshaller as directed by tower/ground control Point both arms upward; move and extend arms outward to sides of body and point with wands to direction of next marshaller or taxi area.
4. 	Straight ahead Bend extended arms at elbows and move wands up and down from chest height to head.
5. a) 	Turn left (from pilot's point of view) With right arm and wand extended at a 90-degree angle to body, make "come ahead" signal with left hand. The rate of signal motion indicates to pilot the rate of aircraft turn.

Signal	Description
5. b) 	Turn right (from pilot's point of view) With left arm and wand extended at a 90-degree angle to body, make "come ahead" signal with right hand. The rate of signal motion indicates to pilot the rate of aircraft turn.
6. a) 	Normal stop Fully extend arms and wands at a 90-degree angle to sides and slowly move to above head until wands cross.
6. b) 	Emergency stop Abruptly extend arms and wands to top of head, crossing wands.
7. a) 	Set brakes Raise hand just above shoulder height with open palm. Ensuring eye contact with flight crew, close hand into a fist. Do not move until receipt of "thumbs up" acknowledgement from flight crew.
7. b) 	Release brakes Raise hand just above shoulder height with hand closed in a fist. Ensuring eye contact with flight crew, open palm. Do not move until receipt of "thumbs up" acknowledgement from flight crew.
8. a) 	Chocks inserted With arms and wands fully extended above head, move wands inward in a "jabbing" motion until wands touch. Ensure acknowledgement is received from flight crew.

Signal	Description
8. b) 	Chocks removed With arms and wands fully extended above head, move wands outward in a "jabbing" motion. Do not remove chocks until authorized by flight crew.
9. 	Start engine(s) Raise right arm to head level with wand pointing up and start a circular motion with hand; at the same time, with left arm raised above head level, point to engine to be started.
10. 	Cut engines Extend arm with wand forward of body at shoulder level; move hand and wand to top of left shoulder and draw wand to top of right shoulder in a slicing motion across throat.
11. 	Slow down Move extended arms downwards in a "patting" gesture, moving wands up and down from waist to knees.
12. 	Slow down engine(s) on indicated side With arms down and wands toward ground, wave either right or left wand up and down indicating engine(s) on left or right side respectively should be slowed down.
13. 	Move back With arms in front of body at waist height, rotate arms in a forward motion. To stop rearward movement, use signal 6.a) or 6.b).

Signal	Description
14. a) 	Turns while backing (for tail to starboard) Point left arm with wand down and bring right arm from overhead vertical position to horizontal forward position, repeating right-arm movement.
14. b) 	Turns while backing (for tail to port) Point right arm with wand down and bring left arm from overhead vertical position to horizontal forward position, repeating left-arm movement.
15. 	Affirmative/all clear Raise right arm to head level with wand pointing up or display hand with "thumbs up"; left arm remains at side by knee. <i>NOTE: This signal is also used as a technical/servicing communication signal.</i>
*16. 	Hover Fully extend arms and wands at a 90-degree angle to sides.
*17. 	Move upwards Fully extend arms and wands at a 90-degree angle to sides and, with palms turned up, move hands upwards. Speed of movement indicates rate of ascent.
*18. 	Move downwards Fully extend arms and wands at a 90-degree angle to sides and, with palms turned down, move hands downwards. Speed of movement indicates rate of descent.

Signal	Description
*19. a) 	Move horizontally left (from pilot's point of view) Extend arm horizontally at a 90-degree angle to right side of body. Move other arm in same direction in a sweeping motion.
*19. b) 	Move horizontally right (from pilot's point of view) Extend arm horizontally at a 90-degree angle to left side of body. Move other arm in same direction in a sweeping motion.
*20. 	Land Cross arms with wands downwards and in front of body.
21. 	Fire Move right-hand wand in a "fanning" motion from shoulder to knee, while at the same time pointing with left-hand wand to area of fire.
22. 	Hold position/stand by Fully extend arms and wands downwards at a 45-degree angle to sides. Hold position until aircraft is clear for next manoeuvre.
23. 	Dispatch aircraft Perform a standard salute with right hand and/or wand to dispatch the aircraft. Maintain eye contact with flight crew until aircraft has begun to taxi.

Signal	Description
24. 	<p>Do not touch controls (technical/servicing communication signal) Extend right arm fully above head and close fist or hold wand in horizontal position; left arm remains at side by knee.</p>
25. 	<p>Connect ground power (technical/servicing communication signal) Hold arms fully extended above head; open left hand horizontally and move finger tips of right hand into and touch open palm of left hand (forming a "T"). At night, illuminated wands can also be used to form the "T" above head.</p>
26. 	<p>Disconnect power (technical/servicing communication signal) Hold arms fully extended above head with finger tips of right hand touching open horizontal palm of left hand (forming a "T"); then move right hand away from the left. Do not disconnect power until authorized by flight crew. At night, illuminated wands can also be used to form the "T" above head.</p>
27. 	<p>Negative (technical/servicing communication signal) Hold right arm straight out at 90 degrees from shoulder and point wand down to ground or display hand with "thumbs down"; left hand remains at side by knee.</p>
28. 	<p>Establish communication via interphone (technical/servicing communication signal) Extend both arms at 90 degrees from body and move hands to cup both ears.</p>


Signal	Description
29. 	<p>Open/close stairs (technical/servicing communication signal) With right arm at side and left arm raised above head at a 45-degree angle, move right arm in a sweeping motion towards top of left shoulder. NOTE: This signal is intended mainly for aircraft with the set of integral stairs at the front.</p>

Table 1.7—Aircraft Pilot Marshalling Signals to a Marshaller

Meaning of Signal	Description of Signal
Brakes engaged	Raise arm and hand, with fingers extended, horizontally in front of face, then clench fist.
Brakes released	Raise arm, with fist clenched, horizontally in front of face, then extend fingers.
Insert chocks	Arms extended, palms outwards, move hands inwards to cross in front of face.
Remove chocks	Hands crossed in front of face, palms outwards, move arms outwards.
Ready to start the engine(s)	Raise the appropriate number of fingers on one hand indicating the number of the engine to be started.

2.0 FLIGHT OPERATIONS

2.1 GENERAL

This section provides airmanship information on various flight operations subjects.

2.2 CROSSWIND LANDING LIMITATIONS

Approximately 10% of all aircraft accidents involving light aircraft in Canada are attributed to pilot failure to compensate for crosswind conditions on landing.

Light aircraft manufactured in the United States are designed to withstand, on landing, 90° crosswinds up to a velocity equal to 0.2 (20%) of their stalling speed.

This information in conjunction with the known stalling speed of a particular aircraft makes it possible to use the following crosswind component graph to derive a “general rule” for most light aircraft manufactured in the United States. The aircraft owner’s manual may give higher or limiting crosswinds. Examples follow.

Figure 2.1—Crosswind Landing Limitations

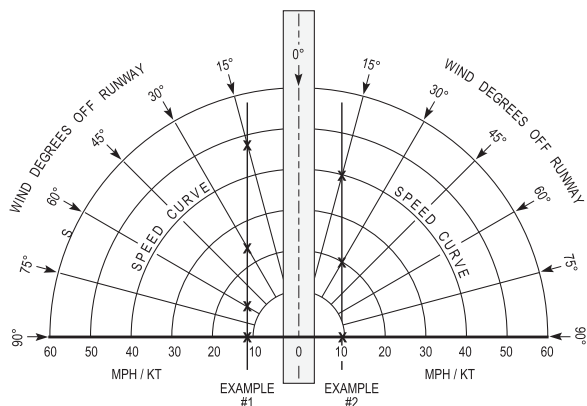


Table 2.1—Example of an Aircraft With a Stalling Speed of 60 MPH

WIND-DEGREE	PERMISSIBLE WIND SPEEDS
90°	(0.2 x 60 MPH stalling speed) 12 MPH
60°	using crosswind component graph 14 MPH
30°	using crosswind component graph 24 MPH
15°	using crosswind component graph 48 MPH

Table 2.2—Example of an Aircraft With a Stalling Speed of 50 KIAS

WIND-DEGREE	PERMISSIBLE WIND SPEEDS
90°	(0.2 x 50 kt stalling speed) 10 kt
60°	using crosswind component graph 12 kt
30°	using crosswind component graph 20 kt
15°	using crosswind component graph 40 kt

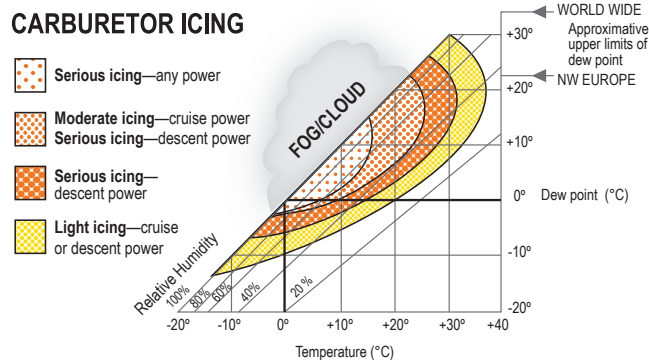
2.3 CARBURETOR ICING

Carburetor icing is a common cause of general aviation accidents. Fuel injected engines have very few induction system icing accidents, but otherwise no aeroplane and engine combination stands out. Most carburetor icing related engine failure happens during normal cruise. Possibly, this is a result of decreased pilot awareness that carburetor icing will occur at high power settings as well as during descents with reduced power.

In most accidents involving carburetor icing, the pilot has not fully understood the carburetor heat system of the aircraft and what occurs when it is selected. Moreover, it is difficult to understand the countermeasures unless the process of ice formation in the carburetor is understood. Detailed descriptions of this process are available in most good aviation reference publications and any AME employed on type can readily explain the carburetor heat system. The latter is especially important because of differences in systems. The pilot must learn to accept a rough-running engine for a minute or so as the heat melts and loosens the ice which is then ingested into the engine.

Figure 2.2—Carburetor Icing

The following chart provides the range of temperature and relative humidity which could induce carburetor icing.



NOTE:

This chart is not valid when operating on MOGAS. Due to its higher volatility, MOGAS is more susceptible to the formation of carburetor icing. In severe cases, ice can form at OATs up to 20°C higher than with AVGAS.



2.4 LOW FLYING

Before conducting any low flying, the pilot should be clear about the purpose and legality of the exercise. Accordingly, all preparations in terms of assessment of the terrain to be overflown, weather, aircraft performance, and selection of appropriate charts are important to the successful completion of the flight.

All known objects 300 feet or more AGL (or lower ones if deemed hazardous) are depicted on visual navigational charts. However, because there is only limited knowledge over the erection of man-made objects, there can be no guarantee that all such structures are known, and accordingly, an additional risk is added to the already hazardous practice of low flying.

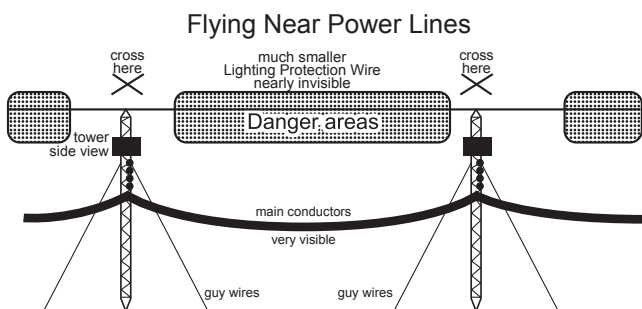
Further, even though structures assessed as potential hazards to air navigation are required to be marked, including special high intensity strobe lighting for all structures 500 ft AGL and higher, the majority of aircraft collisions with man-made structures occur at levels below 300 ft AGL (See Obstruction Markings – AGA 6.0).

Another concern to low flying is the blasting operations associated with the logging industry. The trajectory of debris from the blasting varies with the type of explosives, substance being excavated and the canopy of trees, if any. These blasting activities may or may not be advertised by NOTAM.

2.4.1 Flying Near Power Lines

Main power lines are easy to see, but when flying in their vicinity you must take the time to look for what is really there and then use safe procedures. Remember, the human eye is limited, so if the background landscape does not provide sufficient contrast you will not see a wire or cable. Although hydro structures are big and generally quite visible, a hidden danger exists in the wires around them.

Figure 2.3—Flying Near Power Lines



The figure shown above emphasizes this point. The main conductor cluster is made up of several heavy wires. These heavy, sagging conductors are about two inches in diameter and very visible, so they tend to distract one from seeing the guard or lightning protection wires, which are of much smaller diameter.

Guard wires do not sag the way the main conductors do and are

difficult to pick out even in good visibility. The only way to be safe is to avoid the span portion of the line and **always cross at a tower**, maintaining a safe altitude, with as much clearance as possible.

- When following power lines, remain on the right-hand side relative to your direction of flight and watch for cross lines and guy cables.
- Expect radio and electrical interference in the vicinity of power lines.
- For operational low flying, do an overflight and map check first.
- Leave yourself an “out”—cross at 45 degrees to the line.
- Reduce speed in low visibility (for VFR—one mile visibility; clear of cloud; 165 KIAS max.).

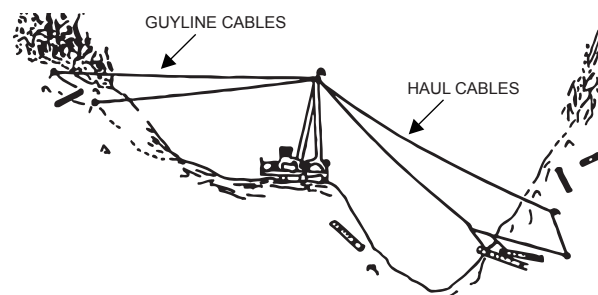
Warning—Intentional low flying is hazardous. Transport Canada advises all pilots that low flying for weather avoidance or operational requirements is a high-risk activity.

2.4.2 Logging Operations

Extensive use is made in logging operations of equipment potentially hazardous to aircraft operations. These include highlead spars, grapple yarders and skyline cranes.

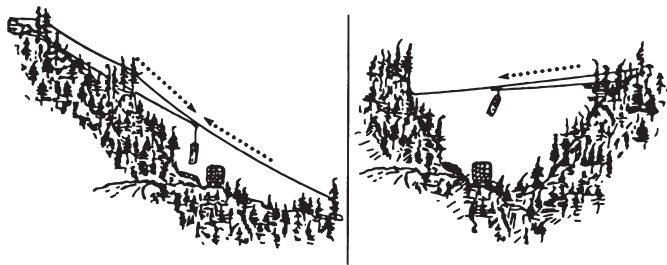
When highlead spars or grapple yarders are used, hauling and guyline cables radiate from the top of the spar or boom. Cables may cross small valleys or be anchored on side hills behind the spar. While spars generally do not exceed 130 ft AGL and are conspicuously painted, the cable system may be difficult to see. This type of equipment operates from a series of logging roads.

Figure 2.4—Highlead Spar



By contrast, skyline cranes consist of a single skyline cable anchored at the top and bottom of a long slope and supported by one or several intermediate poles. This cable generally follows the slope contour about 100 ft AGL, but may also cross draws and gullies and may be at heights in excess of 100 ft AGL. Skyline cables are virtually invisible from the air. Their presence is indicated by active or recently completed logging and the absence of a defined series of logging roads, although a few roads may be present.

Figure 2.5—Skyline Crane



Pilots operating in areas where logging is prevalent must be aware when operating below 300 ft AGL that these types of equipment exist and do not always carry standard obstruction and paint markings.

2.5 FLIGHT OPERATIONS IN RAIN

An error in vision can occur when flying in rain. The presence of rain on the windscreen, in addition to causing poor visibility, introduces a refraction error. This error is because of two things: firstly, the reduced transparency of the rain-covered windscreen causes the eye to see a horizon below the true one (because of the eye response to the relative brightness of the upper bright part and the lower dark part); and secondly, the shape and pattern of the ripples formed on the windscreen, particularly on sloping ones, which cause objects to appear lower. The error may be present as a result of one or other of the two causes, or of both, in which case it is cumulative and is of the order of about 5° in angle. Therefore, a hilltop or peak 1/2 NM ahead of an aircraft could appear to be approximately 260 ft lower, (230 ft lower at 1/2 SM) than it actually is.

Pilots should remember this additional hazard when flying in conditions of low visibility in rain and should maintain sufficient altitude and take other precautions, as necessary, to allow for the presence of this error. Also, pilots should ensure proper terrain clearance during en route flight and on final approach to landing.

2.6 FLIGHT OPERATIONS IN VOLCANIC ASH

Flight operations in volcanic ash are hazardous. Experience has shown that damage can occur to aircraft surfaces, windshields and powerplants. Aircraft heat and vent systems, as well as hydraulic and electronic systems, can also be contaminated. Powerplant failures are a common result of flight in volcanic ash, with turbine engines being particularly susceptible. Simultaneous power loss in all engines has occurred. In addition, volcanic ash is normally very heavy; accumulations of it within the wings and tail section have been encountered, with adverse effects on aircraft weight and balance.

Aviation radar is not effective in detecting volcanic ash clouds. There is no reliable information regarding volcanic ash

concentrations which might be minimally acceptable for flight. Recent data suggests that “old” volcanic ash still represents a considerable hazard to safety of flight. Pilots are cautioned that ash from volcanic eruptions can rapidly reach heights in excess of FL 600 and be blown downwind of the source for considerable distances. Encounters affecting aircraft performance have occurred 2 400 NM from the ash source and up to 72 hours after an eruption.

Therefore: if an ash cloud is visible to a pilot, entry into the cloud must be avoided.

The risk of entering ash in IMC or night conditions is particularly dangerous, owing to the absence of a clear visual warning.

Therefore: if PIREPs, SIGMETs (see MET 6.0), NOTAM (see MAP 3.0), and analysis of satellite imagery and/or ash cloud trajectory forecasts indicate that ash might be present within a given airspace, that airspace must be avoided until it can be determined to be safe for entry.

St. Elmo’s fire is usually a telltale sign of a night encounter, although rapid onset of engine problems may be the first indication. Pilots should exit the cloud expeditiously while following any engine handling instructions provided in the aircraft flight manuals for such circumstances.

Pilots should be aware that they may be the first line of volcanic eruptions detection in more remote areas. In the initial phase of any eruption there may be little or no information available to advise pilots of the new ash hazard. If an eruption or ash cloud is observed, an urgent PIREP (see MET 2.5 and 2.1.1) should be filed with the nearest ATS unit.

2.7 FLIGHT OPERATION NEAR THUNDERSTORMS

2.7.1 General

Thunderstorms are capable of containing nearly all weather hazards known to aviation. These include tornadoes, turbulence, squall line, microburst, heavy updrafts and downdrafts, icing, hail, lightning, precipitation static, heavy precipitation, low ceiling and visibility.

There is no useful correlation between the external visual appearance of a thunderstorm and the severity or amount of turbulence or hail within it. The visible thunderstorm cloud is only a portion of a turbulent system of updrafts and downdrafts that often extend far beyond. Severe turbulence may extend up to 20 NM from severe thunderstorms.

Airborne or ground based weather radar will normally reflect areas of precipitation. The frequency and severity of turbulence associated with the areas of high water content generally increases the radar return. No flight path, through an area of strong or very strong radar echoes separated by 40 NM or less, can be considered free of severe turbulence.

Turbulence beneath a thunderstorm should not be underestimated. This is especially true when the relative humidity is low. There may be nothing to see until you enter strong out-flowing winds and severe turbulence.

The probability of lightning strikes occurring to aircraft is greatest when operating at altitudes where temperatures are between -5°C and 5°C . Lightning can strike aircraft flying in clear air in the vicinity of a thunderstorm. Lightning can puncture the skin of an aircraft, damage electronic equipment, cause engine failure and induce permanent error in magnetic compasses.

Engine Water Ingestion

If the updraft velocity in the thunderstorm approaches or exceeds the terminal falling velocity of the falling raindrops, very high concentrations of water may occur. It is possible that these concentrations may exceed the quantity of water that a turbine engine is capable of ingesting. Therefore, severe thunderstorms may contain areas of high water concentration which could result in a flameout or structural failure of one or more engines. Note that lightning can also cause compressor stalls or flameouts.

PIREP

Remember, a timely PIREP will allow you and others to make the right decision earlier.

2.7.2 Considerations

- a) Above all, never think of a thunderstorm as “light” even though the radar shows echoes of light intensity. Avoiding thunderstorms is the best policy. Remember that vivid and frequent lightning indicates a severe activity in the thunderstorm and that any thunderstorm with tops 35 000 ft or higher is severe. Whenever possible:
 - (i) don’t land or take off when a thunderstorm is approaching. The sudden wind shift of the gust front or low-level turbulence could result in loss of control;
 - (ii) don’t attempt to fly under a thunderstorm even when you can see through to the other side. Turbulence under the storm could be disastrous;
 - (iii) avoid any area where thunderstorms are covering 5/8 or more of that area;
 - (iv) don’t fly into a cloud mass containing embedded thunderstorms without airborne radar;
 - (v) avoid by at least 20 NM any thunderstorm identified as severe or giving intense radar returns. This includes the anvil of a large cumulonimbus; and
 - (vi) clear the top of a known or suspected severe thunderstorm by at least 1 000 ft altitude for each 10 kt of wind speed at the cloud top.
- b) If you cannot avoid an area of thunderstorms, consider these points:
 - (i) Tighten your seat belt and shoulder harness; secure all loose objects.
 - (ii) Plan a course that will take you through the storm area in a minimum time and hold it.
 - (iii) Avoid the most critical icing areas, by penetrating at

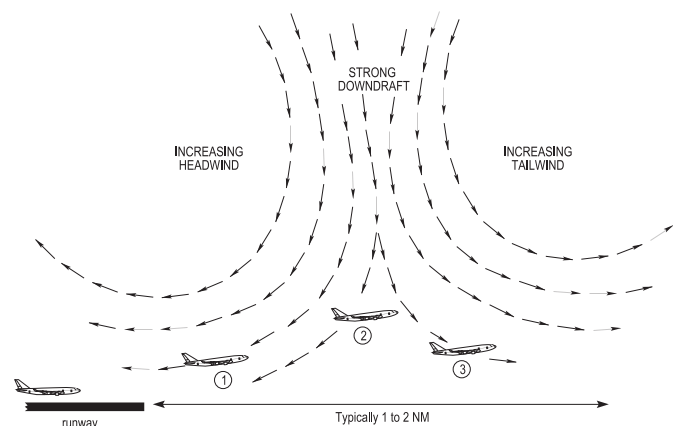
an altitude below the freezing level or above the level of -15°C .

- (iv) Check that pitot, carburetor or jet inlet heat are on. Icing can be rapid and may result in almost instantaneous power failure or airspeed indication loss.
 - (v) Set the power settings for turbulence penetration airspeed recommended in your aircraft manual.
 - (vi) Turn up cockpit lights to its highest intensity to minimize temporary blindness from lightning.
 - (vii) When using the auto-pilot, disengage the altitude hold mode and the speed hold mode. The automatic altitude and speed controls will increase manoeuvres of the aircraft, thus increasing structural stresses.
 - (viii) Tilt the airborne radar antenna up and down occasionally. This may detect hail or a growing thunderstorm cell.
- c) If you enter a thunderstorm:
- (i) Concentrate on your instruments; looking outside increases the danger of temporary blindness from lightning.
 - (ii) Don’t change power settings; maintain the settings for turbulence penetration airspeed.
 - (iii) Don’t attempt to keep a constant rigid altitude; let the aircraft “ride the waves”. Manoeuvres in trying to maintain constant altitude increases stress on the aircraft. If altitude cannot be maintained, inform ATC as soon as possible.
 - (iv) Don’t turn back once you have entered a thunderstorm. Maintaining heading through the storm will get you out of the storm faster than a turn. In addition, turning manoeuvres increases stress on the aircraft

2.8 LOW-LEVEL WIND SHEAR (WS)

Relatively recent meteorological studies have confirmed the existence of the “burst” phenomena. These are small-scale, intense downdrafts which, on reaching the surface, spread outward from the downflow centre. This causes the presence of both vertical and horizontal wind shear (WS) that can be extremely hazardous to all types and categories of aircraft.

Figure 2.6—Low-Level Wind Shear



Wind shear may create a severe hazard for aircraft within 1 000 ft AGL, particularly during the approach to landing and in the takeoff phases. On takeoff, this aircraft may encounter a headwind (performance increasing) (1) followed by a downdraft (2), and tailwind (3) (both performance decreasing).

Pilots should heed wind shear pilot weather reports (PIREPs) as a previous pilot's encounter with a wind shear may be the only warning. Alternate actions should be considered when a wind shear has been reported.

Characteristics of microbursts include:

- a) *Size* - Approximately 1 NM in diameter at 2 000 ft AGL with a horizontal extent at the surface of approximately 2 to 2 1/2 NM.
- b) *Intensity* - Vertical winds as high as 6 000 ft/min. Horizontal winds giving as much as 45 kt at the surface (i.e. 90 kt shear).
- c) *Types* - microbursts are normally accompanied by heavy rain in areas where the air is very humid. However, in drier areas, falling raindrops may have sufficient time and distance to evaporate before reaching the ground. This is known as VIRGA.
- d) *Duration* - The life-cycle of a microburst from the initial downburst to dissipation will seldom be longer than 15 minutes with maximum intensity winds lasting approximately 2 - 4 minutes. Sometimes microbursts are concentrated into a line structure and under these conditions, activity may continue for as long as an hour. Once microburst activity starts, multiple microbursts in the same general area are common and should be expected.

The best defence against wind shear is to avoid it altogether because it could be beyond your capabilities or those of your aircraft. However, if you do recognize WS, prompt action is required. In all aircraft, the recovery could require full power and a pitch attitude consistent with the maximum angle of attack for your aircraft. Aircraft equipped with wind shear detection and warning systems may be provided with guidance to escape WS or, in the case of Predictive Wind Shear Systems (PWSS), to avoid it (see MET 2.3). For more information on WS, consult the *Air Command Weather Manual* (TP 9352E).

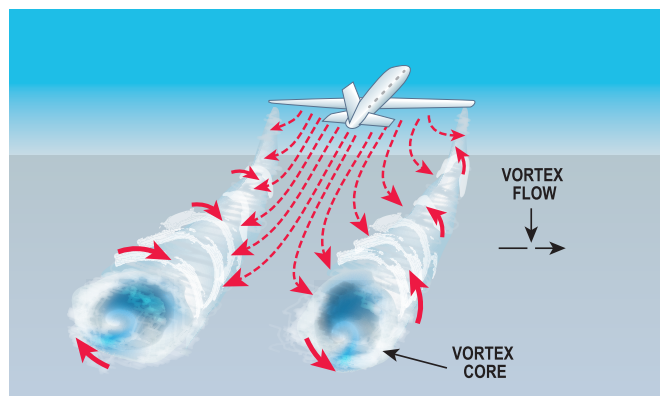
If you experience WS, advise air traffic services (ATS) (see RAC 6.1) and warn others, as soon as possible, by sending a PIREP to the ground facility.

2.9 WAKE TURBULENCE

Wake turbulence is caused by wing-tip vortices and is a by-product of lift. The higher air pressure under the wings tries to move to the lower air pressure on top of the wings by flowing towards the wing tips, where it rotates and flows into the lower pressure on top of the wings. This results in a twisting rotary motion that

is very pronounced at the wing tips and continues to spill over the top in a downward spiral. Therefore, the wake consists of two counter-rotating cylindrical vortices.

Figure 2.7—Wake Turbulence



Vortex Strength

The strength of these vortices is governed by the shape of the wings, and the weight and speed of the aircraft; the most significant factor is weight. The greatest vortex strength occurs under conditions of *heavy* weight, *clean* configuration, and slow speed. The strength of the vortex shows little dissipation at altitude within 2 min of the time of initial formation. Beyond 2 min, varying degrees of dissipation occur along the vortex path; first in one vortex and then in the other. The break-up of vortices is affected by atmospheric turbulence; the greater the turbulence, the more rapid the dissipation of the vortices.

Induced Roll

Aircraft flying directly into the core of a vortex will tend to roll with the vortex. The capability of counteracting the roll depends on the wing span and control responsiveness of the aircraft. When the wing span and ailerons of a larger aircraft extend beyond the vortex, counter-roll control is usually effective, and the effect of the induced roll can be minimized. Pilots of short wing span aircraft must be especially alert to vortex situations, even though their aircraft are of the high-performance type.

Helicopter Vortices

In the case of a helicopter, similar vortices are created by the rotor blades. However, the problems created are potentially greater than those caused by a fixed-wing aircraft because the helicopter's lower operating speeds produce more concentrated wakes than fixed-wing aircraft. Departing or landing helicopters produce a pair of high-velocity trailing vortices similar to wing-tip vortices of large fixed-wing aircraft; the heavier the helicopter, the more intense the wake turbulence. Pilots of small aircraft should use caution when operating or crossing behind landing or departing helicopters.

Vortex Avoidance

Avoid the area below and behind other aircraft, especially at low altitude, where even a momentary wake turbulence encounter could be disastrous.

2.9.1 Vortex Characteristics

General

Trailing vortices have characteristics which, when known, will help a pilot visualize the wake location and thereby take avoidance precautions. Vortex generation starts with rotation (lifting off of the nosewheel) and will be severe in that airspace immediately following the point of rotation. Vortex generation ends when the nosewheel of a landing aircraft touches down.

Because of ground effect and wind, a vortex produced within about 200 feet AGL tends to be subject to lateral drift movements and may return to where it started. Below 100 feet AGL, the vortices tend to separate laterally and break up more rapidly than vortex systems at higher altitude. The vortex sink rate and levelling off process result in little operational effect between an aircraft in level flight and other aircraft separated by 1 000 feet vertically. Pilots should fly at or above a heavy jet's flight path, altering course as necessary to avoid the area behind and below the generating aircraft. Vortices start to descend immediately after formation and descend at the rate of 400 to 500 feet per minute for large heavy aircraft and at a lesser rate for smaller aircraft, but in all cases, descending less than 1 000 feet in total in 2 minutes.

Vortices spread out at a speed of about 5 kt. Therefore, a crosswind will decrease the lateral movement of the upwind vortex and increase the movement of the downwind vortex. Thus, a light wind of 3 to 7 kt could result in the upwind vortex remaining in the touchdown zone for a period of time or hasten the drift of the downwind vortex toward another runway. Similarly, a tail wind condition can move the vortices of the preceding landing aircraft forward into the touchdown zone.

Since vortex cores can produce a roll rate of 80° per second or twice the capabilities of some light aircraft and a downdraft of 1 500 feet per minute which exceeds the rate of climb of many aircraft, the following precautions are recommended.

Pilots should be particularly alert in calm or light wind conditions where the vortices could:

- a) remain in the touchdown area;
- b) drift from aircraft operating on a nearby runway;
- c) sink into takeoff or landing path from a crossing runway;
- d) sink into the traffic pattern from other runway operations;
- e) sink into the flight path of VFR flights at 500 feet AGL and below.

2.9.2 Considerations

On the ground

- a) Before requesting clearance to cross a live runway, wait a few minutes when a large aircraft has just taken off or landed.
- b) When holding near a runway, expect wake turbulence.

Takeoff

- a) When cleared to takeoff following the departure of a large aircraft, plan to become airborne prior to the point of rotation of the preceding aircraft and stay above the departure path or request a turn to avoid the departure path.
- b) When cleared to takeoff following the landing of a large aircraft, plan to become airborne after the point of touchdown of the landing aircraft.

En route VFR

- a) Avoid flight below and behind a large aircraft. If a large aircraft is observed along the same track (meeting or overtaking), adjust position laterally preferably upwind.

Landing

- a) When cleared to land behind a departing aircraft, plan to touchdown prior to reaching the rotation point of the departing aircraft.
- b) When behind a large aircraft landing on the same runway, stay at or above the preceding aircraft's final approach flight path, note the touchdown point and land beyond this point if it is safe to do so.
- c) When cleared to land behind a large aircraft on a low approach or on a missed approach on the same runway, beware of vortices that could exist between the other aircraft's flight path and the runway surface.
- d) When landing after a large aircraft on a parallel runway closer than 2 500 feet, beware of possible drifting of the vortex on to your runway. Stay at or above the large aircraft's final approach flight path, note his touchdown point and land beyond if it is safe to do so.
- e) When landing after a large aircraft has departed from a crossing runway, note the rotation point. If it is past the intersection, continue the approach and land before the intersection. If the large aircraft rotates prior to the intersection, avoid flight below the large aircraft's flight path. Abandon the approach unless a landing is assured well before reaching the intersection.

ATC will use the words “CAUTION – WAKE TURBULENCE” to alert pilots to the possibility of wake turbulence. It is the pilots’ responsibility to adjust their operations and flight path to avoid wake turbulence.

Air traffic controllers apply separation minima between aircraft. See RAC 4.1.1 for these procedures which are intended to minimize the hazards of wake turbulence.

An aircraft conducting an IFR final approach should remain on glide path as the normally supplied separation should provide an adequate wake turbulence buffer. However, arriving VFR aircraft, while aiming to land beyond the touchdown point of a preceding heavy aircraft, should be careful to remain above its flight path. If extending flight path, so as to increase the distance behind an arriving aircraft, one should avoid the tendency to develop a dragged-in final approach. Pilots should remember to apply whatever power is required to maintain altitude until reaching a normal descent path. The largest number of dangerous encounters have been reported in the last half mile of the final approach.

Be alert to adjacent large aircraft operations particularly upwind of your runway. If an intersection takeoff clearance is received, or parallel and cross runway operations are in progress, avoid subsequent heading which will result in your aircraft crossing below and behind a large aircraft.

NOTES:

1. If any of the procedures are not possible and you are on the ground, WAIT! (2 minutes are usually sufficient). If on an approach, consider going around for an other approach.
2. See AIR 1.7 for Jet and Propeller Blast Danger.

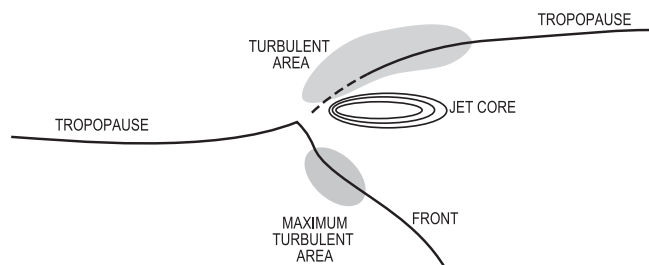
2.10 CLEAR AIR TURBULENCE (CAT)

These rules of thumb are given to assist pilots in avoiding clear air turbulence (CAT). They apply to westerly jet streams. The *Air Command Weather Manual* (TP 9352E) available in Transport Canada discusses this subject more thoroughly.

1. Jet streams stronger than 110 kt (at the core) have areas of significant turbulence near them in the sloping tropopause above the core, in the jet stream front below the core and on the low-pressure side of the core.
2. Wind shear and its accompanying CAT in jet streams is more intense above and to the lee of mountain ranges. For this reason, CAT should be anticipated whenever the flight path crosses a strong jet stream in the vicinity of a mountain range.
3. On charts for standard isobaric surfaces such as the 250 mbs charts, 30 kt isotachs spaced closer than 90 NM indicate sufficient horizontal shear for CAT. This area is normally on the north (low-pressure) side of the jet stream axis, but in unusual cases may occur on the south side.

- f) CAT is also related to vertical shear. From the wind-aloft charts or reports, compute the vertical shear in knots-per-thousand feet. Turbulence is likely when the shear is greater than 5 kt per thousand feet. Since vertical shear is related to horizontal temperature gradient, the spacing of isotherms on an upper air chart is significant. If the 5°C isotherms are closer together than 2° of latitude (120 NM), there is usually sufficient vertical shear for turbulence.
- g) Curving jet streams are more apt to have turbulent edges than straight ones, especially jet streams which curve around a deep pressure trough.
- h) Wind-shift areas associated with troughs are frequently turbulent. The sharpness of the wind-shift is the important factor. Also, ridge lines may also have rough air.
- i) In an area where significant CAT has been reported or is forecast, it is suggested that the pilot adjust the airspeed to the recommended turbulent air penetration speed for the aircraft upon encountering the first ripple, since the intensity of such turbulence may build up rapidly. In areas where moderate or severe CAT is expected, it is desirable to adjust the airspeed prior to encountering turbulence.

Figure 2.8—Clear Air Turbulence



4. If jet stream turbulence is encountered with direct tailwinds or headwinds, a change of flight level or course should be initiated since these turbulent areas are elongated with the wind but are shallow and narrow. A turn to the south in the Northern Hemisphere will place the aircraft in a more favourable area. If a turn is not feasible because of airway restrictions, a climb or descent to the next flight level will usually result in smoother air.
5. When jet stream turbulence is encountered in a crosswind situation, pilots wanting to cross the CAT area more quickly should, either climb or descend based on temperature change. If temperature is rising – climb; if temperature is falling - descend. This will prevent following the sloping tropopause or frontal surface and staying in the turbulent area. If the temperature remains constant, either climb or descend.

6. If turbulence is encountered with an abrupt wind-shift associated with a sharp pressure trough, a course should be established to cross the trough rather than to fly parallel to it. A change in flight level is not as likely to reduce turbulence.
7. If turbulence is expected because of penetration of a sloping tropopause, pilots should refer to the temperature. The tropopause is where the temperature stops decreasing. Turbulence will be most pronounced in the temperature-change zone on the stratospheric side of the sloping tropopause.
8. Both vertical and horizontal wind shear are greatly intensified in mountain wave conditions. Therefore, when the flight path crosses a mountain wave, it is desirable to fly at turbulence-penetration speed and avoid flight over areas where the terrain drops abruptly. There may be no lenticular clouds associated with the mountain wave.

PIREP

Clear air turbulence can be a very serious operational factor to flight operations at all levels and especially to jet traffic flying above 15 000 feet. The best available information comes from pilots via a PIREP. Any pilot encountering CAT is urgently requested to report the time, location and intensity (light, moderate or severe per MET 2.2.2) to the facility with which they are maintaining radio contact. (See MET 1.1.6.)

2.11 FLIGHT OPERATIONS ON WATER

2.11.1 General

Pilots are reminded that when aircraft are being operated on the waters of harbours, ports, lakes or other navigable waterways, they are considered to be a vessel and must abide by the provisions of CAR 602.20. (See RAC 1.10.)

The attention of all pilots and aircraft owners is drawn to the *Canada Shipping Act, 2001*, and the *Canada Marine Act*. The *Canada Marine Act* provides harbour commissions and port authorities with the authority to restrict vessel operations on the bodies of water that are in their jurisdiction

Restrictions established by the above authorities relating to vessels apply to aircraft underway or at rest on the water of a harbour, and operators are advised to furnish themselves with copies of the appropriate regulations as published by such harbour commissions or port authorities.

In addition, the *Canada Shipping Act, 2001*, through the *Vessel Operation Restriction Regulations* prohibits or imposes restrictions on the operation of vessels on certain lakes and waterways within Canada. The bodies of water affected and applicable restrictions may be found in the schedules to the *Vessel Operation Restriction Regulations* <<http://laws-lois.justice.gc.ca/eng/regulations/SOR-2008-120/index.html>>.

2.11.2 Ditching

When flying over water, a pilot must always consider the possibility of ditching. Aircraft operating handbooks usually contain instructions on ditching that are applicable to the type of aircraft. Also, the *Flight Training Manual* (TP 1102E) discusses this topic.

Before flying over water, pilots should be aware of the regulatory requirements, some of which are outlined in AIR 2.11.3.

On the high seas, it is best to ditch parallel and on top of the primary swell system, except in high wind conditions. The primary swell is usually recognized first because it is easier to see from a higher altitude while secondary systems may only be visible at a lower altitude. Wind effect may only be discernible at a much lower altitude from the appearance of the white caps. It is possible for the primary swell system to disappear from view once lower altitudes are reached as it becomes hidden by secondary systems and the wind chop.

Some guidelines can be adopted:

- a) Never land into the face of a primary swell system unless the winds are extremely high. The best ditching heading is usually parallel to the primary swell system.
- b) In strong winds it may be desirable to compromise by ditching more into the wind and slightly across the swell system.

Decide as early as possible that ditching is inevitable, so that power can be used to achieve the optimum impact conditions. This would permit a stabilized approach at a low rate of descent at the applicable ditching speed.

Communicate. Initially, broadcast on the last frequency in use, then switch to 121.5 as many air carriers at high altitude have a VHF radio set on 121.5. Set off the ELT if able; SRSAT has a very good chance of picking up the signal. Set your transponder to 7700. Many coastal radars will detect the signal at extremely long ranges over the water.

Surviving a ditching is one thing, but immersion and the time spent in the cold water is possibly even more hazardous. Ensure that all equipment needed for flotation and the prevention of hypothermia from a lengthy exposure to cold water is on board and available. Brief passengers on their expected actions including their responsibilities for the handling of emergency equipment, once the aircraft has stopped in the water.

2.11.3 Life-Saving Equipment For Aircraft Operating Over Water

Life jackets suitable for each person on board are required to be carried on all aircraft taking off from and landing on water, and on all single-engine aircraft flown over water beyond gliding distance from shore. Complete requirements are contained in CARs 602.62 and 602.63.

2.11.4 Landing Seaplanes on Glassy Water

It is practically impossible to judge altitude when landing a seaplane or skiplane under certain conditions of surface and light. The following procedure should be adopted when such conditions exist.

Power assisted approaches and landings should be used although considerably more space will be required. The landing should be made as close to the shoreline as possible, and parallel to it, the height of the aircraft above the surface being judged from observation of the shoreline. Objects on the surface such as weeds and weed beds can be used for judging height. The recommended practice is to make an approach down to 200 ft (300 ft to 400 ft where visual aids for judgement of height are not available) and then place the aircraft in a slightly nose high attitude. Adjust power to maintain a minimum rate of descent, maintaining the recommended approach speed for the type until the aircraft is in contact with the surface. Do not “feel for the surface”. At the point of contact, the throttle should be eased off gently while maintaining back pressure on the control column to hold a nose high attitude which will prevent the floats from digging in as the aircraft settles into the water. Care must be taken to trim the aircraft properly to ensure that there is no slip or skid at the point of contact.

This procedure should be practised to give the pilot full confidence. It is recommended that the same procedure be used for unbroken snow conditions.

2.12 FLIGHT OPERATIONS IN WINTER

2.12.1 General

The continuing number of accidents involving all types and classes of aircraft indicates that misconceptions exist regarding the effect on performance of frost, snow or ice accumulation on aircraft.

Most commercial transport aircraft, as well as some other aircraft types, have demonstrated some capability to fly in icing conditions and have been so certified. This capacity is provided by installing de-icing or anti-icing equipment on or in critical areas of equipment, such as the leading edges of the wings and empennage, engine cowls, compressor inlets, propellers, stall warning devices, windshields and pitots. However, this equipment does not provide any means of de-icing or anti-icing the wings or empennage of an aircraft that is on the ground.

2.12.1.1 Fan Blade Ice Shedding Procedure

a) General

Ice intake on high bypass jet engines has the potential to cause significant fan blade damage.

The Fan Blade Ice Shedding Procedure may be applied by aircrew during conditions of freezing rain, freezing drizzle, freezing fog or heavy snow.

Weather conditions of 1 SM visibility or less in snow or blowing snow are considered high risk blade damage conditions.

If icing conditions exceed 30 min or if significant engine vibration occurs, the engines may be accelerated for approximately 30 s prior to higher thrust operations. This may occur just prior to takeoff to check engine parameters and ensure normal engine operation.

b) Pilot Requirements

It is imperative that aircrew inform ATS of the intent to perform this procedure, prior to entering an active runway.

Prior to approaching the active runway holding position, pilots should advise ATS that they will require extra time on the runway threshold for ice shedding or any other potential delay.

This information is required to ensure a timely departure and to prevent an arriving flight from conducting an unplanned missed approach.

2.12.2 Aircraft Contamination on the Ground – Frost, Ice or Snow

a) *General Information:* Where frost, ice or snow may reasonably be expected to adhere to the aircraft, the *Canadian Aviation Regulations* require that an inspection or inspections be made before takeoff or attempted takeoff. The type and minimum number of inspections is indicated by the regulations, and depends on whether or not the operator has an approved Operator’s Ground Icing Operations Program using the Ground Icing Operations Standard as specified in CAR 602.11 – *Operating and Flight Rules Standards*.

The reasons for the regulations are straightforward. The degradation in aircraft performance and changes in flight characteristics when frozen contaminants are present are wide ranging and unpredictable. Contamination makes no distinction between large aircraft, small aircraft or helicopters, the performance penalties and dangers are just as real.

The significance of these effects are such that takeoff should not be attempted unless the pilot-in-command has determined, as required by the CARs, that frost ice or snow contamination is not adhering to any aircraft critical surfaces.

- b) *Critical Surfaces*: Critical surfaces of an aircraft mean the wings, control surfaces, rotors, propellers, horizontal stabilizers, vertical stabilizers or any other stabilizing surface of an aircraft which, in the case of an aircraft that has rear-mounted engines, includes the upper surface of its fuselage.

Flight safety during ground operations in conditions conducive to frost, ice or snow contamination requires a knowledge of:

- (i) adverse effects of frost, ice or snow on aircraft performance and flight characteristics, which are generally reflected in the form of decreased thrust, decreased lift, increased drag, increased stall speed, trim changes, altered stall characteristics and handling qualities;
 - (ii) various procedures available for aircraft ground de-icing and anti-icing, and the capabilities and limitations of these procedures in various weather conditions, including the use and effectiveness of freezing point depressant (FPD) fluids;
 - (iii) holdover time, which is the estimated time that an application of an approved de-icing/anti-icing fluid is effective in preventing frost, ice, or snow from adhering to treated surfaces. Holdover time is calculated as beginning at the start of the final application of an approved de-icing/anti-icing fluid and as expiring when the fluid is no longer effective. The fluid is no longer effective when its ability to absorb more precipitation has been exceeded. This produces a visible surface build-up of contamination. Recognition that final assurance of a safe takeoff rests in the pre-takeoff inspection.
- c) *The Clean Aircraft Concept*: CARs prohibit takeoff when frost, ice or snow is adhering to any critical surface of the aircraft. This is referred to as “The Clean Aircraft Concept”.

It is imperative that takeoff not be attempted in any aircraft unless the pilot-in-command has determined that all critical components of the aircraft are free of frost, ice or snow contamination. This requirement may be met if the pilot-in-command obtains verification from properly trained and qualified personnel that the aircraft is ready for flight.

- d) *Frozen Contaminants*: Test data indicate that frost, ice or snow formations having a thickness and surface roughness similar to medium or coarse sandpaper, on the leading edge and upper surface of a wing, can reduce wing lift by as much as 30% and increase drag by 40%. Even small amounts of contaminants have caused (and continue to cause) aircraft accidents which result in substantial damage and loss of life. A significant part of the loss of lift can be attributed to leading edge contamination. The changes in lift and drag significantly increase stall speed, reduce controllability, and alter aircraft flight characteristics. Thicker or rougher frozen contaminants can have increasing effects on lift, drag, stall speed, stability and control.

More than 30 factors have been identified that can influence whether frost, ice or snow will accumulate, cause surface roughness on an aircraft and affect the anti-icing properties of freezing point depressant fluids. These factors include ambient temperature; aircraft surface temperature; the de-icing and anti-icing fluid type, temperature and concentration; relative humidity; and wind speed and direction. Because many factors affect the accumulation of frozen contaminants on the aircraft surface, holdover times for freezing point depressant fluids should be considered as guidelines only, unless the operator’s ground icing operations program allows otherwise.

The type of frost, ice or snow that can accumulate on an aircraft while on the ground is a key factor in determining the type of de-icing/anti-icing procedures that should be used.

Where conditions are such that ice or snow may reasonably be expected to adhere to the aircraft, it must be removed before takeoff. Dry, powdery snow can be removed by blowing cold air or compressed nitrogen gas across the aircraft surface. In some circumstances, a shop broom could be employed to clean certain areas accessible from the ground. Heavy, wet snow or ice can be removed by placing the aircraft in a heated hangar, by using solutions of heated freezing point depressant fluids and water, by mechanical means (such as brooms or squeegees), or a combination of all three methods. Should the aircraft be placed in a heated hangar, ensure it is completely dry when moved outside; otherwise, pooled water may refreeze in critical areas or on critical surfaces.

A frost that forms overnight must be removed from the critical surfaces before takeoff. Frost can be removed by placing the aircraft in a heated hangar or by other normal de-icing procedures.

- e) *The Cold-Soaking Phenomenon*: Where fuel tanks are located in the wings of aircraft, the temperature of the fuel greatly affects the temperature of the wing surface above and below these tanks. After a flight, the temperature of an aircraft and the fuel carried in the wing tanks may be considerably colder than the ambient temperature. An aircraft’s cold-soaked wings conduct heat away from precipitation so that, depending on a number of factors, clear ice may form on some aircraft, particularly on wing areas above the fuel tanks. Such ice is difficult to see and, in many instances, cannot be detected other than by touch with the bare hand or by means of a special purpose ice detector.

Clear ice formations could break loose at rotation or during flight, causing engine damage on some aircraft types, primarily those with rear-mounted engines. A layer of slush on the wing can also hide a dangerous sheet of ice beneath.

The formation of ice on the wing is dependent on the type, depth and liquid content of precipitation, ambient air temperature and wing surface temperature. The following factors contribute to the formation intensity and the final thickness of the clear ice layer:

- (i) low temperature of the fuel uplifted by the aircraft during a ground stop and/or the long airborne time of the previous flight, resulting in a situation that the remaining fuel in the wing tanks is subzero. Fuel temperature drops of up to 18°C have been recorded after a flight of two hours;
- (ii) an abnormally large amount of cold fuel remaining in the wing tanks causing fuel to come in contact with the wing upper surface panels, especially in the wing root area;
- (iii) weather conditions at the ground stop, wet snow, drizzle or rain with the ambient temperature around 0°C is very critical. Heavy freezing has been reported during drizzle or rain even in a temperature range between +8° to +14°C.

As well, cold-soaking can cause frost to form on the upper and lower wing under conditions of high relative humidity. This is one type of contamination that can occur in above-freezing weather at airports where there is normally no need for de-icing equipment, or where the equipment is deactivated for the summer. This contamination typically occurs where the fuel in the wing tanks becomes cold-soaked to below-freezing temperatures because of low temperature fuel uplifted during the previous stop, or cruising at altitudes where low temperatures are encountered, or both, and a normal descent is made into a region of high humidity.

In such instances, frost will form on the under and upper sides of the fuel tank region during the ground turn-around time, and tends to re-form quickly even when removed.

Frost initially forms as individual grains about 0.004 of an inch in diameter. Additional build-up comes through grain growth from 0.010 to 0.015 of an inch in diameter, grain layering, and the formation of frost needles. Available test data indicate that this roughness on the wing lower surface will have no significant effect on lift, but it may increase drag and thereby decrease climb gradient capability which results in a second segment limiting weight penalty.

Skin temperature should be increased to preclude formation of ice or frost prior to take-off. This is often possible by refuelling with warm fuel or using hot freezing point depressant fluids, or both.

In any case, ice or frost formations on upper or lower wing surfaces must be removed prior to takeoff. The exception is that takeoff may be made with frost adhering to the underside of the wings provided it is conducted in accordance with the aircraft manufacturer's instructions.

- f) *De-Icing and Anti-Icing Fluids*: Frozen contaminants are most often removed in commercial operations by using freezing point depressant fluids. There are a number of freezing point depressant fluids available for use on commercial aircraft and, to a lesser extent, on general aviation aircraft. De-icing and anti-icing fluids should not be used unless approved by the aircraft manufacturer.

Although freezing point depressant fluids are highly soluble in water, they absorb or melt ice slowly. If frost, ice or snow is adhering to an aircraft surface, the accumulation can be melted by repeated application of proper quantities of freezing point depressant fluid. As the ice melts, the freezing point depressant mixes with the water, thereby diluting the freezing point depressant. As dilution occurs, the resulting mixture may begin to run off the aircraft. If all the ice is not melted, additional application of freezing point depressant becomes necessary until the fluid penetrates to the aircraft surface. When all the ice has melted, the remaining liquid residue is a mixture of freezing point depressant and water at an unknown concentration. The resulting film could freeze (begin to crystallize) rapidly with only a slight temperature decrease. If the freezing point of the film is found to be insufficient, the de-icing procedure must be repeated until the freezing point of the remaining film is sufficient to ensure safe operation.

The de-icing process can be sped up considerably by using the thermal energy of heated fluids and the physical energy of high-pressure spray equipment, as is the common practice.

- g) *SAE and ISO Type I Fluids*: These fluids in the concentrated form contain a minimum of 80% glycol and are considered "unthickened" because of their relatively low viscosity. These fluids are used for de-icing or anti-icing, but provide very limited anti-icing protection.
- h) *SAE and ISO Type II Fluids*: Fluids, such as those identified as SAE Type II and ISO Type II, will last longer in conditions of precipitation. They afford greater margins of safety if they are used in accordance with aircraft manufacturers' recommendations.

Flight tests performed by manufacturers of transport category aircraft have shown that most SAE and ISO Type II fluids flow off lifting surfaces by rotation speeds (V_r), although some large aircraft do experience performance degradation and may require weight or other takeoff compensation. Therefore, SAE and ISO Type II fluids should be used on aircraft with rotation speeds (V_r) above 100 KIAS. Degradation could be significant on aeroplanes with rotation speeds below this figure.

As with any de-icing or anti-icing fluid, SAE and ISO Type II fluids should not be applied unless the aircraft manufacturer has approved their use, regardless of rotation speed. Aircraft manufacturers' manuals may give further guidance on the acceptability of SAE and ISO Type II fluids for specific aircraft.

Some fluid residue may remain throughout the flight. The aircraft manufacturer should have determined that this residue would have little or no effect on aircraft performance or handling qualities in aerodynamically quiet areas; however, this residue should be cleaned periodically.

SAE and ISO Type II fluids contain no less than 50% glycol and have a minimum freeze point of -32°C. They are considered “thickened” because of added thickening agents that enable the fluid to be deposited in a thicker film and to remain on the aircraft surfaces until the time of takeoff. These fluids are used for de-icing (when heated) and anti-icing. Type II fluids provide greater protection (holdover time) than do Type I fluids against frost, ice or snow formation in conditions conducive to aircraft icing on the ground.

These fluids are effective anti-icers because of their high viscosity and pseudoplastic behaviour. They are designed to remain on the wings of an aircraft during ground operations or short-term storage, thereby providing some anti-icing protection and will readily flow off the wings during takeoff. When these fluids are subjected to shear stress (such as that experienced during a takeoff run), their viscosity decreases drastically, allowing the fluids to flow off the wings and causing little adverse effect on the aircraft’s aerodynamic performance.

The pseudoplastic behaviour of SAE and ISO Type II fluids can be altered by improper de-icing/anti-icing equipment or handling. Therefore, some North American airlines have updated de-icing and anti-icing equipment, fluid storage facilities, de-icing and anti-icing procedures, quality control procedures, and training programs to accommodate these distinct characteristics. Testing indicates that SAE and ISO Type II fluids, if applied with improper equipment, may lose 20% to 60% of their anti-icing performance.

All Type II fluids are not necessarily compatible with all Type I fluids; therefore, you should refer to the fluid manufacturer or supplier for further information. As well, the use of Type II fluid over badly contaminated Type I fluid will reduce the effectiveness of the Type II fluid.

SAE and ISO Type II fluids were introduced in North America in 1985, with widespread use beginning to occur in 1990. Similar fluids, but with slight differences in characteristics, have been developed, introduced, and used in Canada.

- i) *Type III Fluids:* Type III is a thickened freezing point depressant fluid which has properties that lie between Types I and II. Therefore, it provides a longer holdover time than Type I, but less than Type II. Its shearing and flow-off characteristics are designed for aircraft that have a shorter time to the rotation point. This should make it acceptable for some aircraft that have a V_r of less than 100 KIAS.

The SAE had approved a specification in AMS1428A for Type III anti-icing fluids that can be used on those aircraft

with rotation speeds significantly lower than the large jet rotation speeds, which are 100 KIAS or greater. No fluid has yet been identified that can meet the entire Type III fluid specification. Pending publication of a Type III Holdover Time Table and availability of suitable fluids, the Union Carbide Type IV fluid in 75/25 dilution may be used for anti-icing purposes on low rotation speed aircraft, but only in accordance with aircraft and fluid manufacturer’s instructions.

- j) *Type IV Fluids:* A significant advance is Type IV anti-icing fluid. These fluids meet the same fluid specifications as the Type II fluids and in addition have a significantly longer holdover time. In recognition of the above, Holdover Time Tables are available for Type IV.

The product is dyed green as it is believed that the green product will provide for application of a more consistent layer of fluid to the aircraft and will reduce the likelihood that fluid will be mistaken for ice. However, as these fluids do not flow as readily as conventional Type II fluid, caution should be exercised to ensure that enough fluid is used to give uniform coverage.

Research indicates that the effectiveness of a Type IV fluid can be seriously diminished if proper procedures are not followed when applying it over Type I fluid.

All fluid users are advised to ensure that these fluids are applied evenly and thoroughly and that an adequate thickness has been applied in accordance with the manufacturer’s recommendations. Particular attention should be paid to the leading edge area of the wing and horizontal stabilizer.

Further information on aircraft critical surface contamination may be found in When in Doubt... Small and Large Aircraft—Aircraft Critical Surface Contamination Training for Aircrew and Groundcrew (TP 10643), a TC publication available online at www.tc.gc.ca/eng/civilaviation/publications/tp10643-menu-1118.htm. A CD-ROM, with the same title and an accompanying workbook, is also available for order. The priced CD-ROM and workbook may be ordered from the TC Publications Order Desk using one of the methods listed below.

Transport Canada Publications Order Desk
Operational Support Services (AAFBD)
2655 Lancaster Road
Ottawa ON K1B 4L5

Tel. (toll-free in North America):..... 1-888-830-4911
.....613-991-4071
Fax:..... 613-991-1653
Email:..... publications@tc.gc.ca
Web site:..... www.tc.gc.ca/en/transport-canada/corporate/publications.html



2.12.3 Aircraft Contamination in Flight – In-flight Airframe Icing

Airframe icing can be a serious weather hazard to fixed and rotary wing aircraft in flight. Icing will result in a loss of performance in the following areas:

- a) ice accretion on lifting surfaces will change their aerodynamic properties resulting in a reduction in lift, increase in drag and weight with a resultant increase in stalling speed and a reduction in the stalling angle of attack. Therefore, an aerodynamic stall can occur before the stall warning systems activate;
- b) ice adhering to propellers will drastically affect their efficiency and may cause an imbalance with resultant vibration;
- c) ice adhering to rotor blades will degrade their aerodynamic efficiency. This means that an increase in power will be required to produce an equivalent amount of lift. Therefore, during an autorotation this increase can only come from a higher than normal rate of descent. In fact, it may not be possible to maintain safe rotor RPM's during the descent and flare due to ice contamination;
- d) ice on the windshield or canopy will reduce or block vision from the flight deck or cockpit;
- e) carburetor icing, see AIR 2.3; and
- f) airframe ice may detach and be ingested into jet engine intakes causing compressor stalls, loss of thrust and flame out.

2.12.3.1 Types of Ice

There are three types of ice which pilots must contend with in flight: Rime Ice, Clear Ice and Frost (see MET 2.4). For any ice to form the OAT must be at or below freezing with the presence of visible moisture.

Rime ice commonly found in stratiform clouds is granular, opaque and pebbly and adheres to the leading edges of antennas and windshields. Rime ice forms in low temperatures with a low concentration of small super-cooled droplets. It has little tendency to spread and can easily be removed by aircraft de-icing systems.

Clear ice commonly found in cumuliiform clouds is glassy, smooth and hard, and tends to spread back from the area of impingement. Clear ice forms at temperatures at or just below 0°C with a high concentration of large super-cooled droplets. It is the most serious form of icing because it adheres firmly and is difficult to remove.

Frost may form on an aircraft in flight when descent is made from below-freezing conditions to a layer of warm, moist air. In these circumstances, vision may be restricted as frost forms on the windshield or canopy.

Additional references on icing include MET 2.4 and the *Air Command Weather Manual* (TP 9352E).

2.12.3.2 Aerodynamic Effects of Airborne Icing

Commercial pilots are familiar with the classic aerodynamic effects of ice accumulation on an aeroplane in flight. These can include:

- a) reduced lift accompanied by significant increases in drag and increases in weight;
- b) increases in stall speed and reduced stall angle of attack as ice alters the shape of an airfoil and disrupts airflow;
- c) reduced thrust due to ice disrupting the airflow to the engine and/or degrading propeller efficiency. Ice ingested into a jet engine may induce a compressor stall and/or a flame out;
- d) control restrictions due to water flowing back into control surfaces and freezing;
- e) ice adhering to rotor blades will degrade their aerodynamic efficiency. This means that an increase in power will be required to produce an equivalent amount of lift. Therefore, during an autorotation this increase can only come from a higher than normal rate of descent. In fact, it may not be possible to maintain safe rotor RPM during the descent and flare due to ice contamination;
- f) ice on the windshield or canopy will reduce or block vision from the flight deck or cockpit; and
- g) carburetor icing (see AIR 2.3).

2.12.3.3 Roll Upset

Roll upset describes an uncommanded and possibly uncontrollable rolling moment caused by airflow separation in front of the ailerons, resulting in self-deflection of unpowered control surfaces. It is associated with flight in icing conditions in which water droplets flow back behind the protected surfaces before freezing and form ridges that cannot be removed by de-icing equipment. Roll upset has recently been associated with icing conditions involving large super-cooled droplets; however, it theoretically can also occur in conventional icing conditions when temperatures are just slightly below 0°C.

The roll upset can occur well before the normal symptoms of ice accretion are evident to the pilot, and control forces may be physically beyond the pilot's ability to overcome. Pilots may receive a warning of incipient roll upset if abnormal or sloppy aileron control forces are experienced after the autopilot is disconnected when operating in icing conditions.

Corrective Actions

If severe icing conditions are inadvertently encountered, pilots should consider the following actions to avoid a roll upset:

1. Disengage the autopilot. The autopilot may mask important clues or may self disconnect when control forces exceed limits, presenting the pilot with abrupt unusual attitudes and control forces.
2. Reduce the angle of attack by increasing speed. If turning, roll wings level.
3. If flaps are extended, do not retract them unless it can be determined that the upper surface of the wing is clear of ice. Retracting the flaps will increase the angle of attack at any given airspeed, possibly leading to the onset of roll upset.
4. Set appropriate power and monitor airspeed /angle of attack.
5. Verify that wing ice protection is functioning symmetrically by visual observation if possible. If not, follow the procedures in the aircraft flight manual.

2.12.3.4 Tail Plane Stall

As the rate at which ice accumulates on an airfoil is related to the shape of the airfoil, with thinner airfoils having a higher collection efficiency than thicker ones, ice may accumulate on the horizontal stabilizer at a higher rate than on the wings. A tail plane stall occurs when its critical angle of attack is exceeded. Because the horizontal stabilizer produces a downward force to counter the nose-down tendency caused by the centre of lift on the wing, stall of the tail plane will lead to a rapid pitch down. Application of flaps, which may reduce or increase downwash on the tail plane depending on the configuration of the empennage (i.e. low set horizontal stabilizer, mid-set, or T-tail), can aggravate or initiate the stall. Therefore, pilots should be very cautious in lowering flaps if tail plane icing is suspected. Abrupt nose-down pitching movements should also be avoided, since these increase the tail plane angle of attack and may cause a contaminated tail plane to stall.

A tail plane stall can occur at relatively high speeds, well above the normal 1G stall speed. The pitch down may occur without warning and be uncontrollable. It is more likely to occur when the flaps are selected to the landing position, after a nose-down pitching manoeuvre, during airspeed changes following flap extension, or during flight through wind gusts.

Symptoms of incipient tail plane stall may include:

- a) abnormal elevator control forces, pulsing, oscillation, or vibration;
- b) an abnormal nose-down trim change (may not be detected if autopilot engaged);
- c) any other abnormal or unusual pitch anomalies (possibly leading to pilot induced oscillations);

- d) reduction or loss of elevator effectiveness (may not be detected if the autopilot is engaged);
- e) sudden change in elevator force (control would move down if not restrained); and/or
- f) a sudden, uncommanded nose-down pitch.

Corrective Actions

If any of the above symptoms occur, the pilot should consider the following actions unless the aircraft flight manual dictates otherwise:

- a) Plan approaches in icing conditions with minimum flap settings for the conditions. Fly the approach on speed for the configuration.
- b) If symptoms occur shortly after flap extension, immediately retract the flaps to the previous setting. Increase airspeed as appropriate to the reduced setting.
- c) Apply sufficient power for the configuration and conditions. Observe the manufacturer's recommendations concerning power settings. High power settings may aggravate tail plane stall in some designs.
- d) Make any nose-down pitch changes slowly, even in gusting conditions, if circumstance allow.
- e) If equipped with a pneumatic de-icing system, operate several times to attempt to clear ice from the tail plane.

WARNINGS

1. At any flap setting, airspeed in excess of the manufacturer's recommendations for the configuration and environmental conditions, accompanied by uncleared ice on the tail plane, may result in a tail plane stall and an uncontrollable nose-down pitch.
2. Improper identity of the event and application of the wrong recovery procedure will make an already critical situation even worse. This information concerning roll upset and tail plane stall is necessarily general in nature, and may not be applicable to all aircraft configurations. Pilots must consult their aircraft flight manual to determine type specific procedures for these phenomena.

2.12.3.5 Freezing Rain, Freezing Drizzle, and Large Super-Cooled Droplets

The classical mechanism producing freezing rain and/or freezing drizzle aloft involves a layer of warm air overlaying a layer of cold air. Snow falling through the warm layer melts, falls into the cold air, becomes supercooled, and freezes on contact with an aircraft flying through the cold air. Freezing rain and freezing drizzle are therefore typically found near warm fronts and trowals, both of which cause warm air to overlay cold air. Freezing rain or freezing drizzle may also occur at cold fronts, but are less

common and would have a lesser horizontal extent due to the steeper slope of the frontal surface. The presence of warm air above has always provided a possible escape route to pilots who have encountered classical freezing precipitation aloft through a climb into the warm air.

Recent research has revealed that there are other non-classical mechanisms that produce freezing precipitation aloft. Flights by research aircraft have encountered freezing drizzle at temperatures down to -10°C at altitudes up to 15000 feet ASL. There was no temperature inversion—that is, no warm air aloft—present in either case. Pilots must be aware that severe icing may be encountered in conditions unrelated to warm air aloft. They must also understand that, if non-classical freezing drizzle is encountered in flight, the escape route of a climb into warmer air may not be immediately available; however, climbing remains the preferred escape route. It should allow the aircraft to reach an altitude above the formation region, while a descent may keep the aircraft in freezing precipitation. It should be noted that, while ascending, the aircraft might get closer to the source region with smaller droplets, higher liquid water content and conventional icing.

2.12.3.6 Detecting Large Super-Cooled Droplets Conditions in Flight

Visible clues to flight crew that the aircraft is operating in large super-cooled droplets conditions will vary from type to type. Manufacturers should be consulted to assist operators in identifying the visible clues particular to the type operated. There are, however, some general clues of which pilots should be aware:

- a) ice visible on the upper or lower surface of the wing aft of the area protected by de-icing equipment (irregular or jagged lines of ice or pieces that are self-shedding);
- b) ice adhering to non-heated propeller spinners farther aft than normal;
- c) granular dispersed ice crystals or total translucent or opaque coverage of the unheated portions of front or side windows. This may be accompanied by other ice patterns on the windows such as ridges. Such patterns may occur within a few seconds to one half minute after exposure to large super-cooled droplets;
- d) unusually extensive coverage of ice, visible ice fingers or ice feathers on parts of the airframe on which ice does not normally appear; and
- e) significant differences between airspeed or rate of climb expected and that attained at a given power setting.

Additional clues significant at temperatures near freezing:

- a) visible rain consisting of very large droplets. In reduced visibility selection of landing or taxi lights “on” occasionally will aid detection. Rain may also be detected by the audible impact of droplets on the fuselage;
- b) droplets splashing or splattering on the windscreen. The 40 to 50 micron droplets covered by Appendix C to Chapter 525 of the Airworthiness Manual icing criteria (Appendix C lists the certification standard for all transport category aeroplanes for flight in known icing), are so small that they cannot usually be detected; however freezing drizzle droplets can reach sizes of 0.2 to 0.5 mm and can be seen when they hit the windscreen;
- c) water droplets or rivulets streaming on windows, either heated or unheated. Streaming droplets or rivulets are indicators of high liquid water content in any sized droplet; and/or
- d) weather radar returns showing precipitation. Whenever the radar indicates precipitation in temperatures near freezing, pilots should be alert for other clues of large super-cooled droplets.

2.12.3.7 Flight Planning or Reporting

Pilots should take advantage of all information available to avoid or, at the very least, to plan a safe flight through known icing conditions. As well as FAs, TAFs, and METARs, pilots should ask for pertinent SIGMETs and any PIREPs received along the planned route of flight. Significant Weather Prognostic Charts should be studied, if available. Weather information should be analyzed to predict where icing is likely to be found, and to determine possible safe exit procedures should severe icing be encountered. Pilots should routinely pass detailed PIREPs whenever icing conditions are encountered.

2.12.4 Landing Wheel-Equipped Light Aircraft on Snow Covered Surfaces

During the course of each winter, a number of aircraft accidents have occurred due to pilots attempting to land wheel-equipped aircraft on surfaces covered with deep snow. This has almost invariably resulted in the aircraft nosing over.

Light aircraft should not be landed on surfaces covered with snow unless it has previously been determined that the amount of snow will not constitute a hazard.

2.12.5 Use of Seaplanes on Snow Surfaces

The operation of float-equipped aircraft or flying boats from snow covered surfaces will be permitted by Transport Canada under the following conditions:

- a) the pilot and operator will be held responsible for confining all flights to those snow conditions found to be satisfactory as a result of previous tests or experimental flights in that type of aircraft;
- b) passengers should not be carried; and
- c) a thorough inspection of the float or hull bottom, all struts and fittings, all wing fittings, bracing, wing tip floats and fittings should be carried out after every flight to ensure that the aircraft is airworthy.

Seaplanes should not be landing on, or taking off from, snow surfaces except under conditions of deep firm snow, which should not be drifted or heavily crusted.

Flights should not be attempted if there is any adhesion of ice or snow to the under surface of the float or hull. When landing or forced landing a ski or float equipped aeroplane on unbroken snow surfaces, the procedure in AIR 2.11.4 is recommended.

2.12.6 Landing Seaplanes on Unbroken Snow Conditions

It has been found practically impossible to judge altitude when landing a skiplane or seaplane under certain conditions of surface and light. Under such conditions the procedures for landing seaplanes on glassy water should be used (see AIR 2.11.4).

2.12.7 Whiteout

Whiteout (also called milky weather) is defined in the *Glossary of Meteorology* (published by the American Meteorological Society) as:

“An atmospheric optical phenomenon of the polar regions in which the observer appears to be engulfed in a uniformly white glow. Neither shadows, horizon, nor clouds are discernible; sense of depth and orientation is lost; only very dark, nearby objects can be seen. Whiteout occurs over an unbroken snow cover and beneath a uniformly overcast sky, when with the aid of the snowblink effect, the light from the sky is about equal to that from the snow surface. Blowing snow may be an additional cause.”

Light carries depth perception messages to the brain in the form of colour, glare, shadows, and so on. These elements have one thing in common, namely, they are all modified by the direction of the light and changes in light intensity. For example, when shadows occur on one side of objects, we subconsciously become aware that the light is coming from the other. Thus, nature provides many visual clues to assist us in discerning objects and judging distances. What happens if these clues are removed?

Let's suppose that these objects on the ground and the ground itself are all white. Add to that, a diffused light source through an overcast layer which is reflected back in all directions by the white surface so that shadows disappear. The terrain is now virtually devoid of visual clues and the eye no longer discerns the surface or terrain features.

Since the light is so diffused, it is likely that the sky and terrain will blend imperceptibly into each other, obliterating the horizon. The real hazard in whiteout is the pilot not suspecting the phenomenon because the pilot is in clear air. In numerous whiteout accidents, pilots have flown into snow-covered surfaces unaware that they have been descending and confident that they could “see” the ground.

Consequently, whenever a pilot encounters the whiteout conditions described above, or even a suspicion of them, the pilot should immediately climb if at low level, or level off and turn towards an area where sharp terrain features exist. The flight should not proceed unless the pilot is prepared and competent to traverse the whiteout area on instruments.

In addition, the following phenomena are known to cause whiteout and should be avoided if at all possible:

- a) water-fog whiteout resulting from thin clouds of super-cooled water droplets in contact with the cold snow surface. Depending on the size and distribution of the water droplets, visibility may be minimal or nil in such conditions.
- b) blowing snow whiteout resulting from fine snow being plucked from the surface by winds of 20 kt or more. Sunlight is reflected and diffused resulting in a nil visibility whiteout condition.
- c) precipitation whiteout resulting from small wind-driven snow crystals falling from low clouds above which the sun is shining. Light reflection complicated by spectral reflection from the snow flakes and obscuration of land marks by falling snow can reduce visibility and depth perception to nil in such conditions.

If at all possible, pilots should avoid such conditions unless they have the suitable instruments in the aircraft and are sufficiently experienced to use a low-speed and minima rate of descent technique to land the aircraft safely.

2.13 FLIGHT OPERATIONS IN MOUNTAINOUS AREAS

The importance of proper training, procedures and pre-flight planning when flying in mountainous regions is emphasized.

In the Pacific area, the combined effect of the great mountain system and the adjacent Pacific Ocean lead to extremely changeable weather conditions and a variety of weather patterns. Some of the factors to be taken into consideration regarding the

effect on aircraft performance when operating under these conditions include the following:

- a) elevation of the airport;
- b) temperature and pressure;
- c) turbulence and wind effect; and
- d) determination of safe takeoff procedures to ensure clearance over obstacles and intervening high ground.

In the western mountainous region VFR routes may be marked by diamonds on visual navigation charts. The routes are marked for convenience to assist pilots with pre-flight planning. The diamond marks do not imply any special level of facilities and services along the route. Pilots are cautioned that the use of the marked routes does not absolve them from proper pre-flight planning or the exercising of good airmanship practices during the proposed flight. Alternative unmarked routes are always available, the choice of a suitable route for the intended flight and conditions remains the sole responsibility of the pilot-in-command.

2.14 FLIGHT OPERATIONS IN SPARSELY SETTLED AREAS OF CANADA

(See *AIP Canada (ICAO)* GEN 1.5)

2.14.1 Single-Engine Aircraft Operations in Northern Canada

(See *AIP Canada (ICAO)* GEN 1.5)

2.15 FLIGHT OPERATIONS AT NIGHT

There are many risks associated with operating aircraft in dark-night conditions where maintaining orientation, navigation and weather avoidance may become extremely difficult. Takeoff and landing may be particularly dangerous for both VFR and IFR pilots.

A variety of illusions may result at night because of a lack of outside visual cues. Your best defense, if you do not hold an instrument rating, is to receive some instrument training, and to be aware of the illusions and their counter measures.

2.16 VERTICAL PATH CONTROL ON NON-PRECISION APPROACHES (NPAs)

2.16.1 Controlled Flight Into Terrain (CFIT)

Controlled Flights Into Terrain (CFIT) continue to be a major threat to civil aviation safety in Canada. A stabilized final approach during an NPA has been recognized by the ICAO CFIT

Task Force as an aid to prevent CFIT. The step-down technique presumed by NPA procedure design may have been appropriate for early piston transport aircraft, but it is less suited to larger jet transport aircraft.

When using the step-down technique, the aircraft flies a series of vertical descents during the final approach segment as it descends and levels off at the minimum IFR altitudes published for each segment of the approach. The successive descents and level-offs result in significant changes in power settings and pitch attitudes and for some aircraft, may prevent the landing configuration from being established until landing is assured. Using the step-down technique, the aircraft may have to be flown at minimum IFR altitudes for each segment of the approach and consequently be exposed to reduced obstacle separation for extended periods of time. A premature descent or a missed level-off could render the aircraft vulnerable to a CFIT accident.

Many air operators require their flight crews to use a stabilized approach technique which is entirely different from that envisaged in the original NPA procedure design. The stabilized approach is calculated to achieve a constant rate of descent at an approximate 3° flight path angle with stable airspeed, power setting, and attitude, and also with the aircraft configured for landing. The safety benefits derived from the stabilized final approach have been recognized by many organizations including ICAO, the FAA and TCCA. Those air operators not already doing so are encouraged to incorporate stabilized approach procedures into their SOPs and training syllabi.

CAUTION:

Caution should be exercised when descending below the MDA while following an FMS-generated vertical path. Unlike vertically guided approaches, which have their OCSs verified below the DA, OCSs on LNAV procedures below the MDA have NOT been assessed. As a result, obstacles may penetrate the computer-generated flight path. Pilots are reminded to visually scan for obstacles before descending below the MDA.

VASI and PAPI are calibrated for a defined geometric vertical path angle. In cold temperatures, a non-temperature compensated barometric FMS-generated vertical path may be lower than that of a calibrated VASI or PAPI. In high temperatures, a barometric FMS-generated vertical path will be higher than that of a calibrated VASI or PAPI. Pilots should be aware of this limitation and operate accordingly.

2.16.2 Stabilized Approach

An approach is considered stabilized when it satisfies the associated conditions, typically defined by an air operator in their company operations manual (COM) or SOPs, as they may relate to the:

- a) range of speeds specific to the aircraft type;
- b) power setting(s) specific to the aircraft type;

- c) range of attitudes specific to the aircraft type;
- d) configuration(s) specific to the aircraft type;
- e) crossing altitude deviation tolerances;
- f) sink rate; and
- g) completion of checklists and flight crew briefings.

Stabilized approach procedures should be defined for all approaches and may include the following:

- a) a flight profile should be stabilized at an altitude not lower than 1 000 ft above the threshold when in IMC;
- b) a flight profile should be stabilized at an altitude not lower than 500 ft above the threshold;
- c) a flight profile should remain stabilized until landing;
- d) a go-around is required if a flight profile is not stabilized in accordance with these requirements or if the flight profile subsequently becomes destabilized.

2.16.3 Vertical Path Control Techniques

There are typically three vertical path control techniques available for an NPA:

- (i) step-down;
- (ii) constant descent angle; or
- (iii) stabilized constant descent angle (SCDA).

NOTE:

Constant descent angle is equivalent to ICAO's constant angle descent, and SCDA is considered a form of ICAO's continuous descent final approach (CDFA). In the interest of respecting terminology already in use in the Canadian civil aviation industry and standardization with NAV CANADA charting, the above terminology has been adopted.

While NPA procedures themselves are not inherently unsafe, the use of the step-down descent technique to conduct an NPA is prone to error and is therefore discouraged where other methods are available. When using the step-down technique during the final approach segment, the flight crew member flies an unstable vertical profile by descending and levelling off at the minimum altitudes published for each segment of the approach and then, if the required visual references have been acquired, descending from the MDA to a landing.

The risks associated with conducting an NPA can be mitigated by using an angular vertical profile instead of the step-down technique described above. The use of an angular vertical profile increases the likelihood of the approach being conducted in a stabilized manner. When conducting an NPA using an angular vertical profile, the vertical path may be intercepted prior to the FAF at a higher altitude.

Ideally, the angle to be used for an angular vertical path is obtained from the approach chart. If the approach chart does not contain a published constant descent angle, the angle may be calculated using an approved method provided to the flight crew in the air operator's SOPs or by using tables such as those found in Appendix 1 of *Advisory Circular (AC) 700-028*. Flight crew members must be aware of the risks associated with manually calculating the descent angle as a calculation error could lead to the use of the wrong descent angle. It is strongly recommended that flight crew members become proficient with manually calculating the descent angle before doing so under high workload conditions.

Regardless of the type of vertical path control technique used on an NPA, the lateral "turning" portion of the missed approach may not be executed prior to the MAP. However, the climb portion of a missed approach procedure may be commenced at any point along the final approach. In addition, during cold weather operations, a temperature correction must be applied to all minimum altitudes, no matter what type of vertical control path technique is used.

Except in the case of an air operator conducting operations in accordance with an exemption to Paragraph 602.128(2)(b) of the CARs, a flight crew member may not descend below the MDA if the visual references required to land have not been acquired. A correction to the MDA may be required to ensure that the aircraft does not descend below the MDA during the transition from a descent to the climb required by a missed approach procedure.

In 2013, NAV CANADA will begin the publication of approach charts which include constant descent angle information in a tabular form and in the profile view. The inclusion of this information is intended to facilitate the use of the stabilized approach techniques described in *AC 700-028* and to reduce the possibility of calculation errors.

To facilitate the stabilized descent, some avionics, such as baro-VNAV-capable (barometric vertical navigation) and WAAS-capable (wide area augmentation system) systems, generate a calculated vertical profile and the guidance to follow this profile. When conducting an NPA, the vertical guidance generated by the navigation system is advisory only. Flight crew members must use the barometric altimeter as the primary altitude reference to ensure compliance with any and all altitude restrictions. Special consideration is required when using advisory vertical guidance generated by WAAS-capable equipment. Flight crew members should refer to the manufacturer's operating guides or limitations.

Further information and descriptions of the techniques available for conducting the vertical portion of an NPA are contained in *AC 700-028*. <www.tc.gc.ca/eng/civilaviation/opssvs/managementservices-referencecentre-ac-700-menu-511.htm>

3.0 MEDICAL INFORMATION

3.1 GENERAL HEALTH

A healthy pilot is as essential to a safe flight as a mechanically sound aircraft. There is no precise regulation that tells pilots whether they are fit to fly and there is no pre-flight inspection to ensure fitness. Therefore, individuals must base their decision to fly on common sense, good judgement, and training prior to each flight. While flying an aircraft, a pilot must not have any condition that impairs alertness, reaction time or decision-making ability. Persons with conditions that could result in sudden or subtle incapacitation, such as epilepsy, heart disease, diabetes requiring insulin, or psychiatric illnesses, cannot be medically certified until their case is reviewed by the Civil Aviation Medicine Branch. Conditions such as anaemia, acute infections and gastrointestinal illnesses are temporarily disqualifying. When there is any doubt about their health, pilots should consult their physician or Civil Aviation Medical Examiner (CAME).

3.1.1 Mandatory Medical Reporting

Pilots are reminded that section 6.5 of the *Aeronautics Act* requires them to identify themselves as the holder of a pilot's licence prior to the commencement of any examination by a physician or optometrist. Section 6.5 further requires that the attending physician or optometrist notify the Minister of any finding that may constitute a hazard to aviation safety.

Section 6.5 also deems the pilot to have consented to the release of aviation-related findings by the physician or optometrist to the Minister.

3.2 SPECIFIC AEROMEDICAL FACTORS

3.2.1 Hypoxia

The literal definition of hypoxia is "low oxygen". Therefore, hypoxia implies a lack of sufficient oxygen for the body to operate normally. Its onset is insidious and may be accompanied by a feeling of well being, known as euphoria. Even minor hypoxia impairs night vision and slows reaction time. More serious hypoxia interferes with reasoning, gives rise to unusual fatigue and, finally, results in a loss of consciousness. Hypoxia is classified into four different types; all are relevant to pilots and merit consideration.

a) Hypoxic hypoxia

Hypoxic hypoxia is the result of low oxygen levels in the bloodstream. In pilots, this most often occurs with exposure to altitude (hypobaric hypoxia). At low altitudes, the partial pressure of oxygen in the atmosphere is adequate to maintain brain function at peak efficiency. Atmospheric pressure and the partial pressure of oxygen both decline at higher altitudes. At 8 000 ft ASL (2 440 m), some people may notice a slight

increase in heart rate and speed of breathing (respiratory rate). By 10 000 ft ASL (3 030 m), the partial pressure of oxygen is low enough that all pilots will experience mild hypoxia and some will become symptomatic. Pilots operating at this altitude or higher should be alert for unusual difficulty completing routine calculations and should take corrective action if difficulties are noted. To avoid hypoxia, do not fly above 10 000 ft ASL (3 050 m) without supplemental oxygen or cabin pressurization.

b) Anaemic hypoxia

Oxygen in blood is carried by haemoglobin, which is found in red blood cells. When the red blood cell count decreases, or the haemoglobin does not function properly, less oxygen can be carried by the blood. This can occur in conditions such as heavy bleeding, some cancers, sickle cell anaemia, or carbon monoxide poisoning, to name a few. A person suffering from anaemia may notice symptoms such as breathlessness, fatigue, or chest pain, and symptoms will worsen at higher altitudes, as the effects of hypoxia and anaemia are additive.

c) Ischaemic hypoxia/stagnant hypoxia

The term ischaemia refers to inadequate supply of blood, and ischaemic hypoxia occurs when there is inadequate blood flow to body tissues. This can occur with constriction of blood vessels (for example, this is often seen in fingers and toes exposed to cold) as well as in situations of low blood pressure and cardiac output such as fainting, or during exposure to high sustained accelerations (stagnant hypoxia). Oxygen therapy is not very helpful in this form of hypoxia. The best remedy is to correct the underlying cause.

d) Histotoxic hypoxia

Histotoxic hypoxia refers to an inability of the cells of the body to use the oxygen available. This type of hypoxia is rare in pilots, but it can occur with certain conditions such as cyanide poisoning, chemical poisoning, and intoxication with certain drugs. Histotoxic hypoxia can also be caused by high blood alcohol levels.

3.2.2 Carbon Monoxide

Carbon monoxide is a colourless, odourless, tasteless gas that is a product of incomplete combustion. Haemoglobin, the oxygen-carrying chemical in the blood, picks up carbon monoxide over 200 times more readily than it picks up oxygen. Thus, even minute quantities in the cockpit (often from improperly vented exhaust fumes) may result in pilot incapacitation.

The symptoms of carbon monoxide poisoning are insidious. Initially, there is an inability to concentrate, thinking becomes blurred, and subsequently dizziness and headache develop. If any of these symptoms are noticed, pilots should turn off the heater, open the air ventilators and descend to a lower altitude

if it is safe to do so. If oxygen is available, it should be used. If an exhaust leak is suspected, the pilot should land the aircraft as soon as possible.

Smoking is a source of carbon monoxide. Smokers carry some carbon monoxide in their blood all the time, and may have 5 to 10 percent of their haemoglobin saturated with carbon monoxide. This reduces the oxygen-carrying capacity of the blood and smokers may become hypoxic at altitudes below 10 000 ft ASL (3 050 m).

Catalytic heaters consume oxygen and can produce carbon monoxide. For this reason they should not be used on an aircraft.

3.2.3 Hyperventilation

Hyperventilation most commonly occurs in association with anxiety, fear, or during intense concentration on a difficult task, such as performing a complicated approach procedure. Normally, the rate of breathing is controlled by the amount of carbon dioxide in the lungs and in the blood. In hyperventilation, carbon dioxide is blown off and the level of carbon dioxide in the blood drops below normal. Pilots may notice dizziness, a feeling of coldness, a sensation like a tight band around the head and pins and needles in the hands and feet, and cramping and spasms of the hands and feet. Paradoxically, they will often feel as though they cannot get enough air. Continued hyperventilation may result in a loss of consciousness. The symptoms of hyperventilation, particularly the shortness of breath, are not unlike those of hypoxia, so rather than trying to make the diagnosis, follow the procedure below:

- a) Breathe oxygen, if available, at 100 percent. If hypoxia is the cause, the symptoms will improve markedly after three or four breaths.
- b) If the symptoms persist, consciously slow the rate of breathing to 10–12 breaths per minute and do not breathe deeply. Breathing slowly and deeply into a paper bag is helpful, although obviously not always practical during flight. Keep the respiratory rate slow until the symptoms disappear. If below 8 000 ft ASL (2 440 m), hypoxia is unlikely to be the cause of the problem.

3.3 DECOMPRESSION SICKNESS

At ground level, the body tissues are saturated with nitrogen, the inert gas that makes up 80 percent of our atmosphere. During a rapid ascent, the rapid lowering of the external barometric pressure allows the nitrogen gas to form small bubbles (an example of this phenomenon is the bubbles formed when a bottle of pop is opened). The nitrogen bubbles form in and around blood vessels, joints and muscles, causing pain and cramps (the bends). They can also form under the skin, causing itching and tingling (the creeps), or in the lung, causing chest pain and shortness of breath (the chokes). Severe cases may result in a loss of consciousness. The risks associated with decompression sickness increase with high rates of climb, age, obesity, physical activity

and low temperatures. Flight operations above a cabin altitude of 20 000 ft ASL (6 100 m) should not be attempted unless crew members and passengers have completed specialized high-altitude indoctrination training. When decompression sickness is encountered, an immediate descent to a lower altitude is required.

3.4 SCUBA DIVING

Although normally decompression sickness does not occur below 20 000 ft ASL (6 100 m), people who fly after scuba diving may develop the symptoms at much lower altitudes. Atmospheric pressure beneath the water increases by one atmosphere for every 33 ft (10 m) of descent. Divers who breathe pressurized air for more than a few minutes supersaturate their tissues with nitrogen. For this reason, as the aircraft ascends, nitrogen bubble formation may take place, causing the bends. After dives of less than 33 ft (1 atmosphere pressure), where decompression stops were not required, flights up to altitudes of 8 000 ft ASL (2 440 m) should be avoided for 12 hr. Where decompression stops have been required while returning to the surface, the interval should be 24 hr. For flights above 8 000 ft ASL (2 440 m), the interval is 24 hr regardless of the type of dive, as even pressurized aircraft may lose cabin pressurization.

3.5 VISION

The retina of the eye is more sensitive to hypoxia than any part of the body; one of the first symptoms of hypoxia is a decrease in night vision. For this reason, pilots flying at night are advised to use oxygen, if available, from the ground up.

Many factors affect vision. Hypoxia, carbon monoxide poisoning, alcohol, drugs, fatigue and smoking are only a few of these. After time spent in bright sunlight, the eye is slow to adapt to darkness and this may reduce night vision. To improve dark adaption, pilots should use sunglasses during the day to avoid eye fatigue. At night, cockpit lights should be kept low to maintain the dark adaption needed to see clearly outside the cockpit.

Despite modern electronics, pilots still fly in a “see-and-be seen” world. For best results, good vision is only one of the requirements. In the cockpit, it must be reinforced with good visual scan practices, especially at night. Such practices are an acquired, not an inherent, skill. In performing a visual scan, the eyes should be focused at a range that will ensure detection of traffic while there is still time to take avoiding action. This requires that pilots take an object on the horizon, focus on it and then scan all sectors of the sky, refocusing as needed to avoid “empty-field myopia” (empty-sky myopia), which can result from gazing at a featureless landscape or cloudscape. Conscientious scanning of all sections of the sky, interspersed with brief interludes of focusing on distant objects, will improve a pilot’s ability to detect distant aircraft. A clean canopy is also essential, particularly with bright sunlight. Spots on the windshield easily lead to dazzle glare and can interfere with long-range focus.

The same scan is required at night, with one difference: the part of the eye that is best suited for night vision is not in the centre. An object detected in barely adequate light will disappear if viewed directly, but will often reappear if one looks 10 to 15° to one side of the object.

Technological changes and medical experience has brought forward a proliferation in the availability and options in eye surgery directed at improving visual acuity. The Civil Aviation Medicine Branch continues to monitor this progress and has adapted the medical guidelines regarding certification for flight to reflect the growing body of knowledge and experience in this important area. The most recent information and recommendations on eye surgery can be found on the following Civil Aviation Medicine Web site: www.tc.gc.ca/eng/civilaviation/opssvs/cam-eyesurgery-75.htm.

3.6 MIDDLE-EAR AND SINUS DISCOMFORT OR PAIN

The middle ear is similar to a box: closed at one end by a flexible cover (the ear drum) and drained at the other end by a thin, straight tube (the Eustachian tube). As the aircraft climbs, air in the body cavities expands as the barometric pressure decreases. Normally, air will escape from the middle ear and the sinuses and pilots will only notice their ears “popping”. The outlet of the Eustachian tubes, however, is narrow and, if the pilot has a head cold or a throat infection, local swelling may narrow it. On ascent, air may still be able to escape, but on descent—particularly at high rates—the outlet may close like a flap, preventing air from re-entering the middle-ear cavity. The increasing ambient air pressure will then force the eardrum inward. This can lead to severe pain and decreased hearing.

Pressure in the ears can be equalized by opening and closing the mouth, swallowing, yawning, chewing gum or by holding the nostrils shut while gently blowing the nose. If the pressure in the ears (or sinuses) cannot be relieved by these manoeuvres, it is best to climb back to the original altitude or to a higher level (if this is necessary, ATC should of course be kept informed). The ears should then be cleared and a gradual descent made, clearing the ears frequently on the way down. Sometimes, the pressure in the middle ear on descent is so low relative to the external pressure that the eardrum can bleed and even rupture. This is known as barotrauma. If barotrauma occurs, a physician familiar with aeromedical conditions should be seen for treatment as soon as possible after landing.

The best advice to pilots or passengers who are suffering from head colds, sore throats or allergies is to wait until the inflammation has subsided before flying. Nasal sprays can help provide relief, but this is only temporary. A cold lasts only a few days, but a blown eardrum may take weeks to recover!

3.7 DISORIENTATION

Pilots sometimes refer to disorientation as “vertigo”, by which they mean not knowing which way is up. On the ground, spatial orientation is sensed by the combination of vision, muscle sense, and specialized organs in the inner ear that sense accelerations and position. Vision is the strongest of the orienting senses. However, in a whiteout or when flying in cloud, it is sometimes impossible to orient oneself by reference to the horizon. Under these conditions, the pilot is completely dependent upon the flight instruments and learned flying skills for control of the aircraft. Under no circumstances should the pilot rely upon his senses alone for orientation.

Although the organs of balance in the inner ear give useful information on the ground, they can give rise to dangerously false information in the air. For example, once a turn has been entered and is being maintained at a steady rate, the sensation of turning will disappear. Upon recovering from the turn, pilots may feel as though they are turning in the opposite direction and erroneously re-enter the turn, even causing the aircraft to enter into a spin or a spiral. This has been responsible for many accidents. False impressions of position may also be encountered if pilots align the aircraft with a sloping cloudbank or when the horizon is distorted or apparently bent by the Northern Lights. The rule of survival when disorientated is **RELY ON YOUR FLIGHT INSTRUMENTS!**

In their training, all pilots should be exposed to disorientation by their instructors and should have had experience in recovering from unusual attitudes. Such experience will help overcome subsequent, unexpected instances of disorientation. Pilots without instrument flight training must maintain a visual horizon at all times and should never flight plan VFR into areas where bad weather or low visibility may be encountered. An instrument rating does not prevent disorientation, but the training required to obtain the rating provides the pilot with the ability to overcome it.

3.8 FATIGUE

Fatigue slows reaction time, reduces concentration and leads to errors of attention. The most common causes are insufficient rest, lack of sleep, and overexertion. Fatigue can also be aggravated by other stresses such as business pressures and financial or family problems as well as common illnesses, such as anaemia, sleep apnoea, influenza, and head colds. Pilots should be aware of the subtle effects that acute or chronic fatigue can have on motor skills and judgement, and avoid flying when either of these are present. Pilots should also practice good sleep hygiene to prevent fatigue. Pilots who find that they are often troubled by fatigue or drowsiness, even while not flying, should see their health-care provider for a thorough medical evaluation.

Boredom and fatigue aggravate each other. One method of overcoming boredom is to keep busy by making frequent ground-speed and fuel-consumption checks, and staying mentally active. Planning for diversion to alternates or studying relevant airfield charts are also helpful.

3.9 ALCOHOL

Never fly while under the influence of alcohol. It is best to allow at least 24 hours between the last drink and take-off time. Alcohol is selectively concentrated by the body into certain areas and can remain in the fluid of the inner ear even after all traces of alcohol in the blood have disappeared. This accounts for the difficulty in balance that is experienced in a hangover. Even small amounts of alcohol (0.05 percent) have been shown in simulators to reduce piloting skills. The effect of alcohol and hypoxia is additive, and at 6 000 ft ASL (1 830 m), the effect of one drink is equivalent to two drinks at sea level. The body metabolizes alcohol at a fixed rate and no amount of coffee, medication or oxygen will alter this rate. ALCOHOL AND FLYING DO NOT MIX.

3.10 DRUGS

Taking medicine in any form immediately before or while flying can be hazardous. Over-the-counter and herbal remedies, such as antihistamines, cough medicines, sleeping pills, and appetite suppressants (to name just a few) may cause drowsiness, decrease mental alertness, and seriously impair the judgement and co-ordination needed by the pilot. A condition for which medicine is required may impair a pilot's proficiency, even though the symptoms are masked by medicine. Unless cleared by a Civil Aviation Medical Examiner (CAME), pilots should not fly under the influence of prescription or over-the-counter drugs or herbal remedies any more than they should fly under the influence of alcohol.

Air traffic controllers, especially those working at the centre, are particularly susceptible to sedative side effects due to their workplace environment. The need to perform repetitive tasks over prolonged periods, often in a low-light environment, makes them particularly susceptible to drowsiness. The same restrictions applied to the pilot must be observed. Additionally, since controllers are more likely to report for work while suffering from a cold than pilots are, the effects of over-the-counter cold cures must be stressed.

It should go without saying that recreational drug use has no place in aviation and illicit drug use may result in the refusal to issue, refusal to renew, or suspension of a medical certificate.

NOTE:

The regulation specific to the use of alcohol or drugs by crew members is included in the RAC chapter, Annex 2.0, *Canadian Aviation Regulations*, 602.03 (<<http://laws-lois.justice.gc.ca/eng/regulations/SOR-96-433/page-82.html#h-751>>).

3.11 ANAESTHETICS

Questions are often asked about flying after anaesthetics. With spinal or general anaesthetics, or with serious operations, pilots should not fly until their doctor says it is safe to do so. It is

difficult to generalize about local anaesthetics used in minor operations or dental work. Allergic reactions to these, if they occur, are early and by the time the anaesthetic has worn off the risk of side effects has passed. However, after extensive procedures (such as the removal of several wisdom teeth), common sense suggests waiting at least 24 hr before flying.

3.12 BLOOD DONATION

In a completely healthy individual, the fluid reduction caused by donating one unit of blood is replaced within several hours. In some people, however, the loss of blood causes disturbances to the circulation that may last for several days. While the effects at ground level are minimal, flying during this period may entail a risk. Generally, active pilots should not donate blood, but if blood has been donated they should wait at least 48 hr before flying.

3.13 IMMUNIZATIONS

After receiving routine immunizations, such as flu shots or tetanus shots, pilots should remain at the clinic for the amount of time recommended by their health-care provider. In general, this ranges from 15 to 30 min after the immunization. If the pilot feels well and there is no evidence of an adverse reaction, they may resume flying immediately without restriction. If they feel unwell or experience an adverse reaction, they should wait for 24 hr and be assessed by a health-care provider prior to flying. The Civil Aviation Medicine Branch will monitor any new immunization developments and guidelines, and recommendations will be provided as needed.

3.14 PREGNANCY

Pilots may continue to fly up to 30 weeks into their pregnancy, provided the pregnancy is normal and without complications. However, there are certain physiological changes that may affect flight safety, and the foetus may be exposed to potentially hazardous conditions. Pilots should be aware of the hazards so that they can make informed decisions on whether they choose to fly or not.

As soon as a pilot realizes that she is pregnant, she should seek prenatal care from a qualified physician or midwife and she should ensure that her maternity-care provider is aware that she is a pilot. Should problems develop with the pregnancy before the 30th week, the Regional Aviation Medical Officer (RAMO) must be notified.

In the first trimester, nausea and vomiting are common and may be worsened by turbulence, engine fumes and G forces. In the first and second trimester, there is an increased likelihood of fainting, but this is uncommon in a sitting position. However, G tolerance may be reduced. A relative anaemia may occur after the second trimester and may affect the pilot's susceptibility to hypoxia. Hypoxia is not a problem for the foetus below 10 000 ft ASL (3 050 m).

Cosmic radiation is of particular concern because of the unborn child's susceptibility to ionizing radiation. Dose equivalent is the measure of the biological harmfulness of ionizing radiation, and the present international unit of dose equivalent is the sievert (Sv). One sievert is equal to 1 000 millisieverts (mSv). The current recommendation is that the foetus should be exposed to no more than 1 mSv during the entire pregnancy, and no more than 0.5 mSv in any given month of pregnancy. For comparative purposes, the recommended annual limit for occupational ionizing radiation exposure for an adult is 50 mSv, with a 5-year average of no more than 20 mSv per year.

Cosmic radiation is greater at the poles than at the equator and increases with altitude. On transpolar flights at 41 000 ft ASL (12 505 m), the estimated exposure is about 0.012 mSv/h, although in a solar flare this can increase by a factor of 10. The exposure at the equator is about one-half of this. A flight from Athens to New York at 41 000 ft ASL (12 505 m) would expose a pilot to approximately 0.09 mSv. A pilot flying 500 hours per year at 35 000 ft ASL (10 675 m) between 60° and 90° latitude would be exposed to 1.73 mSv annually. Although the radiation risk to the foetus is small, it does still exist. The decision to expose the foetus to this minimal degree of radiation rests with the pilot. In general, flying shorter flights at lower latitudes will decrease exposure to ionizing radiation. Further information can be obtained from the Regional Medical Office or from the FAA Advisory Circular (AC) 120-61B, dated November 21, 2014: <https://www.faa.gov/regulations_policies/advisory_circulars/index.cfm/go/document.information/documentID/1026386>.

Pilots with a normal pregnancy are considered temporarily unfit and should cease flying after the 30th week of pregnancy. The pilot may resume her flying privileges six weeks after delivery if there are no significant medical issues. A brief medical report from her attending physician should be forwarded to the RAMO. Air traffic controllers may work until the onset of labour, and may resume their duties six weeks after delivery. A medical report of fitness should be forwarded to the regional office.

3.15 POSITIVE AND NEGATIVE G

Many pilots think that unless they are performing aerobatics, knowledge about acceleration (G) is unnecessary. However, this force affects pilots in all aircraft—from the smallest ultralight to the biggest jet.

3.15.1 What is G?

G is the symbol for the rate of change of velocity and so represents both a force and a direction. The most common example is the force of gravity (g), which is 32 ft/s². This means a body in a vacuum would fall at a speed that increases by 32 ft/s in each second of the fall. By international convention, G is described in three planes relative to the body. These are transverse (G_x), lateral (G_y), and longitudinal (G_z) (see Figure 3.1).

Convention also requires an indication of whether the force is positive (+) or negative (-). For example, acceleration from the feet to the head is positive G_z and from the head to the feet is negative G_z. The effect of acceleration on the body is due to the displacement of blood and tissues. It is important to realize that the displacement is caused by the inertia of the tissues and this will be opposite in direction to the acceleration force. If you were fired into the air from a cannon, the acceleration would be upward, but inertia would result in a relative downward displacement of your organs and blood.

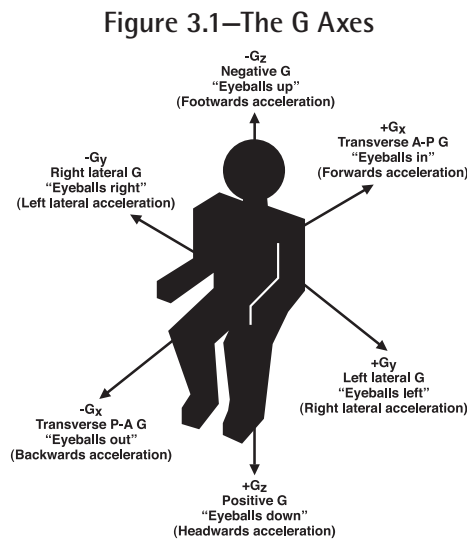
Only G_x and G_z are of practical significance to civilian pilots and the most significant result of G_x is disorientation; thus, when we speak of positive or negative G, we are referring to G_z unless otherwise noted.

3.15.2 The Effects of G

G tolerance varies greatly with the individual. Because the symptoms are caused by the displacement of blood and tissues, we would expect that a pilot with good muscle tone would have a better tolerance. This is correct. Tolerance is lowered by obesity, ill health, low blood pressure, pregnancy and many medications. It may vary from day to day in relation to fatigue, smoking, hypoxia or hangovers.

In absolute figures, G tolerance is affected by the peak value, the duration of the G force and the rate of onset. If the rate of onset is very high, positive G can result in unconsciousness, known as G-loss of consciousness (G-LOC), without any other symptoms.

The increased weight of limbs and organs interferes with movement, and forces greater than +3G make it almost impossible to escape from an aircraft in uncontrolled flight. Fine movements are less affected. Heavy equipment such as a protective helmet can cause problems with increasing G. At about +6G a pilot's head would be flexed on the chest by the increased weight of a crash helmet.



The most serious effect of positive G is the draining of blood away from the head toward the feet, causing (stagnant) hypoxia of the brain; the first symptom is vision deterioration. As G forces are experienced, the blood pressure to the retina decreases because the weight of the column of blood between the heart and the eye (and therefore the work of the heart) increases. Therefore, the retinal blood supply decreases. Vision, beginning in the periphery, starts to become dim and colourless; this is called “grey-out.” As the G forces increase further, the blood flow in the back of the eye will be completely interrupted and “black-out” (temporary loss of vision) will occur, although the pilot remains conscious. There is a delay of 5–7 s between the onset of G and the visual changes because of the oxygen dissolved in the fluids of the eyeball. If G forces stabilize, there may be an improvement in the visual symptoms after 10–12 s because the body’s reflexes automatically increase blood pressure.

Grey-out begins at about +2G and black-out is usually complete at +4G in the relaxed, unprotected pilot. As the G force increases, hypoxia of the brain develops and consciousness is usually lost in the unprotected pilot at over +6G (G-LOC). When the G forces decline, consciousness is quickly recovered, but there is always a brief period of confusion on awakening.

Negative G is poorly tolerated. Here, because the acceleration is from feet to head, blood pressure in the eyes and the brain is increased so “red-out” (a red haze in the vision) is experienced. Negative G in excess of -5G may cause rupture of small blood vessels in the eyes and prolonged negative G may cause brain damage. Negative G is experienced in a push-over or “bunt” and in an outside loop.

Transverse G is well tolerated; this is why astronauts recline on blastoff. Levels of up to +50 G_x can be tolerated for short intervals without tissue damage, although the acceleration interferes with breathing. In current aircraft, G_y is not a significant problem.

3.15.3 G Straining Manoeuvres

Valsalva’s manoeuvre consists of bearing down against a closed glottis (the trap door between the throat and chest) while holding the nose. The same procedure, without holding the nose but with the mouth held closed, elevates the blood pressure and increases G tolerance temporarily. This manoeuvre is widely used by acrobatic pilots and may increase G tolerance by about +2G. Valsalva’s manoeuvre is the original anti-G straining manoeuvre, but it is difficult to maintain.

3.15.4 Dealing with G

G tolerance is affected by diet and good physical conditioning. High tolerance requires adequate hydration and normal blood sugar; hypoglycaemia (low blood sugar) markedly lowers tolerance. Tensing the muscles in the calves and thighs to reduce blood pooling and squatting down in the seat or leaning slightly forward while tensing the abdominal muscles, all reduce the distance between the heart and the brain and increase blood pressure. Physical training can be beneficial, but pilots who wish

to develop high G tolerance do best with a weight-lifting program rather than intensive aerobic training. Moderate aerobic training—20–30 min daily—and running distances less than 5 km is helpful, but long-distance running decreases G tolerance by slowing the resting heart rate, which increases the chance of sudden loss of consciousness (G-LOC). A well-trained, experienced pilot can tolerate up to 9G for as long as 30 s, but there is a lot of individual variation. Acrobatic pilots who regularly fly high G manoeuvres develop high tolerance, but quickly lose it if they are no longer exposed.

4.0 MISCELLANEOUS

4.1 AIR TIME AND FLIGHT TIME

Air Time is the period of time commencing when the aircraft leaves the supporting surface and terminating when it touches the supporting surface at the next point of landing.

Flight Time is the total time from the moment an aircraft first moves under its own power for the purpose of taking off until the moment it comes to rest at the end of the flight. This should be recorded in all Pilot Log Books.

NOTE:

Air Time and Flight Time should be recorded to the nearest 5 minutes, or to the nearest 6 minutes when using the decimal system as follows:

Table 4.1—Rounding of Air Time and Flight Time

0 to 02 = .0	03 to 08 = .1	09 to 14 = .2
15 to 20 = .3	21 to 26 = .4	27 to 32 = .5
33 to 38 = .6	39 to 44 = .7	45 to 50 = .8
51 to 56 = .9	57 to 60 = 1.0	

4.2 CONDUCT OF EXPERIMENTAL TEST FLIGHTS

The C of A requires that aircraft be maintained and operated in accordance with the aircraft type certificate, Weight and Balance Report and Aircraft Flight Manual. If, for test demonstration or experimentation, an aircraft is to be flown outside of the approved Aircraft Flight Manual envelope, with unapproved equipment installed, with equipment intentionally disabled, or with inoperative equipment not covered by an approved Minimum Equipment List or maintenance deferral action, the C of A will be invalid. In these cases, flights may only be authorized through a Flight Permit issued by TC.

It must be emphasized that experimentation beyond the limitations imposed by the aircraft certification documentation (type certificate, C of A, Aircraft Flight Manual, Minimum Equipment List) may be hazardous as it can reduce the safety margins designed into the aircraft and, thus, jeopardize the safety of the crew. Consequently, experimental or developmental flight testing

should normally be conducted only under controlled conditions by specifically qualified aircrew after adequate engineering analysis and planning have taken place.

Before a test flight, the determinations of the conditions and limits of testing, normal and emergency procedures specific to the test, and expected aircraft handling characteristics are essential if risks are to be minimized. If companies or individuals wish to conduct a flight test program, they should apply for a Flight Permit and consult with the aircraft manufacturer and TC, who can help them to assess the risks and their capability to conduct the tests safely.

Careful planning, covering all foreseeable exigencies, is critical to safe testing.

4.3 PRACTICE SPINS

Intentional practice spins conducted at low altitudes have resulted in fatal accidents. All practice spin recoveries should be completed no less than 2 000 feet AGL, or at a height recommended by the manufacturer, whichever is the greater.

4.4 CARGO RESTRAINT

4.4.1 General

Regulations, guidelines, and references have been established to assist commercial air carriers to obtain appropriate airworthiness approval and develop suitable operational procedures to ensure adequate restraint for cargo in aircraft.

4.4.2 Regulations

Canadian Aviation Regulations (CARs) 602.86, 703.37, 704.32, and 705.39 and the associated standards, govern the requirement for proper weight and balance procedures to ensure the load is properly distributed in accordance with the C of A or flight permit.

The intent of these regulations is to ensure that the loading and restraint of cargo are such that the aircraft conforms to a configuration which is in compliance with the applicable airworthiness standards at all times. If the approved C of G or floor load limits are not adhered to the aircraft is unairworthy. Similarly, if the configuration of the restraint system does not meet the standards of the basis of certification or approval for the aircraft type, the aircraft is also unairworthy.

In this context it should be understood that the term “flight” includes all phases of operation of the aircraft including the applicable emergency landing conditions. These emergency landing conditions are defined in the various airworthiness standards and are an integral part of any basis of certification or approval.

4.4.3 Guidelines

Aircraft data is normally considered to be material provided by the aircraft manufacturer, and should include identification of hardpoints, floor loads, C of G travel and related limits. Capacity of hardpoints and floor loads takes into account the properly factored gust, manoeuvre and emergency landing loads specified in the type approval of the aircraft.

The air carrier, through his flight crew and persons responsible for loading aircraft, must ensure that the cargo, as loaded, does not cause the aircraft to be unairworthy. Examples of typical loads and capacities may be provided by the aircraft manufacturer, given the calculated strength of ropes, belts, nets and containers. Unusual loads (pipe lengths, drill rod, fuel barrels, etc.) present unique problems and are likely to require specific approval of the restraint system. Where doubt exists as to the adequacy of the proposed method of restraint, the air carrier must submit a substantiating load and strength analysis to the Regional Manager of Airworthiness for engineering approval against the requirements of the aircraft certification or approval basis.

4.4.4 References

The air carrier is responsible to acquire and review the following Cargo Restraint Reference Material prior to submitting application to a region.

- Airworthiness Manual, Chapters 523.561
525.561
527.561
529.561
523.787
525.787
527.787
599.787
- FAA Advisory Circular 43.13-2A (a general guide useful in preparing initial application to the RMA for engineering approval. It includes critical static test load factors for FAR 23, 25, 27 and 29 aircraft)
- FAA Advisory Circular 121-27
- CAR 3.392 Cargo Compartments
- CAR 4b.359 Cargo Compartments
- FAR 23.787 Cargo Compartments
- FAR 25.787 Stowage Compartments
- FAR 27.787 Cargo and Baggage Compartments
- FAR 29.787 Cargo and Baggage Compartments
- FAR 91.203 Carriage of Cargo
- FAR 121.285 Carriage of Cargo in Passenger Compartments

- FAR 121.287 Carriage of Cargo in Cargo Compartment
- ICAO/IATA Training Manual, Book 4, Load Planners and Cargo Handlers

4.4.5 Approval

Because of the magnitude in variety, the complexity of cargo loads and the aircraft restraints involved, the following is only a generalized approval process and requires review by the Regional Managers, Aircraft Maintenance and Commercial and Business Aviation.

- The carrier (applicant) reviews the preceding regulations, aircraft data and reference material, relates that to type(s) of aircraft involved and submits application to the Regional Manager, Aircraft Maintenance for engineering approval. (Application includes manufacturer's aircraft data and type approval or certificated data, sample typical loads and proposed methods of restraint.)
- Concurrently, the carrier submits an application to the Regional Manager, Air Carrier concerning operational procedures for each aircraft type involved (including training) in an amendment to the Operations Manual.
- Following joint review, the Regional Manager, Aircraft Maintenance may issue engineering approval of the application and the Regional Manager, Commercial and Business Aviation may process the Operations Manual amendment. These are then both forwarded to the carrier. The air operator issues the amendment to the Operations Manual.

4.5 COLLISION AVOIDANCE – USE OF LANDING LIGHTS

Several operators have for some time been using a landing light(s) when flying at the lower altitudes and within terminal areas, both during daylight hours and at night. Pilots have confirmed that the use of the landing light(s) greatly enhances the probability of the aircraft being seen. An important side benefit for improved safety is that birds seem to see aircraft showing lights in time to take avoidance action. Therefore, it is recommended that all aircraft show a landing light(s) during the takeoff and landing phases and when flying below 2000 feet AGL within terminal areas and aerodrome traffic zones.

4.6 USE OF STROBE LIGHTS

The use of high intensity strobe lights while taxiing or awaiting takeoff holding short of the active runway can be very distracting, particularly to pilots in the final stages of approach or during the initial landing phase.

It is recommended that high intensity strobe lights not be used while the aircraft is on the ground when they adversely affect

ground personnel or other pilots. Circumstances permitting, high intensity strobe lights should be activated anytime the aircraft is occupying an active runway, including awaiting takeoff clearance while holding on the active runway. They should be extinguished after landing once clear of the active runway.

High intensity strobe lights should not be used in-flight when there is an adverse reflection from clouds or other weather phenomena.

4.7 MANNED FREE BALLOON OPERATIONS

Pilots and owners of balloons, like all other aircraft pilots and owners, must comply with the CARs with respect to crew licensing, aircraft registration and operating procedures.

4.7.1 Balloon Operations with Fare-Paying Passengers

CAR 603.17 states, “No person shall operate a balloon under this Division unless the person complies with the provisions of a special flight operations certificate - balloons issued by the Minister pursuant to Section 603.18.”

To qualify for a special flight operations certificate to permit the operation of balloons with fare-paying passengers, operators must:

- maintain balloons in accordance with the requirements of CAR 605;
- ensure that the balloons are properly equipped for the area and type of operation; and
- employ flight crew members who meet the requirements of CAR 623.21, namely, who:
 - are at least eighteen years of age,
 - hold a Balloon Pilot Licence issued by Transport Canada,
 - hold a Medical Certificate, Category 1 or 3,
 - have accumulated a minimum of 50 hours flight-time in untethered balloons or are the holder of a Canadian Balloon Licence with a valid Flight Instructor Rating - Balloon Category, and
 - demonstrate annually a satisfactory level of knowledge and ability to perform normal and emergency operating procedures on the specific AX class of balloon to be operated.

4.8 PARACHUTE JUMPING/SKYDIVING

Parachuting or skydiving is a high-risk activity that can result in death or serious injury. As such, any individual participating in this activity must take full responsibility for their personal safety.

Transport Canada **does not** regulate the sport of parachuting directly. Transport Canada **does not** regulate or have licensing

or certification requirements for parachute equipment, parachute packers/riggers, parachuting instructors or coaches.

E-mail:.....admin@hpac.ca
Tel.:.....877-370-2078

It is strongly recommended that persons participating in parachuting activities be conversant with the procedures and standards established by associations representing parachuting activities. In Canada, that association is:

Canadian Sport Parachuting Association (CSPA)
300 Forced Road
Russell ON K4R 1A1
Tel.:613-445-1881

Transport Canada regulations pertaining to parachuting are in place to ensure the safety and efficiency of the air navigation system in which parachuting takes place and to ensure the safety of persons and property on the ground.

CAR 602.26 states, “Except where permitted in accordance with section 603.37, no pilot-in-command of an aircraft shall permit, and no person shall conduct, a parachute descent from the aircraft

- a) in or into controlled airspace or an air route; or
- b) over or into a built-up area or an open-air assembly of persons.”

CAR 603.37 states, “...a pilot-in-command may permit and a person may conduct a parachute descent under this Division if the person complies with the provisions of a special flight operations certificate - parachuting issued by the Minister pursuant to Section 603.38.”

4.9 HANG GLIDER AND PARAGLIDER OPERATIONS

Hang gliders and paragliders are not required to be registered or to bear identification marks. There are no airworthiness standards or requirements imposed by the CARs. The CARs do not impose any training requirements for hang glider or paraglider pilots, and the regulations do not require these pilots to hold any pilot licence or permit to operate their aircraft. There is, however, a requirement to successfully complete a written examination before piloting hang gliders and paragliders in controlled airspace. Section 602.29 of the CARs outlines airspace requirements for hang gliders and paragliders. Hang glider operators may use an ultralight aeroplane to tow a hang glider. Before doing so, these operators are required to notify Transport Canada.

The Hang Gliding and Paragliding Association of Canada (HPAC) has developed standards for pilot ratings, competitions, setting records, safety procedures and reporting, as well as for solo and two-place pilot instruction. Information regarding HPAC operations and procedures may be obtained from:

Margit Nance
Executive Director
Hang Gliding and Paragliding Association of
Canada (HPAC)
308-1978 Vine Street
Vancouver BC V6K 4S1

4.10 ULTRA-LIGHT AEROPLANE

Pilots interested in flying ultralight aeroplanes or advanced ultralight aeroplanes are encouraged to contact their Transport Canada regional office for information on regulation and licence requirements. See GEN 1.1.1 for addresses and telephone numbers.

Pending amendment of the CARs, the *Ultra-light Aeroplane Transition Strategy* outlines requirements for the operation of ultralight aeroplanes in Canada. This document can be obtained from Transport Canada offices or viewed online at: <www.tc.gc.ca/eng/civilaviation/standards/general-recavi-ultralight-menu-2457.htm>.

A copy of the *Study and Reference Guide—Pilot Permit—Ultra-light Aeroplane* (TP 14453E) is available at: <www.tc.gc.ca/eng/civilaviation/publications/menu.htm>.

4.11 CIRCUIT BREAKERS AND ALERTING DEVICES

Automatic protective devices (circuit breakers) are provided within aircraft systems to minimize distress to the electrical system and hazard to the aircraft in the event of wiring faults or serious malfunction of a system or connected equipment. Alerting devices provide the pilot with a visual and/or aural alarm to direct the pilot’s attention to a situation that may require an immediate intervention by the pilot.

Good operating practices suggest a popped circuit breaker can indicate that there is a potential problem being protected. The practice of attempting one reset should only be considered if the equipment rendered unusable is considered essential for the continued safety of the flight. Depending on the amperage of the circuit breaker and its location within the circuit being protected, resetting a popped circuit breaker may create a more adverse situation than simply leaving the circuit breaker out. Indiscriminately resetting popped circuit breakers should be avoided.

Crew members are cautioned against pulling circuit breakers on board an aircraft in order to silence an alerting or warning device that may in fact be providing a valid warning or alarm. Examples of such alarms include landing gear warning horn with certain flap/slat combinations, overspeed warnings, ground proximity warning system alerts and washroom smoke detectors. Deactivating the alerting or warning device by pulling circuit breakers compromises or may compromise the safety of flight. Exceptions would be acceptable for an obvious malfunction resulting in continuous erroneous warnings. In these cases, a defect entry in the aircraft journey log book must be made.



4.12 DESIGN EYE REFERENCE POINT

Some aircraft manufacturers provide reference points which the pilot uses while making the seat adjustments. These reference points could be something as simple as two balls affixed to the glare shield which the pilot must line up visually. In a two-pilot aircraft the reference points could be formed by three balls in a triangle and each pilot would adjust the seat until the respective reference balls line up. The intent, of course, is to have the pilot adjust the seat in order for the eyes of the pilot to be at the optimum location for visibility, inside and outside the cockpit, as well as the correct position for access to the cockpit switches and knobs. The engineering that results in the manufacturer placing these balls on the glare shield is called **ERGONOMICS**. This optimum position for the pilot's eyes is referred to as the **Design Eye Reference Point**.

If there is no information on the design eye reference point in the aircraft operating manual, then it is suggested that the pilot could write the manufacturer and request the information. Failing that, the following guidelines should be considered when attempting to locate the correct seat placement (height, as well as fore and aft placement):

- a) all flight controls must be free of restriction throughout the full travel of the controls;
- b) flight instruments and warning lights must be visible to the pilot without being obscured by items such as the top of the glare shield;
- c) forward out-of-the-cockpit visibility should be sufficient to ensure that things such as the nose of the aircraft do not block the view of the pilot, especially during a normal approach and landing; and
- d) the chosen seat position should be comfortable for the pilot.

4.13 FIRST AID KITS ON PRIVATELY OWNED AND OPERATED AIRCRAFT

CAR 602.60 requires a first aid kit to be carried on board every power-driven aircraft, other than an ultra-light aeroplane. For a list of recommended items that should be carried in a first aid kit on board aircraft that are privately owned and operated, refer to Part 9 - First Aid of the Aviation Occupational Health and Safety Regulations (SOR/2011-87). <<http://laws-lois.justice.gc.ca/eng/regulations/sor-2011-87/page-9.html#h-85>>

4.14 SURVIVAL ADVISORY INFORMATION

A basic survival manual should be carried, appropriate to the area of flight.

Private pilots should obtain some training in certain aspects of

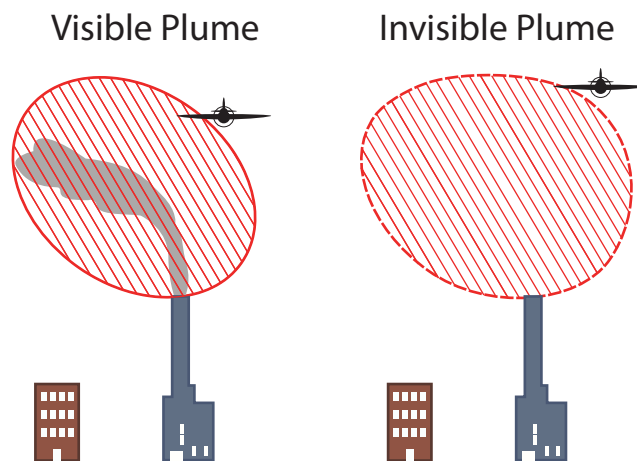
survival if they have never spent time in the bush in winter or summer. Those planning to fly above the tree line should obtain more specialized training.

Locating and saving people in aeronautical emergencies has been greatly improved by the changes implemented by the SARSAT/COSPAS members. Today the SARSAT/COSPAS system provides global detection capability by satellite. The improvements in reliability of ELTs in conjunction with the global application SARSAT/COSPAS systems has greatly increased the chances of early detection and location of crash survivors. The carriage of food is no longer a critical item in survival and is left as a personal choice of the individual operator. (See *AIP Canada (ICAO) GEN 1.5*)

4.15 POTENTIAL FLIGHT HAZARDS FOR AIRCRAFT

4.15.1 Avoid Flight in the Vicinity of Exhaust Plumes

Figure 4.1—Visible and Invisible Plumes



Exhaust plumes are defined as visible or invisible emissions from power plants, industrial production facilities or other industrial systems that release large amounts of vertically directed unstable gases. High temperature exhaust plumes may cause significant air disturbances, such as turbulence and vertical shear. Other identified potential hazards include, but are not necessarily limited to, reduced visibility, oxygen depletion, engine particulate contamination, exposure to gaseous oxides, and/or icing.

When able, pilots should fly upwind of possible exhaust plumes. Encountering a plume may result in airframe damage, aircraft upset, and/or engine damage/failure. These hazards are most critical during low altitude flight in calm and cold air, especially in and around approach and departure corridors or in airport traffic areas.

When a plume is visible via smoke or a condensation cloud, remain clear and realize that a plume may have both visible and

invisible characteristics. Exhaust stacks without visible plumes may still be in full operation, and airspace in the vicinity should be treated with caution. As with mountain wave turbulence or CAT, an invisible plume may be encountered unexpectedly.

Whether plumes are visible or invisible, the total extent of their turbulent effect is difficult to ascertain. Some studies predict that the significant turbulent effects of a thermal plume can extend over 1 000 ft above the top of the stack or cooling tower. Any effects will be more pronounced where the plume is very hot and the surrounding air is calm, stable and cold. Fortunately, studies also predict that crosswinds help dissipate the effects. However, the size of the tower or stack is not a good indicator of the plume's predicted effect. The effects are primarily related to the heat or size of the plume effluent, the ambient air temperature, and the wind speed affecting the plume. Smaller aircraft can expect to be affected at a higher altitude than heavier aircraft.

Pilots are encouraged to reference the CFS for the location of structure(s) emitting exhaust plumes, such as cooling towers, power plant stacks, exhaust fans and other similar structures.

Pilots encountering hazardous plume conditions should report time, location and intensity (light, moderate, severe or extreme) to the facility with which they are maintaining radio contact.

4.15.2 Pilot Procedures When Exposed to Laser and Other Directed Bright Light Sources

4.15.2.1 General

Directed bright light sources projected near airports or into any navigable airspace can cause potential flight control disruptions and/or eye injury to pilots, crew members, and passengers. The number of laser illuminations affecting aircraft has significantly increased during the past few years. In particular, the number of laser incidents reported involving law enforcement helicopters has substantially increased.

Canada and the USA have both recorded numerous instances of laser exposures that have been disruptive to flight operations. Flight crews may be startled; they may be affected by glare, flash blindness and/or afterimage due to laser occurrences.

Directed bright light sources, particularly laser beams, projected near airports or into any navigable airspace can cause two flight safety concerns:

- a) The primary concern is when non-injurious, bright, directed light unexpectedly enters the cockpit. Depending on the brightness level, the light could startle (a) flight crew member(s); cause glare, making it difficult to see out the windscreen; or cause temporary vision impairment (flash blindness and/or afterimage). The illumination and glare may be short—one or a few bright flashes—but the startle and afterimage effects could persist for many seconds or even minutes.

- b) A secondary concern is a laser beam so powerful that it causes temporary or permanent eye injury to pilots, crew members, or passengers. Fortunately, this is only a remote possibility because the laser power required to cause eye injury greatly exceeds that of lasers in common use today.

Therefore, the most likely in-flight safety hazard is a bright non-injurious flash causing disruption in the cockpit workflow. This disruption poses significant flight safety hazards when the cockpit workload increases below 10 000 ft AGL, such as during critical phases of flight (approach and landing); in dense traffic areas (terminal environment and en route areas); and in proximity to airports.

Even laser pointers can cause pilots to become distracted from their immediate tasks. Reports of pilots exposed to persons using laser pointers have been increasing in number. Pilots flying law enforcement helicopters have been particularly targeted by lasers.

4.15.2.2 Procedures

The primary purpose of this subsection is to outline preventive measures and incident procedures that pilots can follow to either prevent potential illuminations or minimize cockpit disruption. For simplicity, the following procedures refer to laser illumination incidents; however, the same procedures should be applied regardless of the source, whether it is a laser or any other directed bright light, such as a searchlight.

4.15.2.2.1 Preventive Procedures

During aircraft operations into navigable airspace where laser illuminations are anticipated, flight crews should:

- a) Consult NOTAMs for temporary laser activity. The NOTAM should include the location and time of the laser operations.
- b) Avoid known permanent laser displays (e.g. Disney World). In the USA, these sites are published in the *Airport/Facility Directory*, a Federal Aviation Administration (FAA) publication available at www.faa.gov/air_traffic/flight_info/aeronav/digital_products/dafd/. Currently, there is only one permanent laser display site in Canada, located at the Shaw Millennium Park in Calgary, Alta., (510258N 1140530W 5 NM SW AIRPORT) but it is only being used for special events (e.g. Canada Day). A NOTAM is published on those specific days.
- c) Turn on additional exterior lights to help ground laser safety observers locate the aircraft, so they can respond by turning off the laser beam.
- d) Turn on thunderstorm lights to minimize cockpit illumination effects.
- e) Engage the autopilot.

- f) Have one flight crew member stay on the instruments to minimize the effects of a possible illumination while in the area of expected laser activity.
- g) Consider using notch filter eye spectacles that protect against 514- and 532-nanometre laser wavelengths, if flying a helicopter engaged in surveillance or medical evacuation.

4.15.2.2.2 Incident Procedures

If a laser beam illuminates a pilot in flight, the pilot should:

- a) Immediately look away from the laser source or try to shield their eyes with their hand or a hand-held object to avoid, if possible, looking directly at the laser beam.
- b) Immediately alert the other flight crew member(s) and advise them of the illumination and its effect on their vision.
- c) If vision is impaired, immediately transfer control of the aircraft to the other flight crew member. If other flight crew members have been illuminated, engage the autopilot (if equipped).
- d) Be very cautious of spatial disorientation effects (e.g. the leans). After regaining vision, they should check cockpit instruments for proper flight status.
- e) Resist the urge to rub their eyes after a laser illumination, as this action may cause further eye irritation or damage.
- f) Contact ATC and advise of a “LASER ILLUMINATION”. Use this terminology for all laser incident/accident reports. If the situation dictates, declare an emergency.
- g) When time permits, provide ATC with an incident report that includes the laser location, direction, and beam colour as well as the length of exposure (flash or intentional tracking) and the effect on the crew.

NOTE:

To ensure that TC has sufficient information to analyze and investigate occurrences, please complete the “Directed Bright Light Illumination Incident Report/Questionnaire” at http://www.wapps.tc.gc.ca/wwwdocs/Forms/26-0751E_1405-03_E_X.pdf and send the completed form to services@tc.gc.ca.

4.15.2.2.3 Medical Follow-up Procedures After an In-flight Illumination

A crew member who has been subjected to a significant illumination and who experiences persistent symptoms, such as pain or visual abnormalities (e.g. flash blindness and/or afterimage), should seek immediate medical attention. In addition, they should contact a RAMO or an aviation medical officer at the earliest opportunity. The medical officer will provide assistance in locating the nearest ophthalmologist or medical facility with experience in evaluating laser injuries. If outside Canada, contact the Civil Aviation Medicine Branch in Ottawa. An eye damaged by a laser beam starts to repair itself immediately. Therefore, it is strongly recommended that an ophthalmologist, familiar with laser injury examination requirements, evaluate the crew member within five hours of the exposure to determine the nature of the injury and if further follow-up action is needed.

NOTE:

Because diagnosis can be difficult, especially for medical personnel who rarely, if ever, see laser eye injuries, it should not be automatically assumed that a particular symptom, abnormality or injury was caused by a given laser exposure.

For assistance, please contact one of the following.

Table 4.2—Civil Aviation Medicine Branch Offices

HEADQUARTERS	ATLANTIC REGION
<p>Civil Aviation Medicine Transport Canada 330 Sparks Street Place de Ville, Tower C, Room 617 Ottawa ON K1A 0N8</p> <p>Tel.: 613-990-1311 Fax: 613-990-6623</p>	<p>New Brunswick, Nova Scotia, Prince Edward Island, Newfoundland and Labrador</p> <p>Civil Aviation Medicine Transport Canada 330 Sparks Street Place de Ville, Tower C, Room 617 Ottawa ON K1A 0N8</p> <p>Tel.: 1-800-305-2059 Fax: 613-990-6623</p>
QUEBEC REGION	ONTARIO REGION
<p>Quebec</p> <p>Civil Aviation Medicine Transport Canada 330 Sparks Street Place de Ville, Tower C, Room 617 Ottawa ON K1A 0N8</p> <p>Tel.: 1-800-305-2059 Fax: 613-990-6623</p>	<p>Ontario</p> <p>Civil Aviation Medicine Transport Canada 4900 Yonge Street, 4th Floor North York ON M2N 6A5</p> <p>Tel.: 1-800-305-2059 Fax: 416-952-0569</p>
PRAIRIE AND NORTHERN REGION	PACIFIC REGION
<p>Alberta, Yukon, Manitoba, Saskatchewan, Northwest Territories and Nunavut</p> <p>Civil Aviation Medicine Transport Canada 1140-9700 Jasper Avenue Edmonton AB T5J 4C3</p> <p>Tel.: 1-800-305-2059 Fax: 780-495-4905</p>	<p>British Columbia</p> <p>Civil Aviation Medicine Transport Canada 800 Burrard Street, Room 620 Vancouver BC V6Z 2J8</p> <p>Tel.: 1-800-305-2059 Fax: 604-666-0145</p>

RPA—REMOTELY PILOTED AIRCRAFT

1.0 GENERAL INFORMATION

The following parts of this chapter provide detailed information for the safe operation of a remotely piloted aircraft system (RPAS). This information is intended to be used in conjunction with regulations and associated standards found in Part IX of the *Canadian Aviation Regulations* (CARs). Part IX rules apply regardless of the purpose of the RPAS use (e.g. recreational, commercial, work, research).

This chapter has been organized to follow the order in which information is described in Part IX of the CARs with a description of the regulation, ways to meet the regulation's objective, and additional related information.

While an RPA refers to the aircraft vehicle itself, RPAS includes the aircraft as well as the related system components – battery, payload, control station, and command and control (C2) link.

As RPA is defined as a navigable aircraft under CAR 101.01 - Subpart 1, other sections of the CARs may also apply, such as CAR 601.04 and 601.16, and section 5.1 of the *Aeronautics Act*. These regulations restrict the use of airspace to all "aircraft". For more information, refer to RAC 2.8.6 Class F Airspace in the *Transport Canada Aeronautical Information Manual* (TC AIM).

The Part IX of the CARs is enforced by delegated peace officers such as a member of the Royal Canadian Mounted Police (RCMP) or by Transport Canada (TC) inspectors and investigators. TC is also partnering with other provincial and municipal law enforcement agencies to obtain delegation to enforce Part IX. Refer to TC AIM LRA 6.4 for more information on monetary penalties and to CAR 103 Schedule II, where they are designated and listed.

In addition to Part IX and other regulations in the CARs, other regulations apply when an RPAS is flown. The provisions of the *Criminal Code* could apply if an individual is creating mischief, fatigued, flying under the influence of alcohol or drugs, or endangering the safety of people or an aircraft. Other rules such as the *Privacy Act*, the *Personal Information Protection and Electronic Documents Act*, or provincial privacy legislation may also apply. Be respectful of people's privacy. It is a good practice to let people know you will be flying in the area and what you are doing with your RPA; you should also obtain an individual's consent if you are going to record private information. Privacy guidelines can be found online at <canada.ca/drone-safety>.

Be mindful of other laws that may apply to drone flying like the *Species at Risk Act*, *Marine Mammal Regulations*, *Migratory Birds Regulations*, etc.

2.0 MICRO REMOTELY PILOTED AIRCRAFT SYSTEMS (mRPAS) – LESS THAN 250 G

Micro remotely piloted aircraft systems (mRPAS) are made up of a remotely piloted aircraft (RPA) weighing less than 250g and its control station. The weight of the control station is not factored in to the weight calculation when determining whether an RPA is a micro RPA (< 250 g) or a small RPA (250 g to 25 kg). However, the weight of any payload carried, such as optional cameras, will be considered part of the weight.

Pilots of mRPASs are not subject to Subpart 1 of Part IX of the *Canadian Aviation Regulations* (CARs), so they are not required to register their RPAs or obtain a certificate to fly them. However, they must adhere to CAR 900.06 and ensure they do not operate their RPA in such a reckless or negligent manner as to endanger or be likely to endanger aviation safety or the safety of any person. While there are no prescriptive elements of the regulation that inform the pilot how to accomplish this objective, there is an expectation that the pilot of an mRPA should use good judgment, identify potential hazards, and take all necessary steps to mitigate any risks associated with the operation. This should include having an understanding of the environment in which the RPA pilot is operating, with particular attention paid to the possibility of aircraft or people being in the same area.

As a rule of thumb:

- a) Maintain the mRPA in direct line of sight;
- b) Avoid flying your mRPA above 400 ft in the air;
- c) Keep a safe distance between your mRPA and other people;
- d) Stay far away from aerodromes, water aerodromes, and heliports;
- e) Avoid flying near critical infrastructure;
- f) Stay clear of aircraft at all times;
- g) Conduct a pre-flight inspection of your mRPA;
- h) Keep the mRPA close enough to maintain the connection with the remote controller; and
- i) Avoid advertised events.

These guidelines will help you avoid flying in a negligent or reckless manner and being subject to monetary fines. They will also help ensure that you enjoy a safe flight and minimize the risk of an incident. Remember: if you feel that a flight is risky, do not fly.

If CARs 601.04 and 601.16 as well as section 5.1 of the *Aeronautics Act* prohibit for all "aircraft" the use of airspace, they therefore apply to micro RPAs because they are considered aircraft under

the *Aeronautics Act* and the CARs. For more information, see RAC 2.8.6 Class F Airspace in the *Transport Canada Aeronautical Information Manual* (TC AIM).

Micro RPAs are therefore prohibited from entering the following zones without proper authorization:

- a) Class F Special Use Restricted airspace;
- b) Zones for which a NOTAM for forest fire aircraft operating restrictions has been issued; and
- c) Zones in which section 5.1 of the *Aeronautics Act* restricts the use of airspace for all aircraft.

A pilot that is found to have created a hazard either to aviation safety or to people on the ground is subject to an individual penalty of \$1,000 and/or a corporate penalty of \$5,000 (CAR 103, Schedule II).

3.0 SMALL REMOTELY PILOTED AIRCRAFT SYSTEMS (sRPAS) – 250 G TO 25 KG

3.1 REGISTRATION

All small remotely piloted aircraft (sRPA) in Canada must be registered, and the registration number must be on the aircraft and clearly visible (*Canadian Aviation Regulation* [CAR] 901.02, 901.03). The method of marking the registration on the RPA is left to the discretion of the owner. The RPA pilot should consult the manufacturer's instructions to ensure affixing the registration will not affect the aircraft's airworthiness. The registration should be located on the main body of the aircraft and not on frangible or removable parts such as batteries, motor mounts, or payloads; it should contrast with the primary colour of the RPA and be clearly visible when the aircraft is not in motion; and it should be durable because, in most cases, the registration will stay with the RPA for the duration of its service life regardless of any changes of ownership. If the marking degrades (e.g. permanent marker wears off or a label's glue wears out) such that the number is no longer visible, the pilot is responsible for making the number visible again (e.g. re-write or create a new label).

Registration is completed online through the Drone Management Portal (<www.canada.ca/drone-safety>) and a registration number is provided immediately once the required information is submitted and the associated fee is paid. In order to register a small RPA, the applicant must meet the requirements of CAR 901.04.

A pilot is required to present proof of registration, digital or physical, upon request from a peace officer or a person delegated by the Minister of Transport such as a Transport Canada inspector (CAR 103.02(1) and 901.09). Failure to register, mark, or present

proof of registration of an RPA can result in individual penalties of up to \$1,000 and/or corporate penalties of up to \$5,000.

3.1.1 Modifying a Registration

3.1.1.1 Cancelling a Registration

An RPA registration is cancelled once any of the conditions detailed in CAR 901.07 are met. It is the responsibility of the registered owner to notify the Minister within 7 days if their registered RPA is destroyed, permanently out of service, missing for more than 60 days, missing with a terminated aircraft search, or transferred to a new owner. The registration is also cancelled if the owner of the aircraft dies, the entity that owns the aircraft ceases to exist, or the owner no longer meets the requirements of CAR 901.04.

Notification can be provided to the Minister through the Drone Management Portal.

It is important to note that the registration is cancelled immediately when any of the conditions above are met and not when the Minister is notified.

If an RPA for which the registration has been cancelled and for which the Minister has been notified has been found, fixed, or otherwise brought back into service, an application for a new registration must be completed.

Failure to notify the Minister in accordance with CAR 901.07 may result in individual penalties of up to \$1,000 and/or corporate penalties of up to \$5,000.

3.1.1.2 Change of Name or Address

Registered owners of RPAs are required to notify the Minister within 7 days of a change of name or address. Notification can be provided to the Minister through the Drone Management Portal.

Failure to notify the Minister in accordance with CAR 901.08 may result in individual penalties of up to \$1,000 and/or corporate penalties of up to \$5,000.

3.2 GENERAL OPERATION AND FLIGHT RULES

This subpart describes general rules for small RPASs; these rules apply to both basic and advanced operations unless there are specific exclusions.

3.2.1 Line-of-sight

Visual line-of-sight (VLOS) RPAS operations rely on the LOS concept to ensure safety and regulatory compliance. This concept assumes an imaginary line between the pilot, through the control station, and the RPA, unimpeded by any obstacles or excessive distance. Line-of-sight can be broken into two distinct categories:

1. Visual line-of-sight by way of the pilot keeping a visual reference with the RPA unaided throughout the flight.
2. Radio line-of-sight (RLOS), which is a function of the C2 data link between the control station and the RPA for the purposes of managing the flight. Both the VLOS and the RLOS share the same foundational idea but can have different applications in RPA operations.

3.2.1.1 Visual line-of-sight (VLOS)

The CARs define VLOS as “unaided visual contact at all times with the remotely piloted aircraft that is sufficient to be able to maintain operational control of the aircraft, know its location, and be able to scan the airspace in which it is operating to detect and avoid other aircraft or objects.” (CAR 900.01). CAR 901.11(1) requires that pilots operating RPASs maintain VLOS at all times during flight. Losing sight of the RPA behind buildings or trees or into clouds or fog is strictly prohibited even for a short period of time.

Maintaining VLOS can be achieved by an individual pilot keeping the RPA within sight for the duration of the flight or by using one or more trained visual observers. The RPA must remain in VLOS with the pilot or at least one visual observer at all times. The pilot may take his or her eyes off the aircraft for brief moments to operate the control station or perform other flight-critical tasks without being considered to have lost VLOS. If a task will require extended loss of visual contact, the pilot should use a visual observer or land the aircraft until the task is complete.

While the maximum range for VLOS is not prescribed by regulation, pilots are required to determine the maximum distance the RPA can travel away from them before it becomes a hazard (CAR 901.28(c)). The factors to consider when determining this range are discussed in paragraph 3.2.6.2(a) Limitations of the Eye in this chapter. However, the manufacturer’s instructions or user manual takes precedence in this matter and should be consulted prior to determining the maximum range.

It is important to note that the regulations require VLOS be unaided. Pilots and visual observers may not use binoculars, telescopes, or zoom lenses to maintain VLOS, but unmagnified night-vision devices are permitted for night VLOS operations provided they are able to detect all light within the visual spectrum (CAR 901.39(2)). Glasses, such as sunglasses or prescription glasses, are not considered to be aids and are permitted.

Maintaining VLOS is a fundamental requirement for safe RPA operations as it is the primary, and often only, means of avoiding other airborne traffic. Failure to maintain VLOS can result in individual penalties of up to \$1,000 and/or corporate penalties of up to \$5,000.

3.2.1.2 Radio line-of-sight (RLOS)

The signal used by most small RPAs is often transmitted in the 2.4 GHz part of the electromagnetic spectrum, mainly because

of range performance and the fact that it is a part of the spectrum that does not require a licence to transmit. This frequency band is crowded by many users, and an RPA pilot can experience electromagnetic interference from these other devices. In addition, signals in this band are susceptible to interruption by physical interference from buildings and trees. It is critical, therefore, to ensure that there is uninterrupted RLOS between the control station and the RPA, regardless of the distance between the two. A control station that is powerful enough to transmit a signal a few kilometres away may nevertheless be unable to control an RPA a few metres away if there is an obstacle or interference in RLOS.

3.2.2 Emergency Security Perimeters

In cases where a public authority has established a security perimeter around an emergency area (e.g. fire, police incident, earthquake, or flood) RPA pilots are required to stay outside of the perimeter unless they are acting in the service of the public authority that created the perimeter, acting to save a human life, or working with first responders such as police or fire authorities (CAR 901.12).

Security perimeters can generally be identified as places where public officials limit or restrict access, where caution or police perimeter tape has been erected, or where first responders are on the scene. It is critical that RPA pilots and their aircraft do not enter or fly over these areas as they may conflict with or prevent lifesaving activities.

Failure to respect these perimeters can result in individual penalties of up to \$1,000 and/or corporate penalties of up to \$5,000.

3.2.3 Airspace

3.2.3.1 Canadian Domestic Airspace

Canadian RPA pilots are required to keep their RPA within CDA as detailed in RAC subpart 2.2 of the TC AIM and the *Designated Airspace Handbook* (DAH) (CAR 901.13).

Failure to remain within CDA can result in individual penalties of up to \$1,000 and/or corporate penalties of up to \$5,000.

3.2.3.2 Controlled Airspace

RPA pilots are required to keep their RPA clear of controlled airspace unless:

- a) the pilot holds a Pilot Certificate - RPA (VLOS) - Advanced Operations as described in section 3.4.1 of this chapter;
- b) the RPAS manufacturer has declared that the unit meets the appropriate safety assurance profile as described in section 3.4.3 of this chapter; and

- c) the RPA pilot has received an authorization from the appropriate air navigation service provider (ANSP) as described in section 3.4.4 of this chapter.

All three conditions must be met to gain access to controlled airspace and each will be discussed in an individual section of this chapter.

For the purposes of RPAS operations, controlled airspace includes Class A, B, C, D, and E. Class F airspace can be controlled airspace, uncontrolled airspace, or a combination of both.

A basic description of controlled airspace can be found below. Additional information can be found in the DAH and in the subpart RAC 2.8 of the TC AIM. Flight within each class is governed by specific rules applicable to that class and are contained in CAR 601.01, *Division I — Airspace Structure, Classification and Use*. CAR 601 can be found at <https://lois-laws.justice.gc.ca/eng/regulations/SOR-96-433/FullText.html#s-601.01>.

a) *Class A Airspace*

RPA Pilots wishing to operate in Class A airspace require specific authorization from both TC and NAV CANADA. See section 3.6.1 of this chapter for information about SFOC - RPAS.

Class A airspace is generally defined as high-level airspace starting at FL 180 or approximately 18 000 ft in Southern Domestic Airspace, FL 230 in Northern Domestic Airspace, and FL 270 in Arctic Domestic Airspace. This type of airspace is not denoted on aeronautical charts. Given the high-level nature of Class A airspace, it is rarely a concern for small RPA pilots. More information on Class A airspace can be found in the TC AIM RAC 2.8.1.

b) *Class B Airspace*

RPA pilots wishing to operate in Class B airspace require specific authorization from both Transport Canada and the ANSP. See section 3.6.1 of this chapter for information about SFOC - RPAS.

Class B airspace is generally defined as low-level controlled airspace and exists between 12 500 ft and the floor of Class A airspace but it may include some control zones and control areas that are lower. The specific dimensions of Class B airspace in Canada can be found in the DAH.

c) *Class C Airspace*

Class C airspace is considered an advanced operating environment. See section 3.4.3 of this chapter for more information.

Class C airspace is controlled airspace and generally exists around large airports and extends from the surface to an

altitude of 3 000 ft AGL, but the exact size and shape of the space is dependent on local airspace management needs. Class C airspace is depicted on all VFR Navigation Charts (VNC) and VFR Terminal Area Charts (VTA) as well in the DAH and the National Research Council Canada Drone Site Selection Tool.

d) *Class D Airspace*

Class D airspace is considered an advanced operating environment. See section 3.4.3 of this chapter for more information.

Class D airspace is controlled airspace and generally exists around medium-sized airports and extends from the surface to an altitude of 3 000 ft AGL, but the exact size and shape of the space is dependent on local airspace management needs. Class D airspace is depicted on all VNCs and VTAs as well in the DAH and the National Research Council Canada Drone Site Selection Tool.

e) *Class E Airspace*

Class E airspace is considered an advanced environment. See section 3.4.3 of this chapter for more information.

Class E airspace is controlled airspace for aircraft operating under IFR and can exist around an airport as a control zone or away from an airport where an operational need exists to control IFR aircraft. Class E control zones usually extend from the surface to an altitude of 3 000 ft AGL. It can also often exist from 2 200 ft AGL and up in a control area extension surrounding a control zone. When this type of airspace is not associated with an airport it usually begins at 700 ft AGL and extends to 12 500 ft ASL, but the exact size and shape of the space is dependent on local airspace management needs. Class E airspace is depicted on all VNCs and VTAs as well as in the DAH and the National Research Council Canada Drone Site Selection Tool.

f) *Class F Airspace*

Class F Airspace is special use airspace and can be either restricted or advisory. Class F can be controlled airspace, uncontrolled airspace, or a combination of both, depending on the classification of the airspace surrounding it.

(i) *Class F Restricted Airspace*

Class F restricted airspace is denoted as CYR followed by three numbers (e.g. CYR123). The letter D for danger area will be used if the restricted area is established over international waters. Class F restricted airspace is identified on all VNCs and VTAs as well as the National Research Council Canada Drone Site Selection Tool and should be avoided by all airspace users except those approved by the user agency. CYRs can be found over federal prisons and some military training areas, for example. Additional information can be found in RAC 2.8.6 of the TC AIM. To gain access to Class F

Restricted airspace, RPA pilots should contact the user agency as listed for the specific block of airspace in the DAH.

(ii) Class F Advisory Airspace

Class F Advisory airspace is denoted as CYA followed by three numbers (e.g. CYA123). Class F advisory airspace is identified on all VNCs and (VTAs as well as the National Research Council Canada Drone Site Selection Tool. CYA denotes airspace reserved for a specific application such as hang-gliding, flight training, or helicopter operations. RPA pilots are not restricted from operating in advisory airspace and no special permission is required, but pilots should be aware of the reason the airspace has the advisory and take steps to identify any additional risks and mitigate them. Many activities in a CYA often bring directly piloted (manned) aircraft into airspace below 400 ft AGL and are therefore a greater risk to RPA operations. Additional information can be found in RAC 2.8.6 of the TC AIM.

g) Class G Airspace

Class G airspace exists in any space that is not Class A, B, C, D, E, or F. Class G airspace is uncontrolled and is considered the basic operating environment for RPAS, assuming the conditions regarding proximity to people, airports, and heliport are met. These will be discussed in RAC 3.2.14 and 3.2.35.

3.2.3.3 Drone Site Selection Tool

This online interactive tool provides information regarding airspace restrictions around airports, heliports, and aerodromes to facilitate flight planning and ensure compliance with the regulations. It was designed to help RPA pilots determine areas where drone flight is prohibited, restricted, or potentially hazardous. The Drone Site Selection Tool can be found at <https://cnrc.canada.ca/en/drone-tool/>.

The tool is powered by a Google Earth engine that uses colour to identify areas that require additional caution or where RPA flights are prohibited according to a basic or advanced RPA operation category. Users should start by selecting the appropriate category of drone operations (i.e. basic or advanced). Areas filled with red are prohibited. Areas filled with yellow require additional caution due to other air traffic. Areas filled with orange require permission from NAV CANADA, Parks Canada, National Defence, or an airport operator.

When a user clicks on the control zones, information is displayed regarding the emergency contact information, airspace class, flight permission requirements, and more. It is important that the user verify the information before initiating the RPAS operation; it is the pilot's responsibility to contact the responsible authorities if he or she wishes to enter restricted airspace.

Data regarding airports and heliports comes from the *Canada Flight Supplement (CFS)*, a NAV CANADA publication, and is updated every 56 days. The airspace data comes from the *Designated Airspace Handbook (DAH)* of NAV CANADA. The national park data was extracted from the Canada Lands Surveys web services. A limited amount of data has been added manually to extend and improve upon the tool. An example of this is the inclusion of the restrictions surrounding Quebec corrections facilities as identified in NAV CANADA's *AIP Supplement 20/19*.

3.2.3.4 Inadvertent Entry Into Controlled Airspace

RPA pilots must be aware of not only the airspace in which they are operating but also the surrounding airspace, specifically their proximity to controlled airspace and restricted airspace, both laterally and vertically. If the RPAS operation is taking place at a location from which the RPA might enter controlled or special use airspace in the event of a fly-away, the RPA pilot should have the contact information for the appropriate ANSP or user agency immediately available. In the event that the RPA enters or is about to enter controlled airspace or special use airspace, the pilot must immediately notify the appropriate air traffic control (ATC) unit, flight service station (FSS), or user agency (CAR 901.15). Failure to notify the appropriate agency or agencies when unauthorized entry into controlled or restricted airspace may occur could result in individual penalties of \$1,000 or corporate penalties of \$5,000.

3.2.4 Flight Safety

RPA pilots are legitimate airspace users but are new entrants into a complex environment. It is the responsibility of the RPA pilots to take their role in the aviation environment seriously and ensure all necessary steps are taken to mitigate any possible risks. RPA pilots must keep in mind that the risk of injuring a person is greater than colliding with another aircraft, and a good safety margin should be kept according to the situation, especially for advanced operations within 30 m of the public. It is the RPA pilot's responsibility to manage the flight to ensure a safe outcome. He or she is to use all resources available to make appropriate, safe decisions to continue with the RPA flight or to end or re-schedule operations if needed.

If, during an operation, the pilot becomes aware of any situation that endangers aviation safety or the safety of persons on the ground he or she must immediately cease the operation until it is safe to continue (CAR 901.16). Failure to do so may result in individual penalties of up to \$1,000 and/or corporate penalties of up to \$5,000.

3.2.5 Right of Way and Risk of Collision

RPA pilots must give way to all other aircraft, including balloons, gliders, airships, and hang gliders heavier than air aircraft (CAR 901.17). It is critical that this rule is respected and that RPA pilots take their role in ensuring collision avoidance seriously as pilots of other aircraft may not be able to see the RPA as well as the RPA pilot can see and hear other aircraft. RPA pilots must

not operate so close to another aircraft as to create the risk of collision (CAR 901.18). If a collision with another aircraft becomes likely, RPA pilots must take immediate action to exit the area by the quickest means possible. This often means rapidly reducing altitude.

Failure to give way to other aircraft or to remain far enough away from other aircraft to avoid the risk of collision may result in individual penalties of up to \$1,000 and/or corporate penalties of up to \$5,000 and could constitute endangering an aircraft under the *Criminal Code*.

3.2.6 Detecting and Avoiding Traffic

3.2.6.1 General

When flying an RPA within VLOS, pilots practise “detect-and-avoid” (DAA) as a primary method of minimizing the risk of collision with other aircraft. DAA requires the pilot to look away from the control station and become aware of his/her aircraft and the surrounding environment. If the pilot can acquire skills to compensate for the limitations of the human eye, the DAA practice can be greatly improved and effective in facilitating a safer flight environment altogether. More information on how pilots can improve their visual skills is available in 3.2.6.2(b) Visual Scanning Technique.

In addition, the RPA pilot has other tools to detect traffic, such as hearing an approaching aircraft, monitoring a local ATC frequency, and using transponder or ADS-B monitoring devices, which are becoming more common.

3.2.6.2 Seeing Traffic

a) *Limitations of the Eye*

The eye is the primary means of identifying what is happening around us, as 80% of our information intake is conducted through the eyes. During flight we depend on our eyes to provide basic input necessary for flying, such as proximity to other air traffic, direction, speed, and altitude of the RPA. A basic understanding of the eyes’ limitations in target detection is important for avoiding collisions.

Vision is influenced by atmospheric conditions, glare, lighting, temperature, aircraft design, and so forth. On a sunny day, for example, glare is worse. Glare makes it hard to see what is at a distance as well as making the scanning process uncomfortable.

Vision can be affected by different levels of illumination:

- (i) Bright illumination: reflected off of clouds, water, snow, and desert terrain; produces glare resulting in eye strain.
- (ii) Dark Adaptation: Eyes must have at least 20 to 30 minutes to adjust to reduced light conditions.
 - (A) Red light helps night vision; however, it distorts colour and makes details hard to perceive;
 - (A) Light adaptation can be destroyed in seconds, though closing one eye may preserve some.

Additionally, vision is impaired by exposure to altitudes above 5 000 ft ASL, carbon monoxide inhaled from smoking and exhaust fumes, a deficiency of Vitamin A in one’s diet, and prolonged exposure to bright sunlight.

One significant limitation of the eye is the time required for accommodation, or refocusing of objects both near and far. It takes 1 to 2 seconds for the eyes to adjust during refocusing. Considering that you may need up to 10 seconds to spot aircraft traffic, identify it, and take action to avoid a mid-air collision, each second is critical. Looking at an empty area of the sky causes empty field myopia and will impair your ability to focus. You should look at a cloud patch or tree line to allow your eyes to focus.

Another eye limitation is the narrow field of vision. While the eyes can observe an approximate 200-degree arc of the horizon at one glance, only a very small centre area called the fovea, in the rear of the eye, has the ability to send clear, sharply focused messages to the brain. All other visual information that is not processed directly through the fovea will be less detailed. More information is available in subpart AIR 3.5 Vision.

b) *Visual Scanning Technique*

Avoiding collisions requires effective scanning from before takeoff until the aircraft comes to a stop at the end of a flight. The best way to avoid collisions is by learning how to use your eyes for efficient scanning, as well as understanding the visual limitations described above and not overestimating your visual abilities.

Before takeoff, visually scan the airspace around your intended take-off location. Assess traffic audibly as well, listening for engine sounds and, if possible, radio transmissions. After takeoff, keep scanning throughout the flight to ensure that no other traffic will be a hazard to your aircraft.

Scanning your eyes over a large area of sky at once without stopping to focus on anything is ineffective. Because the eyes can focus only on a narrow viewing area, effective scanning is achieved through short, regularly spaced eye movements that bring successive areas of the sky into the central visual field. Movement can be detected more effectively through peripheral vision, so this pause in a visual scan allows for easier detection of threats such as aircraft and birds. An effective scan is a continuous process used by the pilot and observer to cover all areas of the sky visible from the control station.

Although horizontal back-and-forth eye movements seem to be preferred by most pilots, every pilot should develop a scanning pattern that is most comfortable for them and then adhere to it to assure optimum scanning. Pilots should realize that their eyes may require several seconds to refocus when switching views between items in or on the control station and distant objects. The eyes will also tire more quickly

when forced to adjust to distances immediately after close-up focus, as required for scanning the control station. While there is no “one size fits all” technique for an optimum scan, many pilots use some form of the “block” system scan. This scan involves dividing the sky into blocks, each spanning approximately 10 to 15 degrees of the horizon and 10 to 15 degrees above it. Imagine a point in space at the centre of each block. Focus on each point to allow the eye to detect a conflict within the foveal field, as well as objects in the peripheral area around the centre of each scanning block.

Good scanning requires constant attention-sharing with other piloting tasks, and pilots should remember that good scanning is easily degraded by conditions such as boredom, illness, fatigue, preoccupation with other tasks or ideas, and anxiety.

3.2.6.3 Hearing Traffic

One advantage an RPA pilot has over a pilot of a manned aircraft is the ability to hear approaching traffic. The first indication an RPA pilot will have of approaching traffic will often be the noise from the engines and/or rotors, both of which can be useful cues to direct the pilot’s attention to traffic detection. Even though these noise cues can be distorted by terrain, buildings, or wind, they are still a credible means for the RPA pilot to focus on identifying approaching aircraft until they can be visually acquired.

a) *Monitoring Air Traffic Frequencies*

It is possible that an RPA pilot will have access to a radio for monitoring ATC frequencies. This radio may be part of a pilot’s risk-mitigation efforts in the event of a non-standard operation. In any event, this radio can be an extremely valuable source of traffic information, provided the RPA pilot is aware of the correct frequency to monitor. Aviation frequencies can be found on aviation maps as well as in the CFS.

Table 3.1—Air Traffic Frequencies

Frequency (MHz)	Usage
126.7	Uncontrolled airspace
123.2	Uncontrolled, unassigned aerodromes

While monitoring the radio, a pilot can build up a mental picture of the other traffic in the local area and, depending on the level of the pilot’s knowledge of aviation, he or she can use the radio calls from other aircraft to determine potential hazards to the RPA operation.

In accordance with section 33 of the *Radiocommunication Regulations*, a person may operate radio apparatus in the aeronautical service [...] only where the person holds [a Restricted Operator Certificate with Aeronautical Qualification (ROC-A), issued by Innovation, Science and Economic Development Canada]. Also, all radio equipment used in aeronautical services must be licensed by Industry Canada.

For more information on the standard radio phraseology used in aviation, see Innovation, Science and Economic Development’s study guide RIC-21 for the ROC-A, COM 1.0 in the TC AIM, or NAV CANADA’s *VFR Phraseology Guide*.

3.2.6.4 Avoiding a Collision

Once an aircraft is detected and it is determined to be a conflict, the RPA pilot is responsible for avoiding a mid-air collision. The best way to fulfill this obligation will vary depending on the scenario, and RPA pilots should plan how they are going to react to a potential collision prior to taking off or launching to ensure their strategy best fits the operation. The fastest method of resolving a potential conflict is likely reducing altitude.

The RPA pilot must always give way to other airspace users (CAR 901.17), and RPA pilots should recognize that the pilot of the other aircraft likely will not see the RPA with sufficient time to react. The responsibility of avoiding a collision lies with the RPA pilot, and it is a responsibility that should be taken very seriously as the lives of the people in the other aircraft may depend on it.

3.2.7 Fitness of Crew Members

All members of the crew including the visual observers, pilots, and others involved in the operation of the RPAS must not be under the influence of any drugs or alcohol or fatigued when conducting an operation with an RPAS (CAR 901.19). Additional information can be found in the TC AIM *AIR – Airmanship*, Part 3.0 *Medical Information*.

It is strictly prohibited under CAR 901.19 to act as a pilot or crew member of an RPAS within 12 hours after consuming an alcoholic beverage, while under the influence of alcohol, or while using any drug that impairs a person’s faculties. It is also strictly prohibited under PART VIII.1 section 320.14(1) of the *Criminal Code* for a person to act as a pilot or crew member of an RPA while the person’s ability to operate is impaired, to any degree, by alcohol, drugs, or a combination of both. All aircraft pilots and crew members must remain fit to fly.

If an RPA pilot takes prescription drugs, it is his or her duty to ensure they do not alter his or her ability to safely engage in RPA operations. It is each individual’s responsibility to consult with a physician in a case of doubt and to advise other members of the team of the situation if deemed necessary.

Cannabis became legal, for both recreational and medical purposes, in Canada in October 2018 by virtue of the *Cannabis Act*. Whether it is used recreationally or medically, cannabis has the potential to cause impairment and adversely affect aviation safety. All aircraft pilots and flight crew members (including RPA pilots and visual observers) must abstain from cannabis use for at least 28 days when conducting operations with an RPAS.

Fatigue is as dangerous as drugs or alcohol when it comes to impairment and is oftentimes harder to detect. Fatigue will influence judgment, motor response, and mental capability. Its effects can be present without the person realizing it, making it particularly dangerous. It is important to consider that sleep itself is not the only factor influencing the degree of a person's fatigue. Lack of sleep, work-related stress, family issues, emotional state, and general health are all factors that contribute to the fatigue level of a particular individual. A comprehensive guide to manage fatigue, the Fatigue Risk Management System (FRMS) Toolbox for Canadian Aviation, is available on Transport Canada's Web site: <www.tc.gc.ca/en/services/aviation/commercial-air-services/fatigue-risk-management/frms-toolbox.htm>. It is a great tool to help understand, manage, and mitigate the risks associated with fatigue in an aeronautical context.

It is not just fatigue, alcohol, or drugs that can leave a crew member unfit for duties. Illness and many other conditions may diminish crew members' ability to perform their functions and might render them unfit for the operation. It is the responsibility of individual crew members to conduct a self-assessment to ensure they are fit before accepting any duties related to the operation.

Reviewing a checklist prior to flight can help a crew member determine if they are fit to fly. A simple IM SAFE checklist can be found below but several other examples can be found online. If the answer to any of the questions below is "Yes", you are likely not fit to act as a crew member.

Table 3.2—IM SAFE Checklist

I	Illness Are you suffering from any illnesses that could impair your ability to complete your duties?
M	Medication Are you under the influence of any drugs (over-the-counter, prescription, or recreational) that will impair your ability to complete your duties?
S	Stress Are personal or professional matters causing stress to the point that you are distracted or otherwise impaired?
A	Alcohol Have you consumed any alcohol within the previous 12 hours?
F	Fatigue Have you had sufficient rest in the previous 24 hours and do you feel alert?
E	Eating and drinking Have you had sufficient and proper nutrition and hydration?

Failure to abstain from acting as a crew member of an RPAS while unfit may result in individual penalties of up to \$1,000 and/or corporate penalties of up to \$5,000. Acting as a crew member within 12 hours of consuming alcohol or while under the influence of drugs or alcohol may result in individual fines of \$5,000 and/or corporate penalties of \$15,000.

3.2.8 Visual Observers

In some cases, a visual observer is needed to assist the pilot in maintaining a constant VLOS with the RPA to comply with the CARs. In complex operating environments like urban areas, the RPA pilot and the visual observer have to maintain communication for updates to any impending conflict between the RPA and terrain, obstacles, aviation traffic, weather, etc. Visual observers shall be trained to perform any duties as assigned to them by the pilot. This includes visual scanning techniques, aircraft identification, communications, and any other knowledge that may be required to successfully perform their duties. The pilot and visual observer(s) shall remain in constant and immediate communication throughout the RPAS operation, as stated in CAR 901.20.

Before beginning an operation, the crew should agree upon consistent communication language specific to the mission at hand. Important information sought by the pilot could be the RPA's relative distance, altitude, and flight path in relation to manned aircraft but also other hazards like terrain, weather, and structures. The visual observer must be able to determine the RPA's proximity to all aviation activities and sufficiently inform the pilot of its relative distance, altitude, flight path, and other hazards (e.g. terrain, weather, structures) to prevent it from creating a collision hazard.

The visual observer will also help the RPA pilot to keep the operational environment sterile (that is, free of irrelevant conversation) during the flight and minimize the disturbances to the RPA pilot and crew.

Visual observers are not required to possess an RPA pilot certificate.

3.2.9 Compliance With Instructions

In any type of safety-critical operation there is a requirement for one person to have the final word on how and when various tasks will be performed. In aviation this person is called the pilot-in-command or pilot. For RPAS operations all crew members are required to follow the instructions of the pilot.

Failure to follow the instructions of the pilot can result in unsafe situations and may be punishable by individual penalties of up to \$1,000 and/or corporate penalties of up to \$5,000.

3.2.10 Living Creatures

RPA pilots are prohibited from operating an RPA with a living creature on board (CAR 901.22). As with the entirety of Subpart I of Part IX, this regulation applies only to sRPAs. In order to operate large RPAs for the purpose of carrying persons, an SFOC - RPAS issued in accordance with CAR 903.03 is required (see subpart 3.6 of this chapter).

The operation of an sRPA with a living creature on board may result in individual penalties of up to \$1,000 and/or corporate penalties of up to \$5,000.

3.2.11 Procedures

3.2.11.1 Normal Operating Procedures

RPA pilots are required to establish procedures for the pre-flight, take-off, launch, approach, landing, and recovery phases of flight. The procedures established must allow the aircraft to be operated within any limitations prescribed by the manufacturer and should be reviewed by the pilot on a regular basis to ensure they contain the most up-to-date information and be available to the pilot at the crew station during all phases of flight in either a written or digital format. Caution should be exercised if the procedures are on the same mobile device that is being used to pilot the RPAS. This practice is not recommended.

3.2.11.2 Emergency Procedures

RPA pilots are required to establish emergency procedures for control station failures, equipment failures, RPA failures, lost links, flyaways, and flight terminations. The procedures established must allow the aircraft to be operated within any limitations prescribed the by manufacturer and should be reviewed by the pilot on a regular basis to ensure they contain the most up-to-date information and be available to the pilot at the crew station during all phases of flight in either a written or

digital format. Caution should be exercised if the procedures are on the same mobile device that is being used to pilot the RPAS. Following all emergencies, the PIC should log the events and follow-up actions in accordance with CAR 901.49.

a) *Control Station Failure*

Whether the RPAS is controlled via a laptop, RC, or another device, its crew should have troubleshooting items committed to memory for immediate action. Pilots should know and be prepared for how their aircraft will respond to a crashed app, powered down transmitter, or low battery scenario.

b) *Equipment Failure*

While some equipment will not be flight-critical, crews should know which items require aircraft grounding and which are safe to fly without. Establishing a manufacturer-advised minimum equipment list is a good practice.

c) *RPA Failure*

Crews should be aware of items that will cause a critical failure of the RPA and what flight condition these failures will create. While fixed wings may glide, most multirotors will descend with varying levels of control. Immediate actions should involve establishing a safe area and preparing for injury or incident response.

d) *Lost Link*

Immediate action items should include troubleshooting (which, depending on the system used, may involve reorienting antennas), confirming or exchanging the cable connection, or selecting a flight termination system. The crew should monitor the aircraft and the airspace until connection can be regained or the aircraft lands safely; otherwise, flyaway procedures should be initiated.

e) *Flyaway*

A flyaway indicates an unresponsive aircraft and should warrant immediate action by the crew to mitigate associated risks both in airspace and on the ground. After initial troubleshooting, action should be taken to alert the ANSP of a deviation from the planned flight path and any potential conflict that may exist. This is why it is critical that pilots understand the airspace surrounding their operating environment both laterally and vertically.

f) *Flight Termination*

Flight termination can take many forms and may be as simple as a normal landing or as complex as a fragmentation system or parachute. Another common flight termination system is return-to-home, or RTH. Crews should know when and how to activate RTH and how to cancel or override, if possible.

3.2.12 Pre-flight Information

3.2.12.1 Pre-flight Inspections

Pre-flight inspections should be conducted before every takeoff the aircraft conducts in order to verify the physical, mechanical, and electronic integrity of the RPAS. The following is a brief example of components to be inspected prior to flight and is not all-encompassing. In all instances, the RPAS manufacturer's instruction manual shall be consulted to determine all the components that must be inspected or require a function check prior to flight. The initial inspection to confirm the RPAS is in a fit and safe state for flight is the most extensive to be conducted before each new day of operations and should include a thorough inspection of the following components, in compliance with the RPAS manufacturer's operating manual recommendations, including (but not limited to):

- a) Airframe;
- b) Landing gear;
- c) Power plant;
- d) Propellers/rotors;
- e) Battery or fuel;
- f) Control station/receivers/transmitter;
- g) Control station device and cables (tablet, phone, laptop, or other).

The crew also needs to be briefed on the following points before takeoff:

- a) Roles and responsibilities of each individual crew member;
- b) Flight plans and anticipated procedures (e.g. command hand-off);
- c) Emergency and contingency plans;
- d) Location of the safety equipment and who is trained to use it;
- e) Public management plan.

Just after takeoff, a brief test flight should be conducted first within short VLOS range in order to verify commands response, flight behaviours, response to current weather conditions, and crew cohesion beforehand.

A brief inspection should also be conducted after each landing (e.g. battery change) and a full inspection should be conducted after each crash or malfunction, or when changing location.

3.2.12.2 Fuel and/or Energy

Estimation of the fuel/energy consumption for the operations should be considered prior to takeoff and described in the flight planning summary. It is important to take into consideration that the stated endurance of the aircraft with a given amount of fuel/energy is a suggested indication from the manufacturer that might change according to different variables. Those factors might include but are not limited to environmental factors (e.g. wind, outside temperature, and altitude), human factors (e.g. piloting skills and/or behaviour), fuel/energy sources quality (e.g. quality of the fuel or battery), and mechanical factors (e.g. engine malfunction, motor friction). The aircraft might not operate properly or predictably when its fuel/energy levels are low. Unexpected circumstances might arise between the initiation of the return procedure and the landing of the aircraft. Therefore, it is recommended that the pilot consider factors that might influence the aircraft endurance and plan the flight time accordingly.

Finally, it is important to consider that RPASs are multi-component systems and that the factors listed above will influence the endurance of other components such as the remote control, ground station, first-person view (FPV) goggles, etc. These should also be taken into consideration when estimating the endurance of the RPAS. Refer to the manufacturer's instructions provided to verify the aircraft and the components endurance rating. In the absence of specific guidance from the manufacturer, it is recommended that pilots take a cautious approach.

3.2.13 Maximum Altitude

In uncontrolled airspace, RPAs are normally limited by regulation to a maximum altitude of 400 ft AGL or 100 ft above the tallest obstruction within 200 ft laterally (CAR 901.25). However, if a pilot is operating under an SFOC - RPAS, the conditions of the SFOC may state a maximum altitude higher or lower than 400 ft (CAR 903.01). In controlled airspace, the maximum altitude permitted for a specific flight will be determined by the ANSP; in most cases, this will be NAV CANADA. The RPA pilot must keep the RPA in VLOS at all times, regardless of the altitude allowed by the ANSP. The maximum altitude possible in VLOS depends on several factors including the RPA's visibility, colour, size, etc. The vast majority of small RPAs are not visible at more than 400 ft AGL in good weather conditions.

3.2.13.1 Types of Altitudes

In aviation, the altitude at which an aircraft flies is normally measured as either above ground level (AGL) or above sea level (ASL). Depending on the geographic location of your launch site, the difference between AGL and ASL can be a few feet, or as much as several thousands of feet, so it is important to know what type of altitude your RPA control station is displaying and what traditional aircraft are using in your local flight area. This is important because traditional aviation aircraft are usually flown with reference to ASL, so procedures and communication will be conducted using altitudes that may seem odd to an RPA pilot. For instance, an RPA operation may have a limit of

400 ft AGL, but in a location like Calgary, this altitude equates to approximately 4 000 ft ASL, as the Calgary airport is at 3 600 ft ASL. An RPA pilot monitoring ATC radio frequencies in this situation might get confused when trying to determine the location of aircraft if differing altitude measurements are used. In another scenario, an RPA flying near Tofino, BC would have a much easier time trying to reconcile AGL and ASL as the Tofino airport is only at 80 ft ASL.

a) *Station Height*

Station height is the altitude measured at a weather reporting station, often an aerodrome, relative to sea level.

b) *Above Ground Level (AGL)*

AGL involves an altitude of zero feet (or metres) measured when the RPA is sitting on the ground and, as the aircraft flies, altitude changes are measured in reference to the ground below the RPA, or the initial ground position. In an RPA, this altitude is often calculated by a GPS position or a downward-pointing laser rangefinder.

It is important to note that many RPAs reference their altitude AGL from the point of launch. This means that the aircraft's altitude AGL may have to be inferred as the aircraft travels over uneven ground. For operations with large ground level height changes where the aircraft is operated near the operational limit of 400 ft, a buffer may need to be included to prevent exceeding the allowable maximum altitude.

c) *Above Sea Level (ASL)*

ASL requires a pressure measurement from a local weather station, which is then input into a pressure altimeter on the aircraft. This will then provide an altitude read-out which is relative to sea level. Traditional aircraft and some larger RPAs will be equipped with pressure altimeters and use ASL altitude measurements.

3.2.13.2 Measuring Altitude

a) *Pressure Altimeters*

The pressure altimeter used in aircraft is a relatively accurate instrument for measuring flight level pressure but the altitude information indicated by an altimeter, although technically “correct” as a measure of pressure, may differ greatly from the actual height of the aircraft above mean sea level or above ground. As well, the actual height of the aircraft above ground will vary as the aircraft flies between areas of different pressure.

For more information on pressure altimeters and their uses and errors, see subpart 1.5 Pressure Altimeter in the AIR—*Airmanship* chapter of the TC AIM.

b) *Global Positioning System (GPS) Altimeters*

The GPS receiver in an RPA typically needs to clearly see a minimum of four satellites to get an accurate position over the earth. GPS is a helpful aid to aviation, but it is important to recognize that there are errors that may affect the accuracy of the position and altitude calculated and displayed by your RPA. In altitude, errors resulting from poor satellite geometry, reception masking by obstacles, or atmospheric interference can result in errors of up to 75 ft (approx. 23 m).

For more information on GPS and other GNSSs, see subpart 5.1 Global Navigation Satellite System (GNSS) in the COM—*Communication* chapter of the TC AIM.

3.2.14 Horizontal Distance

RPA pilots are required to remain 100 ft or 30 m from people not associated with the operation. The distance from people must be maintained regardless of the altitude at which the RPAS is operating.

It is the RPA pilot's responsibility to plan the route of flight in a manner that ensures the RPA does not fly within 30 m of any person, except for crew members and other people involved in the operation. (CAR 901.26) Examples of people involved in the operation are: construction site or mine workers, film crews, or wedding guests and others involved in a wedding (facility staff, caterers, etc.). These people are considered part of the operation if they have been briefed on the RPA hazard and have the opportunity to leave the RPA operation site if they are uncomfortable with it. People inside vehicles or inside buildings are not factored into the 30-metre horizontal distance rule (CAR 901.26). Even if an RPA can fly within 30 m of vehicles, buildings, crew members, or other people involved in the operation, this needs to be done safely (CAR 900.06). The RPA pilot should have contingency plans in place in the event that a person not associated with the operation comes within 30 m of the RPA and should be prepared to take immediate action to restore the safety buffer. Some examples of contingency plans may be rerouting the RPA, returning to land, or holding over a secure area until the minimum distance can be restored. Whatever action is taken to maintain the safety distance, the pilot must ensure the RPA does not fly within 30 m of one person while trying to remain 30 m away from another person. Pre-planning and site preparation during the site survey have proven to be effective at reducing the risks associated with maintaining the required 30-metre safety buffer.

Operations between 30 m and 5 m from another person are considered “near people” and are an advanced operation.

To operate an RPA “near people”, the RPA pilot needs to:

- a) possess a Pilot Certificate - Advanced Operations; and

- b) use the right RPAS in accordance with CAR 901.76 and CAR Standard 922 *Remotely Piloted Aircraft Systems Safety Assurance*. This eligibility is written on the RPAS certificate of registration.

Different Systems for Measuring Distance - km/SM/NM

km: The kilometre is a standard metric measurement that is the most commonly used in the world; 1 km equals 1 000 m. Most maps and software will use the metric system.

SM: The statute mile comes from the imperial system and refers more commonly to the U.S survey mile, which is equal to 5 280 ft or 1 609.347 metres. It is most commonly used in the U.S.A. and the United Kingdom and is still commonly used in aviation.

NM: A nautical mile represents one latitudinal minute of the earth spheroid. The most commonly used spheroid for calculating the nautical mile is the WGS84 geoid, which equates 1 nautical mile to 6 046 ft, 1 825 metres, or 1.15 statute mile. It is the main distance unit used in aviation and marine applications.

Two methods can be used to measure distances at the field site without being directly on the ground. Using the scale on your maps or chart, calculate the distance using a metric or imperial ruler and translate the distance calculated on the map. For example, if the map scale is 1:20 000, then 1 linear centimetre calculated on the map represents 20 000 centimetres on the ground. The second method would consist of using an online Geographic Information System platform (e.g. Google Earth and ArcGIS Earth) that has spatial calculation tools that provide instant measurements of the terrain surface.

3.2.15 Site Survey

3.2.15.1 Understanding Your Area of Operation

It is important to understand your area of operation prior to conducting your flight mission. Multiple options are available for this preliminary step, including looking at satellite imagery or topographic/aviation maps and visiting the site in person. Satellite imagery is now freely available on the web through multiple service providers and applications (e.g. Google Earth and Bing). The GeoGratis spatial products portal of Natural Resources Canada also offers free topographic information, Digital Elevation Models (DEMs), satellite imagery, and more. Aviation charts are available at a cost through NAV CANADA and through mobile and web apps. Ensure that these third-party applications are using up-to-date and official NAV CANADA information. It is best to use site coordinates in order to localize the area of operation on a map or other imagery source. If coordinates are not available, using a landmark, nearby structure, or point of reference is a reasonable substitute.

Once the site has been identified, the following points must be defined:

- a) Operation boundaries;
- b) Airspace classes and applicable regulatory requirements;
- c) Routes and altitudes to be followed during the entire operation;
- d) Proximity of manned aircraft and/or aerodromes;
- e) Location and height of nearby obstacles;
- f) Security measures for warning the public of the RPAS operations site;
- g) Predominant weather conditions for the area of operation;
- h) Minimum separation distances from persons;
- i) An alternate landing site in case of precautionary or emergency landing; and
- j) Aviation maps and symbols.

3.2.15.2 Locating Local Aerodromes and Airports

To identify an aerodrome or an airport, it is recommended that a combination of aeronautical charts and the CFS issued by NAV CANADA be used. The two main charts used by pilots are the VNC, meant for low- to medium-altitude flights at a 1:500 000 scale, and the VTA, meant for providing information about the most congested airspace within Canada at a scale of 1:250 000. The CFS is a reference document updated every 56 days containing all the information relevant to the registered aerodromes and certified airports in Canada. For information regarding water aerodromes, refer to the *Canada Water Aerodrome Supplement* (CWAS).

To identify the different symbols presented on the maps and charts, you should refer to the legend presented in the first pages of the charts and the CFS. Information with regard to date of publication, author, projection, scale, and more would also be found there.

3.2.15.3 Identifying Classes of Airspace

To identify the classes of airspace present at the field site, it is recommended that you use resources such as the Drone Site Selection Tool, the CFS, the aeronautical charts of the area of operation, and the DAH. Airspace will be classified according to the Canadian airspace classification (a range from A to G).

Anyone holding an RPA Pilot Certificate (Basic or Advanced) can operate within uncontrolled airspace only, in class G and some class F airspace.

For flight within controlled airspace, the RPA pilot must:

- a) possess an RPA Pilot Certificate - Advanced Operations;
- b) receive an authorization from the local ANSP; and
- c) use the right RPAS in accordance with CAR 901.76 and CAR Standard 922 *Remotely Piloted Aircraft Systems Safety Assurance*. This eligibility is written on the RPAS certificate of registration.

3.2.16 Other Pre-flight Requirements

Prior to commencing flight the pilot must be satisfied that the RPA has a sufficient amount of fuel/energy to safely complete the flight, the crew members have received sufficient instruction to perform their duties, and any required emergency equipment is on site, with its location and method of operation known and readily accessible.

In addition to the requirements above, the pilot must determine the maximum distance the RPA can safely be flown from the control station for the planned flight. This distance may vary depending on the environment (e.g. visibility, cloud cover, and wind), the location (e.g., a background of buildings can make the RPA difficult to see), and the RLOS (the strength of the radio signal and the presence of interfering signals).

3.2.17 Serviceability of the RPAS

All RPASs, just like all aircraft, must be inspected before flight to ensure they are safe to operate and also after landing at the conclusion of the flight to check that they are safe for the next flight. The RPA pilot is responsible for ensuring that the RPA is serviceable and the RPAS has been maintained (CAR 901.29). The list below is generic in nature but includes points for inspection applicable to most RPAS. For details, refer to the manufacturer's instructions for the specific type of RPAS.

Following the "walk around" or RPAS visual inspection, a fully charged battery can then be installed for the next flight. For a larger RPAS, a normal engine ground run can be carried out on the ground for a check of the flight controls and avionics systems. Just after takeoff, a short test flight and/or a ground run should be completed to make sure all controls and switches are functioning and correct.

3.2.17.1 Airframe (All Types)

Depending on the weight of the aircraft (25kg or less), pick up the RPAS or walk around it and inspect the entire aircraft. Pay attention to the following:

- a) Check all antennas, ensuring they are secure and in good condition;
- b) Check the battery emplacement and secure attachment, and ensure that there are no cracks;
- c) Check that all lights are operating normally;
- d) Check the pitot tube (if applicable) and make sure it is secure and clear of any obstructions;
- e) Check that the GPS is receiving satellites and providing a navigation solution (if applicable).

For fixed wings, check:

- a) Wings, ensuring that they are securely attached to fuselage;
- b) Wing leading edge surfaces;
- c) Top and bottom of wing surfaces;
- d) Wing tip surfaces;
- e) Rear of wing and all flight control surfaces for freedom of movement, security, and any skin damage (composite/metal).

For rotary aircraft:

- a) Inspect the top and bottom of the airframe arms for cracks, loose parts, or signs of damage;
- b) Check that the levels of all fluids (oil/hydraulic fluid) are within limits and ensure there are no leaks.

3.2.17.2 Landing Gear

Check that the landing gear is secure, as applicable.

Larger RPASs may have retractable or fixed landing gear and may have wheel brakes. Check for leaks on oleos and leaks in the brake system as appropriate. Check brake wear indicators if applicable.

For servicing and scheduled maintenance items, always refer to the manufacturer's maintenance manual. If in doubt, contact the manufacturer directly for technical support.

Inspect skids or wheels as applicable depending on type, especially the attachment points, which should be secure with no cracks. In addition, check for cracks in welds.

3.2.17.3 Powerplant

Inspect the following:

- a) Cowling or motor casing as applicable;
- b) Power plant for security of engine mounts;
- c) The presence of any cracks;
- d) All lines, ensuring there are no fluid leaks (fuel, oil, or hydraulic);

- e) All wiring and connectors, ensuring there are no cracks, loose connections, or chaffing;
- f) The oil level, ensuring it is within limits, if applicable.

3.2.17.4 Propellers

Inspect the following:

- a) Spinner(s), if installed, ensuring that they are secure and there is freedom of movement;
- b) The propeller, ensuring it is secure;
- c) The propeller blades, checking for nicks, chips, or cracks, especially on the plastic blades on RPASs weighing 25kg or less. Chips, nicks, or cracks on a plastic blade mean it is time to replace the propeller. For metal blades refer to the manufacturer's instructions to see what the limits are to file the nicks or chips before replacing the propeller.

3.2.17.5 Battery—Lithium Polymer

Inspect the battery for overall condition. There should be no signs of swelling, external leaking, or other defects.

Ensure the battery wiring and connectors from the battery and the aircraft are connected securely.

The battery and spare batteries necessary to complete the operation should be adequately charged before flight to complete the mission.

Be careful not to pinch the wires when installing the battery, attaching the connectors, and closing the battery door.

3.2.17.6 RPAS Control Station/Receiver/Transmitters

The battery and spare batteries (if applicable) necessary to complete the operation should be adequately charged before flight to complete the mission.

Check that all flight interface is functioning normally.

3.2.18 Availability of RPAS Operating Manuals

In order to ensure the RPAS can be operated within the limitations specified by the manufacturer, it is important that the pilot and crew members have access to the most current system operating manuals. These manuals can be available either in digital format or in print; the key is that they are immediately available for the pilot and crew members (CAR 901.30).

Failure to have manuals immediately available could result in individual penalties of up to \$1,000 and/or corporate penalties of up to \$5,000.

3.2.19 Manufacturer's Instructions

RPASs are complex systems that have both system and environmental limitations that allow them to operate in a predictable manner. To ensure the maximum reliability of the RPAS it is required that the RPAS be operated in accordance with the manufacturer's operating instructions (CAR 901.31).

Failure to operate the RPAS in accordance with the manufacturer's instructions could result in individual penalties of up to \$1,000 and/or corporate penalties of up to \$5,000.

3.2.20 Control of RPAS

RPA pilots are not permitted to operate autonomous RPAs for which they are unable to take immediate control of the aircraft. (CAR 901.32).

Automation (i.e. "automated" or "automatic") refers to a deterministic system that behaves in a predictable manner using pre-set rules. This type of system will always produce the same output given the same set of inputs, user error notwithstanding. An example of this in an RPAS context would be a user plotting a route on the control station and the aircraft following that route on autopilot while the pilot monitors the flight.

In contrast, an autonomous system is goal-based and not deterministic. The path to the desired outcome may not be easily predicted and the system may model behaviours that result in unique outcomes in each instance of operation. An autonomous RPA is one that operates without pilot intervention in the management of the flight, and in fact, there may be no mechanism for pilot intervention by design. An autonomous RPA may react to changing environmental conditions or system degradations in a manner that it determines on its own.

Pilots found to be operating autonomous RPAs for which they are unable to take immediate control are subject to individual penalties of up to \$1,000 and/or corporate penalties of up to \$5,000.

3.2.21 Takeoffs, Launches, Approaches, Landings, and Recovery

Prior to conducting an RPAS operation the pilot must ensure that there is no likelihood of a collision with another aircraft, a person, or an obstacle and that the site chosen is suitable for the operation (CAR 901.33).

When choosing a site for an RPA's takeoff, launch, landing, or recovery, the pilot should ensure that he or she has the land owner's permission to use the site and that the site is free of obstacles that could interfere with the operation of the RPA. Obstacles include physical obstacles like trees, buildings, or open water as well as non-physical obstacles like electronic or magnetic interference. It is also important that the site selected be secured to ensure bystanders do not venture too close to or enter the take-off or landing area. Securing a site can be done by erecting physical barriers to ensure the public does not access

the area during the operation or by having crew members perform a crowd control function. It is important that the RPA pilot understand and follow any municipal, provincial, and federal laws and regulations when securing a site. In some situations, restricting public access to a site may not be allowed.

3.2.22 Minimum Weather Conditions

The weather is a primary concern for pilots of all types and should be something of which they have a thorough understanding. The minimum weather requirements for sRPA pilots are different from those of more traditional aircraft pilots and even large RPAs. For sRPAs, the weather need only be sufficient to ensure the aircraft can be operated in accordance with the manufacturer's instructions (i.e. temperature, wind, precipitation, etc.) and to allow the pilot or visual observer to keep the RPA within VLOS at all times.

3.2.22.1 Sources of Weather Information

Climate data, weather forecasts, and real-time weather conditions are a central pillar of every aeronautical operation. Aircraft are particularly vulnerable to the elements due to the medium in which they operate, as the atmosphere does not provide any shielding from the weather. Various sources of information are available for monitoring weather and ensuring the safe conduct of the RPAS operations. Depending on the time scale at which the weather or climate needs to be determined, different sources of weather information might be required.

For climatic and long-term predictions of a few months or more Environment and Climate Change Canada's (ECCC) *Canadian Climate Normals* is available on the ECCC Web site: http://climate.weather.gc.ca/climate_normals/. This tool is more suitable for evaluating whether operations at a given time/location would be possible given the historical climatic patterns. This should be used as a means of evaluation for long-term operation planning and/or in Canadian regions where pilots are not familiar with the weather patterns at a given time. The portal gives pilots access to a large array of data and graphs giving punctual measurements of weather conditions along the Canadian weather stations system. Data is freely available to download in .csv format. Thirty-year averages (1981-2010/ 1971-2000/ 1961-1990) are also available for analysis. For example, this would help a pilot to establish when the ground is snow-free and the air temperature is above 5°C according to the last 30 years, permitting the planning mission in advance.

For medium- to short-term predictions of the weather, multiple online and broadcast versions exist. ECCC offers daily weather forecasts and forecasts up to two weeks in advance on its Web site, https://weather.gc.ca/canada_e.html. Weather radar data is available for up to 3 hours and satellite imagery is offered at varying time intervals for the present day. This source of weather information can be used for mission planning and/or the same day.

For same-day weather information one of the most detailed sources of information is the online tool provided by NAV CANADA called the Aviation Weather Web Site (AWWS): https://plan.navcanada.ca/flight/awws_wx_notam. This Web site is one of the main sources of weather forecasts, reports, and charts used for flight planning by aviation professionals. For more information regarding the AWWS, how to interpret different charts and reports, and the general procedures associated with the Web site, see the MET—*Meteorology* chapter of the TC AIM.

Additionally, there are a variety of weather apps available that pull weather data from a variety of sources. Check to ensure you are using NAV CANADA official data whenever possible.

Finally, no matter what tool is used, which preparations have been made, and what the given predictions are for the day of operation, it is essential to evaluate the weather at the site before launching the operation. Weather is a complex science and can be subject to unpredicted fluctuations, especially on a small geographic scale. Never operate an RPAS if the weather on site is outside your manufacturer's recommended operating limits, or if you judge based on your experience that local weather could adversely affect your flight, even if the weather forecasts say otherwise.

3.2.22.2 Micro vs. Macro Climate Environments

a) *Micro Climate*

Micro climate is defined as climatic variations localized in a small or restricted area that differs from the surrounding region. It is important to consider small climatic variations when planning RPAS flights. The altitude, nearby water bodies, topography, ground surface, and obstacles are all factors that can and will influence the conditions experienced at a specific site. Those variations might manifest themselves in the form of variable wind strength and/or directions, convecting/advecting air movements, variable temperatures, localized precipitation, variable visibility levels, and more. These must be considered carefully; weather forecasts for the region might be good, but localized variations might compromise flight operation safety.

Due to the nature of most RPAS VLOS flights, which are flown at low altitudes and over short distances, it is most likely that the pilot will experience some impact from the micro climate at the site. Recognizing factors that might influence weather patterns at the site prior to takeoff will help mitigate possible accidents or annoyances during the operations. Due to the high variability of micro climate it is hard to establish the site-specific conditions on a given day, before being physically there.

b) *Macro Climate*

A macro climate will describe the overall climate of a large area and represents the normal climatic patterns. This is what the pilot needs to consider as the general pattern for

the operation, and it serves as a first step when considering weather information in flight planning. As mentioned above, the low flight altitude of most RPASs makes it more likely they will be subject to micro climatic variations. Macro climate will be more significant for beyond visual line-of-sight (BVLOS) flight over a large area, as a simpler means to evaluate weather due to the altitude and distance covered by the RPAS.

3.2.22.3 Wind

RPA pilots should refer to the manufacturer's RPAS operating/flight manual with regards to the aircraft's wind speed tolerance. If no such recommendation is made, the pilot should exercise common sense and avoid conducting an RPAS flight in winds that might compromise safety.

Wind is the movement of air across the earth's surface and is one of the most important weather phenomena for pilots of all types of aircraft. Wind speeds are expressed in kilometres per hour (km/h) or knots (kt) and the direction will represent where winds originated.

RPA pilots will most likely be subject to surface wind, which generally extends a couple thousand feet AGL. Surface winds vary depending on surface roughness, temperature, waterbodies, and obstacles (see the paragraph on micro climate above), and they can therefore be very different from one geographical location to the next. Wind speed in aviation weather forecasts is usually expressed in knots and is classified according to the Beaufort Wind Scale (see AIM MET 2.6 Pilot Estimation of Surface Wind), which is a scale ranging from breeze to hurricane.

Upper-level winds will not influence the vast majority of RPA pilots as the altitude is much higher than standard flight altitude. However, BVLOS flights with a large RPAS and a specially trained crew might be conducted within this environment.

3.2.22.4 Visibility

For an RPAS flight conducted in VLOS, visibility should be at a minimum equal to or greater than the extent of the desired operation. While there is no minimum visibility prescribed in Part IX of the CARs, the visibility must be sufficient to keep the RPA in VLOS at all times.

Visibility is dynamic, can change rapidly, and might require the pilot to adjust or end an ongoing operation if conditions change. Local factors such as waterbodies and topography might create heterogeneous visibility levels on a large or small scale. Flight planning should take those variables into consideration.

3.2.22.5 Clouds

RPA pilots are prohibited from entering clouds as the RPA would no longer be within VLOS.

Clouds are a great source of meteorological information for pilots since they are a direct manifestation of the atmospheric conditions at a given moment. Clouds are classified as low, middle, or high altitude clouds and vertical development clouds. The cloud ceiling is important information for RPAS flight and is established based on the lowest layer of clouds on that day. Cloud conditions and types will be influenced by the presence of weather fronts, atmospheric pressure, winds, and topography. Information regarding cloud conditions for a given day can be found on the AWWs Cloud and Weather chart. For more information on this matter, please see MET–*Meteorology* 4.11 Clouds and Weather Chart of the TC AIM.

3.2.22.6 Precipitation

In the absence of manufacturer guidelines for flights in precipitation, it is recommended that pilots avoid flying in precipitation as it might compromise the airworthiness of the aircraft and create hazards.

Precipitation is atmospheric water vapour produced from condensation that falls under gravitational force toward the ground. Precipitation will manifest itself in liquid (drizzle and rain) or solid forms (hail, snow pellets, snow ice prisms, and ice pellets) and will have significant impact on RPAS operations. Exposure to precipitation can impact an RPAS' ability to perform as expected. RPASs have varying levels of tolerance with respect to precipitation. Refer to the RPAS manufacturer's operating/flight manual to verify the aircraft capability in precipitation.

3.2.22.7 Fog

Do not operate an RPAS in fog if visibility is too poor to maintain proper VLOS with the RPA, even if it is equipped with lights.

Fog represents condensed water droplets found at the ground level, or in other words, a low-level cloud. It usually brings precipitation in the form of drizzle and will cause low visibility conditions at ground level. This is of high concern for RPAS operations in VLOS, as direct visual contact will be greatly reduced in fog. Fog is dynamic, thus conditions at takeoff might change during the operation and cause a threat to the RPA, manned aircraft, and the public.

3.2.22.8 Temperature

Air temperature is also an important concept for RPA pilots. Since the human body is accustomed to a narrow temperature range, cold temperature can physically impair the efficiency of pilots and ground crews if they are not dressed properly. A pilot's dexterity can decrease significantly and cold temperature stress can add to other stress, such as that caused by fatigue. Cold temperature will directly affect all other components of the weather system and thus have a great impact on the aircraft itself. You must operate the RPAS within the operational limits set by the manufacturer of the RPA, as each aircraft will have a different range of temperature tolerance. Operating an RPA outside of those suggested ranges will compromise the

airworthiness and safety of the aircraft, and your operation. It is also important to consider that RPASs are multi-component systems. Although the aircraft might be approved for a certain temperature range, other parts of the system might not be—particularly if you have made any modifications to the payload or aircraft. Consider all components when assessing flight suitability in the field.

RPASs are operated within the airspace and are therefore subject to atmospheric temperature changes, due to the adiabatic lapse rate. Under normal conditions, atmospheric air temperature will decrease with an increase in altitude due to lower atmospheric pressure. This phenomenon is called the adiabatic lapse rate. Water vapour content within the air column will decrease the lapse rate experienced, as more latent energy is required for an equal change in temperature change in moist air. The adiabatic lapse rate of unsaturated air is 3°C/1 000 ft and 1.5°C/1 000 ft for saturated air. Those values are set as standard but will be variable in real-world scenarios as the water content will dictate the precise lapse rate value. RPA pilots need to take the lapse rate into consideration if operating in high-altitude BVLOS flight or within a high-altitude environment as the weather forecast and the conditions experienced by the aircraft might differ greatly.

3.2.22.9 Sun

Sun will influence the conditions encountered by the RPAS in direct and indirect ways. The pilot and visual observers need to be aware of the sun glare that might prevent them from maintaining proper visual line-of-sight with the RPA. Crew members should take care to reduce the amount of time facing into the sun and looking at the sky. In the event that the RPA is flying in line with the sun, the crew should stare to the side of the aircraft and the sun. Polarized sunglasses can cause visibility issues on tablet displays, so they may not be a viable option for all crew members.

Solar activities can also create geomagnetic interferences that have been shown to impact the navigation system (e.g. GPS, GLONASS) and electronic components of the RPAS, specifically the C2 link. For more information about the solar activity forecast in Canada, refer to the Space Weather Canada forecast Web site:

<www.spaceweather.gc.ca/index-en.php>

<www.spaceweather.gc.ca/forecast-previous/fluence/sffl-en.php>

It is recommended that pilots refer to the Energetic Electron Fluence forecast and use caution in periods of moderate or higher radiation. The greater the electron fluence, the lesser the range and quality of the C2 link, and the greater the possibility of lost link.

3.2.23 Icing

Icing refers to atmospheric water droplets that are often defined as supercooled (< 0 °C), which freeze upon contact with a surface.

Icing intensity is classified from trace to severe and icing types are rime, clear, and mixed ice. Icing is common on all types of aircraft and RPAs are no exception. Icing can occur before and during the flight, greatly compromising the ability of the aircraft to operate properly. Formation of ice on the propeller and frame of the aircraft will increase take-off weight, change the aircraft's aerodynamic properties, and prevent components from operating properly. Critical surfaces such as wings, control surfaces, rotors, propellers, and horizontal and vertical stabilizers should all be confirmed clear of contamination prior to takeoff and must remain so, or the flight be terminated. Refer to the RPAS operating/flight manual provided by the manufacturer to verify the aircraft's tolerance of icing. In the absence of an RPAS Safety Assurance, it is recommended that you avoid flying in icing conditions unless a method exists to de-ice and provide anti-ice capabilities in flights. For more details about icing, please see MET—*Meteorology* subpart 2.4 of the TC AIM.

3.2.24 Formation Flight

Formation flights between two or more RPAs or between an RPA and another aircraft are permitted. If a formation flight is to be undertaken, it must be pre-arranged; impromptu formations are not permitted (CAR 901.36). Formation flights of more than 5 RPAs that are controlled by a single pilot from the same control station are only authorized under an SFOC - RPAS (CAR 903.01 e).

The purpose of the pre-arrangement requirement is to ensure that all the pilots associated with the operation are aware of how the aircraft are to be flown to eliminate the risk of collision (CAR 901.18 prohibits the operation of an RPA in such proximity to another aircraft as to create a risk of collision) and to identify and mitigate any risks associated with the flight.

3.2.25 Operation of Moving Vehicles, Vessels, and Manned Aircraft

Pilots are prohibited from operating an RPA while at the same time operating a moving vehicle (CAR 901.37). If it necessary to operate an RPA from a moving vehicle, there must be a dedicated person operating the vehicle while the pilot operates the RPAS. If a visual observer is used in the operation, they are also prohibited from operating the vehicle while performing their duties as a visual observer (CAR 901.20(4)).

When launching from a vehicle (e.g. a boat) that is in motion or that will be in a different location when the RPA is recovered, consider that the return to home (RTH) automatic function may register the initial position at takeoff. Some RPASs give you the option of using the launch point or alternatively, going to the location of the transmitter. Plan ahead for manual landing, or other landing procedures, in a specifically designated location and adjust the contingency plans to avoid having the RPAS return to a dangerous location.

Failure to abide by these prohibitions may result in individual penalties of up to \$1,000 and/or corporate penalties of up to \$5,000.

3.2.26 First-person View (FPV) Devices

FPV offers an immersive RPA piloting experience but cuts the pilot off from his or her surroundings and greatly affects detect and avoid capability (i.e. the pilot's ability to scan for other aircraft). If you are using an FPV system that reduces the field of view of the pilot, visual observers must be used. The number of visual observers needed will depend on the complexity and area of the operation. The area surrounding the pilot should also be safe and free of hazards, as the FPV will also prevent the pilot from being aware of his or her own surroundings.

3.2.27 Night Flight

There are risks associated with night flight that result from operating in an environment of reduced visibility. From the RPA pilot's perspective, the greatest concern is maintaining VLOS with the RPA and detecting and avoiding unlit objects on or near the ground like trees and power lines.

Night is legally defined in aviation as the period of time that starts at the end of evening civil twilight and ends at the start of morning civil twilight. In the evening, civil twilight ends when the centre of the sun's disc is 6° below the horizon and is descending, approximately 25-35 min after sunset. In the morning, civil twilight begins when the centre of the sun's disc is 6° below the horizon and is ascending, approximately 25-35 min before the sunrise. The evening civil twilight is relative to the standard meridians of the time zones, the period of time that begins at sunset and ends at the time specified by the Institute for National Measurement Standards of the Standards Council of Canada and available at: <https://www.nrc-cnrc.gc.ca/eng/services/sunrise/index.html>.

Night, in practice, is when you cannot effectively see the hazards that would be visible during the day. In these situations, a day site survey is advisable to ensure separation between the RPAS flight path and any dangers that are not visible.

Night operations are permitted in both the basic and advanced operating environments provided that the RPA is equipped with position lights sufficient to allow the aircraft to be visible to the pilot and any visual observer.

3.2.27.1 Detecting Aircraft During Night Operations

a) *Scanning Technique*

The approach to scanning the sky for aircraft at night is much the same as scanning the sky during the day; however, limitations of equipment and human physiology should be taken into account. With sufficient lighting on the aircraft, it is very often easier to track your aircraft and other aircraft than doing so during the day.

Aircraft are easier to identify at night, but it is more difficult to determine the range of these aircraft. It is therefore possible the RPAS could be within VLOS, but much farther away than what would be by day operations.

Manned aircraft will also be easier to detect but may be at a greater distance and appear much closer than they actually are.

Depth perception at night is difficult, which affects the assessment of relative position. Although it may be easier to spot aircraft lights at night, judging the distance to an aircraft is challenging.

b) *Noise*

In some cases sound may be the only way to detect other aircraft when operating at night. For this reason it is important that the crew enforce a sterile environment around the control station and anywhere visual observers are stationed. Any unnecessary talking or noise should be avoided to ensure the best chance of detecting other aircraft. Sound is also useful to monitor your own aircraft's performance when visual cues are limited. Rapidly changing motor sounds on a multirotor may indicate wind at altitude, for example.

c) *Vision*

Vision can be affected at night, and there are several illusions that can affect the pilot or observer's ability to detect aircraft. Additional information on vision can be found in AIR 3.5 Vision of the TC AIM.

3.2.27.2 Aircraft Lighting

Traditional aircraft are equipped with special lights to aid in their detection and orientation. Traditional aircraft are required to have position lights, which include a red light on the port side (left side when sitting in the pilot's seat), a green light on the starboard side (right side when sitting in the pilot's seat), and a white light on the tail. An observer can determine which way an aircraft is travelling by identifying the lights they can see. For example, if the observer can see a red and white light, the aircraft is travelling across their field of view from right to left and moving away from them. If the observer can see only a green light the aircraft is moving across their field of view from left to right and may be moving towards them. If the observer can see both a green light and a red light, the aircraft is coming at them.

Aircraft are also equipped with anti-collision lighting, typically an omnidirectional rotating or flashing red beacon. This light can be affixed to either the top or bottom of the aircraft. Some aircraft are equipped with strobe lights, landing lights, or recognition lights. Strobe lights are generally white and attached to the wing tips or the sides of the aircraft. They flash in a repeating pattern and make an aircraft very visible, especially at night. Landing lights are generally white and affixed to the inboard sections of the wing, the front of the fuselage, or the landing gear. Landing lights will be brightest when an aircraft is coming towards the observer. Not all aircraft will have landing lights on when flying at night so they should not be relied upon to detect aircraft. Recognition lights are generally white and

affixed to the sides of the aircraft. Unlike strobe lights, they do not flash and generally point in the direction of flight much like a landing light.

Not all aircraft are required to have lights when operating at night. Some aircraft such as those used by law enforcement pilots, military, and first responders may have mission requirements that necessitate operations without lights. RPA pilots and visual observers should be particularly alert for an aircraft that may only be identifiable by sound.

3.2.27.3 Use of Lights

Pilots operating RPASs at night shall ensure their RPA is lighted sufficiently to ensure the pilot and the visual observer (if used) can maintain VLOS with the RPA. It's the pilot's responsibility to ensure the lights are functioning prior to takeoff or launch.

3.2.27.4 Night Vision Goggles

Night vision goggles can be used to supplement the RPAS crew's view of the RPA but caution should be exercised as night vision may inhibit the pilot's ability to detect and avoid other aircraft. Many aircraft are equipped with LEDs instead of the traditional incandescent lights. These LED lights may emit light that is outside the combined visible and near infrared spectrum of night vision goggles and, as a result, may not be visible. For this reason it is required that all RPA crews have a method of detecting all light within the visible spectrum. The simplest way to meet this requirement is to employ a visual observer using unaided vision as part of the detect and avoid system.

3.2.28 Multiple Remotely Piloted Aircraft (RPA)

Pilots may operate up to five RPAs from one control station provided the system is designed for such an operation (CAR 901.40). Special care must be taken when operating more than one RPA from a single control station as there is a significant risk the pilot can become distracted and lose track of one or more of the RPAs.

The risks associated with this type of operation can be mitigated by careful pre-planning and site surveys. Pilots should take extra care to ensure that sufficient visual observers are employed to ensure that each aircraft is kept within VLOS and monitored.

Piloting more than five RPAs from one control station requires a Special Flight Operations – RPAS (see subpart 3.6).

3.2.29 Special Events

3.2.29.1 Special Aviation Events

An SFOC - RPAS for a special aviation event is needed when a pilot is operating an RPA as a performer in this event (referred to as an "airshow"). See CARs 901.41 and 903.01(f).

If the RPAS operation is not a performance that is part of the

special aviation event (i.e. the operation is conducted for taking videos or photos of the event, or for surveillance or security purposes), the SFOC - RPAS application is to be processed as it would be for an advertised event.

3.2.29.2 Advertised Events

An SFOC - RPAS for an advertised event is needed when a pilot is operating an RPAS less than 100 ft away of the boundaries of an advertised event (CAR 901.41 and 903.01 f). For reference, see also in this chapter: 3.4.6 Operations Near People, 3.4.7 Operations Over People, and 3.6 Special Flight Operations – RPAS.

The boundaries of an advertised event (outdoor event including a concert, performance, festival, market, or sporting event, etc.) are limited by perimeter fences and at the gates where people are restricted by the event personnel, volunteers, and security or peace officers.

Where no such perimeter is defined for outdoor advertised events like marathons, triathlons, cycling, swimming, skiing, fishing derbies, sailing, cruise ships, fireworks, and so on, it is expected that the boundaries of the advertised event be at least 100 ft from people participating in the advertised event and 100 ft from the track of the sporting event for all categories of RPA pilot certificates and models of RPAs.

3.2.30 Handovers

If an RPAS command handover is to be conducted during the operation, a handover plan agreed upon by all responsible parties has to be established before takeoff (CAR 901.42). The plan must lay out the procedures to follow for the handover, the plan to mitigate the loss of control during the handover, and the plan for how the see and avoid measures are to be continued during the exchange.

3.2.31 Payloads

Laser-based systems, including LIDAR, are becoming increasingly popular payloads on RPASs for a number of operations. Class 1 lasers, as designated by Health Canada, are considered to be incapable of causing harm and will not create a hazard to manned aircraft provided that they are operated as per the manufacturer's specification. If the laser equipment that the operator intends to use is classified as Class 1 or Class 1M, has an average output power of less than 1 mW, and utilizes a non-visible beam, no further assessment or notification is required. The operator is still responsible for safe operation within the bounds of the manufacturer's specifications and operating instructions.

Operators who want to operate an RPAS fitted with laser equipment other than the types noted in the previous paragraph in accordance with the manufacturer's instructions must notify TC that they intend to operate a laser in airspace shared with manned aircraft (CAR 601.21). RPAS operators shall complete

a Notice of Proposal to Conduct Outdoor Laser Operation(s) and submit it to their TC regional office. An aeronautical assessment is then conducted and the NOHD calculated by the operator is validated. The normal processing time is at least 30 days to review the notification and determine if a laser authorization can be issued.

For more information and further guidance on the regulation of lasers, refer to sections 601.20, 601.21, 601.22, and 901.43 of the CARs.

In addition, if the RPA pilot intends to carry or deliver payloads with an RPA, the pilot must also comply with *Transportation of Dangerous Goods Regulations* and Canadian Transportation Agency (CTA) regulations, as applicable.

A pilot may operate an RPAS when the aircraft is transporting a payload referred to in CAR 901.43 (1) if the operation is conducted in accordance with an SFOC - RPAS. For more information, see section 3.6.1 of this chapter.

3.2.32 Flight Termination Systems

A Flight Termination System is a system that, upon initiation, terminates the flight of an RPA in a manner so as not to cause significant damage to property or severe injury to persons on the ground. In order to avoid flyaway situations and safeguard other airspace users, RPASs that lack redundancies may need to have an independent flight termination system that can be activated by the RPA pilot. The process and procedures for initiating and activating a flight termination system vary significantly depending the manufacturer and operating procedures for each system. Initiation of a flight termination system may only be done if it does not endanger aviation safety or the safety of any person (CAR 901.44). Attachment of a flight termination system to an RPAS which is not standard equipment for the RPAS is a modification and must meet the requirements of CAR 901.70.

3.2.33 Emergency Locator Transmitters (ELT)

RPAs are prohibited from being equipped with ELTs (CAR 901.45).

RPAs are permitted to have other types of tracking devices that would allow pilots to locate them without notifying first responders.

ELTs provide an emergency signal to SAR in the event of a missing aircraft. In order to ensure valuable resources are not dispatched to find missing aircraft where no life is at stake, RPAs are not permitted to have ELTs on board. More information on ELTs can be found in SAR part 3.0 Emergency Locator Transmitter (ELT) of the TC AIM.

Pilots operating RPAs equipped with ELTs are subject to individual penalties of up to \$1,000 and/or corporate penalties of up to \$5,000.

3.2.34 Transponders and Automatic Pressure-Altitude Reporting Equipment

RPAs are not typically equipped with transponders and, as a result, they pose a challenge for ANSPs who, depending on the airspace, are mandated to provide separation between IFR/VFR aircraft that appear on radar and RPAs that do not appear on radar.

Transponders increase the capabilities of radar, allowing ANSPs to see the position and, when a transponder is equipped with pressure altitude reporting, its altitude. Being able to see an aircraft's position and altitude is key to an ANSP's safe management of Canada's airspace system. In order to ensure separation between other aircraft and RPAs, ANSPs need to be advised when and where RPAs will be operating in transponder-required airspace.

3.2.34.1 Transponder-required Airspace

Transponders are required in all Class A, B, and C airspace as well as some Class D and Class E airspace. The requirement for a transponder in Class D and E airspace can be found in the DAH (CAR 601.03). Additional information can be found in COM subpart 8.2 of the TC AIM.

3.2.34.2 Transponder Requirements

ANSPs may allow an RPAS to enter transponder-required airspace without a transponder if the pilot requests permission prior to entering the area and aviation safety is not likely to be affected (CAR 901.46(2)). Except when permitted by the ANSP, all aircraft flying in transponder-required airspace including RPAs are required to have transponders (CAR 901.46(1)).

The decision as to whether aviation safety is likely to be affected depends on a variety of factors that may not be readily apparent to the RPA pilot. These factors may include the volume of air traffic in the area, a potential emergency or priority situation, system capability, equipment failures, and a myriad of other factors. RPA pilots should understand that ANSPs may not be able to grant all requests to enter transponder airspace without a transponder. Flexibility and patience on the part of the pilot will be required.

Entering transponder airspace without a transponder or without permission from the ANSP puts other aircraft in the area at risk and may result in individual penalties of up to \$1,000 and/or corporate penalties of up to \$5,000.

3.2.35 Operations at or in the Vicinity of an Aerodrome, Airport, or Heliport

Operations in the vicinity of or at aerodromes, airports, and heliports are higher risk. The pilot should carry out coordination with the aerodrome operator when operating an RPA at or near an aerodrome. The RPAs should stay clear of the established traffic pattern.

Operations inside a 3-NM (5.6 km) radius from the centre of airports or a 1-NM (1.8 km) radius from the centre of heliports are reserved for those pilots and RPAS who are certified to operate in the advanced environment (CAR 901.47). Coordination with the airport or heliport operator should be made when the pilot is operating an RPA at or near an airport or heliport.

If the airport or heliport is inside controlled airspace, the RPA pilot needs an advanced pilot certificate, has to receive an authorization from the appropriate ANSP as described in section 3.4.4 of this chapter, and requires a manufacturer declaration that the RPA meets the appropriate safety assurance profile as described in section 3.4.3 of this chapter. See subsection 3.2.3.2 for information about RPA operation in controlled airspace.

If the airport or heliport is not within controlled airspace, the RPA pilot needs an advanced pilot certificate and must also contact the airport or heliport operator, obtain proper permission from this operator, and comply with their guidance, schedule, and other requests they deem necessary. RPA pilots must always give way to manned aircraft and keep the RPAS within VLOS.

An aerodrome means any area of land, water (including the frozen surface thereof) or other supporting surface used, designed, prepared, equipped, or set apart for use either in whole or in part for the arrival, departure, movement, or servicing of aircraft and includes any buildings, installations, and equipment situated thereon or associated therewith. All registered and certified aerodromes are listed in the CFS or the CWAS.

An airport means an aerodrome in respect of which an airport certificate issued under Subpart 302 of the CARs is in force. In practice, you can tell if an aerodrome has a certificate by looking in the *Canada Flight Supplement* for the word “Cert” in the Operator (OPR) section.

A heliport means an aerodrome in respect of which a heliport certificate issued under Subpart 305 of the CARs is in force.

An operation within 3 NM (5.6 km) of an aerodrome conducted under the authority of the Minister of National Defence is possible if the operation is conducted in accordance with an SFOC – RPAS. To be issued an SFOC for the operation of an RPA within 3 NM of an aerodrome operated under the authority of the Minister of National Defence (903.01 h), the RPA pilot needs an advanced pilot certificate, must receive authorization from the Minister of National Defence aerodrome authorities, and requires a manufacturer declaration stating that the RPA meets the appropriate safety assurance profile as described in section 3.4.3 of this chapter. See section 3.6.1 for information about SFOC – RPAS.

3.2.36 Records

Every owner of an RPAS shall keep a record containing the names of the pilots and other crew members who are involved in each flight and, in respect of the system, the time of each flight or series of flights. This record shall be available to the

Minister on request and is retained for a period of 12 months after the day on which it is created (CAR 901.48 1(a)).

Every owner of an RPAS shall keep a record containing the particulars of any mandatory action and any other maintenance action, modification, or repair performed on the system, including the names of the persons who performed them and the dates they were undertaken. In the case of a modification, the manufacturer and model, as well as a description of the part or equipment installed to modify the system and, if applicable, any instructions provided to complete the work are required. This record shall be available to the Minister on request and is retained for a period of 24 months after the day on which it is created (CAR 901.48(1)(b)).

Every owner of an RPAS who transfers ownership of the system to another person shall also deliver to that person at the time of transfer all of the records containing the particulars of any mandatory action and any other maintenance action, modification, or repair performed on the system (CAR 901.48(3)).

3.2.37 Incidents and Accidents

A pilot who operates an RPA shall immediately cease operations if any of the listed incidents or accidents (CAR 901.49 (1)) occur, until such time as an analysis is undertaken as to the cause of the occurrence and corrective actions have been taken to mitigate the risk of recurrence:

- a) injuries to any person requiring medical attention;
- b) unintended contact between the aircraft and persons;
- c) unanticipated damage incurred to the airframe, control station, payload, or command and control links that adversely affects the performance or flight characteristics of the aircraft;
- d) any time the aircraft is not kept within horizontal boundaries or altitude limits;
- e) any collision with or risk of collision with another aircraft;
- f) any time the aircraft becomes uncontrollable, experiences a flyaway, or is missing; and
- g) any incident not referred to in paragraphs (a) to (f) for which a police report has been filed or for which a CADORS report has resulted.

The RPA pilot shall keep a record of the incident or accident analyses for a period of 12 months after the day on which the record is created (CAR 901.49 (2)). An RPAS incident report for an RPAS operated under an SFOC does not need to be sent to the TSB or to TC unless it meets one of the conditions listed above, from a) to g).

In addition to the criteria listed in CAR 901.49, most RPAS accidents need to be reported to the TSB, especially when:

- a) a person is killed or seriously injured as a result of coming into contact with the RPA or a part of an RPA;
- b) the RPA sustains structural damage; or
- c) the RPA is missing or inaccessible.

The purpose of an aviation safety investigation into an aircraft accident or incident is to prevent a reoccurrence; it is not to determine or apportion blame or liability. The TSB, established under the CTAISB Act, is responsible for investigating all aviation occurrences in Canada involving civil aircraft registered both in Canada and abroad. A team of investigators is on 24-hr standby.

TC AIM GEN 3.0 provides additional information on aircraft accident reporting to the TSB including time limits and what information to report. An RPA is defined as an aircraft in CARs.

3.2.38 Tethered Drone

CAR 101.01 defines a remotely piloted aircraft (RPA) as “a navigable aircraft, other than a balloon, rocket, or kite that is operated by a pilot who is not on board.”

When a drone is tethered to the ground in a way that prevents it from being manoeuvred or navigated, it no longer meets the definition of an RPA and the regulatory requirements contained in Part IX of the CARs no longer apply; instead, operators of tethered objects must meet the obstruction requirements of CAR Standard 621 Chapter 11.

This interpretation recognizes that drones that are prevented from being navigated along a path pose a different set of hazards from drones that are free-flying. If the RPA is being manoeuvred or navigated while on the tether, it is navigable and it once again meets the definition of an RPA, and Part IX of the CARs will apply.

A tether can be used to extend the flight time of the RPAS by supplying power to the RPA from the ground. A tether can also be used as a means to mitigate the risk of the flyaway by physically restricting the drone from reaching certain locations. A tether should not be used as a means to circumvent or exempt an operation from the safety requirements of Part IX.

As an example:

- a) A drone tethered to the ground by a power cable hovering at a specific location without pilot input while it serves to boost a communication signal does not meet the definition of an RPA.
- b) An RPA attached to a line while it is being manoeuvred or navigated by a pilot does meet the definition of an RPA, and the regulations governing sRPASs apply.

- c) A tether should not be used for the sole purpose of exclusion from the safety requirements of Part IX. Tethered RPAs should comply with the requirements of Part IX that are applicable to the type of operation being performed.

The addition of a tether is considered a modification to an RPA. Therefore, if a safety assurance declaration has been made under CAR section 901.76 for Advanced Operation, the installation of a tether will invalidate these safety assurance declarations unless (a) the modification was performed according to the instructions from the manufacturer of the part or equipment used to modify the system (CAR 901.70 (b)), or (b) the pilot installing the tether is able to demonstrate that the system continues to meet the technical requirements set out in Standard 922 — RPAS Safety Assurance that are applicable to the operations referred to in subsection 901.69(1) for which the declaration was made (CAR 901.70 (a)).

Best practices dictate that tethered RPAS operations should not be conducted closer to people than the length of the tether restraining the RPA. For example, if the length of the tether is 120 m, a safety margin of more than 120 m from people extending laterally from the point the tether is attached to the ground should be maintained.

3.3 BASIC OPERATIONS

3.3.1 General

Basic Operations require sRPA pilots to have the necessary qualifications and skills.

Basic Operations are for those intending to operate an RPA:

- a) in uncontrolled airspace (CAR 901.14);
- b) at a distance of 100 ft (30 m) or more from another person except from a crew member or other person involved in the operation (CAR 901.26);
- c) at a distance of three nautical miles (5.6 km) or more from the centre of an airport or an aerodrome operated under the authority of the Minister of National Defence or one nautical mile (1.8 km) or more from the centre of a heliport (CAR 901.47).

For more information, refer to 3.2.35 Operations at or in the Vicinity of an Aerodrome, Airport, or Heliport.

Pilots carrying out Basic RPA operations without a Pilot Certificate - Small Remotely Piloted Aircraft (for basic or advanced operations) may be subject to individual penalties of up to \$1,000 and/or corporate penalties of up to \$5,000.

3.3.2 Pilot Requirements

3.3.2.1 Pilot Certificate

A Pilot Certificate - Small Remotely Piloted Aircraft (VLOS) - Basic Operations is issued by the Minister to those that are at least 14 years of age and have successfully completed the RPAS Basic Operations examination (CAR 901.54, 901.55). A person of less than 14 years of age may fly in basic operations if they are under the direct supervision of the holder of a basic or advanced RPA pilot certificate (CAR 901.54 (2)).

3.3.2.2 Recency Requirements

Holders of the Basic or Advanced RPA pilot certificate must keep up their skills and knowledge by showing that they have met the recency requirements within the last 24 months (section 921.04 of CAR Standard 921). This involves being issued a Basic or Advanced RPA pilot certificate (CAR 901.55 or 901.64) and successfully completing a flight review (CAR 901.64(c)) or recurrent training (section 921.04 of CAR Standard 921), including attendance of a safety seminar or self-paced study program endorsed by Transport Canada Civil Aviation (TCCA), or completion of an Advanced RPAS recurrent training program which includes human factors, environmental factors, route planning, operations near aerodromes/airports, and applicable regulations, rules and, procedures.

RPA pilots who fail to maintain recency but continue to undertake operations may receive individual penalties of up to \$1,000 and/or corporate penalties of up to \$5,000.

3.3.2.3 Access to Certificate and Proof of Currency

When operating an RPAS, the pilot must be able to easily access both their Basic or Advanced RPA pilot certificate (CAR 901.55 and 901.64) and documentation demonstrating recency (CAR 901.56).

RPA pilots failing to demonstrate recency may receive individual penalties of up to \$1,000 and/or corporate penalties of up to \$5,000.

3.3.2.4 Examination Rules

It is not permitted to copy or remove all or any portion of the RPAS examination, to help or accept help from any person during the examination, or to complete any portion of the examination on behalf of any other person (CAR 901.58). If a person fails the examination or flight review they must wait at least 24 hours before a retake (CAR 901.59).

3.3.3 Small Remote Pilot Aircraft (sRPA) Requirement

No RPA manufacturer declaration is needed for Basic operations but the RPA needs to be operated in accordance with the manufacturer's instructions (CAR 901.31). The sRPA must have

an issued registration number issued that is clearly visible on the remotely piloted aircraft (CAR 901.03 and 901.05).

3.4 ADVANCED OPERATIONS

3.4.1 General

Advanced Operations are for those intending to operate an RPA (CAR 901.62):

- a) in controlled airspace;
- b) near people (horizontally less than 30 m, up to 5 m);
- c) over people (horizontally less than 5 m over people);
- d) within 3 NM from the centre of an airport or a military aerodrome; or
- e) within 1 NM from the centre of a heliport.

RPA pilots require the necessary qualifications and skills and must follow the established procedures of airports and heliports (CAR 901.73) and operate an RPA that has a manufacturer safety assurance declaration for the type of operations and distances from people (CAR 901.76(1)). The manufacturer's safety assurance declaration eligibility is written on the RPAS certificate of registration.

RPA pilots carrying out advanced operations without the advanced RPA pilot certificate and necessary RPA manufacturer's safety declarations may receive individual penalties of up to \$1,000 and/or corporate penalties of up to \$5,000.

3.4.2 Pilot Requirements

3.4.2.1 Pilot Certificate

A Pilot Certificate – Remotely Piloted Aircraft (VLOS) – Advanced Operations is issued by the Minister to those that have demonstrated they are at least 16 years of age and have successfully completed the RPAS Advanced Operations examination and flight review (CAR 901.64). A person younger than 16 years of age or a person undergoing a flight review may fly in advanced operations if they are under the direct supervision of the holder of an Advanced RPA pilot certificate (CAR 901.64(c)).

3.4.2.2 Recency Requirements

Holders of the Advanced RPA pilot certificate must keep up their skills and knowledge by showing that they have met the recency requirements (CAR 901.65) within the last 24 months. This involves being issued a pilot certificate (CAR 901.64) and completing a flight review (CAR 901.64(c)) or a recurrent training program (section 921.04 of CAR Standard 921), including attendance of a safety seminar or self-paced study program

endorsed by Transport Canada Civil Aviation, or completion of an Advanced RPAS recurrent training program which includes human factors, environmental factors, route planning, operations near aerodromes/airports, and applicable regulations, rules, and procedures.

RPA pilots failing to maintain recency that continue to undertake operations may be subject to individual penalties of up to \$1,000 and/or corporate penalties of up to \$5,000.

3.4.2.3 Access to Certificate and Proof of Currency

When operating an RPAS, the pilot must be able to easily access both their advanced RPA pilot certificate (CAR 901.64) and documentation demonstrating recency (CAR 901.65).

RPA pilots failing to demonstrate recency may be subject to individual penalties of up to \$1,000 and/or corporate penalties of up to \$5,000.

3.4.2.4 Examination Rules

It is not permitted to copy or remove all or any portion of the RPAS examination, to help or accept help from any person during the examination, or to complete any portion of the examination on behalf of any other person (CAR 901.58). If a person fails the examination or flight review they must wait at least 24 hours before a retake (CAR 901.68).

3.4.3 Manufacturer Declaration

Advanced operations require that the manufacturer of an RPA provide the Minister with a safety assurance declaration (CAR 901.76) stating that it is intended for these advanced operations (CAR 901.69), has all necessary documentation (CAR 901.78), and meets the technical requirements set out in CAR Standard 922. The RPA eligibility is written on the RPA's certificate of registration.

Manufacturers failing to maintain or demonstrate adherence to these requirements may be subject to individual penalties of \$3,000 and/or corporate penalties of \$15,000.

3.4.4 Operations in Controlled Airspace

Operations in controlled airspace are advanced operations, and the RPAS must have the relevant manufacturer's safety assurance declaration (CAR Standard 922), which states that the RPA has the required positional accuracy, at least +/- 10 m laterally and +/- 16 m altitude. The required accuracy for operations within controlled airspace is identified for purposes of communications with other users of the airspace (e.g. the control tower) in order to provide a minimum confidence related to the altitude and position reports from an RPA pilot (CAR Standard 922.04). This eligibility, stipulated in 922.04, is written on the RPAS certificate of registration.

The ANSP unit may approve the use of airspace above 400 ft

AGL only within the airspace under that unit's jurisdiction, subject to all other provisions (CARs 901.71 (2)).

The RPA pilot must communicate with the ANSP in the area of operations in advance of the operations ANSP. A pilot may not operate an RPA in controlled airspace unless he or she has received a written RPAS Flight Authorization from the ANSP (CAR 901.71(1)). The pilot must then comply with all instructions given by the ANSP (901.72). An ANSP Flight Authorization Request can be completed on NAV CANADA's Web site: <http://www.navcanada.ca/EN/products-and-services/RPAS/Pages/default.aspx>.

The following is required:

- a) the date, time, and duration of the operation;
- b) the category, registration number, and physical characteristics of the aircraft;
- c) the vertical and horizontal boundaries of the area of operation;
- d) the route of the flight to access the area of operation;
- e) the proximity of the area of operation to manned aircraft approaches and departures and to patterns of traffic formed by manned aircraft;
- f) the means by which two-way communications with the appropriate ATC unit will be maintained;
- g) the name, contact information, and pilot certificate number of any pilot of the aircraft;
- h) the procedures and flight profiles to be followed in the case of a lost command and control link;
- i) the procedures to be followed in emergency situations;
- j) the process and the time required to terminate the operation; and
- k) any other information required by the ANSP that is necessary for the provision of air traffic management.

3.4.5 Operations at or in the Vicinity of an Airport, Heliport, or Water Aerodrome – Established Procedure

RPAS pilots are required by CAR 901.73 to conduct their operations in accordance with the established access procedures. The official TC access procedures are currently stated below. Please also refer to the Drone Site Selection Tool.

Pilots must make every reasonable attempt to contact the airport, heliport, or water aerodrome operator to fly within the zones indicated by orange-shaded shapes on the Drone Site Selection Tool. If unable to establish communications with air traffic

through the airport operator, the advanced drone operator is required to establish communications with and avoid other aircraft using standard radio and visual procedures.

Access procedure:

- a) Ensure that you have an RPAS (VLOS) – advanced operations pilot certificate.
- b) Adhere to the CARs, and prior to your operation, consult the CFS to research the airport/heliport/water aerodrome where operations are to be conducted so that you understand the relevant information.
- c) Contact the airport operator to establish communications and exchange information regarding air traffic for the duration of the proposed operation.
- d) Comply with the airport operator’s guidance, schedule, and other requests.
- e) If you are unable to establish communications with the airport operator, contact air traffic on the applicable frequency found in the CFS. This could mean making a “blind call” initially to attract attention. Use standard radio procedures. The person operating the VHF Radio must have a valid Restricted Operator Certificate with Aeronautical Qualification (ROC-A).

A radio call generally consists of four parts: the call-up, the reply, the message, and the acknowledgement, for example:

 - (i) Pilot Call-up: Who are you talking to, airport traffic or a specific aircraft? Who are you and which aircraft are you operating? Where are you? Provide cardinal quadrant or distance and direction relative to the runway, with altitude in ft ASL.
 - (ii) Station Reply: Wait for a reply on that frequency.
 - (iii) Pilot Message: Intentions and duration of operation.
 - (iv) Station Acknowledgement: Wait for an acknowledgement on that frequency.
- f) Respect the limits of the privileges granted by your TC RPAS certificate with regards to Part IX of the CARs.
- g) Always give way to manned aircraft and keep the RPAS within VLOS.

Pilots should note that they are not obligated to follow these access procedures if their operational area is located outside of the orange-shaded areas depicted on the Drone Site Selection Tool. The access procedures are only applicable if pilots are within neither controlled airspace nor a zone controlled by DND. The orange areas on the Drone Site Selection Tool represent the areas with the highest air traffic due to approach, landing, and take-off patterns at the airport/heliport/water aerodrome in question and are therefore protected.

Even if no access procedures are established for the area outside of the orange areas on the Drone Site Selection Tool, pilots are

required to apply due diligence. If a pilot chooses to fly in these areas and sees other aircraft being operated, it is recommended that the pilot land the RPAS and reassess the situation. If regular aircraft activities are observed in those areas, it is recommended that pilots contact the airport/heliport/water aerodrome operator to have a better understanding of the local traffic patterns and to coordinate their operations.

3.4.6 Operations Near People

Operations near people (section 922.05 of CAR Standard 922) are those less than 100 ft (30 m) but more than 16.4 ft (5 m) horizontally from people, except for the crew or people involved in the operation. For these operations, the pilot must have their Advanced RPA pilot certificate (CAR 901.64) and the RPAS must have the relevant Manufacturer’s Declaration (CAR 901.76). This eligibility, stipulated in CAR Standard 922, is written on the RPAS certificate of registration.

3.4.7 Operations Over People

Operations that pose the highest risks when it comes to the system reliability of the RPAS are those over people (CAR 922.06) less than 16.4 ft (5 m) away who are not included in the crew and are not involved in the operation. For these operations, the pilot must have his or her Advanced RPA pilot certificate (CAR 901.64), and the RPAS must have the relevant manufacturer’s declaration (CAR 901.76) required by Standard 922 — RPAS Safety Assurance, confirming that no single failure of the RPAS may result in severe injury to a person on the ground and that any combination of failures of the RPAS which may result in severe injury to a person on the ground must be shown to be remote. This 922.06 eligibility is written on the RPAS certificate of registration.

3.5 FLIGHT REVIEWERS

3.5.1 General

The flight review is an in-person, holistic operational assessment of an RPA pilot’s skills. Flight Reviews are conducted by qualified flight reviewers who have undergone additional Transport Canada testing and are monitored closely by both the self-declared RPAS training organization with which they associate as well as Transport Canada. In addition to confirming that advanced category applicants have the CARs required documentation – site survey (CAR 901.24), normal checklists and emergency checklists (CAR 901.27) – they are also acting to validate the identity and knowledge of the candidate as well as their operational and flight skills.

3.5.2 Pilot Requirements

3.5.2.1 Flight Reviewer Rating

Flight Reviewers must meet and maintain several requirements before they are able to qualify as flight reviewers. Flight reviewers

must be over 18, have a good record with respect to aviation, and have no enforcement action against them, past or pending. They are expected to read, understand, and comply with TP115395 (*Flight Reviewer's Guide for Pilots of RPAS*) and meet the knowledge requirements outlined in TP-15263 (*Knowledge Requirements for Pilots of RPAS*). Additionally, they must hold an Advanced RPA pilot Certificate for at least 6 months before qualifying to write the flight reviewer exam to receive the endorsement and must remain affiliated with a TP-15263 Self-Declared RPAS Training provider to exercise the privileges of their endorsement.

3.5.2.2 Examination

The flight reviewer exam is available in the Drone Management Portal to Advanced Certificate holders with more than 6 months of experience. The examination is 30 questions, requires a mark of 80% to pass, and focuses on both advanced category operations and flight review requirements. Once successful, applicants pay a fee to have the flight reviewer endorsement added to their pilot certificate. To exercise the privileges of a flight reviewer, the reviewer must remain associated to at least one TP15263 Self-Declared RPAS Training Provider, though multiple associations are also permitted.

3.5.3 Conduct of Flight Reviews

Flight reviews are conducted in-person at a site of the candidate's choosing. They can be conducted in controlled or uncontrolled airspace though as the flight review itself is not exempt from complying with Part IX of the CARs, the applicant must be able to meet the requirements to operate within that airspace with the exception of having the Advanced RPA pilot certificate.

The flight review consists of both ground-based and flight assessment items. If any of the 8 assessed items are determined to not meet the requirements or if the candidate displays unsafe flying or behaviour, does not complete an appropriate site survey, lacks training or competency, or does not use effective scanning techniques, the flight review is marked a failure. Candidates who have failed flight reviews may reattempt after 24 hours have elapsed.

Following a successful flight review, the reviewer shall enter the required information into the Drone Management Portal within 24 hours. The successful candidate will then be automatically notified via email and routed to the Drone Management Portal to pay for the issuance of the Advanced RPA pilot certificate.

3.6 SPECIAL FLIGHT OPERATIONS – RPAS

3.6.1 General

Not every operational consideration can be addressed through regulation. This is particularly true in industries where technology is rapidly evolving such as the RPAS industry. Part IX of the

CARs allows the Minister to issue an SFOC - RPAS to allow certain operations that are not covered by the Part IX regulation. These operations include:

- a) RPAS with a maximum take-off weight greater than 25kg;
- b) BVLOS operations;
- c) foreign operators;
- d) operations at altitudes greater than 400 ft AGL;
- e) operation of more than 5 RPAs from a single control station;
- f) operation at a special aviation event or an advertised event;
- g) operations with restricted payloads;
- h) operations within 3 NM of an aerodrome operated under the authority of the Minister of National Defence;
- i) any other operation determined by the Minister to require an SFOC.

3.6.2 Application for a Special Flight Operations Certificate – RPAS (SFOC – RPAS)

The procedures for applying for an SFOC - RPAS are detailed on Transport Canada's Web site (<www.canada.ca/drone-safety>) as well as Advisory Circular 903-001. The applicant should be able to demonstrate an operational need for the type of certificate requested as well as a robust risk management plan that not only identifies any possible hazards associated with the proposed operation and their corresponding risks but proposes a plan to mitigate them. Applicants should anticipate at least 30 days of lead time to receive an SFOC but should be aware that, depending on the complexity of the operation and the completeness of the application, it could be longer.