



# THIS MONTH IN P/A

*Progressive Architecture*® March 1966

## EDITOR

Jan C. Rowan, AIA

## MANAGING EDITOR

Burton H. Holmes, AIA

## SENIOR EDITOR

James T. Burns, Jr. *P/A Observer*

## ASSOCIATE EDITORS

Ellen Perry *Features*

C. Ray Smith *Features and Interior Design Data*

Edward K. Carpenter *News Report*

Maude Dorr *Features*

Forrest Wilson *Features*

Peter M. Green *Materials and Methods*

## COPY EDITOR

George Lubasz

## ASSISTANT EDITORS

Jean Hatton Duffy *Assistant to the Editor*

Alis D. Runge *Materials and Methods*

Jean Cauthorne Ely *News Report*

Ruth Helen Cheney *Book Reviews*

## CONTRIBUTING EDITORS

Norman Coplan *It's The Law*

Bernard Tomson *It's The Law*

E. E. Halmos, Jr. *Washington/Financial*

William J. McGuinness *Mechanical Engineering Critique*

Harold J. Rosen *Specifications Clinic*

## GRAPHICS

Gary Fujiwara *Art Director*

Elizabeth White *Assistant Art Director*

Nicholas R. Loscalzo *Chief Draftsman*

Paul R. Doran *Draftsman*

## EDITORIAL PRODUCTION

Marion Feigl

## EDITORIAL ASSISTANTS

Phyllis C. Fleckner

Suzanne L. Stephens

Deborah A. Clark

## PUBLISHER

Philip H. Hubbard, Jr.

## ADVERTISING SALES MANAGER

William R. Evans, Jr.

## RESEARCH AND PROMOTION MANAGER

Burchard M. Day

## PRODUCTION DIRECTOR

Joseph M. Scanlon

## ADVERTISING PRODUCTION MANAGER

Daniel H. Desimone

## CIRCULATION MANAGER

David N. Whitcombe

## SUBSCRIPTION MANAGER

Sue Feldman

## COVER

Soft light filters through massive stained-glass window by Samuel G. Wiener, Jr., to engulf the spacious interior of a synagogue in ethereal light (p. 154). Photo: David Hirsch.

## 6 VIEWS

Some strong opinions on the Design Awards issue; an inspired architect's poem; plus other comments.

## 49 NEWS REPORT

News highlights: McCue takes Berkeley chair . . . First National Bank to alter Seattle skyline . . . New York's Astor Hotel and Stork Club coming down . . . Controversy in Atlanta . . . Products, Data.

## 135 TITLE PAGE

This month's quote is from Marshall McLuhan's book, *Understanding Media: The Extensions of Man*.

## 136 FRONTISPIECE

In a scene that oddly blends the mystical and the festive, children in esonarthex of Greek Orthodox Church light votive tapers (p. 140). Photo: Orlando R. Cabanban.

## 137 EDITORIAL

P/A's Editor discusses the old controversy about the interaction between form and function.

## EDITORIAL FEATURES

138 DOES ARCHITECTURAL DESIGN SHAPE LITURGY: To what extent does the conflict between liturgical demands and the architect's design conscience influence the ultimate form of a religious structure?

140 REINTERPRETING AN ANCIENT LITURGY:

140 A GREEK ORTHODOX CHURCH: A design that in its simplicity and dignity reveals anew the living roots of an ancient religion. EDWARD D. DART, ARCHITECT.

146 SYNAGOGUE DESIGN: FORGING AN AESTHETIC UNBOUND BY TRADITION

146 BETH DAVID SYNAGOGUE: A synagogue design notable for its display of formal imagination and planning skill. WERNER SELIGMANN, ARCHITECT.

151 TEMPLE SHALOM: A synagogue that derives from the traditional forms of the Polish and Russian synagogue. OPPENHEIMER, BRADY & LEHRECKE, ARCHITECTS.

154 TEMPLE AGUDATH SHALOM: A strong, fortress-like exterior, and an assertively religious interior space, create a structure intended as a community meeting house. DAVIS, BRODY & ASSOCIATES, ARCHITECTS.

158 CHURCH DESIGN: THE ARCHITECTURE OF COLLABORATION

158 UNITARIAN MEETING HOUSE: Given a sloping site, the architect has created a series of interlocking forms that terminate in a meeting hall at the ridge of the slope. JULES GREGORY, ARCHITECT.

162 EVANGELICAL LUTHERAN CHURCH: Contrast between huge, shingled roof "tent" and exposed concrete block creates architectural richness. JULES GREGORY, ARCHITECT.

- 165 PRESBYTERIAN CHAPEL: A chapel in the jungles of Guatemala, built of native materials by the congregation, was designed for use of natural light and ventilation. JULES GREGORY, ARCHITECT.
- 166 FUSING FAITH AND FUNCTION  
UNITARIAN CHURCH OF LEXINGTON: A church which, in its functionalism and design solution, emphasizes an earth-bound theology. HERB GREENE, ARCHITECT.

- 168 RICHARDSON AND SULLIVAN IN SCANDINAVIA: An article uncovering evidence that the design ideas of these two architects had widespread impact in Scandinavia.

#### INTERIOR DESIGN DATA

- 172 DOWN FOR DECORATION AND UPPING THE NATURE OF MATERIALS: Two startling pieces of furniture that raise serious questions as to the nature and direction of decoration and design.

- 176 AIRLINE DESIGNS FOR PASSENGERS: Braniff's ambitious plan to give every detail of air travel a color boost, a new look; as executed by Alexander Girard.

- 180 FOR FORMAL DINING: BLACK GRANITE?: A restaurant that raises the question: Is a strong yet severe design suited to leisurely dining?

- 184 SELECTED DETAIL: Structural System, Unitarian Church of Lexington, Ky.

#### MATERIALS AND METHODS

- 186 LIGHT IN THE TEMPLE: Analysis of a synagogue lighting system that is both functional and dramatic.

- 188 COMING SOON: FULLY AUTOMATED CLIMATE: Computerized heating and air conditioning of large buildings that requires no personal supervision.

- 190 CURVED BEAMS SUPPORT REPEATED ROOF SLABS: Structural philosophy of an airport terminal building enclosed by five huge roof slabs.

- 192 GOOD ROOM PROPORTIONS IMPROVE ACOUSTICS: How room shape and proportions affect hearing conditions in large auditoriums.

#### P/A OBSERVER

- 194 MIES AT 80: P/A pays tribute to the man, who, in a lifetime unswervingly devoted to his ideals of architecture, remains at 80 a guiding light to the profession.

- 196 PARKS ARE NOT FOR PLANNERS: Plans for a new park in New York's Bedford-Stuyvesant section offers hope for a revitalized approach to brightening deteriorated areas.

- 199 HOME OF THE BRAVES: Atlanta has built itself a fine stadium. All it needs now is a ball club.

- 201 FURNITURE AS PERSONAL OBJECTS: A five-man furniture show of imaginative pieces that may make sitting in a chair a dangerous experience.

- 204 PARTICIPATE, NOT EVACUATE: Energy, pride of achievement, and community participation mark this redevelopment project in a low-income San Francisco area.

- 207 HONOLULU REDEVELOPMENT: Latest project in the continuing redevelopment of Honolulu is a multi-use "Cultural Plaza" that poses some design dangers.

- 210 MECHANICAL ENGINEERING CRITIQUE  
William J. McGuinness explains how use of extra insulation saved a company money.

- 212 SPECIFICATIONS CLINIC  
Harold J. Rosen emphasizes that specifying the right material for the right application can reduce failures in building materials.

- 214 IT'S THE LAW  
Bernard Tomson and Norman Coplan discuss a recent case involving bidding on public contracts.

- 216 BOOK REVIEWS  
Books on religious architecture are featured.

- 284 JOBS AND MEN

- 286 DIRECTORY OF PRODUCT ADVERTISERS

- 289 READERS' SERVICE CARD  
A monthly service to P/A readers who desire additional information on advertised products and those described in the News Report, who wish to order Reinhold books, or who want to enter their own subscriptions to P/A.



PROGRESSIVE ARCHITECTURE, PUBLISHED MONTHLY BY REINHOLD PUBLISHING CORPORATION, 430 PARK AVENUE, NEW YORK, N.Y., 10022. RALPH W. REINHOLD, CHAIRMAN OF THE BOARD; PHILIP H. HUBBARD, SR., PRESIDENT AND TREASURER; FRED P. PETERS, EXECUTIVE VICE-PRESIDENT; KATHLEEN STARKE, SECRETARY AND ASSISTANT TREASURER; C. M. BURNAM, JR., H. R. CLAUSER, PHILIP H. HUBBARD, JR., THOMAS N. J. KOERWER, HARRY I. MARTIN, JR., JAMES B. ROSS, VICE-PRESIDENTS, EXECUTIVE AND EDITORIAL OFFICES, 430 PARK AVENUE, NEW YORK, N.Y., 10022.

SUBSCRIPTIONS PAYABLE IN ADVANCE, PUBLISHER RESERVES RIGHT TO REFUSE UNQUALIFIED SUBSCRIPTIONS. SUBSCRIPTION PRICES TO THOSE WHO, BY TITLE, ARE ARCHITECTS, ENGINEERS, SPECIFICATIONS WRITERS, ESTIMATORS, DESIGNERS, OR DRAFTSMEN, AND TO GOVERNMENT DEPARTMENTS, TRADE ASSOCIATIONS, ABOVE TITLE GROUPS ON TEMPORARY MILITARY SERVICE, ARCHITECTURAL SCHOOLS, ARCHITECTURAL STUDENTS, ADVERTISERS AND THEIR EMPLOYEES: \$5 FOR ONE YEAR; \$8 FOR TWO YEARS; \$10 FOR THREE YEARS. ALL OTHERS: \$10 A YEAR. ABOVE PRICES ARE APPLICABLE IN U.S., U.S. POSSESSIONS, AND CANADA. ALL PRACTICING ARCHITECTS AND ENGINEERS OUTSIDE THESE AREAS: \$10 FOR ONE YEAR; \$16 FOR TWO YEARS; \$20 FOR THREE YEARS. ALL OTHERS: \$20 A YEAR, SINGLE COPY: \$2, PAYABLE IN ADVANCE.

© REINHOLD PUBLISHING CORP., 1966, TRADE MARK REGISTERED, ALL RIGHTS RESERVED. INDEXED IN ART INDEX, ARCHITECTURAL INDEX, SECOND-CLASS POSTAGE PAID AT NEW YORK, VOLUME XLVII, NO. 3.



## Honor Roll:

### MODEL 7J

**HAWS DRINKING FOUNTAIN**  
Model 7J: honored for design achievement in rugged Tenzaloy aluminum—hard anodized to a muted bronze-colored finish. Serves well with popular push-button valve. It's one of a kind: unique design from the receptor to the sculptured bubbler head. Another Haws exclusive.

## VIEWS

### *P/A Design Awards: A Mixed But Stimulating Brew of Reactions*

Dear Editor: Congratulations to the winner of the First Design Award [JANUARY 1966 P/A]. The enlightened solution Daniel, Mann, Johnson, & Mendenhall brought to the critical problem of urban land use marks a significant beginning . . . to the future of California's beautification program, and provides an inspiration to the Governor's conference [on that problem]. To you and to your magazine, my further congratulations for your invaluable contributions to the improvement of the national scene.

STEWART L. UDALL  
U.S. Secretary of the Interior  
Washington, D.C.

Dear Editor: Congratulations to architect Cesar Pelli for his powerful earth-city [First Design Award]. It's heartening to see such architecture applauded.

MALCOLM B. WELLS  
Cherry Hill, N.J.

Dear Editor: As a designer who did not enter the P/A Design Awards Program and may thus be an impartial observer, may I ask the distinguished jury members one question? With the possible exception of one or two of Kevin Roche's projects, what have you done lately that's good enough to qualify you to speak as you do?

PAUL WIERS  
Phila., Pa.

Dear Editor: In the February 3 issue of *The New York Review*, Dwight Macdonald discusses "a new kind of reporting that has become widespread, . . . from journalism's best to its worst."

Get maximum protection  
on fire barrier doors  
with U.L. listed Corbin  
**FIRE EXIT HARDWARE**



...plus easy exit  
when required



UL-4923  
 Underwriters Laboratories, Inc.  
 LISTED  
**FIRE EXIT HARDWARE**  
 NO. 00000  
 P & F CORBIN - NEW BRITAIN, CONN.

**UL LISTED:**  
 Labeled as Fire Exit Hardware for all classes of labeled doors.

... for openings up to  
7'4" wide x 7'2" high

heavy duty / solid vertical rod / drop forged lever arms / nylon bearings / brass, bronze, stainless steel / specify No. 322OU

*it pays to make it Corbin throughout!*



**P. & F. CORBIN**  
 DIVISION OF EMHART CORPORATION  
 NEW BRITAIN, CONNECTICUT 06050

## They'll love Reserv-A-Roll with its new **Fash'n-Front**



### RESERV-A-ROLL, THE AUTOMATIC DISPENSER THAT SOLVES TISSUE CONTROL PROBLEMS

For the discriminating architect, Reserv-A-Roll tissue dispensers now have a new Fash'n-Front to give your project's restrooms a note of creative individuality. The compact, recessed dispensers, available in a variety of handsome Fash'n-Fronts, and utilizing standard 4½" x 4½" rolls, will solve your client's tissue problems; and, by compelling the use of all the tissue, reduce his restroom maintenance costs.

What's more, Reserv-A-Roll dispensers are completely automatic. Just press the release bar. The empty core disappears into the fixture and the reserve roll locks into place. For a complete color folio on the new Fash'n-Front models and all Reserv-A-Roll dispensers, write today or see our listing in Sweet's Catalog 26e/Re.

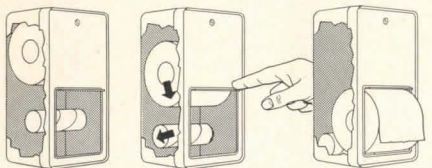

ONLY after the first roll is used up . . .

will the push button allow . . .

the second roll to fall and lock into place AUTOMATICALLY.

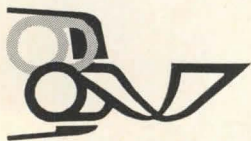

**THE RESERV-A-ROLL CO.**  
602 Sul Ross/P. O. Box 66069/Houston, Texas 77006

On Readers' Service Card, circle No. 454

body knows which end is, at the moment, up."

I think the "Jury Comments" and "Discussion" of the "Design Awards Program" suggests that a new kind of architectural criticism is emerging, one that exploits the objective authority of criticism and the atmospheric license of the tabloid's "*aesthetique du schlock*," producing a paracriticism that exists somewhere between analysis and "just funning." It may amuse the advertisers but is of little value to the architects or, more seriously, the students, to whom it is ostensibly directed.

Bob Nevins and I were square enough to submit a low-budget, free-standing house, which we felt "had no irony to it all . . . really a kind of seriously considered architectural statement." It represented our concern with the building type (*pace*, Vincent Scully) which we, if not the jurors, have observed is consuming the American landscape and now threatening France; a building type that "responsible" architectural firms eschew for the greater good (and fee) of the "urban renewal projects," whose value critics such as Lewis Mumford, Herbert Gans, and Jane Jacobs seriously question; a building type that offers young architects like myself a chance to explore "the clichés and devices" that have been presented to us as architecture in the magazines, exhibits such as the recent "Modern Architecture, U.S.A.," and the schools; a building type that represents one of the few real opportunities for architects to give shape to the dreams of people other than corporate and institutional executives.

The paracritics must be "just funning" when they argue that the house to be "premiated" ("given a prize" according to Webster's unabridged dictionary, for those unfortunates who had access only to the O.E.D., or, preserve us, an abridged dictionary) "is pure pastiche. It's absurd. Nobody really believes that. You're playing at farmhouse. We've got it here because we're not taking houses seriously." It's a ball to read—until one tries to understand what critical judgment has been made, and why.

HARRIS STONE  
New Haven, Conn.

Dear Editor: We have received the copies of our recent P/A Design Awards Citation for our associates, for which we thank you. I hope we have been successful in our efforts to congratulate them on the Citation without allowing them to see the jury's report, though we suppose that there must be some advantage in

being among the favored few at whom the jury's opprobrium is actually flung, instead of being among the many upon whom it is simply heaped. We don't really mind being called derivative, since, as nearly as we can make out, everyone is derivative from something, and the only people who are not accused of it are the ones who derive closely and without too much effort from Mies van der Rohe. What stings is the notion that our work and others' is "pastiche"—if that noun is delivered, as one supposes, explosively and in anger, with a pop and a long wet hiss. Of course it's pastiche, if by that the juror meant that it is made with reasonable simplicity, though we hope with some newly derived (is that derivative?) insights from pieces found in the common culture we are involved in up to our necks. I would have thought, if there was a reason to preminate our entry, that that was it. Apparently it was not. Dare I, dear goose, golden-egg-wise, ask what was?

CHARLES W. MOORE  
New Haven, Conn.

Dear Editor: It seems that the yearly fiasco (the Design Awards Program) is over. The juror gods have descended from their thrones, after throwing a few crumbs to the practitioners. This year, I believe, they have topped all previous years for amazing choice, and for arrogant chatter in support of their choice of awards. How can you, who are in the roles of leadership, ever expect the state of our current architecture to be any different than it is, when you condone and applaud such goings on? You've created a country of "bandwagon architecture." Beware, oh Architect, lest ye fall by the wayside! And beware, lest ye don't!

Someday, the world (and architects, I hope) will look back at the "geometric gang of boxes and swirls" that is being pushed today, and wonder whatever happened to beauty in their day?

CHARLES N. JOHNSON  
Lakeland, Fla.

Dear Editor: The comments of a distinguished panel of North American architects at the recent annual conference of the Manitoba Association of Architects remarkably coincided with those of the jury in the Design Awards issue.

These comments may be summarized in two general statements: (1) aesthetics must result from a profound understanding of social and psychological function. (2) Housing rather than "a house" is the important contemporary problem for

Continued on page 16

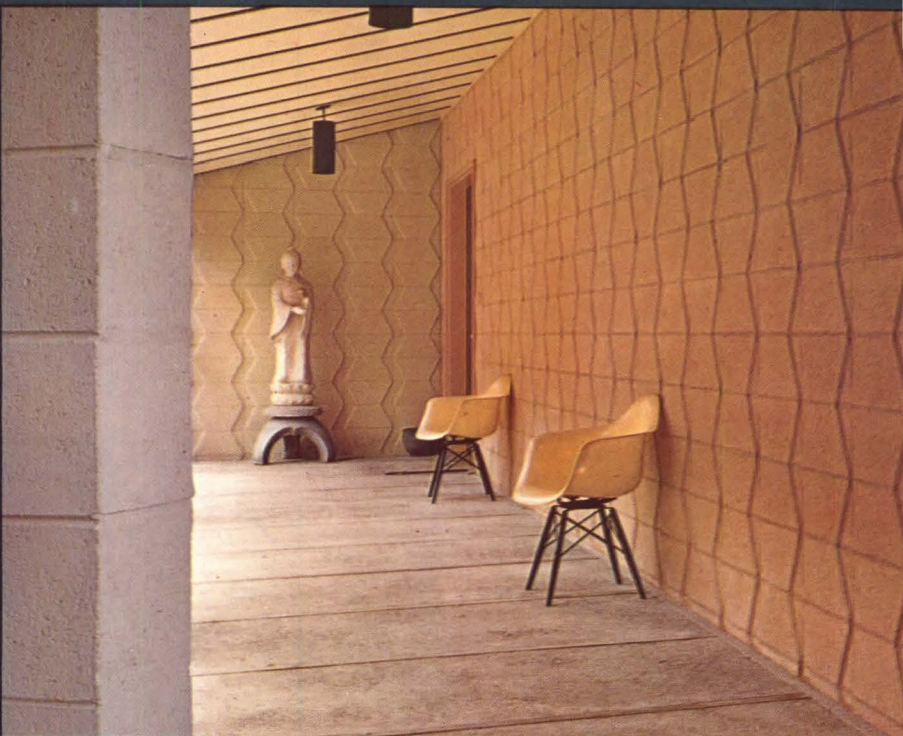
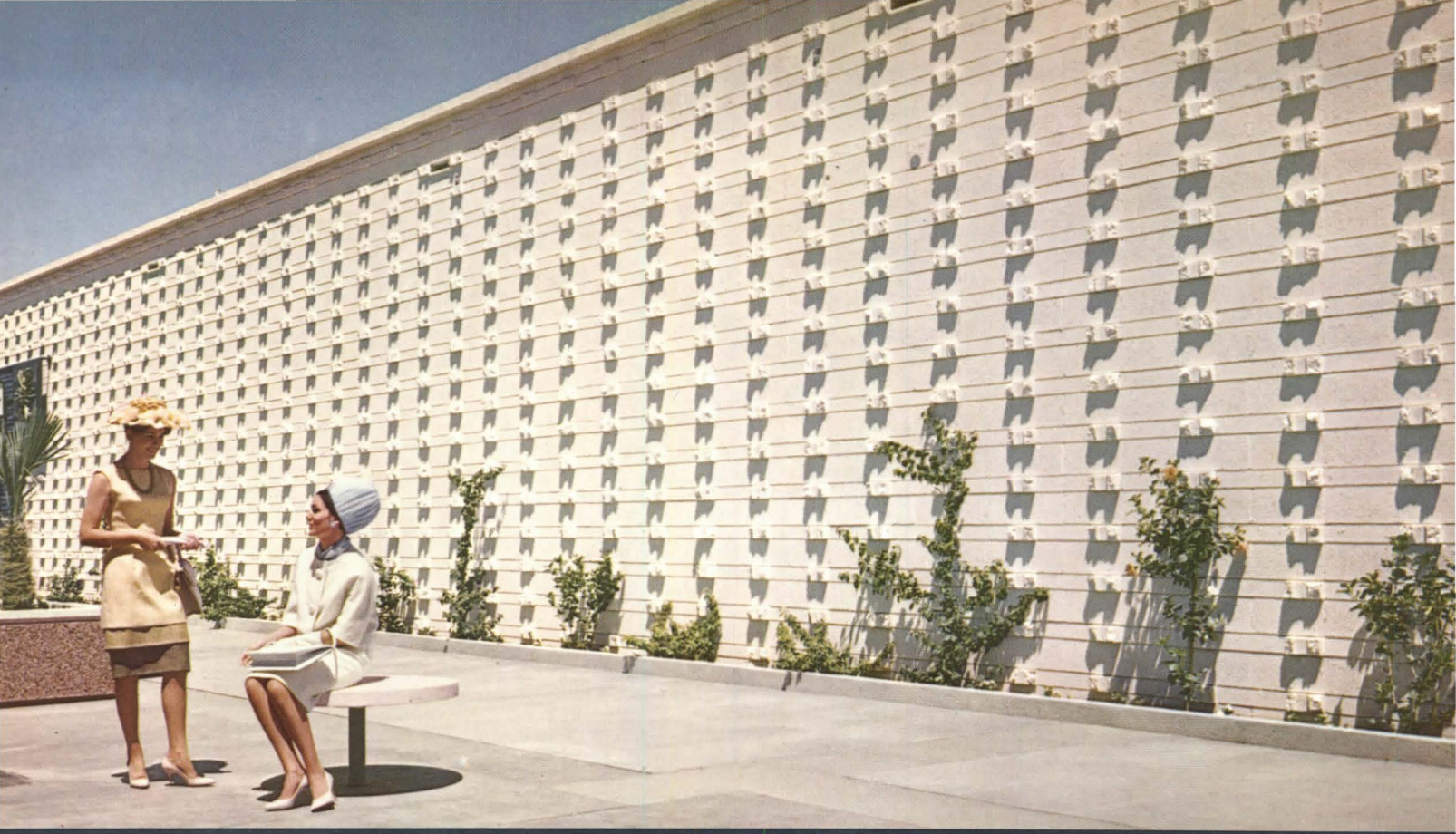

**Build better masonry walls**

**with Dur-O-wal**

**and Dur-O-wal Products...**

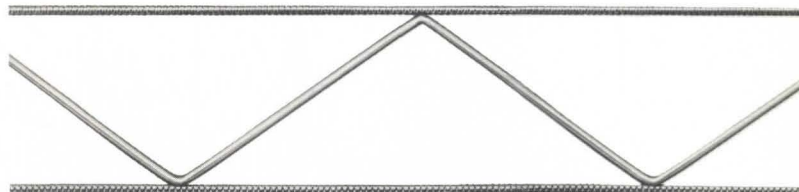

# What is Dur-O-waL?

Dur-O-waL brand is the original masonry wall reinforcement with the truss design. Specially designed to give greater strength and bond to masonry walls, Dur-O-waL also minimizes shrinkage, temperature and settlement cracking in masonry. Dur-O-waL is manufactured from high-tensile steel, deformed and electrically butt-welded to give you the highest quality masonry wall reinforcement material known to construction today. Insist on Dur-O-waL.

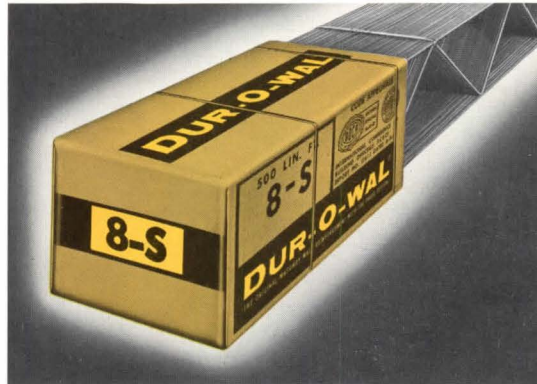

# How does Dur-O-waL work?

Like nothing else on the market. This truss design reinforcement increases flexural strength of your masonry walls 79 to 261 per cent, depending on the weight of Dur-O-waL used, type of mortar and number of courses. And note how the side rods are scientifically deformed on four sides for the best possible gripping contact with mortar. Choose from a complete range of Dur-O-waL brand shapes and sizes.

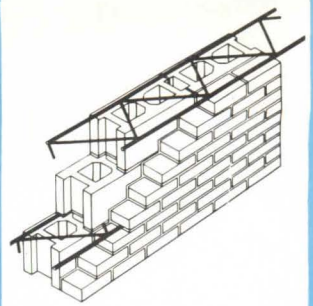
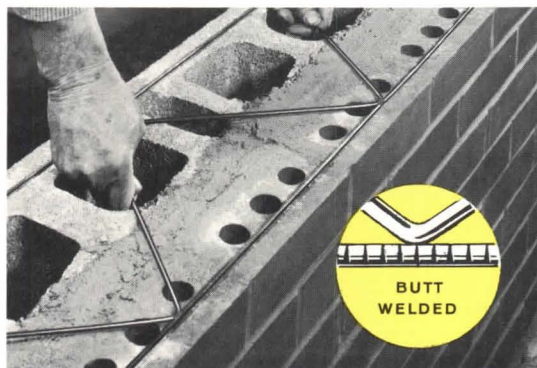

COMPOSITE WALLS

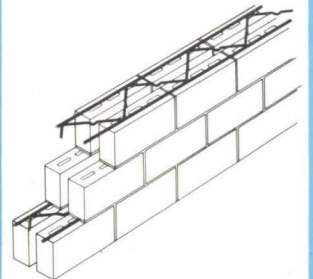

CAVITY WALLS

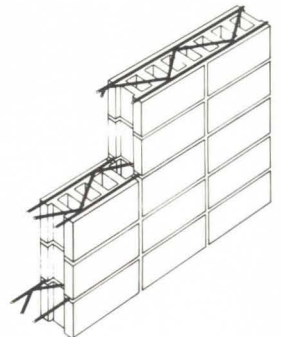

PLAIN WALLS

**Use Dur-O-waL to reinforce plain, composite and cavity walls**

Dur-O-waL gives your masonry walls increased compressive strength, increased transverse strength and marked improvement in resistance to moisture penetration in composite walls.

# DUR-O-WAL®

THE ORIGINAL MASONRY WALL REINFORCEMENT WITH THE TRUSS DESIGN



# Are you familiar with these other versatile products made by Dur-O-wal?

## Adjustable Wall Ties

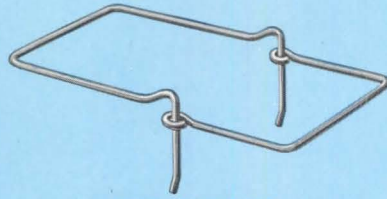

RECTANGULAR



Z-TYPE

## Continuous Rectangular Ties (Tab-Tie)

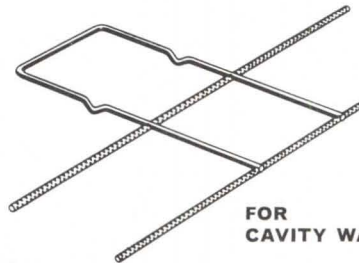

FOR CAVITY WALLS

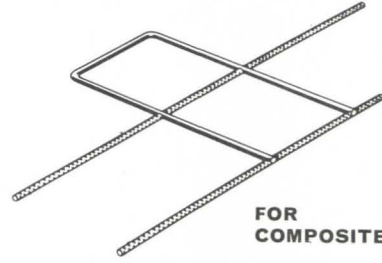

FOR COMPOSITE WALLS

## Rapid Control Joint

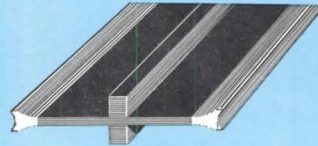
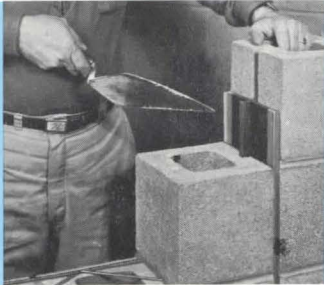

NO. 8 WIDE FLANGE

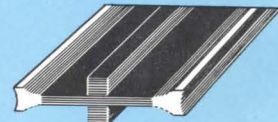

NO. 6 WIDE FLANGE

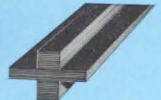

REGULAR

## Ladur Type<sup>®</sup> Reinforcement

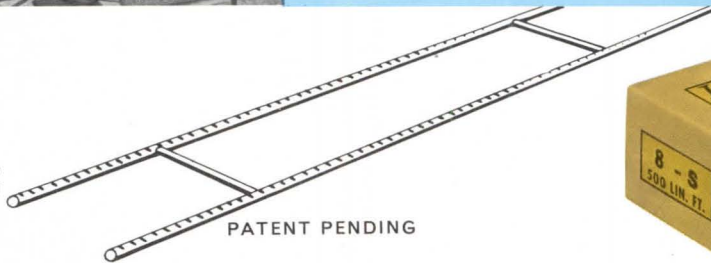

PATENT PENDING

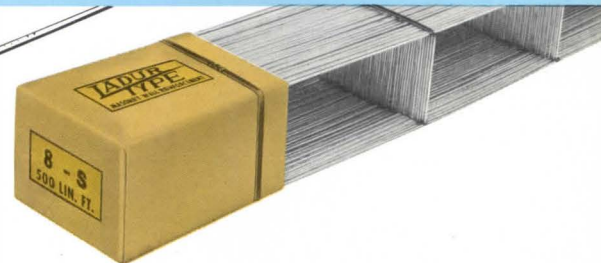

Clip this coupon and mail to Dur-O-wal National Inc., Post Office Box 150, Cedar Rapids, Iowa, for complete information on Dur-O-wal brand masonry wall reinforcement and other Dur-O-wal products.

Please send me information on the following:

- Dur-O-wal Truss Design Masonry Wall Reinforcement
- Ladur Type Reinforcement
- Adjustable Wall Ties
- Continuous Rectangular Ties (Tab-Tie)
- Rapid Control Joint
- Please have a Dur-O-wal representative call.

Name \_\_\_\_\_

Firm \_\_\_\_\_

Address \_\_\_\_\_

City \_\_\_\_\_ State \_\_\_\_\_ Zip Code \_\_\_\_\_

Clip and mail to Dur-O-wal

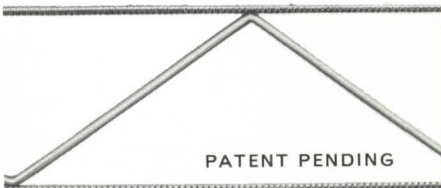

PATENT PENDING

MORE FROM DUR-O-WAL ON THE NEXT PAGE

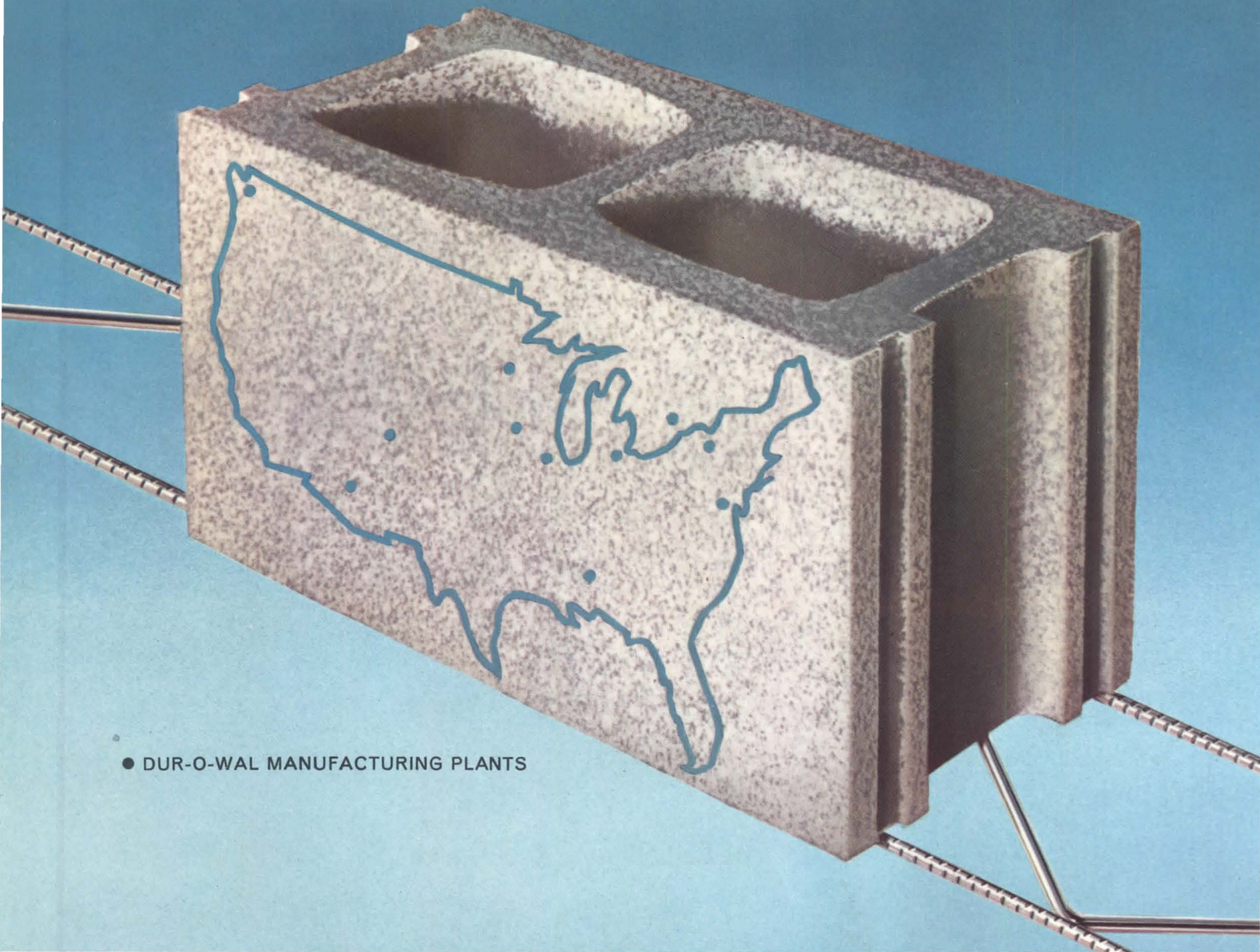

● DUR-O-WAL MANUFACTURING PLANTS

## You can get Dur-O-wal wherever you get masonry

Not only is Dur-O-wal as versatile as masonry, but it's as accessible as masonry itself. Over 8,000 dealers now recommend and stock Dur-O-wal wherever and whenever you need it. Truss designed Dur-O-wal also carries material approvals for multiple use in masonry wall construction by the following code organizations: Building Officials Conference of America (BOCA), Southern Building Code Congress (SBCC), International Conference of Building Officials (ICBO). When you specify Dur-O-wal, make sure you *get* Dur-O-wal. Look for the original truss design. Look for the Dur-O-wal end wrap. They're your assurance you've found the way to make masonry walls live longer than ever before.

PATENT PENDING

# DUR-O-WAL®

THE ORIGINAL MASONRY WALL REINFORCEMENT WITH THE TRUSS DESIGN

**DUR-O-WAL MANUFACTURING PLANTS** • Cedar Rapids, Iowa, P. O. Box 150 • Syracuse, N. Y., P. O. Box 628  
• Baltimore, Md., 4500 E. Lombard St. • Birmingham, Ala., P.O. Box 5446 • Aurora, Ill., 625 Crane St. • Pueblo, Colo., 29th and Court St. • Toledo, Ohio, 1678 Norwood Ave.  
• Mesa, Ariz., 213 So. Alma School Rd. • Seattle, Wash., 3310 Wallingford Ave. • Minneapolis, Minn., 2653 37th Ave. So. • Also manufactured in Canada.

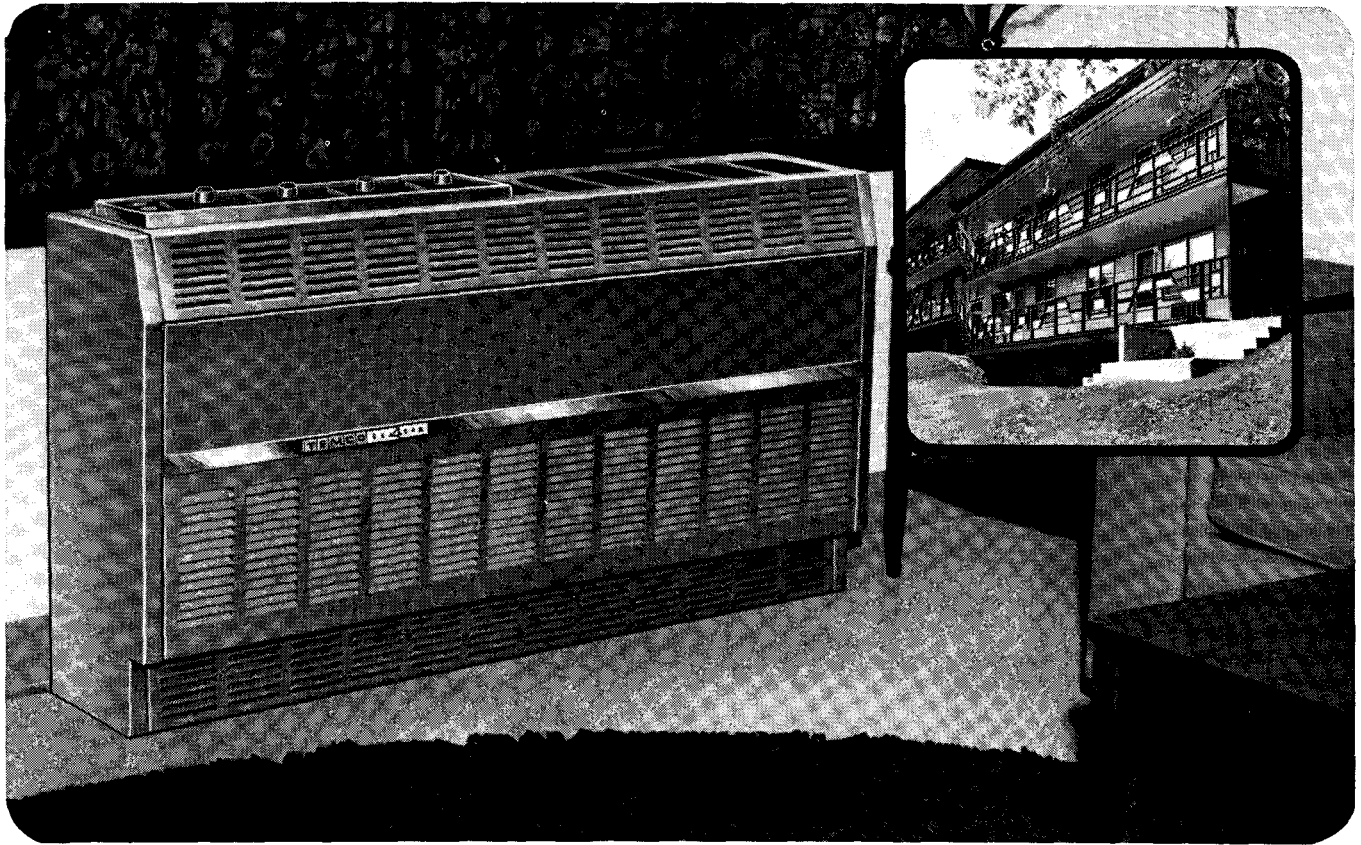

*Key Apartments, Dubuque, Iowa, reports*



# TENANTS LIKE TEMCO 4-SEASONS 100%

Dale Wernecke, owner, KEY APARTMENTS, Dubuque, Iowa, says, "The Temco 4-Seasons Heating and Cooling Units are ideal for apartments because we can meter each tenant separately for both heating and air conditioning."

He also says that the 4-Seasons is less expensive and accomplishes the same end as a centralized system yet offers the advantages of the tenants' needs for either air conditioning or heating.

Tenants at the Key Apartments like the 4-Seasons because it permits them individually to select exactly the apartment temperature they want. They can switch from heating to cooling with a press of a button. Small wonder Mr. Wernecke says, "My tenants and I like it real fine, just 100%!"

Your clients will be as pleased with their heating and air conditioning system as Mr. Wernecke . . . if you specify Temco 4-Seasons. Get full information today. Mail coupon.

**TEMCO<sup>®</sup>, inc.**

Dept. PA 3, 4101 Charlotte Ave.  
Nashville, Tenn. 37202



See Sweet's Light Construction Catalog File, Section 30a/Te.

Please send me the complete facts on Temco 4-Seasons Heating and Cooling Units.

Firm \_\_\_\_\_

Name \_\_\_\_\_

Address \_\_\_\_\_

City \_\_\_\_\_ State \_\_\_\_\_



Stippled®—in regular or grey glass



Grassweave



Surf®

**We just made**

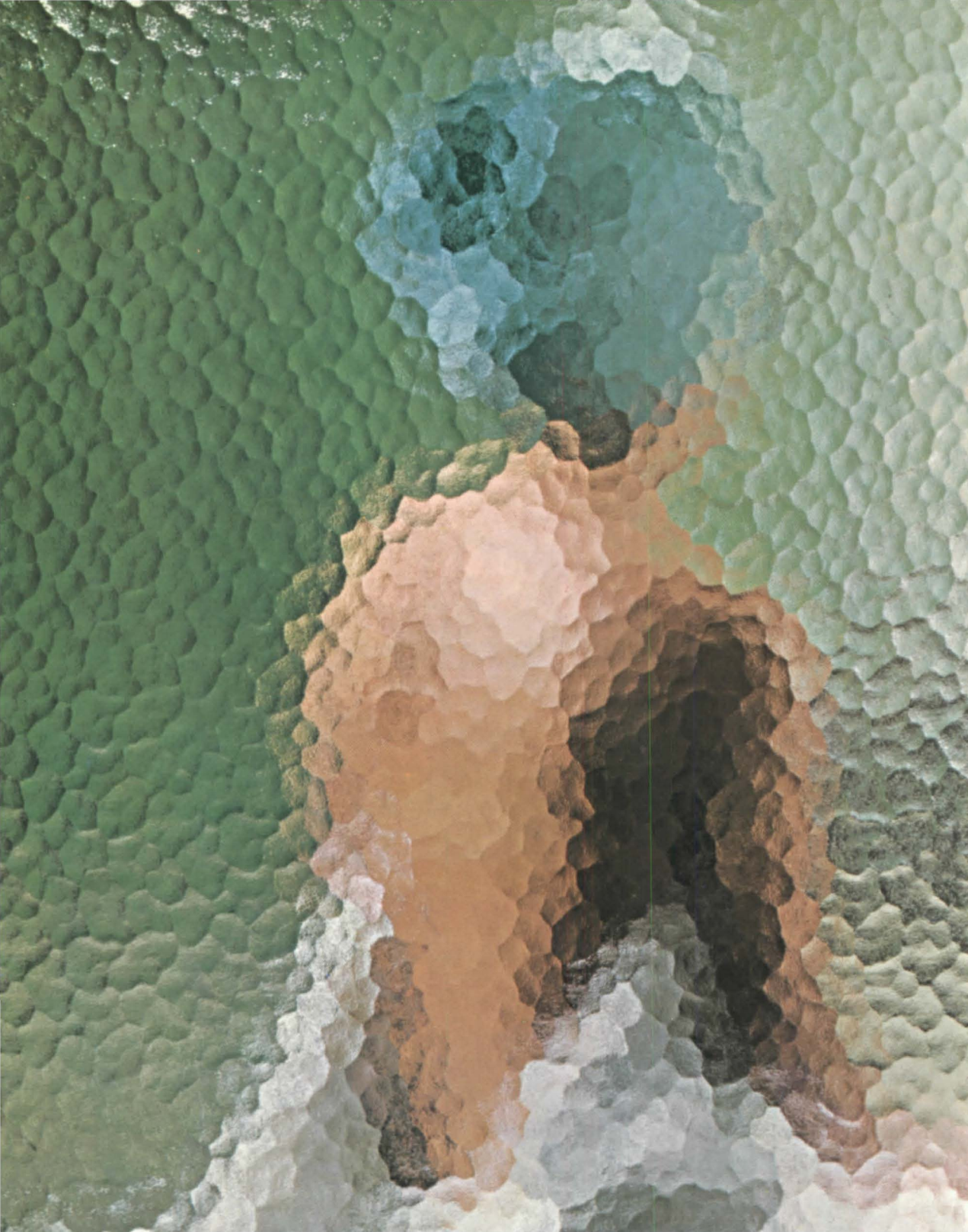

Bamboo®



## privacy inviting

We did it with L·O·F patterned glass "originals" like these.  
But we'd like you to see all 12 of our patterns. Each one puts the whole idea of privacy in a new light. Call your nearby L·O·F distributor or dealer (listed under "Glass" in the Yellow Pages). Ask him for samples.

**Libbey·Owens·Ford Glass Co.**  
Toledo, Ohio



COMPARISON PROVES...

**Vulcathene®**

DRAINLINE SYSTEMS

MEET

EVERY CHALLENGE

**COMPARE** the low material cost . . . your first big advantage when you specify Vulcathene for acid waste and drainage.

**COMPARE** the ease of installation. Standard 20' lengths are light in weight . . . easy to handle . . . require fewer joints. In seconds, Vulcathene fittings and pipe are actually fused into *one homogeneous piece* with our patented Polyfusion® technique. Vulcathene is the only system where the joint is stronger than the pipe itself . . . permanent and leakproof!

**COMPARE** the maintenance! There is none—ever, on properly installed Vulcathene systems. Just years of dependable, continuous service.

**COMPARE** the material! Only Vulcathene drainline systems are made entirely of *one* material—premium-grade, virgin polyethylene . . . from sink to dilution tank. Vulcathene is corrosion-resistant; able to withstand impact, shock and temperature—handles corrosive wastes, radioactive material or distilled, deionized or potable water.

**COMPARE** the advantages—and you'll specify Vulcathene . . . the economical, all-purpose drainline system. Write for our complete Catalog V-65, Dept. 3527.



DIVISION OF THE NALGE CO., INC.

**NALGENE PIPING SYSTEMS**

75 PANORAMA CREEK DRIVE, ROCHESTER, N. Y. 14625

*First with polyolefins for corrosion resistant drainline systems*

Visit our Booth No. 1035, National Plant Engineering & Maintenance Show, Cleveland, March 21-25  
On Readers' Service Card, circle No. 377

16 Views

◀ On Readers' Service Card, circle No. 367

Continued from page 8

the architectural profession.

While I agree in part with these conclusions, perhaps they are mostly a reaction against the aesthetic plagiarism of some talented architects by the profession. We have an aesthetic "escape" attitude culminating in Yamasaki's Gothic architecture, Rudolph's personalized sculpture, and Johnson's refined packages. Now we have a moralizing social protest—a reaction to aesthetics per se, and a rejection of architectural aesthetics overly complex for a specific function.

We conclude that "Architecture" is not *the* problem and that individuality of design preference is always leading to mere vanity of art form.

Many years ago, I asked Walter Gropius how it could be possible to do profound and beautiful urban solutions if one could not shape a large living area in a single-family dwelling, one that would uplift the human spirit as well as solving more pedestrian functional needs. Is the contemporary urban design problem a more profound problem because it affects more people? It seems to me that the degree of architectural merit may be more controlled by the increased humanistic disciplines of an urban problem, but, as always, architectural quality is established by the architect—not by his problem.

I have heard, many times in recent months, that "The house is not an architectural problem *now* of any significance" (p. 158, JANUARY 1966 P/A). Once again, we have 19th-Century criticism: e.g., the architecture of the Renaissance was bad because of "honesty" or "social standards" of the Renaissance architect (*The Ethical Fallacy of Criticism*, by Geoffrey Scott).

In much of North American contemporary life, we are trying simply to control our technical means, which in turn have given enormous freedom for a design departure point. In the absence of external limitations, our *internal* maturity has come to be the fundamental design criteria for the synthesis stage of our individual talents.

DR. T. MATOFF,  
Assistant Professor of Architecture,  
Faculty of Architecture,  
The University of Manitoba  
Winnipeg, Canada

### Magnificent

Dear Editor: The photographs by Baltazar of Philadelphia's Municipal Services Building (DECEMBER 1965 P/A) are magnificent.

A. H. LESTER  
Victoria, B.C.

Continued on page 24

MARCH 1966 P/A

On Readers' Service Card, circle No. 407 ▶



**Enriching the environment for the educational experience:  
Architectural materials and systems by United States Plywood.**

# For today's fresh conceptions in college architecture: one source enriches the total environment.

## Match-grained wood paneling for a 60-foot wall.

In the student lounge at Boston College, architects M. A. Dyer Company specified Makori Flexwood® on one virtually unbroken long wall. Flexwood is real wood, 1/85" thick with a fabric backing. This permits you to utilize the continuity of a single flitch on extremely large walls, curved or straight. No joints show, no furring needed. And when it's bonded to an incombustible surface, no fire problems. Installation by Carlson-Powell, Inc. of Boston.



## Glasweld®, the colorful touch for the maintenance-free exterior.

In the College Center building at Goucher College, Baltimore, Glasweld plays a colorful role. This all-mineral panel with a permanently colored surface needs only an occasional washing, is virtually maintenance-free. Glasweld is highly abrasion-resistant, remains optically flat, will not "pillow" or "oil can," and is 100% incombustible. Designed by Pietro Belluschi and Rogers Taliaferro Kostriksy and Lamb, associated architects.

## Weldwood architectural doors with 2 kinds of faces.

On the exterior, these Weldwood doors are Duraply®-faced. Their smooth resin-fiber-overlaid faces make an excellent paint surface that prevents grain raise and checking. Paint flows on smoothly, evenly, economically.

The interior faces of these doors are handsomely grained elm veneer. Architects can fill complete door schedules with

Weldwood doors. They can be supplied factory-primed and finished, and premachined to order for hardware and openings. Shown: main entrance to the Kraushaar Auditorium, Goucher College.







### Six systems of movable walls.

For space division, Weldwood® Movable Walls offer the architect a maximum degree of flexibility in design. Yet they appear to be permanent walls. Each of the six systems accommodates panels of identical 1¾" thickness up to 6' x 12' in a full selection of domestic and exotic hardwood faces on Weldrok® and Novoply® cores. Painted and vinyl surfaces are also available. Shown: Design 777™ in the W. E. Upjohn Institute for Employment Research, Kalamazoo, Mich. Architect: Smith Smith Haines Lundberg & Waehler, N. Y. Installer: Tieco Products Inc., Southfield, Michigan.



### An uncommon commons.

The main resident dining hall in McElroy Commons at Boston College is a large room: 170 feet long and 88 feet wide. Yet the walls of Portuguese marble topped with Weldwood architectural figured quartered walnut paneling give the room an atmosphere of warmth and intimacy. The 4' x 12' panels are separated by 1½" gold-leafed wood splines, and sequence-matched to echo the simple continuity of the over-all design. All veneers were cut from just two giant flitches placed at the architects' disposal from United States Plywood's vast inventory of fine wood veneers. Sample veneers in infinite variety and price range are available for your inspection at any of our 161 branch offices.



## Architectural materials and systems by United States Plywood.

# Specification details of Architectural materials and systems by United States Plywood.

Name \_\_\_\_\_

Firm \_\_\_\_\_

Address \_\_\_\_\_

City \_\_\_\_\_ State \_\_\_\_\_ Zip Code \_\_\_\_\_

- |    |     |
|----|-----|
| 1. | 6.  |
| 2. | 7.  |
| 3. | 8.  |
| 4. | 9.  |
| 5. | 10. |

For complete information on Weldwood® architectural materials, you need only telephone your nearest United States Plywood branch. One of our Architects' Service Representatives will be happy to work with you, help you analyze your requirements, and offer samples for your inspection. Or if you prefer, just circle the appropriate number for data booklets listed below and mail this coupon to: **United States Plywood, Dept. PA 4-66, 777 Third Avenue, New York, N. Y. 10017.**

- 1. Weldwood architectural doors:** Information on a complete line of standard construction doors and special purpose construction doors, factory finishing, fitting, machining, detailing, facings, guarantees.
- 2. Weldwood architectural paneling:** Specifications and grades, veneer selection and matching, cores, finishes, installation services, coordinating products.
- 3. Weldwood prefinished paneling:** Specification information, grade description, recommended installation and design usage for the full line of prefinished woods.
- 4. Weldwood guaranteed sidings:** Specifications, features and variety of designs, finishes, installation details, guarantees for a full line of wood sidings.
- 5. Weldwood Novoply®:** Engineering details, suggested usage and machining, installation details, edge and joint treatment for a quality 3-ply particle laminate board.
- 6. Weldwood Movable Walls and partitions:** Design and structural specifications, maintenance and cost studies for a variety of both standard and custom

designed wall systems.

- 7. Micarta®:** Technical and application information, color selection, for high-pressure decorative laminates made by Westinghouse, distributed by United States Plywood.
- 8. Glasweld®:** Description of properties, color and pattern choice, installation suggestions and examples, guarantee, and specifications for an exterior grade panel with a permanent finish.
- 9. Weldwood Flexwood®:** Wood selections, dimensions, fire rating specifications, and installation details for a completely flexible wood veneer and backing applicable to almost all surfaces, curved and flat.
- 10. Weldwood preservatives and finishes:** Product and specialized use description for Weldwood preservatives (Woodlife®, Penta®, Stormy Weather®, Rainchek®, and Woodhealth®) and Weldwood Finishes (Color Tones®, Deep Finish Firzite®, P.A.R.®, Patiolife®, Satinlac® and White Firzite®).



**Where lumber won't behave, Flexwood® will.** One element in the unique screen at left posed a problem: the floor-to-ceiling posts. Originally the design called for 2' x 2' posts of solid walnut. But warping made many of them unusable. Solution: walnut Flexwood wrapped around aluminum posts. Result: the posts retained their shapes, and a more uniform grain matching was achieved. Library of the W. E. Upjohn Institute for Employment Research. Installer: Tieco Products Inc.



**Doors that were made to be painted.** Architects LaPierre & Litchfield & Partners used 60 Type 3A Weldwood Duraply®-faced doors for classrooms, laboratories, and lavatories in the new Science Building at Peddie School, Hightstown, N. J. The 5-ply lumber core doors were supplied factory-primed to permit fast, economical, on-site paint finishing with excellent lasting results.



**Permanently colored Glasweld®—it outweathers the weather.** Behind a grille of Chilean cypress, Glasweld's crisp blackness contrasts with copper roof, and walls of wood, glass, and stone. Inaccessible areas such as this are where Glasweld's 28 maintenance-free colors most convincingly prove their value to creative new designs. College Center, Goucher College.



# UNEQUALLED LIGHTING PERFORMANCE

If performance of industrial lighting fixtures is important to you — here's significant news! Certified tests prove the new Ballasted Hg-400 Mercury Units by Miller, with mirror finish, *Specular Alzak Aluminum Reflectors*, out-perform *all* other 400 watt mercury vapor luminaires. A fact, regardless of maker or reflector materials used. Compared with prismatic glass, diffuse aluminum, porcelain enameled steel — or “combined aluminum and glass”— our Hg-400 Specular tests out with *the* highest efficiency and unexcelled light distribution. So investigate the facts. Learn first hand how Hg-400 gives you more useable light with up to 50% less weight hanging from the ceiling . . . uniquely simple installation eliminates need to hand support or balance cumbersome ballast weight when making line connections . . . cool operation in ambients up to 50°C. with *standard* ballast components, and so on. All Hg-400 units completely prewired with constant wattage autotransformer; diffuse aluminum and porcelain enameled steel reflectors also available.

Send today for Hg-400 catalog — 8-pages complete with performance data.

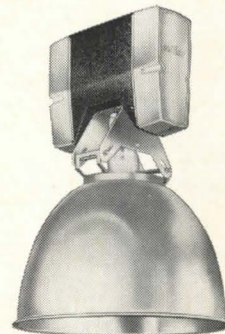

THE miller COMPANY  
MERIDEN, CONNECTICUT • UTICA, OHIO



On Readers' Service Card, circle No. 375

FOR HIGH, MEDIUM AND LOW BAY INDUSTRIAL AREAS

Another PLUS VALUE from General Mills Chemicals

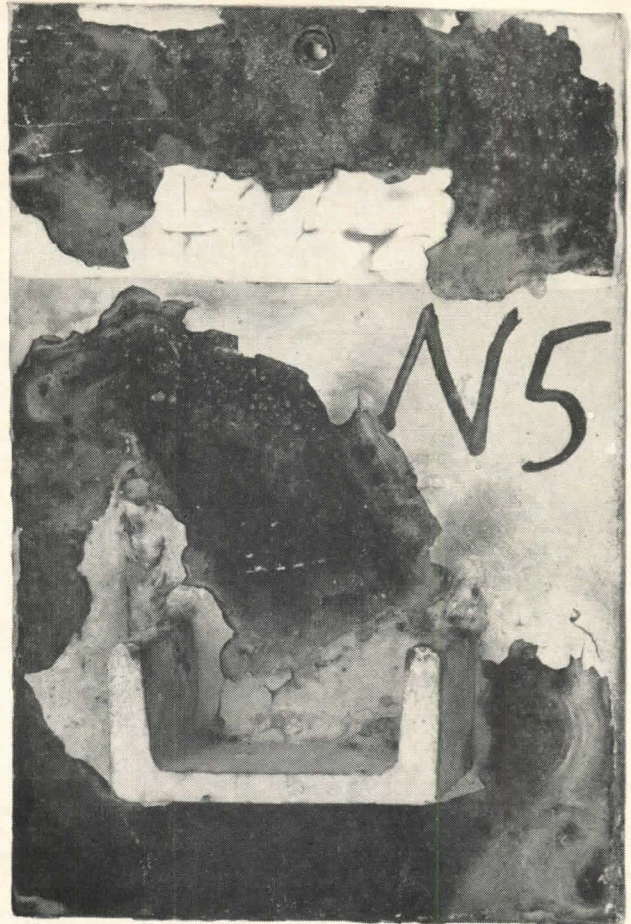
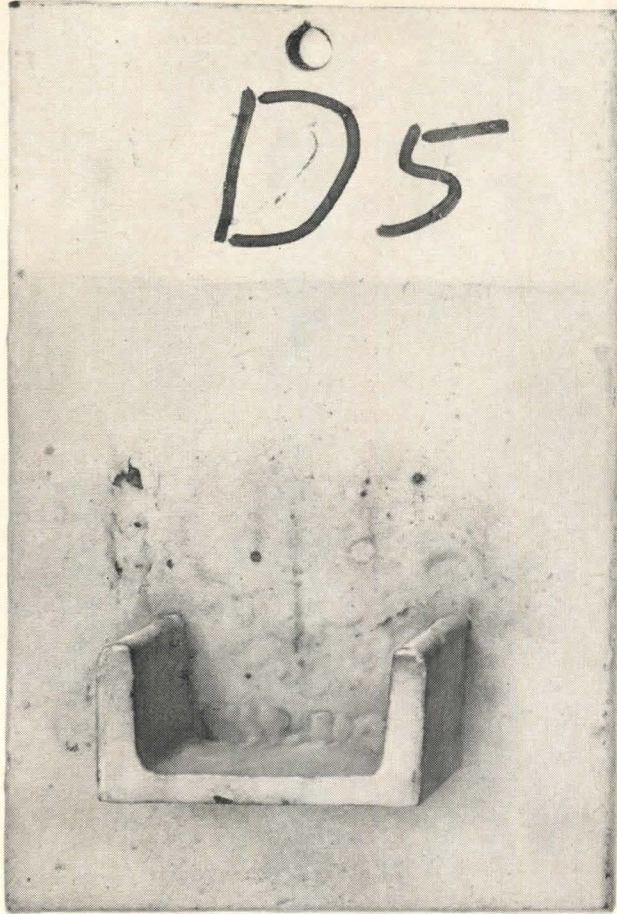

**What makes this epoxy coating\*  
so much better?**

## Versamid® polyamide resin – the curing agent with Plus Protection

Seven years ago, General Mills put these Tator panels on the test rack. Year after year, the elements hammered away in the brutal freeze-thaw winters and warm, moist summers of Minnesota.

In these continuing tests, Versamid resins prove again that they do more than cure epoxies. They are polymeric coreactants—imparting unique Plus Values of their own to the cured coating. Extra benefits like added toughness, flexibility, and resistance to chemicals and corrosion.

In corrosion-inhibiting action, Versamid resins offer protection above and beyond that supplied by the pigment—an extra margin of safety. These panels are proof of it.\*\*

As surface-active agents, Versamid resins enable the paint vehicle to disperse pigments evenly, give better flow-out, minimize fisheyes and pinholes. Their wetting ability also gives the film a better “bite” on hard-to-paint surfaces—even when they are damp or imperfectly prepared.

Versamid-cured epoxies offer many other advantages. Compared to amine curing agents, they are non-toxic and non-sensitizing. Their mixing ratios are non-critical. A small error in proportioning components will not affect the performance of the coating.

General Mills' technical staff works closely with paint formulators in developing epoxy coatings for a broad range

of applications. For more information, ask your coatings supplier for the free booklet “The What, Why, How, When of Versamid/Epoxy Maintenance Coatings.” Or get this booklet and a list of coatings manufacturers using Versamid resins by writing General Mills, Inc., Chemicals Division, Dept. PA-3, Kankakee, Ill.

*\*Plate D5 is protected with a 35:65 Versamid-epoxy vehicle containing 35% red lead pigment. Plate N5 is coated with an amine-cured epoxy containing 35% red lead. Both were coated with three brushed coats of primer to a total dry film thickness of about four mils.*

*\*\*Information demonstrating corrosion inhibiting and surface active properties of Versamid resins is available on request.*

 **CHEMICALS**   
GENERAL MILLS KANKAKEE, ILL.

# Amarlite Curtain Walls

Design . . . Strength . . . Function

. . . all packaged with on-the-job service!

It's architect designed . . . engineered to more precise specifications . . . for one to one-hundred stories . . . finished with anodized hard-coat . . . in a wide range of standard systems (or custom walls) with greater strength and more dramatic exterior styles! Most important, we provide nation wide on-the-job supervision by our own engineering professionals to assure smooth-going and fast installation. ■

Select from Sweet's, or write Amarlite,

Main Office, P. O. Box 1719,

Atlanta, Georgia . . . for

product information

or the name of our

representative in your area . . .

for *ALL THAT'S NEW!*

Entrances

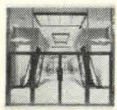

Curtain Walls

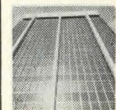

Store Fronts



Windows



LaPorte



Sliding Doors



Catalogs  
Available!

ENGINEERED FOR DISTINGUISHED ARCHITECTURE . . .

**Amarlite**<sup>®</sup>  
OF ANACONDA ALUMINUM

Atlanta • Chicago • Cleveland • Dallas • Paramus, N.J. • Los Angeles • Export throughout the Free World  
On Readers' Service Card, circle No. 430

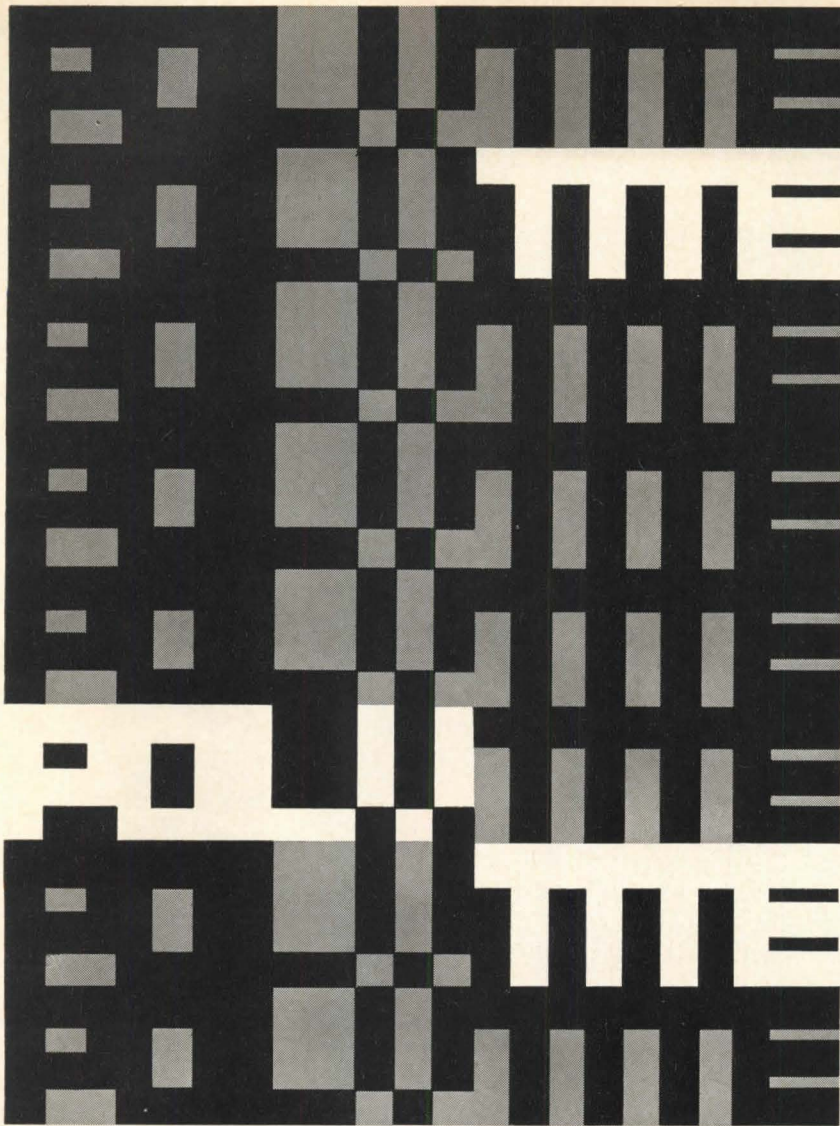

Poly-Tite should be an integral part of every building because it is the one, one-step joint sealant that has universal applications. It has proven ideal for precast and curtain wall construction, glazing, or any type of interior or exterior construction joint. You can do anything you want to Poly-Tite except make it misperform. A compressible polyurethane foam impregnated with polybutylene, Poly-Tite is the only sealant that can be applied to panels prior to assembly. Completely water-tight either above or below grade, Poly-Tite is compatible with *all* building materials, won't stain or corrode surfaces, and remains flexible and pliable from  $-40^{\circ}\text{F}$  to  $+200^{\circ}\text{F}$ , assuring a weather-tight seal even when the joints expand or contract.

# POLY-TITE<sup>®</sup>

Poly-Tite always offers a better joint seal . . . a better way.



**SANDELL MANUFACTURING COMPANY, INC.**

82 SHERMAN STREET, CAMBRIDGE, MASSACHUSETTS 02140 • PHONE (617) 491-0540

*Continued from page 16*

### ***Lifting the Spirits***

Dear Editor: The article in the DECEMBER 1965 P/A on the Grinnell "Student Union" was really impressive. In fact, it was so impressive that I think I now like the building. It has worked out very well for our campus. It is being well used and it sure lifts the spirits of everyone during a long winter.

RICHARD D. MEYER  
Grinnell, Iowa

### ***Lament After A Morning Spent Catching up on the Recent Issues of P/A***

Once upon a time  
Not so long ago  
The planner and the architect  
Knew all they had to know  
The city was an evil place  
Full of noise and grime  
We'd tear down all the tenements  
And get rid of all the crime  
Get the kids out of the alleys  
Live in belts of green  
Pleasant sunny suburbs  
With freeways in between  
We didn't like the Renaissance  
Baroque was even worse  
The long dead hand of history  
We knew to be a curse  
We stripped off decoration  
Simplicity was best  
The ghost of old Palladio  
Was finally laid to rest  
We thought that in a building  
Modesty was all  
A cage of beams and columns  
And a simple curtain wall  
And when the Beaux Arts laws  
were gone:  
Composing, styling, mass  
A new and happy man would walk  
Through streets of steel and glass

Now we sing again of pleasures  
That only cities bring  
Excitement, noise and clamor  
*Diversity's* the thing  
Dirt and overcrowding  
No longer are disgraces  
What once were dingy alleys  
Are informal community spaces  
Historical romancing  
No longer is a sin  
Neo-Medieval roofscapes  
Are definitely in  
Order and simplicity  
Have fallen by the way  
Interest and excitement  
Are the watch words of today  
You have to be original

*Continued on page 30*

Bethlehem announces...

# 6 new lightweight sections



B18L x 35 lb

B18L x 40 lb



B21L x 44 lb

B21L x 49 lb



B24L x 55 lb

B24L x 61 lb

*All immediately available from regular rolling schedules!*

Advertising Division, Industrial and Public  
Relations Department  
Bethlehem Steel Corporation  
Bethlehem, Pa.

Send more information on your 6 new lightweight sections.

Send revised pages for Catalog 1836, Bethlehem Structural Shapes.

Name \_\_\_\_\_

Company \_\_\_\_\_

Address \_\_\_\_\_

City \_\_\_\_\_ Zone \_\_\_\_\_ State \_\_\_\_\_

These new sections are tailored to today's modern design techniques, to today's new high-strength steels. They are a logical addition to the BL series engineers have found so useful and economical.

These six new sections increase Bethlehem's BL series to 18-in., 21-in., and 24-in. nominal depths. And we'd just like to add that Bethlehem has now introduced a total of 17 new lightweight sections in the past five years. If you'd like to know all about them, mail the coupon. Or phone our nearest sales office. Bethlehem Steel Corporation, Bethlehem, Pa.



**BETHLEHEM STEEL**



**ACME** *America's most  
complete line of  
compact kitchens*

Made by the oldest and largest  
manufacturer of compact kitchens  
to the exacting standards required  
for rugged institutional use.  
Write for catalog.

see our  
catalog in  
*Sweet's*



**SD51F**  
24"W x 34½"H x 25"D



**RE5F**  
27"W x 36"H x 25"D

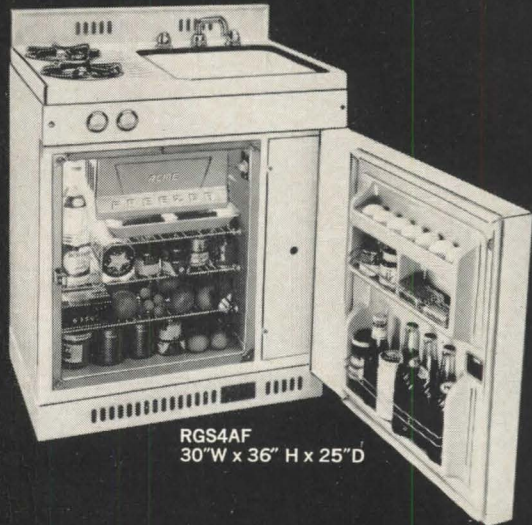

**RGS4AF**  
30"W x 36" H x 25"D

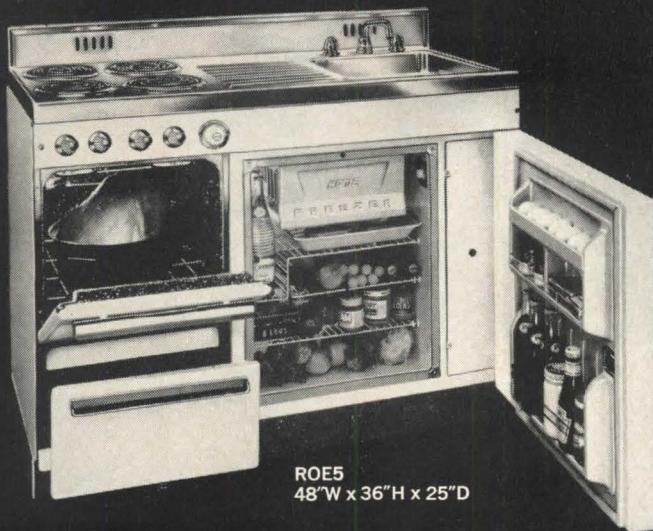

**ROE5**  
48"W x 36"H x 25"D

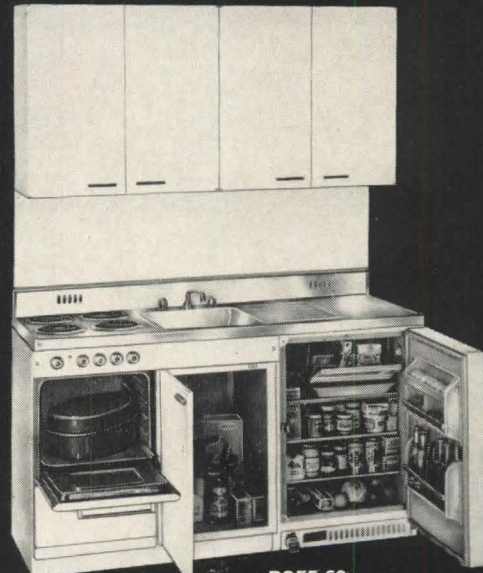

**ROE5-60**  
60"W x 36"H x 25"D

**ACME NATIONAL REFRIGERATION CO., INC.**

Offices and Factory: 19-26 Hazen Street, Astoria, N.Y. 11105 • Mailing Address: P. O. Box 188, Astoria, N.Y. 11105



# Our wallboard has better nailing qualities:

Bestwall is the original glass fiber reinforced wallboard. This unique core of gypsum and uniformly dispersed glass fiber filaments literally anchors a nail (or screw) driven through its body, pressing hard against the side of the metal, resisting flexural stresses, cracking or sagging. Let our salesmen tell you about Bestwall wallboard systems, ceilings and partitions available for every specification.



**GEORGIA-PACIFIC**



**GYPSON DIVISION**

2 INDUSTRIAL BOULEVARD, PAOLI, PENNSYLVANIA

On Readers' Service Card, circle No. 418

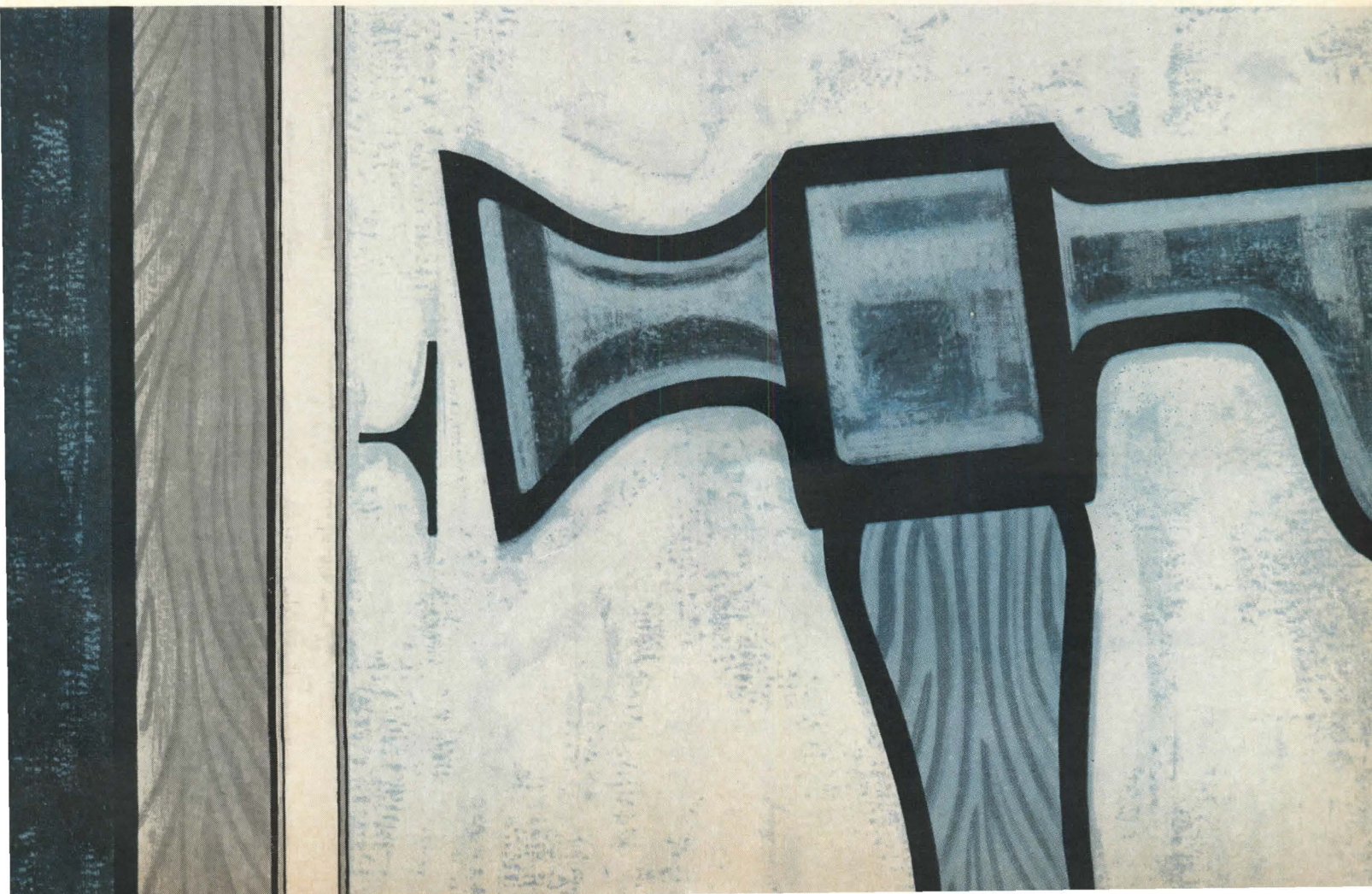



**The first Risom desk is hardest to come by...**

Like any executive privilege, it has to be earned, but it's always worth the effort.

Supremely functional. Yet comfortable and distinctive. It does things for your ego and working effectiveness.

Well-planned Risom furniture makes good sense for progressive organizations with ambitious young executives.

Lightly scaled and compact, Group SEVEN desks will even make a cost-accountant smile.

Risom design skill provides generous space and ample storage that takes advantage of limited working areas. Notice the front panel is inset so a visitor's chair can be pulled right up against the desk.

See the imaginative Group SEVEN collection of desks, cabinets and chairs at our showrooms nationally.

*The answer is Risom.*



49 E. 53rd St., N.Y. Also: Atlanta, Chicago, Los Angeles, San Francisco **Jens Risom Design Inc.**

On Readers' Service Card, circle No. 388 ➤

PRESIDENT'S OFFICE,  
WESTERN SAVINGS BANK,  
Buffalo, N. Y. Duane Lyman  
and Associates, Architects.  
P&L products used: Vapex  
Wall Primer, Lyt-all Flowing  
Flat, Vitralite Enamel, Lyt-all  
Stippling Eggshell, Tonic  
Wood Stain, "38" Pale  
Trim Varnish.



BUFFALO AND  
ERIE COUNTY PUBLIC  
LIBRARY, Buffalo, N. Y.  
James William Kidney  
& Associates, Architects-  
Engineers. Paul Hyde  
Harbach & Elon B. Clark, Jr.,  
Associated Architects. P&L  
products used: Lyt-all  
Stippling Eggshell, Lyt-all  
Flowing Flat, Vitralite Enamel,  
Tonic Wood Stain, "38"  
Pale Trim Varnish.

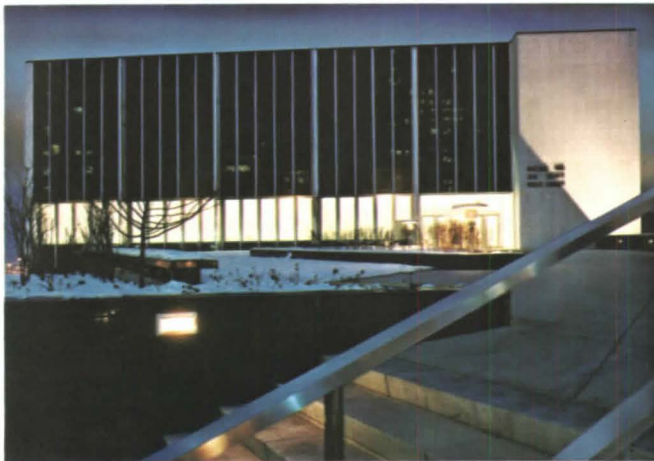

MARY AGNES HALL,  
D'YOUVILLE COLLEGE,  
Buffalo, N. Y. Foit &  
Baschnagel, Architects.  
P&L products used: Lyt-all  
Stippling Eggshell,  
Vitralite Enamel.



CLASSROOM, SWEET HOME  
JR. HIGH SCHOOL,  
Amherst, N. Y. Stanley C.  
Podd and Associates,  
Architects. P&L products  
used: Lyt-all Stippling  
Eggshell, Solidex, Lyt-all  
Flowing Flat, Tonic Wood  
Stain, "38" Pale Trim  
Varnish.



## Pratt & Lambert Paint and Varnish... The Predominant Choice of Leading Architects

The extraordinary qualities of Pratt & Lambert products make them favorites with architects. Accurate, scientifically controlled and tested formulations yield paint and varnish which apply well, look attractive and last long on job after job.

Exclusive P&L Calibrated Colors® offer the architect ample choice. They are scientifically selected for their decorative correctness, both traditional and contemporary.

Pratt & Lambert Architectural Service Departments are eager and able to assist architects. They will offer recommendations for painting or finishing any interior or exterior surface, or develop a complete color plan for a building. Call or write your P&L representative or the Architectural Service Department nearest you. No obligation, of course.

P&L ARCHITECTURAL SERVICE DEPARTMENTS  
LONG ISLAND CITY, N. Y. 11101, 3301 38th Avenue  
BUFFALO, N. Y. 14207, 75 Tonawanda Street  
CHICAGO, ILL. 60632, 4900 South Kilbourn Avenue  
ORANGE, CAL. 92669, 1405 North Batavia Street  
FORT ERIE, ONTARIO, CANADA



*Craftsmanship in the Package*

## Pratt & Lambert-Inc.

*Made and Sold Throughout All of North America*

Continued from page 24

To make the magazines  
The simplest seaside cabin  
Must have lofts and mezzanines  
Roofs that slant and slope  
In seven different planes  
Big shingle covered skylights  
And tiny window panes  
"Startling spatial concepts"  
Arouse the critics' passion  
Something new and something different  
Form follows fashion  
If being firstest with the latest  
Is the method of survival  
I'll have a beer and wait  
For the Neo-Mies Revival

ROBERT B. RILEY  
Albuquerque, New Mexico

### Correction

Dear Editor: Neill Smith was a valued associate, but *Western Architect and Engineer* had only one Editor in its 30 months of existence, namely

DONALD CANTY  
New York, N.Y.

*P/A* apologizes to Mr. Canty, currently Managing Editor of Architectural Forum, for not crediting him with his proper role in the good old days. Neill Smith, author of the article on Wurster Hall in the JANUARY 1966 *P/A*, served as Architectural Editor of *Western Architect and Engineer*.—Ed.

### NOTICES

#### New Addresses

ROBERT R. BLEEMER ASSOCIATES, Designers, 64 Northeast 40th St., Miami, Fla.

GRAY & KAROLYI ASSOCIATES, Architects and Engineers, 265 Little Tor Rd. S., New City, N.Y.

HOLLAND SHADE CO., 306 E. 61st St., N.Y., N.Y.

VICTOR GRUEN ASSOCIATES, Architects, Planners and Engineers, 6330 San Vicente Blvd., Los Angeles, Calif.

HIRSCH-HAMMERBERG-KAESTLE, Architects, 1 Prospect St., New Britain, Conn.

JENSEN & HALSTEAD, Architects, Engineers, and Consultants, 600 S. Michigan Ave., Chicago, Ill.

LUNDQUIST & STONEHILL, Architects, 539 E. 81st St., N.Y., N.Y.

McQUAYS, INC., 13600 Industrial Park Blvd., P.O. Box 1551 Minneapolis, Minn.

DELORES MILLER & ASSOCIATES, Interior Designers, 21 E. Superior St., Chicago, Ill.

PHELPS-MCCLESKEY, Architects, 205 N.

Continued on page 264

more and more great  
American architects  
are using Marmet

## new laboratory in the sky

### RESEARCH INSTITUTE OF THE ILLINOIS INSTITUTE OF TECHNOLOGY CHICAGO

One of the newest structures in the growing research complex at the Illinois Institute of Technology's Research Center is this twenty story Research and Administration Building.

All fenestration components are finished in a rich black Reynocolor which provides striking contrast to the light masonry structural members. Special five inch extrusions were custom engineered and fabricated by MARMET for the quarter inch plate glass windows. On the main floor, ultra slim stile MARMET 2200 service doors complement custom engineered entrance sections. Doors and lobby fenestrations are also treated in the black Reynocolor as well as the upper level, aluminum louvers which cover heating and air conditioning units.

More and more...experienced architects find that specifying MARMET . . . with its **single source capability, close liaison on design** . . . and **laboratory** checks on quality control . . . is a long step toward successful execution of all fenestration components.

**MARMET**  
corporation

SWEETS CATALOG 17a and 16a  
or write MARMET MAR 322-R Bellis Street  
Wausau, Wisconsin

On Readers' Service Card, circle No. 369

ARCHITECT:  
**SCHMIDT,  
GARDEN &  
ERICKSON**  
Chicago, Illinois

Fenestration  
by  
MARMET CORPORATION

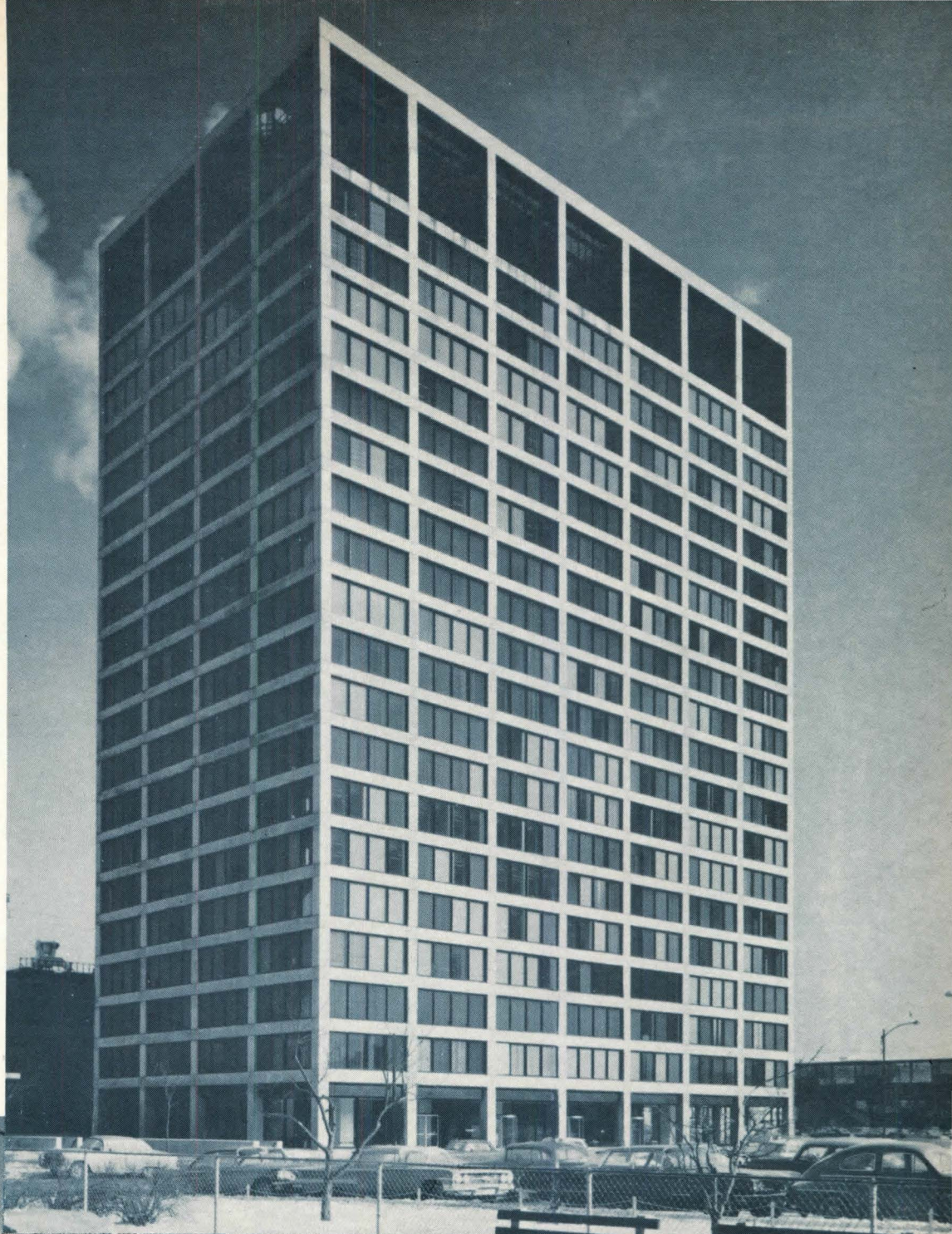

*photograph by Hedrich-Blessing*

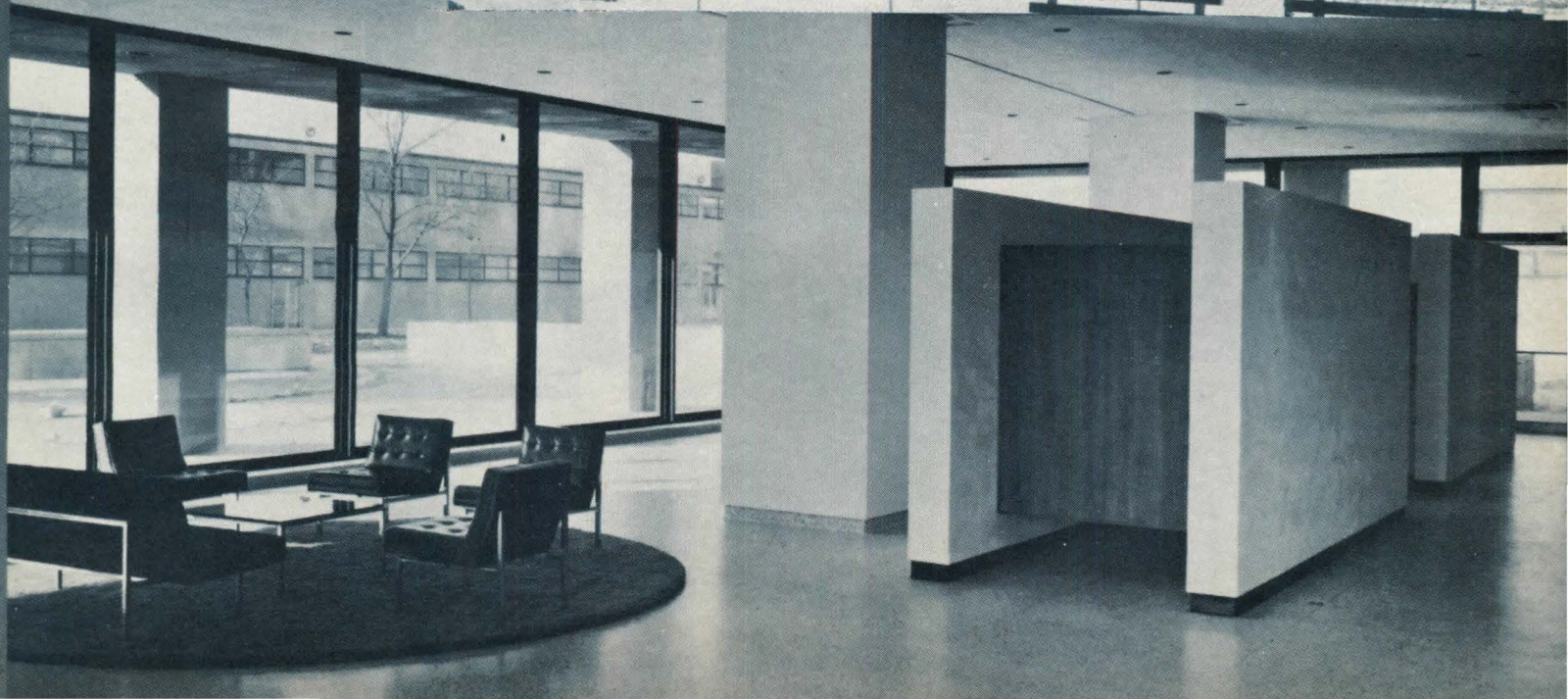



(Above) First Methodist Church, San Diego, California. Architects: Perkins & Will. Structural Engineers: Rutherford-Chekene. General Contractor: M. H. Golden Construction Co. Prestressed Elements: San Diego Prestressed Concrete Co. Pozzolith Ready-Mixed Concrete: San Diego Consolidated Rock Products.



(Left) North Shore Temple, Glencoe, Illinois. Architects: Minoru Yamasaki and Associates. Engineers: Worthington; Skilling, Helle and Jackson. General Contractor: George A. Fuller Company. Pozzolith Ready-Mixed Concrete: Material Service.

(Right) Holy Family Catholic Church, Parma, Ohio. Architects: Conrad & Fleischman. Structural Engineers: R. M. Gensert Associates. General Contractor: The Martini Construction Company. Pozzolith Ready-Mixed Concrete: Clifton Concrete & Supply Co.

(Below) St. Pius X Church, Rock Island, Illinois. Architect: Ed Lerch. Consultants: R. C. Sandberg and T. W. Arnold. Engineers: Interstate Engineering Company. General Contractor: The Leo Waters Construction Company. Pozzolith Ready-Mixed Concrete: Consumers Ready-Mixed Concrete.

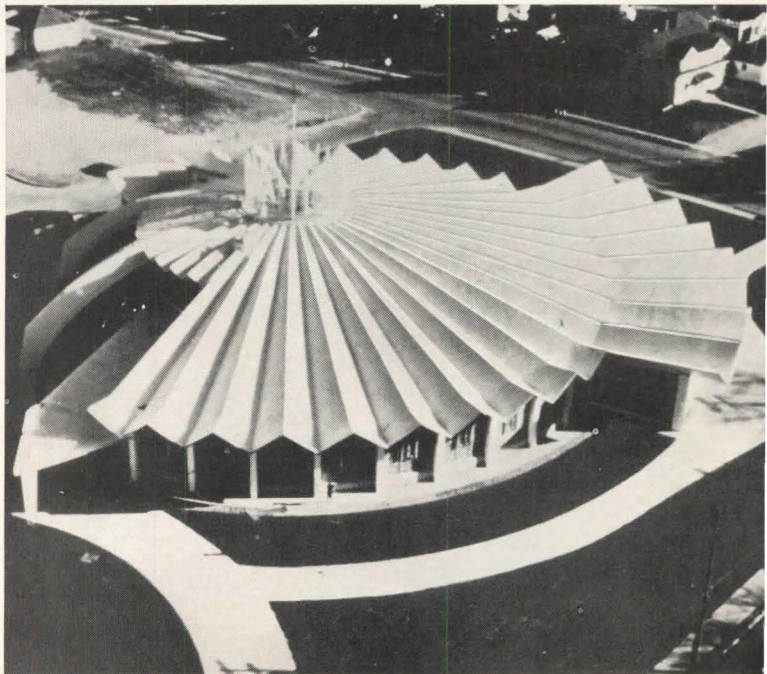

# Church design, concrete and **Pozzolith**

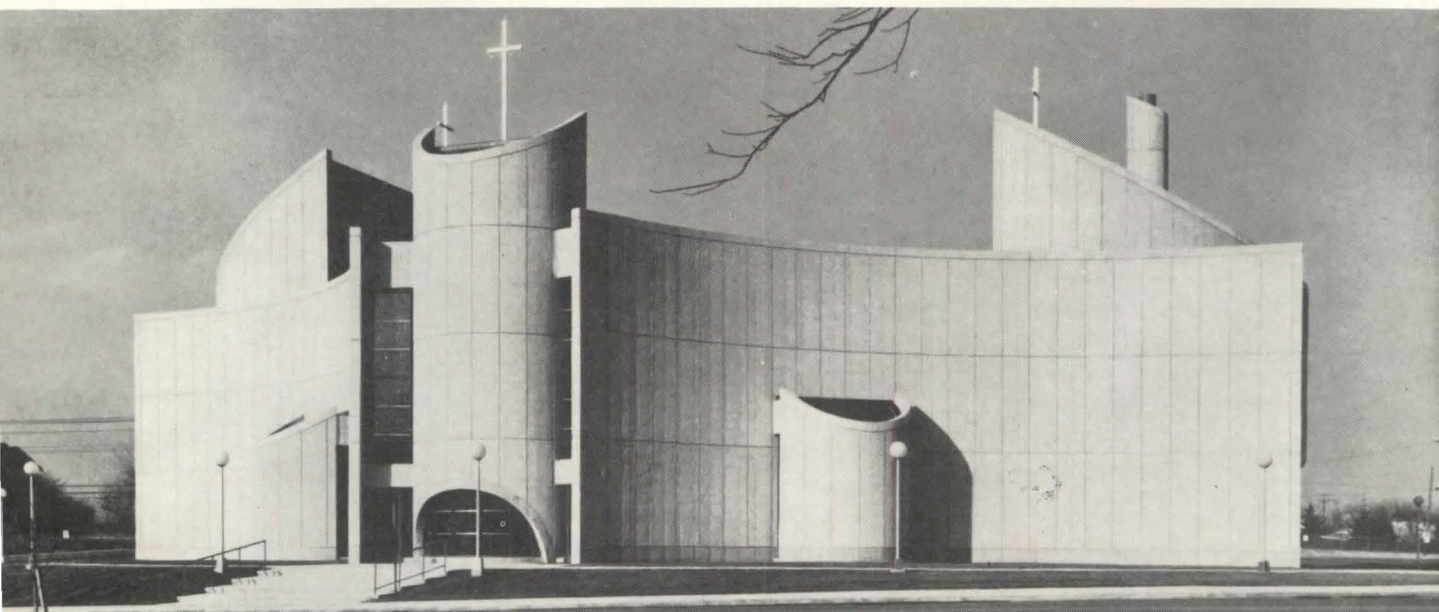

**F**resh architectural concepts are being visibly expressed in the design of today's churches.

The focus is unity and beauty. The expression is arches, shells, circles, textures. The preferred material is concrete.

Outstanding results of this creative freedom are being produced with Pozzolith concrete, a versatile and predictable material that ensures faithful execution of the most imaginative design concepts. Pozzolith—the most widely used concrete admixture—imparts superior workability, strength and durability to *all* concrete.

If you would like more information on how Pozzolith can benefit your next project, call your Master Builders field man, or write Master Builders, Cleveland, Ohio 44118 and Toronto 15, Ontario.

**POZZOLITH\***  
manufactured only by  
**MASTER BUILDERS**

\*POZZOLITH is a registered trademark for Master Builders water-reducing, set-controlling admixture for concrete.

# COLOR PLATING with FLUROPON by De Soto

Never think of De Soto Fluropon™ as *paint* or *lacquer* or *enamel*. It isn't! Fluropon is truly a color plating—fused to and on the metal before or after fabrication. It is a rare break-through in surface protection and coloration which gives widened horizons to the architect's ability to design for new beauty and utility.

Fluropon lives comfortably in corrosive atmospheres. Does not delaminate, chip or shatter. Its impact resistance is equal to that of the metal it protects. It is as cleanable as a china dish. Detergents cause no impairment.

Life? We can guarantee it for twenty years, and we are conservative.

Colors? A wide variety of pigments whose quality is equal to that of the vehicle.

We believe your client will like your investigation of Fluropon and your delineation of what you can do with it for his benefit in designing structures of distinction and low maintenance.

We will welcome a conference on how you could use Fluropon. De Soto Chemical Coatings, Inc., 1700 S. Mt. Prospect Road, Des Plaines, Illinois 60018

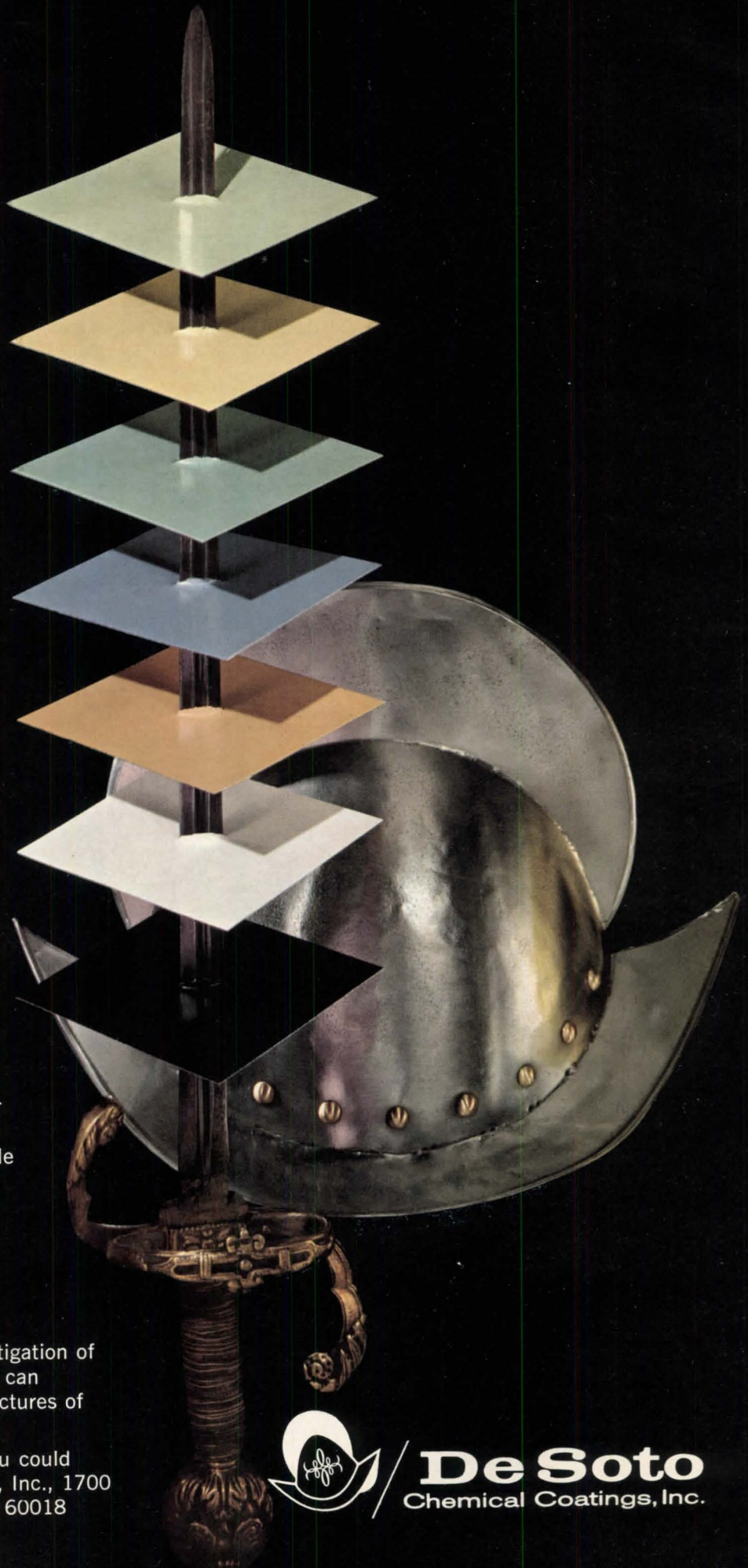

**De Soto**  
Chemical Coatings, Inc.



# A DISTINCTIVE CONCRETE SCHOOL DESIGN

that combines space,  
esthetics and economy

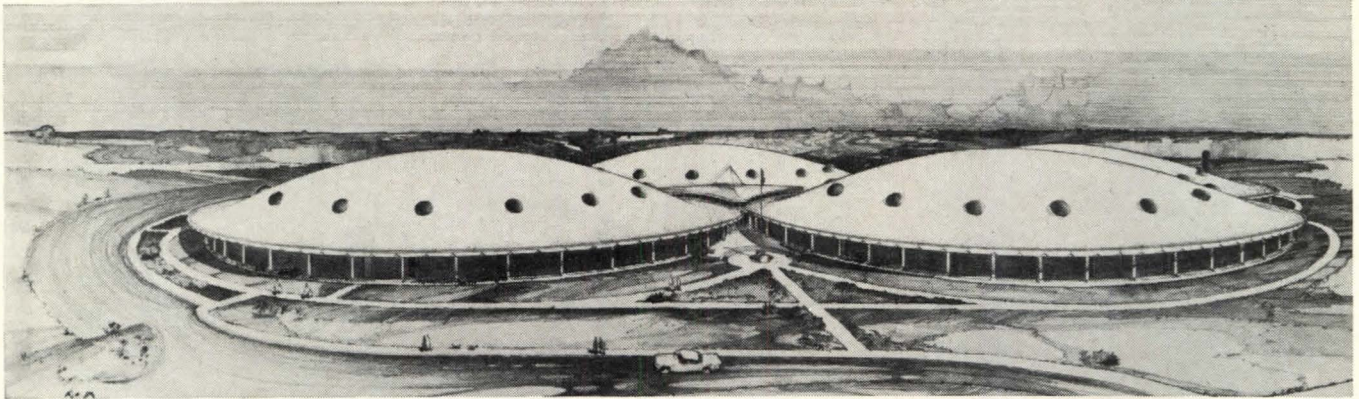

Coleman Junior High School in Wichita, Kansas will contain facilities for 1200 students. Two of the four domes have three floors of classroom space. One houses the girls' and boys' gymnasiums. The fourth contains auditorium, shop facilities and art and music rooms.

## USING LEHIGH CEMENT

This new public school is composed of four huge, thin-shell concrete domes with a roofed over section for a "Commons" area. The design provides maximum teaching space within the confines of the real estate. And concrete was chosen as the material which would yield the most graceful and pleasing appearance consistent with structural economy.

Concrete for the project had to be placed by bucket crane and by pump. A crane could reach only half the roof area. Thus, extremely exacting slump requirements had to be met to facilitate pump placement of the concrete. And here, as in important construction projects throughout the country, Lehigh Cement contributed to the quality concrete required for smooth, on-time completion. Lehigh Portland Cement Company, Allentown, Pa.

*Owner:*  
Wichita Board of Education, Wichita, Kansas

*Architects:*  
McVay, Peddie, Schmidt & Allen, Wichita, Kansas

*Prime Contractors:*  
Coonrod, Walz and Vollmer Construction Company, Inc., Wichita, Kansas

*Ready-Mixed Concrete:*  
A-One Concrete, Inc., Wichita, Kansas

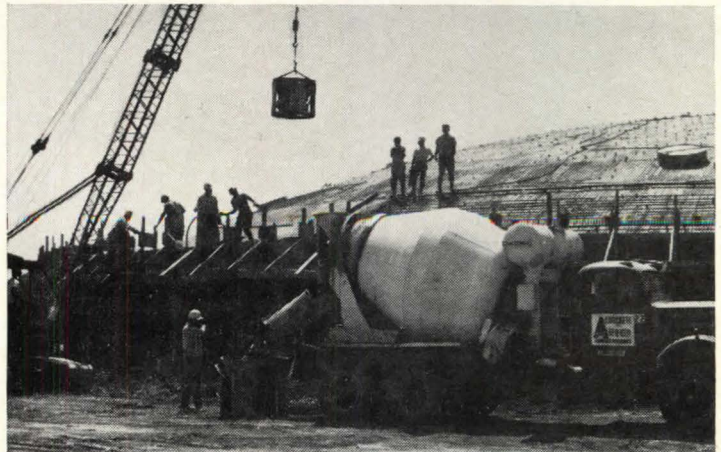

Concrete was placed over cement excelsior sheets which, in most areas, will be left exposed. Wherever possible crane and bucket were used for placement. In those areas which could not be reached by this method, concrete was placed by pump.

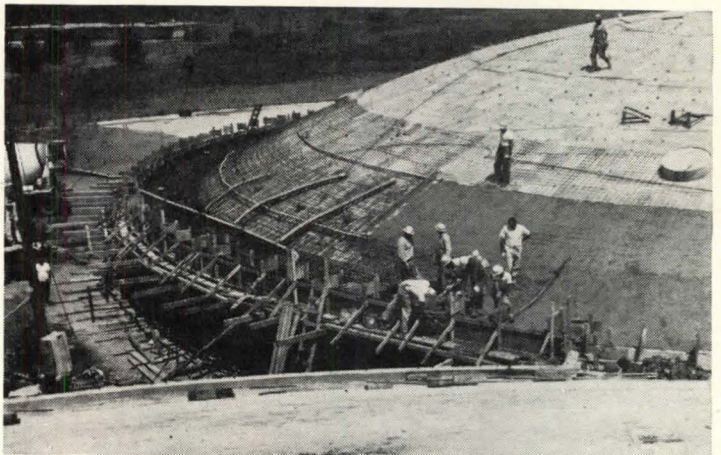

The thin-shell roofs range from 4" thick at top to 8" thick at the base and 16" thick at the tension ring. Domes are 33' high at center and 180' in diameter.

**LEHIGH**  
CEMENTS



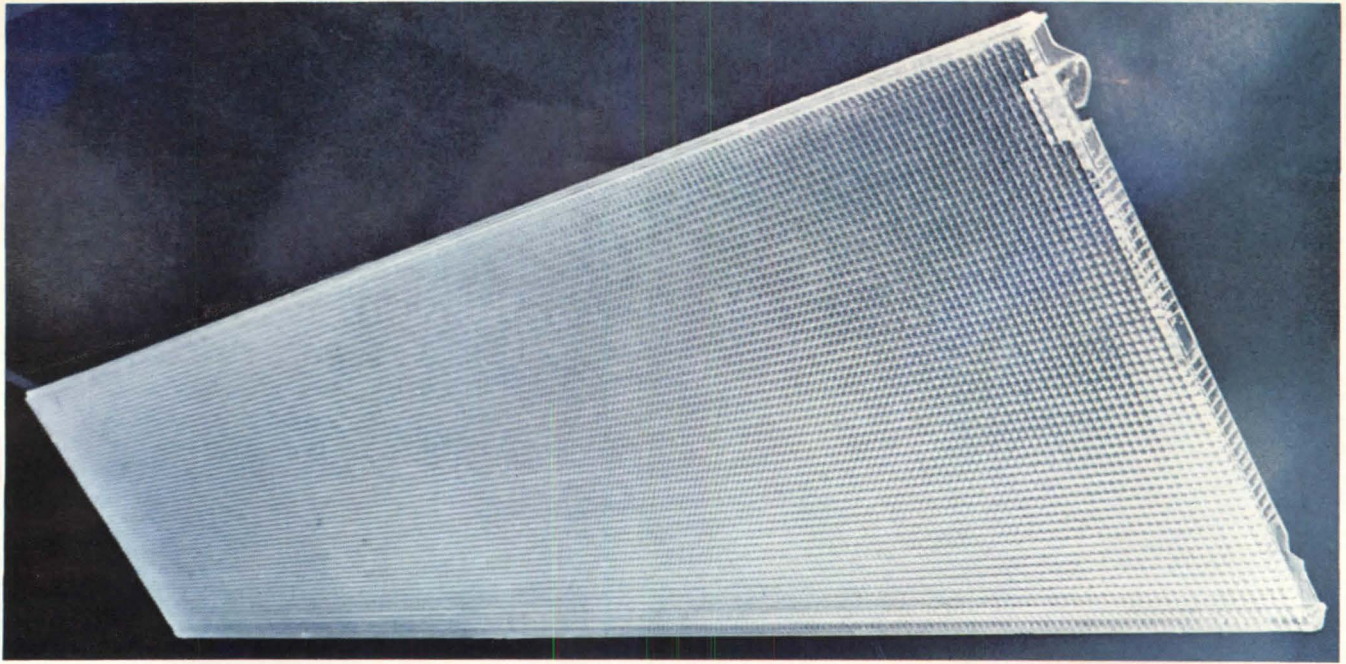

*At bold new Century City*

## Holophane frameless lenses provide low brightness, high output illumination



More than ten thousand Holophane frameless lenses were specified to bring efficient, prismatically-controlled illumination to the new Gateway East and Gateway West buildings in Los Angeles. These 14-story twin office buildings mark the first stage of Century City,

a monumental development which will eventually include more than six million square feet of office buildings and extensive apartment, shopping and recreation facilities.

At Century City, as in hundreds of new buildings throughout the country, Holophane frameless lenses provide lighting of optical excellence, low brightness and high output. The precision-engineered prismatic structure of the lens gathers and redirects light to provide comfortable, glare-free illumination. And there are no lamp streaks at usual angles of view. High pressure injection molding and rigid quality control guarantee the uniformity and accuracy of each Holophane lens. One-piece design is clean-lined and trim. There are no visible latches or hinges.

For complete information about Holophane's extensive line of frameless lenses, write: Dept. G-3, Holophane Company, Inc., 1120 Avenue of the Americas, New York, N.Y. 10036.

Architect: Welton Becket and Associates

Luminaires by Columbia Lighting

Owner: Aluminum Company of America

Frameless Controlens<sup>®</sup> by **HOLOPHANE**

On Readers' Service Card, circle No. 424

# OVER 100 AC SWITCHES TO CHOOSE FROM

SPECIFICATION GRADE  
**TOGGLE SWITCHES**  
15, 20 and 30 Ampere



Toggle



Lock-Type

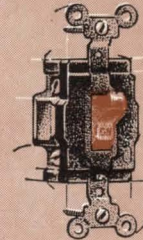

Toggle

SPECIFICATION GRADE  
**PRESSWITCH®**  
SWITCHES  
15 and 20 Ampere

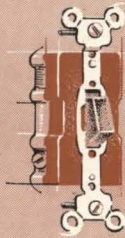

Ivory Button



Lighted Button  
(Button lights in  
"OFF" position)



Red Pilot Light Button  
(Button lights in  
"ON" position)

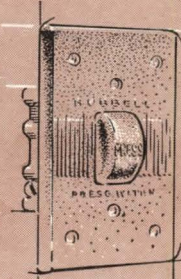

Combination of  
PRESSWITCH and  
weatherproof  
Hypalon plate

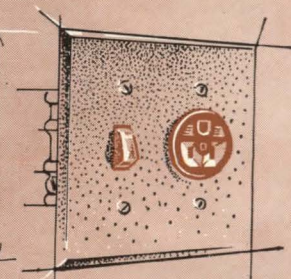

Combination of plate,  
pilot light PRESSWITCH  
and grounding outlet

SPECIFICATION GRADE  
**HUBBELLETTE®**  
INTERCHANGEABLE SWITCHES  
15 and 20 Ampere



Screw Terminals



Screwless Terminals

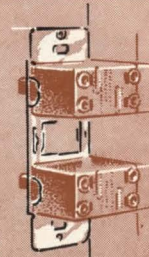

Three fit one strap  
in standard boxes

SPECIFICATION GRADE  
TWO-CIRCUIT  
**MOMENTARY CONTACT**  
SWITCHES  
15 and 20 Ampere



Toggle



Lock-Type

SPECIFICATION  
GRADE  
**MAINTAINED  
CONTACT**  
SWITCHES  
15 and 20 Ampere  
(Double throw,  
center off)



Toggle



Lock-Type

SHALLOW  
INTERMEDIATE GRADE  
**PACEMAKER®**  
SWITCHES  
15 and 20 Ampere



Ultra-shallow  
Toggle



Lock-Type



STANDARD GRADE  
**PACEMAKER JR.**  
STRAP-TYPE SWITCHES  
15 Ampere



Screw Terminals



Screwless  
Terminals

The cost of replacing "or equal" switches  
is your soundest reason for installing

# HUBBELL AC SWITCHES

You have more than 100 AC Switches to choose from in the Hubbell line. It includes switches for every possible application and budget.

Hubbell specification grade switches are the sturdiest that money can buy. In fact, our intermediate and even standard grade types have more quality built into them than many so-called specification grade products.

So, if your application requires good, better, or best . . . Hubbell has the right switch for your job, *engineered* and built to operate with complete reliability. To contractors this means freedom from profit-eating call-backs. To users, it means protection from work stoppages and needless labor costs for replacing switches that fail in service.

The chart at your left is a digest of the basic categories of AC switches available from Hubbell distributors. Each group comes in several ratings and types.

Your local Hubbell representative or franchised distributor will give you specifying information. Available for ready reference is our brochure "Hubbell AC Switches." Write for your copy today.

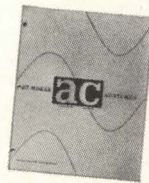

## These Design Refinements Mean Faster Wiring . . . Faultless Performance

Hubbell binding screws have extra-deep slots and 20% wider heads for faster installation.



On the underside of screwheads, annular ring, above right, penetrates oxide on wires for better contact.

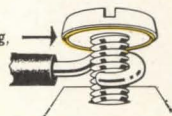

Long lasting silver cadmium contacts.



For speed and ease of installation, our specification grade AC Switches provide for back or side wiring.

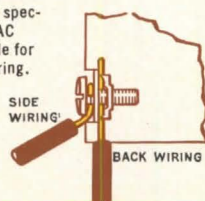

Patented feed-thru terminal provided on single pole "Presswitch" Switches saves time and splicing.

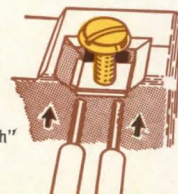

Only  $2\frac{1}{2}$ " deep, our "Pacemaker" AC Switches free more inner space for wiring, even in 2" boxes.



Convenient strip gage, molded in housing of switch, indicates proper length of insulation to be removed from conductors.

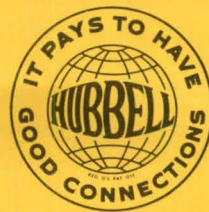

HARVEY  
**HUBBELL**  
INCORPORATED

Bridgeport, Connecticut  
In Canada: Ajax, Ontario



# Want carefree elegance design them with FORMICA®



Colors and patterns of FORMICA® laminate: Feature wall, Paldao, 351, and White, 949. Background walls: French Blue, 928. Furniture: White and Paldao. Concord Blue, 853.

FORMICA® brand laminated plastic surfacing is timeless . . . a material compatible with functional interiors of every mood. The decorative qualities of FORMICA® laminated plastic are legion. The solid color line is long . . . woodgrain selection ranges from restrained to exotic . . . and special screened prints can individualize a room that will spark appreciation in the eyes of every visitor.

Reception areas, lobbies, and offices can be outstandingly impressive when FORMICA® laminated plastic is used creatively. Results are admirable, whether in vast vertical reaches of paneling, custom furniture, or doors that can color accent individual offices. The realities of maintenance are subdued: over the years FORMICA®

# for reception areas? laminated plastic surfaces



Your Formica  
representative  
is ready  
to serve you.

He has the complete story of the versatility of FORMICA® brand products in commercial and institutional buildings. A good man to know, he will be happy to provide samples, estimates, literature, and spec information.

Free brochure...

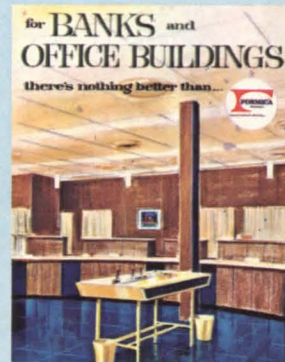

describes how FORMICA® laminate surfaces keep all office areas beautiful... from lobby to executive suite. Design, application, and maintenance information are included. Ask your Formica representative for a copy, or write Dept. MP-10.

lamine is the one surfacing material that will stay beautiful, while offering the owner the satisfaction of installations that require no additional expense... no painting or refinishing.

Go ahead... express your distinctive good taste... you'll please clients and the public for years to come. For additional information on FORMICA® laminated plastic, see our catalog in Sweet's Architectural File,  $\frac{22b}{Fo}$ , or call your Formica representative.

**Leadership through innovation • FORMICA CORPORATION**  
CINCINNATI, OHIO 45232 subsidiary of **CYANAMID**

FORMICA® is our brand name for laminated plastic, wall paneling, toilet compartments, industrial plastic, adhesives and flakeboard.

**FORMICA**  
BRAND  
products





# Jim can be conned

Into writing up your paint specs  
from Alkyds to Zinc.

Into mixing you a custom batch.

Into showing your painters the  
fine art of putting on epoxies.

Jim can be conned.

But he knows you can't be.

Which is why he won't specify  
three coats for a two-coat job.

Or vice versa.

Which is why he'll tell you  
exactly what a glaze coating can do.

And what it can't.

Which is why he doesn't waste  
your time with sweet talk—when  
you want facts.

That's our Jim. And Hank.  
And Larry.

And every man at Devoe.

They know which side their  
bread is painted on.

You can depend on  
the **Man from Devoe.**



**DEVOE**

A MEMBER OF THE CELANESE GROUP

We always look at both sides of a problem. Front and back. Anyway you look at it, Myrtle Desk's 900 Series is an exciting step into the contemporary world of designs for business. The crisp, clean lines are boldly defined by the shining severity

of mirror chrome legs and distinctive pulls. Through the skills of Myrtle Desk craftsmen, the mellow richness of hand rubbed genuine Walnut reveals its own beauty. □ The 900-Series is sheer impressiveness — executive desks, secretarial group

Why does Myrtle Desk's new design  
always back you up so beautifully?

We work at it.

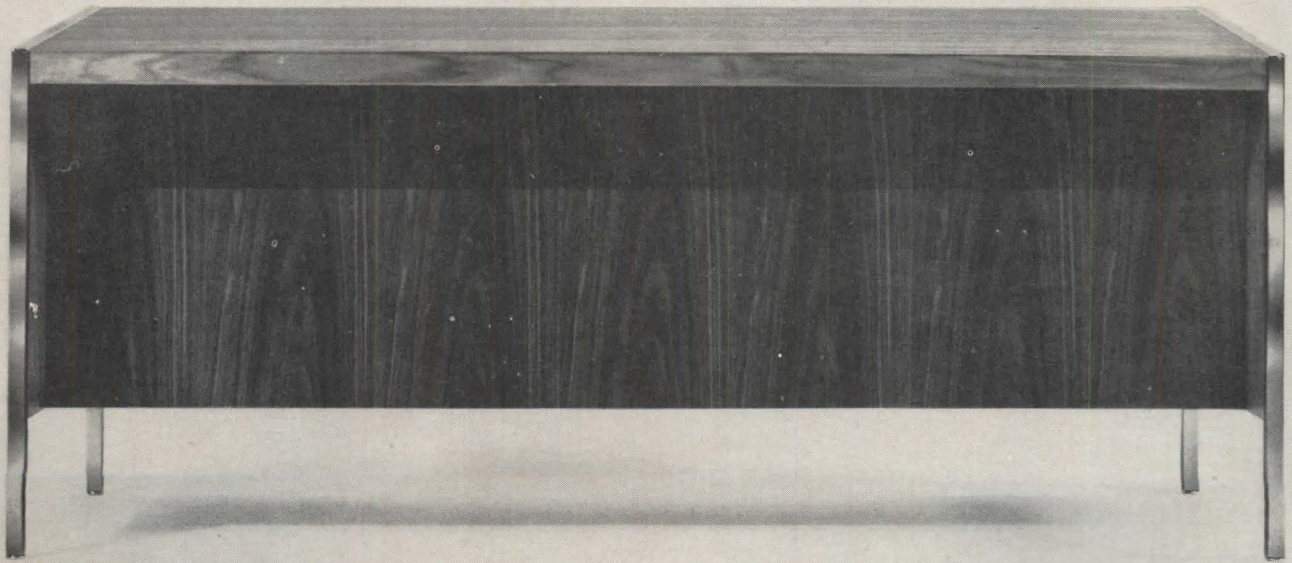

ings, and credenza-type service units that are as limitless in arrangement as your imagination. Correlated seating pieces, too. Options in the series include flush drawer fronts without pulls; matching textured plastic tops □ How can this totally

fresh design concept back up your plans for today's forward thinking offices? There's more information waiting for your inquiry: write to Myrtle Desk, Dept. P36, High Point, N. Carolina.

**MYRTLE  
DESK!**

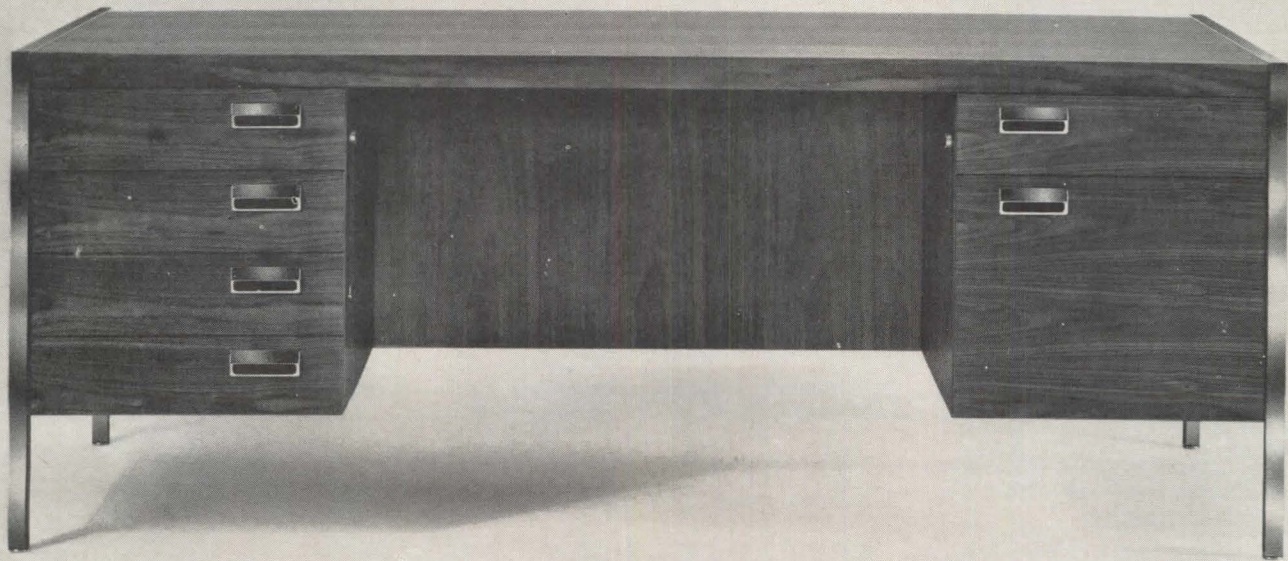

# KINNEAR

New architectural dimension . . . for modern buildings of all types

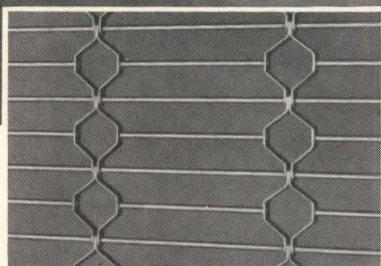

HexArt

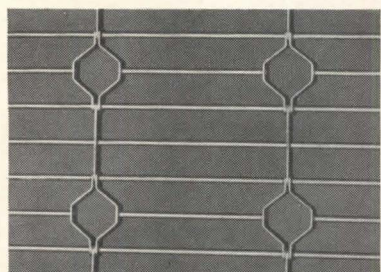

HexLinc

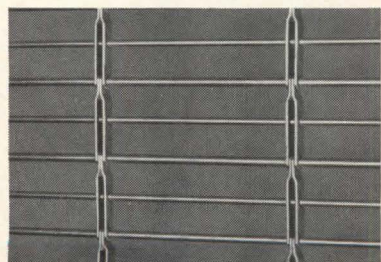

LincArt



Write TODAY  
for copy of this  
new grille catalog.

## ROLLING GRILLES

Functional Design in a selection of patterns . . .

. . . and their 9" maximum spacing of vertical links provide the strongest grille on the market. That's why more Building Designers—from coast to coast—are using and prefer Kinnear Rolling Grilles. They offer today's most efficient way to barricade an opening without the sacrifice of air, light or vision—in an architecturally attractive manner. But even more important, Kinnear Grille designs offer the right degree of strength and protection needed for extra wide retail arcade store fronts (like 60 ft. span shown) or for a school corridor where its purpose is to prevent public traffic in a restricted area. They are frequently installed in industrial buildings in conjunction with Rolling Doors, thus blocking trespassers when the door is open in mild weather. Their application is unlimited! By coiling UP and out of sight, Kinnear Grilles take no usable floor or wall space. They are inherently well designed for electric motor operation when maximum efficiency is wanted.

Built in any size required and in steel, aluminum or stainless steel, Kinnear Rolling Grilles deserve consideration for many of your projects. And when you specify KINNEAR, you're assured of quality design and construction backed by a nation-wide service organization.

Also manufacturers of Rolling Doors, Power Operators, Automatic Rolling Fire Doors and Shutters, Rolling Counter Shutters and RoL-TOP (overhead type) Wood or Metal Doors.

## KINNEAR<sup>®</sup>

Saving Ways in Doorways  
SINCE 1895

The KINNEAR Manufacturing Co.  
and Subsidiaries

1906-20 Fields Ave., Columbus, Ohio 43216  
FACTORIES: Columbus, Ohio 43216  
San Francisco, Calif. 94124 • Toronto, Ont., Canada



Offices & Representatives in All Principal Cities—listed in Yellow Pages under "Doors." Also see Sweet's!

**Color integrity's  
locked in,**



# when you specify new DU-LITE\*

\*DU-LITE is Du Pont's registered trademark for its fluoropolymer enamel.

At Du Pont, we define color integrity precisely: a color change of less than five National Bureau of Standards units through eight years of exposure to the elements.

That's what we lock into new DU-LITE fluoropolymer enamel. DU-LITE is available precoated on steel or aluminum. Ask your mill, coil coater, or building panel manufacturer about availability.

Put your finger on color integrity: Remember DU-LITE when you specify color enamel on prefinished metal exposed to the weather. It's your assurance from Du Pont.

E. I. du Pont de Nemours & Co. (Inc.)  
Coil Coating Sales  
308 E. Lancaster Ave., Wynnewood, Pennsylvania 19096  
Send DU-LITE color samples and specifications.

Name \_\_\_\_\_  
Company \_\_\_\_\_  
Address \_\_\_\_\_  
City \_\_\_\_\_ State \_\_\_\_\_ Zip \_\_\_\_\_

Erosion rate of DU-LITE vs. other exterior finishes equated with weight loss over a period of time in accelerated weatherometer.

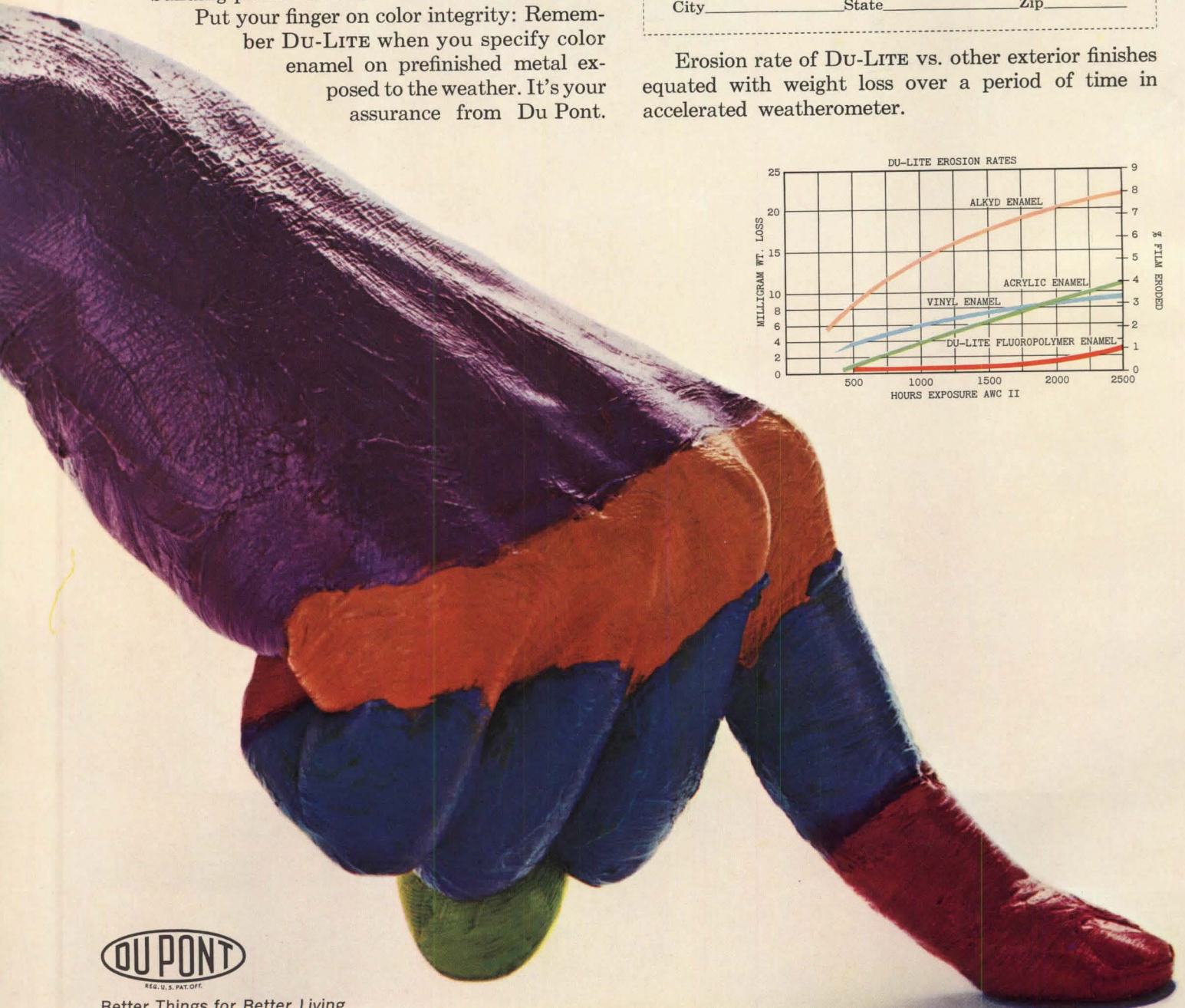
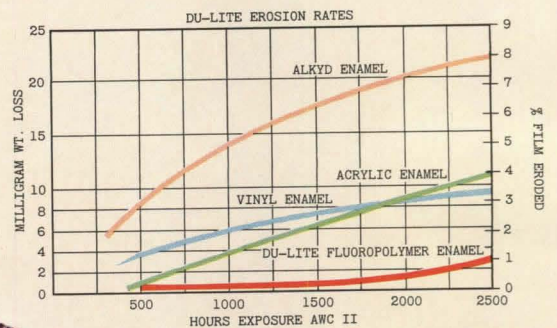

Better Things for Better Living  
...through Chemistry

# NEWS REPORT

*Architecture's Monthly News Digest of Buildings and Projects, Personalities, New Products*

## Expo '67: Japan and Russia Enter

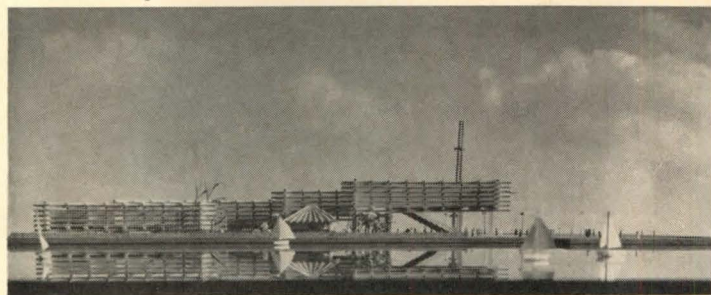

1

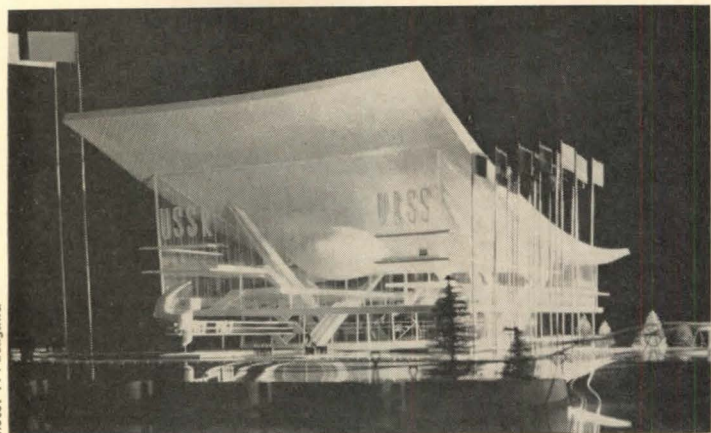

2

Photo: Y. Futagawa

MONTREAL, CANADA Work on the site of Expo '67 is proceeding at a steady pace in preparation for the opening of the next world's fair a year from this April. Shown here are models of the Japanese (1) and U.S.S.R. (2) pavilions. Both are scheduled for completion this fall.

The Japanese contribution, designed by Tokyo architect Yoshinobu Ashihara, will use Japanese-manufactured pre-stressed concrete beams for quick assembly and dismantlement.

The Soviet pavilion, designed by R. R. Kliks, A. A. Mndoyants and A. N. Kondratiev, of Moscow, will be a large, pre-fabricated structure (which reportedly will use enough steel

to build a 30-story building) containing a 600-seat theater, restaurants, bars, and exhibit areas. A key attraction should be "Cosmos Hall," where visitors will be invited to experience the sense of weightlessness, a sort of do-it-yourself space-feel. The U.S. pavilion (see pp. 56-58, NOVEMBER 1965 P/A) will also feature space exploration. The two pavilions share a remarkable similarity of concept and presentation. In the U.S.S.R. pavilion, exhibits are set on a series of suspended levels, much like those to be used in the U.S.'s, Buckminster Fuller-TAC, transparently covered geodesic dome. And, as luck would have it, the two pavilions will face each other.

## McCue Becomes Chairman at Berkeley

BERKELEY, CALIF. Gerald M. McCue, 37, a Berkeley architect and, since 1954, a member of the University of California faculty, has been named chairman of the Department of Architecture there. McCue's

firm, Gerald M. McCue & Associates, is known primarily for its design of research facilities. Among their projects are the 88" cyclotron building at the University of California's Lawrence Radiation Labora-

tory in Berkeley, the Chevron Research Laboratories and Stauffer Research Center in Richmond Calif., and the Dow Chemical Company Research Center in Walnut Creek, California. McCue and his firm are currently project architects for the Bay Area Rapid Transit District subway stations in Oakland.

McCue takes over a department of 900 students, said to be "the largest department of architecture in the English-speaking world." In announcing the appointment, Dean Martin Meyerson said: "Professor McCue has the imagination and administrative talent to lead the department in the period ahead when a new focus is being developed. This means the aesthetic orientation of architecture must be wedded to an intellectual one as well. In the process, the department must develop the closest ties with other fields in technology, the humanities, and the social and natural sciences." What

Meyerson was referring to is a revision of Berkeley's architectural curriculum, to take effect in the fall. Instead of a five-year program, the department will offer one that runs four years plus two. First three years will include heavy dollops of liberal arts courses.



The fourth will concentrate on structure and design. Following the fourth year, a B.A. will probably be awarded; and at the end of two more, which will concentrate on advanced structure and design, an M.A. will be granted.

## Chandelier for Seattle

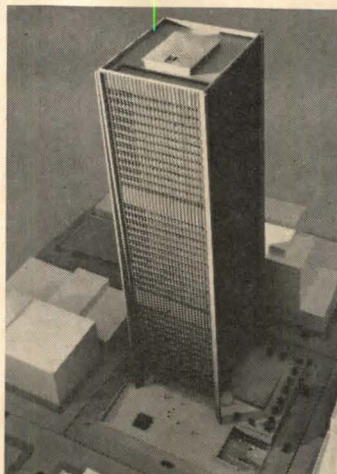

SEATTLE, WASH. "At night, with its illuminated plaza, it will become Seattle's chandelier," Pietro Belluschi, consulting architect for the headquarters building of the Seattle First National Bank, is quoted as saying. Whether or not it becomes a chandelier, the \$28-million building, scheduled to get under way in August, will



radically alter Seattle's skyline. At 50 stories, it will be Seattle's second-tallest building, topped only by the San Francisco Bank building now going up on an adjacent site. More than that, it will add a distinctive contemporary architectural note to a skyline almost devoid of highlights.

Architects Naramore, Bain, Brady & Johanson's design calls for a rectangular tower



## I use DURCON® sinks... year after year after year

And I think they're wonderful. They are corrosion resistant, look good, and are so easy to keep clean. I pour almost everything into DURCON sinks; acids, alkalis, salts and solvents. They don't corrode; nor do they chip or crack. I'm glad we have DURCON sinks in our laboratories.

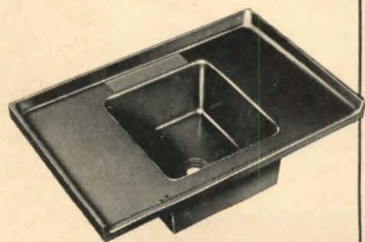

THE DURIRON COMPANY, INC. DAYTON, OHIO







supported at the corners by four Y-shaped columns, tapering from an 18' width at ground level to a 4' width at the top, and running the equivalent of three stories below ground for maximum earthquake resistance. A core cluster of 36 steel columns provides central support.

On its façade, the building will have bronze-tinted aluminum mullions and bronze-tinted windows. About two thirds of the site, which takes in an

entire city block, will be an open plaza (built up at one end to level the sloping site), landscaped with trees, shrubs, fountains, and reflecting pools. On the lower edge of the sloping site will be a 32'-high, glass-enclosed lobby. Parking on three levels will accommodate 600 cars. The top story will contain a public restaurant and observation lounge with a view rivaling that of the Space Needle. The roof will house a heliport.

## Brainstorming the Roosevelt Memorial

WASHINGTON, D.C. Tucked away in President Johnson's current budget message is an appropriation of \$50,000 for the design of a memorial to Franklin D. Roosevelt. The original competition-winning design, by Pedersen, Tilney, Hoberman, Wasserman, Beer, founded

on the rocks of controversy thrown up by the Roosevelt family (see p. 59, AUGUST 1964 P/A). Now, according to Rep. Eugene J. Keogh, a design will be determined by "sounding out" 10 to 15 leading architects, and using a compilation of their ideas.

## Look What the Stork Left

NEW YORK, N.Y. The days of the Stork Club (1934-1965) are over. The famous watering spot and haven for café society, writers and starlets, has closed its doors, the land sold from under it to be turned into a park. From the 30's to the late 50's, this was, as frequenter Walter Winchell put it, "the Newyorkiest place in town." Here Grace Kelly announced her engagement to Prince Rainer; Hemingway and Louis Untermeyer had their famous fist fight (Untermeyer accused Hemingway of not having hair on his chest, so Hemingway took off his shirt and poked him); here Ethel Merman had her own waiter/whose sole duty it was to light her cigarettes. Dorothy Lamour, J. Edgar Hoover, the Duke of Windsor, Al Jolson,

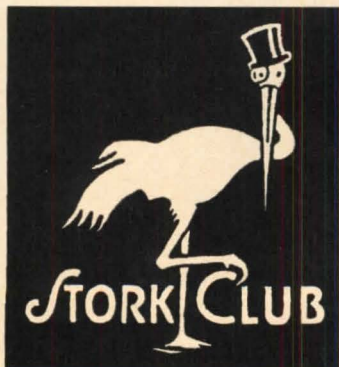

Brenda Frazier, Tallulah Bankhead, Tommy Manville—they all enjoyed the glamour of the club and the favors of its owner, one-time bootlegger and Leavenworth resident, Sherman ("Sherm") Billingsley.

During the heyday of the Stork Club, Billingsley catered to these celebrities, who brought in the dollar-bearing

tourists the way chimpanzees at zoos bring in kids with peanuts. Those he liked or needed were rewarded. And gifts of flowers, perfume, vintage champagne—even cars (some two dozen were given away during his reign)—were not unusual tokens of his esteem. Those who crossed him were treated accordingly. The most famous banishment was that

Plaza, after Paley's father, will be the first vest pocket park in midtown Manhattan.

The 42'x100' park, designed by the New York firm of Zion and Breen Associated (Robert Zion, partner-in-charge), will have 24 full-grown locust trees spaced at 10' intervals and leading back to a high "water wall" in the rear. This miniature waterfall will have water



of Humphrey Bogart, who had the distinction of being the only man on record to say "You stink" to Sherm's face.

Today, the names and faces that made the Stork Club what it was have gone away or grown old. And the peculiar mixture of extravaganza and frivolity that was the Stork Club's stock in trade is no longer wanted. When it was forced to close its doors last October, the club announced it would relocate. No one really believes it will.

The club is now within days of being completely demolished. The land that once sported the frenzied energy of café society will become a place of comfort and rest for the footsore and weary. CBS Chairman William S. Paley has set up the Greenpark Foundation to finance and maintain the park. The park, to be known as the Samuel Paley

running continually over jagged, exposed aggregate—a soothing respite to the cacophony of New York streets. Arches and mirrored paneling will be used on the side walls to increase the spaciousness of this tiny retreat. The park will also have a Philip Johnson-designed refreshment stand. Individual chairs, the steps, and low side walls will provide the seating for those who wish to linger. Paley hopes that, in the future, occasional concerts and art exhibits can be held here.

The cost of this project, which has been "set aside for the enjoyment of the people of New York," is estimated at \$1 million, with three-fourths of the money going for the purchase of the land. By June or July of this year, the park should be functioning on a full-time (8 A.M. to 10 P.M.) schedule.

## Mass Transit Gloria Mundi

NEW YORK, N.Y. "We're trying out the Los Angeles method of transportation in New York," said New York architect William Conklin, speaking at P/A's 13th Annual Design Awards luncheon in Los Angeles. And although Conklin's jest drew a well-deserved laugh from his West Coast audience, it would probably not have fared so well in New York.

By January 10, the day of the luncheon, New York was in its second week of the 12-day mass transit strike, and tempers were growing short. Probably never before had it been so apparent how dependent today's crowded urban centers are on mass transportation. Thus deprived, New York came almost to a standstill, its streets clogged with cars inch-

ing through a 10-hour long rush hour, its sidewalks overflowing with mobs of trudging pedestrians, its business concerns losing an estimated \$50 million a day. Obviously, what New York does not need is Traffic Commissioner Henry Barnes' suggestion for more parking garages. (One proposal calls for spending \$34 million on them.) It is almost as if the automobile were a biological organism with a life of its own. Efforts to placate it, to make conditions more pleasant for it, only lead to its proliferation, the way rabbits multiply in a new cabbage patch.

New York's problems are, of course, magnified by the compact area of its Manhattan business districts. While a single subway track can bring 60,000 persons per hour into Manhattan from Brooklyn or the Bronx, a single lane of the Lincoln Tunnel can bring in only 8,700 cars and buses in the same time, and a single lane of the East River Drive, only 3,300 private cars. But the greater efficiency of mass transit holds equally true for other urban centers, and slowly, belatedly, some of them are

beginning to act on this truth. Seattle, Los Angeles, Washington D.C., Detroit, and Atlanta have ambitious studies underway. San Francisco is translating its study for the Bay Area Rapid Transit District into steel rails and sleek rapid-transit cars. And although the program is currently embroiled in a gigantic political morass, it will probably be successful.

The New York transit strike, like any urban crisis, had its bright moments, visible only from a poststrike perspective. In a Brooklyn warehouse district at the foot of the Brooklyn Bridge, for example, commuters parked their cars on the sidewalks, before walking into Manhattan, giving the area a narrow-streeted, no-sidewalk European look. And outside Pennsylvania Station, policemen hailed passing motorists, had them give rides to pedestrians headed in the same direction. "What kind of a car do you want?" a policeman asked a young woman coming out of the station. "A Cadillac," she replied. "What color?" he asked. "Blue." He got her a ride. The car was not a Cadillac, but it was blue.

Ray Tucker, with Jacob Robbins as Professional Advisor) commended Mittelstadt's solution for its visual strength and placement as a strong symbol of civic activity.

The architect's solution (below, left) would indeed

seem a strong enough building for a city that is yearning for symbols of action and power. But in a design that seems so blatantly a pastiche of Rudolphian, Corbusian, and Wrightian forms, one wonders about this city's individuality.

## Olympic Facilities for Munich?

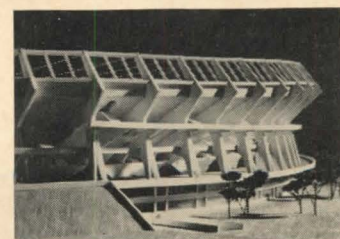
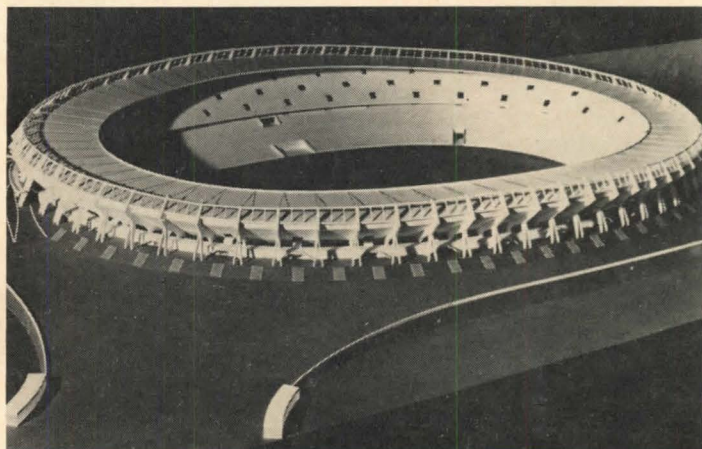
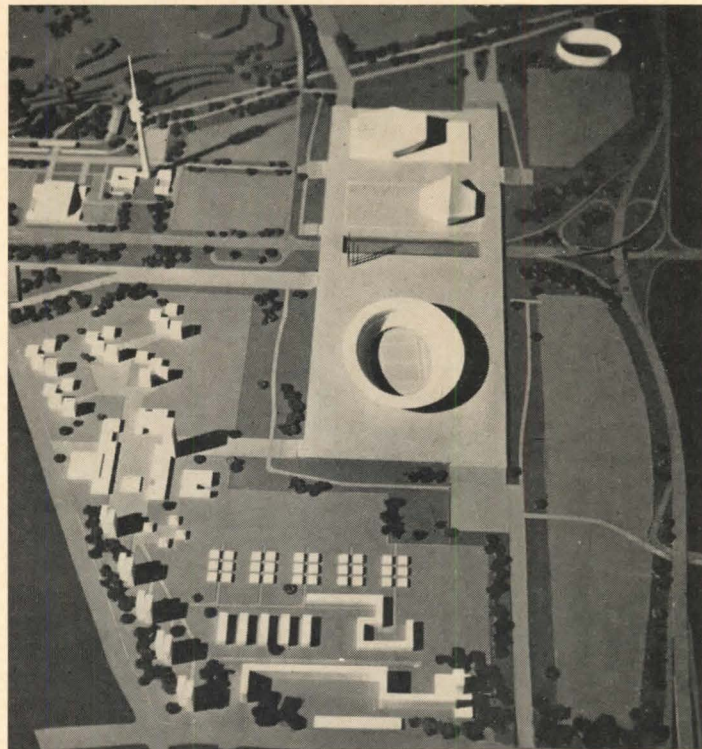

## FREMONT GETS A CITY HALL

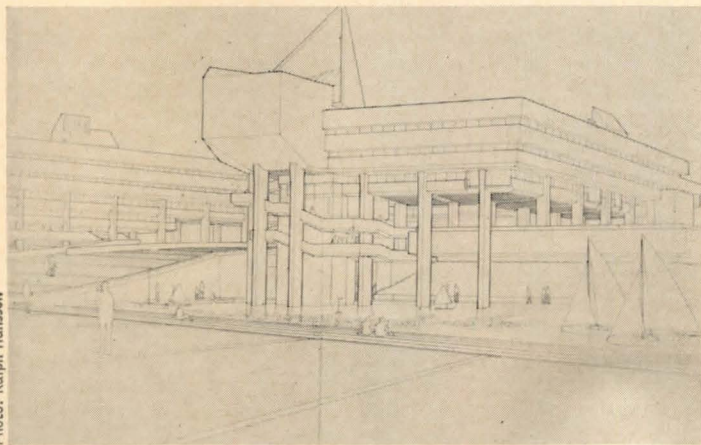

Photo: Ralph Hansson

FREMONT, CALIF. The city of Fremont (population 90,000) has been looking for a city hall for all 10 years of her life. City officials did not take kindly to working in an old schoolhouse that had been condemned for educational purposes yet thought fit for governmental functions. But now things are looking up, and Fremont is getting a city hall.

In January of this year, the winner of the Fremont Civic-Cultural Competition was announced, and two weeks later the City Council unanimously approved the design of the building that will house the

City Hall, the Hall of Justice, and other governmental offices on the 70-acre, water-bound civic center site. Winner out of a field of 66 entries is Robert J. Mittelstadt of Racine, Wisc. The 31-year old Mittelstadt, who graduated from Yale in 1964, then captured the Prix de Rome fellowship for the following year, has worked in the offices of Harry Weese, Eero Saarinen & Associates, Paul Rudolph, and is now associated with The Architects Collaborative in Rome.

The jury (made up of Pietro Belluschi, Paul Rudolph, John Merrill, Lawrence Halprin, and

MUNICH, WEST GERMANY Munich hopes to host the 1972 Olympics. To back its application to the International Olympic Committee, the city plans to enlarge its sports facilities and the surrounding parking area. This will cost about \$139 million, with approximately \$20 million going for a circular stadium capable of seating close to 100,000. To be built on the former airfield, Oberwiesenfeld, the area would provide parking for 10,000 cars. The model of the proposed area shows the Olympic Vil-

lage housing in the foreground. Behind it, to the right, are the stadium and two halls. Behind these, at the upper right, will be a cycling stadium. And to the left, a radio tower and an ice-skating hall.

Photos: D. P. A. Pictorial

# It's Not Sleepy Time Down South

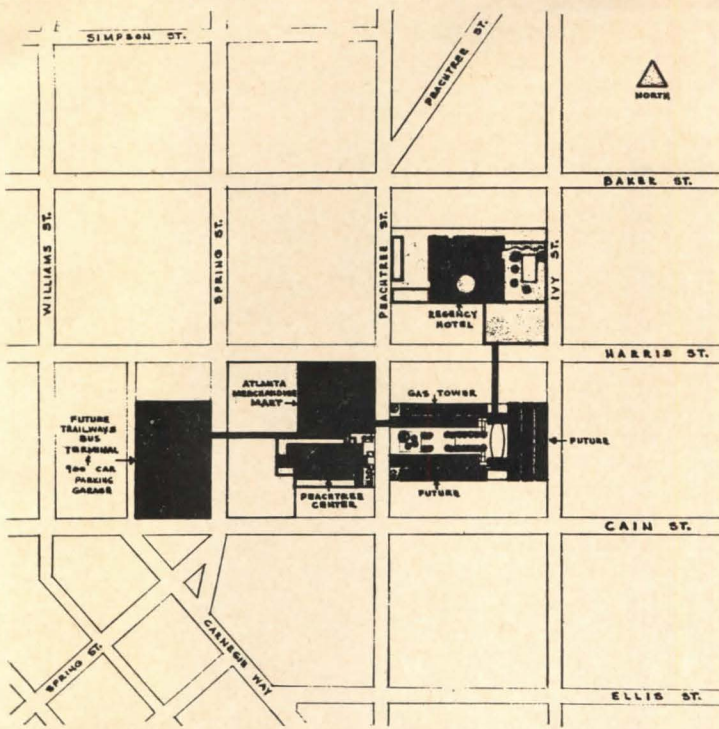

3



2

ATLANTA, GA. With the construction of a sizeable new baseball stadium (see P/A OBSERVER), Atlanta is on the verge of acquiring a National League baseball team and the Big Time status that goes with it. In the eyes of many, however, Atlanta has been Big League for some time. While many other urban centers have lost initiative and vitality to outlying areas, Atlanta, with the help of a group of young, concerned business leaders, has

managed to maintain a relatively flourishing downtown area, with a solid tax base. This vitality has grown considerably in the past few months, and an outside observer cannot help but feel that downtown Atlanta, now in the midst of a bold building boom, has prosperity, and perhaps even architectural distinction in its future.

With the building boom has come an awareness of good design. Several years ago, two downtown department stores—Rich's and Davison's—with the aid of pedestrian bridges across downtown streets, expanded their facilities. Rich's built an annex and connected it to the original store by a pedestrian bridge. Davison's did the same with a parking facility. Neither of these bridges was particularly handsome, and when architect-developer John Portman announced plans for a pedestrian bridge to link his Peachtree Center tower (1) with his Trailways bus terminal now under construction, controversy bloomed. In the

course of it, the combatants discovered that Portman also had plans to connect his Gas Tower building (2), now under construction, with the Merchandise Mart, across Peachtree Street, the main thoroughfare, as sacred in Atlanta as the Champs Elysée is in Paris, and immediately the controversy had a focus. For a while, Atlanta's alderman considered an ordinance that would establish guidelines for overhead bridges. Writing in the *Atlanta Journal*, James H. Finch, a former president of the North Georgia Chapter, AIA, said: "I object to the private bridge solution for the following reasons:

"First, Franklin Garrett, Atlanta historian, contends that our chaotic street pattern is the result of ill-advised granting of permits for new streets by early officials. These unfortunate decisions were based on official whim or pressure from powerful individuals or organizations. These influences still affect our planning and regulatory agencies. It would be regrettable if we compounded our disastrous street situation with an equally bad system of bridges.

"Second, if bridges are permitted to some, in fairness, it would be necessary to allow all to bridge. If we have numbers of bridges, past performance indicates that there will be many more ugly than handsome. We have enough ugly in Atlanta."

However, Paul Muldawer, chairman of the AIA chapter's Urban Design Committee, took this position in the *Journal*: "It is the opinion of the Urban Design Committee of the AIA, North Georgia chapter, that pedestrian bridges perform an important function in Atlanta's central business district and are vital to the city growth. . . . Pedestrian bridges allow downtown business facilities to expand beyond limiting street boundaries. If Rich's could not have expanded their downtown store by pedestrian bridge, they might have had to move to the suburbs. . . . Pedestrian bridges can give scale and identity to an area. . . . From below, pedestrian bridges can frame a view similar to looking through a colonnade. . . . We should all be alert to see that the city administration be extremely careful not to pass ordinances that may possibly set dangerous precedents which could inhibit or retard the growth of the central business district."

And the *Atlanta Constitution*, in an editorial entitled "Peachtree Street: Ribbons in Her Hair?" had pointed out earlier: "Atlanta's aldermen are considering an ordinance that would establish rules for overhead bridges. Such proposals as establishing a minimum height above the street and paying the city for the air rights are sensible. But the ordinance should not be too specific about design details, since these should depend on the site and the buildings involved. We approve of a suggestion for having a nonpolitical rotating panel of professionals pass on proposed bridge designs on an individual basis."

To an extent, the furor has subsided. Portman is building one bridge (3), from the Trailways bus terminal to the Merchandise Mart, and plans a short connecting pedestrian bridge from the Peachtree Center tower to the Mart next door. The aldermen have passed no restricting ordinance. But if Atlanta was not too conscious of aesthetics before, she now shows signs of a growing awareness. The mayor has formed a committee to review Atlanta's entire downtown area. And the Peachtree Center Association, composed of the largest investors in the area, brought in Hideo Sasaki, Dawson, Demay Associates, Inc. of Boston to design landscaping for an eight-block downtown area. It looks as if Atlanta, unlike many cities throughout the country, is not content to wait until it is too late to take action.

## Slowly I Turn...

NIAGARA FALLS, ONTARIO An old vaudeville routine, still seen occasionally on TV, has the straight man saying something to the comic about Niagara Falls. The words seem to trigger a complex change in the comic, transforming him into a monster bent on revenge. His eyelids droop, his hands become talons; he raises his arms and stalks the straight man, saying ominously, "Slowly I turn . . ."

Slowly turning 500' above Niagara Falls is a circular restaurant set on tapered concrete legs, in the tradition of Seattle's Space Needle. Completed recently, it is the fourth observation tower at the Falls and the third on the Canadian

side. It is also the tallest. Its three legs taper from a width of 37' at ground level to 17' just before they flare to meet the circular observation platform-restaurant. Engineers Farkas, Barron & Jablonsky devised a method of slip-form-



Photo: Bregman & Hamann, Architects and Engineers

ing these tapering legs. What they did was design adjustable sides on the forms, controlled by a series of lock nuts. As the forms slid upwards, pulled by hydraulic jacks on steel rods, the nuts were tightened and the excess slip forms trimmed off. Rising at the rate of 1" every 10 minutes, the forms allowed completion of the legs in 40 days. Three outside elevators rise from the two-story exhibition-center base, riding between the legs into the observation deck. According to architects Bregman & Hamann of Toronto who designed the Niagara International Center, as it is called, an average of 200 persons can eat in the restaurant at one time. The restaurant makes one

complete revolution each hour, but the kitchen, located in the core, does not. Waitresses find their moving customers with the aid of color-coded table and chairs.

## How Trivial Can You Get?

Evidently Trivia (see p. 52, JANUARY 1966 P/A) is played with as much zest in drafting rooms around the country as it is in the P/A editorial offices—and with greater accuracy. In response to our list of movies whose main characters were architects and the names of actors who played them, we were reminded that William Holden, not Barry Nelson, played the architect in the movie version of *The Moon Is Blue*. Correspondents also remembered that Henry Fonda was an architect in *Twelve Angry Men*.

Leslie R. Center, Jr., of Houston, wrote that the comic strip *Mickey Finn* currently has an architect in it. But that's a wholly different category: architects in comic strips. We can't think of any others. Can you?

## Or Would You Rather Swing in a Crane?

NEWARK, N.J. After any major strike where the union members have obtained a significant wage increase, you hear talk in the drafting room, or at cocktail parties, that goes something like this: "Why are we wasting our time designing buildings when we could be making more money laying bricks." Announced here recently was a three-year contract signed by Local 825 of the Operating Engineers (Crane Operators) Union, A.F.L.-C.I.O. It provides top wages of \$7.75 an hour for large-crane operators, which is \$16,120 a year based on a 40-hour week. Apprentices will get only \$4.55 an hour, or \$9464 a year. Of course, crane operators do not work all year. "Our employment is seasonal," says Peter W. Weber, president of Local 825, "and we are fortunate if we work four months of the year. Under the circumstances, a man has to make a decent wage." It looks as if, in New Jersey, they're well on their way.

## A Bang-Up Job

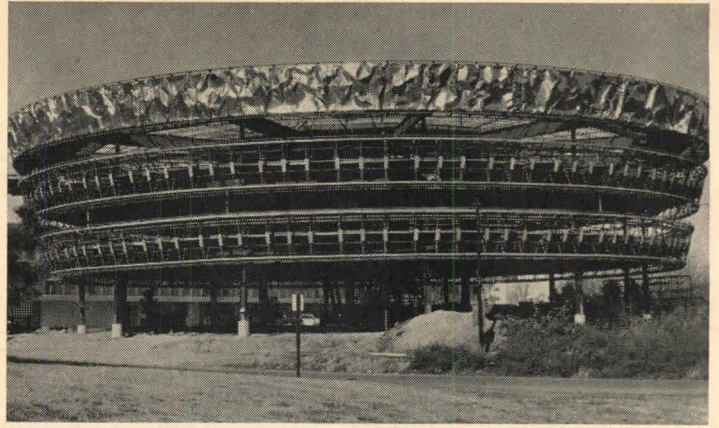

RICHMOND, VA. Shown at right is architect Haigh Jamgochian of this city, hard at work on his circular office building for Markel Service, Inc. The three-story structure, to be completed in the spring, has 700' of continuous aluminum siding wrapped like Indian headbands around each story. Jamgochian dents the siding with a sledgehammer while workmen on the inside secure it with screw nails at top and bottom. The reason behind all this is, as Jamgochian puts it, "to achieve a free-form, textured pattern while staying within the budget of the project." Where conventional paneling would have cost the owner \$50,000, the continuous roll, with dents, cost only \$10,000 (a sum equally divided between labor and materials). The architect also found that, because of its light weight—less than 1 lb per sq ft—this roll-on, bang-up siding saved structural steel work. The stiffness gained from folds of the texturing made undercoating the aluminum unnecessary. The speed with which the building can be enclosed—3' a



Photos: Tom Howard, Richmond Times-Dispatch

minute—also contributes to its economy. What is more, the dents and wrinkles have a structural purpose: They allow the aluminum to absorb the differences in expansion and contraction between itself and the structure.

Architect Jamgochian is still not sure of other uses for his siding technique. But he is pleased with this trial run: "The spandrels on this building are as natural-looking as the side of a mountain cliff." And they would be, if mountains were made of aluminum.

## \$6 Million Adds Up to 287,000-sq-ft Math Building

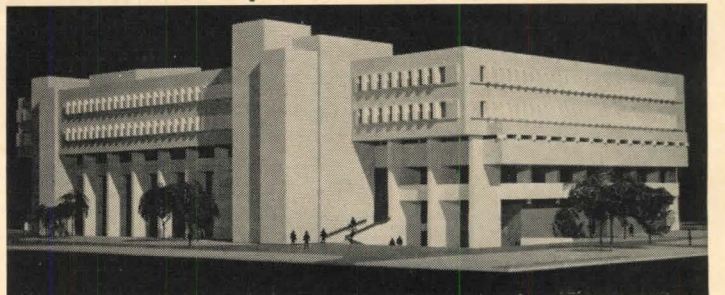

Photo: Webb, Zerafa, Menkes & Matthews, Architects

WATERLOO, ONTARIO On the lower floor, behind its strong vertical structural elements, the Mathematics and Computer building for the University of Waterloo will house computer areas. Architects

Webb, Zerafa, Menkes & Matthews designed these lower elements to reflect the large scale of the floor areas inside. This scale is reduced on the façade of the intermediate floors, which hold assembly areas and

large classrooms, by the addition of broad spandrels. And on the upper two floors of the six-story structure, the small interior offices and study areas are expressed by an enclosed frame and by digital, heavy-block sunscreens. Four strong vertical service and circulation

cores break up what might otherwise be an overly repetitive façade, and at the same time tie upper and lower levels together visually. Exterior precast panels will be used extensively as permanent forms for the poured concrete frame. Construction begins this spring.

Line is an indication of what could be done in the U.S. Similar trains, travelling at 100 mph, will soon be connecting Boston, New York, and Washington, D.C.

Wheels or tires running on rails will probably dominate the rapid transit of the immediate future, but there were tantalizing hints of "far-out" ways of getting around.

MIT has been doing research on an air-cushion type of transportation. But Professor Miller of MIT sounded a rather discouraging, yet probably realistic, note. "Transportation is not receptive to change," he said. "Therefore, technology is not rushing in to develop the industry."

However, Westinghouse's new Skybus — automated, rubber-tired cars running on elevated tracks—was taking visitors around a two-mile track at South Park outside Pittsburgh. (See photo; P/A will publish a feature article on the system next month.) And an ancillary display by Teletrans, a company promoting automated, four-passenger tube cars with electromagnetic drive, showed a system that has been proposed for Detroit.

By way of a final flourish, Carnegie Tech announced the establishment of a Transportation Research Institute, which will be available to do research for just about anyone who needs it. It will also develop a transportation program at the graduate level. The staff will include representatives from the department of architecture.

At the end of the two-and-a-half day conference, one nameless gentlemen kept repeating, "But who cares if you can move X number of people from A to B in Y time? Who cares?" We hope not too many feel so very overwhelmed.

Although self-interest on the part of Pittsburgh industry (U.S. Steel, Westinghouse, Alcoa, etc.) and the Chamber of Commerce (which sponsored the conference) was evident, the Golden Triangle City, long recognized for its interest in urban renewal, deserves a plaudit for giving a boost to transportation renewal.

The delegates went home not so much wiser in solutions, perhaps, but hopefully more aware of pitfalls and possibilities. And determined, we assume, to wean us from our cars.

## Getting There Is Not Half the Fun

PITTSBURGH, PA. Setting the tone for the First International Conference on Urban Transportation, held here on February 1-3, was part of a luncheon benediction: "Bless us as we leave the city, and help us, O Lord, as we return."

An impressive roster of speakers from government, banking, industry, education,

planning was recognized as a must.

Megalopolitan centers urgently need revamping. It does not make much difference how renewed "downtown" may be if people cannot get to it from the suburbs, or move around in it after arriving. Charles Luckman, among others, suggested the "systems" approach



and architecture addressed almost 1300 attentive delegates looking for a way out of the traffic strangle.

Rapid transit (defined as public transportation on exclusive rights-of-way) held the spotlight. Problems were posed and suggestions made. What kind of system is best? How should it be financed? How about regional cooperation? Should public transit be free? What about labor and automation? Can't we get more out of what we have? And . . . how can the independent American be tempted out of his car and onto public transportation?

Several speakers said that the Federal Government should finance research and give aid to cities in trouble. Also, the Government should appoint a Secretary of Transportation to consolidate Government agencies whose functions now overlap. Cooperation between cities, counties, and states in regional

to integrated planning of cities and transportation. This approach to problem analysis, which has proven so successful in the areospace program, might be the answer for city/transit master planners.

In opting for rapid transit instead of more freeways, San Francisco leads the way toward better planning. The Bay Area Rapid Transit District expects to woo passengers with speed and comfort, although the system may not be as flexible or accessible as some planners would like.

It was generally agreed, however, that the automobile is here to stay and that the "right mix" of cars, buses, and trains is necessary. For city transportation, many speakers favored rubber tires and electric power for their noiseless, fumeless operation.

Planners are also keeping their eyes on high-speed intercity trains. Japan's Tokaido

## U.N. School Plans Modified

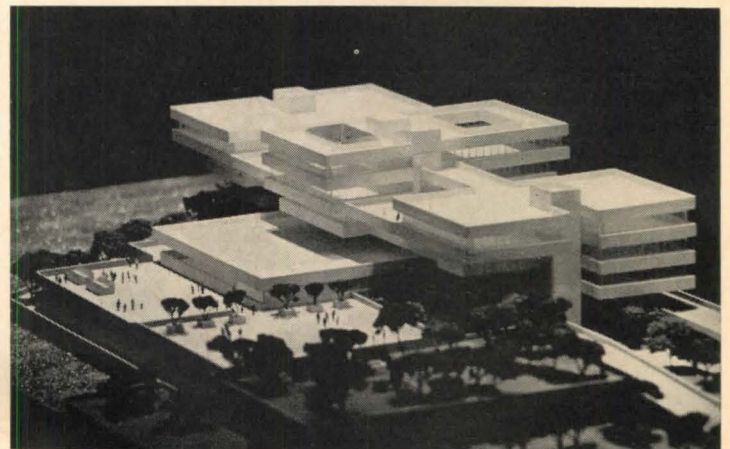

UNITED NATIONS, N.Y. Since the time architects Harrison & Abramovitz released the model photo of their United Nations International School in late January (shown here), they have made several modifications. For one thing, the auditorium and gymnasium area that appears as a slab extending from beneath the left of the model is now a separately articulated unit, on that side, connected to the main building by a narrow neck. For another, the top floor is now cantilevered out beyond the floors be-

neath, which are set back at varying distances. And a student center has been added on the roof. Fifteen hundred students, from kindergarten through high school, will fill the building, with each section—high school, junior high, grade school—housed on a separate floor of the six-story structure.

To be built on filled land in the East River, about a mile south of the United Nations site, the school will replace a pier that is now being taken down. The city is leasing the

land to the U.N. for 99 years at a dollar per year. Construction costs will be met by the Ford Foundation (\$7,500,000 for building and equipment) and the Rockefeller family (\$1 million to prepare the landfill).

One of the nicest features of the site is that it will leave unsullied the open, landscaped lawns just to the north of the U.N. building, where the school was originally going to be located.

## Lincoln Center's Mirage Solidifies

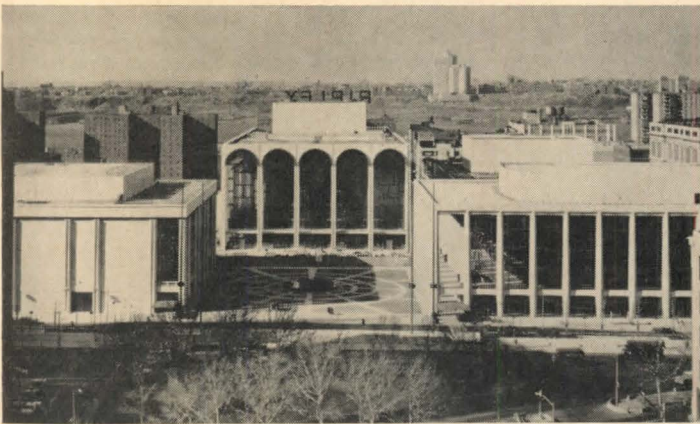

NEW YORK, N.Y. With the scheduled opening of Wallace K. Harrison's Metropolitan Opera at Lincoln Center only six months away, it looks as if the Lincoln Center's financing is also nearing completion. One other structure is still to be built, of course: The Juilliard School of Music. And there are rumblings about possible need for executive space for the center, and dormitories for Juilliard. But at least temporarily, with \$165,400,000 in the capital fund, the budget seems fulfilled—or nearly so. Still needed, according to current goals, is \$1,400,000.

In 1957, when Clarence Francis (shown), chairman of the campaign committee, went to work, the goal was \$75 million. But building costs, like any other mirage, are never quite what they seem to be.

Even then, though, the goal was one that gave lesser men much apparent cause for concern. No such sum had ever been raised philanthropically

for the arts, and indeed the performing arts were in what appeared to be a TV-caused slump. Francis and his group of volunteer fund raisers, in spite of the odds, or perhaps by way of disproving them, turned in what is surely Lincoln Center's finest performance so far.

On their way to raising funds for what one periodical called "the nation's most extraordinary urban renewal project" (because the land was acquired through urban renewal machinery and because

\$40,100,000 was donated by Federal, state, and local governments), they set these records:

Greatest total of gifts by individuals to a single artistic institution: \$50 million.

Largest foundation grant to an artistic institution: \$25 million (Ford Foundation).

Largest total of gifts from corporations to an art center: \$10,100,000.

Largest donation from a foreign government to a single U.S. artistic institution: \$2,500,000 from West Germany.

Moreover, fund-raising costs have been held to 1.25 per

cent of the total raised, less than the interest earned by short-term investment of the funds awaiting use.

Lincoln Center, Francis says, "has been privileged to pioneer a wholly new concept which had been widely adopted as an example of community development of cultural resources." Last month, some 35 communities throughout the U.S. with performing art centers in the building or planning stage, and 70 others with civic center projects under way that make provisions for the performing arts, were watching Lincoln Center's unusual performance.

## George Washington Would Have Slept Here



Photo: Weiss & Ross

NEW YORK, N.Y. The father of our country never lived to number among the Astor's celebrated guests. But just about everybody else has. This hotel—where W. C. Fields entertained, where Toscanini kept a landscaped suite, where General Douglas MacArthur honeymooned, where Will Rogers gathered material for his comedy routines, and where Charles Evans Hughes went to bed as President of the United States only to learn the next morning that the California returns had re-elected Woodrow Wilson—this hotel, the Astor, will soon be just a pile of disjointed bricks. This past January, developers Sam Minskoff & Sons bought the hotel property for more than \$10,500,000 and plan to build a 40-story office building in its stead.

William B. Astor, who, because of his extensive holdings, was called "the landlord of

New York," would have been pleased. Sometime before his death in 1875, he bought the old Medref Eden Farm for \$34,000. And many thought him a fool for investing in land that far uptown. In 1904, \$8 million of Astor money went to build a hotel on the old farm land, designed by Clinton & Russell in the French Renaissance style. When the Astor opened its doors (one for women and one for men), the rich, the established, and the well-known of New York flocked in to see the 22'-high gold and marble lobby colonnade, the 14,000 electric bulbs (making it the "most electrified hotel of 1904"), and the largest ball and banquet room in the country (maximum: 2500 dinners at one time). More than 15 million guests have stayed at the Astor since it opened. By the end of 1966, the last guest will have left.

The hotel's sale and the pro-

posed construction of an office building has been greeted with favor by West Side businessmen. Apart from the Allied Chemical Corporation's remodeling of the Times Tower, the office building will be the only major building project in the area for 39 years. Already an "astonishing expression" of interest has come from prospec-

tive tenants. Minskoff will have a full house.

But the Astor—the thirty-third New York hotel to close down since World War II—is more than real estate and per-sq-ft income. In the past, it was a generator of energy, interest, and life in the Times Square area. Without it, the Square will not be the same.

## Interama Revived Again

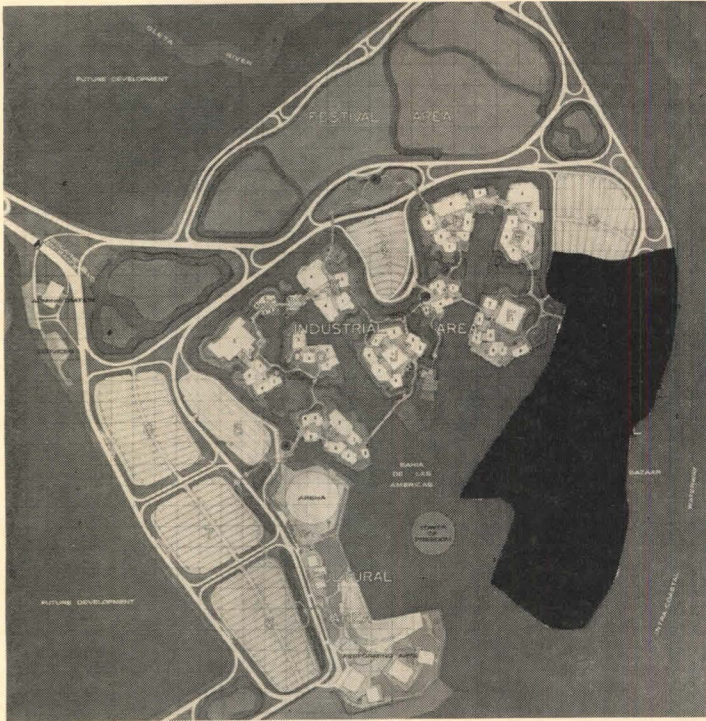

MIAMI, FLA. If current plans mean anything, Miami will have an Inter-American Trade and Cultural Center, a sort of permanent, limited-scale World's Fair by the end of 1967. To be known as Interama, the project is being promoted by Dr. Irving Muskat, an erstwhile scientist, who took over active leadership of the project (which has been talked about in one form or another since 1918) in 1961. Now backed by funds from a private bond issue which raised about \$20 million, plus a Federal-Government-approved loan (through the Community Facilities Administration) of approximately \$22 million, work has been done in arranging the land, 680 acres of swampland north of Miami Beach.

Also under discussion are plans for six pavilions in Interama's International Area to be designed by six leading architectural firms. All architectural work is being coordinated by Miami architect Robert B. Browne, who has engaged Marcel Breuer, José Luis Sert,

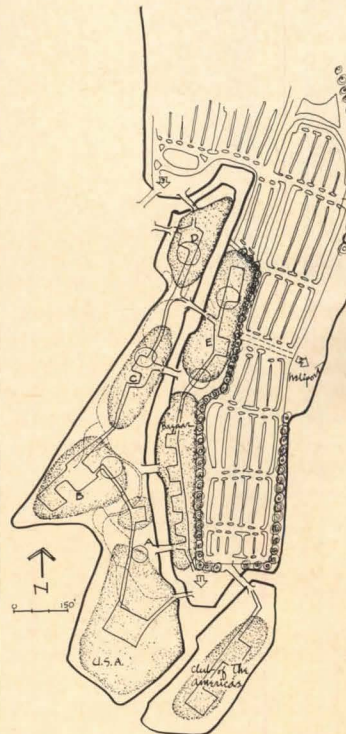

Louis I. Kahn, Harry Weese, Paul Rudolph, and Edward Durrell Stone. Stone will design

the \$4.4 million U.S. pavilion. Breuer will be architect for the Eastern Group's (Brazil, Argentina, Uruguay and Paraguay) pavilion. Sert will design the Western Group pavilion, budgeted at \$2.6 million, to house the exhibits of Venezuela, Columbia, Peru, Chile, and Bolivia. Kahn is handling the Central Group \$2.4 million pavilion (Mexico, Panama, Guatemala, Honduras, San Salvador, Costa Rica and Nicaragua). The Caribbean pavilion (Jamaica, Haiti, Santo Domingo, Trinidad, and Tobago), at \$1.1 million, is being done by Weese. And Rudolph has contracted to design a \$2.4 million all-nations bazaar.

Browne's job is to do the site

plan (shown here), to handle landscaping, and get the architects to cooperate. This last seems a highly difficult task, but Browne is confident that the six highly individualistic architects he has commissioned will produce a "harmonious juxtaposition of harmonious buildings." He has already conducted several meetings among them and told P/A that progress is being made. All have agreed to work in white concrete.

Recently, the U.S. Senate approved a \$9.5 million Federal contribution to the project. It seems that, two years ago, LBJ, in an incidental helicopter flight over the swamp site, casually said he liked the idea.

## THE SKIN TRADE

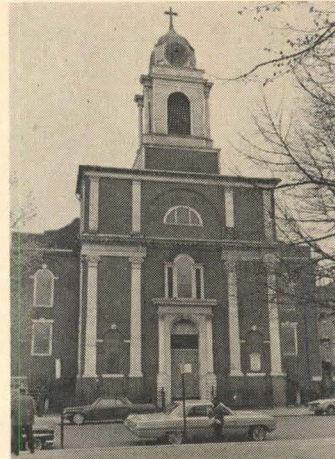

Before

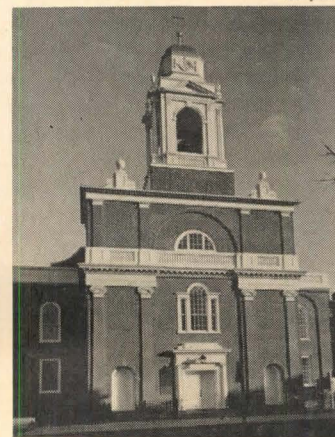

After

BOSTON, MASS. When the Roman Catholic diocese of Boston bought the New North Church in 1862, they altered its design radically and renamed it St. Stephen. Originally designed in 1804 by Charles Bulfinch, it represented his first church design. Now, under the guidance of architect Chester Wright of Waltham, Mass., the church has been restored to its original design. When he was called in to do the redesign in

1961, Wright's problem was that he had no plans from which to work. Months of architectural detective work turned up only three documents that could be useful: an 1850 woodcut perspective, a sheet of dimensions of the "New North Church," signed by Bulfinch, and a Study Perspective of the interior. The rest of what Wright needed to know turned up only as workmen began stripping off the outer skin that had been added in 1862. Some of the original finish still clung to the wide boards Bulfinch originally used. Beneath the wood onion dome of the spire was the original Paul Revere copper dome. Some of the original window frames were still intact and so were a few of the original sash. Old hand-forged nails in the brickwork gave clues about Bulfinch's applied balustrades.

Underneath what Wright calls the "horribly over-colonialized main entrance" was the outline of the original doorway. And on either side of it, two original entrances, complete with their doors, were found bricked up. The tracery of original mullions and muntins was found in spite of mutilation by substitutions.

Inside, workmen restored the ornately painted ceilings and walls to their original oyster white. The flat arches between Bulfinch's original column caps were removed. And original paneling, hidden behind 20th-Century wood and plywood, was restored. Bulfinch used only three basic moldings, varying in their size and ar-

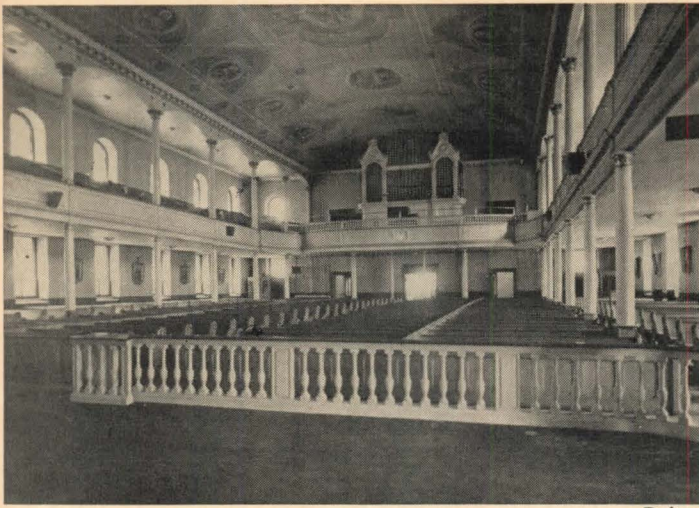

Before



After

range. These were recreated from fragments of the original moldings found in several places.

Probably the most complex task facing the restorers was the need to lower the building. In 1862, it had been raised 6'-9" to accommodate a basement. In 1964, the grandsons and great-grandsons of the man who had done the work in 1862 lowered the building to its original level.

On completion of the project earlier this winter, Chester Wright wrote to P/A: "After

four years of research and drawing and a year and a half of construction by Thomas O'Connor & Co., of Boston, St. Stephen Church stands today as Charles Bulfinch designed it. True, steel has replaced some of the original dry-rotted framing. But from brownstone quarried from the original quarry site to Bulfinch moldings, from pews and pulpit detailed from the originals to the original organ, Charles Bulfinch's church stands in all its graciousness in the North End of Boston in 1966 as it did in 1804."

## The Fifth Kling for Norfolk

NORFOLK, VA. Five years ago, this city embarked on a civic venture with Philadelphia architect Vincent G. Kling. Five Kling-designed civic buildings now stand on the 17.4-acre site set aside for the \$15 million Civic Center: a Public Safety Building; a two-story Corporation Courts Building; a Utility Building; a one-story Public Services Building; and—largest so far—a 14-story Municipal Office Building (shown here adjoining the Public Services Building at ground level).

The unique feature of the



Photo: Taylor B. Lewis, Jr.

building is its window wall treatment of the 10 office floors, which cantilever over the two-story lobby base but come to a sad end with a rather heavily handled mechanical and electrical core at top. The

"sun break" wall of glass is arranged in two layers 3' apart. The inner layer is made up of 9'-high clear glass panes that are installed flush with the face of the building. The outer glass layer is supported on tubular metal frames that project from the exterior columns. The panes are heavy-duty, plate-tested to withstand wind forces up to 125 mph and are tinted brown to reduce solar heat and glare. Kling maintains that the tinted glass, coupled with louver sun shields and the free

air convection between the two glass layers, "reduce the solar load so that the result is the equivalent of a building with only 40 per cent glass."

Also associated in the design of the Norfolk Civic Center are Oliver & Smith of Norfolk, Associated Architects; Fraioli, Blum & Yesselman of Norfolk, Consulting Engineers; Charles S. Leopold, Inc., of Philadelphia, Consulting Engineers; and Ebasco Services, Inc., of New York, Space Planning Consultants.

## Mediterranean on the Pacific

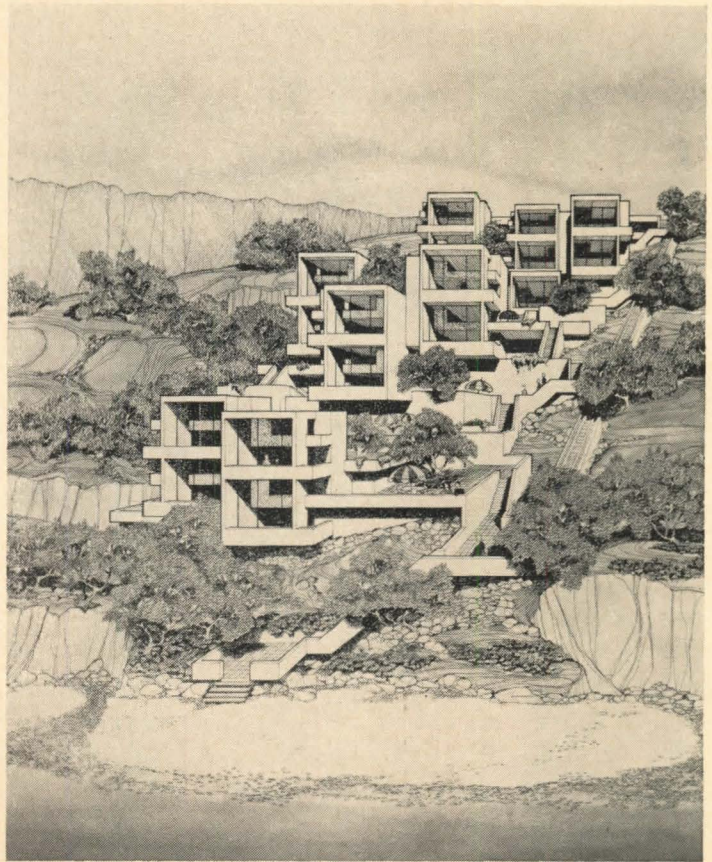

LAGUNA BEACH, CALIF. Sprawling down a steep hillside to the Pacific, these 16 duplex apartments reproduce a little of the effect of a Mediterranean sea-coast town. Their white stucco exteriors help this effect, and so does the sculptural quality of their arrangement.

Terraces, both public and private, wind through the units binding them together visually and physically. These terraces

and steps also provide visual relief from the vast expanse of the Pacific, which all the units face.

Known as Los Ocho, the \$270,000 project is the brain-child of eight Los Angeles actors, writers, and directors, who own eight of the units. The other eight will be sold as condominiums.

Architect is Edwin L. Fields, Beverly Hills, Calif.

## Eavesdroppings

"For five years, architects are taught in most schools to regard themselves as mini-Mieses, given unlikely problems and the minimum of contact with

the site. They are then thrown out on a market where they can earn good money in plan-factories with little creative work, or they pour out their souls and build five houses in a

Continued on page 62



AMERICAN FLETCHER NATIONAL BANK, INDIANAPOLIS.

Quartette's wall-to-wall installation covers 35,000 sq. ft. second floor of Operations Center. All-electric building utilizes heat-of-light for space heating. Provides uninterrupted "outdoor sky" of glare free, 450 footcandles lighting over all general office areas, data processing enclosures and private offices; efficient exchange of cooled or heated conditioned air in each office space; finest overall acoustical absorption and attenuation.

Architect: Reid, Quebe, Thompson & Associates, Inc., Indianapolis, Ind. Engineer: Scharres & Associates, Incorporated, Chicago, Ill.

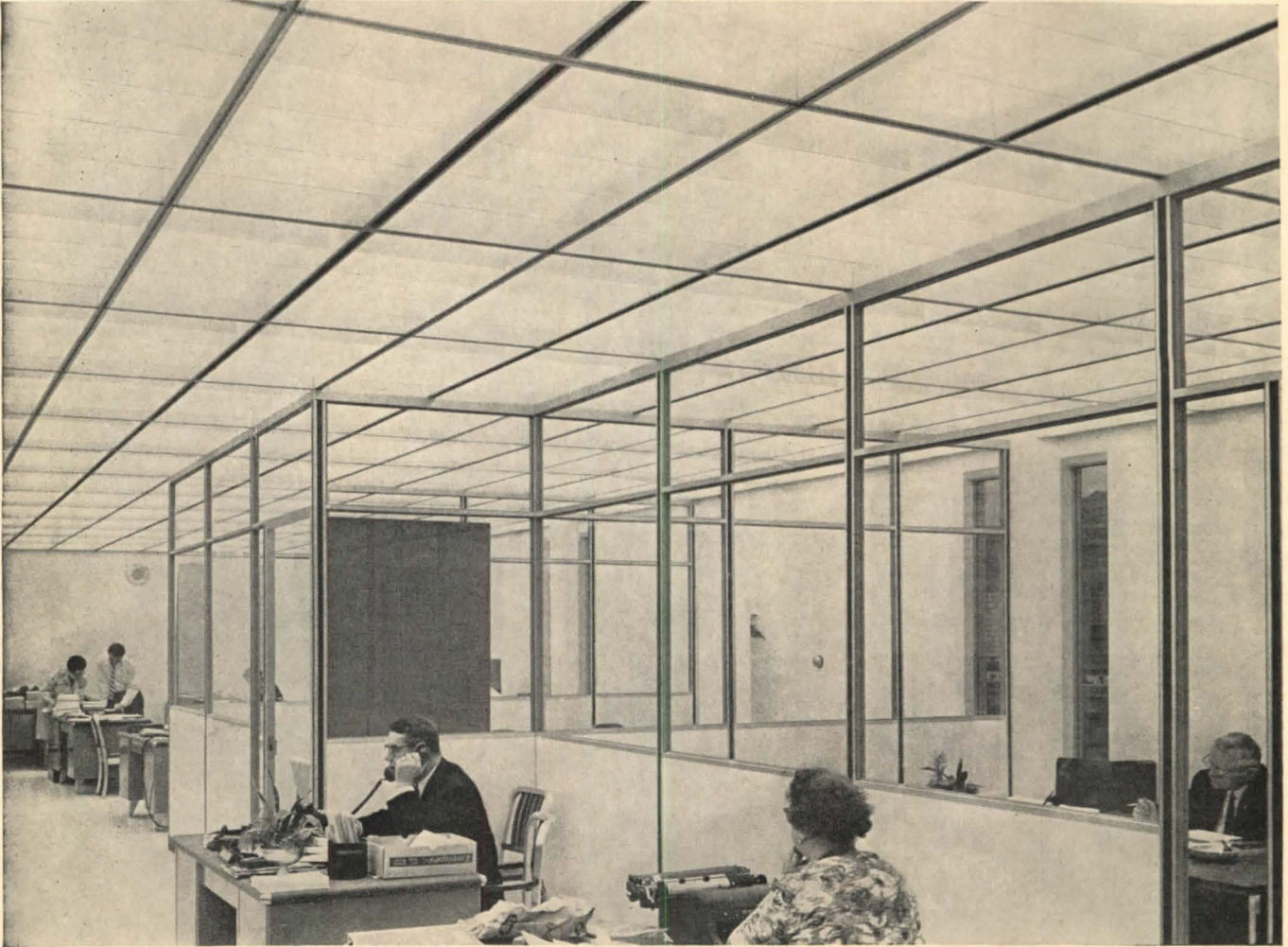

**This is Quartette, the total integrated ceiling system. Lighting of 450 footcandles without glare. Complete air exchange. Unbelievable acoustics. And full partition support. All packed in custom-sized modules to fit your next job. There's no ceiling in the world to compare with it. Write for details. Be amazed.**

QUARTETTE, THE TOTAL INTEGRATED ENVIRONMENT CONTROL CEILING, SECOND ONLY TO NATURE.

**Luminous Ceilings Inc.**

3701 North Ravenswood Ave.  
Chicago, Illinois 60613  
Telephone, (312) 935-8900

Gentlemen: Please send us all available information on the Quartette total integrated ceiling.

Name  Title

Company

Address

City  State  Zip

**This is one thing  
Hetron<sup>®</sup>-based panels  
don't do.**



They don't shatter. Even under attack by vandals, hail or high winds. Hetron panels prevent the broken window problem, reduce maintenance and replacement costs.

But that's not all Hetron panels don't do.

They don't spread a fire. They are qualified to carry the Factory Mutual seal of approval and the U/L label.

They don't admit glaring light. Since they are translucent, they diffuse the light, help eliminate shadows.

They don't corrode. They with-

stand severe chemical environments.

They *do* shrug off weather.

And they *do* install easily and economically because of their light weight and high strength. No extra framing is required when used on standard purlin spacings.

We make the Hetron. Fabricators supply the panels. Large or small, corrugated or flat, for replacement or new construction. We'll be glad to provide detailed information. Just write Durez® Plastics, 7703 Walck Road, North Tonawanda, N.Y. 14212.

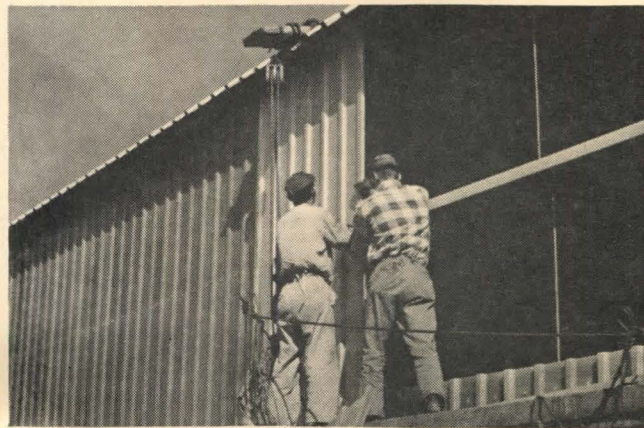
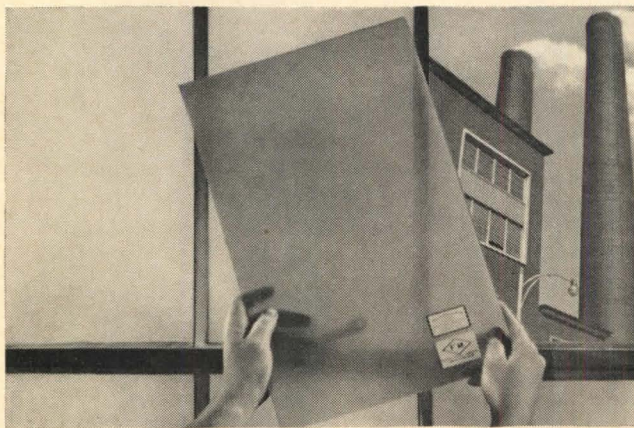

DUREZ PLASTICS DIVISION

On Readers' Service Card, circle No. 451

Continued from page 58  
decade. The result, very often, is an added person producing added architecture." *Ian Nairn, "Stop the Architects Now," The Observer, February 13, 1966.*

"On more than one occasion, a speaker has resorted to the earliest statement which we have on record. This statement goes back to classical times when Athens was in full flower, and the pledge of its citizens, taken a thousand years ago, has even a greater meaning for us today. 'We shall never bring disgrace to this our city; we shall fight for the ideals and sacred things of the city; we shall revere and obey its laws; we shall strive unceasingly to quicken the public sense of civic duty that in all these ways we may pass on this city, greater, better, more beautiful than it came to us.'" *Kenneth B. Smith at the Stratford Seminar on Civic Design.*

"Architects, engineers, and scientists are all what I call slave professions. They don't go to work unless they have a patron. But architects are the most slavish of all, and they work under a system that hasn't changed since the time of the Pharaohs. When you're an architect, the patron tells you where he's going to build, and just what he wants to do. And he says, 'My brother's in the hardware business, and my wife wants this, and here's the building code, and the labor laws, and here are the zoning regulations, and here's Sweet's catalogue. I don't want anything special outside of it.' So the architect is really just a tasteful purchasing agent. He discovers he's inherited a skeleton frame and guts, and all he can do is put in exterior decorating." *Buckminster Fuller, quoted in The New Yorker.*

## Haughwout Wins Out

NEW YORK, N.Y. Charles MacKay, in his *Life and Liberty in America or Sketches of a Tour in the United States and Canada in 1857-58*, was overwhelmed with Broadway, its bustle and beauty. He especially admired a building that gave "its most imposing character to this busy and beautiful street." "The iron palace," as he called it, commonly known as the E.V.

Haughwout Building (pp. 133-135, FEBRUARY 1958 P/A) still stands today—one of the finest examples of cast iron architecture and possibly the first building in America to use the

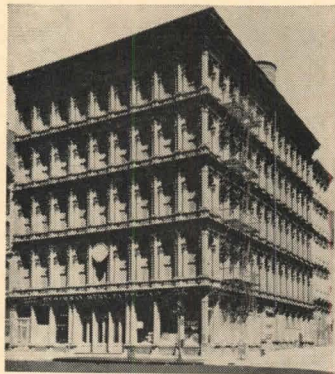

safety elevator. The Venetian-Renaissance styled and J. P. Gaynor-designed Haughwout Building may have added another distinction to its list by being the first to cross New York's Robert Moses, chairman of the Triborough Bridge and Tunnel Authority. The building has been named a landmark by the city, which designation has been upheld by the Board of Estimate. Moses had appealed to the Board to "take no action" on this, as "these premises are directly in the right of way for the Lower Manhattan Expressway." It looks as though the highly controversial Expressway, Robert Moses' baby—in the making since the mid-40's—may have a longer wait yet.

## Onward and Upward



Photo: George Bettridge, Saans Photography

SALT LAKE CITY, UTAH. Man's progress—if it can be called that—from his beginnings close to the earth, through a humanistic period, to his present glossy, untouched-by-human-hands existence, can be visually

traced in this photograph from the capital of the Mormons.

The log cabin is one of Utah's first buildings, and is now enshrined on the Temple Square grounds of the Mormon Tabernacle beneath a Western-

style Parthenon. Behind, looming like the embodiment of the mid-20th Century, is the new office building of Kennecott Copper Corporation by Ashton, Brazier & Montmorcency of Salt Lake City.

## LET THERE BE WATER AND POWER

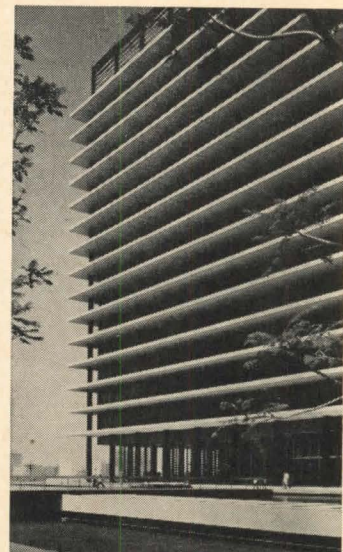
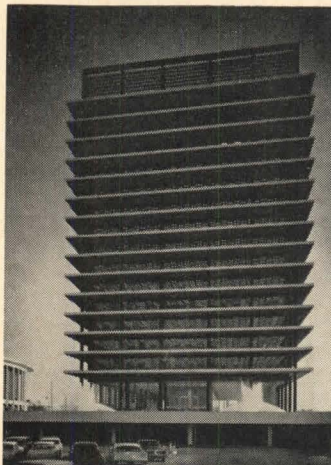

Photos: Julius Shulman

LOS ANGELES, CALIF. Right across the street from the Los Angeles Music Center (see pp. 46-48, JANUARY 1965 P/A) stands the recently completed 17-story headquarters of the Los Angeles Department of Water and Power. With today's push to integration, buildings as disparate in purpose as these can be next-door neighbors and scarcely raise an eyebrow. But, architecturally, the Water Works upstages the Music Center. Not only is it a cleaner, less frivolous building, but it has a better site with room for a pleasing reflecting pool. This pool, with its eight fountains, surrounds the building, carries one-third of the building's air-conditioning load, and serves as a roof for a three-level parking garage for 2300 cars.

Were it not for the contrast with the Music Center, the Water and Power Building

would probably look even more mechanical than it is. What personality it has stems from wrap-around horizontal exterior concrete canopies, cantilevered 15' beyond the exterior steel columns. These canopies, of course, serve as sunscreens, lightening the air-conditioning load. The building's 880,000 sq ft gross floor area is heated by bootstrap heating: heat from the lighting fixtures is captured and circulated.

Constructed at a cost of \$32 million, the building provides office space for 3200 employees and is said to have sufficient space to house 4300, the department's estimated headquarters work force by 1990.

Architects were Albert C. Martin & Associates.

# Macomber does a lot of little things to help architects and builders do a better job...for example:

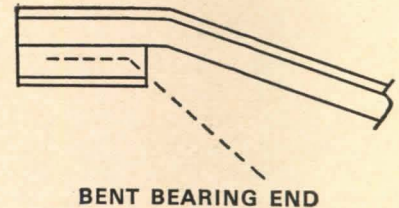
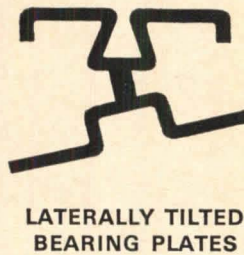
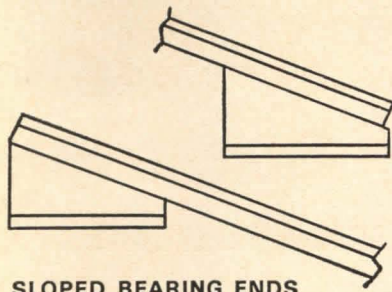

Macomber representatives can provide architects and builders with more building for their dollar. This is no idle boast, but fact based on thousands of construction jobs. Macomber representatives are experienced building people who work closely with architects and builders in providing their clients with a custom-steel-framed building that exactly suits the need, as well as getting the most usable area from the site. Macomber V-LOK® open-web framing systems have become extremely popular because they combine maximum strength and flexibility with ease of erection. V-LOK can be modified to meet almost any requirement, including the systems approach.

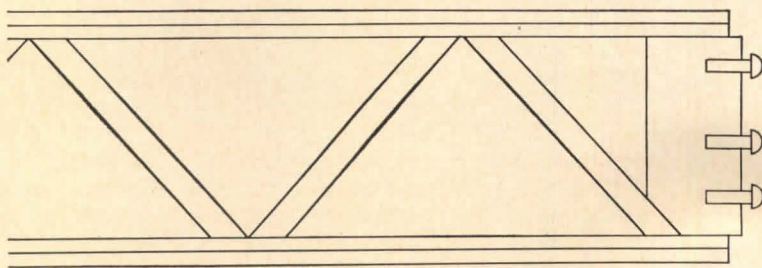

OPEN-WEB V-LOK GIRDER

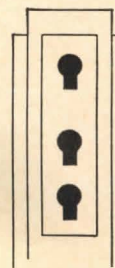

SQUARE V-LOK COLUMN

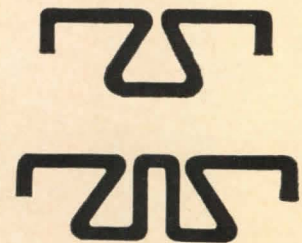

V-SECTION CHORDS

Prove it to yourself. Talk to the Macomber man in your area and discover how a sturdier custom-steel-framed building can be built to meet any specific style and set of requirements at costs equal to or even below other types, including prefabs. Literature and name of nearest representative upon request.



**MACOMBER INCORPORATED**

CANTON, OHIO 44701

SUBSIDIARY OF SHARON STEEL CORPORATION

## High-Rise Home

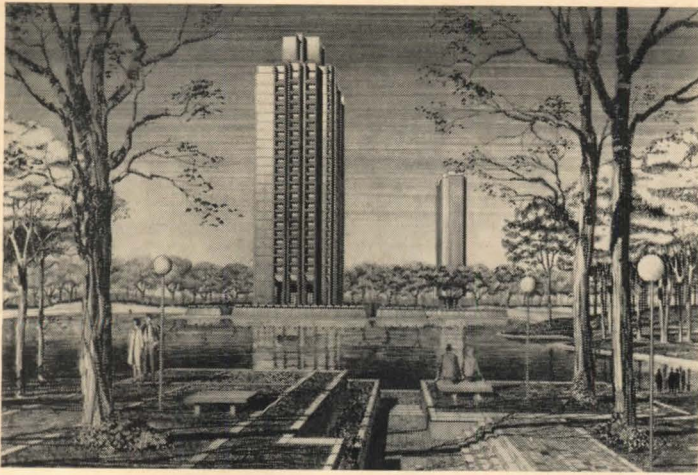

DETROIT, MICH. Too often, the only consideration given the elderly in housing built for them is in the name. These projects usually have names that say something about Senior Citizens or Golden Years, and site plans that include too many steps.

Soon to open near the heart of downtown Detroit is a 22-story apartment house for the elderly that provides more than a token offering for the comfort of its aging tenants. What makes the building distinctive, in an era too addicted to institutional-looking housing for the aged, is not only its site, which is adjacent to a park and a small lake, and its handsome façade, but also its carefully thought-out interior. The floors of public halls and bathrooms are of nonskid ceramic tile and

all have handrails and grab-bars. All doors are wheelchair-width. And elevators, which service all floors including the basement-level parking facilities, have doors timed for delayed starts and are wide enough to accommodate wheelchairs and walkers. Each floor has seating at elevator lobbies and two laundry facilities.

The building will contain 264 apartments, either studio or one bedroom, each with floor-to-ceiling glass and balconies overlooking Detroit and the park. Architects John P. Morgan & Associates plan a snack bar in the lobby and community rooms in the basement of the building, an area completely surrounded by a 15'-wide sunken garden court. Entrance to the lobby is via a bridge across this court.

## The Building Forms a Gateway



ROME, ITALY In 1936, Benito Mussolini set aside a generously proportioned site five miles south of Rome for a world's fair. With one thing and another, the fair never materialized, and the land, with its covering of towering Roman pine trees, lay ripe for development. About 10 years ago, the development started in ear-

nest. Since then, more than 150 corporations and several government ministries have set up offices in what has become Esposizione Universale Roma (EUR), a planned city of skyscrapers, long, low government buildings, hotels, apartments, and expensive villas. Latest planned additions to EUR are a pair of identical office struc-

tures, which will flank the broad highway leading into the complex, forming a gateway to it. Plans for the first of these, a building for Esso Standard Italiana, were recently released. Designed by Roman architects Professor Vittorio Ballio Morpurgo and Professor Luigi Moretti, with Lathrup Douglas of New York as consulting architect, the building is set on a terraced marble podium that houses a cafeteria, a computer center, and a three-level parking garage. In form, the structure will consist of two massive rec-

tangular blocks, both about 400' long: a two-story block set upon a three-story one. These are separated visually by a recessed intermediate floor containing management offices. The upper story is defined by a cap of white marble facing, which reiterates the marble of the base. Every 2½', vertical sun baffles cut the bronze aluminum curtain wall façade. Completion of the Esso building is scheduled for July 1966. The second building, to be occupied by Societa Generale Immobiliare, will be finished a few months later.

## Japanese-American Church

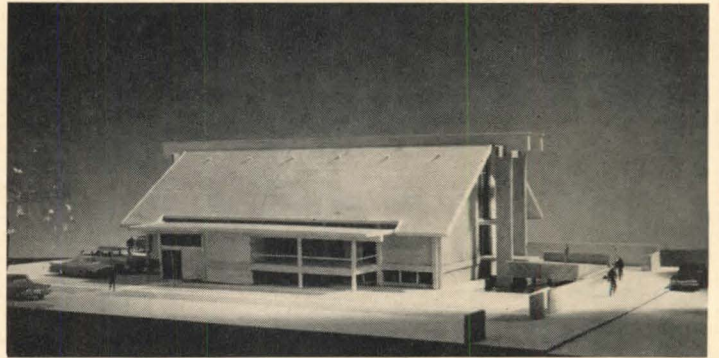

Photos: Robert Lindsay & Associates

LOS ANGELES, CALIF. Using the traditional form of the Japanese temple, but substituting two precast, post-tensioned concrete beams for wooden roof beams, the firm of Kajima International, Inc., has fashioned the Seicho-No-Ie Church

for a Japanese religious organization in Gardena, California. Almost completed, at a cost of \$200,000, the church will seat 300 in its main assembly hall and have classrooms in its half basement. Engineers are Mofatt & Nichol, of Long Beach.

## The Day of the Hexagon

PONCE, P.R. Puerto Rico has many attractions, but until last December, major art museums were not among them. Now there is one, in Ponce, the island's second largest city, 75 miles from San Juan. Ponce is

the hometown of financier and philanthropist Luis E. Ferré, who, feeling the lack of adequate museum facilities, in 1959 asked Edward Durell Stone to design such a structure. The result is a multipur-



CHF 989



ADJUSTABLES

# CHF VERSATILITY

CHICAGO HARDWARE  
FOUNDRY CO.  
North Chicago, Illinois

WHERE FURNITURE DESIGNS GET NEW IDEAS



DETACHABLES

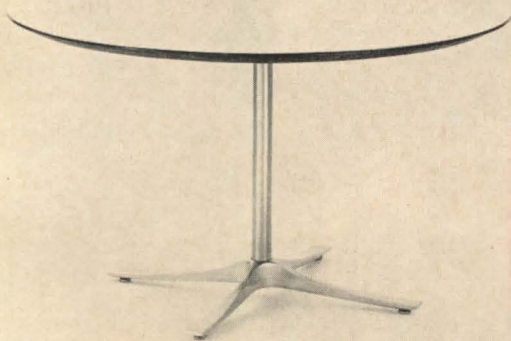

CHF 984



FLIP TOPS

On Readers' Service Card, circle No. 335



pose, \$2 million, two-story, troweled marble structure that houses \$3 million worth of art.

The major portion of El Museo de Arte de Ponce's art collection will be displayed in seven, second-floor galleries that are hexagonal in shape, with narrow grillework at the corners. The six-sided gallery will let a visitor stand in one spot and view work hung on all walls with equal ease. The walls are covered with a heavy cloth, a very loose jacquard weave, which will facilitate hanging and wall care. Hexagons are everywhere; Stone repeats his motif in the ceiling's recessed triangles and on the



floor's terrazzo tiles.

El Museo stands in Ponce, squarely, solidly, and a bit magnificently.

## Competitions

Royalmetal Corporation has launched its 1966 student competition for the design of a general office for eight people with an adjoining reception area. Entries must be in by April 30, and should be mailed to Royalmetal Corporation, Dept. ODC, 1 Park Ave., New York 16, N. Y. . . . The deadline for the NIAE- and Pittsburgh Plate Glass-sponsored competition is April 22. This year's theme is "The Image of a State—A Hospitality Center on a Turnpike." Entry forms and further information are available from the National Institute for Architectural Education, 115 E. 40th St., New York 16, N. Y.

The Architectural League of New York has announced that under the J. Clawson Mills Fellowship in Architecture—a grant of \$7500—it will now be possible for instructors who have completed all but one final year of studies to finish their requirements and receive an advanced degree in architec-

ture. The grant would finance the year of schooling, as well as a three-months period of actual work with an established architectural firm. Applications should be submitted to the Architectural League of New York, 115 East 40th St., New York 16, N. Y., and should not arrive later than April 1.

## Obituaries

JAMES RUDERMAN, structural engineer whose work totaled more than 40 million sq. ft. of space in New York City, died there on January 27 at the age of 67. So many of his steel-framed buildings lined Park Avenue that it was often called "Ru(e) der man Boulevard."

## Awards

Architect Howard Ashley of Kuala Lumpur, Malaya, has been selected to receive the Pan Pacific Architectural Citation of the Hawaii Chapter, AIA . . . The city of Charleston, S. C., has received the

AIA's Citation for Excellence in Community Architecture . . . The Hawaii Chapter, AIA, also gave honor awards for outstanding architecture to John P. Tatom and the firm of Lemon, Freeth, Haines & Jones.

## Roney Plaza Coming Down

MIAMI BEACH, FLA. The grand dame of Miami Beach hotels is coming down. Developer Harry Mufson has announced plans to begin demolition of the Roney this summer to make

way for a \$25 million resort hotel to open in November of 1967. The new 600-room hotel will, he says, be "the most sophisticated resort complex in the world." Such a statement should rock the palms and fuchsias of the 40-year-old Roney. After all, with 280 rooms (one of which, the Presidential Suite, boasts a terrace large enough to accommodate 150 people for cocktails), 1500' of ocean-frontage and six acres of gardens and landscaping (which, thoughtfully enough, will be preserved), the Roney was not exactly dull.

## Mountain Greenery College



BENT, ORE. Hard by the Cascade Mountains on the Deschutes River in central Oregon, the town of Bend (population: 11,409) stands firmly on its bed of solid volcanic rock. Besides the sawmills and furniture factories, the town has, since 1949, been the home of Central Oregon College. The college, lacking adequate space and facilities, has not fared

well. (At one time, full-time student enrollment was down to one.) Today, Central Oregon College enrollment is up to 400. Instead of using the Bend High School rooms at night, COC, with the help of state and Federal funds, now has 145 acres on the west slope of Awbrey Butte with four new classroom buildings, an administration building, a student



*Specified in MORE and MORE fine construction..*

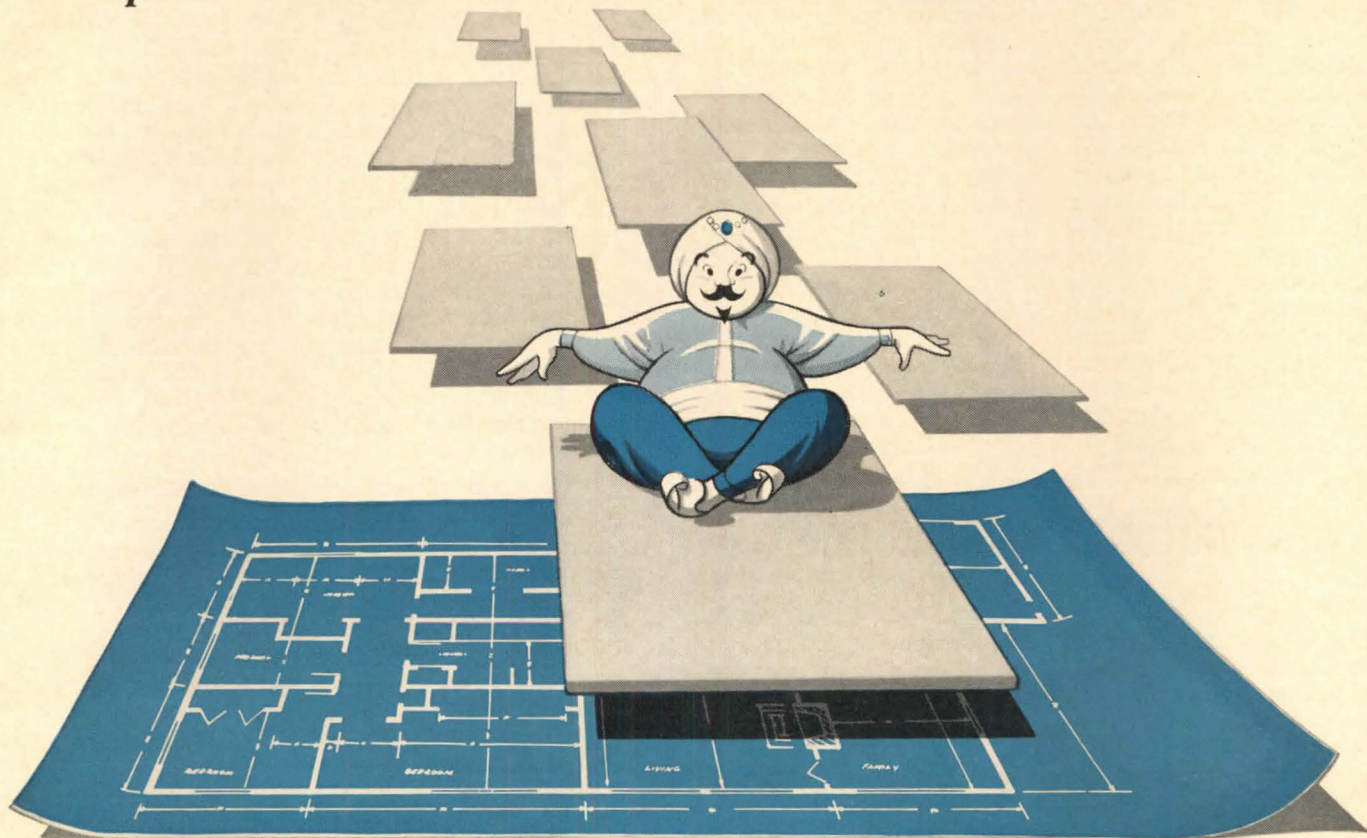

## HOMASOTE RESILIENT UNDERLAYMENTS

put a "magic carpet" cushion—  
under flooring over concrete

Hard, cold concrete becomes softer-feeling, warmer, insulated — with Homasote wood-fibre insulating panels. Better still, their just-right resiliency brings welcome cushioning and quiet\* to wall-to-wall carpeting in high and low-rise apartments, institutions and homes.

All wood-fibre Homasote is available in  $\frac{3}{8}$ ",  $\frac{1}{2}$ " and  $\frac{5}{8}$ " thicknesses — in easily handled 4' x 4' or 4' x 8' sizes. Weather-proof, termite protected and non-bituminous. Applied to concrete above-grade with adhesive, for conventional installation of carpet and pad with tackless (or other) methods.

CUSH-N-BASE, the prefinished parquet panel has a Homasote underlayment built-in. Panels are 12"x12"x11/16" for application by adhesive to concrete (above grade) and to old floors. Solid parquet, in Red and White Oak or Dark Brown Oak, is factory prefinished.

For additional details on Homasote Underlayments and "Cush-N-Base" Parquet Panels, write Dept. C-2.

\*STC 47. INR + 19 with carpet and 32 oz. felt pad over 15/32" Homasote and 5" concrete slab. Tested in accordance with ISO-R-140 and FHA #750. Test data available on request.

CUSH-N-BASE

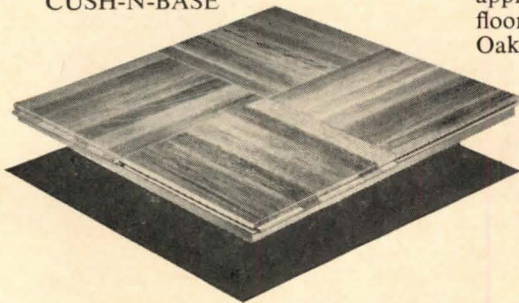

6-026

**homasote** Company

Trenton, N. J. 08603

On Readers' Service Card, circle No. 434

center and a library now under construction. Wilmsen, Endicott & Unthank of Portland are architects for the junior college's new campus. By 1975, dormitories, a cultural center, physical education, applied science, forestry, agricultural and vocational arts buildings will be added, for about \$2 million.

Because of limited funds (cost on the first seven buildings averaged \$16.93 per sq ft) and lack of skilled labor, the architects kept a similar pattern of construction for all the buildings. Foundations, slabs, and columns are of reinforced concrete, with exposed surfaces sandblasted in-

side and out. Exterior nonbearing walls, and the deep, overhanging fascia, are of frame construction faced with wood shingles. The shingles have not been stained and have already weathered to a buck-brush gray. Roofs are flat and framed with wood joists. The design mirrors exactly a transitional stage in the changing coastal architectural style—from wood shingle to concrete.

Wilmsen, Endicott & Unthank have kept their architecture low-lying and low-keyed. The volcanic rock, the pines and buck brush, the overwhelming view of the Cascade Skyline—these are undisturbed.

## Calendar

March 21-24 are the dates for the **Industrial, Institutional & Commercial Building Exposition** to be held at the Public Auditorium in Cleveland, Ohio. Information and registration forms are available from Clapp & Poliak, Inc., 341 Madison Avenue, New York 17, N. Y. . . . From March 29-30, the Jung Hotel in New Orleans will house the second Building Research Advisory Board's symposium on **The Performance Concept in Building**. For more information, write Information Service, Building Research Advisory Board, Na-

tional Academy of Sciences—National Research Council, 2101 Constitution Ave., NW, Washington, D. C. 20418 . . . **The National Association of Architectural Metal Manufacturers** will convene at the Mark Hopkins Hotel in San Francisco April 24 to 29 . . . **The Boston Educational Center** will celebrate the opening of its new building with a program of films, lectures, a building products exhibit, and a conference on the "Future of Architecture" from May 8-14 . . . **The Consulting Engineers Council** will have its annual meeting in Tulsa, Okla., from May 4-6.

## WASHINGTON/FINANCIAL NEWS

BY E. E. HALMOS

There's a real possibility that the President's much-cherished "beautification" program for highways may result in a cover-up with figurative chintz and a little ivy—and very little else.

With the exception of a few forlorn voices, the emphasis seems to be on covering everything in sight with trees, flowers, and shrubbery. There's no stress at all on the possibilities of beauty inherent in design of roads and the structures that are part of them. The idea seems to be that the road itself must be somehow hidden from view behind a screen of greenery, rather than being made an integral part of its surroundings.

Of course, nobody denies the value of shrubbery, or extols the beauties of most advertising signboards, or argues that obnoxious things should not be removed or hidden. Only trouble is the almost total concentration on this aspect of the problem.

An example is the recent White House meeting of the "First Lady's Committee for a More Beautiful Capital." (Similar sessions are being promoted elsewhere, to spark the beautification program.) As reported by the press, the meeting was concerned with sprucing up some of the admittedly horrendous highway approaches to the city. A number of socially (and financially) prominent guests pledged money for purchase of flowers and trees.

The U. S. Bureau of Public Roads, for one, is conscious of

the possibilities of beauty from design, and recently (see FEBRUARY 1966 P/A) appointed an unsalaried board of consultants as an advisory group on selection of rights of way for new roads, which will be increasingly concentrated in urban areas.

But it is making little headway against the trees-flowers-shrubs-and-grass concept that seems to have taken over the program now.

### Public Library Expansion Likely

Little noted in the crush of more spectacular items occupying Congressional attention these days is the probably successful move (embodied in S.2802 and HR 12133) that would continue and expand the 10-year-old Library Services Act, which expires officially on June 30.

The program under this act has been a relatively quiet one, but it has involved considerable construction work, as well as made available funds for purchase of books, hiring of professional personnel, and expansion of library services.

In the extension bills now before both Houses, funds would be set aside for construction of library facilities: \$75 million for (fiscal year) 1967, \$100 million for 1968, and \$125 million in both 1969 and 1970.

Allocation of these funds is based on a Government report that indicates existing libraries need an additional 40,500,000 sq ft of space—at an

estimated cost of \$941 million—to meet public calls on their services this year.

### National Budget: Fact and Fiction

As usual, the annual budget presented to Congress in late January is up for consideration and debate. And, again as usual, it doesn't have too much relation to the actual bills that will be presented to the taxpayer.

That is not, in many ways, the President's fault, but the result of Uncle Sam's very peculiar bookkeeping methods, which take no account of what he is obligated to spend, but only of actual present expenditures.

Thus, the President sought appropriations of \$112,800,000,000. But the real measure of what the Government will or can spend is to be found in his requests for "New Obligational Authority" (NOA)—a sort of blank check from Congress authorizing future spending. If you add up these requests, they amount to more than \$145 billion. And, added to more than \$106 billion of "NOA" not used in previous years, it could yield an authorized spending total of nearly \$251 billion.

The cuts and stretch-outs of Federal programs will have some long-range effect on funds available for construction. Unless the situation in Southeast Asia changes radically, however, the effect on building won't be felt this year.

### Funds For Government Building

For construction (and planning) of facilities, the budgeted total amounts to nearly \$10

billion (this includes new Government buildings for many agencies, assistance grants for various public works projects, and highways). If you add to this funds for continuing programs such as housing and urban renewal now taken over by the new Housing and Urban Development Department and others, the total comes out to something close to \$17 billion—very little below the figure a year ago.

Some few cuts and slow-downs are apparent in some of the programs, particularly in the matter of the already announced cut in military housing (down \$100 million to \$544 million); and in aid to "impacted" schools (where children of Federal employees put an overload on local districts), which will be cut from \$397 million in 1966 to \$206 million for the next fiscal year.

But the General Services Administration program for 33 new Federal buildings, and the design of 10 more—to cost \$262 million in the next year—was not cut. (Neither was the Army Corps of Engineers' request for \$967 million for flood control and other work.)

### More Taxes

Most distasteful part of the budget message—to election-minded Congressmen—was the call for new or reimposed taxes to produce an additional \$4,800,000 in revenues to support the President's hope for a smaller deficit.

### Research Into Residential Walls

Through its wholly owned Research Foundation, the National Association of Home Builders has embarked on an

ambitious research project that will serve as a basis for performance standards for load-bearing and nonloadbearing walls (interior) for residential use.

First step will be a search of any existing literature related to interior walls, including findings of manufacturers and universities, as well as any other research that may not have been published generally.

Hope is to produce a mathematically expressed performance standard; and develop, or adapt, any needed new standard test methods to measure performance of walls.

### Financial

Biggest exercise for anyone concerned with the construction industry this month continues to be study of the enormous Federal budget, and, particularly, of Congress' reaction to it. With more than \$9,800,000,000 in direct appropriations for construction, plus perhaps \$7 billion in loans and other programs that foster construction, a lot of the industry's business rides on what happens next. As March began, Congressional hearings had given no indication that the lawmakers would make any drastic change in plans in this area.

Despite a last-minute spurt in the number of "starts," the housing field, as expected, lagged behind totals for the previous year. Census Bureau estimates a total of 1,500,000 new, privately owned housing units were started in 1965—down 3 per cent from 1964. Possibly because of mild weather in some areas of the U. S., December starts jumped to 101,000, compared to 96,700 in 1964.

Nobody should ignore the contribution of state and local governments to the construction economy. According to the Commerce Department, in the 12 months ended in September 1965, these groups spent \$17,400,000 on construction. And there are numerous indications that the spending rate has increased.

So far, there's little indication that recent increases in interest rates on loans have tightened money available for construction. One indicator seemed to suggest quite the contrary: FHA said its application volume was a record 1,100,000 in 1965.

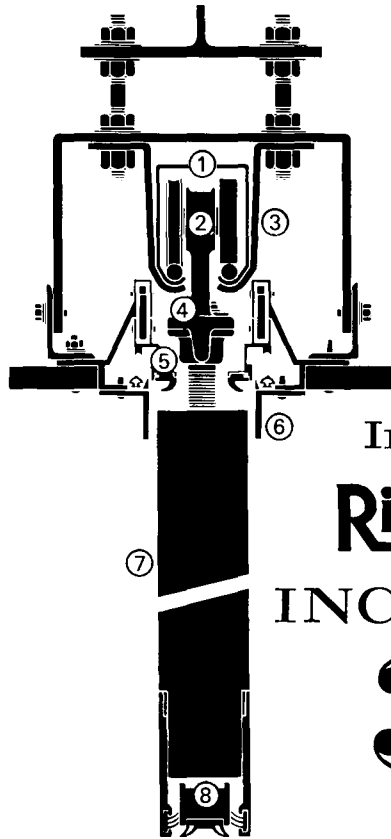

## Introducing the **Richards-Wilcox** INCOMPARABLE **380**

**A NEW DIMENSION IN OPERABLE CLASSROOM WALLS**

**All mechanical . . . and yet, it opens and closes so easily even a 90 lb. teacher can do it . . . effortlessly.**



### The ultimate in simple operation and sound control

1. Sturdy R-W special design No. 888 track made of 9-gauge steel—the strongest track being used by any maker of movable walls.
2. R-W special design hanger for ease of operation. Four sealed ball bearings, plus thrust bearing, virtually eliminates starting or rolling friction.
3. Cold-rolled bar runways minimize friction. Self-cleaning track, no maintenance.
4. Friction-free thrust bearing makes folding action of panels easy.
5. Continuous retractable 4-point top sound seal locks into place.
6. Durable aluminum top guides eliminate maintenance.
7. Sound retardant wall ratings as specified. Choice of panel surfaces.
8. Fully retractable floor seals. No floor track, dragging seals, motors, electrical fixtures, pneumatic or hydraulic operation.

WRITE FOR BULLETIN F-266

**HUPP**  
CORPORATION

**RICHARDS-WILCOX DIVISION**  
120 THIRD ST. • AURORA, ILLINOIS 60507

On Readers Service Card, circle No. 456

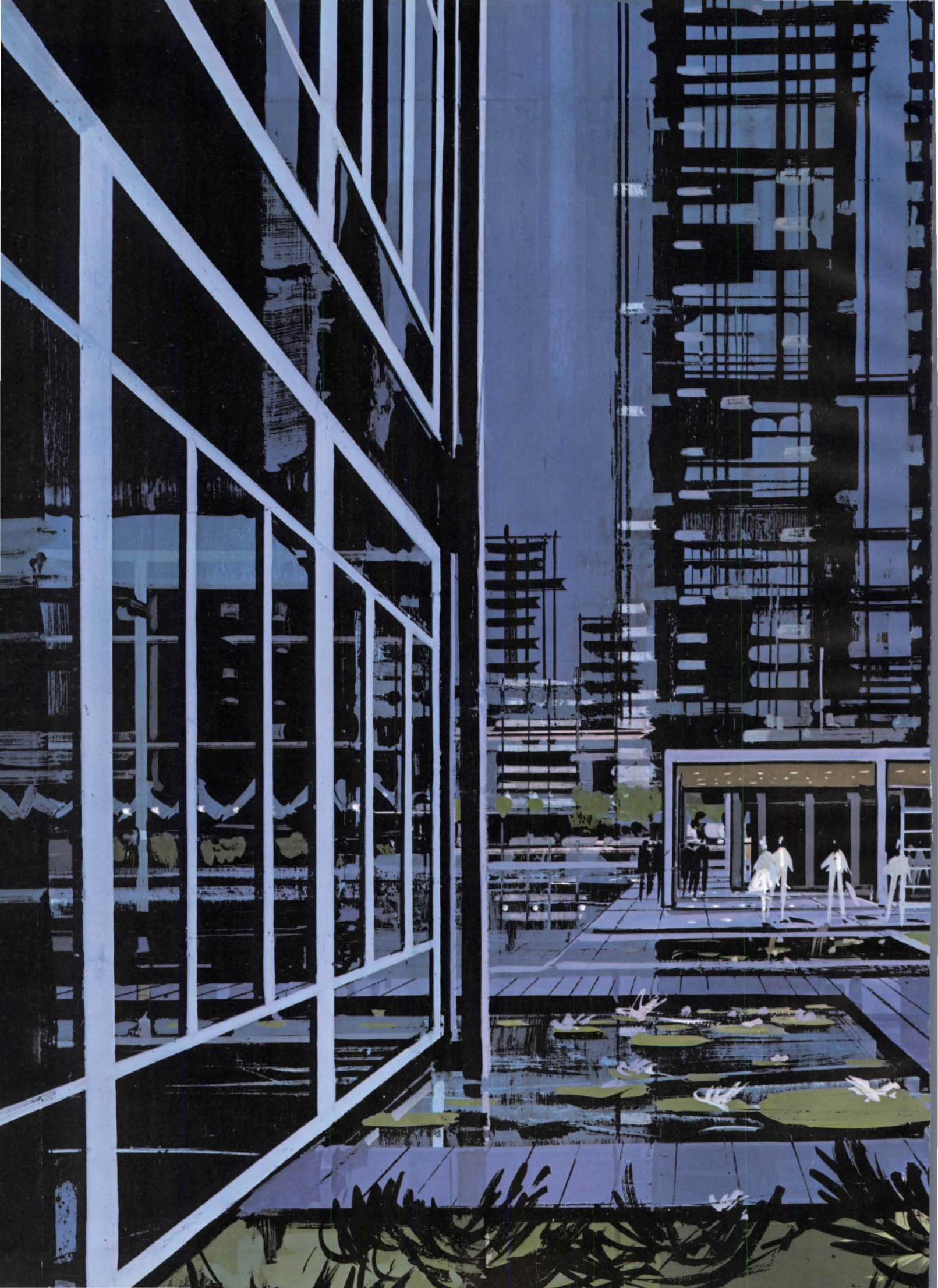



This steel window won't rust.

It's finished  
in polyvinyl  
chloride.

Polyvinyl chloride is impervious to moisture. We put it on our window four times as thick as paint, using a Ceco-researched method, an exclusive process. This is a resilient finish. It doesn't crack or chip. It gives. We call it Cecoclاد. There is no other finish like it.

The Cecoclاد window is in the price range of a galvanized-and-painted steel window and a hard-coat-anodized aluminum window. The Cecoclاد window needs practically no maintenance. Your client can keep it looking brand new by washing it down with water when the glass is washed. That's all.

We'll be glad to sell you whatever window you want. We make them all. But if you'll take our unbiased advice, you'll specify the Cecoclاد window. It's incomparable.

Send for colors, test data, specifications, samples and comprehensive list of projects built with Cecoclاد windows throughout the country. The Ceco Corporation, general offices: 5601 West 26th Street, Chicago, Illinois 60650. Sales offices and plants in principal cities from coast to coast.



**CECOCLAD / STEEL WINDOWS**

encased in colored polyvinyl chloride four times thicker than paint.

**Trapezoids—  
design flexibility with  
Therm-O-Proof  
insulating glass.**

The trapezoids in this residence are an example of the more than 200 different design combinations possible with Therm-O-Proof insulating glass.

This wide variety of sizes, shapes and types of glass lets you design with insulating glass in more ways than ever before.

Your building schedule is important to us, also. Popular standard sizes are shipped in three days, and most non-standard sizes in three weeks or less.

The quality of every Therm-O-Proof unit is backed by a 10 year warranty.

Include Therm-O-Proof insulating glass in your specifications



Robert G. DeRue, M.D., Residence  
Sandusky, Ohio.

**Therm-O-Proof**  
INSULATING GLASS

Made more ways—  
to fit more ideas.

See Sweets 7a  
Th

Thermoproof Glass Company  
4815 Cabot Avenue  
Detroit, Michigan 48210  
Subsidiary of:  
Shatterproof Glass Corp.  
44 years of glass experience

On Readers' Service Card, circle No. 406

Again the choice is  
**VERDIN BELLS**

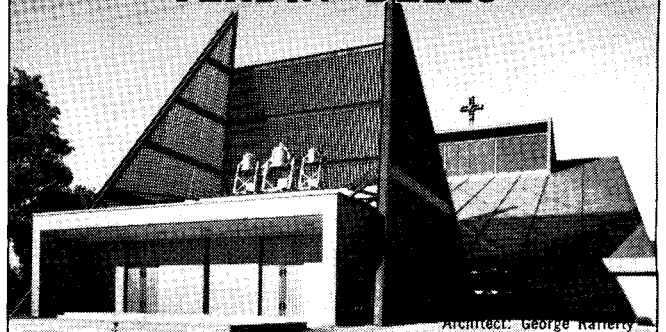

Architect: George Hartley

Peal of three Verdin Bronze Bells with automatic ringers  
**ST. JUDE CHURCH, Grand Rapids, Mich.**

- AMERICA'S MOST BEAUTIFUL BELLS
- AVAILABLE IN SINGLE BELLS, PEALS, CHIMES AND CARILLONS
- FULLY AUTOMATIC RINGING
- VERDIN BELLS AND BELL RINGING NOW IN OVER 6500 CHURCHES
- COMPLETE ARCHITECTURAL CO-OPERATION

Write for  
brochure  
illustrating  
unusual bell  
arrangements.

THE I. T. VERDIN CO.  
2021 Eastern Avenue. • Dept. M  
Cincinnati, Ohio 45202

**VERDIN** "THE BELL RINGERS OF AMERICA"  
CARILLONS—CHIMES—PEALS

On Readers' Service Card, circle No. 408

**REINHOLD**

**DESIGN AND FORM:  
THE BASIC COURSE  
AT THE BAUHAUS**  
by Johannes Itten.  
7 3/4 x 10 3/4. 200 pages.  
160 illustrations. \$12

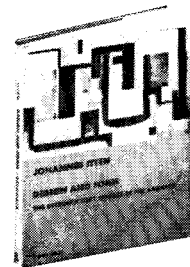

A complete description of the content and purpose of the famous "Introductory Course" at the Bauhaus, by the man who established it. Used as a trial semester to judge incoming students of varying educational backgrounds, the purpose of this course was three-fold: to determine creative talent; to facilitate choice of career; to teach elementary design.

REINHOLD BOOK DIVISION  
430 Park Avenue, New York, N.Y. 10022

## PRODUCTS

### Brains for Buildings

Computers can now take over complete control of mechanical and electrical systems for large buildings. Centralized equipment for monitoring and adjusting all services will be installed for the first time in Main Place, a complex of buildings under construction in Dallas, Texas.

The Dallas system is one of four recently developed by Honeywell to handle the control of any project from a high-rise office building to a 40-building network.

All four systems are built around a compact console (4' x 4' x 2' deep). From this console, an operator can "lock in" on as many as 250 systems with 10 or more checkpoints each. When the desired system is located by means of a push-button code, its schematic is projected on a screen. The selected system can then be turned off or on, temperature set point adjusted, or damper position changed. Only one set of switches for temperature set point and damper positioning is required on the central panel. Two-way intercom, digital clock, and an alarm annunciator are built into the console.

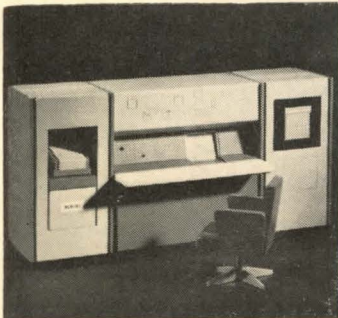

System 10, least automated of the four, controls up to 100 systems. It can tell actual temperature set points and damper positions, and operator can make adjustments. A solid-state scanner alerts operator to off-normal conditions with an audible alarm and then prints out information. A multichannel recorder can automatically record temperatures for making system analyses or to observe trends.

System 11 is similar to the 10 but is equipped with a memory; automatic off-on programming is optional.

System 20 has what Honeywell calls "cerebral centralization," and is all solid state. It

has off-on programming, a digital computer for high-speed data acquisition, and digital computer for summing



up variables, such as energy totals, on the run. It is capable of operating up to 250 remote mechanical systems with 10 or more checkpoints each and can scan up to 10,000 points per minute. Critical points are examined more frequently. Two electric printers offer uninterrupted logging of information on points scanned at set intervals, plus alarm readings noting time, type, location, and value.

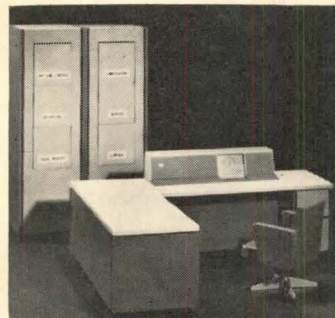

System 20 is engineered to grow into System 30 by adding a drum memory and direct on-line control with a computer. Fully automated controls analyze performance, compare it with ideal conditions, and make necessary adjustments to keep system running at peak efficiency. It keeps one eye on mechanical systems and the other on variables such as outside temperatures, interior heating and cooling loads, fuel and power costs. It automatically makes decisions on economic factors, such as whether it would be cheaper to run the air conditioning all night or to shut down the chillers and start up early in the morning.

All systems are equipped with a manual control, so that an operator has the final judgment if necessary. Honeywell, Inc., Minneapolis, Minn. 55408.

*On Readers' Service Card, Circle 100*

### Air/Temperature

#### Big Boiler

Commercial gas-fired copper hydronic boiler has capacity of 670,000 Btuh. Dual temperature controls and dual gas valves prevent waste heat by dropping gas input to 40% of capacity when water temperature approaches set point. Largest in manufacturer's commercial hydronic line, the boiler weighs 330 lb when full of water. A. O. Smith Corp., Kankakee, Ill.

*On Readers' Service Card, Circle 101*

#### Big Coolers

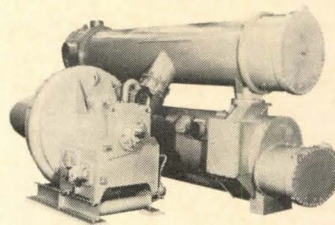

Two series of centrifugal water chillers extend the range of comfort cooling equipment from 450 tons to 5000 tons. Some 27 models of these single-compressor, open machines, which use inexpensive refrigerants, can be powered with a wide variety of prime movers. Rigid shafts allow fast speeds without vibrations of conventional flexible shafts. Carrier Corp., Syracuse 1, N.Y.

*On Readers' Service Card, Circle 102*

#### Air Curtains for Industry

Cold air is stopped at open doors in plants and warehouses by air heated by steam or hot water coil units or direct gas-fired burners. In summer, "Miniveil" can be used to reduce inflow of hot, humid air from outside. Berner Industries, Inc., New Castle, Pa.

*On Readers' Service Card, Circle 103*

### Construction

#### White Masonry Cement

White cement, designed for mixing masonry mortar, will not stain limestone blocks or

panels. Colored mortar can be made by adding pigments to the white masonry mortar. White masonry cement contains gypsum to regulate setting time; an air-entraining agent to provide plasticity, water-retention, and durability in the mortar mix; and a water-repellent additive. Universal Atlas Cement, Div. of United States Steel Corp., 100 Park Ave., New York, N.Y. 10017.

*On Readers' Service Card, Circle 104*

### Doors/Windows

#### Door Core

Flush interior door with solid core of low-density particle-board is said to have excellent fire and sound-dampening characteristics. May be veneered with any available hardwood species. Weyerhaeuser Co., Tacoma, Wash. 98401.

*On Readers' Service Card, Circle 105*

#### Patterned Steel Door

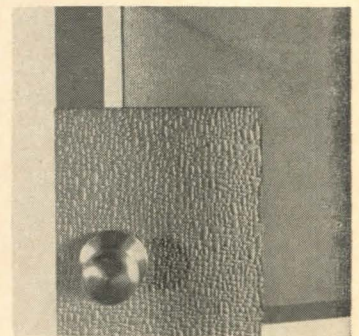

An embossed pattern stiffens 20-gage steel plates sufficiently to form a sandwich-type flush door. The plates are bonded to a phenolic resin impregnated Kraft honeycomb core. Door is available in 1 3/8" or 1 3/4" widths and can carry a three-hour "A" label fire rating from the Underwriters' Laboratories, according to the manufacturer. Steelcraft Mfg. Co., 9017 Blue Ash Rd., Cincinnati, Ohio. 45242.

*On Readers' Service Card, Circle 106*

#### Fermez la Porte

Slim door closer has simple lines suitable for offices, motels, or any room where a neat appearance is important. Available in brushed brass or brushed aluminum; other fin-

# Want the most from electric heat? Consider Styrofoam.

That's because an installation system using Styrofoam® brand insulation board doesn't make demands on floor space the way other insulations do. The combination of properties offered by Styrofoam makes it unusually effective. So much so that you get more permanent insulation value per square inch, and get a maximum of usable floor space, too. How else is Styrofoam good for electric

heat? Once in, Styrofoam is in for good because it doesn't rot, mold, or deteriorate. It needs no vapor barrier. It's flame retardant. And is lightweight and easy to install. Where does Styrofoam insulation go? Just about anywhere. Over walls of unit masonry or poured concrete, as form liners for conventional concrete, in foundations and slabs. And it makes an excellent base for gypsum wallboard,

wood paneling or plaster. Have we almost made a sale? Then to clinch it, write us or consult Sweet's Architectural File 10a/Do. The Dow Chemical Company, Plastics Sales Department, Midland, Michigan 48640.

---

Styrofoam is Dow's registered trademark for expanded polystyrene produced by an exclusive manufacturing process. Accept no substitutes... look for this trademark on all Styrofoam brand insulation board.



(It's the least  
you can do.)





ishes are made to order. Shelby Corp., East Smiley Ave., Shelby, Ohio. 44875.

*On Readers' Service Card, Circle 107*

## Electrical Equipment

### On the Up and Up



In-the-ground fixtures for up-lighting of trees, monuments and buildings are concealed except for grate openings. Said to be tamperproof and easily focused, fixtures are available for incandescent, quartz iodine, or mercury lamps. Stonco Electric Products Co., 333 Monroe Ave., Kenilworth, N.J. 07033.

*On Readers' Service Card, Circle 108*

### Don't Bug Me!

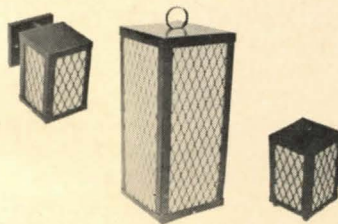

Plastic lens "hides" light of ordinary incandescent bulbs from insects. White light from post and portable fixtures using lens, apparently cannot be seen by insects, thus eliminating their swarming around outdoor fixtures. Meredith Separator Co., 707 Helmers Ave., Cleveland, Mo. 64734.

*On Readers' Service Card, Circle 109*

## Finishes/Protectors

### A Glittering Façade

"Diamond Dust" or "Tinsel" irregularly shaped glass flakes are used for light-reflecting effects on cement or asphalt walks and patios; building façades; and walls, ceilings, and other interior applications. Flakes are available in sizes ranging from .0037" to .139". Material can be sprayed or dusted on the surface of cement or plaster while it is still wet; secured to walls, ceilings, or other surfaces with standard, commercially available adhesives. Flake colors are red, green, blue, silver, yellow, copper, and clear. All colors are bleedproof and fade-resistant. Permafrost Corp., P.O. Box 569, West Caldwell, N.J. 07007.

*On Readers' Service Card, Circle 110*

### Silicone Topping

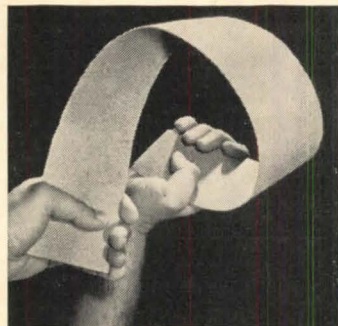

Silicone rubber material vulcanizes to a flexible concrete-like substance. It is water-resistant, and, with a primer, may be used as a protective coating over concrete, steel, or wood. "Silicone Traffic Topping" is recommended to be trowelled onto horizontal surfaces, and may also be used as a grout for tile and stone, or to repair cracks. It is available in fade-resistant colors. General Electric, Silicone Products Dept., Waterford, N. Y.

*On Readers' Service Card, Circle 111*

## Furnishings

### The Perfect Couples

Two recent marriages in the vinyl wall-covering field are Durawall's Suwide and Vyn-dura with "Tedlar," DuPont's nonstainable coating. In addition to the many textures and colors offered, the manufacturer claims almost every de-

sirable property one could demand: it is stainproof, insuring easy and low-cost maintenance, and has great elasticity, will shrink or stretch with the substrate in extreme temperature variations, as well as being impact- and tear-resistant. Durawall, Inc., 509 Madison Ave., New York, N.Y.

*On Readers' Service Card, Circle 112*

### Mexicana

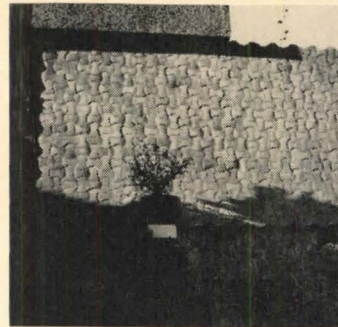

Hand-made wall and floor tiles from Mexico are offered in a variety of shapes, patterns, and colors. Both glazed and unglazed tiles are said to be highly wearable and frostproof, thus suitable for commercial and outdoor installations. Delivery from 50-80-days (limited selection available for immediate delivery), custom specifications. Elon Imports, 1428 Lexington Ave., New York, N.Y.

*On Readers' Service Card, Circle 113*

### That Scandinavian Look



Among ICF's interesting and comfortable Scandinavian furniture are: a strong, simple, all-wood chair designed by Olavi Hanninen; it is quite simple and has been used in seminars because of its obvious symbolism. Two neat and distinctive upholstered executive chairs, one by Yrjo Kukkapuro and the other by Olli Mannermaa, are available on alumi-

num swivel bases on legs. Secretarial chairs with whimsical and comfortable arm rests designed by Olli Mannermaa have completely adjustable seat, back, and height, plus aluminum base. Also offered is a cast bronze pedestal base with a hobnail pattern that gets polished, not scraped, as shoes scuff it; designed by Yrjo Kukkapuro, it can be used for restaurant tables, bar stools, or for other standards. ICF, 145 E. 57th St., New York, N.Y.

*On Readers' Service Card, Circle 114*

### Square Furniture

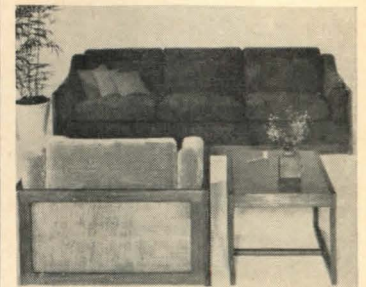

Designer Folke Ohlsson aims to combine the architectural cube with the "luxurious soft look" in a furniture group which consists of a lounge chair, ottoman, three-seat sofa, and three tables. The cube group items have walnut frames, optional cane or wood panel inserts, and polydacron cushions; tables feature hand etched brass tops to combine craftsmanship with resistance to heat and stains. Dux, Inc., Burlingame, Calif.

*On Readers' Service Card, Circle 115*

### Temporary Furniture for Temporary Needs



Ideal for toys, books, soft goods, and all sorts of paraphernalia, is Design Workshop's functional, low-cost (retail: \$10), disposable storage system. The system is composed of six 12" rigid craft-board modules (white) with three removable shelves and supporting struts of colorful plastic; it is easily assembled

without tools. The Design Workshop, P.O. Box 7974, Kercheval Station, Detroit, Mich.

*On Readers' Service Card, Circle 116*

## Portable Exhibits



Aluminum telescoping legs and 2' x 4' foam-plastic panels permit fast showing of photos, posters, etc. (which are stapled on beforehand). The units, which are obtainable in any number of panels and legs, can be formed into a convention booth or island, and into wall-covering displays. Each unit weighs less than 4 lb, and all units fit into a carrying case 2' x 4' that is easily portable. Porta-Panel, 12 E. Grand, Chicago, Ill.

*On Readers' Service Card, Circle 117*

## On Their Metal



Office Spann II is an "architectural" line of desks, cabinets, and chairs of steel construction in a variety of colors and with a choice of seven wood or leather-grain plastic laminate tops. The desks offer an abundance of leg room, and have brushed chrome legs and drawer pulls (nonsnag rounded corners). Chairs have deep foam seats and backs. Simmons Co., Merchandise Mart, Chicago, Ill.

*On Readers' Service Card, Circle 118*

## Vinyl Masonry

"Coarse Texor," a vinyl wall-covering simulating sand plaster or fine stucco, is available in a good range of 18 colors, including three shades of white.

The material is said to be color-fast, stain- and fade-resistant, and is easily cleaned. Interchemical Corp., Coated Fabrics Div., Toledo, Ohio.

*On Readers' Service Card, Circle 119*

## Folded Rhythms

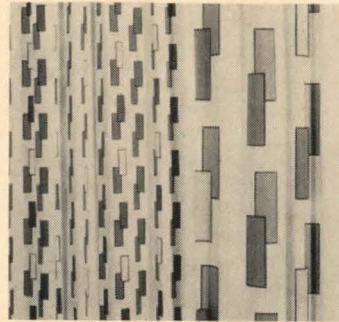

Architect Alden Dow has designed a group of printed drapery fabrics based on rhythmic repetition of geometric elements. The designs are silk screened on linens, Sarans, and cottons in open and closed weaves; colors are formulated to designers' needs. Samples on request. Edwin Raphael Co., Inc., Infinity Lane, Holland, Mich.

*On Readers' Service Card, Circle 120*

## Veil of Tears

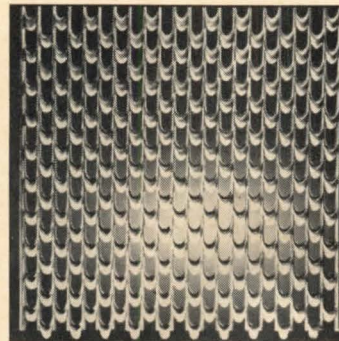

Among a series of molded-and-pierced, lightweight panels is one that is a new interpretation, in new materials, of ancient imbrication—"Tear-drop" (illustrated). Panels are usable both outdoors and indoors and are finished on edges and both sides. Approximately 2' square, they vary in thickness from 3/8" to 1 3/8" and weigh from 2-2/3 lbs to 8 1/2 lbs. Galway, Inc., Contract Div., 320 W. Ohio St., Chicago, Ill.

*On Readers' Service Card, Circle 121*

## Insulation

### One-Ply Vapor Barrier

A single-sheet vapor barrier, used instead of a conventional

two-ply, asphalt-mopped system, is said to cut the overall application cost 30 per cent. "Vaporstop 710" is an extensible Kraft, polyethylene-laminated sandwich with edges reinforced with glass fiber. Its moisture vapor transmission rate is 0.28 perms. Vaporstop 710 is recommended as a vapor barrier on any roof deck except Class I metal deck construction. Manufacturer claims that Vaporstop has inherent ability to stretch, and tensile strength that prevents ruptures and preserves the barrier when expansion occurs. The material resists moisture entrapment and absorption, and also resists the heat of asphalt during application. St. Regis Paper Co., Sisalkraft Div., Attleboro, Mass.

*On Readers' Service Card, Circle 122*

## Cryogenic Insulation

"Series 200" urethane foam insulation can be used for special cryogenic applications in environments as frigid as -450 F. Material is a two-component, polyester fluorocarbon-blown rigid foam that, manufacturer says, has a high strength-to-weight ratio, maximum dimensional stability, and minimum shrinkage and collapse at cryogenic temperatures. K-factor ranges from 0.13 for 1.5 density foam to 0.34 for 16 lb density foam when measured at 74 F. K-factor decreases proportionately with temperature at cryogenic levels. Manufacturer claims that less than half the thickness usually required for conventional insulation may be specified for 200 Series cryogenic foam. Upjohn Co., 555 Alaska Ave., Torrance, Calif.

*On Readers' Service Card, Circle 123*

## Sanitation/Plumbing

### A Three-Wall Stall

Fiberglass shower stall consists of floor, three walls, and seat molded into 60"-wide by 75"-high unit. Seam-free construction prevents water leakage. Available in six colors. Universal-Rundle Corp., New Castle, Pa.

*On Readers' Service Card, Circle 124*

## Self-Seal Sink . . .

. . . fits directly over countertop. Eliminating metal trim means faster, more economical installation. Available in single

or double compartments in several colors of enameled iron. Kohler Co., Kohler, Wis.

*On Readers' Service Card, Circle 125*

## Red Hot/Cold Blue

Color disc in lavatory and shower faucets shows red for hot water, blue for cold and part red, part blue for mixed temperatures. A single push-pull acrylic dial controls off and on flow. Fixtures in solid brass with chromium finish. Speakman Co., Wilmington, Del.

*On Readers' Service Card, Circle 126*

## Down the Drain

Redesigned garbage disposer reduces splash back into sink, is said to be quieter and corrosion-resistant. A 1/2-hp motor powers high-strength shredder. In-Sink-Erator Manufacturing Co., 4700-21 St., Racine, Wis.

*On Readers' Service Card, Circle 127*

## Services

### Translucent Hangar Doors



Vinyl-nylon sandwich doors let light into airplane hangars, are said to be secure in winds up to 80 knots and unaffected by extreme temperatures. Electric motors roll 90' x 25' doors up or down in two minutes. Quiet operation, freedom from jamming due to ground heave, small storage space, and economy are said to be some of the advantages. Shown is installation at Cincinnati Lunken Air Transportation Center (doors closed). R.L. Kuss & Co., Findlay, Ohio.

*On Readers' Service Card, Circle 128*

## Walls of Glass and Epoxy

Chunks of stained glass are embedded in a matrix epoxy

# LEAD establishes a new sound barrier

Today, foreign sounds invading your privacy need not be tolerated in office or factory. Thin-sheet lead, used as a plenum or over-ceiling barrier effectively reduces noise transmission from one area to another. Tests have confirmed that thin-sheet lead used as a plenum sound barrier as in the State Street Bank's new Boston headquarters (illustrated below) is acoustically superior to any other conventional building material.

The movable partitions in this \$30-million concrete and glass tower were terminated at a hung ceiling height, creating a plenum space immediately above. Then, thin sheets

of non-porous, naturally limp lead were hung from the slab and dropped to the partitions below. The result was unmatched sound attenuation, substantially reducing the transmission of air-borne noise. And thin-sheet lead is workable . . . cuts easily simplifying installation around ducts, piping and conduits. Furthermore, lead is economical and salvageable.

For additional information write for our Practical Application of Sheet Lead For Sound Barriers brochure. Dept. N-3, Lead Industries Association, 292 Madison Ave., New York, New York 10017.

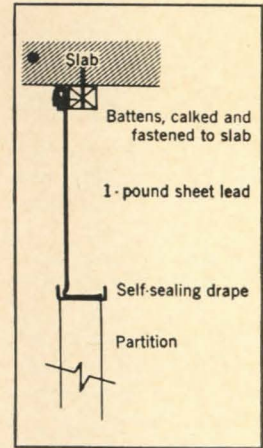

**LEAD INDUSTRIES ASSOCIATION, INC.**

On Readers' Service Card, circle No. 366

*Look Ahead with Lead*

Gypsum Partition & Lead Barriers: Wallboard Construction Co., East Natick, Mass.

Office Planning & Design: Rodgers Associates, New York

Associate Architects: Eggers and Higgins, New York

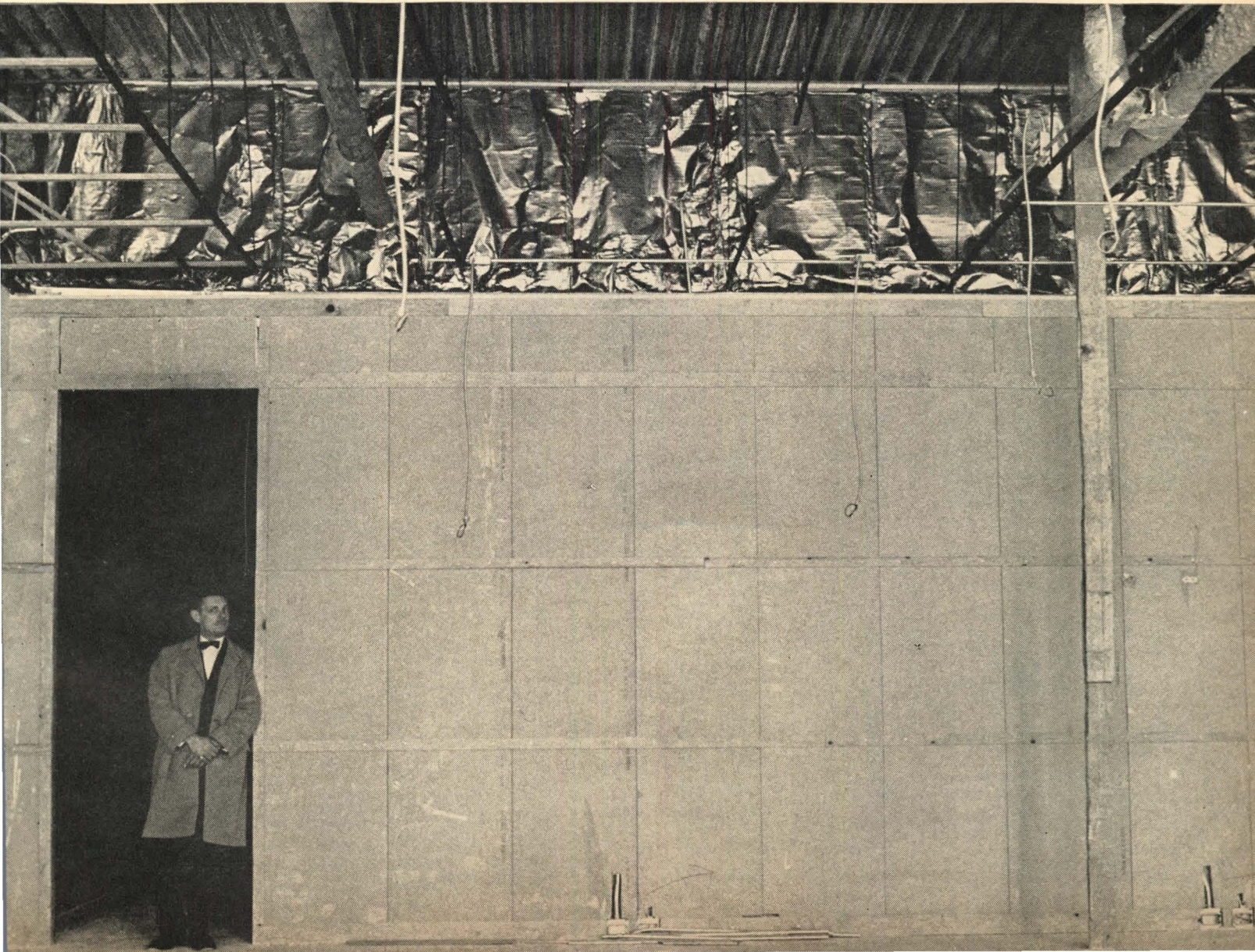



resin for church window-wall panels. Cast glass (approximately 1" thick) is chipped or faceted on interior face to disperse light passing through window. Set in modular steel frames, the glass and epoxy binding are reinforced with steel rods. Conrad Schmitt Studios Inc., 1325 S. 43 St., Milwaukee, Wis. 53214.

On Readers' Service Card, Circle 129

## Special Equipment

### Handrails Wood Rather Be Vinyl

Vinyl handrail in dark, wood-grain finish called Brazilian Walnut is available in six profiles for flat bar and channel installations. RC Div., Hooker Chemical Corp., Hicksville, N.Y.

On Readers' Service Card, Circle 130

### Highly Irregular Ice

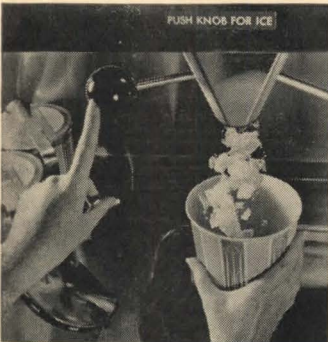

"Hospital Ice Station" dispenses two sizes of ice in irregularly shaped granules. Floor- or wall-mounted models produce 350 lb of ice per day at 15 lb per hr. Market Forge Co., 35 Garvey St., Everett, Mass.

On Readers' Service Card, Circle 131

### Economy Intercom

For buildings containing up to 32 apartments, the "Phonette System" increases tenant security at low cost, claims manufacturer. Package includes

two-way speaker system between lobby and each apartment; main entrance release button for each tenant; small power supply cabinet and door release. Auth Electric Co., Inc., 34-20 45 St., Long Island City, N.Y. 11101.

On Readers' Service Card, Circle 132

### Executive Touch

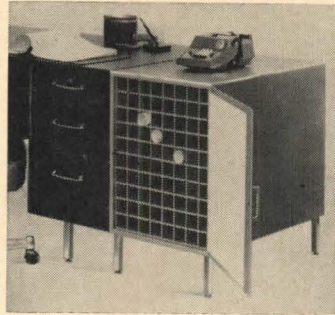

Furniture-coordinated file makes plans easily accessible to a man at his desk. Desk-height steel cabinet is available with twenty 4½"-square cubicles or with eighty 2½" cubicles. Finished in 11 colors; wood-grain vinyl top optional. Plan Hold Corp., 21611 Perry St., Torrance, Calif.

On Readers' Service Card, Circle 133

### Molded to Match

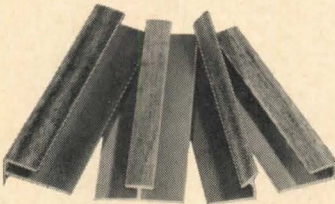

Wood-grain vinyl moldings in several profiles can be furnished to match paneling. The rigid vinyl is said to be resistant to chemicals, scratching or chipping, and to be easy to work with. Colorful pattern finishes are also available. Jarrow Products, Inc., 2000 North Southport Ave., Chicago, Ill. 60614.

On Readers' Service Card, Circle 134

### New Math—Electronic Style



"Victor 3900" electronic calculator can add, multiply, subtract, or divide. The calculations and results show on a 4" x 2½" illuminated screen that can accommodate 20-digit figures. The machine features five display registers: three calculating registers show the two factors and the result in the lower three rows in logical sequence; two storage registers hold running totals, or constants for repeated use. Another feature is an automatic round-off/drop-off that provides accurate answers to whatever decimal place is selected up to 15 before dropping unwanted decimal places. Weighs 25 lb. Victor Comptometer Corp., 3900 North Rockwell St., Chicago, Ill. 60618.

On Readers' Service Card, Circle 135

### Safety Mat for Playground Equipment



"Safety-Surf," a 1"-thick interlocking rubber matting, provides permanent, maintenance-free installation beneath playground equipment, says the manufacturer. A waffle-like network of honeycombed ribbing on the underside of the matting absorbs impact of children's bodies. Safety-surf is available in 2' squares, and can be installed with recessed bolts over any hard-surfaced base. Matting is nontoxic and cannot harbor rodents or insects. Mitchell Rubber Products, 2120 San Fernando Rd., Los Angeles 35, Calif.

On Readers' Service Card, Circle 136

### Surfacing

#### Par for the Clubhouse

"Par" spike-resistant carpeting, designed especially for country-club locker rooms, bars, and pro and coffee shops, meets the challenge of spiked golf

shoes. Sheared virgin nylon is fused to an extra-tough ¼" vinyl base; the carpet rebuffs dirt, as well as spikes. "Par" is available in three tweed colors: beige, gray, and red in roll lengths up to 90'. International Rubber Corporation, 83 High St., Boston, Mass.

On Readers' Service Card, Circle 137

### Carpet Unaffected by Golf Shoes

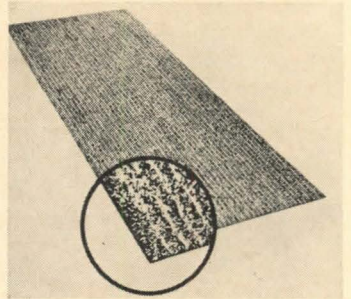

"Deluxe Heavy Duty Nylon-On-Vinyl Matting" is a 100 percent cut-pile nylon, permanently bonded to a ¼"-thick vinyl backing. Cut-pile nylon is nonflammable, does not catch high heels or spiked shoes, and is easily cleaned. Matting does not break, crack, rot, or become brittle; it is said not to be affected by grease or chemicals. Gray or beige tweed stripped or red tweed designs are available in 34", 46", or 70" widths and in any length up to 30'. Matting has flush-finished edges and no borders. R. C. Musson Rubber Co., Akron, Ohio. 44306.

On Readers' Service Card, Circle 138

### Step Softly

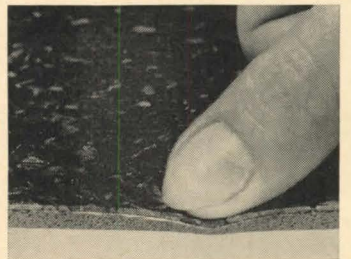

Three-layer vinyl flooring has foamed vinyl cushion back for comfort, noise reduction, and warmth. Top layer is inlaid vinyl chips, and second layer is glass fiber to protect against dents from furniture or sharp heels. Noise reduction is said to be considerable. 8 colors. Armstrong Cork Co., Lancaster, Pa.

On Readers' Service Card, Circle 139

**A HILLYARD SPECIFICATION  
FOR RECREATION AND  
ATHLETIC FACILITIES**

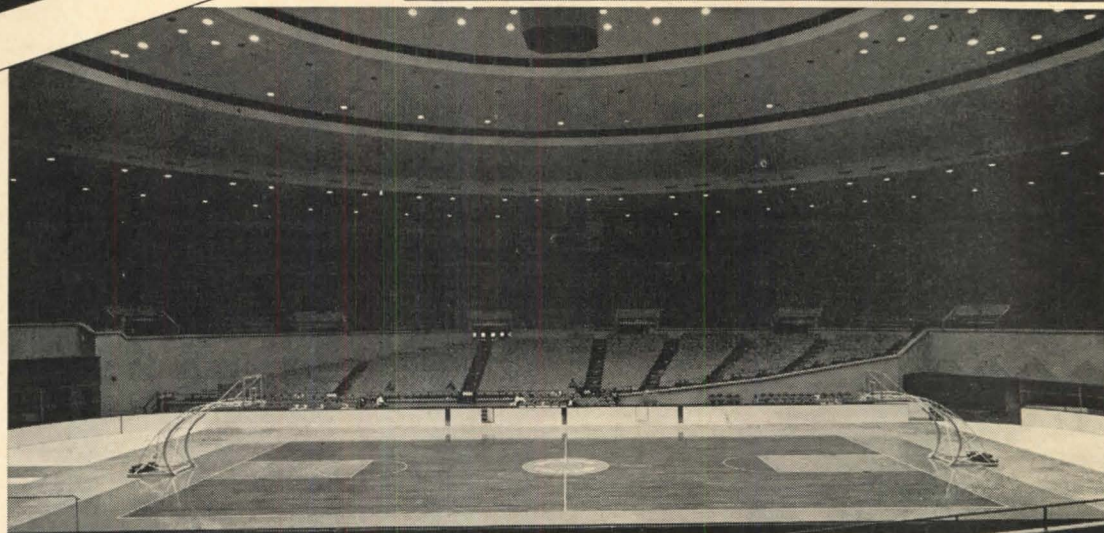

New Mid-South Coliseum, Memphis, Tenn. / Architects: Furbringer & Ehrman; Robert Lee Hall & Assoc.

**HAVE A HILLYARD ARCHITECTURAL CONSULTANT  
DETAIL SPECIFICATIONS ON  
TROPHY<sup>®</sup> GYM FLOOR FINISHING**

**DESCRIPTION:** A seal and a finish specially formulated for wood gymnasium floors to give a light, durable, slip resistant playing surface that will resist rubber burning and marking.

**SPECIFICATION AND HOW TO APPLY:** An epoxy seal and finish. Apply with lambswool applicator. Seal coat fills porous wood surface. Additional seal coat may be required on highly porous wood. Game markings, using Hillyard Gym line paint, are painted in before finish coats are applied. Two finish coats are required. See Sweets Arch. File for detailed specification.

**COVERAGE (Average):** Trophy Seal — 350 sq. ft. per gallon. Trophy Finish — 500 sq. ft. per gallon.

**TECHNICAL DATA:** N.V.M.: Trophy Seal—28%, Trophy Finish—40%. Color: Gardner (typical) 4-5 (extremely light). Drying time: 7 hours to overnight (depending on humidity). Produces a glare free surface with proper light refraction. Exceeds all standards for abrasion resistance.

Non-darkening—eliminates need for removing or sanding off finish for 10-15 years.

**GUARANTEE:** Controlled uniformity. Vacuum-packed. When applied according to directions and under supervision of a Hillyard representative, all claims for the product are guaranteed—provided containers are received at job site with factory seal unbroken.

**MAINTENANCE:** Regular treatment with Hillyard Super Hil-Tone dressing for conditioning and dust control.

**APPROVALS:** Maple Flooring Mfrs. Assn., Institutional Research Council. Listed by Underwriters' Laboratories as "slip resistant". In use: 12 years on all major basketball tournament floors.

**REFERENCES:** Sweets Architectural File, section 13n Hi

A.I.A. File No. 25G  
A.I.A. Building Products Register

*Free follow-up "job captain" service protects your specifications. A graduate Hillyard Architectural consultant will gladly consult with your specification writers on proper, approved procedures and materials for the original treatment of any type floor you specify. Write, wire or call collect.*



**HILLYARD  
FLOOR TREATMENTS**

ST. JOSEPH, MISSOURI U.S.A.  
TOTOWA, NEW JERSEY  
SAN JOSE, CALIFORNIA



SINCE 1907

*The most widely recommended and approved treatments for every surface*

On Readers' Service Card, circle No. 358

**Living proof it's waterproof!**



# FOAMGLAS<sup>®</sup> roof insulation is completely waterproof. See for yourself. Send for your free FOAMGLAS planter.\*

We made this little conversation piece for you out of FOAMGLAS Cellular Glass Roof Insulation. We're offering it—complete with palm plant—so you can put it on your desk, water the plant as often as you need to (or want to) and see for yourself: our claim holds water. FOAMGLAS is absolutely waterproof. It's the only completely waterproof insulation.

All other roof insulation will absorb moisture if the roof leaks or if vapor migrates from within the building. That can mean expensive repairs or replacements. FOAMGLAS stays dry and always keeps its original efficiency.

FOAMGLAS is guaranteed for 20 years. Once it's down on your client's roof, he's protected.

Send for your free FOAMGLAS planter. And learn about the new bevel-edged FOAMGLAS-BOARD.

In Western Europe, Foamglas<sup>®</sup> cellular glass insulation is manufactured and sold by Pittsburgh Corning de Belgique, S.A., Brussels.

Pittsburgh Corning Corporation  
Department PP-36  
One Gateway Center  
Pittsburgh, Pa. 15222

- Please send "Living Proof" Foamglas planter.\*  
 Please have your representative call.

Name \_\_\_\_\_ Title \_\_\_\_\_

Firm \_\_\_\_\_

Address \_\_\_\_\_

City \_\_\_\_\_ State \_\_\_\_\_ Zip Code \_\_\_\_\_

\*Due to customs regulations, offer good only in continental United States.

**PITTSBURGH** **PC** **CORNING**

On Readers' Service Card, circle No. 452

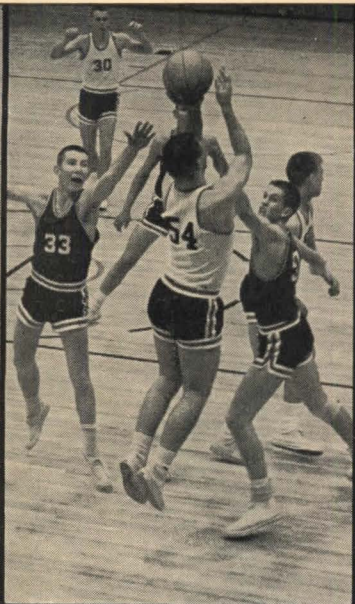

**NEW! ROBBINS**  
**LOCK-TITE®**  
**FLOOR SYSTEM**

- 33/32" T&G Maple flooring
- LOCK-TITE flooring clip
- LOCK-TITE steel channel
- Resilient insulation board
- Vaporproof film

**For gymnasiums, stages, shop floors,  
 bakeries, manufacturing plants**

Robbins LOCK-TITE is an improved mechanically-fastened wood floor system at lower cost. Dimensional stability results from completely integrated design of 33/32" MFMA Northern Hard Maple flooring locked into steel channels anchored to slab. Asphalt-impregnated insulation board isolates the slab, improves rebound action through more uniform resilience, and reduces sound transmission. All installations of LOCK-TITE Floors are made and jointly guaranteed by Robbins and authorized Robbins floor contractors throughout North America. Mail coupon for complete data.

ROBBINS FLOORING COMPANY  
 Dept. PA-366  
 White Lake, Wisconsin 54491

Send complete information on the Lock-Tite floor system  
 Advise name of authorized installer in this area

Name \_\_\_\_\_  
 Firm \_\_\_\_\_  
 Address \_\_\_\_\_

**ROBBINS**   
*flooring company*  
 Subsidiary of E. L. Bruce Co.

On Readers' Service Card, circle No. 389



# MANUFACTURERS' DATA

## Air/Temperature Fin-Coil Units

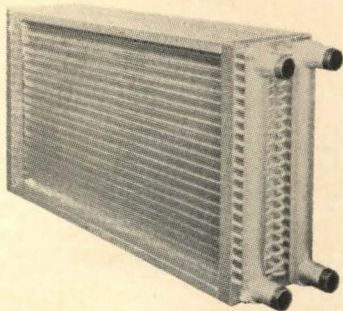

Two-part booklet covers fin-coil units constructed of copper tubes and aluminum or copper fins for systems using: (1) water for heating and cooling; and (2) R-12 or R-22 refrigerant for cooling and dehumidifying. Booklet contains photos, comprehensive charts, graphs, and tables giving performance and selection data, and information on installation and maintenance. 60 pages. Westinghouse Electric Corp., Sturtevant Div., Hyde Park, Boston, Mass. 02136. *On Readers' Service Card, Circle 200*

## Construction Redwood Siding



Photos illustrate varied use of redwood siding in residential work. Pamphlet describes redwood grades, finishes, and siding patterns. California Redwood Assn., 617 Montgomery St., San Francisco, Calif. 94111. *On Readers' Service Card, Circle 201*

## Expansion Joint

Pamphlet illustrates applications of a flexible expansion joint for roof decks. "Metalastic," a butyl strip bonded to metal flanges, can be applied like sheet metal flashing or snapped on to curbs. Tables

give sizes of available types. Great Lakes Carbon Corp., 333 N. Michigan Ave., Chicago, Ill. 60601. *On Readers' Service Card, Circle 202*

## Plexiglass For Lighting

Revised and expanded design data by Rohm & Haas discusses physical and optical characteristics of Plexiglass. Booklet gives tables on physical properties, sheet sizes and thicknesses for translucent, transparent, and patterned

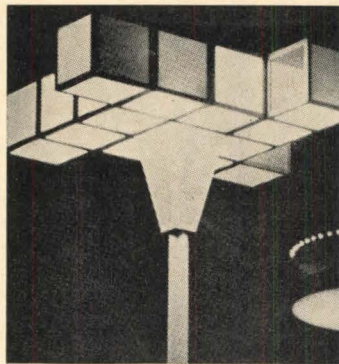

sheets; transmittance and distribution curves and coefficients of utilization are given for fixture diffusers. Booklet discusses museum lighting and luminous-ceiling design. 44 pages. Rohm & Haas, Philadelphia, Pa. 19105. *On Readers' Service Card, Circle 203*

## Copper Flashing

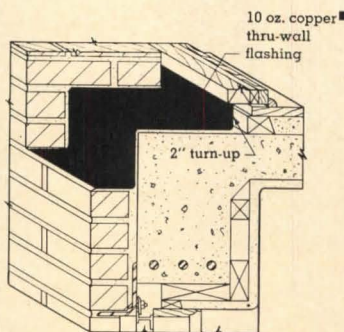

Four types of copper flashing are described in a 16-page booklet: (1) through-wall interlocking system with bonding ribs; (2) two-piece cap flashing—one member laid in wall and second member snapped in after roofing; (3) two-piece reglet system—reglet attached to wood form before pouring of concrete inner walls; (4) lightweight wrought copper, laminated both sides to polyethylene film. First three systems are ribbed; fourth is smooth surface. (Sample is at-

tached to booklet.) Installation details, specs, photos, and explanatory text. Revere Copper and Brass Inc., 230 Park Ave., New York, N.Y. 10017. *On Readers' Service Card, Circle 204*

## Glazed Concrete Blocks

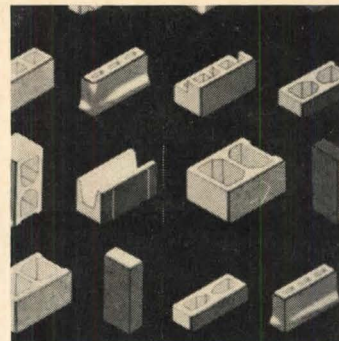

Brochure gives color charts, available shapes and sizes, and construction details for two series of glazed lightweight concrete blocks: Functional Series and Design Series. The latter includes scored faces, concave and convex surface patterns, and monogrammed blocks. 16 pages. The Burns & Russell Co., P.O. Box 6063, Baltimore, Md., 21231. *On Readers' Service Card, Circle 205*

## Electrical Equipment

### On the Wall

Globes, cylinders, and square-section lighting fixtures for wall mounting are available in plastic, metal, and "half & half." Two catalogs, for indoor and outdoor fixtures, give charts and photos. Habitat Inc., 341 E. 62 St., New York, N.Y. 10021. *On Readers' Service Card, Circle 206*

### Let It Rain

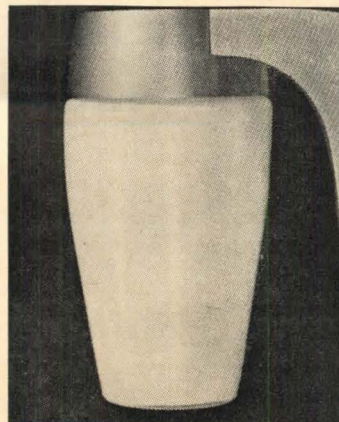

Catalog of lights for indoor, outdoor, and wet locations,

gives sizes, descriptions, sections, and photos of weather-proof and corrosion-resistant cast aluminum fittings. Booklet includes wall, ceiling and post units, night lights, step lights and edge-lit directionals. 20 pages. McPhilben, 1329 Willoughby Ave., Brooklyn, N.Y. 11237. *On Readers' Service Card, Circle 207*

## Doors/Windows Glass Sandwiches

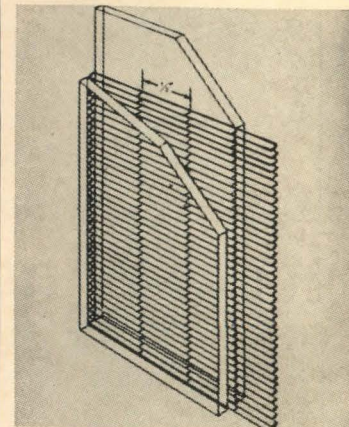

"Acousta-Pane," a glass and plastic laminate especially designed to stop sound, is available in transparent, white translucent, or tinted sheets. Another sandwich of small horizontal bronze louvers (17 or 23 per inch) sealed between glass lights, is called "Comfor-Lite." Also described are amber glass, frosted glass, shatter- and bullet-resistant glass—all laminates. Brochure gives light-transmittance tables, charts, specs, sizes, photos, and comparison curves for sound transmission. 12 pages. Amerada Glass Corp., 2001 Greenleaf Ave., Elk Grove Village, Ill. 60007. *On Readers' Service Card, Circle 208*

## Snappy Doors

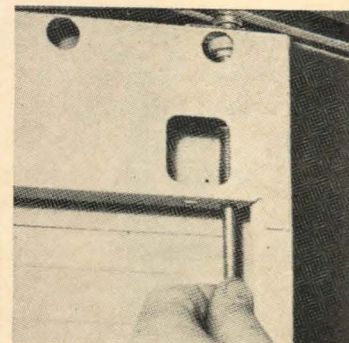

Steel folding doors with baked enamel finish snap into alumi-

## It's a Mirror.. (from the brighter side)



## It's a Window.. (from the dimmer side)



*Mirropane* is used for observing consumer marketing reaction panels at Fuller & Smith & Ross Inc., advertising agency, Los Angeles, Calif.

## It's Mirropane®.. (the "see-thru" mirror)

*Mirropane* lets you observe without being seen. It's now available in *Parallel-O-Grey*® plate glass to work satisfactorily with only a 2-to-1 difference in illumination. For more facts, phone your L·O·F glass distributor or dealer, listed under "Glass" in the Yellow Pages, or write

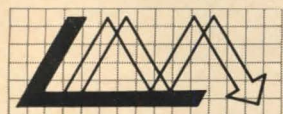

**LIBERTY MIRROR**

A DIVISION OF LIBBEY-OWENS-FORD GLASS COMPANY  
8236 L·O·F Building, Toledo, Ohio 43624



On Readers' Service Card, circle No. 468

num tracks with plunger-type hardware. Louvered doors, assembled in two- and four-door units, are suitable for residential, commercial, or institutional use. Two pamphlets illustrate doors and give selection charts, specs, styles, and installation procedures. Kenatrack, Ekco Building Products Co., 1250 Bedford Ave., S.W., Canton, Ohio 44701.

On Readers' Service Card, Circle 209

### Finishes/Protectors

#### Danish Finish

Polymerizing action of "Danish Oil Finish" penetrates wood to harden and seal. It is natural-looking, has a low-gloss *patina*, comes in four shades for interior panelling and furniture, and is easy to apply. Data sheets give description, application, specifications. Postcard sample available. Watco-Dennis Corp., 1756-22 St., Santa Monica, Calif.

On Reader's Service Card, Circle 210

#### Coatings for Any Wall

Ten wall coatings are formulated to meet varying requirements. There is a coating to resist fire, and one to resist chemical abuse, a coating that "breathes," one for irregularly shaped roofs, one to bridge minor cracks and resist chemicals, one for application on structural steel and metal panels, two that incorporate exposed aggregates of various grades, a textured acoustical coating, and a cementitious glaze-type coating that bonds to masonry. Flooring and roof decking are also included in a pamphlet with descriptions and photos. Desco International Assn., P. O. Box 74, Buffalo 5, N. Y.

On Readers' Service Card, Circle 211

### Furnishings

#### Space Savers

Four succinct pages show the Howard Miller Inner-Wall Cabinet line, which includes several types of shallow, compact storage cabinets for bathrooms or bedrooms in hotels, hospitals, dormitories, and elsewhere. Some have mirrors, electrical outlets, clock and radio, others are simply shelf units for odds and ends; also a hamper and drier. Designed

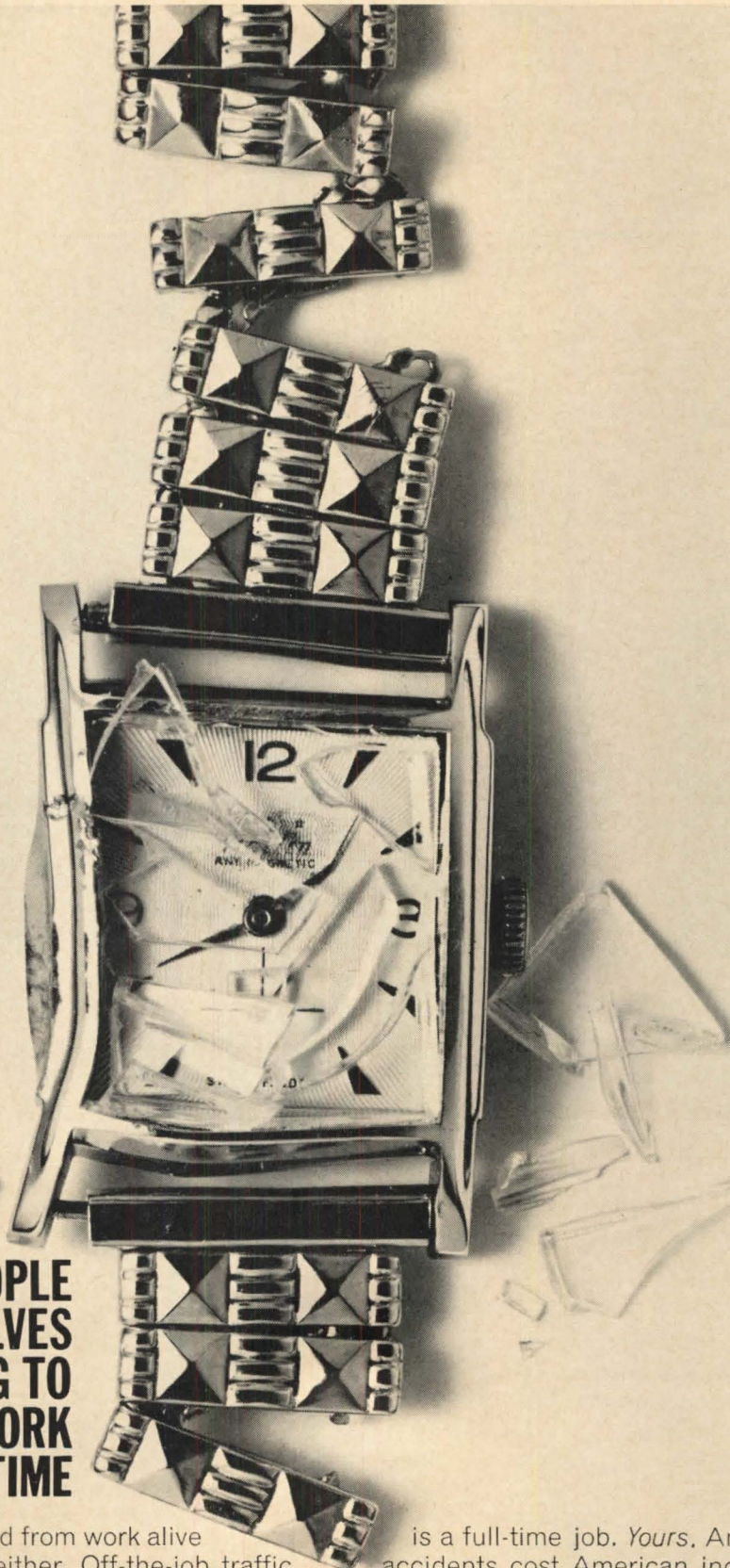

**SOME PEOPLE  
KILL THEMSELVES  
TRYING TO  
GET TO WORK  
ON TIME**

Getting your employees to and from work alive is a full-time job. *Yours*. And it's not just a matter of public welfare, either. Off-the-job traffic accidents cost American industry millions of dollars in lost time, training and production every year. Last year alone, more than twenty thousand workers were killed in off-job motor vehicle accidents. And more than 750,000 were injured. Motor vehicle accidents claimed more than 1½ times as many lives as on-the-job accidents. Can you do something about it? You really can't afford not to. Write now, to the National Safety Council for information on what you and your company can do. Address your letter to the Director of Public Information, National Safety Council, 425 N. Michigan Avenue, Chicago, Illinois 60611. *Published to save lives in cooperation with The Advertising Council and the National Safety Council.*



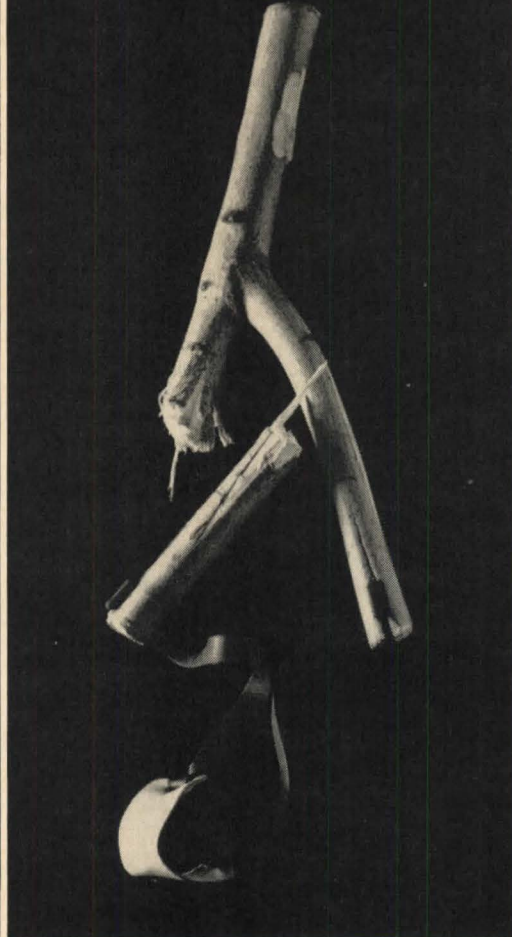

**DONLEY PRE-ENGINEERED  
SUCCESSFUL INCINERATORS  
FOR EVERY SCHOOL NEED**

Every new building can use a Donley pre-engineered incinerator. Donley provides the package . . . dimensional drawings, parts, burners, doors, air vents, grates, etc. for installation by local masons.

Flue-Fed or Direct-Fed, large capacity or small, constant or varying requirements . . . Donley is the efficient, automatic incinerator for schools, high rise apartments, commercial buildings or wherever common burnable refuse happens. Easy, too . . . just specify Donley. Write for handy selector chart and new incinerator catalog.



**THE DONLEY BROTHERS COMPANY**

13900 MILES AVENUE, CLEVELAND, OHIO 44105

**Donley**



to be built into the wall or surface-mounted, the entire line of 24 combinations is designed around six basic modular units. Offered in natural wood finishes or epoxy colors. Prices, measurements, specifications, one-year guarantee. Howard Miller Clock Co., Zeeland, Mich.

*On Readers' Service Card, Circle 212*

**Lamidall a Wall**

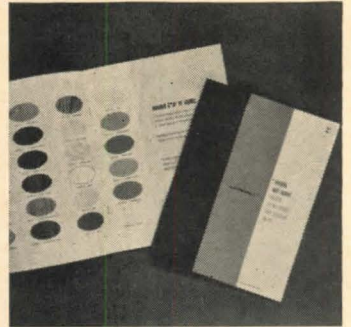

Complete information on Lamidall wall paneling is available in eight-page booklet: installations are illustrated, data and specifications given, corner and edge treatment detailed (strips in wood grains and, rather touching, anodized gold aluminum; feature and divider strips), and the 23 patterns are pictured. These include a dozen wood grains — six walnuts to a white Indian teak, nine solid colors (fair to middlin' range), one white marble, and the too-perennial "gold-sparkle." Lamidall, Div. of Wood-all Industries, Inc., 425 Maple Ave., Carpentersville, Ill.

*On Readers' Service Card, Circle 213*

**Stainless-Steel  
Debutante**



The serviceable "Sabre" series makes its debut in a 15-page brochure. Eighteen different chairs (arm, swivel, stacking, secretarial) and several multiple seating units are covered in Naugahyde, other coverings optional. All arms upholstered or wood-capped; 3"-thick seats

◀ On Readers' Service Card, circle No. 344

have hardwood frames with heavy-gage sinuous springs attached, and are covered with molded polyfoam. Heavy-duty frame construction of 7/8" tube 16-gauge steel has welded joints. Same design available at a lower price with frames of chrome or enameled steel. Milwaukee Chair Co., 3022 W. Center St., Milwaukee, Wis.

On Readers' Service Card, Circle 214

## Let Clients Plan Kitchens

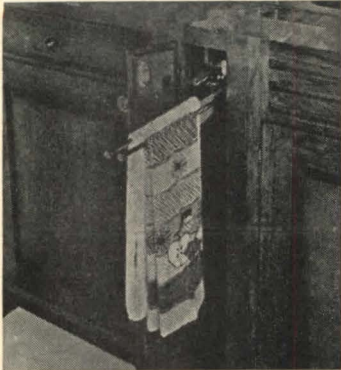

Kitchen Planning Portfolio, designed to give the consumer a practical guide for all phases of kitchen planning, will be a valuable aid for clients. Portfolio includes the basic rules of design, function, and construction; graph paper and tracing guide for floor plan designing; and a color guide. A "clip and save" section contains information on materials, construction, processes. "Cabinetmaker Kitchens" album (\$1) and "Kitchen Planning" guide (no charge) available separately; complete portfolio, \$2. Mutschler Brothers Co., Nappanee, Ind.

On Readers' Service Card, Circle 215

## Sculptured Walls

Three four-page brochures offer three variations of Erwin Hauer's sculptured walls. Black-and-white photos demonstrate the versatility of the modular blocks in a range of interior and exterior uses. Smallest in

# Terrafino

**"INSTANT" TERRAZZO  
SAVES TIME AND MONEY!**

**... is easier to design with**



TERRAFINO is the original 12"x12"x3/16" flexible tile with real #1 and #2 marble chips permanently bedded in a tough epoxy plastic matrix. The TERRAFINO floor pictured above (Calico Kitchen Restaurant, Cheltenham, Pa.) is a typical example of the benefits to be derived from this modern way to install terrazzo.

### TERRAFINO SAVES TIME

It is rapidly installed in the same manner as resilient tile—with a trowelled mastic. This terrazzo floor can be installed and ready for traffic in one working day!

### TERRAFINO SAVES MONEY

In addition to the savings involved in cutting a week or more off conventional terrazzo installations, TERRAFINO saves money two other important ways:

1. It usually costs less than conventionally placed terrazzo.
2. It maintains like terrazzo—for far less than resilient tile.

### WIDENS DECORATIVE SCOPE OF TERRAZZO

TERRAFINO can be used with conventional vinyl feature stripping for many practical and decorative effects.

Learn more about how TERRAFINO flexible terrazzo tiles may solve your flooring problems. Send coupon for samples, descriptive literature and specifications to:

**TERRAFINO COMPANY, P.O. BOX 52, CARLSTADT, NEW JERSEY**

	TERRAFINO CO., P.O. BOX 52, CARLSTADT, N.J. Please send <input type="checkbox"/> Samples <input type="checkbox"/> Literature on TERRAFINO to:
	Name _____
	Firm _____
	Street _____
	City _____ State _____ Zip No. _____

On Readers' Service Card, circle No. 405

scale is available in white gypsum for interior installation only; others available in white

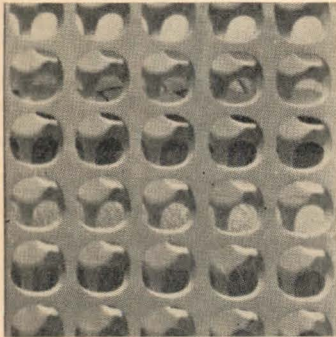

or gray concrete (for exterior use) and white gypsum. Brochures include installation instructions. Arts for Architecture, Inc., 50 Rose Place, Garden City Park, N. Y.

On Readers' Service Card, Circle 216

## Wholly Light

Four-page brochure shows aluminum and opalescent glass lighting fixtures for churches. Four styles are perceptively titled: "Futura," "Moderne," "Contemporary," and "Early American." Fixture construction includes rings, poles, brackets, and covers; nave and

companion lights. Diagrams, black-and-white photos, complete specifications. Also shown: fiberglass baptistry, church spires. Wiedemann Industries, Inc., P. O. Box 672, Muscatine, Iowa.

On Readers' Service Card, Circle 217

## Carpet Kit

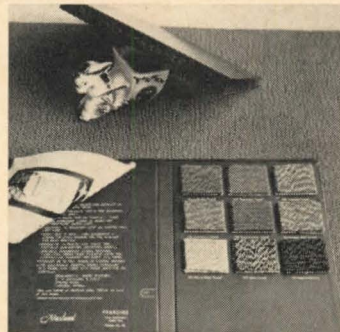

A kit from Masland features "Paradine," a velvet-weave carpet of the Hercules Powder Company's Herculon olefin fiber. A sturdy 8½" x 11" book-type folder, Paradine kit contains samples of the nine tweed colorations and pertinent information: The commercial carpet is said to be stain-resistant, color-fast, eas-

ily cleaned, dimensionally stable, and virtually static-free. Stocked in 12' widths. Contract Carpet Dept., C.H. Masland & Sons, Carlisle, Pa.

On Readers' Service Card, Circle 218

## Insulation

### Insulate Four Ways

Booklet covers four types of insulation: water-repellent vermiculite masonry fill, a rigid polystyrene insulating board, granular vermiculite for attics, and glass fiber batts. Wall systems using polystyrene sound-deadening board are also discussed. Guide specs, "U" value tables, coverage tables, and recommended applications. 12 pages. Zonolite Div., W. R. Grace & Co., 135 S. LaSalle St., Chicago, Ill. 60603.

On Readers' Service Card, Circle 219

## Sanitation/Plumbing

### For the Bath

Catalog contains specs, photos, installation details for an extensive line of bathroom hard-

ware. 36 pages. Hall-Mack Co., 1380 W. Washington Blvd., Los Angeles, Calif. 90007.

On Readers' Service Card, Circle 220

## Constant Hot Water

Steam fed heat-exchange unit heats water and mixes it with cold to supply water within 8 F of preset temperature, between 110 F and 180 F. No storage tank required. Two models deliver 30 or 60 gpm. Shop drawings, piping layouts, and tables included on data sheets. Leslie Co., Lyndhurst, N. J. 07071.

On Readers' Service Card, Circle 221

## Surfacing

### Set A Tile

"1966 Handbook for Ceramic Tile Installation" has spec guides, grouting and setting data, details for installing tile on interior and exterior walls, floors, swimming pools, refrigerator and steam rooms. Special section sets forth Tile Council's testing and Quality Certification program recently established for ceramic tile

# FREE

## HOW TO IMPROVE LOADING DOCKS

Get your copy of this step by step picture report

How much does it cost? How long will it take? How long will the dock facilities be tied up? All these questions and many more are answered in this 4-color, on-the-spot picture report of an actual remodeling job.

No need for your clients to put up with inadequate or slow dock facilities. See for yourself how quickly and easily Kelley Dockboard experts can convert your present dock.

Send for your copy today!

55-85R3



**KELLEY** KELLEY COMPANY, INC.

6740 N. Teutonia Ave., Milwaukee, Wisconsin 53209

On Readers' Service Card, circle No. 459

Wonderful Words . . .

**"NO LEAKS NOW-OR EVER!"**

with

**SUPERIOR**

**CUSHION-LOCK®**  
**REGLETS**

For Counterflashing and Metal Window Frames

- LOWER IN-PLACE COST
- NO ON-THE-JOB CAULKING
- 5 DESIGNS FOR ALL TYPES OF CONSTRUCTION

When you specify Superior Cushion-Lock Reglets, you can be assured of permanently leak-proof joints, so why take chances with inadequate or unspecified substitutes that may cause serious problems. Installation is fast and because of the labor-saving advantages, total "in-place" cost is lower. Shipped ready for application. Available in extruded PVC or aluminum. For details see Sweet's File 8g/Su or write for Bulletin CL-3.

Pat. No. 2,822,762;  
other patents pending.

**SUPERIOR** Concrete Accessories, Inc.

9301 King St., Franklin Park, Ill. Phone (312) 678-3373  
2100 Williams St., San Leandro, Cal. Phone (415) 352-2830  
New York • Houston • Los Angeles • Rexdale (Canada)

On Readers' Service Card, circle No. 442

**Don't  
Stack it...**

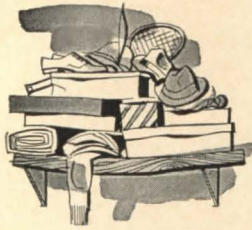

**Rak it!**

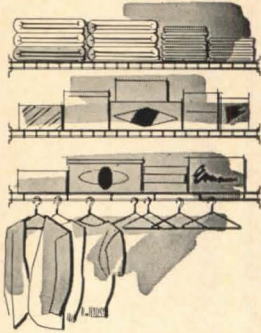

...with Pemco custom-made steel Rod Raks®

Versatile Rod-Raks® are used in:

<b>Apartments</b>	<b>Hotels-Motels</b>	<b>Institutions</b>
<b>Dormitories</b>	<b>Public Housing</b>	<b>Industries</b>

Rod-Raks are the modern answer to general and wardrobe storage. Factory finished and cut to size, Rod-Raks are shipped ready to install complete with necessary hardware.

**Specify Rod-Raks® — get what you specify.**

Rod-Raks are distributed nation wide. Write for free "Complete line" literature.

**PEMCO-KALAMAZOO**

1872 Ravine Road  
Kalamazoo, Mich.  
Phone 342-0239  
AC 616

On Readers' Service Card, circle No. 384

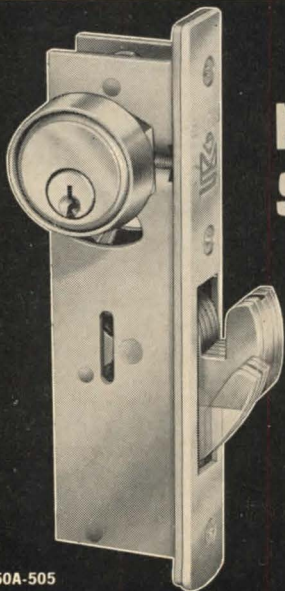

MS 1850A-505

**MAXIMUM  
SECURITY  
FOR  
GLASS  
DOORS  
THAT  
SLIDE**

The space-saving advantage of sliding doors in enclosed malls and other commercial buildings is unmistakable. Fortunately, there is one locking device available: the MS® "Hookbolt" deadlock. It's the same rugged MS® mechanism used in swinging doors except its laminated steel bolt is notched. Use any make standard mortise cylinder, protect it with an Adams Rite® MS 4042 hardened cylinder guard as shown. Add a 4417 armored steel strike plate for total protection. Write Adams Rite Manufacturing Co., 1425 Grand Central Avenue, Glendale, California 91201.

**ADAMS RITE**

On Readers' Service Card, circle No. 321



75 Years of Leadership in the Electrical Industry

**For dust and moisture  
problem areas**

HERE'S THE GROUNDING OUTLET  
TO USE WHERE OTHERS WON'T DO

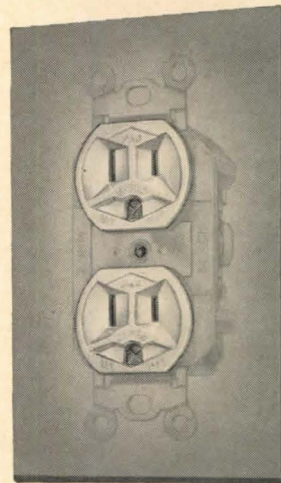

Fabric reinforced Neoprene gaskets protect the P&S 6207 from dust and moisture at all times by wiping cap blades and providing positive closure. Cellular Neoprene mat under wall plate further seals against penetrating elements.

Like all P&S Super Outlets, the 6207 (15 amp. 125 volt) has individually recessed, reinforced contacts and a dead back safety feature.

Where to use it? Industrial plants, laboratories, workshops, garages, cellars, carpenter shops—in any areas where dust and/or moisture are problems. (This device is not recommended for unprotected outdoor areas.)

Want more information? Write Dept. PA 356,  
Pass & Seymour, Syracuse, New York 13209

**P&S** PASS & SEYMOUR, INC.  
SYRACUSE, NEW YORK 13209

BOSTON • CHICAGO • LOS ANGELES • SAN FRANCISCO

On Readers' Service Card, circle No. 383



## STAINED & FACETED GLASS

Nationwide service. Inquiries invited

STUDIOS OF  
*George L. Payne*

15 Prince St., Paterson 1, New Jersey

Studios in America, France,  
England and Germany

On Readers' Service Card, circle No. 416

made in U. S. Tile Council of  
America, Inc., 800 Second  
Ave., New York, N. Y. 10017.  
On Readers' Service Card, Circle 222

### Plain and Fancy Tiles

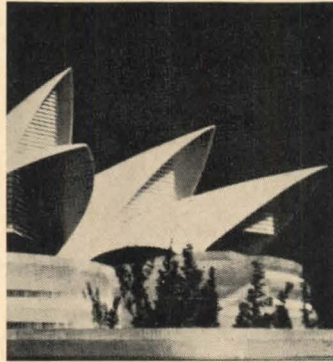

Catalog illustrates glazed and unglazed tiles in many colors, surfaces, and sizes for walls and floors of commercial, industrial, and residential buildings; decorative relief tiles in a number of patterns and profiles; swimming pool tiles; and precast panels. The roof of the Sydney (Australia) Opera House is clad with Hoeganaes tiles. In addition to color photos, illustrations show available shapes with size/color/weight tables, installation details, and brief specs. 16 pages. Hoeganaes Ceramic Co., Taylors Lane, Riverton, N. J. 08077.

On Readers' Service Card, Circle 223

### Colored Cork Tiles

Brochure illustrates "Color-Cork" natural cork tiles and rolls impregnated with variety of colors for use on floors and walls. It has a noise reduction coefficient of 0.11. Cork resists water, dirt, and stains. Color-Cork is available in 16 solid colors, eight "Jaspe" colors (a blend of two of the standard solid colors) and eight "Multi-color" colors (a blend of three or more either contrasting or harmonious colors). 4 pages. Gotham Materials Inc., New Rochelle, N.Y.

On Readers' Service Card, Circle 224

### PROGRESSIVE ARCHITECTURE NEWS REPORT

REINHOLD PUBLISHING CORPORATION  
430 Park Avenue, New York, N.Y. 10022

Editor .....Jan C. Rowan  
Associate Editor .....E. K. Carpenter  
Publisher .....P. H. Hubbard, Jr.  
Advt. Sales Mgr. ....W. R. Evans, Jr.  
Production Mgr. ....Joseph M. Scanlon

# anything NEW IN KITCHEN VENTILATION YES



The  
**GAYLORD**  
VENTILATOR

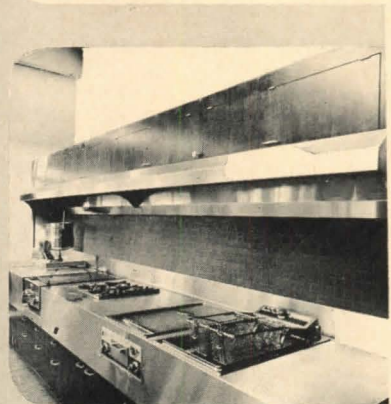

- No Filters – or removable parts
- Automatic Water Cleaning – Daily
- Centrifugal Grease Extraction
- Requires less air
- Removes grease, heat, odors
- 24 hour Automatic Fire Quenching
- Fire System thermostatically controlled
- Underwriters' Laboratories Inc. Listed National
- Sanitation Foundation Approved
- Regional Fire Underwriters Approved
- Reduced Insurance Rates
- Reduced Maintenance Costs
- Guaranteed Performance

## AUTOMATION WITH A FLAIR

**DESIGN SERVICE** – The Gaylord Ventilator is adaptable to all equipment – upon request we will provide design services and layout drawings for each of your installations showing not only our recommendations for the utilization of the Gaylord Ventilators but complete air engineering for the job – at no cost or obligation.

For Complete Literature:  
**GAYLORD INDUSTRIES**

P. O. BOX 19044  
Portland, Ore. 97219 - 503-246-8835

On Readers' Service Card, circle No. 441



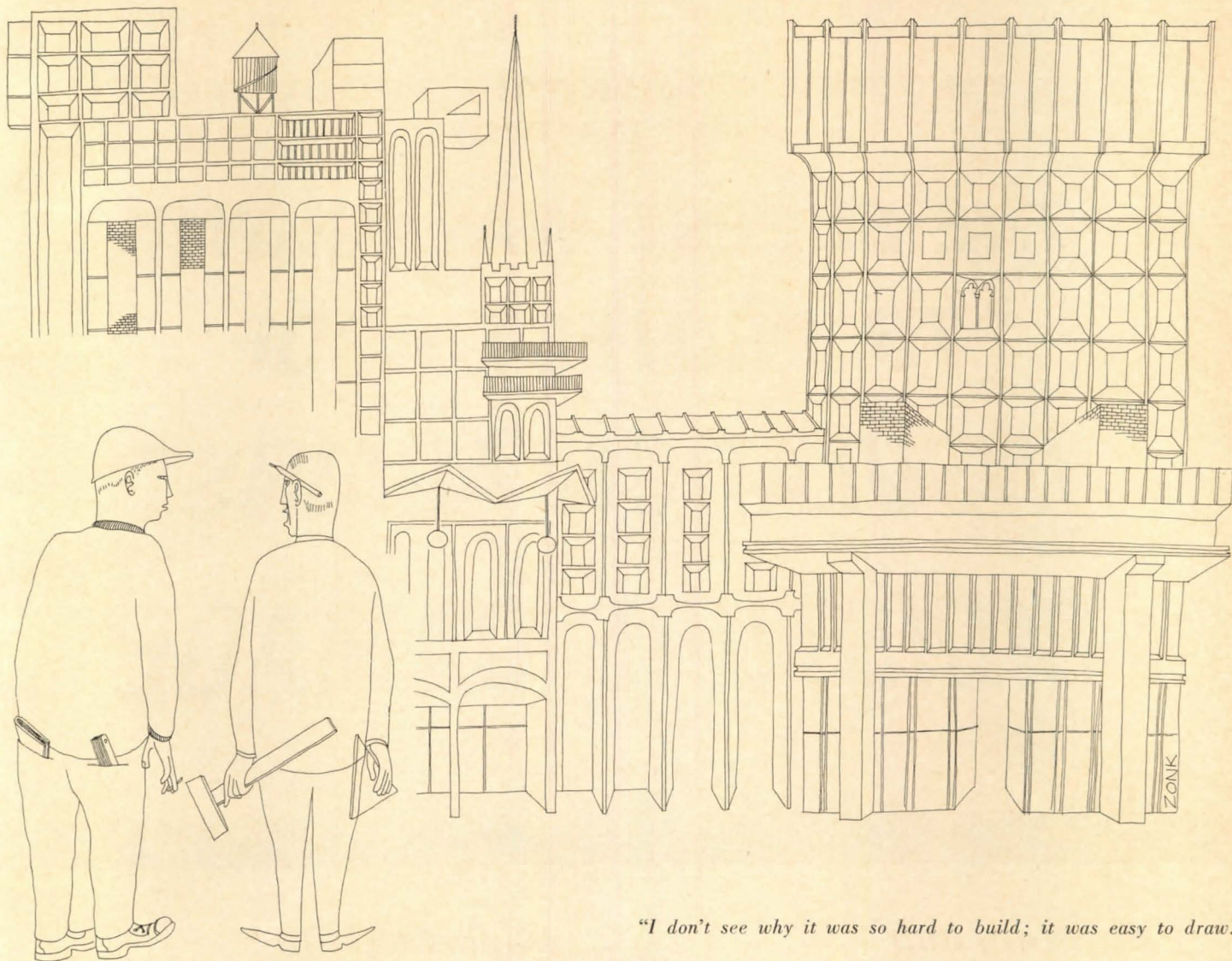

*"I don't see why it was so hard to build; it was easy to draw."*

## **NEXT MONTH IN P/A**

**HARD-HAT ARCHITECTURE:** *The second of a series of P/A articles that helps close the gap between design theory and practical building requirements.*

**ARCHITECTURAL TOYS:** *Picture-story study of the role of modern toys in shaping taste, design sense, and understanding of structures.*

**CAMPUS PLANNING:** *British architects update the traditional form of the college campus.*

**INTERIOR DESIGN:** *An evaluation of the interiors of the Library-Museum for The Performing Arts at Lincoln Center in New York.*

**SUBSCRIBE NOW:** *Check Column #3 on Readers' Service Card or write to Circulation Manager, Progressive Architecture, 430 Park Avenue, New York, New York 10022.*

**TWO NEW SISALKRAFT® PRODUCTS  
NOW PROVIDE**

**THE SUREST WAY KNOWN  
TO PROTECT ROOF  
INSULATION AGAINST  
MOISTURE DAMAGE**

**PyroKure® 600**

For Class I Metal Decks

This extremely low permeance vapor barrier (0.25 perms) offers three times the protection given by plastic film conventionally used on metal decks. PyroKure 600 is Factory Mutual Approved for use with asphalt and has rugged toughness that resists abrasive damage. Its non-wrinkle roll-out and easy application by customary roofer equipment give you added assurance that the roof insulation will be completely protected against moisture damage.

**VaporStop 710**

For Concrete, Gypsum and Wood Decks

Just **one** layer of VaporStop 710 does the job vs. two layers of felt. Application costs are sharply lower; roof load is 85% less. 47 lbs. of VaporStop 710 per 10 squares vs. 325 lbs. of felt. In addition, VaporStop 710 is a **complete** vapor barrier **before** it is laid down. Unlike felt, protection of the insulation against moisture damage is controlled in the factory not on the job.

Write for samples and more facts. Sisalkraft, 56 Starkey Avenue, Attleboro, Mass.

**ST REGIS**  
SISALKRAFT DIVISION

On Readers' Service Card, circle No. 443

On Readers' Service Card, circle No. 333 ➤

for entry ways...dining areas...enclosed patios

# ETRUSCAN ceramic tile

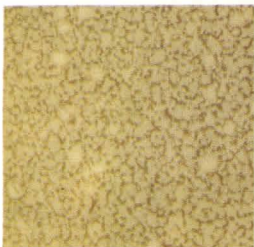

680 Etruscan Gold

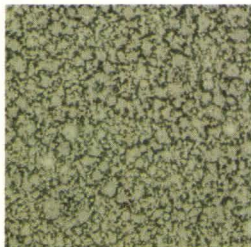

610 Etruscan Sage

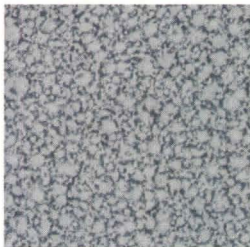

650 Etruscan Blue

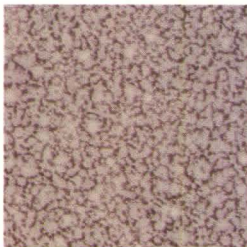

640 Etruscan Rose

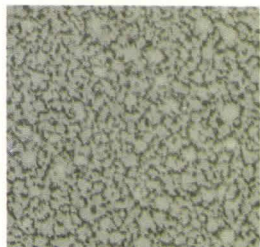

630 Etruscan Silver

Your first impression of an entry area with Etruscan tile is one of carefree elegance. Floors gleam softly with any of the 5 rich, beautiful colors—Etruscan Sage, Silver, Rose, Blue and Gold. (680 Etruscan Gold shown in photo above) □ Available in large 6" x 6" flat tiles, Etruscan can be used effectively in entrance areas, breakfast or dining areas, enclosed patios and many other areas. Glazed surface will not scratch or scuff, never needs waxing. Combines lasting beauty with easiest, no-expense maintenance. Etruscan also can be used effectively for accent walls. Sample kits available to architects, decorators and builders who write on their business letterhead. Address Dept. — E6.



**The Cambridge Tile** Mfg. Co., Cincinnati, Ohio 45215



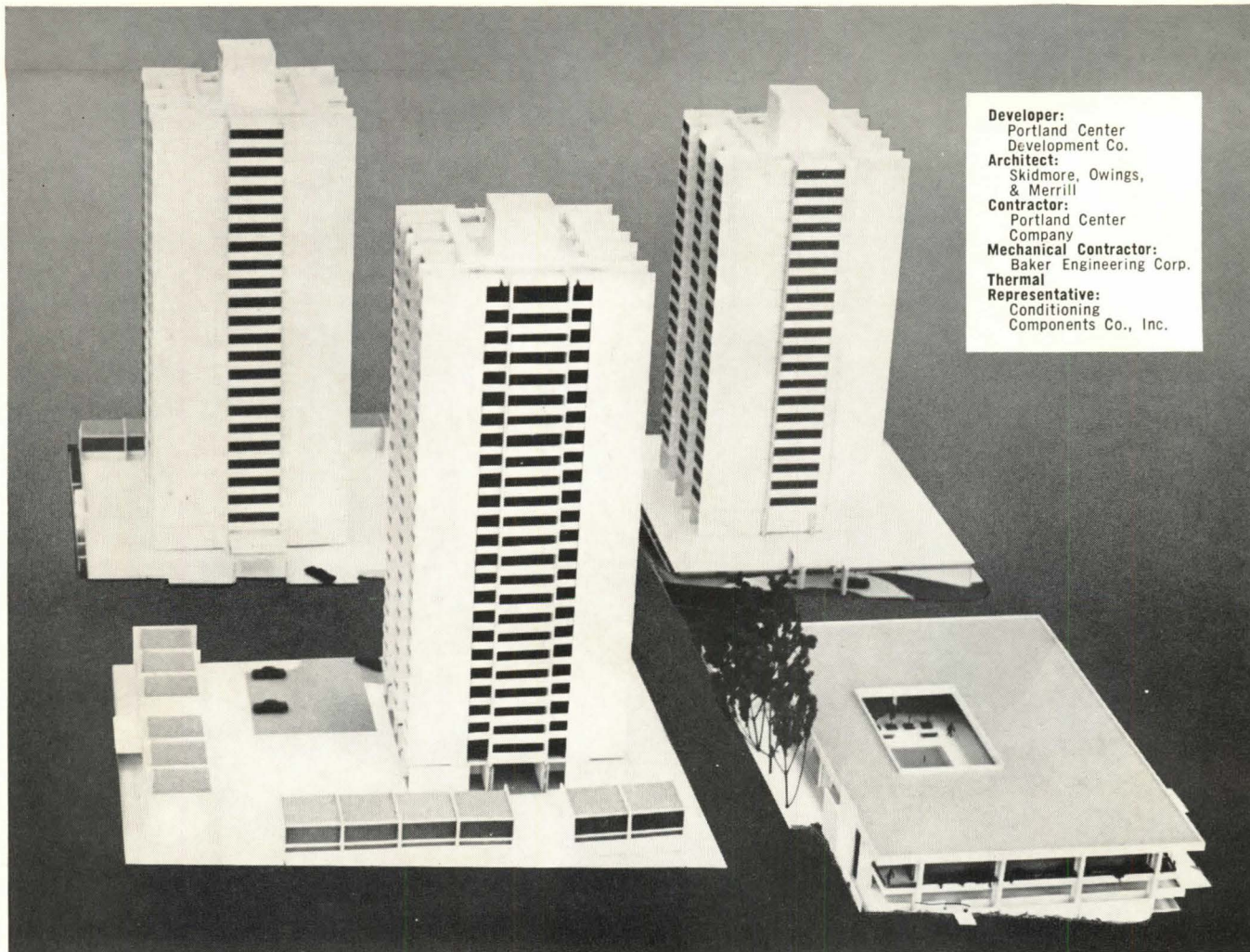

**Developer:**  
 Portland Center  
 Development Co.  
**Architect:**  
 Skidmore, Owings,  
 & Merrill  
**Contractor:**  
 Portland Center  
 Company  
**Mechanical Contractor:**  
 Baker Engineering Corp.  
**Thermal  
 Representative:**  
 Conditioning  
 Components Co., Inc.

## MAJOR VENTILATION JOB HANDLED BY THERMAL UNITS

Portland, Oregon's projected \$57 million urban renewal development includes 3 high-rise apartment towers, two commercial buildings and a parking facility in the first phase. Thermal Engineering cabinet-type ventilators were selected.

Thermal Air Handling Equipment offers the widest range of flexibility and versatility to meet any unusual condition. For this reason more and more owners, architects, engineers, and contractors specify Thermal Air Handling Apparatus. The line includes: multi-zone conditioners (remote and self-contained), central plant conditioners, sprayed coil units, heating and cooling coils, air-cooled condensers, air-cooled condensing units, heating and ventilating units, plus many other items for commercial or industrial applications.

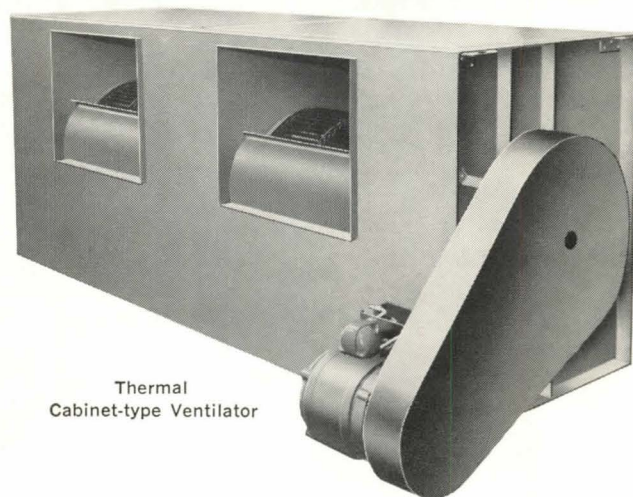

Thermal  
Cabinet-type Ventilator

*Do your files contain our latest catalogs and technical bulletins? Write for your copies.*

Quality Products Since 1945

**THERMAL ENGINEERING CORPORATION**

P. O. BOX 19483  
10522 OLD KATY ROAD • HOUSTON, TEXAS 77024

REPRESENTATIVES IN PRINCIPAL CITIES THROUGHOUT THE WORLD

THINK COPPER...



## Do you measure architectural excellence by the pound-price?

Coppermetals are not the cheapest material you can specify for architectural accents—nor are they always the most expensive. But no other metal offers the inherent beauty, range of colors, forms, versatility and durability of true copper alloys. Furthermore, you can attain *all* these advantages without upsetting budgets, by using coppermetals in locations where the eye can appreciate fine design and component quality. And remember, the texture and colors of copper architectural metals are more than skin-deep. Copper may cost a bit more than substitutes. Don't you think it's worth it?

**ANACONDA**<sup>®</sup>  
AMERICAN BRASS COMPANY

To see what imaginative designers can accomplish through the judicious use of coppermetals, turn page 

# Here's why leading architects use the coppermetals in modern design

- Enduring and consistent color
- Distinctive elegance, yet friendly and warm
- Combine beauty with durability
- Offer greater opportunities for creative design
- Unequaled in providing the desirable accent to other high-quality building materials.

Consider these advantages when you are selecting metals and don't overlook the wide range of true, natural colors available in the copper alloys—from the

red of copper to the warm, rich golds of the brasses and bronzes to the soft, silvery white of the nickel silvers. And for the most economical use of these quality metals, consult with fabricators in the early planning stages. They can help you apply standard forms and sizes of sheet, rod, wire, tube, extruded and drawn shapes to your designs. Write for publication, "Architectural Metals by Anaconda," A.I.A. File No. 15. Anaconda American Brass Company, Waterbury, Connecticut 06720. In Canada, Anaconda American Brass, Ltd., Ontario.



*Lehigh County Courthouse, Allentown, Pa.  
Architects: Wolf & Hahn, Allentown, Pa.  
Fabricator: Trio Industries, Inc.,  
Bridgeport, Conn.*

Window Frames and Reversible Sash are Everdur<sup>®</sup>, an Anaconda high-strength engineering and architectural copper alloy. Tubular components are fabricated from strip by the economical roll-forming process.



*First National Bank, Wilkes-Barre, Pa.  
Architects: Lacy, Atherton & Davis,  
Wilkes-Barre, Pa.  
Fabricator: J. W. Fiske Architectural  
Metals Inc., Paterson, N.J.*

Here the rich beauty of bronze in sheet, rod and tube products accentuates the fine marble, ceramic tile and wood used in this circular stairway and elevator shaft. This is a typical example of architectural beauty with bronze.



*First National Bank Bldg., Lincoln, Nebr.  
Architects: Davis & Wilson;  
Clark & Enersen, Lincoln, Nebr.  
Fabricator: Fenestra, Inc., Lima, Ohio*

Bronze-clad steel standard curtainwall units on the eight-story section of this building provide the beauty and durability of bronze at a cost considerably lower than for custom-built, solid bronze curtainwall construction. 65-0733

**ANACONDA<sup>®</sup>**  
AMERICAN BRASS COMPANY



Dividend Engineering — to stretch your building dollar while improving building performance.

## FIBERGLAS ROOF INSULATION

Move the deck and see what happens  
to the built-up roofing with  
a Fiberglas<sup>®</sup> Taped Joint Roof Insulation System.

Place  
left thumb  
here and shift.

Place  
right thumb  
here and shift.

Nothing.

And that's just the point. The roof doesn't buckle. Ridge. Wrinkle. Or split. No matter what the deck does. This kind of independence from normal deck movement comes only with the unitized roofing you get with the Fiberglas Taped Joint System. A combination of Fiberglas roof tape and Fiberglas roof insulation.

The insulation lays flat. Stays flat. And it's constructed to act as a slippage plane.

The Fiberglas Roof Tape holds the joints

so firmly together you get the strongest joints in roofing. Result: normal deck movement is distributed over a wide area. Naturally, Fiberglas Taped Systems are trouble-free over the years. Which makes them less expensive than other systems.

That's quite a lot for "Nothing," isn't it?

Owens-Corning Fiberglas Corporation,  
Industrial and Commercial Division,  
717 Fifth Avenue, New York, N.Y. 10022.

OWENS-CORNING

**FIBERGLAS**

\*T-M (REG. U.S. PAT. OFF.) O-C.F. CORP.

Fiberglas roofing tape completely unitizes a roof. Holds the joints together. Firmly. Tenaciously. Moisture can't seep through. With Fiberglas roofing tape there are no cracks. No crevices. No loss of first mopping ply.

Fiberglas tape works well with all roof insulations. But it works even better with Fiberglas insulation. Together, they're a team. A system. Maintenance-free for years. And less expensive in the long run. Make it a real long run.

Use the whole system and reduce your roofing failures.

For more information on the Tape Joint System, write Owens-Corning Fiberglas Corp., Industrial and Commercial Division, 717 Fifth Ave., New York, N.Y. 10022.

OWENS-CORNING  
**FIBERGLAS**



What's mopped on top  
stays on top of a Fiberglas\* taped joint.



IONOSPHERE  
STRATOSPHERE  
TROPOSPHERE  
**OTISPHERE**

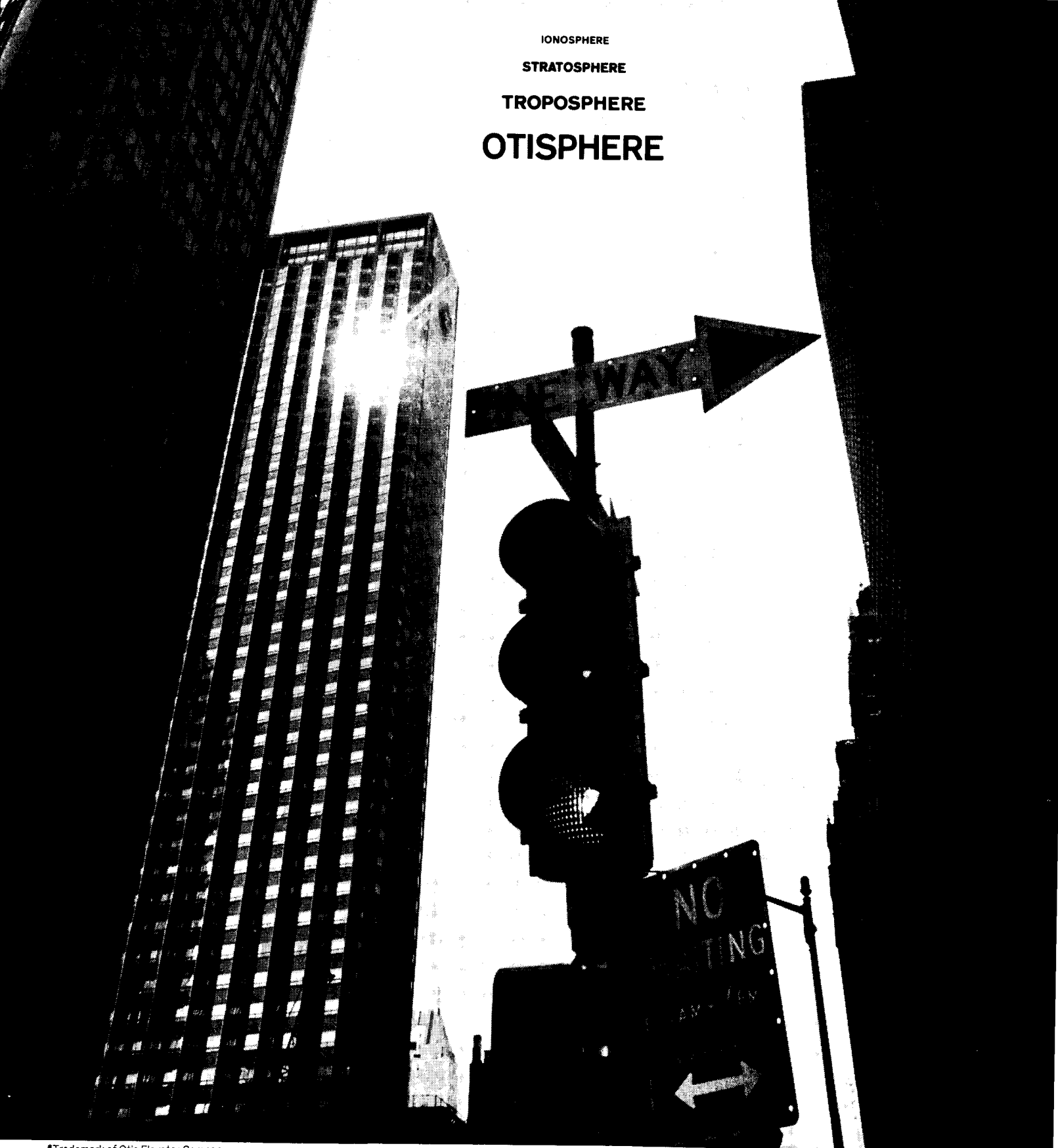

\*Trademark of Otis Elevator Company

**In the Otisphere all signals are "Go"**

With new "INSTANT ELEVATORING"\* just touch the button...and your Otis is on its way. Any time. This remarkable V.I.P. system of electronic controls automatically adjusts elevating service

to any traffic needs. Anticipates service demands and instantly dispatches cars to where they're needed.

Call your Otis man in on your building designs. Ask him for

complete details on this remarkable Otis development...how "INSTANT ELEVATORING" can be designed exactly to the needs of your client.

Otis Elevator Company, 260-11th Ave., New York, 10001.

**Otis**<sup>®</sup>  
ARCHITECTS' SERVICE

Electric and Hydraulic Passenger & Freight Elevators • Escalators • Moving Walks • Dumbwaiters • Elevator Modernization & Maintenance • Military Electronic Systems • Gas & Electric Trucks by Baker Division

On Readers' Service Card, circle No. 422

←On Readers' Service Card, circle No. 382

# If you're specifying switches that only turn lights on and off...

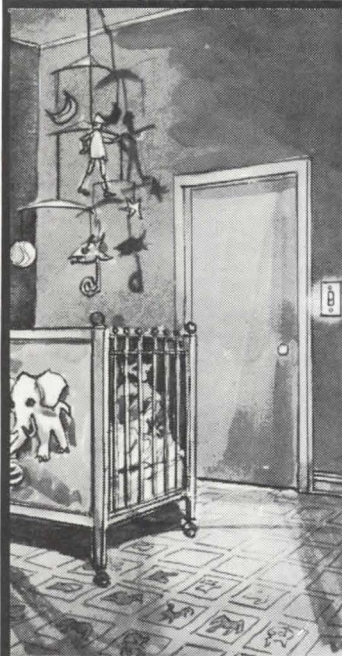

## LIGHTED HANDLE AC QUIET SWITCH #700LH

Neon lamp in the ivory handle glows softly when current is off. Baby has a friendly light to comfort him... without a click to disturb him. Useful as night light or off-indicator. Also available as red handle pilot light to indicate power on. A convenience and safety feature.

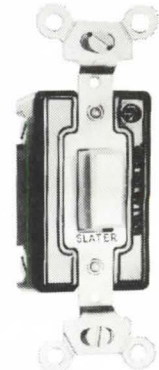

## TOUCH PLATE SWITCH #780

A light tap or a mere brush with the shoulder or elbow and this switch is activated. Handy when someone has an armload of parcels. Spec grade, heavy duty design permits convenient control of motors and machines that are turned on and off frequently during operation.

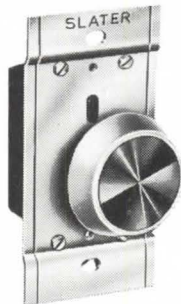

## ROTARY DIMMER #RDCP-600

Adjust room lighting to suit the activity... or create atmosphere with lighting that can change the mood of a room. Slater offers a complete line of electronically controlled dimmers—in full range 0 to 100% adjustment—that mount in standard boxes. For residential or commercial applications. Incandescent and fluorescent, single pole and 3-way models.



## TIME DELAY SWITCH #TD-100

You can turn off the switch in the garage and walk into the house before the lights go off. Or you can turn off the bedroom light and be in bed before the lights are out. Time delay activates switch automatically. A convenience and safety feature for halls, stairways, bathrooms, basements, exits, etc.

# they're doing only half the job!



SLATER ELECTRIC INC. • GLEN COVE, N.Y.



**New designer's coordinator of  
colorful ideas in SHEETROCK\* Vinyl Panels  
teams up with "working" walls**

**a new design concept!**

Now, for the first time, superior wall systems are combined with an imaginative collection of wall coverings—beautiful vinyls factory-laminated to SHEETROCK, the architect's first choice in gypsum wallboard.

And what a collection it is! Dozens of designs, colors, and patterns in durable, washable, stain-resistant vinyl that offer you complete design capability. No more cumbersome swatch books. No more disappointments because of discontinued patterns. The U.S.G. designer's *coordinator* is always up to date, ready to serve you.

No other source offers so much, so ask your U.S.G. representative to see the *coordinator* and your special edition of *Form & Function* magazine, devoted to wall design. Or write to us at 101 S. Wacker Drive, Dept. PA-62, Chicago, Illinois 60606.

\*Reg. U.S. Pat. Off.

**COORDINATED WALL DESIGN...  
another breakthrough by**

**UNITED STATES GYPSUM**

On Readers' Service Card, circle No. 458

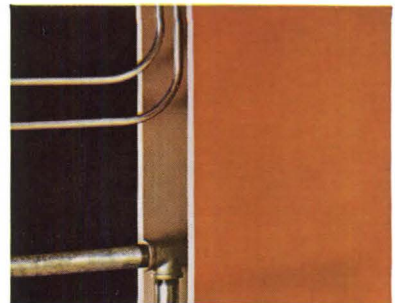

**A "WORKING" WALL CAN BE A WORK OF ART.** USG® Double-Solid Partitions are ideal for party walls and pipe chases. Low cost compared to partitions of equal sound control efficiency: up to 60 STC; 2-hour fire rating; design flexibility. A "working" wall, does the work you want it to do. Work with the *coordinator* for beautiful results.

# Her boss is burning up.



He never heard of solar control, but he knows something's wrong when a building's temperature runs hot and cold. You avoid lopsided temperatures and lopsided cooling bills by specifying "FLEXALUM" Venetian Blinds. FLEXALUM aluminum takes the heat off air conditioners, lowers operating costs when the temperature climbs. And, of course, controls glare, light and solar radiation. So specify "FLEXALUM" aluminum venetians. And watch overhead go down when FLEXALUM blinds go up! Write for the study, "Cost Analysis of Solar Controls".

ALCAN ALUMINUM CORPORATION



*Flexalum* DIVISION

111 West 50th Street, New York, N. Y.

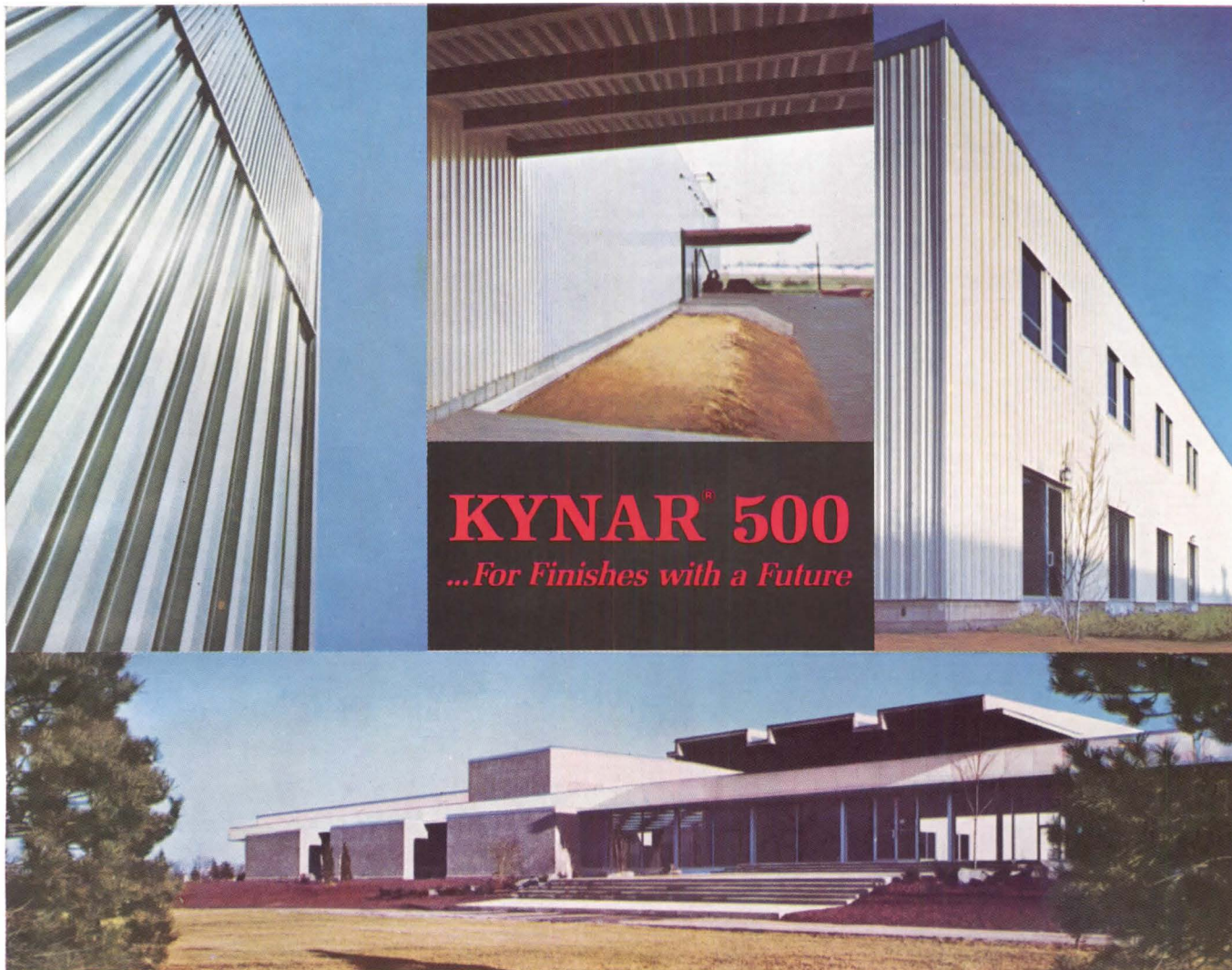

Consulting Architects: Chappelle & Crothers

Designers and Constructors: United Engineers & Constructors Inc.,

## New manufacturing plant features finishes of Kynar\* 500

- long life—tests project 30 years or more of useful, maintenance-free life. Performance comparable to porcelain enamel or top quality anodized finish.
- excellent color retention — standard colors immediately available; custom colors depending on size of the job.
- lowest cost—finishes of Kynar 500 cost less per square foot than any other type of finish in the 30-year class.
- perfect color match—finish is liquid, can be roller coated or sprayed on for perfect match between flat and contoured components.

Get the full story; write for our colorful, informative booklet that gives cost comparisons, test data and other pertinent facts. Write Plastics Department, Pennsalt Chemicals Corporation, 3 Penn Center, Philadelphia, Pa. 19102.

*\*Kynar is a registered trademark of Pennsalt Chemicals Corporation. Kynar 500 is the fluorocarbon resin used by leading paint manufacturers in new long-life finishes.*



high strength steel reinforced concrete buildings are

# On the rise!

everywhere

■ Yes, it really is high! The 1000 Lake Shore Plaza Apartment Building, Chicago, has set a new height record for monolithic reinforced concrete construction. It towers over 600 feet from sidewalk to rooftop. ■ A-432 steel, one of the new reinforcing steels having 50% greater yield strength, made this building possible in concrete. Using high strength steel reinforcement, the designers achieved slimmer columns . . . greater usable floor space . . . the reduction of overall construction costs. Modern flat slab design also provided a record number of stories within the total height. ■ On your next building, consider the advantages of reinforced concrete construction. There is no more economical, versatile, or creative material for buildings, high or low. Ask your consulting engineer, too, about the many other benefits of using new A-432 steel in modern reinforced concrete building designs.

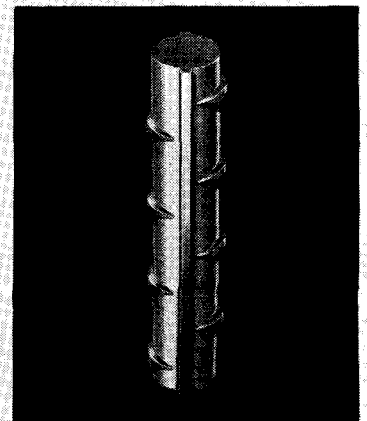

CONCRETE REINFORCING STEEL INSTITUTE

228 North La Salle Street • Chicago, Illinois 60601



1000 Lake Shore Plaza Apartments, Chicago, Illinois  
Developer: Harold L. Perlman  
Architects: Sidney H. Morris & Associates  
Structural Engineers: William Schmidt & Associates



**Clear, lustrous  
Starlux plate glass  
relieves a  
powerful facade  
of concrete**

Architect: Paulsen, Gardner and Associates

© American Saint Gobain 1966





Its upper windows aglow like firing slits of a fortress, Shapero Hall of Pharmacy at Detroit's Wayne State University makes a bold silhouette against the dusk. The building's upward-and-outward configuration is completely functional. It places those activities most in need of space and isolation (such as animal quarters and large laboratories) in the top levels. Heavy traffic activities are centered in the two-story base which includes a lobby and 160-seat lecture hall.

Shapero Hall is glazed with ASG's Starlux® twin-ground, polished plate glass. Floor-to-ceiling lights of Starlux ring the lower floors, making them open,

light-filled and inviting. After dark, these extensive walls of superbly clear glass form a pedestal of light for the building's powerful superstructure. Here, slim Starlux windows help relieve the weight of the massive concrete tiers.

Starlux contributes to this unusual building the unique qualities of the finest polished plate glass—superior clarity, visual fidelity and lustrous transparency. Starlux is the premier product in the full line of architectural glasses manufactured by ASG. For complete information about Starlux, write: Dept. E-3 American Saint Gobain Corporation, P. O. Box 929, Kingsport, Tennessee 37662.

*Starlux twin-ground plate glass by...*



*clean living on the West Side in New York*

## Mayfair Towers keeps clean with SPENCER Central Vacuum System

Stretching from 72nd to 73rd Streets, Mayfair Towers, the tallest apartment residence on the West Side, offers many advantages for comfortable living. Thorough housekeeping throughout the corridors of its 36 floors is another.

A Spencer central vacuum cleaning system makes it possible. Maintenance people merely insert hose into inlet valves strategically located along the corridors. Spencer vacuum does the rest: dust and lint are whisked through piping to collection tanks in the basement.

It's quick, sanitary, inexpensive. On your next project, Specify Spencer—the complete housekeeping facility. Call your Spencer representative. He's in the Yellow Pages. Or write Spencer for complete information, Bulletin No. 160.

Architects:  
*Horace Ginsbern & Associates, N.Y.*  
Mechanical Engineers:  
*Mayer Associates, N.Y.*  
Structural Engineers:  
*Farkas & Barron, N.Y.*



The **SPENCER**  
**TURBINE COMPANY**  
HARTFORD, CONNECTICUT



# For contemporary elegance, nothing beats wool. Except Acrilan®.

The carpet below looks just like wool, doesn't it?

Well, it isn't.

That deep luxurious pile is pure Acrilan® acrylic fiber. It's warm as wool. As rich-looking as wool. In fact, it has all the advantages of wool, plus something extra.

Acrilan acrylic is easier to clean than wool. It's non-allergenic, mothproof, mildewproof. And the bounciness of Acrilan is built right into the fiber.

These are the practical reasons for

specifying Acrilan. But the best reason, of course, is this: carpets of Acrilan acrylic fiber are beautiful.

The finest carpet mills make carpets of Acrilan acrylic...all labeled with the big red Acrilan "A." In rich colors and patterns, and in hundreds of styles—from the supermodern to Early American.

Demand carpets with the red "A." It means you are getting genuine Acrilan acrylic fiber.

For additional information write: Contract Carpet Dept., Chemstrand,

350 Fifth Ave., New York, N. Y. 10001.

These are among the mills now licensed by Chemstrand: for Acrilan: Barwick, Bigelow, Cabin Crafts, Callaway, Coronet, Crestline, Downs, Forrest, Gulistan, Hardwick and Magee, Hightstown, James Lees, Loomweave, Magee, Masland, Monarch, Philadelphia Carpet, Roxbury, Wunda Weve. In Canada: Barrymore Carpets, Crossley/Karastan, Harding Carpets.



Chemstrand, N.Y. 10001. Division of Monsanto



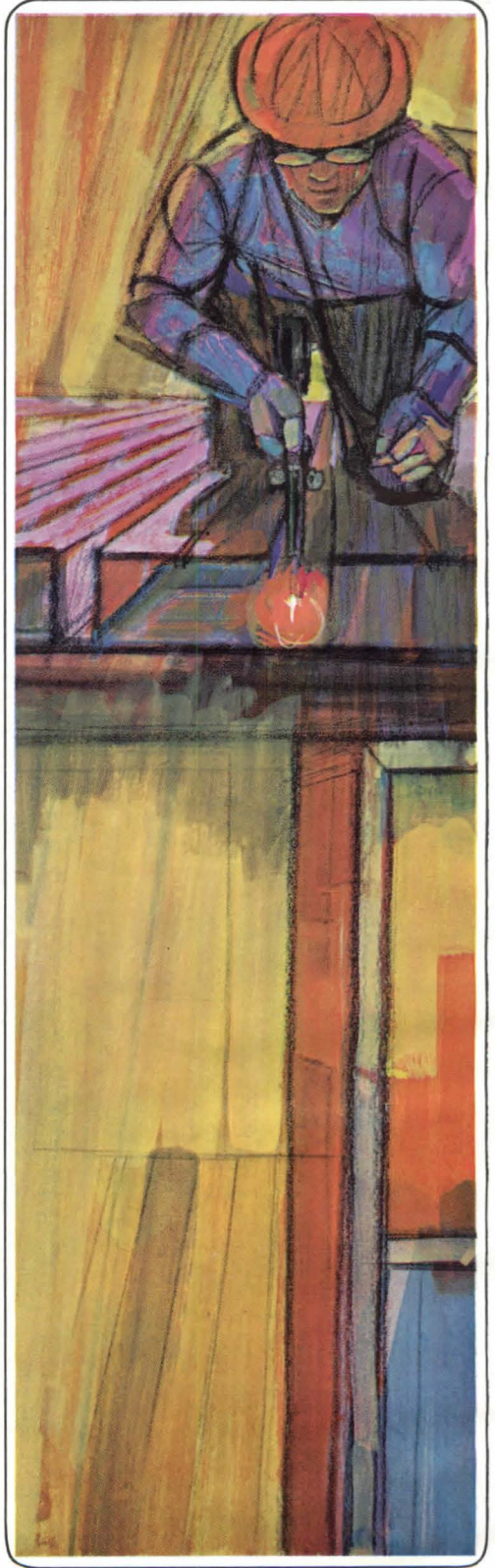
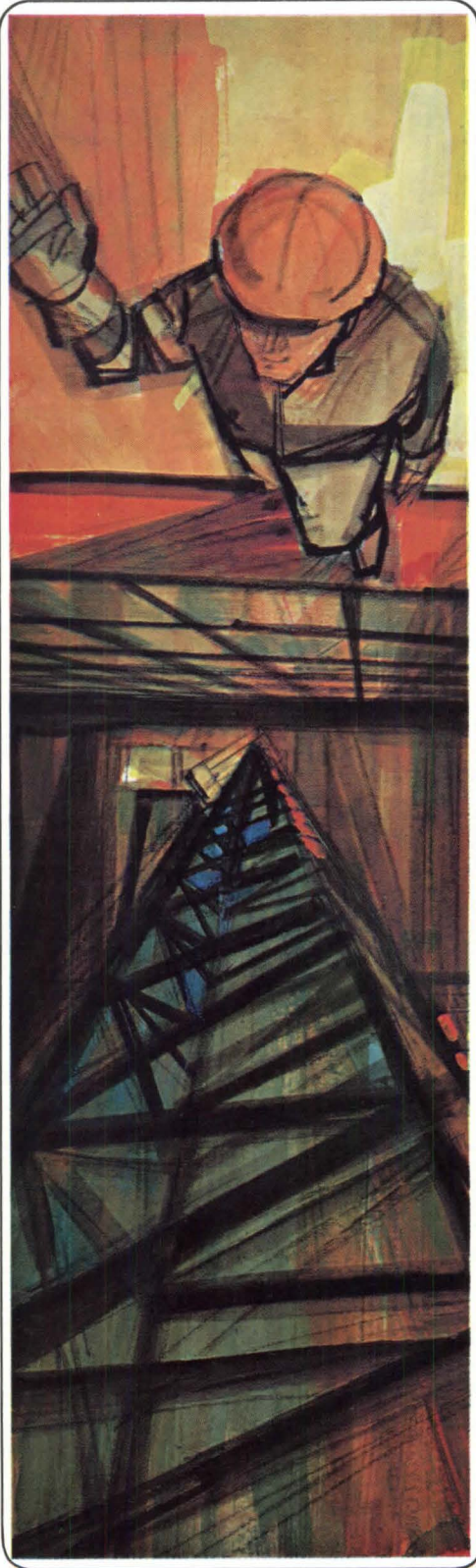
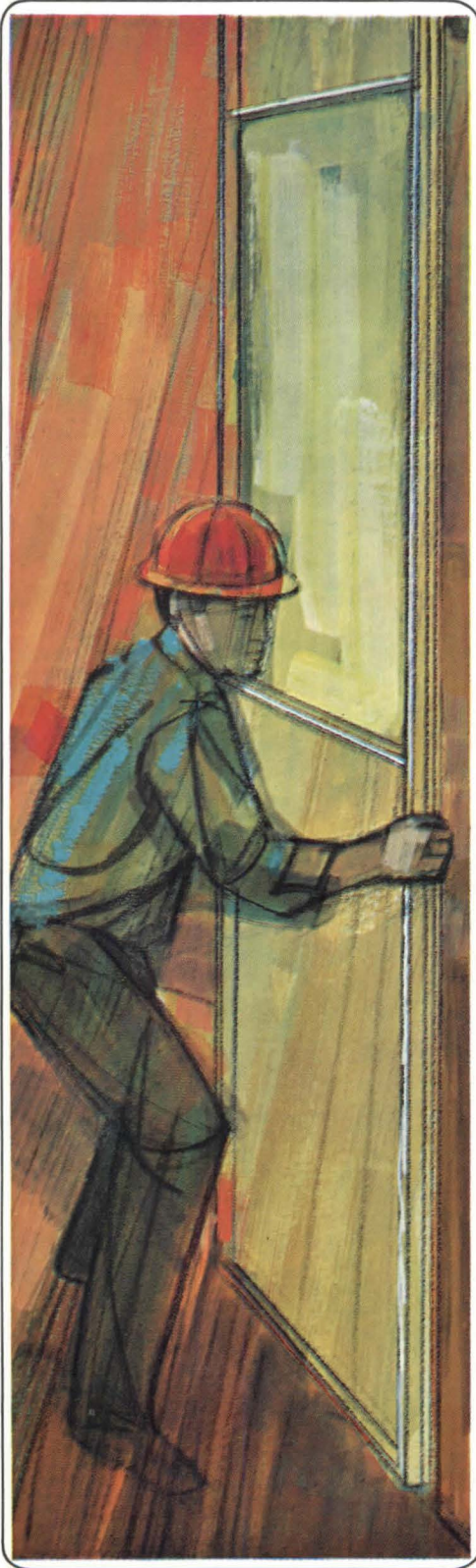

## New Pre-engineered Wall Systems

Fenmark wall systems offer pre-engineered answers to a variety of design requirements for one, two and multi-story buildings; for example, carrying the massive area of grayed glass on this Lowell, Massachusetts office building designed by Gensemer & Barton of Cambridge. Only steel is strong enough; only Fenestra offers a five-year performance warranty, and only Fenmark has all these features: hundreds of component combinations and sizes; watertight integrity; no exposed fasteners; condensation draining design and a rugged new oven-cured, two-coat, silicone-alkyd copolymer finish.

Performance begins with fast installation and compatibility with other systems: 1) To shear walls, add any of a variety of Fenmark units. 2) On one and two story buildings, top it off with D-Panel, the lightweight, longspan structural deck that provides a finished ceiling, plain or acoustical. You get the ultimate in simplicity and strength — one product, one trade, one responsibility. For the full story, check with your Fenestra engineering representative or write Fenestra, Inc., 1101 E. Kibby Street, Lima, Ohio.



# FENESTRA

# FENMARK GRID WALL SYSTEMS



Architects: Stanfield, Imel & Walton/University of Oklahoma Fine Arts Building and Auditorium/Norman, Oklahoma

**Mo-Sai Dramatics** The Fine Arts Building and Auditorium at the University of Oklahoma employs slender Mo-Sai column covers and facing panels to dramatize the extended roof and exterior walls. Mo-Sai panels with flamingopink exposed quartz aggregate form a dramatic backdrop for the “mushroom-topped” white Mo-Sai columns. Versatile Mo-Sai can be cast in almost any form imaginable—as windowwalls, curtain walls or decorative features and reinforced, prestressed or post tensioned to take structural loads. Let your imagination soar . . . design your next building in the enduring beauty of dramatic Mo-Sai.

**MO-SAI INSTITUTE, INC.**, 110 Social Hall Ave. / Salt Lake City, Utah 84111

**BADGER CONCRETE CO.**  
Oshkosh, Wisconsin

**BEER PRECAST CONCRETE, LTD.**  
Toronto, Ontario, Canada

**BUEHNER & CO., INC.**  
Mesa, Arizona

**CAMBRIDGE CEMENT STONE CO.**  
Allston, Massachusetts

**ECONOMY CAST STONE CO.**  
Richmond, Virginia

**FORMIGLI SALES CO.**  
Philadelphia, Pennsylvania

**GEORGE RACKLE & SONS CO.**  
Cleveland, Ohio

**GOODSTONE MFG. CO., INC.**  
Rochester, New York

**GRASSI AMERICAN CORP.**  
South San Francisco, California

**HAMILTON CONCRETE PRODUCTS CO.**  
Chattanooga, Tennessee

**HARTER CONCRETE PRODUCTS, INC.**  
Oklahoma City, Oklahoma

**JACKSON STONE COMPANY, INC.**  
Jackson, Mississippi

**OLYMPIAN STONE CO., INC.**  
Seattle, Washington

**OOLITE INDUSTRIES, INC.**  
Ojus Br. Miami, Florida

**PLASTICRETE CORPORATION**  
Hamden, Connecticut

**SOUTHERN CAST STONE, INC.**  
Knoxville, Tennessee

**SUPERCRETE, LTD.**  
St. Boniface, Manitoba, Canada

**TEXAS INDUSTRIES, INC.**  
Arlington, Texas

**WAILES PRECAST CONCRETE CORP.**  
Pomona, California

**WILSON CONCRETE CO.**  
South Omaha, Nebraska

*Mo-Sai*<sup>®</sup>

PRECAST, PRESTRESSED CONCRETE  
WITH EXPOSED AGGREGATE

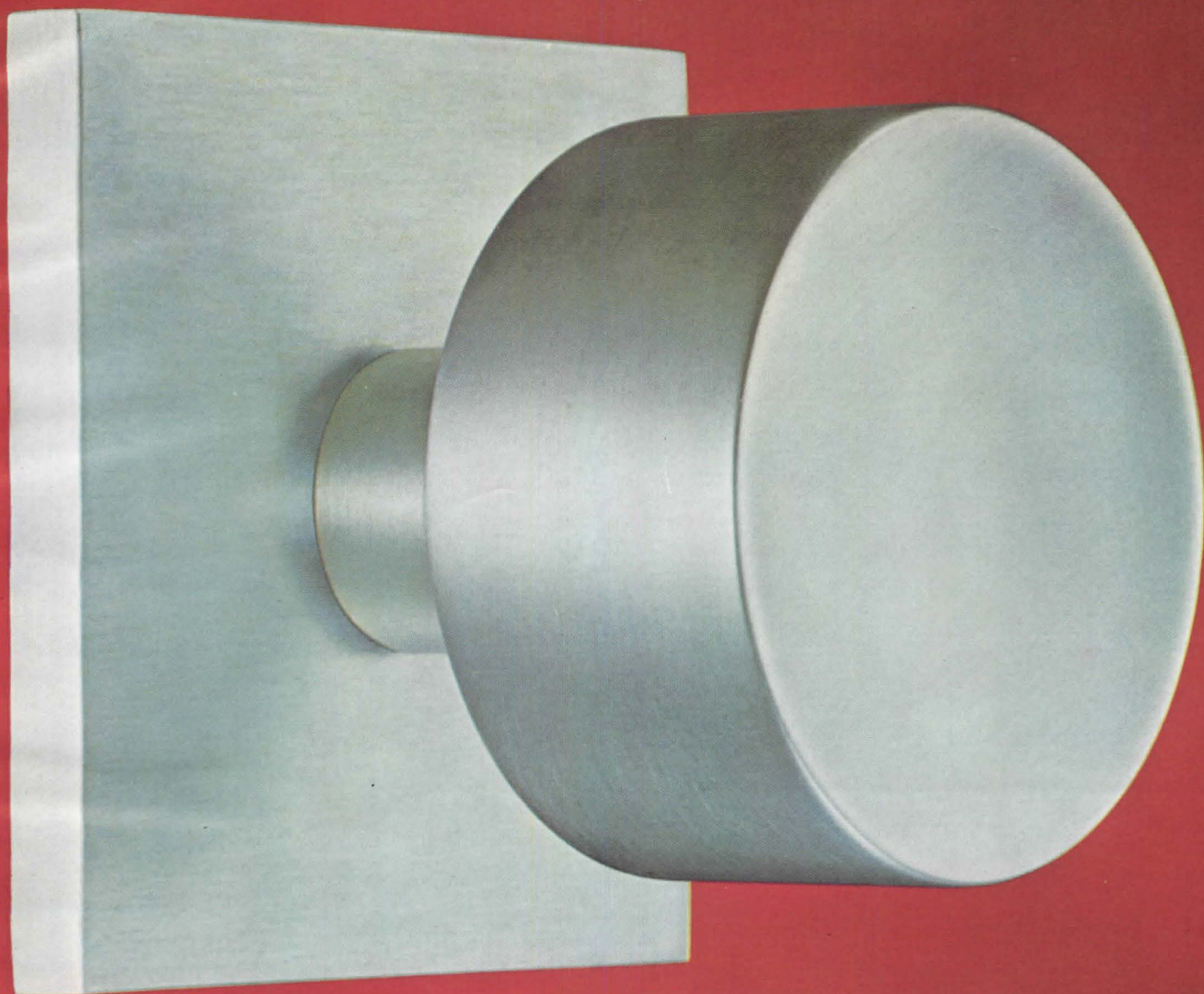

A handful. The shape of styling, heft, security. A flair for high fashion. SARGENT. Many more shapes, many more locksets with this creativity in metal — this unbelievable finish. A complete line of advanced architectural hardware:  **SARGENT®**

SARGENT AND COMPANY • 100 SARGENT DRIVE, NEW HAVEN 9, CONNECTICUT • PETERBOROUGH, ONTARIO • MEMBER PRODUCERS COUNCIL

On Readers' Service Card, circle No. 394



Ball State Teachers College P. E. Building — Muncie, Ind. / Seating Capacity — 7000 / Architects: Walter Scholer & Associates — Lafayette, Ind.

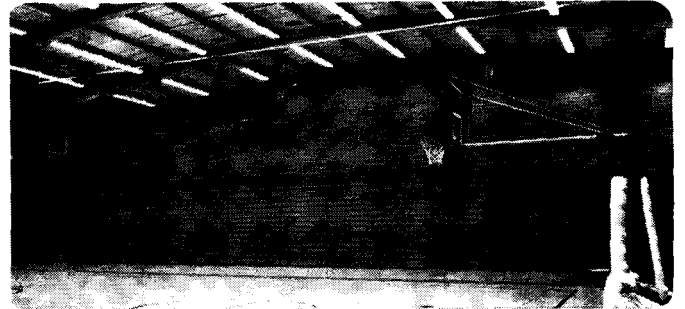
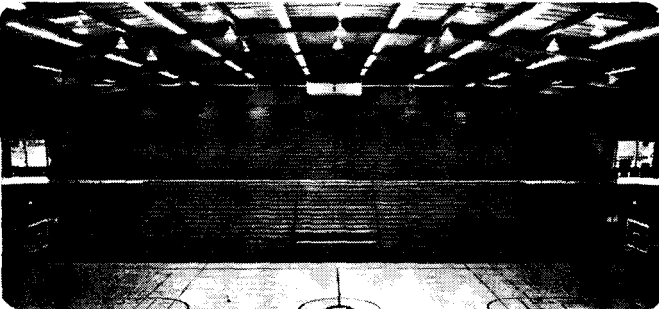
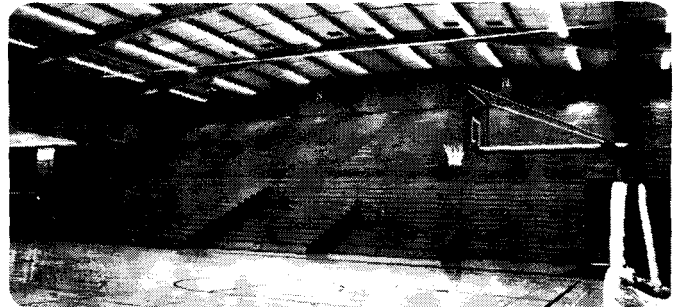
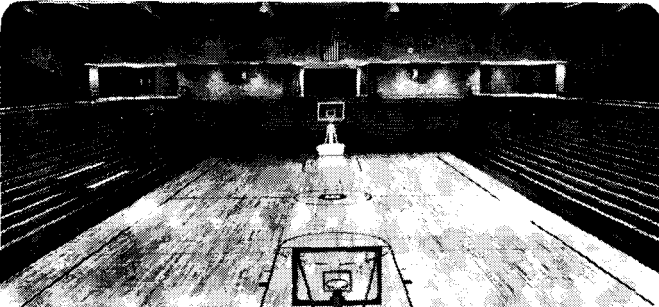

**SAFWAY TELESCOPING GYMSEATS** provide comfortable spectator seating and safety. Designed for maximum floor space utility — Safway's rugged steel understructure with extensive bracing insures complete safety reliability under all operating conditions. Safway gymseats are available in a variety of heights, widths, and seat spacings, for any building — large or small. Our engineers will provide you with detailed recommendations at no obligation.



Write today for your copy of Safway's descriptive illustrated gymseat literature and the address of your local authorized Safway dealer.

SAFWAY STEEL PRODUCTS, INC.  
P.O. BOX 1991  
MILWAUKEE, WIS. 53201



Impressions  
in wood...



**PELLA**  
WOOD CASEMENT WINDOWS



FIRST  
CLASS  
PERMIT  
NO. 1  
PELLA,  
IOWA

POSTAGE WILL BE PAID BY

**BUSINESS REPLY MAIL**

No Postage Stamp Necessary if Mailed in the United States

**PELLA** ROLSCREEN CO.  
PELLA, IOWA 50219

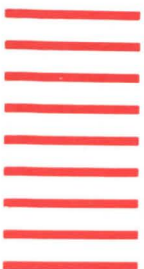

**Eliminate 6 window chores.** No putting up, taking down and storing screens and storms twice a year! And, PELLA Wood Casement windows are the **only** Windows with ROLSCREEN®, the original "instant screen" that rolls down in spring, up and out of sight in fall. (Inside flat frame screens available.) Stainless steel, spring-type weather stripping and self-storing storms contribute to year 'round comfort-conditioning. PELLA Casements are the only wood windows designed to install in masonry or other openings without wood bucks, brick mould or exterior trim. Select from 18 ventilating units to 24" x 68" glass size and 48 fixed units. Achieve the traditional look with snap-in, snap-out muntin bars in regular or diamond shapes. For bays, 30°, 45° and 60° joining mullions are standard. Or, specify other angles.

ARCHITECT: JOSEPH C. HAYES - DECORATOR: JANE NEWMARK, A.I.D.

ARCHITECT: STADE-DOLAN & ASSOC. - BUILDER: VERN BENGSTON



ARCHITECT: PETERSON, CLARK & GRIFFITH INC. - BUILDER: JOHNSON & JASPER

**ROLSCREEN CO.  
PELLA, IOWA**

**YES**, via first class mail, rush me more color pictures and information about the following PELLA products:

- PELLA WOOD CASEMENT WINDOWS
- PELLA WOOD MULTI-PURPOSE AND TWINLITE® WINDOWS
- PELLA WOOD DOUBLE HUNG WINDOWS
- PELLA WOOD FOLDING DOORS
- PELLA WOOD FOLDING PARTITIONS
- PELLA WOOD SLIDING GLASS DOORS

Name \_\_\_\_\_

Firm \_\_\_\_\_

Address \_\_\_\_\_

City \_\_\_\_\_ State & Zip Code \_\_\_\_\_

R123

Printed in U. S. A.

**MAIL CARD  
TODAY!**

(Your Request  
Answered  
within  
24 Hours)

**WANT MORE INFORMATION ON PELLA PRODUCTS?** Mail the postage-paid card at the left. Or, call your PELLA distributor. You can find his name in the Yellow Pages of your telephone directory. Or, see SWEET'S Architectural or Light Construction Files for PELLA product details. **ROLSCREEN COMPANY, PELLA, IOWA.**

**PELLA**

**WOOD CASEMENT WINDOWS  
WITH ALL EXTERIOR SURFACES FACTORY PRIMED**



**PELLA MAKES QUALITY WOOD WINDOWS, WOOD FOLDING DOORS & PARTITIONS AND WOOD SLIDING GLASS DOORS**

# "Fiberglas\* Beta\* solves problems most drapery fabrics can't"

## "Fiberglas allows for versatility and dimension of design... does away with that typical hospital look,"

says Dan Ferziger, leading hospital interior design consultant, responsible for the entire design of the new St. Barnabas Hospital in Livingston, New Jersey.

Dan Ferziger specified 15,000 yards of Fiberglas Beta draperies in this hospital installation:

"Fiberglas is the most outstanding hospital drapery fabric on the market today . . . it's the answer to hospital interiors . . . Fiberglas makes 'foolproof' draperies . . . is flame-resistant, nonabrasive, nonexplosive, wrinkle-resistant, and sanitary. It washes, drip-dries and can be rehung in a matter of minutes. This laundering reduces maintenance costs."

The 600-bed St. Barnabas Hospital was designed by architects, Ferrenz & Taylor, New York, and furnished by Fisher-Cohen Co., Newark, N. J. Dan Ferziger Inc. was responsible for total design coordination. Fiberglas gave him a freedom

of design that allowed beautiful color, screen printing, and exciting texture.

You'll be sold on Fiberglas drapery fabrics too, when you consider how Fiber-

glas answers the problems of cost, environmental control, along with creative interior design, as no other fabric in the world can.



Reception lobby of St. Barnabas Hospital.

On Readers' Service Card, circle No. 460

For information about Fiberglas architectural fabrics write:  
Owens-Corning Fiberglas Corporation, Decorative and Home Furnishings Division,  
717 Fifth Avenue, New York, New York 10022.

OWENS-CORNING  
**FIBERGLAS**



Front facade of the five-wing St. Barnabas Hospital.

# Now you can subdue radiant heat at window areas with PPG Feneshield® fabrics

The sunny side of any building on a clear day presents the problem of controlling the amount of heat entering through vision areas. Building occupants working closest to window areas can be uncomfortably warm. If the air conditioning is increased to make them comfortable, people further back from the windows may be too chilly.

One way to handle this problem is to contain the heat at the window by means of Feneshield-fabric window treatment and heat-absorbing vision glass before heat can affect the interior climate.

Mechanical shading devices do limit transmittance of the sun's radiation by

reflecting much of it back to the outdoors. But they also tend to absorb the heat they intercept and reradiate it inward.

A practical and economical solution to radiant heat control is the use of Feneshield fabrics, made of PPG Feneshield® fiber glass yarns. Tests conducted by PPG show that Feneshield fabrics produce an astounding reduction in solar heat.

A large percentage of radiant heat from the sun is reflected back to the outdoors by the Feneshield treatment. Heat absorbed by the fabric is removed largely by contact with conditioned air. Very little heat is reradiated inward. Uniform interior comfort is maintained right up

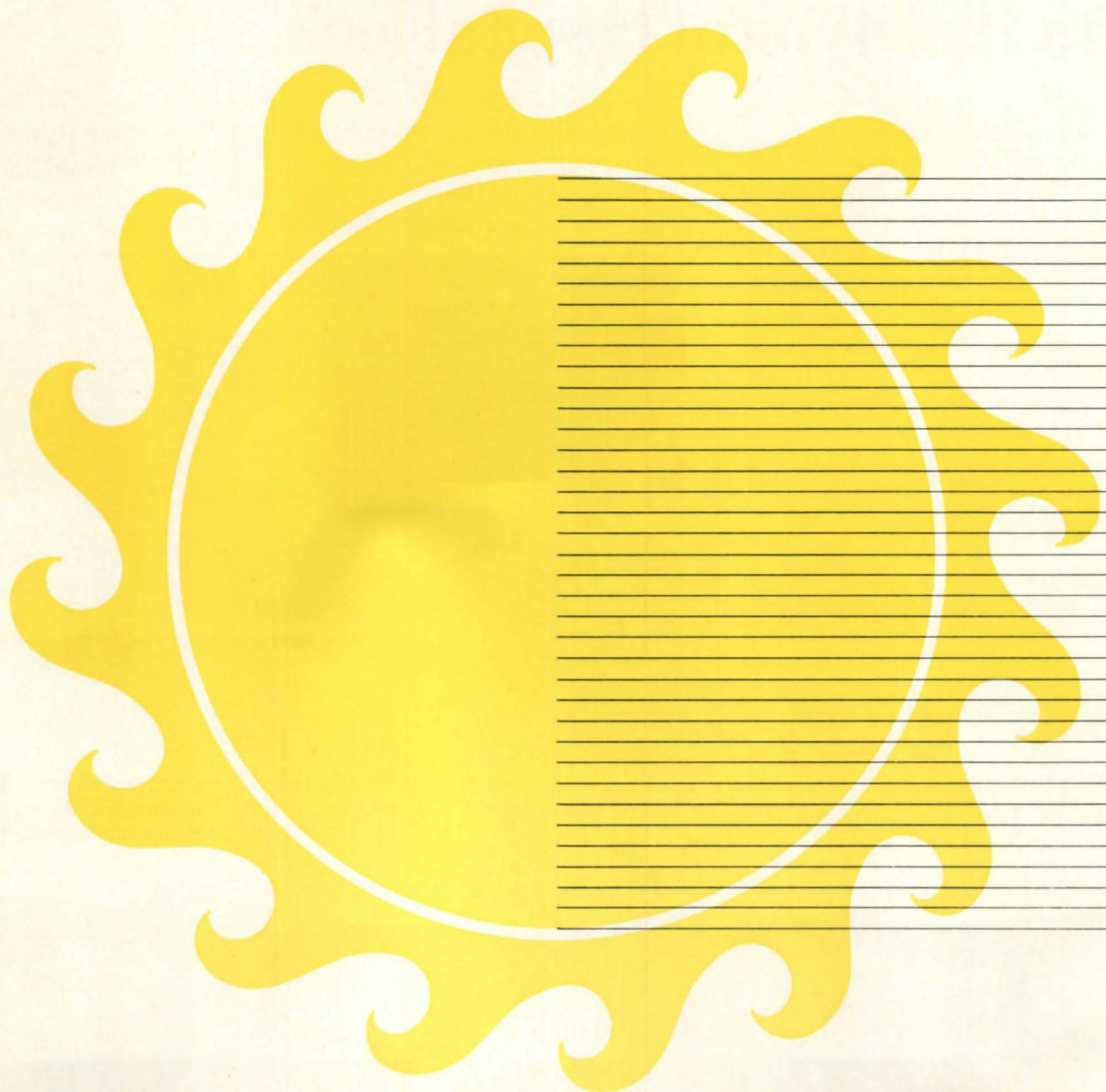

to window. And, of course, air conditioning loads are reduced.

**Get technical facts.** Results of PPG tests on Feneshield fabrics and other shading devices are yours for the asking. This research has produced a new system, based on fabric characteristics, which provides a scientific method for selecting fiber glass draperies to meet any given environmental control need.

Through the Feneshield rating system, you can also choose Feneshield fabrics to control glare, improve acoustics, enhance a good view or modify a bad one. Moreover, Feneshield fabrics offer you substantial savings in maintenance

over other types of shading devices.

**Personal help for you.** Participating Feneshield fabric drapery converters have authorized drapery fabric presentations which show the wide range of fabric weaves and colors available. They can help you select fabrics for specific installations through the use of PPG technical data. Write PPG for names of converter representatives near you and for technical information. Use the coupon.

 **fiber glass**  
*...the fiber glass for finer fabrics*  
PPG makes the Feneshield fiber glass yarns only, not the fabric.

Pittsburgh Plate Glass Company  
Fiber Glass Division, Dept. 701  
One Gateway Center  
Pittsburgh, Pennsylvania 15222

- Please send me technical information on Feneshield fabrics.
- Please send me names of authorized Feneshield converters.

Name \_\_\_\_\_  
Title \_\_\_\_\_  
Company \_\_\_\_\_  
Address \_\_\_\_\_  
City \_\_\_\_\_  
State \_\_\_\_\_ Zip Code \_\_\_\_\_

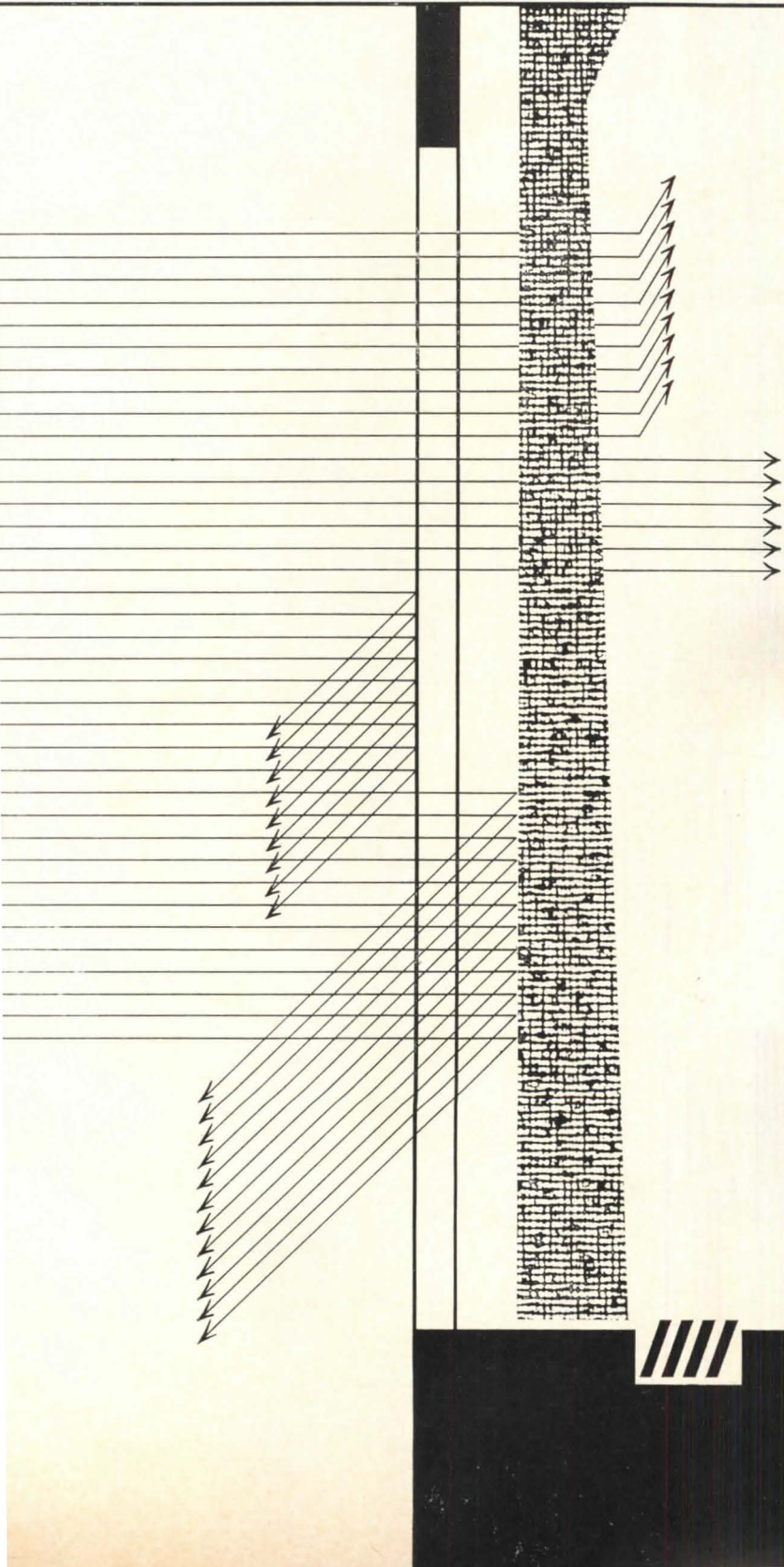

*Even in intense sunlight, occupants of a room can work in comfort near a window treated with the proper type of light-colored Feneshield fabric. Most radiant heat is reflected back to outdoors by the Feneshield drapery. Heat absorbed by the fabric (as indicated by upward arrows, far right) is removed largely by contact with conditioned air; there is very little reradiation inward.*



*where only the finest is adequate...*

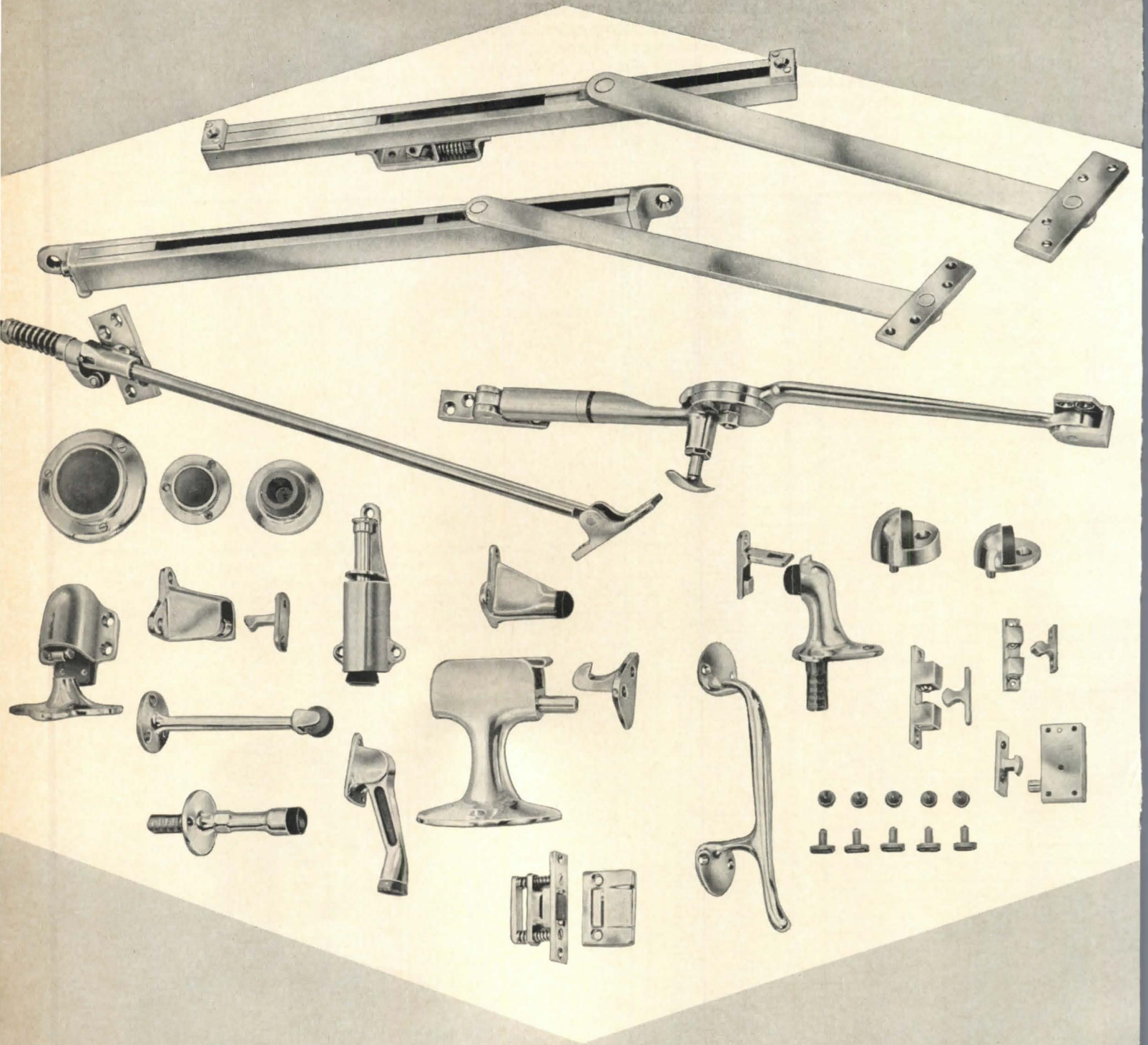

**GLYNN · JOHNSON**  
**door control hardware**



*since 1923*

write for details and templates **GLYNN-JOHNSON CORPORATION** • 4422 north ravenwood ave. • chicago, illinois 60640

## A Good Fire Extinguisher Doesn't Have to be Ugly!

A tastefully designed building deserves an attractive fire extinguisher. Unfortunately architects haven't had much choice in the past.

The new Ansul ENSIGN was designed to complement your architectural design—not to create an eye-sore. If the classic lines of the extinguisher aren't sufficient proof, try color. It's available in 48 different decorator colors.

The ENSIGN'S Beauty is more than skin

deep. It's made of fiberglass . . . in fact, it's the world's first U.L. listed pressurized fiberglass water extinguisher. It will perform better, last longer and look better than the traditional metal water extinguishers. Nor will it dent, corrode or explode like the old-fashioned units.

Write for our new brochure on the ENSIGN . . . or call your local Ansul Man for complete information. He's listed in the "Yellow Pages."



THE ANSUL COMPANY, MARINETTE, WISCONSIN



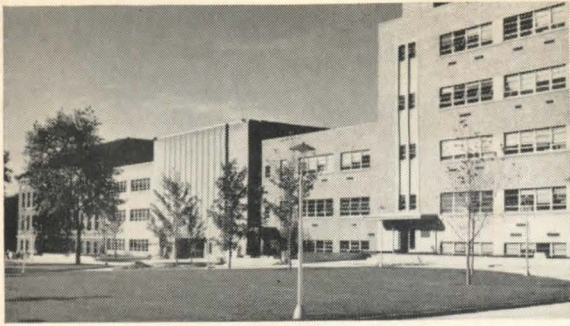

Case Institute of Technology  
Cleveland, Ohio

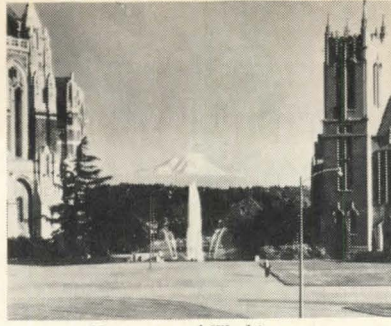

University of Washington  
Seattle, Washington

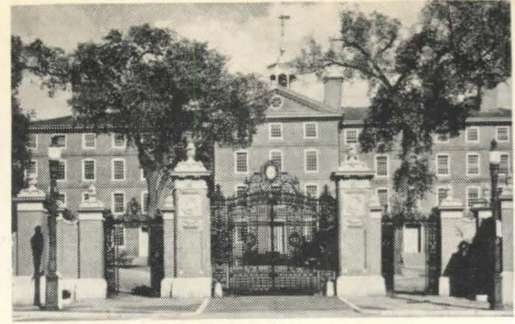

Brown University  
Providence, Rhode Island



Philadelphia  
College of Bible  
Philadelphia, Pennsylvania



Vermont College  
Montpelier, Vermont



Carnegie Institute of Technology  
Pittsburgh, Pennsylvania



Stanford University  
Stanford, California

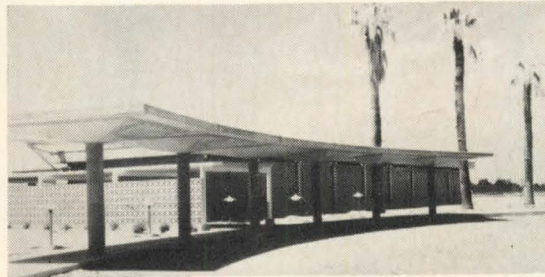

Eastern Arizona Junior College  
Thatcher, Arizona



Paulist Fathers' Novitiate Oak Ridge, New Jersey

## for college or university walk-in

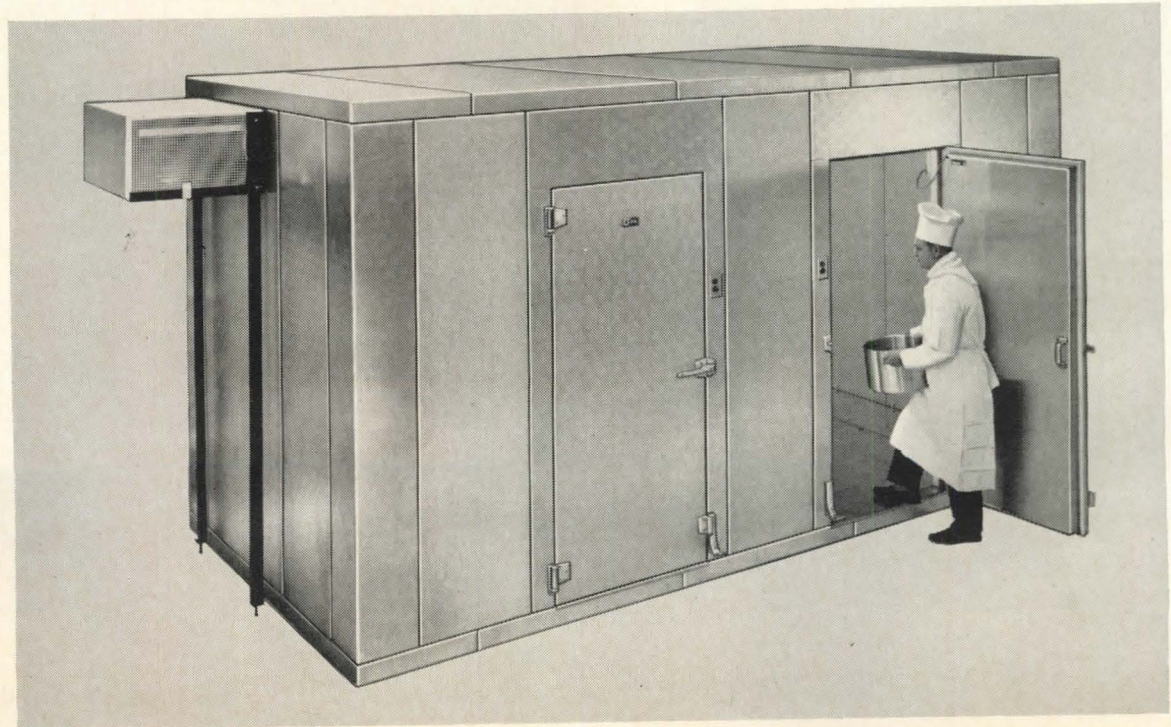





Washington and Lee University  
Lexington, Virginia



Cornell University  
Ithaca, New York

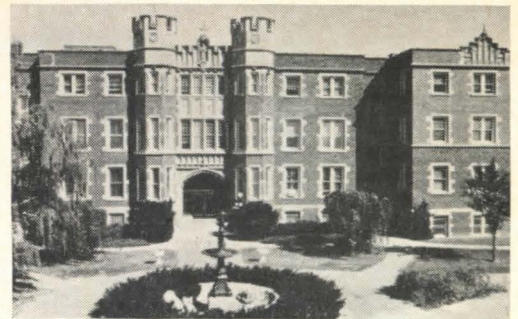

St. Benedict's College  
Atchison, Kansas

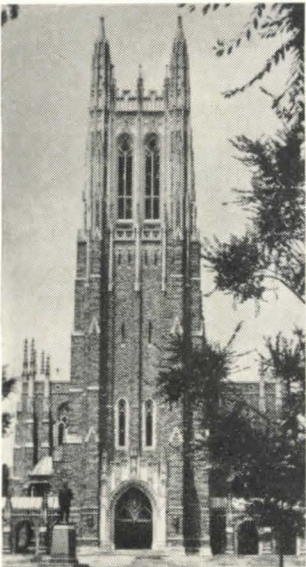

Duke University  
Durham, North Carolina



University of North Carolina  
Chapel Hill, North Carolina

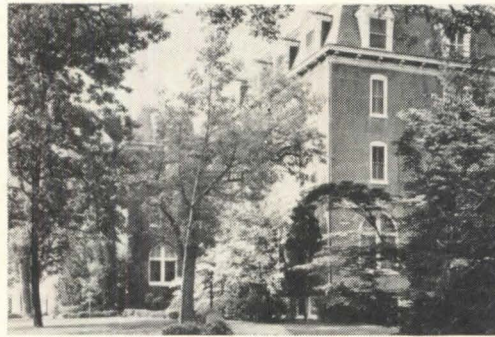

Perkiomen School  
Pennsburg, Pennsylvania



Lincoln College Lincoln, Illinois

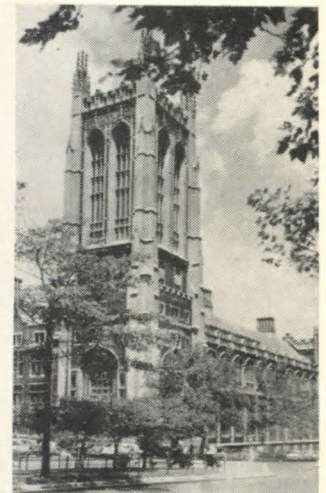

Union Theological Seminary  
New York, New York

## refrigeration needs... specify Bally prefabs

These colleges and universities, like many other institutions and places of business, are benefiting from Bally Walk-In coolers and freezers with revolutionary construction techniques and design features. Bally has set a new high in refrigeration efficiency.

When you specify Bally you can be sure that your clients will get many advantages not found in conventional prefab Walk-Ins...never available in on-the-site "built-ins"...and at far lower cubic foot cost than "reach-ins". There is never a need to accept an "or equal" or a substitute. Bally Walk-Ins are available to all dealers everywhere at uniform published prices.

*Write for Fact File with new brochure, specification guide and sample of urethane wall.*

*See Sweet's File 25a/Ba.*

Bally Case and Cooler, Inc.  
Bally, Pennsylvania





Concordia Lutheran Junior College — A College of the Lutheran Church, Missouri Synod—Ann Arbor, Michigan  
Architect: Vincent G. Kling, FAIA Philadelphia, Pa. Roofing Contractor: Detroit Cornice & Slate—Detroit, Michigan

**ROOFS, ARCHITECTS, AND IMAGINATION.** On the one hand, there is a renewed interest in visually significant roofs. And on the other, there is a notable increase in the specification of Follansbee Terne. We believe that both of these trends happily reflect a greater emphasis on purely imaginative elements in contemporary architecture, a welcome departure from the "anti-septic line". And both are essentially interdependent, for terne is unique among roofing materials in that it provides maximum creative latitude at relatively modest cost.



**FOLLANSBEE STEEL CORPORATION** Follansbee, West Virginia *Follansbee is the world's pioneer producer of seamless terne roofing*

NOTHING LIKE IT ON THE MARKET!

New...distinctively different  
carpeting for heavily-trafficked  
areas...

Downs *FORWARD* LOOK  
Acrilan<sup>®</sup> face, Quality Wilton



*Shown in Copper Blaze / See Full Color Range Next Page*

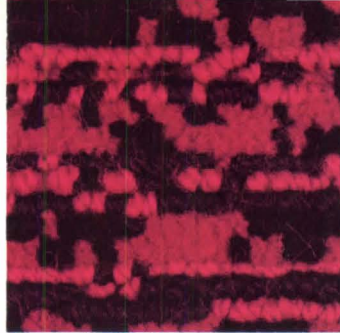

Grenadier Red

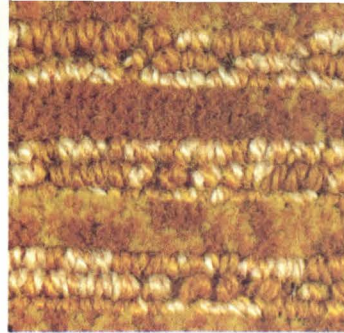

Gilded Gold

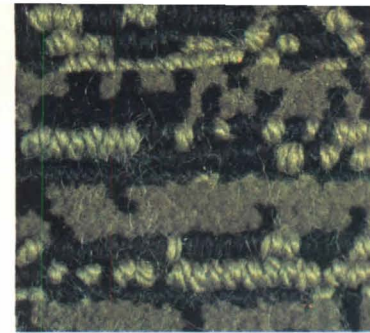

Greengage

Downs new  
**"Forward Look"**  
 ... long-awaited  
 flooring artistry. A  
 soft, striated classic  
 wilton weaving pattern  
 of Acrilan® face.

Here is richness, quality  
 and hand ... superbly  
 crafted. **"Forward Look"**  
 will cover the largest  
 public flooring expanses  
 down to the smallest  
 conference room  
 areas ... magnificently.



Fan Tan

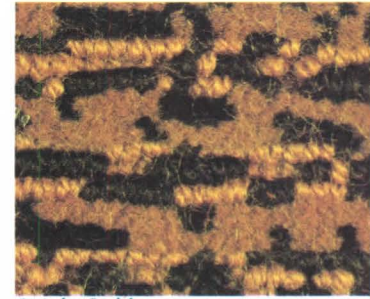

Oriole Gold

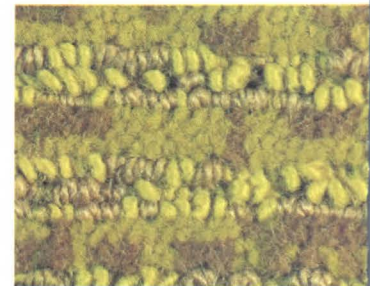

Limerdo

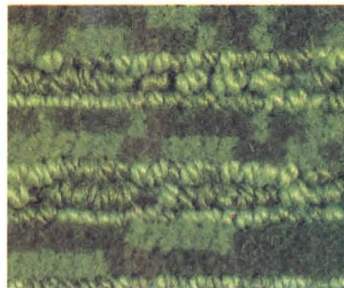

Sorrel Green



Marquestan Blue



Copper Blaze

The play of different pile heights against two colors classifies "FORWARD LOOK" as a stylish new wilton interpretation . . . an interpretation which immediately suggests countless contract applications. The carpet pile made with Acrilan® acrylic fiber, plus its value-laden price, are two additional reasons that also suggest your looking into "FORWARD LOOK" at once.

**DOWN'S**

Quality Carpets Since 1865



THE MARK OF CARE

**FREE!**  
**Swatch Folder**  
**and Contract**  
**Brochure. Write**  
**Contract**  
**Department**  
**FL265**



DOWN'S CARPET COMPANY, INC., Philadelphia, Pa. 19134

**We've got another new product.  
 We've got another new product.  
 We've got another new product.  
 We've got another new system.**

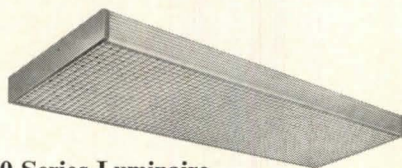

**6300 Series Luminaire**

New! An architecturally-styled, all plastic enclosed lighting series. With simplicity and contemporary appearance, these new luminaires offer the widest selection of widths (from 1 to 4 lamp configurations) with matching contours.

**58600 Visionaire-5®**

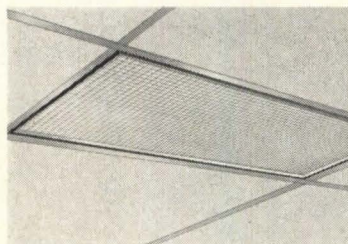

Here's a marriage of architectural design and mechanical perfection in a recessed-mounted lighting and heat-exchange (or air-handling) unit coordinated to create a balanced environment.

Visionaire features a "floating" appearance as a result of a continuous, recessed air slot surrounding the light diffusing panel.

**Examatron® Medical Examination Light Patented.**

Exclusive! Sunbeam Lighting introduces the first self-contained, fold-away lighting instrument of its kind. Designed especially for the medical examination task, the EXAMATRON features a high-intensity, quartz iodine lamp with a color-corrected filter.

Specify for examination rooms in the doctor's office, medical center and hospital.

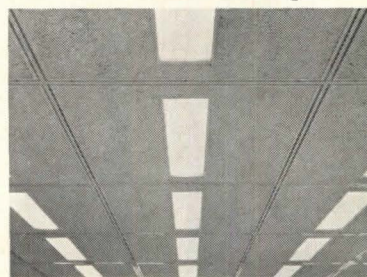
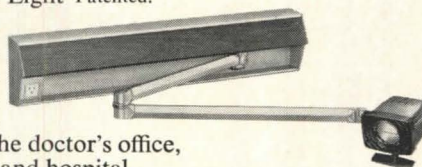

**ISI-100 Modu-Flo® Interior System**

Due to an incredible modular capability, this total lighting and air distribution system was designed for flexibility for the life of a building. Unique Modu-Flo linear air bars assure the most uniform air distribution available. Total coordination for almost any room increment you name!

For complete information on Sunbeam Lighting Company's new products and systems write:

**Sunbeam Lighting Company**

Los Angeles, California / Gary, Indiana ■ 777 East 14th Place, Los Angeles, Calif. 90021



## Load-bearing units of precast white concrete cut construction time and costs

Precast concrete can be used as the structural system itself. As a load-bearing unit, it offers the economy of a combined decorative and structural building material. Consider the free-standing white concrete columns, weighing 25 tons each, that form the portico of this 6-story building. They were cast in one piece on the job site and erected with no expense for scaffolding. Prestressed by the post-tensioning method, the 80-foot by 2-foot-square columns support precast flared tops which form arches that give the structure its classic appearance. This was emphasized by using ATLAS WHITE portland cement concrete with an exposed quartz aggregate finish. ■ For more information on the aesthetics and structural economies of precast white concrete, see your local precast concrete manufacturer. Or write Universal Atlas, 100 Park Avenue, New York, N. Y. 10017. "ATLAS" is a registered trademark.

**Atlas**  
WHITE CEMENTS

WF-79

 **Universal Atlas Cement Division of United States Steel**



Headquarters, Northwestern National Life Insurance Company, Minneapolis. Architects and Engineers: Minoru Yamasaki & Associates, Birmingham, Mich. Structural Engineers: Worthington, Skilling, Helle & Jackson, Seattle. Contractor: George A. Fuller Company, Chicago. Precast Concrete Contractor: Aggregate Surfaces, Inc., Detroit. Post Tensioning: Hufschmidt Engineering Company, Sussex, Wis.

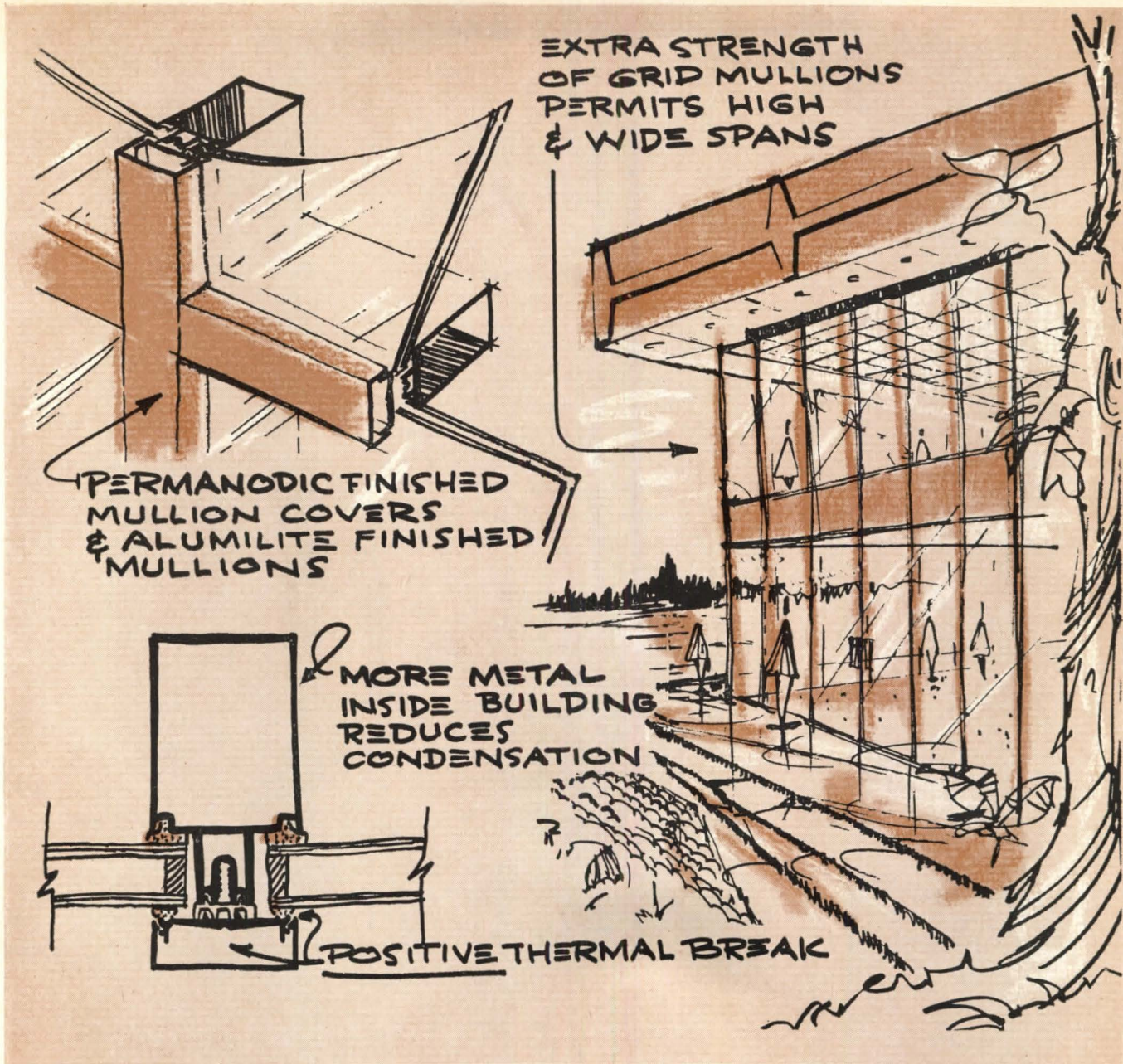

**the Kawneer 1600 curtain wall system  
that solves condensation problems!**

EXCLUSIVE THERMAL BREAK ELIMINATES METAL-TO-METAL  
CONTACT BETWEEN OUTSIDE AND INSIDE SURFACES!

- You'll never hear a complaint about condensation causing damage to wall coverings, drapes, carpets, etc. There is little thermal transfer to cause condensation, discomfort, or high costs for heating or air conditioning. Also, there is more metal inside and less outside which in itself tends to minimize heat flow.
- The Kawneer 1600 Wall System is ideal for high rise and 1-or-2 story applications with *high and wide spans* because of extra strength in the grid mullions. Available with both plate and insulating glass.
- *Clean, crisp lines and Permanodic\*, too!* Available in non-fading Permanodic hard color finishes.

You can add rich color economically by combining Permanodic finished mullion covers with Alumilite finished mullions. ■ For more information, write for File No. WS-65. Address Kawneer Product Information, 1105 N. Front St., Niles, Michigan.

\* Trademark of Kawneer Company, Inc.  
© 1966 Kawneer Co., Inc.



**Kawneer Company, Inc., a Subsidiary of American Metal Climax, Inc.**  
Niles, Michigan • Richmond, California • Atlanta, Georgia • Kawneer  
Company Canada, Ltd., Toronto, Ontario • Kawneer de Mexico, S.A. de  
C. V., Mexico City, Mexico • Kawneer Company (U. K.) Ltd., London •  
Kawneer GmbH, Rheydt, Germany • Showa Kawneer, Tokyo, Japan

**"HERE'S AIRTEMP'S BRAND-NEW, AIR COOLED CONDENSING UNIT. IT'S ALUMINUM-LIGHT!** This little sweetheart, the HAR-50 [50 ton model], is light and compact [2,860 lbs., covers 76.5 sq. ft.]. It's the strong, silent outdoor type [aluminum construction in cabinet frame, heat-transfer surfaces and legs]. Of course you'll want to know more about this whole series [20-100 tons]. Just ask my Airtemp friends. They're listed in the Yellow Pages."

**Airtemp**

**CHRYSLER CORPORATION**





# ACRYLIC

# LOUVERS

## CLASS I MATERIAL

**ABSOLUTE COLOR STABILITY**—an egg-crate louver injection molded of 100% pure virgin acrylic. 45°x45° shielding is provided by 1/2x1/2x1/2 inch cells which allow maximum illumination and excellent brightness control over 45°.

**HIGH EFFICIENCY** as over 70% of the panel is open and the 100% virgin acrylic has over 50% transmission factor, the efficiency approximates an exposed lamp.

**HIGH MAINTAINED EFFICIENCY** as there is a minimum area for dust collection, dirt falls through, eliminating a dust film on the top side, high foot-candle, shadowless illumination is maintained. Louvers are destaticized to repel dust.

**REDUCED GLARE** the height of the panel, and the open cubes of the louver construction allow most light to come through instead of "brighting up" the panel. Reducing irritating and fatiguing glare without sacrificing light.

**AIR CIRCULATION** the open cubes allow free air circulation, enabling lamps and ballasts to operate cooler, increasing their efficiency and life.

**DIMENSIONALLY STABLE** the rigid, one piece construction provides a durable, impact resistant panel, impervious to scratching, tearing, washing or marring, American louvers' edges stay straight and unaffected by temperature and humidity fluctuations. However, they can be cut to any specifications, offering unlimited design and installation flexibility.

**SIMPLE LOW COST MAINTENANCE** as dirt and dust falls through, maintenance is minimized. Just lift out for relamping; a quick detergent dip for cleaning. Economical because of their durability and maintenance ease. Destaticized panel requires minimum of cleaning.



AMERICAN LOUVER COMPANY

5325 N. ELSTON AVE.

CHICAGO, ILLINOIS 60630

CANADA—15 TIDEMORE ST., REXDALE, ONTARIO

On Readers' Service Card, circle No. 325

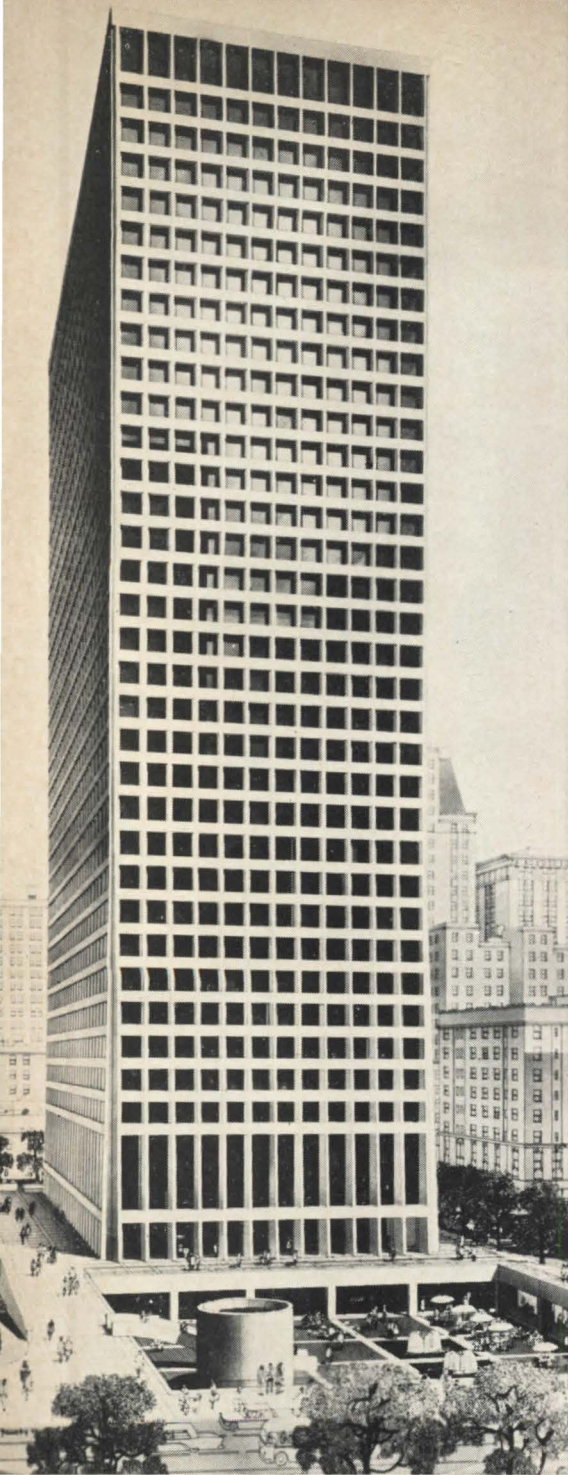

**DALLAS, TEXAS:** 34-story, 1,000,000 sq. ft. One Main Place office building. *Architects:* Skidmore, Owings & Merrill; Harwood K. Smith and Partners. *Engineer:* Herman Blum. *Contractor:* Henry C. Beck.



**CHICAGO, ILLINOIS:** 33-story, 600-room Holiday Inn motor hotel. *Architect/Engineer:* William Bond & Associates. *Contractor:* Turner Construction Company.



**WHITTIER, CALIFORNIA:** 172,000 sq. ft. Broadway department store. *Architect:* Charles Luckman Associates. *Electrical Engineer:* C. E. Mauk.



**SPRINGFIELD, MASSACHUSETTS:** 5,000 sq. ft. Metropolitan Life Insurance Company branch office building. *Contractor:* A. C. Dufault. (Design by Metropolitan Life Insurance Company architects.)



**TAMPA, FLORIDA:** 8-story, 97,000 sq. ft. IBM office building. *Architect:* Aeck Associates. *Engineer:* Blakely-Daniels and Associates. *Contractor:* International Construction Co.

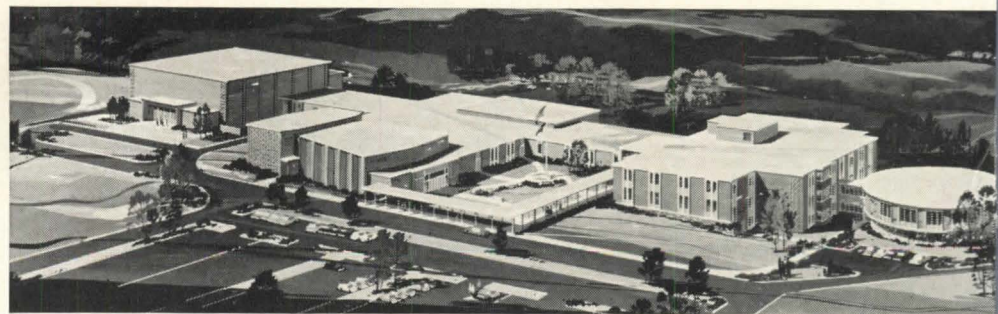

**JOHNSON COUNTY, KANSAS:** 2000-student, 287,400 sq. ft. Shawnee Mission South High School. *Architect:* Tanner, Linscott & Associates. *Engineer:* Scott, Kinney, Holloway and Perkins. *Contractor:* Sharp Brothers Construction Company.

## Now...the big ones are going All-Electric

More and more architects and engineers are finding that all-electric design, with flameless electric heating and cooling, can hold down first costs for clients in buildings of all types through the elimination of such items as boiler rooms, fuel storage, stacks and long pipe or duct runs.

Annual costs can also be reduced, since simpler control systems and lower maintenance require fewer employees.

Moreover, because of the wide variety of equipment types to choose from, all-electric design permits greater architectural freedom and flexibility. Expansion becomes easier, too. And all-electric design can also provide from 5% to 10% more

usable floor space for additional building capacity.

For more facts about the proven advantages of applying all-electric design to your industrial and commercial buildings, call your local electric utility company. They will welcome the opportunity to work with you.

This plaque identifies a modern building, meeting the standards of electric heating, cooling, lighting and other applications set by Edison Electric Institute.

**BUILD BETTER ELECTRICALLY**

Edison Electric Institute, 750 Third Ave., New York, N.Y. 10017



*"It remained for the airplane to complete the confusion by amplifying the mobility of the citizen to the point where urban space as such was irrelevant. Metropolitan space is equally irrelevant for the telephone, the telegraph, the radio, and television. What the town planners call 'the human scale' in discussing ideal urban spaces is equally unrelated to these electric forms. Our electric extensions of ourselves simply by-pass space and time, and create human involvement and organization for which there is no precedent. We may yet yearn for the simple days of the automobile and the superhighway."*

MARSHALL MCLUHAN



## EDITORIAL

**Should form follow function or function follow form?** This favorite architectural parlor game, played so intensely somewhere between 1945 and 1955, seems to be popular again. The reason for the revival is the current religious buildings explosion that coincides with an important theological revolution.

When the functionalist theory was rampant, function was defined at first in the practical use-sense, and, later, when justification for certain irrationalities became necessary, it was widened to include emotional and aesthetic needs. Whichever way one defines it, function was much better known in the past than it is today.

In a static society, strong traditions inevitably develop and the way man lives is determined by well-established philosophies, customs, and mores. The proper way to be born and to die, how to eat and to sleep, what and how to learn, who the gods are and how to worship them, and all the other ways of man's life on earth (and in heaven or hell), used to be put into rules that were not only rigid but also well known, and, except for relatively infrequent upheavals, unchanging.

So when the dictum "form follows function" came into being, there was a discussion about the truism of the slogan itself, but not about the possibility that function is not clearly definable, and, therefore, a form truly expressive of function not realizable. Because even in the 19th Century, in spite of the impact of the Industrial Revolution, there was much more certainty about the function of a building, including a religious building, than there is now.

The Church today (and this is true of all the various religions and denominations) is in a state of flux. Rigid dogma and ritual, and clear understanding about the place of religion in society, have given way not only to many changes, including the uncertainty about the role of religion within our pluralist civilization, but even to such monumental heresies as the God is Dead movement within the Christian ranks. When respected theologians say that man has learned to live without God and perhaps the next stage of Christianity is a religionless Christianity; when respected churchmen say that possibly the future of religion is to become a social rather than spiritual force and therefore churches (buildings for worship) are no longer required; when congregations do not really know whether they are building sanctuaries (or is it schools, or perhaps social centers where boy meets girl and businessman meets prospect); when such confusion about the basic purpose exists, how can form follow function? Obviously it cannot, because there is no clear function to follow.

Should, then, function follow form? This is what many churchmen hope for. At several meetings I attended recently, the question was actually put to architects: Why don't you, through your buildings, tell us what religion is today.

Such requests are dangerous. They not only indicate the doctrinal fiasco, but also represent an attempt to throw the responsibility for concept-giving on those whose task it should be only to translate concepts into three-dimensional forms. For architects to determine the nature of religion surely goes way beyond even the wildest comprehensive service idea. And, besides, judging by the appearance of most current church buildings, if architects become theologians, we shall be stuck with some pretty sick religions.

So what is the answer to that old question of what follows what, be it chicken and egg, or function and form? One is tempted to say that God only knows; but if God is really dead, then there is no one who knows. ■

Jan C Rowan

# DOES ARCHITECTURAL DESIGN SHAPE LITURGY?

There is an often stated dogma of religious design that architecture should be shaped by worship, not worship by the architect. It is certain that meaningful religious buildings cannot be designed today on this assumption and it is doubtful that they ever were in the past. Such thinking assumes a fixed traditional ritual, dictating an architectural form that can only be true in the regurgitation of past architectural forms to embalm dead theological concepts. If either theology or the form of a religious structure is fixed, the generating interaction that injects life into both architecture and worship is negated.

It cannot be denied that the transference of worshippers from the temple of Jerusalem to the desert synagogue, or from the catacombs to the basilica, did not shape worship. Architecture is conceived to house worship, but to maintain that the architect, particularly the contemporary architect, does not and should not affect

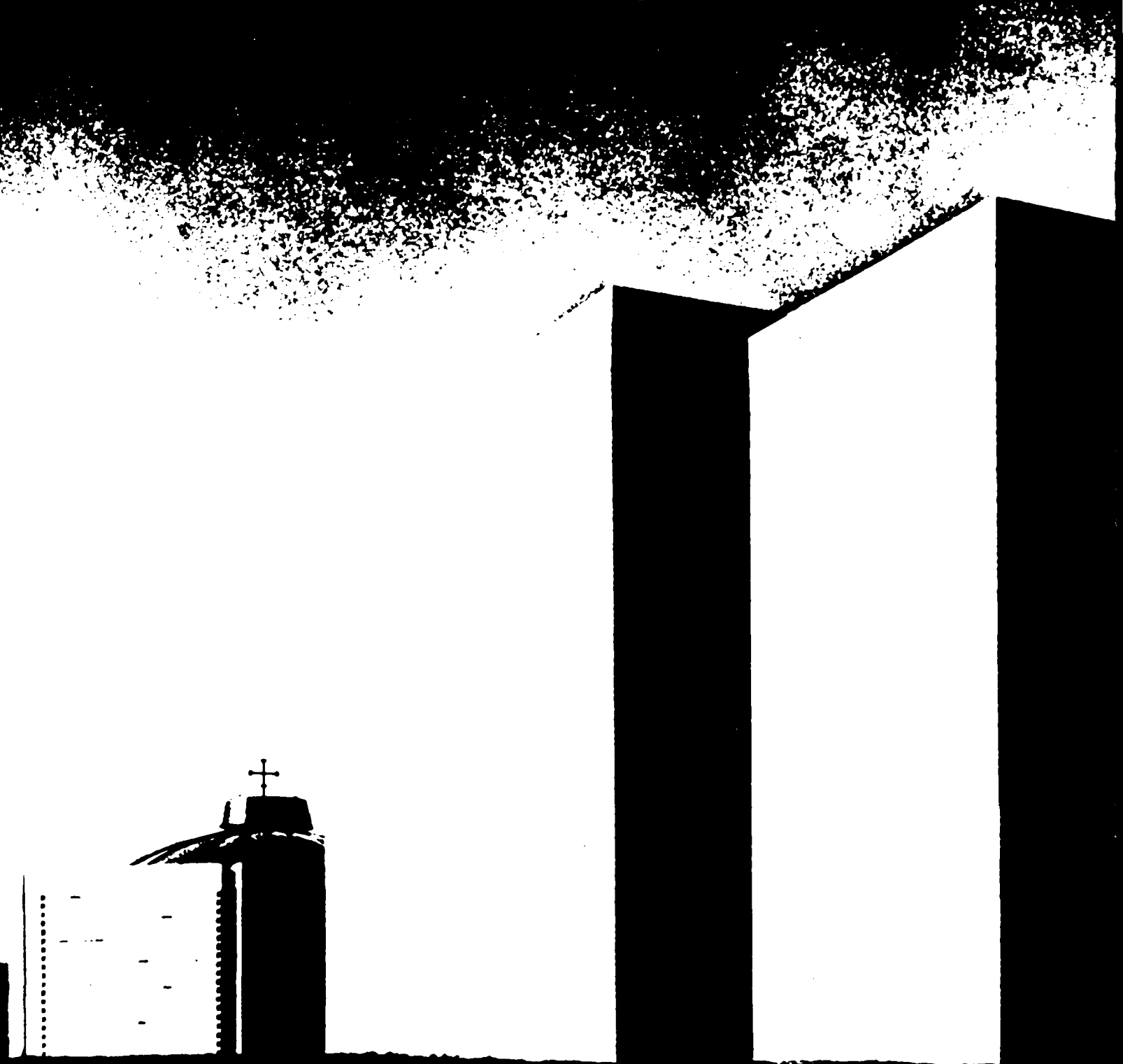

the form of ritual is to deny the meaning of architecture and to equate the Eucharist celebrated in a classroom to the same ceremony performed in Ronchamp.

The unique conditions of our time, which combine a questioning theology and an experimenting architecture, accentuate the impossibility of church architecture as a preordained unity of religious dogma and architectural style. The modern architect is forced by a fragmented society to evolve a philosophy and explain the formal implications of his work, leading to the architect's personal evaluation of theology and ritual. The architect collaborates in the creation of sectarian form — usually not as a member of the congregation or even as one affiliated with organized religion. Ritualistic needs thus serve as directional devices for formal solutions, rather than as commandments. This carries with it the implication of the architect who is not the servant of theology but its interpreter. The architect, in other words, in

creating a church or synagogue, may be performing an act with theological implications. The result is that the design of religious buildings has become predominantly an intellectual and aesthetic function on the part of the architect; it is not, as it was in the past, an extension of faith.

Each of the buildings presented on the following pages has in common the close collaboration between architect and clergyman, with each undeniably influencing the other. The aesthetics of architecture and the intellectual interpretation of ritualistic needs are obvious; the sectarian faith of the architect is not. None of these structures, whether church or synagogue, is anything other than a house of worship. They have one quality in common, and that is that they have provoked in the clergyman or rabbi a response of undeniable enthusiasm — although often for varying reasons — for the meaning the building gives to worship. No one feels that these structures are monuments to the architect. — FW



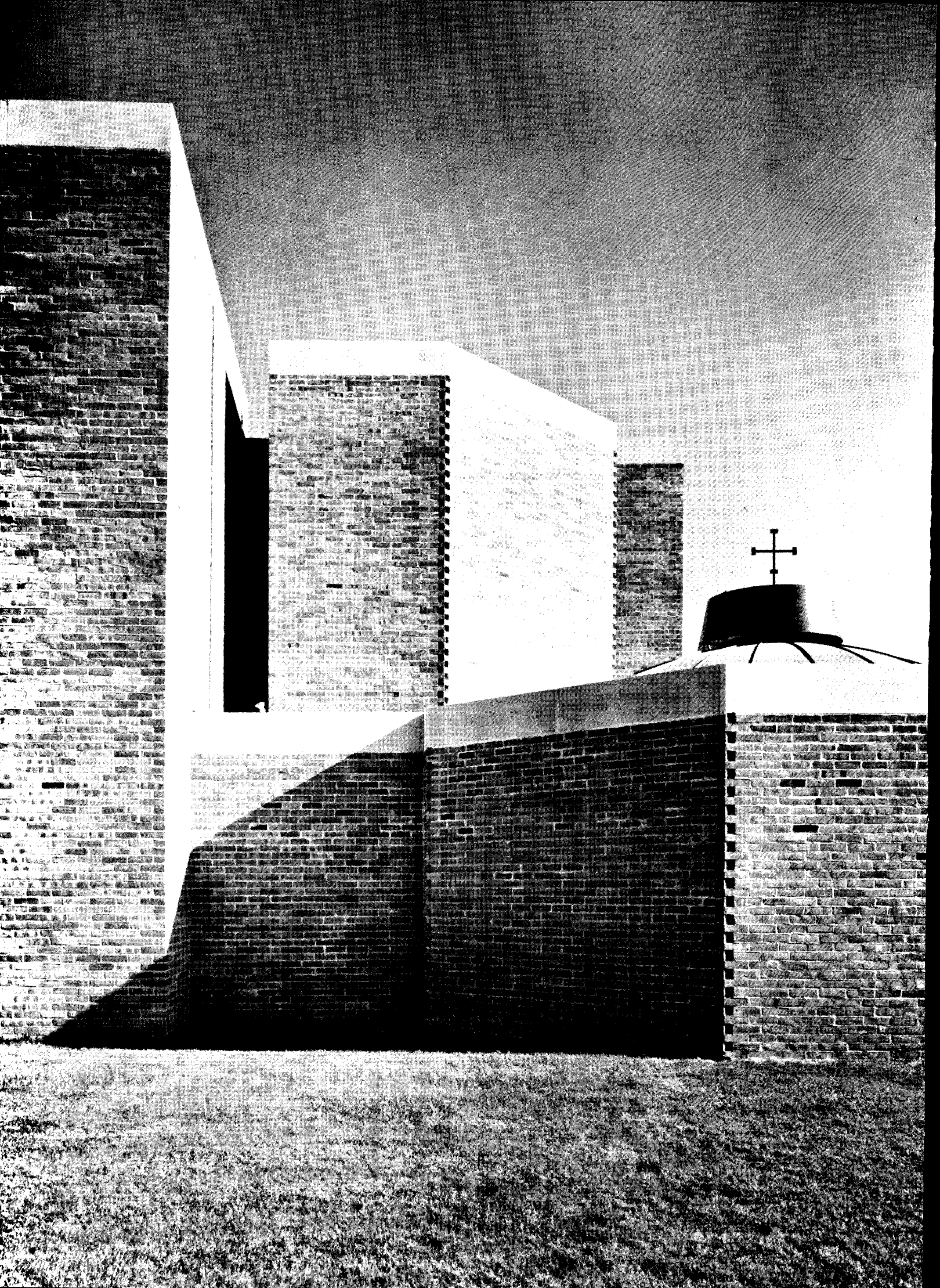



HOLY APOSTLES GREEK ORTHODOX CHURCH, Westchester, Illinois. **Architects:** Edward D. Dart of Loeb, Schlossman, Bennett & Dart; assisted by Edward P. Straka. **Site:** Five acres of former prairie area now under development. **Program:** Provide worship, educational, and church administration facilities for Greek Orthodox congregation of 350 families. **Structural System:** Wood roof deck either wall bearing, or, in the case of the multipurpose room, supported on laminated beams; system for main roof, and roofs of exo and eso narthes and baptistry, is of poured concrete. **Mechanical System:** Fully air conditioned. **Major Materials:** Brick, concrete, finished and unfinished wood. **Consultants:** Samartano & Robinson, Structural; Frank Riederer & Associates, Mechanical; Bolt, Beranek & Newman, Acoustics. **Art:** Iconography by Margo Hoff. **Cost:** \$414,811. **Photography,** except as noted: Orlando R. Cabanban.

## REINTERPRETING AN ANCIENT LITURGY

**A Greek Orthodox Church in the Chicago suburbs proves that notable architecture can be achieved within the liturgical framework of a traditional creed, providing the humanistic impulse motivates both client and architect.**

### A Greek Orthodox Church

Western architects who have attempted designing Greek Orthodox churches have had, in the main, a tough time of it. For the most part, they have been seduced by a romantic dream of Byzantine opulence that has led them either to bedizen their churches in trappings outrivaling the *contes* of Scheherazade, or, in a kind of reverse reaction, to produce domed, whitened sepulchres where only the necessary iconography gleams.

When the congregation of Holy Apostles Greek Orthodox Church sought an architect for its new building, about 20 architects were interviewed, the overwhelming majority of them of Greek descent. The Greek community's amazement with the award of the commission to Edward D. Dart, a Chicagoan transplanted from Louisiana, was voiced in a disapproving editorial in the local Greek newspaper. It expressed concern that a non-Greek would be unable to express the Hellenic tradition and the ancient liturgy of the

Greek Orthodox Church in three-dimensional terms. That Holy Apostles has now emerged as far and away the most successful contemporary interpretation of the church form in this country, has been happily realized and enthusiastically applauded by the same Greek community. Father William S. Chiganos of Holy Apostles says that the architect's "approach and concept is extremely fresh and he has adhered to the liturgical forms of Orthodox tradition. The building is alive, it speaks, and if we have truly achieved this in our design then I must confess we have in Holy Apostles a true House of God where men can congregate and worship in a spirit of humility."

Dart sees tradition and ancient customs as peculiarly significant to the Greek Orthodox Church, most of these precursors having come down through the centuries in a singularly intact state. The Church's historic dedication to ecumenicism and its emphasis on redemption,

resurrection, joy, reward, and the Incarnation (God to man) rather than the more familiar Western concern with repentance, penalty, punishment, and death, make the church, as old and encrusted with tradition as it is, an extraordinarily human entity to house, the architect feels. Accordingly, he chose to reflect these attributes of warmth and directness rather than panoply and aloofness. "The church building is by no means the one important aspect of the church," Dart remarks. "Just as man is not the object of worship, so the building cannot be. It is recognized that the building is simply a medium, a vehicle for worship, not the object of worship. The structure is to be used, not just looked at."

A sense of progression, of going from a prosaic Chicago suburb toward the inner sanctuary, is one of the architect's major concerns here. In the ancient church, there were two narthes: an exonarthex, usually in the form of a porch where the unbaptized congregated, and an eso—or inner—narthex leading to the nave. At Holy Apostles, Dart has brought the exonarthex inside and made it the circulation node of the building. From here, parishioners can reach the baptistry and nave, the education area, or the administrative offices. Here also, coats are doffed, candles are dispensed, and there is pre- and post-service socializing. The space is square and topped by a shallow concrete dome with an oculus at its top. Moving toward the sanctuary, the congregation passes through a low vestibule to arrive in the esonarthex. The space here is long, high, narrow, and dimly lit by votive candles and subdued natural and artificial lighting. Still another space is on axis with the narthes: the baptistry.

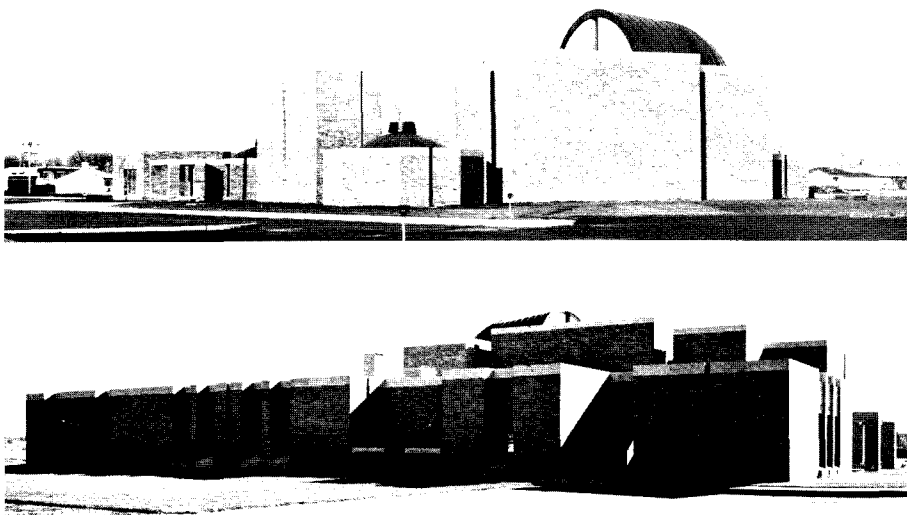

This room is octagonal with a domed concrete ceiling recalling that of the exonarthex. A second oculus sheds light on the octagonal granite font.

Entering the nave through heavy oak doors from the esonarthex completes the visual journey that began when the half-dome over the sanctuary was seen from down the street. The architect's desire to catch the visitor's interest "and work on him continuously—from the angles of the main entry walk which give direction to the entry porch or canopy through the front doors to the exo and esonarthex, etc., and ultimately to the nave"—has been successful in a series of evocative spatial experiences.

In the nave, the congregation sits beneath a concrete canopy supported on four concrete columns topped with widely flaring octagonal capitals. Light filtering through clear glass block above this ceiling (see section) washes down the brick walls, providing illumination that is of low intensity but warm in nature. A special scale model was made during the design process to insure the quality of natural light desired. The soft light of the nave gives even more prominence to the focus of the room, the light-flooded inner shell of the half dome, which will eventually receive the major traditional icon of the Virgin (to be executed in the earth tones of the church's brick).

The aim, and it is one that was successfully realized, was to use "humble" materials—brick, concrete, dark-stained oak, limestone, quarry tile—and imbue them with the richness and dignity they inherently possess. Aside from the iconography of the half-dome and the traditional altar screen, the main applied ornament is seen in the limestone lintels of the nave, esonarthex, and baptistry. These have incised Biblical sayings in Greek, the calligraphy especially designed for decorative purposes.

The nonceremonial areas of the church are appropriately lower in the hierarchy

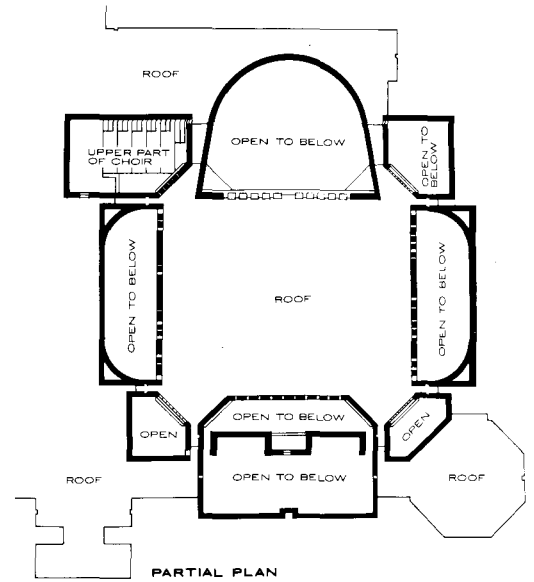

Facing page: entrance plaza (1); exonarthex (2); exonarthex showing taper stands (3); esonarthex, interior detail (4); esonarthex, exterior detail (5); esonarthex (6); entrance to nave (7); view of nave from baptistry (8). Pages 144-145: general and detail views of nave and sanctuary.

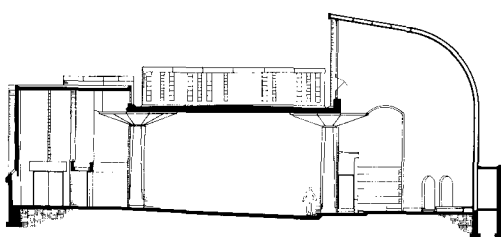
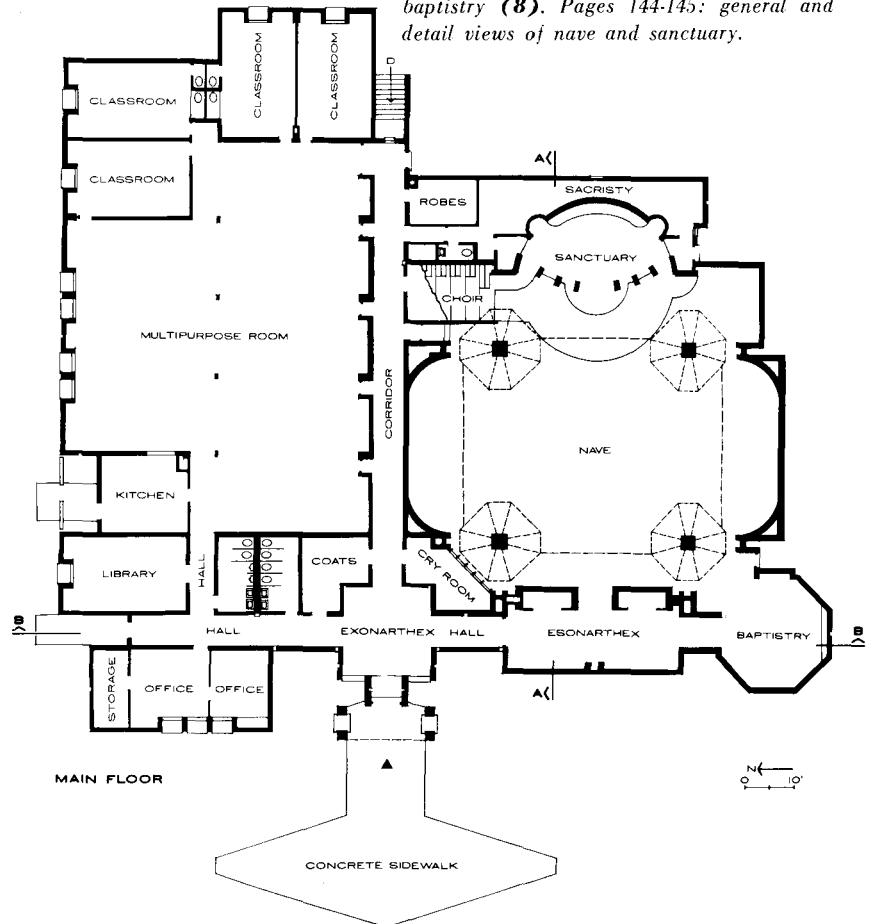

SECTION A-A

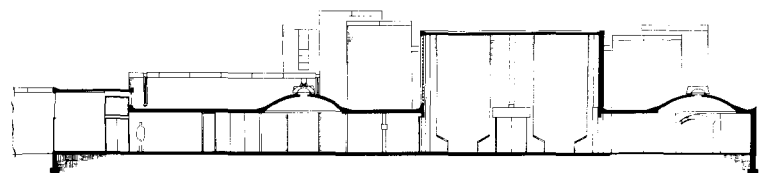

SECTION B-B



1



2

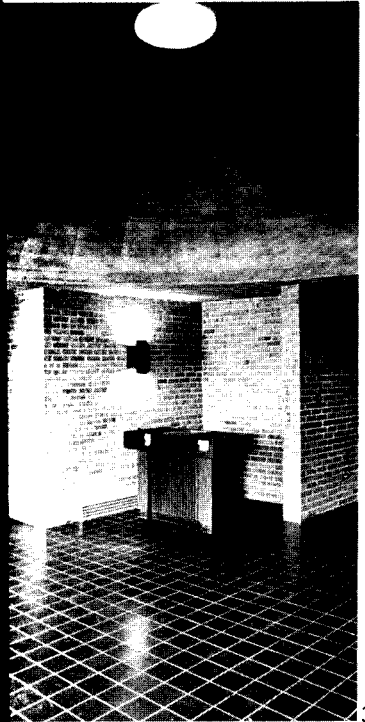

3

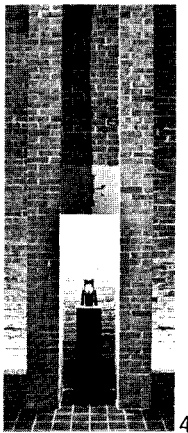

4

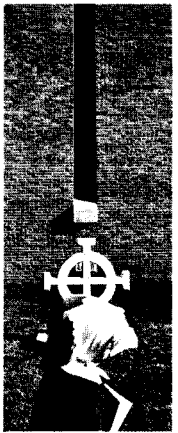

5

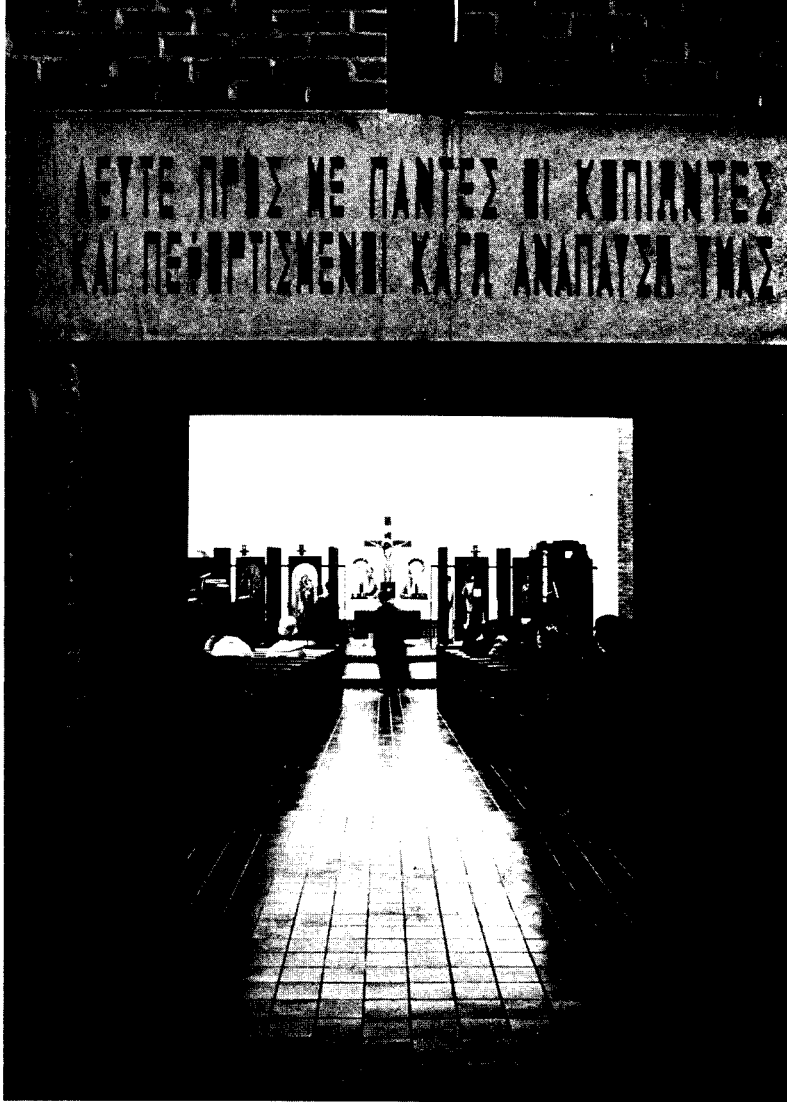

7



6

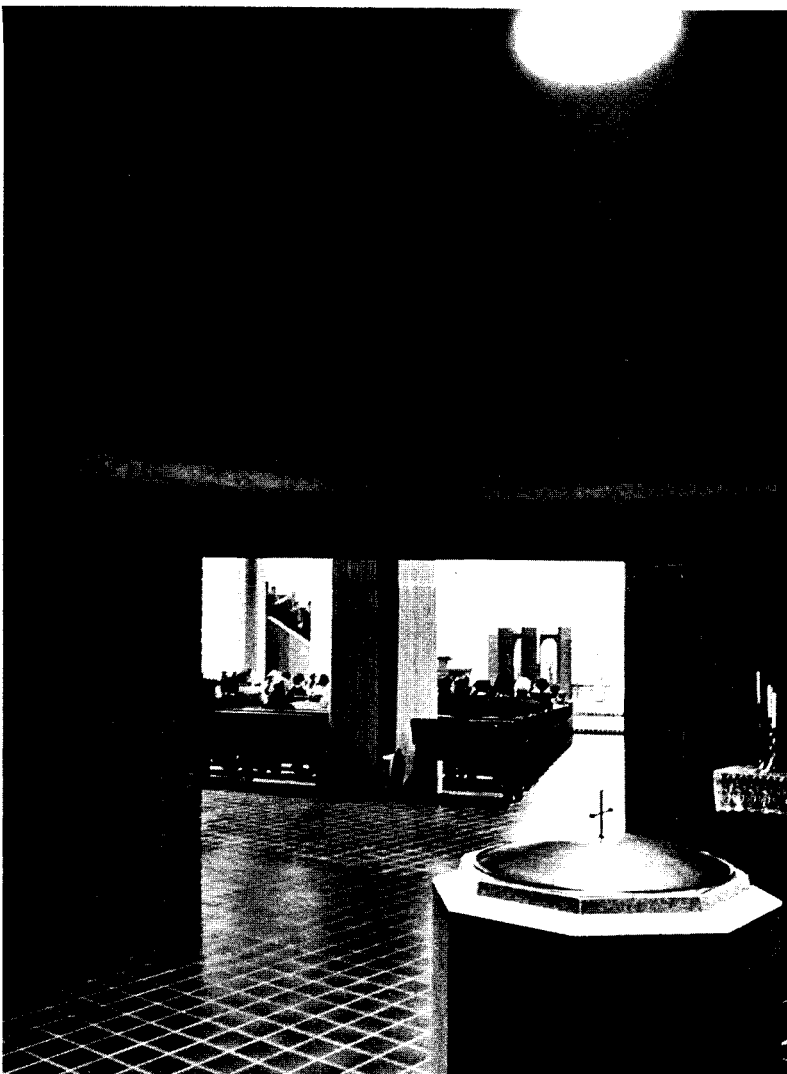

8

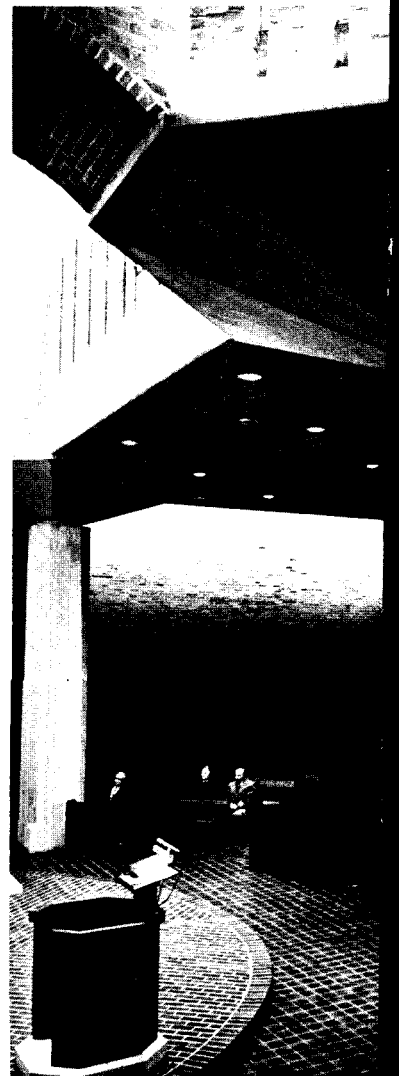
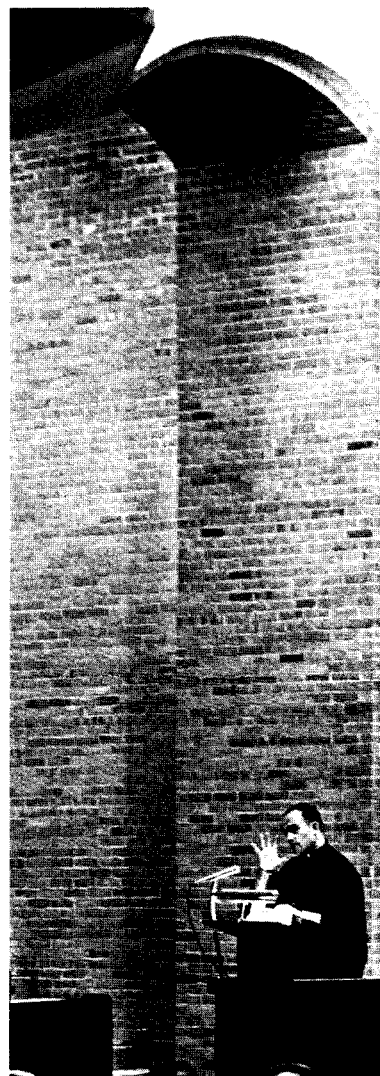
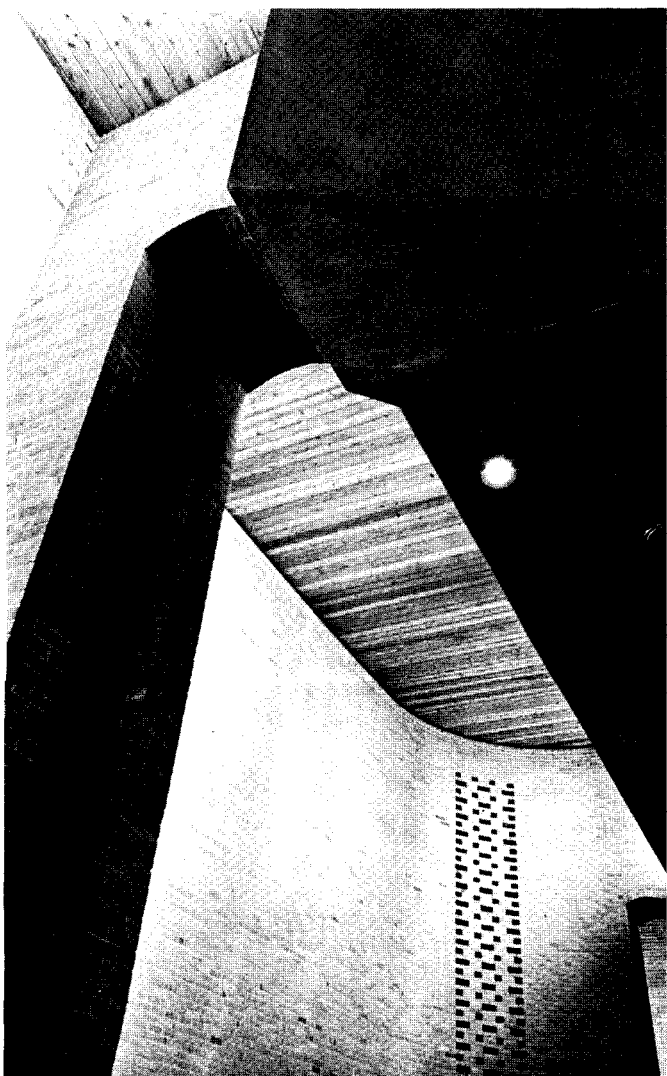



of spaces than the nave and sanctuary. The educational and multipurpose areas are located across the corridor that bisects the building from the nave (see plan). The architecture here is naturally less imposing than the major spaces, but there are many good details: the deep-cut windows (creating, on the inside walls, generous shelves or banquettes), the use of regular overhead garage doors for dividers in the multipurpose room (they were found to be good for sound control), the continued use and careful detailing of the same warm-toned materials. In the future, additional classrooms will extend to surround the sanctuary.

"One of the major goals in the over-all quality of the architecture sought for here was an attempt not to have forms impose themselves upon the building, but to allow the building to happen." Dart says. He notes that the site is not overly attractive, but "Christianity is not a pretty religion—I will be disappointed if our church is classed as a pretty church. Polite architecture will never succeed here." His aim was for a church that "quietly symbolizes the strength and conviction of the faith it represents." Father Chiganos adds: "The Byzantine era was a Golden Period in our church history. It gave us a wealth of architectural splendor and fine art which symbolizes the magnificent beauty created in the early church. I can honestly say, however, that Holy Apostles is truly a 'neo-Byzantine' church in design. That is to say, its architecture reflects something of the old by the use of modern materials. In this respect, Dart has successfully interpreted Orthodox tradition. The materials used are earthy and simple, representing the strength indicative of the church of Christ, while at the same time they are rich in elegance, symbolizing the ritual and tradition of the Greek Orthodox Church."

Warmth, strength, and ecumenicism of spirit, a knowledge of tradition translated to be as appropriate to the populated prairie as to the Golden Horn—these are some of the characteristics called forth by the architect for a congregation celebrating one of the oldest Christian liturgies in the American Midwest, far from its native home. To one visitor, at least, he has succeeded. Architecture, after all, can be elevating, whatever the persuasion of the viewer. Without a complete knowledge of the Greek liturgy, one viewer felt the ages-old background of the new church in Westchester, Illinois. This means, he deduced, that the building interprets the religion, rather than the liturgy dictating the architecture. And this is what the architect wanted.

# SYNAGOGUE DESIGN: FORGING AN AESTHETIC UNBOUND BY TRADITION

Traditionally, the synagogue has taken on the form of the surrounding architecture of the countries to which the Jews have been dispersed. The consequences have not always been fortunate. Synagogues in America have been built in almost all styles: "Borrowed from the pattern book of past history . . . as imitations of Greek temples, medieval chapels, and Renaissance domes," as Eric Mendelsohn described it. Styles that Rabbi Merzel of Seligmann's Beth David termed "Yiddisha Mishagothic." But the implications do not have to be this unfortunate. The lack of historic formal precedent can free the architect to face, unhampered, the abstract problem of religious space within the context of contemporary architecture.

The problems of synagogue design are complex. The building must serve many functions: as a place of assembly (as its name implies), as a house of study, and as a house of prayer. The sanctuary must be capable of spatial elasticity by allowing itself to be enlarged for the high holy days, yet must function as naturally for the reduced congregation during the remainder of the year. The location of the ark and bema in their polarity are traditionally specified. The bema, at the center of the sanctuary, creates the difficult problem of the round church. The separating screen between men and women, demanded by Hebraic tradition, is resented as much by the architect as it is by the contemporary congregation, for it tends arbitrarily to divide the spaces as it does the sexes.

The formal problems of designing a synagogue are complex, but the prime architectural requirement is probably the most stimulating: it merely has to be beautiful — "as simple as that," to quote Philip Johnson.

BETH DAVID SYNAGOGUE, Binghamton, New York. **Architect:** Werner Seligmann; Kenneth Carswell and Charles F. Rogers, Assistants. **Site:** Urban corner lot among large homes built around the turn of the century. Building area within setback restriction, 80' x 120'. **Program:** Orthodox synagogue with a sanctuary for 400 persons; a social hall for 200 and classrooms; daily chapel that will also house the library; offices; a ritual bath; separate cooking facilities. Parking space not required. **Structural System:** Steel frame and concrete block; concrete slab floors with metal roof deck. **Mechanical System:** Warm water, gas fired. **Major Materials:** Exposed concrete block, copper fascias, exposed concrete. **Cost:** \$160,000. **Consultants:** Edward A. Fassler, Mechanical Engineers; Snyder and Troxel, Structural Engineers. **Photography:** Louis Reens.

## Beth David Synagogue

Beth David Synagogue was one of the first commissions to go to this young architect, Werner Seligmann. He modestly states that the design was "influenced," and, in places, overdesigned. There are minor design excesses, it is true, but these can be forgiven an architect who coarsed his block and took a major interest in even the most minor detail. And if there are undeniable influences of Corbusier and Wright, then the building is equally undeniably Seligmann.

The architect, working with a restricted site, separated the secular from the sacred by raising the sanctuary to the second floor so as to differentiate it from the social and school spaces on the floor below. The fascias of both sanctuary and chapel roof are of copper, which, in its richness of material, stands in contrast to and serves to differentiate it from the secular areas. The chapel forms a pivotal point for the building and serves as an isolated room used for daily prayer and study.

The synagogue is entered through a gate opening onto an exterior court, with exposed stairs leading directly to the roof outside the second-story sanctuary. The

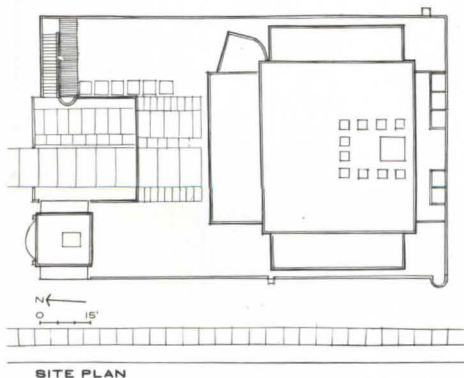





18 885. A. 888 8101



court is a social area for members of the congregation, who use it like a front stoop for visiting. It contains a unique Seligmann feature: a truncated concrete column on which to lean or perch small children while tying their shoes.

The sculptural forms of the building—its massing, window openings, and projecting skylights—overcome the all-too-frequent boredom of exposed block and concrete. Seligmann has produced a lot of good building for very little money. Toward the rear, on the street side, a mound of earth has been supplied for the planting of three trees, which, unfortunately, have not taken root. It seemed to this observer that the mound and the architect's desire to cover the building with ivy are unnecessary. Beth David can stand by itself.

The interior spaces of the first floor await additional funds for their completion. To the rear of the building is a sunken area the architect intends to use as a congregational "living room." To its right, on the same level as the classrooms, is a multipurpose space whose exposed wide flange soffit forms a proscenium arch. The adjoining corridor and classrooms furnish dressing rooms.

Seligmann has delineated the bearing and nonbearing walls by leaving the block of the former exposed and covering the screening walls with white plaster. This logical contrast of materials gives the space an appropriate richness, without reducing the quality of ruggedness accentuated by its economy and its detailing. It is unfortunate that the sanctuary columns do not read in the interior in terms of the function they perform.

The bareness of the interior is partially due to the suppression of the enthusiastic participation of the congregation in doing the interior decoration. It has been decided that no contribution to or alteration of the interior can be made without the approval of the rabbi, the building committee, and the architect. Of course, the rabbi's proprietary interest sometimes backfires, as when he was approached by a member of the congregation who remarked, "Rabbi, if this is your synagogue, your toilet is leaking."

Seligmann's handling of the small circular chapel, with its high ceiling and curved plastered wall, has the feeling of a truly religious space suited to its function—that of study and prayer. It is a space that quietly asks for silence, although it is questionable if the ark, transplanted from the former synagogue to add something old to the new building, is quite wise here. The symbolism overpowers the architectural meaning.

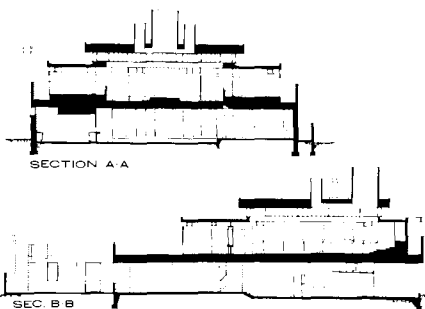
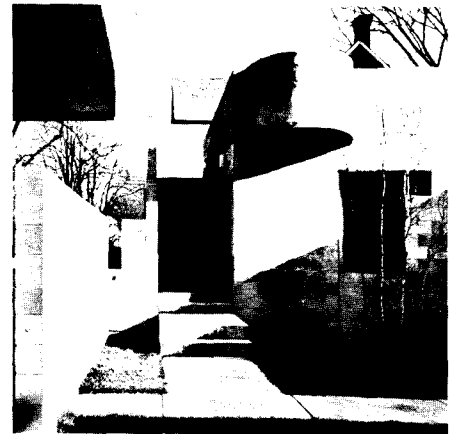
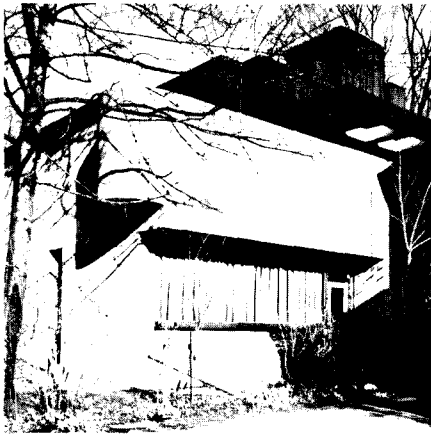

Sanctuary seating and bema woodwork designed by Seligmann was assembled and finished by congregation members (facing page). Entrance court from rabbi's study (1). Stairs to sanctuary from entrance court (2). Rear of synagogue with windows into recreation area and sanctuary (3).

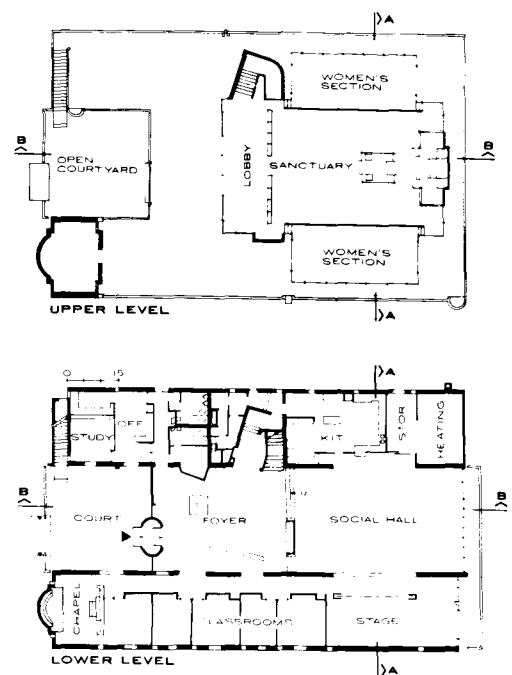

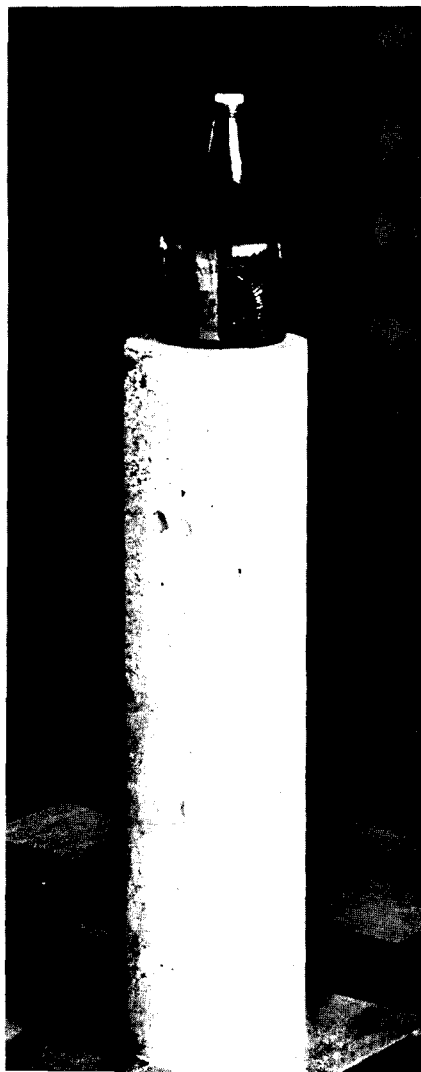
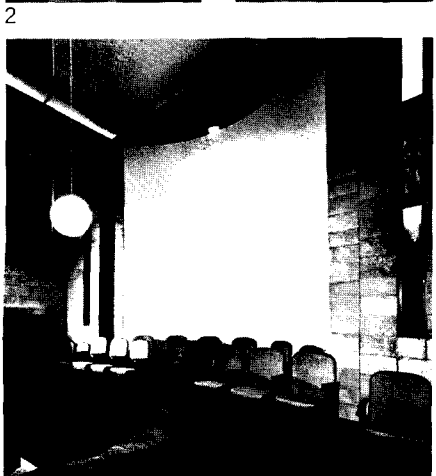
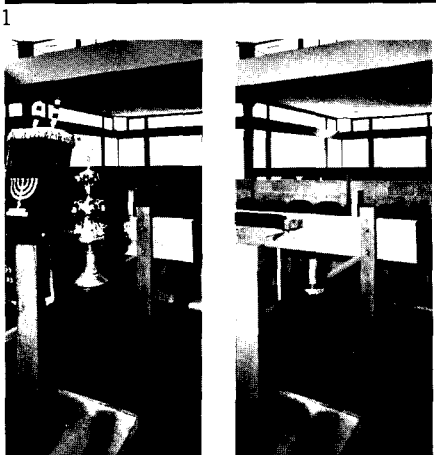

The white plaster of the interior walls adds a texture and exposure of a material that is very much in keeping with the character of the building. Very few architects have the courage to expose the beauty of this material: as the children's marks on the classroom walls and corridors attest, it is a handsome yet impractical solution. Exposing white plaster has nothing to recommend it but its beauty.

The furniture of the rabbi's office, as well as most of the synagogue woodwork, was detailed by Seligmann. The office looks out onto the court and across to the wall of the chapel. It is a pleasant, contemplative space, which, one hopes, will remain so, undisturbed by the occasional acts of vandalism that have marred the synagogue.

The interior stairs that run from the first floor to the sanctuary have been particularly well handled. The perforating skylight, and the detailing of the handrail in its sculptural proportions as it ascends, form an apt entrance to the sanctuary.

The planning of the sanctuary presented the usual difficult problem of polarity and processional. The architect had hoped to use the Sephardic tradition with the bema at the end, facing the ark. The rabbi and the congregation insisted upon the traditional central location.

The bema and the surrounding processional area are illuminated by skylights that project sculpturally from the roof. Once again, in the controversy over symbolism, the rabbi wanted seven skylights, symbolically relating to the Menorah. The architect found this an impossible number and suggested eleven, to conform to the number of tribes of Israel—a number, incidentally, of which he was uncertain, he confided later. This observer counted ten. Symbolically or not, it is a fine solution, shedding natural light on the interior. Doubtlessly, the learning and humor of Rabbi Merzel will find a fitting symbolic interpretation.

*Interior stairs to sanctuary (1). Bema details (2). Chapel interior (3). The enviable degree of ecumenicism at Beth David is demonstrated by the slotted bottle of Christian Brothers brandy for synagogue building contributors (4).*

## Temple Shalom

TEMPLE SHALOM, South Norwalk, Connecticut.

**Architects:** Oppenheimer, Brady & Lehrecke.

**Program:** A Reform synagogue to be constructed in three stages. First stage, now completed, is the social hall, which now serves as the sanctuary. A permanent sanctuary and school are to be added. Present seating, 725.

**Site:** Synagogue located in a gentle saddle to provide seclusion from parking lot and nearby highway. Size of site: 5½ acres.

**Structural System:** Reinforced concrete piers and block walls; laminated beams with 3-in. plank.

**Mechanical System:** Hot air with provisions for future air conditioning.

**Major Materials:** Exposed aggregate concrete walls, stucco, cedar shingles, and cedar plank.

**Cost:** \$115,000, less than \$15 per square foot.

**Consultants:** Meyer, Strong & Jones, Mechanical Engineers; Goldreich, Page & Thropp, Structural Engineers; Kodaras Assoc., Acoustical Consultants.

**Photography:** Ben Schnall.

Oppenheimer designed Temple Shalom to combine traditional and contemporary elements. The rough walls are reminiscent of the Wailing Wall, and the cedar planks and shingles recall the materials used in the construction of the Temple of Jerusalem. He designed a roof form symbolic of the Russian and Polish synagogues destroyed in the Nazi holocaust: "I wish to make this building tangible proof that Polish synagogues have not been completely destroyed, but that their spirit in some way continues. The forms of the synagogue roof recall the tent form that made up the earliest synagogues and restate their continuity."

The lantern forms a six-pointed star, echoed by the six buttressing walls from which the wooden bents spring to support the roof. This motif of the six-pointed star will be reiterated and transformed in the

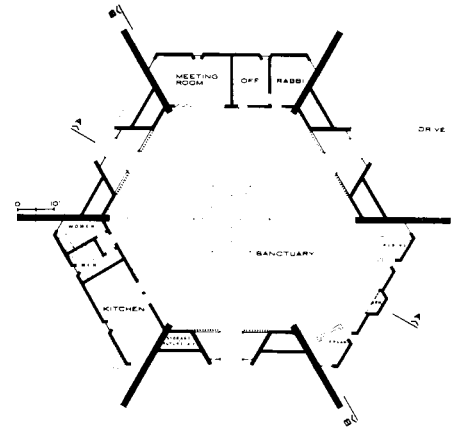
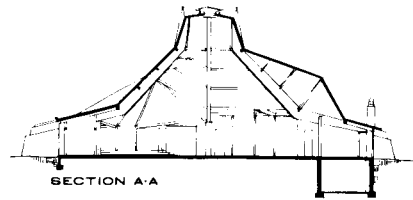
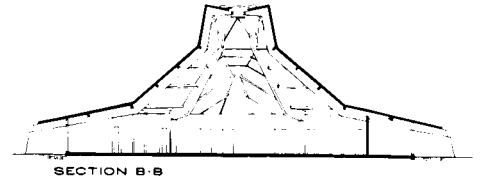



planned additions—the sanctuary and classroom clusters—which will be hexagonal. The entire formal design pattern is derived from the traditional six-pointed lantern star.

Basing the design of a religious building on a religious symbol is one of the most difficult design techniques to employ unselfconsciously in contemporary design, although, historically, its success cannot be denied. Yet if such a relationship cannot be expressed in a religious building, it cannot be achieved at all. Regardless of motivation, the building will ultimately have to stand on its formal values alone.

The buttressing walls that perforate the building's exterior perimeter, and the supporting laminated bents that give the building the contemporary touch within its traditional form, present design difficulties. The strong structural emphasis of the laminated beams—which begin at the buttressing walls, disappear underneath the shingled roof, and reappear in the lantern—lose their identity in the sculptural modeling of the roof. The lighter framing that hips the roof contradicts their function. There is also a certain awkwardness in the joining of the roof to the laminate bents as they rest on the buttressing walls.

The present Temple Shalom is in reality the social hall of a much larger complex of rooms that will be added as separate buildings until they form one complex under a mass of varied roof forms. This is a difficult problem, whose success or failure must await completion of the total building. This first building, designed as a social hall, is successful in imparting the religious feeling sought by Oppenheimer, proven by its successful use as a sanctuary.

The Reform ritual allowed Oppenheimer to place the sanctuary against the rear wall, opposite the entrance, with a movable ark behind on the bema platform. It will have the same location when the new sanctuary building is added and the social hall becomes part of the sanctuary for high holy days. The dichotomy between secular and sacred will be minimal in the combination of the two spaces because of Oppenheimer's design of the present social hall. He has come close to a solution of one of the most difficult problems of synagogue design—that of the expanding sanctuary.

In the proposed sanctuary, the bema acts almost like a thrust stage that intrudes into the audience area, thus increasing the processional distance and placing the rabbi almost at the center of his congregation, which conforms to Orthodox tradition. Oppenheimer's synagogue

has no separate screen or architectural device for separating men and women, as was required by the Orthodox tradition of both Seligmann's and Davis' buildings.

Any comparison attempted between the three synagogues presented here—the completed buildings of Seligmann and Davis with the first building of Oppenheimer's complex—must focus on the design approach. Oppenheimer's exploration of the formal possibilities inherent in the rich cultural heritage of Judaism, is, in terms of the contemporary world of form, a daring act. It is too easy to equate such an effort with the regurgitation of traditional form, so characteristic of much of today's religious architecture. One forgets that many of the greatest symphonies are based on folk melodies.

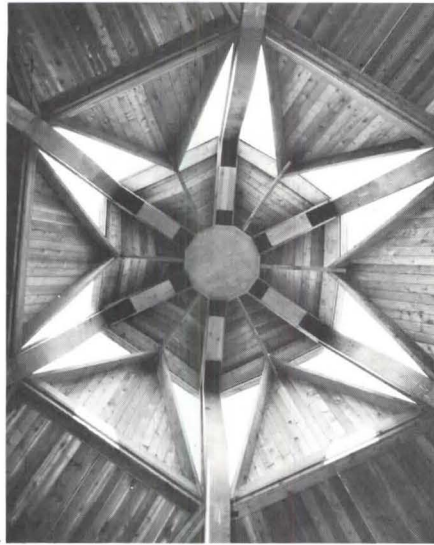

Sanctuary lantern (1). Exposed aggregate buttressing wall projecting into the interior (2). Plan and elevation of proposed building complex (3, 4).

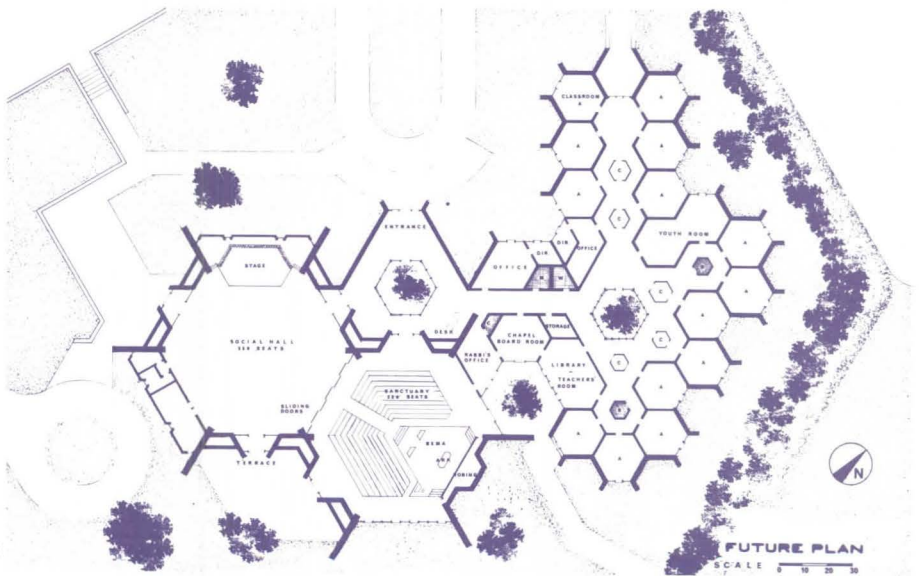

# Agudath Shalom Synagogue

AGUDATH SHOLOM SYNAGOGUE, Stamford Connecticut. **Architects:** Davis, Brody & Associates. **Site:** Sloping corner site in prosperous residential district. **Program:** Synagogue for an Orthodox congregation of about 600. Expansion up to 1400 on high holy days. Adjacent parking. **Structural System:** Load-bearing masonry, bar joists, concrete and metal decking. **Mechanical System:** Combined warm air and convectors, hot water system. **Major Materials:** Brick walls, copper fascias, tinted glass at balcony level. **Cost:** \$535,000, not including some landscaping. **Consultants:** Wiesenfeld & Leon, Structural Engineers; Wald & Zigas, Mechanical Engineers; Sylvan R. Shemitz, Lighting. **Art:** Samuel G. Wiener, Jr., Stained Glass; Zevi Blum, Panels on Ark Canopy; Ludwig Wolpert, Memorial Lights and Screen at Entrance; Raymond Sherman, External Light in Chapel and Sanctuary, Exterior Menorah, Memorial Tablets. **Photography:** David Hirsch.

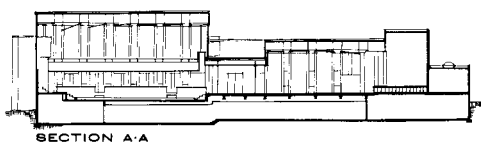
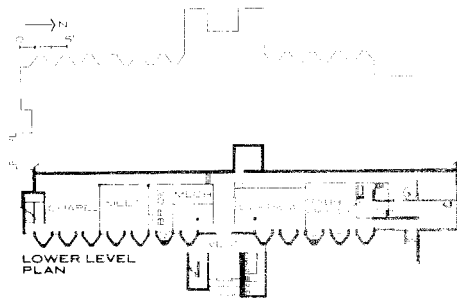
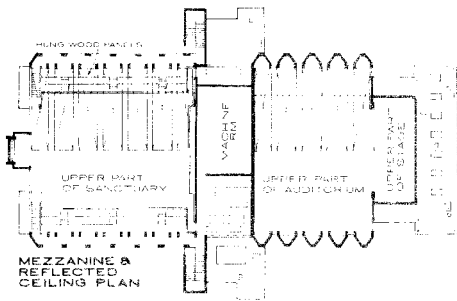
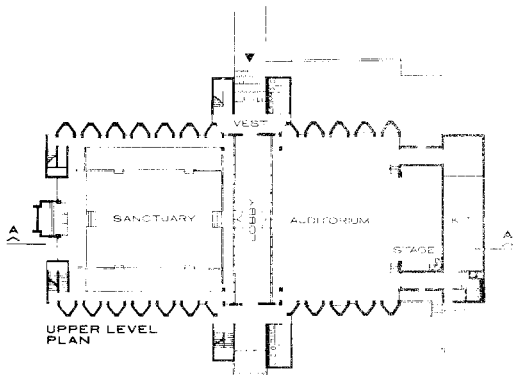

“A camel is a horse designed by a committee,” was the old saw used by architect Davis in discussing the role of the architect in the design of liturgical space. If the congregation numbers 600, there will be 600 answers. The architect’s function, Davis points out, is to translate the liturgy according to his own artistic conscience.

Rabbi Ehrenkranz of Agudath Shalom agrees with Davis as to the function of the architect: He described the synagogue as in reality a community meeting house, and says the purpose of the architect is to translate the community needs. Ehrenkranz and the synagogue committee selected the architect not because they liked a previous synagogue Davis had done and which they had inspected—they feel it is not nearly as successful as their own—but because they heard the architect was “good to work with.”

The truth of Davis’ statement is familiar to most architects who design religious buildings. The attitude of Rabbi Ehrenkranz is unfortunately not common. In his belief that the liturgy can be performed in any space and that the architect’s function is to enrich the liturgy through the design of that space, he allows the architect a great deal of freedom. It is this that is probably as responsible for the successful design of the Agudath Shalom sanctuary as was the creative talent of the architects.

From the monumentality of its appearance, it would be difficult to identify Agudath Shalom as a religious building from either the front or rear elevation. But when one approaches from the side, where the ark wall with the stylized Menorah and the seven gas lamps set in

the wall of stained glass can be seen, the nature of the building becomes apparent.

The Davis, Brody synagogue has been designed within no set tradition. It differs as much from Oppenheimer’s Temple Shalom as Chagall does from Mondriaan. The triangular brick piers form slotted windows below the sanctuary balcony level, giving an appearance of great structural solidity that is contradicted above, where their perforations for the balcony aisles, behind the glazing, expose their “curtain wall” function. Nonetheless, they create an exciting geometry, both from the exterior and interior.

Agudath Shalom has a textural richness in its oiled copper fascias, brick-and-tinted-glass façade. The form of the building is solid and pleasing, although this observer felt that the end wall containing the ark did not carry the building around.

The chapel has been located in the basement and is entered from the street through a door in the ark wall. Its one wall with windows opens onto the planting and the parking lot located at the lower level.

In the interior, the sanctuary—in contrast to the exterior—is assertively a religious space. Its bema is set in the center, with the ark at the far end. The sexes are separated by the traditional screen, which here becomes a low railing. The pews are well designed and comfortable. The slatted ceiling, with its black troughs for the mechanical function, follows the structural logic of the piers.

To permit expansion during high holy days, the walls of the central corridor—in reality movable partitions—are removed to allow the auditorium and sanctuary to be joined. Temporary seating is placed on the auditorium floor and the expanded congregation participates in the services from there. The division of the building is complete. Davis did not attempt to make one room out of two, but obviously connected the sacred and the secular.

The entire logic of the building is centered on the enclosure of the sanctuary space. All other functions are subservient. The interior exposes the logic of the structural system. The piers, which, on the exterior, express a deceptive solidarity, in the sanctuary become a light, perforated, almost serpentine wall, which, combined with the magnificent stained-glass surrounding the ark, gives purpose to the entire design. Within this fortress-like structure, Davis, in creating a powerful religious space to express the liturgical needs of the congregation, has at the same time enriched the liturgy.

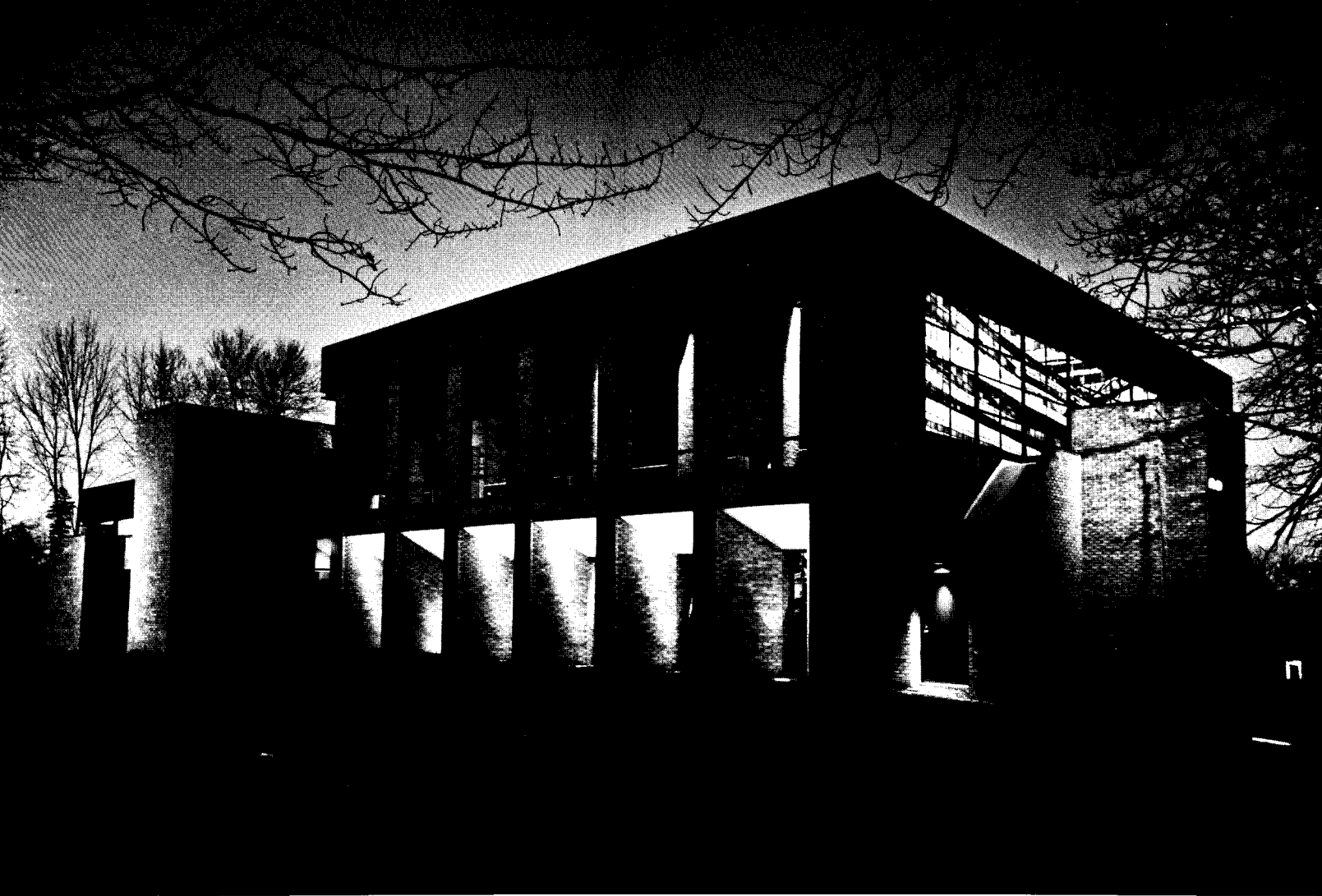





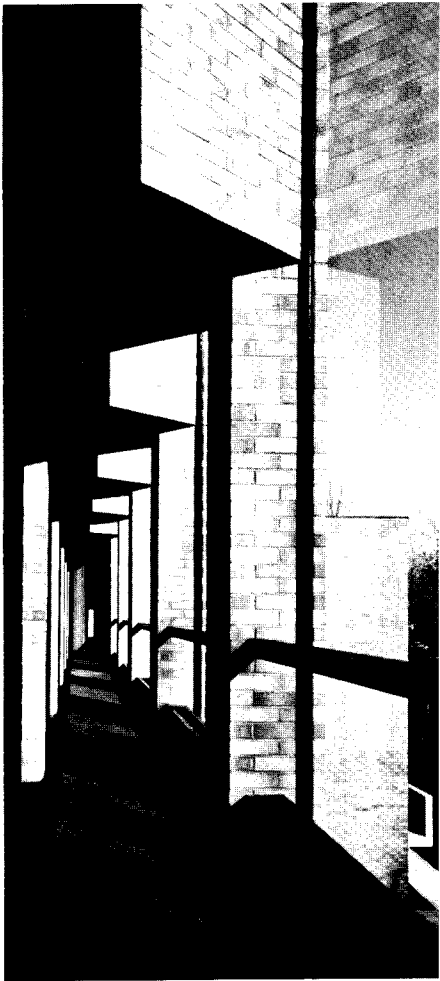

2

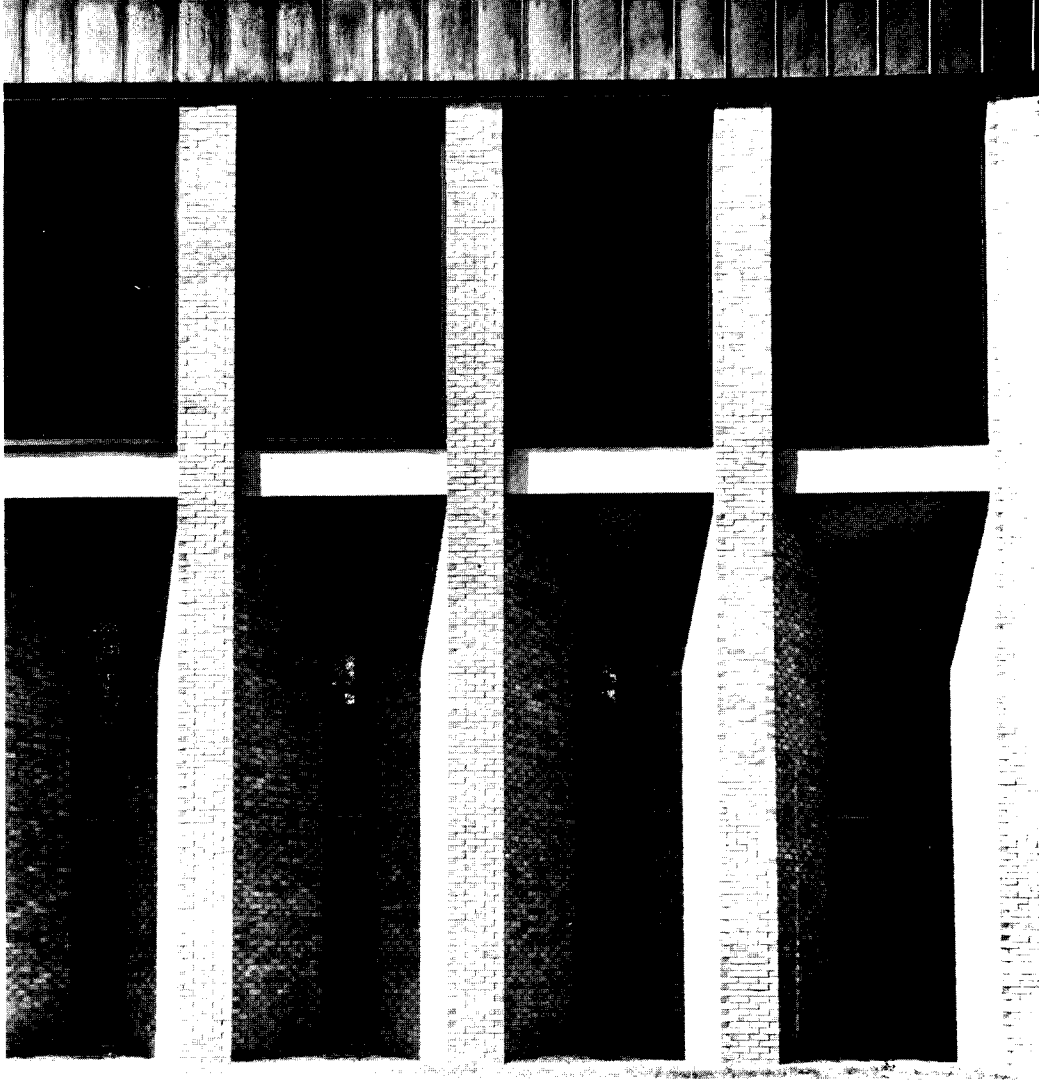

3

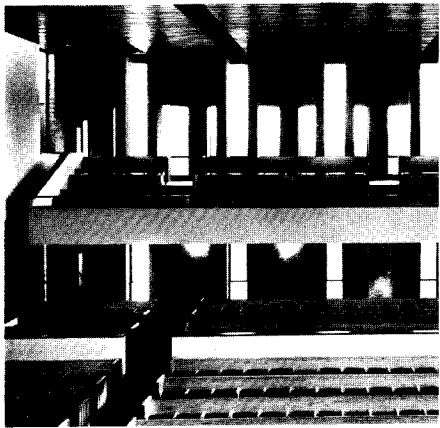

4

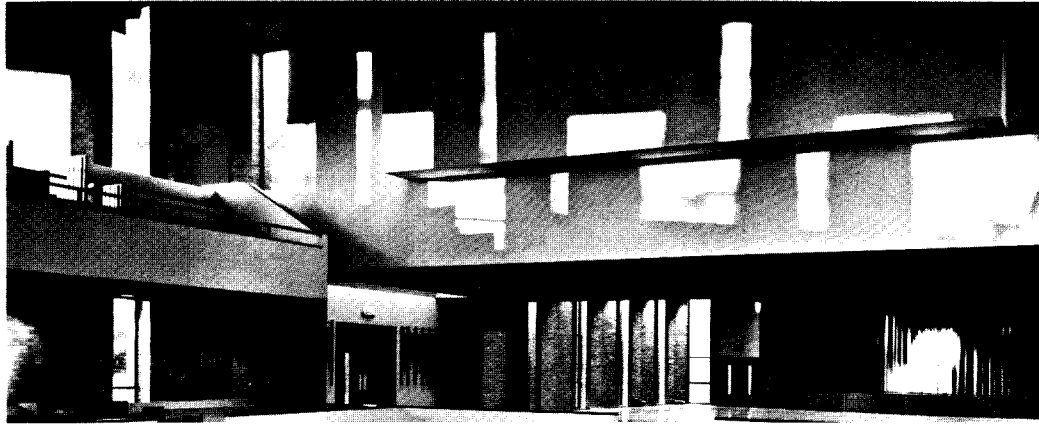

5

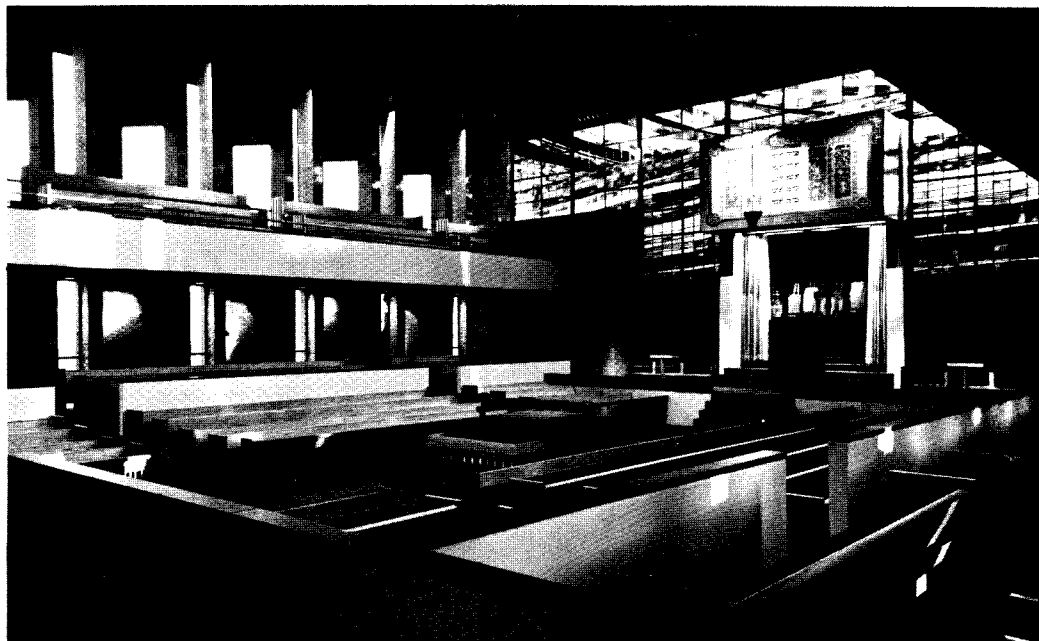

6

*Reading table in foreground looking toward ark and stained-glass wall (1). Exterior aisle wall (2). Chapel windows (3). Sanctuary balcony (4). Sanctuary looking toward auditorium partitioning walls opened to create one space. Bridge over for air conditioning equipment (5). Ark, Wiener's stained-glass wall, and balcony (6).*

# CHURCH DESIGN: THE ARCHITECTURE OF COLLABORATION

The three buildings shown on the following pages, with their diverse theological implications, are the work of one architect. Jules Gregory designed the Unitarian Meeting House, the Evangelical Lutheran Church, and the Presbyterian Chapel. The sites are as varied as the religious convictions of their congregations. The architect designed the buildings in conformity to their religious convictions, as he made them appropriate to their sites.

The meeting house and its classrooms is partially concealed on a wooden knoll, in an accessible but secluded section of New Jersey not yet raped by the bulldozer. The Evangelical Lutheran Church boldly proclaims its evangelical function, surrounded by development houses, at the side of a busy New Jersey highway. The Presbyterian Chapel will rise in the Guatemalan jungle, as the highest building in the midst of the classrooms and administrative outhouses of a missionary encampment.

Even if the architect could, with intellectual integrity, have changed his spiritual convictions with each commission, it would not automatically have solved his design problems. A church is more than the liturgy the architect must interpret. Besides being a house of worship, it must also house a churchman and his congregation, whose requirements, like the needs of their religion, must be interpreted. Aside from whatever religious convictions the designer may have, these are architectural problems dependent not on the nature of his belief in God, but on the nature of his architecture.

ASSEMBLY AND EDUCATION BUILDING, UNITARIAN SOCIETY OF NEW BRUNSWICK, *New Brunswick, New Jersey. Architect: Jules Gregory; Allen M. Blauth, Associate. Site: Long, thin, irregular 5-acre site opening on two roads. A 40-ft difference in grade from low to high point. Building located slightly below a knoll, which is the highest point of the site. Program: An assembly hall (with a capacity of 125) and lounge where coffee is served after service. Combination church office and kitchen; 10 classrooms, two of which are slightly larger to accommodate toilet rooms for the nurseries. Future expansion to include an additional study school wing and additional assembly area. When the additions are completed, the present assembly area will be turned into a Fellowship Hall and exhibition area. Structural System: Wood framing, stud rafters, and trusses on concrete slab. Mechanical System: Warm air with auxiliary electric units. Major Materials: Plywood, vinyl-covered. Cost: \$125,000. Consultants: Bliss & Hanle, Engineers. Photography: David Hirsch.*

## Unitarian Meeting House

The Unitarian meeting house is not a church. Its use can best be understood by its "Bond of Union": "In the spirit of brotherhood and service, we unite in the quest for those values which give our

lives deeper meaning and spiritual satisfaction, reserving to each individual the right to his own beliefs as to the nature of God and the universe." Whoever feels in accord with the purpose of the group may become a member of the society by signing its membership book. As half-humorously stated by minister Colpitts, "We accept agnostics; that is accepted. We accept atheists, but that is not accepted."

The siting of Gregory's Unitarian building, as well as its formal arrangement, symbolizes the nonevangelical, freely accepted, dependent relationships of its members. The forms are a succession of interconnected shapes moving up the gentle slope to the meeting hall, where they change from the flat roofs of the classrooms to the ridged sections of the meeting hall. They are telescoped together by means of glass-connecting links that bring light into the rooms. The building is screened and barely visible from the roadway. Parking is sunken and both the lot and its entrance roadway are hidden from the building.

The great variety of functions the meeting hall can accommodate reflects the varied interests and activities of the society: Sunday meetings, weddings, discussion meetings, dancing and games, youth activities. The hall, which will eventually be used for music and art exhibitions, is occasionally rented to other groups. Minister Colpitts reports that the Y.W.C.A. has made arrangements to use the meeting room for "slimnastics," and, since the girls will wear tights, he deduces this means a form of calisthenics—which, to the casual observer, might be viewed as a form of worship.

To design a single room for these varied purposes is, of course, impossible; but to use a room designed primarily for one function for all of these purposes is, of course, possible. To understand the prime function of the space, it must be considered as a meeting room. As Colpitts says, "We are a talking group," and, for this, the nonparallel surfaces give excellent acoustics.

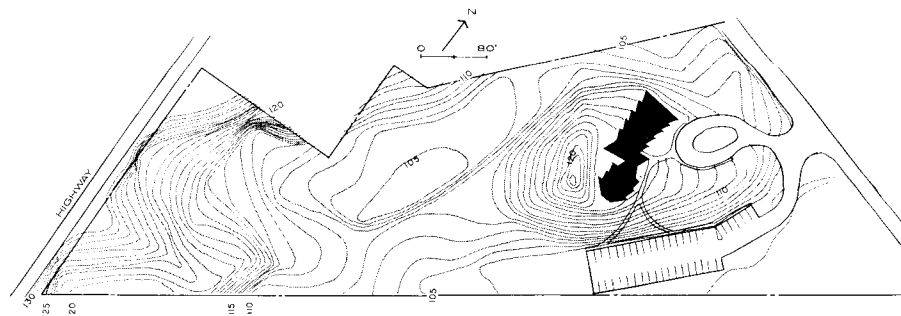





The geometry of the meeting room is accentuated by the lapped plank walls and ceiling, whose lines give added perspective. The observer is surprised to note the size of the minister beside the lectern.

Conversely, the perspective reverses itself, bringing the congregation closer to the speaker when viewed from the lectern. The minister feels that this relationship is ideal: It sets aside the speaker but brings his listeners closer, to support the reading relationship.

The architectural validity of such methods might be argued in contemporary terms as constituting trickery. However, it may be recalled that such diverse schools of architecture as the Japanese and the Mannerists used similar techniques. Trickery implies deception, which is not the architect's intent. Colpitts feels that the "physical upset"—the visual instability of structure with the deceptive center line—has similarities to a Zen building in its nonsymmetry. He says this supports the Unitarian belief that truth is not revealed, that it symbolizes the quest and the open end, not once and for all completed.

The meeting hall seats from 150 to 200 for its many uses. Movable chairs are usually arranged in a semicircle for meetings and are either removed or rearranged for other functions.

The building entrance is a little above the center of the building, allowing those entering to either turn left to the classrooms or right to the meeting hall. Here again Gregory was conscious of scale. He felt that an entrance to the classroom corridor on the front elevation would give a scale to the building, which seems much larger than it is: Its massing tends to negate scale.

This Unitarian congregation is a small group, and the stringent budget requirements meant that members could pitch in and contribute a fair share of the work: The entrance steps to the rear of the meeting hall, the landscaping, the planting and the wooden railings from the parking lot all represent the work of congregation members. The taste with which these improvements were made shows a genuine respect for the building and the landscape, which is about as fine a tribute to a building as an architect can expect.

The present buildings form the center of a proposed trident-shaped complex. This congregation has grown from about 10 members 10 years ago, meeting in members' homes, to its present size of over 100 families, illustrating the minister's contention that the more universal a church is, the more it will grow, a statement that characterizes the philosophy of both the Unitarians and the architect.

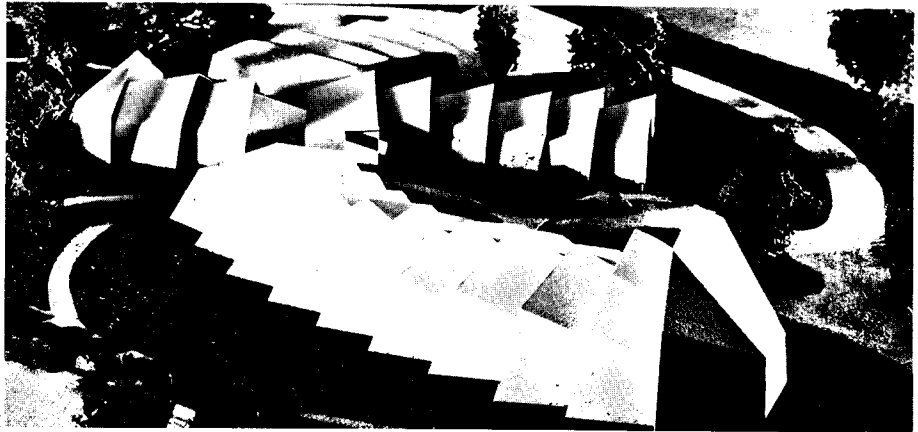
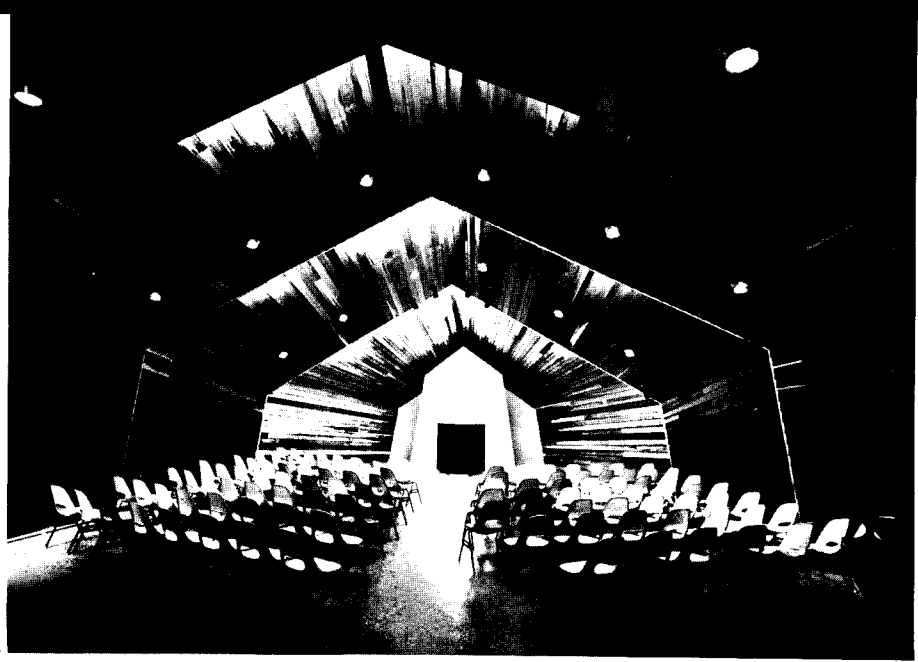

Meeting hall looking toward lectern (1). Model of proposed project as completed (2). Stepping stones at rear of building (3). Classroom fenestration (4).

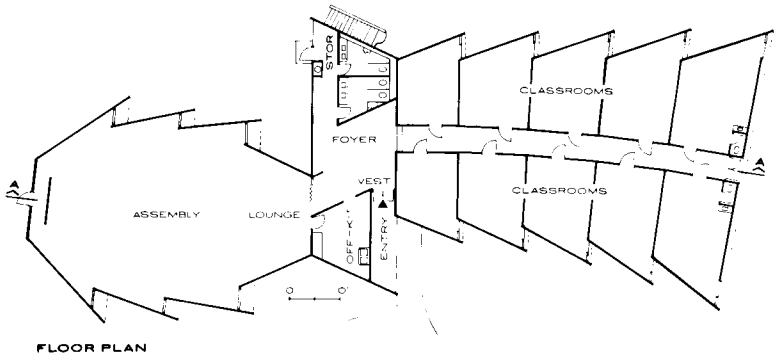
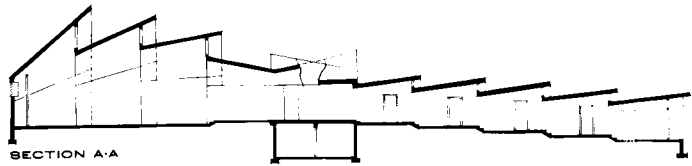

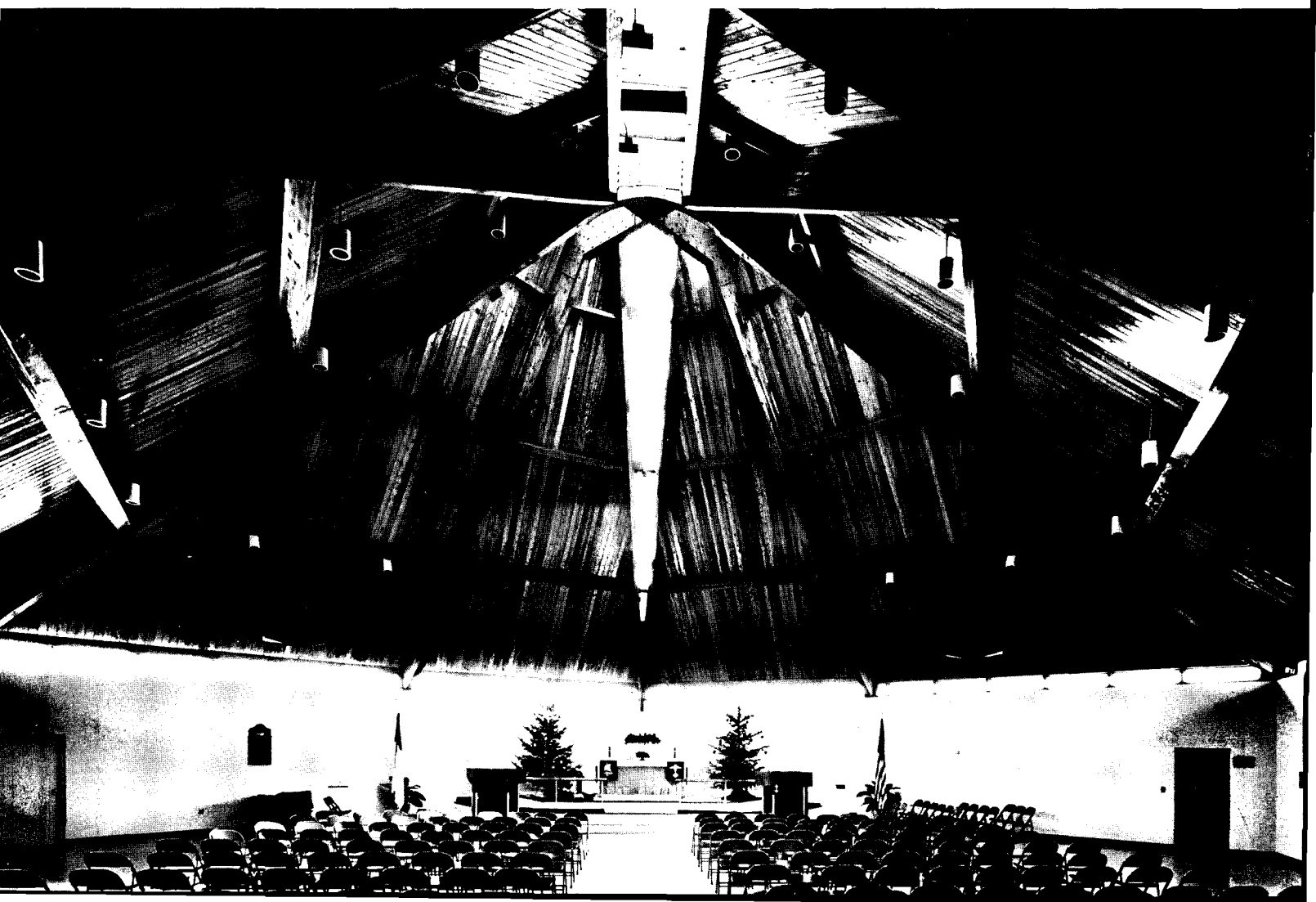



LUTHER MEMORIAL, EVANGELICAL LUTHERAN CHURCH, New Shrewsbury, New Jersey. **Architect:** Jules Gregory; Allan M. Blauth, Associate in Charge. **Site:** Sharp turn on a major highway. Site, 10,200 sq ft, slopes downward from highway. **Program:** See text. **Structural System:** Flat roof of steel beams and columns with wood joists bearing concrete block walls. Nave of laminated wood beams restrained by concrete anchors beneath walls; additional tie beam beneath nave floor; walls of concrete block. **Mechanical System:** Forced warm air, gas fired. **Cost:** \$158,000, including everything except seeding, court landscaping, and furnishings; however, the altar construction and communion rail were included. Approximately \$8000 of total cost was for site, roadwork, and paving. **Major**

**Materials:** Exposed concrete block, built-up roof surfacing on flat roof and red cedar shingles on nave. Floors of vinyl asbestos tile; ceilings of exposed fir decking in nave and fiberglass panels in other areas. **Consultants:** Bliss & Hanle, Mechanical Engineers; Richard Hoisington, Structural Engineer. **Photography,** except as noted: Alexander Georges.

The Luther Memorial Church asserts its evangelical message on a site that is surrounded by housing developments and borders a sharp turn of a major New Jersey highway. It is "a tent along the highway for 'born-again' people," according to its pastor, Daniel D. Rein-

heimer. In his words, "97.4 per cent of the congregation love the building."

The site slopes downward from the highway. Gregory kept the flat roof of the nonworship spaces unperforated and free of mechanical obstructions so that it would serve as a base for the tentlike roof structure.

The roof is a pyramidal tent structure of eight angled walls of the sanctuary. The panels are separated by colored-glass skylights. Pastor Reinheimer described the skylights: "Our nave is split by a stained-glass cross. The scarlet red above reminds us of the five wounds of Christ. Here is the symbol of God's new covenant that warms us with the assurance of forgiveness, blood bought."

The building program was undertaken by a two-year-old congregation in a rapidly developing area of New Jersey and was planned as the initial part of facilities that would ultimately include a Christian Day School and gymnasium. Also required were a sanctuary and separate areas for education and fellowship, and a nave that furnishes space for seating 300, with provision for overflow crowds in the narthex.

The paved church parking lot is situated next to the church, as befits the serv-

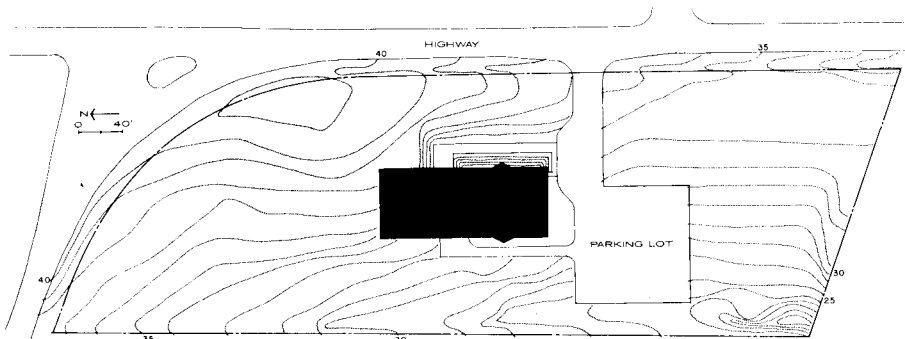



1

ices of this type of community, whose converts expect to turn in off the highway as they would to a supermarket.

Every inch of the building is used by its more than 200 members. Even the kitchen and the tractor garage double as Sunday school classrooms to house 180 children. The sanctuary, which can normally house 200, may accommodate 400 by overflow into the aisles and narthex. Its chairs can be removed for social functions.

The pastor sees the church as a structure for people to gather in worship, not as a building focussed on the processional. He says that he must speak "loud and clear to the people who do not understand his language." And that is exactly what both the pastor and the form of the church do. The mayor of the town says the church put the town on the map.

As with Gregory's Unitarian meeting hall, the budgeting problems led to much do-it-yourself help, although the Lutherans did not seem to be quite as fortunate in their landscaping. Gregory's restrained interior garden is disappearing in a selfless contribution of questionable form, which, one hopes, will be covered with some sort of lush vegetation. However, the ladies of the congregation have sewn church symbols on vestments, which, although reminiscent of Matisse, are strictly their own and very beautiful.

Gregory has built an assertive church for a pastor with an aggressive theology. It does not need the Cross to assert its meaning. Its central beliefs are almost diametrically the opposite of the Unitarian philosophy. Yet both men—minister and pastor—are pleased. Dollar for dollar, there is not a man as pleased with what he got for his money as Pastor Reinheimer. And whatever the religious convictions of Gregory may be, he has handled the architectural problems not as if they were dependent upon his theological beliefs, but as problems implicit in the nature of design.

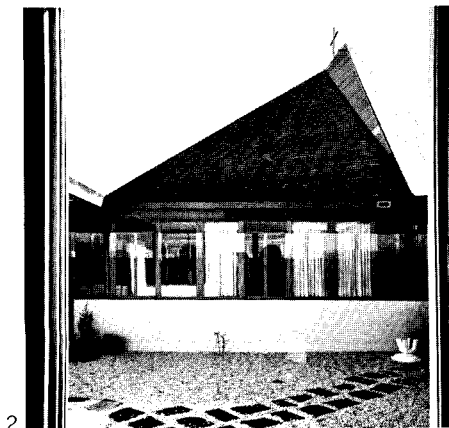

2



3



4



5

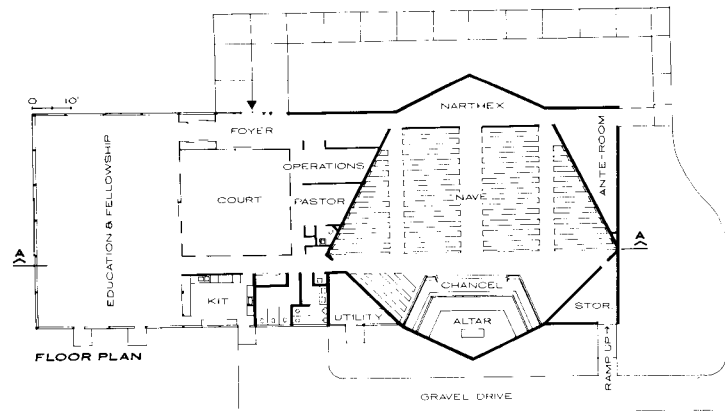
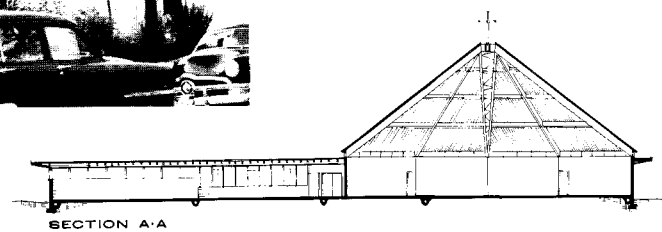

Church entrance (1). Original interior court (2). View from corridor of court and classrooms beyond (3). Temporary church used by congregation before present building was finished (4). Interior of the temporary church (5).



## Presbyterian Chapel

The chapel was designed for the center of a missionary encampment in the Guatemalan jungle, and was detailed to be built by the men of the settlement using local materials. A fired block with heavy cell walls will be tied together by steel reinforcing rods cemented into the cores, forming a construction of reinforced masonry.

The symbolic use of natural light, one of Gregory's favorite devices, was mandatory on this project, since it would serve as the principal lighting source for the chapel. The architect placed a shaft of light over the altar, while the ascending lights, located on the pyramids' sides, create interior light walls in front, with dark walls behind. This, maintains Gregory, "allows the observer to look at and behind everybody."

The pyramidal form was chosen not because it was reminiscent of the Mayan structures of Guatemala, but because of the surrounding mountains: It will form a lofty, echoing shape in its plateau location. This may very well have been the reason the ancient Maya, whose descendants will build the chapel, chose a variation of the same form.

The Seminario Presbiteriano involves the simplest bookkeeping in Gregory's office. It is his donation to the work of a friend.

SEMINARIO PRESBITERIANO, San Felipe, Guatemala. **Architect:** Jules Gregory. **Site:** Missionary settlement on the west coast of Guatemala, enclosed by jungle. **Surrounding buildings:** adobe with tile roofs. **Program:** Planned seating for about 120, with choir space for 30. Glass areas on side act as louver; no plumbing or heating, and minimum or no electrical work. Height from floor to skylight is 45 ft; collar, 5 ft. Platform will be raised from natural grade, 3 ft at the lowest and 7 ft at the highest point. Building span, 60 ft; longest dimension on diagonal, 100 ft. **Structural System:** Native tile with cores rodded and filled with concrete to form a slab.

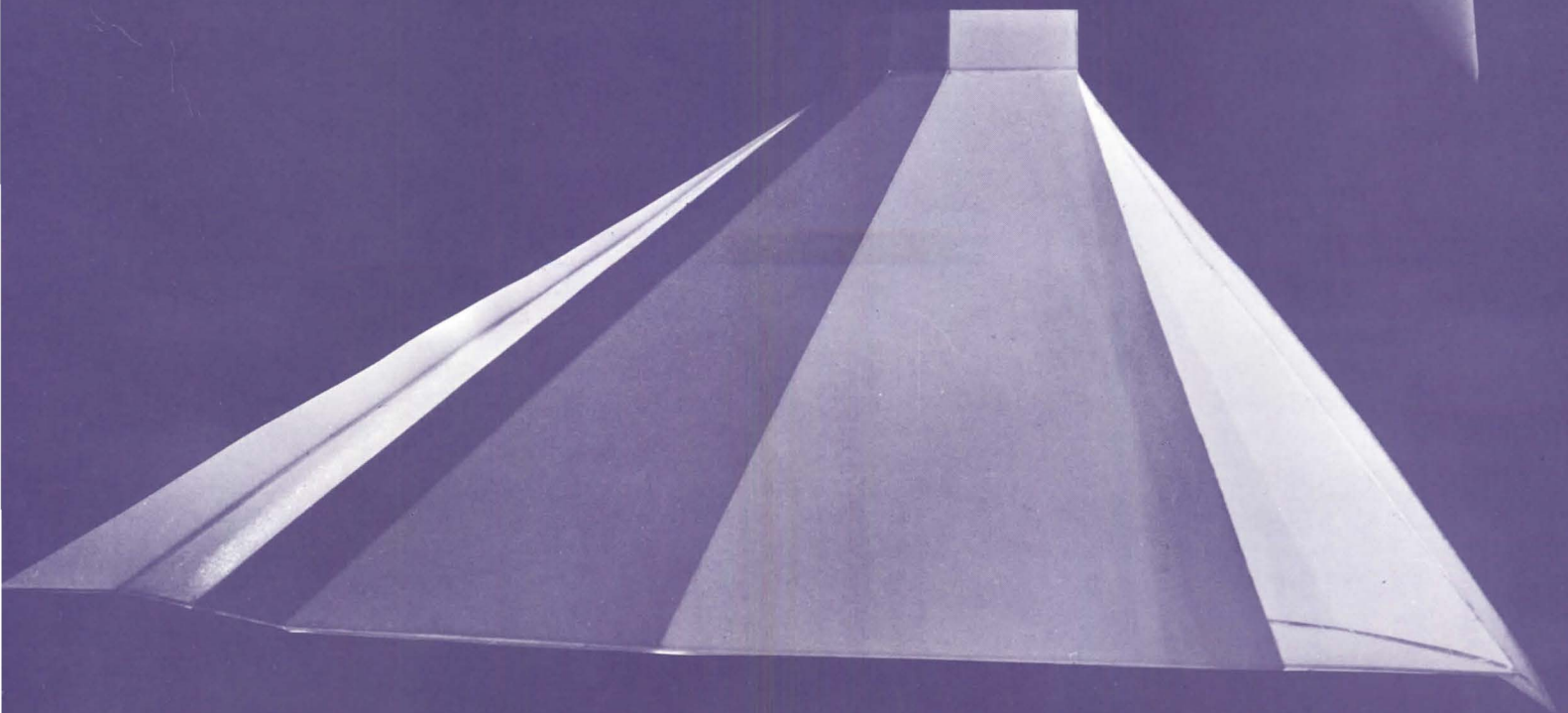
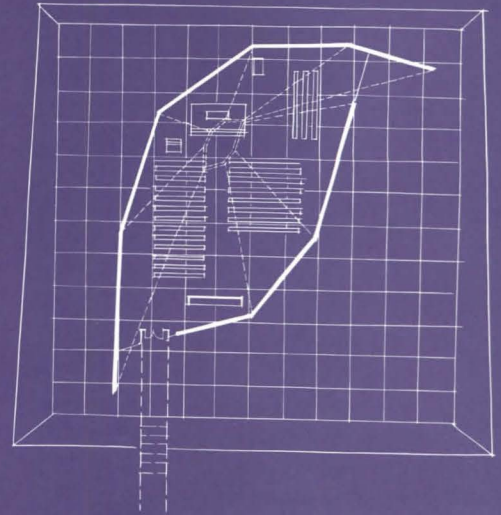
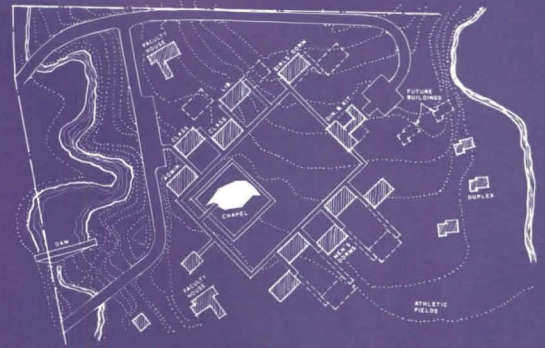

# FUSING FAITH AND FUNCTION

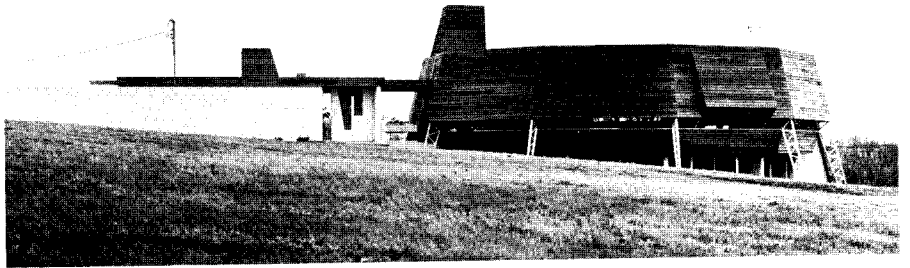

A Unitarian church in Kentucky, which, in its functionalism and a design solution that opens the structure to the surrounding world of nature rather than to the sky, emphasizes a rationalistic and earth-bound theology.

UNITARIAN CHURCH OF LEXINGTON, Lexington, Kentucky. **Architect:** Herb Greene. **Site:** Seven acres of sloping land outside of Lexington. Building will be high hedged with fast-growing evergreen trees. Land is covered with blue grass. **Program:** A low-budget church to include several classrooms, kindergarten rooms, nursery, crafts room, crib room, a large multipurpose room, and a larger, column-free auditorium for church services, lectures, etc. **Structural System:** Steel trusses and wood joists for church roof, reinforced concrete frame and slab, concrete block infill. **Mechanical System:** Gas-fired, forced air with ducts sized for future air conditioning. **Major Materials:** Exterior wall surface is of concrete and masonry and cedar bevel siding. Interior: cedar siding applied to auditorium walls, ceiling, and foyer walls. **Cost:** \$93,100, not including landscaping. **Consultants:** Guy Carter & Associates, Mechanical Engineers; J. Palmer Boggs, Structural Engineer. **Photography:** Bob Bowlby.

## Unitarian Church of Lexington

There is a certain glimmer of quality in this Unitarian Church outside of Lexington, Kentucky, that recalls Herb Greene's individuality as it was revealed in his Oklahoma houses (see MAY and NOVEMBER 1962 P/A's; and MAY 1965 P/A). They are at one and the same time ro-

mantic and formal, serious and whimsical, poetic and utilitarian. But a church is not a house; or rather, it is a special kind of house with an altogether different purpose, and perhaps it should not be romantic, whimsical, or poetic. The Unitarians might have carried it off, but they needed a meeting place not restricted to church services only. Square dances, weddings, theater-in-the-round, and musicales had to be accommodated also. The program, combined with a tight budget, afforded the architect stringent boundaries within which to exercise inspiration.

The two-story building is set on a seven-acre site that will soon be surrounded by cheap colonial cacophonies; it is a 10-sided, circular form of concrete, wood, and steel. The architect felt that the circular form had a "connotation of unity, which I tried to work with in image and sensibility." The flat, truss-supported roof was appropriate for the Unitarians since it has a "less traditional religious reference." The 10 steel trusses that support the umbrella of the roof structure are painted white so that the building will relate to the fences, barns, and houses in the area. Each truss member is welded onto an I beam at a point 10 ft from the center of the compression ring. (See SELECTED DETAILS, pp. 184-185.) Truss, beam, and ring form an arch that runs

down to the ground and is bolted onto a concrete footing buried in the earth. The first level, housing classroom space, nestles underneath, supported by concrete columns and forming the open floor of the space above. The roof, sides, and ceiling of the umbrella have been built up and covered with cedar bevel siding so that only the white-painted steel trusses show through. Not only do they appear at first to be decorative, but, from the outside, they look like stilts that have been placed there to keep a heavy wooden structure from tipping.

The interior of the church is cold, inert, and somewhat heartless. But it is functional and the Unitarians like it. Perhaps the thorough rationality, as it is expressed by the windows opening the sides instead of the ceiling opening to the heavens, fulfills the congregation's spirit of dedication to man and the world of nature. The clean, unmysterious character of the interior space is accentuated by the low windows that focus on well-cropped blue grass and open the interior to natural light, untainted by ethereal colors or esoteric emotions—a world immediate, natural, and open. Neither the sky, ponderous old traditions, nor the encroaching ugliness that is soon to appear will intrude here; the openness is controlled and restricted to natural light and blue grass.

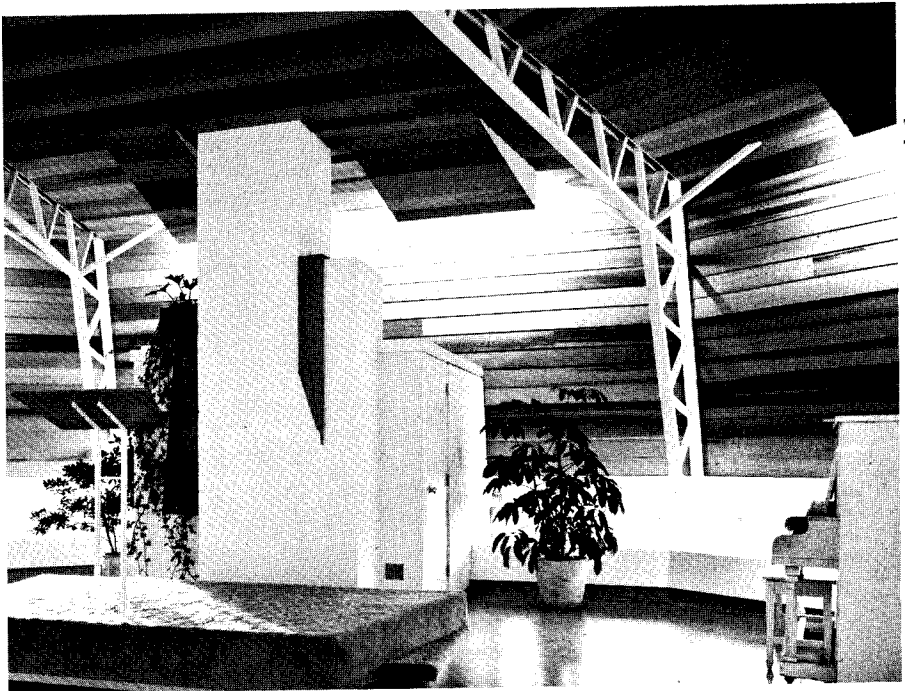

Interior view of pulpit in large meeting room on second floor.

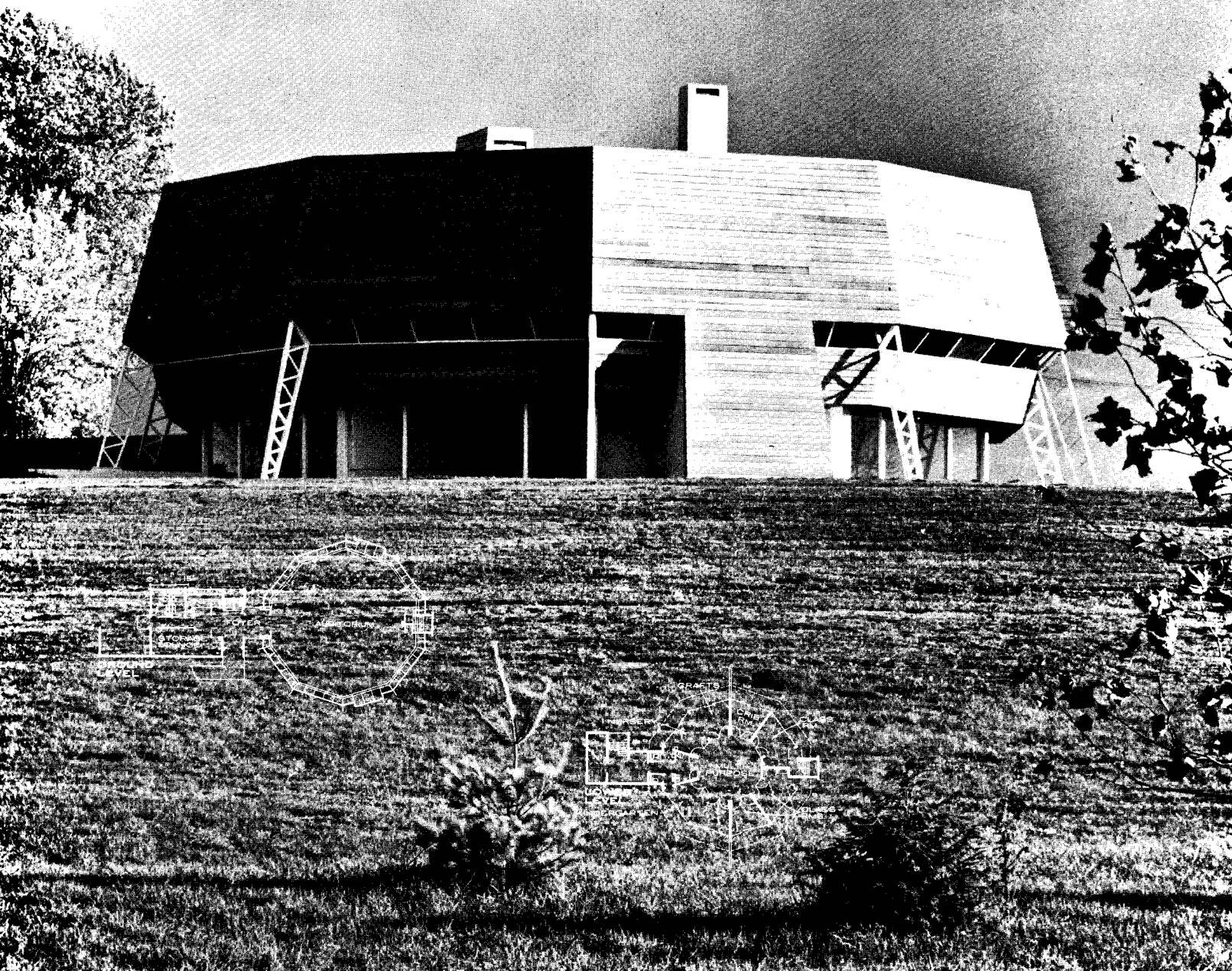
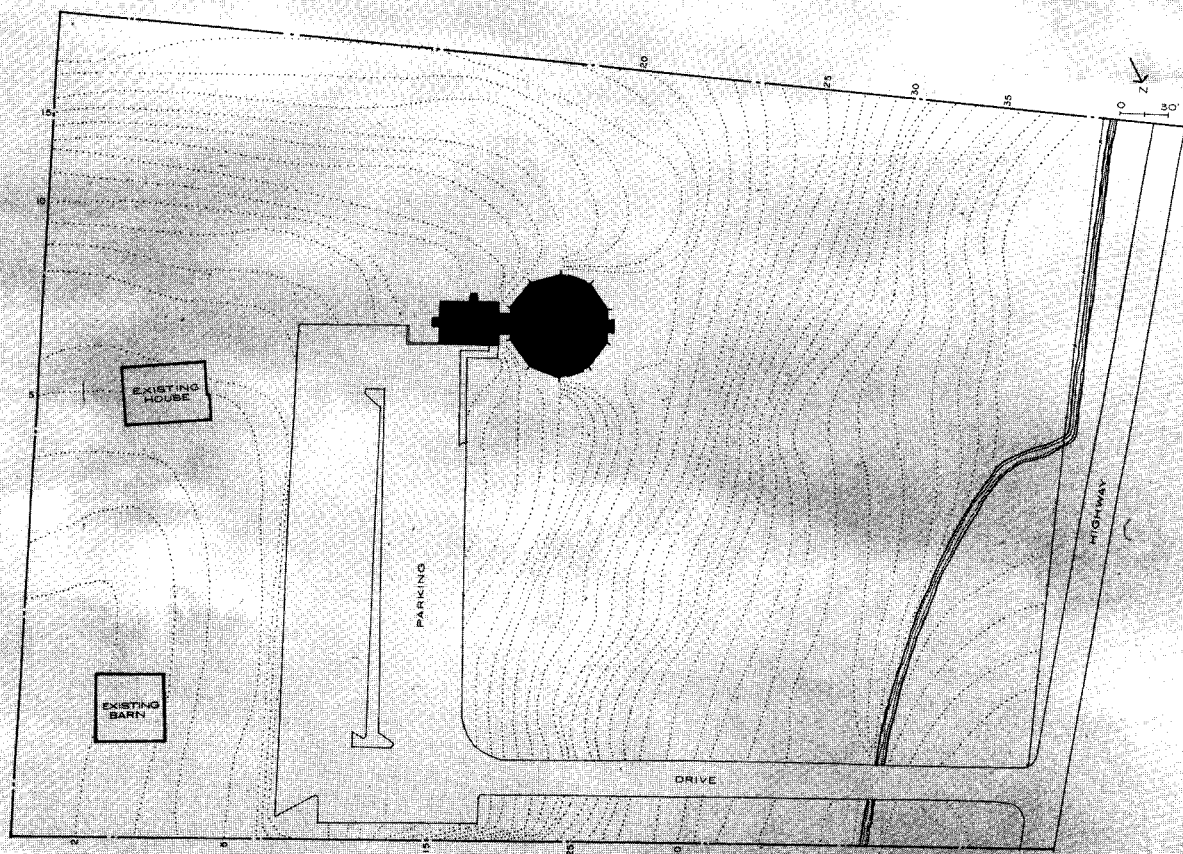

# RICHARDSON AND SULLIVAN IN SCANDINAVIA

**The impact of Louis Sullivan and H. H. Richardson on Swedish and Danish architecture at the turn of the century has been unexplored to date. This author, however, finds their influence surprisingly substantial.**

*By Leonard K. Eaton, professor of architecture at the University of Michigan.*



1

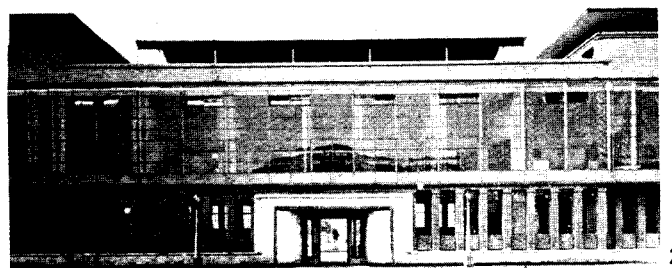

2

Architectural historians customarily date the international impact of American architecture from the extensive publication of Frank Lloyd Wright's work by Wasmuth Verlag (Berlin, 1910). Mies van der Rohe's eloquent statement on the meaning of this event is well known, and the remarkable resemblance has been noted between Wright's Mason City (Iowa) bank of 1909 and the front elevation of Walter Gropius' Model Factory for the 1914 Werkbund Exposition in Cologne (1, 2). While Robert Koch has demonstrated H. H. Richardson's indubitable influence in England (e.g., the Whitechapel Art Gallery by C. H. Townsend in 1897-99), the appearance of the Wasmuth publication is generally attributed as designating a kind of coming-of-age. However, there is ample evidence to suggest that many European designers closely followed the



3



4

work of American architects from about 1880 onwards, paying particular attention to Richardson and Sullivan. In Scandinavia, this is particularly the case.

## **The Garden Suburb**

In Sweden, serious interest in American architecture originated in the 1880's, with a major role played by Johan Henrik Palme, a town councillor of Stockholm. The 1870's witnessed the building of many large and ugly apartment blocks in the city, and Palme, like many civic-minded men of that day, searched for an alternative. In 1888, he visited the United States to look at garden suburbs around Philadelphia, New York, San Francisco, and Chicago. Among those he visited were Yonkers, and, in all probability, Riverside, the outstanding achievement of Frederick Law Olmsted. Palme was impressed by the fact that the purchase of a large tract of land by an individual or a group permitted a unified development and savings on the installation of utilities. On his return to Stockholm, he formed a company with three associates and purchased a substantial tract of land north of the city, Djursholm, for development. Today, it has a startling resemblance to its American prototypes, both in planning and the houses built there.

Much the same can be said for Saltsjöbaden, another garden suburb developed by the Wallenberg family in the 1890's. Many of the dwellings in these Stockholm suburbs of the late 19th Century are Swedish versions of the American Shingle Style, so popular in American resort areas of the same period, such as Richardson's Stoughton House at Cambridge, Massachusetts (3). By comparison, a Swedish house at Saltsjöbaden (4) looks clumsy. The shingles are, of course, an old tradition in this part of the world, but the round tower is decidedly Richardsonian.

## **Swedish Richardsonian**

Many of the shingled houses of Djursholm and Saltsjöbaden have this Richardsonian flavor, but it remained for the Swedish architect Ferdinand Boberg to bring Richardson to the full attention of his countrymen. From the days of his youth, Boberg showed an extraordinary interest in the world outside Sweden, and is credited with having taken 120 trips to foreign countries, including Africa, India, East Asia, and the United States. These journeys convinced him that internationalism was the

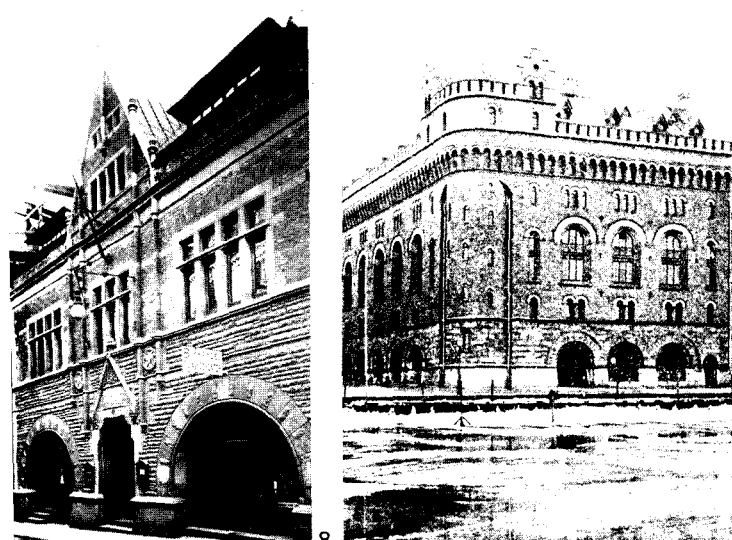
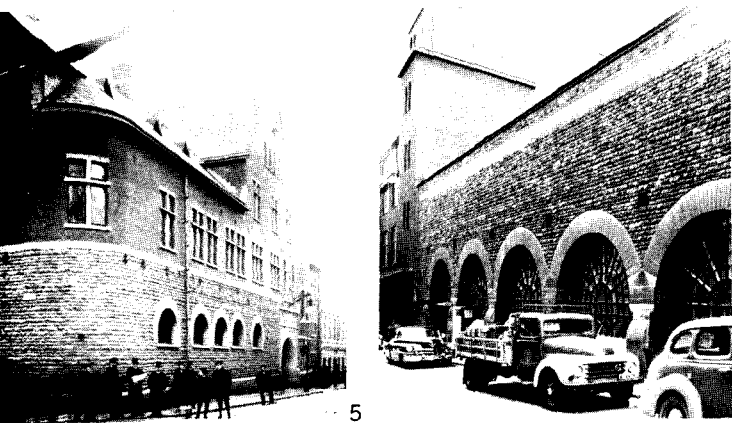

only hope for Swedish culture, which seemed to him narrow and parochial. It is not surprising that young Boberg turned outward; this country had lost its last continental possessions in the Napoleonic wars, and in the latter half of the century lost hundreds of thousands of its productive citizens to the United States through immigration. Until about 1900, it did not share in the rapid economic progress of France, Britain, and Germany, and was often ranked as one of the least prosperous nations in Europe.

Where Boberg first ran across H. H. Richardson is not entirely clear. It may have been in an English or German publication of the 1880's. His first Richardsonian building, the Electric Works for Stockholm (5, 6, 7), dates from 1892. With its powerful arched entryway and rugged ashlar, this structure created a sensation in the city; indicative of Boberg's effort at modernity was the frieze of electric light bulbs, which replaced the egg-and-dart or bead-and-reel molding usually employed. The Electric Works was soon followed by two other Richardsonian buildings: the Workman's Institute by Carl Moller (8), and the Hogonas Store by Ludvig Peterson (9). Like the Electric Works, both were powerful masonry structures with characteristic Richardsonian window groupings.

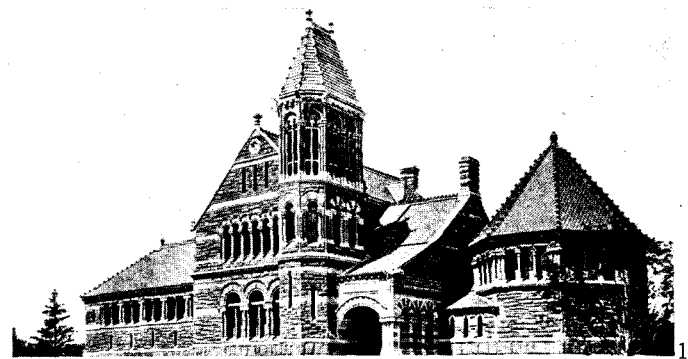

Since all of these edifices have unhappily been destroyed, Stockholm's American inheritance is only barely visible.

Boberg made a trip to the United States in 1893 in connection with the Swedish Pavilion at the Chicago World's Fair, and probably saw in Chicago two of Richardson's greatest works—the Glessner House and the Marshall Field Wholesale Store, both completed in 1887. He was enormously impressed with the development of the public library movement in the United States, and subsequent to this trip wrote two articles dealing with this topic for the *Teknisk Tidskrift*, the ancestor of the present *Arkitektur*. The second article illustrated Richardson's Winn Library at Woburn, Massachusetts (10). While Boberg did not like the combination of local museum and library here, he was full of admiration for Richardson's handling of the problems of circulation and book storage. In addition, he was impressed with Richardson's attempt to get away from the stylistic merry-go-round of the 19th Century and to return to architectural fundamentals.

Boberg's most Richardsonian building, the fire station at Gävle, was executed in 1894, immediately after his return from the United States. This structure, still well preserved, was done in a tawny yellow brick rather than the rough Richardsonian masonry (11). With its powerful conical towers and rhythmical window groupings, it might almost be from the office of the master himself.

After 1900, Boberg gave up the Richardsonian vein to devote himself to a Swedish version of the Jugendstil then sweeping Europe. In this endeavor, he encountered the intense hostility of the national romantic school headed by Ragnar

PHOTOS 4, 11, 13, 17, 18: CARROL K. EATON

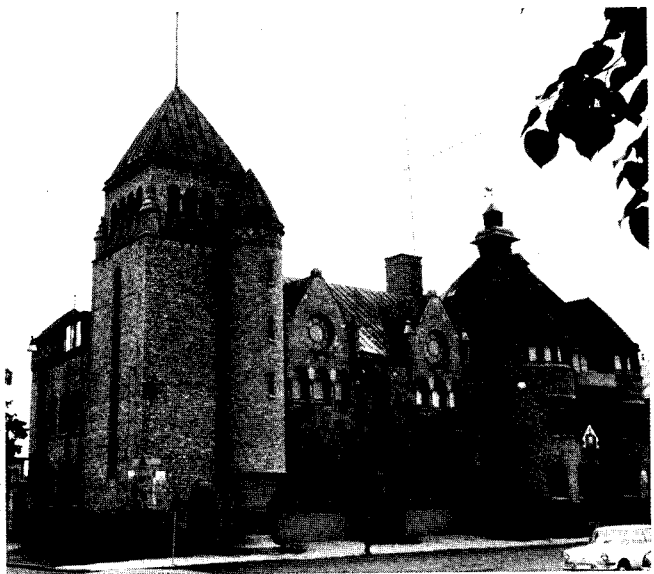

11

SWEDISH INFORMATION SERVICE

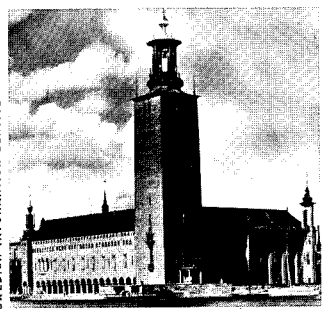

12

DANISH INFORMATION OFFICE

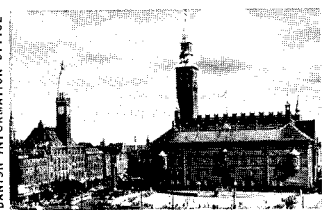

14

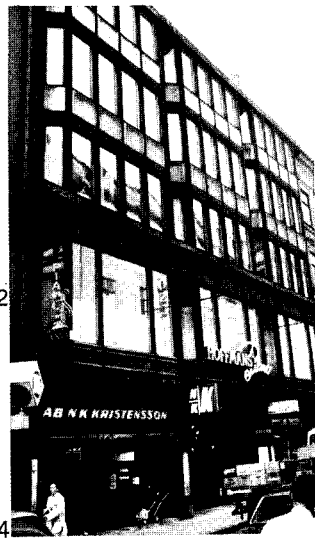

13

Ostberg, architect of the Stockholm City Hall (12). Although Boberg enjoyed an excellent reputation in Stockholm and was responsible for many large buildings there, notably the famous Nordiska Kompaniet department store, he retired from active practice in 1915. Despite the fact that this forceful personality withdrew from active practice at an early age, he performed a most important service to Swedish architecture in his emphasis on international modernism at a time when most of the country's leading designers were absorbed in fruitless historicism.

**Sullivan's Proponent in Sweden**

George A. Nilsson (1871-1949), another prominent architect, described by architectural critic Bjorn Linn as "The Quiet Revolutionary" (pp. 157-169, May 1964, *Arkitektur*) concerned himself largely with the problem of modernizing Swedish school design. In this area, he accomplished an important but unspectacular job. However, he also did two commercial buildings in Stockholm that showed complete awareness of the most advanced principles of contemporary architectural design. The larger, built in 1912 and located at Regeringsgatan 9 (13), is an almost perfect restatement of the principles of the Chicago School. With its beautifully proportioned bays and large glass area, it approximates the structural expressionism of Louis Sullivan. Where Nilsson encountered Sullivan (or perhaps Holabird and Roche) is not known—probably, according to Linn, through magazine publication. In any event, he here created one of the most distinguished commercial buildings in the city of Stockholm—and one that very clearly reveals an American ancestry.

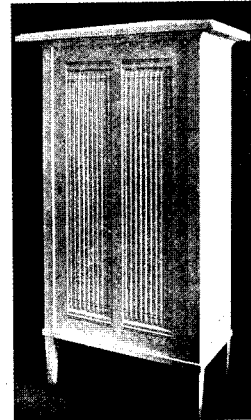

16

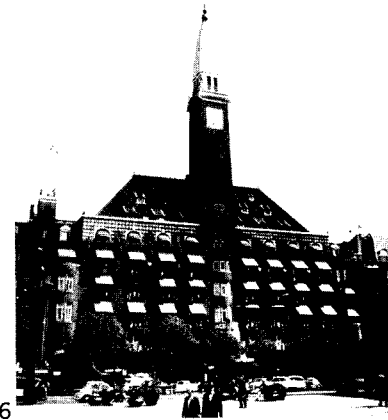

17

**Repercussions in Denmark**

Alfred Rosen's role in Denmark is analogous to that of Boberg's in Sweden. While Rosen (1859-1928) was certainly one of the leading Danish architects of his time, he was overshadowed by the figure of Martin Nyrop, who built the Copenhagen town hall (14). This structure, by far the most important building project of its time in Denmark, insured the pre-eminence of Nyrop, a man totally absorbed in a romantic preoccupation with the Danish past. Indeed, he went so far in this direction that he adorned the town hall with stone walruses and polar bears symbolic of his country's Arctic possessions. Nyrop hated what he understood to be the European modern architecture of his day and actually went so far as to forbid his students at the Royal Academy of Fine Arts to read periodicals featuring it.

Rosen was altogether different from Nyrop in his outlook on architecture and on life, and as a young man traveled widely in Scandinavia and Western Europe. Like Boberg, he was a close follower of international developments and evidently thought that the salvation for Danish architecture lay in turn-

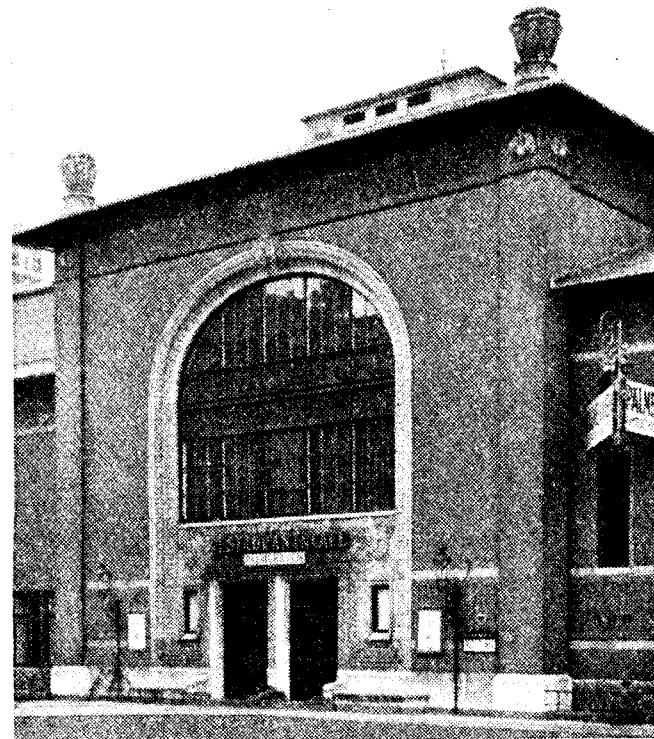

15

ing outward to the rest of the world. Rosen's office attracted the best minds among the younger generation of Danish architects—Kay Fisker, Aage Rafn, Svend Moller, and Lars Sonck, the powerful Finnish contemporary of Eliel Saarinen, all of whom went on to distinguished careers. None of Nyrop's students achieved much eminence.



One of Rosen's most interesting buildings, the Workers' Clubhouse in Silkeborg, a small town in Jutland, is distinctively Sullivanian in feeling and dates from 1895 (15). Unfortunately, it was destroyed during World War II. Also extremely provocative is the furniture done by Rosen for a hospital in Silkeborg (16). The large wardrobe, a kind of diminutive Wainwright Building, might well have come from the office of Sullivan or from that of Purcell & Elmslie. Obviously, it was Sullivan rather than Richardson who meant something to Rosen, and it is a curious unanswered question as to how he acquired his knowledge of the Chicago master.

In Copenhagen, Rosen's best known work was the Palace Hotel (17), whose individual and imaginative form, rich brick ornamentation, and highly original interior (now unhappily rebuilt) ranked it with the best buildings in Europe. Showing a strong German influence, the hotel was nonetheless extremely Danish. More interesting from the American point of view, however, is the Savoy Hotel (18, 19). For this structure, built in 1906, Rosen used an extremely elegant skeleton construction and large areas of glass. The frame was sheathed in bronze, and the ornamentation has the strongly appliqué feeling so characteristic of Sullivan. In fact, the building may be compared with some of the masterpieces of the Chicago School; and although it has not been well maintained, it still adds distinction to the street on which it is located (Vesterbrogade), and it will seem a familiar type to an architect from America.

Rosen's other buildings in Copenhagen are a curiously mixed lot. Some, like the powerful, concrete-framed Metropole Theatre, are very much in the Jugendstil tradition; others are quite nondescript. Rosen's major difficulty may well have been that he was too open to ideas from abroad. For example, his last projects show an attempt to assimilate the emerging international style of the 1920's. Although he rejected Nyrop's romantic preoccupation with the national past, he was unable to find firm ground on which to base himself, and hence his work is extremely uneven in quality. His position, even as president of the Royal Academy of Fine Arts, was undercut by members of the Danish architectural establishment; his influence, therefore, was seen largely in the work of a few gifted disciples such as Fisker and Moller.

### Another Convert

Alfred Ravad, also a Danish architect, came to Chicago in 1890 and remained there until 1914. Although he was disappointed by the World's Fair of 1893, he found Sullivan's Trans-

portation Building a revelation. Its strong architectonic lines, and the lavish decoration of the famous "Golden Door," were seen by him as portents of the future. In 1898, he wrote about this and other Sullivan buildings in an essay on "American Architecture and Louis Sullivan" for *Tidskrift vor Kunstindustrie*, in which he commended the American's conception of architecture as poetry and his view of nature as a source of inspiration.

It should be noted here that the editors of Scandinavian architectural magazines made a reasonable effort to keep their readers informed of developments on the American architectural scene, but that, in general, they tended to limit themselves to coverage of technological innovations and of the official work. Boberg and Ravad then performed a real service in bringing the work of Richardson and Sullivan to their countrymen. There does not appear to have been any notice of Wright in Scandinavian magazines, though he was the subject of a series of lectures at the Royal Academy in 1910.

### A Rough Transition

Although Boberg, Ravad, Nilsson, and Rosen did much to promote awareness of American architectural developments, one must not assume that the transition from historicism to a modern vernacular in Scandinavia was easy. In both Sweden and Denmark, there was a real struggle between this avant-garde (particularly Boberg and Rosen) and an establishment (represented by Ostberg and Nyrop) that sought to preserve the romantic traditions of the national past. The avant-garde wanted to bring architecture into line with 20th-Century requirements; nevertheless, the establishment won the battle. Its monuments are the Copenhagen and Stockholm Town Halls.

Sullivan, too, pitted himself against the establishment in the United States; his enemy was the academic classicism of the East as represented by McKim, Mead & White. The struggles of Boberg, Rosen, and Sullivan resulted in defeats of varying degrees, yet they bore a remarkable similarity. In Boberg's case, defeat was cushioned by connections with some extremely influential people and a very real interest in architectural history. Rosen was simply denied the opportunity, which should have been his, to expound his views at the Royal Academy. With Sullivan, defeat was especially bitter because of personal factors (unhappy marriage and the problem of alcoholism) and the fact that, for a few years in the 90's, the cause actually appeared to be triumphant. However, by World War I, it was clear that the cause was lost for at least a generation.

It is significant that all three architectural innovators, who had difficulty surviving the highly organized opposition of the establishment, have been honored by their respective countries in recent years: A Swedish book on Boberg appeared in 1958, and further publication is in prospect; Rosen's centennial was observed by the Danes with an exhibition; in his *History of Danish Architecture*, Tobias Faber, the new rector of the Royal Academy, gives ample space to Rosen and bewails the fact that he was a lonely figure in Danish architecture. Sullivan's centennial in 1956 was noted with a large exhibition of his work at the Chicago Art Institute, and, since that date, the Sullivan bibliography has been increasing. Louis Sullivan is, in fact, well on his way to becoming a kind of folk hero for American architects.

Thus, although the architectural advances of Sullivan and Richardson had a less obvious impact on Scandinavia than in America, the influence of these architects' work was surprisingly significant. It is quite clearly a mistake to date European awareness of American architecture from the publication of Wright's work by the Wasmuth Verlag.

## DOWN FOR DECORATION

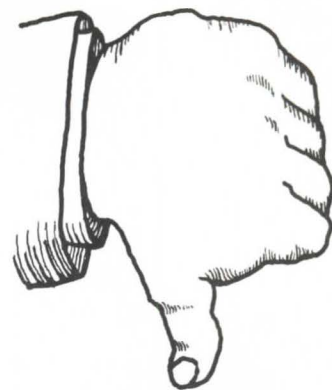

**On the facing page you see a "Suite of Chesterfield furniture" constructed of layers of urethane foam sprayed through a garden hose by Aagaard Andersen, Danish designer and daredevil visionary.**

**On this page is a downy group of fine feathered furniture — glued and feathered by the hand of William J. Cunningham, American madhatter, long-furrier, and creative madcap.**

**Few architects need to be told the difference between design and decoration, or between construction and paint, which these two examples demonstrate. Most recognize that design-from-the-raw-up can be inspired yet outrageous — or even deadly. But many may never have admitted, or thought, that decoration can have psychological and sociological effects as substantial as those of "good design."**

**That latter claim is not made for Cunningham's decorated furniture (left), which was designed as eye-catching display for store windows.**

**Andersen's "Suite," on the other hand, certainly outrages—even repulses—most firstviewers. (Dare one hope that the process will never be employed to make functional stools?) Composed of dobs of urethane foam, which puffs up and then sets, the experimental "Suite" was**



# UPPING THE NATURE OF MATERIALS

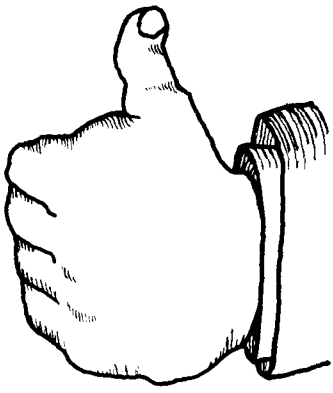

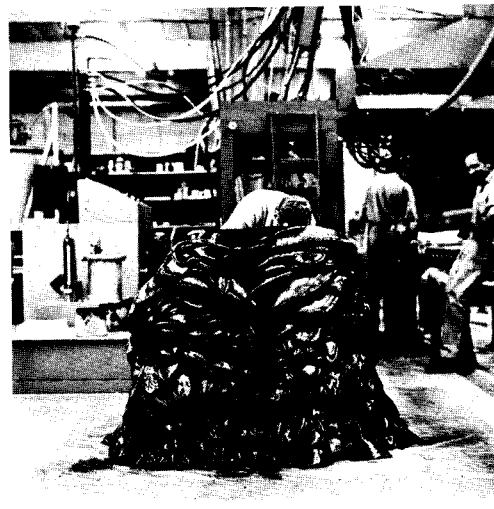
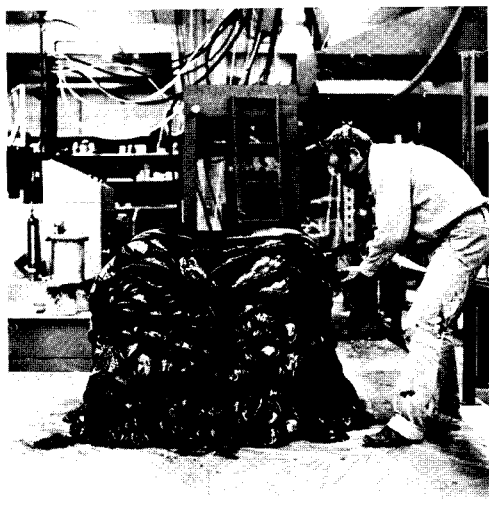
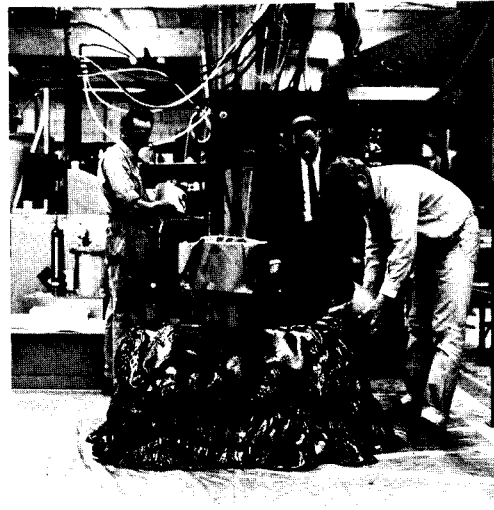
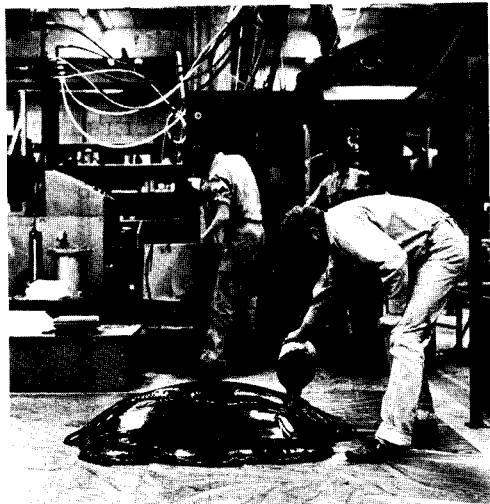
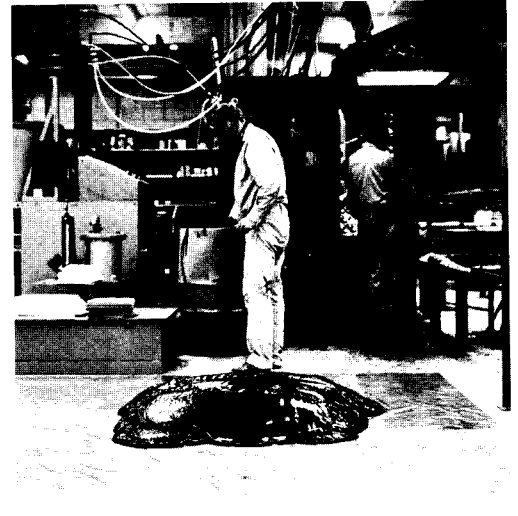
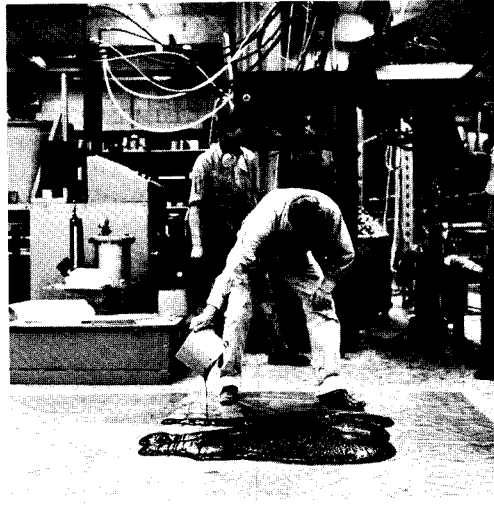
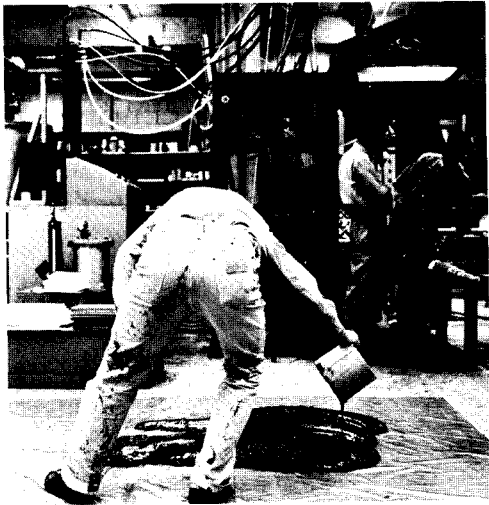
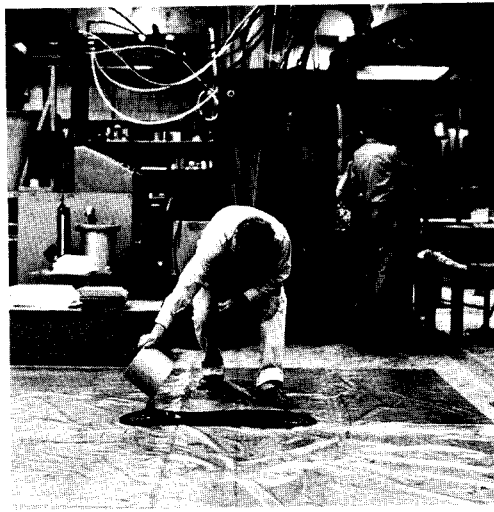
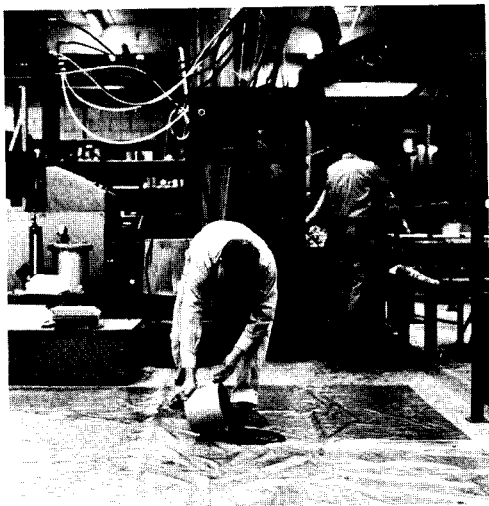

sprayed layer on layer, without a mould, and then painted black. It is laminated foam — feuilletéd furniture.

The photographs on the facing page show Aagaard Andersen in the process of building up one of the chairs when — as editor Gunnar Bratvold of the delightful Danish magazine *Mobilia* points out — “the machine failed and Aagaard had to fill a pail, and, with artistic skill, poured out the urethane.”

Yet while American designers, with all the highly touted technology of our country at their disposal, have brilliantly envisioned and ideally sketched furniture-of-the-future sprayed without moulds (Michael Lax noted the possibility in the last “*Decoration and Design*” exhibition in New York), Aagaard Andersen in Denmark has gone on to do it.

This is only a start — controls have to be introduced to the process to make it more finished — but it is a revolutionary advance in furniture construction techniques, as *Mobilia* immediately recognized, and this fundamental vision is the beginning of design.

Neither of these accomplishments is equivalent to the examples on the following eight pages, although there are similarities in the respective color usages. One example is solid architectural design that has questionable psychological effects, whereas the other is a paint-thin decoration scheme that has vital benefits to social environment.

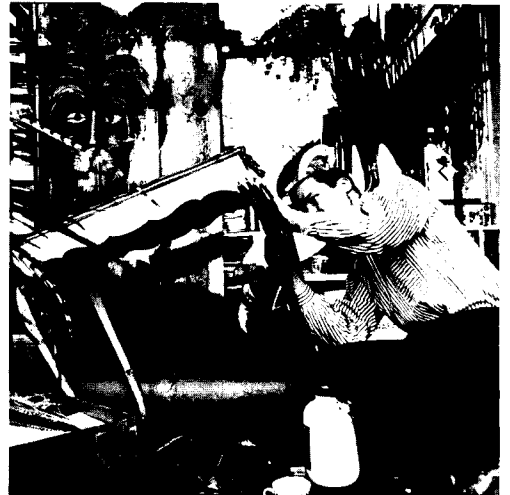

# AIRLINE DESIGNS FOR PASSENGERS

**Alexander Girard's face-lifting scheme for Braniff International Airways is a deep bow to the perceptual sensitivity of passengers.**

Architect Alexander Girard, long a designer of Op-type fabrics and interiors, has extended the vision of another client, Braniff International Airlines, with a wild hot jazz of multicolored, variegated, piebald, warm, cool, solid, checked, striped, patterned posters, upholsteries, wall and window coverings, graphics, and then some.

Braniff is heralding "the end of the plain plane." They can also advertise the end of the plain boarding lounge, the plain ticket counter, the plain poster, plain ground-crew equipment, and plain uniforms (the latter by Italian couturier Emilio Pucci).

The company may become known as "the decorated airline," with its fleet of multicolored equipment looking like a set of plastic tinker toys, but what someone called "Detroit's tapioca look" may well be on the way out as far as flying is concerned.

Braniff's new president, Harding Lawrence, who has been shaking up the airlines business with far-out sounding but down-to-earth ideas, wanted a distinctive *image* that would "add sheer beauty to the exciting technology of flight." His face-lifting program stops short of redesigning or changing the basic architectural shapes of planes, either exterior or interior, or of ticket counters or lounges (facing page, middle). Therefore, Girard's part in the program was essentially a decorating job.

Color, color, color—in fabrics, photos, objects, ink, and paint—was applied everywhere. But a paint job by Girard is one by a master colorist. For, wild as some of his Braniff color situations are, the success of the job is indicated by the fact that some visually untrained observers are left still unsated and want to add even more color.

However, Girard's style has its contrasts and limits: the riotous profusion of rich, fruity hues is set within uniform, pale, off-white envelopes.

Inside the planes, all ceilings, walls, window panels, and lightstrips are painted flat off-white with pale gray, making them seem airy and vast. Gone are the snowflake- and amoeba-patterned, glitter-dusted plastics, which are designed to look so splattered-up with chicken scratches that you will not see the scuff marks—or is it so that you will not see anything at all?

As focal points, bright-colored posters, of which Girard designed 24, are hung at the front of each compartment in a scale large enough to be meaningful from the last seat. But it is in the upholsteries of the plane seats (which are Velcro-ed on so as to facilitate cleaning) that the technicolor extravaganza reaches its climax. In the red plane (there are seven "colorways" of plane interiors), the seating makes staggered patterns with a red linen, a magenta-and-orange striped wool, a fuschia linen, a pale-pink-and-red checked wool, a purple linen, a . . . and so on. The yellow scheme is composed of solids, stripes, and checks in yellows, ochres, orange, and pale lime. The seven interior color schemes utilize 56 fabrics. The airline boasts that one can travel on

Braniff every day of the week and never see the same color combination.

The vigor of the hues within the calm, neutral surround (note that it is not Girard's customary clinical, pure-white wash), gives the eye strong focal points. Instead of straining, restlessly watching the scampering traffic and the unarresting monotony of the usual airline surroundings, the eye is given a resting place. So, too, the spirit is given repose.

In this Jet Age of vast distances, instant changes of climate, time, culture, language, money—everything just hours away—most travelers who have not flown enough to accustom themselves to these wild leaps are psychologically distended by the prospect. Mentally and psychologically, we anticipate an experience to which we have no relationship in our cultural psyche, since, for centuries, until the last 50 years, all travel has been at average speeds no greater than 100 mph. Now—X-15, SST, XB-70, F-111, Gemini VII.

Ultimately, man will have to expand his consciousness to assimilate these rocketing changes. For the nonce, Girard has given the passenger an out. Instead of being carried visually down the length of the plane or beyond the boarding lounge into the terminal (by the bustling traffic or by things that worry one to avoid seeing), and instead of being distracted psychologically by the unassimilable leaps of jet travel, the vibrant colors on the plane and boarding-lounge seating and on the posters close the traveler in and provide him a secure surround at the scale of the individual—a personal ken.

The major contribution of this corporate image design, then, is not its decorative effect, but a broader dimension—the psychological benefits to the individual traveler that masterly decoration can, unexpectedly, provide.

Girard's intention is not couched in these terms. He feels that the color and attractiveness of the spaces will "appeal to tired businessmen as well as to women. I think we have reached a stage of civilization where colors are not the prerogatives of women." And it cannot be denied that this lover of the countries south of our border, this collector of handcrafted objects from around the world, was a wise choice for an airline that flies to Mexico and South America.

One frightening thought about the project is the possible effect on other airlines; therefore, we must give warning to bandwagon followers that this color business must be done by a sensitive, highly personal expert. For the effects of such a widely exposed program on the taste of the country could be enormous.



LOUIS REENS



LOUIS REENS



ALL PHOTOS, EXCEPT AS NOTED: COURTESY BRANIFF



1



2



3



4



5

10



6

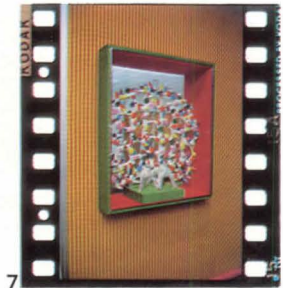

7

11



8

COURTESY BRANIFF



9

COURTESY BRANIFF



12



13



14



COURTESY BRANIFF

ALL PHOTOS, EXCEPT AS NOTED: LOUIS REENS

Girard's color-lift for Braniff is carried throughout the airline's facilities and services from the ground up: in planes, boarding lounges, international lounges, ticket counters, graphics, and in-flight food service. In addition, Braniff's president Lawrence has hitched onto another jet-star, Italian couturier Emilio Pucci, whose stewardess' uniforms also raise the airline to giddy new heights.

The décor in the existing International Lounge at Dallas (10, 11, 15) starts with a plan partitioned into booths to insure privacy of conversation, reading, or writing. Supported by special extruded aluminum poles (4), partitions are covered with a riotous profusion of 28 different fabrics, some of them Girard's designs for Herman Miller (1), some of them Mexican imports.

Handcrafted objects from Latin America are displayed throughout, those of museum quality often placed in see-through niches visible from both sides (7).

A new line of fly-away furniture, designed by Girard (2, 3, 5, 6, 19, 20, 21) and made by Herman Miller, has polished aluminum frames (black wire front legs were temporary during a redesign phase), with upholstered elements covered in several different fabrics to look like laminated, mille-feuille cushions (2). Tabletops are of rosewood, or of one of seven marbles (20).

A graphics program also gets the airline off the ground with new lettering used on planes, tickets, baggage checks, ticket counters (12, 13, 14), signs (17), and a black-and-white fabric (18). Also included are 24 posters: some are soft-focus close-ups of hand-crafted objects (16); some displaying the logo, use Op Art techniques (14).

At ticket counters, posters are extended on frameless panels, and, to continue the geometric rhythm, same-size panels with center cutouts are used to frame televised flight schedules (14). With down-right common-sense vision, another panel is used as a fold-up coverplate and labeled "fire hose" (13).

Food service also has been given a lift-off: since weight is not a significant factor in jet aircraft, dinnerware has been made man-size, and colorful (22, 23, 24), instead of the customary compact, plastic, foxhole ware.

Pucci's uniforms for stewardesses are not in the previous airline tradition of confidence-inspiring, banklike security, but are a riot of color in a multilayered outfit that the girls peel off in a take-off technique that Braniff calls "the airstrip."

For airfield duty, the stewardesses wear chartreuse overcoats that have wildly printed velvet pillboxes (with under-chin earflaps): in bad weather, the girls don clear plastic "Astronet" domes that protect specially designed hairdos and make-up (preceding color page). During flights, they wear magenta-red suits until serving time, when these are peeled off to reveal blue culottes (8). For dinner, the girls sport vivid smocks (9).

All in all, it is a colorful concept colorfully executed. And if the snappy decorating does not grab you, the sight of the girls doing the "airstrip" will send you flying every time.

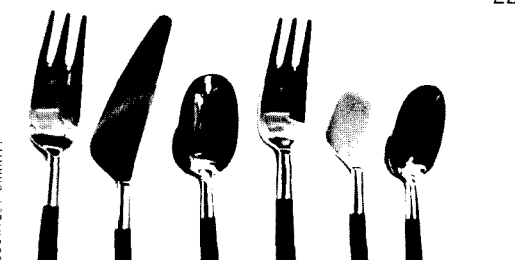
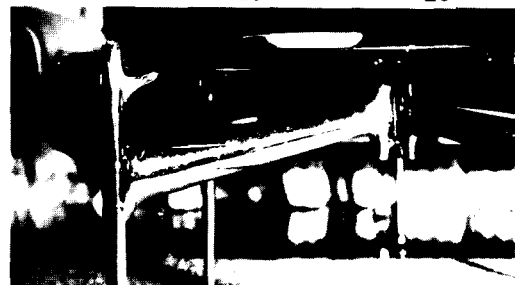
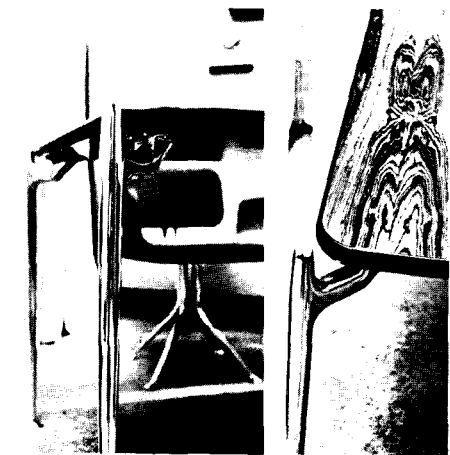

# FOR FORMAL DINING: BLACK GRANITE?

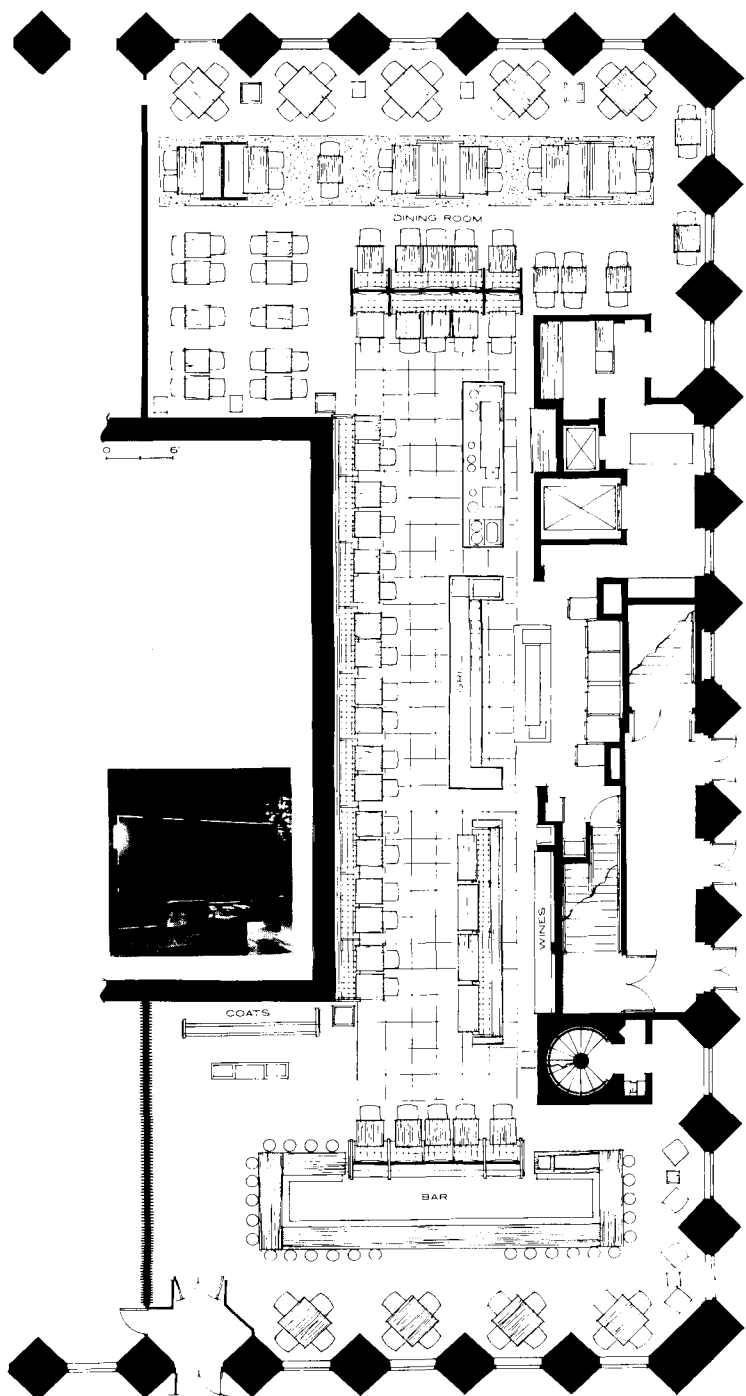

Dark, somber, funereal black is the color of The Ground Floor, the restaurant designed for that location in New York's CBS Building by Eero Saarinen Associates under the direction of Warren Platner.

"Spartan elegance" . . . "Tall, stark, and handsome" . . . "Just like the Moscow subway" are some of the reported comments. "Yiughk, like eating in a coal cellar," said one critic. And an architectural photographer observed epigrammatically, "The understatement is overdone." But, undeniably, it is a powerfully posh design: The place is so blacked out that it is turned on.

Another welcome relief from catchy, radical, papier-maché-and-tinsel restaurants, this solid architectural design starts with acceptance of its location—the black granite piers and walls, the extravagant bronze fins, and 20-ft ceiling height of the lobby, all of which are continued into the restaurant—and goes on to embrace virtually everything visible inside.

The atmosphere is in the idiom of men's clubs—robust, substantial, dignified, and conservative. Rich, quiet materials, such as Honduras mahogany, polished bronze, stainless steel, and tufted leather (brown, not black as might be expected), contribute to the masculine character. Against this positive, raven palette, the food gains a riveted focus.

One of the strongest masculine effects is the exposed kitchen in the grill room at the center of the restaurant (a food-preparation kitchen is downstairs). Originally considered a space-saving device in the small area available, the in-room kitchen was finally adopted because it gives a robust sense of cooking and also because of the current national interest in the creativity and methodologies of the kitchen.

One wishes, however, that these kitchen functions could be even further exposed as an aesthetic expression—though, admittedly, what form that might take is not immediately apparent. At the moment, there is some ambivalence about the grill room kitchen, as is indicated by two secretaries who were surprised because "there are no seats at the counter."

The two most inspired touches exhibit the consistency of approach. First is the principal lighting, which consists of a series of exposed filament bulbs suspended at 10 ft in cages of Honduras mahogany with brass-colored, polished-bronze canopies and clear glass sides. These reflective surfaces give the horizontal lighting system an endlessly tiered appearance of compelling character and make it one of the most impressive of modern chandeliers—a cage of light in a black night.

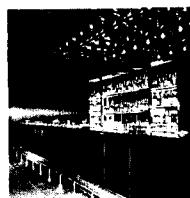





***A posh restaurant poses the question: Is sepulchral elegance a perverse environment for enjoying a buoyant vin rosé?***

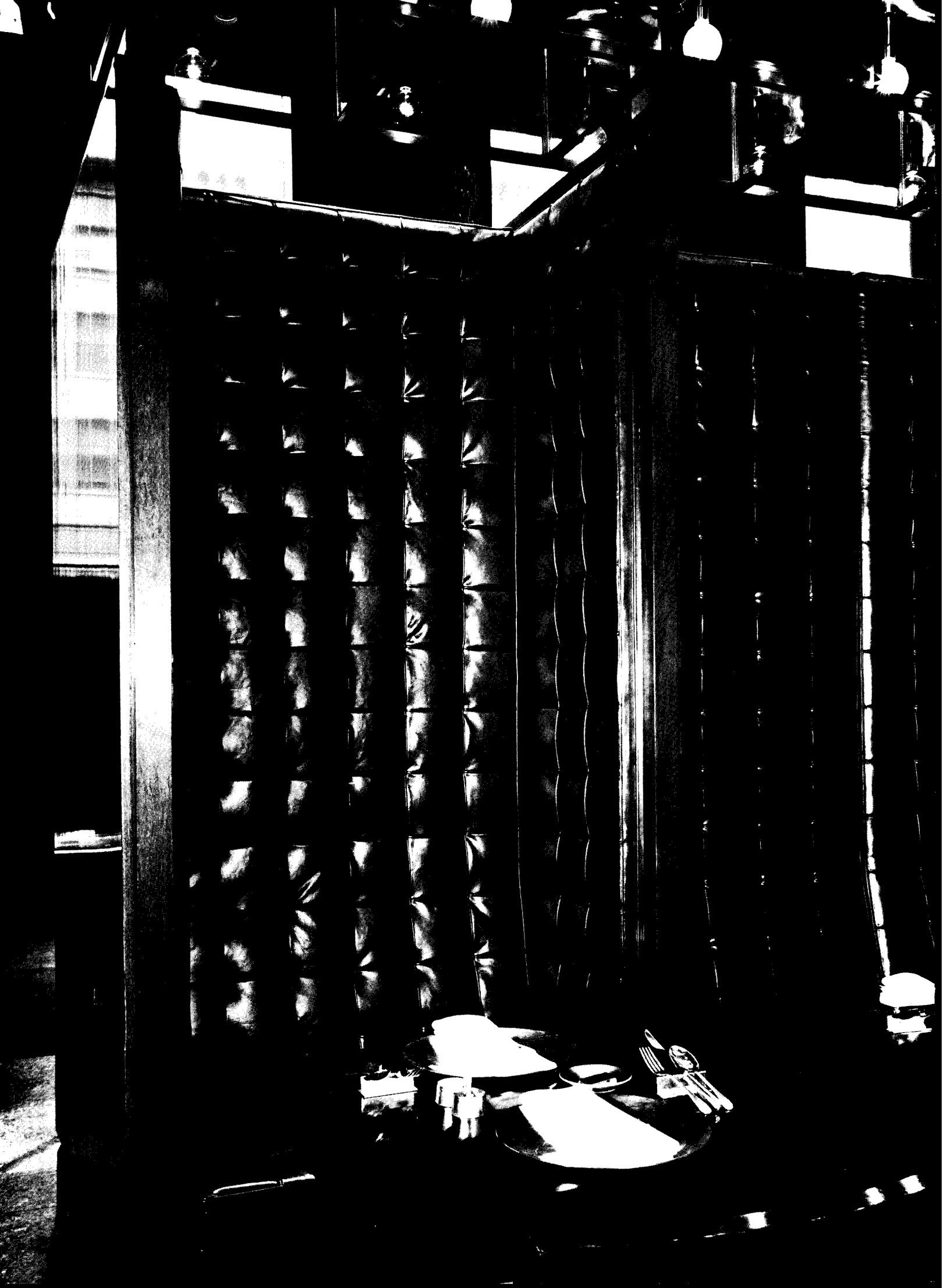

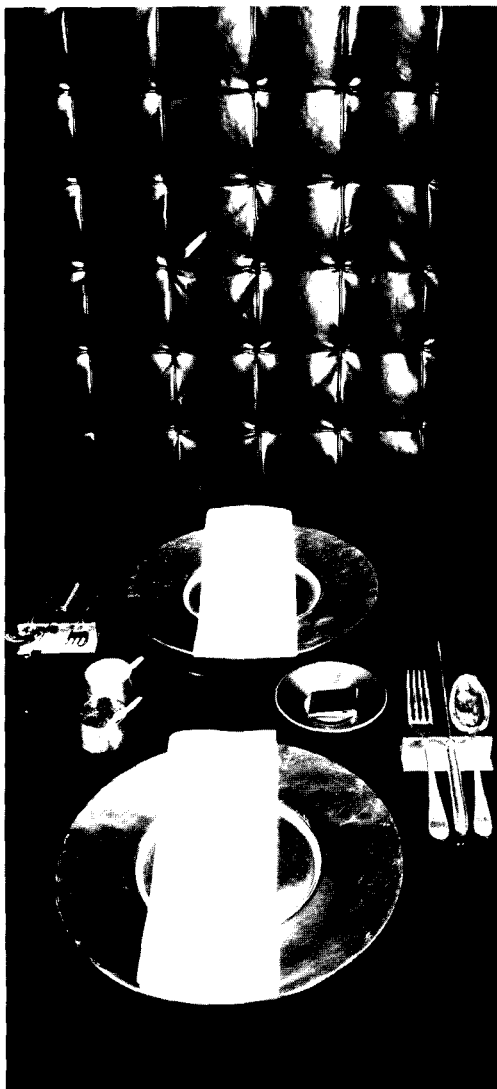
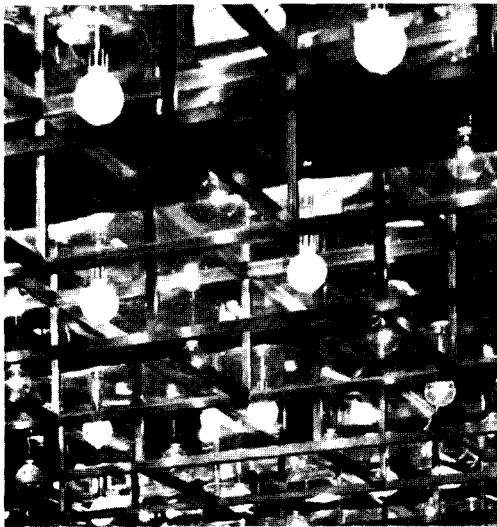
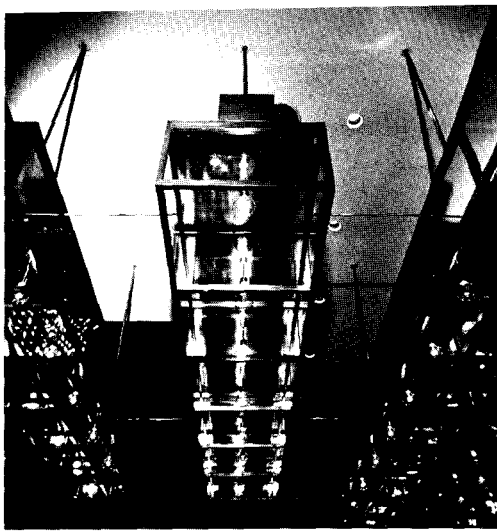

ALL PHOTOS: LOUIS REENS

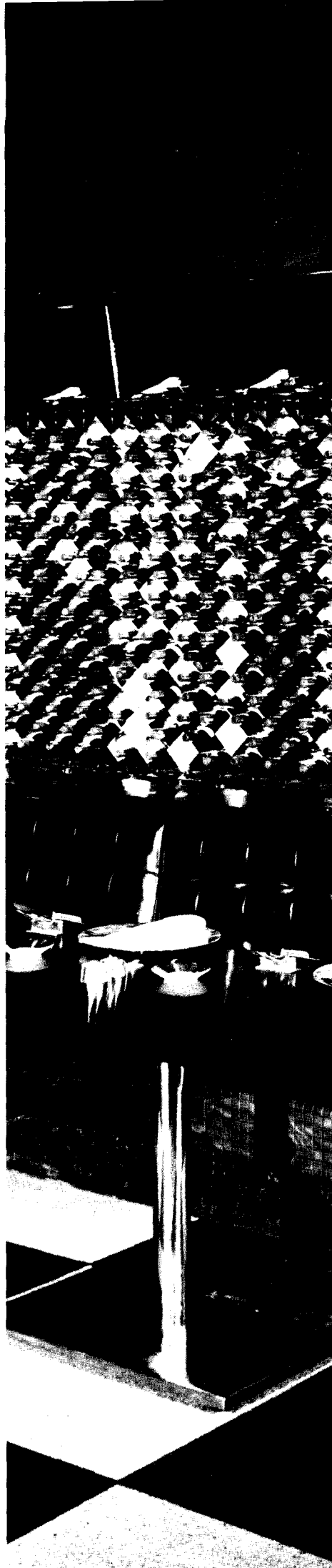

Second is the ingenious, tall booth design that continues the space-saving direction of the in-room kitchen by combining seating and partitioning. These 8'-6"-high upholstered units not only divide the grill room from the bar and the dining room but provide elegant, acoustically protected thrones for diners.

To emphasize the over-all discipline, tabletops are left bare at noon, with splendid silver service plates acting as place mats and silver *portes de couteau* lifting flatware above the mahogany. At dinnertime, creamy Irish linen tablecloths and votive candles atop tall, slender silver candlesticks produce more glamorous settings for entertaining the ladies (who also like the noontime atmosphere).

No matter what hour one dines at The Ground Floor, as the meal progresses the pervading gloom of the pitch-black envelope is gradually dispelled by the flashing of silver, the dazzle of mirror surfaces of polished bronze, glass, steel (like the incised mirrors of Victorian rococo pubs, which Warren Platner visited during the design phase); the glitter in the grill where the cooks' white hats sparkle; the twinkle of the lighting, the glow of the back-lighted, air-cooled wine rack. (Or is the glow from the wine not the design?)

At this writing, the interior still markedly lacks the polished brass-panels proposed as window coverings, which would turn it into a scintillating *galerie des glaces* and further dispel criticism of the somberness.

Finally, however, no matter how much one recognizes the purity and meticulous elegance of the design, no matter how much one recognizes that black velvet is the traditional foil for silver and glassware in shops, a doubt still lingers about whether a powerful black tomb, regardless of its handsome orchestration of textures, can ever be a suitable, psychologically acceptable atmosphere for pleasant dining. A murky eclipse might be appropriate only for a lugubrious *rosé*—if there were such a thing.

**DATA:** Walls: Canadian black granite/thermal stippled, liquid honed/Swenson; flat black tile/American Olean. Floors: same black granite; in grille—alternate squares of white granite/same finish/Rock of Ages Granite Co.; dining room carpeting/red wool/V'Soske. Ceiling: acoustical plaster. Lighting: recessed incandescent downlights/gold anodized reflectors/Century Lighting; suspended grid/mahogany (Honduras throughout), polished bronze, glass/architect-design; exposed filament bulbs/Dirilite. Built-ins: mahogany/John Langenbacker. Built-in Seating: mahogany; cowhide/American Leather Co., red wool upholstery/Sealamandre/Fourmen. Tables: bases/polished bronze/Chicago Hardware Foundry; tops/epoxy-finished mahogany/James Clark Assoc. Chairs: mahogany/architect-design/Lehigh; black-brown upholstery/Jack Lenor Larsen. Hollow Ware: International Silver Co. Table Service: architect-design/Minners & Co. Kitchen: Curtis Kitchen Co. Uniforms: designed by Ben Edwards and Jane Greenwood.





# LIGHT IN THE TEMPLE

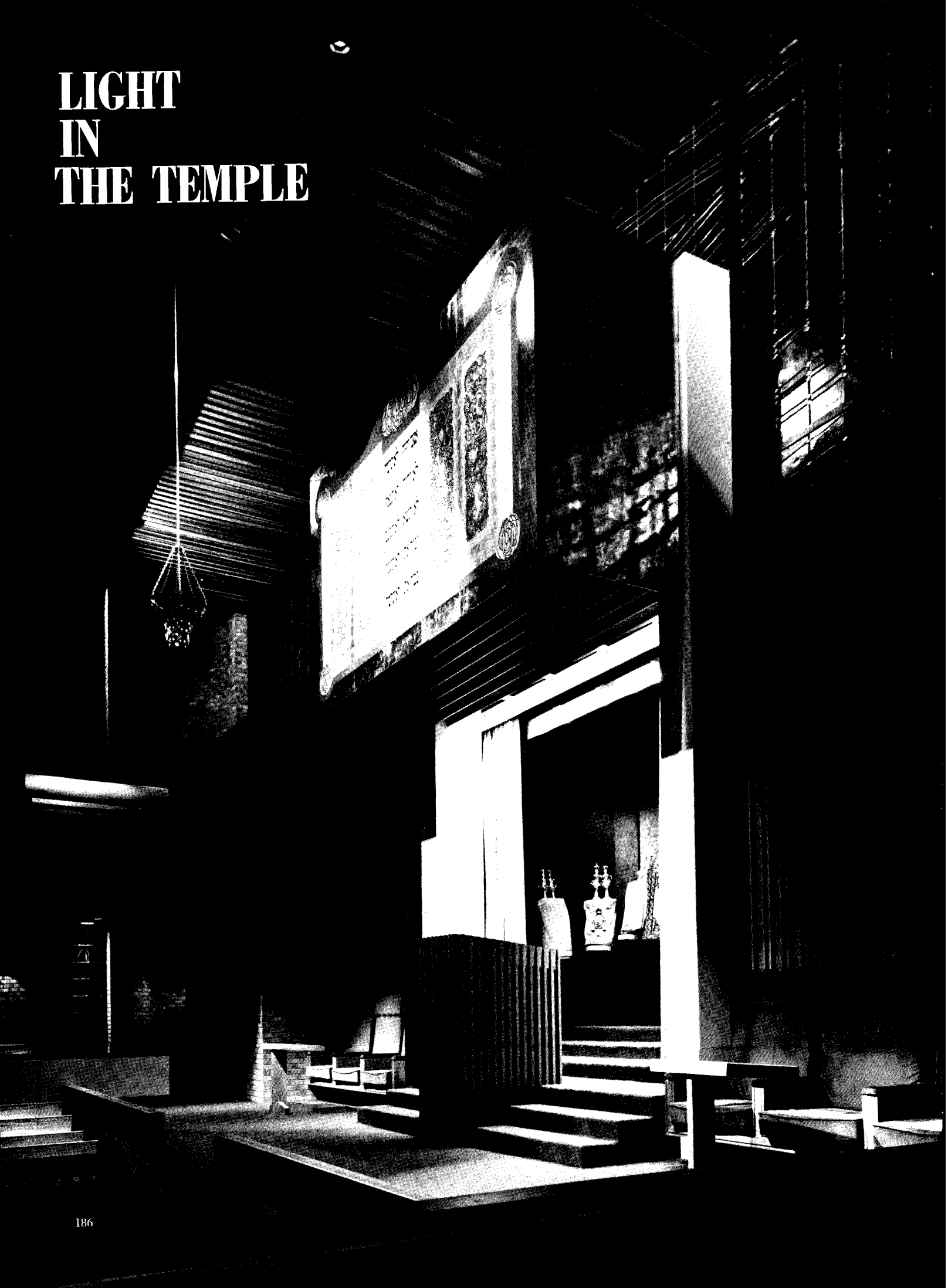

**Lighting designers, like good news reporters, should not reveal their sources. Lights concealed in the ceiling of this synagogue illuminate the sanctuary without the congregation being aware of the fixtures.**

Lighting a synagogue requires a different design approach from lighting a church because of the different relationship between minister and congregation in the two religions. In a church, the minister preaches *to* the congregation, and for this the lighting is focussed on the altar. The seating area of a church sanctuary receives nominal illumination. In a synagogue, however, the rabbi and congregation are more mutually involved, and the sanctuary can be more evenly lighted, except for highlights on the tables from which the rabbi and cantor conduct the service.

Thus, with less subtle lighting requirements, the program for the Congregation Agudath Sholom at Stamford, Conn. (see page 154), simply called for lighting a well-proportioned space. This was achieved with an uncommon degree of success, since the architect and lighting consultant believe that a golden rule for good lighting is not to reveal the sources.

A whole system of downlighting is concealed in the 65' x 75' sanctuary ceiling hung from long-span steel joists supporting the roof deck. The suspended ceiling consists of transverse rows of slatted hardwood panels extending across the sanctuary and spanning 7'-8" from front to back. A 2-ft space separates each row of panels. These spaces remain inconspicuous, however, since the long-span joists and the soffit of the roof deck are painted black.

A row of 10 floodlamps is mounted in each of the six 2-ft spaces between ceiling panels; additional lights pierce the panels at the sides of the sanctuary. All floodlamps are equipped with specular finished black parabolic reflectors to reduce the direct glare when viewed from the floor. The two lamps in the center of the room are 150-w PAR cool beam reflectors; these are flanked by single 200-w PAR floodlamps with an elliptical beam pattern turned in the direction of the room's long axis.

Beyond these lamps, the lighting layout changes due to the balconies that are located on each side of the sanctuary. Since people in the balcony would be uncomfortably close to the large ceiling lights, the consultant called for 75-w PAR floodlamps. To spread the low-

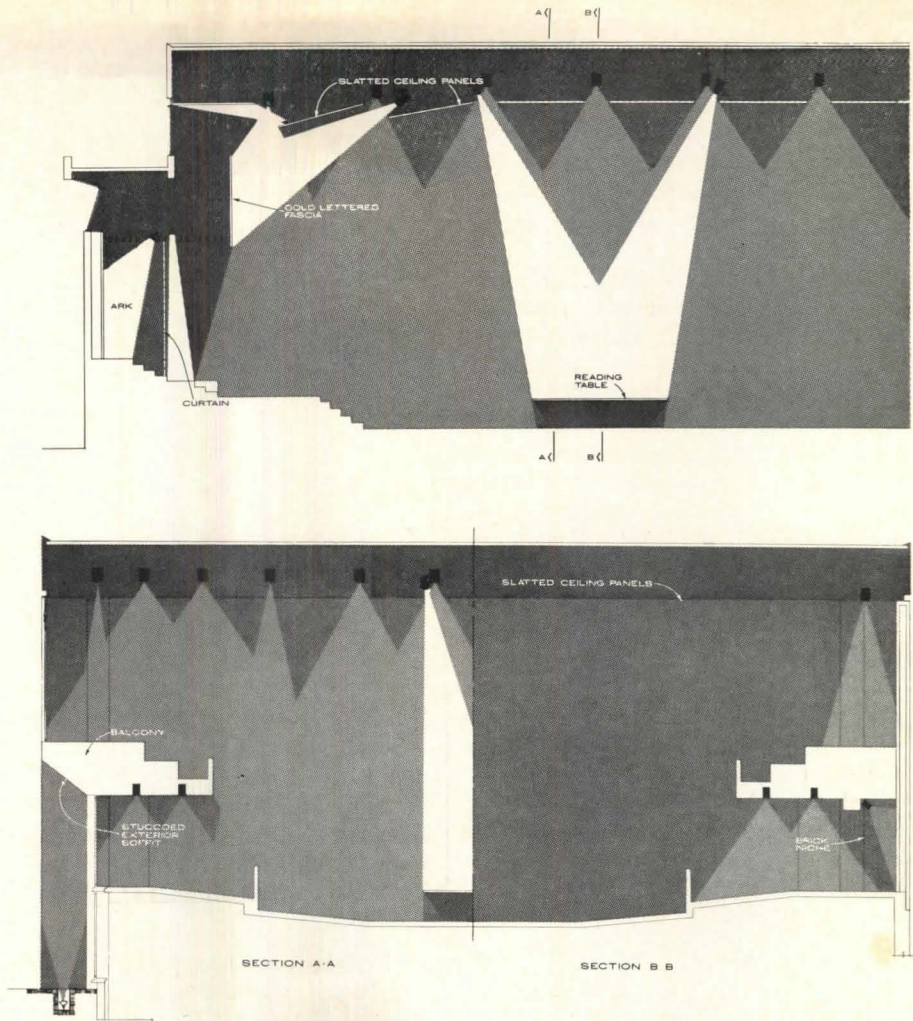

wattage lighting more evenly, two more lamps pierce each suspended panel over the balcony. Finally, at the end of each row of lights, a narrow spot, 200-w lamp with a spread roundel, washes light down the brick jambs on each side of 3-ft-wide windows.

These brick jambs are located in a series of brick piers that support the roof joists and form niches along the two side walls. At the rear of the balconies, the architect pierced the brick piers with door-size openings to form an aisle. A faint splash of light from 150-w PAR spotlamps softens the square-cut head of these openings. These lamps pierce the ceiling panels in a manner similar to the 75-w downlights.

Downlights in the sanctuary ceiling give 25 ft-c illumination at floor level—10 more than the recommended intensity. A good reading illumination is necessary because the synagogue serves an Orthodox congregation, which tends to consist of older persons who would have difficulty following their prayer books in a weak light.

To highlight two areas featured in the liturgy, the designers installed spotlights in the spaces between ceiling panels to

focus on a reading table in the middle of the room's center aisle, and on the ark at the front of the sanctuary.

All spotlights are objective-lens projector units—10-in. dia. and 20 in. deep—with lamps ranging between 500 and 750-w. Some are equipped with an iris; the others have rectangular shutters to adjust the size of the projected light pattern. Four spotlights in a ceiling row shine on the reading table, called a bema, in the center of the sanctuary. In another row between ceiling panels, two lamps aim at a second bema in front of the ark, two at the gold fascia above the ark, and two at each group of three chairs located each side of the ark.

The ark encloses the scrolls, which are the only religious objects permanently in the sanctuary. However, through most of the service, these scrolls remain out of direct sight of the congregation. Each of ten cylindrical scrolls, which stand in front of a velvet-lined wall, is covered with velvet decorated with silverwork.

The beauty of the interior of the ark is discreetly hinted at by covering the front of the ark with semi-sheer curtains, which act as a stage scrim, and

by flooding both sides of the curtain with light. This is done with seven 150-w PAR floodlamps in swivel sockets on an exposed raceway in front of and back of the curtain. A stained wood louver conceals the raceway from the congregation and eliminates the glare from the lamps.

Exterior lighting is simple. Lights set 12 in. below the grade slab shine upward in front of the narrow windows between the brick niches. At balcony level, where the exterior wall changes shape and texture, large dark glass windows form a flat façade between small brick piers. The transition between the two levels is marked by spandrel beams with white stucco splayed soffits sloping down to the heads of the lower windows. The lights in the grade slab illuminate these sloping surfaces and graze the brick piers.

The stained-glass window above the ark is also illuminated at night. Five quartz-iodine spotlights in the ceiling of the sanctuary bounce light off a ceiling panel onto the interior surface of the window. The ceiling panel that deflects the light is sloped toward the window to improve the acoustics of the room.

# COMING SOON: FULLY AUTOMATED CLIMATE

## **Computers hooked onto electronic controls will soon run air-conditioning and heating systems in large buildings.**

Within the next two years, computers will be able to completely run the mechanical and electrical systems of large buildings. At present, computers collect and analyze information from air-conditioning and heating systems, but an operator takes the necessary action to control the system.

Although the new equipment will add considerably to the initial cost of a building, the automated central control is expected to decrease the cost of operating a building's mechanical equipment. Not only will manpower be reduced, but fuel for heating and cooling a building will be used more economically because the computer can regulate the furnace or chiller to suit the outside temperature.

For example, a double-duct system usually maintains the hot deck at about 100 F and the cold deck at about 55 F, without regard for the outdoor conditions, since building operators do not have time to check the outdoor temperature frequently. The chiller therefore supplies extremely cold water in case a heat wave arrives, and at the same time the furnace labors in anticipation of a cold snap. However, a computer would continually check outdoor weather and correct the mechanical system to meet the building requirements. The computer may find that, instead of 55 F cold air, the system can manage with the cold

deck at 60 F. Similarly, the hot air could be reduced to 80 F instead of 100 F. By narrowing the spread between hot- and cold-deck temperatures, the computer would ensure comfort for less operating costs.

Not all buildings can justify the costs of running a completely computer-operated control system, but the more modest central controls are widely used. Five control manufacturing companies have installed over 4000 centralized controls, since the first were installed in the White House in 1951 by Honeywell, Inc.

Two types of controls are available: electronic and pneumatic. Both do the same job of bringing information and control from remote points of a building or complex to one man at a control point, but the methods they employ differ significantly.

An electronic system gives more accurate control than a pneumatic system, is faster, and allows one circuit to serve several inspection points. This is called multiplexing. Electronic systems, however, are also more expensive than pneumatic controls, except on large jobs. The extra cost arises because, although electronic thermostats and sensors are cheaper than their pneumatic counterparts, they cost more to wire back to the main panel. And electronic valves and dampers are not only more expensive to wire, they also cost more than pneumatic valves and dampers.

On an average job, installing centralized controls for an electronic system may cost 10 per cent or more than a

*Architect: Davis, Brody & Associates of New York. Lighting Consultant: Sylvan R. Shemitz & Associates, West Haven, Conn.*



comparable pneumatic installation. As the job gets larger, however, this differential is shaved substantially, until electronic control actually costs less than pneumatic.

Pneumatic valves and dampers are less expensive, last longer, and give greater power and capacity for less money. Pneumatic control is not as sensitive or as accurate as electronic control, however. And, on a large installation, there maybe a time lag with pneumatic control. With pneumatic runs of 500 ft or more, the time lag significantly interferes with good control.

However, there are site considerations that dictate electronic or pneumatic control on specific jobs. For example, in an explosive atmosphere where sparks are dangerous, as in a refinery or hospital operating room, pneumatic control is completely safe. On the other hand,

where accuracy is of prime importance—as in a research laboratory or in a manufacturing clean room—an electronic control is preferable.

### Keep Panels Manageable

The size of a control console should be limited, so that one operator can read all the instruments. Complicated systems lead to complicated panels, like the panel in Detroit's Cobo Hall that extended 72 ft—an unmanageable length for a centralized control system. To reduce panel sizes, engineers developed a technique for showing schematic diagrams of a building's systems on film strips that can be displayed one at a time instead of having all systems permanently shown on a panel.

Screened schematics tied in with multiplexing enable an operator at a small control console to see what is happen-

ing to a system, touch a button to control or change parts of the system, then return to read the system again. The same buttons operate another system when the film strip is changed to show another system's schematic diagram.

Information can swamp an operator unless electronic equipment reads and analyzes the input of data at a centralized control center. The device for this is a logger-scanner. This electronic equipment scans instruments at the control panel, and at intervals logs data on an electric typewriter. If any instruments are off normal, the logger-scanner prints the information in color to bring it to the attention of the operator.

These logger-scanners paralleled the growth of control centers. The first logger-scanners used vacuum tubes and scanned one to three points a second. Later, solid-state devices replaced vacuum tubes, and the speed jumped to 10 points a second. Prices decreased as dramatically as performance increased. Early logger-scanners cost between \$50,000 and \$100,000, but simplified design brought down the cost of a one-point-a-second machine to \$25,000.

Two new systems promise even more dramatic benefits. One is a solid-state unit that checks 15 points a second and costs about \$35,000. Instead of taking 20 minutes to check a thousand-point building complex, this unit could do the job in just over a minute. This particular system requires its own wiring, which raises installation costs substantially because wiring to each sensor duplicates the original hookup.

The other system is a solid-state logger-scanner with remarkable flexibility. This one can scan up to 60 points a second (a 1000-point complex could be checked in 17 seconds), and can program as well as indicate and alarm. Moreover, the system permits high and low alarm points for each setpoint to be individually adjusted. This device costs about \$40,000. Even more important than the speed, however, is that this logger-scanner can be quickly and cheaply converted to a true computer. Adding a drum memory makes the equipment a computer that can check, correlate, and control one or 100 buildings, all operating at optimum efficiency.

This brings the concept of a completely computer-controlled building within sight. Such a system would run all the mechanical equipment in a building complex, making constant checks and corrections, turn equipment off and on as needed, switch malfunctioning units off and turn on stand-bys.

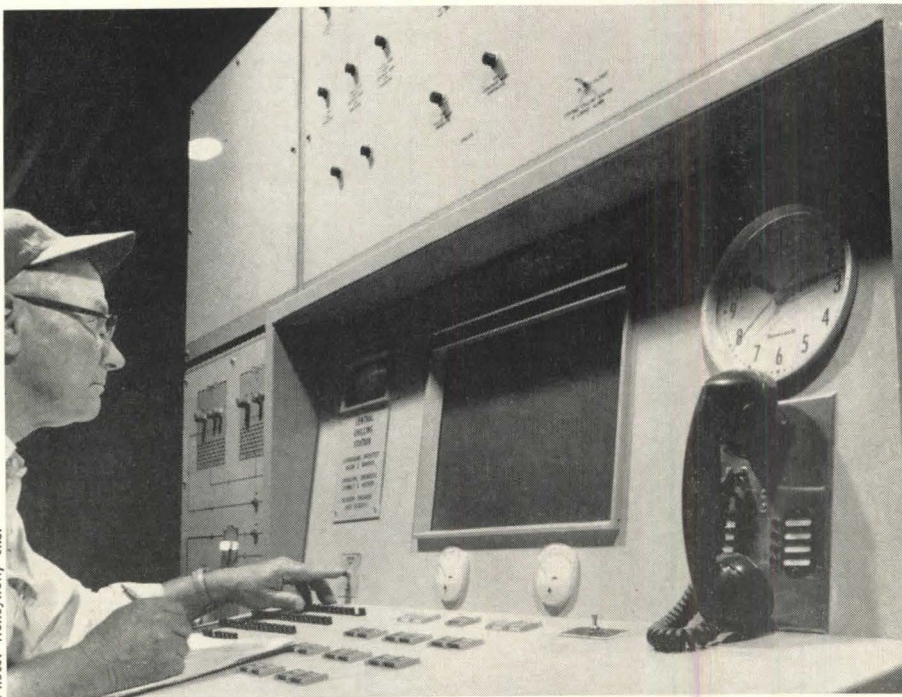

Photo: Honeywell, Inc.

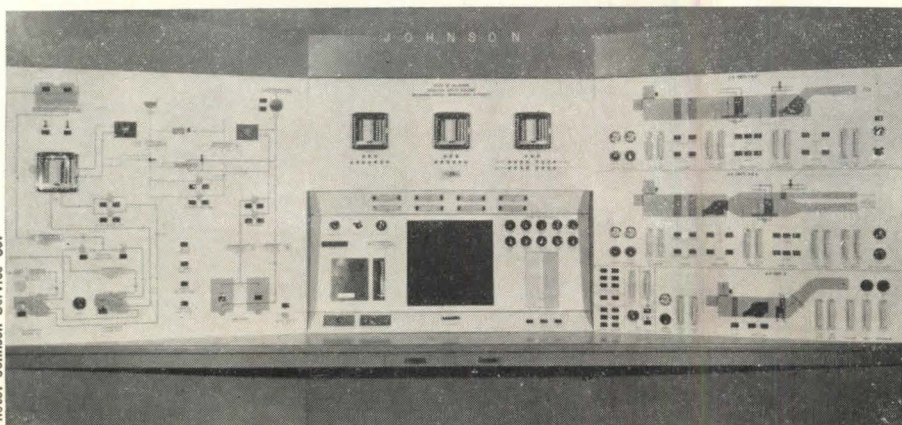

Photo: Johnson Service Co.

# CURVED BEAMS SUPPORT REPEATED ROOF SLABS

**Five prestressed concrete slabs, each supported on two columns spaced 150 ft apart, enclose air terminal.**

Long concrete beams curve gracefully in horizontal arcs between columns supporting five large roof slabs over a new terminal building at the Detroit Municipal Airport. The intersecting arcs create a geometric pattern on an exposed ceiling, and also enable designers to support each 232' x 70' slab on only two columns instead of the conventional four.

Smith, Hinchman & Grylls Associates, Inc., Detroit architects-engineers, designed the roof slabs as separate units so that, if the terminal has to be enlarged, more independent units can easily be added to the ends of the building.

Now nearing completion, the terminal building consists of five panels that, with a 5-ft-wide glass light between them, roof the 232' x 370' structure.

Columns supporting each roof panel are spaced 150 ft apart on the centerline of the 70-ft-wide slabs. The main, arced beams intersect at the columns and cantilever beyond to the corners of the slabs. In addition, straight, transverse beams centered at each column extend to the edge of the slabs where the curved beams are least effective (see plan).

Both transverse and arced beams vary in width and depth. Arced beams widen from 18 in. at midspan to 54 in. at the columns, then taper to 24 in. wide at the cantilevered ends. The cantilevered sections of the arced beams are the same dimensions as the cantilevered transverse beams. All are 54" x 88" deep at the column and 24" x 46" deep at the edge of the slab. Between columns, the arced beam remains 88 in. deep.

To enhance the appearance and further stiffen the large roof slabs, the designers called for 14-in.-wide by 7-ft-deep upstand edge beams. The slab enclosed

Photo: James A. Fox

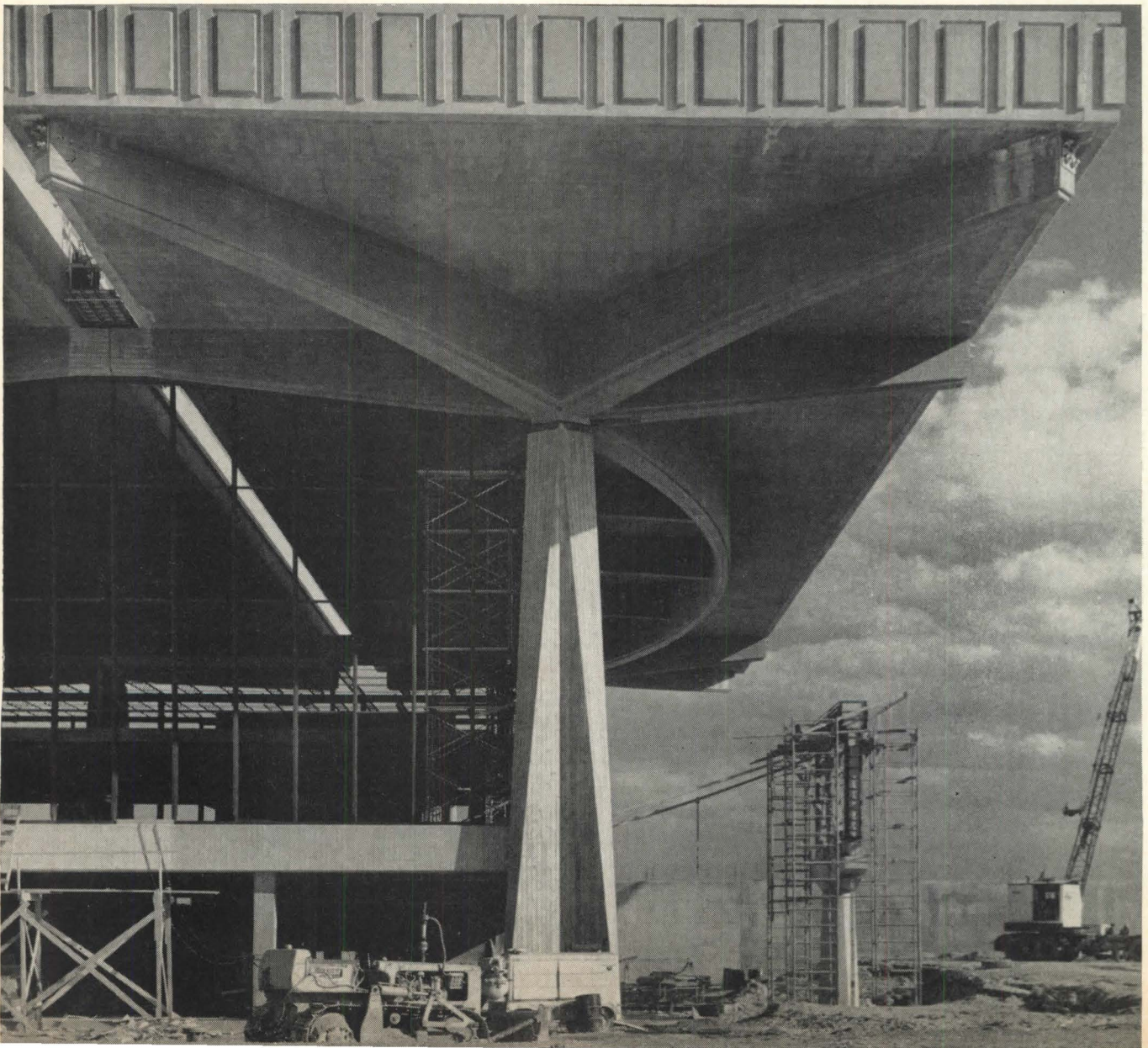

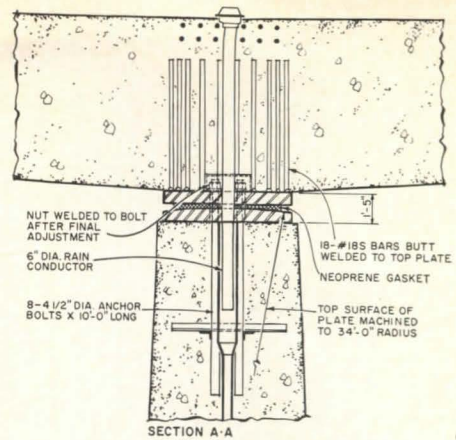
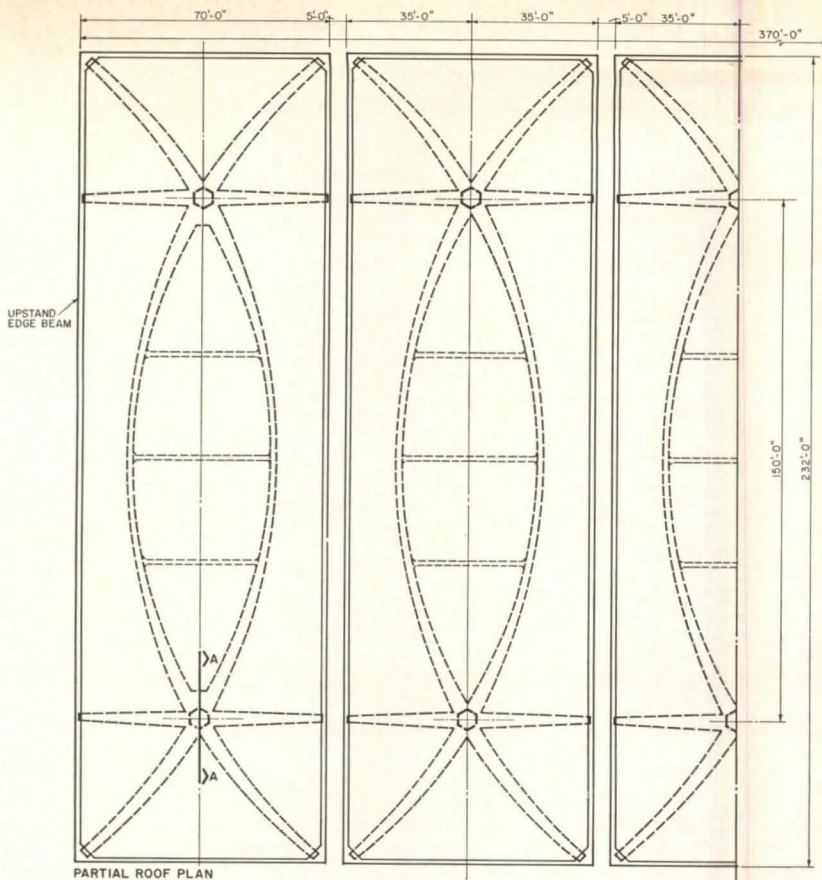

by the edge beams varies in thickness from 9 in. at the perimeter to 6 in. at the column heads, where rainwater conductors are embedded in the columns.

The slabs and the supporting beams were both prestressed, but with different techniques. Slabs were prestressed with unbonded tendons, and beam tendons were bonded with grout. The engineers specified that slab prestressing tendons should be greased, coated with nonhardening mastic, and spirally wrapped with at least two layers of sisal-kraft paper.

Beam tendons, however, were bonded. Stressing tendons were threaded through flexible metal conduits, and after applying the full stressing force, the contractor injected grout into the conduits. Unbonded tendons were called for in the slabs because they are cheaper than bonded tendons. But unbonded, paper-wrapped tendons are impractical in a member as large as the beams, because of the increased chances of tearing the wrapper that minimizes friction between the steel and concrete. Where the wrapping tears, the steel will bond to the concrete. To avoid this condition, the engineers called for the slightly more expensive fully bonded tendons for prestressing the beams.

In designing the prestressed concrete structure, the engineers used the load-balancing concept developed by T. Y. Lin, who served as consultant for the

roof structure. Load balancing is achieved by horizontally compressing a beam or slab with enough force to counteract the gravity loads acting on the member. Prestressing forces subject the beams or slabs to an axial compression that prevents them deflecting from the vertical loads.

In practice, the actual deflection of the Detroit roof panel was extremely small. After the whole roof structure had been prestressed, the architect told the contractor to "lower the forms 2 in. and sit tight for 24 hours." The jest was overly cautious, because the roof deflected only  $\frac{3}{4}$  in. in its 150-ft span.

On each roof panel, the contractor installed a conveyor system to distribute concrete from two cranes to all parts of the roof. With this equipment, workmen could cast 80 cu yd of concrete in an hour, and completed a 900-cu-yd slab and beams in 12 hours. Then the contractor followed this schedule:

- When the slab concrete attained 3500 psi, applied stressing forces to slab.
- Cast upstand perimeter beams.
- When these edge beams reached 3500 psi, applied half prestressing forces.
- Prestressed transverse beams when concrete attained 5000 psi.
- Prestressed curved beams at 5000-psi concrete strength.
- Completed stressing the upstand beams when concrete attained 5000 psi.

### Star-Shaped Columns

To avoid a large, square column to carry the 1100-ton dead load at each roof support, the architect designed star-shaped columns that remain exposed inside the terminal building. At the soffit of the beams, the columns are hexagonal and measure 5'-6" across the flats. The geometry changes below the roof and the columns flare out to a four-pointed star, which at floor level is contained in a 10-ft square.

Because the curved beams span 150 ft between columns, provision is made for the roof to move with temperature changes or deflection under live loads. At one column of each roof panel, the concrete beams are firmly anchored to the column with eight 10-ft long anchor bolts extending through two  $8\frac{1}{2}$ -in.-thick steel bearing plates. At the other end of each roof panel, a lubrite pad inserted between the two bearing plates lowers the frictional resistance to movement between the beams and column. In addition, the top surface of the lower bearing plate is curved to permit the roof panel to rotate sideways, and slots in the steel bearing plates will allow the roof to elongate longitudinally.

General contractor for the terminal building is a joint venture of A. J. Etkin Construction Co., and Paul Hardeman, Inc. Conesco Mid Continent, Inc., is the prestressing subcontractor.

# GOOD ROOM PROPORTIONS IMPROVE ACOUSTICS

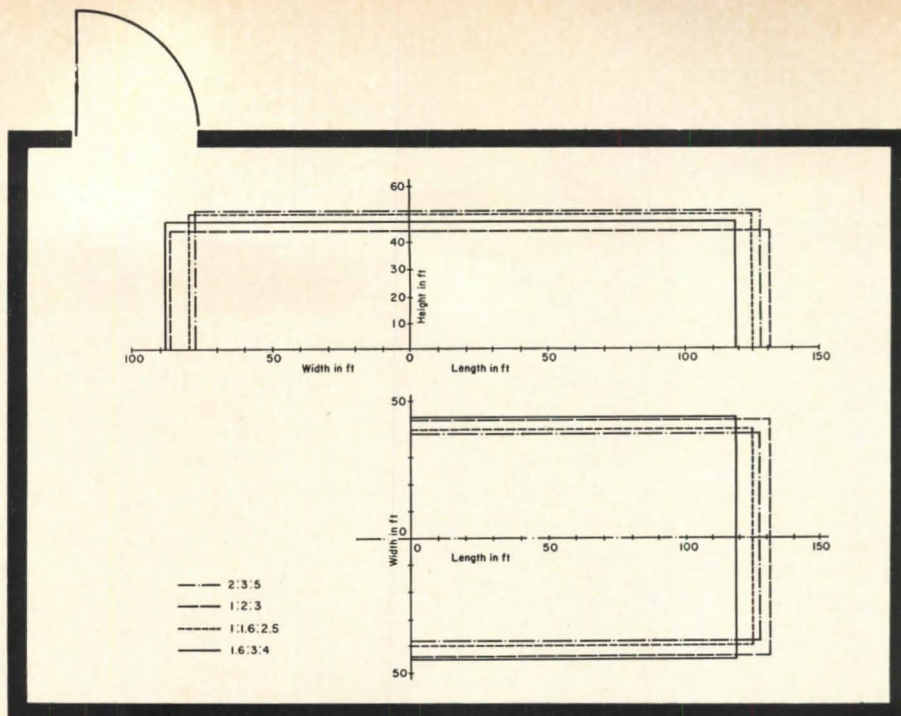

Motion picture theater	1,000 to 2,000 persons	125 to 175 cu ft per person
Auditorium	1,000 to 3,000 persons	150 to 300 cu ft per person
Music rooms	1,000 to 3,000 persons	150 to 300 cu ft per person
Recording studios	10 to 100 instruments	2,750 cu ft per person

with parallel floor and ceiling. Instead, side walls should be slightly angled, and floor and ceiling should slope. For this condition, with an auditorium of between 10,000 and 500,000 cu ft, the preferred ratio of a room's mean height, width, and length is:

$$\begin{aligned}
 &1 : 2 : 3 \\
 &1.6 : 3 : 4 \\
 &1 : 1.6 : 2.5 \\
 &2 : 3 : 5
 \end{aligned}$$

Although these proportions appear to vary widely, the apparent difference diminishes when each ratio is rewritten for a volume of six cubic units.

$$\begin{aligned}
 &1 : 2 : 3 \\
 &1.08 : 2.03 : 2.71 \\
 &1.14 : 1.82 : 2.85 \\
 &1.17 : 1.75 : 2.92
 \end{aligned}$$

Four 500,000-cu-ft rooms drawn to these proportions (Fig. 1) differ by a maximum of 17 per cent in height, 16 per cent in width and 10 per cent in length. The 1.6 : 3 : 4 ratio produces a room with a low ceiling, which reduces the construction cost, and a short length, which improves hearing for an audience.

There are, of course, no optimal ratios for the mean dimensions of a hall or auditorium. The size and shape of a room should be dictated primarily by

its purpose. Thus, if a balcony would improve the sightlines for a large part of an audience, by all means put in a balcony, even if the ceiling height exceeds the height given by any of the previous ratios. An experienced acoustical consultant, given some freedom in the shaping of the ceiling contour and the type of acoustic treatment of the interior, will almost always be able to provide satisfactory hearing conditions.

By the same token, there are also no acoustically optimal ratios for the slant of the side walls, floor, or ceiling. The minimum slant, however, should be about 1 ft in 20 ft. If the slope is less, echoes will flutter between reflective walls. Making the side walls diverge 1 ft in 10 ft satisfactorily directs reflected sound toward the rear of the room. This tapered plan prevents sound from criss-crossing between opposite side walls before reaching the rear wall.

Before applying proportions, the designer must first establish the volume of the room. The amount of space for each occupant varies with the purpose of the room. Typical volume requirements for four types of enclosures are shown in Fig. 2.

## The Ideal Curve

If a circular auditorium roof is domed, a ceiling curvature should be chosen

**Because the ratio of room dimensions affects hearing conditions in auditoriums, the author recommends good proportions for auditoriums, heights for domed rooms, and optimum curvature for a domed ceiling.**

By Michael Rettinger, an acoustics consultant based in Encino, Calif.

Good room proportions please the eye, but the best proportions can also delight the ear. For optimum listening conditions in an auditorium, acoustic specialists recommend one of four sets of proportions. These advisers cannot agree among themselves on which set gives the ideal result, but they concur that a room should not be rectangular in plan

that meets acoustic requirements. When the source of sound is located in the center of the room, the ceiling radius should be at least twice—and, preferably, from four to six times—the ceiling height, in order to avoid sound concentrations within the room. If the radius is more than twice the height, the sound reflected from the center of the room will diverge to the sides where the audience sits. If the radius is exactly twice the ceiling height, sound will be bounced from the ceiling in downward parallel beams. This is undesirable, since noise from the audience will be focused upon the stage.

Ceiling height can be reduced by increasing its radius, yet without reducing the volume of a room. Fig. 3 shows formulas for computing constants, and illustrates ceiling heights as a function of room volume for various ratios of ceiling height to radius. For a given room volume, the graph indicates that when R is large, h is small, and vice versa.

For example, from Fig. 3, the dimensions of a 4000-seat theater with a curved ceiling can be computed thus: Assuming the radius of ceiling curvature is four times the ceiling height (a=4), the

volume is arrived at by multiplying the number of seats (4000) by the cu ft volume required for one person (175), which equals 700,000 cu ft. The graph indicates a height of 39 ft, which, applied to the formula for the diameter D, gives a dimension of 204 ft.

The Circle Star Theater, in San Carlos, Calif., was planned in this manner, with good acoustical results. In the final design, however, the curved ceiling did not rise from the floor, but sprang from atop a 10-ft-high, acoustically treated brick wall that provided space for a 10-ft-wide peripheral corridor.

In dome construction, where the radius is often less than twice the ceiling height, undesirable sound concentrations will occur under the dome. This frequently happens with geodesic domes, which often are hemispheres. To ameliorate the focused echo effects without installing "clouds," the designer has to specify a highly sound-absorbent treatment for the underside of the dome. With metal-framed structures, the treatment effectively dampens the large diamond-shaped panels enclosing a geodesic dome, and in addition increases

both the sound and heat insulation of the building. However, in these structures, it generally is not possible to create the relatively long reverberation periods with which other buildings of equal volume improve the sound of music.

Another way to improve the acoustics of a room with a curved roof is to suspend ceiling panels, called "clouds," to level off the ceiling. Clouds can be designed to reflect or absorb sound; in either case, they tend to be frequency-discriminatory, so their function is really an acoustic compromise.

Flat, reflective clouds suspended over an orchestra reflect the high notes but let the low notes pass through, thus tending to lower the reinforcement of the bass notes. In the interval between the high and low notes, complex resonant effects occur that may either accentuate or attenuate a narrow frequency band. Sound-absorbent clouds generally tend to absorb the higher registers more readily than the lower ones, thus lending to music a flat or dull character.

Clouds should not be confused with shaped ceilings, such as the relatively low, slanting, and corrugated ceilings over indoor or outdoor orchestras. These surfaces are installed as one unit, and are continuous even though they may be irregular in contour. A cloud, on the other hand, always floats in space, suspended from a higher part of a continuous ceiling.

Clouds can be used to great advantage in geodesic domes. The suspended ceiling segments not only avoid the negative effects of sound concentrations, but can also support lights and loudspeakers for stereophonic wind, thunder, and other sound effects. Reproducing these effects from overhead is often more realistic than projecting them from the side and rear walls. If there should be an attenuation or accentuation of low or high frequencies in the reproduced sound due to the clouds, a slight adjustment in the frequency response of the loudspeaker amplifiers can very often achieve the desired tonal balance. These ceiling segments can provide a dramatic architectural impression when they are hung so as to give spectators a good view of the high vault overhead.

In practice, architects and acoustic engineers will have to strive for a satisfactory compromise between desired architectural features and good hearing conditions in a room. The science of architectural acoustics has established principles of room design that cannot be violated without undesirable results.

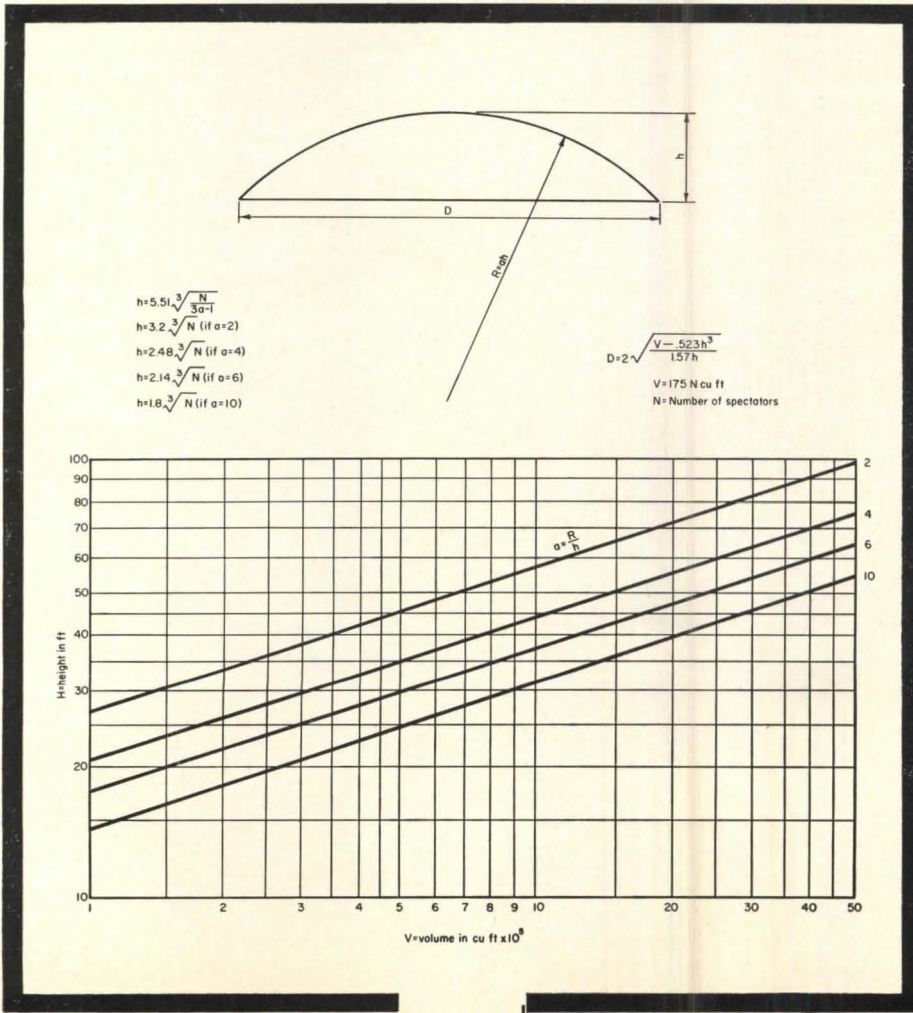

# **MIES AT 80**

---



We extol our great men, pin medals and ribbons on them, then generally misinterpret their lessons and through avarice, sloth, vanity, or just plain noncomprehension, sully the gold of their teachings, turning out second-hand counterfeits. This happened to Wright, whose followers have yet to produce buildings of lasting significance. It is happening now to Le Corbusier, whose lessons of form and light are currently being remolded into their own images by lesser men.

Even the most unambiguous of the traditional three modern "greats," Mies van der Rohe, has suffered this indignity in the frightful proliferation of machine-made, catalog-inspired speculative office buildings and apartments throughout the United States. Mies's approach, however, if too amenable to second-rate imitation, is also the most successfully translated of the three into top-notch industrialized architecture, as the consistently high-caliber production of such a firm as Skidmore, Owings & Merrill testifies.

Mies's single-mindedness through the years has been, of course, a marvel to all. To some, including this observer, it has been a sometime irritant: "Why is he putting those same damn slabs up again?" It cannot be denied, however, that this very granitic, unswerving character has become a much-needed reference point, the North Pole of the fashion-minded, capricious post-World War II architectural world.

As he celebrates his 80th birthday this month, we therefore send Mies our respectful felicitations for many another fine cigar and frosty Martini, many another sublime detail.—JTB

*Top: Friedrichstrasse Office Building, Berlin, project, 1919. Bottom: Bacardi Office Building (detail), Santiago de Cuba, project, 1957.*

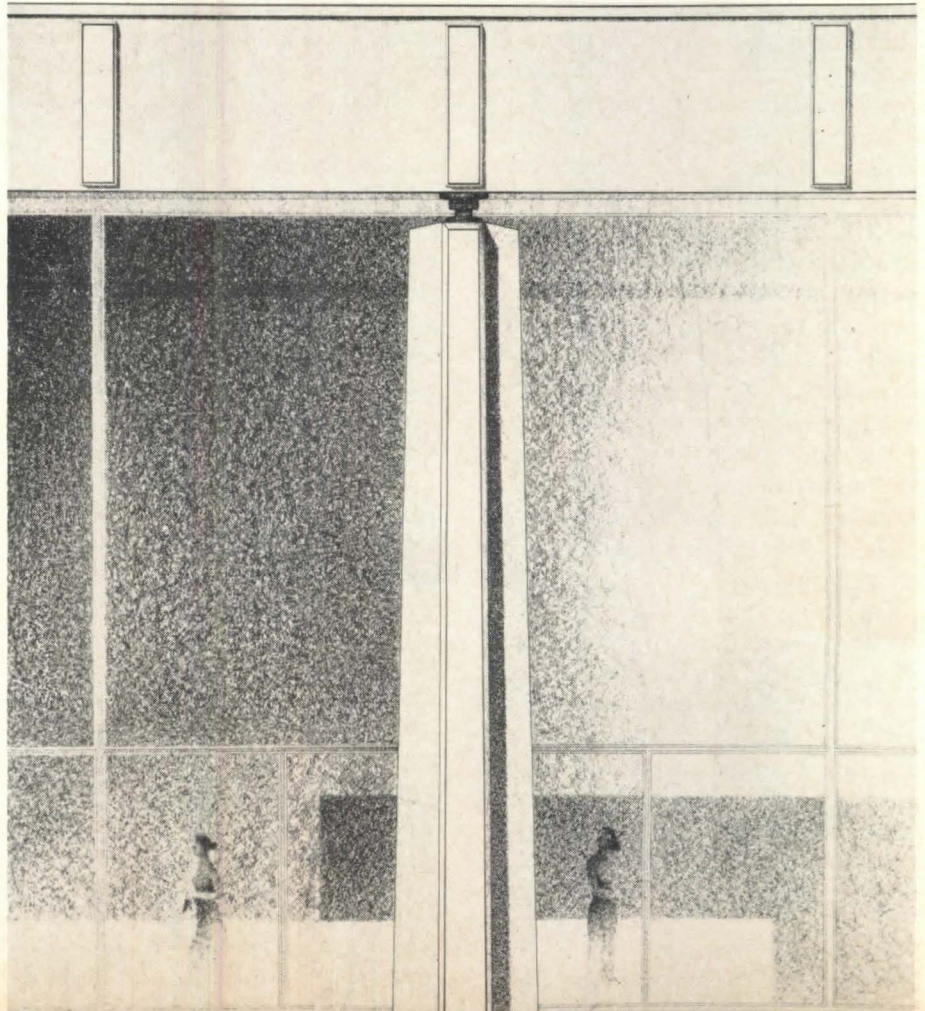
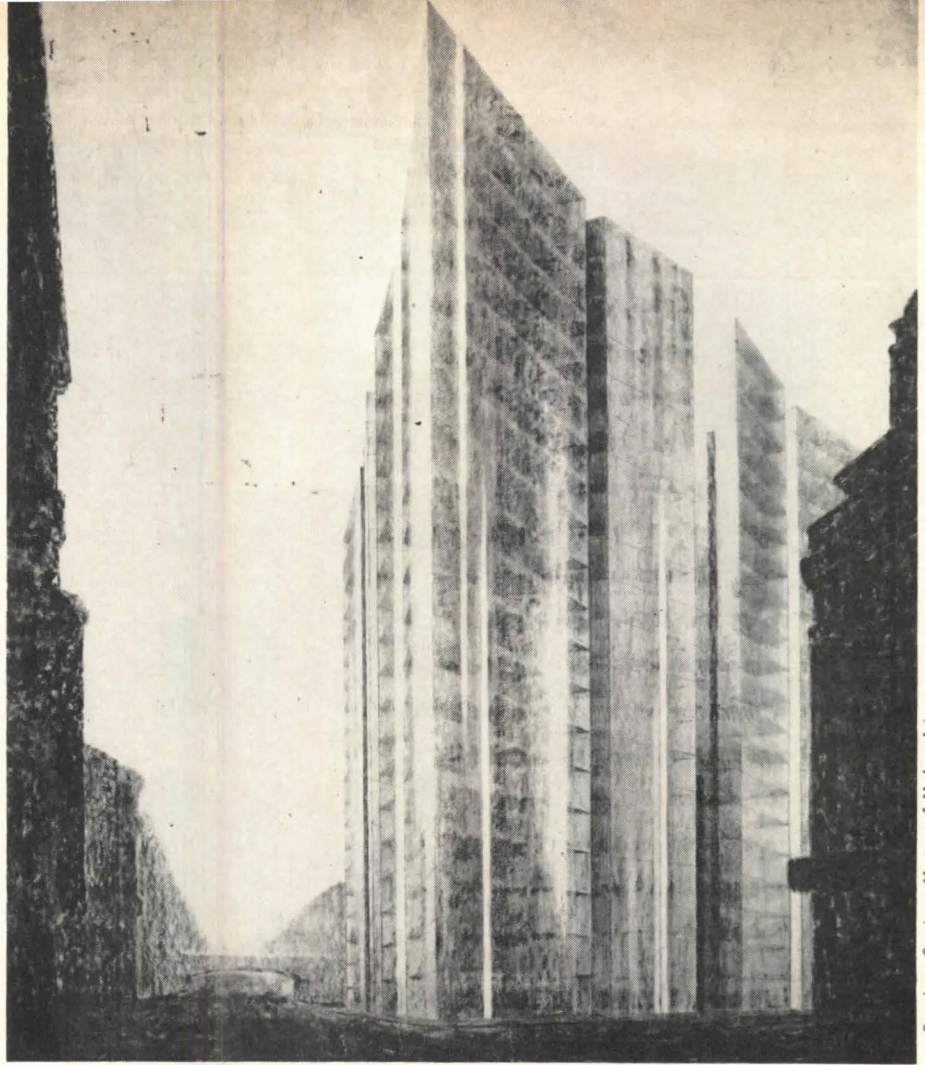

# PARKS ARE NOT FOR PLANNERS



Photos: M. Paul Friedberg

Bedford Stuyvesant is a prosaic name for a not too prosaic section of Brooklyn, New York. It is an area encompassing roughly 450 blocks, 400,000 people, 450 abandoned buildings, 378 vacant lots, and a history of racial violence. In a city where 70 per cent of the park facilities have been built for 20 per cent of the population, where schoolyards are uninviting and often inaccessible, derelict buildings and lots have become the wonderland of the underprivileged child because there is no other place to go. Planners, politicians, and parents have been wrong. Until recently, they have thought "parks" meant acres of green, bridle paths, men selling balloons, and swans on lakes. But in an urban area today, such parks belong to the past. They will not be built again. Increased population and land values will not allow for large-scale park development within the city. And so, lacking land, recreation has gone indoors to boys' clubs and YMCA's, or to schools

where it is called "group activity period" and graded like arithmetic. For outdoor play, the yardless city child has only the streets, the abandoned and broken-down buildings, and the vacant lots.

A few years ago, people began to see these lots as potential playgrounds for children in congested, low-income areas and the phrase "vest pocket park" was born. Lots that once contained nothing except broken beer bottles and rats have been paved for jungle-gyms and swings. Squeezed between existing buildings, these playgrounds have been largely financed and built by outsiders with unimaginative designs and without local community involvement. As such, these parks are not the urban cure-all and end-all some planners would have us believe. Past vest pocket park programs have scattered token lots throughout depressed areas. Such parks have no long-term value to the community they serve.

M. Paul Friedberg, Landscape

Architect, Ronald Shiffman, Director of Pratt Institute's Community Education Program (backed by the Rockefeller Brothers Fund), George M. Raymond, Chairman of Pratt's Planning Department, and the Central Brooklyn Coordinating Council (CBCC) now have built a vest pocket park with a difference.

The initial steps were the usual ones. First, the CBCC collected sufficient funds to lease and insure two back-to-back city owned lots in the Bedford Stuyvesant area. With \$1000 of a \$10,000 grant (the rest went into construction and materials), Pratt purchased a slice of land between the two lots and made the park an out-of-the-ordinary block-through one. Though the space is small, a little over 8000 sq ft, this park, because of its linkage with two blocks, is a more open, viable, and accessible one than the dead-end vest pocket lot.

Construction of the park also took an unusual turn. Instead of being a planner's park, it became a neigh-



borhood venture. Five adult landscape workers from the area who were idle during the winter months were hired for the heavy construction work. Children of all ages came to shovel sand, paint, sweep, run errands, and in general be the working sidewalk superintendants of this rough and ready park. From the very start, the park belonged to the children.

The equipment for the play area is sturdy, permissive, and easily maintained (answering the constant complaint of those who think only in terms of asphalt and chain-link fencing). With the exception of the slide, no manufactured equipment was used. Stumps of two dead trees

left on the lot became supports for a tree house and fire station. Used wood was transformed into sandboxes, seats, see-saws, an amphitheater, jumping blocks, and friendly dragons. Improvisation was such that excessive fencing put up by the city was torn down and the poles were used for bars to hang from, swing on, or jump over. Under the watchful eye of the neighborhood children, Pratt art students painted colorful murals on the walls. Since the work was light, the design uncomplicated, and the volunteers many, the park was finished in a month.

No one will claim that it is a picture-book park. "It was a junk-

pile before we started and a painted junkpile when we finished," says Friedberg. But it fits and it works. When the park was dedicated on January 9 of this year, temperatures dropped to 14 F, yet close to 100 neighborhood children and adults were on hand. The fun of work was finished, the fun of play about to begin.

The real significance of these 8000 sq ft of park is not so much what it offers the children who built, enjoy, and maintain it, but rather what it *could* mean for the whole area. Using the same theory of empty lots and buildings working for neighborhood improvement, Ronald Shiffman and Paul Friedberg

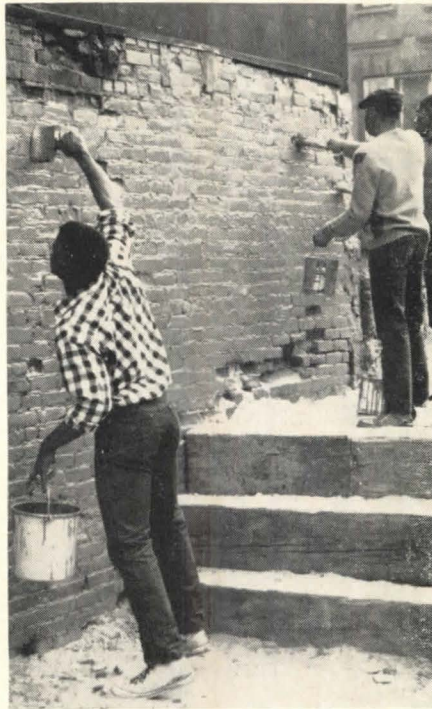
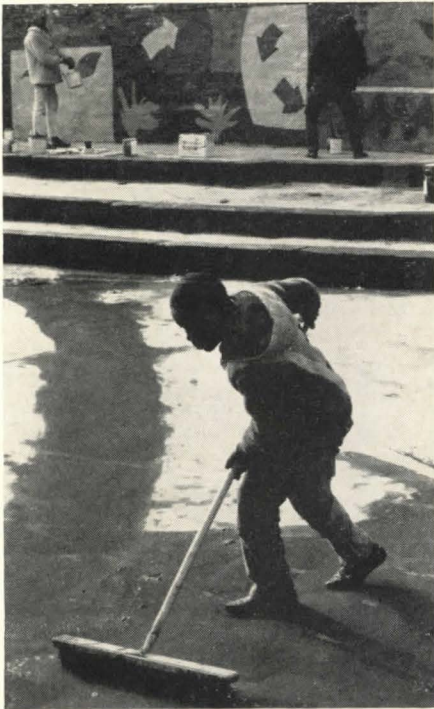

Recreation spaces: (P), pre-school age; (S), grade-school age; (T), teen-age; (A), adult. Community buildings (in white): (1), library and study center; (2), child-care center; (3), community services; (4), restaurant (existing); (5), community services. Circled area is site of new park.

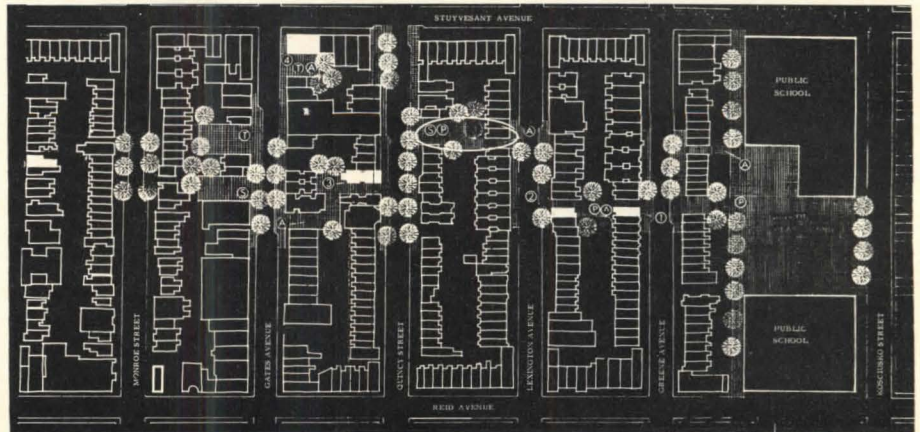

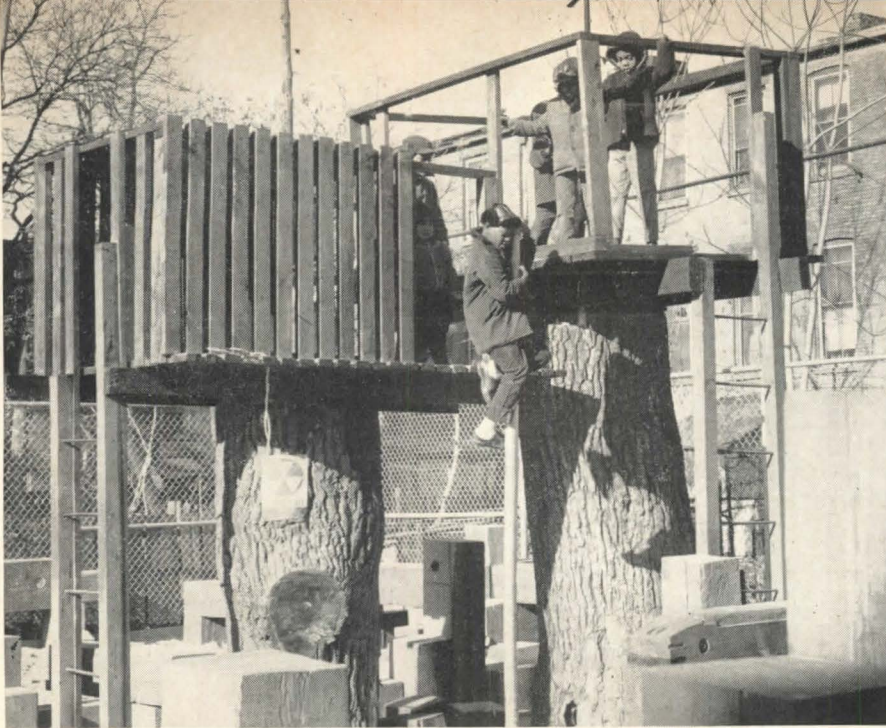

have developed a proposal for a system of linked parks in eight blocks of Bedford Stuyvesant (see plan). Their study would use the through-block pedestrian way as a base. This corridor in and through the neighborhood could be created without disturbing the street fronts by stringing vacant lots together. Community facilities such as branch libraries, child care centers, and community service agencies could be sprinkled throughout this corridor and localized in rehabilitated buildings that lie off the pedestrian way. The whole linked park system would overlap and relate to local transportation facilities and minor food and retail stores. Such a plan could save the neighborhood economically, by bringing money into the area, visually, by lessening the rigid gridiron and creating an enjoyable urban experience, and emotionally, by giving a blighted area dimension and vitality, even hope.

It is time to get away from the token planning of the paint and flower box, vest pocket park variety. Unless our efforts are coordinated within a larger framework of bettering deteriorating neighborhoods, these parks mean little. They are dead-end lots that go nowhere. Parks, like placebos, do not solve problems. But imaginative planning such as Friedberg and Shiffman's linked park proposal does.—JCE

# HOME OF THE BRAVES?

Here Atlanta has gone and built a nice new stadium for a major league baseball team and it cannot get a taker. Actually, of course, the Milwaukee Braves were set to come on down and become the Atlanta Braves, until contractual mix-ups put the kibosh on the move for the time being, at least. Which is too bad, for the Braves have a good-looking home waiting for them. Designed by Heery & Heery and Finch, Alexander, Barnes, Rothschild & Paschal as associated architects, the stadium is a straight-forward, no-nonsense job, unlike Washington's curvy-roofed stadium or the in-progress St. Louis project, where they designed it to stand up, then called on Ed Stone to come in and put on the pretty architecture. The Atlanta Stadium would probably lose "beauty" contests to such designs, but it actually possesses a more rugged charm—the directness of a speedy line drive or

the strong grace of a successfully executed end run.

The playing field is located 30 ft below grade, enabling patrons to enter at the top of the lower grandstand on a concourse level; from here, they ascend to the upper grandstand or proceed down to the lower area (see section). Seating, which accommodates 51,377 for baseball and 56,943 for football (by erecting demountable seats in the baseball outfield; see plan), is all armchair

type with back and fold-up seats. Future plans call for a roof and air conditioning, creating an enclosed space with a 720-ft diameter, 220-ft ceiling height, and 168,000-sq-ft floor area.

Structure consists of 80 welded steel box girders on radius with a diameter of 750.5 ft, supporting upper-stand seating and cantilevering 74 ft over upper seating to support the roof deck and lighting system for the field. These bents are supported by upper concourse framing on the field side and by main concourse framing on the exterior of the structure. Structural steel frames the upper concourse, the club deck, and the ramps down to the main concourse; framing at these levels and the ramps receives a metal deck and poured concrete slab. Framing consists of rolled wide-flange sections, built-up single-web sections, and built-up box sections.



Photos: Alexandre Georges



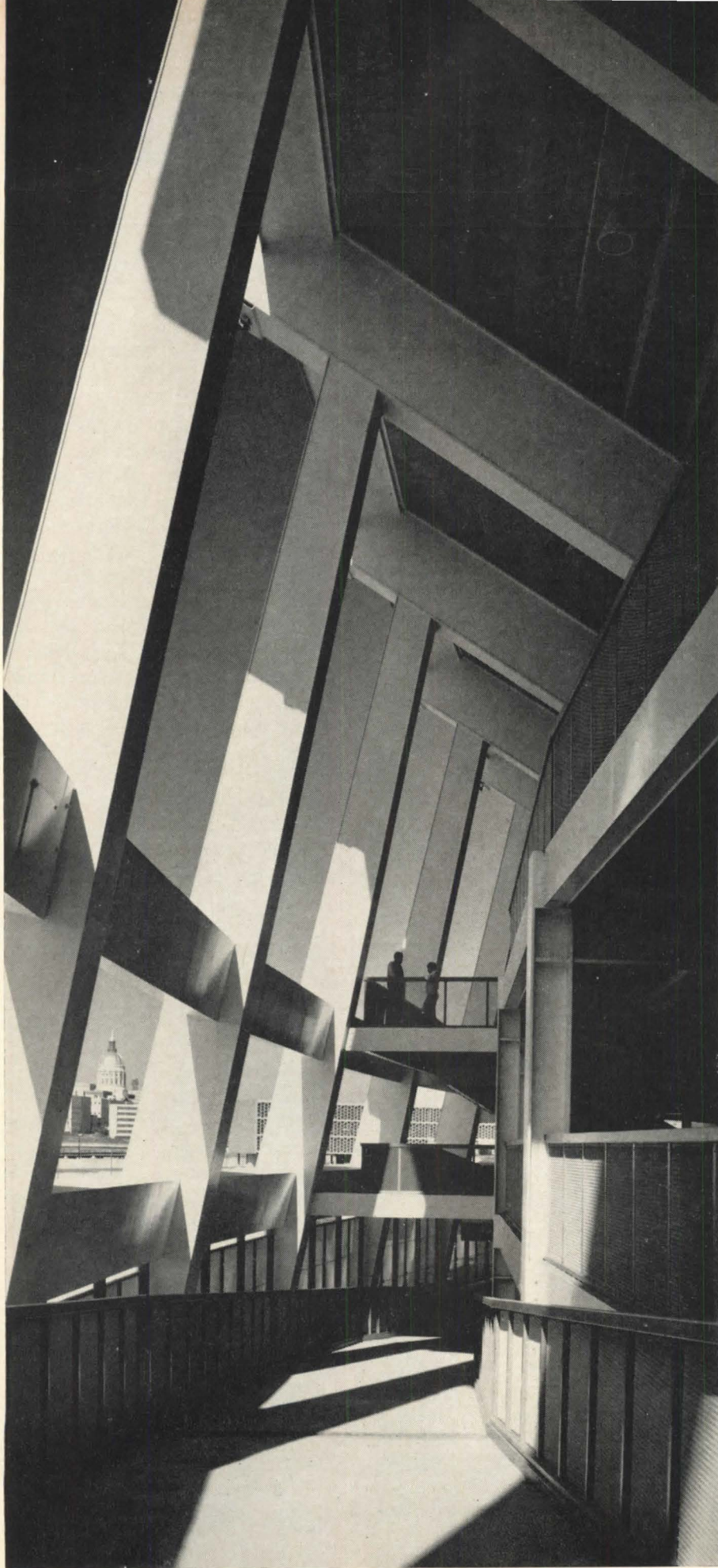

Main concourse level, at grade around the stadium, and the lower grandstand section are framed in reinforced concrete. Lower seating treads and risers combine cast-in-place and 360 precast units. Associated Consulting Engineers: Structural and Civil, Prybylowski & Gravino; Mechanical, Lazenby & Borum; Electrical, Blakely & Daniels. Consultants: Landscape Architect, Edward I. Daugherty; Traffic, Wortham W. Dibble; Lighting, Samuel Hamel; General Consultant, James A. Blaser; Crowd, Andy Frain Organization.

Now that they have erected a good playing space inside a good structural cage, let's play ball!

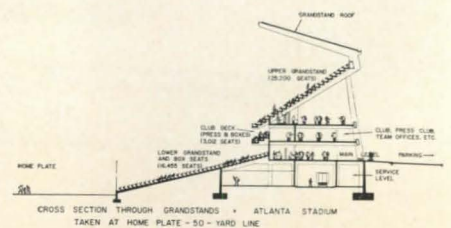
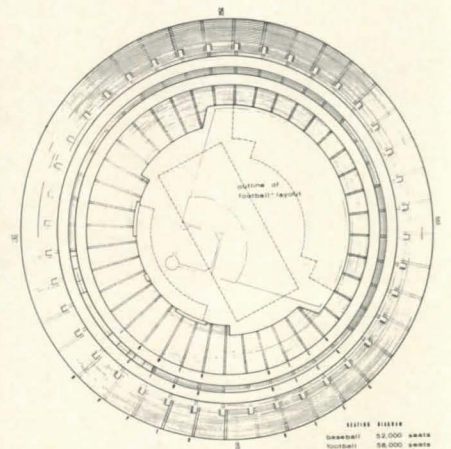

---

# FURNITURE AS PERSONAL OBJECTS

---

Photos: Alexandre Georges





*Castle, Blanket Chest*

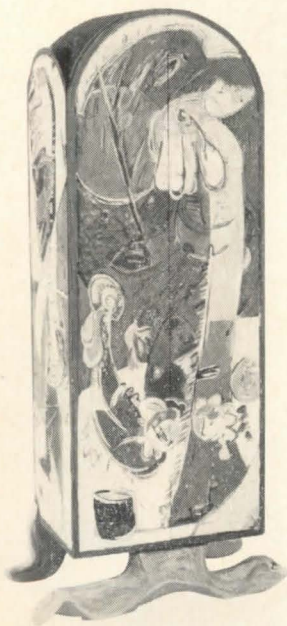

*Simpson, House-Scape Cabinet open and closed*

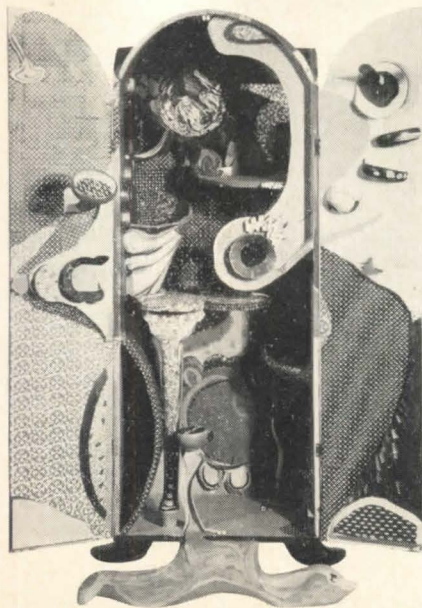

One of the advantages to the wide acceptance of contemporary interior furniture design is that it is easy for practically any architect or interior designer to turn out an acceptable, clean interior by recourse to a few well-known, established sources. Of course, this can, and has, resulted in a lot of interiors as indistinguishable from each other as the catalog pages from which they came.

Five men who wholeheartedly abjure the mass-produced furniture idea have been given a show of their own, very individual pieces at New York's Museum of Contemporary Crafts. In "Fantasy Furniture," Wendell Castle of Rochester, New York, Pedro Friedeberg of Mexico City, Thomas Simpson of Illinois, and Fabio de Sanctis and Ugo Sterpini (working together) of Rome show that furniture still can be made to amuse, startle, satirize, comment, and even frighten (remember those mysterious old overstuffed chairs and armoires in the attic when you were a child?). The furniture, although somewhat reminiscent of the elephant's foot umbrella stand or the chair made from the antlers of that 10-point buck Uncle Sidney shot out West in '97, bears a closer kinship to the fantasies of Hieronymus Bosch or, more contemporaneously, Boris Artzybasheff. Some of it, such as Castle's blanket chest, comes off very well as sculpture purely considered. Other pieces, such as those by De Sanctis and Sterpini, give one the uneasy feeling that one would not like to be in the room with them when the lights are out. Generally, making such objects is not a bad way for grown men to spend their time. It keeps them out of wars.

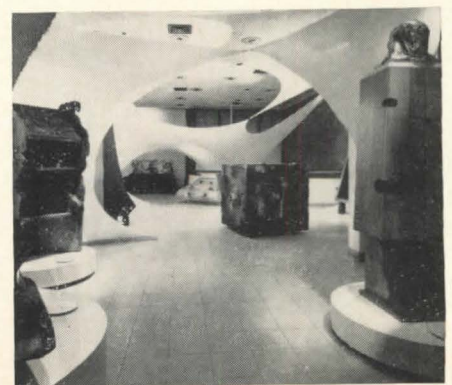
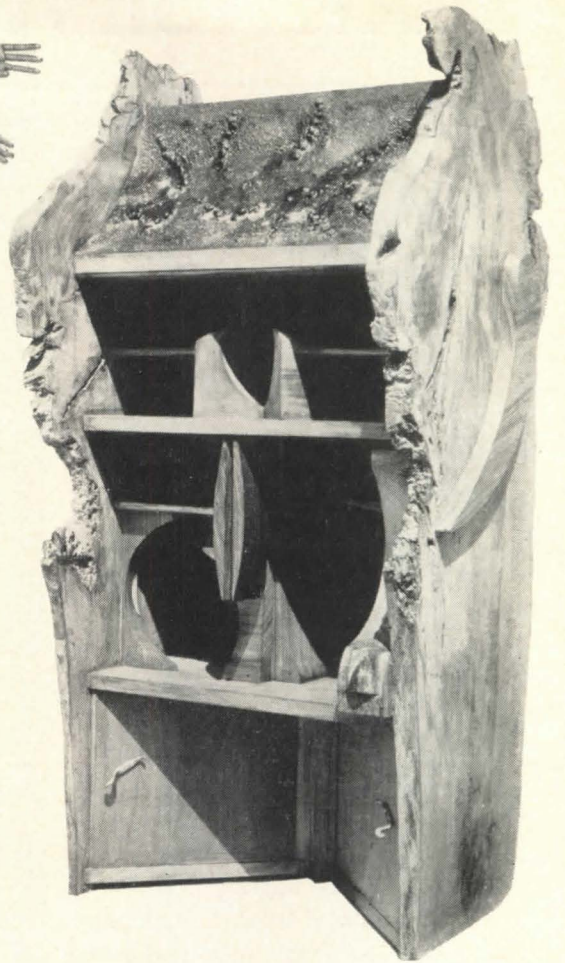
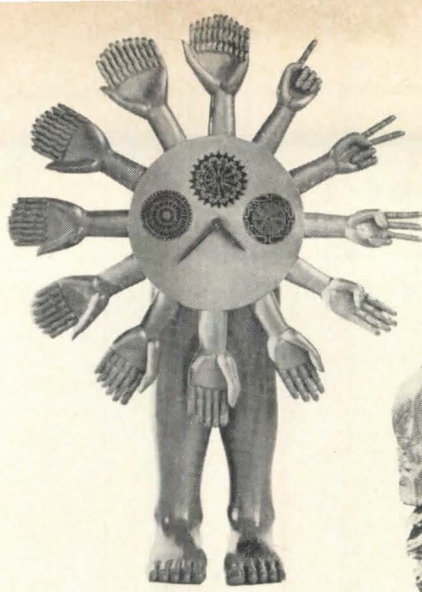
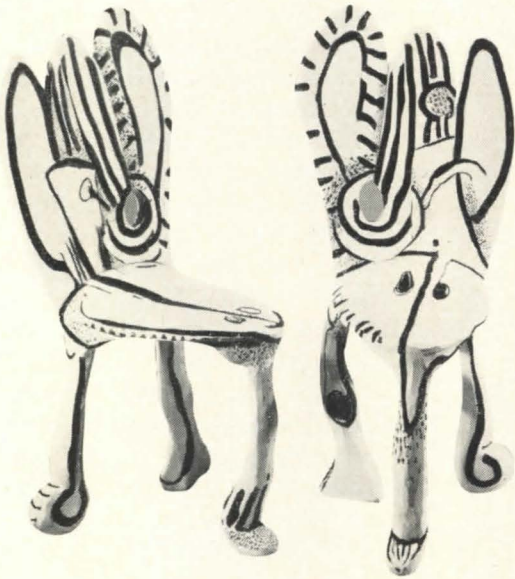

Photo: Louis Mervar

*Friedeberg, Painted Wood Clock*



*Simpson, Rabbit Bird Chairs*



*De Sanctis and Sterpini,  
Le Sfinxi (The Sphinxes)*

*De Sanctis and Sterpini,  
Cielo, Mare, Terra (Sky, Sea, Earth)*

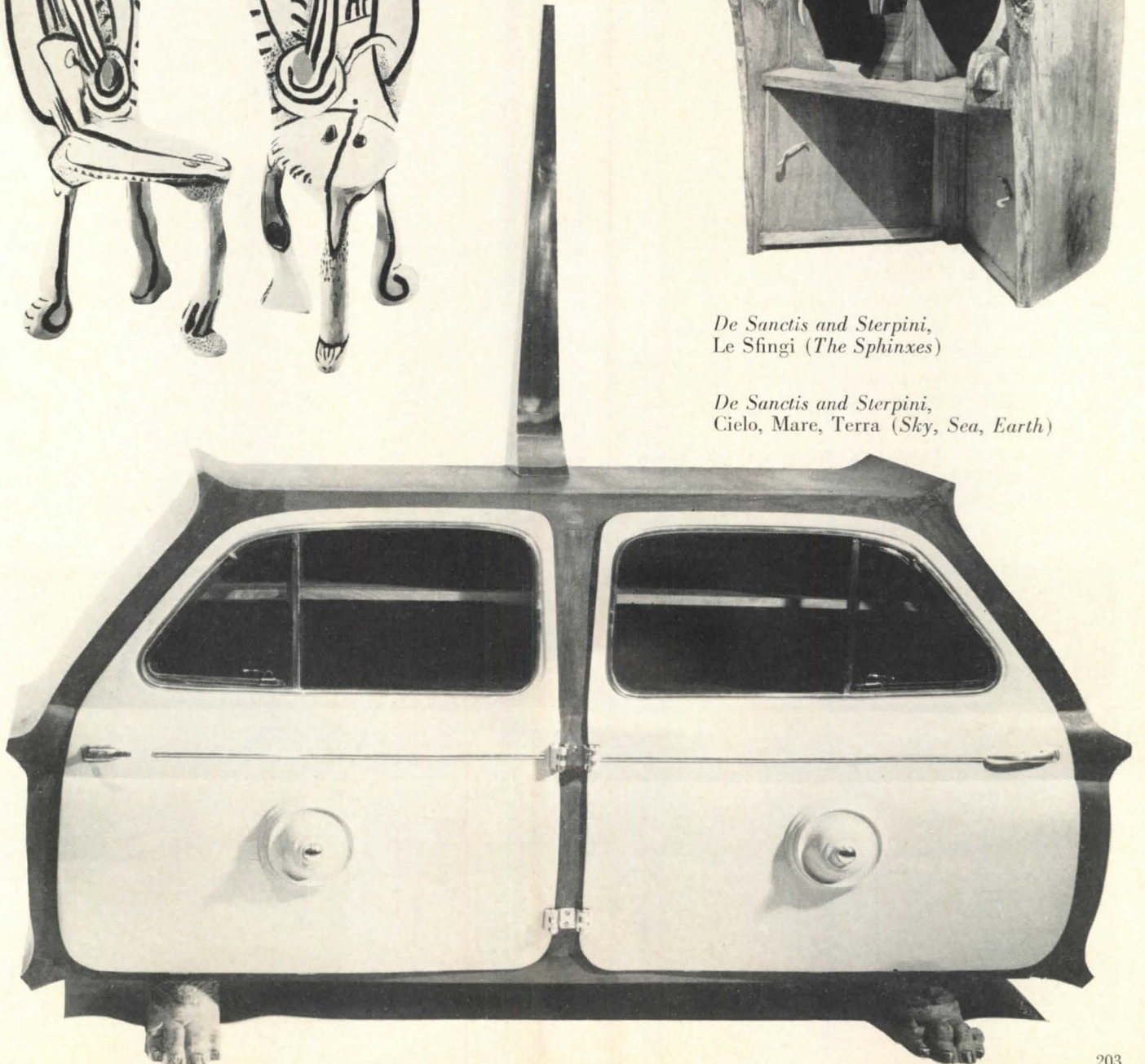

# "PARTICIPATE, NOT EVACUATE"

When John and Sally Woodbridge wrote *Buildings of the Bay Area*, which appeared at the time of the 1960 AIA Convention in San Francisco, they did not even include the area of the Western Addition Redevelopment in their survey of notable buildings, for a very simple reason: There were none there. Subsequently, Director M. Justin Herman of the San Francisco Redevelopment Agency set in motion a phased renewal of the largely lower-income Negro area. This redevelopment brought with it the inevitable dislocation caused by thinking in terms of great schemes rather than house-to-house needs. When the Reverend Hamilton T. Boswell of the Jones Methodist Church realized that his church and congregation were in the path of the redevelopment plan, he determined they would do something about it. "We decided to participate, not evacuate," he says.

Participation involved raising \$41,000 from donations of his parishioners, none of them well-to-do, and obtaining a \$446,000, 50-year, low-interest Federal loan from HHFA (under FHA Program 231: Housing for the Elderly) for the construction of a 32-unit apartment house for the elderly. Morton Rader of the San Francisco architectural

firm of Chan/Rader & Associates was commissioned to design Jones Methodist Church Apartments and help fight the four-and-a-half-year battle against Governmental red tape to get it built.

Rader's design, based on a minimal budget (\$15.50 per sq ft) as well as the sociological and emotional necessity of providing a serene environment for older people, developed as a four-story building facing a major boulevard, with eight one-bedroom apartments on each floor entered at the rear from an open corridor. The architect says the apartments were planned to give a sense of flowing space and therefore larger size. Vertical access is by two stairways and an elevator. Basic structural system is concrete slab floors and concrete bearing walls, which form separations between apartments. Kitchen and toilet are back-to-back in each pair of apartments for economy of structure and equipment. The bearing walls terminate just above the roof, where they are used to form varying areas being developed as tenant's roof gardens. Parking is on grade at the rear, between the apartments and the existing church house. Vertical splayed walls of the bedrooms are colored olive on the exterior and in-

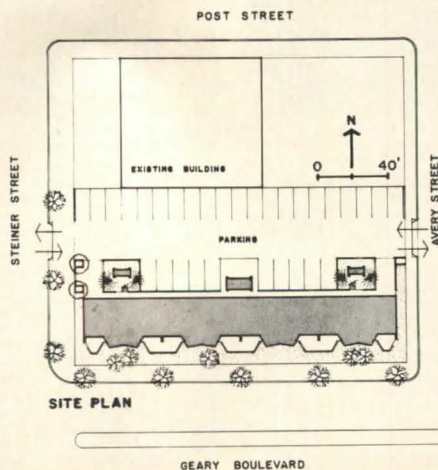
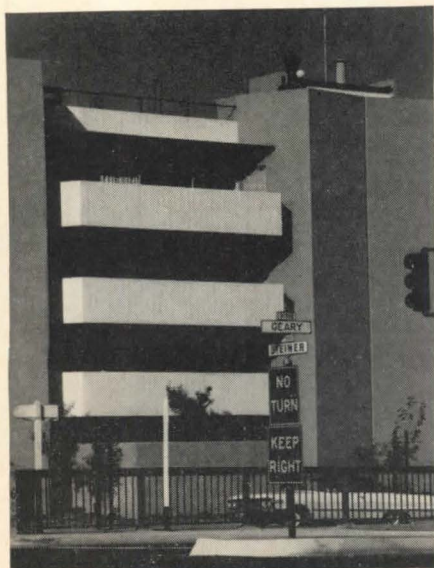
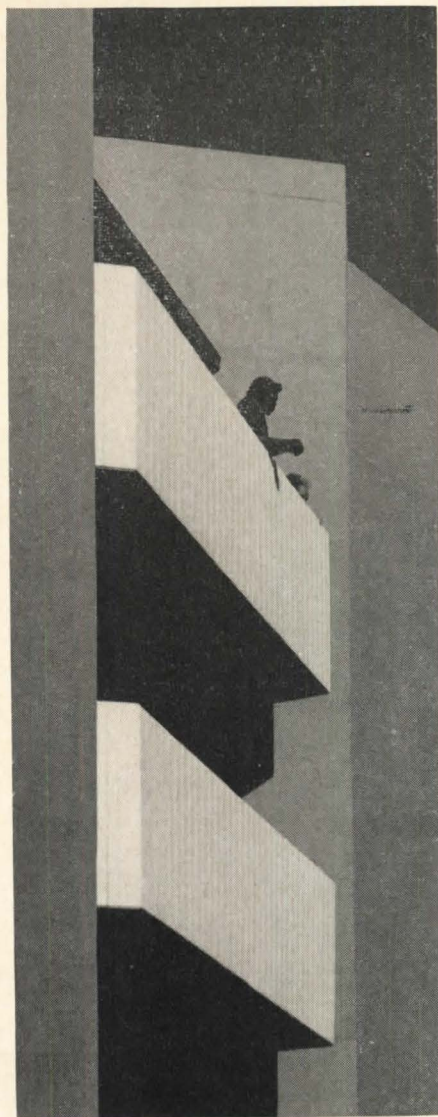



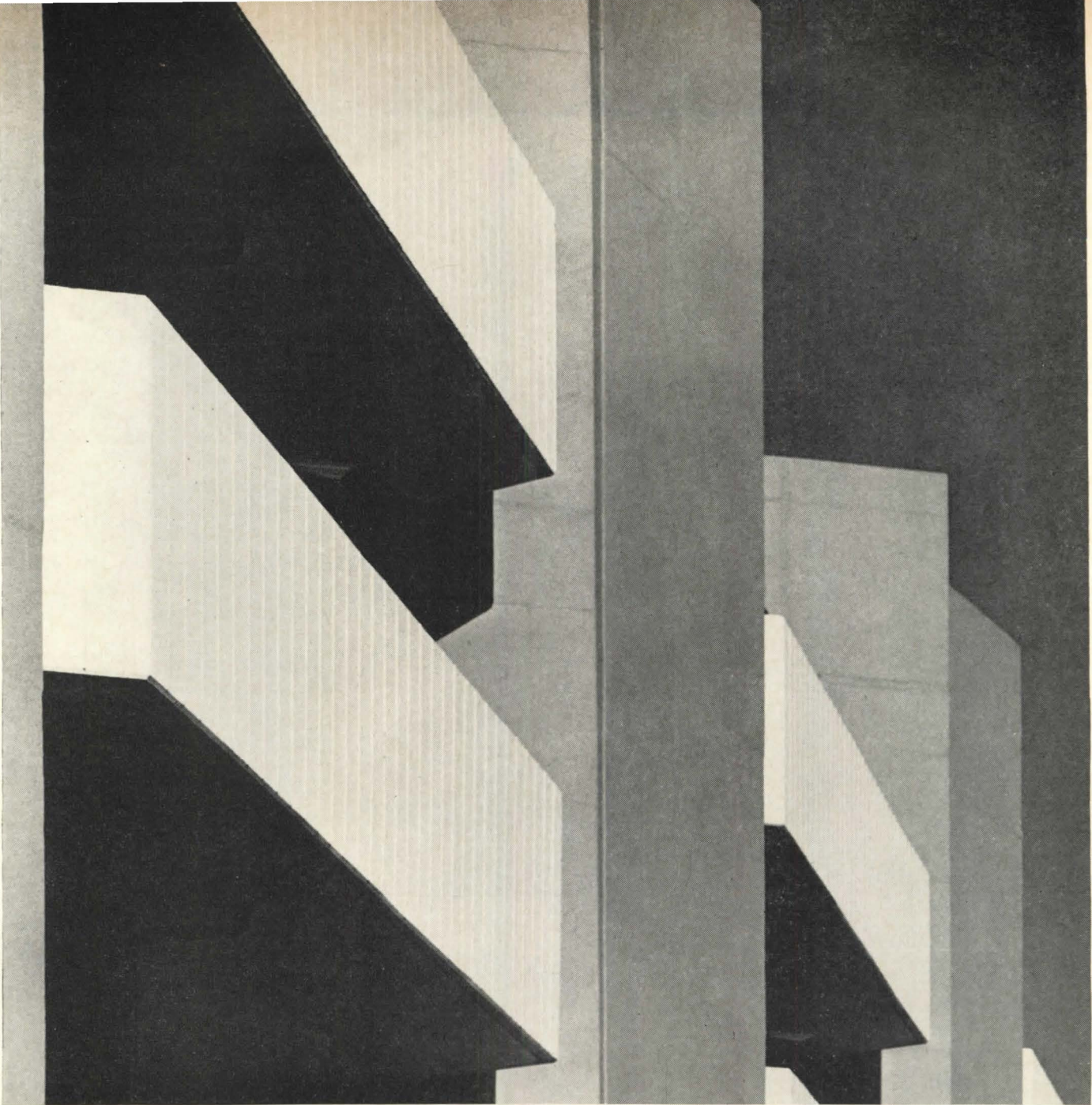

Photos, except as noted: Dandeleit Photographs, Ken Edler

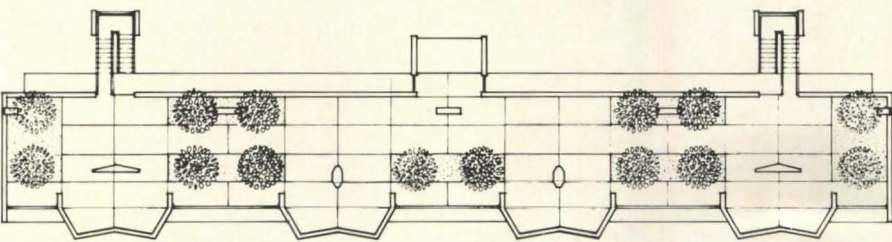

Roof Terrace Plan

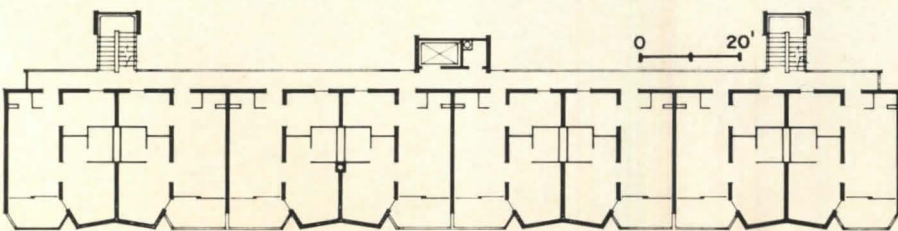

Typical Floor Plan



Photo: Maude Dorr

Pierce, Boswell, Rader



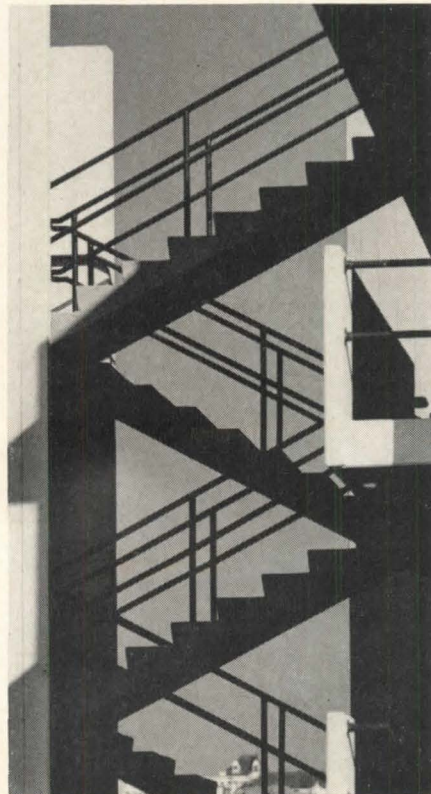
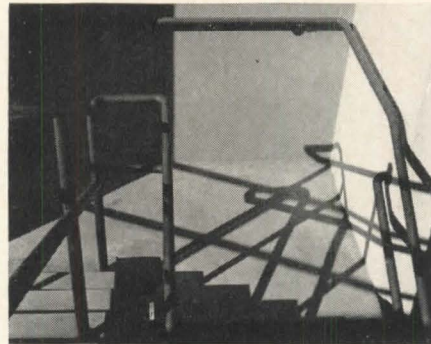
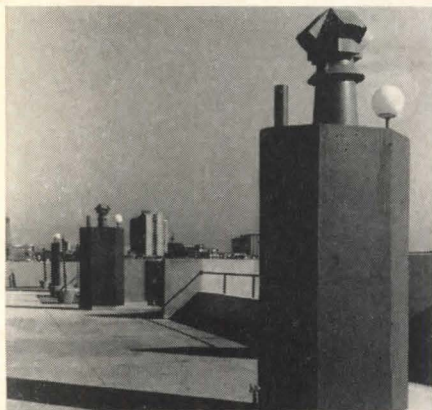
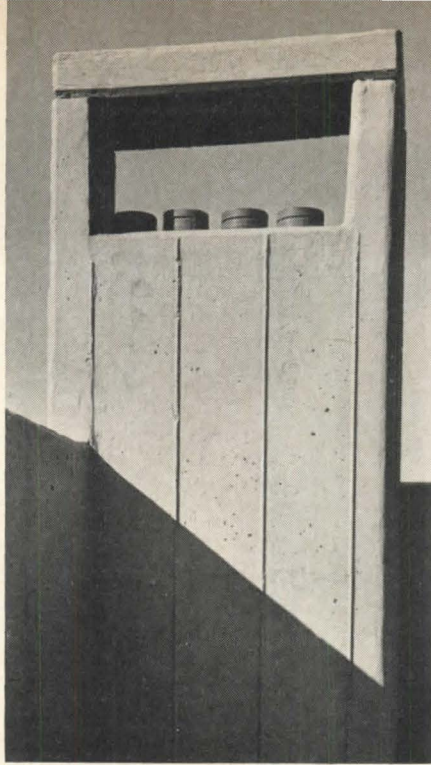
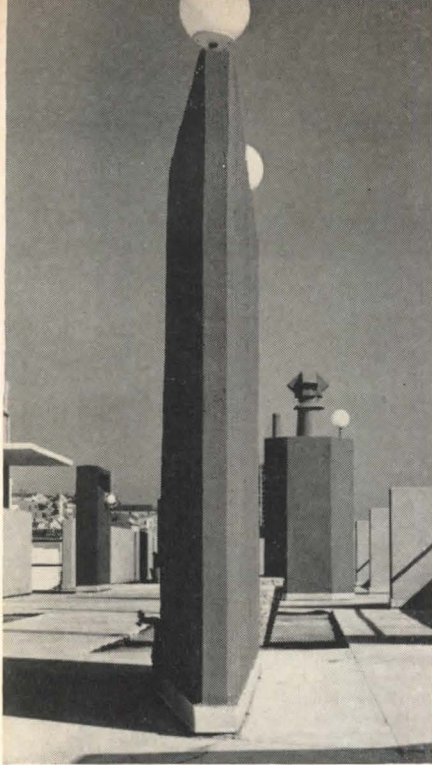

errupted horizontally by the sand-colored balcony spandrels. Future tree planting between the apartment house and the boulevard will relieve the somewhat austere façade.

Floyd L. Pierce, president of Jones Memorial Homes, Inc., stated: "We want to integrate with a vengeance. Our only qualifications are that persons be 62 or over and have a minimum income of \$2500 a year. We want a cross-section of races and economic backgrounds." This aim was well on the way to achievement when Mrs. Grace Mauerhan, a retired white interior decorator, was the first tenant to move into the first Negro-built retirement home in the West (also the first low-cost Federally-financed development for the elderly completed in San Francisco under the direct loan program of the National Housing Act).

Architect Rader recalls that his first meeting with the leaders of Jones Methodist Church began with ". . . a prayer that created a most remarkable spirit. This happens rarely to an architect, and when it does, it is beautiful and it will be with me forever. With all of us since that meeting; we've been holding hands ever since."

*Structural Engineer for Jones Methodist Church Apartments: Stefan J. Medwadowski; Mechanical Engineer, Charles & Braun; Electrical Engineer, Mazzetti, Takahashi & Parish.*

Photo: Gerald Ratto

Photo: Gerald Ratto

# MORE HONOLULU REDEVELOPMENT

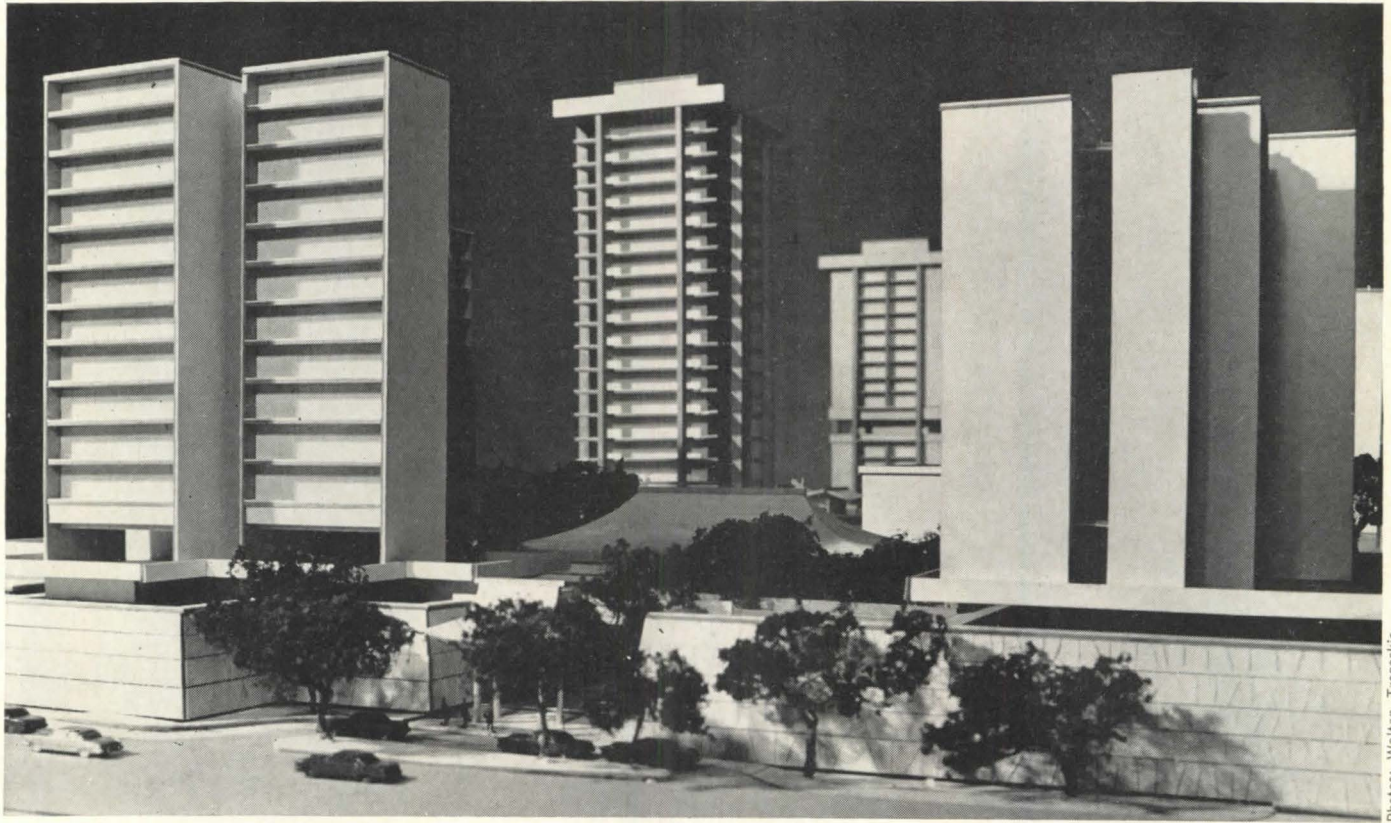

Photos: Walton Tregaskis

The youngest state is coming up with a broth of redevelopment activity that will give its older sisters pause. Last month, we looked at Leo S. Wou's Financial Plaza of the Pacific (pp. 192-194). This month, culture gets a nod with the introduction of the master plan by John Carl Warnecke & Associates (Robert Lamb Hart, partner in charge of planning) for the "Cultural Plaza," a 10-acre phased redevelopment proposal for downtown Honolulu. A much more mixed-use project than Financial Plaza, the Warnecke project will combine high-rise residential, commercial and merchandising areas, a cultural center, and parking. Sponsors are five Chinese societies: Lung Do Chung Sin Tong Benevolent Society, Chee Kung Tong, Kuo Min Tang Society, Leong Jun Society, and Sun Yat Sen School.

The site will be developed as a large block bounded on three sides by streets and on the fourth by River Street, a thoroughfare to be rebuilt



as a pedestrian promenade along Nuuanu Stream. Other major open areas in the project will be a commercial plaza next to buildings housing shops, restaurants, and headquarters for the societies, and a cultural plaza between a theater and a community meeting hall. Two pedestrian spines will lead into the commercial plaza: one from the River

Street mall; and one from Beretania Street (see aerial view of model).

There will be five levels of parking in garages entered from Kukui Street. The architect maintains that this will not add to congested downtown traffic and will also act as a buffer between downtown and a row of mortuaries between Kukui and Vineyard Streets. Apartment buildings will rise above the garages, with the roof decks over the parking facilities turned into recreation areas. Thus, apartments will be lifted up to afford views of mountains and ocean.

The complex of shops, markets, restaurants, night clubs, offices, and society headquarters is expected to have the excitement of an Oriental bazaar. Narrow malls between establishments emblazoned with Chinese characters will give much of the character. The main plaza will have life by day and night, with outdoor restaurants, market stalls, and resting places. Since the area will open

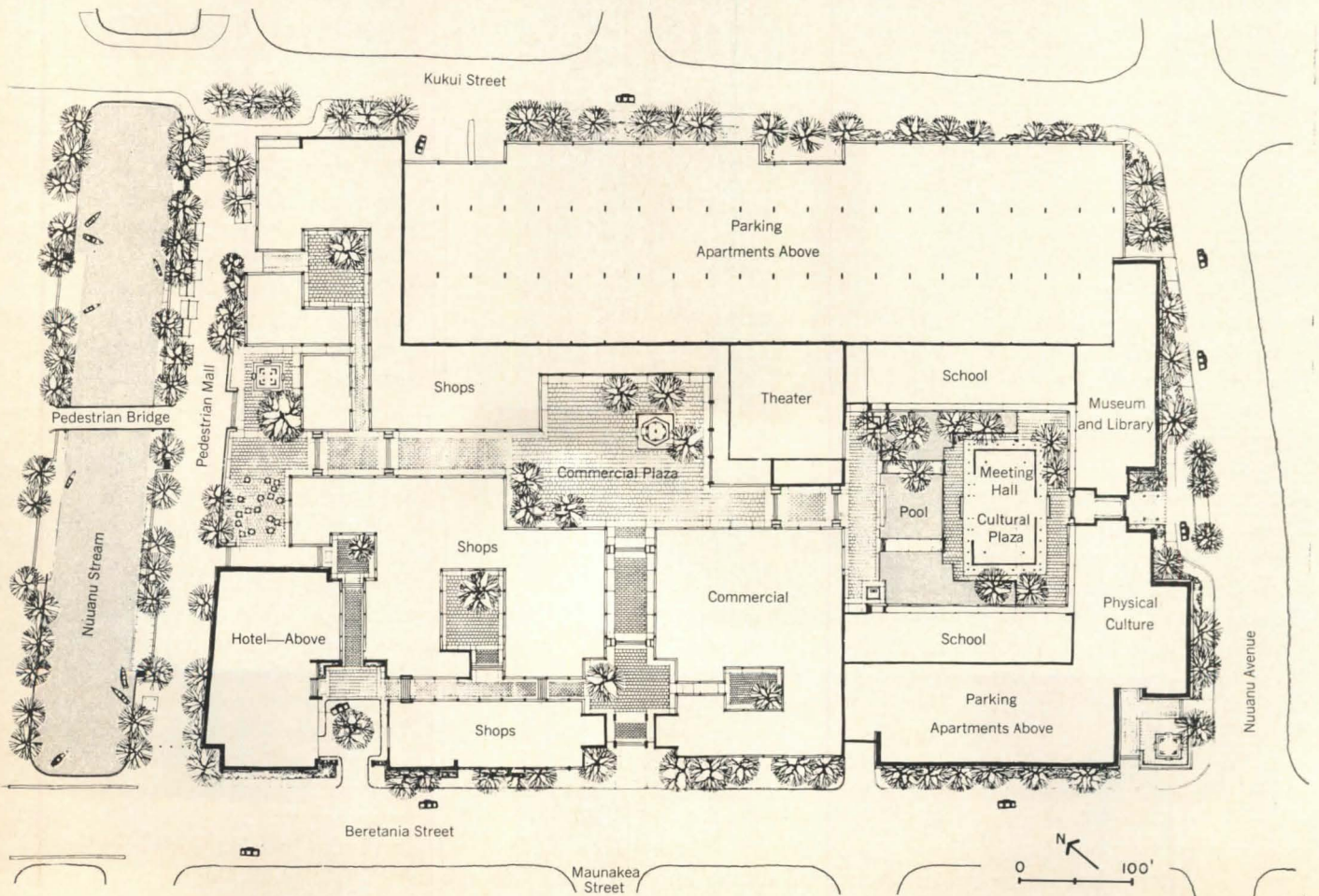
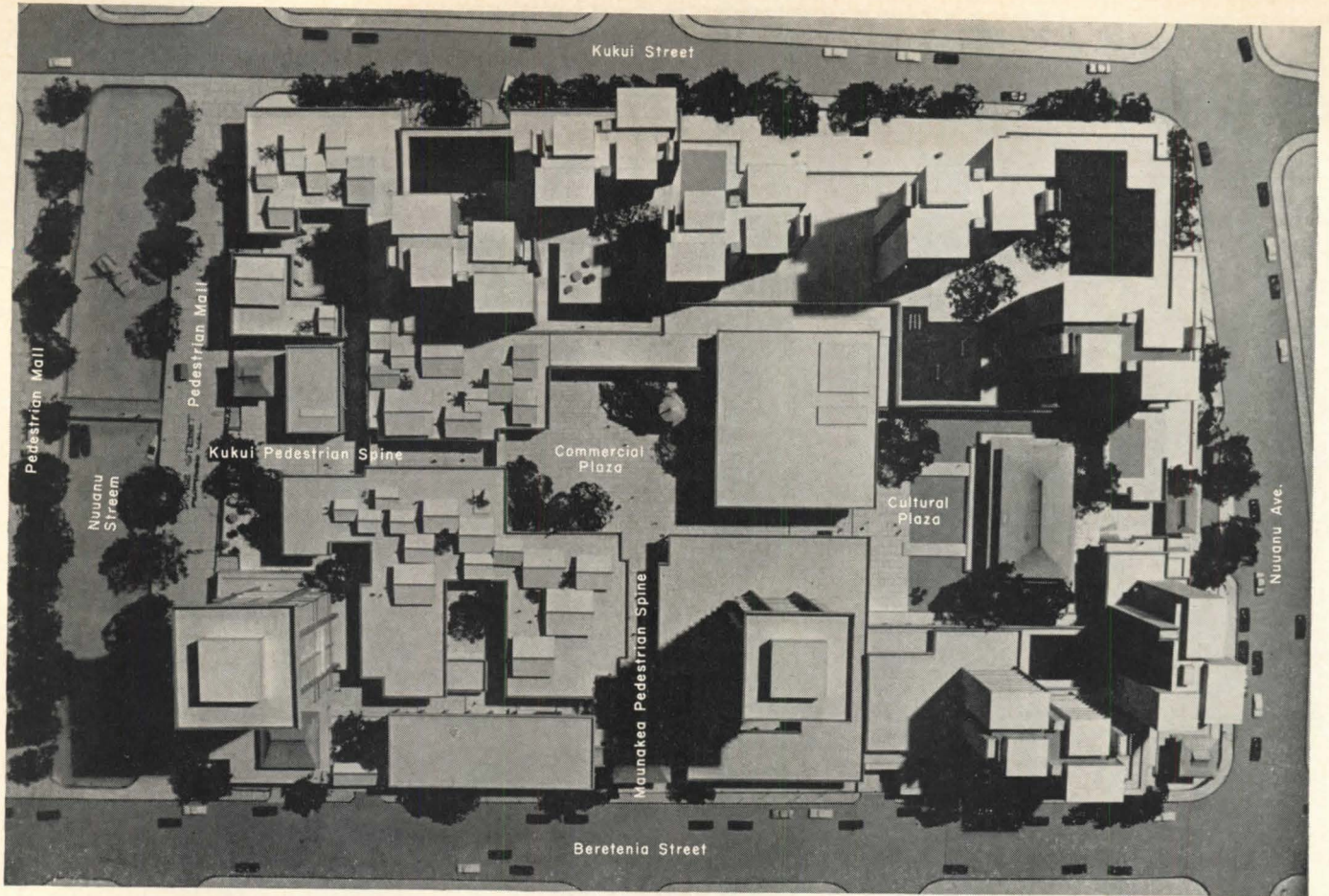

toward the old Chinatown, it will both benefit from and add to the older section. Other commercial activities will eventually include a high-rise office building and a new hotel. A major activity will be the Pacific Area Trade Center, where merchandise from countries all around the Pacific basin will be exhibited.

In addition to the theater and the community meeting hall, the cultural plaza will have Chinese language schools, a youth center, museum and library, and a physical culture gym. The entire site will have a complex of service basements, reached through three entrances at the hotel, the office tower, and the parking garages.

The architect points out that Cultural Plaza will have a distinct Oriental character, "not by corny devices, but by scale, heights, color, open store fronts, active second and third stories, etc." All of the major buildings will be contemporary in design and construction. Occasionally, there will be buildings in the authentic Chinese tradition treated as large atmospheric sculpture. An interesting idea, but one that will have to be watched extremely carefully lest it turn into Charlie Chan-nish camp. Other areas that will require great tact in handling are where the commercial, cultural, and parking elements elbow each other. Smooth transitions must be achieved here for a good flow of space.

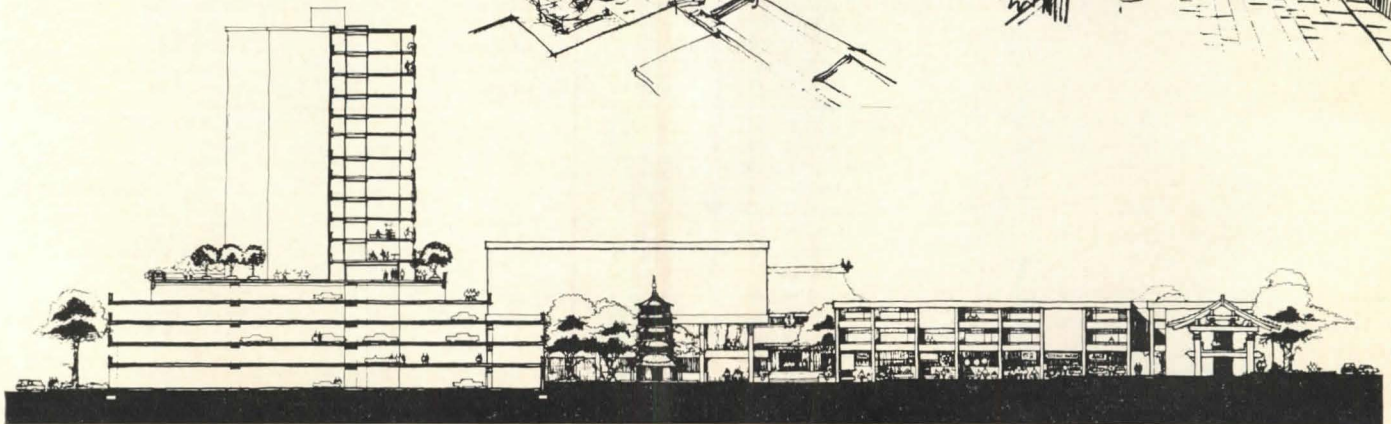
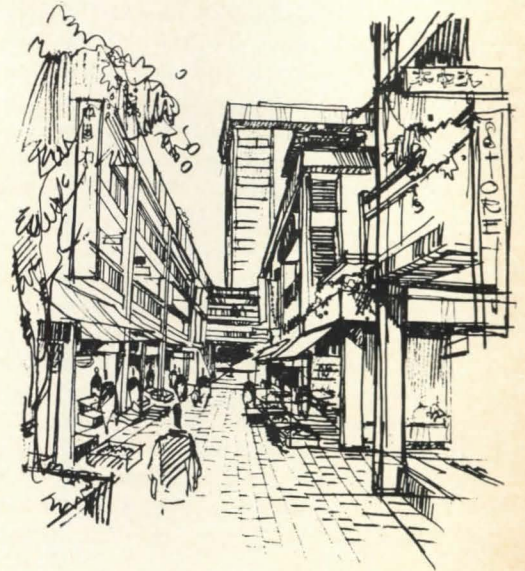
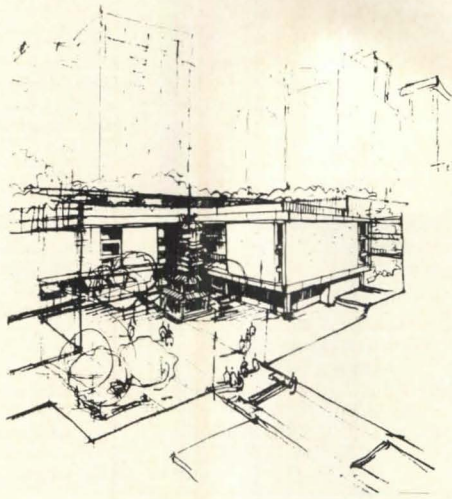
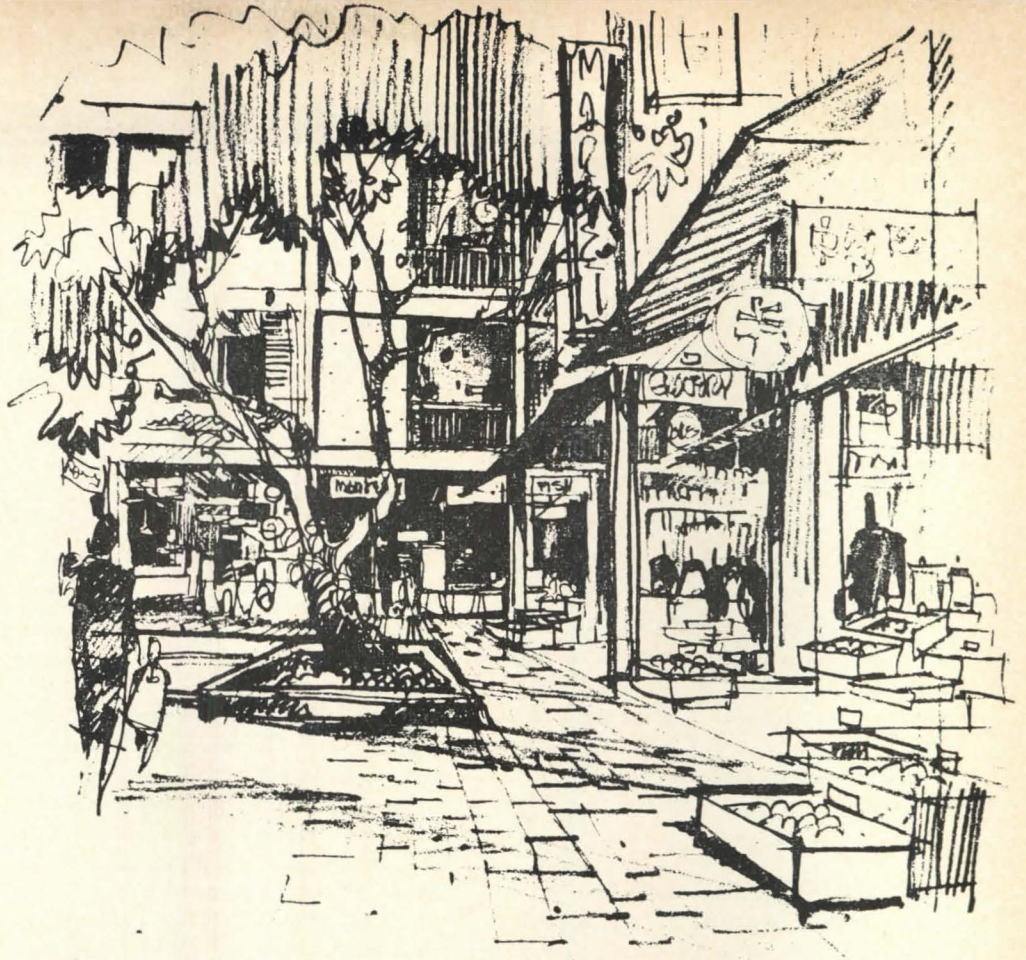

## More Insulation-Less Capital Cost

BY WILLIAM J. McGUINNESS

*Use of extra insulation saved a company money by reducing the size, and cost, of air-conditioning and heating equipment. McGuinness is the Chairman, Department of Structural Design, School of Architecture, Pratt Institute, Brooklyn, N.Y.*

Industrial companies looking for the lowest per-sq-ft construction cost frequently consider insulation an unnecessary expense. However, this penny-wise-pound-foolish attitude is changing as owners begin to realize the economic advantages of insulating a building. One company, The Cain Coffee Company of Oklahoma City, was soon convinced of the extra benefits when it took the advice of its architects and engineers to increase the insulation of one part of a building.

Cain decided to increase insulation in a critical-temperature storage room, and in doing so cut \$3185 from the initial cost of the building. The saving resulted from decreasing the size of the equipment for conditioning the well-insulated building. This, in turn, lowered operating costs by reducing fuel consumption.

The 4900-sq-ft storage room, which contains spices that must be stored at a temperature of 60 F, is enclosed by an exterior wall and three interior partitions, all built with lightweight shale blocks. Metal decking supporting a built-up roof tops the room.

In summer, the outside wall and roof are exposed to a 100 F temperature, and in winter to 0°F. This climate results in a winter temperature differential (TD) of 60 F for roof and exterior wall. Temperatures in the interior of the building adjacent to the storage area average 60 F in winter. This causes no heat flow, but, in summer, a 92 F temperature exceeds that of the storage room by 32 F. For summer loads on the roof and exterior walls, designers assigned ASHRAE's

recommended "equivalent temperature differentials" (ETD) of 63 F and 34 F respectively.

These design criteria prompted the designers to call for more insulation than is customary for this type of construction. With the additional insulation, it became apparent that lighter equipment than had been anticipated could handle the cooling and heating loads.

Original plans called for 1½-in.-thick insulation in the roof, but no insulation in the walls. The revised design called for 1⅞-in.-thick insulation in the roof, and 2 in. for the exterior and interior

block walls. The wall insulation was applied between metal studs, and enclosed with ½-in.-thick gypsumboard.

The additional insulation cut heating and cooling requirements by more than half. And, although the owner spent an additional \$1720 for insulating the room, equipment cost \$4905 less than originally planned—a net saving of \$3185.

Coston-Frankfurt-Short, Oklahoma City, were the architects. The Owens-Corning Fiberglas Corporation compiled the comparison table using cost data supplied by Anderson & House, Inc., general contractor.

				DESIGN COMPARISON	
				ORIGINAL DESIGN	REVISED DESIGN
<b>CONSTRUCTION</b>					
Exterior wall	2280 sq ft		Lightweight shale block	Lightweight shale block	2-in. insulation
			U = 0.38	½-in. gypsumboard	U = 0.10
Partitions	6280 sq ft		Same as exterior wall	Same as exterior wall	
Roof	4902 sq ft		Metal deck	Metal deck	
			1⅞-in. insulation	1⅞-in. insulation	
			Built-up roofing	Built-up roofing	
			U = 0.18	U = 0.12	
<b>SENSIBLE HEAT LOAD:</b>					
<b>SUMMER</b>					
Exterior wall	ETD = 34 F	29,458 Btuh		7752 Btuh	
Partitions	TD = 32 F	48,640 Btuh		12,800 Btuh	
Roof	ETD = 63 F	55,588 Btuh		37,059 Btuh	
		<b>Totals</b>	<b>133,686 Btuh (11 tons)</b>	<b>57,611 Btuh (5 tons)</b>	
<b>SENSIBLE HEAT LOSS:</b>					
<b>WINTER</b>					
Exterior wall	TD = 60 F	51,984 Btuh		13,680 Btuh	
Partitions	TD = 0	0		0	
Roof	TD = 60 F	52,941 Btuh		32,294 Btuh	
		<b>Totals</b>	<b>104,925 Btuh (105 mbh)</b>	<b>45,974 Btuh (46 mbh)</b>	
<b>COST DATA</b>					
Exterior wall (installed cost of insulation and gypsumboard only)		0		\$410.00 (18¢ psf)	
Partitions (installed cost of insulation and gypsumboard only)		0		720.00 (18¢ psf)	
Roof (installed cost of insulation only)		\$784.00 (16¢ psf)		1372.00 (28¢ psf)	
Cooling equipment		8448.00 (\$768/ton)		3840.00 (\$768/ton)	
Heating equipment		525.00 (\$5/mbh*)		230.00 (\$5/mbh*)	
		<b>Totals</b>	<b>\$9757.00</b>	<b>\$6572.00</b>	

\* Prorated share of central boiler cost for entire plant.

# This new tile ceiling will probably deceive you.

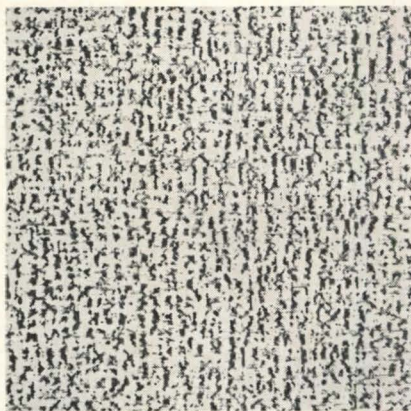

## By design.

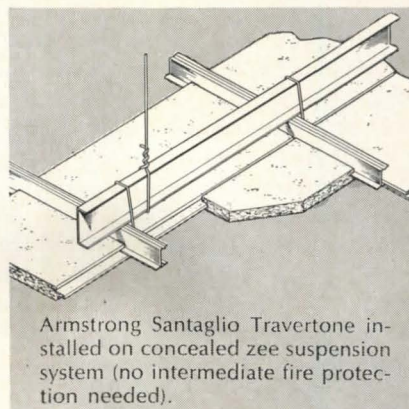

Armstrong Santaglio Travertone installed on concealed zee suspension system (no intermediate fire protection needed).

You'll have to look very closely at an Armstrong Santaglio\* Travertone™ Ceiling to realize that it was put together tile by tile. The barely perceptible joint lines fade away to create an overall monolithic appearance.

We achieved this illusion by extending the meticulously arranged surface design right out to the square, sharp edge of each tile. When the tiles butt together, the pattern blends to create a subtle, bidirectional effect for really striking interiors.

There's nothing illusory about Santaglio Travertone's other characteristics, however. Acoustical efficiency is high, whether the tiles are cemented in place, or mechanically suspended. NRC Specification Range is .65-.75 for the former, .60-.70 for the latter. Average

Attenuation Factor is 41 decibels. Light Reflection Coefficient is "b."

Noncombustible Santaglio Travertone Ceiling Systems provide fire protection, too. UL Label—Class I Flame Spread rating. UL Time-Design rating on floor-ceiling assembly—3 hours.

Santaglio Travertone is available in 12" x 12" x 3/4" tiles, with T & G square edges. The tiles cement quickly to any firm, flat, dry surface. Or they can be installed with standard concealed suspension system.

We could go on about Santaglio Travertone—particularly in relation to specific applications. Want us to? Write Armstrong, 4203 Watson Street, Lancaster, Pa.

\*Design patent applied for.

Ceiling Systems by **Armstrong**

# An Ounce of Prevention

BY HAROLD J. ROSEN

*Architects can reduce failures in building materials by specifying the right material for the right application. Rosen is Chief Specifications Writer of Skidmore, Owings & Merrill, New York.*

Where does responsibility lie when a materials failure occurs? Is it with the architect who selected the material; the manufacturer who produced and furnished it; or the contractor who installed it? Obviously, each specific material failure that results in a court claim must be adjudicated on its own merits. However, there are obligations for all parties involved in selecting, furnishing, and installing a building product.

Architects and engineers are prone to think their judgment is infallible. But they should remember that a judgment in court will be resolved on the pertinent facts of a particular case. Thus, architects, manufacturers, and contractors fare no better and no worse than anyone else who enters into a contractual relationship.

Architects can improve relations between the parties by being more concerned with arriving at solutions for preventing materials failures than with trying to fix responsibility after a failure occurs.

When a man practices architecture or engineering, he is expected to have an adequate knowledge of the science of design and construction, and to exercise reasonable care, judgment, and technical skill to see that the work is properly done. Court decisions have held that an architect is responsible for proper selection and application of material, and for adequate research; and that reliance on advertising literature of a manufacturer or other representations of a manufacturer do not necessarily protect the architect.

The AIA "Policy Statement on Building Product Development and Uses" makes the following observations concerning an architect's obligations: "He is expected to inform himself with respect to the properties of the products

he specifies, though he is entitled to rely on manufacturers' written representations. He is advised to seek the technical opinion of the research or application engineering departments of the manufacturer when his intended use is not clearly included in the printed data of the manufacturer. He is further responsible for uses contrary to supplementary written information on proper use and installation procedures of the manufacturer. The Architect's use of a product and its installation should extend to its compatibility with and relationship to adjacent materials and assemblies, notwithstanding the manufacturer's similar obligations."

In discussing the manufacturer's role, the policy statement contends: "The manufacturer should supply the Architect with all essential data concerning his product, including pertinent information which would involve its installation, use and maintenance.

"Particularly important is information on the product's compatibility and interfitting with interrelated products, as well as precautions and specific warnings on where the product should not be used based on conditions of known or anticipated failures.

"Whenever the manufacturer has specific knowledge of an improper use of his product, he should furnish such information in writing to the Architect.

"The manufacturer is expected to recognize that he is responsible for the failure of his product to perform in accordance with written data supplied by him or his authorized representatives, as well as misrepresentations of such data.

"The manufacturer is expected to investigate the relation of his product to other components likely or logically expected to be used in association with his. Such information should be available to the Architect."

A contractor's basic responsibility is to substantially perform according to the plans and specifications set forth by the architect. A contractor who has, in fact, performed substantially, and built the building accordingly, would be absolved

from any legal responsibility. Failure to perform according to the terms and conditions of the contract would, of course, hold the contractor liable for a breach of contract.

The AIA policy statement sums up the contractor's obligations in these words: "It is the responsibility of the contractor to inform himself concerning the application of the product he uses and to follow the directions of the Architect and manufacturer.

"In the event of disagreement between the Contract Documents and the manufacturer's directions, the contractor is expected to seek written instructions from the Architect before proceeding with the installation.

"If the contractor has knowledge of, or reason to believe, the likelihood of failure, he is expected to transmit such knowledge to the Architect and ask for written instructions before proceeding with the work."

The combination of man-made materials, which are mainly the products of chemistry, highly integrated building designs, and sophisticated construction techniques, require knowledgeable persons on the staffs of architectural, manufacturing, and contracting firms. These skilled persons must be able to cope with the problems related to building products and their incorporation into complex designs.

To lighten the problems, the following "do's" and "don'ts" are recommended as a general guide to selecting materials and reducing the possibility of failure which may result in litigation.

*Do* be certain that the manufacturer knows how his material or equipment will be used in a design.

*Don't* use an unfamiliar material unless it is known to have been used successfully in installations similar to the proposal under review.

*Don't* rely on the manufacturer's statements and claims as the only basis for using a material.

*Don't* be the first to use a material or piece of equipment without the owner's knowledge or consent.



*NOW...*  
SO  
QUIET  
you can  
hear a pin  
drop

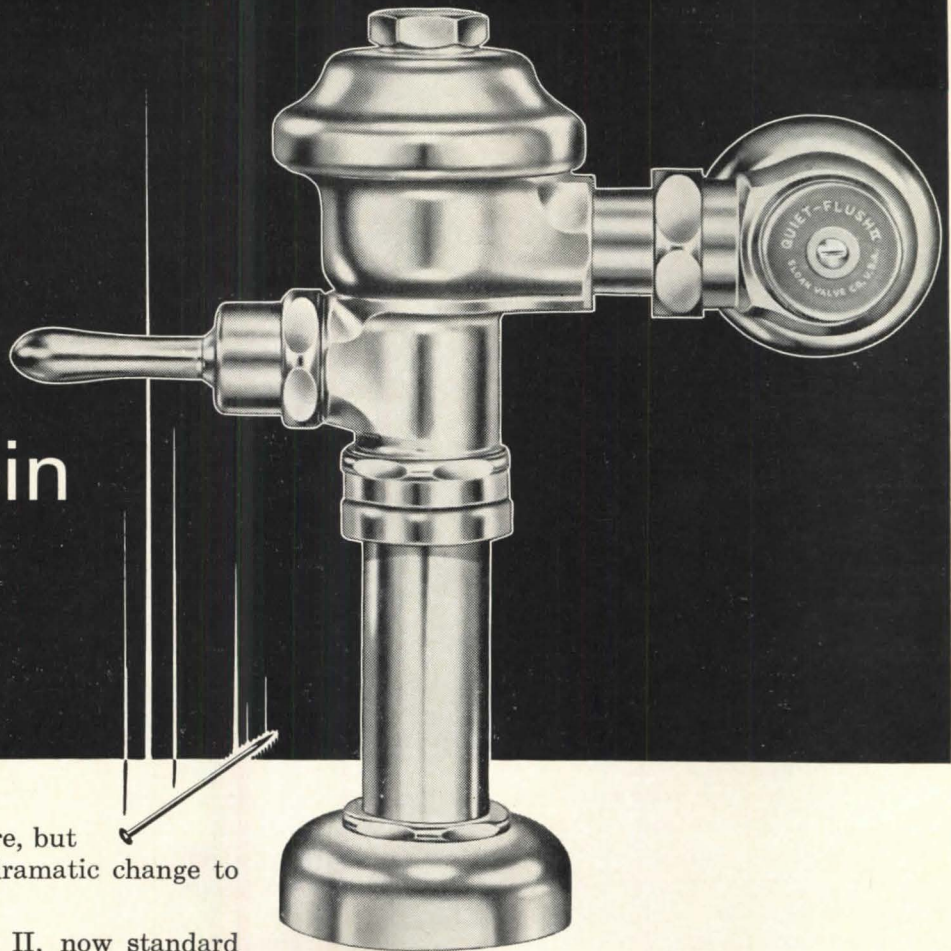

A figure of speech, to be sure, but one which points up this dramatic change to quietness.

Sloan's new Quiet-Flush II, now standard equipment on all ROYAL, NAVAL and CROWN Flush Valves, offers the ultimate in *Quiet* flush valve operation—yes, flush valve quietness you can depend on. These Sloan Flush Valves are ideal for Apartments, Hospitals, Hotels, Motels, private office toilet rooms, or for any installation where quietness is essential.

A major development of Sloan research and engineering, Quiet-Flush II is scientifically designed to quiet the high velocity flow of water due to excessive pressure in the lines (between 50 and 100 P.S.I.). In Sloan Flush Valves special means are employed to guide or interrupt the water so as to cushion and quiet its free flow.

Quiet-Flush II is applied at two points where water is restricted to control operation of the flush valve—(1) the control stop and (2) the

flush valve main seat. Permanently efficient without screening the water, new Quiet-Flush II equipment not only maintains quiet flush valve action, but when used in conjunction with closet bowls specifically designed for quiet operation the ideal result is obtained—total maximum quietness.

Quiet-Flush II is only one of many innovations designed to further improve the quality, dependability, ease of installation, and smart appearance of Sloan Flush Valves. So, for the Flush Valve of Tomorrow—Today—be sure to specify and insist on Sloan.

SLOAN VALVE COMPANY • 4300 WEST LAKE STREET • CHICAGO, ILLINOIS 60624

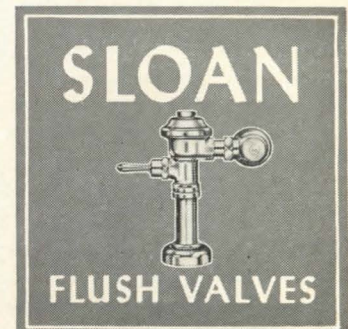

## Bidding on Public Contracts

BY BERNARD TOMSON AND  
NORMAN COPLAN

*P/A's legal team discusses a recent court decision which underscores that the protection generally afforded by competitive bidding on public construction contracts can be affected by the type of plans and specifications the bids are based on.*

In most states, it is the rule that a public contract may be let only to the lowest responsible bidder. The requirement of competitive bidding is based on the philosophy that it will produce public economy and "will preclude favoritism and jobbing." However, the protection afforded by competitive bidding on public construction contracts may be affected by the nature of the plans and specifications upon which the bids are based. If an architect's specifications can only be met by a limited number of bidders, the charge of international favoritism may be made and the contract award may be challenged in the courts on the ground that it subverts the objectives of competitive bidding.

In a recent New York case, *Gerzof v. Sweeney*, 16 N.Y. 2d 206, the Court of Appeals was required to determine a taxpayer's action that sought to annul a construction contract awarded by the board of trustees of the Village of Freeport for the purchase and installation of electric power equipment. It is the rule in New York, as well as in many other states, that a contract is illegal if a municipality has by indirection destroyed the efficacy of competitive bidding by so fixing or manipulating the specifications as to permit unfair advantage or favoritism. The defendant contractor was the only bidder on the project. The taxpayer contended that the specifications had been consciously designed to eliminate all bidders other than the defendant, since it was the only company that could meet the requirements of the project as stated in the specifications.

The Court, in setting forth the facts upon which its conclusion would rest, stated that, in 1960, the Village of Freeport had sought to supplement its power plant and had advertised for bids for the purchase and installation of a 35,000 kw generator. The specifications provided for a two- or four-cycle engine to be tested at the factory, but of no particular cylinder arrangement. In 1961, two bids were received. One bidder offered a four-cycle engine, with a factory test, for approximately \$615,000; and the defendant contractor offered a two-cycle "in line" engine for approximately \$673,000, but, contrary to the requirements of the specifications, without a factory test. The village engineer recommended to the board of trustees that it accept the lower bid.

Before any contract was awarded, a new mayor and two new trustees were elected and some months later the defendant's bid, which was the higher of the two, was accepted and the contract awarded to that company. The low bidder instituted a suit to have the contract award rescinded, and it was, in fact, set aside on the ground that it did not conform to specifications. The Court directed the village to award the contract as required by law.

The village did not award a contract to the low bidder, but instead ordered that new specifications be prepared. The changes in the new specifications were substantial, calling for a 5000-kw generator of a design identical to that submitted by the defendant contractor in its earlier invalidated bid. The new specifications also required that a successful bidder must have constructed at least three similar units showing satisfactory operating experience. The new specifications were submitted to the water and light commission of the village, which by this time had come to the conclusion that the expansion of the village power plant was not an economical venture and objected to the acquisition of any new gen-

erator at all. Despite this objection, however, the board of trustees of the village accepted the specifications as drawn and advertised for bids. Only the defendant contractor was able to meet the requirements of the specifications and his was the only bid.

The trial court refused to annul the contract, which was awarded to the defendant contractor on the ground that, while the evidence established that there was no other manufacturer constructing the equipment required by the specifications, there was "no showing that they could not do so if they felt so inclined." The Court of Appeals, however, reversed this decision and annulled the contract, stating that the trial court's decision "reflected a far too restrictive view of the conclusion to be drawn from the facts." The Court of Appeals stated:

"The record fails to explain or justify inclusion in the specifications of a distinctive design customarily employed by but one prospective bidder. Other manufacturers could, of course, construct the machine but only at a prohibitive cost. . . . Indeed, this impermissible result was assured by the specification requirement that the successful bidder must have had successful operating experience with at least three similar units. Such a scheme or plan is illegal in the absence of a clear showing that it is essential to the public interest."

The Court emphasized that its decision was not to be construed as establishing a rule that specifications could not be prepared which call for a particular product capable of being produced by only one manufacturer, or a limited number of manufacturers, if such specifications are in the public interest. The Court said:

"We do not mean to suggest that specifications for public projects are illegal merely because they tend to favor one manufacturer over another. More must appear in order to render the specifications and the contract based thereon illegal . . . since a particular product, that is, one marketed by only one manufacturer, may be required in the public interest."

Since

# HOPE'S

1818

## WEATHERSTRIPPED STEEL WINDOWS

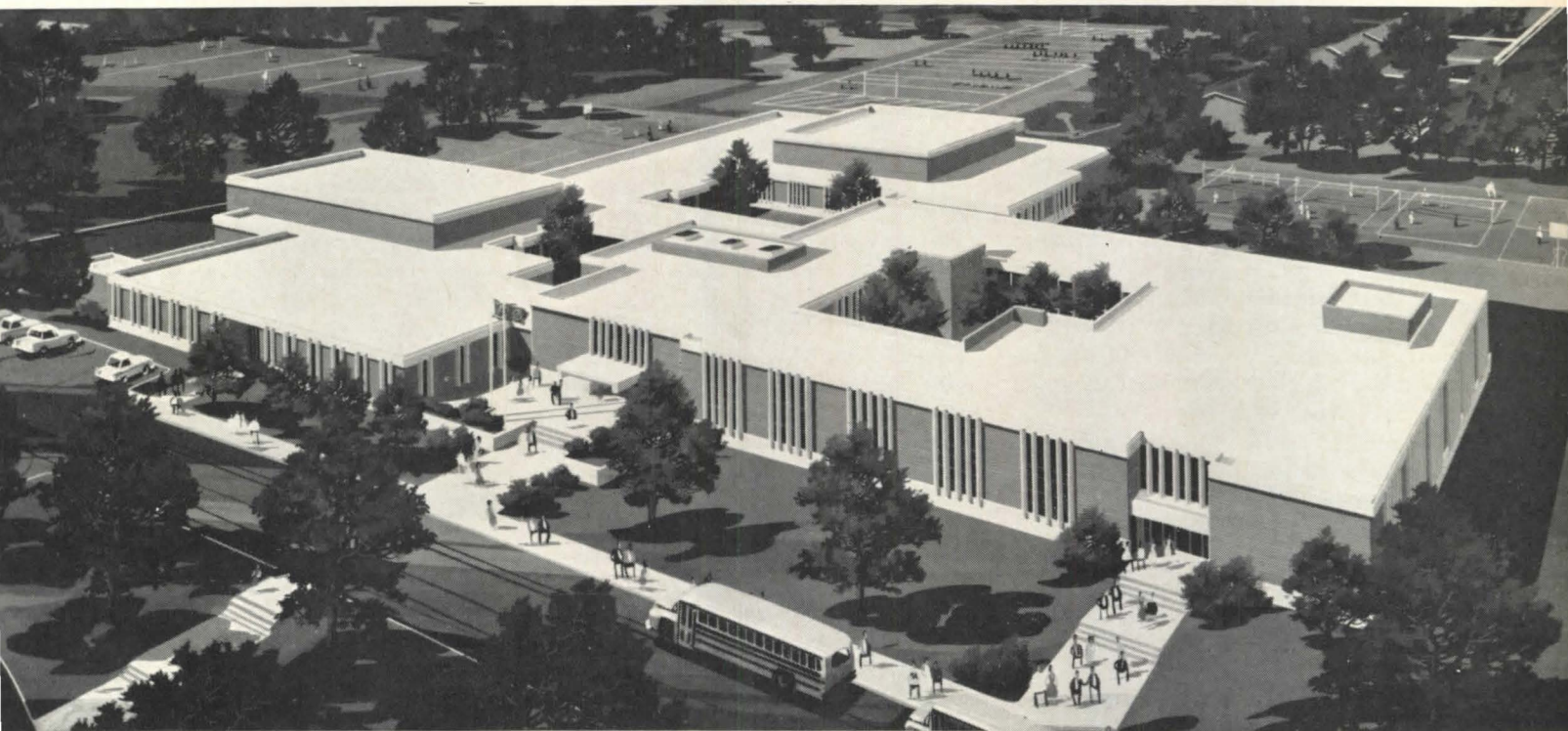

JOHN ADAMS MIDDLE SCHOOL • ALEXANDRIA, VIRGINIA

*Vosbeck-Vosbeck & Associates, Architects*

*M. L. Whitlow, Inc., General Contractors*

This attractive school structure will be well guarded against the cold draughts of winter. It is one of the first to incorporate Hope's revolutionary new Weatherstripped Steel Windows. Through specially designed continuous Neoprene weatherstripping, Hope's engineers have reduced air infiltration by more than 60% (confirmed by independent laboratory tests). These windows combine the strength and rigidity found only in steel, with an air infiltration rate well within the maximum established for weatherstripped aluminum windows. Here are some of the advantages:

- All windows constructed from hot rolled solid steel sections.
- Heavy ventilator section permits use of larger ventilators.
- To reduce maintenance and simplify initial glazing, windows can be inside glazed with continuous metal beads.
- $\frac{5}{8}$ " high glazing rebates comply with glazing requirements for  $\frac{1}{2}$ " insulating glass.
- All frame and ventilator corners mitered and solidly welded for greater strength and rigidity.
- Factory-finishing with Hope's Ultra-Coat available to eliminate field painting.

Hope's engineers are prepared to help you incorporate Weatherstripped Steel Windows in your building design; contact your local Hope's representative in the yellow pages, or write for Weatherstripped Steel Window publication No. 181-65.

## HOPE'S WINDOWS, INC. *Jamestown, N.Y.*

HOPE'S WINDOWS ARE MADE IN AMERICA BY AMERICAN WORKMEN

## Recent Church Literature

The first three books in this section, on liturgical architecture, are reviewed by Forrest Wilson, P/A Associate Editor.

### **Christ and Architecture**

By Donald J. Bruggink and Carl H. Droppers. Wm. B. Eerdmans Publishing Co., 255 Jefferson Ave., S.E., Grand Rapids, Mich., 1965. 708 pp., illus., \$20.

"Architecture for churches is a matter of gospel, and the gospel as understood by the Presbyterian/Reformed Church is worthy of proclamation." This is the evangelical pronouncement zealously propounded by the authors of *Christ and Architecture*.

Most architects will bridle at the opening statement that "Church architecture cannot be left to those of refined tastes, the aesthetic elite, or even the professional architect." However, they will be reassured later by the unequivocal statement: "It is impossible to build a church that is reformed according to the Word without receiving full services at the full architectural fee."

The authors are religiously convinced that architecture should follow worship, although their arguments seem at times to be tinged more with gospel fire and brimstone mysticism than with logical proofs of their contention. They state that if the gospel of Christ is worthy of accurate verbal proclamation, it is also worthy of faithful architectural representation. One could not argue with the logic of such a statement *per se*, but it seemingly fails to recognize the changing interpretations of the gospel that are the basis of the present rejuvenation in both theology and religious architecture. It also admits of the possibility, which the authors underscore, of heretical architecture. This in itself seems a strange concept and smacks of the graven image.

The new forces within the church have undeniably stimulated theology, and, along with it, architecture. They can hardly be ignored. These changes make the concept of a fixed gospel difficult to accept, particularly within narrow limitations. Further, a changing theology makes

*Continued on page 222*

### **Modern Churches Of the World**

By Robert Maguire and Keith Murray. E. P. Dutton, 201 Park Ave. S., New York 3, N. Y., 1965. 160 pp., illus., \$1.75.

"Like all the other material things the Christian Church uses, church buildings are not essential to the Church's life. If this is forgotten, churches quickly become an end in themselves, a danger to the life they should serve."

"We have chosen the buildings in this book for their architectural quality, and by this we do not mean their quality as self-sufficient works of art. Architectural quality is aptness at all levels—a 'nearness to need,' an appropriate place for the activity the building houses (which it houses so well that it becomes a symbol of that activity, of that aspect of man); and a relevance to its environment and the kind of culture of which it is the product, down to the kind of stuff it is made of and the way the stuff is used."

Statements of principle such as these, coupled with the excellent, catholic selection, and the all-too-short comments of the authors, have combined more in this brief paperback to show the emerging excitement of liturgical architecture than the two other volumes under review combined.

From "The Cross as Symbol and Ornament," by Johannes Troyer. Copyright 1961 by W. L. Jenkins, The Westminster Press. Reproduced by permission.



### **For Thy Great Glory: The Building of Washington Cathedral**

By Richard T. Feller and Marshall W. Fishwick. Community Press Publication, 1965, 111 pp., illus., \$15.

According to the authors, the idea of Washington Cathedral is as old as Washington itself. This would seem to be a fairly accurate statement, for it certainly lacks the inspiration of the great cathedral builders of the Middle Ages. In any event, Washington Cathedral has been under construction long enough for everyone to accept it like a mountain. And although the nobility of our nation has not as yet hitched itself to the traces in penitent labor to drag its stones into place, as was the custom in the Middle Ages, they do officiate at its dedications.

If the reader can accept such statements as, "The job of today's cathedral builder is to use technology to glorify God," when these are applied to a Gothic cathedral built some 600 years after the age of the great cathedrals, he should be able to get through the book.

The book bears a strong resemblance to the cathedral it describes. It displays the same lack of dramatic tension, and its form is no more remarkable than the cathedral. It is a chronicle that lauds the men who built the cathedral, and it is heavily weighted toward such issues as the drama of purchasing, for example. One cannot find any bad guys, and, more than that, it would be impossible to uncover a ribald gargoyle on the building. This lack of spirit characterizes both works.

A look at the photographs reveals a fascinating study of time and change: The reader witnesses the emergence of a Gothic cathedral overlooking modern Washington. Ironically, the passage of time is not so much revealed in considering the span of 600 years since the age of the cathedrals, but in the 60 years since construction was begun, when horses were used on construction jobs,

*Continued on page 236*

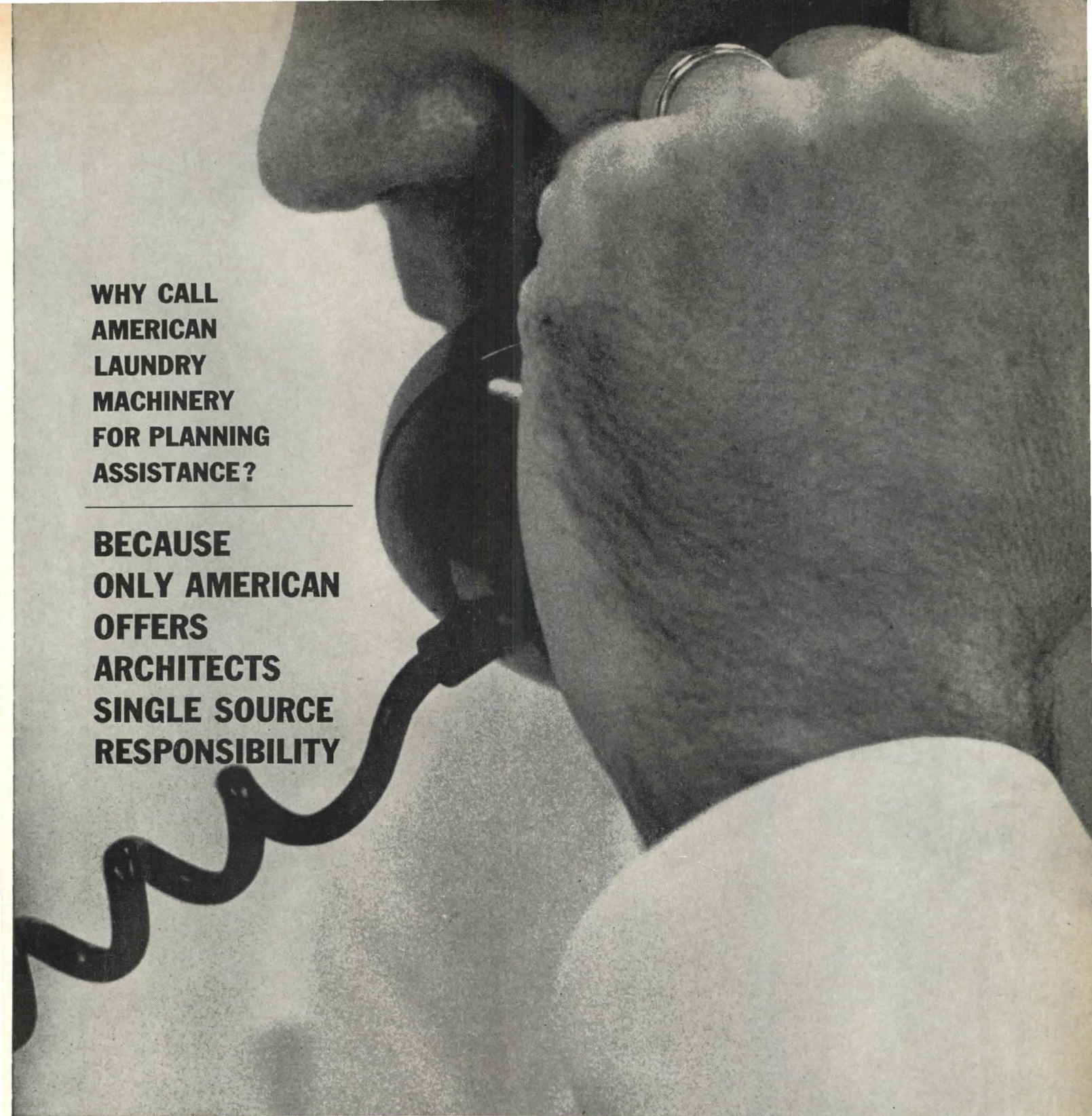

**WHY CALL  
AMERICAN  
LAUNDRY  
MACHINERY  
FOR PLANNING  
ASSISTANCE?**

---

**BECAUSE  
ONLY AMERICAN  
OFFERS  
ARCHITECTS  
SINGLE SOURCE  
RESPONSIBILITY**

**One source** for laundry department survey engineering, floor plan layouts and detailed specifications.

**One source** for laundry equipment of every type and size. With the long life of American equipment this can be extremely important five or ten years after a job is completed.

**One source** for factory supervision of all equipment installation, including wiring, piping, steamfitting, etc.

**One source** for continuous repair parts service and field engineering service for the life of the equipment, anywhere in the country.

Architects we have worked with find this sort of laundry planning assistance invaluable. (A list of these firms is available upon request.) Why not call American today? Our offices and representatives are listed conveniently in the Yellow Pages.



You get more from   
**American**  
American Laundry Machinery Industries • Cincinnati 12, Ohio

On Readers' Service Card, circle No. 324

# NATCOR DOORS

**THE SUPER DOOPER**

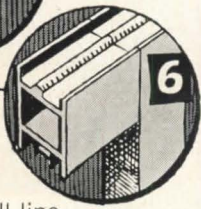
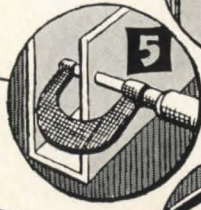
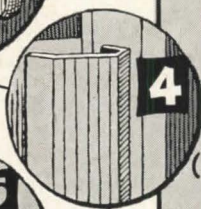
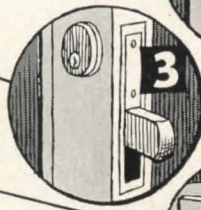
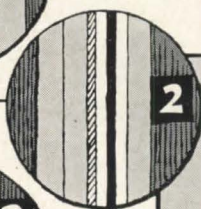
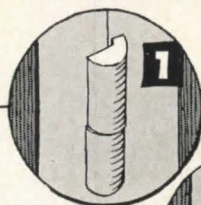
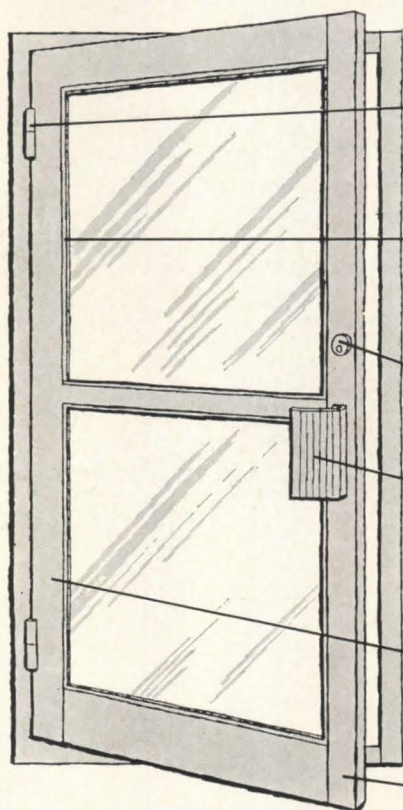

**NATCOR**  
THE  
SUPER DOOPER  
DOOR MAN SAYS:

*"REMEMBER, YOU CAN FORGET NATCOR"*  
(AFTER THE INSTALLATION THAT IS)

Member NAAMM  
For complete information on Natcor's full line of doors and entrances, see our catalog in Sweets or write:



**THE NATCOR COMPANY**  
SINCE 1920  
P. O. BOX 9321 / NASHVILLE, TENNESSEE

- 1** Patented, adjustable Butt Hinge — Ball Bearing with frame reinforcement for extra endurance.
- 2** Snap-In Vinyl Glazing Bead — Only one member to snap in during glazing of door — saves labor.
- 3** Maximum Security Lock — with 13/8" throw, case hardened steel bolt and weather-stripped face plate for pairs of doors.
- 4** "Sure-Grip" Pull Handle — Broad selection of contemporary styled stock interchangeable — Push-Pull Hardware.
- 5** Quality Extrusions — Door Stiles and Rails of fully extruded aluminum 1/8" wall thickness throughout as specified by architects.
- 6** Reinforced Corner Construction — Heavy, concealed reinforcement brackets are firmly bolted to door stiles. Tri-clad welding of each joint after bolting results in complete rigidity.

# Texture



## Texture is the thing about Tectum...

**but not the only thing.** Tectum<sup>®</sup> is a decorative ceiling. Yes. But it is also a structural material. A strong form plank. A rigid roof deck. An insulator with a "k" value of 0.55. An acoustical treatment, with a sound-reduction coefficient up to .90. It's lightweight. Incombustible. Immediately available in widths and lengths to fit your design. Its potential is virtually untapped. So why don't you start tapping? Call your Gold Bond<sup>®</sup> Representative. Or write to National Gypsum Company, Dept. T-16, Buffalo, N. Y. 14225.

Texture is the thing about Tectum...  
but not the only thing.







it difficult to establish heresy, since the pronouncing of heretical beliefs assumes an entrenched theology—and not the living gospel that the authors believe the Presbyterian/Reform Church to proclaim.

Since the book continues to emphasize the Word, one is more and more sympathetic to Mauriac's statement, "How sorry I am for the Protestants, whose worship is nothing but words." This careful and somewhat lengthy sermonizing on

the meanings and derivations necessary to an understanding of the form of a Protestant/Reformed Church will undoubtedly be of great value to the architect who plans to design one. Not only will he be convinced by *Christ and Architecture*; he might well be converted.

The section of the book that deals with the selection of a church architect is intelligently handled, however, in a book the reader begins to dismiss because of its pedantry. The discussion of economy, programming, and structure in church architecture is on an equally good plane

and will be valuable for churchmen and architects alike, since it forms a sort of Graphic Standards of church requirements. These factors, combined with the catholic taste of the authors, make the book valuable, despite its overemphasis on The Word. Numerous photographs, many of them of a high quality (although they occasionally contain pleasant heresies), make the book interesting.

The reader is somewhat startled to find in a not unpleasant A-frame "Gothic" the work of the authors. The objective, unprejudiced evaluation of it adds a slight touch of humor. When the reader turns to the interiors, however, he is even more startled by the excellence of the design and the restrained, religious feeling of the space. In conclusion, it might be best, in evaluating this book, to paraphrase the statement of an old philosopher: "Don't listen to what I say, but look at what I did."

### Who Needs It, And For What?

BY ROBERT B. RILEY

ENCYCLOPEDIA OF MODERN ARCHITECTURE. Edited by Wolfgang Pehnt. Harry N. Abrams, Inc., 6 West 57 St., New York 19, N.Y., 1964. 336 pp., illus., \$25. The reviewer has served as Editor of Potomac Valley Architect and is currently a practising architect and architectural writer based in Albuquerque, New Mexico.

This book, described in the blurb as "the first encyclopedia of modern architecture ever published," is the work of 31 writers from 16 countries. It contains an intelligent introduction on the history of the modern movement, 300 pages of alphabetically arranged text interspersed with illustrations, a brief bibliography, and an index of names. The photographs are of a high quality and the layout is orderly without being dull.

Unfortunately, most current architectural books are produced with no clear idea of their purpose or their audience. The first question that arises, then, is whether an encyclopedia of modern architecture fulfills any need beyond a bookseller's profit. If it is needed, what specifically should or could it cover? Who needs it, and for what? The publishers and editor seem never to have asked these questions, and the book shows it. I wonder if it was not conceived by an enterprising gentleman who, seeing that the publishers' catalogs had no listing under "Architecture: Modern: Encyclopedias of . . ." rushed off to fill

Continued on page 228

## NEWLY DESIGNED COMBINATION UNIT

Bobrick's new stainless steel Paper Towel Dispenser-Waste Receptacle is only 56" high for better washroom design. Installs easily at correct height for convenient use.

### 25% Greater Towel Capacity

Larger cabinet, with concealed tumbler lock. Interior utility shelf provides added storage.

### 15% Greater Waste Capacity

Larger receptacle with wider opening keeps towels off the floor.

### Installs in 4" Wall at No Added Cost

Model B-3944 for 4" wall needs no skirt or side panels. Model B-3900 (shown) recesses in 8" walls. Write for Washroom Equipment Catalog.



**BOBRICK**

## THE BOBRICK CORPORATION

Since 1906 Designers and Manufacturers of Washroom Equipment  
503 Rogers Avenue, Brooklyn, New York • 11611 Hart Street, Los Angeles, California  
On Readers' Service Card, circle No. 433



**ONLY POOL WARRANTED TO END RUST,  
CRACKS, AND LEAKS**

# CHESTER

---

## ALL-ALUMINUM

---

### SWIMMING POOLS

AND

### DIAVAC FILTERS

*Finest operating hydraulic system  
ever developed for swimming pools*



- ALL SHAPES IN GROUND
- ABOVE GROUND — ELEVATED
- ROOF TOP
- INDOOR-OUTDOOR
- CONCRETE BOTTOM (Optional)
- COMPLETE ACCESSORIES
- DIAVAC FILTERS

*In Olympic and A.A.U. Standard Sizes  
or Custom-Designed in All Sizes  
and Diavac Filter Systems*

# CHESTER

## ALL-ALUMINUM

### SWIMMING POOLS

Precision-engineered and fabricated . . . individually adapted to your design. Specified by leading architects throughout the world.

Cost less per year than any other pool. Initial cost competitive, often less. Proved virtually maintenance-free over twelve years in all climates.

Municipalities and Parks



Schools, Indoor Installations

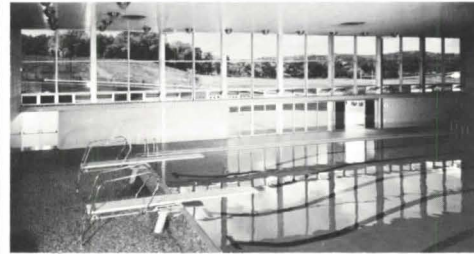

Roof-top and Other Above-ground Installations



Country Clubs and Swim Clubs



**Flexi-Bottom** — Resilient aluminum bottom offsets ground swell due to freezing and other stresses from pressure and temperature changes.

**Integral Recirculating System** — All recirculating piping and gutter built into prefabricated pool walls. Reduces site preparation to minimum.



**Vacuum-Tested Welds** — Pool assembled on site from factory-fabricated sections joined by expert M.I.G. arc-welding. Every weld vacuum-tested for water-tightness.

**Self-Supporting Construction** — "A"-frame plus heavy wall section make wall self-supporting.

**Niche for Underwater Light** — A permanently water-tight receptacle.

**DIAVAC FILTER**—Perfect complement to the Chester Pool for trouble-free, low-cost operation. Vacuum principle with diatomite filter agent sets new standard for easy control, hygienic water. A complete-package-system, self-housed, delivered ready to run, needing only connection to utilities.

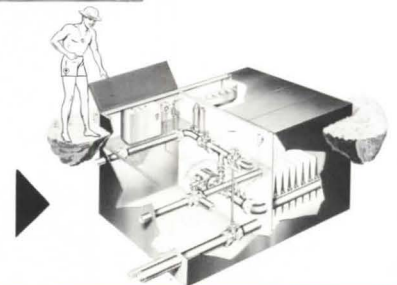

**Chester Products, Inc.**  
 Belle Ave. and B & O RR, Hamilton, Ohio 45015  
 Send full color catalog and list of Chester Pool installations.

Name \_\_\_\_\_

Street \_\_\_\_\_

City \_\_\_\_\_ State \_\_\_\_\_ Zip \_\_\_\_\_

Signed \_\_\_\_\_ Title \_\_\_\_\_

CHESTER  PRODUCTS  
 INC.

Belle Ave. and B & O RR

Hamilton, Ohio 45015

# Our desk file drawer has nothing to hide.



See.

It rolls all the way out. Even beyond the desk front.  
So you can see everything from A to Z.  
Quickly, easily.

And every inch is useable. Takes two rows of files instead of the usual one. Because there's almost twice as much filing space as an ordinary file drawer.

Always opens and closes smoothly, and quietly.  
Special nylon tire rollers make sure of this.

Now note the drawer handle. There isn't one. Instead, we rabbeted the drawer's outside edge. Even your secretary can pull it open with just her finger-tips. Without breaking a nail.

Everything about our contemporary desks is made the way office furniture ought to be. Furniture that looks beautiful and works beautifully—a solid investment for the management who pays for it.



**ART METAL INC**  
JAMESTOWN, NEW YORK

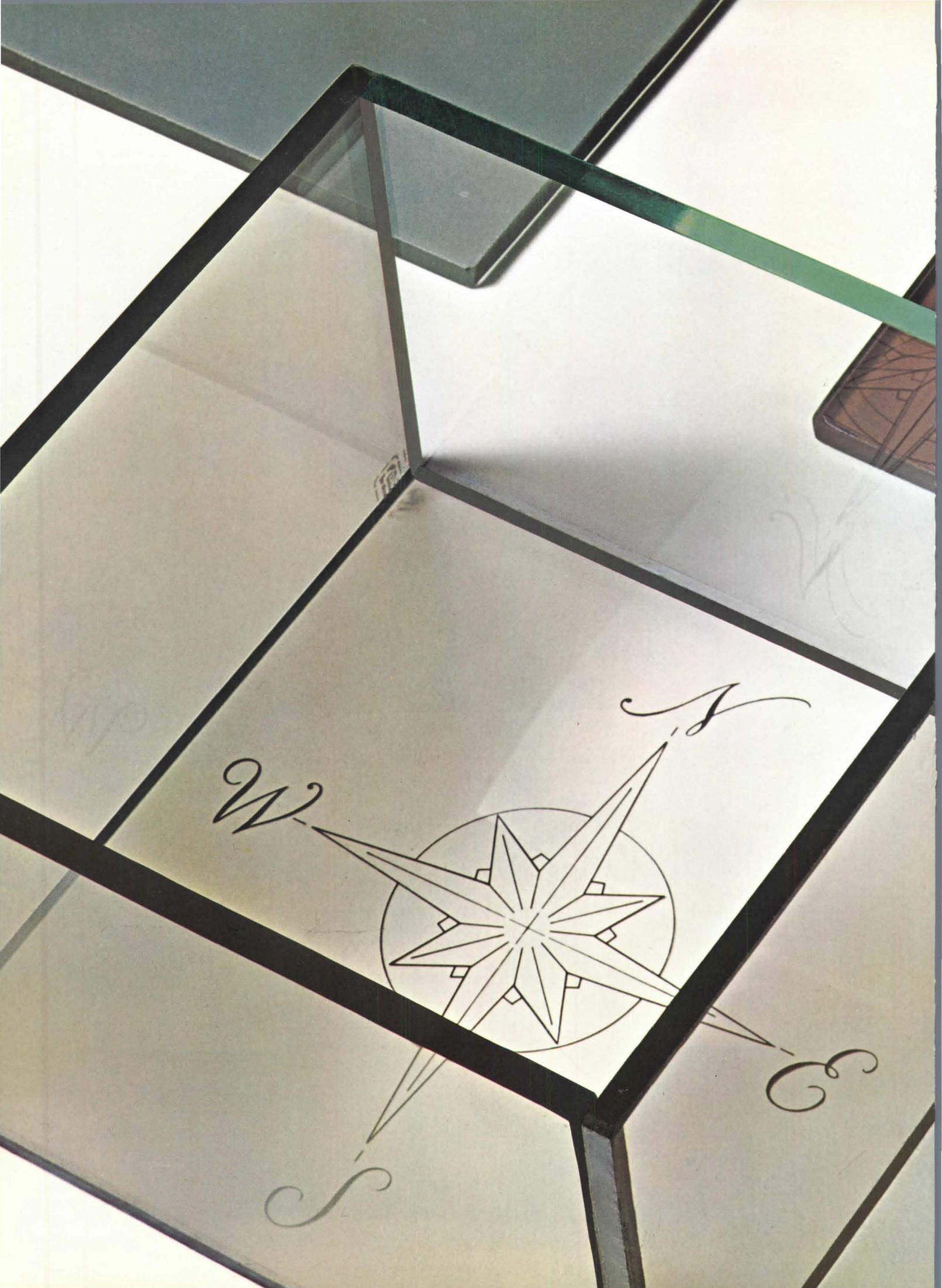

New environmental control  
with Glass Conditioning\* from PPG

The glass you select to control heat loss on the north side of a building may not be the best glass to use on the south side. Each elevation presents a different problem. PPG has the full range of environmental glass to control glare and reduce heat gain or loss for optimum comfort and economy on every exposure of any building.

Your PPG Architectural Representative can bring the advantages of Glass Conditioning to your building. He can help you select the right glasses to provide maximum indoor comfort while contributing materially to lower heating and air conditioning costs. Call him or write: Glass Conditioning Services, Pittsburgh Plate Glass Company, One Gateway Center, Pittsburgh, Pennsylvania 15222.



**PPG MAKES THE GLASS THAT MAKES THE DIFFERENCE**

\*Service mark of the Pittsburgh Plate Glass Company

Continued from page 222

the gap ahead of his competitors.

Despite such carping, the book is of value. It will help the general student who is ignorant of architecture and needs quick, concise, and reliable information on a specific point. Its urbane writing and clean, spacious layout make it ideal for the curious layman fond of browsing through architectural books. People who prepare themselves for cocktail party small talk on the arts, may their souls burn in hell, will use it as a source book. Architects, like myself, who can never remember whether so-and-so

was in the Amsterdam or Rotterdam school, will find it handy. Architects who want a comprehensive reference and research tool will find it scanty and unsatisfactory. In short, it is a fine lay reference book—one that belongs in every general library. But the ideal professional reference book on modern architecture, one that will present in one or more volumes in English a guide to the many buildings, documents, and people that have shaped the last hundred years, still needs to be written.

Within these limitations, the book is good, very good. The style and scholar-

ship are superb, marred only by an inane entry under "Town Planning." Assembling such a book requires value judgments as to who and what is important and unimportant. One man's hack is another man's form giver, so it would be foolish to argue my prejudices against those of the editor. The biggest fault of the book is not that personal judgments are made, but that they are made erratically. Most entries, short or long, are treated in typical encyclopedia style: a chronological account is followed by a critical but detached brief evaluation of the subject's place within the larger scheme of architecture. In other entries, though, the subject matter serves only as a jumping-off place for highly personal thoughts on people, styles, and architectural philosophy. Both of these approaches are valid, but combining them willy-nilly produces an irritating unevenness and likely misinterpretation of the writer's intent. Since the book is of more value to laymen than to architects, the editor would have been wiser to stick to the objective approach. The articles that least belong in the book, however, are just those that the architect will remember—with anger. Reyner Banham, for example, has sneaked in a gratuitous entry on "Neo-Classicism," and used it as a handy forum for his opinions on the Ecole des Beaux Arts and its influence on modern design, current U. S. architecture, and the P/A Design Awards. Banham has the wit and insight to bring this sort of thing off, but his fellow contributors do not.

The book tries hard to be completely current, so some contemporary architects are given more space than they perhaps deserve. Unfortunately, this effort to be up to the minute only includes persons, buildings, and systems prominent in practice, and ignores contemporary visions of new technologies, new systems of analysis and interdisciplinary research, new concepts of city-structure, and the like. This is too bad, for the nonprofessional reader will thereby miss the very ideas that make current architecture vital.

Looking back over the years covered in the book, one realizes that an encyclopedia written in 1955 would have dealt with essentially the same people, the same styles and philosophies as one written in 1925. In contrast, as Wolfgang Pehnt points out in his introduction, this book discusses aspects of architecture undreamt of just 10 years ago. One finishes the book wondering what a 1975 encyclopedia will contain that we in our turn cannot foresee.

new  
edition  
now  
ready!

*our 42nd year*

**The most complete  
and authoritative  
guide for . . .**

- WEATHER STRIPPING
- SOUND-PROOFING
- LIGHT-PROOFING
- THRESHOLDS

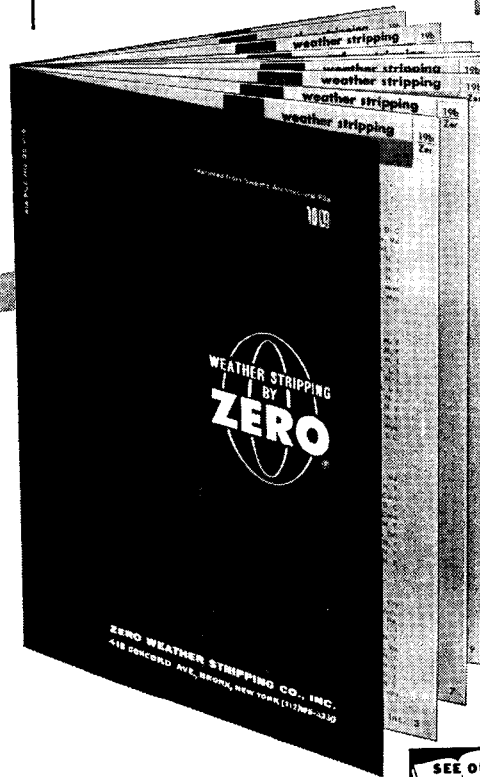

**ZERO'S 1966  
Catalog shows  
many new  
products,  
contains 175  
full size  
drawings.**



**ZERO WEATHER STRIPPING CO., INC.**

Our 42nd year of service to architects

415 Concord Avenue, Bronx, New York 10455 • (212) LU 5-3230



On Readers' Service Card, circle No. 413



Do you know  
that Soundmaster  
is available  
in 400  
different colors?

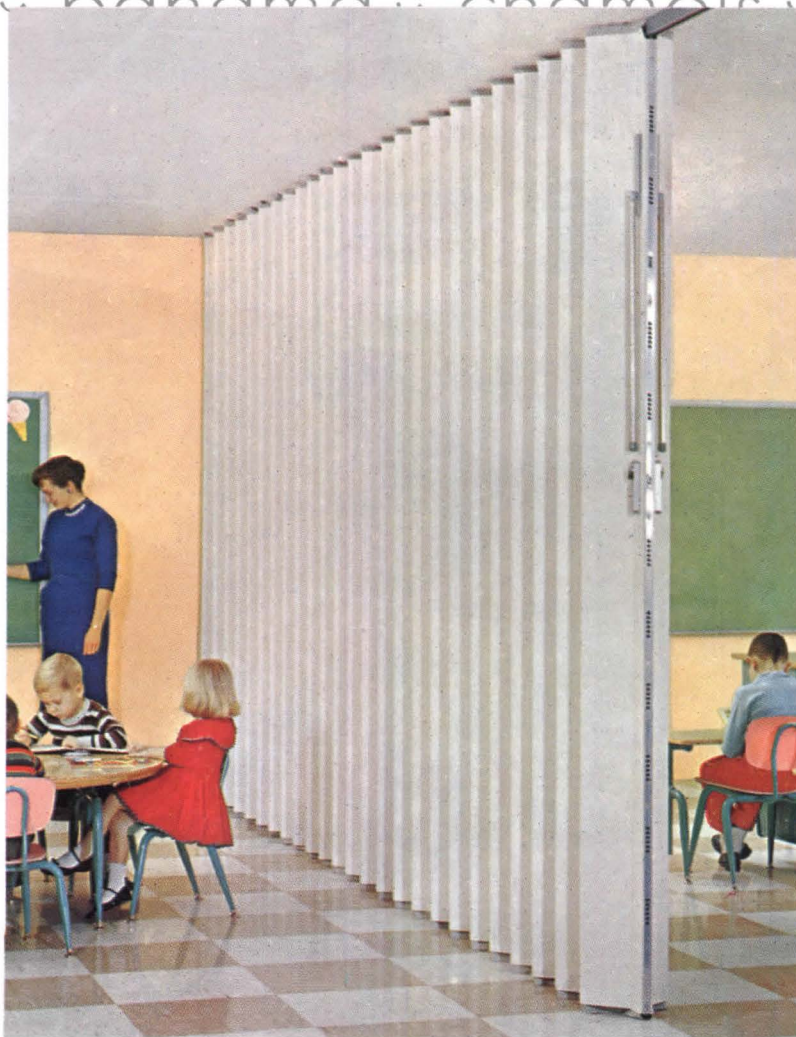

"Yes, Modernfold. What's new?"

**RARE  
EXCITING  
WOODS!**



avodire ✦ ebony ✦ limba ✦ makori ✦ sapeli



eak ❧ zebrawood ❧ paldao ❧ avodire ❧

Let your design thoughts roam the forests of the world. Tanganyika, India, Samoa or Tennessee. Here are the exciting, unmatched patterns, colors and designs of nature.

Create from these rare exotic, or Modernfold's collection of regular veneers, an individual mood for your buildings' interiors.

This is the promise of Modernfold

Woodmaster 800 and 1200. A wood operable wall of superior design and construction. Single sizes up to fifty feet wide, sixteen feet high. Used in pairs or multiples for larger openings. Patterns run uninterrupted top to bottom.

Use Woodmaster in straight line or curves. Electrical operation, too.

Woodmaster is truly the folding partition that can be a design element.



# MODERNFOLD

An unmatched resource for creative designers



Year after year we make more operable walls, in more materials, more sizes, more finishes, for more applications than anyone else.

Modernfold makes every type operable wall—steel, aluminum, fabric accordion, flat surface, wood coiling, wood panel and sound retarding. Walls specifically designed for intended applications. Engineered for today's space divisions needs.



If you have a partitioning need, call your Modernfold distributor. Or call us (Area code 317—529-1450). We will give you his name and assist you in every other way possible. Or write: New Castle Products, Inc., Dept. A New Castle, Ind. 47362.





## Ever try to open a ten-year-old "economy" window?

### Then why would you ever use anything but a Republic 138 steel window?

Designing a building where children will want to raise windows? Where secretaries will want more air? Where windows have to open? Then guard yourself and your building against time, temperature, and deterioration with long familiar favorite Republic 138 Steel Windows. Time tested is a trite phrase, true—but in this example it applies. Consider the reasons why architects, builders, and owners still consider the 30-year-old 138 the finest available:

- Precision manufactured, to machine tool standards. Truly unusual tolerance standards for a building product.
- Fingertip operation. Motor spring type balances with impervious stainless steel tapes insure this rewarding experience for the life of the building.
- Snug fit. No rattles, open or closed. Steel can't warp, swell, stick, or shrink.
- Weathertight. Stainless steel weather stripping locks weather out, keeps heat in. Tightest for air conditioning. Air leakage . . . in . . . out . . . next to zero.

So, we'll ask again—for schools, hospitals, commercial buildings, apartments, dormitories, nursing homes, hotels, office buildings, professional buildings, motels—wherever windows must open and close, why take a chance on anything less certain than the old reliable 138?

Want to know more about why we and past buyers are so prejudiced? Use the coupon.

Another favorite, Republic "DONOVAN" Awning Type Steel Windows . . . outward opening ventilators with a choice of concealed vertical shaft operation, hand operation, hand chain, or loose crank. Selective opening of vents provides combined ventilation and weather protection. Fully described in free catalog, with specifications. Ask for it!

We've been in the business of letting more light in on a remarkable number of subjects, for a remarkable number of years, with windows for residential, commercial, monumental, and industrial buildings—and that's the word for the Republic line of windows—remarkable. Write for our remarkable catalog.

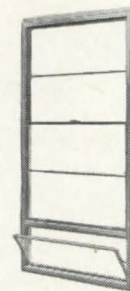

This STEELMARK of the American Steel Industry on a product assures you it is modern, versatile, economical Steel. Look for it on products you buy.



We're thinking ten years ahead, too. Send your remarkable window catalog.

Name \_\_\_\_\_ Title \_\_\_\_\_

Company \_\_\_\_\_

Address \_\_\_\_\_

City \_\_\_\_\_ State \_\_\_\_\_ Zip \_\_\_\_\_



## MANUFACTURING DIVISION

REPUBLIC STEEL CORPORATION  
Dept. PA-2745, Youngstown, Ohio 44505

\*A Trademark of Republic Steel Corporation



THE MAN FROM MANUFACTURING \*

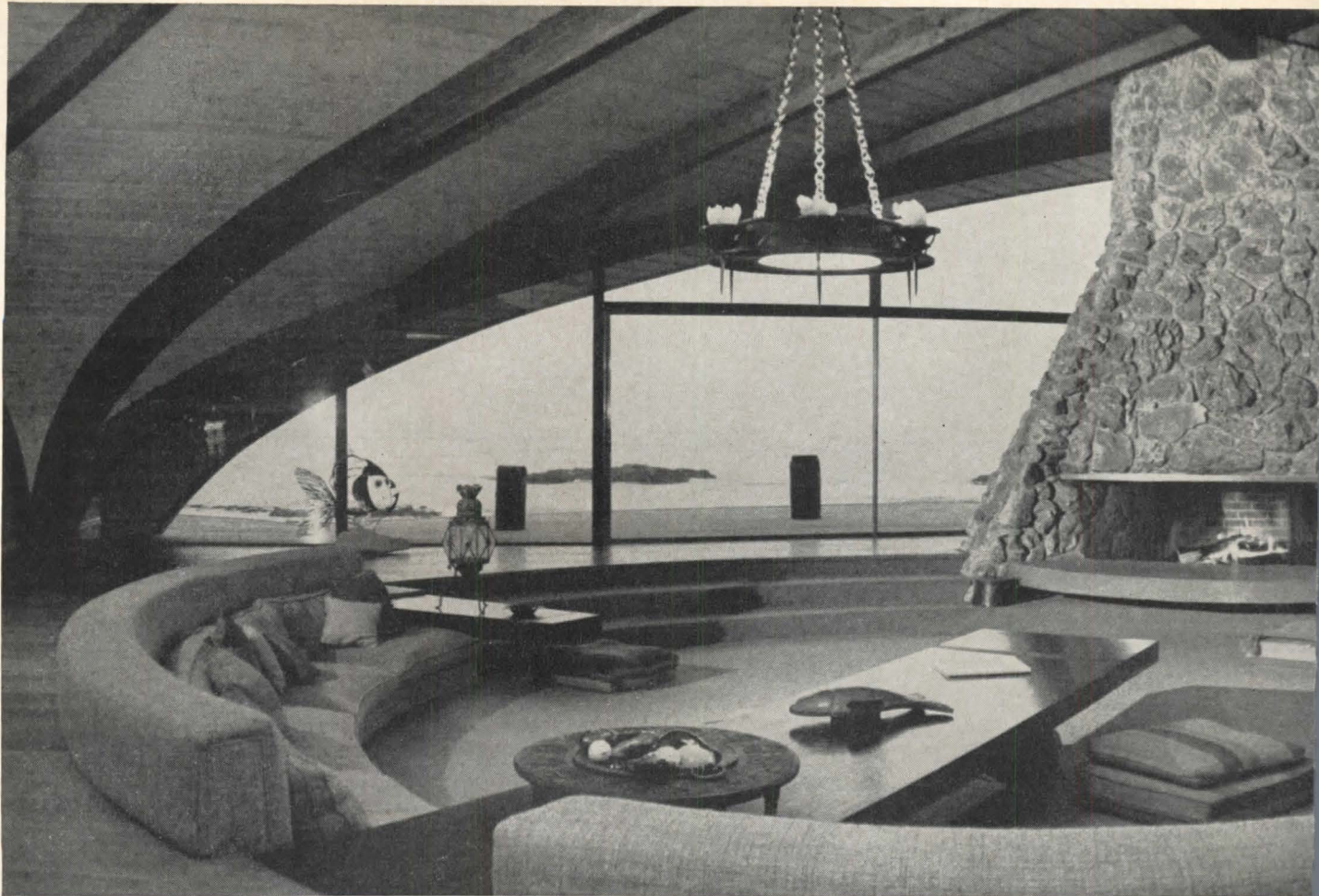

**“Sweeping waves” of Western Wood...  
designed to withstand 100 mph winds with  
beauty and grace.**

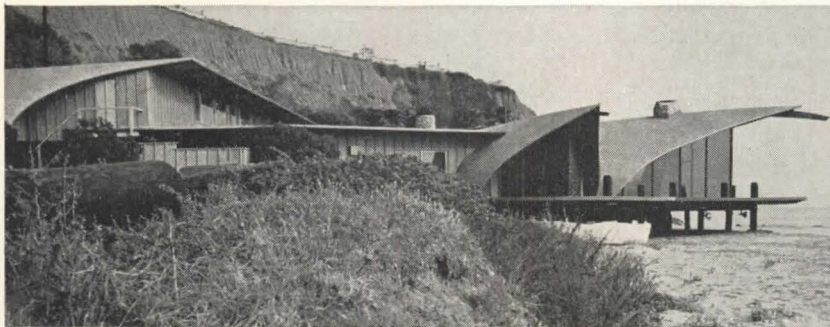

**Blending man-made with nature**

These roof forms were designed to be viewed from any angle, to suggest the waves that are ever present and to blend with and compliment their total environment—the sand, mountains, rock walls and ocean—all incorporated into a house totally integrated with its surroundings.

**Clear spans give space and beauty**

The striking interior features a ceiling spanning 57 feet of clear space, achieving an ultimate height of 18 feet. Graceful Douglas Fir glued-laminated beams support 3-in. knotty Red Cedar decking, over which built-up roofing was laid.



Continued from page 216

when workmen wore mustaches and wide-brimmed hats, and when superintendents, fully suited with gold-watch chains, climbed atop the construction to lordly instruct, "Cut it there for me."

There are also one or two moments of pure joy, such as the photograph of a mason sitting on the stone he is tapping into place. Those with a surrealistic bent may also enjoy the incongruity of cast iron soil lines juxtaposed with the ogive arch. But if one is to take the book seriously, and with it the cathedral, the very concept of the Gothic as a terminal form is entirely contradicted by both contemporary structure and contemporary theology. The idea of a terminal form implies a terminal religion, which neither contemporary religious architecture nor contemporary theology is willing to accept.

If one is willing to forget his architectural prejudices about a building that was begun more than 600 years too late and has been more than 60 years in the building, and overlook the absolutely bad taste of the carving (although the iron work is superb), the book may be enjoyed like the cathedral—because it is there.

### A Potpourri of Current Opinion

BY FRANCES PIVEN

CITIES. *A Scientific American book.* Alfred A. Knopf, 501 Madison Ave., New York, N.Y., 1965. 211 pp., \$2.45 (paper) \$4.95 (cloth). The reviewer is Study Director at the Columbia University School of Social Work and has been a consultant to Mobilization for Youth and the Office of Economic Opportunities.

This is a collection of articles published first in an issue of *Scientific American*, and now commemorated under the auspices of its presumably unifying theme, "Cities." The city may be a subject sufficiently novel to the readers of *Scientific American* to justify a sampling of urban experts and points of view, but for those more regularly exposed to the stream of literature on urbanism, this volume adds little, either in new information or new ideas.

The introductory article by Kingsley Davis, discussing population changes associated with urbanization today, is an exception. The crucial point of this article is that the rapid growth of cities in underdeveloped areas is not associated with a stage of economic development, as was the urbanization of Western nations, but is rather a reflection of the surge in population in underdeveloped areas generally—as evidenced in urban and rural overpopulation alike. A broad and comprehensive context is thus set for the problems of the city—a context that is not, however, exploited by most of the remaining articles. Gideon Sjoberg presents a competent, if unstartling, piece on the evolution of cities, and Hans Blumenfeld writes on the planning of the modern metropolis. These subjects are each so broad that the short space allowed virtually forces the authors to restrict themselves to fairly standard summary statements.

Four articles are devoted to specific cities—Calcutta, Stockholm, Ciudad Guayana, and New York—each presumably selected as archetypes of the modern metropolis. Whatever such a juxtaposition might have yielded in understanding is obscured, however, by the variety of approaches and problems fastened upon by the respective authors: Calcutta is discussed in terms of its ethnic variety, and Stock-

Continued on page 240

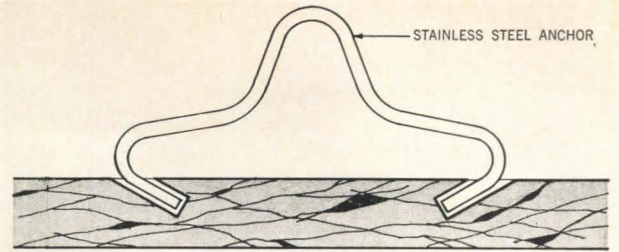

TYPICAL ANCHOR

MARBLE-FACING  
HALF FULL SIZE

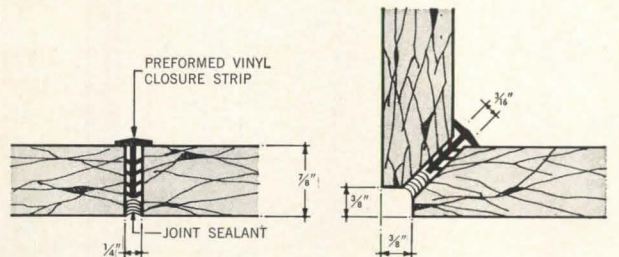

TYPICAL JOINTS

MARBLE-FACING  
HALF FULL SIZE

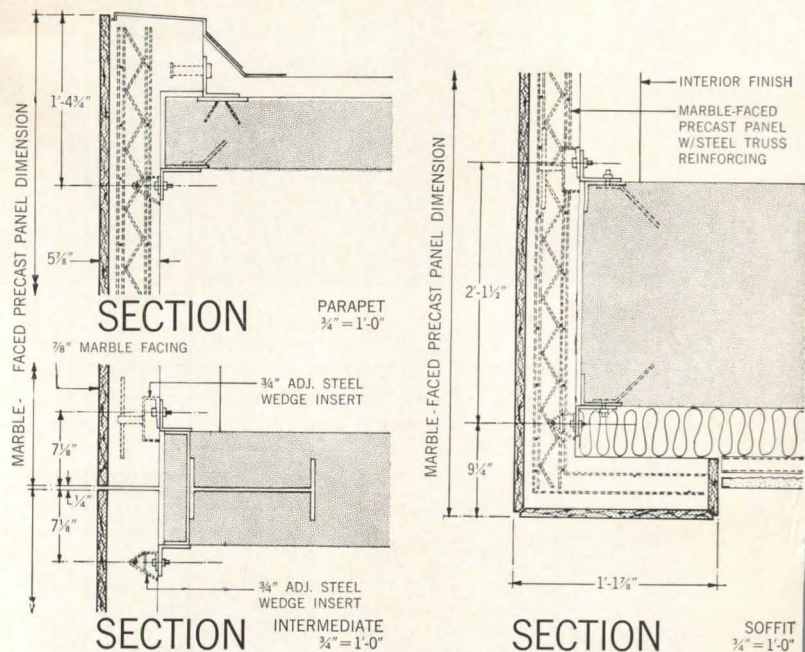

SECTION

PARAPET  
¾" = 1'-0"

SECTION

INTERMEDIATE  
¾" = 1'-0"

SECTION

SOFFIT  
¾" = 1'-0"

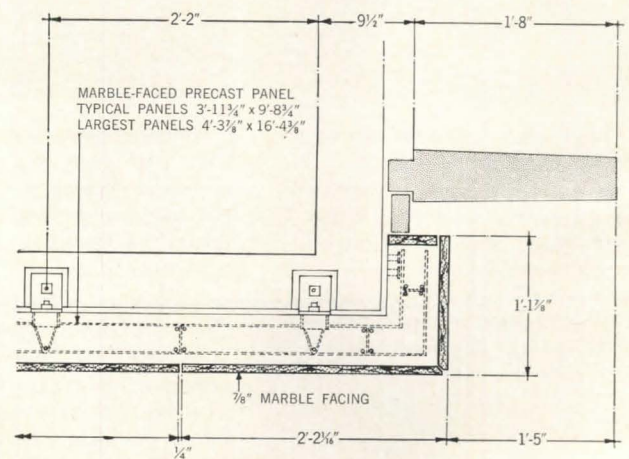

PLAN

END PANEL  
¾" = 1'-0"



# marble-faced precast

adorns award-winning design for the  
headquarters for hemisphere health.

It's an outstanding addition to the panorama of the Foggy Bottom area of Washington. It houses both the Pan American Health Organization and the regional office for the Americas of the World Health Organization.

This design, featuring an unusual application of American-quarried marble, won the competition which solicited designs from all countries throughout the Americas. The end walls of the curved Secretariat Building are distinguished by marble-faced precast panels up to 4 x 16 feet in dimension.

Marble helps good design come to life . . . at a surprisingly small percentage of any building budget. Members of the MIA are ready to assist you with design counsel, technical assistance or any information you might need in the application of marble, exterior or interior.

**MARBLE INSTITUTE OF AMERICA**  
PENNSYLVANIA BUILDING • WASHINGTON, D. C. 20004 • (202) 628-0214

Pan American Health Organization, Pan American Sanitary Bureau Regional Office of the World Health Organization. Designer: Roman Fresnedo Siri and Justement, Elam, Callmer & Kidd, Architects.

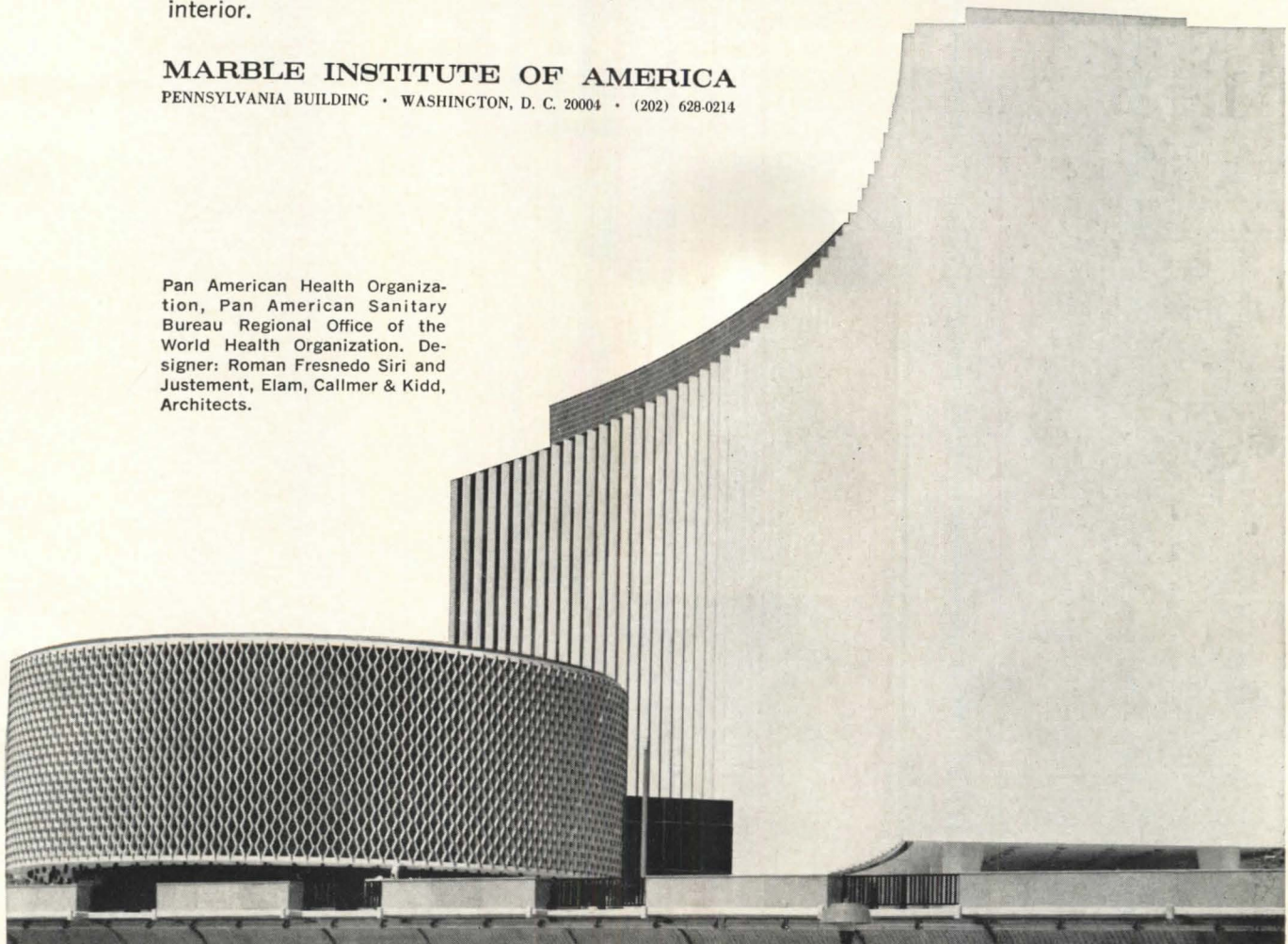
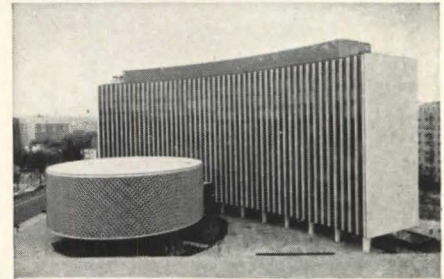
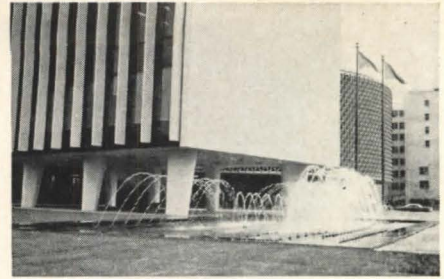

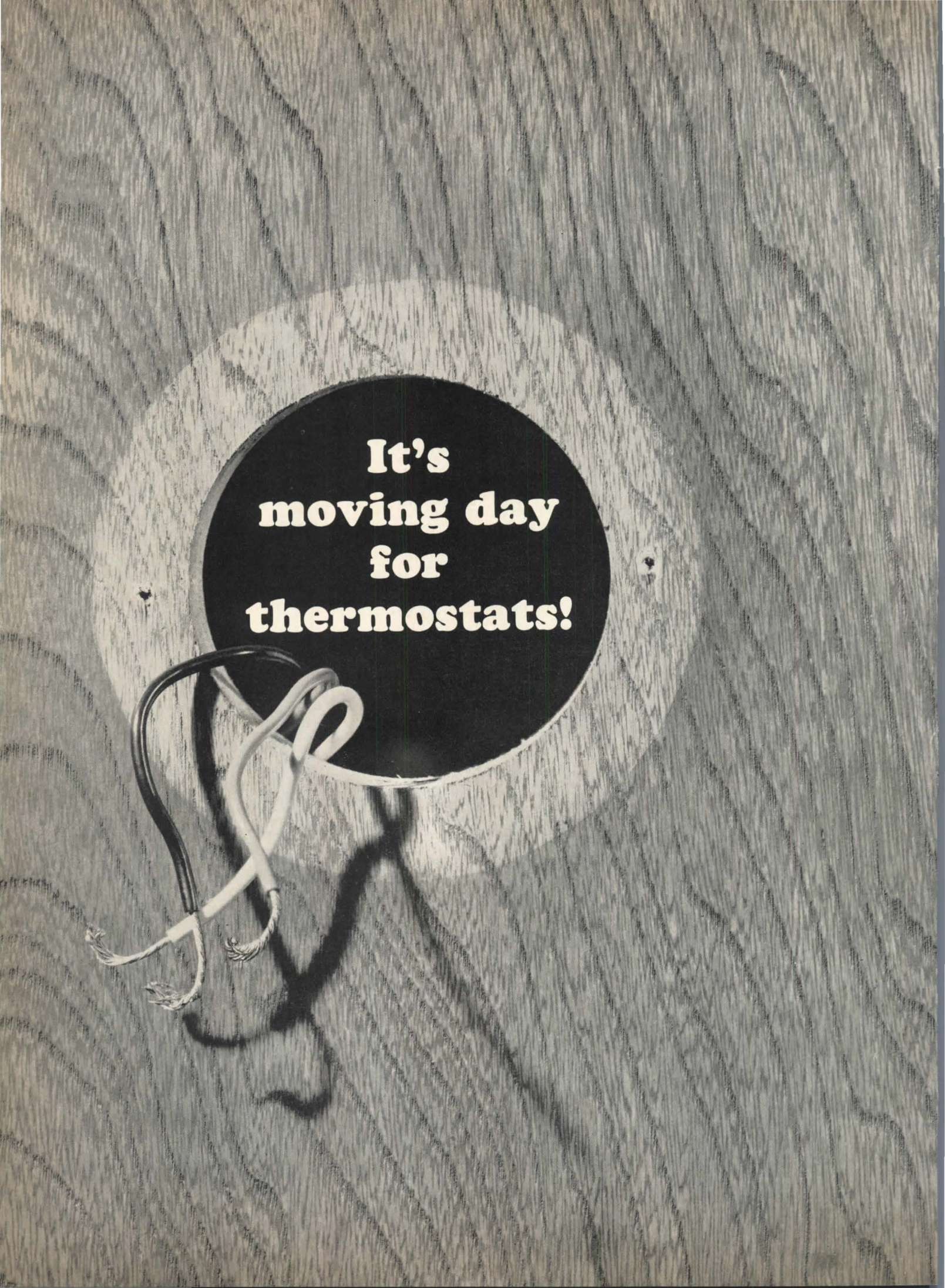

**It's  
moving day  
for  
thermostats!**

**"Room thermostats belong on the wall"**

# **ridiculous!**

**New Barber-Colman Heat-of-Light System puts the thermostat where it works best—in a moving air stream. Result: Temperature changes are detected up to 15 times faster than with wall-mounted thermostats. Clip coupon for complete information.**

**R**oom thermostats belong on the wall." Ridiculous! Walls soak up heat (or cold). Wall-mounted thermostats pick up this heat or cold, so response to room temperature changes is slowed, resulting in overheating (or overcooling).

#### **New temperature sensing element mounts in ceiling diffuser**

Thermostats work best in a *moving* air stream. That's where Barber-Colman puts them in the Heat-of-Light System. Conventional, wall-mounted thermostats have been replaced by pencil-thin electronic sensing elements that fit in the air-handling system (in air/light diffusers, under-the-window units, ceiling diffusers). This new development in thermostat design and application means that the moving air surrounding the people in the room can be continuously sampled. Changes in temperature are detected and acted upon up to 15 times faster than with wall-mounted thermostats. Temperature control is more accurate and uniform.

What's more, moving the thermostat off the wall reduces installation costs. No drilling or channeling for electrical conduit or pneumatic tubing—low-voltage wires connect the electronic sensing element to the control system. Walls and panel dividers can be moved without altering the temperature control system. The costs of re-installing and recalibrating thermostats every time a partition is moved are eliminated.

#### **New system combines lighting, heating, and cooling functions**

Today, lighting levels of up to 150 foot-candles (or more) are common. Up to 85¢ of every dollar you spend for light at these higher levels ends up as

heat. With the new Barber-Colman Heat-of-Light System, much of the heat generated by light, as well as people and equipment can now be put to work heating the building.

Air-handling lighting fixtures remove up to 85% of light-generated heat from the occupied zone. Barber-Colman's Jetronic mixing units capture this heat and use it to warm interior zones and offset heat losses at the building perimeter. Result: Ideal operating temperatures for fluorescent lights (75° to 80°F) are maintained—increasing light output by 15 to 20% over "static" fixtures. Lighting levels can be doubled (up to 200 foot-candles or more) without increasing conditioned air load.

And, there are other important benefits: You realize major savings in the cost of air conditioning. Steam boilers and other high-output heat sources can be reduced in size (or eliminated).

Hot air ducts, reheat coils and piping are not required. Less pipe and duct insulation are needed. And, you get more air conditioning in less space.

#### **Computer helps you evaluate Heat-of-Light for your building**

Now, take the guesswork out of designing your next air conditioning system. A simple one-page Feasibility Study (plus a few minutes work by our Transac 2000 computer) lets you evaluate a Heat-of-Light System before it's installed. The computer carefully studies each floor in the building. It calculates heating and cooling air temperatures for perimeter air systems . . . the number of light fixtures required . . . supply air quantity and temperature . . . and primary air quantities. You get an answer quickly—often within 48 hours. (More than 100 of our customers and prospects have used this computer service in the past six months.)

**Get the facts!** Clip coupon below or contact your nearest Barber-Colman field office for a Feasibility Study.



## **BARBER-COLMAN COMPANY**

ROCKFORD, ILLINOIS 61101

In Canada: BARBER-COLMAN OF CANADA, LTD.

Weston, Ontario

... where originality works for you

**Barber-Colman Company**  
Rockford, Illinois 61101

- Please have your local representative call me to arrange a computerized Feasibility Study.
- Please send me your NEW booklet on the Barber-Colman Heat-of-Light System.

Name \_\_\_\_\_

Title \_\_\_\_\_

Company \_\_\_\_\_

Street \_\_\_\_\_

City \_\_\_\_\_ State \_\_\_\_\_ Zip Code \_\_\_\_\_

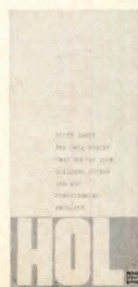

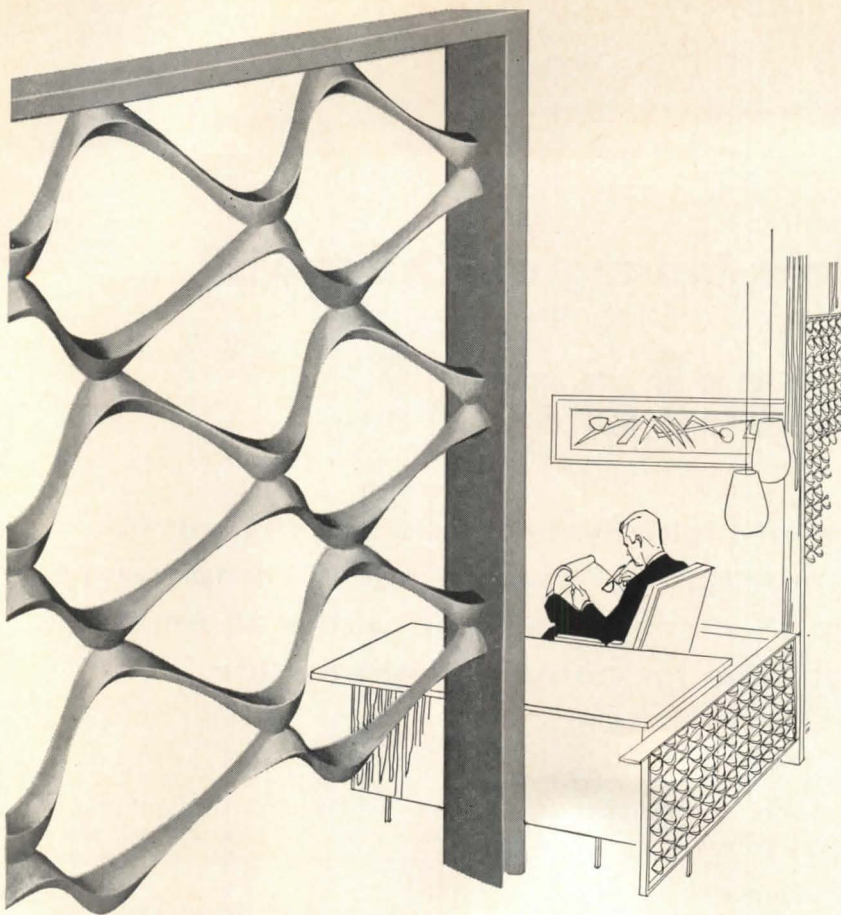

**JB<sup>®</sup> Ondine**  
TREILLAGE

Frankly exotic new **Ondine** pattern will suggest netty hangings or undulating jungle vine in one setting, or simply turn the pattern to achieve another sculptured effect. Thus **Ondine** enhances a range of contemporary interiors and exteriors. **Ondine** is one of many architect-designed JB Treillage patterns, all available in both malleable iron and cast aluminum. Unframed sections, 12" x 27", to be assembled by welding, are highly adaptable to your over-all design for screens, partitions, railing panels, gates, grilles, etc. Ask your local fabricator, write for literature or see Sweet's Architectural File 6e/BL or Industrial File 6b/BL.



**JULIUS BLUM & CO., INC.**, CARLSTADT, NEW JERSEY  
THE MOST COMPLETE SOURCE FOR ARCHITECTURAL METALS  
PHONES: CARLSTADT, (201) GE 8-4600; PHILA., (215) MA 7-7596;  
NEW YORK, (212) OX 5-2236; TELEX 1-25961; TWX 710-485-7673

On Readers' Service Card, circle No. 331

*Continued from page 236*

holm is extolled for its planning activities (without much analysis of the bases for the presumed success in planning). The descriptions of Ciudad Guayana and New York City are more interesting, if only because they are more straight-forward and informative.

Charles Abrams, in an article entitled "The Uses of Land in Cities," puts forward some interesting observations on comparative patterns of land use and control in different societies, although in too brief and scattered a fashion. Three subsequent articles also stake out problems of international pertinence, but in fact deal with these only in the context of American cities. John Dyckman reports on current prospects for transportation solutions, focussing particularly on the potentialities of the new rapid transit system in San Francisco. Abel Wolman gives an accounting of water and air pollution in American cities, and Nathan Glazer recounts the past failures and efforts at solutions of the Federal urban renewal program. Finally, Kevin Lynch presents what is presumably a crowning statement on "The City as Environment" in which we are lifted to a sensory view of the city and are presented, somewhat disconcertingly, with architectural solutions for the variety of far-reaching and perplexing problems suggested in the preceding articles.

In sum, the volume is a potpourri of current opinion among the professions that have prospered from the current vogue in metropolitanism and that have come to regard the city as their professional domain. But while the city and its problems are now a popular theme, it is not a theme which slices out some common substance for discussion, or calls on some shared set of concepts to order a variety of substantive issues. In consequence, the brief introduction to this volume asserts an order for the articles which they do not fulfill. Rather, we are left with a somewhat random sampling of the experts, the issues, and the points of view associated with "cities."

***New York City:  
Experiencing a Change of Heart?***

BY EDWARD K. CARPENTER  
NEW YORK CITY IN CRISIS: A STUDY IN DEPTH OF URBAN SICKNESS. *By the staff of The New York Herald Tribune, under the direction of Barry Gottehrer. David McKay Company, Inc., 750 Third Ave., New York, N.Y., 1965. 212 pp., \$4.50.*  
A CITY DESTROYING ITSELF: AN ANGRY VIEW OF NEW YORK. *By Richard J.*

*Continued on page 245*



VATE

*With an office like this, he's got to be in*

To be sure you're in, too, send for your copy of the Alma 8000 Series catalog and price list.



High Point, North Carolina

# Hust

**If you don't believe us...ask Pratt & Whitney Aircraft.**

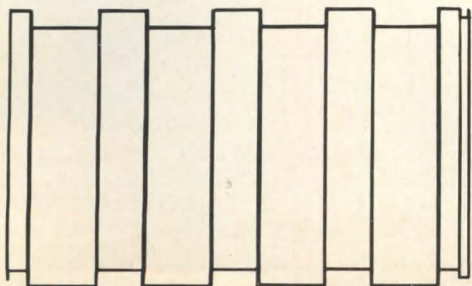

What is all this Wheeling hustle talk? Pratt & Whitney found out.

They found a need for a new building and were really squeezed for time.

Ground was broken in East Hartford, Connecticut, in July '65. The building completed in January. Months ahead of schedule.

How come?

Wheeling's 18-gauge Super-Rib Roof Deck for one thing. 750,000 square feet of it (just like the inch or so shown here).



# Hustle strikes again.

And Wheeling's hustle policy got it all there two weeks early. That's hustling!

What makes our roof deck super? We control the quality from ingot to installation, have a real tough rib design for maximum strength, and use Structural Grade "C" steel.

Our lengths are longer, too. Up to 50 feet.

In addition, Wheeling roof deck offers greater variety.

Galvanized, painted with a primer

coat (or unpainted), and non-galvanized primer-painted. For normal to extra-heavy weight loads.

And gauges from 16 to 22.

We even make a type which absorbs sound.

Like Pratt & Whitney Aircraft you'll find what you need for your job.

Other facts.

Wheeling roof deck is pre-engineered to your specifications.

Easier to handle on site—easier and quicker to install.

Provides work surface for other building trades and it's more durable.

Why are we telling you all this? Frankly, we want your business.

To try Wheeling roof deck for yourself, just give us the word:

"Hustle!"

**Have you looked at Wheeling lately?**

## Wheeling

Wheeling Corrugating Company  
Wheeling, West Virginia

CHARLES DU BOSE—ARCHITECT; JAMES S. MINGES & ASSOCIATES—ENGINEERS; GEORGE A. FULLER—GENERAL CONTRACTOR; NATIONAL STEEL FABRICATORS INC.—STRUCTURAL STEEL

On Readers' Service Card, circle No. 426

# WILL THE INITIAL COST OF YOUR WATERPROOFING BE THE FINAL COST?

**Waterproofing specialties...  
less than 1% of your  
building's cost...can cause  
major problems if they  
don't deliver total  
performance.**

The many waterproofing products that go into a new building are seldom thought of as a system. As a result, a consistently high standard of quality is often missing. Specs shift from brand to brand. Yet the burden of waterproofing an entire building rests upon these products. If just one fails, tremendous water damage can result.

Grace gives you the full-line proven performance that can prevent this: Hornflex, Hornseal and Vulcatex caulks and sealants, Daracone and Hydratite water repellents, Dehydratite dampproofing compounds, Monastite, Waterfoil and many others. Whatever the need, there's a special Grace waterproofing product that fills it best.



**And the new Grace Spec Kit makes specification complete, simpler and more accurate.** A concise, central source for a wide range of specialty products, the Kit lets you select products quickly, spec out entire systems in minutes, actually write specs in a few words. It includes:

- (1) **Preprinted Specification Work Forms** for 45 major products. Simply tear out and fill in your brand choices.
- (2) **Ultra-condensed Product Selector Guide.**
- (3) **140-page Product Handbook.**

Get your free Spec Kit by writing on your firm's letterhead to: Grace Construction Materials, 62 Whittemore Avenue, Cambridge, Massachusetts.

## **GRACE CONSTRUCTION MATERIALS**

**A. C. Horn Products • Darex Construction Chemicals  
Rock Products Chemicals • Serviced Products**

Cambridge, Massachusetts    Chicago    Houston  
Los Angeles    Montreal    North Bergen, N. J.  
San Francisco    Scarborough, Ontario.

On Readers' Service Card, circle No. 343



**Specify Grace  
performance — proven  
construction specialties**

**CAULKS & SEALANTS** — oil base caulking & glazing compounds, elastomeric caulk, polysulfide sealants for curtain wall & expansion joints.

**PREMOLDED JOINT FILLERS AND JOINT SEALERS** — asphalt, cane fiber, plastic foam, cork, sponge rubber joint fillers. Rubberized asphalt and polymeric joint sealers.

**FLOOR MATERIALS** — concrete, wood and terrazzo sealers, protective finishes, hardeners and topping mixes, colorants, non-slip coating, grouting and patching compounds.

**ADMIXTURES** — accelerators, set retarders, air entraining agents, water reducing agents, water repellents, integral colorants.

**WATERPROOFING AND ROOFING MATERIALS** — bituminous damp-proofing compounds, metallic and cementitious surface treatments and silicone coatings, built-up roofing compounds and fabrics.

**WATERSTOPS** — polyvinyl, rubber and extruded base-type waterstops for expansion and construction joints. Premolded sealing strips.

**ADHESIVE AND BONDING AGENTS** — plaster bonding, concrete bonding, topping adhesive, epoxy binder and grout.

**TECHNICAL COATINGS** — corrosion resistant coatings, wood, metal and masonry coating, swimming pool paint.

**SPECIALTY PRODUCTS** — curing compounds, exposed aggregate retarder, form coatings, maintenance products, bridge pads and specialties.

*Spec Grace—You Can Depend On It!*



*Continued from page 240*

*Whalen. William Morrow & Co., 425 Park Avenue South, New York, N.Y., 1965. 127 pp., 95¢. The reviewer is an Associate Editor of P/A.*

There are eight million stories in The Big City, boasts one nighttime TV series. And in its initial chapters, *New York City In Crisis* sets out to tell a couple of them. It seems redundant or beside the point in what bills itself as "A Study In Depth" to remind readers in such an emotionally slanted way that The Big City harbors drug addicts, heightens man's natural inhumanity to man, ignores its infirm and old. But after this false start, the book settles down to marshal some impressive facts about the city's problems, to explain the causes of these problems and suggest solutions.

A partial list of the troubles besetting the metropolis includes: "hesitant leadership, uncoordinated and self-centered public pressures, short-sighted trade unions, financial headaches, crowded streets, spreading blight, plagued businesses, and economically threatened citizens." The worst of these, according to the authors, is hesitant leadership.

In 1961, the City Charter was revised, giving the Mayor unusually strong powers to keep the city from being strangled by its own bureaucracy. "Under a strong, forceful mayor, the machinery of government set up in the charter could function quite well. But under an indecisive mayor, problems multiply and solutions become more difficult to achieve because so much depends upon the chief executive. In Wagner's case, the results were nearly disastrous." The danger, of course, is that a strong, decisive mayor may lead the city along the wrong path. Mussolini, after all, made the trains run on time.

What New York needs is government of courage and vision, and although the book was written before Congressman Lindsay announced his candidacy for Mayor, it was obviously devised partly as an incentive or a plea for him to do so. Now that he has run and been elected, one hopes he can follow his own advice, quoted by the authors on the last page: "You hear a lot of people say that the city is too big to be governed by one man. I don't agree with that at all. It's just a cliché. But to run this city properly and get it going again the Mayor has to be very tough. He's got to ask for the moon and he's got to convince the people to make sacrifices. It will take a man who loves the city and a man who loves its people. If we don't get

*Continued on page 248*

THIS  
**GYM FLOOR**  
— WAS PLANNED TO —  
**AVOID WARPING  
AND BUCKLING**

**Connor's "Laytite"  
edge-grain maple  
FLOORING**

Longer wear and lasting satisfaction are built into every Connor "Laytite" installation. Edge grain (quarter sawn) hard rock maple flooring means 50% less expansion\*, helps prevent any warping or buckling. Specify Connor's "Laytite" for your next job . . . get details today.

"Laytite" is also available in REZILL-CUSH\* System; "CONTINUOUS STRIP" or regular strip — all sizes and grades.

*\*According to Forest Prod. Lab.*

**School and gym floors  
our specialty . . . write**

**Gentlemen:**

Please send me information on the following:

- Connor's "Laytite" Edge Grain Flooring
- Rezill-Cush System — "CONTINUOUS STRIP" & Regular Strip
- Prefinished Kitchen Cabinets

**CONNOR**  
LUMBER AND LAND COMPANY  
VI 2-2091, 343 Thomas St., Wausau, Wis.

® REG. U.S. PAT. OFF.

\*TRADE MARK

On Readers' Service Card, circle No. 338

Book Reviews 245

**Go ahead. Design a ceiling that cools, heats, lights, communicates, controls sound and beautifies just the way you want it to...**

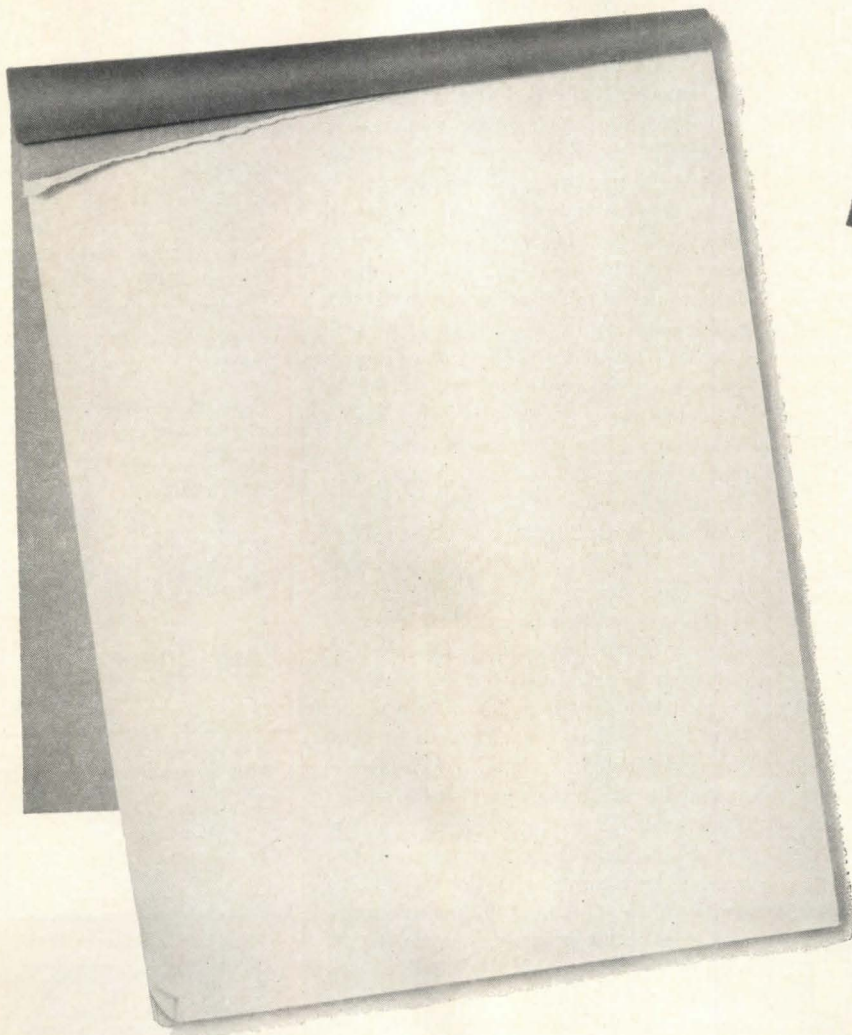

# I will install it. And guarantee its performance, too!

By combining many essential functions into one system, today's electric integrated ceiling gives you new freedom in interior design. Take full advantage of that freedom. Create the ceiling that does what you want it to do, looks the way you want it to look. Then make it part of the electrical specifications and let your qualified electrical contractor take it from there.

Why an electrical contractor? Because most of the functions of an integrated ceiling are powered or controlled

by electricity... and electricity is the electrical contractor's business.

Of course, proper installation will require the services of carpenters, sheet metal men, plasterers, plumbers, heating and refrigeration men. But your qualified electrical contractor has plenty of experience in coordinating the efforts of these specialists—and he has available to him established and recognized procedures through which jurisdictional questions can be settled without delaying the job.

And that's not all. Place the responsibility for your integrated ceiling in the hands of your qualified electrical contractor and he'll guarantee the performance, not only of the electrical functions, but of the entire electrically space-conditioned ceiling system.

NECA has prepared a film on integrated electric ceilings. To arrange a showing, contact the Marketing Division of NECA at the address below.

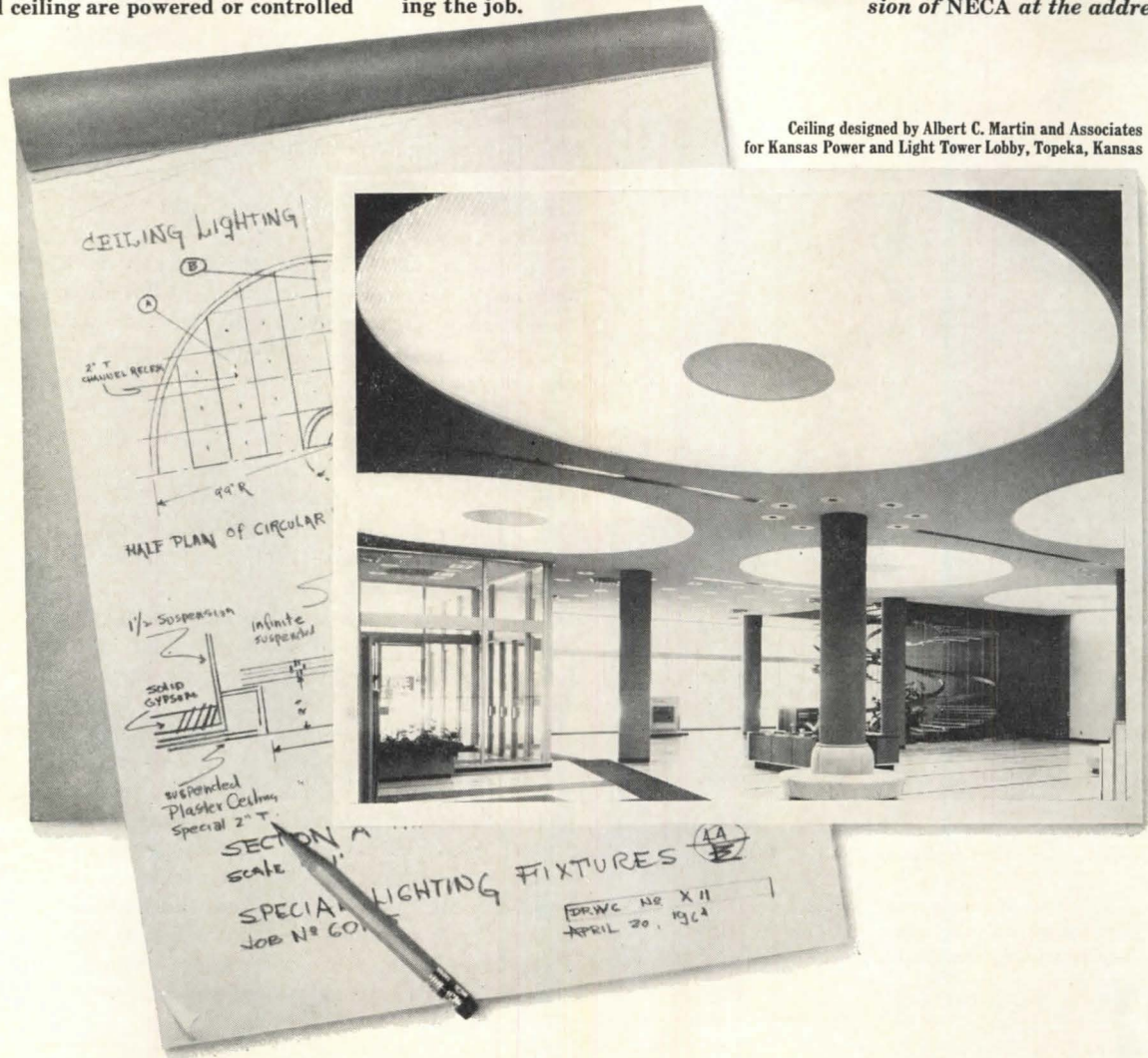

Ceiling designed by Albert C. Martin and Associates for Kansas Power and Light Tower Lobby, Topeka, Kansas

**Your Qualified Electrical Contractor**  
NATIONAL ELECTRICAL CONTRACTORS ASSOCIATION, 610 Ring Building, Washington, D.C. 20036



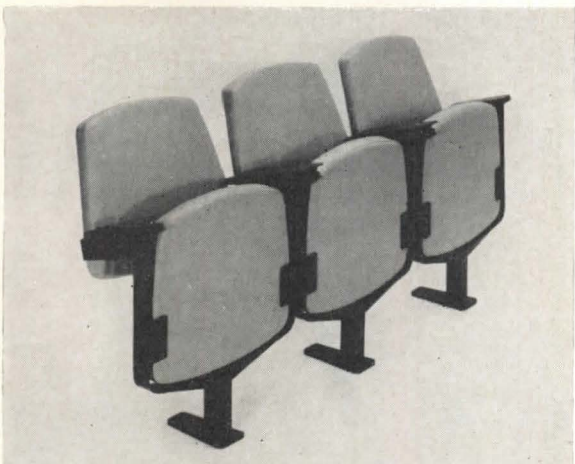
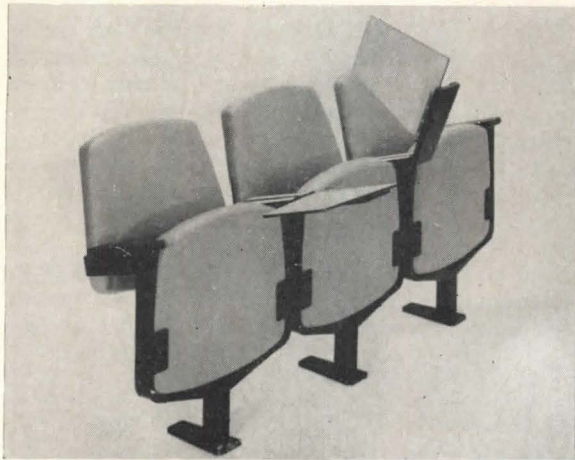
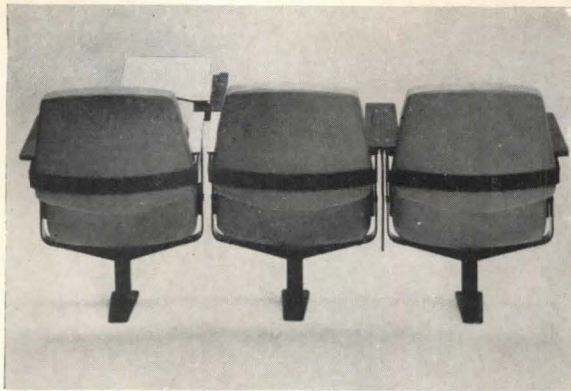

### THE DISAPPEARING TABLET ARM

A versatile accessory for the award winning RACE—JG auditorium seat.

- When closed, arm lies completely within the seat's profile.
- Addition of tablet arm requires no extra seat spacing.
- When closed arm occupies no aisle space—allows minimum front to back and side to side spacing.
- Arm swings to left or right in open position.
- Made of solid melamine with stainless hinge.

Send for specification and layout kit.



JG FURNITURE CO. INC.

160 E. 56TH ST. N. Y. C.

Continued from page 245

going again soon, New York will become a second-class city." Lindsay, of course, could be talking about almost any city in the country. With New York, he has a chance to set an example.

While cataloguing the same ills, more briefly but nonetheless forcefully, Richard Whalen's *A City Destroying Itself* does not put the same hope for salvation in a new Mayor. Like Moral Rearmament disciples, Whalen sees salvation only in a revitalized attitude of the citizens. "No program of reform," he writes in conclusion, "contains the smallest hope of success unless these citizens experience a change of heart—it is as simple and bleak as that. Of what must this indispensable changed attitude consist? Nothing more or less than the conviction, born of whatever individual motive, that the place is worth the bother after all."

### The Meaning of Stones

BY BERND FOERSTER

NATURAL STONE AS AN ELEMENT IN DESIGN. *Gerd Zimmer-schied. Interbuch Berlin, Berlin-Charlottenburg 2, Schluter-strasse 17, West Germany. Distributed by Renouf Publishing Co., 2182 St. Catherine St. West, Montreal 25, Canada. 1961, 321 pp., illus., \$12. The reviewer is a Professor of Archi-tecture at Rensselaer Polytechnic Institute and author of books, articles, and films about architecture.*

This book lives up to the promise of its title by relating the selection of stone and joints to the character of architec-ture. It is a handsome publication that uses excellent illus-trations to present a visual subject. Even the most knowl-edgeable reader will find a great deal to discover in this volume.

The limited text is pertinent and draws attention to fac-tors that cause emotional responses in the observer. Design considerations are explained with admirable brevity and are fully supported by the illustrations. Revealing close-ups ad-join distance shots to show the effect of details on the whole building.

The commentary includes reflections of some subtlety, but the author prepares his readers to accept them as enlight-ening rather than esoteric. The following quotations may serve to show the range of comments:

• "The smooth trunks of the trees, planted not in groups but appearing as individuals to the eye, stand in front of the screen wall of uncoursed rubble masonry thus combin-ing the characteristics of stone and plant in an almost too distinct sharpness, and giving a strange, almost surrealist effect."

• "In Germany stone is frequently used for the entrances to family houses, as it were, to keep up appearances. The entrance becomes, it is said, the visiting card of the house-holder: distinct, simple and modest, ostentatious or without any expression whatsoever . . . In most such cases stone be-comes an unmastered piece of decoration instead of an in-tegral element." (When confronted with photographs of poor designs, such a statement is refreshing to see.)

The inclusion of some unsuccessful examples is not due to an inability to recognize quality, but to a desire to show misuse.

The book contains so much material that it may seem, at first glance, that there is too much of a good thing. But the points are not repetitive, and the book becomes more

Continued on page 254

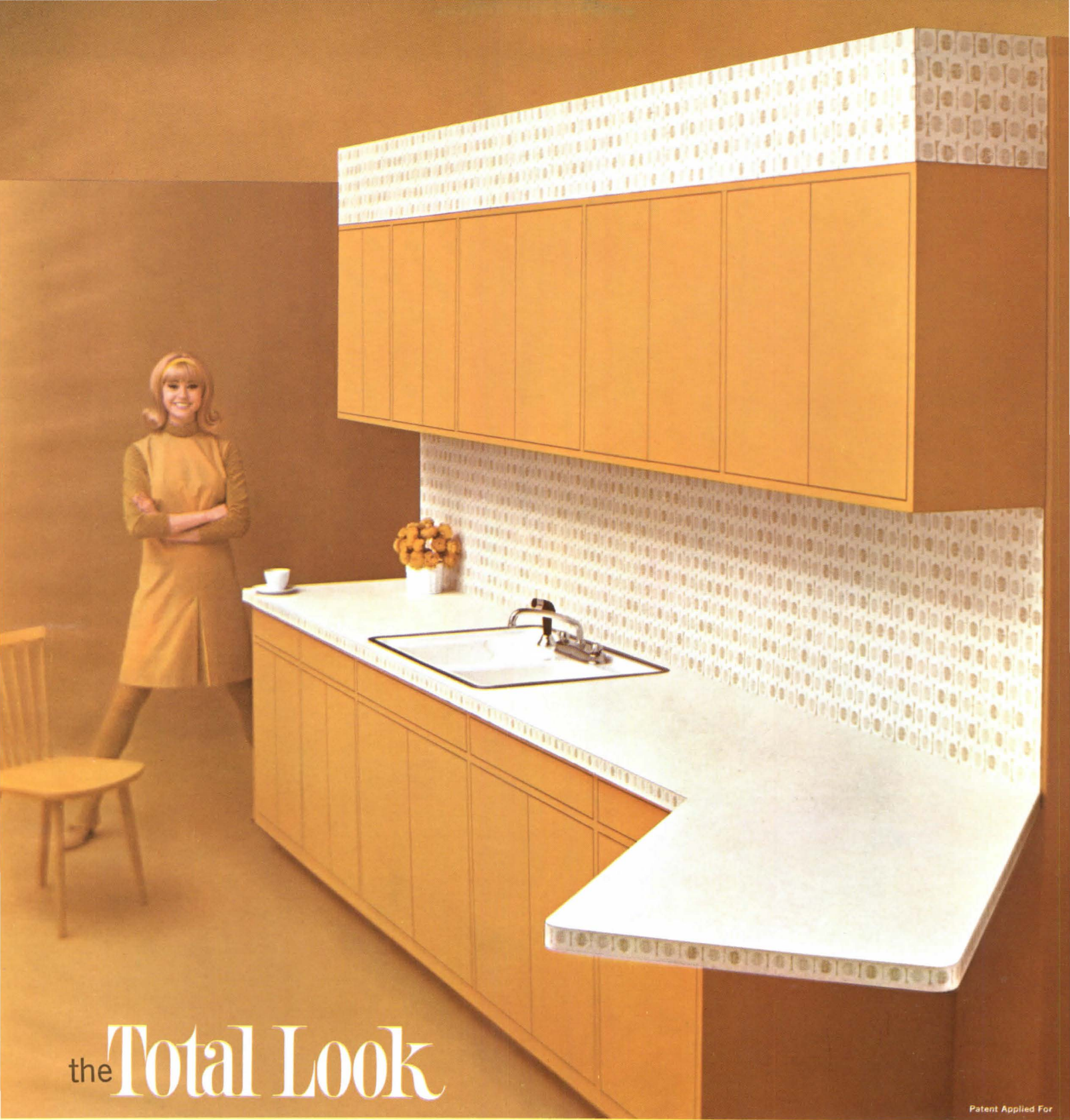

# the Total Look

Patent Applied For

## a new concept of color and pattern harmony in Consoweld laminated plastic

The Total Look brings decorative appeal to the heavy service areas of kitchens and classrooms. In addition to coordinated decor, the Total Look extends the functional use of Consoweld laminated plastic to easily-soiled areas—soffit and backsplash — and eliminates the need for frequent redecorating. Ideal for homes, apartments, and domestic science classrooms where smart decor and maintenance-free surfaces are required. Specify Consoweld laminated plastic in any of five Total Look designs. For more information call your distributor, refer to your AIA File folder under Plastics or write direct to Consoweld Corporation, Wisconsin Rapids, Wisconsin.

*Gold Rondo, above, is available in blue. Counter top is Consoweld Off-White Whisper. Other Total Look designs are shown at the right.*

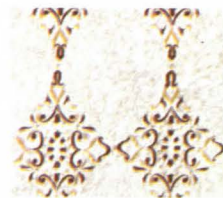

SERENADE



MELODY

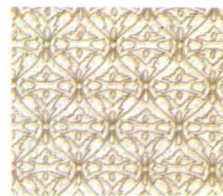

CAPRICE



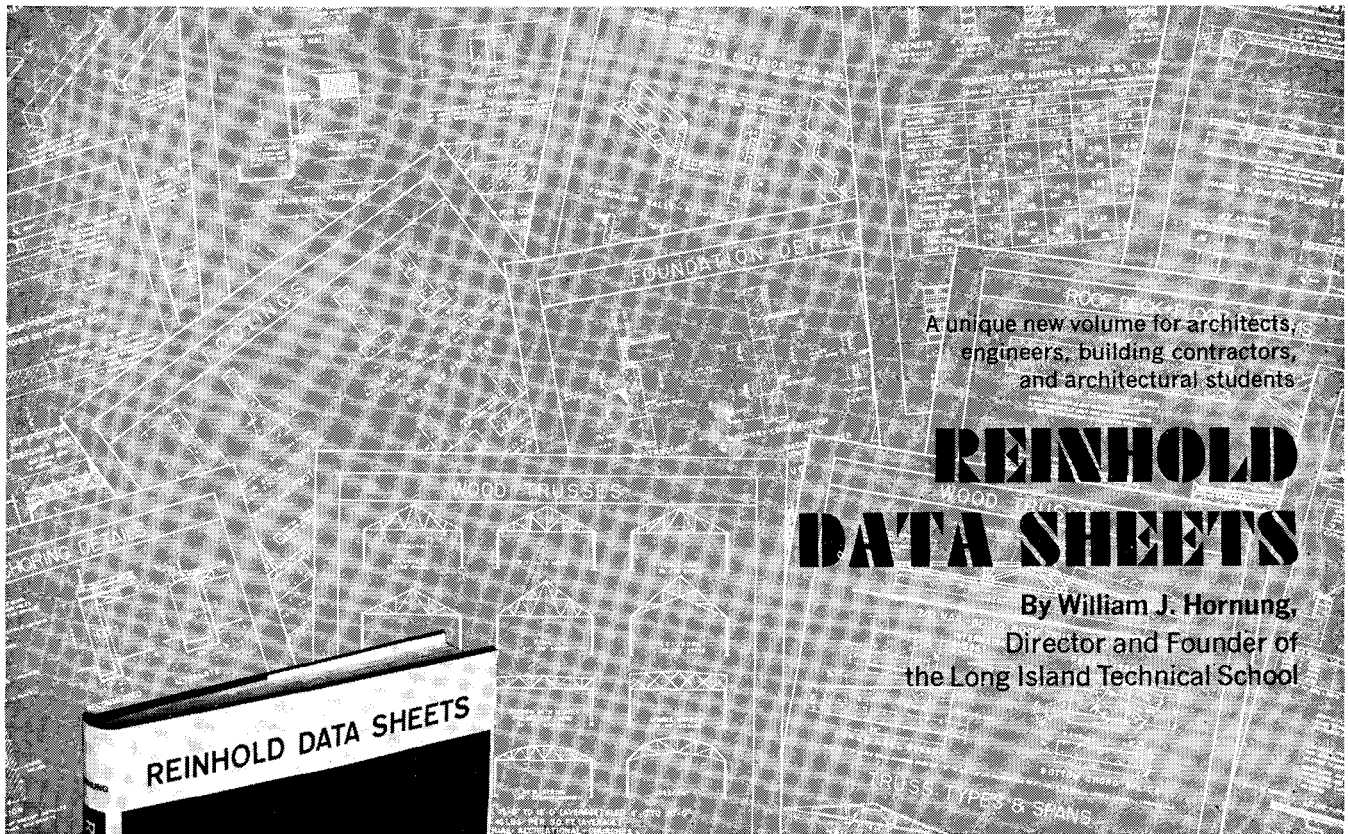

A unique new volume for architects,  
engineers, building contractors,  
and architectural students

# REINHOLD DATA SHEETS

By William J. Hornung,  
Director and Founder of  
the Long Island Technical School

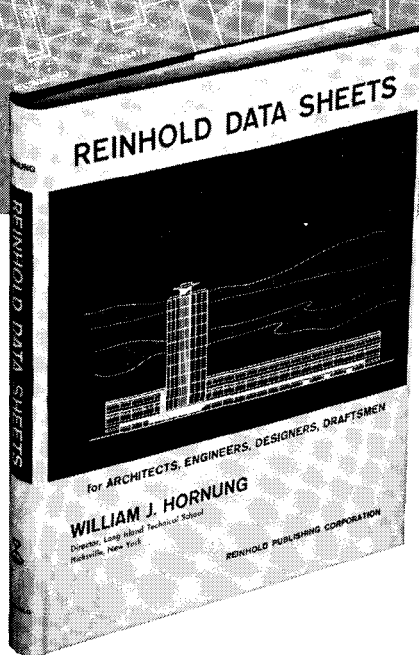

hundreds of  
reference diagrams  
and drawings

This book presents the most up-to-date reference and drawing data in the field of architecture, construction, and design. Here, in a single, conveniently arranged volume, is the latest information on new construction methods, much of which have never appeared before in book form. An extremely practical book, it features the most essential reference data required by the professional in his daily work.

The contents are organized to deal, in order, with the four main aspects of building: sub-soil constructions; wall systems; floor and roof systems; and methods of construction, including details, surface, and finish treatments. The book begins with detail drawings and data for footings and foundations, and its sequence of presentation follows a pattern similar to that used in the actual construction of buildings. Valuable information is given on the various methods of wall, floor, and roof treatments employing new uses of wood, concrete, steel, and stone.

The arrangement of the subject matter is distinguished by the fact that where materials in a certain construction system have been shown in detail, the methods of estimating quantities of these materials have been included. Questions and answers pertaining to mechanical and electrical equipment of buildings have been added for the benefit of those preparing for the Registered Architect's examination.

The practical applications of this book within the building construction, cement, building materials, and equipment manufacturing industries are exceptionally broad. Architects, engineers, and builders will find it especially useful as an up-to-date source of ready reference, and for the contractor it can prove a most efficient aid to becoming better acquainted with new methods of construction. In addition, it is highly adaptable for reference use by students of architectural design and mechanical drawing in technical schools and colleges.

---

September 1965      256 pages      8 1/4" x 10 1/4"      \$15.00

---



REINHOLD BOOK DIVISION 430 Park Avenue, New York, New York 10022



## PLEXIGLAS®... 10 years without discoloring

Lighting diffusers of PLEXIGLAS acrylic plastic were installed 10 years ago at Oak Cliff Savings and Loan Association, Dallas, Texas. The photographs show how they look today—just as white as when the building's lights were first turned on.

In addition to its famed resistance to discoloration, PLEXIGLAS has high breakage resistance, is light in weight, rigid, and easy to clean. As a diffusing material, PLEXIGLAS spreads a uniform brightness of light in all directions. Also, in injection molded and extruded

lens panels, it provides precise lighting control.

Have a lighting problem? PLEXIGLAS makes its solution easy. No other plastic is more proved by time and more widely approved for use in fixtures. Write for literature and the names of lighting equipment manufacturers who can satisfy your lighting requirements with dependable PLEXIGLAS.

®Trademark Reg. U.S. Pat. Off., Canada and principal Western Hemisphere countries. Sold as OROGLAS® in other countries.

**ROHM  
AND  
HAAS**   
PHILADELPHIA, PENNSYLVANIA 19105



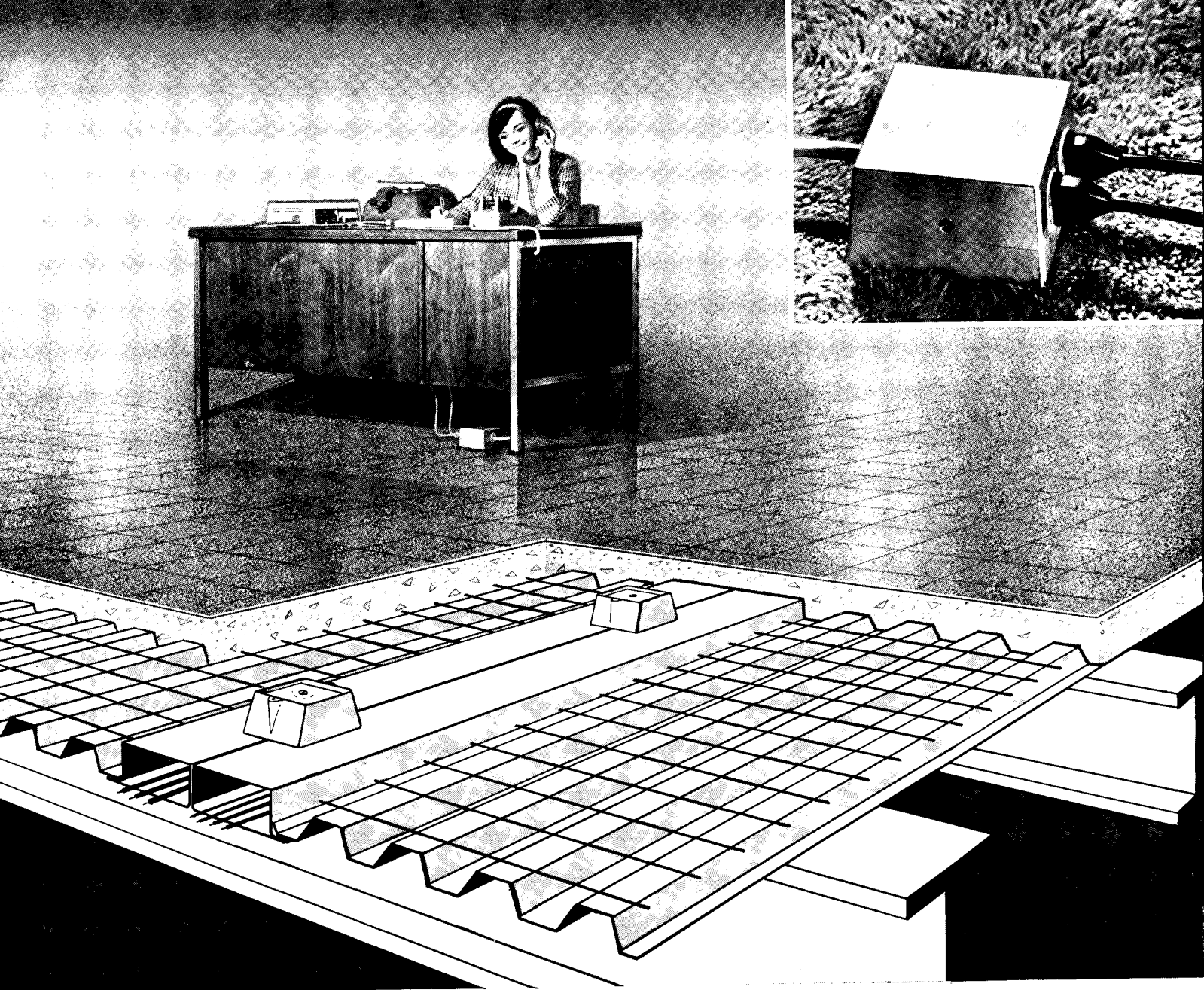

## Put Telephone and Electric Service In One Fitting

*... anywhere it's needed with Cel-Way electrified floors*

Best way to electrify structural floor slabs? Cel-Way! Here's the system that wraps up utility, economy, versatility, beauty and simplicity into one convenient package. The sturdy, large capacity steel cells carry both power and telephone lines. Cel-Way is available in double cell and triple cell units and can be used with all types of Granco permanent steel forms, particularly with Cofar and Cofar Composite. Unique pre-set inserts give easy access to cells for installation of floor outlets at

practically any desired location. Low-silhouette, dual service fittings provide a single outlet for both telephone and power lines. Roomy interiors easily accommodate 100-pair cable or two amphenol jacks. Cel-Way... simple, compact, efficient, low cost. Learn more about this new floor-electrification system. See Sweets file, or write today for Cel-Way Catalog. Granco Steel Products Company, 6506 North Broadway, St. Louis, Mo. 63147. A subsidiary of Granite City Steel Co.



On Readers' Service Card, circle No. 356

*IMAGINATION IS SET!*





EXCITING FLOORS  
TAKE SHAPE . . . AND  
STAY THAT WAY FOREVER!  
CONTOURED QUARRY TILE

*Summitville*



Extruded contoured Quarry Tile promises more than any other floor... it lives up to its promise with unique beauty, shape and color. Summitville extruded tile resists wear, stains, impact and weather . . . will not fade, burn or dent. Available in 8 shapes, 5 exclusive textured antique glazes and 6 natural quarry tile colors. Ceramic tile contractors and distributors have all the facts. Summitville Tiles, Inc., Summitville, Ohio.



FLEMISH



LaVINCHY



FLORENTINE



MADRID



CAPRI



VIKING



FLORETTE



GALLIC

Member-Tile  
Council of America



Unretouched photo. Full scale,  
of Textured Antique floor glaze.

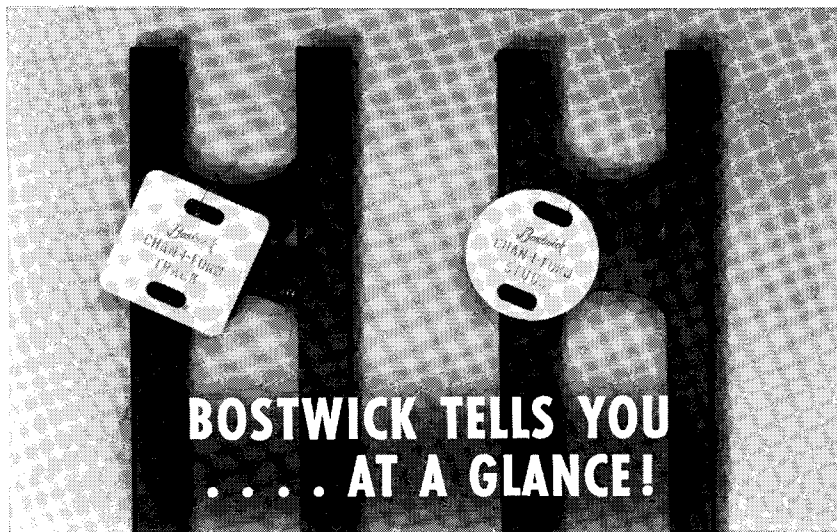

Bostwick's exclusive tagging system saves you time, effort, unnecessary motion. And you don't even have to **read** the tags. (Round tags indicate studs and square tags track.) Just one more customer service from Bostwick.

Bostwick Chan-L-Form Steel Studs are light in weight, non-combustible, quickly and easily erected, economical. Perforations in studs assure exact positioning of openings for conduit, piping and wiring without "juggling".

If construction is uneven or out of plumb, there is no problem in adjustment with Bostwick Chan-L-Form Steel Stud and track installation. Available for non-bearing partitions, furring, for double partitions which allow for ducts or mechanical lines, or for sound prevention between rooms.

Ask us for a free copy of our all new 1966 Product Catalog.

**THE** *Bostwick*<sup>®</sup> **STEEL LATH COMPANY**

108 WEST FEDERAL STREET • NILES, OHIO 44446 • (216) 652-2547

On Readers' Service Card, circle No. 332

*Continued from page 218*

valuable the closer one looks.

The translation is generally skillful, and to this reviewer the English version seems actually superior to a few turgid passages in the original German. I would argue with the separation of some of the chapters by regular numbered pages that contain advertising by the publisher—a questionable device in any book.

Secondly, in a publication so clearly intended for an architectural audience, it is surprising that architects' names and names of buildings were not included. Except for a mention of Frank Lloyd Wright, the closest thing to identification in some 320 pages that can be found are such phrases as "an Arabian architect," "this house from the United States" (Taliesin West), and "a glass pavilion in the United States" (Philip Johnson's Wiley House). But the lack of credit accorded individual artists will not be revenged here. Gerd Zimmer-schied deserves to be complimented as the author of a book that will prove a useful and stimulating companion around the office and a necessary part of architectural libraries.

### *Some Real Goodies*

BY FREDERICK HERMAN

CHINESE MONUMENTAL ART. *Peter C. Swann. Photographs by Claude Arthaud and Francois Hebert-Sterens. The Viking Press, 625 Madison Ave., New York, N.Y., 1964. 276 pp., illus. 816. The reviewer is an architect on the faculty of Old Dominion College, Norfolk, Virginia.*

Believers in international cooperation ought to see in this book a justification for their views. It is an exercise in internationalism with photographs by two Frenchmen, text by an Englishman, printed in Switzerland, bound in Holland, published in England, distributed in the United States, and dealing with China. It is a handsome volume, a pleasure to leaf through, and suitably impressive looking.

A large majority of books of this kind tend to be examples of sumptuous packaging, hiding very little content. In this instance, the wrappings hide some real goodies. The book deals in depth with Chinese cave temples, notably the Yun-Kang, Lung-Men, Tun-Huang, and Mai-Chi-shan complexes, as well as other aspects of Chinese monumental art—much of which is relatively little known in the west.

The photographs are uniformly su-

*Continued on page 258*



Beautiful

**WAY TO  
ILLUMINE A LOBBY**

One of the main attractions in the lobby of the 450 Seventh Avenue Building, New York City, is the ceiling of light dramatically transmitted through textured 7/32" BURLAP glass by Mississippi. Kaufman Management Company, builder and owner, wisely selected translucent glass for its lasting beauty and brilliance . . . qualities that are unaffected by time or exposure. For glass possesses the chemical stability, permanence of finish, color, shape, surface hardness and noncombustibility available in no other glazing medium. Specify Mississippi glass. In a wide variety of patterns and surface finishes at better distributors of quality glass.

*Architect:* John J. McNamara, New York, N. Y.  
*Contractor:* M & J Construction Co., New York, N. Y.



**NEW CATALOG**

Contains pattern descriptions, light distribution charts, transmission data. Send for your free copy today.

See Our Catalog in Sweet's 

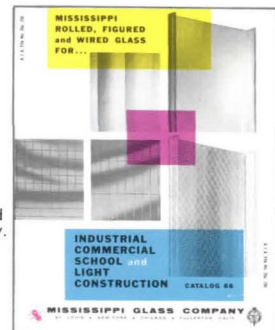

**MISSISSIPPI  
GLASS COMPANY**

88 Angelica St. • St. Louis, Mo. 63147

*Distributors in Principal Cities of the United States and Canada*  
H-#1-66R

# Versatile

**IS THE WORD  
FOR GLASS**

Light filtered through patterned glass offers another dimension for achieving exciting beauty as well as functionality, wherever employed. Rolled glass, with its primary functions of diffusion, decoration and protection, along with a secondary function of heat absorption, provides wide scope for creating interiors and exteriors high in interest and utility. See your nearby Mississippi glass distributor.



a.

**a.** A new peak of practical beauty is achieved with skylight of Polished MISCO wire glass in the "Parisian," Sherman Oaks, Calif., owned and built by E. W. LaTourette and designed by Robert Weaver Stevens.

**b.** Blue-green 1/4" Luxlite COOLITE MISCO, heat absorbing glass, glazed in terrace railings—175 E. 74th Street, New York, N. Y.

Cohen Brothers Realty & Construction Corp., 200 Park Avenue, New York, N. Y. Glazing: Pittsburgh Plate Glass Co., Brooklyn, N. Y.

**c. & d.** Nighttime and daytime versions of windscreen glazed with lustrous BROADLITE glass in architectural establishment of Thor Hesberg, AIA, Los Angeles, Calif. Glass: Ful-Trim Division of Texas Aluminum Co. Glazing: Giroux Glass Company.



b.



c. d.



## MISSISSIPPI GLASS COMPANY

88 Angelica Street • St. Louis, Missouri 63147  
NEW YORK • CHICAGO • FULLERTON, CALIF.

LARGEST DOMESTIC MANUFACTURER OF ROLLED, FIGURED AND WIRED GLASS

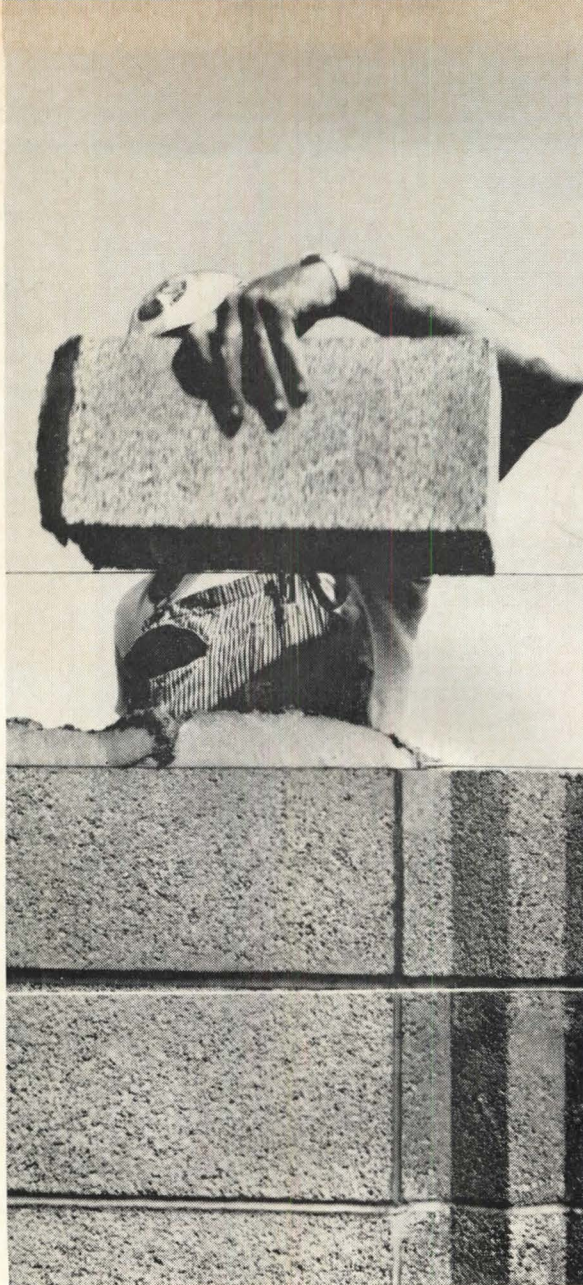
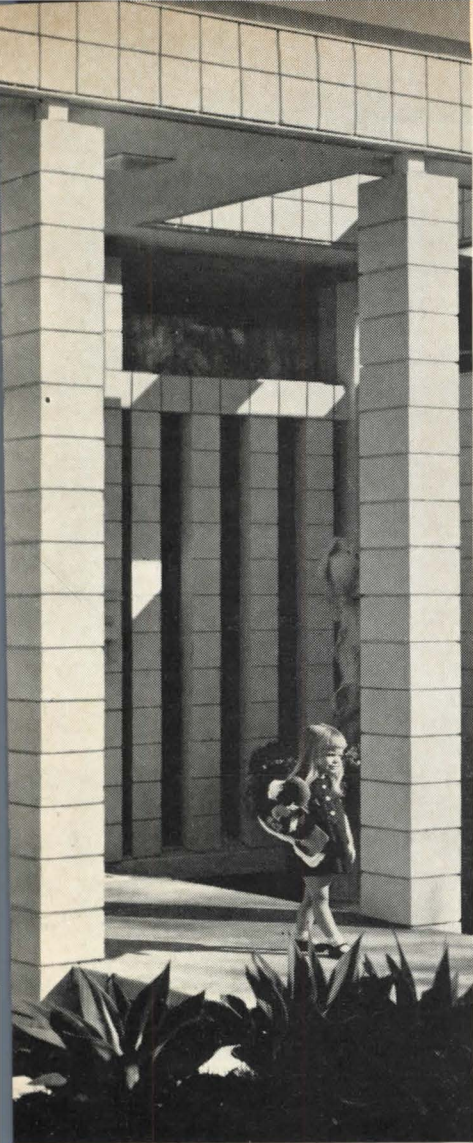

## The Q BLOCK<sup>®</sup> Program stacks everything in your favor

WHEN you're working with quality, things just naturally fall into place. Take the new Q BLOCK program for example. It wasn't long after block producers across the country adopted this national quality control program that building professionals were also eyeing its advantages.

These new standards, set forth by the block industry itself, give architects and builders the opportunity to design and build with maximum assurance of product quality. They have demonstrated their acceptance by *specifying* concrete block produced under the Q BLOCK quality control program—as it reflects all the high standards

that modern research and technical development can provide, backed up by regular product testing to guarantee that these standards are consistently maintained.

Concrete block, made to Q BLOCK specifications, is concrete block at its best. And better concrete block will always mean wider opportunities and more confidence for the modern user of building products.

Members of the National Q BLOCK program are identified by this registered mark. Look for it wherever you specify or use concrete block.

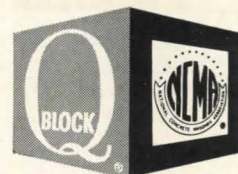

National Concrete Masonry Association • 2009 14th Street, North • Arlington, Virginia 22201



## For thirsty kids less than 42" tall

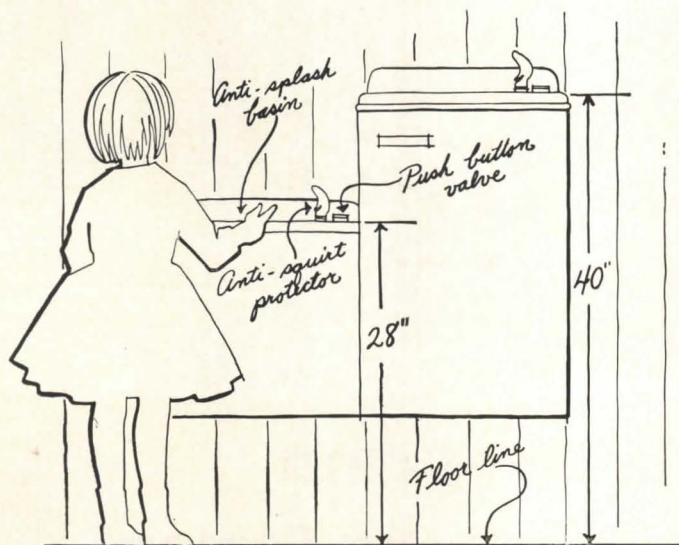

Wall mounted water cooler with low-level accessory fountain — designed with kids in mind. Available in stainless steel cabinet, baked enamel in choice of colors, or vinyl-laminated steel in silver spice, or mocha brown. Write for NEW 1966 Catalog or look us up in SWEET'S FILE or YELLOW PAGES.

# Halsey Taylor®

THE HALSEY W. TAYLOR COMPANY  
1562 THOMAS ROAD • WARREN, OHIO

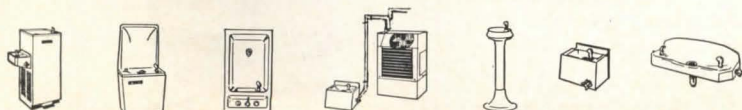

Complete line of electric water coolers and drinking fountains  
On Readers' Service Card, circle No. 403

Continued from page 254

perb; they provide the reader with a real glimpse of an aspect of Chinese civilization that was rarely seen in the past and is now practically impossible to see in person. The text by Peter Swann, though at times dry and pedantic, complements the pictures and is especially noteworthy for its discussion of the various foreign influences on Chinese art.

Any student of Chinese art will find this book a valuable contribution to his library, and, if one has to have regrets, it is that less than 10 per cent of the photographs are in color. They tend to whet the appetite for more and only serve to show how much a black and white photograph leaves out.

### OTHER BOOKS TO BE NOTED

**The Encyclopedia of Furniture.** Joseph Aronson. Crown Publishers, Inc., 419 Park Avenue S., New York, N. Y., 10016, 1965. 484 pp., bibliography, glossary, \$7.95

This third revised edition of the most compact English encyclopedia of furniture is vastly improved visually beyond previous editions by a dictionary format for illustrations and text; it includes photographs and drawings of a wider range of furniture in recognition of more recently acquired knowledge of and interest in other periods. Among them are the more precisely defined 19th-Century categories—Cottage, Craftsman, Art Nouveau, Mission and Modern furniture, even Borax Louis XV. However, the book is still primarily concerned with "antique" furniture prior to 1850.

Inaccuracies appear frequently: e.g., Morris & Company was founded in 1861, not 1862 (an error carried over from the previous edition); Eastlake did not influence Morris, but the reverse; "Van der Rohe, Mies." It is apparent that there is a need for complete rethinking concerning furniture from 1850 on. No encyclopedia of the entire history of the field can omit, as this one still does, feature (as opposed to glossary) listings for Mies, Breuer, Eames, or Saarinen; however, they are included in photographs and in the section on "modern furniture." Since there is no comparable review of the subject in English, this is an invaluable reference for architects and interior designers.

**American Furniture of the Nineteenth Century.** Celia Jackson Otto. The Viking Press, Inc., 625 Madison Ave., New York, N. Y., 10022. 229 pp., index, illus., \$12.00

As scholarship in 19th-Century design increases, the gaps in our appreciation and discussion of its periods are augmented by books such as this addition to Viking's fine Studio Book list, in which the periods and styles of the fulsome century past are more precisely defined by photographs of rooms and furniture details. These will not only help buyers at country auctions but also encourage architects and writers to be less vague than the previously accepted blanket label "Victorian."



See  
what happens  
when  
Contractor  
Ed Krygier  
meets up with  
one  
beautiful  
frame!

**FRAMED**

starring sultry

*Heather Browne*

See Heather install a new FenDry "Clamp-On" frame, complete with a flush-seamless Executive door in ten minutes, fifty-four seconds ...while Ed puts up a conventional frame in the conventional way. FenDry (U. S. patent applied for) is the fastest Drywall frame with a UL Label—and the Executive door is the first standard flush-seamless to earn the UL "B" Label. Send for this new film to show at your next architectural or contractor meeting. Just phone your local Distributor or write Fenestra Door Division, 4040 West 20th Street, Erie, Penna.

**FENESTRA**

*Fenestra is local everywhere*



Steel for Strength

# STRUCTURAL DESIGN NEWS

FROM BETHLEHEM STEEL

No. 13

## ONE CENTER PLAZA IN BOSTON.

The initial design of this new office building called for a framing material other than steel. But the owners and builders changed to a steel frame in order to allow for easy modification of tenant space (additional stairways, increased floor load capacities, etc.) after completion of the building. The eight-story structure will have 600,000 sq ft of space, with underground parking for 400 cars. Bethlehem Steel is supplying some 5,000 tons of structural steel for the framework, which is recessed at the first floor level to provide a pedestrian arcade.



Owner: Beacon Construction Company  
architect: Welton Becket and Associates  
consulting engineer: Wayman C. Wing  
steel fabricator: West End Iron Works

## WHY PENNEY CHOSE STEEL FRAMING.

Final design of J. C. Penney Company's 200,000-sq-ft retail store in Ventura, Calif., was preceded by a detailed analysis of the relative merits of steel framing versus reinforced concrete. Disclosed were significant savings in the choice of steel. Because of the low load-bearing capacity of the soil, foundation piles were required. Since the steel frame was much lighter, fewer piles were required. The lightness of the steel framing also permitted utilization of exterior masonry walls as shear walls. Considerable savings resulted from the simplicity of the steel frame for vertical and lateral loads. Further economy was achieved by designing with uniform bay spacing.



Owner: Gordon L. MacDonald & Associates;  
architect: Mazzetti/Leach, Cleveland & Associates; structural engineer: Samuel Schultz; general contractor: Monitor Construction Company; steelwork: Bethlehem Steel Corporation.

**OLD BRICK, NEW STEEL.** Civic-minded San Franciscans are enthusiastic about a restoration project near famous Fisherman's Wharf. There the brick shell of a circa-1903 fruit cannery is being braced, divided into two buildings, and filled in with three levels of steel framing to house a potpourri of restaurants, pubs, shops, and galleries.

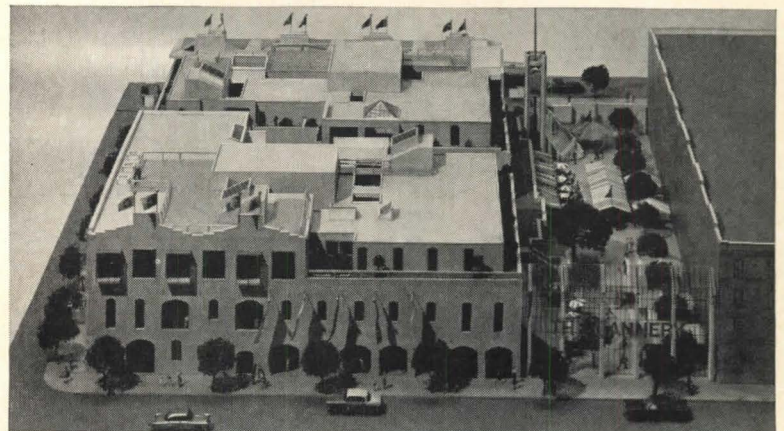

Owner: Leonard V. Martin; architect: Joseph Esherick and Associates; structural engineer: Rutherford & Chekene; general contractor: Greystone Builders; steelwork: Bethlehem Steel Corporation.



BETHLEHEM STEEL CORPORATION, BETHLEHEM, PA.



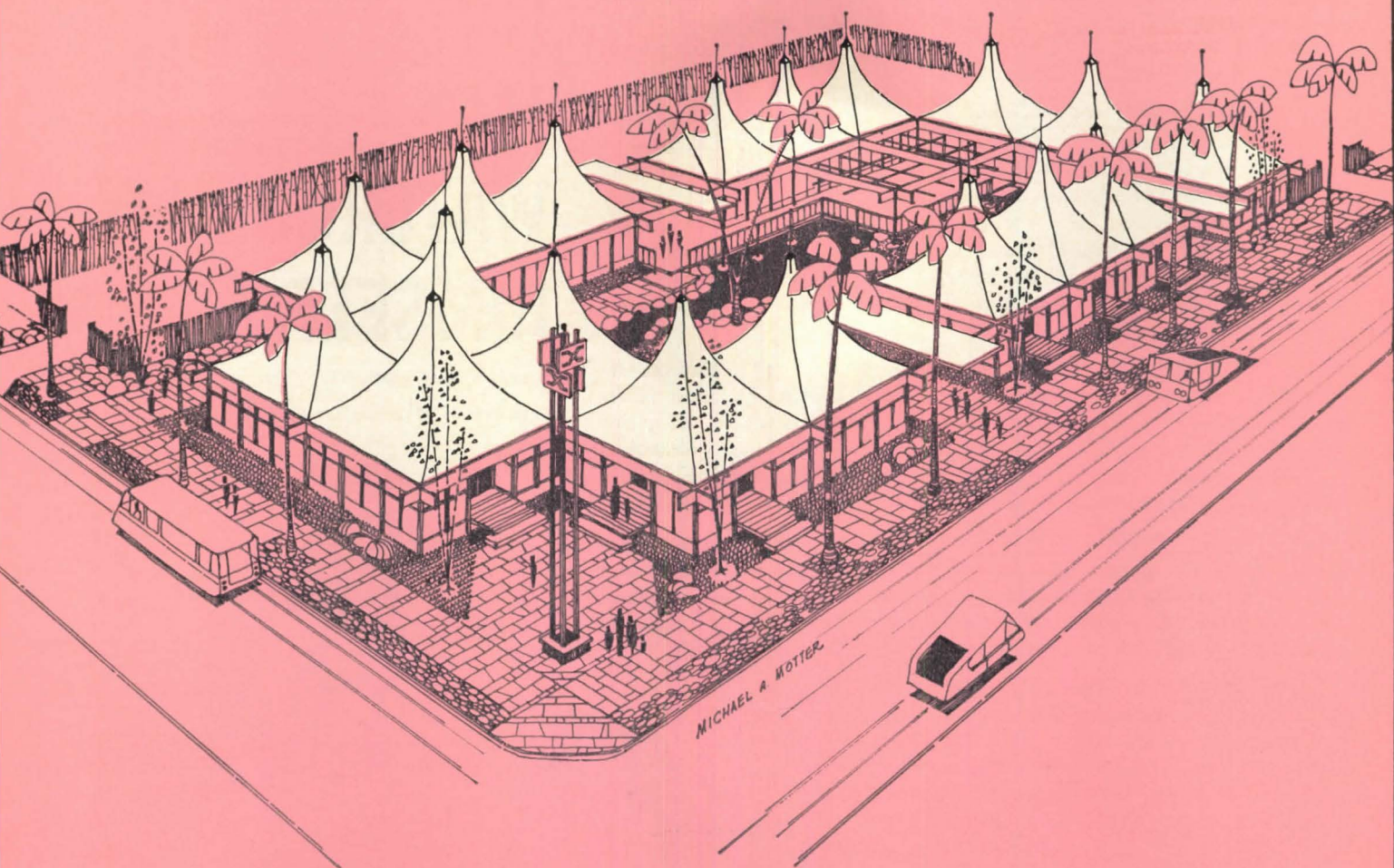

## Go ahead, raise the roof. We'll cover for you.

Let yourself go. Design a roof that looks the way you want it to look. Be bold. Be exotic. Unconventional shapes are no longer a problem. B.F. Goodrich has a remarkable new roofing system that conforms to unusual contours, works on steep slopes. Its name is BFG One-Ply. One-Ply is a laminate of DuPont Hypalon® synthetic rubber backed with neoprene-bound asbestos. It's light. Flexible. Easily installed. Fire resistant. Self-flashing. And so watertight, we guarantee it five years against leaks. Efficient on flat roofs, too. Find out more by writing B.F. Goodrich Building Products Dept. PA-23, Akron, Ohio 44318



On Readers' Service Card, circle No. 355

**Unique New Guide And Reference** Frederic Whitaker, often referred to as "Mr. Watercolor" because of his outstanding reputation and devoted service to the cause of watercolor, has organized his newest book as a series of related themes, to serve both as a working guide for the beginner, and as a reference for the advanced student. The novice can start at the beginning, and progress step by step at his own pace, from basic techniques to advanced technical problems. The more experienced student, aided by a unique cross-reference system, can quickly and easily select those themes which are of particular interest to him.

**Covers The Entire Field In Detail** Here is everything the beginner needs to know about producing watercolors. The author discusses the selection of all materials, from blotter to folding stool . . . describes how to prepare paper, how to handle brushes, how to apply a wash . . . explains, step by step, how to plan and paint a watercolor. Included is a full-color demonstration of the development of a Whitaker watercolor, from small sketch to finished painting, as well as basic instruction in composition, drawing, perspective and color. Also included are many hints on specific problems that plague the beginner.

**Advanced Instruction** For the more experienced student, the author describes various ways to experiment in applying and manipulating watercolor . . . illustrates many tricks for working over watercolor . . . offers tips on finishing a picture. Specific suggestions are given for painting more than 20 familiar picture components, including: clouds, boats, trees, foregrounds, flowers, shadows, portraits and figures.

**Convenient, Workable Reference System** An excellent cross-reference is provided by the numerous marginal notes, directing the reader to related themes in other sections. The experienced student will find this reference extremely helpful in locating information on specific subjects, or for quickly putting his finger on other pertinent material all through the book.

**Special Sections** In "Do's and Don'ts of Exhibiting," Mr. Whitaker gives many useful suggestions gleaned from years of experience on watercolor juries. He tells how to find out about exhibits; how to mat and frame your pictures for exhibition; how to keep records of the paintings you send out; *even* how to avoid irritating the judges. "A Brief History of Watercolor," which traces the development of watercolor as an important art medium in Europe & America, is a first-of-its-kind discussion . . . never before available in any book.

**110 Illustrations . . . 24 In Color**

This lavishly illustrated book contains over one hundred beautifully reproduced paintings and drawings, many created especially for this volume. Lucidly written and easy-to-follow, "Whitaker on Watercolor" is the summing up of the works of a man considered by many to be the dean of watercolor painting in America. 8 $\frac{3}{8}$  x 10 $\frac{1}{2}$ , 164 pp., \$12.50.



Available at your bookstore, or write to: Reinhold Book Division, 430 Park Avenue, New York 22, N.Y.

# IT'S "Mr. WATERCOLOR" HIMSELF

*(with his complete new guide to the watercolor medium)*

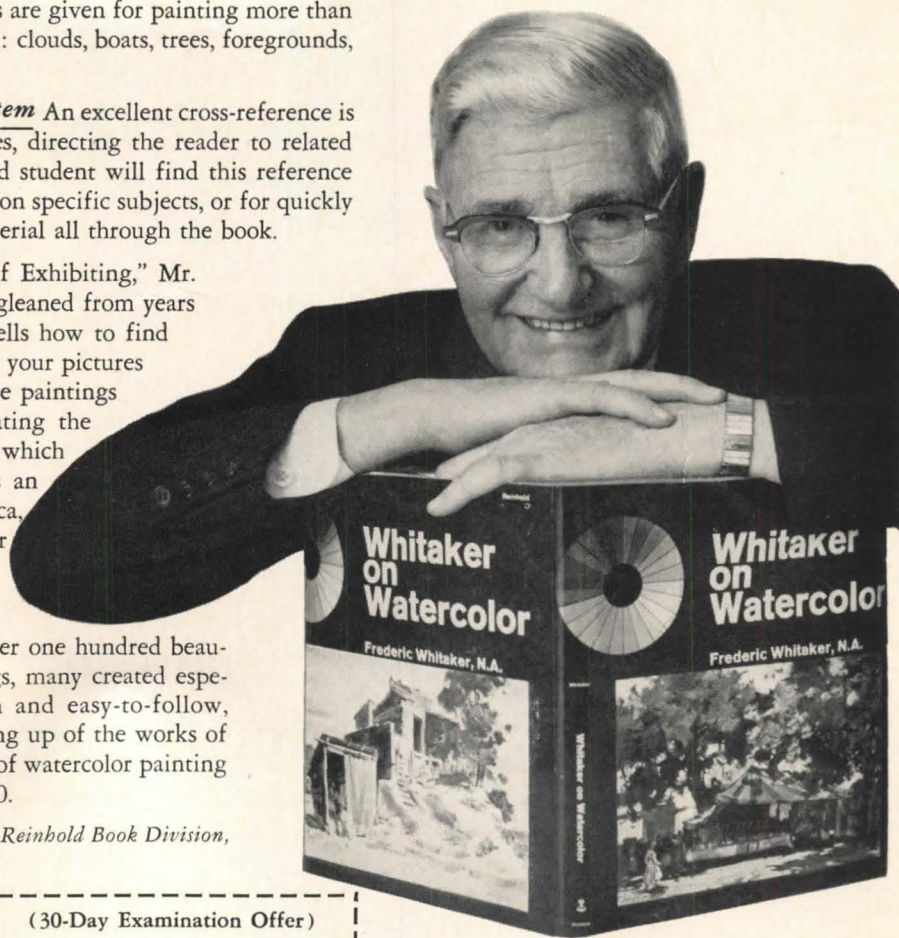

REINHOLD BOOK DIVISION (30-Day Examination Offer)  
430 Park Avenue, N.Y. 22, N.Y.

Please send me "Whitaker on Watercolor" at \$12.50, for 30 days' examination (in U.S.A. only). If I am not completely satisfied I may return it and owe nothing. If I keep it, I will send \$12.50, plus small shipping charge.

NAME \_\_\_\_\_ (Please print)

ADDRESS \_\_\_\_\_

CITY \_\_\_\_\_ ZONE \_\_\_\_\_ STATE \_\_\_\_\_

Save! Send total payment with order. We pay shipping costs. Money refunded if not completely satisfied. Return privilege guaranteed. Add sales tax on N.Y. Ohio and Pa. orders. Check or M.O. only. No cash!

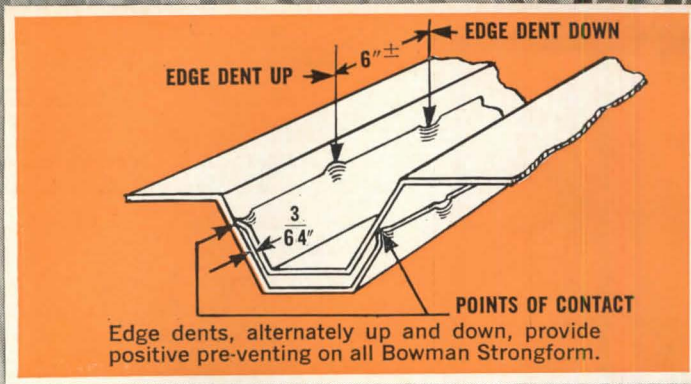

# FOOLPROOF pre-venting on **BOWMAN** STRONGFORM for lightweight insulating concrete roofs

Every section of Bowman Strongform for lightweight insulating concrete roofs is now pre-vented at the factory to give you more uniform quality with improved economy.

- it's pre-vented on both the advancing and trailing edges so that the application is foolproof.
- there are no hard-to-handle vent clips to place.
- factory pre-venting permits faster application, cutting on-site costs.
- it provides positive moisture control.

Bowman Strongform for lightweight concrete roofs and concrete floors is the most economical of all permanent forms. Bowman service—the industry's best—will keep your job on schedule. Let the Bowman representative give you all the facts soon. See the Bowman catalog in Sweet's File or write Bowman Building Products Division, Box 2129, Pittsburgh, Pennsylvania 15230.

**BOWMAN BUILDING PRODUCTS**

On Readers' Service Card, circle No. 421

**cyclops**  
CORPORATION

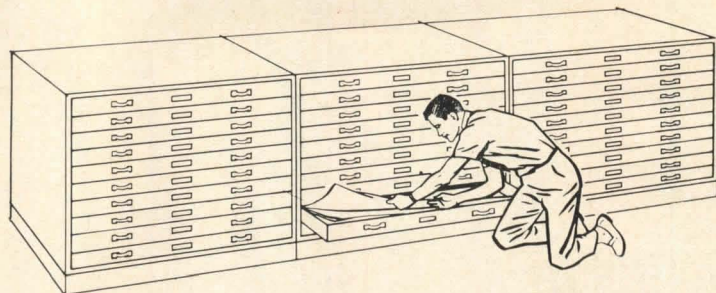

**Why use 38 sq. ft.  
to file 1200 drawings?**

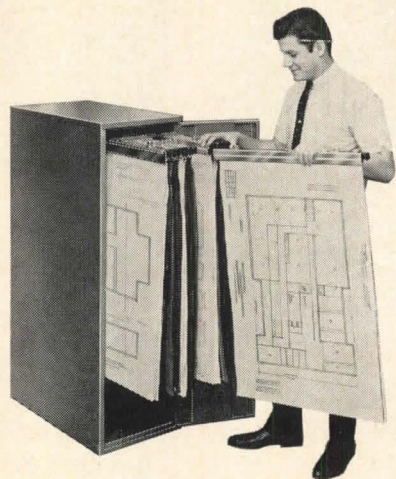

**Plan Hold® files  
1200 drawings in 3½ sq. ft.**

... and a Plan Hold System Saves 75% in Filing Time  
It takes only one Plan Hold Cabinet, with its modern vertical filing system, to file 1200 sheets... but three conventional 10-drawer files are required to accommodate the same 1200 sheets. The savings you get with Plan Hold are: 90% less floor space... 80% less equipment cost... 75% less filing time. And Plan Hold keeps your drawings clean, flat and free of wrinkles and holes. Whether you work with single sheets or large sets of plans in an office, drafting room, plant or field there's a Plan Hold filing system to meet your needs. Our 16 Page Catalog shows the basic Plan Hold systems. We will be glad to send you a free copy. Write Dept. PA64, Box 3458, Torrance, California 90510.



® PLAN HOLD CORPORATION • World's Largest Manufacturer of Plan Filing Systems  
Torrance, California & Aurora, Illinois • Plan Hold Company of Canada, Toronto 18

*Continued from page 30*

Conception St., Mobile, Ala.

PRECO CHEMICAL CORP., Engineers Hill,  
Plainview, N.Y.

REICH & SCHERTZER, Architects, 1478 St.  
Catherine St. W., Montreal, Canada.

LOUIS SAUER, Architect, 2011 Chancellor  
St., Philadelphia, Pa.

CLYDE M. STAUFFER & ASSOCIATES, Archi-  
tects, Engineers, and Planners, 3920 E.  
Indian School Rd., Phoenix, Ariz.

RICHARD G. STEIN & ASSOCIATES, Archi-  
tects, 588 Fifth Ave., New York, N.Y.

TUFTED TEXTILE MANUFACTURERS ASSOC.,  
P.O. Box 8, Dalton, Ga.

ARTHUR V. WYATT, Architect, 529 Grant  
St., Akron, Ohio.

#### **New Firms**

MYRON L. FETCH, Architect, Doylestown,  
R.D. #2, Bucks County, Pa.

HARRIS & JONES, Architects, 3240 McCul-  
lough Ave., San Antonio, Tex.

KENNEDY-BASON-GRIECO ASSOCIATES, Ar-  
chitects, 750 S. Atherton St., State Col-  
lege, Pa.

MITCHELL ASSOCIATES, Design Consult-  
ants, Southwood Rd., Hockessin, Del.

JOHN B. PARKINS ASSOCIATES, Architects  
and Engineers, 1801 Ave. of the Stars,  
Los Angeles, Calif.

ROBERT SILMAN, Consulting Engineer, 45  
W. 34th St., New York, N.Y.

HARRY A. SMITH, Engineer, Racine, Wis.  
W. CALDWELL SMITH, Architect, 374 E.  
Paces Ferry Rd., N.E., Atlanta, Ga.

WILL SZABO ASSOCIATES, Audio-Visual  
Consultants, 121 Wellington Ave., New  
Rochelle, N.Y.

WALLACE A. WENDELL, Architect, Cedar  
Crest, N. Mex.

WRIGHT & MOK, Consulting Engineers,  
817 Silver Spring Rd., Silver Spring, Md.

#### **New Partners, Associates**

FRED BASSETTI & COMPANY, Architects,  
Seattle, Wash., have named PAUL R.  
DERMANIS an associate.

CAUDILL-ROWLETT-SCOTT, Architects,  
Planners, and Engineers, Houston, Tex.,  
have named JAMES M. HUGHES, WILLIAM  
F. PERRY, PHILIP C. WILLIAMS, and  
DONALD B. WINES as associate partners.  
SMITH, HINCHMAN & GRYLLS ASSOCIATES,  
INC., Architects, Engineers, and Planners,  
Detroit, Mich., have named THOMAS H.  
KLAUSMEYER an associate.

DEETER-RITCHEY-SIPPEL, Architects, Pitts-  
burgh, Pa., have named LEANDER H.  
MINNERLY an associate.

FOOD FACILITIES ENGINEERING SOCIETY  
has accepted five new members: ROBERT  
D. CHATFIELD and EDWARD J. STOECKLIN  
as regular members, and ROBERT M.

*Continued on page 270*

for every Architect's File . . .

## The CONNOR "HIGH-HAT" Light/Air Design

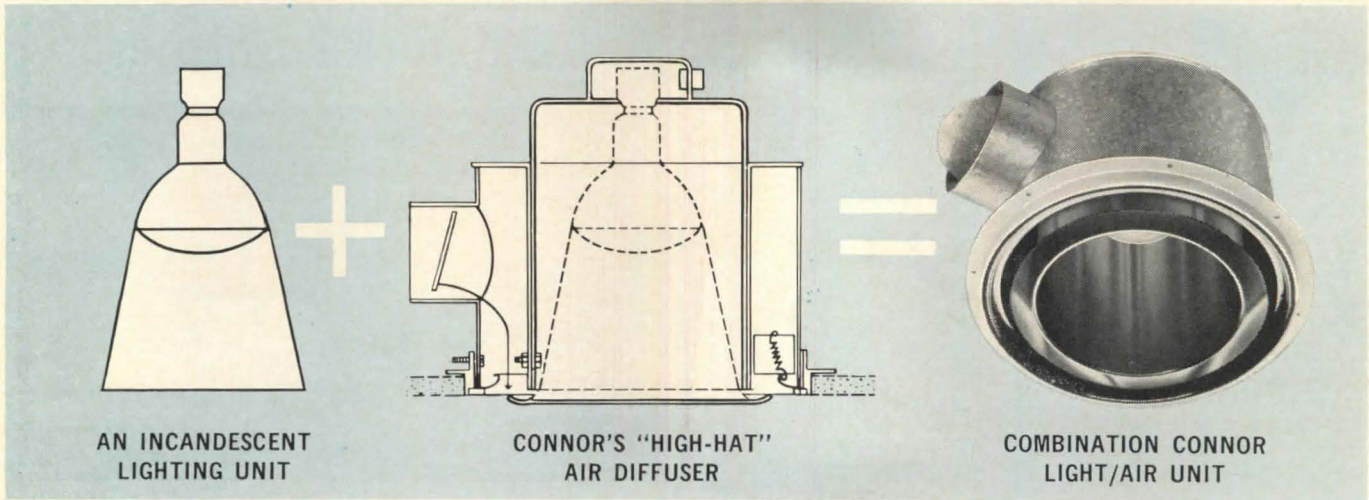

*and here's an application . . .*

lobby of a mid-western bank—

The Kno-Draft "High Hat" overhead air diffuser, combined with incandescent fixture, is another Connor "Architectural" design. It encourages architectural latitude by eliminating separate air diffuser units in the ceiling. Circular and flush-mounted, the design combination discharges air in an effective single circumferential pattern. Drafts are eliminated, and room temperature is equalized. Neat and simple, its styling blends ideally with all types of interior designs.

#### APPLICATIONS

Offers unusual advantages for installations in lobbies, cafeterias, and wherever circular incandescent lighting/air diffuser need exists.



#### WRITE FOR SPECIFICATIONS NOW

The "High-Hat" light/air diffuser is available in a complete air capacity range — and — for many different styles of incandescent lighting units.

Write for specification sheets (K-64) on the complete line of Connor combination light/air units. Connor Engineering Corporation, Shelter Rock Lane, Danbury, Connecticut.



# CONNOR

KNO-DRAFT® air diffusers

Member of Air Diffusion Council



THE WIEDEMANN  
**BAPTISTRY**

*Quality*

WITH THE  
**GUARANTEE**

of Fiberglass,  
of course  
by Wiedemann

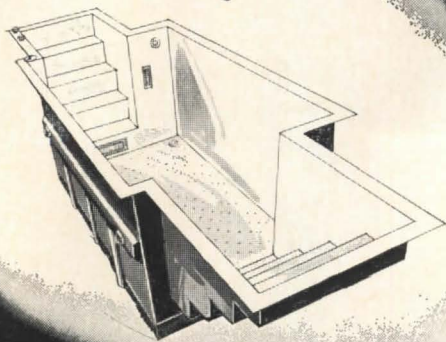

- Quality guaranteed up to 10 years on workmanship and materials
- Superior strength with Wiedemann's exclusive Fiberstressing process.
- Unit-molded.
- Skid-resistant steps and bottom.
- Complete line of heaters and accessories.

Write for free information kit.

Originator and Leading Baptistry Specialists.

*Wiedemann Industries, Inc.*

BOX 672 — MUSCATINE, IOWA



On Readers' Service Card, circle No. 417

**DURAGOLD**<sup>®</sup>

tarnish resistant golds  
for exterior finishes

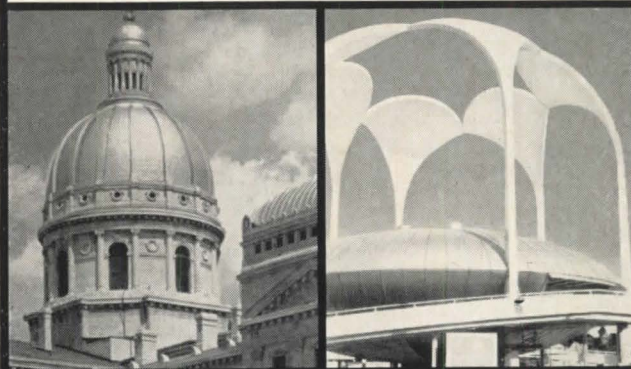

Specify Duragold for bright, economical, durable gold exterior and interior coatings. Shown above, the Indiana State Capitol dome and the Johnson's Wax Golden Rondelle at the New York World's Fair, both covered with coatings containing Duragold pigments. For the names of manufacturers using Duragold, plus a free gold spray can, write or call...



**CLAREMONT Polychemical Corp.**

39 Powerhouse Rd., Roslyn Hgts., L.I., N.Y. 11577 • 516 MA 1-8800

On Readers' Service Card, circle No. 473

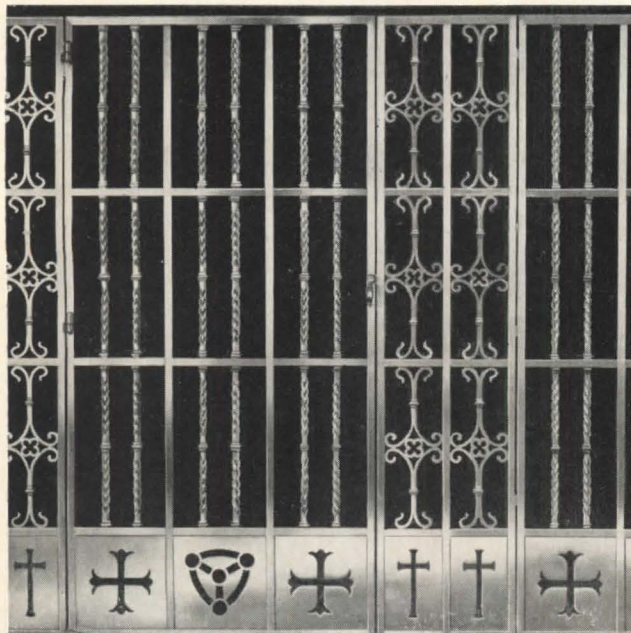

Seibels Memorial Chapel, University of South Carolina, Columbia, S. C.  
Architect: J. Carroll Johnson, Columbia

**BRONZE PARTITIONS**

Near-perfect workmanship fulfills the designer's inspired concept in this bronze ecclesiastical partition with gate by Michaels. The execution includes castings, bar twists, milled shapes, and die cuts and demonstrates flawless welding and finishing. Whether your ornamental metal design is traditional or modern, simple or intricate, you can depend on Michaels skill and integrity, backed by over ninety years of continuous experience. And Michaels' extreme versatility enables you to rely on this one company for the full gamut of architectural metalwork in any building. Heavy duty doors, windows, column covers, railings, grilles, window walls, curtain walls, and virtually all other work in bronze, stainless steel, and aluminum can always be brought into the custom-matched relation you want. Write for details and a discussion of your needs.



**THE MICHAELS ART BRONZE CO.**

**MICHAELS**

Mailing Address: P. O. Box 668, Covington, Ky. • Plant & Office: Kenton Lands Road, Erlanger, Ky.

KolorMate<sup>®</sup> gives you the

# FINEST FINISH

**of any asbestos-cement product for industrial-laboratory table tops**

Nicolet's KolorMate, a monolithic asbestos-cement material, is fast becoming the first choice of industrial designers and architects for use in industrial-laboratory furniture applications. KolorMate is well known as an acid and corrosion-resistant material, and now its superior finish is recognized as adding a new dimension to the normally utilitarian concept of laboratory working surfaces.

KolorMate can be machined and cut using techniques common to stone fabrication. Table tops and fume hoods made from KolorMate lend a new standard of performance and appearance to industrial-laboratory furniture.

KolorMate is available in Charcoal Grey, Cocoa Tan and Bermuda Green, in all popular thicknesses.

To all the advantages of KolorMate, add finish for the final touch, by Nicolet, naturally.

Send for our 1966 KolorMate brochure; write Nicolet Industries, Florham Park, New Jersey.



Quality-Control Laboratory  
Counter Tops



Fume Hood and Table Top



 **nicolet**  
INDUSTRIES INC.



**YOUR CLIENT EXPECTS HIS CONCRETE TO RESIST DEICING CHEMICALS**

... Even though air-entrainment has proven effective in limiting premature deterioration, sufficient air-entrainment is often difficult to accomplish in the field. For less than 1½¢ per square foot material cost a two-coat, spray or roller application of SPENCER KELLOGG Linseed Oil Anti-Spalling Compound locks out water, frost, and deicing agents. It penetrates and seals exterior concrete, preserving utility and beauty... protects it from winter surface spalling. It's easy to apply... it's long-lasting... it's economical concrete insurance. Get the facts on SK Linseed Oil Anti-Spalling Compound from your Building Supply Salesman, Sweet's Architectural File, 9/sp or write Spencer Kellogg Division of Textron Inc., Buffalo, New York 14240. Also available in Canada.



A **textron** division

On Readers' Service Card, circle No. 398

We can turn your design ideas in office furniture from conception into a reality. Desks, Inc. will custom craft your designs or you may select from a vast array of fine office furniture from America's leading manufacturers. If you've an "idea on the wing," let us capture it.

**METAMORPHOSIS**



**DI DESKS inc.**

NEW YORK—71 FIFTH AVE. (at 15th St.) N. Y. C. • 212 255-5454  
NEWARK—At The Prudential Mall • 201 642-3360

On Readers' Service Card, circle No. 466



## Greatest column since 426 B.C.

Available now are new 14" WF column shapes in USS "T-1" Steel weighing 730 pounds per foot. With a minimum yield strength of 90,000 psi, these are the world's strongest rolled steel columns. The same rolled sections are also readily available in USS COR-TEN High-Strength Low-Alloy Steel and A36 Steel.

Rolled sections have big advantages over built-up

sections: simplified design, reduced costs all along the line . . . in fabrication, inspection, handling, and material costs.

We can furnish you complete design and detailing information on these sections. Call our nearest Sales Office or write to United States Steel, Room 8719, 525 William Penn Place, Pittsburgh, Pa. 15230. USS, "T-1" and COR-TEN are registered trademarks.

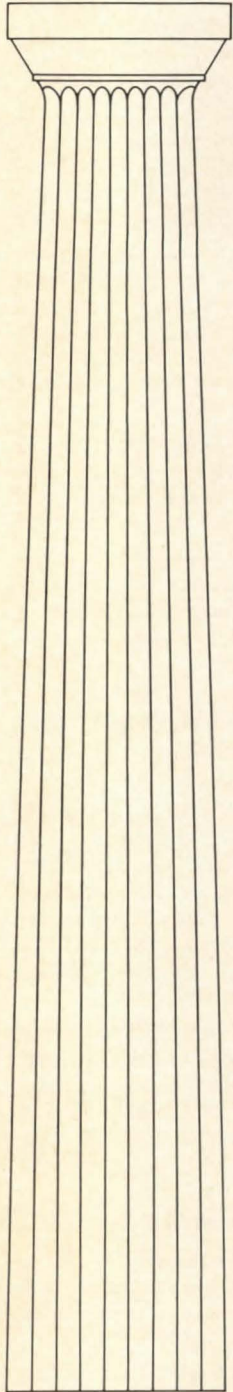

DORIC

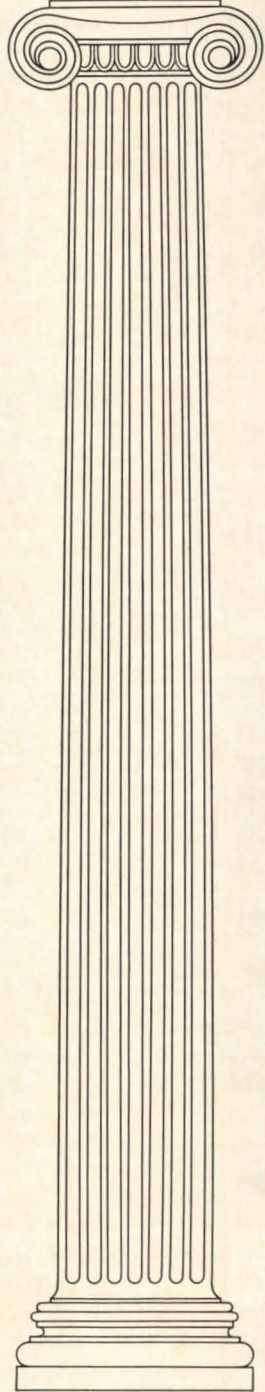

IONIC

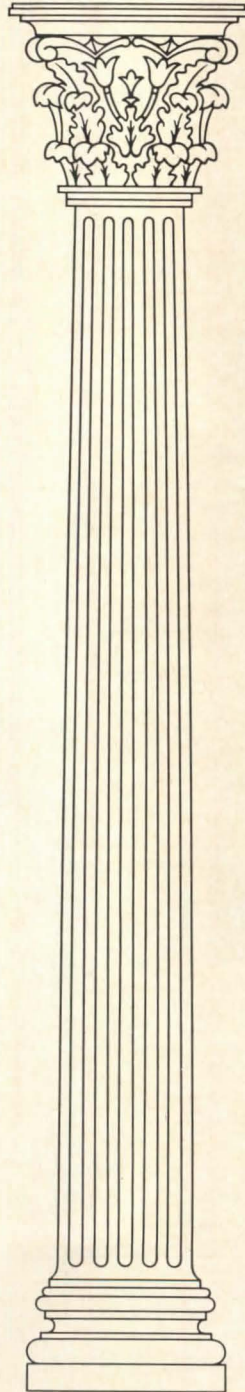

CORINTHIAN

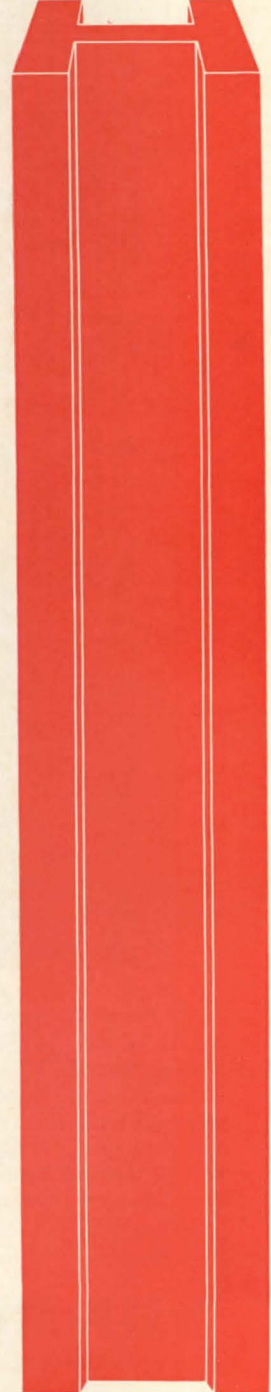

USS 14" WF

**USS** United States Steel: where the big idea is innovation



Wells Fargo Building, San Francisco, tallest building west of Dallas. **Owner:** Dillingham Corp. Honolulu, San Francisco. **Architect and Engineer:** John Graham and Company, Seattle and New York. **Plumbing Contractor:** Scott Co., Oakland, California.

## SUNROC SPECIFIED FOR WEST'S TALLEST BUILDING

Good looks, practical features and timeless styling of this semi-recessed, stainless steel drinking fountain made it a natural choice for Wells Fargo. Sunroc offers air-cooled or water-cooled models in capacities from 5 to 12 gph. Vinyl or stainless steel aprons.

The unique, patented cooling package simplifies installation, effects more efficient service with far less maintenance. Install it as a fountain, convert it any time to a water cooler. Get complete specifications and roughing-in dimensions.

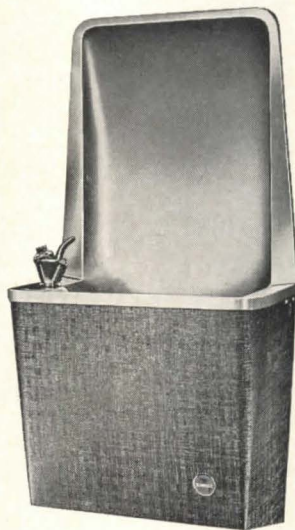

## SUNROC

CORPORATION—Glen Riddle 40, Pennsylvania

Send data on SUNROC fountains.

Name \_\_\_\_\_

Company \_\_\_\_\_

Address \_\_\_\_\_

City \_\_\_\_\_ State \_\_\_\_\_ Zip \_\_\_\_\_

*Continued from page 264*

LINDSEY, MARIO KENT L'ESPERANCE, and DONALD VINTON as associate members.

HELLMUTH, OBATA & KASSABAUM, Architects, St. Louis, Mo., have admitted LEGRAND A. BENEFIEL to the firm as associate director of medical facilities planning.

ABRAHAM LANDOW, Architect, L.L., N.Y., has named LLOYD J. LANDOW a partner in the firm.

ARTHUR LAWRENCE ASSOCIATES, Architects, Cleveland, Ohio, announce that JAMES MAGUIRE has joined the firm.

NICHOLS, MORTON & ZALDASTANI, INC., Consulting Structural Engineers, have named LLEWELLYN S. BOLTON III, JERONIMAS V. DABRILA, MICHAEL J.A.H. JOLLIFFE, and JOHN W. NEVINS as associates.

THE PERKINS & WILL PARTNERSHIP, Architects, Chicago, Ill., have named seven new associates: VYTAUTAS GERMANAS, JOHN M. MARIN, VIRGINIA S. CONKLIN, EDMUND C. SONNENSCHN, LOUIS A. CUOMO, SAUL H. KLIBANOW, and JOHN V. LESLEY.

ROSE, BEATON, CORSBIE, DEARDEN & CROWE, Architects and Engineers, New York, White Plains, and Washington, D.C., have named JOHN N. DURSO an associate.

SMITH, HINCHMAN & GRYLLS ASSOCIATES, INC., Architects, Engineers, and Planners, Detroit, Mich., have named ROBERT W. YOKOM as associate.

EBERLE M. SMITH ASSOCIATES, INC., Architects and Engineers, Detroit, Mich., have announced that VERNON L. WHEELER has joined the firm.

NEILL SMITH & ASSOCIATES, Architects, Mill Valley, Calif., announce that CHARLES D. WILEY has joined the firm. STONE, MARRACCINI & PATTERSON, Architects, San Francisco, Calif., have named four new associates: GEORGE CROWE, CLARKE A. DAVIS, WARREN C. WACHS, and ERNI YOUNG.

JOHN CARL WARNECKE & ASSOCIATES, Architects and Planning Consultants, San Francisco, Calif., have named four new associates: HAROLD L. ADAMS, DONALD SCHAEFER, JOHN BRUCE WEBB, and WAYBURN YUEN.

### *Elections, Appointments*

THE AMERICAN INSTITUTE OF CONSULTING ENGINEERS, N.Y., N.Y. announces the election of JOHN G. HOAD as president for 1966.

BOLT BERANEK & NEWMAN, INC., Acoustical Consultants and Researchers, Boston, Mass., have appointed DR. T. J. SCHULTZ as staff technical manager of the New York City group, and A. S. HARRIS as its administrative manager.

GUNNAR BIRKERTS & ASSOCIATES, Archi-

*Continued on page 278*

On Readers' Service Card, circle No. 401

## URETHANE FOAM PROJECT REPORT

# Builder News III

Part of a series of product-use bulletins published by Mobay to keep architects, engineers, builders and contractors informed on new developments in urethane foam materials for the commercial and residential construction industries.

MOBAY

BN-3

## RIGID URETHANE FOAM UNIFIES PLASTIC AND METAL STRUCTURAL COMPONENTS INTO STRONG, EASILY ERECTED, INSULATED MODULE

Using rigid urethane foam-filled prefabricated aluminum wall and roof sections, two men reportedly can erect a complete 432 sq. ft. building or add a 12' x 36' room to an existing structure in less time than it usually takes to put in the wall studs by conventional building methods.

Developed by the Security Aluminum Co., Detroit, the wall system is composed of foam-core sandwich panels, 4 ft. wide and up to 16 ft. long. The thickness of 5 $\frac{1}{3}$  inches was chosen as a coordinate module of the standard 16-inch building dimension on which all the structural design features are based.

The panel skin is 0.032-inch vinyl-coated aluminum sheet, finished on exposed sides. The studs or cross members are of extruded vinyl, specially slotted to interlock with the aluminum sheet to maintain uniform spacing between the skins prior to foaming, and to impart some rigidity to the finished panels.

But the essential element of the whole idea, according to the manufacturer, is the rigid urethane foam core which provides structural properties that exceed building code requirements for snow and wind loads in any part of the country and a U factor of 0.03—equal to 16 inches of glass fiber.

Other advantages of the urethane foam contribute measurable benefits to the end user. The owner gains by elimination of maintenance expenses caused by corrosion, rotting, rusting, cracks, leaks or termites; lower insurance rates owing to the nonburning classification of urethane foam (ASTM 1692-59T); and lower heating and cooling costs due to its near-perfect insulating properties.

Using factory mass production methods, the panels are fabricated in 10 to 12 minutes each. The metal skins and plastic cross members are assembled in forms with doors and windows set in place. The urethane formulation is then injected into the box void formed by the facing skins.

As the urethane foam expands, it envelops the internal bracing members and completely fills every space. As the foam hardens, it forms a permanent bond with the aluminum skins to create a strong, fully insulated, monolithic structural unit.

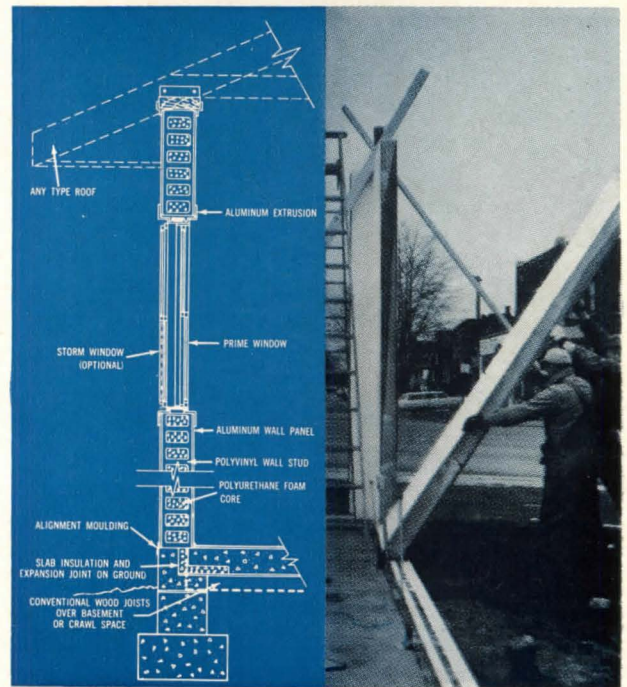

(Left) Cross section shows structural detail of typical modular panel unit positioned on pre-installed footings and floor. (Right) Wall panels are aligned and fitted into pre-caulked and drilled metal channel, secured with self-tapping screws.

During the initial foaming operation, a 2 $\frac{1}{2}$ -inch void is left on either side of the panel. When the panels are connected at the job site, plumbing, wiring and other fixtures are installed in the 5-inch space, which is then filled with urethane foam to unify the entire wall.

### Advantages of Foam Core Wall

- Adaptable to residential and commercial buildings
- Stronger, more rigid than conventional structures
- Offers architect complete design freedom
- Provides excellent sound barrier
- Erected easily, quickly and economically
- Excellent barrier for heat, cold, moisture
- Eliminates maintenance problems

Further information on this application may be obtained from Security Aluminum Co., 385 Midland Ave., Detroit, Mich.; or Callery Chemical Co., Callery, Pa., manufacturer of chemical system.

For additional information on the use of urethane foam in other insulation and construction jobs, write on your letterhead to:

**MOBAY CHEMICAL COMPANY, CODE PA-20, PITTSBURGH, PA. 15205**

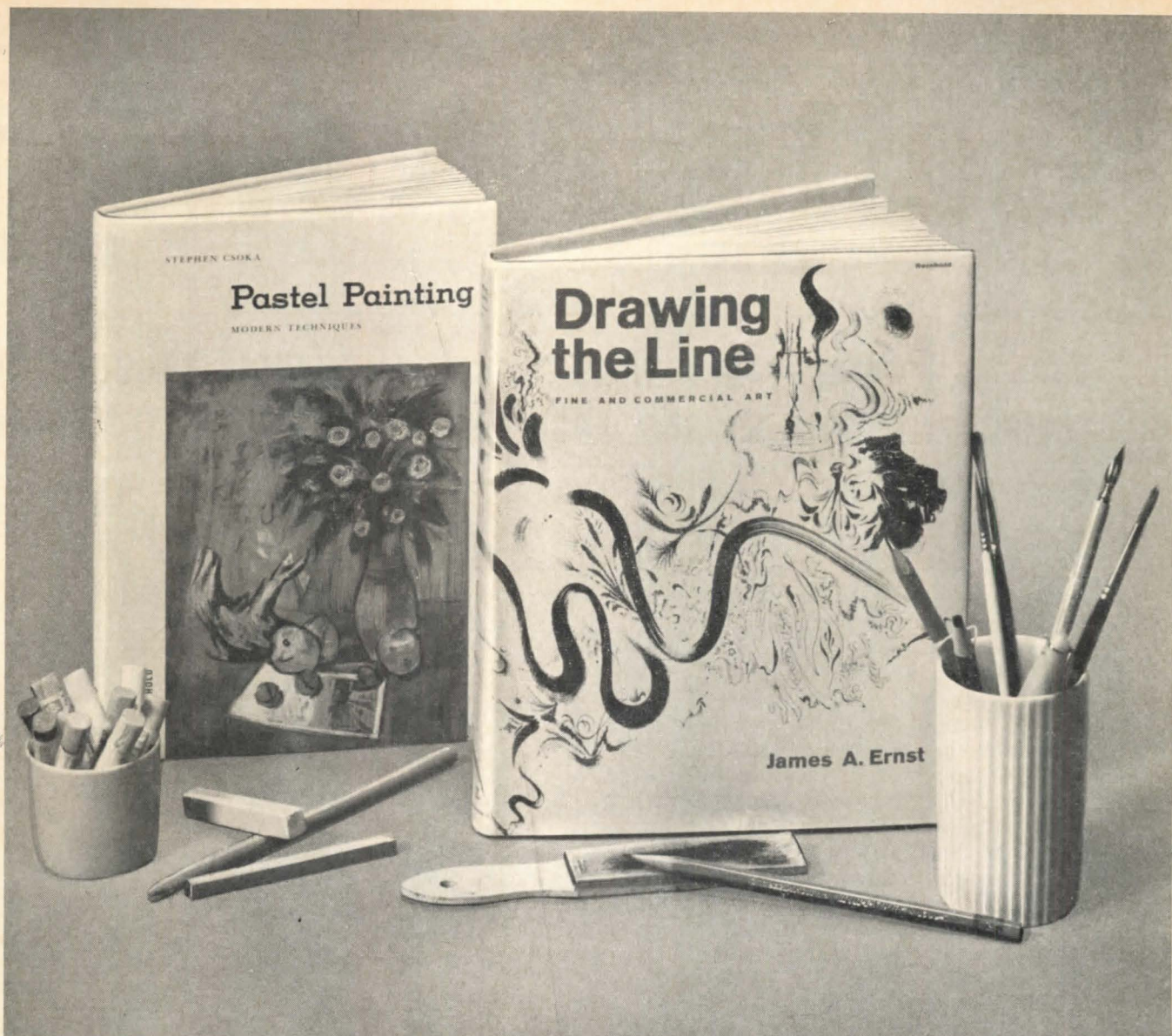

## IF YOU DRAW FOR PLEASURE OR FOR PROFIT you'll find a wealth of helpful information in these new Reinhold books

**PASTEL PAINTING** by Stephen Csoka. A comprehensive guide to this brilliant medium. Complete information on: materials and tools—how to select and use them; technical and artistic problems, including choice of paper and colors; sketching and composition; tips on how to blend and apply color, how to create highlights, how to make corrections. The author reveals secrets discovered in his long years of experience, to help you express yourself better in this easy-to-learn, inexpensive medium. Over 150 black and white illustrations (many step-by-step demonstrations), 8 full-color reproductions, all with lively, informative captions. Chapters on: Landscapes, Texture, Perspective, Still Life, The Human Figure, Babies, The Head, Abstract Painting, plus a *Portfolio of Sketches*. Beginners as well as experienced artists will find pastel a satisfying medium to work in. Commercial artists, designers and decorators will find it particularly useful for quick visual and color combinations. **PASTEL PAINTING**, Modern Techniques by Stephen Csoka, 128 pages, 7 x 10, 150 illus., (8 color). \$9.95

**DRAWING THE LINE** by James Ernst. With special emphasis on its application in commercial art, this book demonstrates all the techniques of line drawing: pen and ink; felt-tip-pen; brush and paint; combination pen and brush; lead, carbon, litho, grease and wax pencils; charcoal, pastel; scratchboard. Each of these techniques is discussed in great detail and illustrated by the author with many concrete examples. Discover

the hundreds of exciting and different effects you can achieve . . . how to make the line crisp or suggestive, sharp or blunt, sweeping or meticulous . . . how to simulate tone with line . . . how to combine lines or vary effects with rough or smooth surfaces. The right implement for drawing each kind of line is specified, and valuable hints are given for making corrections and preserving equipment. Profusely and beautifully illustrated, this easy-to-follow, informative book will prove an invaluable reference for graphic designers, advertising personnel, architects, students and professional artists. **DRAWING THE LINE** by James Ernst. 160 pages, 8 1/4 x 10 1/4, 148 illus. \$10.

### 30-Day Examination Offer

REINHOLD PUBLISHING CORPORATION

480 Park Avenue, New York 22, N.Y.

Please send me the book(s) checked below for 30 days' examination (in U.S.A. only).

- PASTEL PAINTING,  
 DRAWING THE LINE, \$10

Check or M.O. enclosed (ppd.)  Bill Me (plus postage)

NAME.....

ADDRESS.....

CITY..... ZONE..... STATE.....

Save Money! Send total payment. Reinhold pays regular shipping costs. Same return privilege. Add sales tax on N.Y., Ohio and Pa. orders. Check or M.O. only — do not enclose cash!



**Look what just happened  
to the revolution we started  
in good light and good looks.**

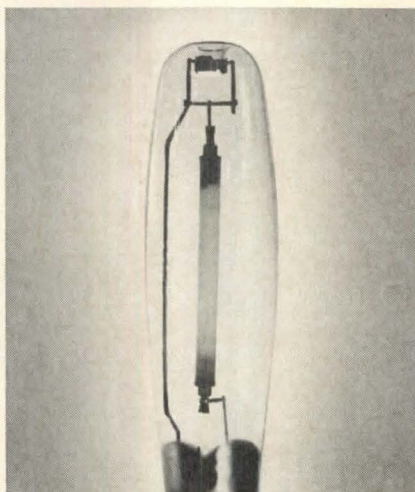

## **Lucalox<sup>®</sup>. From G.E.**

You agreed with us that our new Profile<sup>7</sup> light is a real revolution in outdoor lighting.

Now we give you another important option. For your light source you now can specify General Electric's new Lucalox lamp. Lucalox puts out 105 lumens per watt, and because all of this light is concentrated in a cigarette-size arc, maximum optical control can be obtained. Combination of Profile Light

and Lucalox intensifies the rectangular revolution and makes possible new levels in general area lighting.

So now you can choose Lucalox, color-true metallic vapor, or conventional mercury lamps. You can put any of them to work in our revolutionary Profile Light, the only luminaire with an asymmetric reflector. The only luminaire that lets you put predictable rectangles of

uniform light precisely where you want them.

And rugged, weathertight Profile Light is sleek looking, contemporary in design. Good light. Good looks. An unbeatable combination. Get all the facts from your Crouse-Hinds distributor. Or write: Crouse-Hinds Company, Outdoor Lighting Dept., Syracuse, New York 13201.

**CROUSE-HINDS**

Lucalox is a Registered Trademark of General Electric Company

On Readers' Service Card, circle No. 450

Wells Fargo Bank, San Francisco, Calif.  
Architects: Ashley, Keyser and Runge, San Francisco, Calif.  
Stainless steel vault door and flanking walls:  
The Hermann Safe Co., San Francisco, Calif.

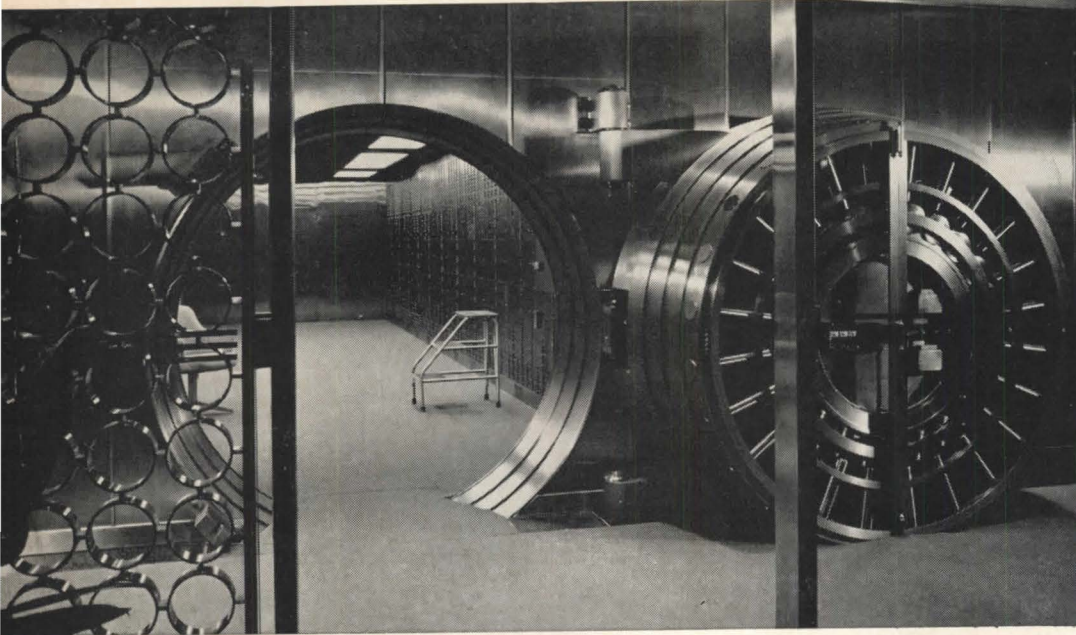

Bowery Savings Bank, New York, N. Y.  
Architects: Gibbs and Hill, Inc.,  
Consulting Engineers, New York, N. Y.  
Stainless steel stair rails:  
Trio Industries, Inc., Bridgeport, Conn.



***When you design and build with stainless steel***

Jefferson Trust and Savings Bank, Peoria, Ill.  
Architects: Lankton, Ziegele & Terry, Peoria, Ill.  
Stainless steel rigidized panel curtain wall:  
Fenestra Incorporated, Lima, Ohio.



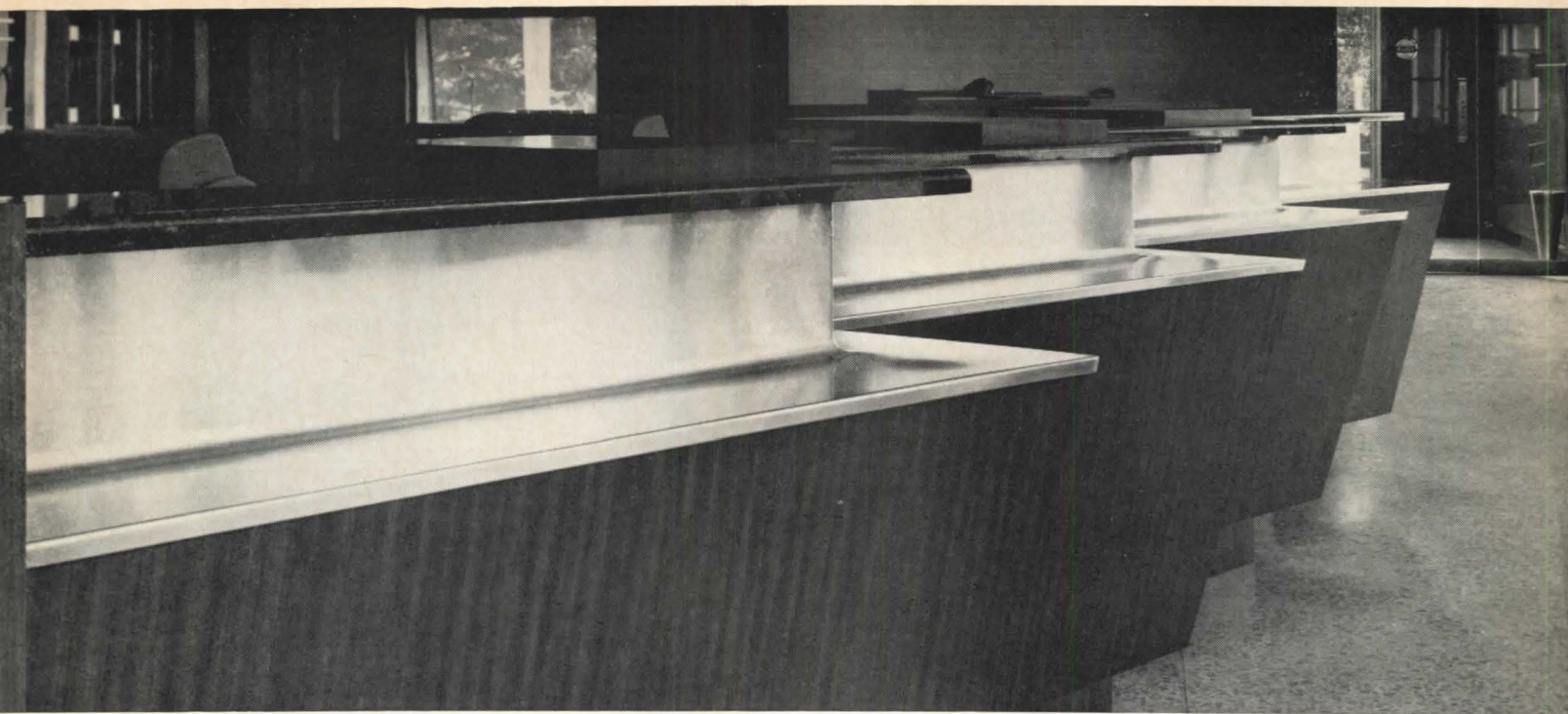

Cayuga Federal Savings and Loan Association, Philadelphia, Pa.  
 Architect: Philip Mastrin, AIA, Philadelphia, Pa.  
 Stainless steel counters: John A. Robbins, Inc., Philadelphia, Pa.

## ***it's like putting money in the bank.***

Architects and builders have more interest in nickel stainless steel than ever. Because it keeps paying dividends for life with lasting beauty, corrosion resistance and low maintenance. And investment in stainless shows immediate returns—its high strength permits the use of light, economical gauges in products designed to meet your budget.

Nickel stainless steel has excellent corrosion resistance. It stands up in almost any atmosphere or climate. There's little danger of corrosion products streaking or staining adjacent materials. Its soft, permanent luster complements, reflects and highlights surrounding materials. Gives buildings a modern, progressive appearance. Gleams beautifully for life and never needs paint—ordinary detergent and water keep it looking like new.

Bank on the advantages of nickel stainless steel for your next design. Find out about available competitive products—including curtain walls, entrances, windows, railings, counters and vaults. And write for Inco's informative "Stainless Steel Architectural Fact Sheet."

### **INTERNATIONAL NICKEL**

67 Wall Street, New York, N.Y. 10005

*Nickel...its contribution is Quality*

On Readers' Service Card, circle No. 361

First National Bank, Dallas, Texas. Architects: Thomas E. Stanley and George L. Dahl, Dallas, Texas. Stainless steel swinging and revolving doors: International Steel Company, Evansville, Ind.



First National Bank of San Jose, Sunnyvale Branch, Sunnyvale, Calif.  
 Architect: Melvin A. Rojko. Consultant: Bank Building & Equipment Corp. of America, St. Louis, Mo. Stainless steel flashing: John B. Shelton Roofing Co., San Jose, Calif.

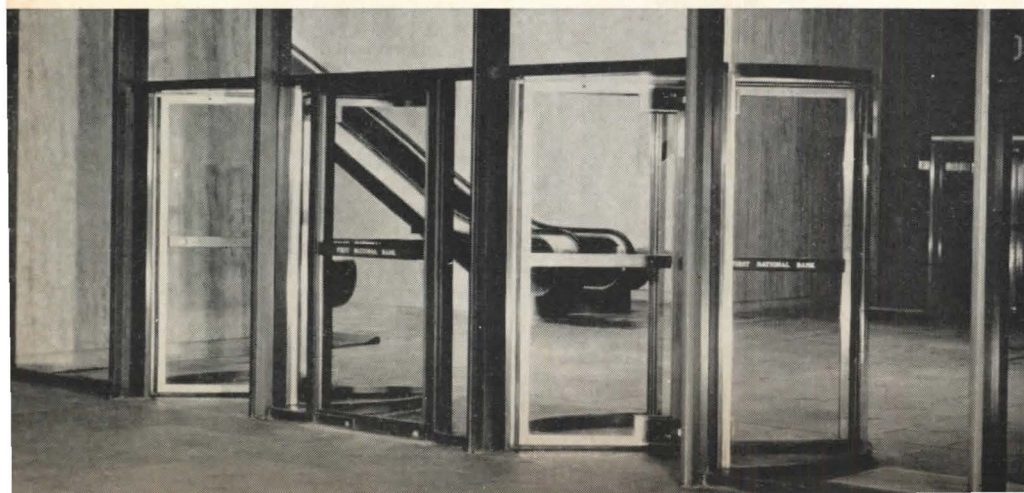

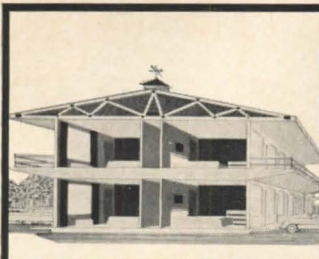

*It pays to*  
**SPECIFY  
SANFORD  
ROOF  
TRUSSES**

Look to the biggest for the best. Your Sanford dealer is backed up by the most experienced engineering department in the industry. What's more, there are 4 strategically located Sanford plants in the U.S.A. to provide rapid dealer service. Write us for the dealer nearest you or for the 24-page Sanford A.I.A. booklet showing the wide variety of uses for money-saving Sanford manufactured trusses.

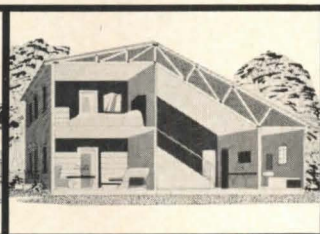

World's Largest Roof Truss System



**SANFORD TRUSS, INC.**

P.O. Box 1177 G

Pompano Beach, Florida 33060

Also: Indianapolis, Indiana/Riverside,  
California/Grand Prairie, Texas

On Readers' Service Card, circle No. 427



Pocket-sized . . . and packed  
with useful information

**TIMBER  
CONSTRUCTION MANUAL**

A Manual for Architects, Engineers, Contractors, and  
Laminators and Fabricators of Engineered Timber  
Buildings and Other Structures.

By the

**AMERICAN INSTITUTE OF TIMBER CONSTRUCTION**

A practical, up-to-date, reliable handbook of technical data  
on engineered timber construction. Part I contains design data  
and construction information; Part II gives American Institute  
of Timber Construction recommended standards and  
specifications.

1966. Approx. 896 pages. \$12.50.

Available from your bookseller, or

**JOHN WILEY & SONS, INC.**

605 THIRD AVENUE

NEW YORK, N.Y. 10016

**AT LAST...**

**the natural  
beauty of wood  
in solid vinyl  
handrail!**

ONLY  
AVAILABLE IN  
**rucorail™**

Now . . . the luxurious look of wood . . . economical solid vinyl . . . adds a warm and inviting touch to your handrail decor, inside and out.

Exclusive rucorail pvc woodgrain handrails are ideal in wood-panelled rooms . . . as room dividers . . . on stairways . . . for outdoor railings . . . and a host of other exciting applications.

Write today for a free sample of this revolutionary handrail and our full-color Designers' Guide containing complete specifications and suggested ways to design with rucorail.

Available  
in six profiles  
for solid bar  
and U channel  
in 25 ft. rolls.



**RC DIVISION/HOOKER CHEMICAL CORPORATION**  
New South Rd., Hicksville, N.Y. 11802 • Phone: (516) 931-8100

