

# The Conservation of Wall Paintings

---

Proceedings of a Symposium  
organized by the Courtauld Institute of Art  
and the Getty Conservation Institute  
London  
July 13-16 1987

# The Conservation of Wall Paintings



# The Conservation of Wall Paintings

Proceedings of a symposium  
organized by the Courtauld Institute of Art  
and the Getty Conservation Institute,  
London, July 13-16, 1987

Sharon Cather, Editor

THE GETTY CONSERVATION INSTITUTE



Cover: Masaccio and Filippino Lippi. Detail of *The Raising of the Son of Theophilus* and *The Chairing of Saint Peter*, after conservation. Brancacci Chapel, Santa Maria del Carmine, Florence. (Photo: A. Quattrone)

**Note:**

***Manufacturers' materials data and safety sheets should be consulted and any necessary precautions applied in the use of any materials referred to in this volume.***

Publication Coordinator: Irina Averkieff, GCI  
Editing: Andrea Belloli and Irina Averkieff  
Technical Drawing: Janet Spehar Enriquez  
Cover Design: Marquita Takei, Los Angeles, California  
Text Design: Marquita Takei and Jacki Gallagher (GCI)  
Typography: Adobe Garamond  
Printing: Tien Wah Press, Ltd.

© 1991 The J. Paul Getty Trust  
All rights reserved

Printed in Singapore

Library of Congress Cataloguing-in-Publication Data

The Conservation of wall paintings: proceedings of a symposium organized by the Courtauld Institute of Art and the Getty Conservation Institute, London, July 13-16, 1987 / Sharon Cather, editor.

p. cm.

Includes bibliographical references.

ISBN 0-89236-162-X (pbk.)

1. Mural painting and decoration--Conservation and restoration--Congresses. I. Cather, Sharon. II. Courtauld Institute of Art. III. Getty Conservation Institute.

ND2552.C64 1991

751.6'2--dc20

91-16526

CIP

Second printing 1996.

## THE GETTY CONSERVATION INSTITUTE

The Getty Conservation Institute, an operating organization of the J. Paul Getty Trust, was created in 1982 to address the conservation needs of our cultural heritage. The Institute conducts world-wide, interdisciplinary, professional programs in scientific research, training, and documentation. This is accomplished through a combination of in-house projects and collaborative ventures with other organizations in the USA and abroad. Special activities such as field projects, international conferences, and publications strengthen the role of the Institute.



# Contents

<i>Miguel Angel Corzo</i>	Foreword	viii
<i>David Park and Frank Preusser</i>	Preface	ix
<i>Frank Preusser</i>	Scientific and Technical Examination of the Tomb of Queen Nefertari at Thebes	1
<i>Ornella Casazza and Sabino Giovannoni</i>	Preliminary Research for the Conservation of the Brancacci Chapel, Florence	13
<i>Karl Ludwig Dasser</i>	Pretreatment Examination and Documentation: The Wall Paintings of Schloß Seehof, Bamberg	21
<i>Claus Arendt</i>	The Role of the Architectural Fabric in the Preservation of Wall Paintings	29
<i>Ivo Hammer</i>	The Conservation in Situ of the Romanesque Wall Paintings of Lambach	43
<i>Fabrizio Mancinelli</i>	The Frescoes of Michelangelo on the Vault of the Sistine Chapel: Conservation Methodology, Problems, and Results	57
<i>Gianluigi Colalucci</i>	The Frescoes of Michelangelo on the Vault of the Sistine Chapel: Original Technique and Conservation	67
<i>S. B. Hanna and J. K. Dinsmore</i>	Conservation of Central Asian Wall Painting Fragments from the Stein Collection in the British Museum	77
<i>Eric M. Moormann</i>	Destruction and Restoration of Campanian Mural Paintings in the Eighteenth and Nineteenth Centuries	87
<i>Andreas Arnold and Konrad Zehnder</i>	Monitoring Wall Paintings Affected by Soluble Salts	103
<i>Mauro Matteini</i>	In Review: An Assessment of Florentine Methods of Wall Painting Conservation Based on the Use of Mineral Treatments	137



# Foreword

**T**he Getty Conservation Institute has devoted particular attention to the problems of wall paintings conservation. Collectively, wall paintings form a record of artistic, cultural, and intellectual developments of historical significance.

The wall paintings of the tomb of Nefertari, in Egypt, have been the subject of an on-going effort for the past six years that is coming soon to a close. Projects in Dunhuang and Yungang, in China, are just now underway to systematically study the causes of deterioration in the sites and to investigate strategies for their long-term protection.

The Courtauld Institute of Art and the Getty Conservation Institute have been collaborating for six years in a wall painting conservation course, a unique three-year postgraduate-level training program.

To facilitate an international dialogue and exchange of information among conservators, scientists, and historians involved in major wall paintings conservation projects, the GCI and the Courtauld Institute of Art organized a symposium on the subject in London in 1987. This symposium was part of the GCI's ongoing efforts to promote a multidisciplinary approach to conservation, to examine issues related to conserving cultural property in situ, and to provide specialized training in conservation. By publishing the symposium's edited papers, we hope to provide a current report on significant projects and developments underway in the field of wall paintings conservation.

*Miguel Angel Corzo*

Director

Getty Conservation Institute

# Preface

In recent decades there has been an increasing focus in all areas of conservation on an interdisciplinary approach. This has been especially true for wall paintings, where indeed a number of special factors make it essential: their physical and aesthetic unity with the architecture; their particular vulnerability, in that they constitute an extremely thin layer which is itself the interface between the support and the environment; the limitations on controlling potential agents of deterioration; and the scale and expense not only of intervention, but also of study and monitoring.

The symposium was planned to reflect this and was organized as part of the postgraduate Course in the Conservation of Wall Painting established in 1985 as a joint venture of the Courtauld Institute of Art and the Getty Conservation Institute. The curriculum of the training program is based on the philosophy shared by the two sponsoring institutions that conservation should be interdisciplinary and involve minimal intervention, requiring that causes of deterioration are adequately understood and monitored. There is, therefore, a consequent emphasis on these aspects both in the training and in the contributions to the symposium.

The organizers invited papers that would represent major programs of wall painting conservation—such as the Tomb of Nefertari, the Brancacci Chapel, and the Sistine Chapel—and would address the issues of diagnosis, documentation, and monitoring, which often tend to be overshadowed by treatment results. Thus the symposium was divided into three general categories: Planning and Diagnosis, Treatment, and Monitoring. Four papers were presented on each of the three days, leaving a considerable amount of time for discussion led by invited specialists—architects, art historians, conservators, and conservation scientists.

For Planning and Diagnosis the preliminary investigations carried out for the Tomb of Nefertari (Frank Preusser) and the Brancacci Chapel (Ornella Casazza and Sabino Giovannoni) were presented, together with the general problems of the architectural support (Claus Arendt) and documentation (Karl Ludwig Dasser). The session was chaired by Frank Preusser, and the discussants were Dr. Eve Borsook (Villa I Tatti, Florence), Mr. Martin Caroe (Caroe & Martin Architects, London), and Mr. Théo-Antoine Hermanès (Ateliers Crephart, Geneva).

Treatment was represented by papers on Central Asian paintings in the British Museum (Seamus Hanna and Jennifer Dinsmore), on the Romanesque paintings of Lambach (Ivo Hammer) and two contributions on Michelangelo's frescoes on the Sistine Chapel vault (Fabrizio Mancinelli and Gianluigi Colalucci). Mr. Paul Schwartzbaum (ICCROM) chaired the session, and Dr. Karl Ludwig

Dasser, Dr. Caroline Elam (*The Burlington Magazine*), and Dr. Lorenzo Lazzarini (University of Rome) led the discussion.

The final session, devoted to Monitoring, was chaired by David Park and included a diverse selection of papers: the effects of soluble salts (Andreas Arnold); a historical survey of the discovery and early treatment of Roman paintings (Eric Moormann); an investigation into the effects of recent treatments of wall paintings in France (Marcel Stefanaggi and Isabelle Dangas, though not included in the present volume); and an assessment of Florentine conservation methods (Mauro Matteini). Dr. Claus Arendt, Mr. Théo-Antoine Hermanès, and Mr. John Mitchell (University of East Anglia) participated as discussants.

Although specific aspects of individual contributions were debated, much of the discussion also focused on broad issues related to the structure, administration, and funding of conservation. There was general agreement that the paradigm of a comprehensive, interdisciplinary approach tended to be realized only in a few select cases. Moreover, it was observed that monitoring wall paintings after treatment—and, perhaps more importantly, as a routine surveillance practice—rarely occurs. This was seen to be due not only to the low priority and consequent lack of funding it is given, but also to the absence of adequate parameters and guidelines for such monitoring.

In a few papers references to the literature published since 1987-88 have been added, but in general the reader is referred to the recent comprehensive bibliography by Anna Miele Pacifici in *Pitture murali: tecniche, problemi, conservazione* (eds. C. Danti, M. Matteini, and A. Moles; Opificio delle Pietre Dure, Florence, Centro Di; 1990:329-371).

We would like to thank those who have contributed both to the organization of the symposium and the publication of the proceedings, particularly Mrs. Marta de la Torre, Training Program Director of the Getty Conservation Institute, who proposed that the symposium be held as part of the teaching and participated actively in the planning. Mr. Luis Monreal, former Director of the GCI, was also closely involved in structuring the symposium, and Professor C. M. Kauffmann, Director of the Courtauld Institute, hosted the meeting. Sharon Cather, of the Courtauld Institute, has, of course, been involved in all phases, most especially in the editing of the contributions, and we owe her a considerable debt. Finally, Irina Averkieff has applied her usual high standards to the publication of the proceedings, ably assisted by Jacki Gallagher.

***David Park***

Director  
Conservation of Wall Painting Department  
Courtauld Institute of Art

***Frank Preusser***

Associate Director, Programs  
Getty Conservation Institute



Plate 1, above. View of the east wall of the vestibule (E) with Kheperi, Isis, and Harakhty, and into the inner chamber (G). 1987.

Plate 2, right. North face of column III in the sarcophagus chamber (K) with Hathor and Nefertari. 1987.

Plate 3, far right. The ceiling at the top of the stairway (I). showing discoloration and damage, and gauze strips applied during emergency treatment. 1987.

Plate 4, bottom far right. West wall of the stairway (I). Detail of Nefertari presenting offerings, showing the relief carving of the plaster. 1990.

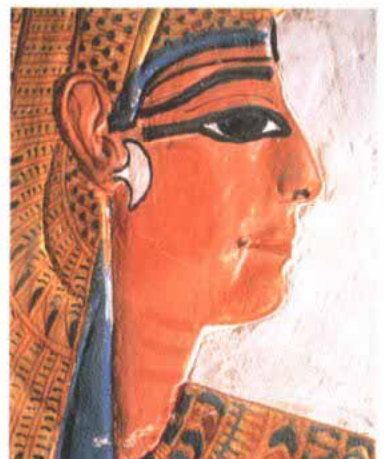
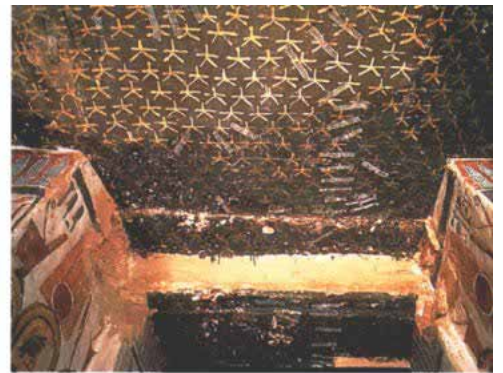





Plate 5, right. West face of column II in the sarcophagus chamber (K) with Osiris. 1991.

Plate 6, top. North wall in the sarcophagus chamber (K). Detail of dangerously detached plaster. 1986.

Plate 7, above. South wall of the vestibule (E). Detail of Nefertari led by Harsiese, showing discoloration. 1987.

Plate 8, bottom left. East wall of inner chamber (G). Detail of Atum, showing extensive reintegration of losses. 1986.

Plate 9, bottom right. North wall in the sarcophagus chamber (K). Reattachment of partially detached plaster. 1987.

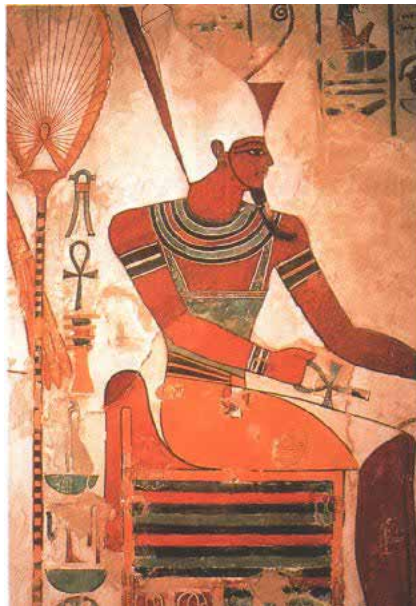



**Ornella Casazza  
and Sabino Giovannoni**

*Preliminary Research for the Conservation  
of the Brancacci Chapel, Florence*

*Plate 10, right. Masaccio, Chairing  
of St. Peter. Detail of two Car-  
melites photographed before conser-  
vation in normal light.*

*Plate 11, far right. As in Plate 1, in  
raking light.*

*Plate 12, below. As in Plate 1, in  
ultraviolet light.*

*Plate 13, below right. As in Plate 1,  
during conservation, showing clean-  
ing along lines of the giornate.*



*Plate 14, above. Masaccio, Tribute  
Money. Detail of St. Peter remov-  
ing coin from a fish. Infrared pho-  
tograph with "false colors," before  
conservation.*







*Plate 15, right. Joseph Ignaz Appiani, ceiling decoration of the Weißer Saal, 1751-1752. Detail of Neptune and the Nile above the east wall. 1977.*

*Plate 16, above. Losses showing the stratigraphy of arriccio and intonaco over lath support. 1984.*

*Plate 17, below right. Deterioration due to moisture in areas painted a secco. 1984.*

*Plate 18, below far right. Losses in paint layer related to excessive organic binder. 1984.*

*Plate 19, bottom. Detail showing the boundary of a work field above the head of the putto. 1984.*

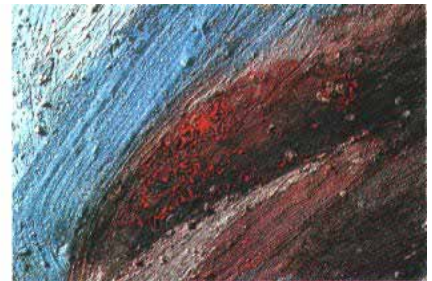
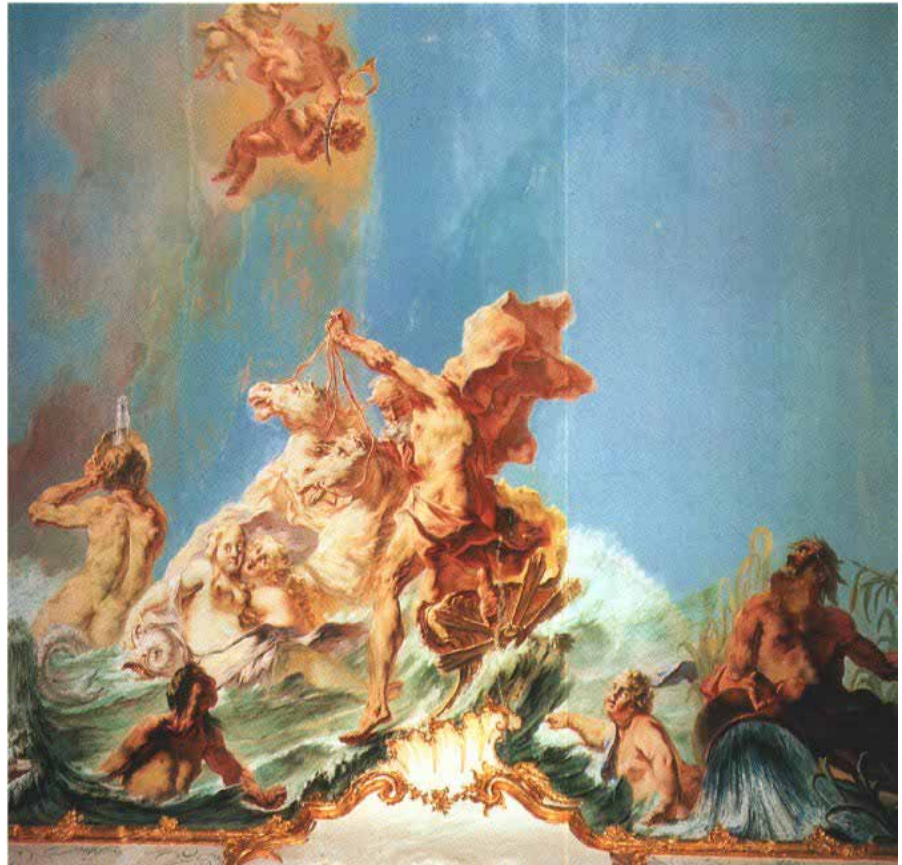



*Plate 20, below. Detail of under-drawing carried out in lead pencil. 1984.*

*Plate 21, right. Highlighting done with pastels bound in vegetable gum. 1984.*



### **Claus Arendt**

#### *The Role of the Architectural Fabric in the Preservation of Wall Paintings*

*Plate 22. Wall painting with cracks requiring protection and monitoring during structural injection grouting.*





**Ivo Hammer**

*The Conservation In Situ of the Romanesque  
Wall Paintings of Lambach*

*Plate 23, right. East wall, south bay.  
Detail of the angel in The Dream  
of Joseph.*

*Plate 24, below left. General view of  
the paintings, toward the southeast,  
ca. 1080.*

*Plate 25, below right. West wall,  
north bay. Detail of Christ Among  
the Doctors, showing iconoclastic  
defacing and damage due to added  
weight of later towers.*

*Plates 26-28, facing page. West  
wall, north bay. Christ Healing the  
Man with the Unclean Spirit in  
the Synagogue at Capernaum.*

*Two-thirds of this scene was desali-  
nated and consolidated with sili-  
cates. Details show an area that  
required treatment (Pl. 26, upper  
left) and an untreated area (Pl. 27,  
upper right).*

*All photographs, 1990.*





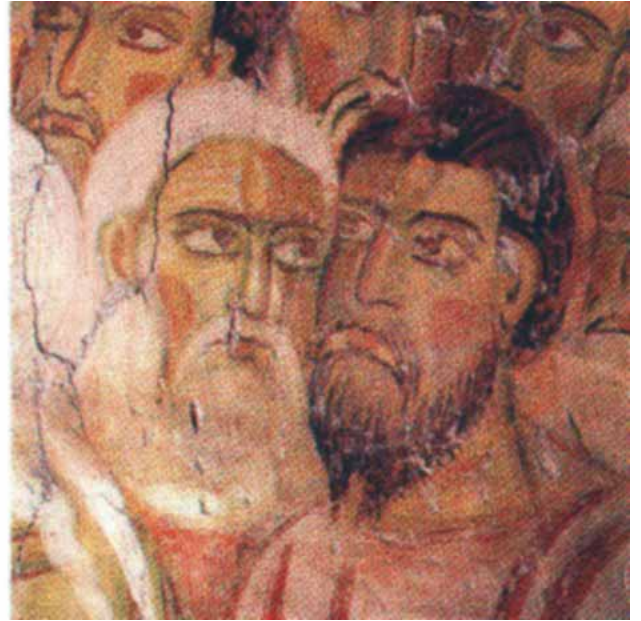



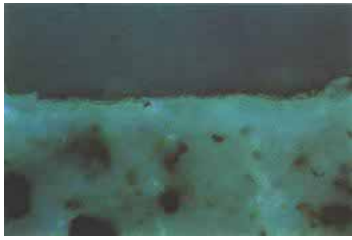
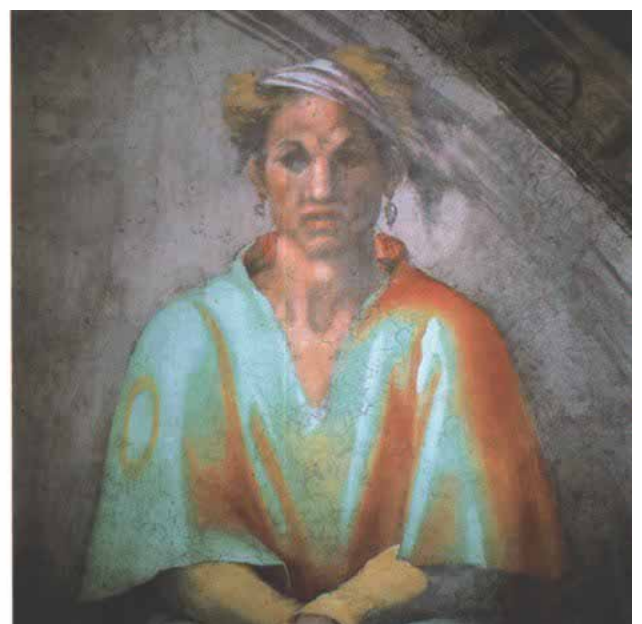
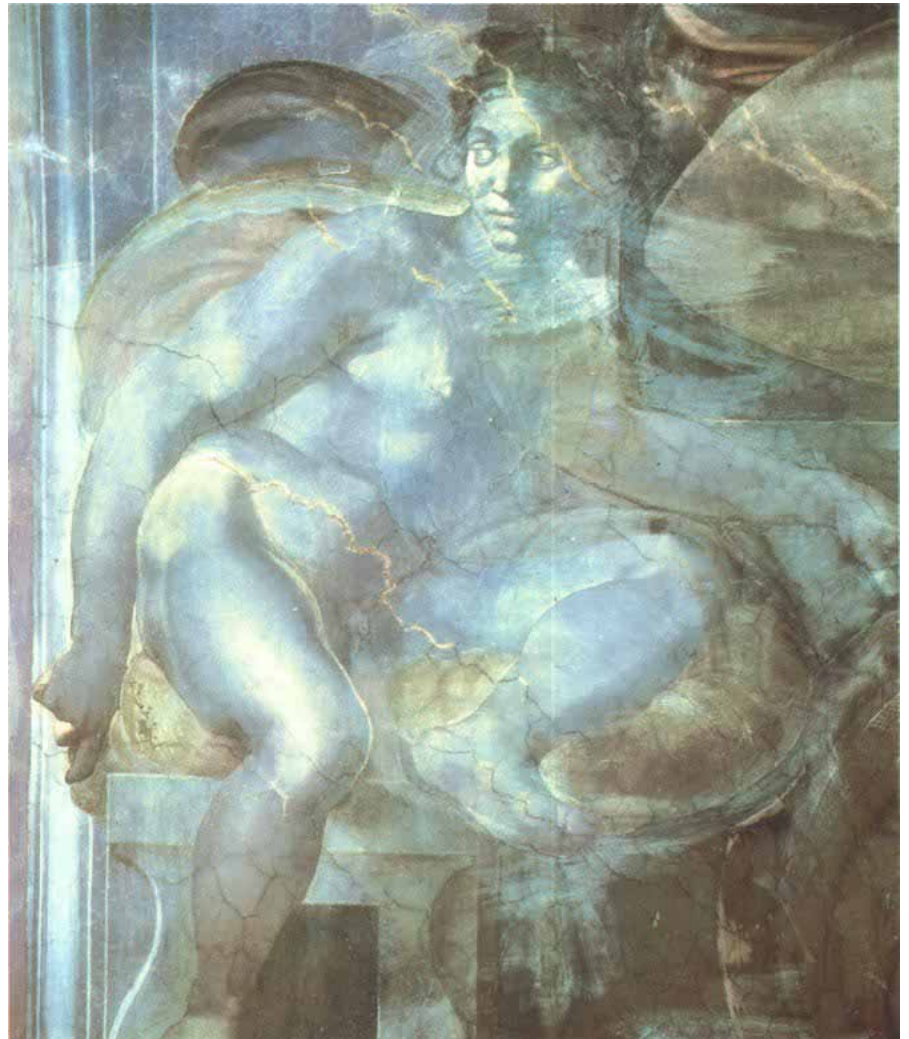

*Plate 29, above. Cross section of the blue sky from The Temptation (before cleaning), photographed in ultraviolet, showing (from the top down) dust and soot, glue, traces of dust and soot, and smalt.*

*Plate 30, right. Ignudo to the left of the Cumaean Sibyl photographed in ultraviolet before cleaning (see also Fig. 7 on p. 70).*

*Plate 31, below left. Detail of a male figure in the Aminadab lunette, before cleaning.*

*Plate 32, below right. As in Pl. 31, after cleaning.*



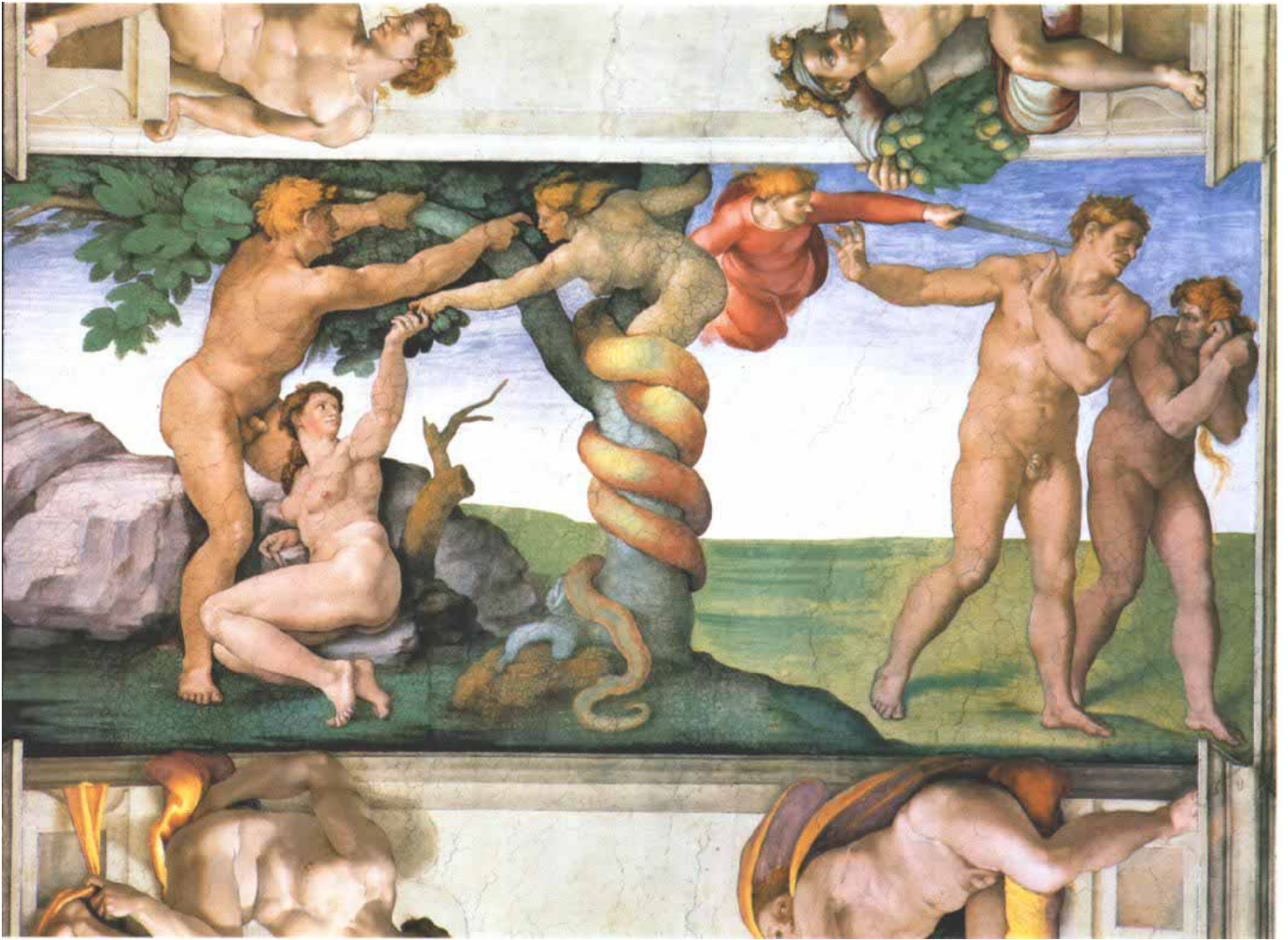
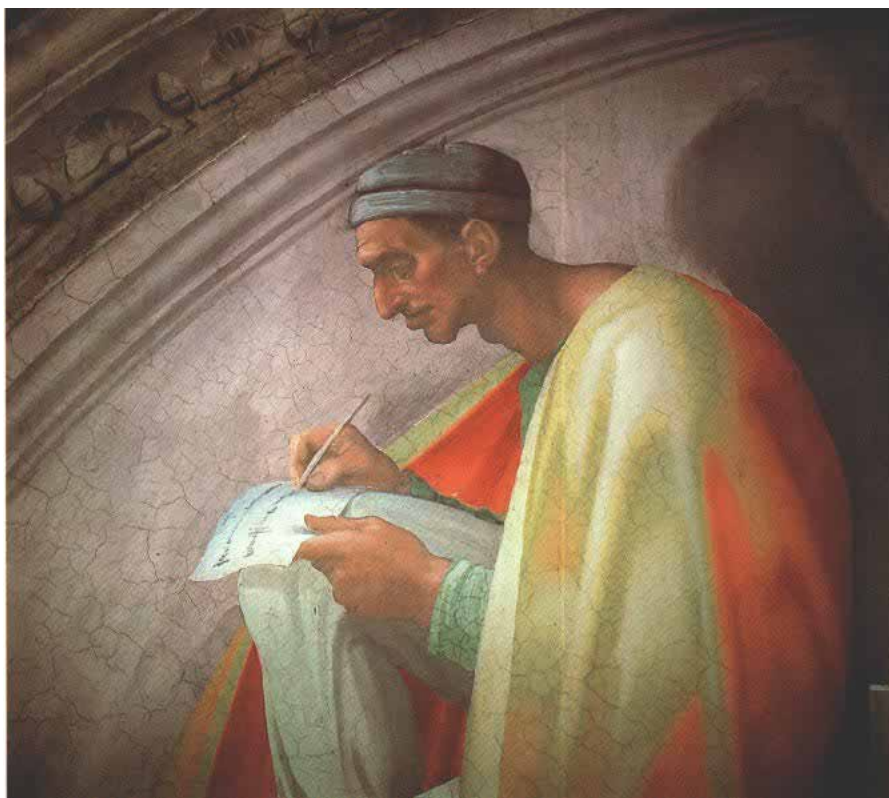

Plate 33. The Temptation and  
Expulsion, *after cleaning* (see also  
Pls. 39, 40).



*Plate 34, right. Detail of a male figure in the Asa lunette after cleaning (see also Fig. 2 on p. 68).*

*Plate 35, below. The Creation of Adam. Detail of the foot of Adam after cleaning, showing indirect incisions, pentimento, and translucent preparatory drawing in black.*



*Plate 36, above. Detail of Erythrean Sibyl after cleaning, showing flesh painting.*

*Plate 37, above right. Detail of ignudo to the left of the Erythrean Sibyl, after cleaning.*

*Plate 38, right. Detail of the head of Holofernes in the Judith pendentive, after cleaning.*

*Plate 39, below left. Detail of the serpent in The Temptation, after cleaning.*

*Plate 40, below right. As in Plate 39, during cleaning (see also Pl. 33, after cleaning).*

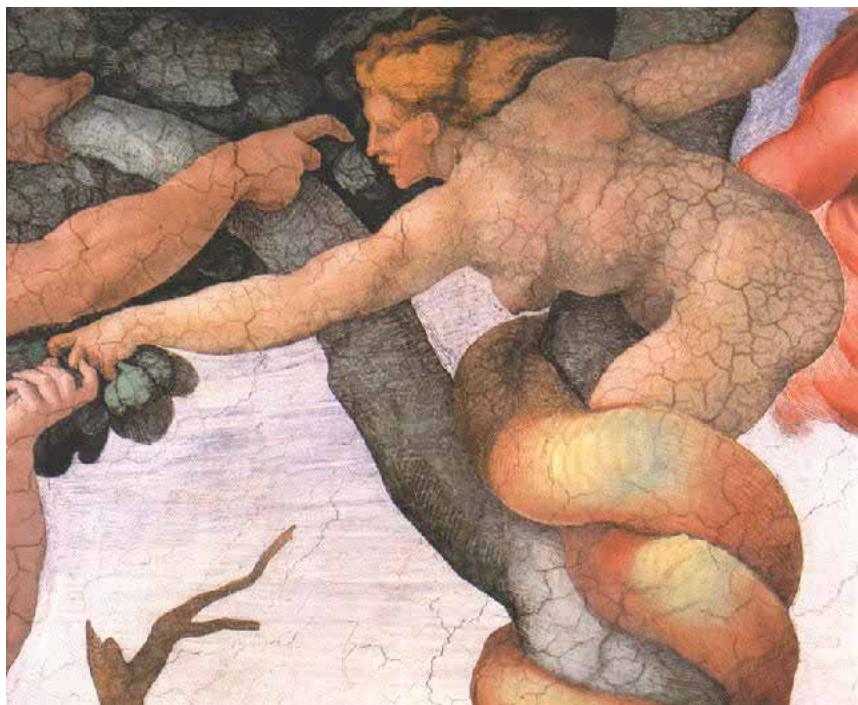

*Plate 41, right. Detail of the ignudo to the right of Ezekiel, after cleaning. This fragment of painting was found below a repair done by Carnevali in 1566 (see also Fig. 11, p. 73).*



**S. B. Hanna and  
J. K. Dinsmore**

*Conservation of Central Asian Wall Painting Fragments  
from the Stein Collection in the British Museum*

*Plate 42. Detail of Monks Receiving Instruction, before conservation. Ming-Oi, 8th-9th century. London, British Museum, OA Mi xiii 9.*



**Eric M. Moormann**

*Destruction and Restoration of Campanian Mural Paintings  
in the Eighteenth and Nineteenth Centuries*

*Plate 43. Deteriorated awning  
intended to protect exposed painting.  
Pompeii.*

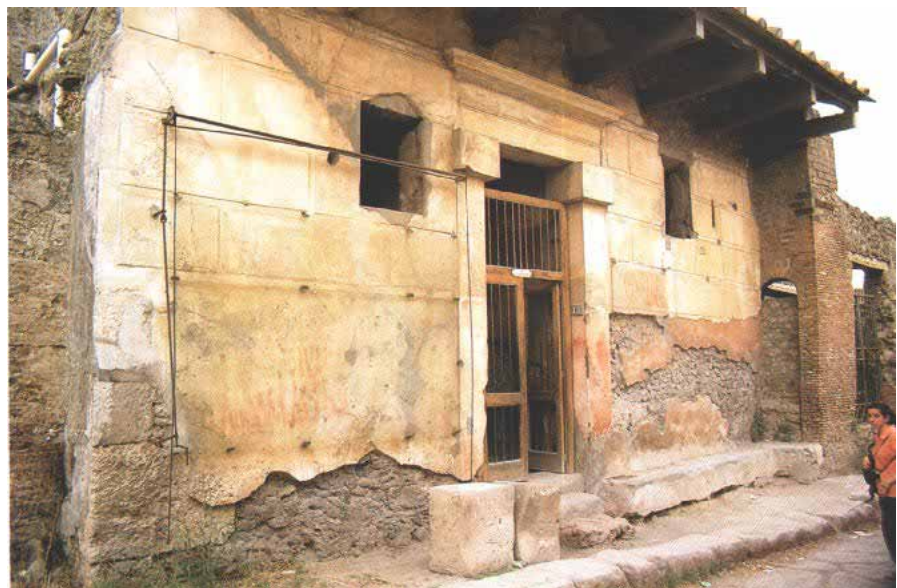



*Plates 44-46. Convent church,  
Müstair, Switzerland. Romanesque  
paintings of ca. 1200 in the apses.  
Plate 44, below. Salt efflorescences  
(presumably of nitronatrite) pushing  
off the paint layer. (Width of area  
photographed: 50 mm.)  
Plate 45, right. Detail of Friderun  
(founder of the church), showing  
damage due to salt crystallization.  
Plate 46, bottom. Detail of stole in  
Pl. 45. (Width of area photo-  
graphed: 37 cm.)*

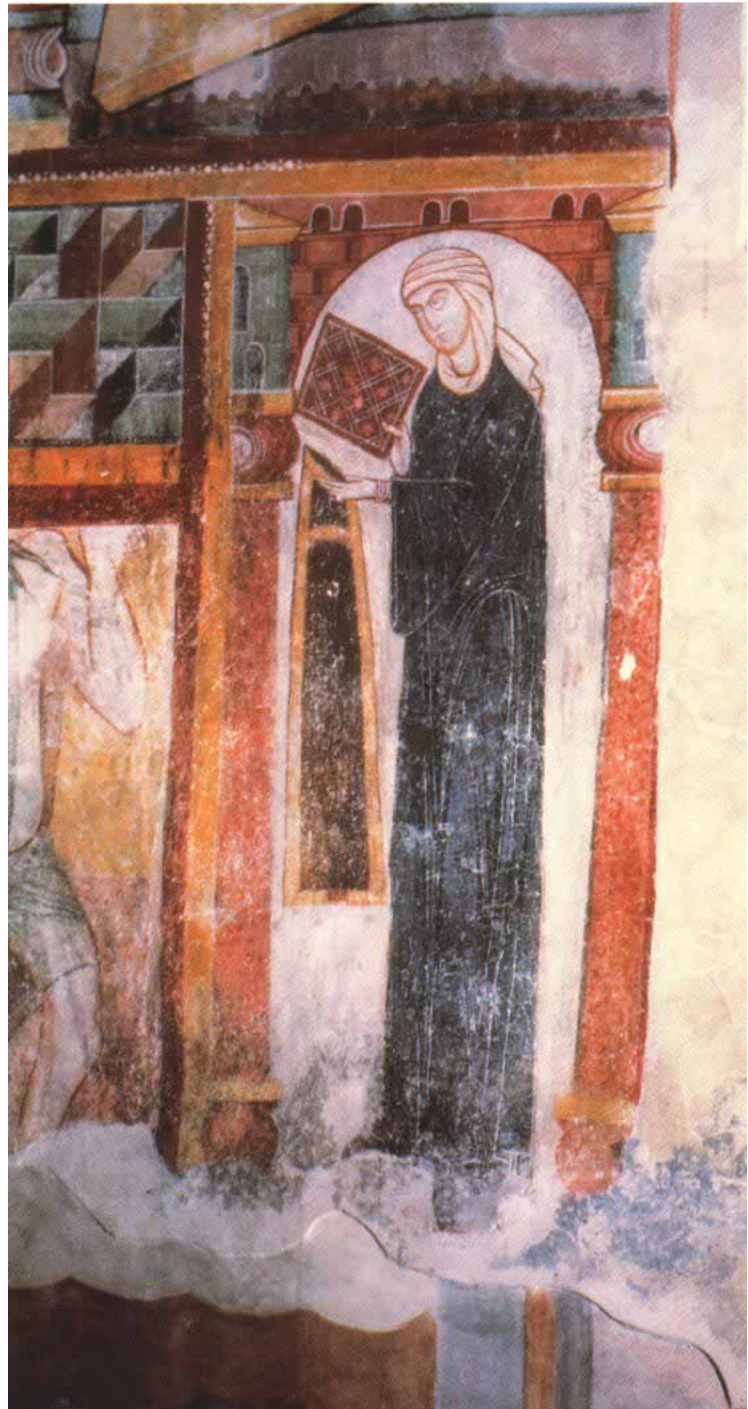

*Plates 47-52. Colorimetric tests for sulfates carried out on cross sections from wall paintings, showing varying distribution of sulfation (violet-pink).*

*Plates 47, right, and 48, far right. Unstained and stained sample, showing gradient of concentration of sulfates near the surface.*

*Plate 49, middle left. The sulfates occur homogeneously and are strongly diffused in the plaster.*

*Plate 50, middle right, top. Accumulation of sulfates under the paint layer.*

*Plate 51, middle right, bottom. Accumulation of sulfates within the paint layer.*

*Plate 52, bottom. The sulfates occur between the paint layer and a thin fixative film on the surface.*

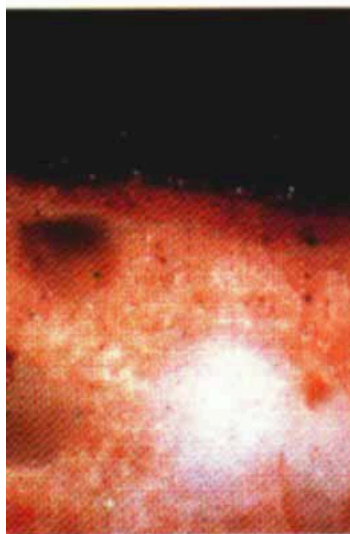
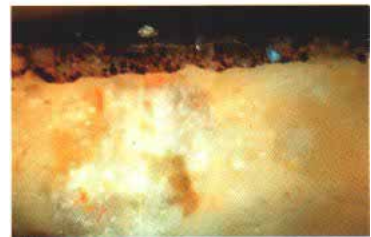
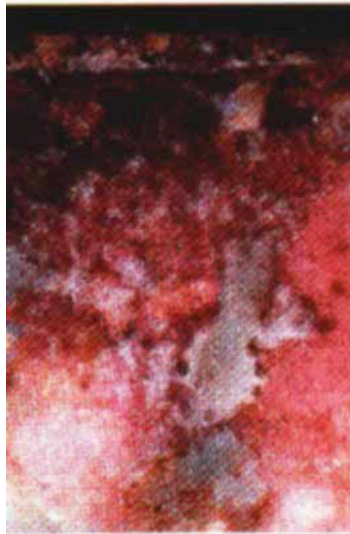
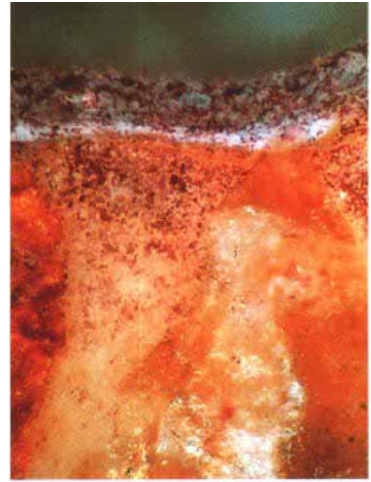
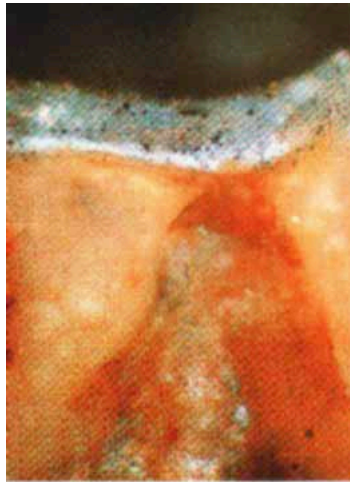





Plates 53 and 54. Fra Angelico, Christ on the Cross Adored by Saint Dominic. Florence, Convent of San Marco, Cloister. Treatment based on barium was carried out in 1973, and these details were photographed in raking light in 1987 (compare Figs. 4, 5 on p. 146).

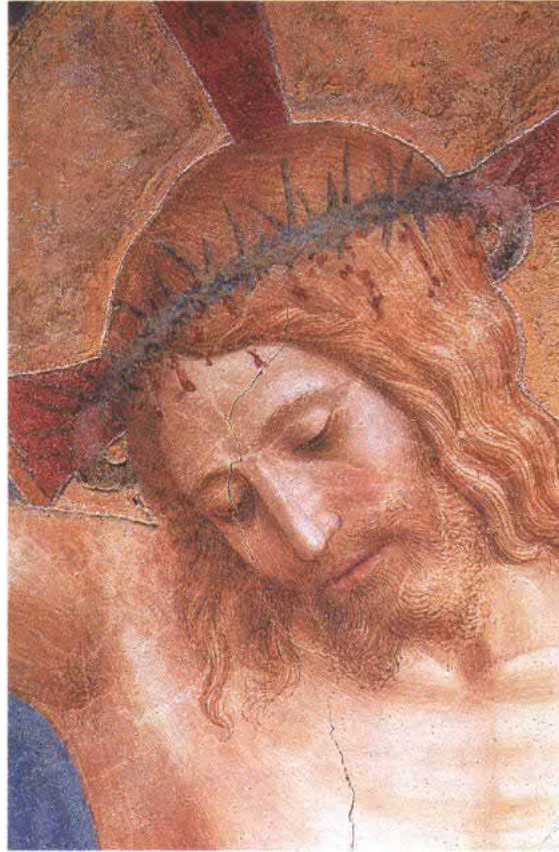

Plates 55 and 56. Giovanni Antonio Sogliani, The Last Supper. Florence, Convent of San Marco, Old Refectory. Treatment based on barium was carried out in 1975, and these details were photographed in raking light in 1987 (compare Figs. 6, 7 on p. 147).





# Scientific and Technical Examination of the Tomb of Queen Nefertari at Thebes



*Figure 1. Nefertari, "For Whom the Sun Shines." Detail of Nefertari led by Harsiese. South wall of the vestibule (E). 1987.*

The favorite wife of Rameses II, Queen Nefertari (Fig. 1) enjoyed a singularly important social and political role, reflected in the dedication to her of the temple of Hathor at Abu Simbel.<sup>1</sup> Although the date of her death is not known, her absence from records after Rameses' 24th regnal year suggests that she may have died about 1255 B.C. Her tomb in the Valley of the Queens (number 66) was discovered and excavated in 1904 by an Italian mission under the direction of Ernesto Schiaparelli, who reported then that the spectacular wall paintings were very deteriorated and in a precarious state of preservation (Fig. 2; Schiaparelli 1923:1:55-56). As with virtually all tombs, it had been robbed in antiquity and the few funerary remains found by Schiaparelli are in the Museo Egizio, Turin. The tomb was open to the public from its discovery until 1933 when concern over continuing damage (Figs. 3, 4) led the Egyptian authorities to severely restrict access, allowing visits only by scholars and selected groups.

Following the closure of the tomb, the search continued for solutions to its long-term preservation. Ahmed Kadry and Feisal Esmael have summarized these, and noted that:

The tomb's problems were initially viewed with the conviction that in restoration lie all desired answers. This perception had persisted and dominated throughout a period of more than forty years. From 1934 to 1977 many restoration experiments were performed with varying degrees of scope, effect, and success. As the need for systematic scientific investigations became apparent, many committees and study groups were formed to assess the tomb's state and to arrive at scientific answers to its core and peripheral problems (1987:35).

In September 1985 the Egyptian Antiquities Organization and the Getty Conservation Institute began to discuss a joint project for the preservation of the wall paintings.<sup>2</sup> As a result, a three-step program was initiated to encompass: (1) scientific study and analysis, (2) emergency stabilization of the wall paintings, and (3) conservation treatment. It was decided that the first year of the project would be fully devoted to scientific studies of the causes of deterioration, emergency treatment, and the development of a treatment plan.



Figure 2, top. Detail of Nefertari before the First and Second Door of the Domain of Osiris. Sarcophagus chamber (K), south wall, east side. Condition when photographed by Schiaparelli in 1904-1905.

Figure 3, right. As in Fig. 2. Condition when recorded by the Metropolitan Museum of Art, ca. 1922.

Figure 4, bottom. As in Fig. 2. Condition in 1986 after emergency stabilization as part of the present program for the preservation of the paintings.

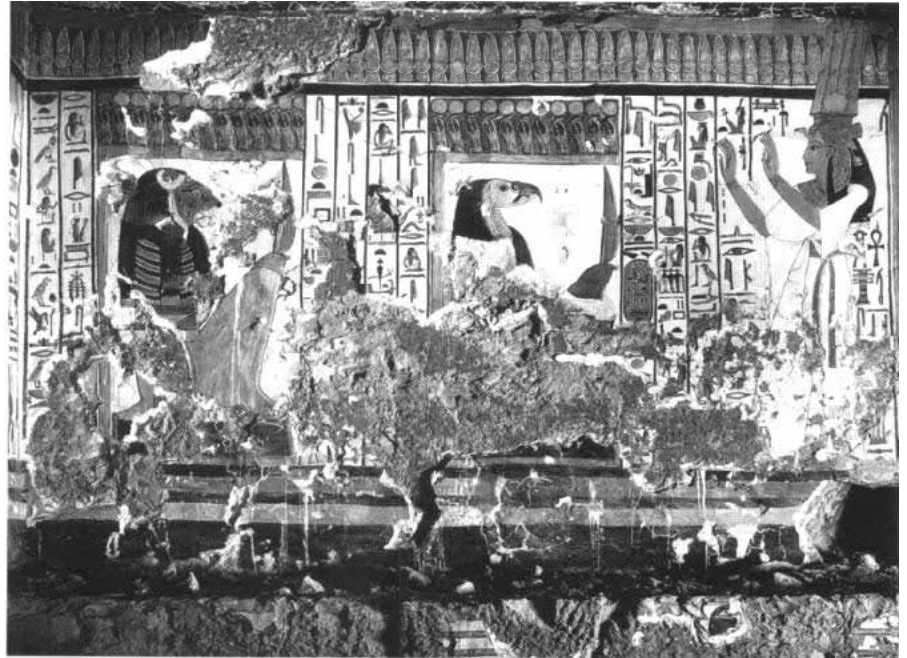
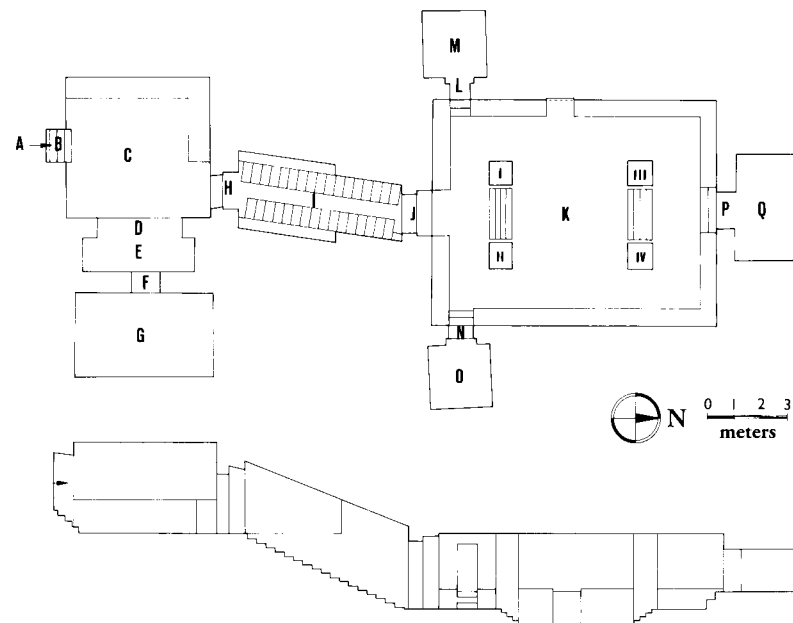



Figure 5. Plan and longitudinal section of the tomb.



### ***The State of Preservation of the Wall Paintings***

Cut into the limestone at the eastern end of the valley to a depth of about 12 m, the tomb consists of seven architectural spaces disposed on two principal levels: an offering hall with a vestibule to an inner chamber at the upper level, and the sarcophagus chamber with side rooms at the lower level (Fig. 5).<sup>3</sup> Although the tomb is comparatively small, the interior surface area—most of which has surviving paint—is about 520 m<sup>2</sup>.

The painting is of outstanding quality (Pls. 1, 2) and the tomb, the most elaborate in the Valley of the Queens, is incomparable for its "artistic superiority and fascination" (Moukhtar 1987:25). The decoration consists of illustrations of chapters from the Book of the Dead and the Book of the Gates, as well as religious and funerary scenes, while the ceilings are painted with yellow stars on a blue background (Pl. 3). Nefertari herself occurs frequently—worshipping and adoring the gods and passing through the nine gates.

Although the preferred technique for a tomb of this quality would have been to carve the stone in low relief which would then have been painted, the poor quality of the highly fractured clayey limestone precluded this.<sup>4</sup> Instead, the interior surfaces were first leveled with a clay render. Plaster was then applied, and this was carved and painted (Pls. 4, 5).

During an initial inspection undertaken in 1985, the condition of the painting was found to vary considerably. Some parts were perfectly preserved, while in others there was powdering or flaking paint. In some areas the paint layer was lost, but the plaster survived in good condition, while in still other, large areas there was a complete loss of plaster. Moreover, there were considerable portions in danger of being lost as a result of the separation of the painted plaster from the limestone support (Pl. 6). Discoloration was also apparent (Pl. 7). There were indications of biological activity in some small areas, and clear signs of damage due to human carelessness (Fig. 6).



*Figure 6, top. Mechanical damage due to carelessness is evident here at the level of the ledge that runs around the sarcophagus chamber (detail of Fig. 7). 1986.*

*Figure 7, above right. Sarcophagus chamber (K), east wall, south side. Guardians of the Second Gate of the Domain of Osiris. Condition in 1987, with facings and repairs from previous interventions.*

*Figure 8, above. Crystallization of sodium chloride pushing off plaster and paint layer. 1986.*

### ***Scientific and Technical Studies***



Throughout the tomb there was evidence of previous restorations. These localized attempts had been carried out at different periods and in different techniques (Fig. 7); although a few of them are of good quality, most are aesthetically unacceptable (Pl. 8), and some pose risks for the survival of the surrounding painting.

It was immediately apparent that a main cause of the deterioration of the wall paintings was the abundance of soluble salts in the rock, plaster, and paint layers (Fig. 8). The fundamental question, however, was whether the deterioration process was ongoing and, if so, what the principal mechanisms of deterioration were. It was therefore decided to study the tomb from a geological, physical, biological, and chemical point of view before deciding on and undertaking a conservation treatment.

### ***Hydrology***

Occasional heavy rainfall has been reported in the area. Since this could lead to percolation of water into the tomb, which would both activate the soluble salts and directly damage the water-soluble paint, it was considered one of the potential main threats. A study of the hydrology of the Valley of the Queens was thus one priority. For this, satellite photographs were obtained by Farouk El-Baz, aerial photographs were studied, and a ground survey was carried out by Earthwatch on 8-13 September 1986 (El-Baz 1987).

In addition to the fact that in only a few small areas were there indications of past liquid water penetration in the tomb, the topographical studies demonstrated that the risk of rainwater actually entering the tomb is fairly low and confined to the entrance area. However, water entering there would raise the relative humidity in the tomb, leading to the damage associated with high humidity and the presence of soluble salts. Therefore it would be necessary to take appropriate measures to prevent water from flowing into the tomb through the entrance.

Date	Microorganism	Sampling Points:			
		Outer Hall C	Sarcophagus Chamber K	Inner Room Q	Open Air
September 8, 1986 (before investigations)	Nonfilamentous microorganisms	2800	3185	2722	2192
	Filamentous microorganisms	141	104	66	804
	Rate of <i>Cladosporium</i> (%)	0	–	–	39
September 11, 1986 (after investigations)	Nonfilamentous microorganisms	5576	5557	–	2174
	Filamentous microorganisms	369	237	–	567
	Rate of <i>Cladosporium</i> (%)	64	72	–	77

Table 1. Numbers of microorganisms before and after investigations in the tomb of Nefertari (number/m<sup>3</sup>).

### Biology

The first study campaign was organized such that Hideo Arai was the first to enter the tomb in order to take air and surface samples for the study of the microbiological activity. Sampling was repeated after investigators had been working in the tomb for several days, and comparative exterior samples were taken on both occasions (Table 1; Arai 1987). A second biological study was undertaken by Mokhtar Ammar et al. (1987). These investigations indicated the presence of silverfish, spiders, beetles, and rodents, and while there were slight differences in the results with regard to microorganisms, these were probably due to differences in sampling strategies and times, and were not significant for the planning of the preservation of the paintings. The results indicate that there is no biological threat to the wall paintings, providing the relative humidity and the moisture content in the walls remain low.

### Microclimate

Thermohygroscopic measurements have been carried out intermittently in the tomb since 1958, and in September 1986, a microclimate monitoring program was begun as part of the present investigation.<sup>5</sup> While both temperature and relative humidity are very stable when the tomb is closed, they nonetheless undergo some seasonal variations. During the period from 18 September 1986 to 8 February 1987, average temperatures in various parts of the tomb ranged from 29 to 30.5 °C and relative humidity from 20 to 34%.

The influence of visitors on the microenvironment depends on their number, the duration of their stay, and the differences between internal and external temperature and humidity. Studies of visitor impact on the climate in the tomb are continuing and some controlled experiments are planned. Based on the data collected, a visitor control plan will be developed and proposed to the Egyptian Antiquities Organization.

### *Analysis of the Plasters, Pigments, and Salts*

Given the substantial number of studies that have been published on the materials of ancient Egyptian wall painting, the emphasis during the first phase of the project was to plan analytical work in anticipation of questions that might arise during conservation rather than to focus on analysis of the painting materials. The limited number and range of samples examined as part of that phase have since been supplemented with further studies that will be discussed elsewhere.

Salt samples were collected, and pigment and plaster samples were taken from some fragments of painting that had previously fallen off and had been stored in room Q (see Fig. 5). The salts, plasters, and pigments have been studied microscopically and analyzed with X-ray diffractometry and X-ray fluorescence spectroscopy with the electron microprobe.

The salts are sodium chloride of relatively high purity. Attempts to elucidate their development and history have thus far been unsuccessful, and the questions of when crystallization occurred and whether it was continuous or discontinuous remain open.

Plasters of various compositions are found in the tomb. The main components are clay, sand, gypsum, and calcium carbonate, in varying combinations. The clay render contains chopped straw. A large proportion of the "gypsum" was found to be anhydrite, which posed the question, as yet unresolved, of whether this may have been due to dehydration caused by the relatively low humidity and high temperatures in the tomb.

Among the pigments identified on the few samples studied at the GCI were Egyptian Blue (cuprorivaite,  $\text{CaCuSi}_4\text{O}_{10}$ ), calcite, and huntite ( $\text{Mg}_3\text{Ca}[\text{CO}_3]_4$ ). Saleh (1987:94-96) reported the occurrence of Egyptian Blue, green frit, red and yellow ochers, huntite, gypsum, and orpiment, though the last could not be confirmed by subsequent analysis.

### *Nondestructive Testing*

Separation of the painted plaster from the limestone support was identified from the outset as a widespread and dangerous phenomenon. In many areas, this loss of adhesion was readily apparent to the naked eye since the plaster was bulging outward. In other areas, however, separation could only be detected by light tapping, and the team was interested in identifying a scientific method of detecting and characterizing such delamination.

A study of the feasibility of using ultrasonic techniques for the detection of voids and incipient delamination of the wall paintings was undertaken by Modesto Montoto. The criteria for investigation, including the considerable constraints imposed by the fragility of the paintings, were set out and a preliminary study made (Montoto 1987). Although it turned out that the techniques were not sufficiently developed to be used within the present conservation program, this initial study led to a multi-year research project aimed at further developing the method based on investigations of historic buildings in Spain.

### *Color Measurements*

Given that conservation treatments of painted surfaces should not alter the appearance of the paintings, some method is required to judge whether this condition has been met. In the past there has been a reliance on visual evaluation and comparison of color photographs taken before and after treatment. Since both methods are subjective and unreliable, it was decided to record objectively the colors of the wall paintings before, during, and after any treatment. A Minolta CR-121 ChromaMeter with a DP-100 data processor was chosen for this because it is portable, allows for multiple calibration, and provides color-space evaluation in four modes.<sup>6</sup>

For the recording every effort was made to select original colors, avoiding previous interventions. Seven areas of painting were chosen and documented photographically. To remove loose surface contaminations, they were first dusted lightly with a soft squirrel-hair brush while air was blown from a bulb syringe. Due to the lack of homogeneity of the painted areas, three measurements were made of each color occurring in each painted area and marked on Polaroid photographs (Fig. 9). Thus for each color there are Y x y values, the range of these values related both to the homogeneity of that color and to surface roughness (Table 2). One composition was completely measured twice in order to assess the reproducibility of the procedure.

*Table 2. Color measurements of location K-2A.*

Area	Y	x	y
1	23.3	0.464	0.362
2	22.1	0.454	0.356
3	21.1	0.464	0.358

*Figure 9. An area (K-2A) on the east wall of the sarcophagus chamber (K) selected for color measurement. 1986. Data for the red is given in Table 2.*



Future plans include the recording of the colors after cleaning and consolidation. This will enable both assessment of the visual impact of the treatments and establishment of a baseline for the long-term monitoring of the wall paintings.

### *Condition Survey*

A necessary preliminary to the development of a treatment plan, including any initial emergency work required, was a full condition survey of the tomb. Full documentation of the state of preservation of all interior surfaces was carried out by a team of Italian conservators under the direction of Paolo and Laura Mora (Mora et al. 1987). Examination was done visually using cold light, both direct and raking, and with the aid of stereoscopic enlargement lenses.

The survey of the decay and alteration required readings at four different levels: those of the support, paint layer, foreign substances, and earlier treatments. Thus the following categories were used:

1. Condition of the support

Cracks in the rock and or plaster

Extrusion of rock chips due to geological displacement

Plaster

Lack of cohesion

Lack of adhesion at varying levels

Lacunae of depth

Loss of entire stratification

Loss of the superficial layers

2. Alterations of the paint layers

Loss of cohesion (powdering)

Detachment of the paint layer (flaking)

Abrasions from mechanical damage

Loss of paint layer

Chromatic alterations (changes in appearance)

Natural deposits

Earth sediments and dust

Insect broods

3. Crystallization of salts

Macroscopic subflorescences

Efflorescences

4. Previous interventions

Fillings of lacunae at surface and subsurface levels

Fillings over painting

Retouching of filled lacunae

Overpainting of original

Shifted colors

Surface treatments (varnishes, consolidants)

Facings

Detached fragments replaced in situ

The entire tomb was documented in black-and-white photographs, printed at a scale of 1:20. Each of the four categories listed above was recorded on a separate acetate overlay for each photograph. Individual phenomena were documented with separate graphic symbols or colors, allowing correspondences between decay phenomena at each of the four levels to be readily ascertained.

For visual reference, line drawings of the paintings were made to scale and the data produced from the in situ survey was then transferred to these. For each acetate sheet, a 50 x 70 cm print was made on nonmodifiable photographic paper (Fig. 10). About two hundred of these were compiled and include titles, topographic references, and scales to provide complete documentation of the condition of the paintings at the time of the survey. In addition, an explanatory volume was produced in which the phenomena recorded in each of the four categories are illustrated with photographs—a sort of visual glossary—which is essential for visualization of the various types of alteration.

In a parallel activity, the GCI began to collect historic photographs of the tomb and its paintings from a variety of sources. This effort is ongoing and the resulting visual record should help determine the rate and extent of deterioration that has occurred since the tomb was excavated in 1904.

### Emergency Treatment

When the condition survey was complete and while the scientific studies were still underway, it was decided to undertake emergency treatment on the most endangered areas of the wall paintings. The goal was to stabilize the paintings using a fully reversible minimal intervention such that the paintings would be secure even if a full conservation treatment were not carried out in the following years.

This treatment consisted principally of securing loose fragments and cracks with small strips of fine-grained Japanese paper (Pl. 9). These were adhered to the wall at both ends with Paraloid B72 (20% solution in trichloroethane). On the ceilings, due to the surface irregularities and weight of the fragments, the pro-

Figure 10. Sarcophagus chamber (K), south wall, eastside. Condition survey of the support (level 1 of four levels) of the area illustrated in Figures 2-4.

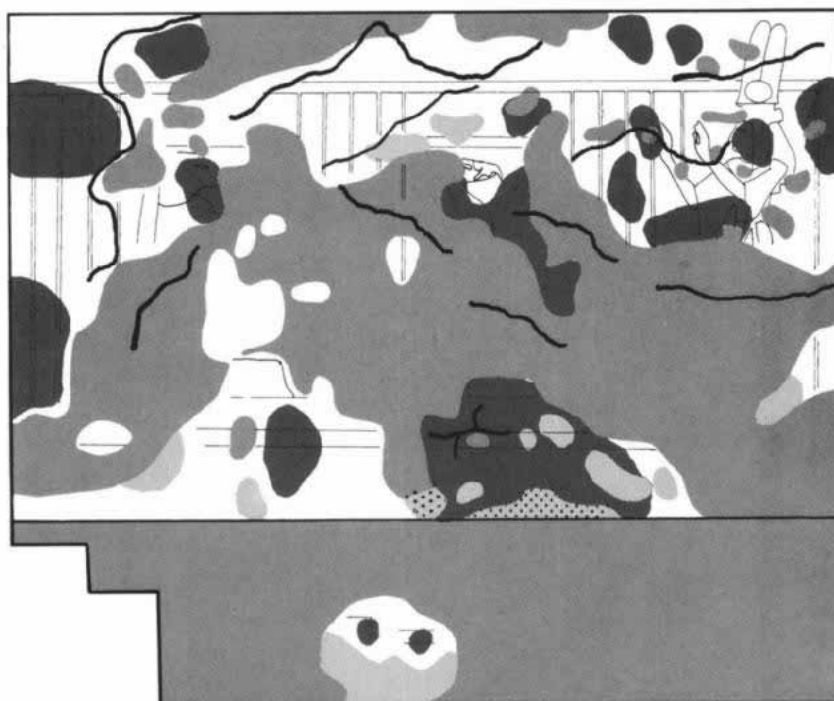
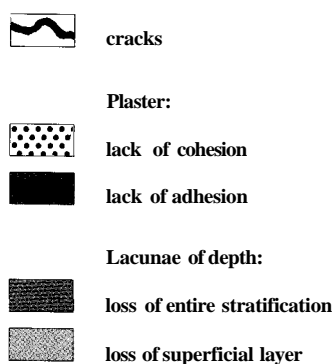



cedure was somewhat modified. Thin strips of cotton gauze were used to provide more resistant and stronger protection (Pl. 3). In cases where fragments were almost completely detached from the support, a drop of the same acrylic resin in emulsion was placed at the center on the underside of the fragment, and then it was then pressed back into its original position using a protective sheet of silicon paper and a spatula. When the treatment was complete, approximately 10,000 strips had been applied to the walls and ceilings.

### ***Treatment Plan***

Many proposals for the preservation of the tomb have been made over the years. They have ranged from conventional treatments to schemes to separate the tomb from the surrounding rock by detaching the paintings and reinstalling them on new supports with an intervening air space between them and the rock, or, most extreme, to transferring the paintings to a museum. The more radical proposals were based mainly on the assumption that removal of the soluble salts was not feasible, since both paint and plaster are highly water-sensitive and the limestone contains a nearly unlimited reservoir of salts. These issues have been discussed frequently by the joint EAO-GCI technical committee, and it was decided that every effort should be made to preserve the wall paintings in situ with the minimum intervention necessary. The long-term protection of the paintings against future deterioration would therefore have to be assured by preventing rainwater from penetrating the tomb, by keeping the internal climate as stable as possible, and by maintaining the relative humidity below the critical levels at which salts are activated.

During the course of the emergency treatment, some initial tests were carried out to assess potential treatment options. These involved trials of consolidation of powdering paint and disaggregated plaster, as well as readhesion of flaking paint and delaminated plaster. The problem of cleaning and reattaching fragments that had been pushed away by crystallizing salts was also examined. For this, a partially detached fragment was faced with polyamide tissue adhered with a 10-20% solution of Paraloid B72 in lacquer thinner. The facing was extended beyond a cracked but unbroken edge, forming a hinge at the crack. This allowed the fragment to be tilted away from the wall and loose or protruding materials, such as salts and rock fragments, to be cleared from behind (Pl. 9). The underside of the fragment was then cleaned and impregnated with a 3% solution of Paraloid B72, and the fragment correctly repositioned and readhered with a mortar similar to the original.<sup>7</sup> These tests were reviewed by the joint technical committee prior to making any decisions on the conservation treatment.

Since this paper was presented in 1987 the full conservation treatment of the wall paintings has begun, and it is anticipated that the work will be completed by the end of 1992. Analytical studies of the materials used in the construction and decoration of the tomb have also continued, and more sophisticated and detailed microclimatic studies are underway. Details of the treatments and the results of the technical studies will be presented in the second progress report, planned for publication at the end of 1991.

## Notes

1. On Nefertari and her historical importance, see Gaballa 1987 and Maher-Taha 1987 and the literature cited therein.
2. On the background and organization of the project, see Corzo 1987.
3. For a detailed description of the tomb and the subject matter of the paintings, see Moukhtar 1987.
4. For a discussion of the nature of the limestone and of the local geology, see El-Baz 1987.
5. Esmael 1987 has summarized both the previous data and his recording undertaken in 1983 and 1986-87.
6. For details of the measurement and calibration procedures, see Preusser and Schilling 1987.
7. The mortar was composed of three parts by volume washed and sieved local sand, one part gypsum powder, a few drops of Primal AC-33, and water as required for fluidity.

## References

- Ammar, Mokhtar, Kamal Barakat, Essam Hohanem, and Asmaa A. El-Deeb**  
1987 "Microflora Investigations." In *Wall Paintings of the Tomb of Nefertari, First Progress Report*: 58-63.
- Arai, Hideo**  
1987 "Biological Investigations." In *Wall Paintings of the Tomb of Nefertari, First Progress Report*: 54-57.
- Corzo, Miguel Angel**  
1987 "Project Background." In *Wall Paintings of the Tomb of Nefertari, First Progress Report*: 41-43.
- El-Baz, Farouk**  
1987 "Geographic and Geologic Setting." In *Wall Paintings of the Tomb of Nefertari, First Progress Report*: 46-52.
- Esmael, Feisal A.**  
1987 "Microclimatic Conditions." In *Wall Paintings of the Tomb of Nefertari, First Progress Report*: 64-68.
- Gaballa, Gaballa Ali**  
1987 "History: Nefertari, For Whom the Sun Shines." In *Wall Paintings of the Tomb of Nefertari, First Progress Report*: 11-17.
- Kadry, Ahmed, and Feisal A. Esmael**  
1987 "Previous Endeavors." In *Wall Paintings of the Tomb of Nefertari, First Progress Report*: 35-38.
- Maher-Taha, Mahmoud**  
1987 "History: The Considerable and Unique Position of Nefertari." In *Wall Paintings of the Tomb of Nefertari, First Progress Report*: 19-23.
- Montoto, Modesto**  
1987 "Nondestructive Testing." In *Wall Paintings of the Tomb of Nefertari, First Progress Report*: 106-110.

**Mora, Paolo, Laura Mora, and Giorgio Capriotti**

1987 "Condition Survey." In *Wall Paintings of the Tomb of Nefertari, First Progress Report*: 112-123.

**Moukhtar, Gamal**

1987 "Archaeology." In *Wall Paintings of the Tomb of Nefertari, First Progress Report*: 25-33.

**Preusser, Frank, and Michael Schilling**

1987 "Color Measurements." In *Wall Paintings of the Tomb of Nefertari, First Progress Report*: 70-81.

**Saleh, Saleh Ahmed**

1987 "Pigments, Plaster, and Salts Analyses." In *Wall Paintings of the Tomb of Nefertari, First Progress Report*: 94-105.

**Schiaparelli, Ernesto**

1923 *Relazione sui lavori della missione archeologica italiana in Egitto (1903-1920). I. Esplorazione della "Valle delle Regine" nella Necropoli di Tebe.* Turin.

**Wall Paintings of the Tomb of Nefertari: First Progress Report, July 1987**

1987 Miguel Angel Corzo, ed. Cairo and Los Angeles: The Egyptian Antiquities Organization and the Getty Conservation Institute.

***Biography***

Frank Preusser received his Ph.D. in Chemistry in 1973 from the Technical University in Munich. From 1973 to 1983 he was head of the Doerner Institute in Munich. He joined the Getty Museum as Conservation Scientist in 1983, and developed the research program and laboratories for the Museum and the Getty Conservation Institute (GCI). From 1985 to 1990 he was Director of the Scientific Research Program of the GCI, where he is currently Associate Director for Programs.

# Preliminary Research for the Conservation of the Brancacci Chapel, Florence

*Ornella Casazza and Sabino Giovannoni*

**T**he cycle of the life of St. Peter painted for Felice Brancacci in his chapel in the church of the Carmine is of pivotal importance in the history of Renaissance art. Yet substantial alterations to the chapel have complicated the interpretation: first, of the nature of the artistic collaboration between Masaccio and Masolino and the extent of the paintings completed by them in the 1420s; and second, of the iconography and its relation to the patron.

Already by the 1480s the original scheme had been significantly altered: Filippino Lippi had painted various scenes in the lower register, and the thirteenth-century painting of the Madonna del Popolo had been transferred to the chapel to replace the altarpiece. The most dramatic changes, however, occurred in the eighteenth century. In 1746-48, Baroque alterations included construction of a new vault, painted with frescoes by Meucci, and provision of an elaborate marble frame for the Madonna del Popolo. Then in 1771 a fire devastated much of the Carmine, though damage to the frescoes was fairly limited (Casazza 1986b). In addition to these alterations, various interventions on the paintings were carried out over the centuries, including applications of organic fixatives. Therefore, the conservation program begun in 1984 encompassed not only treatment of the paintings, but also investigations that it was hoped would help to resolve art historical issues central to an understanding of the art of early Renaissance Florence (Procacci and Baldini 1984).

The scope of the conservation and investigation was set out in its essentials in 1969 by Ugo Procacci (then Soprintendente) in a report approved by the Consiglio Superiore. This called for the restoration of the frescoes as well as for exploratory investigations to ascertain whether any fifteenth-century painting survived below the eighteenth-century alterations. This process had had its inception in 1932 when, by removing small lateral sections of the marble frame of the altarpiece, Procacci discovered an area of painting unaffected by the fire of 1771, providing highly important evidence for the chromatic condition of the painting prior to the fire (Procacci 1932). Then in the decades following the 1969 report, the state of conservation of the chapel was monitored. The in-depth analyses and investigations carried out since 1984, discussed below, provided the basis for the methodology of the interventions, both for correction of the causes of deterioration and for conservation of the paintings.

The range of investigative and analytical techniques employed—many applied for the first time to wall paintings in situ—was made possible not only

through the Istituto Centrale per il Restauro, responsible for the direction of the overall program, but also through the collaboration, scientific coordination, and financial support of Olivetti, through the collaboration of specialized centers of the Consiglio Nazionale delle Ricerche and of technical specialists at Montedison, and through access to the equipment of various departments of the University of Florence.

**Scientific Examination and Analysis**

The scientific examination was intended to elucidate the nature of the original and added materials as well as to establish the state of conservation of the paintings, renders, and support. As a preliminary, full photographic documentation in color and black and white, in both normal and raking light, was carried out (Pls. 10, 11).

Characterization of the surface topography and of the underlying structures was accomplished by the application and correlation of the complementary techniques of photogrammetry, thermography, echography, and holography—all noninvasive techniques.

Within an investigation intended to localize and quantify deformations of the fresco and of the underlying support, the necessity of determining differences in level on the surface assumes particular importance. Photogrammetry was therefore used to provide objective recording of geometrical and dimensional aspects, and to locate characteristics and phenomena that were either concealed or of uncertain reading by direct analysis. Thus a first and significant result of the investigation was the production of a plano-altimetric model of the surfaces, in graphic and numeric form (Fig. 1). However, the relationships between the surface geometry and physical density of the painted walls require that integrated investigations, in particular photogrammetry and thermography, are carried out. Such integration requires, in turn, predetermination of common references at both the data acquisition and elaboration phases.

Figure 1, below. Photogrammetric relief map of the surface topography. Figure 2, below right. Schematic diagram of the method of echographic investigation with ultrasound.

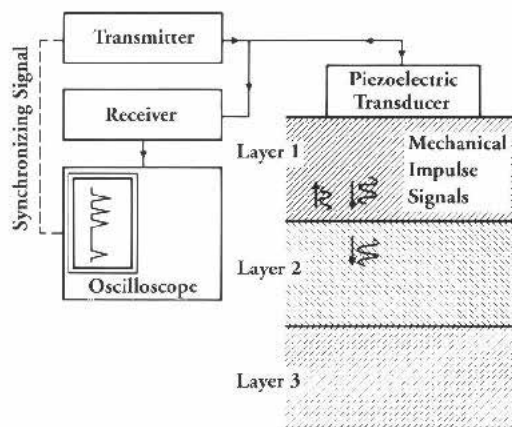
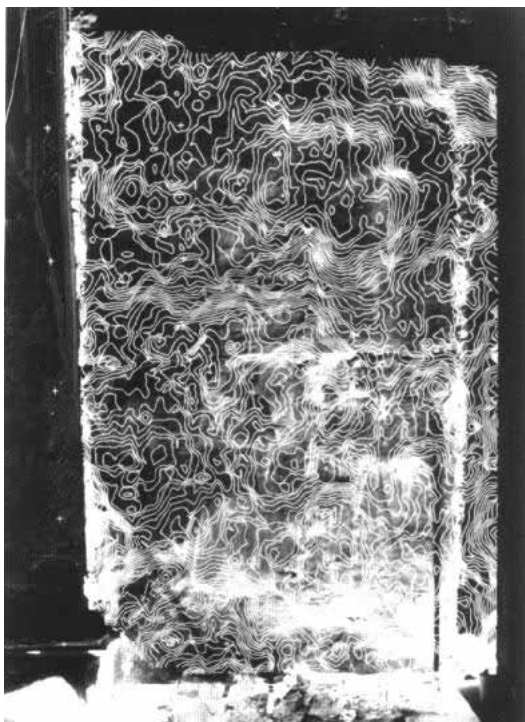
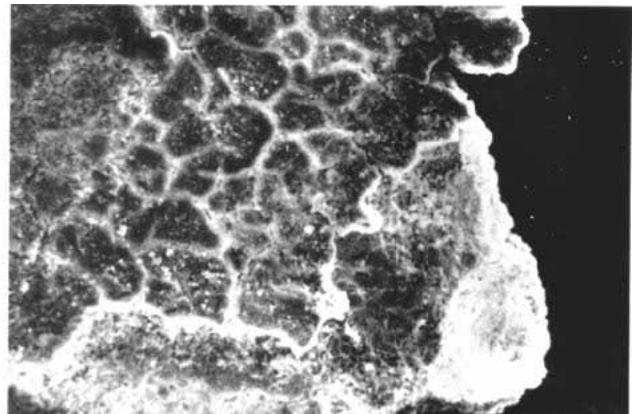
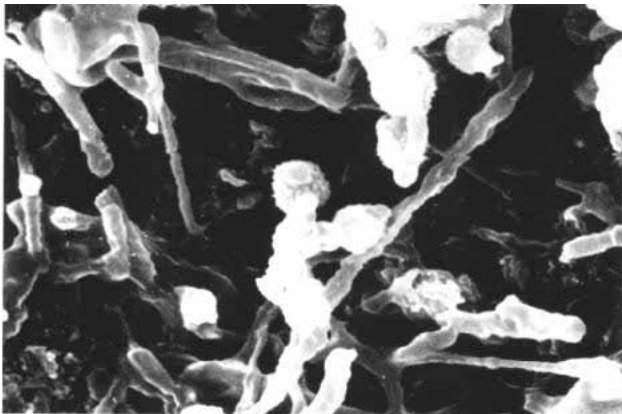
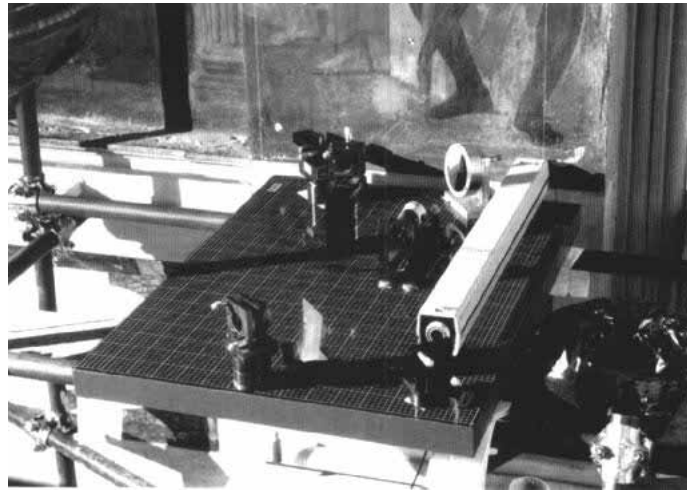

Figure 3, right. Laser holography used in situ for measurement of surface movement.

Figure 4, below. Investigation of the intonaco with SEM.

Figure 5, below right. Determination of the degree of sulfation with a nondestructive method.



Thermography was used to record data relative to the mechanisms of exchange of thermal energy between the structure and the environment, as well as the structural constitution and material discontinuities of the chapel, and the phenomena that affect these. This examination differentiated zones of detachment of the plaster, and, when correlated with information from the photogrammetric and echographic investigations, allowed selection of an appropriate method for intervention.

Echographic examination with ultrasound was used to locate areas of delamination of the *intonaco* and/or *arriccio* (Fig. 2), and, as noted, was correlated with the thermographic and photogrammetric results.

Double-exposure laser holography was used to record movements due to structural settlement, slow drifts, periodic shifts, and for the characterization of superficial regions displaying anomalous behavior. Highly sensitive, this non-invasive technique can measure surface movement to a fraction of a micron. It was the first tentative application of laser holography to the diagnostic study of wall paintings in situ (Fig. 3), involving the installation in the chapel of a small holographic laboratory. The technique proved practicable, permitting study of local behavior as well as visualization of the dynamics of the internal structures.

For examination of the nature and condition of the original and added materials of the paint layer and render (Fig. 4), a variety of examination and analytical techniques was used. In addition to classical stratigraphic and microchemical analyses, a new nondestructive method was used for measuring sulfation (Fig. 5; Parrini

Figure 6. Infrared reflectography used for examination.



and Pizzigoni 1985), a principal cause of deterioration in wall paintings. Study of the values obtained allowed the selection of an appropriate method of cleaning.

Preliminary diagnostic research with infrared photography in "false colors" was oriented toward the acquisition of data that could be correlated with characteristics of reflection, absorption, or transmission of the various pigments and of their stratification (Pl. 14). This allowed the mapping of dishomogeneities, as well as the collection of further information on the technique of execution, the pigments used, and on added materials, such as repairs and repainting.

Ultraviolet fluorescence was used to elucidate the state of conservation of the painted surfaces, and to characterize the presence of fixatives, either at the level of the paint layer or on the surface (Pl. 12). This investigation was carried out both before and after cleaning so that the extent and methodology of the treatment could be assessed by means of objective, point-by-point comparisons.

Spectrophotometric analysis was conducted in situ by means of a fiber optic device able to analyze the light diffusion from the fresco at various wavelengths. The aim of the investigation was to document the color of various parts of the painting before and after conservation, and to characterize statistically the "noise" introduced by the dirt deposited on the surface.

Infrared reflectography—used here for the first time on wall paintings in situ—permits a reading of the "status" of the paint layer by passing through superimposed layers of dirt (Fig. 6). This allows anticipation of what the condition of the paintings is likely to be after cleaning.

Environmental causes of deterioration were assessed in terms of the microclimate and the microbiological load. Study of the environment included particular reference to the measurement of the concentration of ambient sulfur dioxide. Examination of the nature and quantity of suspended particulates (Fig. 7) indicated that they were about 80% carbon, explaining the serious deterioration of the frescoes. Microbiological activity was investigated by sampling both from the painted surface (from scrapings and wet and dry swabs) and from the

Figure 7. Study of the microenvironment included examination of the quantity and nature of the suspended particles.



air. Aerobiological analyses allowed comparison between the biological pollutants of the environment and those of the walls.

Since the conservation program was designed from the outset to ensure the long-term protection of the chapel—well beyond completion of the intervention—it involved not only the whole structural complex of the chapel, but also encompassed contiguous spaces. These allowed for the installation of a control system to ameliorate the effects of the external climate. In addition, a plan will be put into effect to minimize visitor impact in the chapel.

Finally, as part of the preliminary phases, methods of cleaning were investigated. Apart from the obvious criteria that this should cause no alteration to the pigments or paint layer, a method was sought that would chemically remove the organic materials applied in previous restorations. The method developed makes use of the properties of various ion-exchange resins and the reactivity of ammonium carbonate (Pl. 13).

### ***Investigations for Additional Surviving Painting***

At the outset of the investigations it was not known to what extent the Baroque alterations to the chapel may have either destroyed or simply concealed areas of fifteenth-century painting. It was hoped that at least part of the lunettes or the quadripartite vault of the original Gothic structure might have survived. Therefore, following approval by the Comitato di Settore of the Consiglio Superiore Nazionale dei Beni Culturali e Ambientali, and as a first stage in the overall conservation program, explorations were made of the vault, entrance arch, and lunettes.

It was ascertained, however, that the Baroque transformation of the chapel had involved raising the vault. This had resulted not only in the destruction of the original fourteenth-century structure, but also of the entrance arch.

Investigations in the area of the lunettes, however, yielded tangible results. The frescoes of Meucci were temporarily detached, and although no earlier painting or plaster was found on the lateral walls, the fifteenth-century *arriccio* survived on both sides of the tall bifore window on the altar wall. Thus the *sinopie* of the two scenes of the cycle of Saint Peter that flanked the window were recovered (Baldini 1984).

These two episodes provide essential elements for the reading and interpretation of the iconography of the painting cycle and its relation to the patron,



Felice Brancacci. The early sources are unclear about the identification of the subjects in this location, but they are generally referred to as *The Denial of Saint Peter*. Cleaning of the *sinopie* has aided legibility, and that on the left can be securely identified as *The Penitence of Saint Peter*. Although the fragmentary character and deteriorated condition of the right-hand *sinopia* precludes definitive identification of all the figures, it appears certain that there are onlookers in the middle ground, on the margin of an action that would have taken place at the center. Equally clearly, there are four sheep at the lower right. Any reading of this *sinopia* must account for the inclusion of the sheep—appropriate neither to the subject nor to the setting of *The Denial*. The symbolic significance of the sheep leads to the supposition that this scene represents the moment when Christ conferred on Saint Peter his most important power: Feed my sheep (*Pasce agnos meas, pasce oves meas*). Despite the absence of this episode from the descriptions of the chapel in the early sources, it not only has considerable importance in the life of Saint Peter, but would have been indispensable within the context of this painting cycle.

Although nothing survives of the lateral lunettes or vaults, Vasari recorded the subjects as *The Calling of Peter and Andrew* and *The Shipwreck of the Apostles* (lunettes), and *The Four Evangelists* (vault). Vasari located *The Calling* and *The Shipwreck* on the left and right lunettes, respectively. A confirmation of this was provided by Longhi's recognition of a faithful painted copy of Masolino's lost *Calling* in which the light falls from the right as it would have in the Brancacci Chapel (Longhi 1940). The destroyed painting of the soffit of the entrance arch would not have had narrative subjects, but most probably busts of figures similar to those found during the present campaign on the splays of the original window, behind the later altar. Also behind the altar, a fragmentary scene by Masaccio was found which must be identified as *The Martyrdom of Saint Peter* (Baldini 1986).

These discoveries, together with Vasari's descriptions of the lost scenes, now permit identification of all the episodes and, consequently, a new reading of the cycle (Casazza 1986a). When read in a context that emphasizes their instructional and meditational significance, all the episodes lead to theological reflections. If, on the one hand, we consider the patron—a man of the sea and, therefore, like Peter a sailor-fisherman (*The Calling*) who seeks divine assistance against the storms that might overtake him in his mercantile or political life (*The Shipwreck*)—and, on the other, distance ourselves from propaganda motives—the duty of declaring property for the payment of taxes (*The Tribute Money*) and the condemnation of acts of simony (*The Death of Ananias*)—the cycle must be read as the exaltation of the person and role of Peter the Apostle, of the Church as the sacrament of salvation, and of the universal primacy of the pope. All the episodes, their selection and juxtaposition, seem to announce the "*mysterium salutis*," that is, salvation through Christ and his Church, to which—Church and salvation—"we are all called."

## References

---

### Baldini, Umberto

- 1984 "Nuovi affreschi nella Cappella Brancacci. Masaccio e Masolino." *Critica d'Arte* 49(1):65-72.
- 1986 "Restauro della Cappella Brancacci, primi risultati." *Critica d'Arte* 51(9):65-68.

### Casazza, Ornella

- 1981 *Il restauro pittorico nell'unità di metodologia*. Florence: Nardini-Centro internazionale del libro.
- 1986a "Il ciclo delle Storie di San Pietro e la '*Historia Salutis*'. Nuova lettura della Cappella Brancacci." *Critica d'Arte* 51(9):69-84.
- 1986b "Settecento nella Cappella Brancacci." *Critica d'Arte* 51(11):66-72.

### Longhi, Roberto

- 1940 "Fatti di Masolino e di Masaccio." *Critica d'Arte* 5:145-191.

### Parrini, Paolo L., and Giuseppe Pizzigoni

- 1985 Non-destructive Methods for Determination of Surface Alteration of Stone. *5th International Congress of Deterioration and Conservation of Stone, Lausanne 25-27 September 1985*. G. Felix and V. Furlan, eds. Lausanne. 561-569.

### Procacci, Ugo

- 1932 "L'incendio della chiesa del Carmine del 1771." *Rivista d'Arte* 14:141-232.

### Procacci, Ugo, and Umberto Baldini

- 1984 *La Cappella Brancacci nella chiesa del Carmine a Firenze* (Quaderni del restauro, 1). Milan: Olivetti.

## Biographies

Dr. Ornella Casazza received her training in the restoration of paintings at the Opificio delle Pietre Dure, Florence, joining their staff in 1974, and also graduated from the University of Florence with a specialization in art history. She is the author of numerous publications, including *Il restauro pittorico nell'unità di metodologia* (1981), and teaches theory and techniques of restoration at the Università Internazionale dell'Arte.

Sabino Giovannoni trained with Professor Dino Dini in Florence from 1959 to 1965, and collaborated with him in the restorations at the Convent of San Marco from 1968 to 1970. In 1975 he joined the Opificio delle Pietre Dure, where he is currently Chief Restorer of the Ministero dei Beni Culturali. He is the author of various publications and teaches at the Università Internazionale dell'Arte.



# Pretreatment Examination and Documentation: the Wall Paintings of Schloß Seehof, Bamberg

*Karl Ludwig Dasser*

Schloß Seehof, the former summer residence of the Prince-Bishop of Bamberg, was built between 1687 and 1696 by Antonio Petrini of Würzburg (Fig. 1). Today the palace serves as a regional office of the Bayerisches Landesamt für Denkmalpflege. On the upper floor of the west wing is a festival hall, known as the White Hall (Weißer Saal) because of its smooth, white stucco walls with their delicate decoration in blue (see Figs. 2, 7). The entire ceiling, measuring 17 x 8.5 m, and the *cavetto* were painted in fresco in 1751-52 by the court painter Joseph Ignaz Appiani (1706-1785), from the electorate of Mainz.

Above the stucco cornice and the trompe l'oeil architecture in the *cavetto* stretches a celestial vault with scenes of the gods of classical antiquity. The painting is an allegory of the awakening and fertility of nature, hunting and fishing, and is entirely appropriate for a hall used as a banqueting and music room (Fig. 3). The starting point of the fresco is a representation of the sunrise with the allegorical figure of the *prima hora*, the first hour of the day, and of Aurora, goddess of the dawn, riding in a golden chariot pulled by two white horses. Above the window facade is Diana, goddess of the hunt, with Pan, and nearby are Flora, Pomona, Ceres, Venus, and Bacchus, gods and goddesses of vegetation, symbolizing the fertile seasons of spring, summer, and autumn with all their offerings. Above the main entrance Neptune, god of the sea, the personification of the River Nile, and their companions are references to the element of water, to fishing, and to the fountains that were common at Seehof (Pl. 15).

*Figure 1, below left. Schloß Seehof, Bamberg, Germany. The former summer residence of the Prince-Bishop of Bamberg, built by Antonio Petrini, 1687-96. General view of the exterior from the southwest.*

*Figure 2, below right. Schloß Seehof. Interior view of the White Hall toward the east wall.*





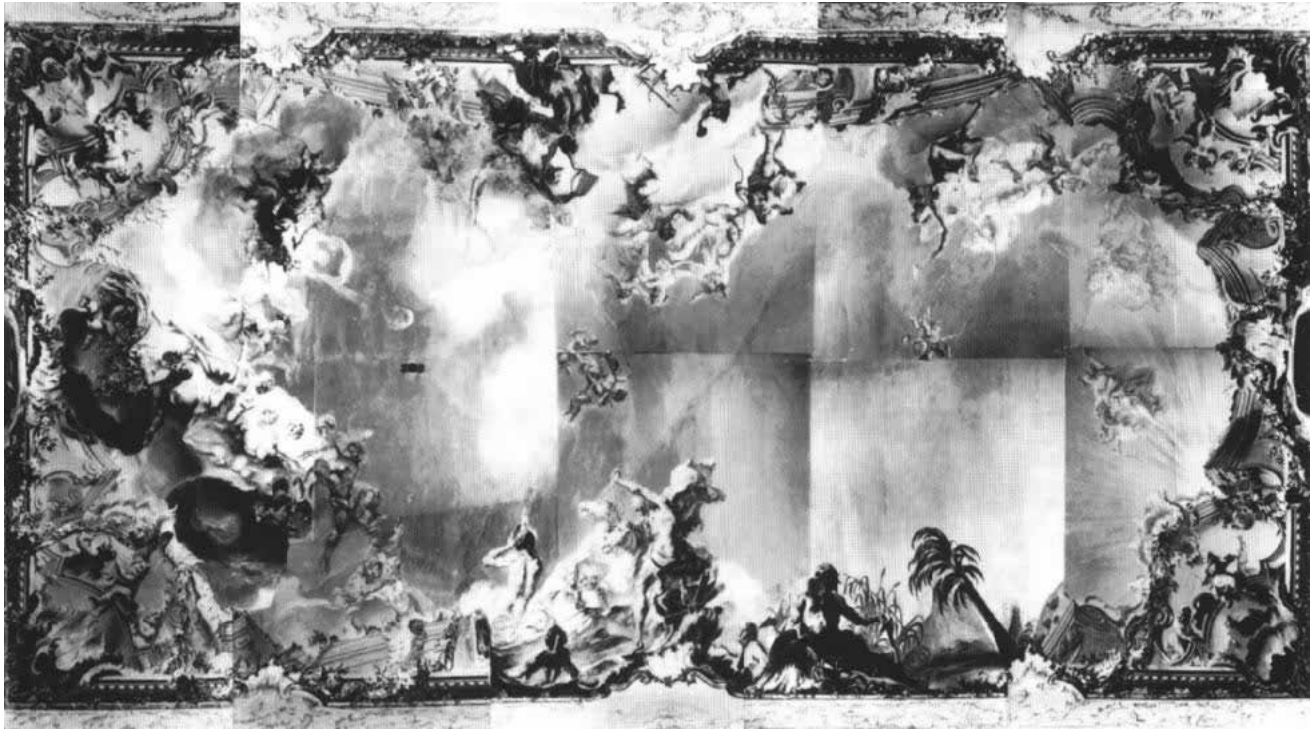

Figure 3, top. Joseph Ignaz Appiani (1706-85). *Schloß Seehof, White Hall, ceiling painting, 1751-52.*  
Photo montage with the east at the bottom.

Figure 4, above. A rotten cross beam in the ceiling. Photographed in 1984.

The load-bearing ceiling construction of the White Hall consists of cross beams that are also attached to a suspender beam. The intermediate spaces are closed off with split laths wrapped in straw and clay and filled in from above with a straw-clay-rubble mixture. The *cavetto* is of wood. The ceiling lath supports the rough-cast render (*arriccio*), which is 2.5-3 cm thick and is reinforced with animal hair, as is the painted render (*intonaco*), which is 2-5 mm thick (Pl. 16).

Water damage and cracks in the fresco indicated a structural deterioration in the roof and ceiling. When the floorboards above the ceiling were taken up in 1984, it was possible to appreciate fully the extent of the danger to the Appiani fresco. Several cross beams were completely rotten where they rested on the plate of the exterior wall (Fig. 4). The treatment of the beams and simultaneous repair of the roof were urgent priorities; without them any treatment of the fresco itself would have been pointless. But before any necessary remedial measures were carried out on the fabric of the building, the condition of the paintings had to be ascertained and any preliminary consolidation or emergency fixing completed.

Although a discussion of the diagnosis of the environmental conditions affecting the painting is beyond the scope of this paper, it must be mentioned that the investigation of wall paintings can never be limited to visible signs of deterioration; rather it is always necessary to take the entire building's situation into account. Atmospheric conditions of the space inside and outside the building, as well as plasterwork, masonry, foundations, and roof must be considered and examined in detail. Too often wall painting restoration is merely superficial, short-lived, cosmetic repair because the improvement of the environment is omitted or insufficiently incorporated into the planning.



*Figure 5. A funnel-shaped loss in the render caused by the slaking of calcium oxide. Photographed in raking light. 1984.*

In planning a conservation program, photographic documentation must be organized as the first step. The type and extent of this photography will depend on the particular work of art. In general, Pretreatment photographs should be taken in the form of black-and-white prints and color slides in at least a 6 x 6 cm format; for large frescoes a larger format is necessary. To facilitate comparison with the final documentation, a record should be made of the film type, camera, lighting conditions, viewpoint, etc. In some cases, the use of photogrammetry is recommended. Because it is almost always necessary to erect a scaffold in order to work on wall paintings, the photographic documentation of their condition before conservation must be planned early, as it cannot be carried out after erection of the scaffold. Insufficient coordination at this point on the part of project participants—the owner, architect, responsible public agencies, conservators, and building firms—can result in a lack of overall photographs, which are indispensable for continuous documentation. The erection of scaffolding should be supervised by a conservator to ensure the optimal working distance from the painting surfaces and to avoid damage caused by careless handling.

Once the scaffolding was erected at Seehof, the restoration workshop of the Bayerisches Landesamt für Denkmalpflege began Pretreatment examination and documentation of the Appiani fresco. The overall project was directed by conservator Jürgen Pursche, and the work carried out by Stefan Hundbiss and Juliane Wolf between October and December 1984, with scientific analysis undertaken by Dr. Hermann Kühn in Munich.

Preliminary consolidation was necessary, and peeling paint layers were secured by means of a temporary facing of Japanese paper with methylcellulose. Methods and materials should be chosen that do not constitute irreversible intervention or predetermine decisions that must be made later on in the conservation process.

The first step was to supplement the overall photodocumentation with appropriate detail photos, taken in normal, raking, or ultraviolet light as necessary. The sensitivity of the paint surface precluded making grid photos since adhesion points and chalk markings necessitate a fully intact and stable paint surface.

The next step was to assess the damage to the render. Most of the large areas of loss caused by water penetration were limited to the area above the west wall (see Pl. 16). Smaller losses occurred along the cracks, and alveolar formations caused by crystallization of salts were found in the surface. In several places, render that had been preconsolidated was flaking off. The adhesion of the two-layer render to the support was good, and there were only a few hollow spaces. Two types of crack formation were apparent: shrinkage cracks, which had formed as the fresco set, and cracks of varying depth and width that had developed later. Another type of damage consisted of small circular areas (1-7 cm in diameter) where the render had lifted off the support; in some places it had already fallen away, leaving a funnel-shaped loss (Fig. 5). This was caused by unslaked lime particles in the render; as they absorbed moisture and were converted from calcium oxide to calcium hydroxide, they increased in volume and deflected upward, leading to the loss of painted render.

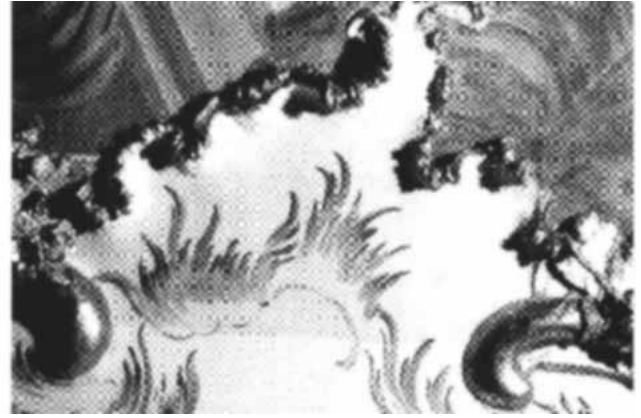

Figure 6, above left. Microbiological infestation in various concentrations manifested as light gray to black spots. 1984.

Figure 7, above right. Detail of a portion of the rocaille stucco cornice which was applied over the painted intonaco (see also Fig. 2).

The most common damage in the paint layer, caused by moisture, related to areas executed *a secco* (Pl. 17). Where an excess of organic binder had been used, the paint was flaking from the underpainting with thick layers dropping off in small particles (see Pl. 18). In other cases the medium had disintegrated, resulting in a loss of cohesion and powdering of the paint layer. Small-scale formations of spots, related to the effects of moisture, occurred relatively often, though whether they are alterations to the pigment or to the organic medium must still be determined scientifically. Graying in the paint layer may have been caused by sintering or by a cracked binding agent. Embrittled wax gilding was flaking in some parts. The most extensive microbiological infestation could be seen near the windows in varying concentrations of light gray to black spots (Fig. 6). The main moisture problems were found on the west side.

A full and accurate assessment and analysis of the nature and causes of damage is the most important parameter for developing a conservation strategy. Only with such knowledge is the conservator able to apply appropriate methods and materials for treating the damage, for reducing or eliminating the causes, and for determining suitable preventive measures. Two other very important areas that must be included in Pretreatment examination are assessment of painting technique and evaluation of previous restorations.

In my view, previous restorations are generally given inadequate attention, although they offer a unique opportunity to study the usefulness and long-term effects of methods and materials. Earlier documentation in the form of reports and drawings are, of course, valuable aids.

The documentation campaign provided a good general view of the limited, earlier interventions in the Appiani fresco at Seehof. Most were confined to areas in the northwest corner destroyed by water penetration, to the lower part of the Pan group, where the paint was reconstructed on a newly applied lime slurry, and to various cracks. Based on the use of artificial ultramarine and on a photograph dating from about 1900, this cautious restoration can probably be dated to the second half of the nineteenth century.

During the conservation of ceiling and wall paintings, investigation of the original painting technique is normally neglected. Expensive scaffolding, fixed deadlines for completion of the work, and lack of funds are usually the

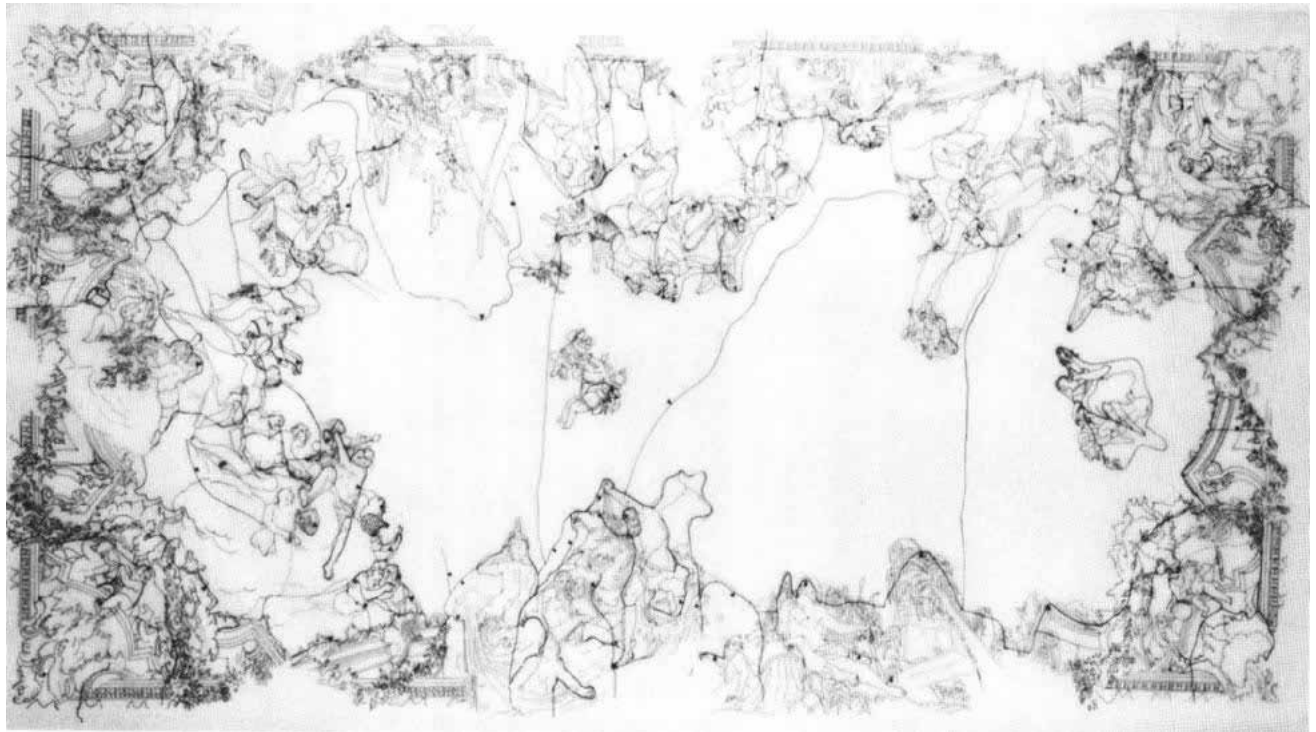

Figure 8, above. Diagram of the work fields, or *giornate*, with the sequence indicated by arrows.

Figure 9a (below) and b (bottom). A detail photographed in normal and raking light to show the freely executed incisions in the fresh *intonaco*.



causes. The fact that an exact understanding of original technique not only serves academic knowledge, but is also necessary for the correct assessment of damage phenomena and optimal treatment, is often overlooked.

In their investigation of the Appiani fresco, the conservators traced and comprehensively documented all aspects of the original techniques. The stucco profile that runs around the room was put in place before the application of the *intonaco*, whereas the *rocaille* stucco that extends into the fresco lies on top of the finished painting (see Figs. 2, 7). These two different phases of execution are also apparent in the color variations in the blue painted decoration on the stucco. Recording of the plaster patches, or *giornate*, was hampered because subsequent patches were applied very precisely, especially along the contours of the figures, obscuring the boundaries, which are not always shown on the overall plan (Pl. 19, Fig. 8). There are also rather small areas of plaster that do not represent a day's work so that it is more accurate to use the term *work fields* rather than *giornate*. The head of Neptune, for example, which consists of one field, probably represents a later correction. The forms were sketched freely by means of incisions in the fresh *intonaco*, often with several lines beside one another, suggesting that cartoons were not used (see Fig. 9a, b). There is also no indication of a grid. In several losses in the *intonaco* in the architectural sections, a black preparatory drawing made with a brush was found. We can assume that the principal pictorial elements were drawn onto the *arriccio* for the hall as a whole, and the individual work fields were executed freely according to the design contract (although the sketch for this is lost, its existence is documented). The deviations from the incisions and preparatory drawings support this theory. The underdrawing on the *intonaco* was carried out with either a lead pencil or painted in red (see Pl. 20). Most of the painting was completed *a secco*. Binding agents were found to be polysaccharides (presumably



vegetable gum) and proteins (most likely casein and glues). A peculiarity is the final working over of the painting with pastels. Bound with vegetable gum, they were used in a wide variety of colors for highlights and hatched modeling (see Pl. 21).

From this brief summary it can be seen that Appiani's working methods and technical procedures at Seehof were both artistically free and unconventional. They demonstrate how important a detailed investigation of an individual work of art is, and that familiar models of working methods are not necessarily applicable. How difficult—indeed, how unthinkable—the preparation of a conservation strategy would be without exact knowledge of techniques. This is well illustrated by an early cleaning attempt at Seehof, when as a result of ignorance of the original technique both *secco* and pastel passages were removed under the assumption that they represented later restorations.

The essential requirement for the successful Pretreatment examination of wall paintings is the skill of the conservator in making clear observations, in recognizing damage and underlying causes, and in correctly assessing technological peculiarities and the behavior of materials. Although a list of all observable phenomena is useful and can be found in the literature, it is the personal, unprejudiced, alert, and conscientious observations of the conservator concerning a specific work of art that are irreplaceable. Only that which the conservator consciously perceives and documents can ultimately become the object of a critical discussion.

A variety of forms of documentation may be used, but it is essential that all recording reflects exactly the specific observations and assessments, and that the extent, purpose, storage, and durability of documentation materials are borne in mind. One must not, however, lose sight of the main goal—the preservation of the work of art. Documentation serves this end and should not be elevated to an end in itself.

Finally, although funding problems are generally excluded from consideration at scientific colloquia, they are of primary significance and should be addressed. Conservators are well aware of how to undertake and document precise Pretreatment examination, but the other project participants are not always persuaded of the necessity of such measures. The problem in practice, experienced daily, is often insufficient insight on the part of the owner, client, or funding source, who may regard extensive preliminary examinations and their documentation as superfluous. Many committed conservators prepare documentation virtually gratis, from a sense of responsibility toward the work of art. But this state of affairs must not be taken for granted. Efforts must be made to persuade all those involved that Pretreatment examination and documentation are vital to the successful planning and implementation of any conservation program and, as such, are prerequisites for the preservation of the wall paintings.

## **Bibliography**

---

### **Alof, Marion**

- 1990 "Joseph Ignaz Appiani (1706-1785), Notizen zu Leben und Werk." *Die Restaurierung der Wallfahrtskirche Vierzehnheiligen* (Bayerisches Landesamt für Denkmalpflege, München, Arbeitsheft 49/1). Munich. 119-125.

### **Bayerisches Landesamt für Denkmalpflege, Munich**

- 1984-85 Unpublished examination reports of the Restaurierungswerkstätten.

### **Kämpf, Margarete**

- 1956 "Das Fürstbischöfliche Schloß Seehof bei Bamberg." *93 und 94. Bericht des Historischen Vereins für die Pflege der Geschichte des ehemaligen Fürstbistums Bamberg*. Bamberg. 25-254.

### **Langenstein, York, and Michael Petzet**

- 1985 *Seehof. Baugeschichte und Restaurierung von Schloß und Park* (Bayerisches Landesamt für Denkmalpflege, München, Denkmalpflege Informationen 53/2). Munich.

### **Lehmann, Jacob**

- 1977 *Staatsempfang auf Schloß Seehof. Ein Kapitel Kulturgeschichte zum Barock und Rokoko in Oberfranken*. Bamberg: Bayerische Verlagsanstalt.

### **Risser, Matthias**

- 1983 Das Fresko Joseph Ignaz Appianis im Schloß Seehof. Unpublished Masters thesis, Universität Würzburg.

## **Biography**

Prof. Dr. Karl Ludwig Dasser is Dean of the Department for Conservation and Restoration of Art and Cultural Property at the Fachhochschule Köln, and is responsible for the training of wall painting conservators. After his art history studies and training as a wall painting conservator, he worked privately from 1965 to 1972 when he joined the Department for Inventory of the Bayerisches Landesamt für Denkmalpflege. From 1976 to 1988 he was head of the Restaurierungswerkstätten of the BLfD, during which time he further developed the conservation laboratories and directed various research programs.



# The Role of the Architectural Fabric in the Preservation of Wall Paintings

*Claus Arendt*

Whenever wall paintings, their state of preservation, the dangers menacing them, and the possibilities of conserving them are discussed, keen attention is paid to paint and plaster layers but often the walls supporting them are not adequately considered. In reality the life of any wall painting depends critically on the status of the wall, and in this context the most decisive aspects are structural stability, moisture, and acidity.

## *Structural Stability*

There are many causes that may lead to a decrease in the load-bearing capacity of a wall. Regarding the structure, distinctions should be made between lesions due to poor foundations, to insufficiently strong structural members, or to some external factor such as war, fire, or excessive loads. In a simplified way we may say that the major causes of structural instability are defective foundations, disturbed load transfers, and insufficient cohesion. In the first two instances, there will be cracks that, in the worst case, continue to widen resulting in the eventual collapse of the building; in the third case the structure will have numerous hair-line cracks caused by slight differences in settling, thermal loads, or other factors.

Without discussing in detail any particular structural measure, there are some criteria that must be met when undertaking repairs to historic buildings, particularly when wall paintings are present. The following must be avoided: the corrosion of auxiliary metal supports; the formation of expanding minerals; the creation of high differentials in acidity within adjoining or directly linked structural components; the formation of cold spots; the modification of the diffusion behavior of the fabric supporting the painting; and process damage due to vibration, fouling, and other factors.

The abbey church of Herrenberg provides a useful example both of a problem of structural movement and of corrective measures. Located on a slope, the church is creeping down the hillside slowly but steadily. Measurements taken since 1932 have confirmed this process (Fig. 1), and extrapolating from these over the period of the building's existence results in parameters that are close to the present actual values. Several centuries ago the choir arch was about to collapse due to this creeping and was therefore reinforced with further masonry. The concept that allowed this church as well as its layers of plaster and wall paintings to be preserved is simple to the point of brilliance. Since individual segments of the structure are characterized by differing movements (note the

Figure 1. Abbey Church, Herrenberg, Germany. The gradual movement of the church down the hillside has been monitored since 1932. The measurements show that the various parts of the structure are moving at different rates.

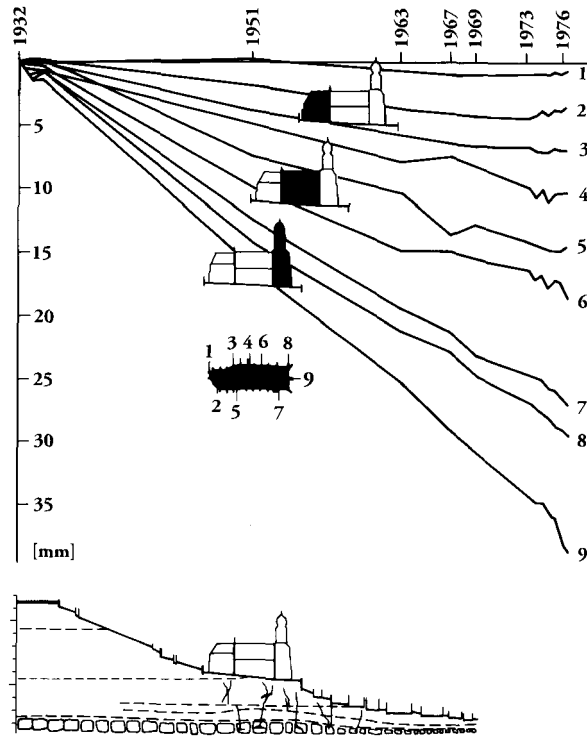

variation, for example, between the movement of the choir and that of the tower, sections 3 and 9 respectively in Figure 1), they were stabilized separately, while the joints between them were left to move relative to one another and can be repaired from time to time as needed at little expense. To reestablish shear value for the walls, internal anchoring was used. In practice this meant that the walls were drilled several times along their entire length (Fig. 2). Thus reinforcements of the choir and external walls are located within the walls and are invisible.

Using this method of reinforcement requires the technology necessary to drill straight over long distances. The equipment permits drilling precision values down to approximately one part in a thousand. This means that maximum drilling deviation at the end of a 40 m wall will be no more than some 4 cm. At Herrenberg metal rods were inserted into the drilled holes, tensioned, and grouted. It was then possible to remove the supplementary brickwork reinforcing the wall so that the interior of the church could be seen, after a very long time, as originally intended. This consolidating measure will remain effective as long as the steel rods suffer no corrosion due to water penetration. If they do, there will be expansion loads due to the rust that will form. In Figure 3 one can see the anchoring head, the recessed thrust plate, and the anchoring steel rod, which must be coated entirely with laitance. In another example (Fig. 4), four anchors are used to pretension the party wall of two houses. Once the operation has been concluded, any demolished sections can be rebuilt using the original material.

Schloß Laupheim is another illustration of the effectiveness of this method of maintaining a wall in its original state without any visible interventions. Two anchors were sufficient to reestablish the shear value of this wall. Moreover they permitted the preservation not only of valuable internal wall surfaces but also of the entire load-bearing structure except for two columns replaced in reinforced concrete (Fig. 5).



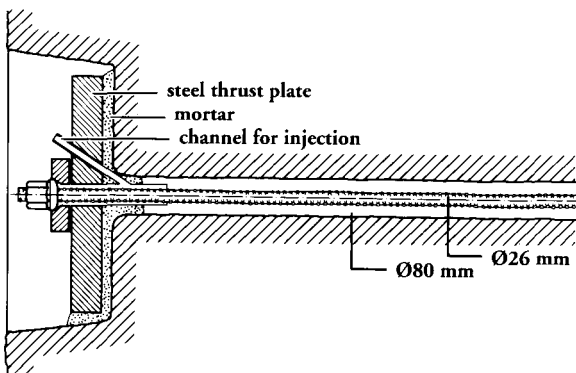
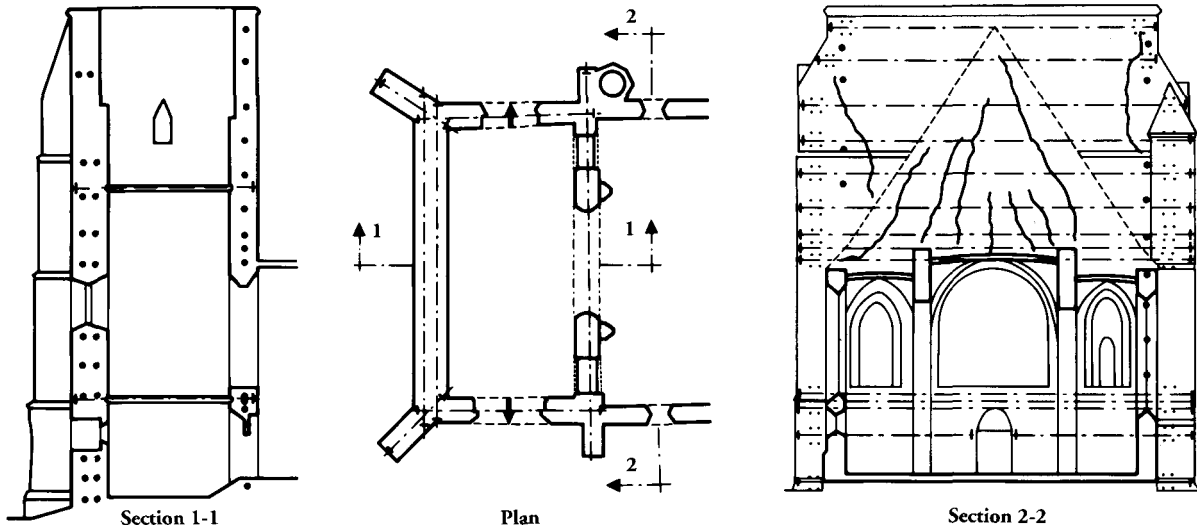

Figure 2, top. Tower, Abbey Church, Herrenberg. Plan and sections showing locations of anchoring rods (see Fig. 3) inserted in the walls.

Figure 3, above. Diagram of recessed steel anchoring rod.

Figure 4, right. The recesses where four anchoring rods have been inserted to pretension this wall can now be filled and concealed.

Figure 5, below right. Schloß Laupheim. Remedial structural measures involved insertion of two anchoring rods and the replacement of two columns (arrows) of the arcade with reinforced concrete columns.

— · · · · · anchoring rods

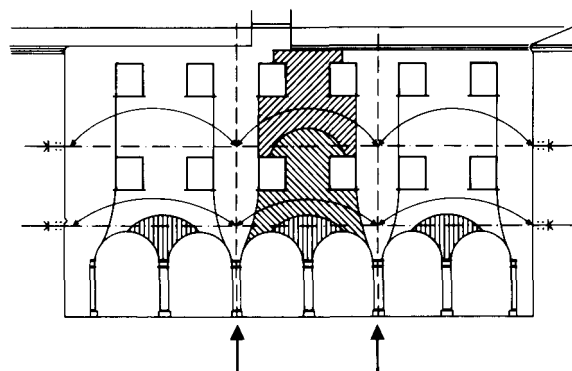

To reestablish stability, cement injections are frequently used. However, particularly with old buildings, this potentially very helpful measure can be so disastrous that the only recourse may be to transfer any painting to a new support. The reactions produced by cement and gypsum and the formation of ettringite ( $\text{Ca}_6\text{Al}_2(\text{SO}_4)_3(\text{OH})_{12} \cdot 26\text{H}_2\text{O}$ ) are well known. It is less well known, though, that even cement grades enjoying high sulfate resistance may react with historic mortars containing a certain amount of gypsum. Thus, prior to injecting cement, any wall to be preserved has to be tested very carefully indeed, by drilling a great number of samples to assess the gypsum content. If this cannot be done or if there is even a slight suspicion that the mortar might contain gypsum, this type of structural rehabilitation is to be excluded.

Both grouting and anchoring as well as any other auxiliary steel or reinforced-concrete structures may increase thermal conductivity. This constitutes no immediate danger to wall paintings, but they may be damaged over time. Even minimal superficial temperature gradients will lead to differing moisture levels, which will enforce differential aging in adjoining areas. Typical damage can be seen in Figure 6, in this instance caused by the different thermal conductivities of mortar and wooden lath.

*Figure 6. Damage resulting from the different thermal conductivity of plaster and wooden lath.*



If an increase in moisture is superimposed on this effect, there may be additional dangers from algae and other organic infestations. Nevertheless, modifying thermal conductivity parameters may be acceptable, or even beneficial, to ensure the ongoing existence of paintings if the effect of thermal insulation can be spread over a large surface. In order to protect wall paintings, all localized "hot spots" are to be avoided. The application of a rock-wool insulation layer to the painted dome of a church, for example, will decrease thermal tensions within the vault without producing detrimental side effects.

The use of resins in building conservation can no longer be stopped and sometimes is to be welcomed. In order to reestablish the load-bearing capacity of a wall or arch, even resins containing little or no mineral fillers are used. Their most important advantage over traditional injection materials is the fact that they have excellent flow properties and can absorb even tensile forces thanks to the fact that they anchor themselves to the sides of any crack. This method allowed the columns of the Nieuwe Kerk, Amsterdam, to be refurbished at a third of the cost that would have been involved in demolishing and rebuilding them. Such material penetrates well and spreads over all surfaces. However, the appropriateness of this method should be checked in each individual case by performing test injections and by drilling cores for analysis, since the use of injected resins may impair the permeability of any structure to vapor.

Injection grouting with resins can also present an immediate risk to wall paintings from vibration and from seepage onto the painted surface (Pl. 22). Both these effects, however, can be prevented if suitable precautions are taken. Vibrations caused by drilling are well understood, and seepage of injected material onto the surface can be avoided by careful preparation. In some instances it may be sufficient to close visible cracks by taping them; alternatively it might be possible to seal an entire surface by spraying or brushing on suitable material. The wall painting itself will have to be tested to determine whether it might be damaged when any such film of material is removed. The best, if the most expensive, method is to have a conservator seal all cracks down to the most minute ones prior to performing any injection. Nevertheless the wall being grouted must be watched closely during injection, so that the material can be depressurized whenever any of it appears at the surface. If resins are used, damage can be limited by removing any material as soon as it appears. This presupposes, of course, that the conservator knows which solvents or cleaning agents may be employed *before* any injection is attempted.

A widespread source of damage in historic buildings is the use of concrete, whether as auxiliary concrete or reinforced concrete, for structural reasons, such as foundation buttressing, reinforcements, or stays. Generally, fresh concrete has highly alkaline properties, while historic walls tend to be neutral or at most slightly acidic. Thus a pH differential will be set up and will generate an electric current, which, depending on the size of the differential, will contribute to capillary rise of moisture in the wall.

To demonstrate these electro-osmotic phenomena we compared the capillary rise of moisture in two brick walls built in our Munich laboratory. Both

were constructed of the same materials and were supplied with water from the base. In one wall moisture rose to the third course of bricks, while in the other wall after more than a year of exposure the water had not risen above the first course. The method used to force the increased moisture rise was to cast a concrete slab onto the test wall and link it in an electrically conductive manner with the moist zone of the brick wall.

## Moisture

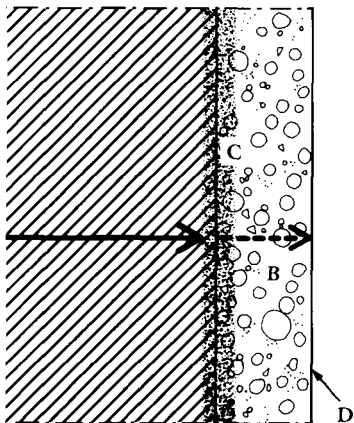
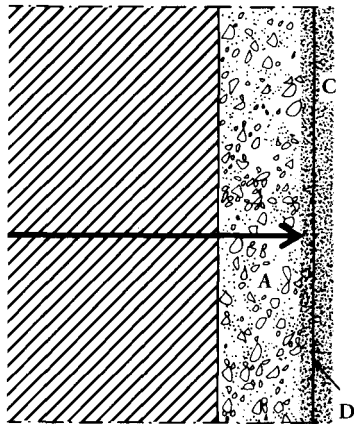

Figure 7a,b. Diagrams showing how the application of a layer of hydrophobic plaster will prevent soluble salts from being transported to the wall surface by liquid water. Key:

- A lime plaster
- B hydrophobic plaster
- C zone of crystallization
- D wall surface
- liquid water
- - - - -→ water vapor

Regarding water, or rather moisture, levels in walls, it would be inappropriate to differentiate for theoretical reasons between salt loads and waterlogging, because salt-free water, apart from attracting algae colonies, has little deleterious effect on wall paintings. In view of this fact, all further comments here will be based on the assumption that any water damage discussed is due to salts contained in the water (see the contribution by Arnold and Zehnder in this volume). It should be noted that liquid water—as differentiated from water vapor—will transport any salts in solution to the level at which the water evaporates. The use of special hydrophobic plastering materials rather than standard lime mortars can keep deleterious salts at deeper levels, where they are less harmful (Fig. 7a,b). Since water vapor does not carry salts, the latter remain at the level of evaporation, where they crystallize. Their volume increases tremendously, as does the pressure they exert on any surrounding material.

Salts have another drawback: being hygroscopic, they tend to absorb humidity from the air. The effects so produced can be seen in Figure 8 where the quantity of water bound to the salt is indicated on the vertical axis as a percentage by weight, while relative humidity is shown on the horizontal axis. A brick containing no salt will remain almost uniformly dry to extremely high humidity ranges; this is the great advantage of brick as compared to other wall materials. A salt-laden brick—exemplified by the top curve corresponding to a 4% (w:w) sodium chloride level, far from unusual under practical conditions—will hold water in a weight percentage ratio of 26%, which means that it will be dripping wet. When the relative humidity decreases to, say, sixty-five percent, a value that may be said to be normal, the same quantity of salt will have a weight percentage ratio of no more than 6%, and the excess water will be free to move within the wall along other pathways.

Whenever the moisture regimen of a wall or the humidity levels of a room are modified, any salt present responds accordingly. Translating the salt characteristics described theoretically into practical terms means that while a moist wall is being dried, further salt crystals will form; moreover any salt remaining within the wall will reabsorb water from the air whenever relative humidity reaches sufficient levels. Further damage to wall paintings is, therefore, to be expected even if drying out of the wall is successful. In other cases, relative humidity within buildings may be so high and surface temperatures so low that condensation will occur throughout the year, leading to proliferating algal growths over any wall painting. The best action to be taken against algae is to increase the temperature at the wall surface or decrease the relative humidity within the room. Both measures will activate evaporation from the wall, which

Figure 8, right. Comparison of the hygroscopic absorption of moisture by bricks containing differing amounts of salt (0, 4, 20, and 40 mg NaCl per cm<sup>3</sup>) at various levels of relative humidity. The percentage weight gain is indicated on the vertical axis, and the relative humidity on the horizontal axis.

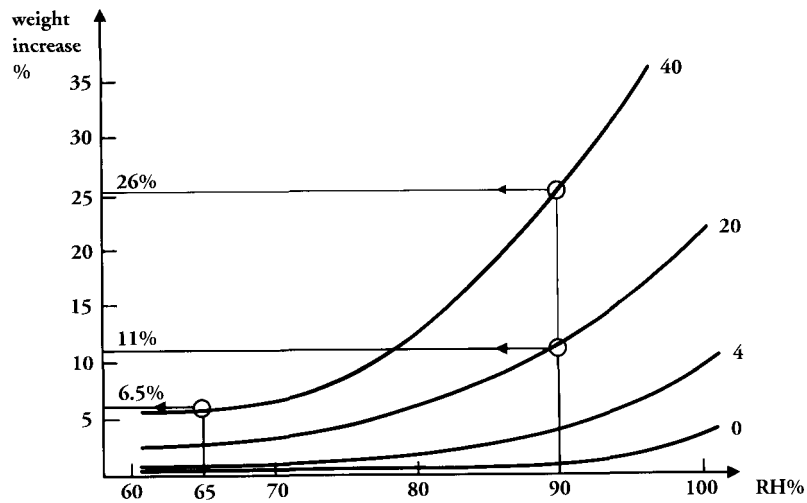
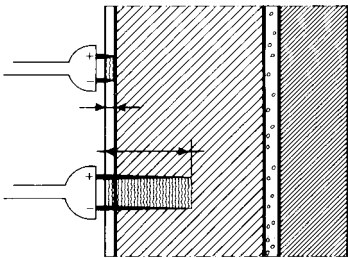

Figure 9, below. Moisture measurement based on electrical conductivity of material between two electrodes.



would have thus far been practically nonexistent owing to the slight differential between the two partial vapor pressure levels. However, increasing evaporation will augment the salt quantities being conveyed within the wall, so that a measure taken against algae on a painting may endanger the painting itself: crystallizing salt may destroy both plaster and paint layers.

For any given case, in the absence of precise data as to water and salt levels no prediction can be made of the various mechanisms that together will lead to damage. It is a crucial question whether water is being absorbed from the soil, is bound hygroscopically to salts, or condenses on or within the wall painting; just as crucial are the quantities of any salts present. The success of any attempt to conserve a painting on a moist wall subject to high salt levels will depend to a large extent on precise measurement of these parameters.

### Moisture Measurement

For moisture measurement, the type of instrument most frequently used is based on electrical conductivity: a current flows from one electrode to the other, varying directly with the conductivity of the sample being measured (Fig. 9). Water increases the conductivity of mortar, so results obtained are said to be proportional to moisture levels. But such measurements can be very misleading since salts present will likewise increase moisture levels, so that what the instrument will show is that the moisture levels of any wall being measured decrease as its height increases—a virtual truism. Averaging a great number of measurements will permit a conclusion as to whether any structural member used to be more or less dry than it is now, a parameter that is likely to be much less relevant to the problems we are considering. Misleading results—sometimes deliberately used for commercial purposes—would be obtained, for example, by applying this instrument to a high-acidity wall on a hot, humid day, a wall on which the salts near the surface would have absorbed a great deal of moisture. Following rehabilitation measures carried out as a result of such evidence, by applying this instrument to the same wall on a dry, cool day all the measurements would indicate substantial reductions in moisture, even though the restoration may have failed. Similar criticisms apply to all other instruments used to measure moisture by means of magnetic fields or similar methods.





*Figure 10. Neutron-based instrument for moisture measurement.*

The neutron-based instrument illustrated in Figure 10 is more reliable, though it is expensive, and its use is subject to relatively stringent requirements. Since it allows comparative moisture levels to be determined, it is necessary to calibrate the instrument by performing at least one, but preferably several, direct measurements on any given wall. Although this is not really a nondestructive measuring method, the level of damage necessary is less than when a sample has to be drilled or chiseled out of a wall.

A carbide meter can provide a sufficient level of precision. A sample taken from the wall is broken up with a hammer, weighed, and poured into a steel cylinder together with steel balls and a cartridge holding calcium carbide. The cylinder is then closed so as to be gas-tight. Shaking the container causes the steel balls to destroy the glass cartridge, releasing the calcium carbide which reacts with any water contained in the sample to form acetylene. The pressure so produced is shown on a gauge, and the moisture content of a given material can then be read from a table. This type of measurement is sufficient to judge on site the effectiveness of a drying method; with experience, it even permits choosing the proper method. For our purposes, however, this is not enough. There still is no nondestructive method that provides the necessary answers concerning water and salt levels and their distribution.

The best method available is to drill a solid core (Fig. 11), since only undisturbed material, not drilling dust, provides information as to porosity percentages. Since it is essential to know the distribution of water within a wall, cores are segmented immediately upon drilling and the segments measured separately, so that a horizontal moisture profile results. Any core so drilled must be sealed immediately in a vapor-tight container for weighing in the laboratory. The first result obtained, the wet weight, corresponds to the weight of the material sampled including moisture. Next the sample is dried to a constant weight (Fig. 12) and re-weighed, giving the dry weight. Finally, the sample is rewetted to a constant weight and reweighed. This final result, the saturation weight, indicates the maximum quantity of water that can be absorbed by the material being tested. From these three values the extent to which any wall is already water-logged can be derived.

Once moisture levels have been determined, the samples can be tested for salts. They are pulverized and run through a series of chemical tests, most of them relatively simple. This gives qualitative and semi-quantitative information on the salts present, a degree of precision sufficient in a building context. Normally, salt levels are graded as: 0—indiscernible; 1—low; 2—medium; 3—high; and 4—extremely high.

*Figure 11, right. Drilling a solid core for direct moisture measurement.*

*Figure 12, far right. Drying solid cores that have been segmented to provide a profile of moisture content.*



The relevance of having measurements both of moisture and salts which can then be correlated is demonstrated in two case studies. In both buildings the observable damage pointed to moisture penetration and the appearance of the two walls in question was identical. In both cases the architect or the ecclesiastical office responsible had been planning desiccation measures. In the first case (Table 1, Wall A), the actual and maximum theoretical moisture levels (wet weight and saturation weight) are very similar, indicating that the wall was already near its saturation point. Incidentally, it would no longer have been possible to dry out this wall by injecting some material, since it was waterlogged to an extent that left no space for other material to be injected.

By contrast, in the second case (Table 1, Wall B) comparison between actual and potential moisture levels indicated an extremely low level of moisture penetration, the saturation percentages ranging from 2 to 10%. Moisture levels of 2, 4, or 6% mean that this wall is as "dry as dust." Nevertheless it is subject to the same kind of damage as the previous example which was extremely wet. The salt levels show why. In the latter instance hygroscopic moisture absorbed by the salts will have to be addressed; moreover the wall may be prone to condensation. Additional measurements would clear up any remaining doubts.

Table 1. In Wall A, comparison of the actual with the maximum potential moisture content (wet weight and saturation weight) of the core samples shows that this wall is near its saturation level. In contrast to Wall A, the moisture content of Wall B is extremely low, with saturation percentages ranging from 2% to 10%.

Wall	Sample number	Wet weight (a)	Saturation weight (a)	Percentage of saturation (b)	Hygroscopic absorption (a)	Soluble salts		
						NO <sub>3</sub> <sup>-</sup>	Cl <sup>-</sup> (c)	SO <sub>4</sub> <sup>-</sup>
A	1	14.62	14.68	99	1.48	0	2	2
	2	12.65	13.37	95	0.79	0-1	1	0-1
	3	11.23	13.27	85	6.90	1-2	4	3
	4	9.88	11.90	83	2.64	0	1	0
B	1	0.60	7.55	8	1.16	0	3	2
	2	0.18	10.00	2	1.28	1	3	2
	3	0.47	7.29	6	1.97	1	4	2
	4	0.41	10.37	4	3.56	3	4	2
	5	0.92	9.18	10	2.22	0	3	2

(a) Given as a percentage of the dry weight of the sample.

(b) The wet weight expressed as a percentage of the saturation weight.

(c) Semiquantitative values given as: 0—indiscernible; 1—low; 2—medium; 3—high; 4—extremely high.

### **Diagnosis and Remedial Measures**

If we return to wall paintings, what conclusions might be drawn based on the two studies discussed above? A definite conclusion is possible only in the second case. Since the amount of moisture in this wall is already extremely low, it would not only be a financial error to invest in decreasing it even further, but the amount of moisture might even be deemed beneficial and not deleterious as regards the future survival of any paintings. Further conclusions in this particular situation would depend, among other things, on the structure of any wall

painting present and thus it is impossible to speculate further. It is obvious, though, that the high salt levels would continue to damage the painting. Therefore the first question to be answered would be: how to remove the various salts from this wall? It would be more important, however, to ascertain their origin, which might involve factors no longer in play and therefore to be disregarded, or a cause that is still active and has to be urgently corrected. For example, with a building formerly used agriculturally or in agricultural surroundings, there is almost no doubt that this source of salt contamination could now be disregarded. It might be worthwhile, though, to do a little low-cost research on the surrounding soil to find out if there is nitrate contamination so that the situation could be improved by soil replacement if necessary. If acidity levels were due to the use of deicing salt, its application would have to be discontinued. Each type of salt must thus be researched.

In order to combat, let alone remove, any salts present in a wall or in the paintings on a wall the studies already mentioned are required. There are two fundamental ways of treating a wall for excessive salt levels: removing the salts, normally by mechanical means, or converting soluble salts into insoluble ones. The options depend on the type of salt present. In a building context, chlorides may be readily converted from a soluble, and thus dangerous, form into insoluble, and thus harmless, compounds, but this is not applicable to wall paintings. Conversion of sulfates can, of course, be carried out under specific conditions (see the contribution by Matteini in this volume), but is not as yet possible for nitrates.

Since any conservator would refrain from adding new agents to a mix of chemicals which may have been in existence for decades or even centuries, the alternatives available are restricted to a single really palatable one. While normal plaster and a large percentage of pointing material can be removed entirely to eliminate most of the damaging salt, this method is clearly out of the question as regards wall paintings. Here the only practicable way of removing the salts is the well-known method of providing them with a sacrificial material into which they may migrate. Formerly, layers of loam kept permanently moist were sometimes packed against the walls in question; now cellulose poultices are a cleaner, if not necessarily a more successful, alternative. With thick walls—and supporting walls tend to be thick—measurable improvements soon appear. However, this may be utterly illusory. Poultices clean salt out of top layers; reaching deeper ones becomes progressively more complicated and expensive. Particularly with dry or relatively dry walls, artificial moisture penetration from inside using salt-free water may improve the effectiveness of this method, though the time required is frequently underestimated by wide margins. In practice this means that using poultices will preserve a wall highly damaged by salt for only a limited amount of time—the time required for the salts within the wall to migrate to the surface. Wherever soluble salts can be converted into an insoluble form, use of a suitable agent should not be rejected out of hand. Whether any such chemical ought to be used on the exterior or—much more efficiently—on the interior of the wall will depend on the chemistry of the wall, particularly in critical cases.

In further case studies, examining the data from core-sampling allows certain conclusions to be drawn regarding the source of moisture. In one case (Table 2, Wall X), the moisture levels present are unmistakable symptoms of rising moisture, decreasing progressively to a height of about 1.8 m. In another case (Table 2, Wall Y), the fact that the moisture decreases as we advance into the wall demonstrates that condensation contributes to the wetting. When damage is due to condensation salt loads may be anywhere from low to high but their effects will be superimposed on those of condensation. However, there is no way to dry out this type of wall except possibly by air conditioning. As mentioned above, measures designed to dry ambient air or to increase wall temperatures will enhance evaporation and thus salt efflorescence. Therefore, when condensation occurs on a wall painting it can only be eliminated or reduced without causing damage if the wall is relatively free from salt.

There are, however, some measures which can be taken to improve such situations. Normally, a wall painting subject to condensation will be destroyed at or near floor level. This means that there will be a 30, 40, or even 50 cm high zone that can be sacrificed. This can be done by applying a new plaster consisting of highly hygroscopic mortar (pure lime) and by installing heating in the form of a cable, tube, or fabric in this surface, at the wall/floor juncture or in the floor next to the wall. With this system, used only to control the temperature of that zone and not to heat the room itself, the sacrificial plaster will absorb some of the moisture flow and at least some of the salts. The new plaster is likely to deteriorate rapidly and become unsightly but can be replaced any number of times.

Another possible measure is analogous to applying poultices. If a painted wall has been damaged by salts and if all measures taken to reduce

*Table 2. Moisture measurement of core samples of brick material. Wall X: In this example, the percentage of saturation of the core samples decreases as the height at which they were taken increases, characteristic of capillary rise of moisture. Wall Y: By contrast, in this wall the moisture content decreases at progressively greater sampling depths within the wall, characteristic of condensation.*

Wall	Sample number	Height at which sample taken, in m	Depth at which sample taken, in cm	Wet weight (a)	Saturation weight (a)	Percentage of saturation (b)
X	1	0.3	–	16.55	17.86	93
	2	0.6	–	15.98	16.77	95
	3	1.0	–	14.54	18.88	77
	4	1.4	–	16.23	19.04	85
	5	1.8	–	6.22	16.87	37
Y	1	–	2	16.41	18.53	88
	2	–	5	11.02	19.74	53
	3	–	8	4.95	16.98	29
	4	–	15	3.27	17.05	19
	5	–	25	3.60	17.95	20

(a) Given as a percentage of the dry weight of the sample.

(b) The wet weight expressed as a percentage of the saturation weight.

moisture levels increase the deterioration due to these salts, a coat of suitable plaster can be applied to the surface. This will absorb the salts as well as provide a new sacrificial layer for evaporation and salt crystallization. The intention is that salts in solution will migrate through the wall painting without damaging it. The real object of any such measure is, of course, to preserve a valuable painting for as long as possible, hopefully until research has found better methods for its direct preservation.

These examples have demonstrated the interdependence between moisture and salt. If the problem is inverted, it might be thought that one solution would be to introduce humidity into the ambient air within a painted room sufficient to prevent evaporation. This is not, however, an alternative since it would subject the building to other pressures likely to increase whenever external temperatures were subject to long-term downward trends. Potentially, this could result in drying and consequent damage due to salt crystallization.

By now it is clear that it is not sufficient to say, "This wall is subject to that amount of moisture; to preserve the painting on it the wall will have to be dried out." To what extent any drying measures will bring about positive or negative consequences cannot be judged except by taking prevailing indoor climates into account; conversely, these considerations permit certain requirements to be established for wall drying. Basically, this means that if a surface such as a wall painting is to be preserved, drying methods cannot be chosen in accordance with criteria that might otherwise apply. For instance even the best method of all, installation of a damp-proof course, may—let us emphasize "may," since there is nothing inevitable about the process—lead to deleterious consequences for a wall surface.

A degree of drying sufficient for practical purposes without introducing serious consequences may frequently be achieved by reducing the moisture supply. The lowest-priced method of doing this is normally to provide the base of the outside face, or both faces, of a wall with a layer of non-capillary material down to the very bottom of its foundation. Thus the adjacent soil will cease to contribute moisture laterally to the wall, and by thus limiting the source of moisture to the underside of the foundation will result in an overall reduction in the height of capillary rise of moisture. Therefore the wall will not be completely dry and damage, if any, will be restricted to the foundations. Normally, this non-capillary layer will consist of a gravel packing that will contribute, to a large extent, to the collection of surface or rainwater. This layer of gravel packing must be drained, so a drainage system will have to be installed. It is important to emphasize that should such a system fail to function properly it will produce long-term damage far graver than that which its installation was intended to correct.

## *Summary*

Structural rehabilitation is possible. Although modern auxiliary structures can be used, their compatibility in any individual case must be precisely reviewed by performing suitably accurate preliminary research. Physical wall parameters such as stiffness and permeability to vapor must not be modified.



The type, quantity, and distribution of any salts present must be known, just as the source of any moisture and its distribution within the wall must be identified. Before the optimum preservation method can be chosen—which frequently will be unsatisfactory all the same—details about exterior and interior climates must be known. Regrettably, it is still not possible to preserve a painted wall subject to salt loads and waterlogging without occasionally sacrificing some material.

---

### ***Biography***

Dr. Ing. Claus Arendt has a doctorate in architecture specializing in the field of technical equipment for buildings. The author of several books on refurbishment and restoration of buildings, he was for many years Head of the Technical Department of the Bayerisches Landesamt für Denkmalpflege. He is currently Managing Director of the IGS (Institute for Building Analyses and Planning of Restoration Measures) and also teaches the subject of preservation technology in buildings at the Technical University of Munich.



# The Conservation in Situ of the Romanesque Wall Paintings of Lambach

Ivo Hammer

The highly important Romanesque paintings of Lambach are located in the former west choir of the Benedictine abbey church (Fig. 1). Dating from ca. 1089, the narrative cycle comprises twenty-three scenes from the life of Christ, covering the walls and vaults—some 200 m<sup>2</sup> (Pl. 24, Fig. 2).<sup>1</sup> As part of the Baroque alterations to the church, in the west choir a floor was inserted and two towers were built on the Romanesque walls in 1639 (see Fig. 3). Concern over the resulting structural instability led in 1680 to the construction of secondary buttressing walls on the interior. Although the added weight of the towers (about 450 tons each) certainly damaged the Romanesque *intonaco* (Pl. 25), the survival of the paintings is due in large part to the protection provided by these walls.

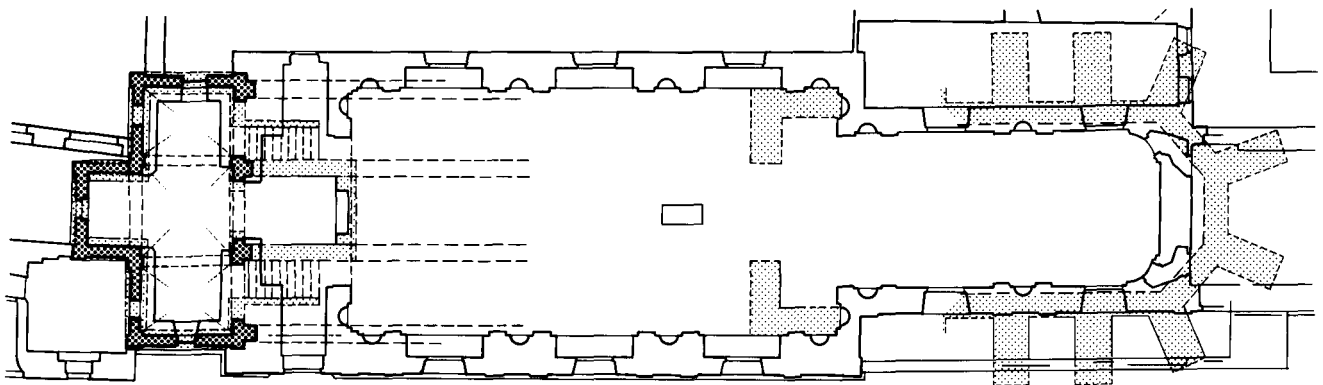

Figure 1, above. Lambach, monastery church, plan.

Figure 2, right. Axonometric view of the former west choir.

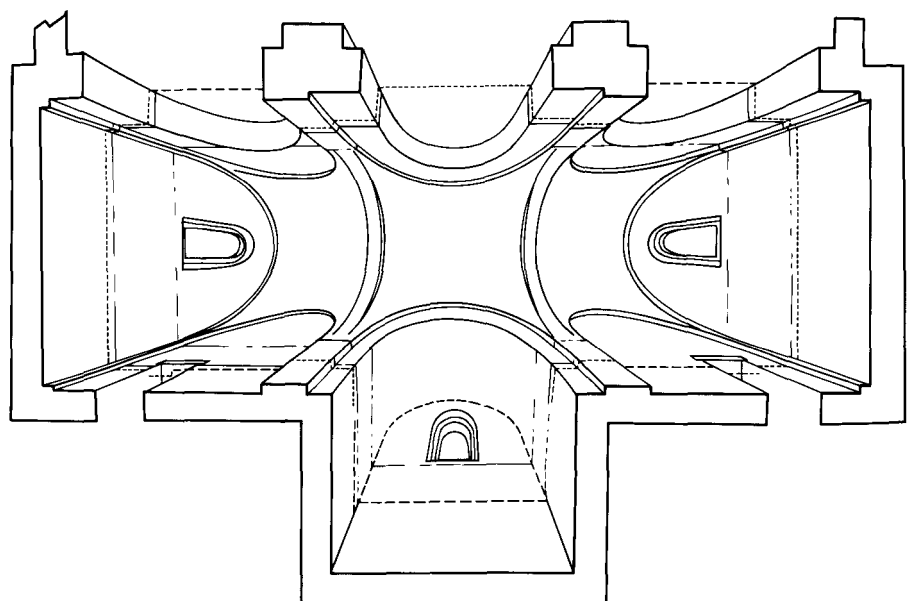



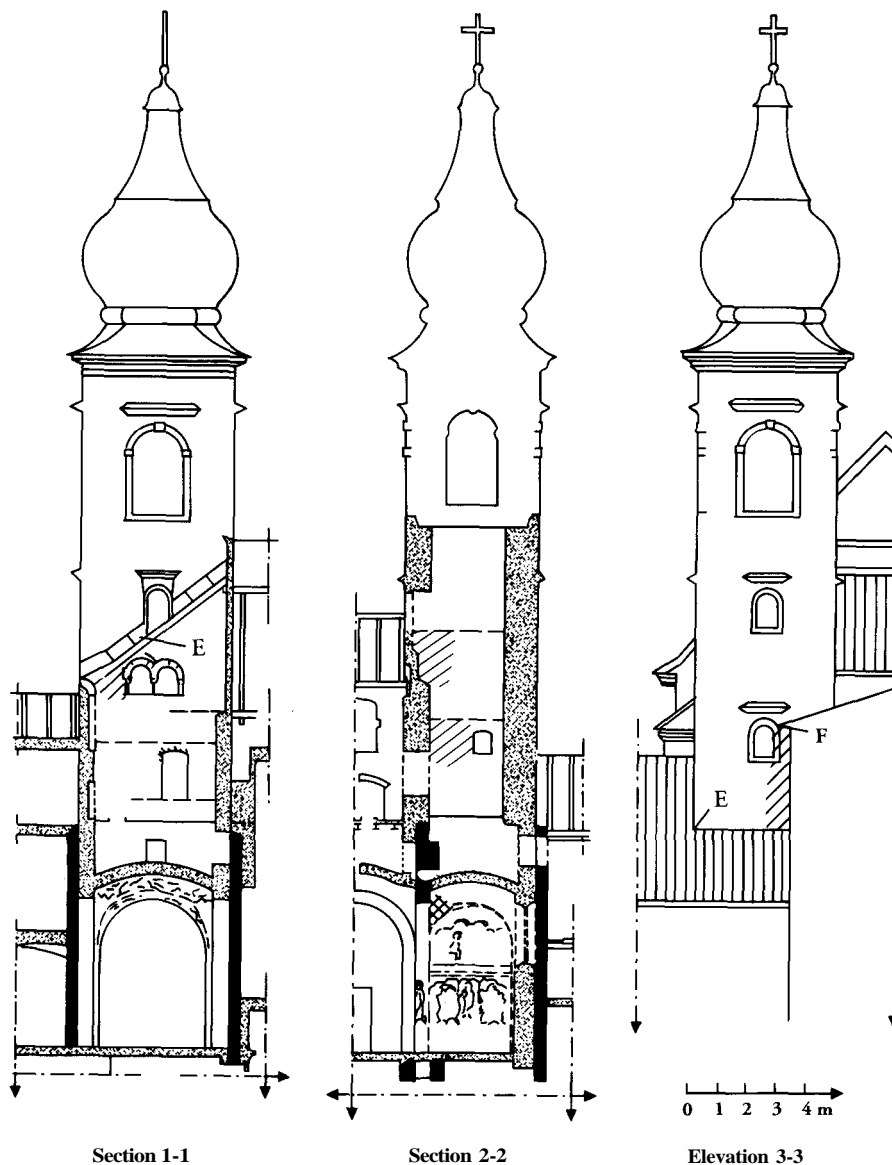
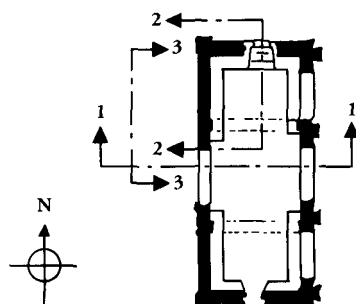

Figure 3. Sections and elevation of the former west choir with the later Baroque towers.

-  A visible moisture damage
-  B algal growth
-  C concrete covering
-  D damaged parts of frescoes

Water infiltration source through:

- E defective roof
- F faulty rain gutter



### Discovery and Previous Interventions

The paintings were discovered in two stages. First, in 1868 those on the vaults were uncovered from beneath several layers of limewash. Treatment at that time included harsh cleaning and repairs done in plaster of Paris. By 1956 the paintings on the vault were covered by veils of salts. These were removed mechanically with Wishab sponges and the surfaces were disinfected with formaldehyde (Waliser 1956). Only then, in 1956, were the remaining paintings on the walls discovered behind the interior buttress walls.

In order to remove the Baroque reinforcement walls and the intermediate floor to reveal the paintings, it was first necessary to shift the weight of the towers. The load was transferred to a steel and reinforced concrete envelope surrounding the original fabric (C in Fig. 3). As a preliminary to these structural measures, the external Romanesque walls were repaired, the cracks and losses filled with a lime-cement mortar, and the walls coated overall with an "isolating" paint (Wibiral 1967:14). In addition, Phonotherm (a material normally used in tunnel construction) was applied in thick sheets to prevent infiltration of liquid cement and to provide thermal insulation.<sup>2</sup>

The condition of the newly revealed paintings varied widely. Although the *intonaco* was badly cracked (Pl. 25) and in many places detached and partly dislocated, in large areas the paint layer survived in excellent condition (Pl. 23). Due to the nature of the architectural joints at the west end, water infiltration was almost inevitable. In the northeast and southeast areas there were carbonate encrustations indicating that the paintings had been damaged before they were covered with limewash in the fifteenth century. From the fifteenth century up to about 1680, three layers of limewash had been applied (Walliser 1959; Wibiral 1967:16). There was some evidence on the south wall that the deterioration process had continued after the construction of the reinforcement walls.

Conservation of the paintings discovered in 1956 was carried out by F. Walliser and others between 1957 and 1966.<sup>3</sup> Deep cracks were filled with a base mortar of lime, cement, and sand, and finished with a lime mortar. To improve adhesion of the *intonaco* to the underlying render more than 1000 liters of calcium caseinate were injected, and casein was also used as an additive for grouting. Once overlying layers of limewash had been removed, cleaning was done primarily with Wishab sponges. Areas of powdering pigments were consolidated with limewater, though unfortunately with the addition of a little PVAC (SINMALON). The final repairs of losses in the paintings were carried out by the conservators with lime mortar, though some large surfaces were plastered by masons with a cement mortar. No retouching was done. The surface was disinfected with formaldehyde.

### *Original Technique*

The original technique of the paintings has been investigated (Kortan 1973), and is obviously relevant both to the processes of deterioration and to the conservation. The Romanesque walls, 80-100 cm thick, are constructed of highly porous and absorbent tuff stone. They are roughly dressed, and, as was usual in the Romanesque period, the covering render was finished in *rasapietra*—fictive ashlar with masonry lines incised into the damp plaster with the point of a trowel. The *intonaco* (average thickness 1.5 cm) was applied in areas corresponding to the pictorial fields; these were set out in red directly on the underlying plaster.<sup>4</sup> The *intonaco* is very "fat," with a calcium carbonate to sand ratio of about 1:1, although it is likely that carbonated calcium hydroxide (*bianco di San Giovanni*) was also used as an aggregate.<sup>5</sup> Despite the unevenness and cracks in the surface, it is clear that it was originally highly polished.

The painting was executed in fresco (Pl. 23), and the use of supplementary limewash grounds was limited to decorative areas. Some of the pigments, such as malachite mixed with green earth, must have been applied *a secco* though no traces of an organic binding medium were found. In any case, by now all the pigments are bound to the *intonaco* in the same way as the original fresco due to the ongoing process of solution and crystallization of the calcium carbonate (*Sinterprozess*).

## *Deterioration and Diagnosis*

Soon after the conservation was concluded in 1966 it was observed that whenever changes of climate occurred condensation and white veils appeared on the west wall, especially at the north end (Walliser 1967). In 1971 surface damage which corresponded to the efflorescences of soluble salts was documented; the principal damage was concentrated on the west wall, though some deterioration processes also became evident on the north and east walls (Kortan and Mairinger 1971a, 1971b). The main damage was the increasing loss of cohesion of the paint layer and surface of the *intonaco*.

From 1972 to 1977 considerable efforts were made to determine the source of the moisture that was transporting the soluble salts to the surface. Walliser (1972) had presumed that the damage was the result of the hygroscopicity of the salts, a view that was strengthened when in the same year it was ascertained that the *intonaco* was damp whereas the wall itself was dry (Wieden 1972; Koller 1973a). Nonetheless, in order to prevent what was presumed to be condensation, dehumidification equipment was installed for two weeks (21 December 1972 to 4 January 1973). This, however, produced negative results (Koller 1973b). Then in 1974 a colloquium of experts decided to implement a program of permanent monitoring of temperature and relative humidity, and to continue measurement of the electrical conductivity of the painted surfaces.<sup>6</sup> In June 1975 electrical heating filaments were installed along the foundations of the walls to inhibit what was supposed to be rising dampness. This was stopped about two years later, however, since no positive result was apparent.

Regular monitoring of electrical conductivity of the *intonaco* was begun in 1972, using a Protimeter Surveymini II. Monitoring was carried out on a 15 cm grid, concentrating particularly on the northern end of the west wall where the deterioration was most severe. In 1974 significant oscillations in the conductivity of the west wall were observed, and from that time it rose steadily to maximum values, where it stabilized (Fig. 6).

Deterioration of the paintings on the west wall accelerated in 1976, corresponding to increases in electrical conductivity. A simultaneous radial spreading both of deterioration and increased conductivity was observed. The rate of loss of the paint layer reached an alarming 20 g per week (Paschinger 1978). The loss of cohesion of the surfaces was so extreme that even weak drafts occasioned by the rapid closing of the door could result in loss (Fig. 4). Local consolidation of particularly endangered areas with synthetic resins somewhat diminished the amount of loss, but did not affect the deterioration process (Koller 1978).

Between 1973 and 1977 a number of measures were taken to modify the building in order to prevent water infiltration, including repair of the roofs and the closing of some windows in the towers (Wibiral 1974; Reichhart 1977). But it was only in 1976 that the main source of infiltration was found: the sewers from adjacent shower rooms and toilets. Despite the reservations of the state conservator, these sanitary facilities had been installed in 1966 at a distance of only 80 cm from the Romanesque wall. As a precaution, an "intervening room" had been constructed between the two. Since no humid spots were visible in the intervening room, it was assumed that it had been functioning effectively.

Figure 4. West wall, north bay, detail of Christ Healing the Man with the Unclean Spirit in the Synagogue at Capernaum, in raking light, showing the condition in 1979.





However, in March 1976 a construction fault was identified under the floor; the intervening room had no vertical insulation, and contaminated water was reaching the Romanesque wall through a small area that was not encased by the surrounding reinforced concrete structure.<sup>7</sup> Because of the concrete envelope, the evaporation surface for the Romanesque wall is identical with the interior painted surface, and therefore the damaging salts were being transported to the painting.

Laboratory analysis of efflorescences of the soluble salts in the areas of painting most severely damaged confirmed that the salts were associated with the sewerage leak. However, this diagnosis was complicated by two factors. Salt efflorescences and powdering of the paint layer also occurred in areas that were not near the sanitary rooms, and no change in electrical conductivity or in the processes of deterioration resulted from the removal of these facilities.

A precise diagnosis of the principal cause of deterioration was finally made only in 1978, when the scientific laboratory of the Bundesdenkmalamt, under H. Paschinger, carried out precise analysis (Paschinger 1978). The starting points for this determination were the following observations:

1. Despite the high electrical conductivity readings for the surface, the wall was dry (measured with a calcium carbide meter in lacunae);
2. The intensity of losses of the paint layer was subject to periodic oscillation, reaching maximum levels in winter.

These phenomena could be explained by the hygroscopicity of the salts—and salt mixtures—concentrated at the surface due to evaporation. Although the hygroscopic behavior of soluble salts was, of course, known, its importance for deterioration had not been adequately recognized in the literature. With hygroscopic salts, the surface is subject to wetting when the relative humidity surpasses the equilibrium for a given salt at a given temperature. Moreover, for mixtures of salts these equilibrium values are not yet known, and are influenced by the substrate (see the contribution to this volume by Arnold and Zehnder). Thus even small variations in relative humidity can lead to cycles of wetting and drying due to solution and crystallization of salts. Differences between surface and ambient temperature can increase this phenomenon.

At Lambach the frescoed room has little ventilation and is not heated. The temperature reaches 20 °C in summer and falls slowly to about 5 °C in winter. The relative humidity of the air oscillates between about 60 and 80%. There was a direct correlation between high levels of electrical conductivity and visible wetting and the areas of salt efflorescence. No thermal condensation was observed. The seasonal variation in the intensity of loss of the paint layer—that is, the increased crystallization of salts in fall and winter—could be explained by the effect of temperature on the solubility of the salts and mixtures of salts. Salts tend more strongly toward crystallization during the colder season. This process was increased by a certain amount of drying of the wall over the summer.

The destruction of wall paintings by soluble salts does not occur as the result of a single cycle of crystallization and increased pressure, but is due

to frequent cycles of crystallization and solution. Moreover, the deterioration process may become independent of the initial sources of salts and moisture, and damage may continue as a result of secondary effects. At Lambach we can presume that the fluctuation between crystallization and solution occurred frequently, possibly several times a day, with visitors in the small room contributing to oscillations in the relative humidity. Seasonal temperature variations probably only influenced this process in one direction at a time. Thus a change in the climate of the room could lead only to a reduction of the rate of loss. Prevention of the total destruction of the wall paintings, however, could only be accomplished either by removing the destructive salts or by detaching the paintings from the wall.

## ***Proposed Treatment***

### ***Detachment***

Severe and accelerating loss of the paint layer led to proposals to detach the most endangered areas of painting (Koller 1975; Enzinger 1976). There were, however, fundamental objections to this. First, the integrity of the relationship between the paintings and their architectural context would have been compromised. Second, there were technical difficulties associated both with the detachment itself and with the durability of artificial supports. In addition, at Lambach the scene of *Christ Healing the Man with the Unclean Spirit in the Synagogue at Capernaum* posed a particular dilemma. Although it was the most deteriorated of the scenes, only about two-thirds of the painting was affected (see Pls. 26-28). Therefore, the alternatives were to either detach sound areas of painting or to cut through the painting in order to selectively detach the endangered areas.

### ***Consolidation and Desalination***

Due in large part to the views of the conservator, Norbert Wibiral, the proposals to detach the paintings were abandoned. Instead, the scientific laboratory and the wall painting section of the Bundesdenkmalamt jointly focused their efforts on finding a suitable method of conserving the paintings in situ. Since it had been determined that the principal cause of damage was the hygroscopic salts, a method of extracting these salts was therefore sought. The objective of the desalination was to substantially reduce the quantity of harmful salts near the surface; the porosity of the *intonaco* would then be sufficient to accommodate crystallization cycles of the remaining salts, rendering them harmless. In order to carry out this treatment three main problems had to be resolved: choice of a material for the consolidation and fixation that was required before desalination; identification of a method for ensuring that the salts remained in solution during treatment; and selection of a suitable material for the poultices to extract the salts.

The choice of a material for consolidation was conditioned by several factors. As with any consolidant, it was important that it had good penetration, and would not reduce the porosity, alter the color, or compromise future treatment. In addition, it was essential that the consolidant would not in any way adhere the salts to the substrate or impede the passage of the liquid water neces-

sary for their extraction. Given these criteria, it was decided that synthetic resins, such as Paraloid B72, were unsuitable. The material selected was methyl silicate (MKSE), a silicon ester developed by an Austrian scientist, Theodor Chvatal.<sup>8</sup> At that time, it had been in use for about ten years in Switzerland and Germany for the treatment of stone, and, to a lesser extent, wall paintings.<sup>9</sup> Tests carried out in 1978 in association with conservation in the subterranean chapel of Saint Virgil in Saint Stephen's Square, Vienna, indicated that methyl silicate had several advantages when compared with the better-known ethyl silicate.<sup>10</sup> A significant disadvantage, however, was the extreme health risk.<sup>11</sup>

The second problem—ensuring that the salts remain in solution—was affected by the use of MKSE, since crystallization of the salts is encouraged by the evaporation of the solvent of the consolidant (in this case, acetone). To overcome this difficulty, the salts were maintained in solution by controlling the relative humidity and temperature of the room. Beginning in November 1978, the climate was maintained at about 20 °C and 80% RH by sealing the windows and providing heating and humidification. In this way, crystallization was inhibited, and in addition the environmental conditions were advantageous for the reaction of the MKSE.

For the determination of a suitable poultice, various tests were conducted. Several materials, including sepiolite, were considered, but the best results were obtained with a cellulose pulp of beech wood, mixed with deionized water and a disinfectant (Thymol, a phenol derivative).

## **Conservation**

Conservation was begun in 1980.<sup>12</sup> Since completion of the previous conservation in 1966, about 15% of the wall paintings—some 30 m<sup>2</sup>—had deteriorated, half of that in imminent danger of loss. Treatment therefore began with the most threatened areas. Due to the powdering and flaking of the paint layer, the initial application of the consolidant was with a small brush, a drop at a time. Subsequent applications were by spray. The consolidant was applied three to four times a day, on each of four days, at two-week intervals. A large quantity—about 8 liters per m<sup>2</sup>—of the consolidant was absorbed by the highly porous tuff stone of the Romanesque wall. In some areas the flaking paint had been dislocated, and although after each application the painted surface was pressed down through an intervention layer of Melinex, some parts retained a certain roughness. To eliminate surface gloss, white cotton sheets impregnated with acetone were gently pressed against the surface, and the results checked with raking light.

When the climate control was unavoidably interrupted for a few days in December 1980, it was clear that climatization was necessary to prevent crystallization. Powdering and flaking recurred, though less severely than previously.

For the desalination, the first poultice was applied two weeks after the consolidation was completed (Fig. 5). The humidification in the room was stopped but the heating was continued so that evaporation—and therefore salt crystallization—could occur only on the surface of the poultice. A further three poultices were applied at approximately two-week intervals. The poul-

Figure 5. Northwest corner. Cellulose poultices applied to extract soluble salts, 1980.

Figures 6, 7, facing page. West wall, north bay. Electrical conductivity measurements carried out before treatment in 1979 (Fig. 6, left) and after salinization in 1981 (Fig. 7, right). The darker the shading, the greater the conductivity.

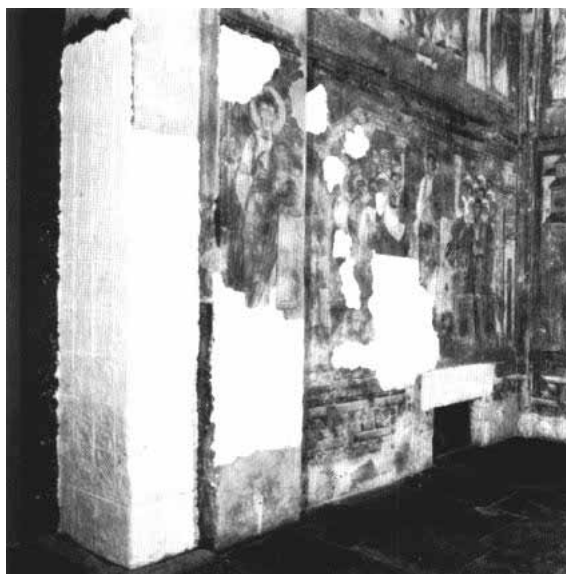

tices were highly effective: up to 1 kg (dry weight) of salt per m<sup>2</sup> was extracted. The first two poultices were easily removed and did not require an intervention layer of Japanese paper. Removal of subsequent poultices, however, became more difficult. Due to the dissolution and swelling of the casein used in the previous conservation, a weak solution of ammonia was required.

After conservation, electrical conductivity measurements were repeated (Fig. 7). These had decreased to zero, except in some small areas where the surface appeared darker. In these areas the adhesion of the *intonaco* to the stone support (examined by percussion) seemed to be better than elsewhere, suggesting greater capillary movement of water and hence a higher quantity of salts. Beginning some years later, these areas were treated locally with poultices each winter. A few months after the conservation was completed, the slight difference in brightness between treated and untreated areas disappeared. This was especially important for the partially treated scene of *Christ Healing the Man with the Unclean Spirit* (Pls. 26-28). Subsequently, no alteration of color or surface bloom was observed.

### ***Follow-up Examination and Treatment***

The paintings were examined at six-month intervals after the treatment, and no negative alterations were observed. In the locally retreated areas, electrical conductivity continued to diminish and differences in brightness became hardly perceptible. In 1983 a follow-up treatment was carried out.<sup>13</sup> Slight remnants of the poultices were removed from the south and west walls, which were cleaned mechanically to remove dirt, traces of casein, and remains of limewash.<sup>14</sup> In the areas that had been most severely damaged, a few loose surface encrustations were found. It appeared that the salt efflorescences that had formed as a result of the treatment had been consolidated by the methyl silicate. The plaster repairs from the previous intervention had darkened due to the consolidation, presumably because of the PVAC additive and the retouching. These were replaced with new repairs intended to imitate the deteriorated surface of the original unpainted



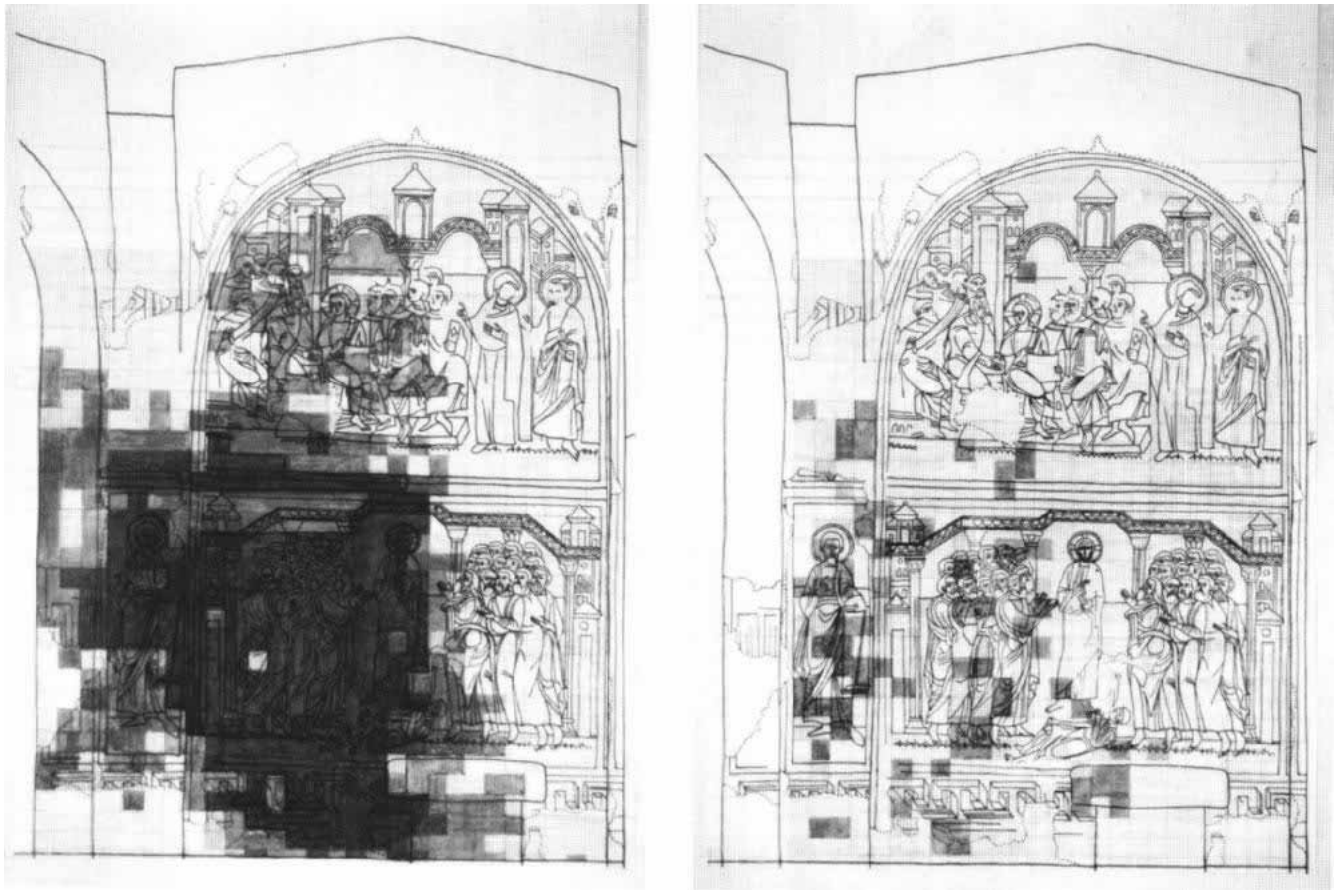

render. For the aggregate, sand similar to the original in grain and color, and carbonated calcium hydroxide (corresponding to the bright lime inclusions of the original) were used. Brick dust was added to adjust the color. A percussion examination carried out during this treatment indicated that the adhesion of the *intonaco* to the support had not been adversely affected by the partial extraction of the casein. Further follow-up treatment of the north and east walls is planned.<sup>15</sup>

## Conclusion

Despite advances in the technical procedures, the detachment of wall paintings remains a controversial method of conservation. The ethical issue has been succinctly stated by Mora, Mora, and Philippot:

... a mural painting is an integral part of the architecture it completes. Therefore, any separation of the painting from its original support constitutes a radical and irreversible alteration of both, and is consequently an extreme measure, which would only be resorted to if an examination of the situation as a whole established without any doubt that the primary causes of alteration could not be eliminated in situ (1984:245).

It is doubtful that in recent decades—at least in Austria—the possibilities for conservation of wall paintings in situ have been adequately considered before resorting to detachment. In some cases, of course, such alternatives may not have been available.<sup>16</sup> An increasing number of paintings detached ten or twenty years ago—often in extremely poor condition—now require a second, or even a third, transfer to a new support. It should be emphasized, however, that this situation is due only in part to lack of training of the conservator.

As early as 1958 Taubert had stressed the need to find alternatives to detachment and to develop methods for conservation in situ, specifically mentioning possibilities "for removal of efflorescences and elimination of their causes" (Taubert 1958; see also Wibiral 1989). In this context, the conservation of the wall paintings at Lambach may be regarded with cautious optimism as an encouraging example, even though losses following the removal of the reinforcement walls are, of course, irreversible. Lambach may demonstrate that methods for preservation in situ can be developed by accurate research into the causes of deterioration through collaboration between conservators and scientists, despite the difficulties in transforming such diagnosis into suitable intervention methods.

## Notes

1. On the paintings and the conservation history, see: Demus 1970: 137-138, 624-627, Pls. 278-287; Wibiral 1966, 1968, 1985; and Hammer 1987, 1987/88a, b, c.
2. The work was carried out under the direction of State Conservator N. Wibiral. The team of experts included: F. Pongratz (Technische Universität, Vienna) and B. Reichhart (Bundesdenkmalamt) for the construction; F. Walliser (freelance) and M. Koller (Bundesdenkmalamt) for the conservation; and H. Kortan (Akademie der bildenden Künste, Vienna) for the painting technique.
3. Results of the conservation were observed by the author in 1983.
4. For the analysis, see Mairinger 1973. On the use of carbonated calcium hydroxide as an aggregate, see the report on the conservation of the wall paintings at the church of Saak-Nötsch (Hammer 1987/88b).
5. This brief summary of the conservation includes the information relevant for the subsequent analysis and treatment discussed below. During conservation, remains of paintings were found in the former crypt, but due to the necessity to preserve the entrance of the church, they could not be retained in situ. They were detached and mounted on new supports and are displayed in the museum adjacent to the frescoed room. On the use of PVAC (SINMALON), see Koller 1973.
6. The group included, among others: P. Mora (ICR/ICCROM, Rome); F. Mairinger and H. Kortan (Akademie der bildenden Künste, Vienna); G. Tripp, N. Wibiral, and M. Koller (Bundesdenkmalamt). Report 27.5.1974, Bundesdenkmalamt no. 4880/74.
7. Grundner 1976. The examination was carried out by a team of experts, see Wibiral 1976.
8. On MKSE (prepolymerized tetramethoxysilane; in German, Methylkieselsäureester), see Chvatal 1974a, and 1974b. In the literature on stone consolidation, the publications of Chvatal have received little attention and have occasionally been misunderstood (Stambolov and van Asperen de Boer 1976). For a more detailed discussion on the selection of consolidants for wall paintings, see Hammer 1987/88c. Chvatal (1974c) had proposed consolidation with MKSE and extraction of soluble salts using the K2R method (with poultices of rice-husk ash). Similarly, in 1977 the author had developed a conservation plan involving consolidation with MKSE and desalination.
9. Previous examples of the use of MKSE on wall paintings include: in 1970 by the W. Hammer workshop, the vaults of the west porch, Münster, Ulm, Germany; and from 1969 forward by the O. Emmenegger workshop in the Graubünden, Switzerland: secu-

lar paintings of ca. 1580, Bärenloch House, Chur; facade and interior paintings of ca. 1320, church, Waltensburg; fourteenth-century paintings on the facade, church, Pitatsch ob Vals; ninth- and seventeenth-century paintings, church, Rodls; paintings of ca. 1320, Magdalen Chapel, Tusch; mid fifteenth-century paintings, church of Saint John, Celerina; paintings of ca. 1230 and ca. 1490, church of Saint Mary, Pontresina; and paintings of the end of the fifteenth century, Chapel of Saint Sebastian, Zuoz. I am grateful to Oscar Emmenegger for sharing with me his considerable experience in consolidation of wall paintings with MKSE.

10. Since, as a rule, silicate without hydrophobic action is identified in the literature with ethylpolysilicate, e.g. Wacker OH, the number of references is very high. See, for example, Lazzarini and Laurenzi Tabasso 1986 and the contributions of M. Laurenzi Tabasso, U. Santamaria, E. de Witte, E. E. Charola, R. P. Sherry, S. M. Bradley, S. Z. Lewin, and G. E. Wheeler in *5th International Congress* 1985.

11. Although breathing apparatus is indicated for both ethyl and methyl silicate, it is particularly important with methyl silicate, and was used at Lambach. Methyl silicate reacts quickly in humid and alkaline conditions. There is a risk of the formation of silicate on the cornea, leading to painful, though possibly temporary, blindness. The danger seems to be due primarily to the rapidly reacting silicate rather than to the methyl alcohol. This was suggested by measurements carried out by the scientific laboratory of the Bundesdenkmalamt during use of MKSE in the chapel of Saint Virgil.

12. The conservation was undertaken by the Department of Conservation (M. Koller, Head of Department) in collaboration with the Scientific Laboratory (H. Paschinger) of the Bundesdenkmalamt, and carried out by I. Hammer, J. Rutherford, H. Höfler, and J. Grundner.

13. Conservation was carried out by I. Hammer, H. Schwaha, C. Serentschy, A. Hochgatterer, C. and M. Podgorschek, and H. Höfler.

14. Mechanical cleaning was done with Wishab sponges, scalpels, fiberglass brushes, and in part with air abrasive using alumina powder.

15. Tests to remove the thick carbonate crusts on the north wall (*Baptism of Christ*) indicated that the legibility could be improved.

16. See, for example, Koller 1987. Treatment of sulfation with barium (see the contribution in this volume by Matteini) was not known in Austria before 1982.

## References

### Chvatal, Theodor

- 1974a "Die Festigung von Stein. Chemische Grundlagen und praktische Erfahrungen mit Kieselsäureestern." *Arbeitsblätter für Restauratoren* 1:40-51.
- 1974b "Vergleichende Untersuchung der wichtigsten modernen Steinkonservierungsmittel." *Maltechnik/Restauro* 80:87-97.
- 1974c Bundesdenkmalamt no. 4991/74, May 20.
- 1979 "Erfahrungen mit den Natriumsulphat-Testen bei verschiedenen Steinarten und Konservierungsmitteln." *Restauratorenblätter* 3:206-217.

### Demus, Otto

- 1970 *Romanesque Mural Painting*. London: Thames and Hudson.

### Enzinger, S.

- 1976 Bundesdenkmalamt no. 3879/76, 4 December.

*5th International Congress on Deterioration and Conservation of Stone, Lausanne  
25-27 September 1985*

1985 G. Felix and V. Furlan, eds. Lausanne.

**Grundner, J.**

1976 Bundesdenkmalamt no. 2867/76, March 3.

**Hammer, Ivo**

1987 "Chronologie der Konservierung der romanischen Wandmalereien um 1080 im ehemaligen Läuhaus der Stiftskirche Lambach/OÖ." *Konservieren/Restaurieren. Mitteilungen des Österreichischen Restauratorenverbandes* 1:61-66.

1987/88a "Zur in situ-Konservierung der romanischen Wandmalereien der Stiftskirche Lambach." *Restauratorenblätter* 9:89-97.

1987/88b "Nachfreilegung und Restaurierung der Wandmalereien an der Südfassade der Pfarrkirche Saak." *Restauratorenblätter* 9:139-147.

1987/88c "Organisch oder Anorganisch? Probleme der Konsolidierung und Fixierung von Wandmalerei." *Restauratorenblätter* 9:59-72.

**Koller, Manfred**

1973a Bundesdenkmalamt no. 5130/73, July 4.

1973b Bundesdenkmalamt no. 7198/73. September 24.

1975 Bundesdenkmalamt no. 2201/75.

1978 Bundesdenkmalamt no. 6023/78, June 13.

1987 "Zur Problematik der Übertragung von Wandmalereien." *Maltechnik/Restauro* 93:17-22.

**Kortan, H.**

1973 "Zur Untersuchung der Maltechnik an den romanischen Fresken im Läuhaus der Stiftskirche zu Lambach." *Festschrift Otto R. v. Lutterotti zum 14. Januar 1974*. Innsbruck. 235-250.

**Kortan, H., and F. Mairinger**

1971a Bundesdenkmalamt no. 1024/71, May 24-25.

1971b Bundesdenkmalamt no. 6626/71, June 2.

**Lazzarini, Lorenzo, and Marisa Laurenzi Tabasso**

1986 *Il restauro della pietra*. Padua.

**Mairinger, F.**

1973 Bundesdenkmalamt no. 2771/73, March 27.

**Mora, Paolo, Laura Mora, and Paul Philippot**

1984 *Conservation of Wall Paintings*. London: Butterworths.

**Paschinger, H.**

1978 Bundesdenkmalamt nos. 5862/78; 7848/78, July 2.

**Reichhart, B.**

1977 Bundesdenkmalamt no. 1285/77, January 26.

**Schaible, V.**

- 1985 "Historisches und Ethisches zur Abnahme von Wandmalereien."  
*Historische Technologie und Konservierung von Wandmalerei*. Bern: Schule für Gestaltung. 143-150.

**Stambolov, T., and J. R. J. van Asperen de Boer**

- 1976 *The Deterioration and Conservation of Porous Building Materials in Monuments: A Review of the Literature*. Rome: ICCROM.

**Taubert, J.**

- 1958 "Restaurierprobleme alter Wandmalereien." *Maltechnik* 64:102-104.

**Tripp, G., Norbert Wibiral, and Manfred Koller**

- 1974 Bundesdenkmalamt no. 4880/74, May 27.

**Walliser, F.**

- 1956 Bundesdenkmalamt no. LK1217/56, June 4-22.  
1959 Bundesdenkmalamt no. 3141/59, February 24.  
1967 Bundesdenkmalamt no. 1735/67, November 5.  
1972 Bundesdenkmalamt no. 3453/72, April 30.

**Wibiral, Norbert**

- 1966 "Die Arbeiten im alten Westchor von Lambach, 1956-1966." *Kunstchronik* 19:113-122.  
1967 "Le dégagement des peintures murales du XI<sup>e</sup> siècle dans l'ancien chœur occidental de l'église abbatiale de Lambach (Autriche)." *Monumentum* 1967.  
1968 "Die Wandmalereien des 11. Jahrhunderts im ehemaligen Westchor der Stiftskirche von Lambach." *Alte und moderne Kunst* 99:2-13.  
1974 Bundesdenkmalamt no. 1035/74.  
1976 Bundesdenkmalamt no. 2726/76.  
1985 "Zum Bildprogramm der frühromanischen Wandmalereien in Lambach." *Kirche in Oberösterreich: 200 Jahre Bistum Linz*. Exhibition catalog. Nos.85-89; pp.360-370.  
1989 "Frühe Bauten und Bilder in Lambach." *900 Jahre Klosterkirche Lambach*. Exhibition catalog. Linz. 33-42; 160-187.

**Wieden**

- 1972 Bundesdenkmalamt no. 3810/72, May 5.





# The Frescoes of Michelangelo on the Vault of the Sistine Chapel: Conservation Methodology, Problems, and Results

*Fabrizio Mancinelli*

Conservation of the frescoes by Michelangelo was begun in June-July 1980. Treatment of the lunettes and of the fifteenth-century series of popes below them was finished in November 1984 and conservation of the vault itself was completed in the autumn of 1990. Apart from the obvious need to reestablish the overall chromatic and tonal equilibrium of the chapel following the 1964-75 cleaning of the fifteenth-century cycle of the Lives of Moses and Christ on the chapel walls (Mancinelli 1977:122, 124, 129, 134, 137), from a technical point of view it was the discovery of widespread flaking that led to the decision in the summer of 1980 to undertake the cleaning. The layers of animal glue covering Michelangelo's frescoes were causing flaking of varying degrees of severity across the entire painted surface (Fig. 1). That this glue did not form part of Michelangelo's painting but was applied after a period of time—presumably during treatment by Mazzuoli in the eighteenth century<sup>1</sup>—was established by the fact that there was a layer of dirt between the paint layers and the glue (Pl. 29), and likewise that the extensive formations of carbonates and sulfates (Fig. 2), caused by periodic infiltration of rainwater since the sixteenth century,<sup>2</sup> occurred above the paint layer but below the glue. The discovery of the flaking made the removal of the glue both necessary and urgent, even though initial tests showed unequivocally that such cleaning would lead to a radical revision of the prevailing understanding of Michelangelo as a painter.

*Figure 1, below left. Michelangelo, Sistine Chapel ceiling, 1508-12. Detail of the ignudo to the left of the Cumaean Sibyl, before conservation, showing the flaking caused by the contraction of the glue.*

*Figure 2, below right. Detail of the hand of the pregnant woman in the Roboam lunette after removal of the glue layer, showing the salt efflorescences (carbonates).*



Figure 3. View of the mobile scaffolding used for the conservation, with the access tower shown at right.



To anticipate and, to a certain extent, to help shape the reactions that would inevitably result from this change, it was decided to implement a comprehensive information campaign at all levels: by using scaffolding that concealed only a part of the vault, allowing the public to follow the progress of conservation (Fig. 3); by providing access to the scaffolding for conservation specialists and scholars studying Michelangelo and the Renaissance, thus ensuring a continuous, independent surveillance of the work; by reporting on the conservation program as it progressed in articles, scholarly studies, and seminars and conferences both in Italy and abroad; and, finally, by holding periodic press conferences intended to report as widely as possible on the intentions, problems, and results of the project.<sup>3</sup>

A particular problem, and one for which no satisfactory solution was found, was that of color photographic documentation of the frescoes before, during, and after cleaning and, above all, reproduction of this material in print. Color photography of the ceiling requires a far stronger light than the paintings receive under ordinary viewing conditions and far stronger still than that available at the time they were executed. Since a photographic lens is much sharper and more penetrating than the human eye, and since a camera is essentially unable to balance the amount of light absorbed by different surfaces, the result is inevitably the following: photographs taken before cleaning do not reflect the actual condition of the ceiling but rather an intermediate stage between the uncleaned and cleaned states of the paintings; photographs taken after cleaning often lack those subtle tonal passages characteristic of Michelangelo's technique, nullified by the excessive light that tends to flatten the image against the background; finally, in photographs taken during treatment, cleaned and uncleaned areas are generally out of balance due to the impossibility of adjusting the lens aperture such that it would be suitable for both areas at once. Even though it may be possible to correct these problems to a certain degree at the time the photo-

graphs are taken, it is virtually impossible to guarantee an optimum result when a color transparency is entrusted to a publisher for printing, above all in the non-specialized journals on which the general public depends for information.

Regarding the conservation, apart from the selection of a cleaning agent—necessarily a nonexperimental product<sup>4</sup>—the problem was to decide on the optimum level of cleaning. Cleaning of the Sistine Chapel frescoes for the first time since Mazzuoli's intervention of 1710-12 began in 1964 with the cycles of the lives of Moses and Christ on the chapel walls. In the absence of any certain knowledge of the technique employed by Michelangelo for the vault and the Last Judgment, and anticipating the uproar that cleaning would—and did—cause, Deoclecio Redig de Campos, later Director of the Vatican Museums, decided at that time to thin the thick brownish layer that veiled the fresco surfaces, the effects of which had led to the installation of electric lighting in 1950. Thus the cleaning carried out on the walls was both partial and selective: the restorers intervened more decisively in the lighter parts but only cautiously thinned the dirt layer in the darker ones, balancing the various areas during the retouching phase. The necessarily subjective character of this approach explains the differences in levels of cleaning apparent among the various scenes of the *quattrocento* cycle. From the very first cleaning tests carried out on the Eleazar lunette in 1980, however, it was clear that the criteria adopted for the cleaning of the walls could not be applied to the lunettes and vault painted by Michelangelo.

The technique employed by Michelangelo in these zones is the same as that of his predecessors, and explains the essential chromatic and tonal identity of the upper and lower zones of the chapel. It was the *buonfresco* technique that, with the normal limitations, was used by his contemporaries and that was codified in the treatises of Cennino (1913) and Vasari (1966), and, though somewhat later and outside the Tuscan tradition, also of Armenini (1988).

Passages carried out *a secco* are extremely restricted and relate primarily to the constraints of the medium. They are virtually absent in the lunettes and in the vault are limited to the gilded *tondi* and a few *pentimenti*. Michelangelo's palette is also typical for a fresco painter: for the whites, *bianco San Giovanni* (lime white); for the reds, red ochers and *morellone*; for the yellow, Mars yellow and yellow ochers of various tonalities; for the browns, Mars brown, raw umber and burnt sienna; for the greens, *terra verde*; and for the blues, lapis lazuli (on the draperies) and smalt (for the skies in the Genesis scenes).<sup>5</sup>

Having to work in the darkest parts of the chapel—the lunettes and vaults—Michelangelo adopted a type of handling of the paint which, though special, was well known to his contemporaries. Also in the Vatican at the same period we find Perugino using this technique on the vault of the Stanza dell'Incendio. It results in a highly luminous painting intended to overcome the gloom of the shadows and to ensure maximum legibility of the images under all weather conditions. The color, generally very liquid, was applied much like watercolor, in successive translucent washes that reveal the underlying colors. By contrast in areas of flesh painting, particularly on the vault, the color was applied densely but then thinned by being drawn across the surface.

Figure 4, facing page, above. The Temptation and Expulsion. Graphic documentation of damage to the support.

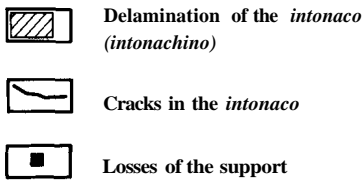
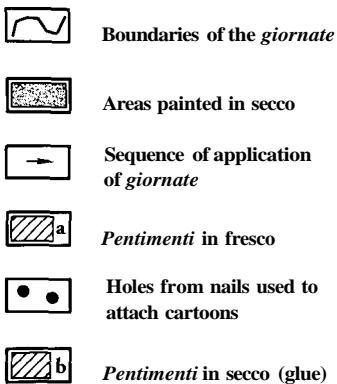

Figure 5, facing page, below. As in Fig. 4, showing original technique.



Given this technique of painting, if the brownish veil of extraneous material exceeds certain levels—necessarily minimal—the effect is a radical modification of the values of the lightest tones and half-tones, with a consequent flattening of the image against the background. Thus the level of the current cleaning was not determined by subjective criteria, but rather by the goal of complete recovery of the chromatic passages intended by Michelangelo.

This decision, in a sense obligatory, was favored on the one hand by the very limited extent of painting *a secco* (where alteration of the binding medium could have created problems), and on the other by the extraordinary state of conservation of the frescoes which have come down to us virtually undamaged despite restorations of the past centuries and deterioration caused by infiltration of rainwater. Since the present intervention was conceived fundamentally as conservation rather than restoration, damage such as alteration caused by silicates was left visible, and retouching, carried out exclusively in watercolor, was limited essentially to the lacunae.

Every conservation program, over and above the obvious treatment objectives, is at the same time a unique, unrepeatable opportunity to study the structure of the work of art: those elements which may in great part explain its nature, genesis, chronology, and so on. As in an archaeological excavation, the opportunities for documentation and research are indissolubly tied to the moment of intervention; once this moment is past, especially in a case such as the Sistine ceiling situated some 20 m above floor level, the possibilities of investigating in *corpore vivo* become extremely problematic. This is why at the Vatican, as in the rest of Italy, responsibility for the overall coordination of conservation programs is entrusted to an art historian.<sup>6</sup>

Particular care was thus given to documentation before, during, and after cleaning. Photographic documentation in the case of the Sistine Chapel comprised images executed with normal indirect light, raking light, ultraviolet (Pl. 30), and infrared. Since the area concerned is some 1,200 m<sup>2</sup>, this documentation was one of the most demanding aspects of the entire program. An idea of the scale of the task is provided by the statistic that by the summer of 1987 approximately 9,000 photographs in color and black and white had been taken.

From the outset of the program all data relating to the state of conservation of the frescoes, to Michelangelo's painting technique, and to the photographic documentation were recorded on summary graphic tables. From February 1987 this information was input directly on a computer equipped with a color monitor and plotter and installed on the scaffolding. A 72 megabyte memory capacity for this data bank allowed recording of all types of information on the paintings during the cleaning phase. A graphic display of any given area with all relevant data could be called to the screen, and by means of the plotter printed in hard copy.

Essential data on the altimetric profile of the vault, on the contours of the figures, and on all the related measurements was collected during a photogrammetric campaign begun in November 1985. This will also allow future monitoring of the static conditions of the chapel vault. A software program was

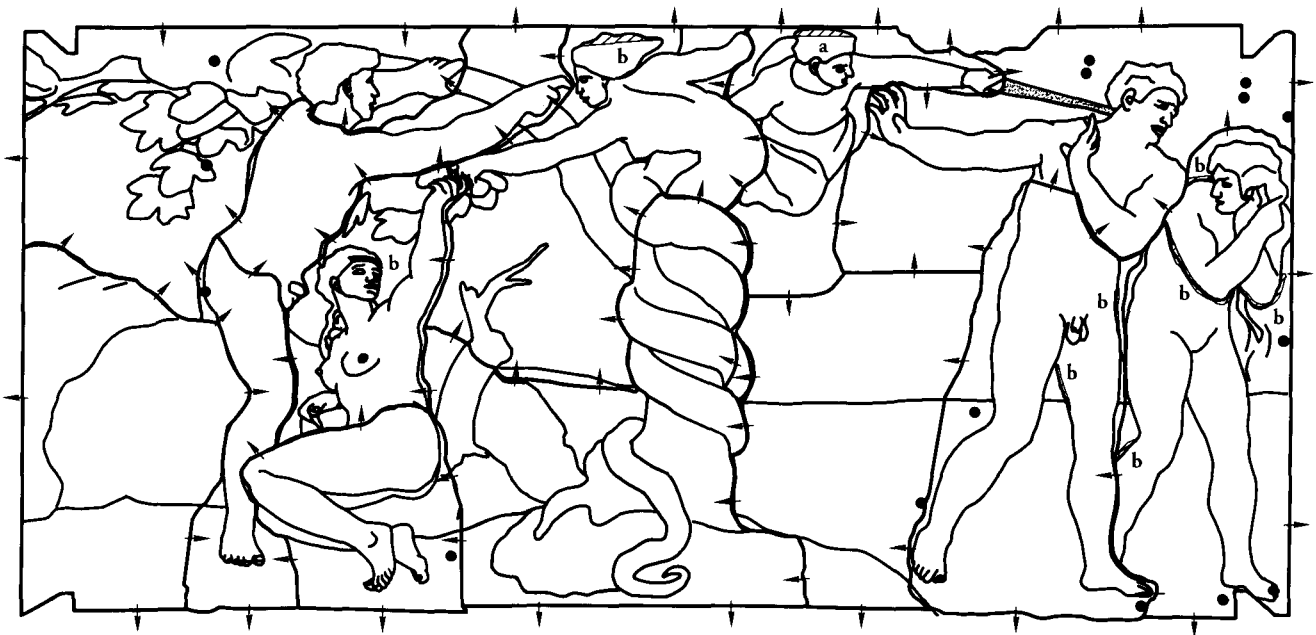
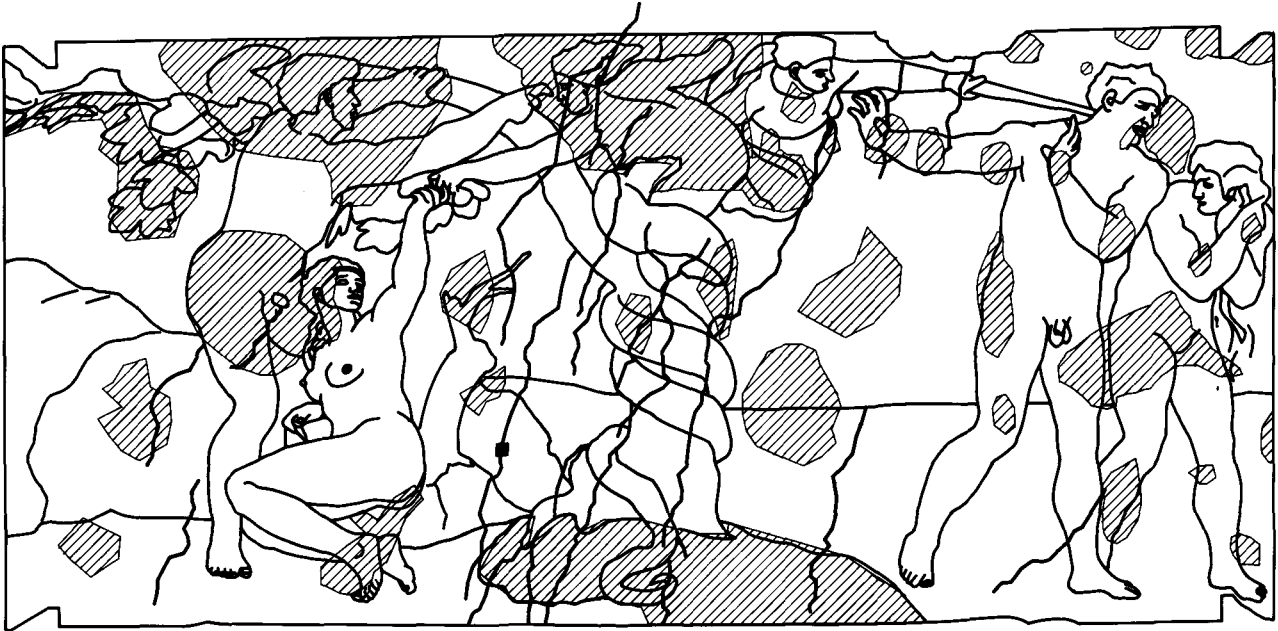

then designed which allows recording on graphic displays corresponding to Michelangelo's cartoons not only of all the measurements already in memory but also the following information:

1. data on the state of conservation, including:
  - damage to the support (wall structure, *intonaco*, etc.; Fig. 4)
  - damage to the paint layer
  - extraneous substances present on the painted surface (glues, gums, dust, soot, etc.)
  - evidence of previous restorations
2. data on Michelangelo's technique, including:
  - *giornate* (Fig. 5)
  - methods of transfer of cartoons (pouncing, incisions, etc.)
  - techniques of execution (*pentimenti*, areas painted *a secco*, etc.; Fig. 5)





Figure 6, top. Detail of one of the scaffolding holes used by Michelangelo at the base of the Asa lunette. Note the drips of paint from above on the arriccio.

Figure 7, above. Detail of the wife of Noah (by an assistant of Michelangelo) in *The Sacrifice*, after cleaning.

Other information included:

3. location of samples taken for analysis and stratigraphic sections
4. data on the analysis of original and extraneous materials
5. references to archival documentation
6. bibliographical data

In order to gain a better understanding of Michelangelo's technique certain strategies were consciously adopted to correspond as closely as possible to Michelangelo's own. Scaffolding was installed in the same holes he used so that the platform would correspond, *mutatis mutandis*, to a small section of the area on which he had worked (Fig. 6).<sup>7</sup> Cleaning was begun where the sources tell us that Michelangelo began to paint (Vasari 1987:6:37). Even though it may have been coincidence that cleaning commenced in the Eleazar lunette—in all probability the first executed by Michelangelo—the decision was taken quite deliberately to begin the vault from the entrance wall, where the sequence of *giornate* has now confirmed Biagetti's statement that *The Flood* was the first part painted by the artist (Biagetti 1936).

Following is a brief and necessarily incomplete discussion of the results of the conservation. First, and most importantly, the cleaning has led to the rediscovery of Michelangelo's color (Pls. 31, 32): a comprehension virtually lost—certainly from the eighteenth century forward—due to the alteration of the glue layers and the ever-increasing interventions of retouching; a color which proclaims a clearly Tuscan origin and explains the extremely early impact of Michelangelo's color on artists such as Rosso Fiorentino, Pontormo, Andrea del Sarto, and Beccafumi. The other element which emerged is his technical mastery of the medium, a mastery which is not adequately explained by the initial presence of Granacci, Bugiardini, and the other painters summoned from Florence, but which appears to be due at least in part to his youthful apprenticeship in the Ghirlandaio workshop.

The role of the assistants—the majority of whom, significantly, were from the same workshop—was not restricted however to secondary areas but also included contributions to the first three scenes: *The Flood*, *The Sacrifice* (Fig. 7) and *The Drunkenness of Noah*. Variations in technique in these scenes (particularly in *The Flood*), a general timidity of execution, a sense of contour as limit (Fig. 7) are unthinkable in Michelangelo and are entirely absent in the indisputably autograph figures such as the prophets and sibyls (Pl. 36; Fig. 8), the *ignudi* (Pl. 37), and ancestors of Christ. Likewise there is no evidence of work by assistants in *The Temptation and Expulsion* (Pl. 33), and in all probability they were not employed thereafter. This may have been due to the increase in scale of the figures and perhaps also as an economy measure.

It is again the Ghirlandaio workshop that provides the source for the rapid and sketchy execution of the lunettes (Fig. 9);<sup>8</sup> a significant precedent is the upper register of the fresco cycle in the Tornabuoni Chapel in Santa Maria Novella. There, taking account of both the distance from the spectator and the steep viewpoint, the brushwork becomes more summary and hurried as the height increases. At Santa Maria Novella, however, these parts were entrusted

*Figure 8, right. Detail of the Delphic Sibyl, after cleaning.*

*Figure 9, below right. Detail of a male figure in the Azor-Sadoch lunette, after cleaning.*



to assistants who worked from the master's simplified cartoons, whereas in the Sistine the absence of preparatory cartoons and the size of the *giornate* in the lunettes testify that they are indeed autograph.

It is these technical considerations and not notions of chronological or stylistic order that determine the differences between the lunettes and the vault above. By the same token, the fact that the form of the central inscription panel and the scheme of the *giornate* in the lunettes change exactly at the center of the chapel indicate that in these areas Michelangelo's work was interrupted, just as in the vault, by the departure of Pope Julius II for Bologna in 1510.

Michelangelo has emerged through this cleaning as an artist perfectly integrated with the technical traditions of his period and, what is more, the numerous radical *pentimenti* of the vault reveal a technical mastery that allowed him to prolong the creative moment far beyond the phase of preparation of the cartoon, well into the execution of the fresco itself.

## Notes

- 
1. On the restoration by Mazzuoli in 1710-12, see Cicerchia and De Strobel 1986:148-152.
  2. The first indications of the appearance of salts are contained in a letter of 1547 from Giovio to Vasari, where they are referred to generically as "salnitro" (Frey 1923:198).
  3. On the problems, methods of intervention, and results, those responsible for the conservation have published the following studies (listed in chronological order): Pietrangeli 1982; Mancinelli 1982; Colalucci and Mancinelli 1983; Mancinelli 1983a; Mancinelli 1983b; Mancinelli and Colalucci 1985; Mancinelli 1986a; Colalucci 1986a; Mancinelli 1986b; Colalucci 1986b; Mancinelli, Colalucci and Gabrielli 1987; Gabrielli 1987; and Rotondi 1987. In addition, Weil-Garris Brandt 1987 is a particularly comprehensive discussion of the problems relating to the cleaning.
  4. The method used, with some variations, has been published in Mora and Mora 1972 and 1974, and Mora, Mora, and Philippot 1977. For details on the cleaning, see the contribution by Colalucci in this volume.
  5. On Michelangelo's palette, see Gabrielli 1987:157. Red lead, notoriously unsuitable for fresco, occurs only in the first zones executed by Michelangelo, when the technique employed still presented some uncertainties. It is found in *The Flood*, but not in the succeeding scenes.
  6. The treatment was carried out by the chief restorer of the Vatican Museums, Gianluigi Colalucci, assisted by Maurizio Rossi, Piergiorgio Bonetti, and Bruno Baratti. Research and laboratory analysis was undertaken by the Gabinetto Ricerche Scientifiche of the Vatican Museums under the direction of Nazzareno Gabrielli, assisted by Luigi Gandini, Giorgio Barnia, and Fabio Morresi. The photographic documentation was done by Felice Bono, Danilo Pivato and Pietro Zigrossi. A film of all phases of the cleaning was made by Nippon Television Network, and all illustrations of the Sistine Chapel reproduced here are courtesy of them and of the Vatican Museums. The conservation was carried out under the supervision of Professor Carlo Pietrangeli, Director General of the Vatican Museums, and the Consultant for the Restoration, the late Professor Pasquale Rotondi, former director of the Istituto Centrale per il Restauro, Rome.
  7. On Michelangelo's scaffolding, see Mancinelli 1982:9-15. Diverse opinions have been expressed in Hartt 1982 and Gilbert 1980.

8. For the most thorough examination of Ghirlandaio's working methods, see Rosenauer 1986.

## References

### Armenini, G.B.

1988 *De' veriprecetti dellapittura*. M. Gorreri, ed. Turin. First edition, Ravenna 1587.

### Biagetti, B.

1936 "La volta della Cappella Sistina." *Rendiconti della Pontificia Accademia* 12:212-220.

### Cennino Cennini

1913 *Il libro dell'arte*. Simi Renzo, ed. Lanciano.

### Cicerchia, E., and Anna Maria De Strobel

1986 "Documenti inediti dell'Archivio Segreto Vaticano sui restauri delle Stanze di Raffaello e della Cappella Sistina nel Settecento." *Monumenti, Musei e Gallerie Pontificie. Bollettino* 6:105-152.

### Colalucci, Gianluigi

1986a "Tecniche di restauro." In *La Cappella Sistina. I primi restauri: la scoperta del colore*. Novara. 260-267.

1986b "Le lunette di Michelangelo nella Cappella Sistina." In *Tecnica e stile: esempi di pittura murale del Rinascimento Italiano*. Eve Borsook and Fiorella Superbi, eds. Florence. 76-81.

### Colalucci, Gianluigi, and Fabrizio Mancinelli

1983 "Michelangelo Buonarroti: le lunette con Eleazar-Mathan, Jacob-Joseph, Achim-Eliud, Azor-Sadoc, Josias-Jeconias-Salathiel." *Monumenti, Musei e Gallerie Pontificie. Bollettino* 4:143-160.

### Frey, Karl, ed.

1923 *Der literarische Nachlaß Giorgio Vasaris*. Munich: G. Müller.

### Gabrielli, Nazzareno

1987 "Aspetti scientifici nel restauro degli affreschi di Michelangelo nella Cappella Sistina." *Monumenti, Musei e Gallerie Pontificie. Bollettino* 7:151-162.

### Gilbert, Creighton

1980 "On the absolute dates of the parts of the Sistine Chapel ceiling." *Art History* 3(2):158-181.

### Hartt, Frederick

1982 "The Evidence for the Scaffolding of the Sistine Chapel." *Art History* 5(3):273-286.

### Mancinelli, Fabrizio

1977 "Arte medioevale e moderna. Restauri: pitture murali." *Monumenti, Musei e Gallerie Pontificie. Bollettino* 1:112-139.

1982 "Il ponte di Michelangelo per la Cappella Sistina." *Rassegna dell'Accademia di San Luca* 1/2:2-6.

1983a "Die Restaurierung der Lünettenbilder Michelangelos in der Sixtinischen Kapelle." *Kunstchronik* 36(3):121-125.

- 1983b "The Technique of Michelangelo as a Painter: A Note on the Cleaning of the First Lunettes in the Sistine Chapel." *Apollo* 117(225):362-367.
- 1986a "Michelangelo all'opera: tecnica e colore." In *La Cappella Sistina. I primi restauri: la scoperta del colore*. Novara. 218-259.
- 1986b "Michelangelo a nuovo." *Atlante* October:64-85.

**Mancinelli, Fabrizio, and Gianluigi Colalucci**

- 1985 "Vero colore di Michelangelo: le lunette della Cappella Sistina." *Critica d'Arte* 50(6):72-87.

**Mancinelli, Fabrizio, Gianluigi Colalucci, and Nazzareno Gabrielli**

- 1987 "Il restauro della Cappella Sistina." In *Scienza e Tecnica. Annuario di aggiornamento della Enciclopedia della Scienza e della Tecnica*. Milan. 339-350.

**Mora, Paolo, and Laura Mora**

- 1972 "Metodo per rimozione di incrostazioni calcaree e dipinti murali." In *Atti della commissione per lo sviluppo tecnologico della conservazione dei Beni Culturali*. Rome.
- 1974 "Metodo per la rimozione di incrostazioni su pietre calcaree e su dipinti murali." In *Problemi di conservazione*. G. Urbani, ed. Bologna. 339-344.

**Mora, Paolo, Laura Mora, and Paul Philippot**

- 1977 *La conservation des peintures murales*. Bologna.

**Pietrangeli, Carlo**

- 1982 "I recenti restauri nella Cappella Sistina." *Rassegna dell'Accademia di San Luca* 1/2:9-15.

**Rosenauer, Artur**

- 1986 "Domenico Ghirlandaio e bottega: organizzazione del lavoro per il ciclo di affreschi di S. Maria Novella." In *Tecnica e stile: esempi di pittura murale del Rinascimento Italiano*. E. Borsook and F. Superbi, eds. Florence. 25-30.

**Rotondi, Pasquale**

- 1987 "La grande luce di Michelangelo nella volta della Cappella Sistina." *Arte Cristiana* 75(721):263-270.

**Vasari, Giorgio**

- 1966 *Le vite de' più eccellenti pittori, scultori e architetti, nelle redazioni del 1550 e 1568*. Rosanna Bettarini and Paola Barocchi, eds. Vol 1. Florence.

**Weil-Garris Brandt, Kathleen**

- 1987 "Twenty-five Questions about Michelangelo's Sistine Ceiling." *Apollo* 126(310):392-400.

**Biography**

Dr. Fabrizio Mancinelli graduated from the Università degli Studi in Milan, with a specialization in art history. Since 1972, he has served as Curator for the Department of Byzantine, Medieval, and Modern Art of the Monumenti, Musei e Gallerie Pontificie. His responsibilities encompass supervision of conservation programs, including that of the Sistine Chapel. He is the author of numerous essays on the Middle Ages and the Renaissance.

# The Frescoes of Michelangelo on the Vault of the Sistine Chapel: Original Technique and Conservation

Gianluigi Colalucci

Both the preliminary studies and those carried out concurrently with the conservation of Michelangelo's frescoes of the Sistine Chapel ceiling clarified and defined in detail the technique of execution,<sup>1</sup> clearing the field of old prejudices and fanciful hypotheses that, because they are deeply rooted, still find credit in reactionary and misinformed circles. A decade of familiarity with Michelangelo's painting allows us to reject decisively the image of a clumsy and bungling fresco painter, constrained by inner torment and lack of skill to continually refine what he had already painted, correcting or modifying line, color and modeling with painting *a secco*, with smears of glue, or with puffs of black, sooty pigments—an image so dear to the romantic supporters of Michelangelo's dark melancholy. The removal of the layers of extraneous substances from the frescoed surface has revealed, on the contrary, the image of a painter with a skilled hand and a crystal-clear mind who still has the power to disturb the onlooker.

## Original Technique

The *intonaco* and the *arriccio* are composed of lime and pozzolana, in accordance with the practice still current in Rome. The very thin *arriccio* (average thickness 1 cm) is only present in the lunettes, whereas on the vault there is at most a simple leveling out of the irregularities. The average thickness of the *intonaco* is 5 mm, with the maximum depth for the architectural elements. In the lunettes the *giornate* are extremely large (up to 5.3 m<sup>2</sup>), whereas on the vault they are of normal size relative to the dimensions of those frescoes.

Michelangelo restricted his palette to pigments rigorously suited to use in fresco, such as iron oxides, clayey silicates, iron silicates, aluminum silicates, and carbonated calcium hydroxide (Gabielli 1987). He very rarely made use of pigments applied *a secco* (tempered with an organic binder rather than with water only as is done in fresco painting), because this technique used on a wall lacks both durability and virtuosity. For this reason, the *pentimenti a secco* are very limited in number and size. Whenever possible, Michelangelo carried out his *pentimenti* in fresco or in *mezzofresco*, taking full advantage of the still slightly damp *intonaco*.

We know that it was common practice for many painters to make use of colors—blues, certain greens and reds—which have to be applied *a secco* because of their sensitivity to the aggressivity of lime, but Michelangelo excluded these from his palette. Even blue was applied in fresco using ultramarine (lapis



lazuli) or smalt, demonstrating that he considered that to resort to painting *a secco* was to diminish the quality of the fresco. This notion was expressed decisively in the sixteenth century by both Vasari and Armenini.<sup>2</sup> Cennino, on the contrary, writing at the end of the fourteenth century, discussed painting *a secco* only in terms of the unsuitability of some pigments for painting in fresco (Cennino 1913:62). At that time it was typical for mural painters to use pigments in tempera over base colors applied in fresco; the resulting poor state of conservation of these paintings is well known. It is only for gilding that the use of an adhesive or mordant is unavoidable, and the gilding of the Sistine is no exception. Here it was applied with an adhesive over a preparation in red ocher carried out in fresco. In the medallions, the figures were modeled largely by means of highlighting in gold and shading in black applied with tempera, reminiscent of the lines made by an engraver's burin (Fig. 1).

Michelangelo always used pure color, preferring to reach the desired hue by means of thin, superimposed pigment layers, rather than by resorting to mixtures of pigments or to thick impasto. The resulting colors are luminous and fresh, as translucent and precious as those of a watercolor (see Pl. 34 and Fig. 2). The colors were almost always applied directly onto the light *intonaco*; however for some colors—for certain yellows and reds—as required by the rule, Michelangelo laid in a base of *bianco San Giovanni*.

The character of Michelangelo's brushstroke contributes remarkably to the image. The motion is quick and sure, caressing and building the forms through modeling, thereby creating effects similar to those of *gradine*, marks on the surface of worked marble (Pl. 35).

The extremely limited number of *pentimenti* indicates careful planning and meticulous preparation for the work by means of cartoons—used for the ceiling but not for the lunettes. In the first half of the ceiling, Michelangelo

Figure 1. Detail of the medallion above the Erythrean Sibyl, after cleaning, showing hatched modeling in gold and black.

Figure 2. Male figure in the Asa lunette, after cleaning (see also Pl. 34).

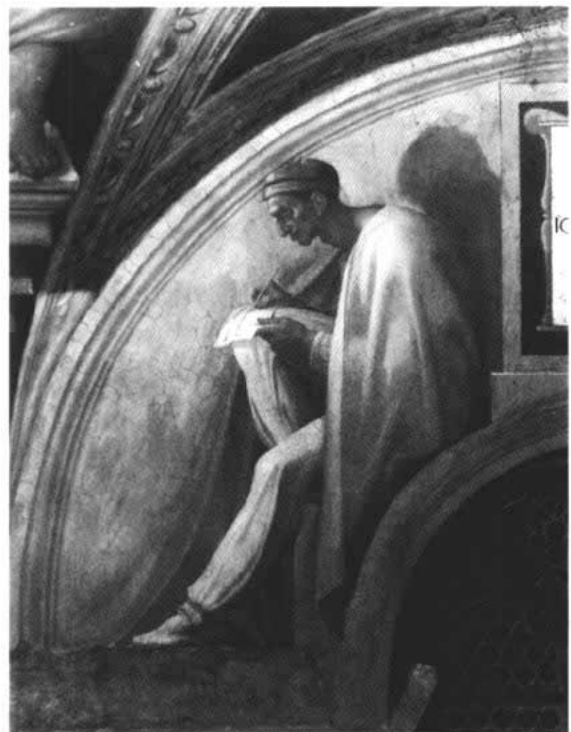

Figure 3, right. Detail from *The Flood*, after cleaning, showing the spolvero from the transfer of the cartoon, and a snapped line.

Figure 4, below. Detail of Adam from *The Expulsion*, after cleaning. Here the spolvero has been drawn over in black with a brush.

Figure 5, below right. Detail of the putto next to the Erythrean Sibyl, after cleaning. In contrast to Figs. 3 and 4, the spolvero here has been strengthened with direct incisions.

Figure 6, bottom. This detail of Noah planting the vineyard, from *The Drunkenness of Noah* (after cleaning), was painted *alla prima*, without transfer from a cartoon or direct incision.



transferred the cartoons by pouncing (Fig. 3) and, more rarely, by indirect incision through the cartoon. In the second half, however, transfer by indirect incision is much more frequent than pouncing (Pl. 35). Often, the light pouncing is traced over in black with the point of a brush (Fig. 4). Sometimes within areas of flesh painting incision directly onto the fresh plaster is done with a thin point (Fig. 5). The lunettes, the nude bronze figures and others—such as Noah planting the vineyard (Fig. 6), or the sleeping soldier in the pendentive of Judith and Holofernes—are all executed *alla prima*, painted without cartoon, directly with color, at times with the aid of a summary preparatory drawing. The resulting painting is broad, almost gestural. When *pentimenti* occur in these areas they are executed during the work and therefore in fresco, but are covered by the overlying colors.

Figure 7, right. Detail of the ignudo on the left of the Cumaean Sibyl, after cleaning.



Faithful to his rule of using pure and transparent colors, for women's flesh painting Michelangelo often first laid in *verdaccio* and then built up the form with brushstrokes of red, pink, and, for the lightest areas, white (Pl. 36). For men's flesh painting he began with raw umber, but in many cases modeled with brushstrokes of white "veiled" with red or umber (Pl. 37). These veils, however, are not done with liquid colors but rather with dense colors drawn over the painting with a brush whose bristles are spread out, almost dry, so as to obtain a vibrant surface texture. In many cases, such as the head of Holofernes (Pl. 38) or the hair of various figures, the highlights were obtained by means of the transparency of the light *intonaco*, as found in the best Florentine fresco painters from Fra Angelico to Ghirlandaio. Shadows were mostly done with complementary or dissonant colors, soft and luminous, often with a burst of light on the point of the modeling of a nude figure where it turns inward (Fig. 7). Rarely did Michelangelo use black for shadows; when used it was applied in neat, black lines, like underscoring, to obtain the type of shadow a sculptor makes in marble with a series of holes drilled closely together.

## ***Condition and Previous Interventions***

The frescoes of the Sistine Chapel ceiling are characterized by an uncommon solidity and resistance to agents of deterioration. However, the appearance of the frescoes when the present conservation was begun was very different from that described above. The dark, brownish, stained tone dimmed the architectural framework and evened the colors; the heavy, blackish shadows accentuated and hardened the modeling, and the extensive Overpainting gave the ceiling a tumultuous, dramatically gloomy character and the paint a material flavor, rich in fascination but diametrically opposed to Michelangelo's vision (Pl. 33).

This degree of alteration is due to five centuries of repeated interventions, either partial or total, and to the accumulation of smoke. In many cases the restorations were necessitated by persistent infiltrations of rainwater from the roof and the uncovered parapet-walk. The water, filtering through the very thick vault and walls, transported to the frescoes salts such as sulfates, nitrates, and carbonates. Silicate damage due to this infiltration is evident in zones with mottled staining that looks like snakeskin.

Past restorations have mainly involved four operations:<sup>3</sup>

1. Cleaning done with the soft part of bread; cloth soaked in water; sponges soaked in Greek wine.
2. Reviving the colors, especially the dark ones or those of intense tonality, and masking the white salt efflorescences by means of applications, each of many coats, of animal glue, probably made fluid in the cold state by adding a very high percentage of vinegar. In more recent periods, vegetable gums have been substituted for the glues. The glues have caused widespread small-scale delamination of the most superficial part of the less compact pigments, and have given rise to myriad small fungus colonies (Fig. 8).
3. Retouching and Overpainting of various kinds, quality, and conception, executed in tempera and sometimes in oil, with dark, often black, colors (Fig. 9).

*Figure 8, below. Detail of Eve in The Temptation, before cleaning. The triangular area was not covered by the glue that is contracting and causing microflaking in the other areas.*

*Figure 9, below right. Detail of Adam in The Temptation, before cleaning. The retouching by Mazzuoli (1710-12) is highly evident (compare Pl. 33).*

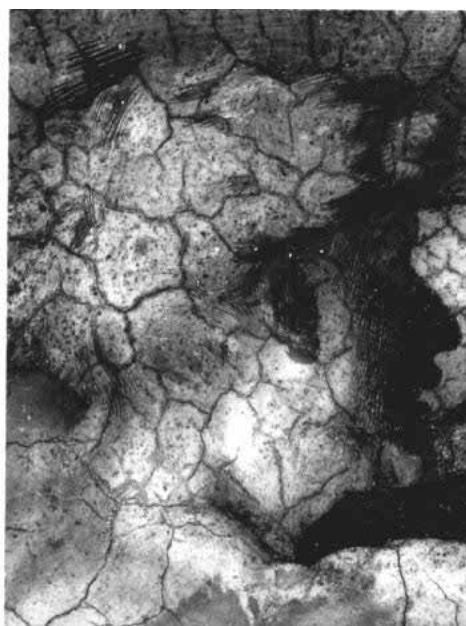

4. Insertion of metal cramps and, in more recent periods, injection of calcium caseinate with oil added as a fluidizer to secure endangered or detached areas of *intonaco* (Fig. 10).

## Conservation

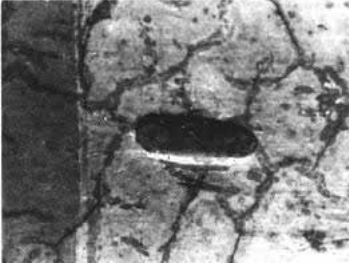

Figure 10. A metal clamp inserted to secure the plaster, probably in the nineteenth century. Note the retouching carried over the clamp and the area at left darkened by the application of glue.

The conservation focused substantially on the removal of extraneous substances damaging to the fresco. Since these consisted essentially of glues applied at various periods, hence with varying levels of tenacity, the cleaning method that gave the best and most consistent results was that based on the use of a mixture composed of ammonium bicarbonate (30 g), sodium bicarbonate (30 g), Desogen (10 g at 10%; Ciba-Geigy), and carboxymethylcellulose (0.6 g) in 1000 cc of water.<sup>4</sup>

After preliminary cleaning with water only, the solvent mixture was applied two or more times, for very short periods, usually from two to four minutes. The contact times were chosen to guarantee maximum security both to the painting and to the conservator. It is the controlled, superficial action of the mixture over time, even over short periods, that allows the conservator to clean gradually and sufficiently evenly. After contact for the length of time determined by testing, the mixture together with the extraneous substances was removed with water and a soft sponge. After 24 hours a second application was carried out in the identical way. At this stage, the cleaning had almost always reached the desired level; if not, further brief localized interventions were carried out. The desired level of cleaning was that at which the pictorial layer was freed of extraneous substances but retained a thin veil of old patina. The work was concluded with abundant rinsing, repeated at intervals of up to several months. The last rinsing was done with distilled water (see Pl. 40, during cleaning).

The parts painted *a secco* were excluded from this treatment since the pigment is bound with glue which would be dissolved by the water. Therefore, the original areas painted *a secco*, as well as those where there was any doubt about authenticity, were identified and protected during the cleaning of the surrounding fresco with an impermeable resinous layer of Paraloid B72 diluted to 5% in thinner (IVI 362068). The layer of Paraloid was subsequently removed with thinner and Japanese tissue and the painting cleaned with organic solvents. Occasionally a more complex method was carried out which combined the use of the solvent- and water-based systems. Thinner was used to dissolve the Paraloid gradually in order to allow the cleaning of the painted surface with ammonium bicarbonate at a low concentration, but without allowing it to penetrate the pigment layer. Obviously this method requires both considerable experience and manual dexterity.

The cleaning methods adopted were based on extensive testing, conducted methodically and continuously, with the objective of anticipating any new situations which might require either alternative methods or modifications of those described above. As is well known, the same solvent may behave differently depending on many variables, such as the way it is used, the substances to be dissolved, and the technique of the painting.

The choice of cleaning methods and materials was oriented along two main programmatic lines: simplicity and reliability. But decisions regarding the

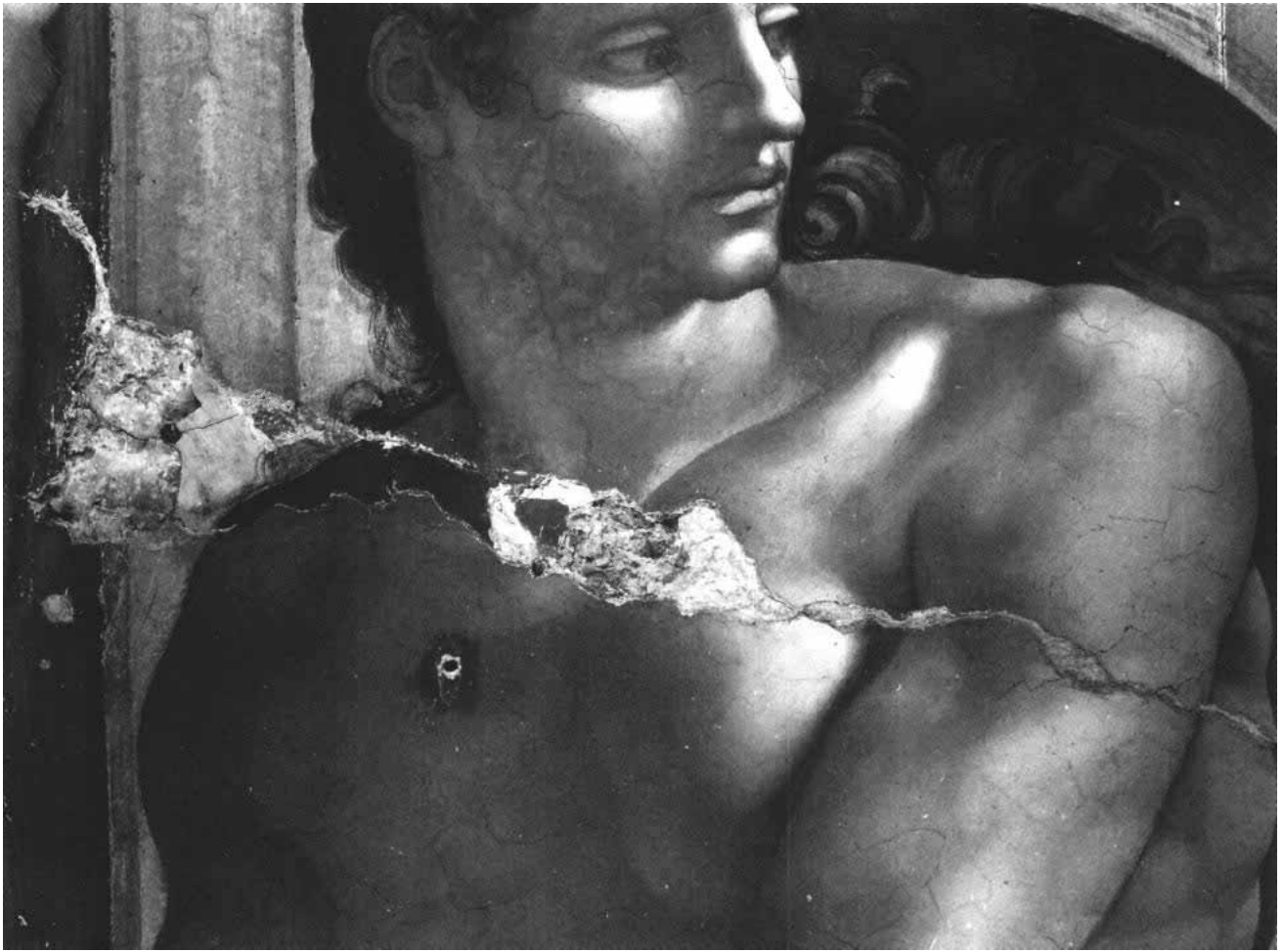

Figure 11. Detail of the *ignudo* to the right of Ezekiel, after cleaning. During the removal of a repair done by Carnevali in 1566, this fragment of painting was found. (See also Pl. 41.)

desired level of cleaning are not based solely on technical considerations, and both critical and scientific principles must be brought to bear. In the case of Michelangelo's frescoes we can say that the choice of the level of cleaning was almost mandatory, since evaluation of all the tests led us to exclude *mezze pulitura*, or partial cleaning. In fact, leaving an inevitably discontinuous and heterogeneous layer of blackish substances on the pictorial layer—so delicate, with modulated tones and the most subtle chromatic variations—would have required a considerable intervention to balance the dirty residue by adding colors and materials extraneous to the fresco—sure sources for premature aging of the restoration. But in my view it would have been the gravest error not to recover completely the original pictorial fabric of Michelangelo. Virtually unknown up to now, it would have remained so even after our intervention. Thus the level of cleaning and methods selected were those that allowed us to reveal Michelangelo's painting in its multiple aspects: form, color, modeling, brushwork, and substance.

A confirmation of the appropriateness of the cleaning level selected was found during the conservation of the *ignudo* to the right of the prophet Ezekiel (Fig. 11). The chest and right shoulder of this figure are crossed by a long crack, part of the considerable damage that can be verified as having occurred on the occasion of the conclave for the election of Pius V (December 1565 to January 1566), who immediately called in Domenico Carnevali of Modena to carry out



restoration. When Carnevali's plaster repair and retouching were removed—it was too altered and out of tone to be retained—under the preparation of lime and pozzolana an original fragment of the flesh painted by Michelangelo was discovered. Wedged into the crack and held in place by two large-headed nails, as was customary for the interventions of Carnevali, the fragment has been totally isolated from subsequent interventions and therefore documents the state of Michelangelo's colors around 1566. It has no traces of glue and its chromatic tone is identical to that brought to light by the cleaning (Pl. 41).

As the conservation proceeded and the proportion of cleaned area increased, the painting which had seemed disturbing gradually recovered its equilibrium over the vast surfaces; it could then be appreciated as being fully within the tradition, as Fabrizio Mancinelli has maintained, both of the painting of its period and that which was a direct consequence.

Although the cleaning was the most significant aspect of the overall conservation program, no less important (although quantitatively minimal) were the interventions related strictly to conservation. For microflaking of the paint layer refixing was done with Paraloid B72 or Primal. For areas of detached *intonaco* readhesion was carried out by means of injections of Vinnapas (PVC-PVA terpolymer of ethylene), and, where required, voids were grouted with La Farge desalinated hydraulic mortars. In most cases old cracks stuccoed by Carnevali were left, but old repairs in wax and Greek pitch were replaced. The metal cramps of various periods were also left in place, except for those that were disfiguring. Plastering of the lacunae was done with lime and marble powder (*stucco romano*), the deeper ones first prepared with lime and pozzolana.

Given the excellent state of the painting, reintegration was extremely limited, carried out with watercolor in vertical or, on the ceiling, hatched lines.

There was no final application to protect or saturate the painting. Initially and only on the first lunette treated, that of Eleazar, a 2% solution of Paraloid B72 was applied, as is commonly done. This practice was subsequently abandoned, and Paraloid was used exclusively in areas where salt efflorescences had caused a loss of cohesion in the paint layer. A specific method of application, however, allowed the removal of any Paraloid on the surface while retaining the resin within the pigment where it acts as a consolidant. This involves the sequential application of thinner (IVI 362068) and distilled water: the thinner dissolves the Paraloid layer and the water coagulates it, preventing it from penetrating elsewhere.<sup>5</sup> Since most of the areas damaged by salts are in the lunettes and pendentives, it follows that in these zones the use of such methods was greater than on the ceiling, where Paraloid was almost never used.

Our decision not to apply a protective material derived from the awareness that any new material which is not homogeneous with the original components of the fresco will undergo rapid degradation, causing, in the best of cases, aesthetic damage. Preservation of Michelangelo's frescoes will rely upon providing suitable microclimatic conditions in the chapel. Following preliminary studies, plans are well advanced for the installation of equipment to control and correct the potentially damaging temporary fluctuations caused by the large

number of visitors (Camuffo and Bernardi 1986). Regarding the question of lighting, after many unsatisfactory tests it has been determined that the best light for viewing the frescoes is the natural light that filters through the windows: the very same light available to Michelangelo.

## Notes

1. On the reasons, problems, procedures, and results of the cleaning, see the studies published by those in charge of the conservation as cited by Fabrizio Mancinelli in N. 3 of his contribution to this volume.
2. See the recent editions of these two important early sources: Vasari 1966:129-130, and Armenini 1988.
3. For the history of the chapel, see in particular Mancinelli and Colalucci 1985, and Cicerchia and De Strobel 1986.
4. On this method, see Mora, Mora, and Philippot 1977:400-401.
5. This method was first published in Colalucci 1983:159-160.

## References

### Armenini, G.B.

1988 *De' veri precetti della pittura*. M. Gorreri, ed. Turin. First edition, Ravenna 1587.

### Camuffo, D., and A. Bernardi

1986 "Dinamica del microclima e atmosfera interna nella Cappella Sistina." *Monumenti, Musei e Gallerie Pontificie. Bollettino* 6:212-257.

### Cennino Cennini

1913 *Il libro dell'arte*. Ed. Simi Renzo. Lanciano.

### Cicerchia, Edith, and Anna Maria De Strobel

1986 "Documenti inediti dell'Archivio Segreto Vaticano sui restauri delle Stanze di Raffaello e della Cappella Sistina nel Settecento." *Monumenti, Musei e Gallerie Pontificie. Bollettino* 6:105-152.

### Colalucci, Gianluigi, and Fabrizio Mancinelli

1983 "Michelangelo Buonarroti: le lunette con Eleazar-Mathan, Jacob-Joseph, Achim-Eliud, Azor-Sadoc, Josias-Jeconias-Salathiel." *Monumenti, Musei e Gallerie Pontificie. Bollettino* 4:143-160.

### Gabrielli, Nazzareno

1987 "Aspetti scientifici nel restauro degli affreschi di Michelangelo nella Cappella Sistina." *Monumenti, Musei e Gallerie Pontificie. Bollettino* 7:151-162.

### Mancinelli, Fabrizio, and Gianluigi Colalucci

1985 "Vero colore di Michelangelo: le lunette della Cappella Sistina." *Critica d'Arte* 50(6):72-87.

### Mora, Paolo, Laura Mora, and Paul Philippot

1977 *La conservation des peintures murales*. Bologna.

### Vasari, Giorgio

1966 *Le vite de' più eccellenti pittori, scultori e architetti, nelle redazioni del 1550 e 1568*. Rosanna Bettarini and Paola Barocchi, eds. Vol. 1. Florence.

## ***Biography***

Gianluigi Colalucci received his diploma in restoration in 1953 from the Istituto Centrale per il Restauro, Rome, under Cesare Brandi. In 1960 he joined the Laboratorio Restauro Pitture of the Vatican Museums, and in 1979 was appointed Chief Restorer. He regularly collaborates with various Soprintendenze in Italy, particularly those of Rome, Naples, Palermo, and the Veneto. He was awarded an honorary Doctorate of Fine Arts by New York University in 1991.

# Conservation of Central Asian Wall Painting Fragments from the Stein Collection in the British Museum

*S. B. Hanna and J. K. Dinsmore*

At the end of the nineteenth and during the early decades of this century, numerous archaeological and scientific expeditions led to the discovery of ruined Buddhist monasteries and cave temples in Central Asia (Hopkirk 1984:1). This area is bounded by the Tien Shan and Kunlun mountains to the north and south, by the Pamir and Karakoram ranges to the west, and by the Lop and Gobi deserts to the east (Fig. 1). Since the Han period, the Silk Roads—the great trade and transport routes connecting China with the West—had run through this area, and numerous settlements had grown up as centers of Buddhist pilgrimage and stopping places for travellers.

Among numerous scholars who led expeditions into this area was the archaeologist Sir Aurel Stein. Stein undertook three expeditions to the area between 1900 and 1915 and brought back a considerable collection of artifacts including wall paintings, manuscripts, paintings on silk, textiles, and ceramics. The British Museum has no fewer than 104 wall painting fragments removed by Stein from deserted Buddhist shrines (Whitfield 1985:3:7). The large quantity of wall paintings from this region represents a holding of major archaeological and art historical importance. Current approaches at the British Museum to the conservation and mounting of this collection will be illustrated here in two case studies of paintings collected by Stein at Dāndān-Oilik and Ming-Oi.

*Figure 1. Map of Central Asia.  
(After Hopkirk 1984:1).*

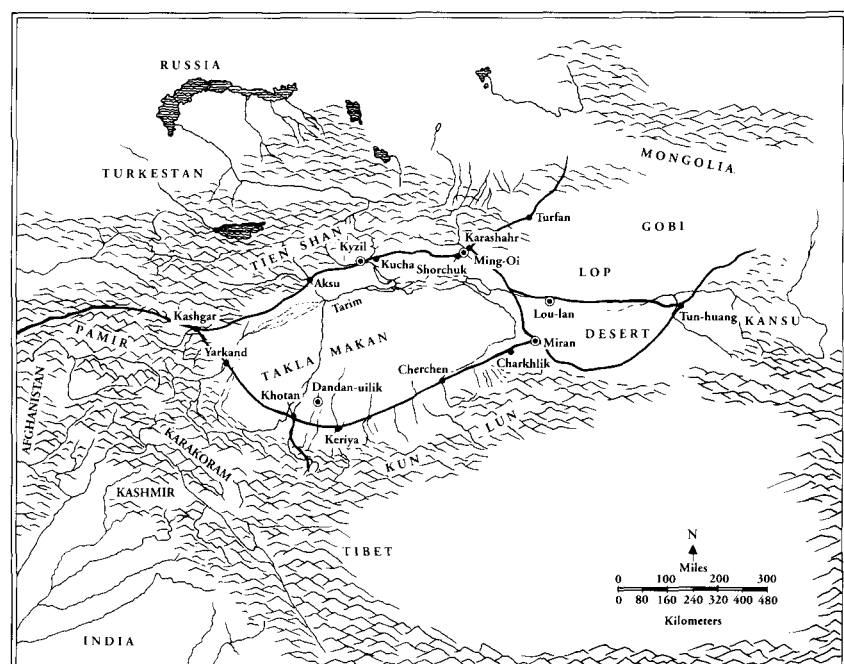

## ***Provenance***

The two paintings from Dāndān-Oilik, referred to here as Fragments 1 and 2, were excavated in 1900. An oasis lying to the southwest of the Takla Makan desert in the region of Khotan, Dāndān-Oilik was deserted in the late eighth century and considerably defaced by occupying Tibetan military encamped there around the same time. At a later date, the shifting desert sands buried the site. Fragments 1 and 2, from the lower part of a wall, provide archaeological evidence of this destroyed but once important Buddhist sanctuary.

The second group of fragments considered here were removed in 1907 from a shrine at Shorchuk, which lies on the northern edge of the Takla Makan. This shrine is in an area referred to by Stein by its local name, Ming-Oi, meaning "Thousand Dwellings." In antiquity, many of these freestanding, unfired mud-brick structures had been destroyed by fire and collapsed inward. The fragments discussed here were detached from one of the shrines (Stein's site number xiii), which was the only identifiable part of a larger building complex. The shrine originally consisted of a large chamber with a screen-wall at one end, forming a narrow vaulted passage, permitting worship by circumambulation. The paintings formed a dado, partly effaced, extending around the three outer walls of this passage. Stein detached twelve sections of this painting, eleven of which are in the British Museum and the other in Delhi (Whitfield 1985:3:328-329).

## ***Method of Construction and Decoration***

Although these two sites lie on different caravan routes separated by the Takla Makan desert, their method of construction and decoration is similar. Sun-dried mud-brick walls and ceilings were plastered with several layers of mud. Chopped straw or reeds were added to the first coat, and succeeding ones contain finer fibers of hemp, grass, or goat hair. A thin surface ground was then applied and left to dry before being painted. The preparatory grounds from paintings at Kizil, west of Ming-Oi, were analyzed by R. J. Gettens (1938:292) and found to contain gypsum. Recent analysis at the British Museum of the ground of the paintings from Ming-Oi has confirmed the presence of gypsum (British Museum B89/AR/80).

The composition seems to have been first outlined in black, then areas of color were applied, and finally the outlines were strengthened again in black. The medium has not been identified but is thought to be glue, possibly from bones. The palette of paintings of this period included bright red, dark red, black, and white, with mixtures of these colors also used. On the Ming-Oi fragments green, yellow-green, and grey-blue are also present.

## ***Two Fragments from Dāndān-Oilik***

Fragment 1, rectangular in shape and measuring approximately 50 x 20 cm, includes the feet of a standing, life-size Buddha resting on an open lotus. There is a single line of inscription in cursive Brahmi characters, similar to those found in manuscripts excavated at the same site that date from between 782 and 787. Fragment 2, of similar shape and size, shows a portion of an aureole of conventional design painted in white and pink and outlined in black. The toes of a large foot can be seen near the middle of the fragment's top edge, and in the spandrel at the lower right, sprigs of flowers with white leaves are roughly sketched. Below the aureole is a grey band with a two-line cursive Brahmi inscription (Stein 1907:1:303).

### *Condition*

Photographs of both fragments provide some evidence for their condition when they entered the collection in 1907 (Fig. 2a, b). The fragments appear to have been in sound condition except for vertical breaks running through both. The paint surface was largely intact and the Brahmi characters legible. By comparison, in 1987 the fragments were in a seriously deteriorated state (Fig. 3a, b).

*Figure 2a, b. Fragments 1 and 2 from Dāndān-Oilik. Each approximately 20 x 50 x 4.2 cm. London, British Museum OA 1907 11-11.61; OA 1907 11-11.80. (Reproduced from Stein 1907:2:LIX, LVIII.)*

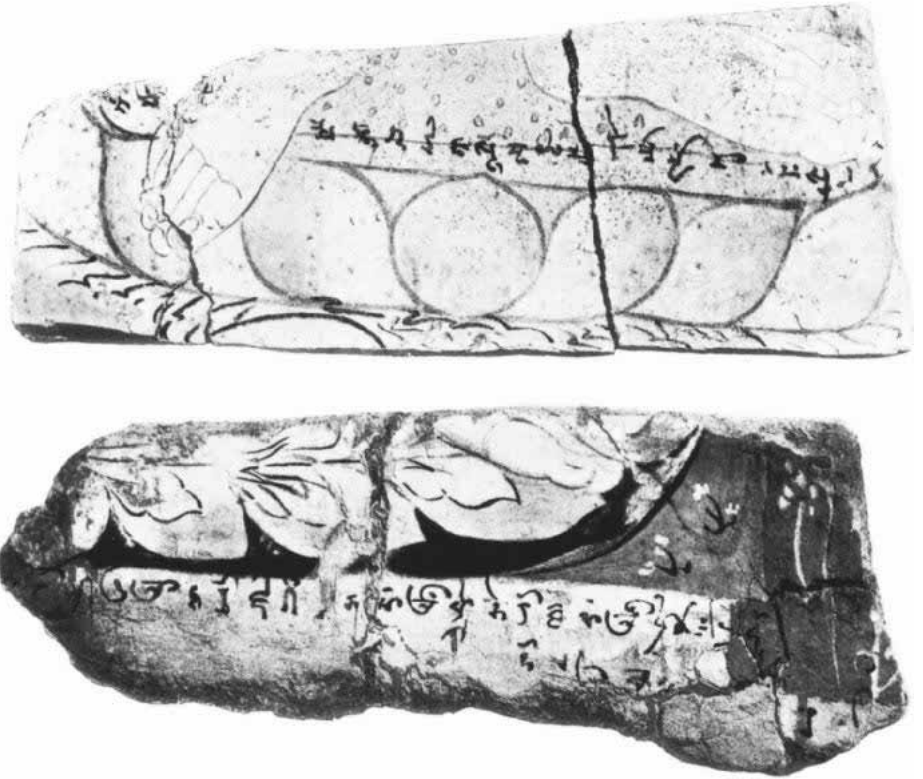

*Figure 3a, b. Fragments 1 and 2 before conservation, 1987.*





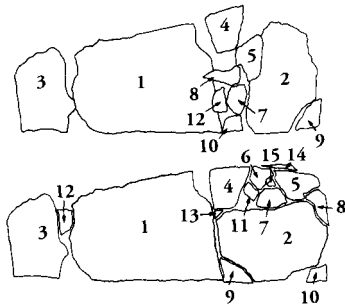

Figure 4a, b. Fragment 1, positions of broken surface-layer pieces before conservation (a), and correctly reassembled (b). (J. James)

In the absence of early treatment records much of the intervening history can only be surmised. The fragments had been placed in shallow, uncovered wood trays in which they were held firmly in position with wood blocks, cotton wool, tissue paper, and wood shavings. The hygroscopic nature of the wood and packing materials, causing them to expand in conditions of high relative humidity, may have placed the fragments under considerable stress. Extensive cracking of the paint surface is evident. Pressure also contributed to the detachment and loss of areas of the paint layer.

Although the storage method was the same for both fragments, in 1987 their condition varied. The surface of Fragment 1 was badly deteriorated, with much of the paint surviving only in small islands. A surface coating, which appears to have been cellulose nitrate, had been applied at some point, presumably in an attempt to stabilize the paint layer. However, with fluctuations in temperature, this resin had softened and absorbed airborne dirt and soot. The paint layer and 3-10 mm of the clay/straw render had been broken into fifteen major pieces, perhaps by being dropped or jarred. The pieces had been replaced on the render substrate but often in the wrong locations and orientations (Fig. 4a); piece number two had been rotated 90° from its original position.

In Fragment 2, although much of the paint layer remained attached to the render, the paint surface had become considerably more friable. Some recent losses had occurred, especially in the center of the upper edge. The render was also friable and in danger of collapse. Both fragments were covered with a thick layer of dust, which largely obscured the painted surface.

### Treatment

The first task in the treatment of Fragment 1 was to return the pieces to their correct locations, based on the photograph (Fig. 2a). This process was aided by removing the surface dust by gentle brushing, but it was felt that further cleaning should be carried out after repositioning so that an even appearance could be attained. Once the realignment was complete, cleaning commenced. Initially a small sable brush, dipped in a 50:50 (v:v) mixture of acetone and industrial methylated spirits (IMS) was tried for removal of dirt and the presumed cellulose nitrate coating. With this method, however, it was difficult to actually lift the dirt off the surface, and there was some concern that hairs of the brush might dislodge the small islands of paint. A poulticing system was then tested. This consisted of small cotton-wool compresses, wetted with the same solvent mixture, placed on an intervention layer of Japanese tissue, and left in contact with the paint surface for ten seconds. This proved to be highly effective in removing the dirt and the coating (Fig. 5). It was also quicker than using a brush and, by tailoring the compresses to the sizes of the fragments, produced a more even cleaning level. Poulticing could be repeated two to three times, if necessary, but further contact led to the wetting of the clay/straw substrate, causing slight discoloration.

The tray in which Fragment 1 was contained was dismantled, revealing that the top and sides of the clay/straw render were friable, though in better con-



Figure 5. Fragment 1, detail during cleaning.

dition than originally suspected. It was also possible to see the laminar nature of the render, evidence that it had been applied in layers to the temple walls. Consolidation was necessary to secure the friable areas of the render and to provide a firm support to which the dislodged pieces of paint layer could be attached. Likewise the render adhering to the underside of these pieces was also friable and therefore required consolidation to ensure good adhesion to the substrate. The paint surface, though fragile, was sufficiently sound not to require overall consolidation, which might have altered the delicate colors and dry appearance of the paint. The edges of lifting flakes were secured with a 10% solution of polyvinyl alcohol in distilled water, which did not affect the appearance of the surface.

To determine the most suitable consolidation method, a number of synthetic consolidants were evaluated by applying them to small, detached pieces of the render. The resins tested were: Paraloid B72 and Mowital B 30 H (polyvinyl butyral), each in a range of solvent concentrations; Wacker Stone Strengthener OH (a type of ethyl silicate); and Raccanello E55050 (an acrylic silane mixture). The last was the most effective in imparting strength and cohesiveness to the coarse-textured render.

All the consolidants darkened the clay/straw render to about the same extent. Although such darkening is undesirable, the condition of the render warranted impregnation, and the curator felt that the inevitable darkening was acceptable, particularly since the render would originally have been darker than in its deteriorated state. An untreated sample was retained for study purposes.

A total of 550 ml of the consolidant was applied with a pipette to the render and to the underside of the fragments of the paint layer. Silane and the solvent contained in Raccanello E55050 (toluene and 1,1,1-trichloroethane) are toxic if inhaled, and therefore consolidation was carried out in a fume cupboard.

With Fragment 2, the friable nature of the paint surface necessitated the consolidation of both that layer and the render prior to other treatments. The same consolidants evaluated for use on Fragment 1 were assessed for this purpose. Again the Raccanello E55050 mixture proved to be the most effective, and 400 ml was applied. Although the consolidant appreciably darkened the render, some of which is exposed on this fragment, the treatment imparted sufficient strength and cohesiveness to permit cleaning, reattachment of loose pieces, dismantling of the box, and removal of the blocking. Cleaning, carried out with the poultice system, revealed the vividness of the colors.

Following consolidation, the upper surface was reattached to the render using a stiff paste of Raccanello E55050 and Gilder's Whiting (calcium carbonate). The thickness of this adhesive layer was adjusted so that all the fragments were brought to the same level. The same mixture, with the addition of dry pigments, was applied under the edges of the paint-layer fragments and chamfered inward so as to be unobtrusive. At this stage Fragment 1 was given a final cleaning to reduce any inconsistencies in cleaning levels. As there were only small areas of dirt, it was possible to use a brush wetted with the acetone/IMS mixture mentioned previously. This treatment has stabilized both objects, and, though fragmentary, their appearance has been enhanced by cleaning (Fig. 6a, b).

Figure 6a, b. Fragments 1 and 2 after conservation.

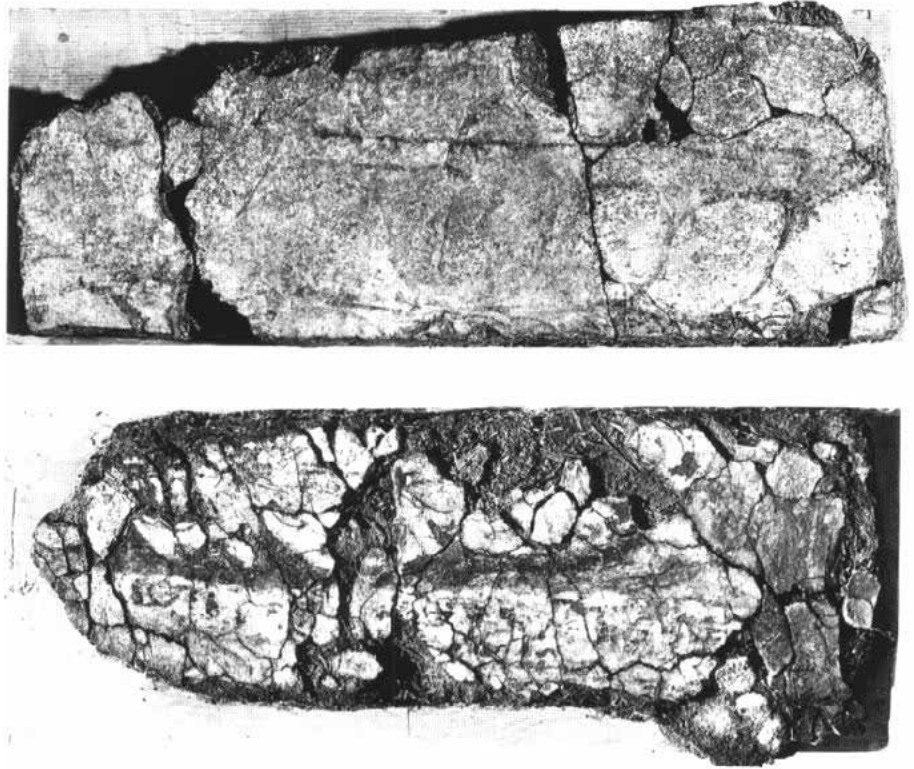

### *Storage*

The fragments will be stored horizontally in a dry, stable environment. Since they are considered primarily as study material, wood storage containers with sliding glass lids have been designed. These offer easy access while providing protection from dust and mechanical damage.

## **Monks Receiving Instruction, from *Ming-Oi***

Dating from the eighth or ninth century, the painting removed from the passageway depicts novice monks receiving instruction (Pl. 42). They kneel before senior monks, and both novices and masters write on tablets. The senior monks are seated on square stools set in niches or hillside caves that rise in a series of steps, reminiscent of the decorated ceilings of many of the Kizil caves lying west of Ming-Oi on the caravan route.

### *Condition*

Cut into sections by Stein for removal and transportation, the painting arrived in the British Museum after his expedition of 1916, and was published in 1921. The illustration from that publication (Fig. 7) shows the irregularly shaped sections correctly aligned to each other. For removal from the wall, the trompe l'oeil border at the bottom was cut in a straight, but stepped line, while the tops of the sections were cut in a less even fashion, perhaps to avoid more deteriorated areas of the painting. Vertical cuts were made along the yellow band that separated the individual scenes of the monks. The original width of this band is not recorded, but traces of it remain on the edges of one section, suggesting that loss was minimal. Much of the damage and deterioration now



Figure 7, above. Monks Receiving Instruction. *Ming-Oi*, 8th-9th century. 77 x 223 x 0.5 cm. London, British Museum, OA Mi xiii 5-9. (Reproduced from Stein 1921: 4:CXXV.)



Figure 8, right. General view of Monks Receiving Instruction before conservation, 1987.

evident is visible in Stein's photographs. Loss of the paint layer and ground has occurred in a number of areas, and in others the exposed clay/straw render is disrupted and friable. There are also numerous cracks and abrasions. Deterioration may have occurred in situ in the course of the destruction of the shrine and from rainwater, which, though rare in this region, could have penetrated the ruined structure. Also, given the brittle nature of the paint and support, damage is likely to have been exacerbated during transportation to England. Finally, there are areas of lifting paint seemingly due to the failure of the bond between the paint layer and ground and the substrate.

The clay/straw render is now about 0.5 cm thick, having been thinned at some stage. For mounting, the sections appear to have been inverted and a plaster of Paris support was cast on the reverse. The five sections were mounted on four panels and joined with mirror plates and the ensemble placed in a glazed frame (Fig. 8). In so doing the sections were displaced from their original alignment and positioned arbitrarily to fit within the rectangular frame. In addition, the vertical timber struts in the frame produced a gap of approximately 10 cm between each section, substantially disrupting the visual flow of the composition.

Fortunately, there has been no damage due to the migration of water from the surrounding plaster of Paris into the paintings; this may be because they were mounted face down, allowing the water to evaporate preferentially through the back. However, new cracks are visible, and old ones appear to have been aggravated by the swelling and shrinking of the plaster of Paris during setting. Elsewhere, portions of the edge have been pulled away by the action of the plaster (Fig. 9).

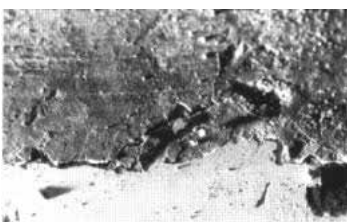

Figure 9. Detail of damage to an edge caused by plaster of Paris.

## *Treatment*

The principal objective of the treatment was to correctly realign the panels. Removal of the plaster of Paris backing layer would have caused considerable damage, and since there was no evidence of progressive deterioration from the backing, and as conditions in the storage area are dry and stable, it was decided to leave the plaster in place, but to remove the wood strip frames and to reduce the surround down to the backing level.

Removal of the plaster surround began by exploring along the edges of the paintings with a scalpel to ascertain whether the render extended under the plaster surround. Once the edges were revealed, the bulk of the plaster was removed with a carborundum cutting disk mounted in a microdrill. A grid was cut into the plaster and the resulting squares were then removed with a small hammer and chisel.

Sections 6 and 7 had been mounted together but misaligned, and it was decided to separate and reposition them correctly. There was no adhesive along the joint line, but some plaster of Paris had seeped between the two sections. Where possible this was removed from the front with a scalpel. To protect the paint surface during this operation and when cutting through the plaster on the reverse, the edges were faced with small strips of acid-free tissue attached with a 2.5% solution of polyvinyl alcohol in distilled water. This facing material was first applied to minute areas to ensure that it could be used and then removed without physical or optical alteration of the surface. The sections were then placed on battens across a gap between two work benches to allow access from underneath. Having located the join on the reverse, a V-shaped channel was cut along the line using a microdrill and scalpels. The wood frame was removed, thus freeing the sections in preparation for realignment.

Once the edges had been revealed, the render was found to be friable in some areas. There were also numerous small islands of paint that had been partially or completely dislodged by the plaster of Paris, and the render had been chamfered back from the edge, leaving the paint layer unsupported. These areas were supported by inserting a stiff paste consisting of a 7% solution of polyvinyl butyral in IMS mixed with white clay and toned with dry pigments. Friable areas of the render were also consolidated with a 5% solution of polyvinyl butyral in acetone and IMS applied by hand-held pipette.

For relaying paint flakes a range of synthetic adhesives in liquid form were tested on small, dislodged flakes. None of these successfully readhered the paint layer, and most caused darkening of the matte paint surface. Resin films were therefore evaluated. Small amounts of a 40% solution of Paraloid B72 in toluene, Raccanello E55050, Vinacryl acrylic emulsion, and Vinamul 6815 polyvinyl acetate emulsion were cast separately onto sheets of polyethylene and allowed to harden. For use, the polyethylene sheet was then peeled away and a piece of the film cut to the appropriate size and inserted beneath a paint flake. The film was softened by the application of a heated spatula to adhere the paint flake to the substrate. The Raccanello E55050 was the most effective in this application.



Figure 10. General view after conservation.

Once the local consolidation, gap filling, and relaying of paint flakes had been done, the five sections were ready to be remounted. By joining them in two units of two and three sections each, they could be held in position but would still be of manageable size for handling. A smooth, neutrally colored surround, level with the paint surface, was required. In addition the painting was to be placed in a glazed frame without the vertical divisions of the previous one.

So that the sections could be brought together and aligned both vertically and horizontally, the plaster of Paris backing was removed along the interior edges. Working from underneath, glass fiber strips (15 cm wide) were applied with Beetle polyester laminating resin along the whole length of the join. For additional strength, further strips (each 5 x 20 cm) were placed at right angles across the joint line. After curing, the strength of the join was checked empirically and showed no evidence of distortion. Substantial polyethylene foam softening placed between the plaster of Paris layer and the timber backing of the frame will minimize the possibility of torque.

The new surround was manufactured from a polyester filler paste, Isopon P38, and incorporated a sheet of polyethylene as a separation layer along the edges of the painting sections. The surface was sanded and painted to achieve a smooth and uniform finish (Fig. 10).

## Conclusion

The approach and solutions to problems of conserving wall paintings in a museum collection need to be as sensitive and well planned as when working in the field. Minimal intervention, with emphasis on preventative measures and environmental control, are preferred. However, as illustrated in the first case study, if deep impregnation is necessary to prevent the total loss of the objects, then such measures will be pursued. Deep impregnation with largely irreversible consolidants such as acrylic silane or ethyl silicate are, nevertheless, only contemplated as a last resort. Such a decision must be reached in a balanced manner with proper research on how the consolidant will affect the material being conserved.

The archaeological approach, whereby fillings, surface treatment, and reintegration are generally kept to a minimum, is appropriate to this type of collection. However, this does not rule out the need to continually explore the most compatible methods and materials for use in such situations.



## ***Acknowledgments***

---

The authors wish to thank Mr. W. A. Oddy and Mrs. J. M. Rawson for permission to publish the text and photographs, respectively. Particular thanks are due to Dr. A. Farrer and Professor R. W. Whitfield for advice on aspects of the art history, and to Ms. A. Aloff, Ms. C. Babington, Mr. J. James, Ms. K. Powell, and Mr. S. Rickerby for their contributions to the study and treatment of these paintings.

## ***References***

### **British Museum**

Department of Conservation, Internal Report, File no. B89/AR/80.

### **Gettens, Rutherford J.**

1938 "The Materials in the Wall Paintings from Kizil in Chinese Turkestan."  
*Technical Studies in the Field of Fine Arts* 6:281-294.

### **Hopkirk, P.**

1984 *Foreign Devils on the Silk Road*. Oxford.

### **Stein, M. Aurel**

1907 *Ancient Khotan: Detailed Report of Excavations in Chinese Turkestan*. 2 vols. Oxford.

1921 *Serindia: Detailed Report of Explorations in Central Asia and Westernmost China*. 5 Vols. Oxford.

### **Whitfield, Roderick W.**

1985 *The Art of Central Asia*. 3 Vols. Tokyo and London.

## ***Biographies***

S. B. Hanna received his bachelor's degree in Fine Art, followed by a postgraduate diploma in conservation of sculpture. He joined the British Museum in 1979, and was appointed head of the Stone, Wall Paintings, and Mosaics Conservation Section in 1985. In 1988 he went into private practice. He has published and lectured widely and is a Fellow of IIC.

J. K. Dinsmore received a Master of Science degree from the H. F. Dupont Winterthur/University of Delaware Art Conservation Program in 1983. She subsequently studied at the Sculpture Conservation Section, Victoria and Albert Museum. Since 1985 she has worked in the Stone, Wall Paintings, and Mosaics Conservation Section of the British Museum.

# Destruction and Restoration of Campanian Mural Paintings in the Eighteenth and Nineteenth Centuries

Eric M. Moormann

In 1738 Charles III, king of Naples, decided to begin explorations in Portici, Resina, and, later, Castellammare di Stabia and Civita, where the ancient cities of Herculaneum, Stabiae, and Pompeii were believed to lie buried. Inspired in part by spectacular finds of architectural sculpture and marble statues in 1719 by Count d'Elboeuf and in part by a desire for treasures to decorate his new summer palace in Portici, Charles wished to locate the ancient cities engulfed by the eruption of Vesuvius on 24 August A.D. 79. We know that some of d'Elboeuf's finds were bought by the king while other pieces were sold elsewhere. For example, the Skulpturensammlung in Dresden still possesses the *Große* and *Kleine Herkulanerin*, statues that appear to have formed part of the facade decoration of the theater at Herculaneum. In the beginning these explorations were surely no more than treasure hunting, but in 1755 the king founded the Accademia Ercolanese to study and publish the finds; the twelve huge volumes of the *Antichità di Ercolano* appeared between 1757 and 1792. Members of this illustrious group were, among others, the architect Luigi Vanvitelli and Bernardo Tanucci, Charles's minister of internal affairs (Herbig 1960).

Exploration was begun in the village of Resina, not far from the pit sunk by d'Elboeuf. Using mining techniques the excavators dug down to the ancient town of Herculaneum—first thought to be Pompeii—going through strata of compact lava material up to 20 m thick (Knight and Jorio 1980). The work was done by paid workmen and probably also by prisoners, such as North African pirates from Tunis and Algiers, all of whom were under the direction of the Spanish officer Roque Joaquin d'Alcubierre and his assistants Francesco Rorro (who substituted for d'Alcubierre between 1741 and 1745) and Bardet de Villeneuf. Between 1750 and 1762 the Swiss engineer Karl Weber was second in command and thereafter Francesco La Vega. The number of workers never exceeded fifty; there was some complaining about the slowness of the work. In the mines, called *grutas* or *grotte*, the men dug along until they hit obstacles such as walls, which then determined the further course of their tunnels. Often they cut holes through the walls in order to proceed in another direction. All objects encountered were reported to the assistants of d'Alcubierre, who, in turn, had to write weekly reports to Tanucci. In so far as possible, movable objects were transported to the summer palace at Portici, where rooms were reserved for the Museum Herculanense, founded in 1758. The French sculptor Joseph Canart and two priests, Camillo Paderni and Antonio Piaggi (according to Johann Joachim Winckelmann the alpha and omega of the

museum), were in charge of restoration and conservation. The museum in Portici was finally abandoned in 1806, when the contents began to be transferred to the Palazzo degli Studi in Naples, now known as the Museo Archeologico Nazionale. However, the transfer was not completed before 1827.

In the weekly reports that fortunately have been preserved in the state archives in Naples and that were largely edited by Giuseppe Fiorelli and Michele Ruggiero in the 1860s and 1880s, we find important data on all matters concerning the workmen, the progress of the work, and the finds in the tunnels.<sup>1</sup> The few notes on architectural remains are unfortunately laconic. The supervisors also made designs and plans of which a certain number are still known. Weber and his successor La Vega, especially, showed interest in such scientific recording. For instance Weber wanted murals to be drawn before fragments were cut out and floor plans to be made before mosaics were lifted. This apparently took too much time to be done in every instance, but the drawings that have survived show an often painstaking accuracy.

When open-air excavations began at Pompeii in 1764 the situation changed. In the first years excavated areas were immediately back-filled (for example, the Villa of Cicero near the Porta Ercolanese and the Praedia of Julia Felix not far from the amphitheater, reexcavated in 1950).<sup>2</sup> Later, however, streets and buildings were left uncovered and accessible to the public.

## **Wall Paintings**

Murals are mentioned for the first time in d'Alcubierre's report of June 23, 1739 (Ruggiero 1885:33):

The aforementioned sculptor Jos. Canart has assisted in the successful removal of the sculpture, at which time I observed on the wall near the place where the aforementioned statue is that there is a painted frieze with two lions in one place and a dragon and a dolphin in another. And the aforementioned sculptor says that in Rome and still more in England such paintings are esteemed highly. Which paintings subsequently are removed from similar walls. Thus, if His Majesty approves, he himself [Canart] will see to the removal of these pieces, one of which measures  $6\frac{1}{2}$  *palme* wide and the other  $2\frac{1}{2}$  *palme*, both  $1\frac{1}{2}$  *palme* high [1 *palma* = approximately 25 cm], on which I await Your Excellency's orders.<sup>3</sup>

This text gives an excellent sense of the interest caused by such finds. Such interest is understandable if we consider the very small number of murals then known from antiquity. Canart must have known of the practice of collecting fragments of murals as a result of his travels to Great Britain and his stay in Rome (Ashby 1914).

Regarding the type of fragments collected, initially nearly every figurative motif was removed at Herculaneum, no matter if it was a specifically figural scene (*pinax*) or a fragment of an architectural composition, a vignette, a border, or a frieze. The excavators were only interested in attractive *pinturillas*: painted pieces to divert the king and his court. This is why the collection in the storerooms of the Museo Archeologico Nazionale contains so many small, often insignificant fragments.<sup>4</sup>

Although the collection of fragments in Naples may now seem haphazard it reflects the contemporary taste for the ornamental, splendidly illustrated in the recent exhibition on eighteenth-century Naples.<sup>5</sup> But most attention was paid to figural scenes. Mythological histories, still lifes, and landscapes frequently were thought to be copies of Greek masterpieces, and enthusiastically described by Winckelmann among others as some of the best expressions of classical Greek and, secondarily, of Roman art. It is important to remember that the excavators in the tunnels of Herculaneum could never see a complete wall and did not have the faintest idea about the schemes and systems of decoration used by the Romans. When they came across a noteworthy detail, the workers had to inform the director; he had to decide whether to cut out a painting or not. It was mainly Paderni who made these choices. Once he even came to the excavation at midnight to give orders concerning a new find. By the time of Winckelmann's first visit, the excavators had collected in this way some thousand *pinturillas* in addition to numerous statues and bronze and ceramic utensils. It is hard to imagine what the miners actually saw in the narrow tunnels, working under the faint light of torches and candles and suffocating in the bad air polluted by gases evaporating from the volcanic material.

Cutting out pieces of fresco was something in which the excavators had no training or experience, and they did not use linen or other facing materials to protect the plaster from breaking during detachment. The selected parts were cut out in small sections, often breaking off in pieces which were collected in cases. In general, the sections removed do not exceed 30 cm<sup>2</sup>. The fragments were also too thin, only 4 or 5 cm, to assure safe detachment. The large panels in the Museo Nazionale consist of numbers of small pieces, and their surfaces give the impression of *craquelure*, notwithstanding Canart's restorations (Fig. 1).

Figure 1. Wall painting from the great peristyle of the Villa of San Marco. Castellammare di Stabia. Naples, Museo Archeologico Nazionale 8891.



Already in these early days of detaching wall paintings, however, the question of how to conserve the painted surface arose. It was observed that the fragments discolored on exposure to the air.<sup>6</sup> Soon experiments were being made with a sort of fixative. A certain Stefano Morricone is known to have prepared a kind of varnish to be put on the fragments immediately after they were uncovered. We read in the report of July 11, 1739, written by d'Alcubierre (Ruggiero 1885:37):

Although I continue to insist to the sculptor Jos. Canart that he continue removing these paintings, he replies to me that it is necessary first to do some trials, that is to say to cover them with a varnish in order to see that they not be damaged while extracting them from the grottoes and exposing them to the air, as happened with the first painting.<sup>7</sup>

A week later these experiments had been carried out, as is clear from d'Alcubierre's report dated July 21, 1739 (Ruggiero 1885:38):

In the letter dated yesterday which has been brought to me by Cavaliere Marcello Venuti I have received the instructions of Your Excellency that I should assist this same man and the artillery officer who has come here with him, in order that he, the latter, should undertake some tests with the varnishes he has brought on the paintings in the grottoes being excavated at Resina. And having completed these instructions to the letter, I have observed that one of the two varnishes he brought particularly revives and gives clarity to the aforementioned paintings as much as one could desire and according to my understanding. And referring to what the same Cavaliere Venuti will have discussed in person with Your Excellency, I must tell you how the sculptor Jos. Canart has offered to send to the grottoes the marble worker who has already cut out the aforementioned paintings so he can continue removing the rest that remain.<sup>8</sup>

*Figure 2, below left. Room 7 in the Villa of Varano. Castellammare di Stabia. The figural scene at the left has been deliberately damaged, while other parts at the right have been removed. Photographed in 1974.*

*Figure 3, below right. North wall of the oecus in the Casa di Argo. Herculaneum. The lacunae contained architectural vistas (bottom left and right) and vignettes (bottom center); other parts have suffered natural deterioration. Photographed in 1974.*

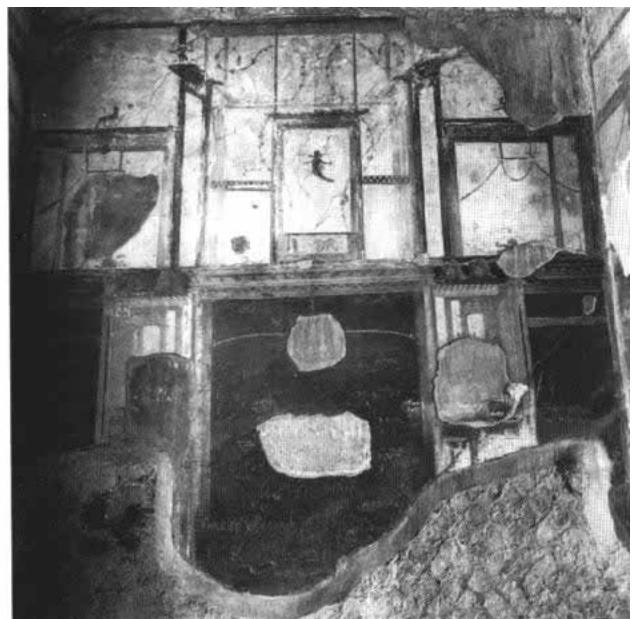
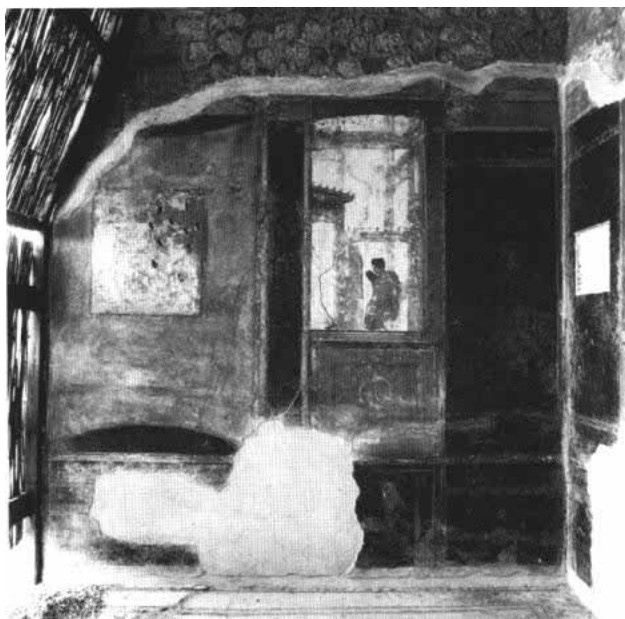

This practice was continued in the following years, although it is not clear whether the varnish was applied in the tunnels or only in Paderni's atelier.

Wall painting fragments that were not brought out intact or that broke during transport were destroyed systematically (see Figs. 2, 3). The workmen were prevented from taking them and selling them to tourists, especially to the English *milordi*, who were thought by the Neapolitan excavators to be real vultures. Even painted surfaces not selected for detachment were not saved from the excavators' destructive hands. We find remarks about picking at them with axes and other tools, for example in Paderni's report of April 20, 1761 (Ruggiero 1885:347):

Yesterday I received two dispatches from Your Excellency, one dated the 14th, the other the 18th of this month; the former reads that Your Excellency commands me that I must ensure that those ancient colored useless intonacoes found in the royal excavations are destroyed in my presence; what Your Excellency orders will be done precisely.<sup>9</sup>

But on November 12, 1763, Tanucci wrote to d'Alcubierre (Ruggiero 1881:206):

Don Camillo Paderni is ordered that he must not dare to lay hands on the antique murals found in the excavations without first referring to His Majesty, because it is not up to this Paderni to decide which paintings have to be carried away from the excavations and which have to remain, because the king has heard to his horror that many of the above-mentioned old paintings have been smashed. Therefore His Majesty commands me to have Your Excellency look after the execution of His Sovereign's resolution.<sup>10</sup>

More explicitly, Tanucci wrote to d'Alcubierre on January 21, 1764 (Ruggiero 1885:434):

Mr. Jos. Canart has informed the king privately by means of the attached report about the state of the paintings in the royal excavations which were damaged from blows of a pickaxe, a fragment of which was sent to the king. And His Majesty commands me to give Your Excellency the enclosed fragment of these paintings and that you look and examine it and express your opinion privately.<sup>11</sup>

The testimony of one of the workmen's supervisors describes the same illegal practice (January 25, 1764, Fiorelli I[2]:146):

From testimony of supervisor Antonio Scognamiglio, authorized by the notary Iennaco from Torre Annunziata, it is clear that by order from Don Camillo Paderni the paintings, which he thought were insignificant, were destroyed by breaking the plaster on which they were painted with pickaxes.<sup>12</sup>

Around Christmas 1763 Paderni went to Rome for a short leave (Fiorelli I[2]:146), during which tempers cooled down, but later continued his job in an arduous way. The quarrel seems to have centered more on his compe-



tence than on real opposition to the practice of extracting and destroying paintings, though Winckelmann states in his *Nachrichten* (1764:32):

It is a matter of complaint that those paintings which are not considered to be important and are not to come into the royal museum are damaged and defaced on express command of the royal government, lest they come into foreign hands.<sup>13</sup>

In various houses and public buildings in Herculaneum, Stabiae, and Pompeii visitors can still observe the scars of this hacking with picks. In some cases, of course, this may reflect the Roman practice of keying a wall in preparation for a new layer of plaster. Figure 2 shows an example of damaged walls from the Bourbon excavations in the Villa of Varano at Castellammare di Stabia.<sup>14</sup> Fortunately, it was not long after the start of the excavations in Pompeii that this kind of destruction ended. The open-air excavations from 1764 forward made the site accessible to tourists, and although the cutting out of precious fragments increased, that of small ornamental pieces stopped almost completely. For the first time the excavators were able to see complete wall designs and could make clearer choices.

The first example of a complete mural to be detached was found July 13, 1755, in the Praedia of Julia Felix, one of the first houses to be explored thoroughly. Here scenes of the forum and of the muses were found at the same time,<sup>15</sup> an event about which an accurate account has survived (Fiorelli I[1]:25):

And recently they discovered in the same place a painted facade of a wall, 17 *palme* and 9 *oncie* wide, 8 *palme* high, in which are various figures and representations, among which are a man carrying a pot of flowers on his back, a woman next to the man, some architectural elements, and, furthermore, a chair, a papyrus, two books with some letters, and other

Figure 4, below left. South wall of the triclinium in the Casa di Spurius Mesor. Pompeii. Reconstruction by A. Mau c. 1880.

Figure 5, below right. The triclinium in Figure 4. Photographed in 1970.

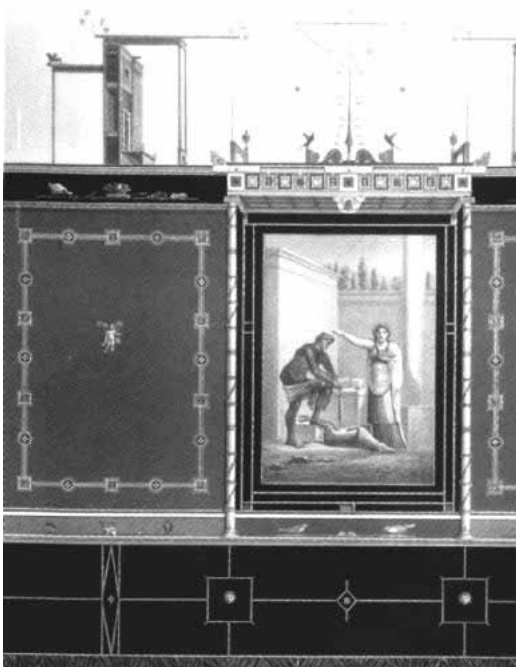

things. And having discussed this painting with the sculptor Canart yesterday evening at Portici, I have persuaded him to cut it cleanly, which he seems inclined to do despite the described length of 17 *palme* and 9 *oncie*. Otherwise, it would be appropriate first to draw the whole facade, including in this drawing the cornice which it has above.<sup>16</sup>

Some months later we find reports of a large wall painting in the Maseria Cuomo, now known as the Insula occidentalis VI 40, in a complex built over the ancient city walls at the seaside. Identifying the original locations for such references can be problematic. In this case, however, part of the edge of the painting was recently found in one of the rooms in that complex making it possible to locate this fragment, formerly associated with the Praedia of Julia Felix or the Villa of Diomedes, which were excavated simultaneously (Moormann 1988:203-204; Kockel 1986:514, n. 271).

Up until the 1880s this policy was not called into question. Sometimes paintings were left in situ to give people the impression of a complete scheme of Roman decoration, but the excavators continued to remove most of the best figural scenes (see Figs. 4, 5). Still today fragments are cut out, even if only when they cannot be conserved adequately in situ.

To return to the eighteenth century, we can read in contemporary travel books and other descriptions that the murals left in situ were not protected in any way and thus were soon lost (compare Figs. 6 and 7). In the amphitheater, for example, a severe frost completely destroyed the painted decoration of the wall around the cavea on February 3, 1816, only a few years after the excavation (Fiorelli I(3):179; *Pompei* 1748-1980 1981:36-39, figs. 4-6; 196-99, figs. 1-3). It was only in the 1860s that Giuseppe Fiorelli, one of the editors of the eighteenth-century excavation reports, started to think about covering the most important rooms. But only the excavation of the Casa dei Vettii in 1894 led to the policy of completely restoring and reconstructing houses and of leaving all finds in situ as far as possible (Presuhn 1881; Overbeck and Mau 1884:25-30; Maiuri 1950; Kockel 1985 and 1986).

*Figure 6, right. West wall of Room 12 in the Villa of Varano. Castellammare di Stabia. Photographed in 1982.*

*Figure 7, far right. Painting from east wall of Room E in the Villa of Varano. Castellammare di Stabia. Naples, Museo Archeologico Nazionale 8912.*

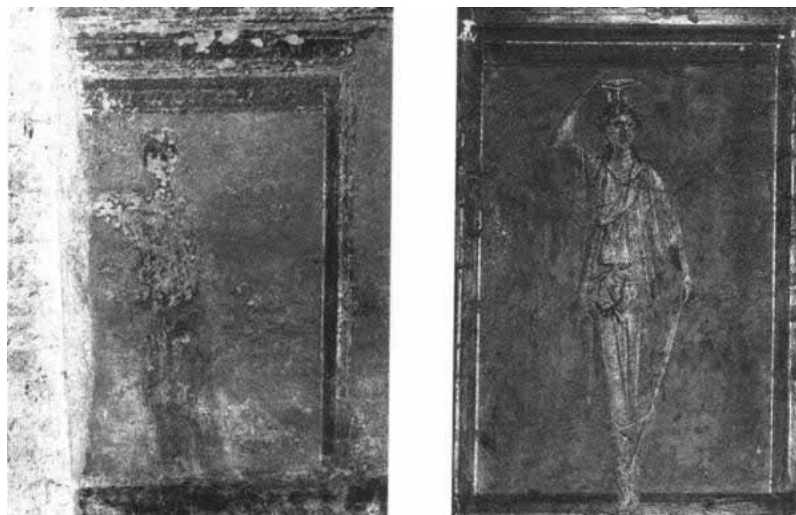

## *Treatment in the Museum*

Fragments transported to the royal palace at Portici were studied by members of the Accademia Ercolanese.<sup>17</sup> Though a sculptor, Canart not only restored marble objects but also was in charge of treating paintings, as we have seen. All objects were inventoried by Paderni and given a sequential Roman numeral. Nowadays these numbers are useful for tracing the find date and original location. In collaboration with Paderni, Canart fitted fragments together into red-painted wooden frames in which the pieces were laid in a bed of gypsum and mortar. Arrangements of single pieces were determined by taste and convenience. The paint surface was covered with the varnish discussed above, which often yellowed and attracted dust. Thus many pieces are very dark today and do not show their original brilliance (see Fig. 1, right side). A certain number of the old frames are deeper than necessary and must have held panes of glass. In the 1850s, during a reorganization of the Museo Archeologico Nazionale under the direction of Minervini, most of the old frames were replaced by those we see today.

If a piece did not fill a normal rectangular frame, the restorers did not hesitate to fit other small fragments around it to form a *quadro*. *Quadretti* artificially composed of small fragments belonging to one or more different decorative schemes were also created (see Fig. 8; Allroggen-Bedel and Kammerer-Grothaus 1980). In my opinion most of the framing decisions were determined by the positioning of the framed fragments in the Museum, whose walls were completely covered with paintings.

As we have seen, even incomplete scenes and motifs were considered worthy of detachment and were brought to the Museum, such as Figure 9 showing a Nereid on a sort of seahorse, of which the upper part is missing. The modern scholar often is not able to do more with these paintings than describe them and use them for iconographical purposes, just as Wolfgang Helbig did in 1868 in his description of the figural paintings.<sup>18</sup> Sometimes it is even impossible to date such excised fragments, although Campanian painting in general is readily

*Figure 8. Four wall painting fragments. Provenance unknown. Naples, Museo Archeologico Nazionale 9409. Here form and subject determined the combination in one frame.*

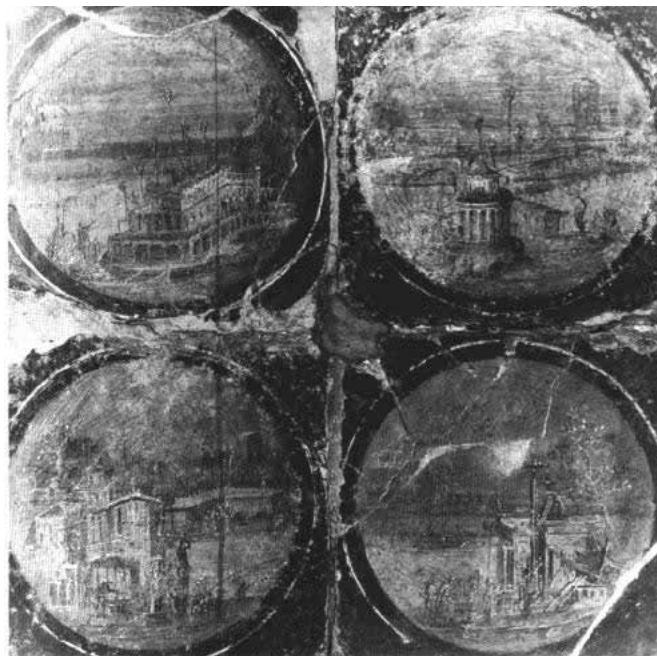
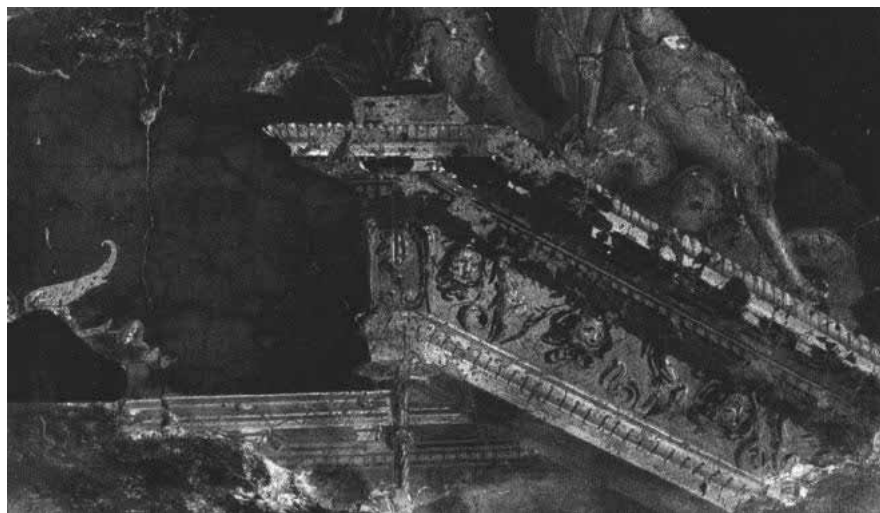

Figure 9. Wall painting fragment.  
 Provenance unknown. Naples,  
 Museo Archeologico Nazionale  
 9787. In removing this detail the  
 figure of the Nereid at upper right  
 was cut through.



dated using the 1882 classification of August Mau into four styles, since refined.<sup>19</sup> One of the first to deal with these old finds in both an historical (archival) and archaeological way, Allroggen-Bedel has demonstrated that it is still possible to reconstruct a considerable portion of these decorations, reassigning them to their original context in the buildings in Pompeii, Herculaneum, and Stabiae, and has thus proven the adequacy of the documentation of the eighteenth-century excavators (Allroggen-Bedel 1977; Allroggen-Bedel and Kammerer-Grothaus 1980; Moormann 1986:123, notes 3, 4).

Winckelmann wrote of the varnish put on the fragments which made it impossible to study their original surfaces and to determine whether the painting was done *alfresco* or *a secco* (Winckelmann 1762:30). The composition of these varnishes remains unknown, although we possess an account of the various materials purchased for the fabrication in a financial declaration by Morricone (Ruggiero 1885:71): "*spirito di rosmarina, spirito di spico, spirito d'acquavite, gomma cupale, carabi, gumma climi, sandareca.*"<sup>20</sup> Although we do not know exactly how these and other ingredients were mixed, we can imagine a treatment consisting of washing the fragments with water and covering them with gum arabic thinned with *aqua regia*. The washing was soon abandoned, however, as it bleached and damaged the colors. Most fragments in the museum are still covered with this gluey film.

In a description by La Vega we find mention of another technical aspect of the treatment done at the Museum. Fragments seem to have been arranged on a piece of what the report calls *pietra di Genova*. Probably slate is meant; that material was found in great quantities in the neighborhood of Genoa and also in southern Italy. Perhaps the term La Vega used was a northern Italian one that had penetrated to the south, replacing *lavagna*. I do not know of traces of stone in the fragments at the Naples museum.

In addition to the reports of treatments with varnish, we read also of experiments with hot wax. These were seen as reconstructions of the ancient Roman encaustic technique, described by Vitruvius in his handbook for architects, *De architectura* VII, 9.<sup>21</sup> Painters would either have prepared the surfaces with melted wax, or painted with pigments combined with wax that would then

have been burned into the plaster, providing great durability. Similar techniques are known to have been used for wooden panels and the surfaces of marble statues and reliefs. The French antiquarian the Comte de Caylus published a study of encaustic techniques in the 1760s and pointed out that mural paintings treated in this way should have a longer lifetime and a brilliant appearance. Since then the problem of encaustics has been dealt with by Otto Donner von Richter, Selim Augusti, and others (Donner von Richter 1868; Augusti 1967; Mielsch 1981:184-186, 252). Unfortunately the practice was immediately imitated at Portici and later at Pompeii on paintings in situ. Although initially the paintings seemed indeed to be more lustrous and clear, after years of heat and humidity, the wax became white and the painted surfaces deteriorated, having had normal evaporation restricted. The fragments in the Museo Archeologico Nazionale have not suffered in the same way from climatological effects, but show an equally unnatural brilliance and sometimes even become white or crusty.

*Figure 10, right. Adonis and Venus in the Casa dell'Adone Ferito. Pompeii. Note the use of lead cramps and the mortar repairs. Photographed in 1930.*

*Figure 11, below right. Detail of Fig. 10. Photographed in 1982.*



Even more serious than the treatment with wax was the lack of shelter in most of the houses in Pompeii (see Pl. 43; Kockel 1986:503, ill. 37, 38), lamented by Winckelmann (1762, 1764), Goethe (in 1787),<sup>22</sup> and many others. Nevertheless some measures were taken and we find early descriptions of lead cramps installed to prevent the plaster layers from falling off the wall. However, many of these have gradually come away leaving holes and other damage (compare Figs. 10 and 11). Workmen smeared the edges of the paintings with ordinary mortar, which even nowadays has not always been replaced by better materials.

Most of the murals of Campania should be considered as wallpaper, replaced every generation or whenever a new trend appeared in interior decoration. Only a few of these decorations were considered valuable and treated with care by the Romans themselves. Illustration for this remark is the almost complete absence of names of artists, either in the painted complexes themselves or in the literary sources.

Our task of conserving the paintings is enormous. Since 1977 Mariette de Vos has supervised a photodocumentation campaign at Pompeii. In 1980 she calculated that the number of extant paintings represents only ten percent of what was found, since we must imagine that nearly every wall was covered with stucco (*Pompei 1748-1980*: 1981; Bragantini, et al. 1981-1986: Prefaces). Another ten percent is known through drawings or photographs. Although nearly too great a task to complete, conservation is still possible if a well-organized international collaboration of archaeologists and restorers can be realized.

## Notes

---

1. Fiorelli 1860-1864; Ruggiero 1881; 1885. Further publications are discussed in Kockel 1985:501-507.

2. Kockel 1985:501-510. For the Praedia of Julia Felix, see Tran 1974:25-34, and Moormann 1988:160-161.

3. *Para la buena dirección de sacarle ha assistido también el referido estatuario Jos. Canart, con el que he observado en la pared vecino al lugar en que está la referida estatua, que hay un friso, pintados en una parte dos leones y en otra un dragón y un delfín. Y el dho estatuario dize que en Roma y más en Inglaterra se aprecian muchísimo estas pinturas, las cuales se quitan de semejantes parajes. Y que si S. M. la aprueba verá él mismo de sacar dos pedazos que el uno tendrá 6 pal. y medio de largo y el otro dos pal. y medio, todos dos con un pal. y medio de altura; sobre lo qual espero las órdenes de V. E.* (Ruggiero 1885:33).

4. A good pictorial overview of the paintings can be found in a huge and glossy but scientifically uninformative volume, Borriello et al. 1986. See also Elia 1932.

5. *Civiltà del '700 a Napoli*, Florence, 1979. See especially the contributions by F. Zevi and C.G. Argan.

6. See Presuhn 1881:29-31. Cinnabar turns black, and blue and green turn black because of the influence of saltpeter.

7. *Y no faltando yo en instar al estatuario Jos. Canart para que se vayan sacando estas pinturas, me dize que conviene prim. haga algunas experiencias poniéndole algún barniz para ver de que no se pierdan en sacarles de las grutas y estar al ayre, como se ha experimentado con la primera pintura* (Ruggiero 1885:37).



8. *Con carta de la datta de ayer que me ha traydo el Cavallero D. Marzello Venuti se ha servido mandarme V. E. assistiesse al mismo y al oficial de artillería que ha venido aquí con él, para hacer el último algunas pruebas con los vernizes que ha traydo, en las pinturas de las grutas, donde se está excavando a Resina. Yhaviendo dado puntual complim. á ello, he observado que el uno en especial de los dos vernizes que ha traydo, revive y deja tan claras las sobredhas pinturas quanto se puede desear, á lo que yo comprendo. Y remitiéndome á lo que el mismo Cavallero Benuti habrá expuesto á boca á V. E., devo manifestarle como me ha ofrecido el estatuario Jos. Canart enbiasá á las grutas al marmolero práctico de cortar las citadas pinturas que vaya continuando en sacar las demás que faltan* (Ruggiero 1885:38).

9. *Ricevei ieri due dispacci di V. Ecc., uno in data de' 14 e l'altro de' 18 corr.; U primo contiene che V. E. mi ordina che in mia presenzafacciagettare a terra quelle tonache antiche colorite inutili che si rinvencono nei R. scavi; che quanto l'E. V. impone esattamente sarà eseguito.* (Ruggiero 1885:347).

10. *Viene ordinato a D. Camillo Paderni che non ardisca por mano sulle pitture antiche che s'incontrano nelle scavazioni, senza prima referirsi alla S. M., non appartenendo ad esso Paderni il decidere quali pitture debbano trarsi dagli scavi e quali rimanervi, giacchè il Re ha sentito con orrore che molte delle suddette pitture antiche si sono fatte diroccare. Mi comanda dunque la M. S. prevenirne V. S. per l'adempimento della Sovrana risoluzione* (Ruggiero 1881:206).

11. *Ha D. Gius. Canart coll'annessa rappresentanza ragguagliato al Re riservatamente lo stato delle pitture de' R. Scavi, delle quali ne ha rimesso un pezzo e che sono state danneggiate dai colpi di piccone. E mi comanda S. M. rimettere a V. S. l'ingiunto pezzo delle dette pitture e dirle che veda questo, esami e dica riservatamente il suo parere* (Ruggiero 1885:434).

12. *Da un attestato di Antonio Scognamiglio capomastro, autenticato dal notaro Iennaco di Torre Annunziata si rileva, che per ordine di D. Camillo Paderni, le pitture che da lui si stimavano inutili, venivano distrutte, rompendosi con i picconi le toniche su cui esse stavan dipinte* (Fiorelli I[2]:146).

13. *Es ist zu beklagen, daß diejenigen Gemähde, welche nicht beträchtlich geachtet werden, und nicht für das königliche Museum bestimmt sind, auf ausdrücklichen Befehl der königlichen Regierung zerfetzt und verderbet werden, damit dieselben nicht in fremde Hände gerathen* (Winckelmann 1764:32). On Winckelmann's travels see Justi 1872:190-198.

14. Allroggen-Bedel 1977:50-52, pls. 18, 19. This article is a masterpiece in its use of archival documents to reconstruct the original situation and its discussion of the murals themselves.

15. The first complete mural is Naples, Museo Archeologico Nazionale 8598 (see Croisille 1965:28-29, pls. 28, 97, 102, 110). On the muses and forum scenes, see Moormann 1988:160-161.

16. *Y ultimamente se ha descubierto en el proprio paraje una fachada de un muro pintada 17 pal. y 9 on. larga y 8 pal. alta, en la qual hay diversas figuras y representaciones, y en ellas un hombre que lleva un tiesto de flores ensima la palda, una muger junta al hombre, diversas porciones de architectura, y mas un sello, un papyro, dos libros con diversos caracteres y otras cosas. Yhaviendo ablado ayer tarde en Portici con el escultor Joseph Canart sobre esta pintura, lo he persuadido a cortarla sana, à lo que parece inclinar sin embayo de ser la longitud citada de 17 pal. y 9 on., y en caso contrario seria muy conveniente el diseñar primero toda la expresada fachada, incluyendo en el diseño la cornissa que lieve ensima* (Fiorelli I[1]:25).

17. For the eighteenth-century restorations and the Museum, see Rossignani 1967, and Allroggen-Bedel and Kammerer-Grothaus 1980, to whom we owe a reconstruction of the arrangement of the finds in the Museum Herculanense and of the way they were treated by Paderni and Canart.
18. Helbig 1868. Still important is Schefold 1957:300-357.
19. See, for example, Herbig 1962, in which many of the pieces discussed actually belong to the Fourth Style, i.e., to the second half of the first century A.D. On chronology, see Barbet 1985 for a recent discussion.
20. Rossignani 1967:38-39, quoted in full in n. 160.
21. See Cagiano de Azevedo 1960:331-335, entry for *encausto*; Calabi Limentani 1960:342, entry for *enkaustès*.
22. For Goethe's reaction, see Schiering 1986:61, 253.

## References

### Allroggen-Bedel, Agnes

- 1977 "Die Wandmalereien aus der Villa in Campo Varano." *Mitteilungen des Deutschen Archäologischen Instituts, Römische Abteilung* 84:27-89.

### Allroggen-Bedel, Agnes, and Helke Kammerer-Grothaus

- 1980 "Das Museo Ercolanese in Portici." *Cronache Ercolanesi* 10:175-217.  
(Also published as "Il Museo Ercolanese di Portici." In *La Villa dei Papiri*, 2. *Supplemento Cronache Ercolanesi* 13:83-128.)

### Ashby, Thomas

- 1914 "Drawings of Ancient Paintings in English Collections, I: The Eton Drawings." *Papers of the British School at Rome* 7:1-62.

### Augusti, Selim

- 1967 *I colori pompeiani*. Rome: De Luca.

### Barbet, Alix

- 1985 *La peinture murale romaine: les styles décoratifs pompéiens*. Paris: Picard.

### Borriello, Maria Rosario, Oreste Ferrari, and Enrica Pozzi

- 1986 *Le collezioni del Museo Nazionale di Napoli: I mosaici, le pitture, gli oggetti di uso quotidiano, di argenti, le terrecotte invetriate, i vetri, i cristalli, gli avori*. Rome: De Luca.

### Bragantini, Irene, Mariette de Vos, and Franca Parise Radoni

- 1981-1986 *Pitture e pavimenti di Pompei*. 3 vols. Rome: Ministero per i beni Culturali e ambientali, Istituto centrale per il catalogo e la documentazione.

### Cagiano de Azevedo, Michelangelo

- 1960 Entry for *encausto*. *Enciclopedia dell'arte antica* 3:331-335.

### Calabi Limentani, Ida

- 1960 Entry for *enkaustès*. *Enciclopedia dell'arte antica* 3:342.

### Civiltà del '700 a Napoli.

- 1979 Florence: Electa.

**Croisille, Jean-Michel**

- 1965 *Les natures mortes campaniennes: répertoire descriptif des peintures de nature morte du Musée National de Naples, de Pompéi, Herculaneum et Stabies.*  
Brussels: Latomus.

**Donner von Richter, Otto**

- 1868 "Die erhaltenen antiken Wandmalereien in technischer Beziehung." In  
Helbig 1868:i-cxxviii.

**Elia, Olga**

- 1932 *Pitture romane nel Museo Nazionale di Napoli.* Rome: Libreria dello Stato.

**Fiorelli, Giuseppe**

- 1860-1864 *Pompeianarum antiquitatum historia.* 3 vols. Naples: Stamperia Poliglotta.

**Helbig, Wolfgang**

- 1868 *Wandgemälde der vom Vesuv verschütteten Städte Campaniens.* Leipzig:  
Breitkopf und Härtel.

**Herbig, Reinhard**

- 1960 "Don Carlos von Bourbon als Ausgraber von Herculaneum und  
Pompeji." *Madridrer Mitteilungen* 1:11-19.
- 1962 *Nugae Pompeianorum: Unbekannte Wandmalereien des dritten pompejani-  
schen Stils.* Tübingen: Wasmuth.

**Justi, Carl**

- 1872 *Winckelmann und seine Zeitgenossen. II: Winckelmann in Rom.* Leipzig:  
F.C.W. Vogel.

**Knight, Carlo, and Andrea Jorio**

- 1980 "L'ubicazione della villa ercolanese dei Papiri." *Rendiconti dell'Accademia  
di Archeologia, Lettere e Belle Arti, Napoli* 55:51-65, pl. xxxviii.

**Kockel, Valentin**

- 1985 "Archäologische Funde und Forschungen in den Vesuvstädten, I."  
*Archäologischer Anzeiger* 495-571.
- 1986 "Archäologische Funde und Forschungen in den Vesuvstädten, II."  
*Archäologischer Anzeiger* 443-569.

**Maiuri, Amedeo**

- 1950 "Gli scavi di Pompei dal 1879 al 1948." In *Pompeiana; raccolta di Studi per  
il secondo centenario degli scavi di Pompei* 9-40. Naples: G. Macchiaroli.

**Mielsch, Harald**

- 1981 "Funde und Forschungen zur Wandmalerei der Prinzipatszeit von 1945  
bis 1975, mit einem Nachtrag 1980." *Aufstieg und Niedergang der römi-  
schen Welt* II(12):157-264.

**Moormann, Eric M.**

- 1986 "Un fior di giardino ed altri frammenti di pittura ercolanese." *Cronache  
Ercolanesi* 16:123-133.
- 1988 *La pittura parietale romana come fonte di conoscenza per la scultura antica.*  
Assen and Wolfenbüttel: Van Gorcum.

**Overbeck, Johannes A., and August Mau**

1884 *Pompeji in semen Gebäuden, Alterthümern und Kunstwerken dargestellt.* Leipzig: W. Engelmann.

***Pompei 1748-1980: i tempi della documentazione***

1981 A cura dell'Istituto centrale per il catalogo e la documentazione; con la collaborazione della Soprintendenza archeologica delle provincie di Napoli e di Caserta e della Soprintendenza archeologica di Roma. Rome: Multi-grafica Editrice.

**Presuhn, Emil**

1881 *Pompeji: Die neuesten Ausgrabungen von 1874 bis 1881.* Leipzig.

**Rossignani, Maria Pia**

1967 "Saggio sui restauri settecenteschi ai dipinti di Ercolano e Pompei." *Contributi dell'Istituto Archeologico dell'Università Cattolica di Milano* 1:7-133.

**Ruggiero, Michele**

1881 *Degli scavi di Stabia dal 1749 al 1782.* Naples.

1885 *Storia degli scavi di Ercolano.* Naples.

**Schefold, Karl**

1957 *Die Wände Pompejis; topographisches Verzeichnis der Bildmotive.* Berlin: W. de Gruyter.

**Schiering, Wolfgang**

1986 "Goethe und die antike Kunst." In *Goethe in Italien: eine Ausstellung des Goethe-Museums Düsseldorf, Anton-und-Katharina-Kippenberg-Stiftung.* Mainz: P. von Zabern.

**Tran, Tam Tinh**

1974 *Catalogue des peintures romaines (Latium et Campanie) du musée du Louvre.* Paris: Editions des Musées nationaux.

**Winckelmann, Johann Joachim**

1762 *Sendschreiben von den herculanischen Entdeckungen an den hochgeborenen Herrn, Herrn Heinrich Reichsgrafen von Brühl.* Dresden: G.C. Walther.

1764 *Nachrichten von den neuesten herculanischen Entdeckungen an Herrn Heinrich Fuessli aus Zürich.* Dresden: G. C. Walther.

**Biography**

Dr. Eric M. Moormann is a lecturer in the Department of Classical Archaeology at the University of Amsterdam. His research focuses on Pompeii, Herculaneum, and Stabiae, including the history of the excavations. In addition to various essays on these sites, he published a monograph on Roman painting, *La pittura parietale romana come fonte di conoscenza per la scultura antica*, in 1988.



# Monitoring Wall Paintings Affected by Soluble Salts

*Andreas Arnold and Konrad Zehnder*

In recent decades it has often been observed that wall paintings decay more rapidly after conservation. Accelerated deterioration of cultural property is commonly attributed to air pollution, however, closer examination of the nature and processes of the decay phenomena in wall paintings reveals that a principal cause is the activity of soluble salts. To preserve the paintings, it is indispensable to understand the genesis and behavior of the salt concentrations, the chemical and physical processes damaging the paintings, and the conditions under which decay occurs.

Weathering by salts is an old but still unsolved conservation problem. Salt-bursting tests have been made for at least 150 years, and numerous studies, mainly theoretical, have been carried out to explain how crystallization and hydration pressures build up and how they can burst stone and plaster structures. But until now no comprehensive work has been published on the ways in which salts disrupt these porous structures. So it may be useful to review briefly the general evolution of salt systems in walls in order to understand the special problems of wall paintings.

## *Salts Found in Walls*

Practically all walls contain soluble salts, either dispersed within the porous materials or concentrated locally. They may be present as efflorescences forming different aggregates of crystals with various forms and habits on the surface, as subflorescences forming crystalline aggregates below the surface, and as solutes in aqueous solutions on and within the walls.

The principal salts known to occur in walls are carbonates, sulfates, chlorides, nitrates, and oxalates of sodium, potassium, calcium, magnesium and ammonia (Table 1). The different salt species, precipitated from the multicomponent systems, vary considerably according to the materials present. The kind of salt may, therefore, very often give indications of its origin. Ettringite and thaumasite, for example, are mainly known from concrete, but now they contribute to the decay of walls in historic buildings that have been reinforced with concrete or grouted with Portland cement.

The oxalates whewellite and weddellite have previously been assumed to result from conservation treatments, but have recently been found on old marbles from monuments as well as on natural outcroppings of carbonate rocks (Del Monte and Sabbioni 1987; *Pellicole ad ossalato* 1989). Gorgeyite is known from Faller (1987).

Table 1. Salts present in walls.

Carbonates	Calcite	$\text{CaCO}_3$	
	Dolomite	$\text{CaMg}(\text{CO}_3)_2$	
	Magnesite	$\text{MgCO}_3$	
	Nesquehonite	$\text{MgCO}_3 \cdot 3\text{H}_2\text{O}$	
	Lansfordite	$\text{MgCO}_3 \cdot 5\text{H}_2\text{O}$	
	Hydromagnesite	$\text{Mg}_5[\text{OH}(\text{CO}_3)_2]_2 \cdot 4\text{H}_2\text{O}$	
	Natron	$\text{Na}_2\text{CO}_3 \cdot 10\text{H}_2\text{O}$	
	Thermonatrite	$\text{Na}_2\text{CO}_3 \cdot \text{H}_2\text{O}$	
	Nahcolite	$\text{NaHCO}_3$	
	Trona	$\text{Na}_3\text{H}(\text{CO}_3)_2 \cdot 2\text{H}_2\text{O}$	
	Kalicinite	$\text{KHCO}_3$	
	Sulfates	Gypsum	$\text{CaSO}_4 \cdot 2\text{H}_2\text{O}$
Bassanite		$\text{CaSO}_4 \cdot 1/2\text{H}_2\text{O}$	
Epsomite		$\text{MgSO}_4 \cdot 7\text{H}_2\text{O}$	
Hexahydrate		$\text{MgSO}_4 \cdot 6\text{H}_2\text{O}$	
Kieserite		$\text{MgSO}_4 \cdot \text{H}_2\text{O}$	
Darapskite		$\text{Na}_3(\text{SO}_4)(\text{NO}_3) \cdot \text{H}_2\text{O}$	
Mirabilite		$\text{Na}_2\text{SO}_4 \cdot 10\text{H}_2\text{O}$	
Thenardite		$\text{Na}_2\text{SO}_4$	
Arcanite		$\text{K}_2\text{SO}_4$	
Bloedite		$\text{Na}_2\text{Mg}(\text{SO}_4)_2 \cdot 4\text{H}_2\text{O}$	
Picromerite		$\text{K}_2\text{Mg}(\text{SO}_4)_2 \cdot 6\text{H}_2\text{O}$	
Boussingaultite		$(\text{NH}_4)_2\text{Mg}(\text{SO}_4)_2 \cdot 6\text{H}_2\text{O}$	
Syngenite		$\text{K}_2\text{Ca}(\text{SO}_4)_2 \cdot \text{H}_2\text{O}$	
Gorgeyite		$\text{K}_2\text{Ca}_3(\text{SO}_4)_6 \cdot \text{H}_2\text{O}$	
Aphthitalite		$\text{K}_3\text{Na}(\text{SO}_4)_2$	
Ettringite		$\text{Ca}_6\text{Al}_2(\text{SO}_4)_3(\text{OH})_{12} \cdot 26\text{H}_2\text{O}$	
Thaumasite		$\text{Ca}_3\text{Si}(\text{OH})_6(\text{CO}_3)(\text{SO}_4) \cdot 12\text{H}_2\text{O}$	
Chlorides		Bischofite	$\text{MgCl}_2 \cdot 6\text{H}_2\text{O}$
		Antarcticite	$\text{CaCl}_2 \cdot 6\text{H}_2\text{O}$
		Tachyhydrite	$\text{CaMg}_2\text{Cl}_6 \cdot 12\text{H}_2\text{O}$
	Halite	$\text{NaCl}$	
	Sylvite	$\text{KCl}$	
Nitrates	Nitrocalcite	$\text{Ca}(\text{NO}_3)_2 \cdot 4\text{H}_2\text{O}$	
	Nitromagnesite	$\text{Mg}(\text{NO}_3)_2 \cdot 6\text{H}_2\text{O}$	
	Nitratite	$\text{NaNO}_3$	
	Niter	$\text{KNO}_3$	
	Ammonium Nitrate	$\text{NH}_4\text{NO}_3$	
Oxalates	Whewellite	$\text{Ca}(\text{C}_2\text{O}_4) \cdot \text{H}_2\text{O}$	
	Weddellite	$\text{Ca}(\text{C}_2\text{O}_4) \cdot 2\text{H}_2\text{O}$	

In some cases salts other than those listed above may be found. Magnesium and calcium formate have been found to deteriorate molasse sandstone previously cleaned with formic acid (Arnold and Zehnder 1983), and a calcium lactate salt has been detected that damaged a coating in a silo.



### *Origin of the Ions*

The salts that contribute to the deterioration of stone, wall paintings, glass, ceramics, and metal are the products of chemical and biogenic weathering of stone and other materials both in nature and on buildings, and of human activity. Salt accumulations in walls originate from the ions leached from rocks, soils, stone and other materials used in building, as well as those deposited from the compounds of natural and polluted atmosphere, and generated by the metabolism of organisms. All liquid water present in walls is more or less a dilute salt solution. For buildings, the following sources have to be considered: building stone and mortar, soil, materials used for conservation and repair, the (polluted) atmosphere, deicing salts, organisms, and unknown sources.

### *Original Building Materials*

When moist, the pores of stone, soil, mortar, and render are filled with dilute salt solutions. Porous stone may contain considerable amounts of salts. Zehnder (1982) has found that the molasse sandstone of eastern Switzerland may contain 150-1500 ppm of soluble sulfates. Thus a 10 cm thick plate of such sandstone would contain 30-300 g of sulfate, that is 3 to 30 times more than the annual deposition from the atmosphere of 3-10 g/cm<sup>2</sup> measured on molasse sandstone in Switzerland (Girardet and Furlan 1982; Arnold and Zehnder 1983). Bläuer (1987) has found 76-274 ppm of total soluble salt content (without Ca and Mg carbonates) in the molasse sandstone of Bern.

In many regions, the lime mortars of old buildings are often made of dolomitic lime. The dolomitic compounds may react with sulfate ions in water as follows (Zehnder 1982):

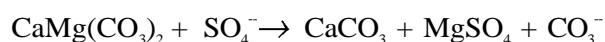

This partially explains the fact that whenever water percolates through walls in eastern Switzerland efflorescences and crusts mainly composed of magnesium sulfate are formed.

### *Ground Water*

The water in soil contains carbonate, sulfate, chloride, nitrate, magnesium, calcium, sodium potassium, and ammonium ions. Therefore, liquid water in soil, as in porous building materials, is more or less a dilute salt solution. Compared to normal soil, solutions present in soil near human activity are enriched in nitrate and chloride, nitrate being produced by microorganisms from organic refuse and chlorides being supplied by the consumption of sodium chloride.

### *Alkaline Building Materials*

Wall paintings are frequently cleaned chemically with acidic and alkaline products, treated with water glass (sodium silicate Na<sub>2</sub>SiO<sub>3</sub>) consolidants, or are located on walls that have been consolidated or isolated against humidity by means of injections of Portland cement, alkali silicates, siliconates, and similar products. It can be shown that most paintings decay very quickly after such

treatments. Thus the use of these incompatible materials for conservation and building repair is an extremely serious problem, at least as important as air pollution. Materials that give rise to salt deterioration are: acids, alkaline solutions, ionogenic tensides, Portland cement, water glass products, silicates, etc. Although most had been used earlier, they were further developed and their use expanded during the nineteenth and twentieth centuries. Modern architecture would be inconceivable without them. But they may become pernicious when used on ancient buildings and monuments, in the wrong places in the wrong manner, as they still frequently are, even on very sensitive artifacts such as wall paintings. One always must consider whether they may have been used in the recent past and may, therefore, be continuing to act as (mostly unnoticed) causes of deterioration. In current practice there is little appreciation of the damage such materials may cause and innumerable monuments are being damaged irreversibly.

Acids (hydrochloric, phosphoric, fluoric, formic, acetic, and others), alkaline solutions (caustic sodium and potassium, sodium potassium, and ammonium carbonate), and ionogenic tensides (e.g., sodium polyphosphates) are used as liquids and in poultices for cleaning. They all form more or less soluble salts. Even the frescoes of the Sistine Chapel have been cleaned using sodium and ammonium bicarbonate in some places (see the contribution by Colalucci in this volume). This does not mean that using them is always incorrect but that the possible secondary effects must be taken into account. It is obvious—but not sufficiently recognized in practice—that acid neutralized with alkaline solutions (and vice versa) always produces salts and that all soluble salts are harmful.

The most important deterioration has been observed from salts issuing from Portland cement and water glass products (Arnold 1985). Hardened Portland cement may contain up to 1% soluble alkalis (McCoy and Eshenour 1968). The ions leached from it form efflorescences of alkali carbonate salts. Since the amounts of Portland cement used in walls are very large, the quantities of soluble salts may become significant. As an example, 100 kg of Portland cement with a content of 0.1% of soluble  $\text{Na}_2\text{O}$  may produce 460 g of natrite ( $\text{Na}_2\text{CO}_3 \cdot 10\text{H}_2\text{O}$ ) or, when reacting with sulfuric acid from polluted air, 520 g of mirabilite ( $\text{Na}_2\text{SO}_4 \cdot 10\text{H}_2\text{O}$ ). Such quantities of salts, especially when locally concentrated and accumulated, lead to very serious and irreversible damage not only to wall paintings but also to stone and mortar.

Water glass, an invention of the beginning of the nineteenth century (Schiessl 1985), was used in the second half of the last century to quite an incredible extent for the consolidation of stone monuments and wall paintings. It has also been used to improve lime mortars and to consolidate plasters and wall paintings, and it is the binding medium of silicate paints.

Already in the nineteenth century the first failures in stone consolidation with alkali silicate were reported. The water glass formed a hard surface layer, which led to accelerated scaling. At least officially it is no longer used for stone consolidation, but it still is used in silicate paints as a consolidant for mortars and plasters. Most frequently, it is injected together with Portland cement to consolidate disaggregating walls and to isolate them against water.

After reaction, water glass may give up 30% of its weight of sodium carbonate and 20% of potassium carbonate. It is often maintained that potassium carbonate is harmless because it is so hygroscopic that it cannot crystallize. That is not the whole truth, however, because when in solution it forms dark spots on wall paintings, and reacting with earth alkali salts it transforms to potassium sulfate, chloride, or nitrate, all of which are less strongly hygroscopic and therefore, as will be shown below, crystallize under "normal" conditions.

Alkali carbonate salts react with the autochthonous salts in ancient walls (Arnold 1985). A synopsis of those reactions is given in Table 2. When exposed to an acidic atmosphere, the alkali carbonates will react to give, for example, sodium and potassium sulfates. When alkali carbonates react with autochthonous sulfates, nitrates, and chlorides of magnesium and calcium, carbonates of magnesium (hydromagnesite and nesquehonite) as well as calcite will precipitate as characteristic salt minerals. Since these carbonates are barely soluble, all the reactions shown in Table 2 will go to the right, and sulfates, chlorides, and nitrates of sodium and potassium will form. So the earth alkali sulfates, nitrates, and chlorides are transformed into alkali sulfates, nitrates, and chlorides.

Table 2. Reactions of Alkaline Salts in Walls.

Sources of salts:	Portland cement, water glass products, alkaline cleaning and sealing materials
Saline minerals:	natrite, thermonatrite, nahcolite, trona, kalicinite = sodium and potassium carbonates ( <b>Na<sub>2</sub>CO<sub>3</sub></b> and <b>K<sub>2</sub>CO<sub>3</sub></b> )
Reactions with acid atmosphere:	$\text{Na}_2\text{CO}_3 + \text{H}_2\text{SO}_4 \rightarrow \text{Na}_2\text{SO}_4 + \text{CO}_2 + \text{H}_2\text{O}$ $\text{K}_2\text{CO}_3 + \text{H}_2\text{SO}_4 \rightarrow \text{K}_2\text{SO}_4 + \text{CO}_2 + \text{H}_2\text{O}$
Reactions of alkali carbonates with sulfates (SO <sub>4</sub> ), nitrates [(NO <sub>3</sub> ) <sub>2</sub> ], and chlorides (Cl <sub>2</sub> ) of magnesium (Mg) and calcium (Ca):	$\text{Na}_2\text{CO}_3 + \text{MgSO}_4 \rightarrow \text{Na}_2\text{SO}_4 + \text{MgCO}_3 \quad   \quad \text{K}_2\text{CO}_3 + \text{MgSO}_4 \rightarrow \text{K}_2\text{SO}_4 + \text{MgCO}_3$ $\text{Na}_2\text{CO}_3 + \text{CaSO}_4 \rightarrow \text{Na}_2\text{SO}_4 + \text{CaCO}_3 \quad   \quad \text{K}_2\text{CO}_3 + \text{CaSO}_4 \rightarrow \text{K}_2\text{SO}_4 + \text{CaCO}_3$ $\text{Na}_2\text{CO}_3 + \text{Mg}(\text{NO}_3)_2 \rightarrow 2\text{NaNO}_3 + \text{MgCO}_3 \quad   \quad \text{K}_2\text{CO}_3 + \text{Mg}(\text{NO}_3)_2 \rightarrow 2\text{KNO}_3 + \text{MgCO}_3$ $\text{Na}_2\text{CO}_3 + \text{Ca}(\text{NO}_3)_2 \rightarrow 2\text{NaNO}_3 + \text{CaCO}_3 \quad   \quad \text{K}_2\text{CO}_3 + \text{Ca}(\text{NO}_3)_2 \rightarrow 2\text{KNO}_3 + \text{CaCO}_3$ $\text{Na}_2\text{CO}_3 + \text{MgCl}_2 \rightarrow 2\text{NaCl} + \text{MgCO}_3 \quad   \quad \text{K}_2\text{CO}_3 + \text{MgCl}_2 \rightarrow 2\text{KCl} + \text{MgCO}_3$ $\text{Na}_2\text{CO}_3 + \text{CaCl}_2 \rightarrow 2\text{NaCl} + \text{CaCO}_3 \quad   \quad \text{K}_2\text{CO}_3 + \text{CaCl}_2 \rightarrow 2\text{KCl} + \text{CaCO}_3$
Observed products:	hydromagnesite Mg <sub>5</sub> [OH(CO <sub>3</sub> ) <sub>2</sub> ] <sub>2</sub> • 4H <sub>2</sub> O nesquehonite MgCO <sub>3</sub> • 3H <sub>2</sub> O

Looking at Table 3 (p. 113), it can be seen that the nitrates and chlorides of calcium and magnesium show equilibrium relative humidities below about 53%. Such low relative humidities on material surfaces are found only exceptionally, for example, in strongly heated rooms (Arnold, Kueng, and Zehnder 1986); thus the nitrates of calcium and magnesium will crystallize only under exceptional conditions, and chlorides very probably not at all. But the newly

formed chlorides and nitrates of potassium and sodium, showing equilibrium relative humidities of between 75% and 96%, will crystallize easily and frequently in humid climates as will sodium and magnesium sulfates. Thus alkaline building materials not only supply more salts to the walls but also transform less harmful salts into more harmful ones.

#### *Polluted Atmosphere*

Acid dissolution and salt weathering are the main effects of polluted atmosphere on stone, mortar, painting, etc. Substances are emitted (*emission*) from natural and manmade sources, transmitted (*transmission*) over short or long distances, arrive in a certain local environment (*immission*), and are deposited as wet or dry particles and gases (*deposition*) on wet or dry surfaces with variable reactivities. These substances are mainly gases (CO<sub>2</sub>, SO<sub>2</sub>, N<sub>2</sub>O, NO<sub>2</sub>, NH<sub>3</sub>, CH<sub>4</sub>), liquid aerosols (acids, salt solutions), and solid aerosols (minerals, metal oxides, sulfides, soot, microorganisms, etc.).

The best-known effects are those of sulfur dioxide, sulfuric acid, and sulfates, which form the black crusts on urban buildings. But not all black crusts are gypsum. Oxalate and siliceous crusts and biologic films can look very similar. In the present context it may be interesting to note that the main deposition of sulfur compounds comes from local sources and that there are strong variations in deposited quantities. According to Girardet and Furlan (1982), dry deposition in western Switzerland is twenty times lower in a rural environment (Longirod, Jura Mountains) than in town (Lausanne) and eighty times lower inside the cathedral of Lausanne than outside. Even if atmospheric pollution is an important source of salt ions, it must not necessarily be considered the main source inside monuments and in rural environments.

#### *Deicing Salts*

Deicing salts, mainly chlorides, are scattered on roads during winter. They are carried to walls by water and also by wind when it becomes very cold.

#### *Biological Metabolism*

The importance of acids and salts produced by microorganisms is increasingly recognized. Chlorides and nitrates have always been concentrated around domestic dwellings because human beings and animals eat and excrete sodium chloride, while microorganisms produce nitrates from excrement and other waste. The biogenic source of saltpeter (potassium nitrate) has been well known for centuries, because it occurs on the walls of stables and in soil and has been made from putrefying plants on "saltpeter farms" to extract nitrate for making gunpowder. But in recent studies, the biogenic production of nitric acid and nitrates has been demonstrated in sandstones far away from soil. According to Bock (1986), nitrificant bacteria oxidize ammonia to nitrous acid, which then is oxidized to nitric acid by nitroso bacteria. Thousands of times more nitrificant bacteria than in garden mold have been found in stones high up on the Cologne cathedral. Ammonium sulfate from polluted air seems to be their nutritive sub-

stance. Nitric acid then forms nitrates, which react with the carbonate minerals in stone to produce nitrate salts. It is also suspected that sulfation can be catalyzed by microorganisms.

It is clear that the role of biogenic weathering has been underestimated. Nitrates certainly originate from biological metabolism, but until now there has been no known biogenic source for the chloride concentrations in similar quantities in the same zone of rising moisture.

### ***Transport, Accumulation, Solute Concentration, Precipitation, Fractionation, and Local Concentration***

In nature, salts leached from soil and by the weathering of stones are transported by surface and groundwaters to lakes and to the sea (*transport*). In lakes without outlet and in the sea, salt ions are supplied continuously and accumulate (*accumulation*). Where water evaporates, the solutions become more and more concentrated (*concentration of solutes*). Where and when a particular salt phase in the system becomes supersaturated, it precipitates (*precipitation*). From multicomponent solutions the different salt phases precipitate in sequences according to the different solubilities or ion activities; the system fractionates (*fractionation*). When fractionation occurs in a stationary solution (salt lake), one salt phase—or coexisting group of salt phases—after the other may precipitate at one place, forming a *chronological sequence*, whereas if the solution is moving, the salt phases will be deposited at different places, forming a *spatial sequence*. When salts dispersed over a large volume concentrate in distinct areas, they are locally concentrated (*local concentration*).

In buildings the same processes are observed, and the terms defined above can be used to describe them. Salt ions leached from the ground, building materials, depositions from polluted atmosphere, and from biological metabolism circulate in aqueous solutions within the walls and porous materials. Where water evaporates, salts accumulate and the solutes concentrate. Where and when supersaturation is reached, different phases precipitate and fractionate from multicomponent systems, most frequently forming spatial sequences of different salts. They become concentrated locally as efflorescences on surface areas, and as invisible subflorescences below the surface of the porous materials.

With the exception of very local salt creeping due to capillary effects of water films on salt surfaces, all salts are transported in aqueous solutions. All kinds of moisture in buildings will transport soluble salts. The water transporting the ions, originating from precipitation, surface and groundwaters, and condensation, flows along the wall surfaces or penetrates and percolates through all structures open and permeable to it. Thus salts are mobilized by all sources of liquid water. Without going into detail of the transport of water and moisture in walls, capillary rise may be used as an example of the evolution of a salt system in walls.

The processes of leaching, transport, accumulation, solute concentration, precipitation, fractionation, and local concentration occur within rising moisture in walls, and thus are characteristic for most salt concentrations. Virtually all his-

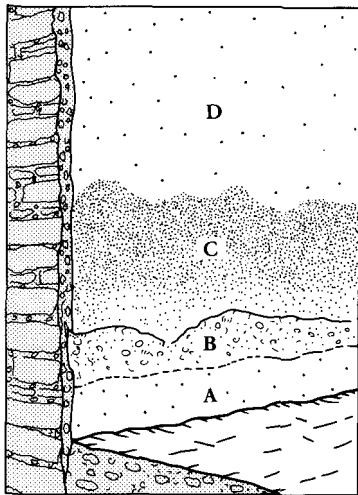

Figure 1. Different zones observed in the area of rising damp on a wall.

toric buildings and monuments show more or less pronounced damage at the bases of the walls due to surface and ground moisture. When wall paintings extend into such zones there is very often damage or complete destruction.

The extensive observations we have made show that in zones with ground moisture the sequence represented in Figure 1 (Arnold 1982; Arnold and Zehnder 1984) is more or less clearly developed. Zone A, just above the socle, shows distinctly less deterioration than Zone B. In Zone B, where most of the painting, mortar, and stone shows granular disintegration, crumbling, and scaling, the most salt efflorescences appear. They are mainly of sodium sulfate, magnesium sulfate, calcium sulfate, and potassium nitrate, but also of sodium carbonate. Thus a certain group of weakly to moderately soluble salts has caused the main deterioration in Zone B. Above, a somewhat deteriorated Zone C, generally appearing dark and damp, is particularly well developed on the walls of stables, churches, and other historic buildings. This zone can be from several centimeters to several meters high. Analyses show that in this zone chlorides and nitrates are locally concentrated and accumulated. Of course not all walls exhibit the entire sequence. When deterioration is well advanced, Zone A may be completely deteriorated too, and sometimes Zone C is not developed or is only just visible.

The distribution of the ions within these zones may be studied by making chemical analyses of aqueous extracts from samples taken along vertical profiles through the entire zone of rising damp, thus showing the whole sequence from A to C. The results of such analyses made from different monuments are presented in Figure 2. These sequences were traced by chemical analyses of the aqueous extracts of renders (Fig. 2a) and of cellulose poultices used for desalination of walls (Fig. 2b-d). The sequences correspond to the distribution of the efflorescences observed on the wall paintings in the convent church of Müstair (Arnold, Kueng, and Zehnder 1986) and on other monuments.

Figure 2a-d, left to right. Ion distribution along vertical profiles through the zone of rising damp, from chemical analyses of aqueous extracts of renders (a) and of cellulose poultices applied to desalinate the walls (b-d).

These profiles show that the salts are locally concentrated and accumulated in a zone from 0.5 m to 2.5-3 m above the ground level, corresponding largely to Zone C in Figure 1. This is situated above Zone B, mainly deteriorated by salt efflorescences under normal external conditions. It is particularly interesting to note that the greatest degree of deterioration does not occur where the most solutes are present. Because the ion mixture in Zone C is strongly hygroscopic, the salts are not usually able to crystallize under normal external condi-

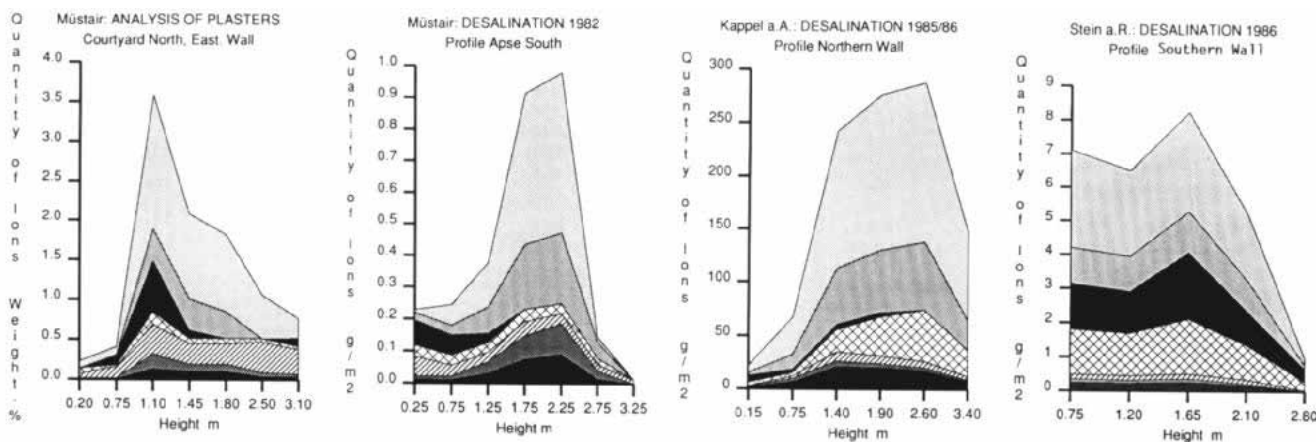
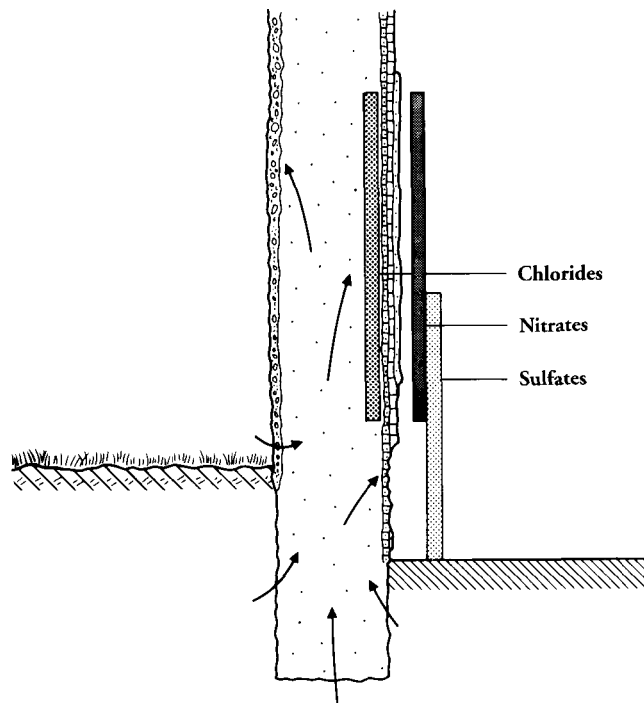

Figure 3. Model of the evolution of salt systems in relation to capillary rise of moisture, based on observations, documentation, and analyses made of the apses of the convent church of Müstair, Switzerland.

The transport of ions (Mg, Na, K, Ca, SO<sub>4</sub>, CO<sub>3</sub>, NO<sub>3</sub>, Cl) is indicated with arrows (see also Fig. 1).



tions in our climate. This zone is both damper and dirtier and therefore looks darker than the wall surface in the other zones.

Within this local concentration and accumulation, the different ions show different distributions but similar sequences on all monuments. The sulfates, as can be seen in Figure 2, are locally concentrated and accumulated in the lower Zones, A and B, while the nitrates and chlorides are strongly enriched in Zone C.

How can this distribution be explained? A model based on the analyses made in the apses of the convent church of Müstair is given in Figure 3. It may be explained as follows: the groundwater is a dilute solution composed of Na, K, Mg, and Ca as the principal cations, and NO<sub>3</sub>, Cl, SO<sub>4</sub>, and CO<sub>3</sub> as the principal anions. The source of the humidity rising by capillary flow up the walls is surface and groundwaters collecting at the base of the walls from rain and melting snow. Evaporation begins externally just above the soil level, and internally just above floor level. The humidity rises to a point where a steady state is reached between the supply of water and the rate of evaporation. Moisture from precipitation and from the ground shows certain variations, so the height of the capillary rise also varies (Pauly 1979).

If the solutes were only of one salt, it would concentrate, accumulate, and precipitate locally at a distinct level above the ground where evaporation had proceeded to the extent that supersaturation had been reached for that salt phase. Actual salt systems, however, consist of many solutes with different ion activities. While evaporating, salts with low solubility become supersaturated and precipitate first at a certain level, while more soluble ions move farther upward. In this way salts separate and undergo spatial fractionation. Observations and analyses show that the less soluble carbonates and sulfates precipitate in Zones A and B, while the chlorides and nitrates move higher up and accumulate in Zone C. Sulfates and carbonates cause the main deterioration in Zones A and B under normal outdoor conditions in humid, moderate climates, while less



decay is observed in Zone C. The chlorides and nitrates accumulated in Zone C form a hygroscopic solution from which normally only potassium nitrate will crystallize, although sodium chloride and sodium nitrate may also crystallize when the outdoor climate becomes exceptionally dry. But most of the solutes in this zone will always remain in solution. That means that these salts concentrate and accumulate locally over the entire lifetime of a monument, which may be many centuries. They can take up more water by condensation than is needed to saturate their pore space. This means that purely hygroscopic humidity may be taken up and spread over greater wall areas and may explain why the upper limit of rising damp is as high as 2.5-3 m in the apses at Müstair.

Such sequences form not only in the upper zones of rising damp, for example, but also adjacent to water which runs along a surface, percolating water, etc. The greater the solubility of a salt, the greater the distance it can be transported from its original source.

We may summarize by stating that salts are transported by the capillary rise of dilute saline solutions from ground moisture and surface water from the base of a wall. The mechanism of transport is evaporation above ground. The transported salts are precipitated in a spatial sequence according to the ion activities of the salt phases in the system. In the lower zone less soluble and less hygroscopic sulfates and carbonates are mainly present, while in the upper zone chlorides and nitrates accumulate, forming highly hygroscopic solutions. Only under special conditions, such as in heated churches, do the salts of Zone C crystallize and cause deterioration.

### ***Conditions for Precipitation and Crystallization***

We have been dealing here with nonhomogeneous salt systems consisting of up to ten different ions in highly concentrated solutions. Methods for thermodynamic calculations to predict the precipitates under real external conditions are not yet available, so we must proceed empirically. If we start with the qualities of concentrated salt solutions, we may get some indications of the basic conditions of precipitation. Two different types of precipitation must be considered: the first, when salts precipitate within an aqueous solution; the second, when salts precipitate on a material surface by hygroscopic reaction with humid air (Arnold 1981; Amoroso and Fassina 1983). When a salt crystallizes in an aqueous solution, the following relations control precipitation:

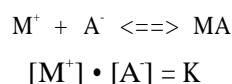

where  $M^+$  and  $A^-$  are the cation and the anion respectively,  $[M^+]$  and  $[A^-]$  are the ion activities, and  $K$  is the equilibrium constant for a definite temperature and pressure. Supersaturation occurs when the actual ion activity product,  $(M^+) \cdot (A^-) = IAP$ , is greater than the equilibrium constant  $K$ :

$$IAP \geq K$$

Thus the ion activity product determines whether or not a salt can precipitate.

An equilibrium is established between the liquid and the vapor phases of a solvent. Because the mass ratio between the vapor phase and the solvent in a dilute aqueous solution is of  $1:5.7 \cdot 10^4$  (at 20 °C), a change in the vapor phase has no practically relevant influence on the system. The solvent conditions the vapor phase and not vice versa, which is why saturated salt solutions are used to condition definite relative humidities in test chambers.

On walls, however, extremely small amounts of salts are in contact with huge masses of humid air. If the air is moving, then the mass that influences the local salt-solution-vapor system is unlimited. Thus the vapor phase or the air humidity, respectively, will condition the solution, predominantly controlling precipitation and dissolution. In this case the following relations apply:

$$\frac{p_{\text{H}_2\text{O}_s}}{p_{\text{H}_2\text{O}_w}} \cdot 100 = \text{RH}_{\text{eq}}$$

where  $p_{\text{H}_2\text{O}_s}$  is the water vapor pressure of the saturated salt solution,  $p_{\text{H}_2\text{O}_w}$  is the water vapor pressure of the saturated air, and  $\text{RH}_{\text{eq}}$  is the relative humidity in equilibrium with the saturated solution. The condition for supersaturation and precipitation is given when

$$\text{RH} \leq \text{RH}_{\text{eq}}$$

where RH is the relative humidity of the ambient air in equilibrium with the actual salt solution. This means that supersaturation, and therefore the condition for precipitation, is given when the ambient relative humidity becomes lower than the equilibrium relative humidity of the saturated solution of the particular salt phase in the system. Equilibrium relative humidities of the salts under consideration are given in Table 3.

Table 3. Equilibrium relative humidities (%) of some salts found in walls listed in ascending order (from Gmelin 1966; Greenspan 1977; and Wylie 1965).

Salt	0 °C	5 °C	10 °C	15 °C	20 °C	25 °C	30 °C
CaCl <sub>2</sub> • 6H <sub>2</sub> O	41	37.7	33.7		30.8	28.6	22.4
MgCl <sub>2</sub> • 6H <sub>2</sub> O	33.7	33.6	33.5	33.3	33.1	32.8	32.4
K <sub>2</sub> CO <sub>3</sub> • 2H <sub>2</sub> O	43.1	43.1	43.1	43.2	43.2	43.2	43.2
Ca(NO <sub>3</sub> ) <sub>2</sub> • 4H <sub>2</sub> O	59	59.6	56.5	54	53.6	50.5	46.8
Mg(NO <sub>3</sub> ) <sub>2</sub> • 6H <sub>2</sub> O	60.4	58.9	57.4	55.9	54.4	52.9	51.4
NH <sub>4</sub> NO <sub>3</sub>						61.8	
NaNO <sub>3</sub>		78.6	77.5	76.5	75.4	74.3	73.1
NaCl	75.5	75.7	75.7	75.6	75.5	75.3	75.1
Na <sub>2</sub> SO <sub>4</sub>					82	82.8	84.3
KCl	88.6	87.7	86.8	85.9	85.1	84.3	83.6
MgSO <sub>4</sub> • 7H <sub>2</sub> O			86.9		90.1	88.3	88
Na <sub>2</sub> CO <sub>3</sub> • 10H <sub>2</sub> O				96.5	97.9	88.2	83.2
Na <sub>2</sub> SO <sub>4</sub> • 10H <sub>2</sub> O				95.2	93.6	91.4	87.9
KNO <sub>3</sub>	96.3	96.3	96	95.4	94.6	93.6	92.3
K <sub>2</sub> SO <sub>4</sub>	98.8	98.5	98.2	97.9	97.6	97.3	97

Under these conditions the relative humidity of the air determines whether or not a salt can crystallize on a wall painting and thus damage it. As long as the ambient relative humidity is higher than the equilibrium relative humidity of a given saturated salt solution, then a solute will remain in solution, or, if crystalline, will dissolve. Only if the ambient relative humidity becomes lower than the equilibrium relative humidity of a given saturated salt solution can the salt crystallize. Simply by varying the relative humidity of the air, one can produce crystallization cycles. And that is just what happens when a room is heated.

Since actual salt systems are complicated mixtures of ions, the values for the equilibrium relative humidities of *pure* salts may not apply directly, but are only indicative. To obtain real values, one must proceed empirically. According to our observations, the following statements can be formulated:

- There is a clear relationship between the variations in relative humidity of a room and the crystallization and dissolution of salts on walls.
- When relative humidity drops, salts crystallize increasingly as the humidity is lowered.
- When relative humidity rises, previously crystallized salts redissolve.
- We have observed that sodium nitrate, with an equilibrium relative humidity of 75.4% at 20 °C as a pure salt, crystallizes on walls when the relative humidity drops below 60% and redissolves when it rises again above this value.
- Magnesium nitrate, with an equilibrium relative humidity of 54.4% at 20 °C, crystallizes on a column in the church at Müstair when the relative humidity of the air drops below 50% and dissolves again when it rises above this value.

### ***Crystallization***

The salts which are precipitated may crystallize either on or beneath the surface of the porous material. When crystallization occurs on the surface efflorescences are formed. These appear in a variety of habits and aggregate forms (Arnold and Kueng 1985). The most common habits of fresh efflorescent salts on surfaces of porous materials are prisms and acicular, hairlike crystals, so-called whisker crystals. Such crystals, which differ from their specific equilibrium crystal forms, are shown in Figures 4 and 5. Idiomorphic cubes of halite displaying their specific equilibrium crystal forms are also visible in Figures 4 and 5. These salts form bristly efflorescences of individual standing crystals (Fig. 5) or loose aggregates of whiskers forming fluffy efflorescences (Fig. 6a, b). All salts, but preferentially the less soluble ones, form crusts as compact aggregates of acicular, columnar, or isometric crystals (Fig. 7a, b).

The same salt may crystallize as isometric grains in crusts and as whiskers in fluffy efflorescences at different places on a wall at the same time, or at the same place at different times. For instance, on a wall affected by ground moisture, a soluble salt is observed to form crusts in a lower, more humid zone, whereas in a higher, less humid zone loose aggregates of the same salt species are formed. As a consequence of increasing humidity, loose aggregates may be trans-

*Facing page:*

*Figure 4, top left. Efflorescence of needle-shaped whiskers and isometric crystals (cubes) of halite (sodium chloride) on ceramic.*

*Figure 5, top right. Halite (sodium chloride) with whiskers standing individually forming bristly efflorescences, and with isometric crystals.*

*Figure 6a, b, middle. Halite (sodium chloride) crystals forming fluffy efflorescences as loose aggregates of whisker crystals on ceramic. (b) represents a detail of (a).*

*Figure 7a, b, bottom. A crust aggregated by prismatic nesquehonite ([b] and upper part of [a]) and hydromagnesite (lower part of [a]).*

formed into crusts by recrystallization (Zehnder, Arnold, and Spirig 1986). The relationship between crystal morphology and local conditions of crystallization has been outlined in an earlier publication (Arnold and Zehnder 1985). From studies of crystal growth it is known that crystal morphology is determined by internal (structural) factors, such as the crystal lattice, and by external factors, such as supersaturation, composition and impurities of the solution, and the shape and current of the solution nourishing the growing crystal (Hartman 1979; Sunagawa 1981). In the present context and with respect to conservation, we are especially interested in the external factors governing crystallization.

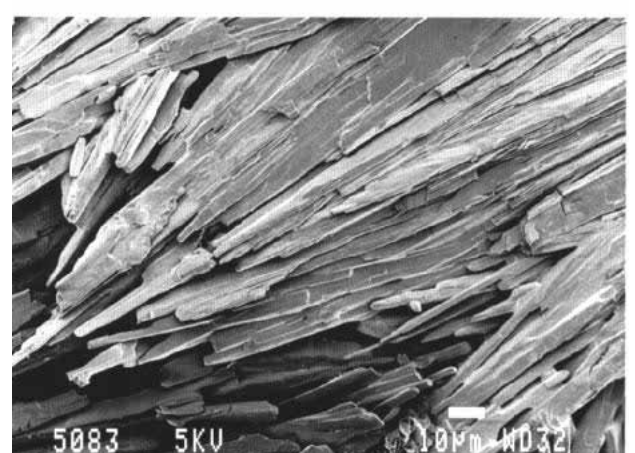
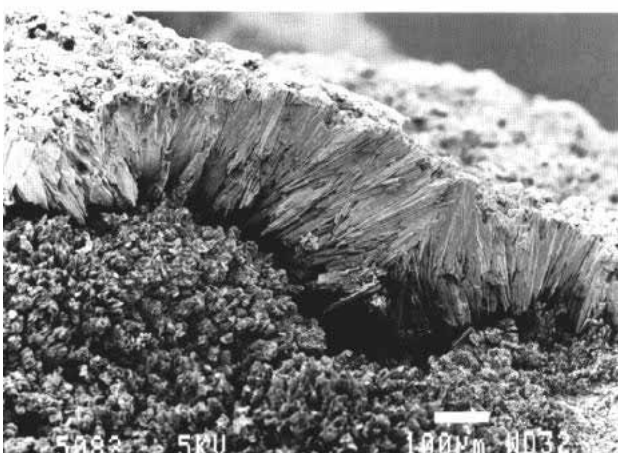
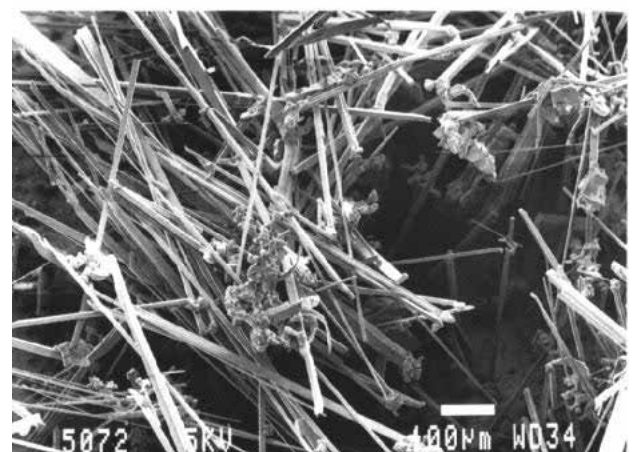
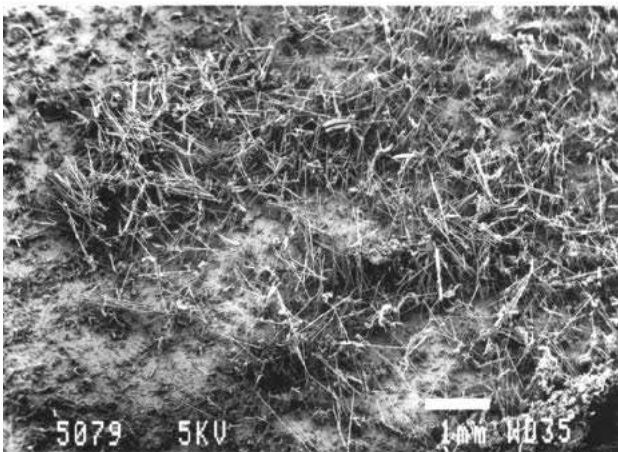
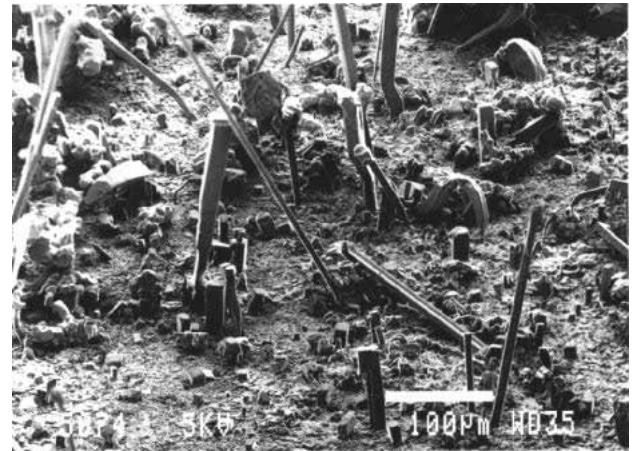
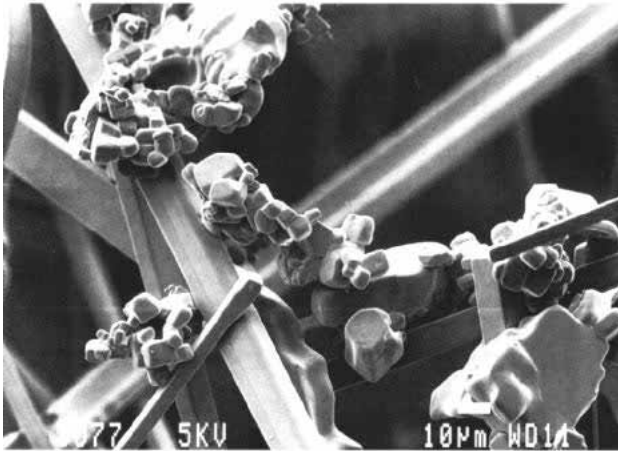

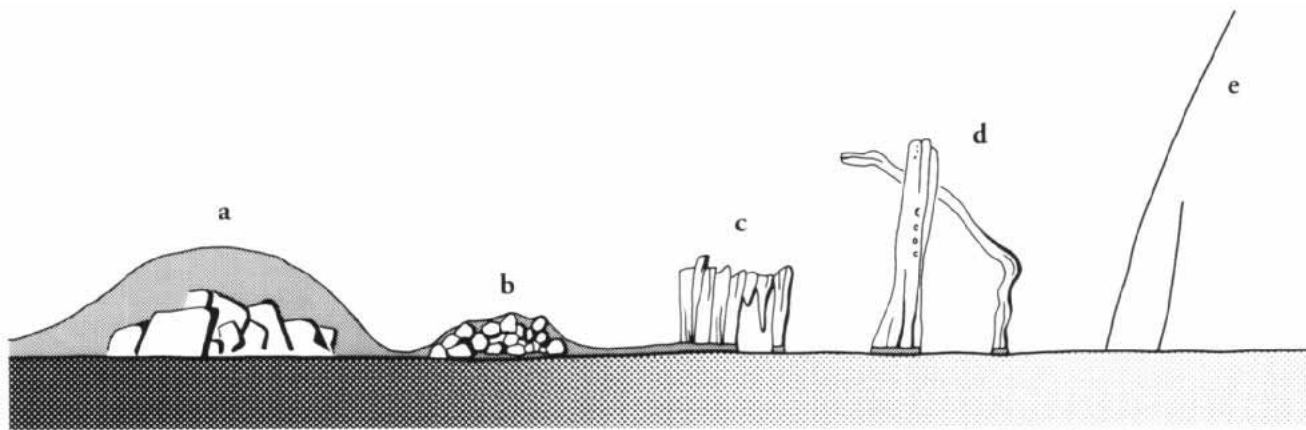

Figure 8. The relationship between crystal morphology and the substrate humidity of a porous material. (a) Large crystals, displaying their specific equilibrium forms, grow completely immersed in a solution film on a wet substrate. (b) A granular crust made up of smaller and isometric crystals grows on a wet substrate. The crystals are just covered by a solution film. (c) A fibrous crust grows into the air from a substrate surface covered by a thin solution film. (d) Columnar and thick whisker crystals grow from a slightly humid substrate; the solution film still forms small spots. (e) Very thin whisker crystals grow into the air from the nearly dry surface with a localized solution supply.

Together with temperature and relative humidity, it was found that the most important external factor was the shape of the solution (Zehnder and Arnold 1988). The relationships which had been observed between the substrate humidity and crystal habits were reproduced in the laboratory with the results illustrated in Figure 8. On a drying substrate, efflorescences are generated in a sequence of crystal morphologies as shown schematically in Figure 8. First, crystals with bulky (isometric) shapes similar to their equilibrium forms, commonly aggregating into crusts, grow from the wet substrate as long as they are immersed in the solution or in a "thick" solution film. Needle-shaped whisker crystals, forming bristly or fluffy efflorescences, grow from the nearly dry substrate when the solution film on it becomes very thin. In between, all transitions from isometric equilibrium shapes to prisms, needles, and hairlike crystals are formed according to the decreasing thickness of the solution film while the substrate dries out.

Crystals growing in pores and thereby causing disruption show rather compact habits. Their morphology, similar to that of the crust-forming crystals on the substrate surface, implies that they grow inside a solution film covering the pores.

### Decay Mechanisms

Crystallizing salts have a disruptive effect. Despite the fact that this phenomenon has been proven, we know little about the actual process. Salt crystallization and weathering is comprehensively reviewed in Evans (1970), which also covers theories concerning growth pressure. Pressure may be generated by growing crystals (linear growth pressure in particular), by hydration (hydration pressure), or by thermal expansion.

Obviously, decay occurs only if salt crystals grow within the pores and other cavities of a material. When efflorescences form on a porous material, a certain portion of the salt may crystallize below the surface (see Figs. 9 and 10). The location of salt precipitation both on and within a porous medium depends on the solution supply and on evaporation. When both are constant, a steady state may develop and persist, so that crystallization is balanced in a distinct zone on and/or below the surface where the salts are accumulating (Lewin 1982). In nonhomogeneous media these accumulations become irregular according to the

existing pore structure. If a solution evaporates from a painted render, the salt may precipitate preferentially between the paint layer and the substrate, as is shown in Figure 9. In other cases salt crystals grow preferentially on mica flakes oriented parallel to the surface of a render. However, for all these modifications of the crystallization site, we consider the disruption mechanism to be essentially the same whether a paint layer or a spall of "homogeneous" material, such as that on ceramics, splits off.

The rate of evaporation also depends on relative humidity. Two equal samples of ceramics containing equal amounts of the same saturated solution of sodium nitrate, but drying out at different humidities (in closed vessels of the same dimensions), showed different amounts of efflorescence. The one dried at 32% relative humidity produced much less efflorescence on the surface than the one dried at 69%. In the former case a larger portion of the salt crystallized in the interior. Thus the location of salt crystallization also depends on the relative humidity of the surrounding air. The more salt that crystallizes beneath the surface, the more decay is produced.

The model for the disruption processes of salt crystallization in porous material (Fig. 11) is based on observations of the crystallization of sodium nitrate and other salts on high porosity (30%) ceramics and on lime plasters painted in fresco. This model is applicable to all moderately porous materials and to most salt species, though some may exhibit different habits.

*Figure 9. Nitronatrite (sodium nitrate) crystals growing on and in porous ceramics. A cross section of a broken surface is shown. (a), right: In a general view a crust formed of prismatic crystals is visible on top of the porous ceramic. (b), below. In a detail of the area marked in (a) some pores are already filled with rhombohedral crystals of nitronatrite. They partially overlap the individual pore spaces and join into compact aggregates, showing that a disruption may have occurred here. (c), below right: Nearby are areas with completely empty pores.*

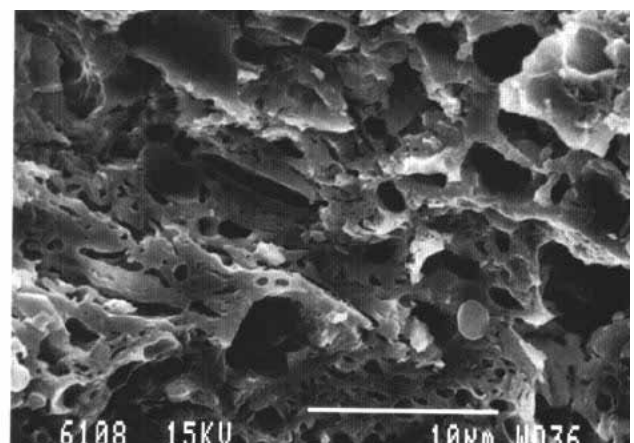
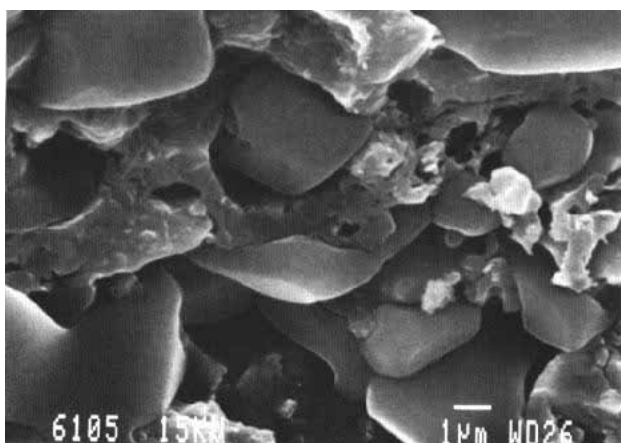
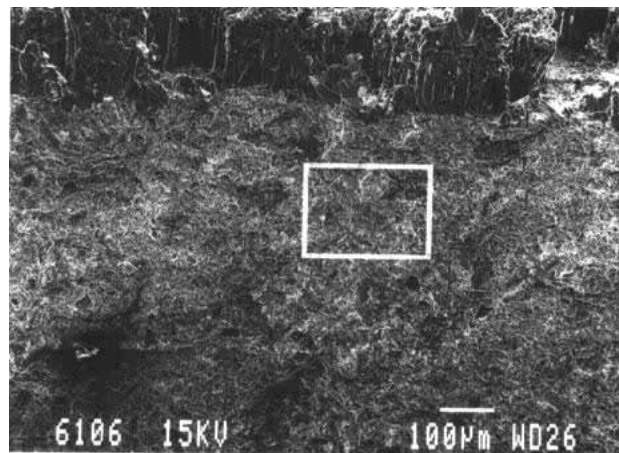

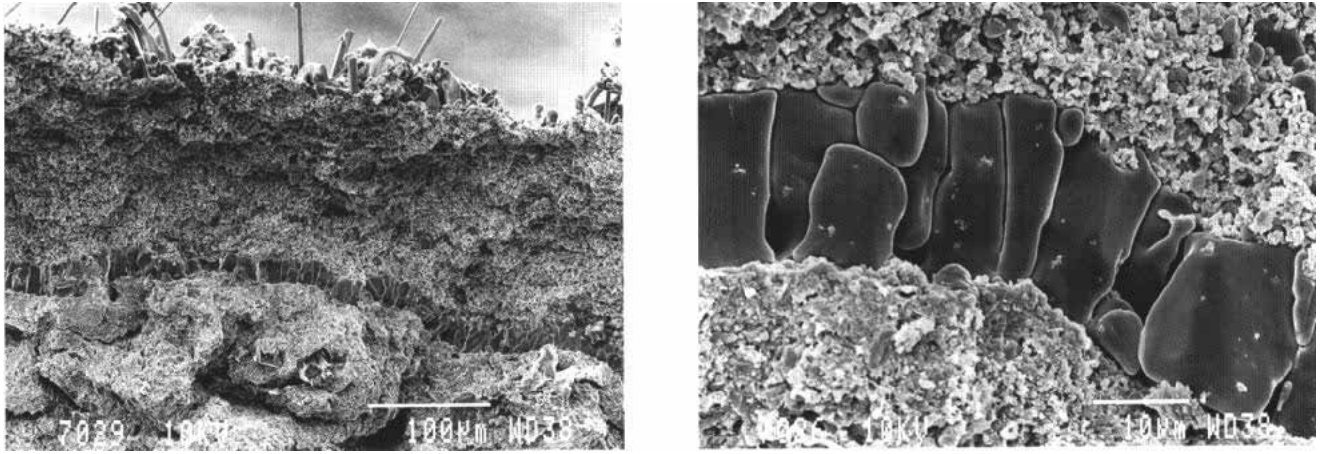

Figure 10. Nitronatrite crystallized in a render covered by a paint layer (fresco technique). (a), above left: In addition to whiskers on the surface, salt has crystallized in a layer underneath the paint layer and disrupted it from the substrate. (b), above right: In a detail of (a) it can be seen that isometric to columnar crystals form an aggregate, indicating the beginning of a cross-fiber structure that will lift the disrupted area.

In the first phase (Figs. 11a, 9b) salt crystals form mainly in pores of about 1-10  $\mu\text{m}$ . Smaller pores as well as larger cavities remain preferentially empty. It is supposed that this results from the solution distribution, since it is calculated from the drying process of a porous material that water evaporates first from the large cavities from whence it retreats successively to smaller ones (Snethlage 1984). Thus crystals grow favorably in large pores connected to empty evaporation channels and supplied by solution from the smaller pores. These idiomorphic crystal habits with equilibrium forms correspond to those of crystals which grow immersed in a solution film forming a granular crust. Thus we can assume that the pores in this phase and at this particular location are largely filled with a saturated or supersaturated solution.

In the second phase (Figs. 11b, 9b) the crystals have already exceeded the pore size and overlap to other pores. The salt now forms clustered, glazelike (at least in the case of sodium nitrate) aggregates, partially coating the surfaces of the larger cavities. Since the pore sizes are exceeded by the crystal size, we must presume that significant pressures build up on the pore walls, resulting in a tensile stress perpendicular to the external surface of the material. In consequence, this force disrupts the structures preferentially by means of fissures parallel to the external surface along a zone where the pores filled by salt crystals are arranged close together and, preferentially, where the material cohesion is less, e.g., at discontinuities such as the interface with paint layers, micas, preexisting fissures, etc.

In the third phase (Figs. 11c, 10b) crystallization is concentrated at fissures, because evaporation is accelerated along the opened and widening structure. As long as the crystals are completely covered and supplied by solution,

Figure 11. Model of disruption process by crystallizing salts (nitronatrite).

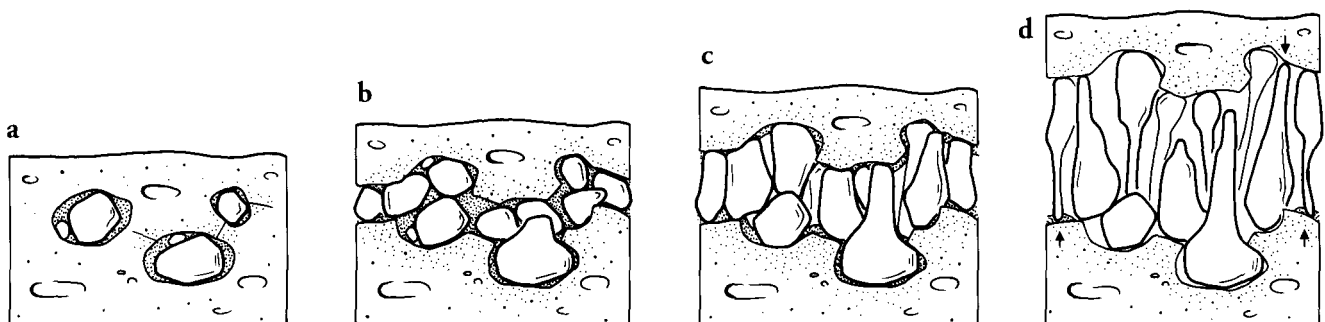



Figure 12a-c. Splitting of a paint layer from a lime plaster on a sample painted in fresco. (a), below left: The paint layer is lifted by long whiskers of nitronatrite (sodium nitrate). The whisker crystals become thinner toward the base from which they grow. (b), below right: Detail of (a) showing the underside of the lifted paint layer with the transition from isometric to whisker crystals. (c), bottom left: Detail of (b) showing how rounded isometric crystal growth passes into mainly linear (columnar) growth.

Figure 13, bottom right. Paint layer lifted by nitronatrite whiskers, thinning out toward their base on the substrate from which they have grown.

they continue to grow isometrically. But as the fissure expands and evaporation exceeds solution supply, the solution is withdrawn to the fissure surfaces. Now solution is supplied only from one or two sides of the fissure, so that crystals grow in a columnar habit. This structure is comparable to the cross-fiber veins in rocks, as was stated by Taber (1917). Crystals growing from their base exert a force on the fissure walls that is strong enough to widen the fissure. This phase corresponds to phase 3 of the crystallization sequence on the substrate surface (Fig. 8c), when fibrous crusts are formed.

In the fourth phase (Figs. 11d, 12a-c) as the fissures are widened and the solution retires, the areas where the crystals contact the solution are reduced more and more. Consequently, columnar crystal growth turns into whisker growth, thinning out progressively as the solution supply is reduced and the substrate dries out. Whiskers continue to grow as long as their growing tips remain in contact with solution. They are able to lift spalls, paint layers, and crusts detached previously. This has been shown in a series of laboratory tests, as well as on wall paintings in situ (Figs. 12-15, Pl. 44).

These explanations of crystal growth on different porous materials are based on numerous observations of such growth and of damage produced on wall paintings in situ that has been reproduced in laboratory tests. The phenomena and processes could be traced in full from the wall paintings to laboratory experiments and vice versa.

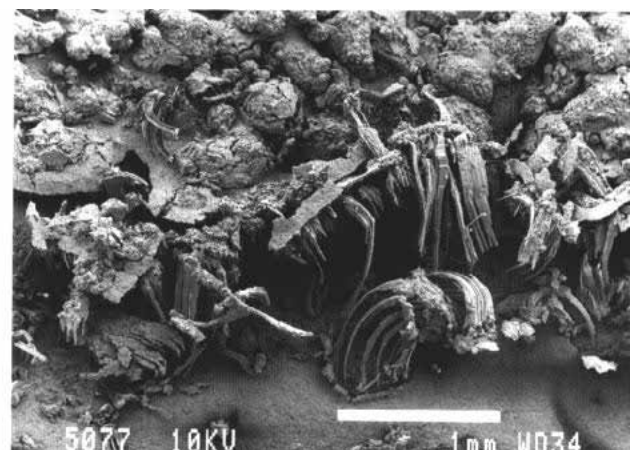
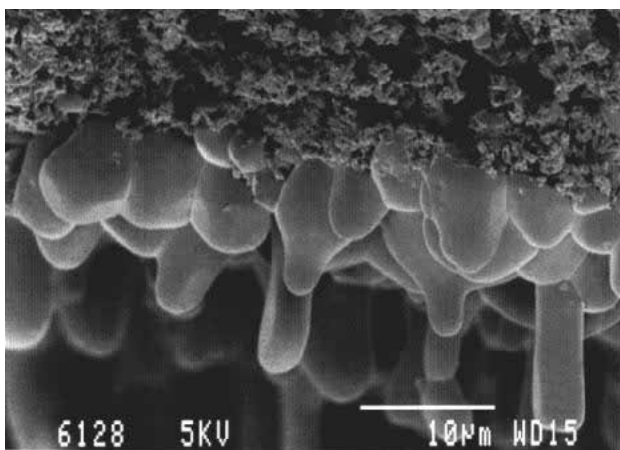
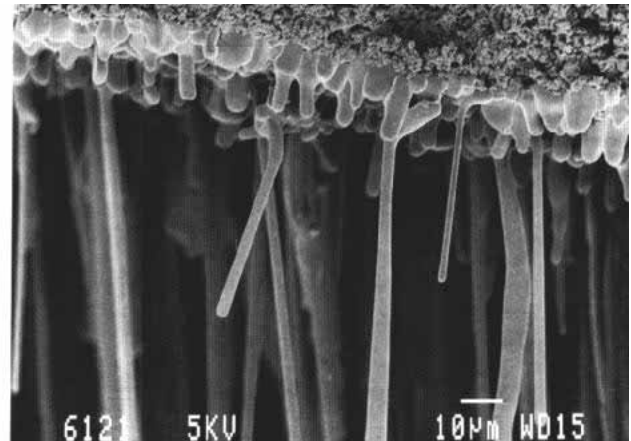

## ***Room Climate and Salt Crystallization***

Another very important aspect of decay is the crystallization of salt phases from a mixture of different solutes controlled by relative humidity.

As part of National Research Program 16 of the Swiss National Science Foundation, the following six churches in Switzerland decorated with wall paintings were studied: the convent church at Müstair; the parish church at Lavin; the church of Saint Martin at Cazis; the crypt of the Grossmünster in Zurich; the Collegiata church at Bellinzona; and Notre Dame de Valère at Sion. In these churches wall paintings, stone, stucco, and plaster have been affected by soluble salts. It has been observed and proven that salt accumulations differing in origin and composition react with humid air, thus leading to periodic crystallization and decay. Since theoretical study of such complex salt systems is impossible in the present state of our knowledge, empirical research was undertaken in situ. This involved the observation, determination, and documentation of decay forms; of the different types, habits, and aggregates of crystalline salts; and of the solutes, and their distribution on and in the walls. From this basis, measurement of room climate combined with periodic observation of crystallized salts over a period of several years then made it possible to determine if and when different salts crystallized, which habit and aggregate they formed, and what kind of decay they produced. Having discussed the general features of salt crystallization on walls, we may now turn our attention to measurements of climate combined with periodic observations of salt crystallization in different room climates.

*Figure 14, below left. Paint particles lifted from the substrate by nitronatrite whiskers. (Width of area photographed: 15 mm.)*

*Figure 15, below right. Paint particles lost by salt crystallization, presumably of nitronatrite on wall paintings in the apses of the convent church at Müstair, Switzerland. (Width of area photographed: 50 mm.)*

### ***Rooms with Continuous Heating***

The crypt of the Grossmünster in Zurich and the convent church at Müstair are heated continuously and show decay on stones and wall paintings caused by periodic crystallization of salts. This crystallization can be described as follows: nitronatrite, with an equilibrium relative humidity of 75.4% (at 20 °C) as a pure salt, crystallizes out of the system previously described whenever the ambient relative humidity drops to values lower than 60% (Arnold, Kueng, and Zehnder 1986; Zehnder, Arnold, and Spirig 1986).

The crypt of the Grossmünster in Zurich (Fig. 16) is heated continuously from November to April (the convent church of Müstair will be discussed separately below). This reduces the relative humidities from values of 60-80%



Figure 16. Relationship of the averaged daily values for relative humidity (RH) and temperature (T) to the observed salt crystallization (shown below) in the crypt of the Grossmünster, Zurich, 1986.

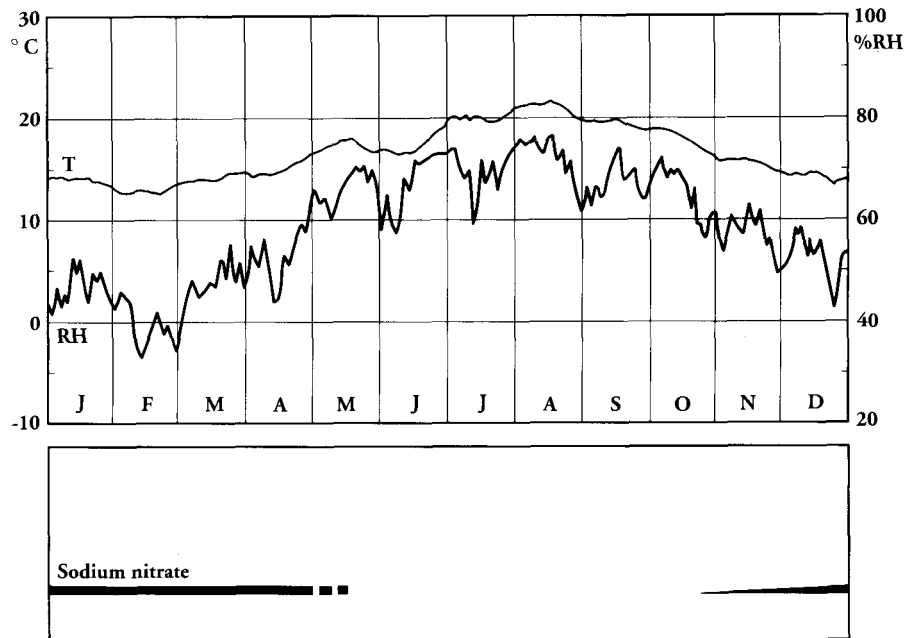

to values between 40 and 60%. Nitronatrite crystallizes during late autumn, when the relative humidity falls below 60%, and crystallization continues, slowing during the following months. During the same period the crystals undergo a kind of aging, with their habits transforming from acicular to more isometric shapes. From May through June, when the relative humidity rises again to values above 60%, the crystalline salts disappear, dissolved at an air humidity above the equilibrium relative humidity.

Thus the main deteriorating events caused by crystallization occur in the crypt when the air is dried drastically by heating the room. This has accelerated the process of decay since the last restoration.

### ***Rooms with Intermittent Heating***

The parish church of Lavin and the Collegiata church in Bellinzona have intermittent heating systems, used only on weekends and holidays. The church of Lavin is heated by electrical heaters; the Collegiata church is heated by gas burners.

At the parish church of Lavin the salt system in contact with the room climate is different from the ones described above. The crystallized salts are mirabilite, epsomite, nitrokalite, natrite, hydromagnesite, nesquehonite, and lansfordite. The salts that crystallize periodically are mirabilite and natrite. The evolution of the room climate during 1986 is shown in Figure 17. Relative humidity was stable over the whole year, varying between 60 and 80%. The temperature curve shows the peaks of weekly heating, but compared to the previous cases, the general course of both humidity and temperature was not strongly influenced by that heating. The stability of the relative humidity is astonishing. Looking, for example, at the climatic curves for January 1986 in Figure 18, it can be seen that the peaks indicating temperature increases of 8 °C caused by the electrical heating do not result in a corresponding decrease in relative humidity,

Figure 17, right. Relationship of the averaged daily values for RH and T to the heating and observed salt crystallization (shown below), Parish Church, Lavin, 1986.

Figure 18, below right. Evolution of values for RH and T, Parish Church, Lavin, January 1986.

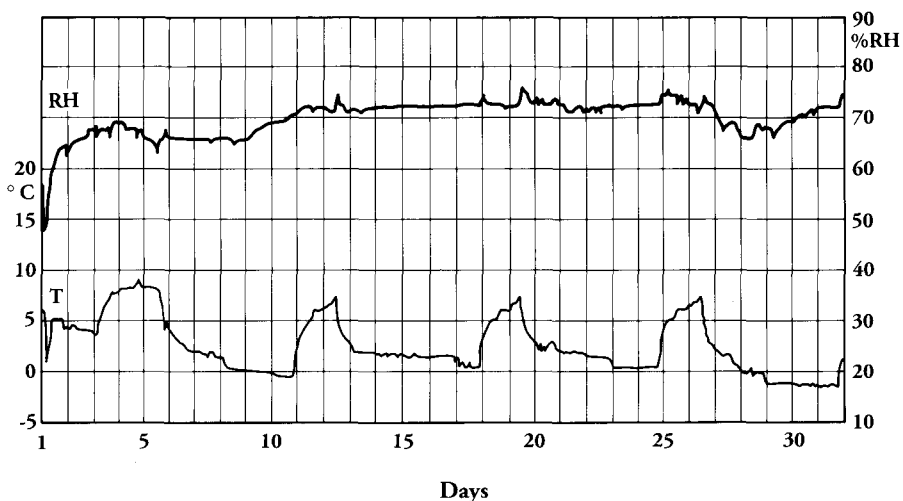
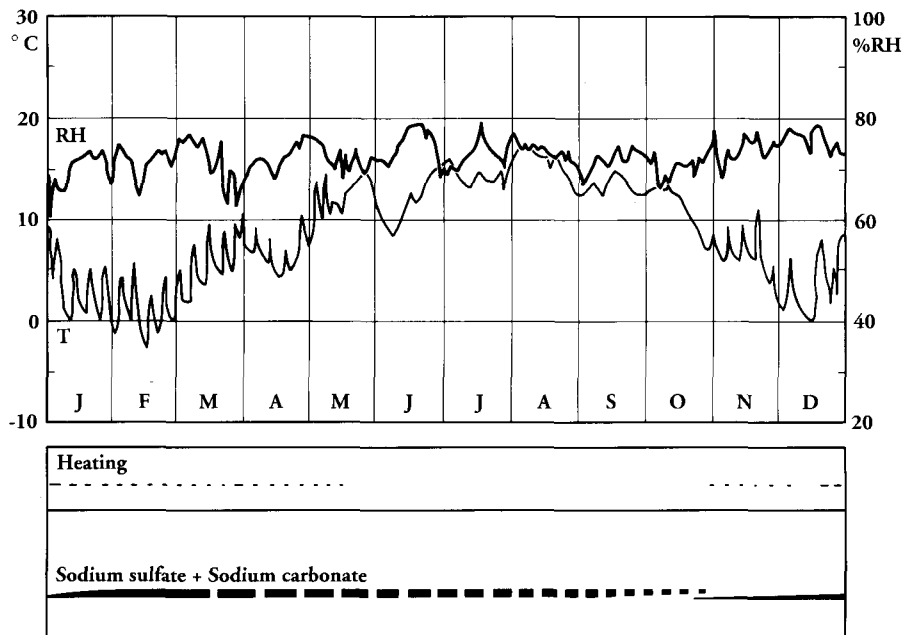

as one would expect. The relative humidity remained stable, and therefore it must have been buffered somehow. This is explained by the fact that there is more than 4500 kg of untreated wood in the small church. Because of its high capacity for water sorption, this wood has enough buffering capacity to stabilize the relative humidity of the entire room during periods of heating.

Thus the periodic crystallization of mirabilite and natrite cannot be related to oscillations in relative humidity, but correlate with the dropping of the temperature from about 15 °C in summer to values below 0 °C in late autumn. As the solubilities of both salts depend strongly on temperature in this range, they crystallize in a flow of humidity evaporating on the wall surface in pulses related to the temperature changes. This also happens when efflorescences of mirabilite and natrite appear on building exteriors in winter, when temperatures drop sharply.

At the Collegiata church of Bellinzona the crystallized salts are epsomite, gypsum, thenardite, nitrokalite, and nitronatrite. The salt that crystallizes

periodically is nitronatrite. Heating by open gas burners does not affect the annual evolution of the room climate significantly (Fig. 19). The detailed climatic curves during heating in January 1986 (Fig. 20) show that the temperature peaks corresponded to relative humidity peaks. This was due to the water vapor produced by the open gas flame. But the humidity induced was not sufficient to strongly affect the humidity balance of the entire room. We have observed that epsomite, once crystallized in the cold vault of the church, remained stable for years and that there were no signs of water condensation effects on salt crusts. Yet we also have observed that nitronatrite crystallizes periodically. Here the periodicity cannot be related to heating but corresponds instead to dry periods outside that influence the interior climate. In Figure 19 we can see that the relative humidity of the room oscillated between about 50% and 75-80% throughout the year. Thus the changes in relative humidity frequently passed through the critical value of 60%, causing frequent crystallization of nitronatrite. Since the areas of this church affected by this kind of salt accumulation are small, the decay produced was rather insignificant.

Figure 19, right. Relationship of the averaged daily values for RH and T to the heating and observed salt crystallization (shown below), Collegiata church, Bellinzona, 1986.

Figure 20, below right. Evolution of values for RH and T, Collegiata church, Bellinzona, January 1986.

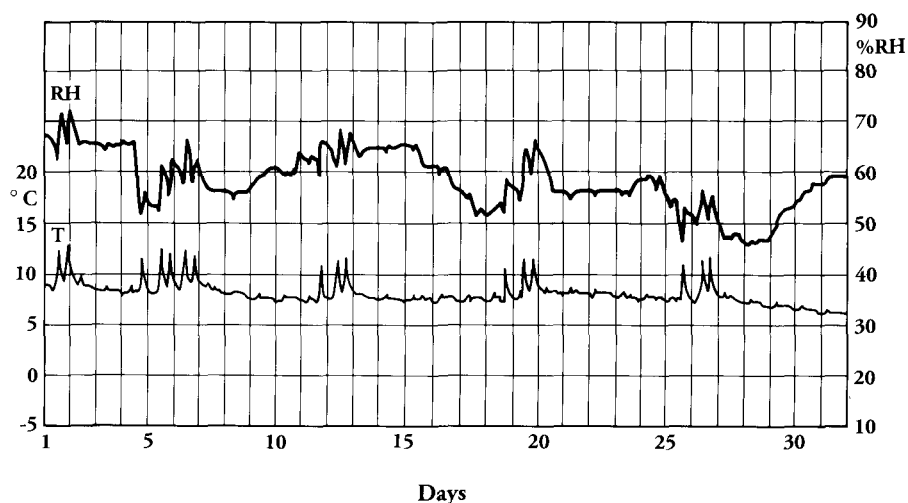
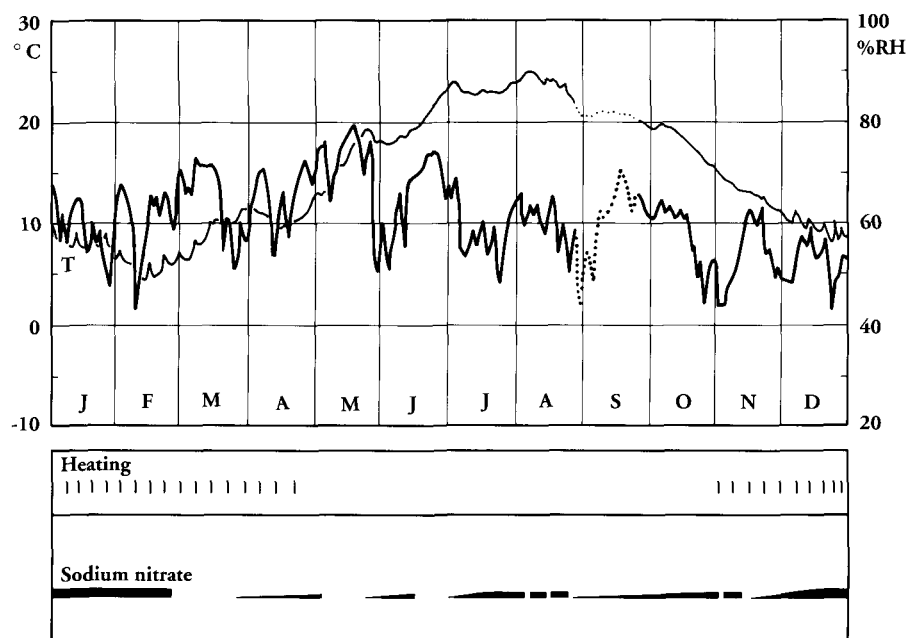

## Unheated Rooms

The churches of Saint Martin at Cazis and Notre Dame de Valère at Sion are practically unheated.

In the small church of Saint Martin, epsomite, gypsum, nitronatrite, and nitrokalite have been observed as crystalline salts. There are only weak seasonal crystallizations of nitrokalite and epsomite. The annual evolution of the room climate given in Figure 21 shows a very stable relative humidity throughout the year, oscillating between 70 and 80%, while the temperature changed from 20 °C in summer to about -5 °C in winter. Therefore the periodicity of the weak seasonal crystallizations must be attributed to changes in temperature.

At the church of Notre Dame de Valère percolating water and consequent crystallization of epsomite and nitrokalite have been observed, but no periodic crystallization could be seen. The room climate presented in Figure 22 was the driest one measured. The relative humidity mainly oscillated between 40% and slightly above 60%. Under these conditions all observed salts, once crystallized, remained stable.

Figure 21, right. Relationship of the averaged daily values for RH and T to the heating and observed salt crystallization (shown below), church of Saint Martin, Cazis, 1986.

Figure 22, below right. Evolution of the averaged daily values for RH and T, church of Notre Dame de Valère, Sion, 1986.

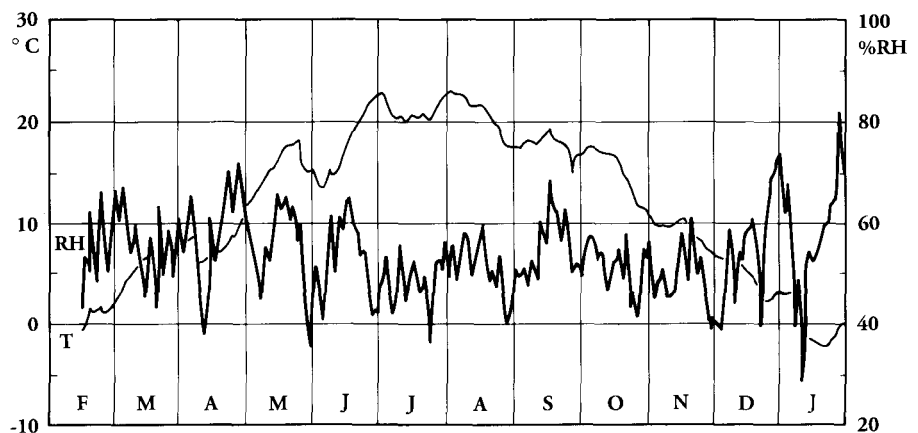
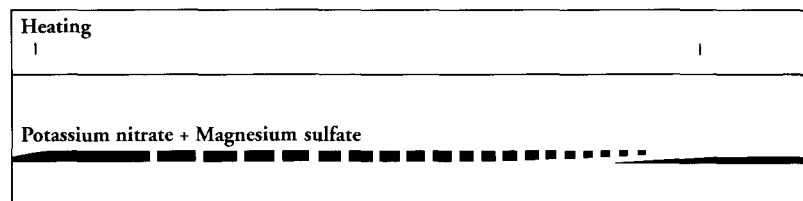
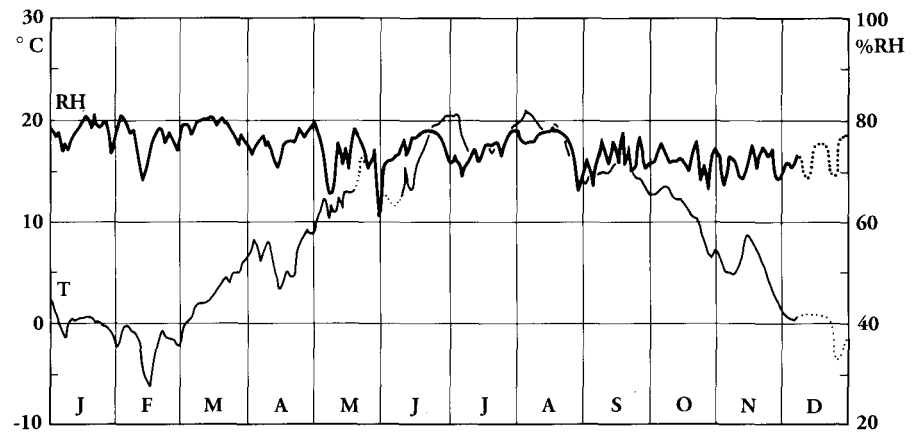

## *Conclusions*

The studies presented in this section show that under certain conditions microclimate contributes in an essential fashion to the weathering activity of soluble salts on stone, mortar, and painting, indoors as well as out. But the role of microclimate can only be established if the processes involved are followed in situ simultaneously with accurate measurement of the microclimate. Sophisticated and extremely precise measurements of the microclimate do not explain anything unless they are related to the real processes occurring in situ. Therefore our measurements have been coordinated with observation. As a result the variations in room climate, expressed in terms of relative humidity and temperature, can be related to the crystallization of distinct salts and to the deterioration they produce.

Room climate and its variations were different in the churches investigated. In rooms with continuous heating, the climate was strongly determined by this heating. Seasonal variations in room climate were very strong, and they led to very low relative humidities during the long heating period. As a consequence, moderately hygroscopic salts such as nitronatrite were precipitated from the hygroscopic solution of sulfates, chlorides, and nitrates, crystallizing and deteriorating the substrate from the beginning of the heating period, as soon as the relative humidity in the room dropped below 60%. The same salt was redissolved after the heating period ended. This would not have happened with the same intensity without heating. Thus crystallization cycles square with heating cycles. The same salt undergoes similar but much weaker cycles where dry periods of the regional climate cause the indoor climate to dry out as well. This was the case with the convent church at Müstair, though not with the crypt of the Grossmünster in Zurich.

In rooms with intermittent heating, the seasonal course of room climate was not considerably influenced by it. In these rooms other salts crystallized in relation to temperature variations. These salts are not significantly hygroscopic, but their crystallization was controlled by temperature decreases, which reduced their solubility. In unheated rooms the situation was similar to those with periodic heating.

### *Decay of Wall Paintings in the Convent Church of Müstair*

The case of the Carolingian and Romanesque wall paintings in the convent church of Müstair in eastern Switzerland demonstrates a methodical approach to monitoring wall paintings affected by salt weathering. The basis for this was an integrated study of the decay and of environmental conditions. Such studies must include the whole site, the building, the wall, individual materials such as stone and render, and the paint layers and minerals. What follows summarizes and completes Arnold, Kueng, and Zehnder (1986).

### *General Situation and Historical Summary*

The convent of Müstair is situated on an alluvial cone at 1250 m above sea level in the Münstertal, a valley on the southeastern border of Switzerland that issues into northern Italy. The alluvial cone is used for farming. The Münstertal consists of eroded crystalline and sedimentary rocks of the Scarl nappe; the main rocks present on both sides of the valley are crystalline schists, Permian arkoses



(Verrucano), and dolomites. Since schistose stones erode very easily, numerous alluvial cones have been formed on the valley bottom. The climate is rather mild for the altitude. The valley is protected against the north wind; south and west winds predominate. Annual precipitation is about 770 mm, and the average temperature is -6 °C in January and 15 °C in July.

The church is integrated into the building complex of the convent, and its southern and eastern sides adjoin the public cemetery. The walls are composed of local rubble stones (schists, gneisses, and rauhakes) and lime mortar, and still carry the original medieval lime renders. In the basal zones affected by ground moisture, the plaster was replaced by render containing Portland cement during the last restoration (1947-51). The walls of the convent show normal signs of rising damp to between 3 and 4 m above the soil.

The inner surfaces of the walls were first covered with Carolingian plaster and a limewash. About 800 the Carolingian paintings were executed on a very thin *intonaco* laid over the limewash. Then about 1200, the Romanesque paintings were carried out on yet another *intonaco*, applied over the Carolingian layers. Preserved portions of the Carolingian paintings are now visible on all walls with the exception of the three apses, where the superimposed Romanesque paintings partially survive.

The church was given a Gothic vault and other changes were made between 1489 and 1492. The paintings were covered with whitewash at the latest during the Baroque period. Following Gothic Revival transformations in the nineteenth century, the Carolingian paintings were rediscovered in 1908-09. The paintings were completely restored between 1947 and 1951. The main events that have affected the mural paintings are summarized in Table 4.

Table 4. Major events involving the mural paintings in the convent church at Müstair.

Date	Event
ca. 800	Execution of the Carolingian paintings
ca. 1000	Rededication of the church after a fire
ca. 1200	Romanesque paintings are superimposed on the Carolingian ones
1489-92	Gothic additions; fire in the roof space
?	Mural paintings are covered by whitewash (at least by the end of the Baroque period)
1878-79	Gothic Revival modifications; entire interior is repainted
1908-09	Rediscovery of the Carolingian paintings
1947-51	Complete restoration of the Carolingian and Romanesque paintings, including drying of the walls, through installation of a ventilated external perimeter drain to reduce rising damp, and installation of a central heating system with radiators
1951-present	Removal of some parts of the Romanesque paintings which were threatening to detach from the Carolingian ones; considerable deposition of dust; delamination of Romanesque paintings with their <i>intonaco</i> ; accelerated decay connected with soluble salts

## ***The Problem***

After being restored in 1947-51, the paintings decayed faster than they had before. Even though the dust deposition was an important factor, and the delamination of the painted plaster seems to have progressed at a considerable rate, the major decay of the mural paintings was caused by salt concentrations and crystallization, which depended in turn on room climate. Hence we had to focus our attention on decay due to salt concentrations in the walls. The effect of pollution can be discounted here.

Ground moisture has risen during the lifetime of the church up to 4 m above floor level, and the salts transported by the moisture have been locally concentrated and accumulated in a spatial distribution within this zone, the less soluble ones below and the more soluble ones above. These salts have increased in quantity and have transformed into more harmful ones by new alkaline salts introduced during the 1947-51 restoration. They now crystallize periodically, in relation to variations in the relative humidity, and thus accelerate decay.

## ***Deterioration Caused by Salt Concentrations***

If we aim to understand the processes of decay comprehensively, we must consider the local concentrations and accumulations, the distribution of forms of decay, the crystalline salt species, and the solutes in the aqueous solution. Then we must observe and study the conditions of crystallization.

Damage from salt crystallization occurs in the zone of rising damp, and affects both the Carolingian and the Romanesque paintings in the apses to a level of about 3-4 m above the floor (Pls. 45, 46).

Within this zone visible deterioration has been observed and documented (see Fig. 23). The different forms of deterioration coincide with efflorescences of identified salts listed in Table 5.

*Table 5. Salts identified on the wall paintings at Müstair.*









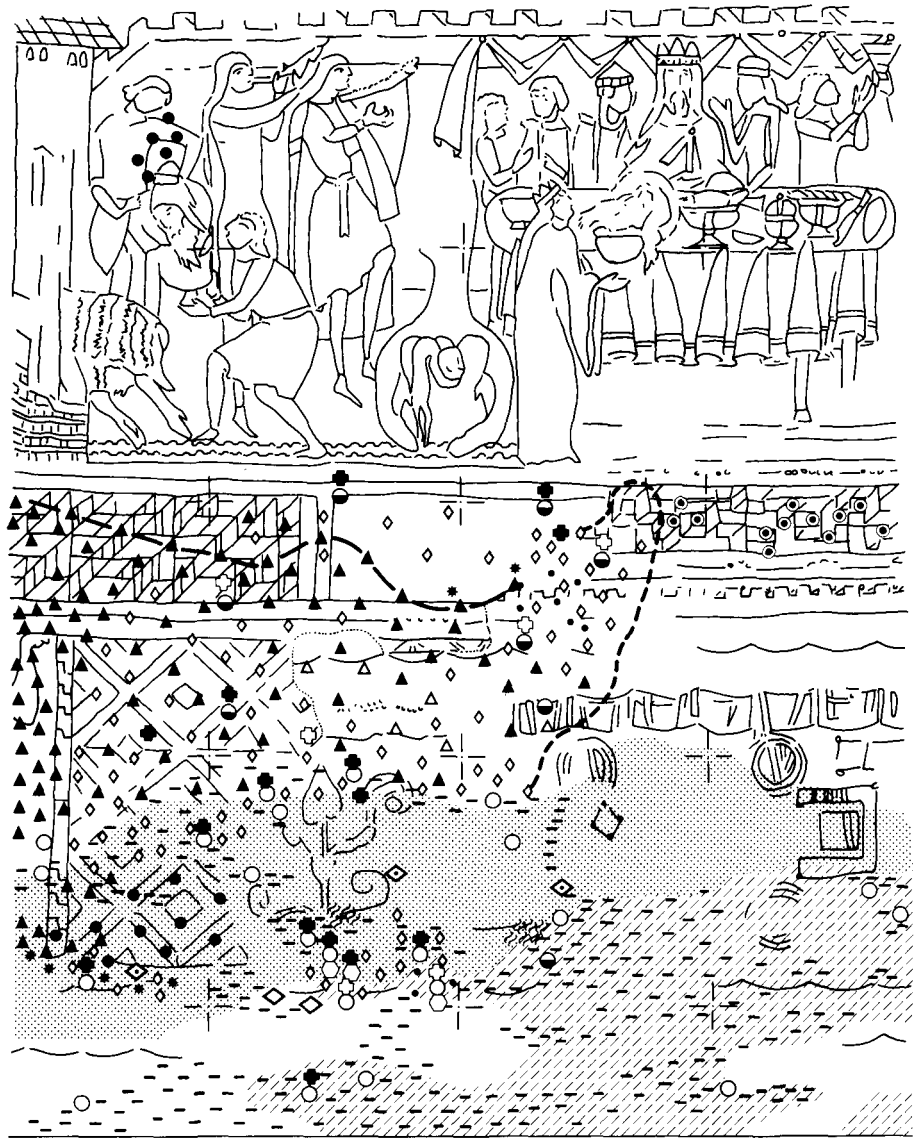









Sulfates	Thenardite	$\text{Na}_2\text{SO}_4$
	Epsomite	$\text{MgSO}_4 \cdot 7\text{H}_2\text{O}$
	Gypsum	$\text{CaSO}_4 \cdot 2\text{H}_2\text{O}$
Nitrates	Nitronatrite	$\text{NaNO}_3$
	Nitrokalite	$\text{KNO}_3$
	Nitromagnesite	$\text{Mg}(\text{NO}_3)_2 \cdot 6\text{H}_2\text{O}$
Carbonates	Thermonatrite	$\text{Na}_2\text{CO}_3 \cdot \text{H}_2\text{O}$
	Hydromagnesite	$\text{Mg}_5[\text{OH}(\text{CO}_3)_2]_2 \cdot 4\text{H}_2\text{O}$
	Nesquehonite	$\text{MgCO}_3 \cdot 3\text{H}_2\text{O}$

The distribution of crystalline salts in Figure 23 shows the following pattern: gypsum is distributed throughout the area under consideration, due also to numerous gypsum repairs; nitrates are concentrated in the upper parts; while



Figure 23a, above. The Dance of Salome documented in Fig. 23b. Figure 23b, right. Map showing forms of deterioration and distribution of saline deposits and salt minerals on a portion of the Carolingian and Romanesque mural paintings in the apses of the convent church at Müstair (Arnold, Kueng, and Zehnder 1986).



-  Fluffy efflorescences
-  Bristly efflorescences
-  Recognizable boundary of areas with bristly efflorescences
-  Salt pustules
-  Salt crust
-  Pulverulent efflorescences
-  Pits, including loosened paint particles
-  Recognizable boundary of areas with pits
-  Old pits, retouched during last restoration
-  Granular disaggregation, paint is lacking
-  Scaling of intonacos and repairs
-  Dark spots of humid aspect
-  Thenardite
-  Epsomite
-  Gypsum
-  Nitronatrite
-  Nitrokalite
-  Thermonatrite
-  Hydromagnesite

soluble sulfates are concentrated in the lower ones. The ionic distributions within the spatial salt concentrations are given in Figure 2b.

The identification of salts from aqueous extracts of poultices is not quantitative, but shows a true picture of distribution of the ions along vertical profiles within the zone of rising damp on the painted surface. This was confirmed by the quantitative results obtained from renders from another location in the convent (see Fig. 2a). The sulfates do not rise as far as the nitrates and chlorides do; in fact they disappear at the level at which nitrates and chlorides show maximum concentrations. The distribution of Mg, Na, and K corresponds roughly to that of nitrates and chlorides.

Hence the distribution of solutes reflects the distribution of crystallized salts. However, considering that chlorides are nearly as concentrated as nitrates in the extracted solutions, it is astonishing that no crystalline chlorides could be found on the walls. This may be due to the fact that Mg and Cl give a very strongly hygroscopic solution, but remains unclear.

The genesis and distribution of the local concentration and accumulation of salts in the vertical profile in the church may be explained as follows (see Fig. 3): dilute aqueous solutions of  $\text{NO}_3$ ,  $\text{SO}_4$ ,  $\text{CO}_3$ , Mg, Na, K, and some Ca rise from the ground and from surface water (rain, melting snow) at its base into the wall; above the floor, evaporation leads to deposition of salts in a sequence according to their solubilities; by this process the solutes are fractionated to form a sequence in which the salts rise higher the more soluble they are. This process which continued for about twelve hundred years at Müstair until the restoration in 1947-51, led to the local concentration of a salt system with a certain composition and distribution.

The natrite, hydromagnesite, and nesquehonite present in this context clearly originate from alkaline materials introduced during the 1947-1951 restoration. From that point the original salt system was transformed according to the reactions shown in Table 2. These new salts contribute to ongoing decay in the following ways. First, the alkaline salts such as natrite that are still present are as harmful as sodium sulfate salts, whose disruptive action is better known, because they form different hydrate phases. Second, the hydromagnesite and nesquehonite (scarcely soluble compounds formed from the reaction of sodium and potassium carbonate with the Mg ions of the solutions; Table 2) formed crusts, causing nonrecurring deterioration of the wall paintings. Some portions of the Romanesque paintings and their *intonaco* were lifted from the supporting Carolingian paintings by such crust formation. Third, some of the highly soluble and hygroscopic solutes (nitrates and chlorides of magnesium and calcium) were transformed into less soluble and hygroscopic ones (potassium and sodium nitrates and chlorides; Table 2). Since the former salts crystallize only very rarely they are much less harmful than the latter ones, which are much less hygroscopic and crystallize frequently.

At Müstair then the local salt concentration and accumulation, with its characteristic distribution of crystalline salts and solutes, represents a salt system interacting with its environment. The main environmental factor that has influenced this interaction is the humidity balance between the wall and the room climate.

Before the measures taken during the restoration of 1947-51 this humidity balance was determined mainly by the supply of moisture to the walls from capillary rise, infiltration, and percolation, on the one hand, and the evaporation of this moisture from the wall surfaces above floor and ground level, on the other hand. To reduce the water at the base of the external walls of the apses, a ventilated trench was installed in 1947-51 to drain dispersed water and to increase evaporation. In addition, during the winter protective boarding is positioned here to direct melting snow away from the wall. Rainwater-disposal goods were repaired in 1975. These measures have been successful, and the base of the walls has now visibly dried out. What remains is the interaction between the room climate and the local salt concentrations in the walls.

### *Conditions of Periodic Salt Crystallization*

The main crystallizing salts in this case are nitronatrite (sodium nitrate) and sometimes also nitromagnesite (magnesium nitrate). Nitronatrite effloresces in winter all over Zone C of rising damp (Fig. 3), extending between 0.5-1 m and 4 m above the floor on the paintings when the air becomes dry, and disappears in summer when the air becomes humid. Nitromagnesite crystallizes on a column when the relative humidity becomes very dry, and disappears immediately when it becomes more humid. The equilibrium relative humidity of pure nitronatrite is 75.4% and that of pure nitromagnesite 54.4% at 20 °C. This means that if pure salts were present, nitronatrite would crystallize only when the relative humidity dropped to values below 75.4% and would be dissolved by humidity when it rose to values above 75.4%. For nitromagnesite the corresponding relative humidity would be 54.4%.

Both in situ and in the laboratory it has been observed that with the salt mixtures present in the walls, and in the actual environment, nitronatrite crystallizes when the relative humidity becomes lower than around 60% and not at 75.4% as with the pure salt.

The climatic evolution curve of the unheated Holy Cross Chapel at Müstair is close to that of the outdoor climate and is given here to compare with the climate in the heated church. In the chapel (Fig. 24), the mean temperature values varied between -5 °C in January and February and 15-18 °C in summer. The relative humidity varied throughout the year, mainly between 60 and 80%, but there were short periods with relative humidities below 60%. In the church (Fig. 25) the temperature in summer was about 2 °C warmer, and the variations in relative humidity were distinctly smaller. When heating began in late October, the room climate in the church became 10-15 °C warmer and 20-30% drier. The relative humidity then was about 45% on the column (where nitromagnesite crystallizes) and 50% on the walls of the apses, where the temperatures were 2 °C lower than in the room. To ensure that the relative humidity does not fall below 60%, the temperature in the church should not exceed 5 °C.

The crystallization of nitronatrite (sodium nitrate) represented in Figure 25 coincided with the periodic lowering of relative humidity, crystallizing in large quantities when heating begins in late autumn and the relative humidity drops below 60% and then continuously during winter. The crystallized salts undergo aging during winter and disappear in spring when the relative humidity rises again to values above 60%. These events have been observed each year since measurement began in 1982.

But some crystallizations of nitronatrite were also observed in June and July 1986. That happened when the outdoor climate at Müstair became very dry and was reflected in the climatic curves from both the church (Fig. 25) and the Holy Cross Chapel (Fig. 24). At that time the climate of the church and that of the chapel nearly corresponded.

Nitromagnesite (Fig. 25) crystallizes when a dry and cold outside climate coincides with interior heating, pushing relative humidity to values beneath 50%, but soon disappears when it rises above this value.

Thus at Müstair a main salt crystallization effect coincided with heating periods and a secondary one related to dry periods outside. This means that in the area under study the main deterioration has been induced by heating but that some minor decay has also occurred during dry periods caused by the natural climate in the Münstertal Valley. The main effects correlating to the use of heating obviously did not occur before it was installed in 1947-51.

### Preservation

In a synergistic action, rising damp, locally concentrated and accumulated salts, and variations of relative humidity have led to the accelerated decay of the wall paintings at Müstair with the greatest effect up to about 4 m above floor level. The elimination of rising damp alone would only stop the supply of new solutes from the ground but not the periodic salt crystallization. On the contrary, if the environment became drier the salt would crystallize more easily, and decay would be accelerated. Moreover, it is impossible to desalinate completely walls that are covered by plaster and wall paintings. Air conditioning alone would be

Figure 24, right. Evolution of the averaged daily values for RH and T, Holy Cross Chapel, convent of Müstair, 1986.

Figure 25, below right. Relationship of the averaged daily values for RH and T to the heating and observed salt crystallization (shown below), convent church of Müstair, 1986.

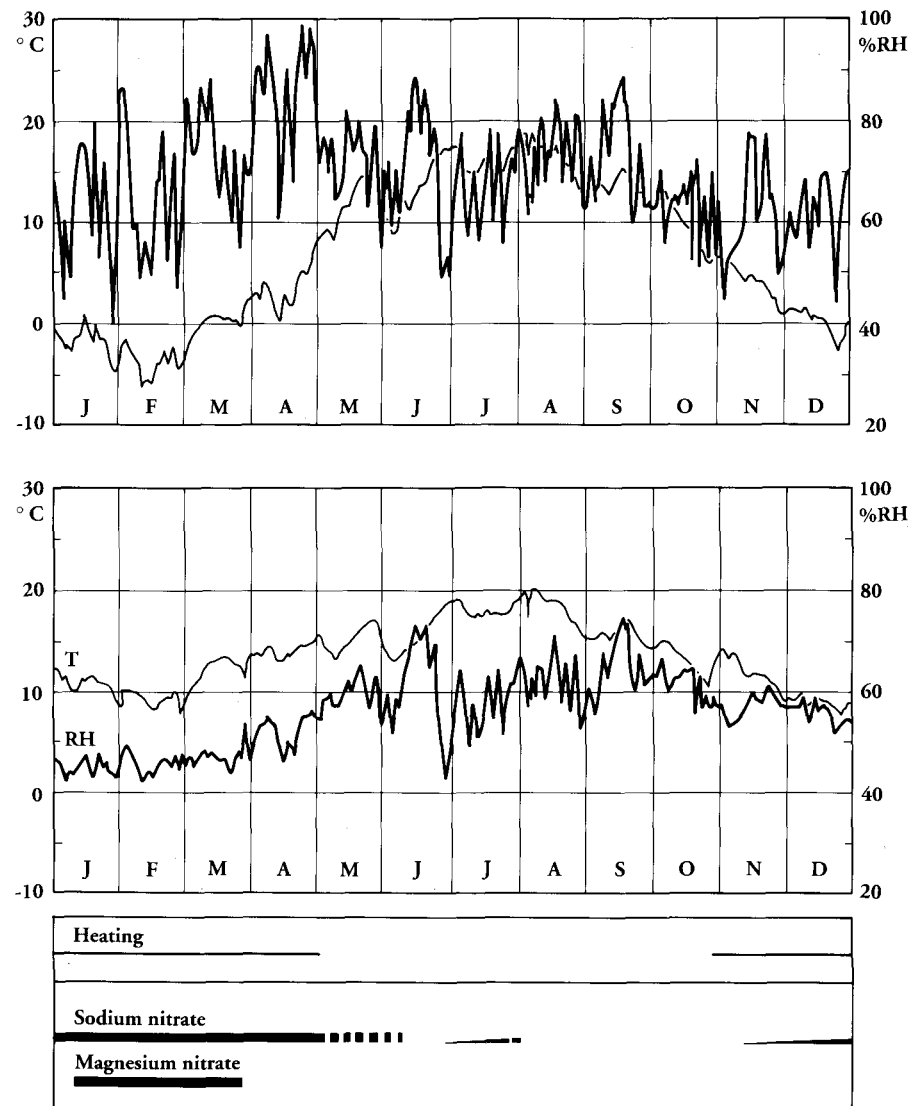

extremely difficult and risky. Humidified air in winter would cause inevitable condensation on cold areas of the church, producing damage by means of water and organisms. For these reasons there is no way to preserve such paintings just by eliminating one cause or intervening in one process. The only practical way is to develop a program of concerted actions designed to minimize the decay. Thus our aim has been to proceed in small and reversible steps to reduce the frequency of salt crystallizations as much as possible.

At Müstair the following actions have already been taken:

#### *Basic Documentation*

- Observation, identification, and registration of the distribution of different forms of deterioration, of crystalline and dissolved salts, and of humidity
- Periodic observation of salt crystallization (forms, habits, aggregates) and resultant decay

#### *Control of Humidity Balance*

- 1947-1951, installation of a ventilated trench along the outside foundations
- Since 1975, installation of new gutters to prevent water from falling directly from the roof onto the outside surface of the wall, to avoid percolation to the interior surface
- Protective wooden boarding positioned along the base of the walls in winter to prevent penetration and percolation of water from melting snow

#### *Work on Reducing Salt Concentration*

- Desalination of the mural paintings in the zone of rising damp by application of wet blotting paper over the entire surface; analyses of the aqueous extracts
- Repeated application of wet blotting paper on areas where important new efflorescences have been observed
- Repeated dry brushing away of crystalline salts during crystallization periods

#### *Monitoring of Room Climate*

- Continuous measurement of room temperature and relative humidity
- Repeated measurements of temperature distribution on the walls
- Reduction of heating during winter

The effects of these actions on the decay processes at Müstair are controlled by periodic observations and documentation of salts and the deterioration they produce, while the room climate is monitored continuously. The cumulative results will allow us to decide whether heating can be tolerated and, if so, which kind. They will also help to determine what other actions must be taken in the future.

In fact we can avoid the crystallization of natrite due to heating at Müstair just by preventing a rise in temperature to more than 5 °C during the



heating period. But if we do this, we will have to avoid accelerating other decay processes such as condensation, frost action, and biological weathering.

This methodical approach—combining investigations made at every level into all materials and into the forms and processes of decay—combined with the monitoring of humidity and climate is not only valid for the cases discussed in this paper. It can apply to all wall paintings affected by similar decay on the condition that it is adapted to each individual case with intelligence and prudence. If we really aim to preserve monuments for the future, they must be monitored regularly.

## Acknowledgments

---

The scientific work presented here was done at the Institute for the Preservation of Monuments and Sites of the Swiss Federal Institute of Technology, Zurich, and was financed by National Research Program 16, sponsored by the Swiss National Science Foundation.

## References

### Amoroso, G. G., and V. Fassina

1983            *Stone Decay and Conservation*. Amsterdam: Elsevier.

### Arnold, A.

1981            "Salzminerale in Mauerwerken." *Schweizerische mineralogische und petrographische Mitteilungen* 61:147-166. Zurich: Leeman.

1982            "Rising Damp and Saline Minerals." *4th International Congress on the Deterioration and Preservation of Stone Objects, Louisville 7-9 July, 1982*. Louisville: The University of Louisville. 11-28.

1985            "Moderne alkalische Baustoffe and die Probleme bei der Konservierung von Denkmälern." *Natursteinkonservierung. Internationales Kolloquium, München, 21./22. Mai 1984* (Bayerisches Landesamt für Denkmalpflege, München, Arbeitsheft 32). Munich. 152-162.

### Arnold, A., and A. Kueng

1985            "Crystallization and Habits of Salt Efflorescences on Walls, Part I: Methods of Investigation and Habits." *5th International Congress on the Deterioration and Conservation of Stone, Lausanne 25-27 September, 1985*. G. Felix and V. Furlan, eds. Lausanne. 255-267.

### Arnold, A., A. Kueng, and K. Zehnder

1986            "Deterioration and Preservation of Carolingian and Medieval Mural Paintings in the Müstair Convent (Switzerland)." In *Case Studies in the Conservation of Stone and Wall Paintings (Preprints of the contributions to the Bologna Congress, 21-26 September 1986)*. London: IIC. 190-194.

### Arnold, A., and K. Zehnder

1983            "Verwitterungsschäden durch Ameisensäure." *Schweizer Ingenieur und Architekt* 36(83):841-845.

1984            "Evaporite und Verwitterung an Bauwerken." *Eclogae geologicae Helvetiae* 77:287-300.

1985            "Crystallization and Habits of Salt Efflorescences on Walls, Part II: Conditions of Crystallization." *5th International Congress on the Deterioration and Conservation of Stone, Lausanne 25-27 September, 1985*. G. Felix and V. Furlan, eds. Lausanne. 269-277.

- Bläuer, C.**  
1987 Verwitterung der Berner Sandsteine. Ph.D. dissertation. University of Bern.
- Bock, E.**  
1986 "Biologisch induzierte Korrosion von Naturstein—starker Befall mit Nitrifikanten." Special number of *Bautenschutz/Bausanierung* 42-45.
- Del Monte, M., and C. Sabbioni**  
1987 "A Study of the Patina Called 'Scialbatura' on Imperial Roman Marbles." *Studies in Conservation* 32:114-121.
- Evans, I. S.**  
1970 "Salt Crystallization and Rock Weathering: A Review." *Revue de géomorphologie dynamique* 19:153-177. Paris: Edition de la Société d'édition d'enseignement.
- Faller, A.**  
1987 "Auswirkung mineralogischer Prozesse auf die Bausubstanz." In *Erhalten Historisch Bedeutsamer Bauwerke* (Arbeitshefte des Sonderforschungsbereich, 315) 6:39-56.
- Girardet, F., and Vinicio Furlan**  
1982 "Mesure de la vitesse d'accumulation des composés soufrés sur des éprouvettes de pierre exposées en atmosphère rurale et urbaine." *4th International Congress on the Deterioration and Preservation of Stone Objects, Louisville 7-9 July, 1982*. Louisville: The University of Louisville. 159-168.
- Gmelin Handbuch der anorganischen Chemie**  
1966 8th Edition, Vol. 3. Weinheim.
- Greenspan, L.**  
1977 "Humidity Fixed Points of Binary Saturated Aqueous Solutions." *Journal of Research of the National Bureau of Standards, Section A: Physics and Chemistry* 81A:89-96. Washington, D.C.: National Bureau of Standards.
- Hartman, P.**  
1979 "Zum Verständnis des Mineralwachstums." *Fortschritte der Mineralogie* 57:127-171.
- Lewin, S.**  
1982 "The Mechanism of Masonry Decay through Crystallization." In *Conservation of Historic Buildings and Monuments*. Washington, D.C.: National Academy Press. 120-124.
- McCoy, W. L., and O. L. Eshenour**  
1968 "Significance of Total and Water-soluble Alkali Contents of Portland Cement." *J. Materials* 3:684-694.
- Nabarro, P., and P. Jackson**  
1958 "Growth of Crystal Whiskers." In *Growth and Perfection of Crystals*, International Conference on Crystal Growth. Cooperstown, New York: Wiley. 13-101.

**Pauly, J. P.**

- 1979 "Circulation de l'eau dans les murs de l'abbaye romane de Nieul." *3rd International Congress on the Deterioration and Preservation of Stone, Venice 24-27 October, 1979*. Padua: Università degli Studi, Istituto di chimica industriale. 557-570.

***Pellicole ad ossalato: origine e significato nella conservazione delle opere d'arte.***

- 1989 *Proceedings of the conference, 25-26 October, 1989, Milan*. Milan.

**Schiessl, U.**

- 1985 "Stereochromie. Zur Entwicklung der Maltechnik mit Alkalisilikaten und der gleichzeitigen Entwicklung der Irrwege der Putz- und Steinkonservierung damit seit 1825." In *Historische Technologie und Konservierung von Wandmalerei*. Bern: Schule für Gestaltung. 158-168.

**Sneathlge, R.**

- 1984 "Naturwissenschaftliche Untersuchungen zur Steinkonservierung." In *Das Südportal des Augsburger Domes, Geschichte und Konservierung*. (Bayerisches Landesamt für Denkmalpflege, München, Arbeitsheft 23). Munich. 95-102.

**Sunagawa, I.**

- 1981 "Characteristics of Crystal Growth in Nature as Seen from the Morphology of Mineral Crystals." *Bulletin de minéralogie* 104:81-87.

**Taber, S.**

- 1917 "The Genesis of Asbestos and Asbestiform Minerals." *Transactions of the American Institute of Mining Engineers* 57:62-98.

**Wylie, R. G.**

- 1965 "The Properties of Water-salt-systems in Relation to Humidity." In *Humidity and Moisture* 3:507-512. New York: Reinhold.

**Zehnder, K.**

- 1982 *Verwitterung von Molassesandsteinen an Bauwerken und in Naturaufschlüssen* (Beiträge Geologie der Schweiz. Geotechnische, 61). Bern: Schweizerischen Naturforschende Gesellschaft, Geotechnische Kommission.

**Zehnder, K., and A. Arnold**

- 1988 "New Experiments on Salt Crystallization." *6th International Congress on the Deterioration and Conservation of Stone, Toruń 12-14 September, 1988*. Toruń. 320-329.

**Zehnder, K., A. Arnold, and H. Spirig**

- 1986 "Zerfall von Wandmalerei durch lösliche Salze." *Maltechnik/Restauro* 92:9-33.



# In Review: An Assessment of Florentine Methods of Wall Painting Conservation Based on the Use of Mineral Treatments

*Mauro Matteini*

The conservation of wall paintings requires special methodologies and treatments that are directly related to their specific physical nature. Three conditions chiefly characterize mural paintings:

1. Their constituent materials have a high and open porosity, resulting in an easy accessibility of both liquids and gases (salt solutions, atmospheric pollutants, water vapor, solutions of materials used for conservation, etc.).
2. They are—and remain after conservation—part of an essentially open physical system, a consequence of contact with contiguous structures (walls, ground, roofs) that are dynamically involved in a series of physical and chemical events.
3. In most cases the surrounding microclimate cannot be controlled.

Together these conditions imply that an intervention strategy should include:

1. The use, in so far as possible, of appropriate conservation methodologies, with a preference for mineral treatments, which, due to their compatibility, have a greater respect for the nature of the fresco itself—a very important factor in obtaining more stable, lasting, and reliable results.
2. Periodic surveillance following conservation.

In this paper, serious problems of sulfation, particularly the effects of gypsum, are reviewed and appropriate tests to evaluate and monitor them are discussed. The methodology of cleaning and conservation based on the use of ammonium carbonate and barium hydroxide, developed particularly to address the problem of sulfation, is described. It has been employed now in Florence for some twenty years, and evidence is given here of the first frescoes—by Fra Angelico and Sogliani—treated with "barium." These paintings were seriously affected by sulfation and had a high level of surface decohesion. Details photographed in raking light before conservation in 1973 and 1975 are compared with photographs taken in 1987, which demonstrate and confirm a generally satisfactory result.

After appropriate conservation has been carried out with scrupulous respect for the constituent materials, a long period usually follows in which the state of conservation of an artifact remains almost static. The materials and structures have been set in conditions of greater stability and the microclimate has been adjusted to normal and constant values. If serious, unforeseeable events do not occur it should be years before problems arise that might necessitate monitoring. But this is only true for those artifacts that can be incorporated into closed or essentially isolated physical systems. This might be the case, for example, with paintings on mobile supports, such as canvases and panels, or outdoor sculpture in stone or metal that can be transferred after treatment to museums or churches and thus removed from the more direct impact of aggressive external agents.

The case of frescoes, and wall paintings in general, is different. Two basic conditions distinguish their behavior from that of other artifacts: their constituent materials have a high and open porosity, and they are essentially open physical systems. As far as the first point is concerned, it is well known that both the plaster and the paint layers are typically structures with a high porosity of open type; in other words their pores can intercommunicate easily. This means that there is a wide specific surface exposed to possible degrading agents, and there is an easy permeability to fluids that come into contact both as liquids (dilute salt solutions in the wall) and as gases (atmospheric pollutants and water vapor).

Regarding the second point—but excluding paintings that have been detached and transferred to a new support—wall paintings remain, even after conservation, open systems in contact with contiguous structures that take part in the dynamics of a whole range of events (Fig. 1). Even if conservation has been successful in eliminating any infiltration, in most cases contact with the ground and adjacent walls continues, providing sources for capillary movement of mois-

*Figure 1. Mural paintings constitute part of an open physicochemical system in which, due to their contiguity with other elements of a building, their situation gradually and continually evolves, before and after conservation interventions.*

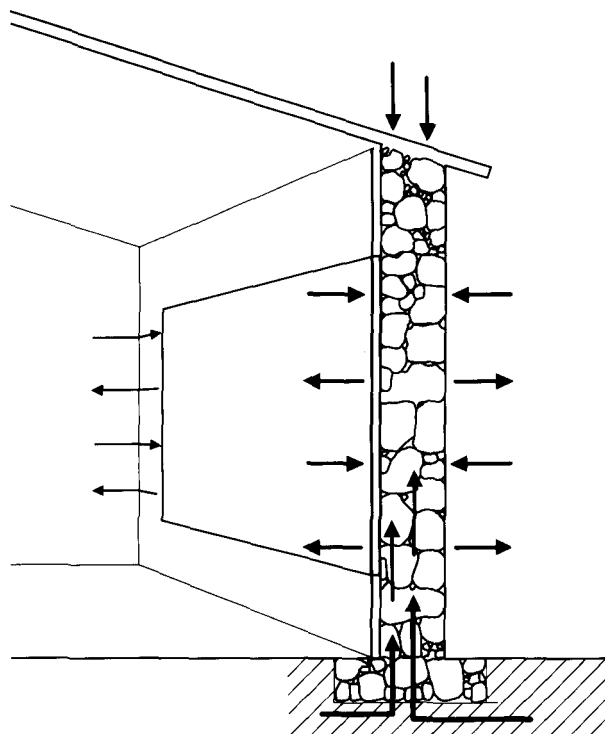

ture. Based on experience, current practice usually excludes cutting and damp-proofing a wall to isolate it from sources of such moisture or employing any other treatment that can lead to complete dehydration of the plaster and mortar. Moreover, some important physical properties, such as microcohesion, adhesion between thin layers, etc., are in fact related to a very small but necessary amount of moisture that such structures must possess permanently.

Since the possibilities for the control of environmental conditions are usually limited for mural paintings *in situ*, the surface of the painting can thus be considered the interface for events that involve the adjacent structures directly but involve the painting itself indirectly. As an open, reactive system, a mural painting requires much more surveillance after conservation than other types of artifacts. The system evolves, altering gradually but continually. Conservation, even if carried out correctly, must not lead to the belief that the physical condition of the painting will be stable, definitive, and unproblematic.

Many specialists are currently involved, quite rightly, in studying the conservation of lithic artifacts exposed outdoors. These artifacts constitute a significant part of the artistic heritage which is deteriorating dramatically. It must be affirmed, however, that the problems of frescoes are no less urgent. In these, the valued matter—that is to say the paint layers—is present in a very small amount, only a few microns in thickness, but with a high exposure to degrading agents. Specialists concerned with mural painting must direct their efforts toward the goal of reliability over time for treatments. To achieve this, the approach should be conditioned by a much more rigid discipline, involving:

1. Minimal tolerance for the use of unsuitable consolidants for the highly porous structures of frescoes;
2. Determination of treatments and materials that are more suitable and compatible over a long period of time;
3. Advance planning for periodic monitoring, to include appropriate tests or examinations to establish the state of conservation.

Periodic monitoring of significant parameters can be rather difficult and expensive. Moreover, a policy for conservation that encompasses such monitoring does not yet exist. It must be created and must include provisions for specialists, programs, and funding. All this will take time but meanwhile something must be done. A primary aspect is the control of environmental conditions, and although proposals are only just beginning to be made it is to be hoped that difficulties can be overcome and effective results obtained. Monitoring of treatments is another important problem; it is facilitated if interventions have been appropriate and were intended to be durable, in which case intervals between examinations can be extended.

What are the primary causes of decay in mural paintings? It can be agreed that the crystallization of soluble salts in the surface layers is the main danger, but inappropriate conservation methods or the use of incompatible materials represent, without any doubt, one of the other principal causes of degradation.



## Soluble Salts

A salt crystallizes from a solution when the concentration exceeds saturation. With the exception of some very particular cases, solutions that circulate and diffuse through pores in wall paintings are usually very dilute, and pronounced evaporation must occur in order to reach saturation values. The volumetric expansion associated with the growth of crystals is the direct cause of the well-known deterioration phenomenon that strongly affects microcohesion, producing disintegration of the plaster and lifting or detachment of fragments of the paint film.

### Solubility

The disruptive behavior of salts in wall paintings may be better evaluated by distinguishing among very soluble salts, slightly soluble salts, and almost insoluble salts (Fig. 2). Those in the first category (a) can reach very high molar concentrations without crystallizing. Given their high solubility, the amount of salt at saturation is also high, and where crystallization occurs it is conspicuous, with the formation of efflorescences. Usually, surface efflorescences are formed, but these are not necessarily damaging, although sometimes some of the salt may also crystallize below the paint layer, causing damage due to the expansion in volume. Slightly soluble salts (b) are the most harmful. Due to their minor solubility, there is a much higher probability that they will reach saturation. They form crystals especially below the surface where evaporation, though inferior, is still present. Damage is very severe. Finally, the last category, almost insoluble salts (c), does not usually produce any striking or dangerous phenomena. Although the salt can also crystallize below the surface or even further inside the wall, it does not produce damage nor is it usually visible since the amount of material involved is not significant. The extremely gradual crystallization of these salts functions, if anything, to reestablish the microcohesion of the material.

Table 1 is a list of the more common salts, arbitrarily subdivided into three categories: (a) very soluble species (>20 times the solubility of gypsum); (b) slightly soluble species (gypsum and salts with similar solubility); and (c) almost insoluble species (<1/100 times the solubility of gypsum).

Figure 2. Distribution and effects of salts in the plaster as well as within and over the surface of mural paintings, in relation to their solubility in water: (a) very soluble, (b) slightly soluble, (c) almost insoluble.

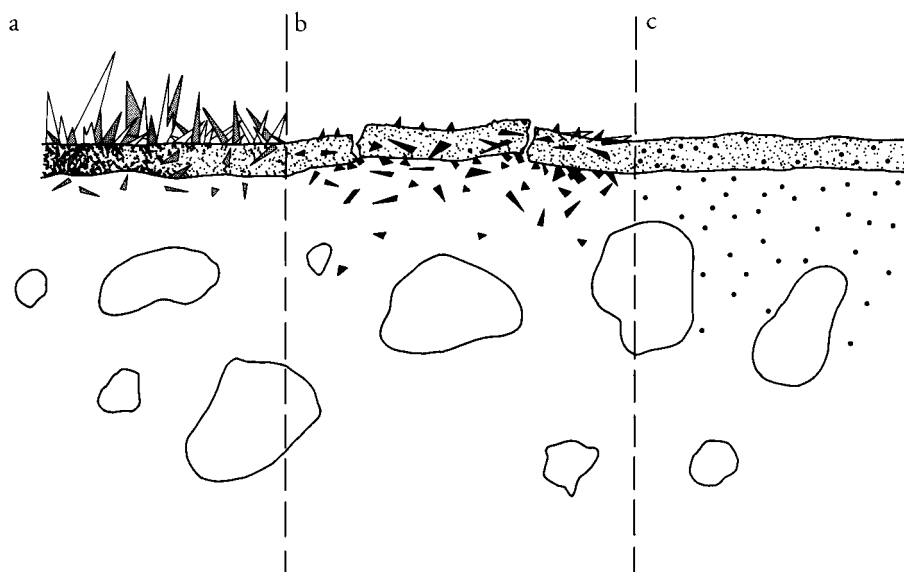

Table 1. Molar solubility of some of the more common salts occurring in the plaster and near the paint layers in mural paintings, divided into three groups on the basis of their solubility relative to gypsum.

Salt	Molar Solubility at 20 °C	Solubility Relative to Gypsum (=1.00)
<i>(a) Very soluble salts (&gt;20 times the solubility of gypsum)</i>		
NH <sub>4</sub> NO <sub>3</sub>	10.4*	696
NaNO <sub>3</sub>	7.2	483
CaCl <sub>2</sub> ·6H <sub>2</sub> O	7.02	468
K <sub>2</sub> CO <sub>3</sub>	5.57	372
NaCl	5.32	355
(NH <sub>4</sub> ) <sub>2</sub> SO <sub>4</sub>	4.88	325
NH <sub>4</sub> Cl	4.79	319
KCl	3.74	249
Ca(NO <sub>3</sub> ) <sub>2</sub> ·4H <sub>2</sub> O	2.9	196
KNO <sub>3</sub>	2.8	184
NH <sub>4</sub> HCO <sub>3</sub>	2.31	154
Na <sub>2</sub> SO <sub>4</sub> ·10H <sub>2</sub> O	2.08	139
MgCl <sub>2</sub> ·6H <sub>2</sub> O	1.87	125
Na <sub>2</sub> CO <sub>3</sub> ·10H <sub>2</sub> O	1.51	101
MgSO <sub>4</sub> ·7H <sub>2</sub> O	1.37	91
K <sub>2</sub> SO <sub>4</sub>	0.62	41
Ba(NO <sub>3</sub> ) <sub>2</sub>	0.34	23
<i>(b) Slightly soluble salts (gypsum and salts with similar solubility)</i>		
CaSO <sub>4</sub> ·2H <sub>2</sub> O	0.015	1.00 (gypsum)
MgCO <sub>3</sub>	0.005	0.34
<i>(c) Almost insoluble salts (&lt; 1/100 times the solubility of gypsum)</i>		
CaCO <sub>3</sub>	9.6 x 10 <sup>-5</sup>	6.4 x 10 <sup>-3</sup>
BaCO <sub>3</sub>	8.7 x 10 <sup>-5</sup>	5.8 x 10 <sup>-3</sup>
CaC <sub>2</sub> O <sub>4</sub> ·H <sub>2</sub> O	4.5 x 10 <sup>-5</sup>	3.0 x 10 <sup>-3</sup>
BaSO <sub>4</sub>	1.03 x 10 <sup>-5</sup>	6.8 x 10 <sup>-4</sup>

\* at 17.5 °C

### Gypsum

Among the various species, the singularity of gypsum stands out. This is undoubtedly to be considered, in my experience, the most diffused and dangerous saline compound for the conservation of wall paintings. The crystallization of gypsum (sulfation) causes serious disaggregation of the plaster on or near the surface, microflaking of the paint layer, and the formation of surface bloom. It should be noted, however, that when gypsum has been used in previous treatments for repairs or as a supporting material for transferred paintings it has almost never resulted in damage characteristic of sulfation. This leads one to suppose that alterations observed on paintings that are due to sulfation from an external source result from a concomitance of phenomena and agents among which gypsum plays a principal but not unique role.

Some of the aforementioned observations on solubility can be seen to be particularly relevant with respect to monitoring the condition of a wall paint-

Figure 3. In cases where the distribution of gypsum is heterogeneous, sampling at varying depths gives results that are misleading with respect to the state of conservation. At right, percentages of gypsum at arbitrary intervals of .25 mm are given. At left are analytical results that would be obtained at sampling depths of .5-3 mm.

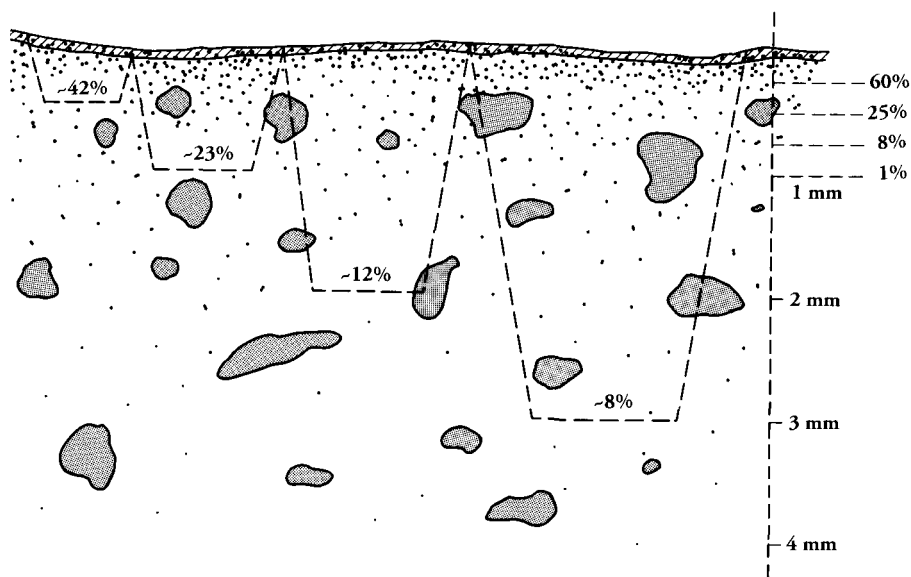

ing, both before and after treatment. Frequently, the analysis is carried out in such a way that misleading conclusions may be drawn in assessing the actual state of conservation. For example, analyses are normally made on samples taken from the painting, and the presence of salt is reported as a percentage by weight with reference to the total weight of the sample. However, an irregular distribution of the salt within the plaster can lead to varied and misleading analytical results as a consequence of sampling at different depths. As can be seen in Figure 3, gypsum typically has a heterogeneous distribution in the plaster, depending on the depth. In most cases it is concentrated in the tens of microns near the surface. We must consider this fact carefully. Even though the thickness of a sample does not usually exceed a few mm, the gypsum occurs in only a fraction of it and normally is not present at depths greater than 0.2-0.3 mm. Analytical data and the implications they have for a diagnosis of the state of conservation may therefore be misleading.

Monitoring the state of conservation of a mural painting should, in many cases, include measuring the amount of gypsum where it actually is located. For this reason data that are less quantitative but more informative with regard to location, such as specific Colorimetric tests, are sometimes to be preferred. Photomicrographs of cross sections of samples taken from the surfaces of various mural paintings are illuminating as to the state of conservation and point to the different mechanisms of crystallization which can occur, depending on local conditions (see Pls. 47-52).

### **Crystallization**

Assuming constant microclimatic conditions, we can say that crystallization depends, to a large extent, on the characteristics of the plaster. In some cases it is slightly porous and very compact. Sulfation then occurs with a heterogeneous distribution, not only in depth but also along the surface. Localized microflaking of the paint layer can occur that is directly related to an accumulation of gypsum below. When, on the other hand, the plaster is uniformly

porous, sulfation may be more homogeneous; the greater specific surface draws large amounts of salts toward the exterior, allowing crystallization in the form of a coherent whitish veil.

In cases where a protective coating has been applied in a previous treatment and has itself become physically degraded and porous, this spongy film attracts salts by capillarity from the bulk of the wall and becomes the site of crystallization. Perhaps this can be considered a fortunate circumstance, since the altered film functions as an auxiliary layer toward which the disintegrating effects of crystallization are directed instead of toward the paint layer.

On the other hand, where a film of coherent and nonporous material occludes the natural porosity of a mural, significant damage can sometimes be observed to occur within ten to twenty years. This means that the consolidation in situ of a mineral and highly porous material such as a wall painting with polymeric resinous materials may be an illusory solution. Objective evidence exists of cases in which the use of polymers, either in solution or in emulsion, has been detrimental for the conservation of frescoes over a long period.

### *Barium Treatment*

For the above reasons, our preference is to use mineral substances, essentially those based on barium hydroxide, for the consolidation of mural paintings. For about twenty years now, the work carried out on frescoes by the Opificio delle Pietre Dure in many regions of Italy has employed this approach. It may be useful to recapitulate in a schematic way the basic chemical reactions involved in this two-step treatment, which involves first cleaning with ammonium carbonate and then, after an interval, consolidation with barium. This will provide a better understanding of the case histories adduced as examples of the monitoring of frescoes after treatment.

#### *Solubilization of gypsum*

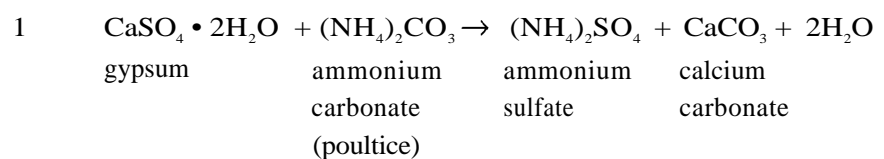

In the first step, the application of ammonium carbonate results in the conversion of gypsum into soluble ammonium sulfate. This is in part absorbed by the compress and in part diffuses into the surface porosities of the fresco. If the calcium carbonate forms within the plaster or paint layer it contributes positively to reestablishing adhesion, but if it forms on the surface it must be carefully removed with a swab after the removal of the poultice. If the conservator does not pay sufficient attention to this operation, there is the risk that an irreversible white bloom will form on the painted surface. Newly formed calcium carbonate, resulting from the treatment with ammonium carbonate, is transparent, colorless, and invisible as long as the surface remains damp, but is easily removed because it is in gel form. On drying, however, it becomes whitish and irreversible.

*Autodecomposition of excess ammonium carbonate*

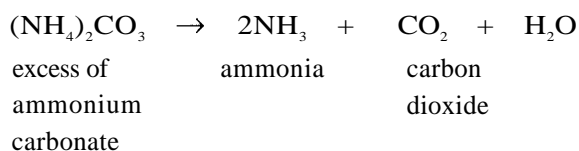

Excess reactant (ammonium carbonate) autodecomposes into volatile products that leave the plaster within a few months.

The treatment with ammonium carbonate, when undertaken carefully, has a number of advantages: it is fundamental to the control of sulfation by means of the conversion of gypsum to ammonium sulfate; it does not contaminate the painting since the products autodecompose; and it facilitates the removal of proteinaceous coatings (egg, glue, etc.) applied in previous interventions by softening them to a gel form.

*Definitive arrest of sulfation*

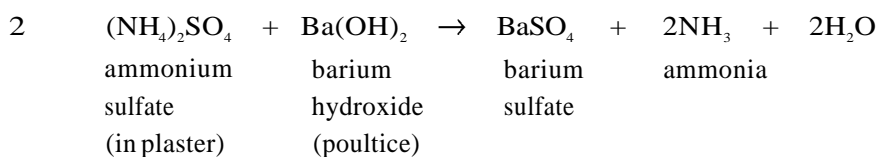

The ammonium sulfate in the plaster formed from Reaction 1 is definitively converted into an inert sulfate ( $\text{BaSO}_4$ ), which is completely insoluble and can no longer cause damage. The by-products of the reaction ( $\text{NH}_3$  and  $\text{H}_2\text{O}$ ) are volatile compounds.

*First consolidating mechanism*

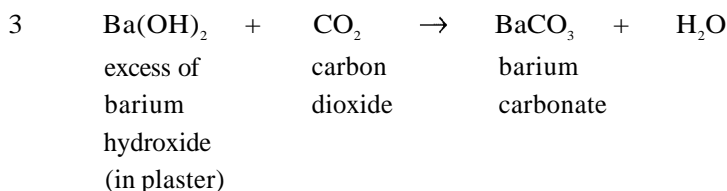

Excess barium hydroxide in the plaster from Reaction 2 is spontaneously converted into barium carbonate. As a result of gradual kinetics it reestablishes microcohesion of the surface through the build-up of a compact crystalline texture.

*Second consolidating mechanism*

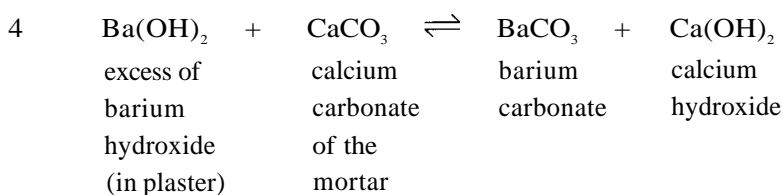

A heterogeneous reaction converts the outer shell of the granules of calcium carbonate—above all those that have disintegrated—into calcium hydrox-

ide in gel form. The reaction is an equilibrium shifting to the left. Only the external surface of the granules is then involved, but it is sufficient to reconnect them to one another.

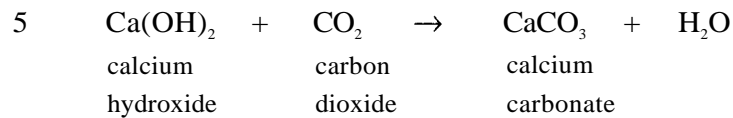

This classic and well-known process of lime carbonation definitely regenerates cohesion. The last mechanism (Reactions 4 and 5) is little known in the literature and is, in fact, still being studied. Although the reaction is demonstrated, the kinetics must be better understood in order to improve conditions for treatment interventions (time, concentration, supports). Confirmation of such a mechanism in the action of barium hydroxide would imply, of course, another significant element in favor of this treatment, since Reaction 5 is the basis for the existence of the fresco itself.

### ***Limitations***

Nonetheless, there are some limitations on the use of barium hydroxide on wall paintings. The three most critical conditions would be when there are high concentrations of nitrates, when there is an organic binding medium, and when an adhesive function is required.

When high concentrations of nitrates of sodium, potassium or calcium are distributed within the plaster, barium nitrate may be formed by a double reaction. It is a moderately soluble salt that forms highly visible crystals on the surface of the painting.

The organic binder of paintings executed in tempera or oil may not tolerate the high alkalinity of barium hydroxide, and could result in hydrolysis and saponification. One may consider, however, that for ancient paintings spontaneous processes of mineralization would by now have transformed the major part of the original organic binding materials into inorganic substances such as calcium oxalates. Usually only a reduced percentage is still present in organic form. In such cases, the paintings, even if originally executed in tempera, can by now be considered to be primarily mineral, similar to a fresco, and as such would be able to tolerate treatment with barium.

For macroscopic alterations, such as exfoliation or macroflaking, that require an adhesive, barium is not suitable since it is only a consolidant and cannot perform the dual function usual with organic polymer consolidants.

### ***Case Studies***

Let us now consider two case studies, both based on the barium method carried out on paintings in the Convent of San Marco in Florence. Both represent early examples of the application of this methodology. *Christ on the Cross Adored by Saint Dominic* in the cloister by Fra Angelico was conserved in 1973, and the *The Last Supper* in the old refectory by Giovanni Antonio Sogliani was treated in 1975. The photographs illustrated here were taken with raking light in order to better evaluate the condition of the surfaces for salt crystallization,

efflorescences, microlifting, etc. Those taken before treatment are only available in black and white (Figs. 4-7).

During monitoring carried out in 1987, color photographs were repeated on the same areas using raking light to document the condition of the paintings more than ten years after the barium treatment (Pls. 53-56). During this time these paintings in situ were subject to normal degradation processes and the photographs demonstrate the validity and appropriateness of the conservation treatment. Analytical examination of the paint layer and plaster are being carried out and some results are now available. In particular it is interesting that new sulfation processes have not been detected with the techniques employed (x-ray diffraction and infrared spectrometry). The presence of barium in the paint layer and upper portions of the plaster appears to be in concentrations of about 1%. This is a small amount (assuming the present data is confirmed) considering the positive initial and continuing effects from the treatments of good cohesion and arrest of sulfation.

In conclusion I wish to underscore the importance of these conservation treatments and of their reliability over long periods of time. A systematic policy for monitoring the conditions of mural paintings is not yet a reality, at least not in Italy. At the same time effective measures for the control of damaging environmental conditions are only now being developed. Thus at present the best approach is a scrupulous adherence to known and tested treatments of proven reliability.

*Figure 4, below left. Fra Angelico, Christ on the Cross Adored by Saint Dominic, detail of the head of Saint Dominic. Photograph taken in raking light before treatment with barium in 1973. Compare Pl. 53, taken in 1987.*

*Figure 5, below right. As in Fig. 4. Detail of Christ. Compare Pl. 54, taken in 1987.*

*Figure 6, facing page, right. Sogliani, The Last Supper, detail. Photograph taken in raking light before treatment with barium in 1975. Compare Pl. 55, taken in 1987.*

*Figure 7, facing page, far right. As in Fig. 6. Compare Pl. 56, taken in 1987.*





### **Acknowledgments**

---

I am grateful to the late Professor D. Dini, restorer of the paintings by Fra Angelico and Sogliani illustrated in this paper; Mrs. S. Hebblethwaite, restorer at the Opificio delle Pietre Dure, Florence; and Mrs. N. Todorow, Mr. C. Lalli, and Mr. A. Aldovrandi, my colleagues at the Laboratorio Scientifico of the Opificio delle Pietre Dure, for their valuable collaboration in preparing this work and in organizing the documentation.

### **Bibliography**

#### **Botticelli, Guido, Cristina Danti, and Sabino Giovannoni**

1984 "Twenty Years of Barium Application on Mural Painting: Methodology of Application." *ICOM Committee for Conservation: Preprints of the 7th Triennial Meeting, Copenhagen, 10-14 September 1984* 2:84.15.6-84.15.11.

#### **Ferroni, Enzo**

1970-1972 "Contributi e prospettive della ricerca chimico-fisica nel restauro degli affreschi." *Atti e memorie dell'Accademia Petrarca di Arezzo* 40:170-179.

#### **Ferroni, Enzo, and Dino Dini**

1981 "Chemical-Structural Conservation of Sulphatised Marbles." *Conservation of Stone: Preprints of the Contributions to the International Symposium, Bologna, 27-30 October 1981* 2:559-566.



**Ferroni, Enzo, V. Malaguzzi Valerj, and G. Rovida**

- 1969a "Experimental Study by Diffraction of Heterogeneous Systems as a Preliminary to the Proposal of a Technique for the Restoration of Gypsum-Polluted Murals." [Paper read at the Amsterdam ICOM meeting in 1969; copy in ICCROM library.]
- 1969b "Utilisation des techniques diffractométrique dans l'étude de la conservation des fresques." *Huitième colloque sur l'analyse de la matière* 7-14.

**Lewin, S. Z., and Norbert S. Baer**

- 1974 "Rationale of the Barium Hydroxide-Urea Treatment of Decayed Stone." *Studies in Conservation* 19:24-35.

**Matteini, Mauro**

- 1979 "Il metodo del bario nel restauro degli affreschi." *Critica d'Arte* 44: 182-184.

**Matteini, Mauro, and Arcangelo Moles**

- 1978 "Barium Aluminates for the Consolidation of Mural Paintings." *ICOM Committee for Conservation, 5th Triennial Meeting, Zagreb 1978*. 78/15/5/1-78/15/5/10.
- 1984 "Twenty Years of Application of 'Barium' on Mural Paintings: Fundamentals and Discussion of the Methodology." *ICOM Committee for Conservation: Preprints of the 7th Triennial Meeting, Copenhagen, 10-14 September 1984* 2:84.15.15-84.15.19.
- 1986 "Elaborazione di un test per il riconoscimento e la localizzazione stratigrafica dei fenomeni di solfatazione nei marmi." *Restauro del marmo: opere e problemi (OPD Restauro special number)*. Florence. 74-78, 82-83.
- 1987 "La metodologia del Bario." In *Restauro delle opere d'arte*. Mantua: Accademia Nazionale Virgiliana. 33-41.

**Sayre, Edward V.**

- 1973 "Investigation of Italian Frescoes, Their Materials, Deterioration and Treatment." *Application of Science in the Examination of Works of Art: Proceedings of the Seminar: June 15-19, 1970*. Conducted by the Research Laboratory, Museum of Fine Arts, Boston, Massachusetts. 176-181.

**Biography**

Dr. Mauro Matteini graduated in chemistry from the University of Florence. Since 1970 he has collaborated as chemist with the Soprintendenza of Florence, dealing with scientific problems in the conservation of works of art, and is presently head of the Laboratorio Scientifico of the Opificio delle Pietre Dure, Florence. He is the author of several publications concerning science applied to various fields of conservation (mural paintings, panel paintings, bronze and marble artifacts, etc.). He has developed several original methodologies for analysis of artistic materials and is a member of Italian and international committees.

## Credits

Grateful acknowledgment is made for permission to reproduce the illustrations published herein.

**Preusser** *The Tomb of Queen Nefertari at Thebes*

Plates 1-9, Figures 1, 4-10: Getty Conservation Institute. Photography: Guillermo Aldana.

Figure 2: Museo Egizio, Turin.

Figure 3: All rights reserved, The Metropolitan Museum of Art.

**Casazza and Giovannoni** *Conservation of the Brancacci Chapel*

Plates 10, 11, 13: A. Quattrone, Florence.

Plate 12: E. DI. TECH, Florence.

Plate 14, Figure 6: Istituto Centrale per il Restauro, Rome.

Figure 1: Laboratorio di Topografia e Fotogrammetria, Facoltà di Ingegneria, University of Florence.

Figure 2: Laboratorio Ultrasuoni e Controlli Non Distruttivi, Dipartimento di Ingegneria Elettronica, University of Florence.

Figure 3: Istituto Nazionale di Ottica, Florence.

Figures 4, 5: Larach, Gruppo Montedison, Milan.

Figure 7: Istituto Donegani, Novara.

**Dasser** *Wall Paintings of Schloß Seehof*

Plates 15-21, Figures 1-9: Restaurierungswerkstätten, Bayerisches Landesamt für Denkmalpflege, Munich.

**Arendt** *Role of the Architectural Fabric*

Plate 22, Figures 1-12: the author.

**Hammer** *Romanesque Wall Paintings of Lambach*

Plates 23-27: Bundesdenkmalamt, Vienna. Photography: A. Sulzgruber, 1990.

Figures 1-3, 6-7: Bundesdenkmalamt, Vienna.

Figure 4: Bundesdenkmalamt, Vienna. Photography: E. Mejchar.

Figure 5: Bundesdenkmalamt, Vienna. Photography: Werkgarner.

**Mancinelli** *Sistine Chapel: Conservation Methodology, Problems, and Results*

Plates 23-28, Figures 1-9: Courtesy of N.T.V., Tokyo, and the Vatican Museums.

**Colalucci** *Sistine Chapel: Original Technique and Conservation*

Plates 34-41, Figures 1-11: Courtesy of N.T.V., Tokyo, and the Vatican Museums.

**Hanna and Dinsmore** *Conservation of Central Asian Wall Painting Fragments*

Plate 42, Figures 2-10: The Trustees of the British Museum.

**Moormann** *Campanian Mural Paintings*

Plate 43, Figures 1, 6-9, 11: with permission of P. Bersch/H. van de Sluis, Catholic University Nijmegen.

Figures 2, 3, 7: Deutsches Archäologisches Institut, Rome.

Figures 4, 5: W.J.Th. Peters, Nijmegen.

Figure 12: Istituto Centrale per il Catalogo e la Documentazione-Gabinetto fotografico nazionale, Rome.

**Arnold and Zehnder** *Monitoring Wall Paintings Affected by Soluble Salts*

Plates 44-46, Figures 1-25: Institut für Denkmalpflege der ETH, Zurich.

**Matteini** *Florentine Methods of Wall Paintings Conservation*

Plates 47-56, Figures 1-7: Opificio delle Pietre Dure, Florence.







© 1993 by the J. Paul Getty Trust

*All rights reserved*

*Printed on recycled paper. Cover stock uses  
100% post-consumer waste.*

ISBN 0-89236-162.-X

Printed in Singapore