

A Revision of New World *Cyamops*
Melander (Diptera: Periscelididae)

ALESSANDRA R. BAPTISTA
and
WAYNE N. MATHIS

SMITHSONIAN CONTRIBUTIONS TO ZOOLOGY • NUMBER 563

SERIES PUBLICATIONS OF THE SMITHSONIAN INSTITUTION

Emphasis upon publication as a means of "diffusing knowledge" was expressed by the first Secretary of the Smithsonian. In his formal plan for the Institution, Joseph Henry outlined a program that included the following statement: "It is proposed to publish a series of reports, giving an account of the new discoveries in science, and of the changes made from year to year in all branches of knowledge." This theme of basic research has been adhered to through the years by thousands of titles issued in series publications under the Smithsonian imprint, commencing with *Smithsonian Contributions to Knowledge* in 1848 and continuing with the following active series:

Smithsonian Contributions to Anthropology
Smithsonian Contributions to Astrophysics
Smithsonian Contributions to Botany
Smithsonian Contributions to the Earth Sciences
Smithsonian Contributions to the Marine Sciences
Smithsonian Contributions to Paleobiology
Smithsonian Contributions to Zoology
Smithsonian Folklife Studies
Smithsonian Studies in Air and Space
Smithsonian Studies in History and Technology

In these series, the Institution publishes small papers and full-scale monographs that report the research and collections of its various museums and bureaux or of professional colleagues in the world of science and scholarship. The publications are distributed by mailing lists to libraries, universities, and similar institutions throughout the world.

Papers or monographs² submitted for series publication are received by the Smithsonian Institution Press, subject to its own review for format and style, only through departments of the various Smithsonian museums or bureaux, where the manuscripts are given substantive review. Press requirements for manuscript and art preparation are outlined on the inside back cover.

Robert McC. Adams
Secretary
Smithsonian Institution

A Revision of New World *Cyamops*
Melander (Diptera: Periscelididae)

Alessandra R. Baptista
and Wayne N. Mathis



SMITHSONIAN INSTITUTION PRESS

Washington, D.C.

1994

ABSTRACT

Baptista, Alessandra R., and Wayne N. Mathis. A Revision of New World *Cyamops* Melander (Diptera: Perisclididae). *Smithsonian Contributions to Zoology*, number 563, 25 pages, 59 figures, 1 table, 1994.—The New World species of the genus *Cyamops* Melander, now numbering eight, are revised. New species (type locality in parenthesis): *C. americanus* (Mexico. Chiapas: El Triunfo (49 km S Jaltenango, 1300–2000 m)), *C. buenorum* (Mexico. Chiapas: Cacahoatan (7 km N)), *C. fasciatus* (Brazil. São Paulo: Serra da Cantareira, Chapado), and *C. colombianus* (Colombia. Rio Raposo). *Cyamops*, with *Stenomicroa* Coquillett as its apparent sister group, is placed in the subfamily Stenomicroinae, which is recharacterized. *Planinasus* Cresson, previously thought to be related to genera within Stenomicroinae, is shown to be more closely related to Perisclidinae. The monophyly of *Cyamops* is clearly demonstrated, as is that for some species groups within the genus. The relationships between species groups, however, are not well known. Phylogenetic studies, even for the fauna of the New World, are hindered by inadequate specimens to investigate many of the characters we have identified. Maps, keys to species, detailed distributional data, and illustrations (scanning electron micrographs and line drawings) are provided to assist in the identification of the species.

OFFICIAL PUBLICATION DATE is handstamped in a limited number of initial copies and is recorded in the Institution's annual report, *Smithsonian Year*. SERIES COVER DESIGN: The coral *Montastrea cavernosa* (Linnaeus).

Library of Congress Cataloging-in Publication Data

Baptista, Alessandra R.

A revision of the new world *Cyamops* Melander (Diptera: Perisclididae)/ Alessandra R. Baptista and Wayne N. Mathis p. cm.—(Smithsonian contributions to zoology ; no. 563) Includes bibliographical references (p.)

1. *Cyamops*—America—Classification. I. Mathis, Wayne N. II. Title. III. Series.

QL1.S54 no. 563 [QL537.P4] 595.77'4—dc20 94-26880 CIP

∞ The paper used in this publication meets the minimum requirements of the American National Standard for Permanence of Paper for Printed Library Materials Z39.48—1984.

Contents

	<i>Page</i>
Introduction	1
Methods	1
Acknowledgments	2
Systematics	3
Family PERISCELIDIDAE Oldenberg	3
Key to Subfamilies of Periscelididae	4
Subfamily STENOMICRINAE Papp	4
Key to Genera of the Subfamily Stenomicrinae	5
Genus <i>Cyamops</i> Melander	5
Key to New World Species of <i>Cyamops</i> Melander	7
Nearctic Species	8
<i>Cyamops halteratus</i> Sabrosky	8
<i>Cyamops imitatus</i> Sturtevant	10
<i>Cyamops nebulosus</i> Melander	11
Neotropical Species	14
<i>Cyamops americus</i> , new species	14
<i>Cyamops buenorum</i> , new species	18
<i>Cyamops colombianus</i> , new species	19
<i>Cyamops fasciatus</i> , new species	20
<i>Cyamops neotropicus</i> Hennig	21
Literature Cited	25

A Revision of New World *Cyamops* Melander (Diptera: Periscelididae)

Alessandra R. Baptista
and *Wayne N. Mathis*

Introduction

This revision concerns *Cyamops* Melander, an obscure genus of acalyptrate Diptera that was first described in the family Geomyzidae, a family-group name that is now a junior synonym of Opomyzidae. The genus was proposed for a relatively rare Nearctic species, *C. nebulosus* Melander, that was described in the same paper and was then designated as the type species of the genus. For decades thereafter the genus was thought to be endemic to the Nearctic Region and was seldom studied largely because of its rarity in collections. Even today specimens are collected infrequently, and comparatively few specimens were available for this study.

Beginning with Hennig (1969), who described *C. neotropicus* from a specimen collected in Peru and *C. australicus* from specimens collected in Australia, species of *Cyamops* were discovered and described from faunas outside the Nearctic Region. Sabrosky (1980) reported an undescribed species from Nigeria, and Khoo (1985) described five additional Australian species. In collections available to us, there are also specimens from the Oriental (Malaysia), Oceanian (islands of Ponape and Yap), and Palearctic (Japan) regions. These discoveries and records indicate that *Cyamops* is essentially pantropical with a few species that extend into temperate zones. Our purpose here is to revise the New World species with emphasis on the largely undescribed Neotropical fauna.

Although *Cyamops* was dealt with infrequently in the literature, its placement in a family has been remarkably varied and unstable. As noted previously, the genus was first described in the family Geomyzidae, now a synonym of Opomyzidae. Brues and Melander (1932) then transferred the genus to the family Periscelididae (as Periscelidae), a precedent that Curran (1934) followed. Two decades later, Sturtevant (1954) placed the genus in the Anthomyzidae, although his study of the female terminalia of the type species, which was reported in the same paper, failed to provide evidence for this association. Sabrosky (1958, 1965) continued recognition of Sturtevant's placement of *Cyamops* in Anthomyzidae. Hennig (1958) first suggested that *Cyamops* should be placed in Aulacigastridae, and later, in a review of the family Aulacigastridae (Hennig, 1969), he included *Cyamops*, because like other genera treated in this family, it lacks ocellar and postvertical setae and has two fronto-orbital setae. Griffiths (1972) studied the male terminalia of *Cyamops* and maintained its placement in Aulacigastridae. Sabrosky (1980), Teskey (1987), and J.F. McAlpine (1989) likewise followed Hennig's placement, the latter paper with considerable equivocation. D.K. McAlpine (1978, 1983) returned the genus to Periscelididae, and most recent authors (Khoo, 1985; Mathis and Papp, 1992; Mathis, 1993; Grimaldi and Mathis, 1993) have adhered to D.K. McAlpine's placement, usually with *Cyamops* in the subfamily Stenomicroinae. Khoo and Sabrosky (1989) likewise recognized *Cyamops* to be related to *Stenomicroa* Coquillett but accorded family-level status to this lineage as Stenomicroidae, a precedent Papp (1984) first established. In this study we continue to recognize *Cyamops* in the family Periscelididae under the subfamily Stenomicroinae, but hasten to add that the evidence to support this association is not overwhelming (see discussion after the diagnoses and description of the family, subfamily, and genus).

METHODS.—The descriptive terminology follows J.F. McAlpine (1981) with the modifications listed below. We follow Sabrosky (1983) in using the term "microtomentum" rather than pruinosity. Setae posterior to the "pseudovibrissae"

Alessandra R. Baptista and Wayne N. Mathis. Departamento de Entomologia, Museu de Zoologia da Universidade de São Paulo, Caixa Postal 7172, São Paulo 01064, São Paulo, Brazil (ARB). Department of Entomology, NHB 169, Smithsonian Institution, Washington, D.C. 20560, USA (WNM).

Review Chairman: John M. Burns, National Museum of Natural History, Smithsonian Institution, Washington, D.C. 20560. Reviewers: David A. Grimaldi, American Museum of Natural History, New York, New York 10024-5192; Terry A. Wheeler, Department of Environmental Biology, University of Guelph, Guelph, Ontario, Canada N1G 2W1; Norman E. Woodley, Systematic Entomology Laboratory, USDA, c/o National Museum of Natural History, Washington, D.C. 20560.

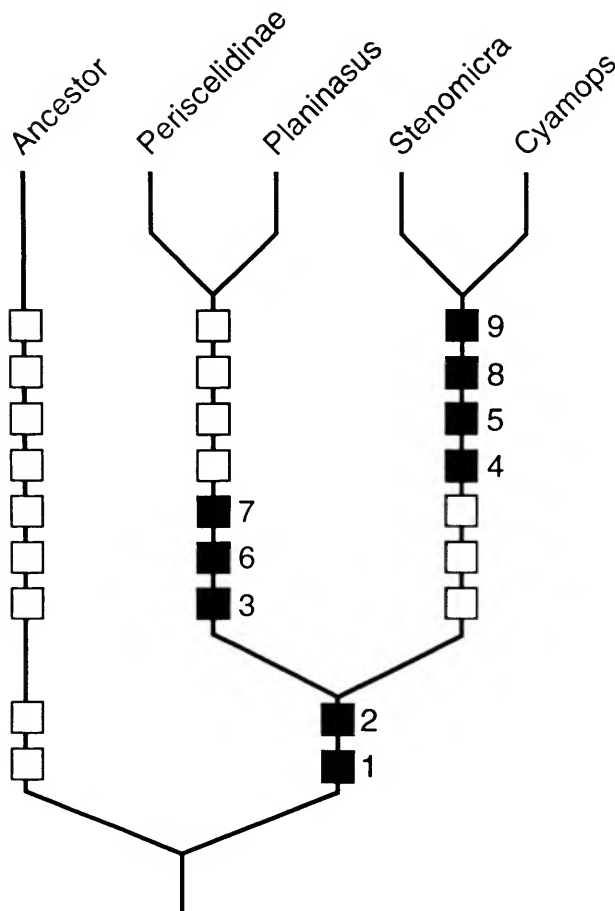

FIGURE 1.—Hypothetical phylogeny for genera of Stenomicrinae. Numbers correspond with those used in the text.

are called peristomal setae. Because specimens are small, all less than 3.50 mm, study and illustration of the male and female terminalia required use of a compound microscope. Species' descriptions are composite, including information on the holotype and other conspecific specimens. All species exhibit sexual dimorphism to some degree, although not always the same characters. To account for this variation in the descriptions, we describe the male first, followed by a section on differences in the female. Characters cited in the generic description are not usually repeated under the species. The terminology for structures of the male and female abdomens, including the terminalia, is provided directly on Figures 2-7 (*Cyamops halteratus*) and 16 (*C. nebulosus*) and is not repeated for comparable illustrations of other species. The following ratios are used in the descriptions (2♂ and 2♀ were measured for each species when available, cases to the contrary are indicated under the appropriate species description).

1. Wing ratio: the greatest length of wing/the greatest width of wing.

2. Costal vein ratio I: the straight line distance between the apices of veins R_1 and R_{2+3} /distance between the apices of veins R_{2+3} and R_{4+5} (only one, slide-mounted wing was measured for this ratio).

3. Costal vein ratio II: the straight line distance between the apices of veins R_{2+3} and R_{4+5} /distance between the apices of veins R_{4+5} and M (only one, slide-mounted wing was measured for this ratio).

A cladogram indicating hypothetical phylogenetic relationships has been generated for the higher-level taxa included within the family Periscelididae, sensu D.K. McAlpine, using Hennig86 (Farris, 1988). As the assemblage of genera in the subfamily Periscelidinae is undoubtedly monophyletic, confirmed by well-established synapomorphies (most of the characters used in the key to subfamilies, p. 4, with the exception of the well-developed ocellar seta), it was treated as a whole. Character states were arranged into transformation series, and their relative plesiomorphic or apomorphic conditions were determined by outgroup comparison. As the sister group of Periscelididae is probably to be found within the families Aulacigastridae (Hennig, 1971; J.F. McAlpine, 1989) or Neurochaetidae (D.K. McAlpine, 1978, 1983), their included genera were used as outgroups. D.K. McAlpine (pers. comm.) is now investigating the relationships between these families, and his study should clarify the familial limits and determine the sister-group relationships. Although we made no attempt here to list autapomorphies for the terminal taxa on the cladogram, except for the genus *Cyamops*, we are reasonably sure that they are natural groups.

ACKNOWLEDGMENTS.—Although this study is based primarily on specimens in the National Museum of Natural History, numerous others were borrowed, particularly type specimens of the species previously described. To our colleagues and their institutions listed below who loaned specimens, we express our sincere thanks. Without their cooperation this study could not have been completed.

ANSP	Academy of Natural Sciences of Philadelphia, Pennsylvania, USA (Jon K. Gelhaus and Donald Azuma)
CNC	Canadian National Collection, Ottawa, Ontario, Canada (J.M. Cumming)
MNRJ	Museu Nacional do Rio de Janeiro, Rio de Janeiro, Brazil (Márcia Souto Couri)
MZUSP	Museu de Zoologia da Universidade de São Paulo, São Paulo, Brazil (Francisca do Val)
TAU	Tel Aviv University, Tel Aviv, Israel (A. Freidberg)
UGE	University of Guelph, Guelph, Canada (T.A. Wheeler)
USNM	former United States National Museum, collections now in the National Museum of Natural History, Smithsonian Institution, Washington, D.C., USA

TABLE 1.—Characters states used in the phylogenetic analysis with description of their relative plesiomorphic and apomorphic states.

Character	Plesiomorphic	Apomorphic
1. Pedicel	Not cap-like, without a dorsal cleft	Cap-like, with a dorsal cleft
2. Cell dm of wing	Smooth, without folds	With a fold running entire length
3. Antennae	Approximate, touching each other in dry specimen	Greatly separated, never touching each other in dry specimen
4. Ocellar seta	Present	Absent
5. Postpronotal seta	Present	Absent
6. Pseudovibrissa	Present	Absent
7. Surstylus	Articulated with epandrium	Fused with epandrium
8. Hypandrium	Symmetrical	Asymmetrical
9. Male 6th tergite	Large	Narrow, less than $\frac{1}{4}$ the 5th

Ms. Hollis B. Williams prepared the distribution maps; Peter J. Viola assisted with the scanning electron microscopy, Victor Krantz assisted with production of the photographs, Elaine R.S. Hodges labeled the illustrations, and George Venable prepared Figure 1. Dr. Terry A. Wheeler provided records of specimens from the University of Guelph. For reviewing a draft of this paper we thank Drs. Amnon Freidberg, Claudio J.B. de Carvalho, and Nelson Papavero. This research was supported in part by a Short-Term Visitor's grant from the Office of Fellowships and Grants, Smithsonian Institution, and also by a Master of Science's grant from the Conselho Nacional de Desenvolvimento Científico e Tecnológico (CNPq), Brazil. We are also grateful to Dr. Stanwyn G. Shetler, Deputy Director, National Museum of Natural History, for financial support to conduct field work through grants from the Research Opportunity Fund.

Systematics

As a preface to our revision of the species of *Cyamops* from the New World, we first characterize the family Periscelididae and subfamily Stenomicroinae. We also provide a key to the subfamilies and present a provisional cladogram and discussion of the relationships of some genera.

Family PERISCCELIDIDAE Oldenberg

Periscelidinae Oldenberg, 1914:41.

Periscelididae.—Hendel, 1916:297.

DIAGNOSIS.—*Head:* Frons with 1–2 fronto-orbital setae; postocellar setae usually divergent or absent (divergent, convergent, or parallel in *Stenomicroa*). Pedicel cap-like and with a dorsal cleft, bearing 1 or more dorsoapical setae; flagellomere 1 frequently sharply deflexed, arising from ventral surface of pedicel; dorsobasal arisal rays frequently bifurcate. Face uniformly sclerotized and arched, setose laterally.

Thorax: Dorsocentral setae usually 2 (0+2), sometimes 1 (0+1), none presutural; posterior intra-alar seta reduced;

supra-alar seta usually present; scutellum with 1–2 pairs of marginal setae; scutellar disc bare; anepisternal seta usually lacking (present in *Planinasus* and some species of *Cyamops*). Wing: Subcosta rudimentary, not reaching costal margin, but not fused apically with R_1 ; no costal breaks (a weakness in the costa just apical of the humeral crossvein in *Planinasus*); costa extended to vein R_{4+5} or vein M; cell dm with a fold running entire length; cell *cup* usually present (absent in some *Stenomicroa*), although vein CuA_2 either well developed or extremely short. Mid tibia bearing a prominent, apicoventral seta.

DISCUSSION.—As noted earlier, the concept of Periscelididae adopted here follows D.K. McAlpine (1978, 1983). D.K. McAlpine characterized Periscelididae primarily by the cap-like pedicel, which has a dorsal cleft (character 1, Table 1). Although this character is common to all Periscelididae, it also occurs in Neurochaetidae (D.K. McAlpine, 1978; Woodley, 1982), Neminidae (accorded family status in Freidberg, 1994), and perhaps other genera. Whether these genera should likewise be included in Periscelididae or whether the cap-like pedicel is a synapomorphy are questions that are not resolved. A second synapomorphy for Periscelididae is the fold that runs lengthwise through cell dm (character 2, Table 1).

The monophyly of Periscelididae, as here characterized, must be considered provisional with so few synapomorphies. Another factor that should be considered in future phylogenetic studies of Periscelididae is taxa in related groups, such as genera now included in the families Neurochaetidae and Neminidae. These genera should be considered, as most if not all of them have the two synapomorphies noted previously that characterize Periscelididae.

In the key to subfamilies that follows, we have not definitively placed the genus *Planinasus* (it is keyed separately). Its inclusion within Periscelididae is unquestioned, however, especially given the compelling evidence. Here we discuss its phylogenetic position and relationships but prefer a more exhaustive study, including taxa of the two other families that are probably related, before making changes in the higher classification.

Key to Subfamilies of Periscelididae

1. Fronto-orbital seta 1; ocellar setae present. Costa short, extended to vein R_{4+5} ; vein CuA_2 weak or lacking, lacking a cell *cup*; postpronotum bearing a well-developed seta **PERISCELIDINAE**
- Fronto-orbital setae 2; ocellar setae absent. Costa long, extended to vein M; vein CuA_2 usually well developed, usually with a distinct cell *cup* (weak or lacking in *Stenomicra*); postpronotum lacking a well-developed seta 2
2. Frons with 1 pair of intrafrontal setae; eyes bare. Katepisternum with 2 subequal setae. Hind femur bearing an anterodorsal, preapical seta **Planinasus** Cresson
- Frons lacking intrafrontal setae; eyes microsetulose, sometimes sparsely. Katepisternum bearing 1 prominent seta. Hind femur lacking an anterodorsal, preapical seta **STENOMICRINAE**

Subfamily STENOMICRINAE Papp

Stenomicridae Papp, 1984:61.

DIAGNOSIS.—Head: Frons with 2 fronto-orbital setae, 1 reclinate, 1 proclinate, lacking intrafrontal seta; at least 1 vertical seta (apparently the outer) present; postvertical setae usually lacking (present in some species of *Stenomicra*, where they are slightly divergent, parallel, or convergent); ocellar setae lacking; "pseudovibrissa" present, anaclinate or dorsoclinate; pedicel bearing 1 or more dorsoapical setae; eyes bearing interfacetal microsetulae; palpus small, compressed.

Thorax: Postpronotum frequently polished, lacking a well-developed seta; katepisternum bearing 1 prominent seta. Wing: no costal breaks, although with weak areas; costa extended to vein M; vein CuA_2 usually well developed. Hind femur lacking anterodorsal preapical seta.

Abdomen: Male: preabdomen consisting of 5 segments; tergite 6 narrow, reduced in length; tergite 7 asymmetrical, fused to synternite 6–8 on right side (*Cyamops*) or on both sides, forming a complete ring (*Stenomicra*); sternite 6 asymmetrical, usually highly modified; surstylus loosely articulated with epandrium; hypandrium asymmetrical, expanded posteriorly on each side into convex, bowl-shaped structures. Female: tergite and sternite of segment 7 either free from each other (some Australasian species of *Cyamops*) or fused, forming a complete ring; 2–4 spermathecae present.

DISCUSSION.—As a preliminary effort toward resolution of the phylogenetic relationships within the family Periscelididae, we propose the following hypothetical phylogeny as outlined in the cladogram (Figure 1). The characters used to generate this cladogram are explained and listed in Table 1, with scoring and arrangement of characters as indicated in the matrix for the analysis (Table 2, the same sequence of characters is used for Tables 1 and 2).

The subfamily Stenomicrinae was first proposed as a monogeneric family with *Stenomicra* as its type genus (Papp, 1984). Some years later, Khoo and Sabrosky (1989) also placed the genus *Cyamops* in this family. Mathis and Papp (1992), Mathis (1993), and Grimaldi and Mathis (1993), following

TABLE 2.—Character Matrix for Some Genera of Periscelididae.

Ancestor	00000000
Periscelidinae	111001100
Planinasus	111111100
Stenomicra	110110011
Cyamops	110110011

D.K. McAlpine's precedent, transferred both of these genera plus the genus *Planinasus* back to Periscelididae as the subfamily Stenomicrinae. As we accept D.K. McAlpine's proposal that *Stenomicra* is related to *Planinasus* and *Cyamops* and that this assemblage of genera and those of the subfamily Periscelidinae are likewise related, we prefer recognition of an expanded concept of Periscelididae, with Periscelidinae and Stenomicrinae as included subfamilies.

Our interpretation of generic relationships among these two subfamilies, however, is slightly altered from that presented in the recent publications cited previously. The synapomorphies that we have discovered and analyzed indicate that the genus *Planinasus* is more closely related to the genera of the Subfamily Periscelidinae than to *Stenomicra* and *Cyamops*. This interpretation is supported by at least three synapomorphies, as outlined in the cladogram (Figure 1).

Another possible synapomorphy for both groups, Periscelididae *sensu stricto*, is the shape of the sixth tergite of the male abdomen. This tergite is large, apparently unmodified, and subequal in length to the fifth tergite (character 9, Table 1). In *Stenomicra* and *Cyamops*, this tergite is narrow, slightly reduced in length, and in the outgroup (probably Aulacigastriinae), it is fused posteriorly to the syntergite seven+eight. J.F. McAlpine (1989) considered the different modifications of the sixth abdominal tergite in the superfamily Asteioinea to be independently derived and interpreted the character state found in *Planinasus*, other genera of Periscelidinae, and some Asteiidae, to be plesiomorphic. Although J.F. McAlpine's interpretation seems to be correct, it is also possible, and not less parsimonious, to consider the large sixth tergite of *Planinasus* and the genera of Periscelidinae as a synapomorphy

(a "pseudosimplesiomorphy" as defined by Hennig).

The characters shared by *Planinasus*, *Stenomicro*, and *Cyamops* (characters 4 and 5, Table 1) are considered to be homoplasies, following strict parsimony. These characters also occur widely in related groups and are thus less reliable as evidence of close relationships.

The sister-group of *Cyamops* is apparently *Stenomicro*, although synapomorphies that confirm this relationship are not wholly convincing. The shape of the hypandrium could be a synapomorphy (character 8, Table 1). The hypandrium is expanded posteriorly on each side in both genera to form a convex, asymmetrical, bowl-shaped structure. In *Stenomicro* these structures articulate posteriorly with the base of the aedeagus, a feature not found in *Cyamops* or related groups and which is probably an autapomorphy for *Stenomicro*. The shape of the sixth tergite (narrow and reduced in length) is another probable synapomorphy for *Stenomicro*+*Cyamops*. As dis-

cussed above, the Perisclidinae have a large, well-developed sixth tergite. In Aulacigastridae and *Neurochaeta* the sixth tergite exhibits still different modifications. Other possible synapomorphies for Stenomicroinae are as follows.

1. Specimens small and slender. Overall reduction in size, however, also occurs in *Neoscutops* (Perisclidinae) and related groups and is not a good indicator of close relationship.

2. Palpus reduced and compressed. The form of the palpus, however, is not a well-studied feature within the Perisclididae, Aulacigastridae, and Neurochaetidae, making its polarization very imprecise.

3. Seventh tergite asymmetrical, fused to sternites 6-8 on right side. In *Stenomicro*, the seventh tergite is fused to sternites 6 on both sides, forming a complete ring. This may be another step in a transformation series. The character state found in *Cyamops* is also present in *Aulacigaster*, probably by convergence.

Key to Genera of the Subfamily Stenomicroinae

- Inner vertical seta present, proclinate; mesofrons more or less flat, not depressed; face in profile angulate, dorsal surface flat. Supra-alar seta lacking; male postabdomen with segment 7 a complete annulus; surstylus symmetrical; female segment 6 with tergite and sternite separated *Stenomicro* Coquillett
- Inner vertical seta absent; mesofrons depressed, concave; face in profile shallowly and vertically arched, lacking a flat, dorsal area. Supra-alar seta present, well developed; male postabdomen with tergite and sternite of segment 7 fused on left side only; surstylus asymmetrical; female segment 6 with tergite and sternite fused, forming a complete annulus *Cyamops* Melander

Genus *Cyamops* Melander

Cyamops Melander, 1913:291. [Type species: *Cyamops nebulosus* Melander, by original designation].—Curran, 1934:323 [generic key, Perisclididae].—Brues, Melander, and Carpenter, 1954:371 [list, Perisclididae].—Sturtevant, 1954:557-559 [revision, Anthomyzidae].—Sabrosky, 1958:169-171 [revision, Anthomyzidae]; 1965:820 [Nearctic catalog, Anthomyzidae]; 1980:648 [Afrotropical catalog, Aulacigastridae].—Hennig, 1958:640 [discussion, Aulacigastridae]; 1969:610-614 [discussion, Aulacigastridae]; 1971:39, 46 [discussion, Aulacigastridae].—Griffiths, 1972:211-212 [description ♂ terminalia, Aulacigastridae].—D.K. McAlpine, 1978:274, 277 [discussion, Perisclididae]; 1983:56 [discussion, Perisclididae].—Khoo, 1985:527-536 [revision Australian species, Perisclididae].—Teskey, 1987:392 [generic key, discussion, Aulacigastridae].—Khoo and Sabrosky, 1989:551 [Australasian/Oceanian catalog, Stenomicroidae].

DESCRIPTION.—Adult: Small flies, length usually 1.65–3.30 mm, with slender habitus.

Head: Typically dark brown in ground color; fronto-orbits below the insertion of fronto-orbital setae, parafacial and genal region usually with silvery white microtomentum; occipital region shiny, sparsely microtomentose; lower face usually strongly microtomentose below genal region; median plate of clypeus shiny brown; head usually broader than thorax; postcranium strongly concave; eye bearing interfacetal setulae, shape of eye in profile more or less diagonal, lower anterior

facets enlarged and encroaching on facial region more in males than in females (males and females of two new species from Oceanic Region have the face with almost the same width); eyes closer together at lower edge of frons than at top of head; frons slightly longer than wide; ocellar tubercle small, situated near vertex; mesofrons somewhat depressed, concave; antennal form as for other Perisclididae; arista 3-segmented (see D.K. McAlpine, 1983), branched, in some species with basal bifurcate rays; face in profile nearly straight to distinctly angulate, ventral portion (below narrowest gap between eyes) more broadly developed, sometimes shallowly carinate medially, carina narrow to broad, but always broader in females; lower epistomal margin of mesofacialia extended around oral opening to form a narrow peristomal area; clypeus a large inverted U, somewhat retracted in males but easily visible in females; palpus short, compressed, with silver luster when viewed under certain angles. Chaetotaxy: Outer vertical setae slightly to strongly divergent, curved outward; inner vertical and postocellar setae lacking; 2 pairs of fronto-orbital setae, inner pair reclinate, sometimes oriented outward, outer pair proclinate, in most cases pointed inward; inner fronto-orbital seta usually about $\frac{3}{4}$ the length of outer, rarely weaker; fronto-orbits typically bearing small setulae below setae; true vibrissa apparently absent, but uppermost pair of facial setae

developed as porrect, anaclinate "pseudovibrissae," followed by a row of peristomal setulae and setae at margin of genae; pseudovibrissae sometimes placed externally to row of peristomal setae.

Thorax: Shiny, brown to dark brown, sparsely whitish microtomentose, microtomentum more dense at lower portion of katepisternum; calypteres brown; postscutellum developed; greater ampulla convex; prosternum bare. Chaetotaxy: Acrostichal setulae in 2 more or less regular rows, slightly diverging behind, being strongly reduced in some species; dorsocentral setae 0+1 or 0+2, 1st seta, when present smaller; 1 row of dorsocentral setulae in front of setae; some setulae also present between acrostichal and dorsocentral rows in some species; supra-alar seta 1, preceded by small setulae, which can be sometimes strongly reduced; scutellum typically with 1 or 2 pairs of setae, basal pair, when present, smaller; notopleural setae 1+1, 1st seta usually longer; katepisternal seta 1, located dorsally (sometimes a 2nd, smaller and weaker seta is present); anepisternum bare or with 1 seta and few setulae along posterior margin. Wing: Costal vein without true costal breaks, but with a weakness before end of vein R_1 ; costal vein extended to vein M; crossvein bm-cu either present, delimiting discal cell from cell bm (species in Afrotropical, Australian, Nearctic, Neotropical, Oriental, and Palearctic regions), or absent (some Oceanian species); anal vein sometimes strongly reduced in length; anal cell present, well delimited. Legs: Posteroventral setulae of fore femur sometimes differentiated as a row of distal small, spine-like setulae; mid tibia bearing an apicoventral spine.

Abdomen of Male: Sparsely microtomentose, brown to dark brown; 6th tergite somewhat narrowed, asymmetrical, extended more on right side near 6th sternite; 7th tergite narrow, asymmetrical, fused to 6th-7th sternites on left side; 7th right spiracle, sometimes also the left, in 7th tergite; surstyli articulated with epandrium, asymmetrical (left usually longer), connected with hypandrium posteriorly by a weak membrane; cerci small, weakly sclerotized to completely membranous, bearing some setae on posterior half; hypandrium asymmetrical, expanded posteriorly on each side into convex, bowl-shaped structures, sometimes bearing a ventral projection on left side, visible near base of 6th sternite ("hypandrial projection"); parameres apparently absent (a single, setulose postgonite in *C. nebulosus*); gonopods present; aedeagal apodeme long, free or joined posteriorly with hypandrium; aedeagus completely sclerotized; ejaculatory apodeme developed, variously shaped.

Abdomen of Female: Syntergosternite 6 a complete ring (tergite and sternite fused), with spiracle within sclerotization; tergite and sternite 7 either fused (Nearctic, Neotropical, Oceanian species), forming a synterosternal ring enclosing spiracle, or separate (Australian), with spiracle in sternite; segment 8 with tergite and sternite separate, sternite either free (Nearctic and Neotropical species) or partially fused with 7th (Australian species); 2-4 spherical to oblong spermathecae (2

in Australasian/Oceanian species, 3 in Nearctic species, 4 in Neotropical species).

SEXUAL DIMORPHISM.—Several characters have a tendency to exhibit sexual dimorphism, although with some overlap in most characters. The characters that demonstrate more pronounced sexual dimorphism are the following: (1) females generally darker, especially the face and legs; (2) clypeus of females generally more conspicuous; (3) anteroventral eye facets of males enlarged, encroaching more on face than in females (the face in both sexes of two undescribed species from the Oceanian Region show little or no sexual dimorphism).

New World species.—The following characteristics were observed in all New World species and will not be repeated under the species descriptions: Outer fronto-orbital setae inclinate, inserted laterad of inner fronto-orbital seta; pseudovibrissae aligned with row of peristomal setae, not laterad; supra-alar and acrostichal setulae present, not greatly reduced; first notopleural seta longer or subequal in length to second; vein bm-cu present, separating discal cell from cell bm; anal vein not strongly shortened in length.

DISTRIBUTION.—*Cyamops* is known to occur in the following faunal regions: Afrotropical Region (Sabrosky, 1980); Australasian Region (Hennig, 1969; Khoo, 1985; Khoo and Sabrosky, 1989); Nearctic Region (Sabrosky, 1965; Teskey, 1987), Neotropical Region (Hennig, 1969), and Palearctic Region (Japan, one specimen in USNM).

NATURAL HISTORY.—Baptista collected two species of *Cyamops* at pools, near streams, often on leaves of *Calathea* G.F.W. Meyer (Maranthaceae). Specimens of *Cyamops* appear to have the same habits as many species of *Planinasus* Cresson. Australian *Cyamops* have been collected (Khoo, 1985:528) "on rocks in streams, near waterfalls, in marshy situations (on broad-leaved plants such as *Allocasia*) and beside pools in almost dry river beds."

According to Sturtevant (1954:558) the eggs of *C. nebulosus* are white and have short, thick, anterodorsal filaments similar to those found in *Drosophila* Fallén. Nothing more is known about the immature stages.

DISCUSSION.—The phylogenetic relationships among species within *Cyamops* are not well established. The lack of specimens for detailed study, together with the wide occurrence of homoplasies for many characters in related groups were the main impediments to this portion of the study. Some observations, nevertheless, are given below as preliminary results.

Cyamops is clearly monophyletic with synapomorphies as follows: 1. Inner vertical setae lacking; 2. Mesofrons deeply concave (also in an undescribed genus from the neotropics that is related to *Aulacigaster*); 3. Fronto-orbits below level of fronto-orbital setae silvery-white microtomentose (also in undescribed genus related to *Aulacigaster*); 4. Male clypeus retracted, tending to fill the oral opening; 5. Surstyli asymmetrical (also in some *Periscelis* and *Aulacigaster* according to Papp, 1988:276 and 1984:60, respectively); 7. Aedeagus broad,

with very complex sclerotization; 8. Tergite and sternite six of female postabdomen fused, forming a complete ring.

The following characters are synapomorphies that support some subgroups within *Cyamops*.

1. Anteroventral facets of eye enlarged, encroaching on facial region more in males than in females. This sexually dimorphic character is present in males from all regions, except for two species from Yap and the Caroline Islands (Oceanian Region). The plesiomorphic state is for the face of males and females to have essentially the same width. The distribution of this character, however, must be considered provisional, as males are lacking for many species that were considered in this study.

2. Four spermathecae present. This character state is a synapomorphy for the Neotropical species (two species from the neotropics were analyzed). The transformation series of this character remains uncertain, however. Within the family Periscelididae two or three spermathecae are found (genera of Periscelidinae sensu stricto have three, *Planinasus* and *Stenomicra* have two), and the same numbers of spermathecae occur in related groups.

3. Presence of spine-like setulae on femur I. This character seems to have evolved independently in unrelated species of the genus.

Some characters are polymorphic in the genera *Cyamops* and/or *Stenomicra*, making it impossible to determine their polarity by outgroup comparison only. These characters are as follows.

4. Female abdomen with tergite and sternite of segment 7 fused to each other, forming a complete ring. This character occurs in the genera of Periscelidinae, sensu stricto, the majority of species of *Cyamops*, and all

species of the genus *Stenomicra*. In Australasian species of *Cyamops* (Khoo, 1984), however, the tergite and sternite of this segment are free from each other. We accept, following strict parsimony, the fusion of the seventh tergite and sternite as the generalized or plesiomorphic condition, which would indicate that the Australasian species are apomorphic for this character.

5. Dorsocentral setae 0+1 or 0+2. Both characters states are also found in related groups.

6. Lateral scutellar seta one or two. For this character, it is relatively clear that the plesiomorphic state for the family is two scutellar setae, as in the outgroup. The plesiomorphic number for *Cyamops* also seems to be two, and only *C. imitatus* and an undescribed species from the Afrotropical Region show the apomorphic state of one seta. The loss of a seta apparently occurred independently in these two species, as there is no other evidence linking these two species.

7. Anepisternal setae present or absent; the same observation for character 5 applies here.

8. Crossvein bm-cu of wing present or absent. The presence of this crossvein seems to be plesiomorphic for Stenomicrinae by outgroup comparison. It is present and complete in the Periscelidinae. In *Stenomicra*, as well as in the outgroup, all degrees of sclerotization in this crossvein occur, and it is impossible to know what is the plesiomorphic state for *Cyamops*.

A more detailed phylogenetic study is needed for the family Periscelididae to clarify many questions about polarization of characters. Chaetotaxic characters of the head and thorax seem to have evolved independently many times within the family and related groups. These problems will only be solved by investigation of other characters.

Key to New World Species of *Cyamops* Melander

1. Anepisternum setose along posterior margin, usually with 1 seta and a few setulae 6
 Anepisternum bare along posterior margin 2
2. Scutellar setae 2 (apical) *C. imitatus* Sturtevant
 Scutellar setae 4 (apical and basal) 3
3. Wing hyaline (Canada and USA) *C. halteratus* Sabrosky
 Wing at least partially infusate 4
4. Vein R₂₊₃ sinuous; mid and hind tibiae mostly yellow; scutellar disc slightly convex;
 (Canada and USA) *C. nebulosus* Melander
 Vein R₂₊₃ straight or nearly so; mid and hind tibiae lightly infusate to brown;
 scutellar disc flat 5
5. Male right surstylus as narrow as left; hypandrial projection large; 7 or 8 sternites
 reduced (Brazil. Rio de Janeiro, São Paulo) *C. fasciatus*, new species
 Male right surstylus much broader than left; hypandrial projection of normal length,
 not large; 7 or 8 sternites well developed, fused to 5th sternite (Mexico.
 Chacahoatan) *C. buenorum*, new species

6. Face of ♂ and ♀ in profile angulate, sloped anteroventrally from base of antenna to vibrissal angle; facial carina lacking in the male; ♂ frons entirely depressed below insertion of fronto-orbital setae; eye densely microsetulose (Colombia. Rio Raposo) *C. colombianus*, new species
 Face of ♂ shallowly and vertically arched, never angulate; facial carina present in ♂; ♂ frons depressed only medially; eye microsetulae sparse, difficult to discern 7
7. Cell r_{4+5} usually completely infuscate, dividing subapical white spot; mid and hind femora mostly yellow (Mexico. Chiapas) *C. americanus*, new species
 Cell r_{4+5} with a conspicuous, undivided subapical white spot; mid and hind femora mostly dark *C. neotropicus* Hennig

Nearctic Species

Cyamops halteratus Sabrosky

FIGURES 2-8, 22

Cyamops halteratus Sabrosky, 1958:170; 1965:820 [Nearctic catalog].

DESCRIPTION.—Length of ♂ 1.65–1.95 mm; wing length 1.70–2.0 mm; wing width 0.60–0.80 mm. Length of ♀ 2.30–2.55 mm; wing length 2.30–2.50 mm; wing width 0.80–0.90 mm.

Head: Ocellar tubercle sparsely microtomentose; frons subshiny, moderately microtomentose, with polished area immediately laterad of lateral ocellus; mesofrons deeply concave, velvety black; antenna mostly yellow, with dorsal half and sometimes apex of 1st flagellomere brown; facial region mostly yellow; posterior $\frac{1}{3}$ of gena mostly brown; labellum and palpus mostly white to pale yellow; face in profile shallowly and vertically arched, not angulate; facial carina shallow and narrow; eye sparsely microsetulose. Chaetotaxy: Inner fronto-orbital setae nearly parallel; fronto-orbits very sparsely setulose; arista with 9 or 10 dorsal/3 ventral rays; peristomal setae 7-9.

Thorax: Anepimeron sometimes polished anteriorly; halter mostly white to gray, mostly black at base; mesonotum slightly longer than wide; scutellum conical, disc shallowly convex. Chaetotaxy: Dorsocentral setae 0+1, subequal in length to basal scutellar seta; mesonotal setulae small; scutellar setae 2, the basal pair about $\frac{3}{4}$ length of apical; anepisternum bare. Legs: Mostly yellow; fore coxa pale yellow, with mostly white microtomentum; mid coxa brown on dorsal $\frac{1}{2}$, whitish microtomentose; mid and hind femora brown on apical $\frac{1}{2}$ – $\frac{2}{3}$; apical and sometimes subapical tarsomere of each leg brown; spine-like setulae 6–9, black, easy to discern. Wing (Figure 22): Completely hyaline; costal vein ratio I: 2.9 (slide-mounted wing); costal vein ratio II: 2.28–3.33 (slide-mounted wing 3.23); wing ratio: 2.55–3.03 (slide-mounted wing 2.56).

Abdomen (Figures 2, 3, 5): Epandrium polished centrally; 7th tergite a narrow band; 6th–7th sternites as in Figure 3. Terminalia of ♂ (Figure 3): Left surstylus elongate, angulate medially; right surstylus shorter and broader than left; hypandrial process small, width less than base of left surstylus;

ejaculatory apodeme (Figure 5) very large, hatchet-like; aedeagal apodeme free from hypandrium.

Female: Head: Antenna sometimes entirely brown; mesofacialia brown to dark brown, shiny on lower $\frac{1}{3}$ of median carina; palpus mostly yellow to mostly brown; median plate of clypeus sometimes polished anteriorly. Abdomen and terminalia (Figure 4, 6, 7): Boundary between 6th and 7th segments weak dorsally; 7th segment completely separate from 8th sternite; 9th tergite (= "epiproct" in J.F. McAlpine, 1981) weakly sclerotized medially; 3 spherical spermathecae.

TYPE MATERIAL.—The holotype male is labeled "Washburn Co Wis T39N R12W B32 25 VIII 1951 Coll R H Jones/HOLOTYPE *Cyamops halteratus* ♂ C.W. Sabrosky [pale pink]/TypeNo 64220 [red]/*Cyamops halteratus* SABR. det Sabrosky [black submargin]." The holotype is double mounted (glued to celluloid point), is in fair condition (left antenna missing, a hole in scutum), and is deposited in the USNM (64220).

OTHER SPECIMENS EXAMINED.—**CANADA.** *New Brunswick.* Glebe Road, Chamcook, 14 Jul 1965, G.E. Shewell (1♀; CNC). *Newfoundland.* Portugal Cove (sedge fen), 27 Jun 1987, T.A. Wheeler (1♂; UGE). *Nova Scotia.* Halifax Co., Lawrencetown, 19–20 Jul 1967, D.M. Wood (1♀; CNC). *Ontario.* Ottawa, 4–12 Jul 1956, J.R. Vockeroth (1♂, 2♀; CNC); Ottawa, Mer Bleue, 23 Jun–31 Jul 1952, 1958, 1964, 1966, A.L. Melander, D.D. Munroe, G.E. Shewell, J.R. Vockeroth (3♂, 3♀; CNC, USNM); Point Pelee National Park, Leamington, 8 Jul 1980, K.N. Barber (3♀; UGE). *Quebec.* Old Chelsea, 18 Jun 1963, J.R. Vockeroth (1♂; CNC).

UNITED STATES. *Massachusetts.* Barnstable Co., Woods Hole, 28 Jun–29 Aug 1950, 1954, A.H. Sturtevant (4♂, 7♀; USNM); Mashpee, 28 Jul 1950, A.H. Sturtevant (1♀; USNM). *Middlesex Co.,* Concord (marshy pond), 27 Jul 1961, W.W. Wirth (5♀; USNM). *Plymouth Co.,* Rochester, 21 Jul 1950, A.H. Sturtevant (2♀; USNM). *New Hampshire.* Cheshire Co., Mt. Monadnock, 26 Jul 1926, A.L. Melander (1♀; USNM). *Ohio.* Portage Co., Kent (marsh, swept from *Carex stricta* Lam.), Horning Road, 2 Jul 1989, B.A. Foote (1♀; USNM). *Utah.* Rich Co., Laketown, 12 Jul 1938, G.W. Knowlton, F.C. Harmston (1♂; USNM). *Wisconsin.* Washburn Co., 6 Jul 1951, R.H. Jones (1♀; USNM).

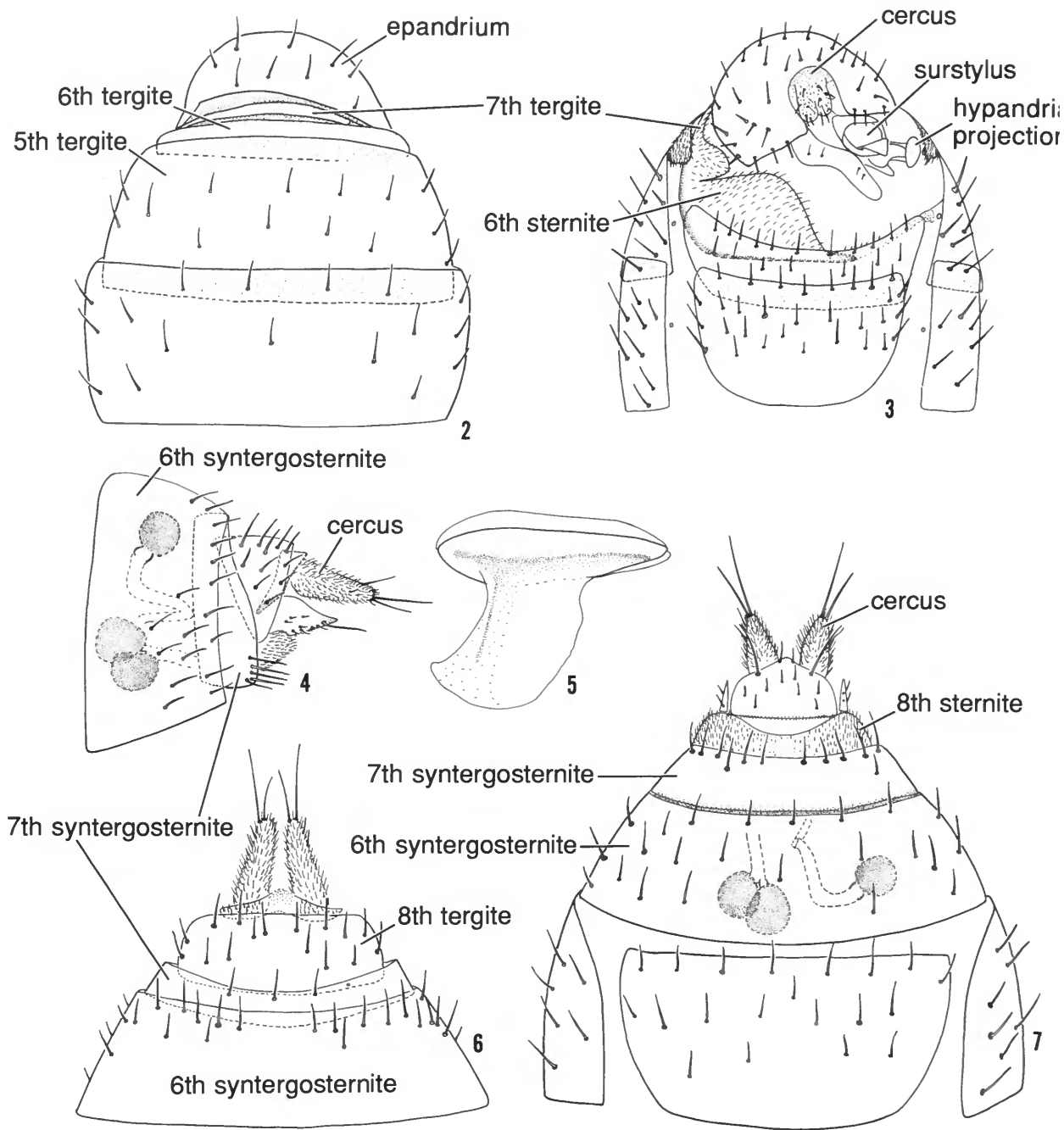

FIGURES 2-7.—*Cyamops halteratus*: 2, male tergites 4-7 and epandrium, dorsal aspect; 3, male abdominal segments 4-6, epandrium, and surstyli, ventral aspect; 4, female abdominal segments 6-9, spermathecae, and cercus, lateral aspect; 5, ejaculatory apodeme, lateral aspect; 6, female tergites 6-9, cerci, and spermathecae, dorsal aspect; 7, female abdominal segments 5-9, cerci, and spermathecae, ventral aspect.

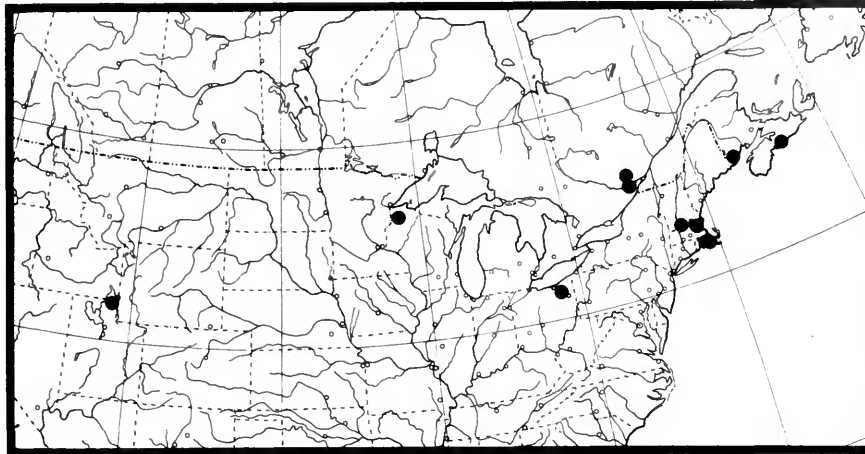

FIGURE 8.—Distribution map for *Cyamops halteratus*.

DISTRIBUTION (Figure 8).—Nearctic. Canada (NB, NF, NS, ON, QB). United States (MA, NH, OH, UT, WI).

REMARKS.—*Cyamops halteratus* is similar to *C. nebulosus* externally and in characters of the male and female terminalia. Indeed, the shape of the aedeagal apodeme and right surstylus of the two species seem to be synapomorphies that establish their sister-group relationship. Specimens of *C. halteratus* are easily distinguished from *C. nebulosus*, however, by the

completely hyaline wing, which is unique in the genus. The depressed portion of the frons of this species is moderately densely microtomentose, appearing velvety.

***Cyamops imitatus* Sturtevant**

FIGURES 9–12, 23

Cyamops imitatus Sturtevant, 1954:559.—Sabrosky, 1958:169 [key]; 1965:820 [Nearctic catalog].

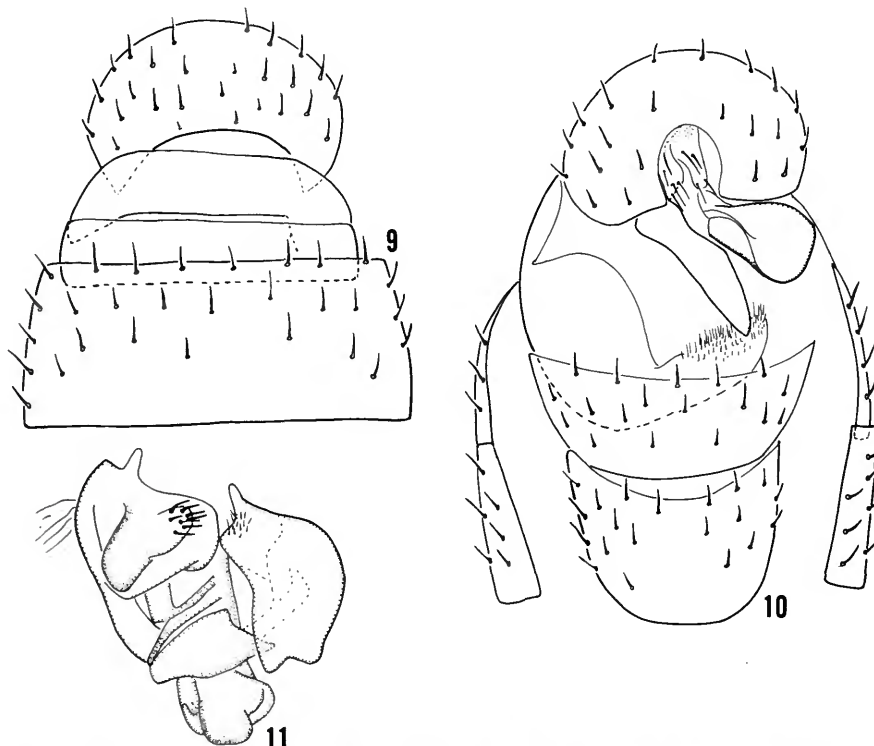

FIGURES 9–11.—*Cyamops imitatus*: 9, male tergites 5–7 and epandrium, dorsal aspect; 10, male abdominal segments 4–7 and epandrium, ventral aspect; 11, internal male terminalia, posteroventral aspect.

DESCRIPTION.—Length of ♂ 1.9 mm; wing length 1.70 mm; wing width 0.60 mm; length of ♀ 2.50 mm; wing length 1.95 mm; wing width 0.75 mm.

Head: Ocellar tubercle slightly microtomentose; region of frons immediately laterad to ocellar tubercle scarcely microtomentose, this region sometimes extended to the level of the upper orbital seta; mesofrons velvety brown; antenna mostly yellow, infuscate to brown at dorsal $\frac{1}{2}$; parafacial and gena mostly yellow to brown in ground color, gena becoming darker toward occipital region; face brown to dark brown, almost bare of microtomentum between insertion of antenna and vibrissal angle; palpus brown; face not angulate; facial carina narrow. Chaetotaxy: Inner fronto-orbital seta a little weaker and ranging about $\frac{1}{2}$ of outer fronto-orbital seta; arista with $\frac{8}{3}$ rays, of which the first 2–4 are clearly bifurcate; peristomal setae 3–7; fronto-orbits almost bare of setulae; eye only sparsely micropubescent.

Thorax: Anepimeron polished anteriorly; halter mostly yellow, slightly infuscate at base; mesonotum slightly longer than wide; scutellum conical, disc convex. Chaetotaxy: Dorsocentral setae 0+1, subequal in length to scutellar seta; mesonotal setulae small; scutellar setae 1; anepisternum bare. **Legs:** Fore femur slightly infuscate along anterior margin and in apical $\frac{1}{4}$; fore tibia and tarsus entirely light brown to brown; mid and hind femora mostly brown to dark brown at apical $\frac{1}{2}$ – $\frac{3}{4}$; hind tibia infuscate; apical tarsomeres of each leg mostly brown. Wing (Figure 23): mostly dark colored, cells r_1 completely and r_{2+3} mostly hyaline, posterior margin and apex of cell r_{2+3} dark, posterior portion of cell m and somewhat cell cu_a with hyaline area; costal vein ratio I: 0.80 (slide-mounted wing); costal vein ratio II: 2.8–3.4 (slide-mounted wing); wing ratio: 3.0 (slide-mounted wing 3.30).

Abdomen (Figures 9–11): Generally shiny with sparse microtomentum. 6th and 7th tergites subequal in length; 4th and 5th sternites subequal in length; sternites 6–7 with posterior process simple, margins nearly straight (Figure 10). Terminalia as follows (Figures 10, 11): Left surstylus long, narrow; right surstylus conspicuously shorter than left, much wider, becoming slightly wider toward apex, apex broadly rounded; hypandrial projection lacking; ejaculatory apodeme small, in lateral view with extended process almost parallel sided except for expanded apex, in dorsal view tear-drop shaped with extended process in lateral view straight sided, slightly expanded immediately before truncate apex.

Female: **Head:** Face distinctly angulate; facial carina broad. **Thorax:** Dorsocentral and acrostichal setulae more conspicuous than in male. **Legs:** Fore and hind tibia infuscate, fore tarsus mostly brown.

TYPE MATERIAL.—The holotype female is labeled “LaFayette, Ind. VII-6-15/JM Aldrich coll/TYPER [lavender]/TypeNo 61474 U S N M [number handwritten; red]/*Cyamops imitata* Sturt. [handwritten].” The holotype is double mounted (smaller pin bent and wound around main pin), is in excellent condition,

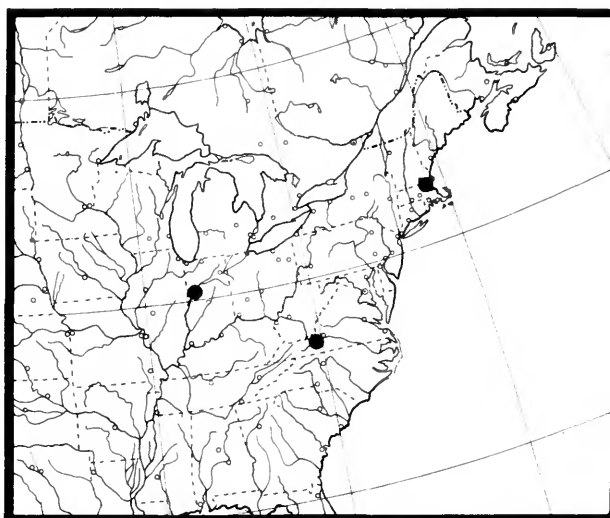

FIGURE 12.—Distribution map for *Cyamops imitatus*.

and is deposited in the USNM (61474).

OTHER SPECIMENS EXAMINED.—**UNITED STATES.** *Massachusetts.* Middlesex Co., Concord (marsh), 17 Jul 1961, W.W. Wirth (2♂, 1♀; USNM). *Virginia.* Montgomery Co., 20 Jun 1961, S.E. Neff (1♀; CNC).

DISTRIBUTION (Figure 12).—Nearctic. United States (IN, MA, VA).

REMARKS.—This species is represented by few specimens, and the range of variation is perforce largely unsampled. The specimens available to us are easily distinguished from congeners, however, by the presence of a single pair of scutellar setae (lateral) and the wing pattern.

Cyamops nebulosus Melander

FIGURES 13–21, 24

Cyamops nebulosus Melander, 1913:292.—Sturtevant, 1954:558 [revision].—Sabrosky, 1958:170 [revision]; 1965:820 [Nearctic catalog].—Teskey, 1987:893 [figure of head].

DESCRIPTION.—Length of ♂ 2.0–2.50 mm; wing length 1.90–2.20 mm; wing width 0.70–0.85 mm. Adult ♀ length 1.95–2.75 mm; wing length 2.10–2.60 mm; wing width 0.76–1.05 mm.

Head: Ocellar tubercle slightly microtomentose, shiny; mesofrons subshiny to dull microtomentose, not so deep as in *C. halteratus*, bearing a small polished area laterad of lateral ocellus; antenna mostly yellow, with apical half and apex of 1st flagellomere slightly infuscate to brown; antenna of some specimens entirely brown; facial region mostly yellow to light brown; posterior $\frac{1}{3}$ – $\frac{2}{3}$ of gena light brown to brown; labellum and palpus mostly white to pale yellow; face in profile shallowly and vertically arched, not angulate; facial carina shallow and narrow; eye sparsely microsetulose. Chaetotaxy:

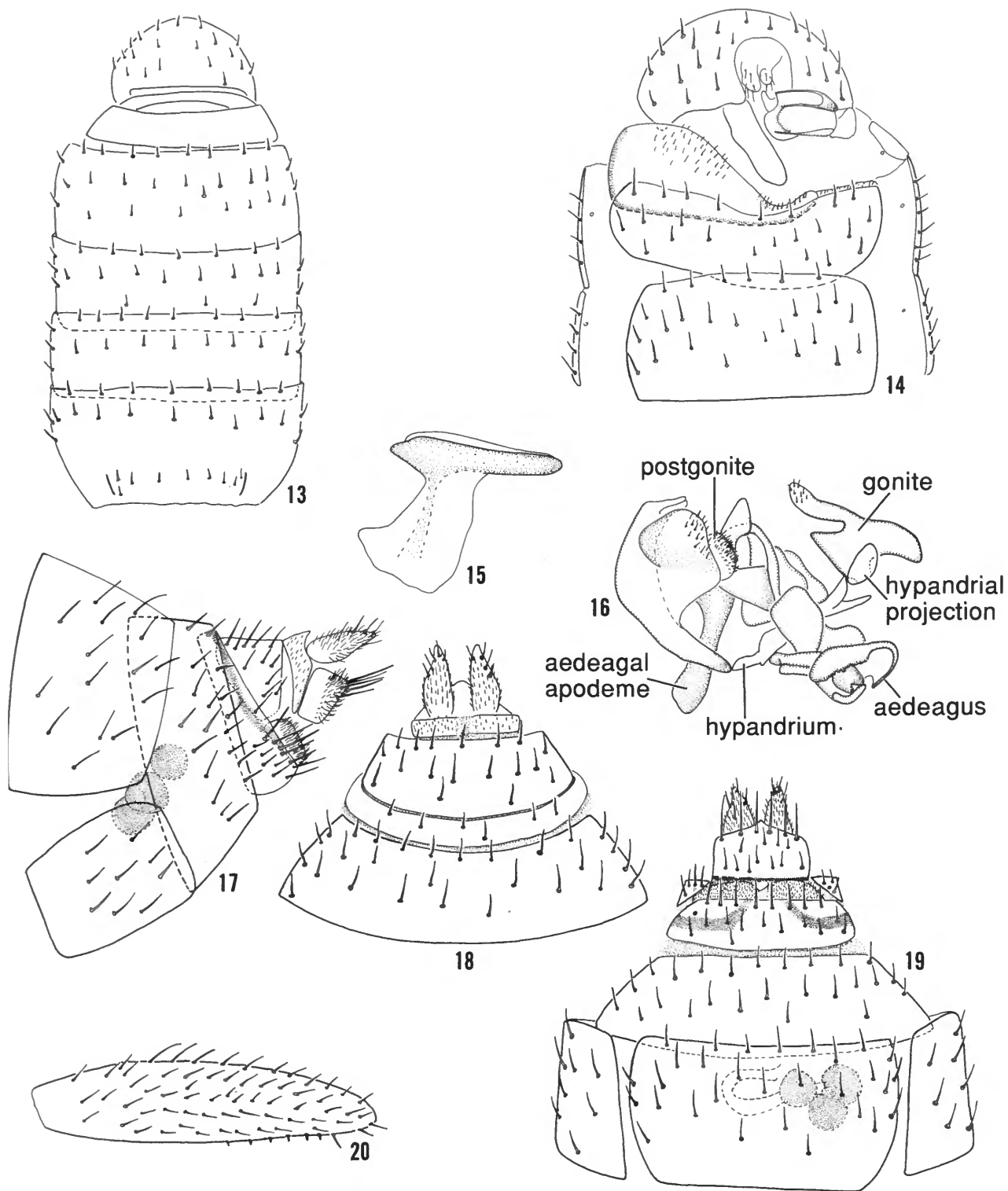

FIGURES 13-20.—*Cyamops nebulosus*: 13, male tergites, dorsal aspect; 14, male abdominal segments 4-7 and epandrium, ventral aspect; 15, ejaculatory apodeme, lateral aspect; 16, internal male terminalia, posteroventral aspect; 17, female abdominal segments 5-9, cercus and spermathecae, lateral aspect; 18, female tergites 6-9 and cerci, dorsal aspect; 19, female abdominal segments 5-9, cerci and spermathecae, ventral aspect; 20, fore femur and spine-like setulae, posteroventral aspect.

Fronto-orbital setae nearly parallel; arista with 11–12 dorsal/3 ventral rays; peristomal setae 8–10.

Thorax: Anepisternum, anepimeron, and katepisternum partially polished in some specimens; halter white, mostly brown at base; mesonotum slightly longer than wide; scutellum conical, disc shallowly convex. Chaetotaxy: Dorsocentral setae 0+1, subequal in length to scutellar setae; mesonotal setulae small and weak; scutellar seta 2 pairs, basal pair about $\frac{3}{4}$ length of apical; anepisternum bare posteriorly. **Legs** (Figure 20): Mostly yellow; fore coxa pale yellow, whitish microtomentose and sometimes infuscate at base; fore femur sometimes infuscate anteriorly; mid coxa brown at dorsal $\frac{1}{2}$, gray microtomentose; mid femur slightly infuscate to brown at apical $\frac{1}{5}$ – $\frac{3}{4}$, but completely yellow in some specimens; hind femur slightly infuscate to brown at apical $\frac{1}{2}$ – $\frac{3}{4}$; apical and sometimes subapical tarsomeres of each leg brown; spine-like setae 8–9, black, easy to discern. **Wing** (Figure 24): Mostly hyaline but with brown infuscation at center (over crossveins r-m and dm-cu, from costal vein margin to along vein CuA₁ to its apex posteriorly) and at apex (coloration sometimes faint and difficult to discern); vein R₂₊₃ sinuous, narrowing cell r₂₊₃ about midlength; costal vein ratio I: 2.60 (slide-mounted wing); costal vein ratio II: 3.0–3.5 (slide-mounted wing 3.2); wing ratio: 2.7–2.9 (slide-mounted wing 2.70).

Abdomen (Figures 13–16): Epandrium polished centrally. Terminalia of ♂ (Figures 14, 15): As described for *C. halteratus*; for more information see Griffiths (1972).

Female: Head: Mesofacialia light brown to dark brown, centrally shiny on lower $\frac{1}{3}$ of median carina; gena mostly yellow to brownish; palpus yellowish to brown. Abdomen and terminalia (Figures 17–19): As described for *C. halteratus*.

TYPE MATERIAL.—The holotype female is labeled “Woods Hole 7-7-2 [7 Jul 1902] Mass[achusetts]/TYPE *Cyamops nebulosa* Mel. [red]/ALMelander Collection 1961 [right third stippled green]/*Cyamops nebulosa* Typ. Mel. [handwritten, black submargin]. The holotype is double mounted (pin in rectangular card), is in good condition, and is deposited in the USNM.

OTHER SPECIMENS EXAMINED.—**CANADA.** *New Brunswick.* Kouchibouguac National Park, 2 Jul 1977, J.R. Vockeroth (1♀; CNC); St. Andrews, 20 Jul 1978, S.A. Marshall (1♂; UGE). *Nova Scotia.* Lockeport, 25 Jul–1 Aug 1958, J.R. Vockeroth (2♂, 3♀; CNC). *Ontario.* Guelph, 12 Jul 1974, R.E. Roughley (1♀; UGE); London, 12 Aug 1967, W.W. Judd (1♂; CNC). *Quebec.* Knowlton Lodge, 17–18 Jul 1968, J.R. Vockeroth (6♂, 3♀; CNC).

UNITED STATES. *Connecticut.* Windham Co., Putnam Park, 22 Jul 1939, A.L. Melander (1♂; USNM). *Florida.* Alachua Co., Chantilly Acres (Malaise trap), 25 Apr 1970, W.W. Wirth (1♀; USNM); Gainesville, 27 Apr 1970, W.W. Wirth (1♀; USNM). Calhoun Co., Torreja State Park, 30 Apr 1973, G.C. Steyskal (1♂, 3♀; USNM). Highlands Co., Archbold Biological Station, 15–16 Apr 1989, A.L. Norrbom (2♂; USNM); Highlands Hammock State Park, 20 Mar–17 Apr 1955, 1989, F.W. Mead, J.R. Vockeroth (2♂; CNC, USNM);

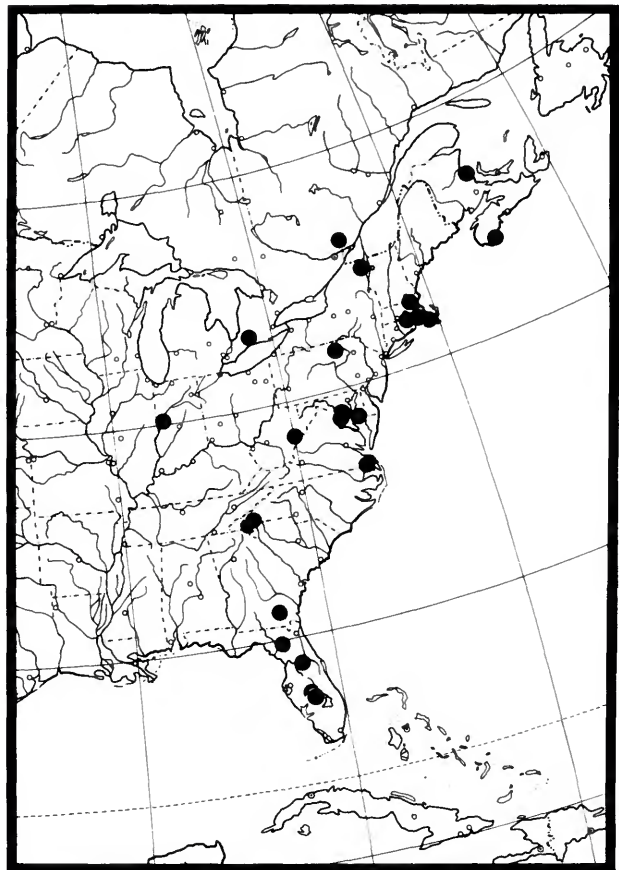

FIGURE 21.—Distribution map for *Cyamops nebulosus*.

Sebring, Highlands Hammock State Park, 15 Apr 1970, W.W. Wirth (15♂, 3♀; USNM). Orange Co., Rock Springs, 21 Apr 1970, W.W. Wirth (1♂, 3♀; USNM). *Georgia.* Ware Co., Waycross, 8 May 1911 (1♂; ANSP). *Indiana.* Tippecanoe Co., La Fayette, 16 Jun 1916, J.M. Aldrich (1♀; USNM). *Maryland.* Dorchester Co., Lloyds, 10 Jul 1907, H.S. Barber (1♂, ♀; USNM). Prince Georges Co., Beltsville, 4 Jul 1916, W.L. McAtee (1♀; USNM). *Massachusetts.* Barnstable Co., Woods Hole, 4 May–29 Aug 1946, 1950, 1952, A.H. Sturtevant (9♂, 13♀; USNM). Middlesex Co., Bedford (swamp), 20 Jul 1961, W.W. Wirth (10♂, 13♀; USNM); Concord (fern pond, marshy pond), 22–27 Jul 1961, W.W. Wirth (5♂, 6♀; USNM). Plymouth Co., Rochester, 21 Jul 1950, A.H. Sturtevant (1♂, 1♀; USNM). *New Jersey.* Highway 539 (4 mi (= 6.4 km) N Highway 72; in cedar bog), 15 Jun 1985, B.V. Brown (1♀; UGE). *North Carolina.* Brunswick Co., Southport, 5 Jun 1948, C.W. Sabrosky (1♀; USNM). Jackson Co., Dulaney Bog (7 mi (= 11.2 km) S Cashiers, Malaise trap), 19 Jun 1986, W.W. Wirth (1♂, 3♀; USNM). Macon Co., Highlands, 29 Jun 1957, W.R.M. Mason (1♀; CNC); Highlands Lake Ravenel (Malaise trap), 14–15 Jun 1986, W.W. Wirth (3♂; USNM). *New York.* Clinton Co., Saranac, 17 Jul 1952, W.A. McDonald (2♂;

USNM). *Pennsylvania*. Bradford Co., Le Roy (2 mi (= 3.2 km S), 10 Aug 1981, G.C. Steyskal (1♀; USNM). *Virginia*. Alexandria (Osmundo bog, reared from puparia), 30 May 1951, W.W. Wirth (1♂, 1♀; USNM). Fairfax Co., Dead Run 25 Jul 1915, R.C. Shannon (1♂; USNM); Falls Church, 15 Jul 1954, W.W. Wirth (1♂, 1♀; USNM). Norfolk Co., Lake Drummond, 8–11 Jun 1905, H.S. Barber (1♂, 1♀; USNM). *West Virginia*. Pocahontas Co., Cranberry Glades, 16 Jul 1955, C.W. Sabrosky (15♂, 15♀; USNM).

DISTRIBUTION (Figure 21).—Nearctic: Canada (ON, NB, NS, QB), USA (CT, FL, GA, IN, MD, MA, NC, NJ, NY, PA, VA, WV).

REMARKS.—*Cyamops nebulosus* varies widely in color, even among specimens from the same locality, and some of the variation appears to be sexually dimorphic. The coloration of the wing and legs is typically darker in females, although the pattern is inconspicuous in some specimens. Females are also typically larger than males, although many females are as small as males that were collected at the same locality.

This species is apparently closely related to *C. halteratus* (see discussion of *C. halteratus* above). The sinuous vein R_{2+3} , making cell r_{2+3} narrow near its midlength, and wing pattern distinguish this species from *C. halteratus*.

Neotropical Species

Cyamops americus, new species

FIGURES 25, 30–36

DESCRIPTION.—Adult ♂ length 2.0–2.90 mm; wing length 1.90–2.60 mm; wing width 0.90–1.0 mm. Adult ♀ length 2.15–3.0 mm; wing length 2.80–3.25 mm; wing width 1.05–1.20 mm.

Head: Ocellar tubercle sparsely microtomentose to polished; vertex in most specimens bearing a small polished area between outer vertical seta and top of eye; rest of frons subshiny microtomentose, velvet at deepest portion; antenna mostly yellow, slightly infuscate at dorsal margin; facial region mostly yellow; palpus and labellum mostly white; face in profile shallowly and vertically arched, not angulate; facial carina narrow, becoming broader towards oral margin; eye sparsely microsetulose. Chaetotaxy: Inner fronto-orbital setae slightly divergent; arista with about 8:3 rays, 3–4 basal ones clearly bifurcate; peristomal setae 8–10.

Thorax: Postpronotum very sparsely microtomentose to polished; halter mostly white to mostly gray, infuscate at base; mesonotum slightly longer than wide; scutellum trapeziform, disc flattened. Chaetotaxy: Dorsocentral setae 0+1, subequal in length to the 1st scutellar seta; many setulae present between dorsocentral and acrostichal rows in most specimens; setulae of mesonotum well developed, some $1/3$ – $1/2$ the length of dorsocentral seta; scutellar setae 2 pair, basal pair about $2/3$ length of apical; anepisternum setulose posteriorly. Legs (Figure 35): Mostly yellow; fore coxa pale yellow, whitish microtomentose; mid coxa dark brown on dorsal $1/2$, gray

microtomentose; apical $1/4$ of hind femur, apical and sometimes subapical tarsomere of each leg brown; spine-like setulae 3–5, weakly differentiated and difficult to discern. Wing (Figure 25): Partially hyaline, mostly with dark pattern; cell r_{4+5} usually entirely infuscate, dividing subapical white spot; brown area near apex of vein R_1 ; pale specimens with only traces of brown on the veins around cell r_{4+5} ; costal vein ratio I: 1.1 (slide-mounted wing); costal vein ratio II: 3.74–4.85 (slide-mounted wing 4.16); wing ratio 2.74–3.04 (slide-mounted wing 2.81).

Abdomen (Figures 30–32): Coloration as described for the thorax, without polished segments; 6th and 7th tergites large, subequal in length; posterior process of 6th and 7th sternites wide, somewhat parallel sided with rather angulate corners. Male terminalia as follows (Figure 31): Left surstylus narrow, elongate, tapered gradually to point; right surstylus shorter but wider, somewhat quadrate although wider basally; hypandrial process apparently lacking; ejaculatory apodeme (Figure 32) large, length subequal to combined length of 6th and 7th tergites, with extended process expanded toward apex, fan-like; aedeagal apodeme free from hypandrium.

Female: Antenna with dorsal $1/2$ and apex of 1st flagellomere brown; mesofacialia dark brown, shiny on facial carina; gena light brown to brown in ground color; palpus brown; face in profile angulate, sloped anteroventrally from base of antenna to vibrissal angle, thereafter slightly receded to oral margin. Thorax: Dorsocentral setulae typically better developed than in the males. Legs: Base of fore coxa sometimes mostly black. Abdomen (Figures 33, 34): Demarcation between 7th and 8th tergites weak dorsally; 8th sternite fused to 7th; 4 spermathecae present, oblong, one pair slightly smaller than other.

TYPE MATERIAL.—The holotype male is labeled "MEXICO. Chiapas: El Triunfo (49 km S Jaltenango), 13, 15 May 1985, 1300–2000 m, W.N. Mathis/HOLOTYPE ♂ *Cyamops americus* Baptista & Mathis USNM [handwritten except for "HOLOTYPE" and "USNM"; red]." The holotype is double mounted (minuten in a block of plastic), is in good condition, and is deposited in the USNM. Paratypes (33♂, 68♀; TAU, USNM) bear the same locality data as the holotype.

OTHER SPECIMENS EXAMINED.—*COSTA RICA*. Bahía Carrillo National Park (10°10'N, 84°07'W, 500 m), 10 Apr 1985, H. Goulet, L. Masner (1♂, 1♀; CNC).

MEXICO. Chiapas. Bochil Yerba Buena (6500 ft, 20 mi (= 32 km) N), 24 Jun 1969, W.R.M. Mason (1♀; CNC).

DISTRIBUTION (Figure 36).—Costa Rica and Mexico (CHI). **ETYMOLOGY.**—The species epithet, *americus*, refers to the New World, where this species occurs.

REMARKS.—The specimens we examined were very uniform in the coloration pattern of the legs and wing. Among species that have a setose posterior margin of the anepisternum, this species is most similar to *C. neotropicus* but can be easily distinguished from it by the completely infuscate cell r_{4+5} , the coloration of the legs, and several characters of the male terminalia.

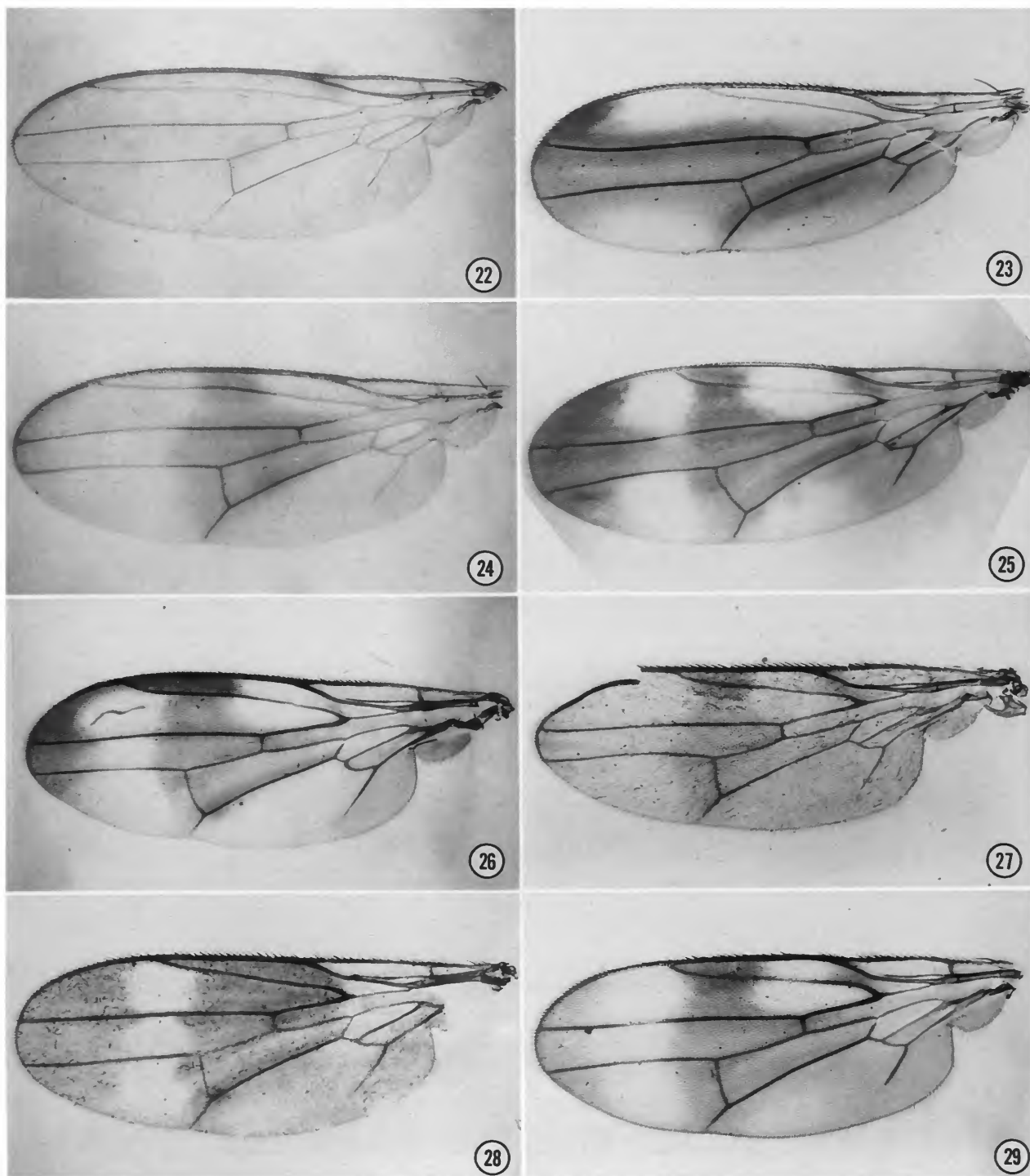

FIGURES 22-29.—Wings of species of *Cyamops*: 22, *C. halteratus*; 23, *C. imitatus*; 24, *C. nebulosus*; 25, *C. americanus*; 26, *C. buenorum*; 27, *C. colombianus*; 28, *C. fasciatus*; 29, *C. neotropicus*.

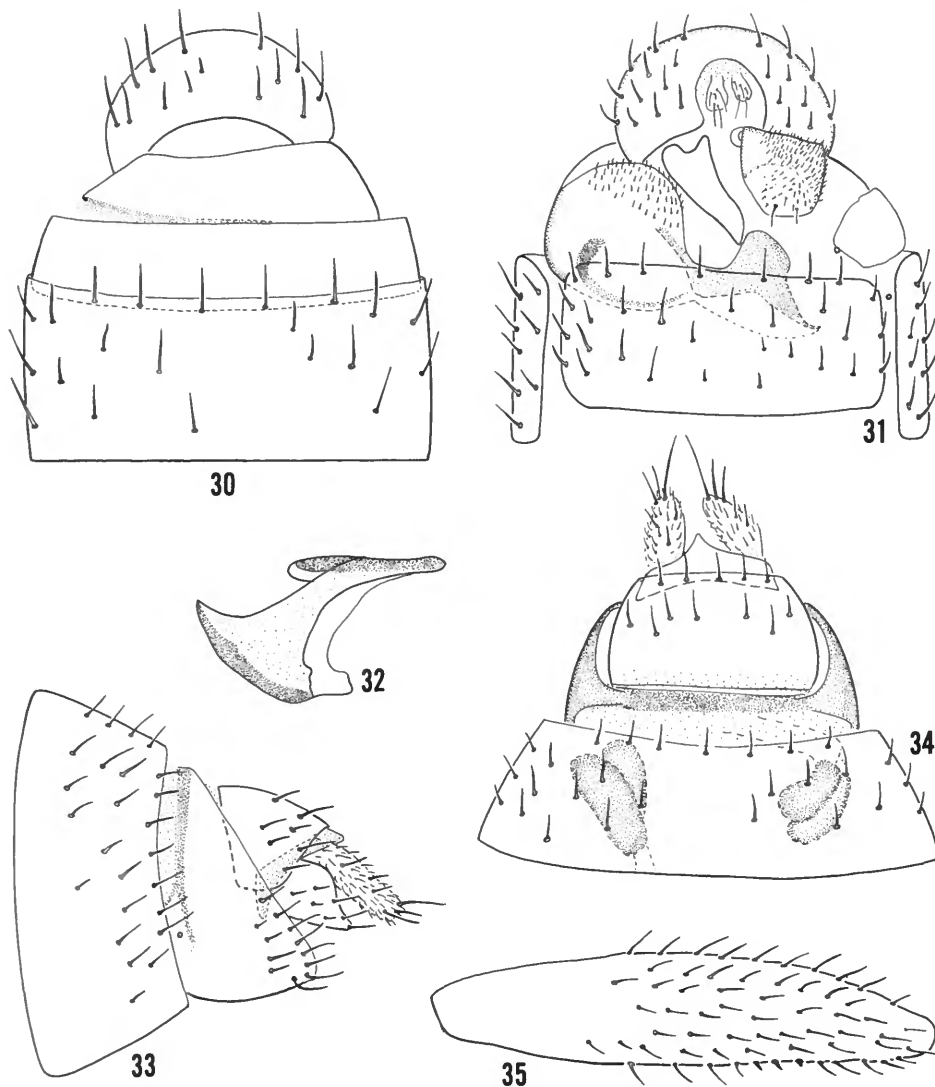

FIGURES 30-35.—*Cyamops americus*: 30, male tergites 5-7 and epandrium, dorsal aspect; 31, male abdominal segments 5-7 and epandrium, ventral aspect; 32, ejaculatory apodeme, lateral aspect; 33, female abdominal segments 6-9, cercus and spermathecae, lateral aspect; 34, female tergites 6-9, spermathecae and cerci, dorsal aspect; 35, fore femur and spine-like setulae, posteroventral aspect.



FIGURE 36.—Distribution map for *Cyamops americanus* (filled diamonds), *C. buenorum* (filled dot), *C. colombianus* (filled triangle), *C. fasciatus* (filled square), and *C. neotropicus* (open, upside down triangles).

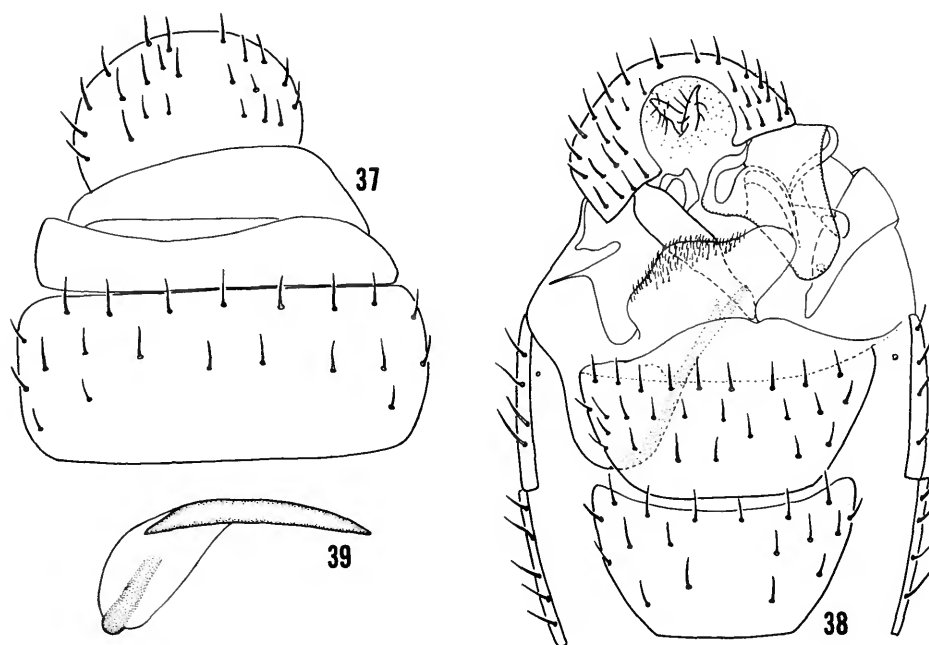

FIGURES 37-39.—*Cyamops buenorum*: 37, male tergites 5-7 and epiandrium, dorsal aspect; 38, male abdominal segments 4-7 and epiandrium, ventral aspect; 39, ejaculatory apodeme, lateral aspect.

Cyamops buenorum, new species

FIGURES 26, 36-39

DESCRIPTION.—Adult ♂ length 2.30 mm; wing length 2.10 mm; wing width 0.75 mm. Adult ♀ length 2.90 mm; wing length 2.80 mm; wing width 1.15 mm.

Head: Ocellar tubercle sparsely microtomentose; frons subshiny microtomentose, with a polished region immediately laterad of lateral ocellus; antenna $\frac{1}{2}$ dorsal and apex of 1st flagellomere light brown to brown; facial region yellowish; palpus and labellum whitish; face in profile shallowly and vertically arched, not angulate; facial carina as in *C. americanus*; eye sparsely microsetulose. Chaetotaxy: Inner fronto-orbital setae nearly parallel; peristomal setae 6-7; arista with 12 or 13 dorsal/3 ventral rays, 3 or 4 basal rays clearly bifurcate.

Thorax: Halter mostly white, infuscate at base; mesonotum slightly longer than wide; scutellum trapeziform, disc flattened. Chaetotaxy: Dorsocentral seta 0+1, subequal in length to 1st scutellar seta; many setulae present between dorsocentral and acrostichal rows; setulae of mesonotum weakly developed; scutellar setae 2 pairs, the basal pair about $\frac{2}{3}$ length of apical; anepisternum bare. **Legs:** Fore coxa mostly yellow, infuscate at base, invested with mostly white microtomentum; fore femur infuscate along anterior margin, mostly brown on apical $\frac{1}{3}$; mid coxa brown at basal $\frac{1}{2}$, microtomentose; mid femur mostly brown on apical $\frac{4}{5}$; hind coxa entirely light brown; hind femur and tibia brown on apical

$\frac{3}{4}$ - $\frac{4}{5}$; spine-like setulae 12-13, black and easy to discern. **Wing** (Figure 26): Partially hyaline, with distinct dark pattern; irregular, transverse stripe near middle over both crossveins and at apex brown; both irregular stripes connected narrowly anteriorly; costal vein ratio I: 1.60 (slide-mounted wing); costal vein ratio II: 4.0; wing ratio 2.92-3.03.

Abdomen (Figures 37-39): No polished segments. Male 7th tergite slightly smaller than 6th; 4th and 5th sternites subequal in length; sternites 6-7 with posterior process wide, margin irregular (Figure 38). Male terminalia as follows (Figures 37, 38): Right surstylus at base almost 3 times as wide as left surstylus, narrowed gradually toward apex, subtriangular in shape, ventral margin broadly rounded; left surstylus narrow, slightly longer than right, gradually tapered to pointed apex; ejaculatory apodeme (Figure 39) small, greatest length subequal to that of 5th tergite, in dorsal view with basal margin truncate, gradually expanded to apical $\frac{1}{3}$, thereafter tapered to apex, extended process in lateral view short, relatively narrow, apex irregular with median portion longer; hypandrial process present, small, covered by right surstylus.

Female: **Head:** Antenna $\frac{1}{2}$ dorsal and apex of 1st flagellomere brown; mesofacialia dark brown, shiny centrally; parafacial and gena mostly brown; face in profile angulate, as in female of *C. americanus*. **Thorax:** Postpronotum polished. **Legs:** Base of fore coxa sometimes mostly black.

TYPE MATERIAL.—The holotype male is labeled "MEXICO: Chiapas[,] Cacahoatan, 7km N[,] 22 April 1983[,] Wayne N.

Mathis/HOLOTYPE ♂ *Cyamops buenorum* Baptista & Mathis USNM [handwritten except for "HOLOTYPE" and "USNM"; red.] The female paratype bears the same label data as the holotype. The holotype is double mounted (minuten in a block of plastic), is in good condition (abdomen removed, dissected, stored in an attached microvial), and is deposited in the USNM.

DISTRIBUTION (Figure 36).—Mexico (Chi).

ETYMOLOGY.—The species epithet, *buenorum*, is a genitive patronym to recognize the entomological contributions and generous hospitality of Drs. Joaquin and Silvia Bueno, Universidad Nacional Autonoma de México, Mexico City.

REMARKS.—This species is distinguished from congeners by the patterned wing, infuscate mid and hind tibiae and characters of the male terminalia, especially the shape of the right surstylus.

Cyamops colombianus, new species

FIGURES 27, 36, 40–42

DESCRIPTION.—Length of ♂ 1.95 mm; wing length 1.80 mm; wing width 0.65 mm. Adult ♀ length 1.70 mm; wing length 1.75 mm; wing width 0.65 mm.

Head: Ocellar tubercle and frontal region subshiny microtomentose; antenna brown on upper 1/2; mesofacialia upper 1/2 brown, lower 1/2 centrally mostly yellow, becoming light brown laterally; parafacial and gena mostly yellow to brown; palpus light brown, labellum mostly white; frons with anteromedian depression more extensive, extended posterolaterally to include insertion of reclinate fronto-orbital seta; eye bearing numerous interfacetal setulae; face angulate, sloped

anteroventrally from base of antenna to vibrissal angle, thereafter nearly oblique to peristomal area; upper and lower face flattened areas, without facial carina. Chaetotaxy: Inner vertical setae slightly divergent; arista with 8 dorsal/3 ventral rays, 2–3 basal rays clearly bifurcate; peristomal setae 7–8.

Thorax: Halter mostly white, infuscate at base; mesonotum slightly longer than wide; scutellum trapezoid-shaped, disc flattened. Chaetotaxy: Dorsocentral setae 0+1, but setulae immediately behind dorsocentral seta ranging up to half length of dorsocentral seta; dorsocentral seta a little longer than the 1st scutellar; anepisternum setulose posteriorly; mesonotal setulae weakly developed; scutellar setae 2. Wing (Figure 27): Mostly hyaline, brown pattern reduced, limited to faint apical stripe and narrow transverse stripe through area of crossveins r-m and dm-cu, the 2 stripes not connected anteriorly; costal vein ratio I: 1.1 (slide-mounted wing); costal vein ratio II: 4.0; wing ratio 2.75 (slide-mounted wing). Legs: Mostly brown; fore coxa mostly yellow, whitish microtomentose, infuscate at base; also yellowish are the first and mid tibiae, basal 1/5 of hind femur, hind tibia at basal 1/3 and all tarsi, except apical and subapical tarsomeres; spine-like setulae 5–7, black, well differentiated.

Abdomen (Figures 40–42): Male 7th tergite as wide as 6th, both tergites without seta; 5th sternite reduced, about 1/2 length of 4th. Male terminalia (Figure 41): Right surstylus wide, left surstylus slightly longer, narrow; lacking hypandrial projection; ejaculatory apodeme (Figure 42) small, greatest length subequal to that of 5th tergite.

Female: Head: Face dark brown to black; upper half of mesofacialia polished; palpus brown; frons depressed only on mesofrons; facial carina well developed, broad. Legs: Fore leg

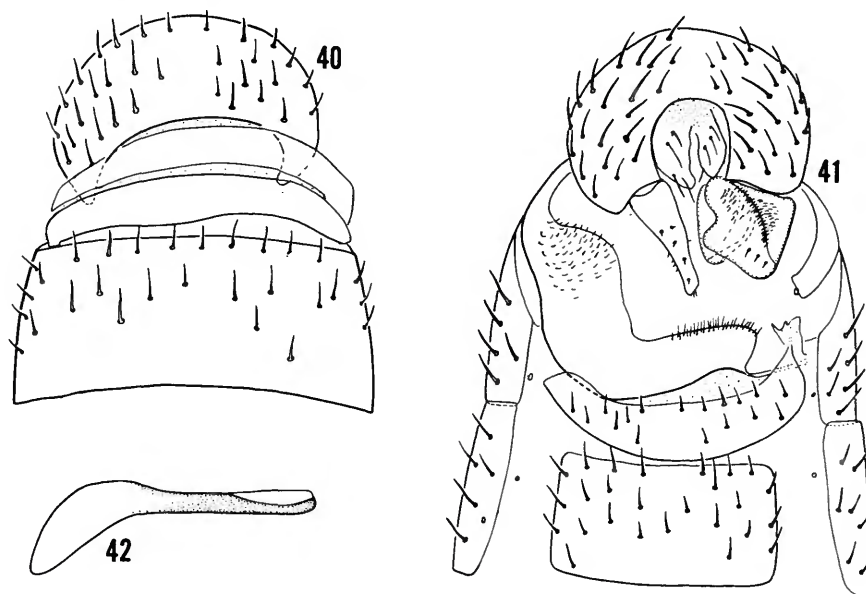

FIGURES 40–42.—*Cyamops colombianus*: 40, male tergites 5–7 and epandrium, dorsal aspect; 41, male abdominal segments 4–7 and epandrium, ventral aspect; 42, ejaculatory apodeme, lateral aspect.

entirely light brown to brown, apical $\frac{1}{2}$ of mid tibia mostly brown, fore and hind tibiae brown.

TYPE MATERIAL.—The holotype male is labeled "COLOMBIA[.] Rio Raposo V [May] 1964, VHLee, light/HOLOTYPE ♂ *Cyamops colombianus* A. Baptista & W.N.Mathis USNM [handwritten except for "HOLOTYPE" and "W.N.Mathis USNM"; red]." The holotype is double mounted (glued to a point), is in moderately good condition (the specimens was collected in alcohol, and the wings on the specimen, which is now dry mounted, are wrinkled; right wing removed and slide mounted; abdomen removed, dissected, in an attached microvial), and is deposited in the USNM. A female paratype (USNM) is from the same locality but was collected in October 1964.

DISTRIBUTION (Figure 36).—This species is known only from the type locality in Colombia.

ETYMOLOGY.—The species epithet, *colombianus*, recognizes the 500th anniversary of the epic voyage of Christopher Columbus and the country where this species was collected.

REMARKS.—This species is very distinctive and unique among New World species of the genus in lacking a facial carina on the male; it can also be easily diagnosed by the dense micropubescence of the eyes, the sharp facial carina of the female, and the angulate face of the male.

Cyamops fasciatus, new species

FIGURES 28, 36, 43

DESCRIPTION.—Adult ♂ length 2.65–2.75 mm; wing length 2.70 mm; wing width 1.0 mm. Adult ♀ length 3.30 mm; wing length 2.95–3.10 mm; wing width 1.15–1.20 mm.

Head: Ocellar tubercle sparsely microtomentose; mesofrons subshiny to dull microtomentose, polished in small area immediately laterad of lateral ocellus; antenna mostly yellow, slightly infusate at dorsal margin; facial region mostly yellow; gena light brown posteriorly; labellum and palpus mostly white to pale yellow; face in profile arched, protruberant, but not angulate; facial carina narrow, broader ventrally near oral margin; eye strongly diagonal, sparsely microsetulose. Chaetotaxy: Fronto-orbital setae slightly divergent; arista with 9:3 rays; peristomal seta 6–8.

Thorax: No polished pleura; halter mostly white to mostly yellow, light brown at base; mesonotum slightly longer than wide; scutellum with disc flattened, trapezoid. Chaetotaxy: Dorsocentral setae 0+1, subequal in length to the 1st scutellar seta; scutellar setae 2, the basal pair about $\frac{2}{3}$ the length of the apical; mesonotal setulae small; anepisternum bare. **Legs:** Mostly yellow; fore coxa yellow, mostly white microtomentose, with blackish basal infuscation; fore femur infusate at apical $\frac{1}{3}$; mid coxa brown at basal $\frac{1}{2}$; hind coxa brown to dark brown; mid femur brownish to brown at apical $\frac{1}{2}$; hind femur brown at apical $\frac{4}{5}$; hind tibia yellowish to brown; apical and subapical tarsomeres of each leg brown; spine-like setulae 13–14, black, well differentiated. Wing (Figure 28): Central,

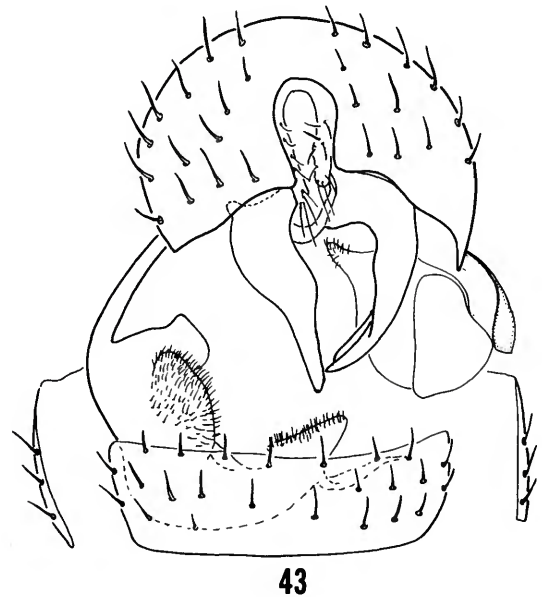

FIGURE 43.—*Cyamops fasciatus*: male abdominal segments 5–7 and epandrium, ventral aspect.

transverse stripe wide, margin more regular, connected narrowly with wide apical stripe; costal vein ratio I: 1.0 (slide-mounted wing); costal vein ratio II: 2.64–2.85 (slide-mounted wing 2.72); wing ratio: 2.5–3.26 (slide-mounted wing 3.26).

Abdomen (Figure 43): 7th tergite of male about $\frac{1}{2}$ length of 6th. Terminalia of male (Figure 43): Epandrium polished; right and left surstyli elongate, tapered on apical half to rounded point; left surstylus straight; right surstylus longer than left but curved medially at apical $\frac{1}{3}$; hypandrial projection greatly enlarged; aedeagal apodeme joined to right side of hypandrium; ejaculatory apodeme small.

Female: Head: Antenna $\frac{1}{2}$ dorsal and apex of 1st flagellomere brown; mesofacialia dark brown, centrally shiny; palpus mostly brown; face in profile angulate as described for female of *C. americanus*. **Legs:** Fore coxa brown to dark brown, mostly white microtomentose; fore, mid, hind femora and hind tibia brown.

TYPE MATERIAL.—The holotype male is labeled "[BRAZIL.] Est[ado]. S[ão]. Paulo[,] S[erra]. [da] Cantareira Chapadão [sic, = Chapado] [M.P.] Barretto col. 12 - 945 [Dec 1945; date printed across left side of label]/HOLOTYPE ♂ *Cyamops fasciatus* A. Baptista & W.N.Mathis [handwritten except for "HOLOTYPE" and "W.N.Mathis"; red]." The holotype is double mounted (minuten in a block of cork), is in fair condition, and is deposited in the MZUSP. Paratypes: BRAZIL. Rio de Janeiro: Parque Nacional Itatiaia, Maromba (near stream on leaves of Maranthaceae), 13–17 Dec 1991, A. and R. Baptista (2♂, 1♀; 1 ♂ dissected, wings in poor condition; other

♂ without wings; ♀ in a good condition, abdomen has been removed and dissected, MZUSP).

DISTRIBUTION (Figure 36).—Brazil. São Paulo and Rio de Janeiro.

ETYMOLOGY.—The species epithet, *fasciatus*, is of Latin derivation and refers to the pale, subapical stripe or line in an otherwise mostly infusate wing.

REMARKS.—The holotype differs slightly from the other males of the type series in having the halter mostly yellow and hind tibia completely yellowish. This specimen, however, is in good condition, and no other differences were found to justify the description of a second species.

This species, although similar to *C. buenorum*, may be distinguished by the shape of the right surstylus (Figure 43), which is nearly as narrow as the left, not nearly quadrate, as in *C. buenorum* (Figure 38).

Cyamops neotropicus Hennig

FIGURES 29, 36, 44–59

Cyamops neotropicus Hennig, 1969:612.

DESCRIPTION.—Length of ♂ 1.85 mm; wing length 2.20 mm; wing width 0.80 mm.

Head (Figures 44–50): Ocellar tubercle and frons subshiny microtomentose; antenna with dorsal $\frac{1}{2}$ and apex of 1st flagellomere mostly black; facial region completely yellowish, sparsely microtomentose medially, genal region darkened posteriorly; face shallowly and vertically arched, not angulate; facial carina narrow, slightly widened below; eye bearing sparse interfacetal setulae. Chaetotaxy: Inner fronto-orbital setae nearly parallel to slightly divergent; fronto-orbits setulose; arista with 10 dorsal/3 ventral rays, not clearly bifurcate; peristomal setae about 5.

Thorax (Figures 52–56): Halter mostly white, brown at base; mesonotum slightly longer than wide; scutellum trapeziform, disc flattened. Chaetotaxy: Dorsocentral setae 0+1, subequal in length to the 1st scutellar setae; mesonotal setulae not well developed; scutellar setae 2, the basal pair about $\frac{1}{2}$ the length of the apical; anepisternum setulose posteriorly. Legs: Mostly yellow; fore femur infusate along anterior margin; mid coxa at basal $\frac{1}{2}$ and hind coxa light brown to brown; mid and hind femora brown at apical $\frac{3}{4}$; apical and sometimes subapical tarsomeres of each leg brown; spine-like setulae 7–8,

well differentiated, black. Wing (Figure 29): Mostly hyaline but with distinct brown pattern; central, irregular, transverse stripe comparatively narrow, not connected with apical stripe anteriorly; with small brown spot over apex of vein R_1 ; costal vein ratio I: 1.2 (slide-mounted wing); costal vein ratio II: 3.17, wing ratio: 2.45 (wings somewhat folded).

Abdomen (Figures 57–59): Male 7th tergite as long as 6th, both tergites lacking setae; sternites 6–7 with posterior process an evenly rounded, somewhat shallow, median extension. Male terminalia as follows (Figure 58): Epandrium polished; right surstylus large, about as wide as long, apical margin convoluted, irregular; left surstylus narrow, gradually tapered to point, length slightly longer than right; hypandrial projection apparently absent; ejaculatory apodeme (Figure 59) moderately large, almost equal to combined length of 5th, 6th, and 7th tergites, in lateral view hatchet-shaped, extended process parallel sided, in dorsal view somewhat teardrop shaped with basal margin truncate and apical margin with nipple-like extension.

TYPE MATERIAL.—The holotype female, which is apparently in poor condition, was not examined, and its study was not felt to be critical as its abdomen, according to Hennig (1969:612), is damaged. The head and wing are illustrated (Hennig, 1969:611), and the locality data are as follows: PERU. Cuzco. Quince Mil (700 m), 15–30 X 1962, L. Peña. The holotype is deposited in the CNC (9932). Hennig was unsure as to the sex of the holotype because the abdomen is damaged. The wide face, as illustrated, is characteristic of females, which is likely to be the gender of the holotype.

OTHER SPECIMENS EXAMINED.—**BRAZIL**. São Paulo. São Paulo, Jardim Botânico, 11 Feb 1992, A. and R. Baptista (1♂; MZUSP).

COSTA RICA. San José, Zurqui de Moravia (10°03'N, 84°01'W, 1600 m, Malaise trap), May 1992, P. Hanson (1♀; USNM).

DISTRIBUTION (Figure 36).—Neotropical. Brazil (São Paulo), Costa Rica (San José), and Peru (Cuzco).

REMARKS.—This species, like *C. colombianus* and *C. americus*, has at least one seta along the posterior margin of the anepisternum. It differs from either of these, however, by the pattern of the wing, especially cell r_{4+5} that has a conspicuous, undivided, subapical white spot (cell r_{4+5} mostly infusate in *C. americus*).

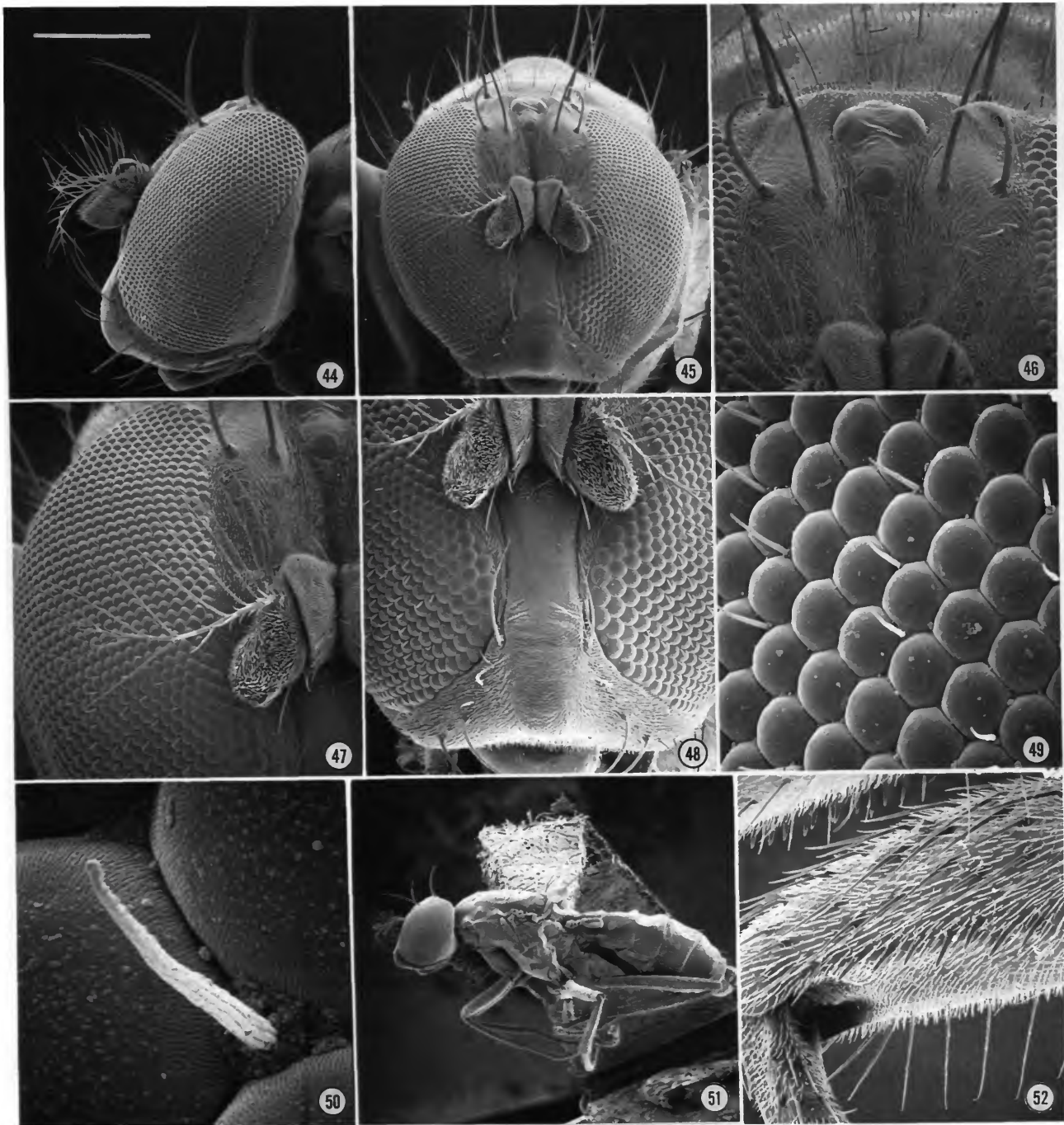

FIGURES 44–52.—Scanning electron micrographs of *Cyamops neotropicus* (♀, Costa Rica. San José: Zurqui de Moravia (10°03'N, 84°01'W, 1600 m, Malaise trap), May 1992, P. Hanson; scale length in parenthesis; scale for all photographs = Figure 4): 44, head, lateral aspect (250 μm); 45, same, anterior aspect (250 μm); 46, frons, anterodorsal aspect (100 μm); 47, right antenna, anterior aspect (120 μm); 48, face, anterior aspect (136 μm); 49, eye facets and interfacetal setae of left eye, lateral aspect (24.8 μm); 50, close up of interfacetal seta of left eye, lateral aspect (4.3 μm); 51, habitus, lateral aspect (0.86 mm); 52, apex of right femur, anteroventral aspect (60 μm).

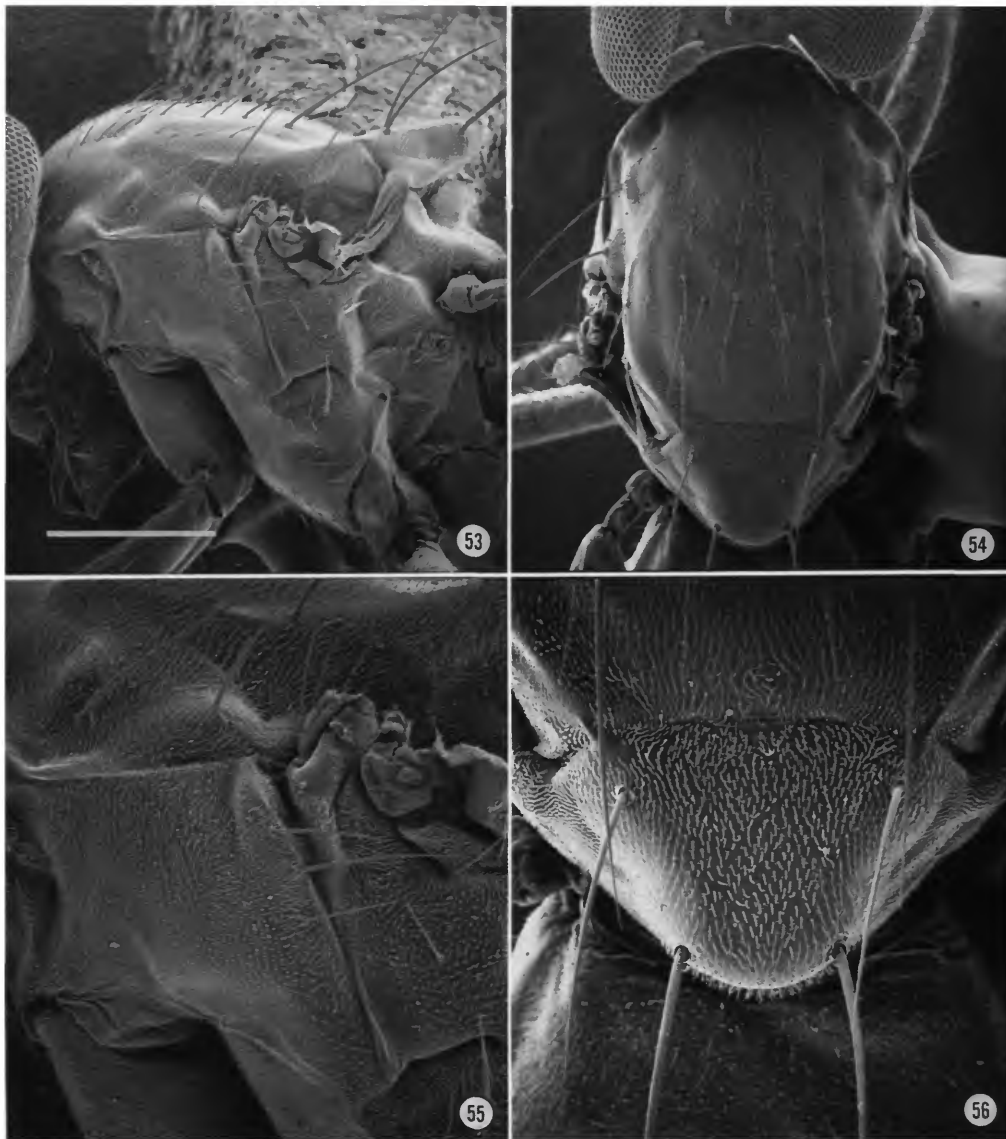

FIGURES 53–56.—Scanning electron micrographs of *Cyamops neotropicus* (♀, Costa Rica. San José: Zurqui de Moravia (10°03'N, 84°01'W, 1600 m, Malaise trap), May 1992, P. Hanson; scale length in parenthesis; scale for all photographs = Figure 53): 53, thorax, lateral aspect (0.30 mm); 54, mesonotum, dorsal aspect (0.33 mm); 55, notopleuron and anepisternum, lateral aspect (150 μ m); 56, scutellum, dorsal aspect (150 μ m).

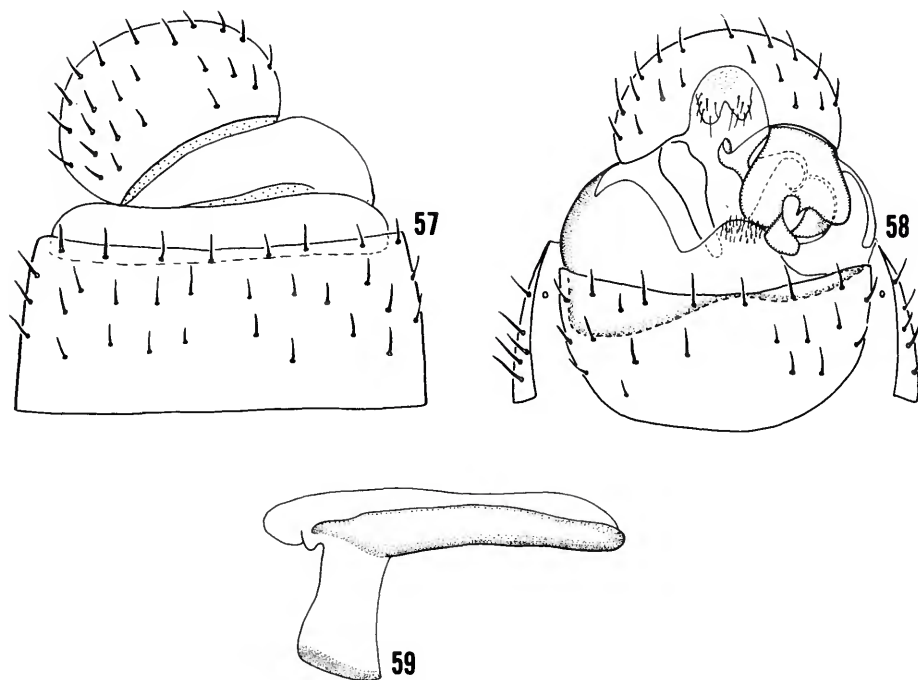

FIGURES 57-59.—*Cyamops neotropicus*: 57, male tergites 5-7 and epandrium, dorsal aspect; 58, male abdominal segments 5-7 and epandrium, ventral aspect; 59, ejaculatory apodeme, lateral aspect.

Literature Cited

- Brues, C.T., and A.L. Melander
 1932. Classification of Insects: A Key to the Known Families of Insects and Other Terrestrial Arthropods. *Bulletin of the Museum of Comparative Zoology*, 63:1-672, 1121 figures.
- Brues, C.T., A.L. Melander, and F.M. Carpenter
 1954. Classification of Insects; Keys to the Living and Extinct Families of Insects, and to the Living Families of Other Terrestrial Arthropods. *Bulletin of the Museum of Comparative Zoology*, 108:1-917, 1214 figures.
- Curran, C.H.
 1934. *The Families and Genera of North American Diptera*. 512 pages, 235 figures, 2 plates. New York: The Ballou Press.
- Farris, J.S.
 1988. Hennig86, version 1.5. New York: Port Jefferson Station.
- Freidberg, A.
 1994. *Nemula*, a New Genus of Neminidae (Diptera) from Madagascar. *Proceedings of the Entomological Society of Washington*, 96(3): 471-482, 20 figures.
- Griffiths, G.C.D.
 1972. The Phylogenetic Classification of Diptera Cyclorrhapha, with Special Reference to the Structure of the Male Postabdomen. In E. Schimitschek, editor, *Series Entomologica*, 8: 340 pages, 154 figures, 2 plates. The Hague: Dr. W. Junk.
- Grimaldi, D.A., and W.N. Mathis
 1993. Fossil Periscelididae (Diptera). *Proceedings of the Entomological Society of Washington*, 95(3):383-403, 17 figures.
- Hendel, F.
 1916. Beiträge zur Systematik der Acalyptraten Musciden (Dipt.). *Entomologische Mitteilungen*, 5(9/12):294-299.
- Hennig, W.
 1958. Die Familien der Diptera Schizophora und ihre phylogenetischen Verwandtschaftsbeziehungen. *Beiträge zur Entomologie*, 8(5/6): 505-688, 365 figures.
 1969. Neue Gattungen und Arten der Acalyptratae. *The Canadian Entomologist*, 101(6):589-633, 72 figures.
 1971. Neue Untersuchungen über die Familien der Diptera Schizophora (Diptera: Cyclorrhapha). *Stuttgarter Beiträge zur Naturkunde*, 226:1-76, 108 figures.
- Khoo, K.C.
 1985. The Australian Species of *Cyamops* Melander (Diptera: Periscelididae). *Australian Journal of Zoology*, 32(1984)(2):527-536, 15 figures.
- Khoo, K.C., and C.W. Sabrosky
 1989. 75, Family Stenomericidae. In N.L. Evenhuis, editor, *Catalog of the Diptera of the Australasian and Oceanian Regions*, 86: page 551. Honolulu: E.J. Brill and B.P. Bishop Museum special publication.
- Mathis, W.N.
 1993. A New Species and Subgenus of *Periscelis* Loew from Australia (Diptera: Periscelididae). *Journal of the Australian Entomological Society*, 32:13-19, 4 figures.
- Mathis, W.N., and L. Papp
 1992. A New Genus of Periscelididae (Diptera) from the Neotropics. *Proceedings of the Biological Society of Washington*, 105(2):366-372, 5 figures.
- McAlpine, D.K.
 1978. Description and Biology of a New Genus of Flies Related to *Anthoclusia* and Representing a New Family (Diptera, Schizophora, Neurochaetidae). *Annals of the Natal Museum*, 23(2):273-295, 28 figures.
 1983. A New Subfamily of Aulacigastridae (Diptera: Schizophora), with a Discussion of Aulacigastrid Classification. *Australian Journal of Zoology*, 31:55-78, 30 figures, 2 tables.
- McAlpine, J.F.
 1981. Morphology and Terminology—Adults. In J.F. McAlpine et al., editors, *Manual of Nearctic Diptera*, 1:9-63, 146 figures. Ottawa. [Volume 1 is Monograph 27 of Research Branch Agriculture Canada.]
 1989. Phylogeny and Classification of the Muscomorpha. In J.F. McAlpine et al., editors, *Manual of Nearctic Diptera*, 3:1397-1518, 10 figures. Ottawa. [Volume 3 is Monograph 32 of Research Branch Agriculture Canada.]
- Melander, A.L.
 1913. A Synopsis of the Dipterous Groups Agromyzinae, Milichiinae, Ochthiphilinae and Geomyzinae. *Journal of the New York Entomological Society*, 21(4):283-300.
- Oldenberg, L.
 1914. Beitrag zur Kenntnis der europäischen Drosophiliden (Dipt.). *Archiv für Naturgeschichte*, 80A(2):1-42.
- Papp, L.
 1984. Family Aulacigastridae. In A. Soós and L. Papp, editors, *Catalogue of Palearctic Diptera*, pages 60-61. Budapest: Elsevier Science Publishers and Akadémiai Kiadó, 10.
 1988. *Periscelis kabuli* sp.n. and *P. kaszabi* sp.n. with Notes on Larvae and Pupae of the Families Aulacigastridae and Periscelididae (Diptera). *Acta Zoologica Hungarica*, 34(2-3):273-284, 31 figures.
- Sabrosky, C.W.
 1958. New Species and Notes on North American Acalyptrate Diptera. *Entomological News*, 69:169-176.
 1965. Family Anthomyzidae. In A. Stone et al., editors, *A Catalog of the Diptera of America North of Mexico*, pages 810-820. Washington, D.C.: United States Department of Agriculture Handbook, 276: iv + 1696 pages.
 1980. 66, Family Aulacigastridae. In R.W. Crosskey, editor, *Catalogue of the Diptera of the Afrotropical Region*, pages 648-649. London: British Museum (Natural History).
 1983. A Synopsis of the World Species of *Desmometopa* Loew (Diptera, Milichiidae). *Contributions of the American Entomological Institute*, 19(8):1-69, 28 figures.
- Sturtevant, A.H.
 1954. Nearctic Flies of the Family Periscelidae (Diptera) and Certain Anthomyzidae Referred to the Family. *Proceedings of the United States National Museum*, 103:551-561.
- Teskey, H.J.
 1987. Aulacigastridae. In J.F. McAlpine et al., editors, *Manual of Nearctic Diptera*, 2:891-894, 6 figures. Ottawa. [Volume 2 is Monograph 28 of Research Branch Agriculture Canada.]
- Woodley, N.E.
 1982. Two New Species of *Neurochaeta* McAlpine (Diptera: Neurochaetidae), with Notes on Cladistic Relationships within the Genus. *Memoirs of the Entomological Society of Washington*, 10:211-218, 3 figures, 1 table.

REQUIREMENTS FOR SMITHSONIAN SERIES PUBLICATION

Manuscripts intended for series publication receive substantive review (conducted by their originating Smithsonian museums or offices) and are submitted to the Smithsonian Institution Press with Form SI-36, which must show the approval of the appropriate authority designated by the sponsoring organizational unit. Requests for special treatment—use of color, foldouts, case-bound covers, etc.—require, on the same form, the added approval of the sponsoring authority.

Review of manuscripts and art by the Press for requirements of series format and style, completeness and clarity of copy, and arrangement of all material, as outlined below, will govern, within the judgment of the Press, acceptance or rejection of manuscripts and art.

Copy must be prepared on typewriter or word processor, double-spaced, on one side of standard white bond paper (not erasable), with 1¹/₄" margins, submitted as ribbon copy (not carbon or xerox), in loose sheets (not stapled or bound), and accompanied by original art. Minimum acceptable length is 30 pages.

Front matter (preceding the text) should include: **title page** with only title and author and no other information; **abstract page** with author, title, series, etc., following the established format; **table of contents** with indents reflecting the hierarchy of heads in the paper; also, **foreword** and/or **preface**, if appropriate.

First page of text should carry the title and author at the top of the page; **second page** should have only the author's name and professional mailing address, to be used as an unnumbered footnote on the first page of printed text.

Center heads of whatever level should be typed with initial caps of major words, with extra space above and below the head, but no other preparation (such as all caps or underline, except for the underline necessary for generic and specific epithets). Run-in paragraph heads should use period/dashes or colons as necessary.

Tabulations within text (lists of data, often in parallel columns) can be typed on the text page where they occur, but they should not contain rules or numbered table captions.

Formal tables (numbered, with captions, boxheads, stubs, rules) should be submitted as carefully typed, double-spaced copy separate from the text; they will be typeset unless otherwise requested. If camera-copy use is anticipated, do not draw rules on manuscript copy.

Taxonomic keys in natural history papers should use the aligned-couplet form for zoology and may use the multi-level indent form for botany. If cross referencing is required between key and text, do not include page references within the key, but number the keyed-out taxa, using the same numbers with their corresponding heads in the text.

Synonymy in zoology must use the short form (taxon, author, year:page), with full reference at the end of the paper under "Literature Cited." For botany, the long form (taxon, author, abbreviated journal or book title, volume, page, year, with no reference in "Literature Cited") is optional.

Text-reference system (author, year:page used within the text, with full citation in "Literature Cited" at the end of the text) must be used in place of bibliographic footnotes in all Contributions Series and is strongly recommended in the Studies Series: "(Jones, 1910:122)" or "...Jones (1910:122)." If bibliographic footnotes are

required, use the short form (author, brief title, page) with the full citation in the bibliography.

Footnotes, when few in number, whether annotative or bibliographic, should be typed on separate sheets and inserted immediately after the text pages on which the references occur. Extensive notes must be gathered together and placed at the end of the text in a notes section.

Bibliography, depending upon use, is termed "Literature Cited," "References," or "Bibliography." Spell out titles of books, articles, journals, and monographic series. For book and article titles use sentence-style capitalization according to the rules of the language employed (exception: capitalize all major words in English). For journal and series titles, capitalize the initial word and all subsequent words except articles, conjunctions, and prepositions. Transliterate languages that use a non-Roman alphabet according to the Library of Congress system. Underline (for italics) titles of journals and series and titles of books that are not part of a series. Use the parentheses/colon system for volume (number):pagination: "10(2):5-9." For alignment and arrangement of elements, follow the format of recent publications in the series for which the manuscript is intended. Guidelines for preparing bibliography may be secured from Series Section, SI Press.

Legends for illustrations must be submitted at the end of the manuscript, with as many legends typed, double-spaced, to a page as convenient.

Illustrations must be submitted as original art (not copies) accompanying, but separate from, the manuscript. Guidelines for preparing art may be secured from the Series Section, SI Press. All types of illustrations (photographs, line drawings, maps, etc.) may be intermixed throughout the printed text. They should be termed **Figures** and should be numbered consecutively as they will appear in the monograph. If several illustrations are treated as components of a single composite figure, they should be designated by lowercase italic letters on the illustration; also, in the legend and in text references the italic letters (underlined in copy) should be used: "Figure 9b." Illustrations that are intended to follow the printed text may be termed **Plates**, and any components should be similarly lettered and referenced: "Plate 9b." Keys to any symbols within an illustration should appear on the art rather than in the legend.

Some points of style: Do not use periods after such abbreviations as "mm, ft, USNM, NNE." Spell out numbers "one" through "nine" in expository text, but use digits in all other cases if possible. Use of the metric system of measurement is preferable; where use of the English system is unavoidable, supply metric equivalents in parentheses. Use the decimal system for precise measurements and relationships, common fractions for approximations. Use day/month/year sequence for dates: "9 April 1976." For months in tabular listings or data sections, use three-letter abbreviations with no periods: "Jan, Mar, Jun," etc. Omit space between initials of a personal name: "J.B. Jones."

Arrange and paginate sequentially every sheet of manuscript in the following order: (1) title page, (2) abstract, (3) contents, (4) foreword and/or preface, (5) text, (6) appendices, (7) notes section, (8) glossary, (9) bibliography, (10) legends, (11) tables. Index copy may be submitted at page proof stage, but plans for an index should be indicated when the manuscript is submitted.

