

COMPUTER GAMING WORLD

The #1 Computer Game Magazine

February 1994
Number 115



Simulations Issue

**Build Your Own Flight Sim
With Domark's Revolutionary
Flight Sim Toolkit**

**PLUS
SimCity 2000
IndyCar Racing
Aces Over Europe
F/A-18 Hornet
And More!**

The Empire Strikes Back
LucasArts' *Tie Fighter*

\$3.95 USA \$4.95 Canadian

02



0 29074 12158 9

Spear of Destiny

A Wolfenstein 3D Graphic Adventure

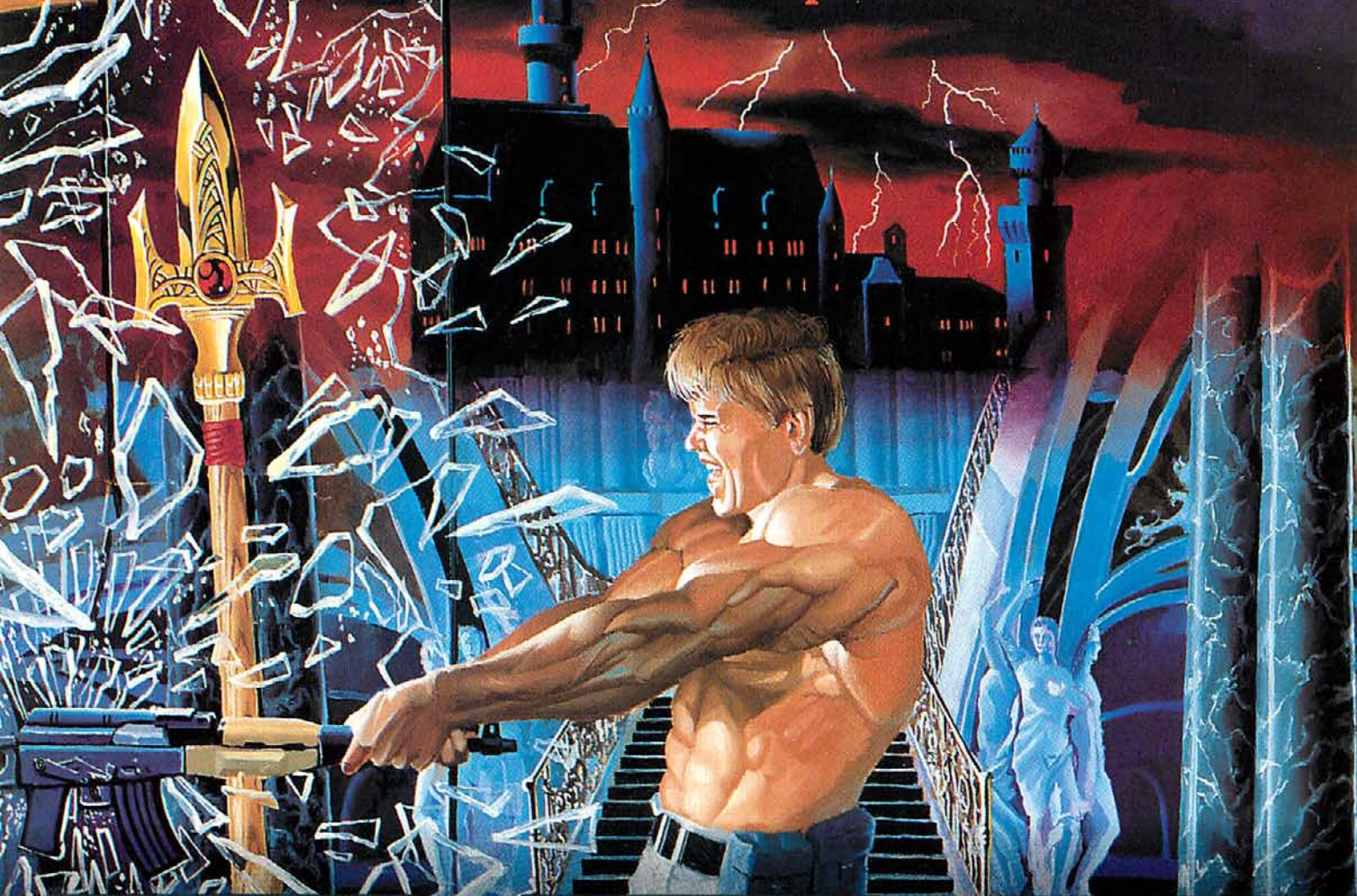

Virtual Reality!

Spear of Destiny brings virtual reality to the PC, hurling you into an intense battle between good and evil in which only you can save the world! A breathtaking musical soundtrack sets the mood, while amazing "first person" visual perspective and spectacular digital stereo sound effects give an experience like no other game you've ever played!

Features!

- ✘ spectacular VGA virtual reality system
- ✘ breathtaking musical soundtrack for Adlib, Sound Blaster
- ✘ digitized stereo sound effects for Sound Blaster, Sound Source
- ✘ over 20 complete floors to cover
- ✘ 4 levels of play difficulty
- ✘ special extra challenges for advanced game players
- ✘ saves multiple games in process

What the Reviewers Say!

- ✘ "the player is 'there' like no game I've ever played..."
- ✘ "the sound and the visual action, is frighteningly realistic..."
- ✘ "I can't remember a game making such effective use of perspective and sound and thereby evoking such intense physiological responses from its players."

DETROIT

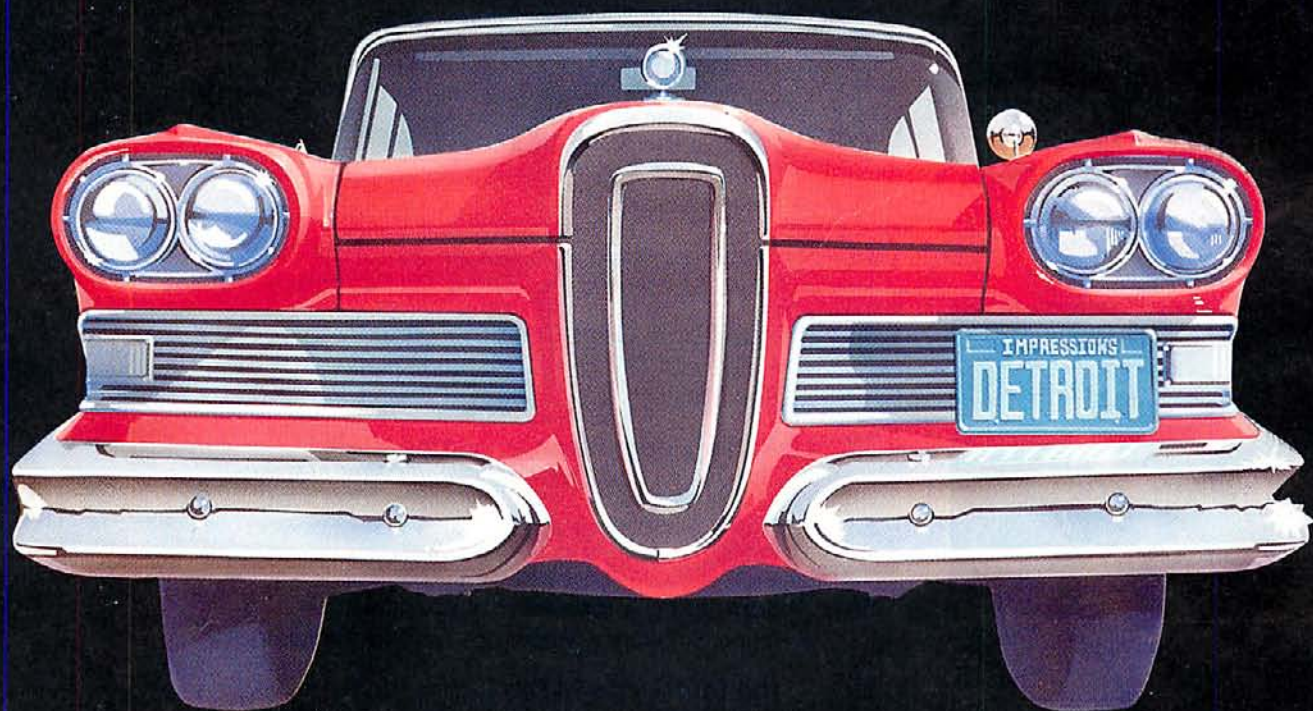

Can You Change Automotive History?

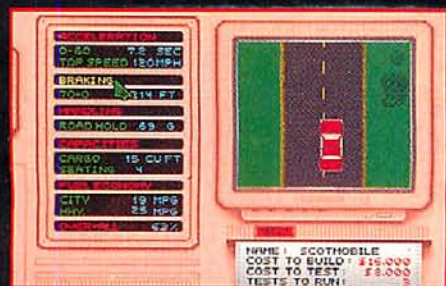

Design cars and put them through their paces with a variety of performance tests!



Create unique marketing campaigns to blow away the competition!



As your auto empire grows, open up new factories and sales offices around the world!

Impressions™

Committed to Excellence in Strategy Entertainment

Impressions Software, Inc. 222 Third Street, Suite 234, Cambridge MA 02142
 Circle Reader Service #72

COMPUTER GAMING WORLD



Tie Fighter pg. 20



Flight Sim Toolkit pg. 16

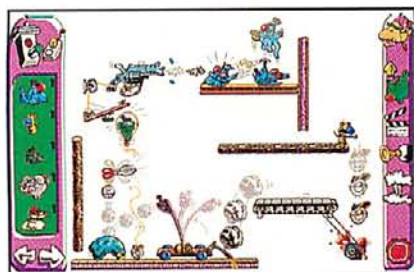

Sid & Al's Incredible Toons pg. 148



Rebel Assault pg. 176

FEATURES

- 14 **SIMULATIONS SECTION**
- 16 **Flight Sim Toolkit**
Bryan Walker Gets More Power From Domark's Latest
- 20 **Darth Vader Wants YOU!**
Chris Lombardi Takes A Walk On The Dark Side In *Tie Fighter*
- 24 **Aces Over Europe Heads For Home**
Tom Basham Reports Back On **Dynamix'** Latest
- 28 **The Keys To *SimCity 2000***
Johnny Wilson Visits *SimCity* After Its Urban Renewal
- 32 **The Learning Curve At 200 MPH**
Gordon Goble Takes The Pole In *IndyCar Racing*
- 42 **Feeling The Sting Of An F/A-18**
Christopher Breen Gets Carried Away On His Mac
- 46 **Jousting Jets In *Combat Air Patrol***
David Moore And Paul Rigby Fly **Psygnosis'** Fighters
- 50 **NovaLogic Goes Over The Edge**
A Flyby Of The New *Maximum Overkill* CD-ROM And Mission Disk
- 52 **Adding More Force To *X-Wing***
Jeff James Flies *Imperial Pursuit* With A *B-Wing*
- 54 **Pilots, Grab Your Joysticks!**
CGW Presents A Gripping Survey
- 68 **Something Bright: *Firefall* Arcade**
Inline Software's Macintosh Arcade Addiction
- 70 **The Tour Guide To The Digital Highway**
CGW's Editor Becomes An Interactive Charles Kuralt
- 74 **The Mutant Wars Of *Unnatural Selection***
Randall Black Explores **Maxis'** Jurassic Phase
- 82 **Aristocratic Appeal In *The Patrician***
Tim Carter Learns Some Merchant Manners
- 86 ***Sam & Max Hit The Road***
Charles Arday Reviews **LucasArts'** *Tour de Farce*
- 92 **Thick As A Brix**
Allen L. Greenberg Builds On **MicroLeague's** Puzzler
- 94 **Star Gazing: Big Time!**
Martin Cirulis Surveys The Year In Space War



About The Cover—Bay Area freelance artist Ocean Quigley conspired with art director Terry Soohoo to blow up this X-wing for LucasArts. Quigley airbrushed stars, nebulae and the explosion on a stock star background. Darth's image came from a photo promoting the original *Star Wars* motion picture. LucasArts artists supplied wire-frame objects for the ships, which Quigley then light-sourced and rendered in *3D Studio* on his 486-66. He then composed all the elements using *Adobe Photoshop*.

ARE YOU READY TO EXPERIENCE THE ULTIMATE IN SQUAD-LEVEL SPACE COMBAT?

The sequel to the immensely popular *Breach 2*, *Breach 3* puts you in command as Squad Leader of the Federated Worlds. Do you have what it takes to command your marines in dangerous missions against destructive enemy forces?

All new features in *Breach 3* include a unique combination of turn-based and real-time play; individual personalities for each marine; stunning 256-color VGA graphics; tree-structured campaigns containing up to 511 scenarios; support for all major sound cards; and modular terrain, objects and opponents.

The fate of the Federated Worlds is in your hands...

BREACH 3



Choose from exciting missions or use the scenario builder to create your own!



Watch marines carry out your orders according to their own unique personalities!



Stop the graphically stunning combat at any time to change your orders!



Impressions



The latest module in Omnitrend's Interlocking Game System. *Breach 3* allows you to interconnect with *Breach 2* and *Impressions' Rules of Engagement 2!*

Committed to Excellence in Strategy Entertainment

COMPUTER GAMING WORLD

Publisher
Russell Sipe
Associate Publisher
Jonathan Lane
Editor-in-Chief
Johnny Wilson
Editor
Chris Lombardi
On-Line Editor
Alan Emrich
Managing Editor
Ken Brown
Technical Editor
Mike Weksler
Assistant Editors
Chuck Miller
Terry Coleman
Art Director
Susan Zurawik
Graphic Artist
Jack Rodrigues
Production Assistant
Christine Kloss
M.I.S. Manager
Gene Allen
Advertising Manager
Lee J. Uniacke
Advertising Sales Coordinator
Kathy Garcia
Contributing Editor
(Adventure Games)
Scorpia
Contributing Editor
(Wargames)
Evan Brooks

Contents are copyrighted by Ziff-Davis Publishing Co., 1994.

Subscription Rate: The subscription rate is \$27.94 for a one year subscription (12 issues). Canada and all other countries add \$11.00 for postage. Airmail subscriptions are \$78.00 per year. Canadian GST registration number is R123669673. Payment must be in U.S. dollars made by check or money order drawn upon a U.S. bank. Visa, MasterCard, AMEX accepted.

Subscription Services: For subscription service questions, address changes or ordering information, call toll free (800) 827-4450 within the U.S. and Canada. All other countries call (303) 446-9330 or fax to (303) 443-5080 (international subscribers only) or write to Computer Gaming World, P.O. Box 57167, Boulder, CO 80322-7167.

Back Issues: For back issues (subject to availability), \$6.00 per issue (\$8.00 outside the U.S.), send check, money order or credit card information to Back Issues Dept., Ziff-Davis Publishing Co., P.O. Box 53131, Boulder, CO 80322-3131.

Psalms 9:1-2

CompuServe (76703.622)

America On-Line: CGW

Prodigy: EXPT40B

GEInet: CGW

Internet: 76703.622@compuserve.com

Telephone: (714) 283-3000

Fax: (714) 283-3444

For advertising information only, call:

Lee J. Uniacke

(714) 283-3000 x41

Printed in the U.S.A.

- 110 **Hard Vacuum**
Merit Software's *Command Adventures: Starship*
- 120 **A Tart And Battery**
Charles Ar dai Slips Into *Metal & Lace*
- 124 **QQP's Lucky's Casino Adventure**
When You're Odd, The Odds Are With You
- 138 **The Verdict On Psygnosis: Innocent Until Caught**
Charles Ar dai Skirts The Law To Pay The Taxman
- 144 **Role-Playing In A Box**
Bernie Yee Opens **ImagiNation's** *Yserbius And Twinion*
- 148 **Sid & Al's Incredible Toons**
Dynamix' Cartoon Construction Kit Sends Neil Harris To The Looney Bin
- 152 **The Hand of Fate Takes Hold Of Scorpia**
Westwood's Latest Outreach Attempt
- 156 **Sex And The Single Adventurer**
Taking Lessons From *Leisure Suit Larry 6*
- 162 **Kids & Computers Software Reviews**
Brain Food For Growing Minds
- 176 **Rebel Assault Strikes Back On CD-ROM**
Paul Schuytema Paints **LucasArts** An Arcade Picture
- 180 **Dripping Onto The Bloodnet**
Doug Seacat Puts The Byte On *CyberGothic Noir*
- 186 **Expanding Your Fantasy Empires**
Sage Advice From King H. E. Dille



COMPUTER WARGAMING WORLD

- 194 **No Ejection Necessary: Flight Commander**
Alan Emrich Straps In For This Strategic Air Combat Game
- 200 **Scaling The Walls of Rome**
A Steep Climb For H.E. Dille
- 206 **Global Domination, Anyone?**
Chuck Moss The Conqueror Gives His Impressions

DEPARTMENTS

- | | | | |
|-----|--|-----|---------------------------------------|
| 8 | Editorial (<i>Mea Culpas</i> and Culpability) | 210 | Opponents Wanted |
| 10 | READ.ME (News) | 211 | Advertiser's Index |
| 62 | Scorpia's View (<i>Dungeon Hack</i>) | 212 | Taking A Peek |
| 66 | Scorpion's Mail | 221 | Hall of Fame |
| 114 | Letters From Paradise | 222 | Top 100 Games |
| 130 | Shareware Reviews | 224 | What's Hot? |
| 134 | Over There (European Software Report) | 225 | Patch File |
| 192 | CWW Editorial (Wargaming The Data Highway) | 226 | The Rumor Bag (<i>Baggus Pipus</i>) |

Computer Gaming World (ISSN 0744-6667) is published monthly by Ziff-Davis Publishing Company, a division of Ziff Communications Co., 130 Chaparral Ct, Suite 260, Anaheim Hills, CA 92808. Second-class postage paid at Erlanger, KY 41011 and additional mailing offices. Permit #672-910.
Postmaster: Send address changes to *Computer Gaming World*, P.O. Box 57167, Boulder, CO 8032

**WHEN
THINGS
GET UGLY
ON THE
OTHER
SIDE OF
THE SCREEN...**

**...YOU'D
BETTER
HAVE A
FALCON
ON YOUR
SIDE.**

If you need the fastest performance for your gaming, personal, or business application, you need to fly a Falcon!

**To Order Call:
1-800-258-6778**

VISA & MasterCard Accepted
Financing Available

FALCON NORTHWEST

COMPUTER SYSTEMS

663 South Bayshore Drive, Coos Bay, Oregon 97420

The Falcon MACH V: The Ultimate Gaming Machine

Intel™ 486 DX-2/66 Processor
VESA Local Bus Graphics
VESA Local Bus Hard Drive Transfer
4 Megabytes of RAM
1.2 & 1.44 Floppy Drives
250 Megabyte 12 ms Hard Drive
MPC™ Compliant 350 ms CD ROM Drive
SoundBlaster Deluxe™ & Multimedia Speakers
CH Flightstick PRO™ and High Speed Gameport
Mini-Tower Case
14" Super VGA Monitor, 28dp
101 Key Keyboard, MS-DOS 6.0™ Mouse
Upgrades are available!

**40+ VGA Frames Per Second
Serious Hardware
For
Serious Players.**

**The MACH V
Is Complete
Including Shipping
For Only
\$2,499**



MACH V with optional 15" monitor shown

Mea Culpas And Culpability

by Johnny L. Wilson

State of the Industry: As we go to press, Senators Lieberman and Kohl have held hearings on Capitol Hill and warned the video game industry to create a viable and consistent ratings system or be ready to have the government intervene. The issue was even hot enough to interest "Good Morning America" to host yours truly as an in-studio guest to discuss the issue. For the record, *CGW* called for voluntary ratings on video and computer games in 1990. Our position was that games with profane language, excessive violence, sexual situations (or nudity, near-nudity) and possibly, occult practices be marked with an L, V, S (or N) and O. We have since modified that system to state that there could be age gradings and combination ratings, so that the equivalent of an R rated movie might be rated LVS-17.

Once such a rating system becomes standard, it will allow purchasers and parents alike to decide for themselves if there was a potential problem with a given game. How is this different (and hopefully, preferable) to the existing rating scheme introduced by Sega or suggestions that the industry create a ratings system similar to the film industry? First of all, it is different from both existing systems in that it provides actual information at a glance rather than a generic warning. An R rating for a film doesn't tell one if it earned said rating because of offensive language or frontal female nudity. The same is true of ratings that simply state that a product is for "Mature Audiences Only."

Further, we do not mean to advocate the establishment of an independent panel to review every game product according to an inflexible set of guidelines. We would propose that software publishers (on whatever platform) adopt an informative labeling system (with labels to be printed on the packaging and displayed on the game's title screen) and that each publisher decide on the appropriate rating. Knowing full well that there could be abuses to the "honor system" of labeling, we suggest that an independent panel be named by the Software Publishers Association that could review the ratings for games that receive complaints from consumers or protests from competitors. In this way, marketing decisions would not have the final influence on all titles.

Finally, I would like to draw an analogy between the entertainment software industry and that of the comic book industry in the early 1950s. The comic book industry of the past was considered "primarily for kids"—just as the video and computer game industry of the present is perceived. Both the ghost of comics past and the spirit of industry present have resorted to violence and gore as a gimmick to sell product. Both the former and the latter have been accused of contributing to violence in our youth. Both the former and the latter have been the subject of U.S. Senate hearings.

In the case of the comic book industry, they were able to survive somewhat by appointing an independent commission to consider each comic against a common code of behavior. Artistic and narrative considerations no longer held relevance. Indeed, many comics publishers opted to get out of the business entirely, rather than be perceived as part of a negative influence upon society. As a result, the comic industry became somewhat stultified in its treatment of the human condition.

We do not want to see a repeat of the "Comics Code" solution in computer and video games. We believe that the voluntary ratings system we have proposed would allow for continued artistic freedom in the world of computer and video games.



State of the Magazine: Remember this beautiful illustration from our console game article in *CGW* #114? The credit for the illustration was deleted at our printer. This was particularly disconcerting to me as editor because it was painted at Continuity Studios, the current home of legendary comic illustrator Neal Adams. Adams has always been one of my favorite artists in the comic book genre and it was with particular pride that we published this illustration.

CGW #114 seemed to be our prime issue for growing pains. A problem with an electronically transmitted file caused one page out of an article on Domark's *SVGA Harrier* to be printed in black and white. Most embarrassing, however, was the inadvertent publishing of a rumor based on confidential information. Industry insiders are very much aware of how *CGW*'s staff prides itself upon the discretion with which we handle "off the record" and "deep background" information. Unfortunately, a staff member tumbled to the knowledge of the formation of Excalibur Games and passed it along to the Rumor Guy without letting old baghead know that one of the principals in the new company had not yet given notice to his former employer. Rumor Guy had heard from a different source that the move was taking place and printed it without realizing that he was printing confidential material. He sincerely apologizes for embarrassment and inconvenience caused by his overzealous publication of the news.

On another note, I wish to offer a public apology to Ed Fletcher and Doug Whatley of MicroProse. In a recent review of *Coaches Club Football*, I allowed Wallace Poulter's assertion that the AI cheats to go unchallenged. It is a well-known fact that many AIs "cheat" (or, at least, "fudge") in order to be able to keep up with human players. For example, Dani Buntzen was once asked how to play-balance a game. Her one word answer was "Cheat." Asked what to do if the gamers complained, she said, "Lie!" The answer elucidated considerable laughter, since such a tactic is a more common way to beef up an AI than most designers admit. So, when I saw that Poulter accused Coaches Club of "cheat"ing, it provoked a "So what's new?" reaction in my mind.

Whatley and Fletcher were horrified at this allegation, however, rightly asserting that a computer football game is *not* a real game if the artificial opponent doesn't have to "guess" what the human opponent is calling. Doug and Ed care far too much about computer games in general and football in specific to settle for such an easy (and in their view, irresponsible) approach to the AI.

CGW

BUY THE BEST OF '93*

And get the best of '91 & '92 **FREE**

*As Chosen by Computer Gaming World & PC Games

OVER
4.6
MILLION
SOLD

Wizardry® TRILOGY

WIZARDRY V, VI & VII

Winner of over 15 International Awards

WIZARDRY, the game that pioneered first-person perspective & defined computer role-playing for more than a decade. Now, the award-winning WIZARDRY V, VI & VII are available in 1 complete package, at 1 incredible price. Three best selling games, with over 500 hours of engaging, replayable adventure, come to you with a savings of 25% off individual suggested retail prices.

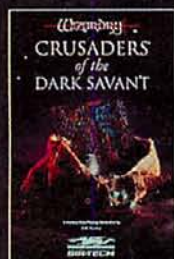

CRUSADERS OF THE DARK SAVANT
REDEFINING ROLE-PLAYING FOR AN ENTIRE INDUSTRY
1993 **ROLE-PLAYING GAME OF THE YEAR**
COMPUTER GAMING WORLD
1992 Fantasy Role-Playing Game of the Year
PC Games
1992 Role-Playing Game of the Year
Strategy Plus Magazine



BANE OF THE COSMIC FORGE
PAVING THE WAY FOR THE SYSTEMS OF THE FUTURE
1991 Best Game of the Year
Strategy Plus Magazine
1991 Best Role-Playing Game of the Year
Strategy Plus Magazine
1991 Top Role-Playing Game, April 1991
Computer Gaming World



THE LEGACY OF HEART OF THE MAELSTROM
BREAKING AWAY FROM THE WIZARDRY SYSTEM OF THE PAST



Ogdensburg Business Center, P.O. Box 245
Ogdensburg, NY 13669 (315) 393-6633
FAX# (315) 393-1525

THE WIZARDRY TRILOGY

Scenarios I, II & III

The original classics that set the trend in fantasy role-playing are now available at a new low price!

Available at a software retailer near you, or call:
(800) 447-1230

READ.ME

THE LATEST NEWS FROM THE GAMING WORLD

Sim Fans—Welcome To The Next Level

ARTIST Graphics' 3GA Chip Feeds The Need For 3D Speed

ARTIST Graphics, a Minneapolis-based hardware manufacturer, has announced a new graphics chip that may transform your work-a-day PC into a high-performance graphics workstation.

Consider the current state of the art: *IndyCar Racing*, Papyrus' hot new game creates a very intense environment for simulated racing action. To do so, it pushes current technology to produce 12,000 flat shaded or 2,000 texture-mapped polygons per second. But imagine how much richer, how much more intense, a simulation could be if it could process 12 million flat-shaded, or 30,000 texture-mapped polygons per second at a higher screen resolution than standard VGA. While this might sound as far off as Gibsonian cyberspace, ARTIST Graphics and their 3GA video processing chips may well make such simulations a very real possibility in '94.

ARTIST Graphics has been a manufacturer of graphics hardware used primarily for Computer Aided Design since 1982. Their chips and video boards are used widely by CAD professionals for applications that need heavy graphics horsepower. Adapting ARTIST Graphics' latest high-end graphics technology to the PC games market is largely the result of a conversation that took place in 1992 between Chris Taylor, senior software engineer at Electronic Arts, and Theodore Beale, "trans-dimensional evangelist" at ARTIST Graphics.

"Chris had called to find out about VESA support on some of our cards," said Beale. "We got to



talking games, and I swapped him a graphics board in return for a couple of EA games. After playing with it for a few weeks, he suggested that we add a few features to our next generation chip that would make it a really killer device for 3D simulators and action games. I went back to our engineers and asked them about adding the features, and lo and behold, the 3GA."

According to ARTIST, the chip is capable of displaying up to 12 million flat-shaded, two-hundred thousand Gouraud-shaded, or thirty-thousand texture-mapped polygons per second in a game. These numbers approach RISC-based graphic workstation performance. Simulated benchmark tests have yielded 90 million WinMarks on the WinBench 3.11 test at

1280 x 1024 x 8 resolution on a 486/66 PCI bus machine (an average local-bus VGA video card at 640x480 yields 6 million WinMarks). Games could be written to run with the 3GA from within Windows, with the game's code written to effectively bypass the Windows' graphics routines. This would allow 3D intensive games to run under Windows without degradation of performance.

The 3GA chip's 64-bit wide local memory bus supports up to 4 megabytes of VRAM and up to 8 megabytes of DRAM. The memory allows a game to load a huge portion of a game's graphic data directly onto the card, thereby relieving the computer of a huge burden. Additionally, the 3GA chip has an on-chip VGA architecture which supports standard VGA text and graphics modes, and VESA SVGA modes up to 1024 x 768 resolution at 8 bits per pixel.

"With this kind of technology," says Fred Savage, director at Origin Systems, "the limitations of the VGA architecture are removed. Anything that allows us to reduce the load on the CPU is going to let us have a much larger scope for our PC-based games."

ARTIST Graphics is currently working on an OEM deal with a major video card manufacturer. For more information, contact ARTIST Graphics at (612) 631-7800.

Three-Sixty Pacific To Ink Pact With Broderbund

Tom Frisina, CEO of Three-Sixty Pacific, is relieved to report that rumors of the software company's demise are gravely exaggerated. "Everyone knows," the executive told CGW, "that we've been through some tough times. Many know that [the possibility of closing down the company] has been a very near thing." As of press time, Three-Sixty Pacific and Broderbund had reached an agreement in principle where the latter would provide a traditional distribution advance to the former in order to become the official distributor of Three-Sixty products.



The traditional distribution advance was proffered in order to assure the completion of Three-Sixty's *Harpoon II* (MS-DOS) and *Victory at Sea* (Macintosh). Both products have aroused great expectations among computer gamers in the wargaming niche, but wargame sales are not normally sufficient to excite distributors.

Broderbund's commitment to the Macintosh and MS-DOS platforms, however, make it possible for the company to have assurance that they can reach the optimal market for such niche products.

The distribution deal should bode well for Three-Sixty in the near future and Frisina indicated to CGW that the tentative distribution deal would make it possible to complete other computer wargame projects that have been hanging in the balance since the Fall of '93. According to the tentative agreement, Electronic Arts (Three-Sixty's former distributor) will retain its circa 20% interest in Three-Sixty and Broderbund will not claim any ownership percentage.

Crystal Dynamix Loves The Feel Of "Growing Pains" Kirk Cameron Stars In *The Horde*

Kirk Cameron, teen star of ABC's "Growing Pains," joins the growing number of TV and film actors with computer game credits. Cameron will play Chauncey, a young servant boy turned knight, in a wonderfully bizarre action/strategy game for 3DO, IBM DOS and IBM CD-ROM systems.

Cameron, along with Michael Gregory (*Total Recall*, *ROBOCOP*, and *The Lawnmower Man*) and Michael McCarty ("Sisters" and "Quantum Leap"), will be featured in live-action video footage interspersed between the game levels of *The Horde* from Crystal Dynamix.

The game play portions of *The Horde* are being developed by Games For Bob (Paul Reiche, Fred Ford and Ken Ford), a group known for high-intensity



action/strategy hybrids. *The Horde* is an odd mix of *SimCity*, *Populous*, and an action game. The player, as Chauncey, is challenged to raise up a thriving farming community in harsh condition, battling both the elements and The Horde. The Horde is a race of ravenous creatures that will scarf anything and everything in their path. Chauncey will have to terraform land for farming, and protect the land from waves of Hordlings by building defenses with moats, walls, archers, and several ingenious Hordling traps. Chauncey will also take sword in hand to hack at the Hordlings in fast action sequences. The animation is superb and the humor twisted—to mention the decent acting and quality set design.

Look for Cameron and *The Horde* in late February of 1994.

Gone, But Not Forgotten

Twin Dolphin Flounders, But *Forgotten Castle* May Resurface

In early December, Twin Dolphin Games officially ceased operation as an entertainment software publisher. The dream company, founded by former Atari controller Stephen Ruzsak and an anonymous investor, had intended to build upon the expertise of its product-oriented veterans (particularly Jim Jennings and Ken Humphries, successful producers at Strategic Simulations, Inc.) and its experienced management team (largely composed of former video game executives) in order to target the *Windows* game market and to capture the technological edge in

high-end DOS games.

The release of its first two *Windows* products, *Nanotank* and *Smokin' Guns*, failed to meet sufficient revenue expectations for continued funding of its very expensive, and much delayed, *Forgotten Castle* game engine. The engine is a 3-D first person perspective toolkit that offers several technological advancements in alias-

ing, texture-mapping and special effects. *Forgotten Castle* itself was designed to be a centerpiece CRPG using the engine. According to Ruzsak, the code and rights to *Forgotten Castle* are currently for sale on an "as is" basis. CGW has received several reports of companies looking at the product, but no word on an official purchase has been released. **CGW**

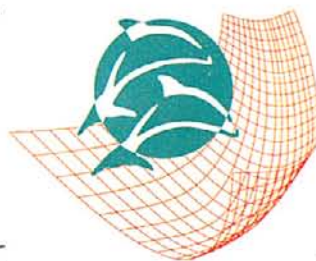

"The best simulator
I've ever seen!"
Rick Zalud, Computer
Game Review

"Makes the term 'virtual'
redundant!"
Dave Moskowitz, Video Games
and Computer Entertainment

"Sets a totally new standard for
helicopter simulations!"
Annie Katz, Electronic Games

"Redefines the state-of-the-art in
computer simulation graphics!"
Computer Gaming World

TEAR INTO A NEW REALITY!

BEYOND THE EDGE OF THE ENVELOPE

COMANCHE™

From NovaLogic™, the creators
of WOLFPACK™

COMANCHE™ MAXIMUM OVERKILL™ is the promise of 3-D simulation action come true! You command the ultimate in 21st Century Attack Helicopters - the Boeing Sikorsky RAH-66 Comanche, not just over, but in and around ultra-realistic 3-D terrain. Can it be true? Absolutely! Thanks to NovaLogic's radical new simulation environment VOXEL SPACE™, which produces graphics 500 times more detailed than any of those tired old polygon graphic games. You'll dive from mountain peaks, dart through winding canyons, and roar through pulse-pounding combat in stunning cloud-filled skies.

So get ready for awesome graphics, unprecedented speed, and sweat-dripping, teeth-clenching, white-knuckle excitement unlike anything you've ever experienced on a personal computer. Tear out to your nearest software dealer and tear into a new reality!

- Smoothest, richest terrain graphics ever seen in a real-time simulator
- First simulator with real-time controls of RAH-66 Comanche
- Unsurpassed speed and maneuverability
- Real-time fly-bys through actual terrain data
- One-minute learning curve
- Superb musical score and sound

CREATED BY



ACTUAL SCREENSHOTS

For the IBM-PC 386 SX or greater, 388/486, 32 bit mode game with 4 megabytes of linear addressed power!
Wolfpack, Comanche, Maximum Overkill, VOXEL SPACE, NovaLogic, and the NovaLogic logo are trademarks of NovaLogic, Inc.,
19510 Ventura Blvd., Ste. 200, Tarzana, CA 91356 © 1992 by NovaLogic, Inc. All Rights Reserved.

Circle Reader Service #103

MAX
MUM
OVERKILL™

WOLF PACK™

Now on CD-ROM!

Since its release, WolfPack™ has set a new standard for submarine simulations. Winner of Tilt Magazine's Tilt D'Or award for best simulation, it has consistently topped the best seller charts, earning raves from the reviewing community:

"WolfPack can only be classified as a genre buster, one of those rare games that sets a new standard for other releases in the same field to live or die by."

Video Games & Computer Entertainment

"The graphics for WolfPack are stunning."
Wargamer

Now WolfPack is available on PC CD-ROM. The same compelling game play of the floppy version allows you to command either a WW2 submarine wolf pack or the surface fleet.

Historically accurate, your weapons and instruments are precisely keyed to the war year that you choose to play. A full construction set is included to allow you to re-create actual battles.

WolfPack CD-ROM also includes:

- 58 new missions, 70 total.
- Over 5 minutes of breathtaking animation sequences.

Pick up a copy at your local software store and find out what underwater warfare is all about.



Actual screen images.

From
NovaLogic™,
the creators of
Comanche™
Maximum Overkill™
and Ultrabots™.

NOVA™

LOGIC

Those Magnificent Sims And Our

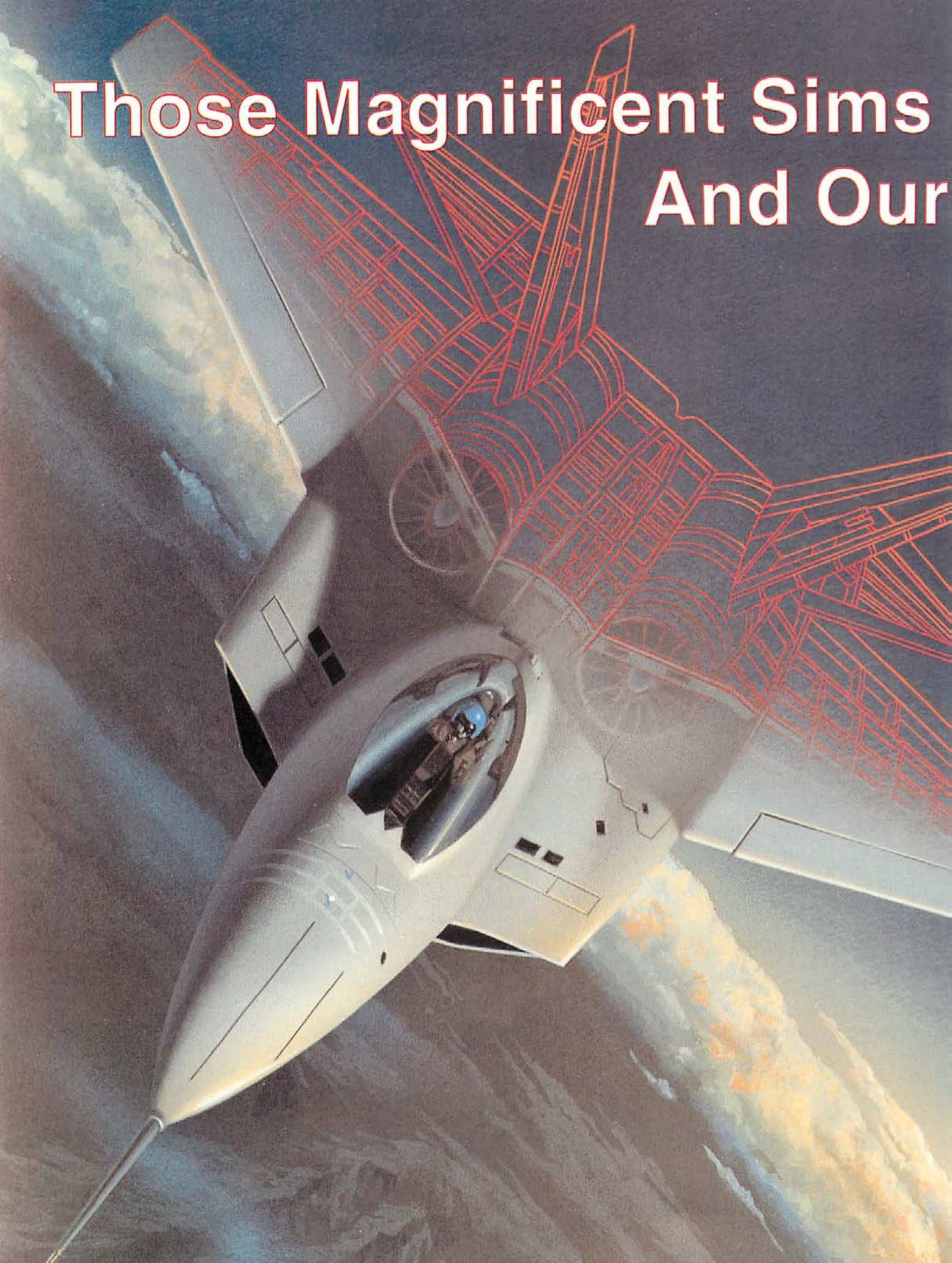

Computing Machines

From the earliest days of computer gaming, designers have done their best to create gaming experiences beyond what could be accomplished with game boards, dice, spinners, cards and booklets. Wargame designers tried various ways of providing limited intelligence, and role-playing designers gravitated toward graphic portrayals of encounters that had previously been limited to lead miniatures and cardboard counters on the tabletop. Yet, the true breakthrough for gamers came when computer games could put them in the seat of a vehicle and allow them to fly or drive from a first-person three-dimensional perspective.

The first flight simulators used wire-frame graphics to depict their worlds. These awkward and empty shapes were all that the limited 8-bit machines were capable of. Veteran designer Damon Slye remembers showing the 8-bit version of *Stellar 7* to his family and discovering that they couldn't figure out what those shapes were that he kept calling tanks. Here he thought he had performed a programming coup, and he discovered that people didn't get it. Apparently, best-selling author Tom Clancy got it. He reminded *CGW* of the glories of the wire-framed *Stellar 7* in a 1988 interview.

Then, someone decided to create images out of polygons. The same basic calculations required to draw lines on the screen could be used to draw shapes which, with a little extra computing power, could be filled with colors. Now, the vehicles were blocky shapes with unrealistic colors, but would-be pilots and drivers could tell what kinds of vehicles were being simulated. By the late 1980s, MicroProse, Dynamix and Spectrum HoloByte were pushing the edge of the envelope for polygon-based technology.

Of course, the state-of-the-art cannot remain the state-of-the-art for very long in a fast-moving technological world, so along came a hybrid piece of software that lurked in limbo somewhere between a pure action game and a simulation. That mighty mutant was *Wing Commander*, and it raised the ante for polygon-

filled graphics again. Although the ships that were flown were basically polygon-filled vehicles with bit-mapped overlays, the graphic result was spectacular. Unfortunately for gamers with older machines (of 286 vintage), this necessitated more processing power than ever before.

Successive releases like *Strike Commander* and *Aces Over Europe* have expanded the detail on the texture maps that cover the blocky polygon shapes and, once again, the technological ante has been upped. Now, gamers need 486s to drive the latest and greatest simulators, whether the vehicles are on land, sea or air.

Will the drive toward more and more processing power ever stop? Not likely. As long as gamers demand more realism of their simulations, designers will be trying to fill that demand, pushing the envelope of technology, our hobby, and computing in general.

This issue, we cover a revolutionary product that allows you to design your own commercial level flight simulations, *Domark's Flight Sim Toolkit*. We also sneak a peek at *Tie Fighter*. We review *Aces Over Europe*, *Fighter Duel Pro*, *F/A-18 Hornet*, the *Comanche: Maximum Overkill* CD, *Combat Air Patrol* and *X-Wing* expansion disks. For those looking for something different, we offer a review of the hot new racing simulation, *IndyCar Racing*, and a look at a familiar systems simulation in a new guise, *SimCity 2000*.

LET THERE BE FLIGHT!

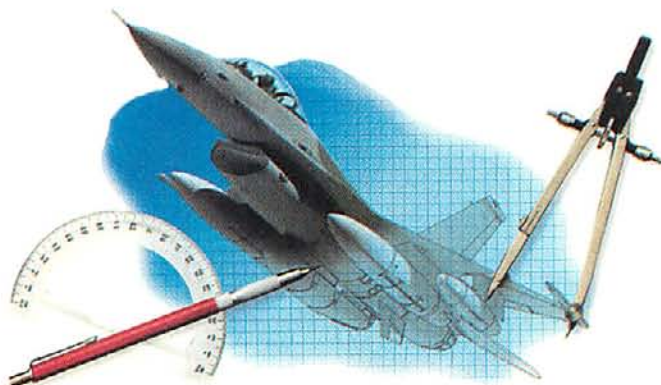

Flight Sim Toolkit Gives Pilots The Power Of Creation

by Bryan Walker

"Now for some REAL user power..."
— Jeff Bridges as hacker Kevin Flynn, from the movie TRON

As long as flight simulators have taxed the power of CPUs, gamers have asked for more. No matter what the state of the art is, the insatiable flight simulator community has always whipped up wish lists that sent designers' heads spinning back to the drawing board. Now, Domark Software has turned the tables in dramatic fashion by offering *Flight Sim Toolkit (FST)*. With *FST*, the *players* have the power to create their own unlimited aerial adventures. Sporting the core program of Domark's full-screen SVGA *Harrier*, *FST's* intent is to launch a surgical strike on the current state of the art, while appealing to the considerable creative urges of flight sim fans.

Power To The People

FST is one muscular program. Fortunately, all of this muscle power is easy to harness, thanks to an array of user-friendly tools that work within the Windows 3.1 environment. The World, Color, Shape, Model, and Cockpit editors of *FST* provide flight sim enthusiasts with far more creative power than any game construction set ever seen on a PC. It comes with two scenarios, Private Pilot and Top Gun, already built in. New players will find these adventures helpful in getting to know the *FST* world quickly, and these prefab scenarios are also excellent templates for early experiments in customizing.

Neato Neo Geos

The World Editor allows you to quickly construct a surprisingly realistic and detailed terrain model. Nearly any geographical feature can be produced and refined with the box of powerful tools that this Editor provides. Using a variety of unique fractal gen-

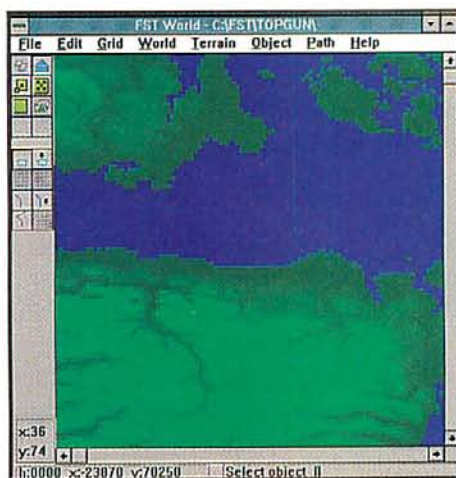

With *FST*, you don't need faith to move mountains.

eration processes, the landscape can be manipulated to achieve very impressive visuals. Elevations can be raised or lowered with a sweep of the mouse, forming lakes and mountains with a single pass. Zooming in or out gives the meticulous designer easy access to the smallest details. With enough attention, *FST* can build attractive terrain models of up to 245 MILLION square kilometers. With a little time, the realism of *FST's* terrain can rival or even surpass most flight sims on the market. Working in conjunction with the World Editor, the Color Editor allows you to select the color palette of the terrain being detailed, making it possible to simulate missions in many different geographical areas. Even the wind and time of day can be altered to put the last finishing touch on a scenario.

Shaping Up

The Shape Editor is easily the most powerful tool in the program. Working much like a full-blown computer-aided design (CAD) program, the Shape Editor allows the development of three-dimensional polygon objects, ranging from a human being to the Nimitz nuclear aircraft carrier. You can choose from *FST's* superb library of 3-D shapes for quick use or modification. You can also go hog-wild and produce nearly any shape imaginable from scratch. While new users might be a little intimidated at first glance, the graphic interface and skillful integration of the professional-quality utilities make working with complex 3-D polygons a simple point-and-click affair. The shapes can be viewed and rotated on any axis, scaled, filled, flipped, mirrored, extruded, colored, and edited in ways nature never intended. Cut and Paste, along with hierarchical Grouping functions make handling several polygons at once a breeze. Even some high-dollar CAD programs don't handle 3-D shapes with *FST's* panache!

A very useful feature is the Parent/Child utility that enables you to develop a variety of shapes representing a single object at various distances. At closer range, a highly detailed

Flight Sim Toolkit



TITLE: Flight Sim Toolkit
 PRICE: \$89.95
 SYSTEM: IBM
 REQUIREMENTS: 386SX or better, 2MB RAM, VGA graphics, 8MB hard drive space, Windows 3.1 or higher, mouse; supports Sound Blaster sound cards, and VESA-compliant graphics accelerators
 PROTECTION: None
 DESIGNERS: Jonathan Newth and David Payne of SIMIS Software
 PUBLISHER: Domark Software, Inc. San Mateo, CA (415) 513-8929



YOU'RE IN L.A.
SHE'S IN CINCINNATI.
AND WITHIN THE
FIRST HOUR OF MEETING HER,
SHE'S STRAFED YOU,
YOU'VE SPLATTERED HER, SHE'S
SMEARED YOU WITH BOOGERS
AND YOU'VE KISSED HER
PASSIONATELY.

IT'S THE START OF A
BEAUTIFUL RELATIONSHIP.

Believe it or not, the above scenario is now a reality with ImagiNation™—the world's first on-line multi-player games network. With your PC and modem, you can engage people in classic board and card games, an arcade-style action park (including the new INN 3-D Golf™), fantasy role-playing games, NTN Trivia, or an adults-only casino. Join now and we'll give you a membership kit and five hours absolutely free (just pay \$5.95 for shipping).

After all, you haven't made a true friend until you've shot them first.

IMAGINATION!

Call 1-800-625-5353, ext. 530 now and receive your first five hours free.

shape is the obvious choice. However, the Parent/Child utility can assign simpler shapes to be displayed at longer ranges, reducing the number of polygons that would otherwise be processed, and improving the frame rate of the simulation. Designers with lower-speed CPUs will find this feature makes a tremendous difference when multiple objects are displayed in the simulation.

Objectionable Conduct

At the heart of any *FST* scenario are the world's Objects. The World Editor integrates the placement, movement, Properties, and Classes of the numerous Objects *FST* can use. An Object can be anything represented by a 3-D or 2-D shape, and each Object has a Class, or function, in the *FST* world. Classes include Cultural window-dressing items, along with navigational aids such as NDBs, VORs and ILSs. You can define an aircraft Class as an indestructible brick for high-speed exploration and testing, or as a military plane capable of carrying a variety of ordnance.

Air defense comes in two Classes, represented by SAMs (Surface-to-Air Missiles) or AAA (Anti-Aircraft Artillery) guns. Any Ob-

ject a finite amount of damage points and the ability to launch aircraft. In the following Properties menu, the "F-14.fsd" file could be selected to be the Nimitz's Aircraft Shape to produce. The choice of Flight Models can range from user-designed to one of several already provided in *FST*. If you desire, a couple of Object Paths and their attributes can be defined, allowing the Nimitz to slowly steam along one route while her F-14 fighter cover takes off and begins patrolling another route. With only a little experience, an *FST* user can easily perform this operation in 60 seconds. How's that for power and flexibility?

Model Citizens

The Flight Model Editor is the utility that flight sim veterans will enjoy most. Using this Editor, *FST* players have the ability to quickly draw a silhouette of the aircraft they envision. (Note that this has nothing to do with the

3-D Shape you can select to depict this aircraft.) This silhouette is then used as a computational model by *FST* to determine some basic performance characteristics such as top and stall

speeds. This model can be further refined by using the Aircraft Properties menu, allowing variables such as weight, wing efficiency, dihedral, control power, and inertia to be easily modified to suit your tastes. Retractable landing gear, flaps, and airbrakes are also some of the options that you can choose from. The accompanying Engine menu may lend itself

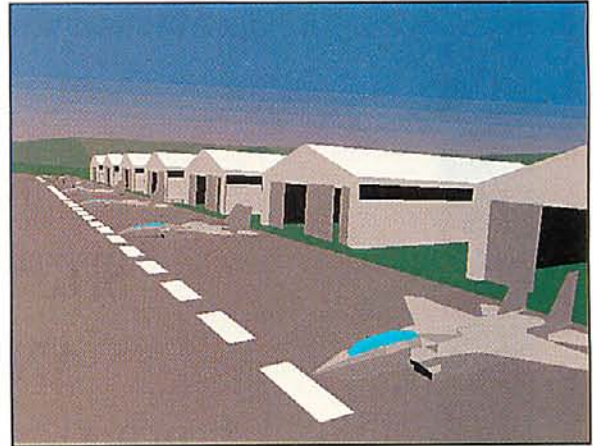

Ducks in a row—set up for a clean strafing run.

to certain abuses when you discover the extra performance "more power" can really provide! Plain and simple, the Model Editor is remarkable, allowing you to quickly design flight models ranging from the Wright Flyer to 21st-century jets. It's that versatile! Interesting possibilities also come to light when one discovers that any 3-D shape can be assigned any flight model. In other words, a Sopwith Camel can have a high-performance jet flight model. Things can get truly bizarre when 3-D shapes such as the Bismarck battleship are given the power of flight and armed with heat-seeking missiles! As a beer commercial asks, "Wouldn't that be great?"

Office Decor

Most players will find the cockpit graphics included in *FST* to be more than satisfactory. Even so, *FST* has a dedicated editor that allows you to design and configure your own cockpit. Functional gauges, lights, and indicators can be placed on any bit-mapped background. A heads-up display and "Marconi" type instruments can be easily integrated to simulate a modern cockpit. The useful ILS, ADF, and VOR navigation instruments are also easy to place with this accommodating Editor. Digitized cockpit photos from real aircraft or hand-designed graphics can be touched up with any .BMP file editor and imported into *FST*. As with nearly everything else in this game, the possibilities are limited only by your imagination.

Owners of a Sound Blaster or 100% compatible sound card can take advantage of a subtle feature that allows you to replace the game's digitized sound effects with any .WAV file. Some may overlook this ability, but it became one of my favorite touches for a custom

Flight simulators have always given players tremendous powers of destruction. Now, Domark and SIMIS have given players the ultimate power—Creation!

ject can also be designated as a Runway, an aircraft-producing Hangar, or a Depot responsible for dispatching resupply vehicles to damaged or depleted Objects. Many of the properties an Object may possess depends on the Class you choose for it. For instance, SAMs can have their Detect Floor, Range, and KP (Damage) ratings adjusted, with AAA guns having variable Burst Rate, Burst Time and Reload Time values. All aircraft Objects can have their flight routes and flight performance models selected by the user. Any Object can also be designated as a Target, allowing you to determine how much damage that Object can absorb before being destroyed. The Path menu allows you to define a route for moving Objects, as well as the altitude and speed the Objects on that route maintain.

Using these functions, creating a complex Object like a functional aircraft carrier is simple. Using the mouse, an Object can be placed in the water. You can then select that Object's Class to be a Hangar, and its Shape to be the "Nimitz.fsd" file from *FST*'s 3-D shape library. Clicking the Target and Run-

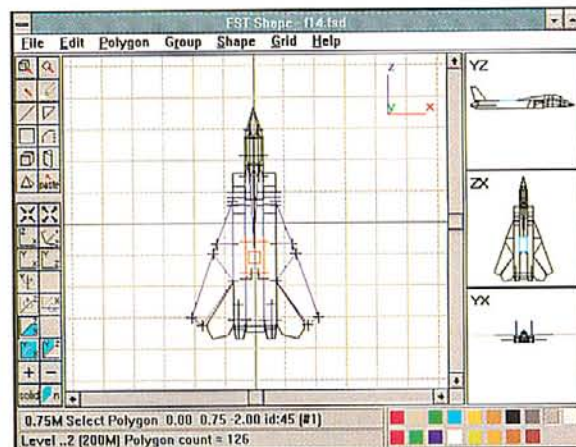

Remember when you made these out of paper?



An impressive example of what can be accomplished by scanning a photograph of a real fighter cockpit and then adding instruments using Flight Sim Toolkit's Cockpit Editor.

scenario. There's a certain appeal to having Homer Simpson announce a missile launch with a panicked scream that just can't be found in other flight sims. A .WAV file editor isn't required to accomplish this, but might help an ambitious designer really flesh out a pet project with wildly original sound effects.

The Price Of Power

While the process of creating can be at least half of the fun, *FST* couldn't be judged a success if the actual flight simulator portion of the program didn't perform. The "Fly" program in *FST* comes loaded for bear with excellent full-screen SVGA visuals. Unfortunately, the SVGA capability demands big-league power: a fast PC and an accelerated video card are absolute musts to enjoy the simulator in 640x480 resolution. Regardless of the PC's CPU speed, non-accelerated or 8-bit SVGA-capable video cards are too slow, with personal experimentation confirming this in no uncertain terms. Domark recommends the ATI or S3 video cards, but a Diamond Viper VLB card delivered effortless graphics performance on my 486-66. Before

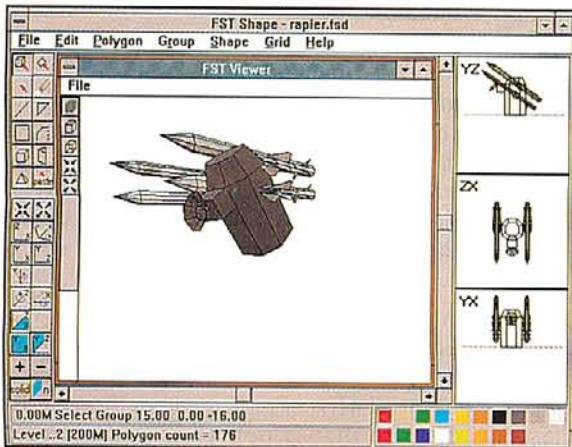

An Anti-Aircraft missile launcher takes shape in the Shape Editor.

owners of less robust systems begin to dial the Suicide Hotline, they should know that the normal 320x200 VGA graphics are very smooth and realistic without bogging down a lower-end machine. Testing the VGA mode on a 386SX-20 delivered a brisk frame rate that will certainly please most players. The shading, haze, and tracer effects are particularly nice in either resolution, and definitely add to the suspension of disbelief that all flight sims strive for.

In-Flight Services

Actually flying in an *FST* scenario is fairly simple. The streamlined control layout covers most of the industry-standard commands and views, but is a far cry from the complexity of *Falcon 3.0*. More akin to a less "serious" flight simulator like *Chuck Yeager's Air Combat*, flying experiences in *FST* can range from leisurely jaunts to real hair-raisers, depending entirely on the scenario and flight models involved. While I found putting around in a civilian aircraft to be pretty uninspiring, a military mission could usually get my blood flowing.

Perhaps the greatest appeal of *FST* will lie in the ability to trade 3-D shapes, Flight Models, Terrain Models, and even entire scenarios with other *FST* fans. It's a sure bet that the major BBS networks will start seeing *FST* paraphernalia within days after the game hits the shelves. The ability for you to show off your creativity and technical artistry will certainly add to the ranks of the flight-simulator community and *FST* fans alike.

With so many strong points and ingenious features, *FST* deserves to attract some serious attention. However, there are legitimate weaknesses that potential buyers should know about before menacing their piggy banks.

Bolting The Trap

Though the ability to build elaborate Military missions may be *FST*'s greatest strength, a number of limitations may dilute the overall game-play value of these scenarios. First, you will always fly solo missions. There can be no wingmen or additional support in ac-

complishing the objectives. Second, the enemy planes and combat vehicles will attack only your aircraft, regardless of the proximity of friendly buildings and vehicles. (Although it's not uncommon for the enemy AAA guns to inadvertently level nearby objects while engaging your aircraft.) Third, the combat AI of the enemy planes is very weak. Using horizontal maneuvers almost exclusively, they offer little challenge in a dogfight. Without a large numerical or performance advantage, the enemy aircraft are barely more than nuisances. Fourth, the weapons and avionics available to users are rather generic in their use and effects. For most players, this will be fine. For *Falcon 3.0* fans, it will be a definite step backwards. Finally, the Flight Models are entirely unaffected by weapons loads, detracting from the sense of realism. John Kavanagh of Domark acknowledged most of these weaknesses while providing some technical

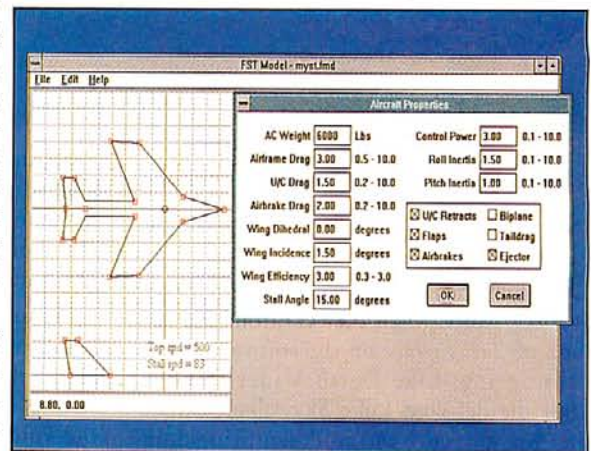

You don't need an engineering degree to tinker with a jet and its flight characteristics.

insight on them. Fortunately, he emphasized that work on at least four upgrade disks for *FST* is already under way. These disks will expand the capabilities of *FST* to include a realistic helicopter simulation, a CD-based terrain model of the entire U.S., modem play, and space exploration. These disks will also have patches aimed at improving the overall play of *FST* itself. So, while the air combat portion of *FST* initially won't challenge dedicated fighter sims such as *Falcon 3.0* and *F-15 SE III*, the future is certainly promising.

Final Approach

While a few titles might outshine *FST* in specific areas, no flight simulator on the shelves can boast the overall ease of use, power, and potential of this superb effort. Though *FST*'s hardware requirements and hefty price tag may cause some to shy away, this game is *definitely* worth a close look. **CGW**

Uncle Vader Wants... YOU!

SNEAK PREVIEW
Game Still In
Development

Join The Ranks Of *TIE Fighter* And Take A Walk On The Dark Side

By Chris Lombardi

"Luke, I am your father. Join me and we'll rule the galaxy as father and son!"

Fans of George Lucas' *Star Wars* films and LucasArts' *X-Wing* simulation may hear a faint echoing of Darth Vader's words when they confront the dark box of *TIE Fighter* on the software shelves this Spring. Like Darth Vader standing over the defeated Luke Skywalker, extending his gloved hand and tempting Luke with the promise of tremendous power, the second major title in the *Star Wars* simulation line reaches out a black, gloved hand to players and offers them a career opportunity in the ranks of the Empire and the Dark Side of the Force. With its alluring screen shots, lists of new features, and tantalizing promises of more hot space combat in 35 to 40 new missions, the box will attempt to seduce *Star Wars* fans to betray everything they've come to value in the *Star*

Wars universe, to betray the many Rebels who've given their lives to secure peace and freedom in the galaxy, and to betray the *X-Wing* player's own efforts in the original game and expansion disks.

Most *X-Wing* fans won't think twice. They'll plunge as eagerly into *TIE Fighter* as young Luke plunged into the void of the Cloud City to escape the same fate. After all, *X-Wing* is a well-loved game, and offering its players more opportunities to romp in its universe is to invite a starving man to feast. What about the fact that they will be playing on the Bad Guys' side? Well, not only does *TIE Fighter* afford a unique opportunity for *Star Wars* fans to see another side of the universe, but it might also be a refreshing change of pace for the typically do-gooding computer gamer.

Even if you have no qualms with joining the Emperor and his band of merry fascists, you'll still feel odd the first time you peer through the multifaceted eyeball of the TIE fighter. When you roll to the right on your first mission, you'll see TIE fighters flying in

formation on your flanks. It's almost a reflex for an *X-Wing* player to pop off a laser volley and cleave the Imperial bastards in two. Of course, you'd best restrain your

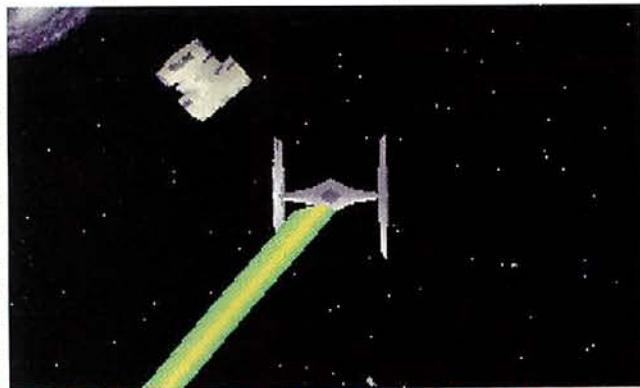

trigger finger: those bastards are now your buddies, and you'll need all the buddies you can get in the missions to come. Yes, the first time your wing of TIE Fighters moves in on an X-Wing and you line up your crosshairs on some young Rebel on "a damn fool idealistic crusade," you'll get the strong sensation—perhaps of a huge shift in the Force?—that you have ducked under the curtain and emerged on the other side.

What does the other side have to offer? A completely different perspective on the *Star Wars* saga. So far, we *Star Wars* fans have only heard the tale from the Rebel's point of view. From them we hear of an Empire that is oppressive, intolerant, power-mad, and of a Rebellion that is fight-

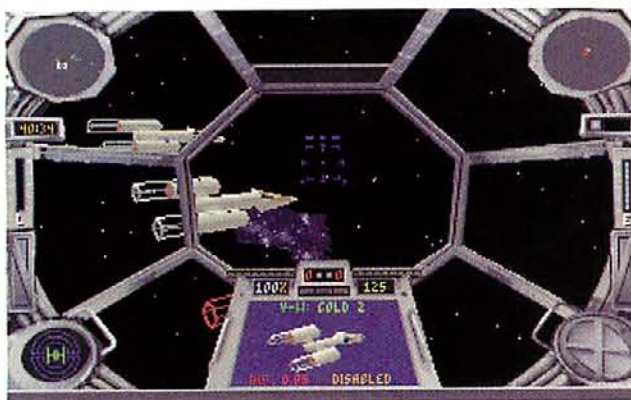

Real Ordinary



ReelMagic



There's more to games than a mouth that sort of moves or tinny sound. Now there's a new way to play PC games that's just like sitting in a theater controlling the action with your joystick.

It's ReelMagic™, the new MPEG playback adapter. Available only from Sigma Designs. This incredible add-in board brings the next generation of CD-ROM

ReelMagic™

games to your PC bigger than life.

Say adios to wimpy graphics. Herky-jerky movement. Bogus sound.

And phony scenarios. ReelMagic pumps up the reality meter so you can crank up the fantasy.

We've also included Activision's *Return to Zork* so you can experience the excitement of full motion video now.

It's not real unless it's ReelMagic. Call 1-800-845-8086 ext. 324 for a dealer demo near you. Or you can stick with real ordinary. Oh joy!

Discover the new generation of ReelMagic games from these manufacturers, and look for more exciting titles coming soon.



256 VS. 32,768 COLORS Why settle for a mere 256 colors, offered by current PC games, when ReelMagic gives you theater-quality graphics with over 32,000?



GRUNTS VS. CD-QUALITY AUDIO Get 16-bit CD-quality sound that plays Sound Blaster™ and Windows™ compatible software. The 8-bit audio you're used to just doesn't compare.



5 FPS VS. 30 FPS ReelMagic-compatible games run at 30 frames-per-second, TRUE full-motion, so you avoid jerky, blocky images.



1/4 VS. FULL SCREEN Now you can get theater-quality video in a full-screen image for a realistic, movie-like experience.



Only ReelMagic Makes It Real.™



© 1993 Sigma Designs, Inc. The Sigma Designs logo is a registered trademark and ReelMagic is a trademark of Sigma Designs, Inc. All other brand names and products are trademarks or registered trademarks of their respective holders.

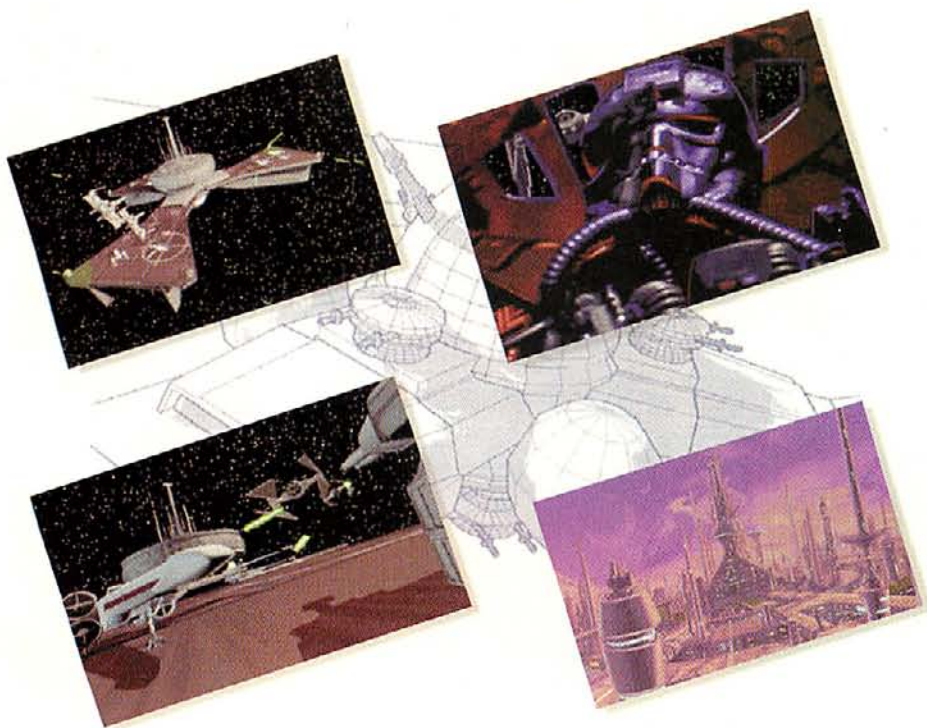

ing for freedom, justice, and democratic rule. But are we getting the clearest of pictures here? Might there be a bit of propaganda in this pot? *TIE Fighter* explores these questions by turning over the Star Wars coin, exposing for the first time the side with the image of the Emperor, and rendering unto Palpatine what is Palpatine's.

The Empire's story is not a completely sanitized version of the tale, though it's not quite as black and white as the Rebels make it out to be. The Empire sees itself as restoring order to a region torn by wars since the breakdown of the Alliance. It is ensuring a peace—albeit a cold and cheerless one—to a region that would otherwise destroy itself in factious infighting. The Rebellion is seen as a band of outlaws who would subvert the system established by the Empire and allow such warfare to continue.

Sure, the Emperor has his own propagandists white-washing his blood-stained picket fence, but this is the world as the young recruit knows it when beginning *Tie Fighter*. As the story develops, and as you rise through the ranks of the Imperial Navy, a more accurate portrayal of the Empire and its problems will unfold, revealing tales of political intrigue, of defections and opportunistic traitors, and of ambitious officers making political powerplays. If you so choose, you might even find yourself involved in covert missions for secret organizations within the Empire, and

perhaps even defending the Empire against corruption within.

You Say You Want An Evolution?

Though the story makes a 180 degree flop in perspective, *X-Wing* players will feel right at home with the *TIE Fighter* game system. Designers Larry Holland and Ed Kilham have taken both the basic program and the lessons learned from *X-Wing* and made many small but significant refinements to the design. The main interface screen, for instance, will feel very familiar. After checking in at a front desk flanked by two Storm Troopers, you'll enter the central corridor of an Imperial space station. The many sliding doors of the station offer well-known game options: the Pilot Proving Grounds will allow new players to practice their skills on a timed obstacle course, the Historical Combat missions offer combat scenarios in a virtual reality environment, the Blueprint Room displays models of the different ship types, and the Film Room enables pilots to view those special combat Kodak moments.

What's new on the scene? Well, the graphics of the simulation have improved somewhat; a layer of Garoud shading has been added to the ships, rounding out their bodies and giving them more subtle colorings. The targeting system has also been changed. Whereas in *X-Wing* the targeting display showed a static display of the targeted ship, it now shows a real-time image of

the ship. There is also a new "Threat Display" that provides real-time information on a targeted ship's heading and its current objective, making it easier for you to keep tabs on that critical enemy craft.

Missions Impeccable

These new graphical improvements are nice, but the real strides have been made in the depth and structure of the missions. The most common complaint about *X-Wing* was the difficulty of its missions. Some of them were very tough and had to be played dozens of times. LucasArts' quick and dirty solution in the *X-Wing* expansion disks were quick and dirty on-line hints. These hints are gone in *TIE Fighter*, but so is the difficulty problem. Holland and Kilham have come up with several different ways to modulate mission difficulty while adding depth to the simulation world.

As a gross solution, there are now three general levels of difficulty: casual gamers can set the game to a casual pace, and masochists can torture themselves with glee. In the subtler vein, the mission objective screen has been remodeled to allow objectives and hints to be doled out at various levels. While the cool animated mission computer is still a part of the game, you will no longer page through the laborious text descriptions of a mission. Now, there is an officer in the mission room that you can question with an adventure-style interface. By selecting from a number of dialogue choices, you can get mission information in as much detail as you desire.

There are also multiple objectives for every mission. Along with the officer in the mission room, there is a mysterious cloaked figure as well. If you so choose, you can speak to him to find out about objectives that go above and beyond the basic military aims of the Empire. Through the cloaked figure, you can become involved in a secret society of elite pilots that moves behind the Empire, shaping the outcome of the war to its own mysterious ends. You can move through the storyline by accomplishing the basic mission objectives, but you can also take on more challenges and become more involved in the background story through the secondary objectives.

The designers have also taken small steps toward reducing the linearity of the plot. Rather than enrolling in Tours of Duty and completing each mission in sequence, you now choose one of four places to be stationed. Each station will have a series of connected battles linked to it. If you become stuck on a mission at one station,

you can relocate to another and try the missions there. There is still only one major plotline that runs throughout the game's planned 35-40 missions, but the ability to relocate your character ensures that you don't get stuck on one mission and find yourself unable to move any farther in the story.

The missions themselves have been given more complexity, and the simulator

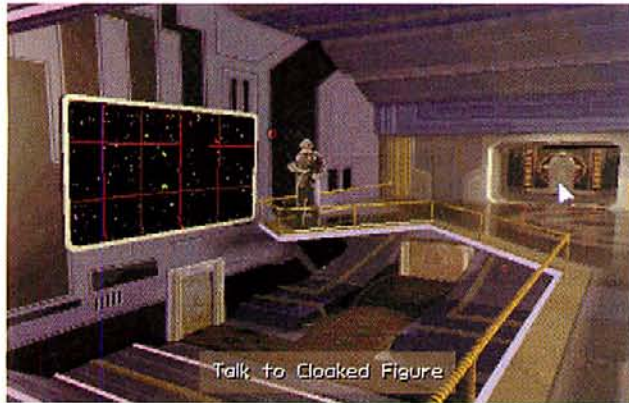

world more depth. The AI has been improved to give computer controlled flight groups more complex assignments, so there are lots of flight groups racing around accomplishing their multiple objectives. Missions can now be much longer, with multiple events, and can have more complex triggering conditions for their beginnings and endings. There are new wingman commands, and the wingmen will respond more readily and accurately to them. Fortunately, with all of this added complexity comes added ease-of-use. The designers have gone to great lengths to provide more combat information to the player and thereby improve his or her situational awareness. In addition to the new tracking systems already mentioned, each mission has unique radio messages (as opposed to the generic kind in *X-Wing*) to help you keep tabs on the events, and the game will no longer keep you guessing if your mission has been a failure and cannot be completed (an annoying problem in *X-Wing*). If you felt like you were playing more of an adventure game than a combat simulator in *X-Wing*, you'll feel it even more so in *TIE Fighter* as these complex missions and their multiple objectives unfold like self-contained combat stories within a larger plot.

Not only are the missions more involved, but the simulation universe has been fleshed out with greater detail. For instance, the missions are grouped together into Battles of three to five scenarios surrounding a single engagement or objective,

and there is continuity between the missions. So, for instance, if you flame that Rebel hotshot, Keyan Farlander, in the first mission of a battle, he won't appear in the remainder. Likewise, if you lose your wingman in the first battle, you can't expect his help in the second. Then again, if you find yourself in deep wookiee dung on a mission, you can call back to HQ to request additional support. If there are ships available (there may not be in some instances), a squad of ships will be dispatched. Using this support feature will not have any adverse effects on a mission's outcome, though your score and your rate of promotion may suffer.

Secret Weapons Of The Empire

Some of the new ship types add depth to play as well. There are dozens of new support ships, like space platforms, various supply vehicles, and medium-sized ships (as opposed to *X-Wing*'s generic "containers" and space tugs). Also, in addition to the standard Imperial craft that *X-Wing* players know and love—the TIE Fighter, TIE Interceptor, TIE Bomber, TIE Advanced, and Assault Gunboat—you will also fly the TIE Deluxe. The TIE Deluxe is a new fighter that will be developed throughout the course of the game. It is a very powerful and flexible ship that can carry a shield system, standard laser weapons, a tractor beam, and missiles with a variety of warheads. Before flying a mission in a TIE Deluxe, you will be able to select its armament load, and if you run out of missiles during a mission, you can fly back to a base and reload!

While on the subject of ships, I'm sure there are many *X-Wing* players wondering how LucasArts is going to handle the balance of combat, as far as the match up of Rebel and Imperial ships is concerned. In *X-Wing* any Rebel starfighter could crack a standard TIE Fighter in half with two or three well-placed shots. I would have guessed that the designers would fudge the figures a bit and give the TIE Fighter a bit more strength. This doesn't seem to be the case. TIE

Fighters are still without shields and still very much the flying confetti eggs we know them to be from *X-Wing*. Two shots from a rebel ship with cross-linked lasers and you've got a funeral with Storm Trooper color guard. You'll learn the meaning of fear when you've got an X-Wing on your tail and you reach for the old rear deflector shield button to find that you don't have one! To deal with this basic imbalance, I suspect that the missions with these fragile craft will be less combat intensive and will emphasize group tactics over individual bravado. I also imagine that the storyline will quickly move the player beyond the basic ships and onto those that have a little more heft and firepower.

One of the most exciting possible additions—and I must stress *possible*—is a custom mission builder. Hollins and Killiam have developed a very slick mission building tool for their own use, and they are considering cleaning it up and including it with *TIE Fighter*. This would allow creative players to develop their own devious missions for others to enjoy. Again, they aren't promising the custom mission builder, though they are considering it. We can only hope.

Even without the custom mission builder, *X-Wing* fans will have a lot to look forward to this Spring. In addition to more hot n' heavy space combat and more gorgeous animated cut-scenes to flesh out the story, there are new ships, more involved missions, more flexibility with the game difficulty, and a whole new slant on the

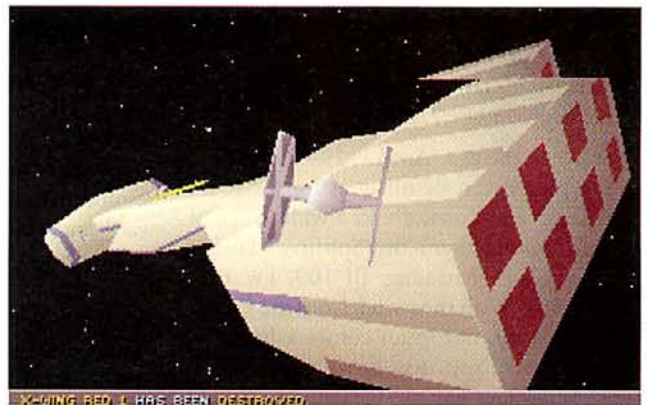

Star Wars universe. The Dark Side beckons, young Jedi, and it's allure is stronger than ever. Indeed, at this point in *TIE Fighter*'s development it seems there will be few reasons to refuse. Even as you've read this, you may have felt your will weakening and your soul giving ear to that familiar, asthmatic baritone: "Join me..." **CGW**

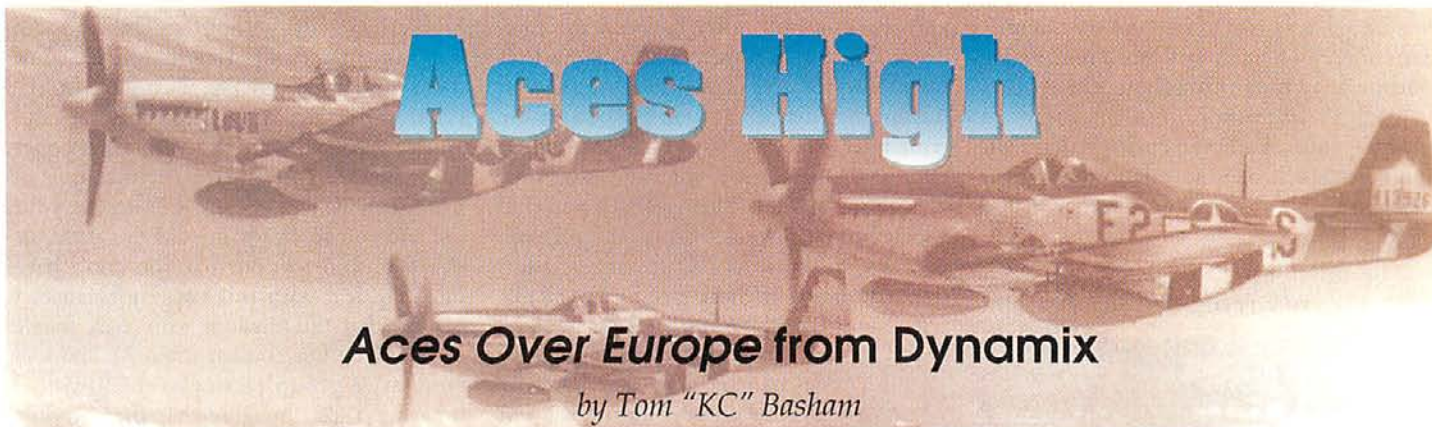

I was performing a "dirty dart," one of those nasty little maneuvers where you have superior altitude on the enemy, wait for him to reach the bottom of his dive, and then cut across and turn his six into metallic pasta. He must have spotted me, though, because he shot forward like his MW50 (methanol/water combination for an extra power boost) had kicked in. I grabbed the wire on my Spitfire's booster and screamed toward him again. He broke into a tight right turn and I managed to rock into a turn and fire a wing cannon. I was in a seesaw where the recoil of each shot would make my wing jerk back, but I kept rocking and kept firing. Suddenly, he explodes.

Such is a paraphrase of an actual encounter between Jerry Collingsworth of the USAAF 31st Fighter Group and an Fw 190. The complete story can be read in James R. Whelan's *Hunters in the Sky: Fighter Aces of WWII* (Washington: Regnery Gateway, 1991), but the experience can be encountered in *Aces Over Europe*, the long awaited sequel to *Aces Over The Pacific*.

Set late in the war (April 1, 1944 to May 7, 1945), players can fly missions for the RAF, USAAF, or the Luftwaffe in a wide range of aircraft, among them the Spitfire, Hawker Tempest, P-15 Mustang, Bf 109, Fw 190, and Me 262. With the switch from the Pacific Theatre to the European comes a few new mission types. You may be asked to attack radar sites, German V-1 facilities, supply trains and tank columns in addition to the standard assortment of tasks found in *AOTP*.

Depending on which air force you fly for, some missions become impossibly difficult. All missions in *AOE* take place after the D-Day invasion of Normandy, by which time the strength of the Luftwaffe was severely waning. When flying for the Luftwaffe, some "scramble" missions begin with Allied pilots strafing the very runway you must taxi down!

A flight of four Fw 190s may be assigned to intercept a bombing raid consisting of eight B-25s escorted by four P-51s! Missions for the Allies are by no means simple, but surviving a tour of duty with the Luftwaffe is a respectable feat by any measurement.

Tally Ho, Bandits 3 O'clock High!

Aces Over Europe (AOE) uses the same basic game engine as *Aces Over The Pacific (AOTP)*, but has several enhancements in its graphics,

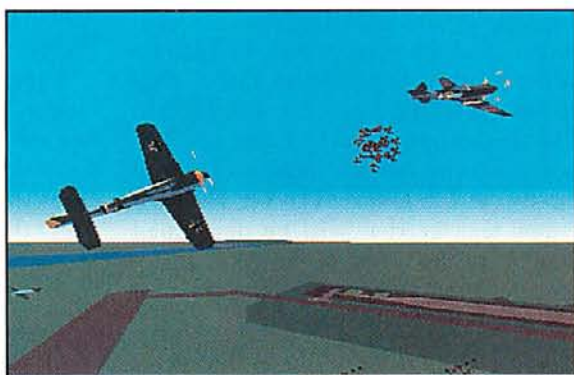

flight modeling, and enemy artificial intelligence. The most noticeable advancement is the new "Tall Res," 320x400 pixel graphics mode. *AOE* supports the standard 320x200 resolution used in *AOTP*, but looks very awkward and "blocky" when compared to the Tall Res mode. The higher resolution of Tall Res makes both the static displays (the cockpit instrumentation) and the dynamic objects (other aircraft) look a lot better. Where bogeys previously were nothing more than a few colored pixels in the distance, the actual bank of the wings can be discerned using Tall Res. It's a welcome and much needed improvement over the original *AOTP* graphics.

Don't let the higher resolution mislead you, though.

There aren't many new *objects* to see in *AOE*, it's just that the objects previously used in *AOTP* look a lot better. The general landscape in *AOE* is the same as its predecessor, a flat world with few details. For the air-to-air combat segments of the game, the texture of the planet doesn't really matter that much, but the ground detail is sparse and uninspiring in ground attack missions. Like *AOTP*, it is difficult to determine how far away the ground is, forcing you to frequently look at your altimeter. In the middle of a dogfight at 300 feet, though, looking down at your instruments for even a second can get you a severe case of lead poisoning.

The higher resolution comes with a price tag: more computer horsepower is needed to update those extra pixels at a reasonable rate. The graphics look very smooth on the testbed 486DX-50, but 386 owners may find their machines just don't pack enough punch for Tall Res, especially if they can't tolerate low frame rates to begin with. If you've got the horses under your hood, you'll find the Tall Res mode is a welcome improvement.

Pushing It To The Tickle

The first question asked of a new flight simulator is almost always, "how is the flight model?" *AOE* has good news and bad news in this department. First, the good news: stall buffet and spins have been added. Buffeting occurs as a wing approaches a stall. As the

Aces Over Europe

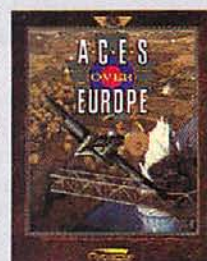

TITLE: Aces Over Europe
 PRICE: \$69.95
 SYSTEM: IBM
 REQUIREMENTS: 386DX or better, 4MB RAM, VGA graphics, 6MB hard drive space; supports AdLib, PAS, Roland MT-32, Sound Blaster and Thrustmaster sound cards and WCS, FCS, and RCS flight control peripherals
 PROTECTION: None
 DESIGNER: Damon Slye
 PUBLISHER: Sierra/Dynamix
 Coarsegold, CA
 (800) SIERRA1

FREE
MORTAL KOMBAT® KAP!

CYBORG BLASTING DINO-STOMPING SHADOW-KICKING RAT-BASHING ACTION FOR YOUR PC.

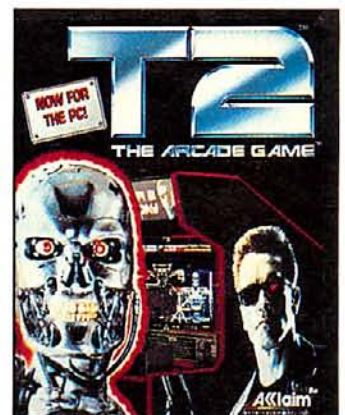
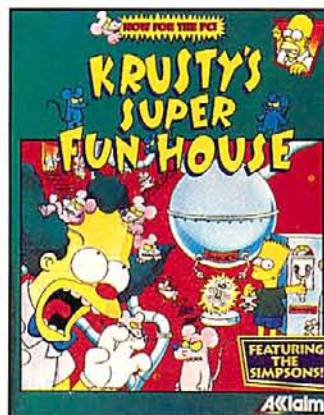
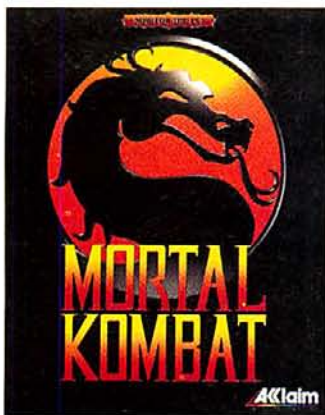

Get ready to blow the lid off your PC. Because every game in Acclaim Entertainment's new line for the PC is a blast. Pick up any two before March 31, 1994, and we'll top you off with a **FREE Mortal Kombat® Kap!***

Circle Reader Service #70

Acclaim®
entertainment, inc.
Distributed by UltraTech

*Send in 2 proofs of purchase with package coupon plus \$4.00 for shipping and handling. See inside box for details. Offer expires 3/31/94. Please allow 6-8 weeks for delivery.

To order see your local retailer, or call 1-800-447-6543 (MC/VISA/AMEX).
These games are available for IBM/Tandy & 100% compatible PCs.

The Simpsons & Characters™ & © 1993 Twentieth Century Fox Film Corp. All Rights Reserved. MORTAL KOMBAT™ & Trogl™ are Trademarks of and Licensed from Midway® Manufacturing Company © 1992 All Rights Reserved - Used by Permission. TERMINATOR™ 2: JUDGEMENT DAY, TERMINATOR, T2, ENDOSKELETON and Depiction of ENDOSKELETON™ & © 1993 Caroko Pictures Inc. All rights reserved. Distributed under license from Acclaim Entertainment, Inc. by UltraTech (212) 941-1224.

angle of attack increases, the airflow over the wing is disrupted, causing the aircraft to bounce and vibrate. If the disruption is severe enough, the wing loses all lift and a stall occurs. The point where the first barely noticeable buffeting occurs is called "the tickle" and indicates the aircraft is flying at the edge of its performance envelope. Combat pilots attempt to fly to the tickle knowing this is the maximum they can demand from their aircraft. When the aircraft stalls in a turn, it stops turning and flies in a straight line tangent to the turn circle. When flying at the tickle, slight buffet can be felt, but the aircraft has not yet stalled and continues to turn. Pulling harder on the stick leads to severe buffet, the aircraft stalls, and stops turning. Demanding more from the aircraft usually results in a spin. Buffeting, therefore, is a valuable indicator to the pilot that the aircraft has reached the edge of its performance envelope. The logical progression here is: normal flight, then the tickle, buffet and stalling next, followed by a spin.

Now for the bad news. Stalls in *AOE* are not handled very well. Stalling during a turn can be seen in the original game, *Aces Over The Pacific*, by flying over a fixed object (such as a road). Reduce speed and make a hard turn over the object. Use the side view to look down your wing and notice how it rotates as you turn. Increase your turn until you stall and notice what happens: the object appears to move in a straight line showing that your aircraft has stopped turning and is now moving in a straight line tangent to the original turn. Unfortunately *AOTP* didn't have buffet or spins, progressing from normal flight to a stall without warning, but never departing into a spin.

AOE has taken a step backwards here, despite the addition of buffet and spins. When you pull into a stall, the image on the screen bounces around simulating buffet like it should, but the aircraft continues to turn. Pulling further on the stick should lead to stronger buffet and a stall, but instead causes a spin. *AOE* basically progresses from normal flight to a severe tickle and into a spin without ever really stalling. At first glance, this may seem like a nit-pick; however, it leads to all stalls and spins having a generic, canned, on/off feel to them, taking away a lot of the uniqueness and individuality of each aircraft.

Aircraft in *AOE* also cannot descend unless pointed at the ground. In the real world, as airspeed decreases the wings generate less lift. If the amount of lift generated by the wings is less than the aircraft weight, you will descend, even if the nose is pointed up. Real aircraft land by keeping the nose level or above the horizon and decreasing speed until the aircraft descends. This cannot be done in either *AOTP* or *AOE*. Realistic landings are not possible.

This isn't meant to imply that the flight models in *AOE* are garbage. *AOE* actually presents a very nice feeling of flight. Relative motion in three dimensional maneuvering is handled quite well. Energy management is very important in *AOE*, and the effects of maneuvering on your energy state is quite apparent during a dogfight. Although stalls may not be overly realistic, they are still quite dangerous and to be avoided by careful energy management. The point is, *AOE* has enough of the basics (stalls, buffet, spins, and energy management) to be challenging, although the hard-core flight simulation crowd will find the implementation of these items a little disappointing. Also, aircraft

no idea what. Many players have voiced discontent with this system, and hopefully Dynamix will no longer use it.

What About The Bugs?

AOE has proven to be very bug-free—quite a task in today's software market. No known crash bugs exist. The screen shaking used to show stall buffet and bullet impacts is caused by varying the video sync pulses. Some video cards have circuitry designed to prevent this, leading to blank screens during flight. *AOE* ships with two utilities designed to address this problem. One tries to make the shaking effect work with the video hardware, the other disables the shaking effect altogether to prevent annoying blank screens during flight.

Improvements in the artificial intelligence has led to a few annoyances as well. Originally, *AOTP* allowed computer-controlled pilots some "leeway" during flight to make up

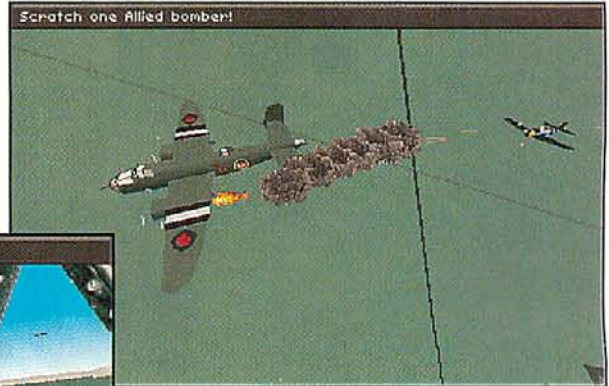
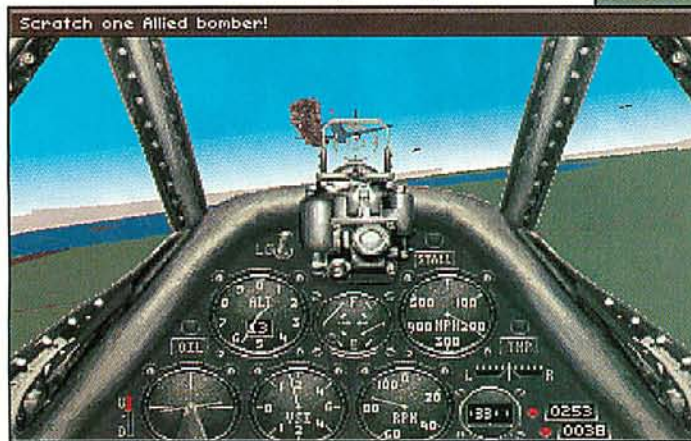

for lack of intelligence. This leeway allowed NPCs to bend the rules of flight slightly and gave them more ammo than human players to make up for their lack of skill. In an open letter from Dynamix posted on CompuServe, Dynamix admits that they improved the skill of the NPCs, but underestimated how much leeway the NPCs were still being allowed. The end result is that NPCs are generally difficult opponents with more ammunition than the human player.

Back At The Officer's Club

AOE is basically *AOTP* with a new suit. It retains the successful elements of its predecessor while making many subtle improvements. Its flight modeling is better than *AOTP*, but not perfect. It uses the same type of world as *AOTP*, but makes it look a lot better with the new Tall Res video mode. And it extends the aircraft and mission types to include new and interesting combat situations. On the whole, *Aces Over Europe* is a significant step in the Great Warplanes Series and a "must-have" product for WWII air combat fans. **CGW**

Prepare for Kombat on your PC!

Experience all the action of the arcade sensation!

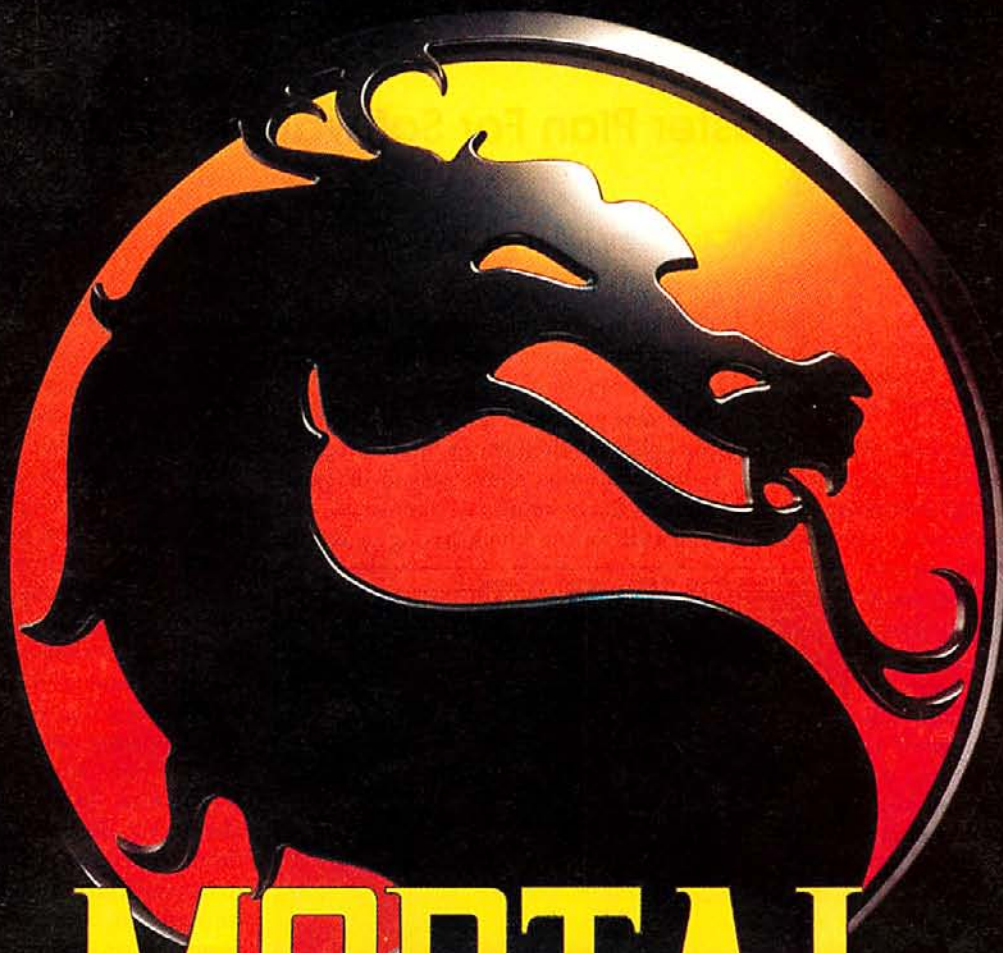

MORTAL KOMBAT

FREE
Mortal Kombat[®] Tattoos
in every box.

Acclaim[®]
entertainment, inc.

Distributed by UltraTech

To order see your local retailer, or call 1-800-447-6543 (MC/VISA/AMEX).
Mortal Kombat is available for the Amiga and IBM/Tandy & 100% compatible PCs.

MIDWAY

Mortal Kombat © 1992 licensed from Midway Manufacturing Company. All rights reserved. Distributed under license from Acclaim Entertainment, Inc. by UltraTech (212) 941-1224.

Circle Reader Service #71

Sim-ply Irresistible: *SimCity 2000*



Maxis' Master Plan For Software Renewal

by Johnny L. Wilson

Johnny L. Wilson is the author of The SimCity Planning Commission Handbook and co-author of The SimCity 2000 Planning Commission Handbook, both published by Osborne-McGraw Hill.

A city, according to Lewis Mumford's *The City In History*, serves as a structure for the storage and transmission of valued goods (an economic purpose), a repository of information and artifacts from its cumulative social heritage (a socializing purpose); and a stable human environment through police and fire protection, the modern equivalent of the walls and armies of the ancient world (a protective purpose). In short, the urban or suburban environment touches nearly every aspect of our lives.

This may well explain why the original *SimCity* touched a nerve and had such wide-range appeal. Nearly everyone could identify with it, because even those who do not live in cities have had to visit them for one reason or another, and nearly everyone thinks that they could do a better job of planning a city than their own local government officials.

Urban Renewal

SimCity 2000 (*SC2000*) offers the same fascination and potential satisfaction as the original *SimCity*, but it offers considerably more tools with which to create an urban utopia. Now, *SimCity 2000* contains built-in terrain editing functions to tweak the landscape without having to leave the City Window; subway and freeway options to help alleviate traffic congestion; and alternative power plants to help alleviate pollution. There are now schools to help shape the future of the city and help determine the types of industry that will dominate in that future city. There are hospitals to increase the life expectancy of your citizenry and proactive government spending options to help

you hone in on specific problems, like attracting new businesses or reducing crime through anti-drug education.

The new game also features the ability to send police and fire-fighting forces directly to trouble spots, and allows you to designate light and heavy industrial, commercial, and residential zones without having to use the

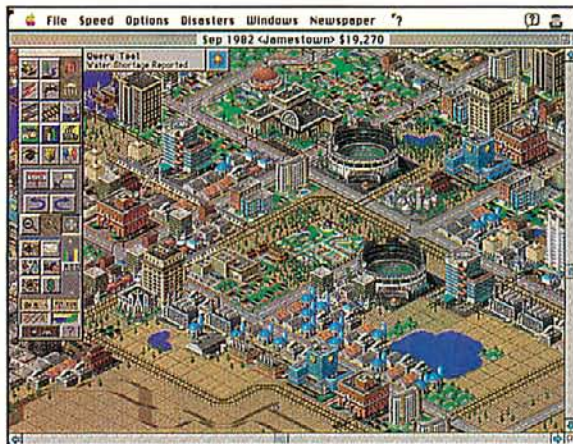

bulldozing trick many of us used in the original. Roads in *SC2000* can be built diagonally, so you no longer have to zig-zag your way across the map in order to recreate Washington, D.C. or Paris. You can even connect your cities to neighboring cities by building roads to the edges of the map.

Stadiums (for baseball, football, soccer, or cricket), recreational areas, and tourist attractions can both customize a city's look and improve its population and economy. Also, the addition of a utility to allow mayors to create customized signposts for their cities is a very nice touch. The Oakland Hills Fire scenario makes excellent use of this tool by indicating Lake Temescal, as well as the former home of designer Will Wright that burned during the fire.

SimCity 2000 can also be more difficult than was the original *SimCity*. To be sure, the Easy mode (where the initial bankroll is \$20,000) is still basically a software toy—accessible enough that almost anyone can feel successful from the beginning. At the Medium level (starting with the coffers at \$10,000) and Hard level (where the city begins \$10,000 in debt because of floating a municipal bond), things are tougher. Not only do you have to handle the specific budgetary issues, but you have to be able to handle NIMBY (Not In My BackYard) issues, as well. Putting that prison near certain high-priced housing can cause a backlash among your citizenry. Not only do you have to plan for the road, freeway, and subway grid, you also have to deal with the Mayor Koch Syndrome (the former NYC mayor says he used to have nightmares about the city's waterlines disintegrating) and deal with the underground water system.

The easier a difficulty level is set, the easier it is for cities to sell their industrial products to neighboring cities and expand the economic base. Further, the harder difficulty levels increase the probability of a city facing a disaster. Finally, some of the new scenarios, like the Oakland Hills Fire, are extremely difficult. There are feelings of déjà vu when playing *SC2000*, but this is not the same game. There are plenty of new challenges.

Finally, the new game also lets you decide on the start date for the game. In turn, the time period in which you begin has an effect on what power plants are

SimCity 2000

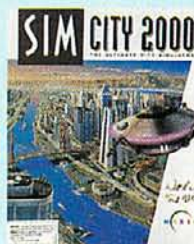

TITLE: SimCity 2000
PRICE: \$69.95
SYSTEM: Macintosh, IBM (early '94)
REQUIREMENTS: LC, Performa, II, Centris, Quadra, Color Classic, and Powerbook; 4MB RAM (2.5MB free), 8-bit color monitor, 4MB hard drive space, System 7.0 or higher
DESIGNERS: Fred Haslam and Will Wright
PUBLISHER: Maxis
Orinda, CA
(510) 254-9700

immediately available and what inventions are already in existence. A 1900 start date allows you to choose between three types of power plants (Coal, Hydroelectric and Oil); allows no subways until 1910, buses until 1920 or highways until 1930; and allows no water treatment plants until 1935 or arcologies (self-sustaining cities in a single enveloping structure) until 2000. A 1950 start date adds gas-powered electric plants with nuclear power plants only five years away, and also allows all forms of transportation and water treatment plants. The year 2000 adds wind- and solar-powered plants, as well as desalinization plants and arcologies to the mix. The year 2050 adds microwave and fusion power plants to the energy pool.

Report From The City Manager

With so much going for it, many might think that *SC2000* is perfect. It isn't quite there, yet. You would think that someone in



my position would be able to proclaim the new game to be everything *SimCity* fans could have desired, since virtually every criticism I leveled at the game in *The SimCity Planning Commission Handbook* was addressed in the design of *SC2000*. Yet, there are still awkward features.

For instance, I complained about the meager terrain features in *SimCity*. Now, there are multiple levels of terrain, complete with "reticulating splines." This means that the formula which generates maps for *SC2000* builds a series of curves and angles within the hillside terrain so that the map presents credible geological structures. It also means that there are lots of little triangular terrain tiles that cannot be improved by zoning or road, rail and/or on-ramp construction.

I also noted that the original game locked the player into a grid plan for city design. The large square commercial, industrial and residential zones virtually assured symmetrical grids where possible. *SC2000* made the basic zones smaller and, as a result, more realistic in

terms of the way property is zoned in real life. This provides for additional flexibility in using terrain features effectively and creating realistic neighborhoods. Unfortunately, it has also meant that some *SimCity* fans do not feel like they can see what's happening in *SC2000* as readily as they could in the original game.

Again, I lamented the inability to build freeways. Now, you can build them, but you must be able to cross an ordinary road at a 90 degree angle in order to do so. Then, you can build on-ramps to the raised highway that will serve as your expressway or freeway. If you do not place the freeway sections at such a stern angle, you will not get viable on- and off-ramps. Also, many novice mayors find themselves frustrated because they cannot build on-ramps on triangular spline sections or at the end of one of the sections of freeways.

Another problem introduced by the additional terrain possibilities has to do with crossing water. Many mayors are frustrated with their inability to change directions with raised wires. You must be certain that you can get *straight* to where you're going *before* you start crossing water. The same holds true when building bridges. You cannot build circular, S-curve or T-intersection bridges.

Another awkward design feature has to do with the customized signposts. Many novice mayors want to customize as much of their city as possible, but end up unhappy with the results. They forget that the sign is about three tiles in height and a minimum of five tiles wide.

In the more dense areas of the city, placing signs will obscure the topographical view of the city and actually reduce, rather than enhance, the enjoyment of the city's growth. Fortunately, the game allows you to toggle off these signposts when they are obtrusive and unsightly (unlike certain stretches of highway in real life).

Of course, once you have gotten used to the conventions used in *SC2000*, none of these are problems that should significantly diminish your enjoyment of the game. They are simply factors that should be considered by fans of the original game.

Tales of the City

The new scenarios are very similar to those in the original game. Charleston is essentially equivalent to Rio, since flooding is the problem whether caused by recurring high tides or recurring hurricanes; Hollywood is essentially equivalent to Tokyo, since a movie prop monster that rampages out of control

through a metropolis is not much different than a Godzilla-type monster; and a depressed economy in Flint, MI is the same as a depressed economy in Detroit.

The main scenarios of distinction, with regard to play, are the Dullsville scenario where you must build a tourist attraction to build business and population, and the Oakland Hills Fire scenario where you must end the conflagration as swiftly as possible. The latter is not so different than the San Francisco Earthquake scenario in the original *SimCity*, but it plays differently because of the necessity of dispatching fire-fighters to the specific terrain squares where they must put out the fire.

Public Opinion Poll

Is *SimCity 2000* a better program than the original *SimCity*? It is without question a superior program. Will Wright and Fred Haslam have addressed the wish lists of nearly every *SimCity* player that has contacted them.

Is it more fun than the original *SimCity*? It is for me. With the additional depth in play and the proliferation of new options, *SC2000* feels more realistic and offers more challenges. It's *Sim-ple* irresistible. **cgw**

Backdraft

How to stop the Oakland Hills Fire seems to be the most commonly asked question from those who know me and my love for both *SimCity* and *SC2000*. The sneakiest way to get the fire out in a hurry is to use the "Raise Terrain" tool to build up the terrain around the affected fire tiles and, as a result, isolate the fire. To those who insist that this is cheating, I insist that real fire-fighters use bulldozers to create fire breaks. I'm just exaggerating that effort.



I also tried to isolate the fire by ringing it with water. The flames jumped the ring of water. Further, I tried to emulate those airplanes and helicopters bombing the fire with water drops by clicking the "Place Water" tool over the flames. This does not work, even though each click costs your city budget as much as if it did.

You're outgunned.
On the run.
Stalked by a relentless
robotic assassin.

You're desperately searching every dark corridor on a deserted spaceship for DNA keys that reveal how to destroy this mechanical killer. Because only then can you disarm the ship's weapons and save the universe before it's blasted into oblivion.

The critics think this futuristic nightmare is a dream come true.

New Media says it's "more than a great game—it's sci-fi space opera and film noir at its best." *Wired* raves that "Helix is a stunner." And that it has the "gun-to-your-head urgency of an arcade game." So you know it's not another CD-ROM game that crawls.

We like to think of *Iron Helix* as a futuristic hunting game. Only you're what's hunted.



For Windows and Macintosh on
CD-ROM

IRON HELIX

Exclusively
on



Available at your favorite retailer
or call 1-800-695-GAME

IF YOU'VE NEVER HAD

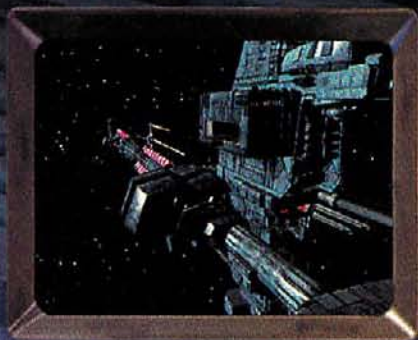

ABOUT

CHASED,

ABO



NIGHTMARES



BEING YOU'RE

UT TO.



Iron Heist © Drew Pictures. All rights reserved.

Circle Reader Service #132

Out Of The Pits

A New Front Runner In Racing Simulations—*IndyCar Racing*

by Gordon Goble

Gordon Goble is a fanatical follower of both real and simulated racing. He has been a member of a racing team and is a frequent contributor to On Track and Formula magazines as a writer and photographer.

In 1989 many of us were still playing games off of diskettes—only a few games required installation—though we still had a hard drive, or rather, many hard drives in Papyrus' *Indianapolis 500 - The Simulation*. And drive we did, over and over and over again, simply because the car we piloted came closer to simulating the actual feel and responses of a real race car than anything we'd ever experienced. *Indy 500* featured no gravity-defying loops, no jumps, no ray guns, just one simple oval track. Boring? Only to the uninitiated. But to those patient folk that stuck with the simulation through its considerable learning curve, then realized the excitement that would stem from cutting just half a second off their best lap time, there was no equal.

To say that Papyrus' new *IndyCar Racing* successfully mimics its predecessor would be a gross understatement. The superb driving sensation of *Indy 500* has certainly not been misplaced, only expanded upon. Yet there is much more to this *IndyCar Racing* story—welcome innovations, questionable calls, and an advanced billing that the program has not quite lived up to.

Auto racing simulations can generally be broken down into five basic elements: The



Driving Experience, Car Set-Up Options, Graphics, Audio, and something we'll call Options and Amenities. Like a pit mechanic with a checklist, we'll look through each and see how the *IndyCar* sizes up.

The Driving Experience

In a word, "Wow!" Computer racing design guru David Kaemmer has outdone himself with *IndyCar Racing*—the only current driving sim where 180 mph feels like 180 mph. An *IndyCar* machine screams down straights and may well drift through corners. Sudden bursts of acceleration (especially from a dead stop) or abrupt applications of the braking mechanism will make for some suicidal handling and possible spins, then torn rubber, as tires

struggle to grip the pavement. Caution must also be exercised at reduced speeds (such as under a yellow flag) as in real life, because a car's high speed ground effects just won't work at such diminished velocity.

In *IndyCar Racing*, the art of "drafting" (following another car closely to use it as an energy-saving wind break) has been presented like never before. Although the application of this technique has been possible in other sims, never have I pulled out from behind the front-running vehicle and felt such wicked turbulence. Trying this sort of maneuver or involuntarily "losing the tow" through any fast corner such as those found on oval tracks will produce undesirable, if not disastrous results. The implementation of this drafting effect is a design masterstroke.

As can be expected from Papyrus, driving an *IndyCar* with a modicum of efficiency

IndyCar Racing



TITLE: *IndyCar Racing*
 PRICE: \$59.99
 SYSTEM: IBM
 REQUIREMENTS: 386-25MHz or better, 4MB RAM, VGA graphics, 15MB hard drive space; supports AdLib, PAS, Roland and Sound Blaster sound cards
 PROTECTION: Documentation look up
 DESIGNER: David Kaemmer of Papyrus
 DISTRIBUTOR: Virgin Games
 Irvine, CA
 (800) 874-4607

takes a great deal of experience and persistence. Yet, once the proper technique has been mastered, rewards are plentiful. You must remember that cars get lighter as fuel decreases, tires wear out, and car handling ebbs and flows. Finesse most often wins out over muscle on both this and the real-life IndyCar circuit, and it is genuinely surprising how such a powerful machine requires such a gentle touch. Surprising and brilliantly accurate.

But getting fast on an open track is just part of the equation. Being good involves dealing with traffic, and while this too is difficult, it is a worthy challenge that offers a fairly accurate racing experience once mastered. Other drivers behave as they should, and slower vehicles will politely move out of the way of a fast approaching machine, while equally powered cars will, grudgingly, give ground. It also seems that certain drivers have been given some real life characteristics, and while no names shall be mentioned, one driver in particular appears to perform in a dependably erratic fashion. But at least he is consistently so.

And now he can be erratic on a number of tracks, as *IndyCar Racing* offers rubber-burning action at a full compliment of racing venues. From the claustrophobic temporary street circuits of Long Beach and Toronto, to the sweeping beauty of Portland and Laguna Seca, or the fire-breathing ovals of New Hampshire, Michigan, Milwaukee and Nazareth, *IndyCar Racing* exposes the vastly different driving styles it takes to compete in an IndyCar season. The player will soon find that while the Milwaukee Mile is one thing, snaking through the walled streets of Toronto is downright frightening.

Apart from the curious omission of curbing, tracks appear faithful to their real-life counterparts, including the extreme changes in elevation at Laguna Seca, where a car will seem quite a bit lighter at the crest of a hill than at its base.



The rest of the IndyCar circuit (with the exception of Indianapolis itself) is promised as an add-on package within the next few months.

The inevitable meeting of mettle with mettle resulting in the meeting of metal with metal will indeed bring about interesting visual thrills, as smoke, departing tires, and the

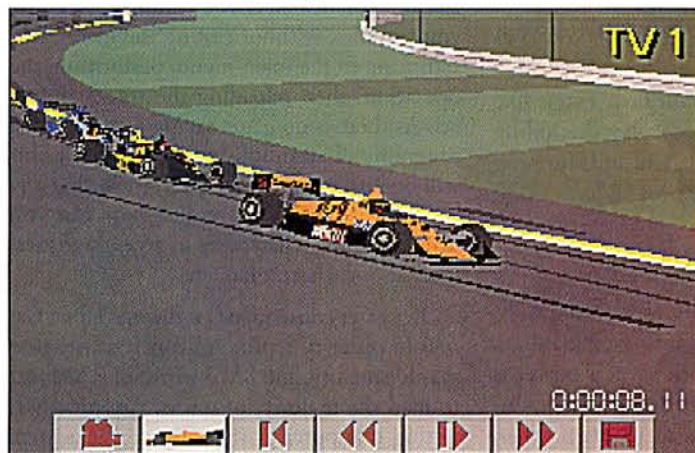

odd flash of flame are depicted on screen. Yet the Papyrus promise of superlative explosions, detached engines, and other assorted carnage is not part of the package. Sadly, too, the audio burst of tire brushing gently against wall is identical to that of car slamming into end of pit wall at 170 mph. One would think

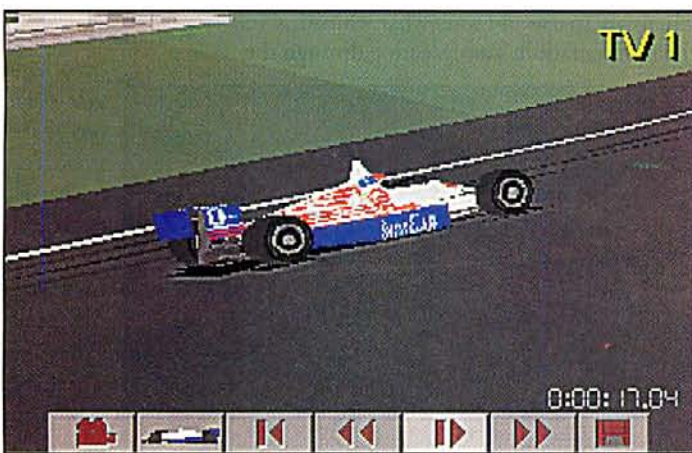

the latter should sound akin to a garbage truck being dropped off the Empire State Building, but such is not the case. That racing's intrinsic viciousness is not brought forth to the ear will bring a tear to the eye of those who enjoy a little mass destruction with their speed.

Overall, though, *IndyCar Racing* presents the closest imitation of the real life racing experience that has ever crossed a hard drive. On my personal scorecard, the graphics earn an "A".

Car Set-Up Options

Plentiful and effective choices are at the ready for anyone who fancies having some mechanical aptitude. Starting with one of three default set-ups (*Easy, Fast, or Ace*), you can then customize your machine. Variances in gear ratio, wing configuration, fuel load, brake bias, and tire pressure, compound and stagger are not uncommon in this quickly evolving class of computer product, yet *Indy-*

Car delves a little deeper into the world of modification possibilities. Steering radius alterations (affecting the sensitivity of steering), and chassis roll compensations (adjustable from within the cockpit) are some of the fresh looks, but fuel mixtures and spark advance are not yet tinkerable (although originally expected).

As in the real world, the driver/mechanic will never be fully satisfied with an *IndyCar Racing* vehicle set-up. Often, modifications to one aspect of a car may nullify the advancements made in other areas. Also, a vehicle's handling will change throughout a race, as will the unpredictable flow of events (high speed chases versus plodding, accident filled affairs). Educated guesswork before and during a race is a most valuable weapon, and nothing can replace a steady, opportunistic driver.

Though missing a few features, the set-up modifications earn an "A-".

Graphic Glory

Papyrus is proud of their new graphical technology, and *IndyCar Racing* is the first racing simulation to join the flight simulators on the 3D texture-mapping bandwagon. From first sight, all other racing simulations are put immediately to shame. Particularly

impressive are the cars themselves, riding for the most part with accurate colors (most cars are digital representatives of the real thing) and logos. On the sideline, towers, signboards, vegetation, and everything else is textured, creating an illusion of depth and realism.

Under actual driving conditions, though, this visual cornucopia does little to improve a driver's perception, and in certain instances, may detract from it. The "ghostly" presence that goes hand-in-hand with the current state of 3D texture mapping fails to draw clear lines between on-track steeds. I found myself asking, "Is Tracy's car just inches away, or feet?", or "It sure didn't seem like we touched" until I figured out from experience what kind of buffer was required around my car. The sensation of depth provided by the 3D graphics can be deceiving, but these perceptive difficulties will cease to become a problem once you learn to trust your experience, and not your eyes.

When taking into account little extras like the beauty of the *IndyCar* replay (including eight, count 'em, eight separate and stunning camera angles), graphics rate a "B".

An Earful Of Audio

There's not much in the way of audio diversity expected from an auto racing sim. A clear engine note that varies when power is applied and when gears are changed, a graduated and precise tire squeal to warn when rubber has reached its adhesion limits, the roar of approaching and receding traffic, and an indication that your vehicle has met with something it shouldn't have are the necessary ingredients.

Arranging auto audio into a working arrangement is a Papyrus specialty. Like *Indy 500*, *IndyCar Racing* provides informative and precise engine buzzes and tire screeches, and the opposition is now heard in all its Dopplerized glory. So far so good, but as mentioned earlier, the sounds of contact are neither varying nor believable. As well, the digitized vocal strains of real-life *IndyCar* announcer Paul Page would have been a nice addition in spots other than the program introduction—perhaps announcing your hard-fought podium ascent and the like.

Giving full credit for accurate engine and tire sounds and that incredible Doppler effect, but subtracting points for contact sounds, the audio earns a "B".

Options And Amenities

The no-nonsense *IndyCar* interfaces and menus belie the wealth of options presented within. Simple menus blossom into sub-menus and branch out from there. This lack of interface fluff is welcome, as hard core racers don't really want to see anything but garage, pavement, other cars, an instrument panel, and a checkered flag.



But a certain inflexibility exists in *IndyCar Racing*. For instance, you cannot recalibrate your joystick without exiting the race-track, returning to the main menu, performing the operation, then reloading the track, and so on. As there is no game saving feature in the program, all accomplishments to that point will be lost, except as a replay, including any spectacular qualifying results. Nor can you print anything whatsoever or access statistics, such as one's fastest lap, etc.

Of greater consequence is the need for a fast 486 in order to reproduce much of the new graphic quality, and 8MB worth of RAM just to load the majority of tracks. On my 4MB testing computer, a mere three tracks were playable, with a maximum allotment of 14 competitors in any given race.

As for written material and helpful instruction, *IndyCar Racing* has taken an odd approach. Although the game manual is steeped in information on the history of the *IndyCar* and hints on ways to squeeze more speed from a car, actual game details (what keys to hit and when) are sparse and somewhat whimsical in their presentation. Vainly leafing through the

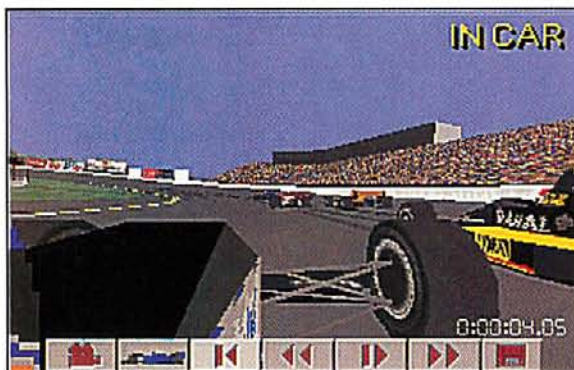

IndyCar manual may become all too common for some.

The *IndyCar* control method options are very powerful. Almost any key, joystick button, or joystick axis can be configured to your input style. In addition, both linear or non-linear steering is at the ready, as are rookie aids such as automatic braking and shifting. Race realism is also variable, and elements like weather, race length, and opponent strength will serve to keep even the most jaded auto jockey enthralled over the long haul. Oh yes, modem play is indeed part of the package, but as of publication time it was not yet working properly for all systems, and Papyrus—like a frantic pit crew—was working feverishly to fix it.

In the cockpit, constantly updated race standings can be viewed at a glance with a mere flick of the F1 key, while tire temperatures and fuel projections are accessed via F2. Pitting is an art unto itself, but a four wheel tire change and fuel replenishment will be completed as quickly as you can tap either a forward cursor or "Enter" key. However, caution should be exercised to keep your joystick consistently calibrated as more than once the program has failed to recognize that the car has come to a complete stop while in the pit area. And, as we all know, a crew won't start working on a moving car.

With these specific reservations in mind, I give *IndyCar Racing's* Options and Amenities a "C+".

The Race Results

IndyCar Racing is the purest driving game ever let loose on the gaming public. Arriving just one year after *World Circuit* took the digital racing world by the arm and led it out of a rather glum situation, *IndyCar Racing* is enough of a product to push simulations to a new level. *IndyCar* doesn't deliver as complete a package as its advanced billing (and my Sneak Preview) had lead us to expect, but it attempted a lot, and even in falling short it sets a new standard.

And there is still hope that *IndyCar* will become all that it can be. On the side panel of the *IndyCar Racing* box is the phrase "First in a Series from Team Papyrus Racing," and one would think this means Papyrus is in this game for the long haul. The development team also appears to be working diligently on the production of updated versions, additions, patches, etc. These are good indications that a solid future awaits this product and its fans. **CGW**

Between The Devil And The Deep Blue Sea.



1942
THE PACIFIC AIR WAR™

**THEY WERE DESPERATE,
DARING AND DEADLY!**

The relentless gunfire of Japanese Zeros. Gravity-twisting dive-bomb attacks. Dropping

torpedo "fish" on unsuspecting carriers. There's no room for error when you're a naval aviator in *1942, The Pacific Air War*, the ultimate simulation of air combat in the South Pacific.

Taking on the same challenges that World War II fighter pilots faced, your tour of duty includes some of the most heroic battles ever fought. Battles that will have you chasing down Wildcats, Corsairs, and Zeros in death-defying dogfights. Performing high-speed dives upon heavily defended carriers. And pushing your skills to the limit as you master WW II air combat in an innovative virtual cockpit.

The outcome of the war in the Pacific turns upon your actions. Your task force is depending on you. And the skies are yours to control in *1942, The Pacific Air War*.

CHALLENGE the enemy at the battles of Coral Sea, Midway, Eastern Solomons, Santa Cruz, and the Philippine Sea!

COMMAND U.S. or Japanese forces!

PILOT any of ten historically-accurate planes, each with its authentic cockpit and flight characteristics!

SWEAT over the comprehensive strategy for all naval forces!

EXPERIENCE the thrill of head-to-head dogfights with a friend via modem connection.

MICRO PROSE®

© 1993 MicroProse. ALL RIGHTS RESERVED.
For IBM-PC/Compatibles.

200 Laps To Glory

IndyCar Racing Strategy And Race Summary

by Gordon Goble

The *IndyCar Racing* default 5% race distance will be a common undertaking for most computer racing buffs. At this length, a complete race can be wrapped up in no time, and with the full car damage option engaged, a serious accident will mean the undoing of mere minutes, as opposed to hours, of arduous driving.

A journey into the realm of actual *IndyCar* race distances is another matter. It is a daunting proposition, but it is a matter of honor, and an undertaking that all serious sim fans must eventually undertake. After all, it's really what the game is all about. A 100% race distance extravaganza will instill a total respect for the concentration, the decisions, and the frustrations facing a Paul Tracy or Bobby Rahal, and it entails a complete modification to your driving style. With these thoughts in mind, I took to the pavement at New Hampshire with all of the switches thrown (Opponent Strength 100%, Full Car Damage, No Driving Aids, Linear Steering through a CH Products Flightstick) and my ears pinned back.

Qualifying

Being a proud *Indy 500* addict for several years had familiarized me with the impressive and authentic car handling and modeling that Papyrus has now incorporated and built upon in *IndyCar Racing*. Although not recommended for rookie drivers, I chose the latter of the three (*Easy*, *Fast* or *Ace*) default set-ups. Accessing *Qualifying* from the menu, I realized that my opponents were recording good but not impossible times, and consider-

ing New Hampshire is the most straightforward of the *IndyCar* tracks, I knew it wouldn't take much in the way of modification to secure a solid grid position.

First to the garage, where a quick drop in fuel supply from 40 to 3 gallons would still get me around for my two qualifying flyers. The car load now lightened, an eight notch decrease in wings (both front and back) helped bring about a top speed of nearly 180



mph at the end of each straightaway, yet the car did not slow appreciably in the corners.

This wing adjustment meant that my engine was now topping out early in its current gear configuration. Taller gears would represent a higher top end, and since a good lap at New Hampshire required only a perfect sixth gear, sixth gear was lengthened by two key-strokes. Now the engine warning light reared its ugly head for just a moment and only at the end of a perfectly carved lap.

On to where the rubber meets the road. Real life *Indy* drivers and mechanics will tell

you that adjustments should be made so as to equalize the inside, middle, and outside temperatures of each tire at the culmination of several hot laps. *IndyCar* allows the experimenting driver to monitor all tire temperatures while in the cockpit by depressing the F1 key.

Various tire pressure and chassis adjustments brought about a little more harmony in the readings, and I believe this helped to squeak out an extra half second or so in my lap times. Incidentally, my new and improved car asked for and received a rethinking of my driving line until I got it just right. Again, this wasn't the *ultimate* car set-up (I was able to turn a 180.2 mph lap in rehearsals), but it would do the trick in qualifying—if the driver held up his part of the bargain.

In the end, all the time I'd spent perfecting a knife-edge setup meant very little in application, as my fastest qualifying lap of 178.83 mph was 8 mph quicker than any of my rivals. Paul Tracy came closest at a 170.32, and I quite possibly could have grabbed the pole with just a low fuel but otherwise stock "Ace" set-up. An unmodified Ace is what I would drive as I attempted the 211.6 miles of New Hampshire.

The Race

The race was held on December 8, 1993 at Loudon, New Hampshire. The weather was

1993
WINNER
ON-LINE GAME
OF THE YEAR.
**COMPUTER
GAMING WORLD**
The #1 Computer Game Magazine

IN CYBERSTRIKE, ALL BEGINNERS WILL BE TREATED FAIRLY. AND THEN DESTROYED.

Beaten all the boxed games? Done the arcades to death? Try CyberStrike™, the wild new multi-player game on GENie where you hop into a two-legged CyberPod and battle it out against other real live humans for control of a virtual reality city. The action's fast and furious. But even if you're new in town, you won't get blown to Kingdom Come. Well, not right away at least. In fact, CyberStrike is so easy to learn, you might actually live long enough to waste someone else first. And best of all, it only costs three bucks an hour.* So strap yourself inside a Pod and come out shooting. You've got nothing to lose. Except your life.

GENie® multi-player games

100% ORGANIC OPPONENTS

SIGN UP NOW: 1. Set your modem for half duplex (local echo) at 300, 1200 or 2400 baud. 2. Dial toll free 1-800-638-8369. Upon connection, enter HHH 3. At the U # = prompt, enter JOINGENIE then press RETURN 4. At the key code prompt enter AMB423 5. Have a major credit card or your checking account number ready. For more information in the U.S. or Canada, call 1-800-638-9636.

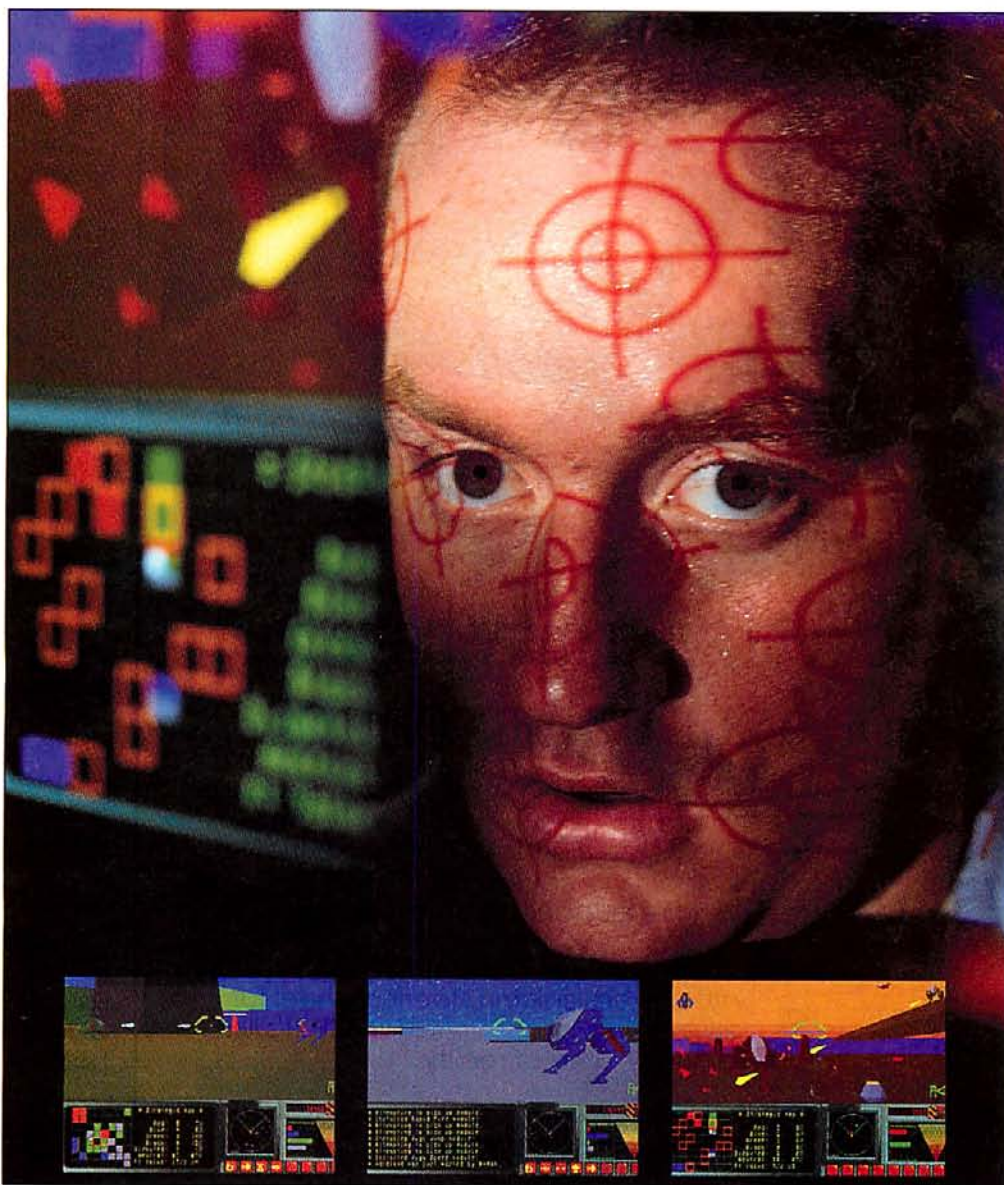

*Here's the fine print. GENie multi-player games and support services are \$3.00 an hour in non-prime time: 6 p.m. to 8 a.m. local time Mon.-Fri., all day Sat. and Sun. and selected holidays. There's also an \$8.95 monthly subscription fee. Each month, you'll get credit for up to four hours of non-prime time usage. Any surcharges incurred apply to all hourly usage, including your first four hours.

 **SIMUTRONICS**
MULTIMEDIA

set at default, and considering the odd time of year for a real event such as this, would not be a factor. My 486-33MHz machine with a measly 4MB of RAM allowed for just 15 entrants, so traffic would be light.

My start was lousy, even though I used my sneaky strategy: start from the back of the pack, hanging back for half the pace lap, and then make a full speed run that will often put me at the front by the green flag. Dirty, yes, and the program shouldn't really allow this sort of thing, yet I'll take any break I can.

I found myself suddenly stuck behind slow traffic. Fearful of pulling



through traffic and eventually passed fellow Canadian Scott Goodyear for third by Lap 10.

Dealing with backmarkers was next on the agenda, and geez!, some

of these guys are painfully slow. Yet the good artificial intelligence of *IndyCar* drivers showed in a hurry as car after car, realizing what a hot shoe I was, moved aside to accommodate me. Staying low in the corners, I began lapping traffic. If this had been a shorter race I would've been taking even more chances, but I'd now moved within six seconds of a front-running Fittipaldi, and I wasn't about to crash out.

Continuing to pause the race after key developments allowed me to feverishly scratch down some notes without losing much in the way of driving rhythm, and we'll go to my grammatically-wanting unedited diary for the remainder of this event.

- Lap 24: Decided to hit F1 Key and have current standings constantly displayed in the top left corner of screen.

- Lap 30: Clear track for the first time today. Just put together three consecutive 170.5 mph laps, and Emmo's in my line of fire. Get Emmo!

- Lap 31: And he assumes the lead! Tires really biting now with dropping fuel load. Lap time: 171.4. I'm in front!

- Lap 53: First pit stop. Been running at full turbo boost, and while my half-lap lead is a definite plus, stopping now isn't. Pits are empty, and everyone else looks to be going a little further on down the road til stopping. Will turn boost down. Too nervous. Hit a couple of wrong keys in pits and took ten seconds longer than I should have!

- Lap 57: I've never, ever run this many laps in one go. I am one with the computer.

- Lap 60: Everyone's pitted now and I'm running second behind Goodyear who must have had a hell of a stop since Fittipaldi is now behind me as well. Maybe he didn't change tires. Maybe I shouldn't have. Maybe I'm losing my mind.

- Lap 78: Up nearly a lap. Mario, you idiot! Should have steered clear of erratic Andretti. We touched, he crashed, I popped a front tire. Luckily, it happened in Turn 4, close to pits. Up against outer wall, I somehow got turned around and hobbled through a line of traffic into the pit



So real, you may have to notify air traffic control.

You no longer have to imagine the experience. Because now you can live the dream.

Introducing G-FORCE, the high-tech flight yoke that lets you pitch, roll, bank, soar and never lose control. Activate dual fire buttons, throttle control, and more!

So flexible, it even transforms into a fixed-column steering wheel for driving simulations. Try G-FORCE. It's like a heavy dose of reality.



Suncom
TECHNOLOGIES

The Hardware Advantage
for Entertainment Software

6400 W. Gross Point Rd., Niles, IL 60714
708/647-4040

Screen shot of WORLD CIRCUIT™ by MicroProse™
Circle Reader Service #134

FOR IBM AND COMPATIBLE PCs.

**From Those
Wonderful Folks
Who Gave You
Gridlock, Blackouts
and Runaway Taxes,
Comes Raw Sewage,
Yellow Journalism
and the Subway
at 3 a.m.**

area. Losing much time! Program told me to "Press Esc" and start again! Stupid program! Crew knew better and fixed my car. Got fuel too.

- Lap 80: Back on track, still under Mario's yellow flag. Be careful running under the yellow—ground effects don't work at slow speeds. It's real easy to lose control.

- Lap 97: Still in second behind Goodyear. Other cars very light - Scott pulling away no matter what I do - 16.2 second lead. But he will have to pit soon. I know he will.

- Lap 99: Halfway through. Saw and heard cars in pits. Checked standings from top to bottom while running. Raoul Boesel out with handling problems, Danny Sullivan with electrical.

- Lap 130: Everyone but me in and out of pits now. Goodyear took his time—tire change? And little ol' me, with turbo at 7, has a 10.3 second lead on Emmo. I'm running a lot lighter and quicker than anyone with my last unscheduled stop.

- Lap 138: Into pits with 62 to go. Went in with one-lap lead, out five seconds behind. Can I go all the way without pitting?

- Lap 152: Rahal suddenly caught behind Jones. Road hog! Unexpectedly came down on me in Turn 2, or was that 4? I don't know anymore... Fittipaldi took the inside. I burst through the middle, inches to spare! Tight, very tight.

- Lap 164: I see Goodyear caught behind two of the slowest cars ever made. I'm now on his tail and I think we both have one more quick stop for fuel. This far into it, I don't

know if I have the guts to try the moves I must make to win this thing.

- Lap 174: Went too wide in traffic, brushed wall, popped tire. Turn 4, next to pits. Good thing! Out again in third, two laps down to Goodyear and Emmo.

- Lap 180: Two cars out with engine failures. Unfortunately, not Goodyear or Fittipaldi, but lots of clear track for the hero. They're duking it out just one lap up and with boost back on 9, it's sprint time!



- Lap 186: Fourteen left and Goodyear and Fittipaldi are going at it just 100 feet in front of me. If only I was on their lap. If I get around them, I can always hope for yellow.

- Lap 190: Fittipaldi into pits! Comes out just four seconds ahead of me. When's Goodyear going to do that?

- Lap 191: I pass Goodyear and am on his lap. He's not moving fast. Low fuel, Scott? No fuel, Scott?

- Lap 198: See you later Emerson. I'm now in second, but Goodyear lives! If I crash out now, I won't give any interviews.

- Lap 200: I did not win. In most cases, second doesn't rate, but I feel fortunate to have made it this far. 13.6 behind the blue and silver machine of Goodyear (average speed of 156.7 mph), and two seconds ahead of Fittipaldi, who was at least two laps up on everyone else. Not bad for a rookie. Five cars did not finish. There was one caution period. Glancing at the clock in the bottom right corner, this race was one hour twenty-nine minutes in length.

- Post Race: Where can I find my fastest lap? Who can find my fastest lap? I know I set the fastest lap in the darn thing, so why can't I find out what it is? And while I'm at it, where is the printer support? Why can't I print this thing out! And why am I not standing on a podium somewhere? I finished second, didn't I? Is that it? Is that all there is? I've got questions!

Delirious? Who, me?

After a cool Molson and some breathing exercises, I regained composure and finally relaxed after this grueling ordeal. Though still a bit perturbed that my 200 commitment wasn't given due treatment by the program (I would have been happy with just the fastest lap stat!), I have to admit that *IndyCar Racing* delivers the best racing experience this side of the crash wall. **CGW**

10 Steps To A Smoking-Fast IndyCar

The following suggestions are not intended for use by amateurs. We will not be responsible for the consequences. The vehicle created as a result of these suggestions will not win any races, and is almost undriveable. Yet, if handled correctly, this machine (*designed for oval tracks*) will respond with one *really* ripping fast lap, and one only. If you think you've got what it takes to handle this monster, here's the scoop:

- 1) Start with the program's default Ace car set-up and reduce the fuel level to 3 gallons, then lower the wing settings until the car becomes "nervous" yet driveable in the turns (reduce front and rear proportionally). Front wings should be one-half to one full degree more than the rear.
- 2) Configure the shocks and sway bars into the upper ranges of stiffness settings (keep the fronts 30 to 50% stiffer than the rears).
- 3) Install a taller top gear until the over-rev light on the dash just blinks lightly at the end of straights.
- 4) Put soft compound tires on all four corners.

- 5) Adjust camber angles and tire pressures until even temperatures across each tire are seen at the halfway point of your first flying lap.
- 6) Double or triple the factory stagger settings. Keep an eye on the tire temps and repeat Step 5 if they change.
- 7) Reduce wings further until you reach the "trade-off point" where lap times become slow despite tremendous straightaway speeds. Alter top gear proportionally.
- 8) Fine tune the sway bars to assist "point-in." Stiff front and soft rear will make the car loose or oversteer—the opposite will induce push or understeer.
- 9) This car is now extremely fast—save it to disk. If you do want to perform any additional customized tweaks, do so *one at a time* or you'll never know which change actually worked.
- 10) Practice. Impress friends. Be a star.

Thanks to professional crew chief, Rick Weaver, and driver, Andy Mahood, for their help in devising this set-up.



Now Entering SimCity 2000™



More SimCity flavor—less salt. The desalination plant pumps fresh water into pipes you lay in the new underground level.

you uptown, downtown, even underground. Now entering SimCity 2000—the ultimate city simulator.



Beneath the polished facade lies a seething cauldron of angry taxpayers, broken water mains and other challenges that will take

This long-awaited follow-up to our software landmark, SimCity® makes simulated real estate, in a word,

realer. In it, you get multiple viewing angles. You get to import your old SimCities. You



Stop the presses! 2000 comes complete with a daily paper that may have you wanting to repeal the first amendment.

get to terraform your landscape. You get total control of a subterranean web of water pipes and subways. And you get it all in gripping, eye-imploding 3-D.

So pack up those old programs and move to SimCity 2000. Everything that started the SimCity revolution. In a vivid new evolution.



Take a bite out of crime. Build SimPrisons—along with SimHospitals, SimSchools and other city SimServices.

The Ultimate City Simulator.



Available for IBM PC & compatibles and Macintosh. © 1993 Sim-Business. All rights reserved. SimCity 2000 is a trademark of Sim-Business. Maxis and SimCity are registered trademarks of Sim-Business. For product or ordering information, contact your local retailer or call 1-800-33-MAXIS.

Circle Reader Service #84

Mac Gamers Are Abuzz Over



by Christopher Breen

F/A-18 Hornet

The number of flight sims currently available for the Macintosh can be counted on one hand and a couple of fingers. Unlike the minions of Big Blue who could easily build a two-story home out of their software boxes, Apple aficionados have had to make do with a few scant offerings—mostly ports of DOS products—that barely cover the major war machines. So, an amount of excitement is understandable when a company like **Graphic Simulations**, makers of the outstanding World War II era *Hellcats Over The Pacific*, trots out a fast and fluid simulation of the McDonnell Douglas F/A-18 Hornet that is designed, expressly, for the Mac.

The F/A-18 is a modern, multi-mission jet fighter and, as such, carries all the goodies that one would expect from a pricey bit of military hardware. We're talking two General Electric F404 engines, fly-by-wire, Head-Up-Display (HUD), AN/APG-65 radar system that employs four air-to-air and two air-to-ground modes, air-to-air weapons that include the M61A Vulcan cannon and the AIM-9 Sidewinder and AIM-120 AMRAAM missiles, a variety of free-fall bombs and electro-optical missiles for air-to-ground attacks, defense mechanisms like chaff, flares, and ECM (Electronic Counter Measures), TACAN (TACtical Air Navigation), ILS (Instrument Landing System), FLIR (Forward Looking InfraRed) pod, RBGM (Real Beam Ground Mapping), other assorted acronyms that probably stand for something useful, and more lights and gauges than you could shake a Gravis MouseStick at.

Whew! Surely you can imagine an aircraft lugging about this kind of technology would require a healthy amount of training by perspective pilots. Just so. Fortunately, that training is a simple "Command-T" away.

The pilot in training is whisked off to the balmy environs of Hawaii, where he practices such skills as airbase and carrier take-offs and landings, navigation, and air-to-air and air-to-ground combat. During this period, although the young ensign is advised to follow

a predetermined course of exercises to hone his abilities, there is nothing that keeps our green warrior from, say, lobbing a BLU-107B "Durandal" anti-runway bomb at Honolulu International or strafing the tourists on Waikiki. Naturally, if this sort of mischief took place during an actual mission, these untoward actions would result in a court-martial and, in addition to blemishing our recruit's permanent record, would remove him from the active-duty roster. But for now, anything goes. Once the pilot is comfortable with flying, shooting, navigating, and dodging, he can elect to move from the tropical to the topical by choosing to fly the only currently available theater of war: Kuwait.



In order to earn a ticket home from this sandy conflict, the pilot must successfully complete a tour of duty made up of seven missions, spanning four levels of difficulty, that are selected by the program from a pool of 28. Successful completion of a mission is defined as meeting the mission goals, returning to friendly territory alive (this doesn't mean that the plane needs to be in pristine condition or even recoverable), and not having destroyed any friendly property along the way. The missions cover everything from offensive and defensive strikes to escort duties to escapes from enemy bases. In each mission, enemy resis-

tance comes in the form of surface-to-air missiles, anti-aircraft fire, and skillfully piloted MiGs.

To begin the tour of duty, you select New Pilot from the File menu. After a brief pause, up pops the Pilot window which contains three folders marked Dossier, Briefing, and Map. Dossier, the default folder, details the pertinent facts of our eager ensign: rank, call sign, number and type of enemy kills, status (active, MIA, court-martialed, dead), number of sorties and aircraft lost, score, awards, and a blank line for a user-assigned name. Clicking on the Briefing folder reveals the objectives of that particular mission as well as a hint or two regarding the kind of resistance the pilot is likely to encounter. True to its name, the Map folder provides a low-detail map of the mission area and waypoint locations. These navigation waypoints indicate the approximate position of primary and secondary targets as well as friendly bases and carriers.

Prior to flying a mission, our pilot must outfit his fighter with a range of weaponry. Although each mission carries a program-recommended load of weapons, the pilot is allowed to overrule these recommendations and select the kind of firepower that he deems necessary for success. Naturally, the pilot is limited to armaments that are intended to fit on a particular weapons station. The only other limitation regards weapons that are not approved for use in a particular mission—no fair dropping a B-57 tactical thermonuclear bomb on that pesky SAM site. In addition to weapons,

F/A-18 Hornet



TITLE: F/A-18 Hornet
 PRICE: \$79.95
 SYSTEM: Macintosh
 REQUIREMENTS: 68020 or better, 4MB RAM, System 6 or higher
 PROTECTION: Manual look-up. Access code is provided with return of registration card.
 DESIGNER: Trey Smith
 Publisher: Graphic Simulations
 P.O. Box 797306
 Dallas, TX 75379
 (214) 699-7400

one has the option to load an extra fuel tank and an FLIR pod.

Once the aircraft is fueled, it's off into the wild blue—or should I say the angular, brown and blue—yonder.

From The Left Side of the Aircraft You'll See...

As with most flight simulators, the outside world is represented as trapezoidal mountains, rhomboid seas, and quadrilateral deserts. Graphic Simulations has attempted to add a bit of spice to the scenery by including the occasional oil field, jeep, and collection of palm trees and sand dunes. These graphic elements are present strictly as window-dressing and are not representations of "real" objects that can have an effect on your well being. To put it plainly, a willing pilot could blast through a grove of date palms at an altitude of eight feet and emerge with no damage to fighter or flora.

Although the surroundings are less than captivating, there are plenty of ways to view them. From inside the cockpit, the pilot has eight 45-degree lateral views around the aircraft as well as one above. A number of external views are also available. These include perspectives from the enemy, nearest ground viewpoint, wingman, and a four-position rotatable camera. For those CNN highlight films, Chase Weapon and Weapon-Eye views can also be selected. These views are important for more than gawking at the scenery; in some cases, there is no radar tracking of incoming missiles, and it's up to the pilot to spot telltale vapor trails.

The Buzz on Hornet

Hornet sports the features found in the best of today's flight sims: Network Play (AppleTalk and Apple Remote Access support), filmed replay of last mission complete with multiple views, determination of the competence of your enemy and the lethality of ground weapons, support for external controllers such as the Gravis MouseStick and Thrustmaster system, multiple monitors, and the ability to make your aircraft more or less susceptible to enemy attack. Admittedly, this is a pretty powerful feature set, but all the features in the world don't mean diddley if the plane flies like a brick or mean diddley if the plane flies like a brick and the scenery strobbs by. No worries here—Hornet feels great. There is absolutely no problem with frame rate, the action is very fluid, and switching from one view to another is seamless. In addition to making the action smooth, Hornet's designers have taken pains to get the little things right. Everything from the interior of the cockpit to the inclusion of McDonnell

Douglas' Hornet owners manual speaks to their attention to detail. In most cases, this detail pays off in a great gaming environment, but at other times, one wishes that things had been fudged a bit.

Take the cockpit, for instance. Rather than cram the necessary monitors, gauges, and indicators into an unrealistic single-screen view, the designers elected to provide two views: The Cockpit View that incorporates the can-

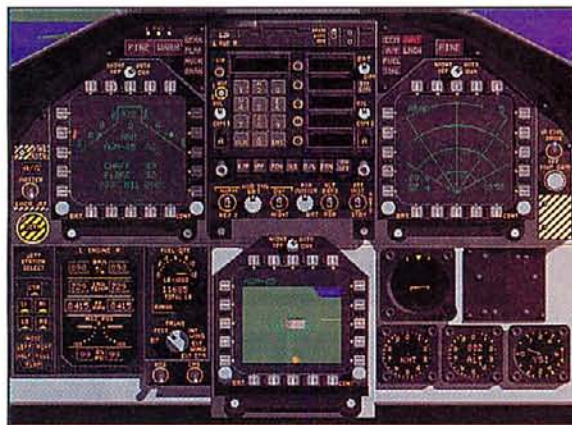

opy, HUD, and weapons and navigation screens; and the Look Down View that contains the MultiPurpose Color Display (MPCD), engine and fuel displays, and analog gauges. The trade off of this split view is that although the integrity of the Hornet's design is maintained, there are times when it's extremely inconvenient to take your eyes off the road. This difficulty is compounded when you consider the kind of simulation we're dealing with.

Modern Warfare

The F/A-18 Hornet is a modern jet fighter that operates under modern wartime conditions. Graphic Simulations has incorporated these conditions into its model and has produced a simulation that is very different from the dog-fighting sims to which we've grown accustomed. In the good old analog days of flying by stick, we were allowed the luxury of engaging our enemies at a reasonable altitude, within sight of each other, machine to machine. No longer.

Today, most air fighters might as well carry bumper stickers on their tailpipes that state, "If you can read this, I'm dead." A modern mission is comprised of listening for the tell-tale radar targeting beep that indicates your enemy is as good as gone, unleashing your missiles, and heading home for a warm supper. As was revealed in the U.N.'s latest conflict, the only way to get a decent look at your adversary is to check his horrified, missile-

mounted video image the second or two prior to immolation. Such is the world of *F/A-18 Hornet*.

The key to survival in an unprotected Hornet (meaning you haven't invoked any of the included cheats that make your fighter invulnerable to attack) is flying low and keeping an eye on the radar screen. Here's where the inconvenience of the Look Down View becomes readily apparent. Because the current version of *F/A-18 Hornet*, in a tribute to accuracy, offers no way to automatically maintain an altitude below 100 feet—Auto Pilot, once engaged, thrusts the aircraft to 1,000 feet, where the pilot becomes so much flying meat—the pilot must hold the stick with a grip of iron. In a low-altitude run when an electro-optical missile is required, the pilot has to switch views, home in on the target using the missile's camera view in the MPCD, and hope that his hand has not strayed on the stick. At this point, one wonders if the real thing wouldn't be easier to fly.

A pilot's first forays into Kuwait may reinforce this notion. Because the simulation is so complex and detailed, the initial learning curve can be a bit steep. The player who chooses to fly without the benefit of cheating can reasonably expect to lose dozens of pilots before making the big breakthrough. Once that breakthrough comes, though, everything changes. It suddenly becomes clear that this is a simulation of strategy as much as of flight. What previously seemed impossible is now only challenging. It's true that dog-fight enthusiasts accustomed to drawing a visual bead on their enemies may be disappointed by this impersonal approach to warfare, but for those pilots willing to move into the modern age of air combat, *F/A-18 Hornet* provides an eye-opening and eminently flyable simulation.

CGW



**.95 MACH, NINETY FEET ABOVE
THE GROUND, BOTH SIDES
TRYING TO SHOOT HIM DOWN.
WOUNDED IN THE ARM, KAPITAN
ALEXANDER ZUYEV GUIDED HIS
MiG-29 TO FREEDOM
LEFT-HANDED. COULD YOU?**

On May 20, 1989 MiG-29 pilot Alexander Zuyev began a desperate plan to steal the Soviet Union's most advanced combat aircraft and fly it to political asylum.

The pilot who wrote the book on the MiG-29, Alexander Zuyev, tells his harrowing story (including authentic Soviet dogfighting tactics) in Fulcrum from Warner Books.

Turkish air defenses to land safely on a civilian airfield in Turkey.

THE FINEST TECHNOLOGY RUBLES CAN BUY

The plane he flew is the MiG-29 Fulcrum, the crowning achievement of Soviet aeronautics.

Now, with

NOTHING WAS LOST IN THE TRANSLATION

The flight model was patterned after actual Mikoyan Gurevich (MiG) design specifications. So you can be sure that every system and every control is accurately modeled. The flight model was patterned after actual Mikoyan Gurevich (MiG) design specifications. So you can be sure that every system and every control is accurately modeled. The flight model was patterned after actual Mikoyan Gurevich (MiG) design specifications. So you can be sure that every system and every control is accurately modeled.



Shot in a life

and death struggle with the sentry, Zuyev managed to take off. Then, flying dangerously low to avoid radar, he eluded pursuing fighters and deadly Soviet and

MiG-29: Deadly Adversary of Falcon 3.0™ Spectrum HoloByte's add-on to *Falcon® 3.0*, you can climb into the cockpit of the F-16's nemesis.

down the Russian-accented cockpit warnings.

IT'LL TEST YOUR SKILL AND YOUR PATRIOTISM

Unlike the F-16, the MiG isn't a fly-by-wire aircraft, so

For Visa/MasterCard orders call 24 hours a day, 7 days a week: (800) 695-GAME. For technical questions call (510) 522-1164 (M-F: 9AM-5PM Pacific Time).

computer never limits your control inputs, whether inspired or foolish. Its twin Isotov RD-33 engines produce 36,600 lbs. of thrust, to the F-16's 25,000. And superb aerodynamics make it controllable at low speeds and high angles of attack that would have enemy pilots

The most fearsome opponent is a human one. With EBS, up to six players can go head-to-head.



fighting to avoid a spin.

THEY WON'T EVEN KNOW WHAT HIT THEM
Your MiG's IRST (Infrared Search and Track) system can track an F-16 without revealing your presence on his threat display. So you can get on his six o'clock before he even knows you're there. Once in range, you'll be able to lock on to the Falcon just by turning to look at him with the MiG-29's helmet mounted sight. Then call "pusk" (launch) as you fire missiles or "ogon" (firing) as you ventilate him with your computer-accurate 30mm gun. Either way, his plane will make a satisfying crunch when it hits the ground.



Next time you have an F-16 glued to your tail, try the MiG-29's "Cobra" maneuver.

1) You pull up past a 90 alpha climb.



2) Your airspeed drops rapidly; the F-16 zooms past.

THE ELECTRONIC BATTLEFIELD SERIES: THE ULTIMATE CYBER-BATTLEFIELD
EBS is the first series of inter-connecting simulations. Each title works with the others to bring you closer to the real thing

Now you can choose from multiple aircraft, multiple theaters, even which side of the conflict to fight on. And you can go head-to-head over a modem or with up to six

3) You abruptly pitch the nose back to level flight. Now you're on his six, with a little score to settle.

players over a network. It all begins when you add on MiG-29 to Falcon 3.0.

Anything more realistic wouldn't be a simulation.



INTRODUCING MiG-29



Choose your weapon. The Falcon is lethal at long distances. The Fulcrum, deadly close-in. Now you can fly for either side.

VS.

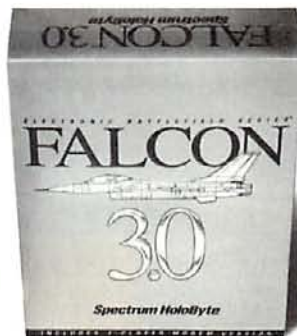

MiG-29 add-on requires Falcon® 3.0. Available on IBM compatibles.

Spectrum HoloByte



ELECTRONIC BATTLEFIELD SERIES®

The fight of your life.



Psygnosis' *Combat Air Patrol* Locks Onto The Amiga

by David Moore and Paul Rigby

Amiga flight simulation enthusiasts have always suffered from a lack of quality flight simulations. The PC has basked in the glory of *Falcon 3.0* and *Aces of the Pacific* while the Amiga has had to endure a serious "sim-deprivation." Ever the champion of Amiga gamers in the U.S. and abroad, Psygnosis has attempted to ride to the rescue with the release of *Combat Air Patrol*. Al-

The game plays very smoothly on a standard A500/600, but players with accelerated machines (such as 68030-based computers) will encounter a rare problem in the flight sim world—the game is unplayably fast! To remedy this, Psygnosis has thoughtfully put a constant speed option on the configuration menu that limits the speed of the game while retaining frame rate.

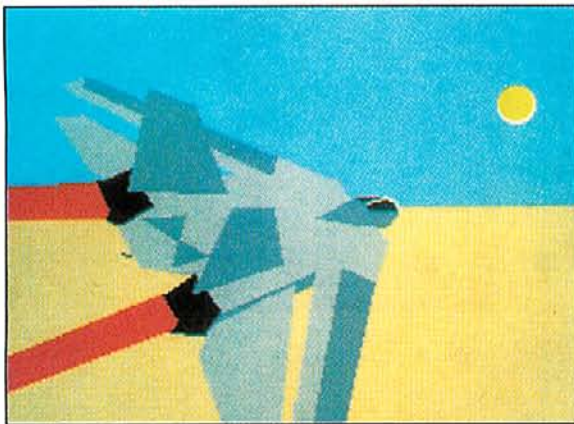

though Psygnosis's first attempt at a complex air combat simulator, they have nevertheless managed to come up with a few new twists that should interest Amiga flight sim enthusiasts.

Combat Air Patrol (CAP) is set within the Desert Storm air campaign of 17 Jan to 28 Feb 1991. More specifically, it simulates F-18 and F-14 missions from the USS Theodore Roosevelt (CVN-71) during this period. You have the choice of flying either attack missions in the F-18 Hornet or air defense and reconnaissance missions in the F-14 Tomcat. Both aircraft will be in demand throughout the course of the game, so it is best to log into the game as two separate pilots.

The game is divided into three sections; Training, Single Missions, and the Campaign. The Training option allows you to try out very tricky carrier landings (both day and night), air to air refuelings (equally tricky), and basic air-to-air and air-to-ground techniques.

The Single Missions option allows such missions as attacking a train, bridge-busting, airfield attack, SAM suppression and the like. The final option, the Campaign, challenges you with the job of removing the Iraqis from Kuwait and is the real meat of the package. Here, a strategy can be devised, air attacks planned, and orders given to coalition ground units. It is easy to see that CAP is more than just a basic flight simulation.

Before each mission, you receive information on friendly aircraft flying with you, as well as a reconnaissance film of the target. It's always nice to have a few Tomcats in tow when flying an attack mission in an F-18, or to have a few mental snapshots of your target when going in for a bombing run.

The weapons selection interface uses the time honored convention of dragging weapons onto the pylons of an aircraft seen from the head-on view. The weapons variety is quite impressive, particularly on the Hornet, which may choose from 15 different types of hardware.

One major fault in the manual is that it does not offer enough information on the many weapon types. One can't tell why one weapon should be used over another. (See *Raiding the Larder* for more information on weapons.) This is a general reflection on the manual as a whole. While not bad, it is at best patchy and does not compare with a standard *Dynamix* or *Microprose* flight simulation manual.

The two jet cockpits are very nicely rendered, with the F-18 looking the more modern of the two. There is an impressive range of views, from full 360 internal view to a range of dramatic external views including one that enables you to follow a bomb or missile to its target.

During flight, the aircraft handle well, with an appreciable amount of inertia when maneuvering. Also, speed is quickly lost when

Combat Air Patrol

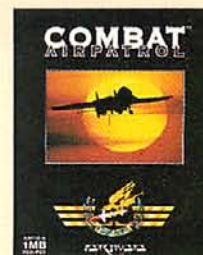

TITLE:	Combat Air Patrol
PRICE:	\$49.95
SYSTEM:	Amiga
REQUIREMENTS:	1MB RAM
PROTECTION:	Documentation look up
DESIGNER:	Ed Scio
PUBLISHER:	Psygnosis Cambridge, MA (617) 497-5457

climbing or in tight turns. The sound effects are good, especially the digitized voices advising the pilot of the next waypoint heading, and there are some great visual effects. The night flying is particularly atmospheric, with tracers arcing up from the target and lights twinkling in the distance.

When a target has been hit, the mission can either be ended, or you can fly back to the carrier, which is, of course, what all "real" pilots will do. The carrier landing is, in my view, the best rendition yet seen on the Amiga, and the night landing is a real test of coordination and nerve. Once back aboard the carrier, the TARPS film of your target will be shown and damage will be assessed—a very nice touch.

The ultimate challenge of the game is the Campaign. In this mode you act as both combat pilot and coalition ground force commander—a tall order in real life. When the Campaign is begun, the briefing room provides details of the first target of the war. The first missions are identical to those in the



Single Mission flights, but there are one or two extras that will not have been seen before.

There is a printer in the crew room that will provide weather information for the target area, and a computer terminal that offers access to the TAMPS—Tactical Aircraft Mission Planning System. This gadget supplies a 3-D representation of the mission route together with any threats. It allows the movement of waypoints, the possibility to add or remove waypoints, the repositioning of the KC-10 refueling tanker to a preferable location and so on. Although not a detailed mission planner, TAMPS does add an extra dimension to the game.

Before the mission is flown, the War Room can be visited where the ground phase of the war is planned. A map of Kuwait can be seen together with the surrounding areas of northern Saudi Arabia and Southern Iraq. Occupying Kuwait are the Iraqi forces shown as blue, and opposing them are the Coalition forces

dressed in brown. Both sides are composed of five different types of units: Infantry, Mechanized Infantry, Tank, Mobile Artillery and Supply. By clicking on an information icon, the status of all units can be seen. Each one has a rating in five categories: Strength, Morale, Supply, Arms and Fuel. Of course, a unit's fuel decreases the further it travels, its strength is depleted by battle, and its morale will be affected by how successful the unit is in battle. For the Coalition forces, each of the categories is measured as a percentage, whereas the Iraqi forces just have High, Medium or Low as a guide to an assessment of their strength.

To move friendly units around the map you simply click on the compass face to select a direction and then click on the unit to move. When a friendly unit moves into an area occupied by an Iraqi unit, battle commences. What you actually see is the final combat resolution, as one of the symbols disappears and the victor remains—with suitably depleted attributes. Common sense needs to be applied in this strategic area in that an infantry unit is unlikely to fare well against a tank unit. When a unit's stock of fuel and weapons is low, supply units (especially captured enemy supply units), can help keep the war machine rolling.

You can order artillery and tank units to barrage enemy units up to three cells away (a cell being the distance a unit can move in one turn). As for the real life Coalition, your initial objective is the ejection of Iraqi forces from Kuwait. Afterwards, you can call a cease fire, as happened historically, or go on into Iraq to defeat Saddam Hussein completely, as some people wanted to happen.

The interface between the flight simulator and the strategy game is provided in the "War Room." Here, you can order air strikes against enemy ground forces—up to three targets per day—and you can select certain tactical strikes against Infantry, Mech Infantry, Tanks, Supply and Artillery. Other tactical missions, such as strikes against SAM sites, AAA sites, road and rail convoys, and all strategic strikes against airfields, bridges and factories are outside of your planning control.

The resultant mission make-up means that the missions that you have personally targeted will be mixed in with missions that you have no control over. When a successful mission has been flown against a target, you can see

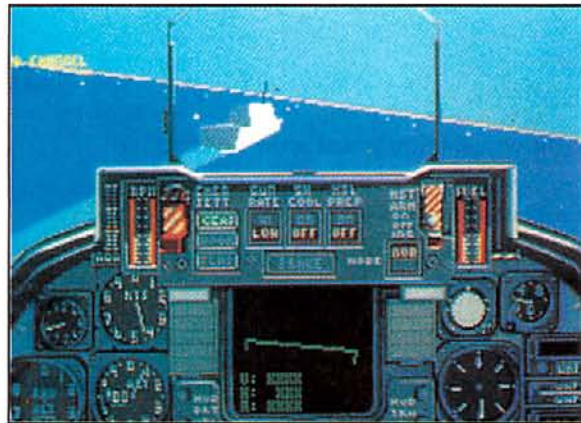

the effects of your strike on the War Room map. If it was a successful mission, the target's attributes will have been reduced, giving friendly ground forces an easier task, or the enemy will have disappeared off the map altogether allowing the Coalition forces to proceed unhindered. This method does give an impression of supporting friendly ground forces, but is not as successful as the troop support implementation in Domark's *AV-8B Harrier* engine.

Combat Air Patrol is a reasonable flight simulator with a few new twists, a sort of souped-up *Interceptor* tied to a rather basic wargame. It would have been vastly improved had all targets appeared on the map, allowing you to schedule all of the missions, possibly assigning targets for other aircraft. A much better manual is also needed. For instance, a lot of the points covered in this review regarding the Campaign and Weapons Delivery were not explained adequately in the manual.

Overall, the game has much to like despite its flaws. What is disappointing is that *CAP* could have been greatly improved quite easily. Having said that, *Combat Air Patrol* is a good first effort from a company with no background in flight simulations. I only hope they keep plugging away at the genre.

Problems With Protection

The answers to the copy protection questions asked on boot-up can be found on the first page of every chapter. The manual does not tell you this, and the necessary data is very easy to miss. More than one reviewer has been fooled by this. None of the UK magazines managed to convey the solution to this problem, and Psygnosis released 5,000 games before the problem was brought to their attention. Inquiries to Psygnosis resulted in an assurance that an addendum sheet is now enclosed with the game to eliminate any possible problems.

Raiding The Larder

The weapons available for the F-18 include:

- Vulcan M61 Cannon—used for close dogfighting and useful against soft targets such as infantry, trucks, trains
- AIM9M Sidewinder—close range air to air heat seeking missile
- AIM7 Sparrow—medium to long range air to air missile
- AGM 62 Walleye—TV guided glide bomb
- AGM 88 HARM—high speed anti-radiation missile
- AGM 65—infra red imaging air to ground missile
- AGM 84A Harpoon—anti shipping missile
- AGM 84E SLAM—Stand off Land Attack Missile
- Mk 82—500lb freefall bomb
- Mk 82—Snakeye high drag freefall bomb
- Mk 83—1000lb freefall bomb
- Mk 84—2000lb freefall bomb
- Paveway Laser guided bombs—based on Mk 83 or 84
- Zuni Rockets—unguided rockets
- Laser Designator Pod—must be carried to use Paveway bombs

The F-14 can carry the following:

- AIM9M Sidewinder
- AIM7 Sparrow
- AIM54 Phoenix—ultra long range air to air missile
- TARPS reconnaissance pod

Use of the fire-and-forget weapons, during a mission is very simple, whereas Paveway and TV-guided weapons such as SLAMs and Walleyes require more operator intervention. When using Paveways (ideal for hardened aircraft shelters and bridges) you must fly towards the target at medium to high altitude. With Paveway as the selected weapon, select the Laser Designator Pod, first making sure that a straight and level attitude is adopted. Notice that the joystick now controls the movement of the Pod itself, not the aircraft. From here you can zoom in on a target and lock onto it. The Laser Pod automatically follows the selected target. When near the target, release the weapons (one Mk 84 will destroy a hardened aircraft shelter, but several may be needed to drop a bridge) and watch them sail down to the target, eerily like the FLIR/DLIR footage that became famous on the Gulf War news coverage.

To use the TV-guided weapons, fly towards the target and select the weapon (SLAM or Walleye), go to the seeker head view and the viewpoint will change to that of the weapon. Once launched, the joystick movements actually affect the flight of the weapon, so the weapon can be flown right onto the target. **CGW**

KEYBOARD COMMANDER CORPS

PREMIUM TEMPLATES™

FALCON & MIG COMMANDER UTILITIES™

*Exciting new utilities for *Falcon 3.0: Operation Fighting Tiger™ and the new **MiG-29: Deadly Adversary of Falcon 3.0™!*

For one low price you get all six:

- **FALCCALC/MIGCALC 3.5:** Superb campaign intelligence gathering tool. Viewable/Printable theater map with detailed info. on every site, ground forces & all flight paths! Printable Fuel consumption, Waypoint timing, Strategic/Tactical reports and "Kneeboard sheet". FalcCalc even tells you the conditions for victory or defeat!!
- **F3/MIG REQUISITION 1.5:** Puts you in command of Falcon® 3.0 squadrons. Customize squadron names and pilot's roster, including names, callsigns, skill ratings and status. Replenish supplies including F-16's! Sort/print roster by rank or skill, Sierra Hotel list and more!
- **F3 MAPPER 6.0:** The famous Red Flag, Instant Action and HUD customizing utility! Change default theaters for Red Flag and Instant Action. Customize and "de-clutter" HUD. Set default view scale. Auto-generates Red Flag missions in any theater. New graphical map shows entire Red Flag theater, flight paths, enemy positions and more!
- **SHOWF3 2.1:** Allows viewing of screen shots from F3's own secret screen-capture program!! New interface makes viewing a snap. New conversion feature saves screen-shots to popular .GIF or .PCX formats. Includes instructions for F3's hidden capture commands!
- **KCCMENU 1.1:** Fantastic menu-shell that brings it all together! Use default menu or customize to user's preferences. Sub-menus can be created and linked to add other sims and games. Completely unloads itself from memory while running a menu selection!
- **KCC'S COMBAT MISSIONS:** All new gut-wrenching, action-packed Red Flag missions. Includes all type missions in different theaters. See if you've got what it takes to say "Mission Accomplished" to these "volunteer only" thrillers!

Mon-Sat
8:30-6:30 EST

To Order Call:

1-800-228-7449, Ext. 522

All other inquiries to: Keyboard Commander Corp. 4819 SW 148 Ave., #402, Davie, FL 33330 000-262-6066

ONLY \$19.95 PER SET! OR

FALCON COMMANDER OR MIG COMMANDER UTILITIES + F3 TEMPLATE ONLY \$24.95!!

IMPORTANT! *FCU is compatible with Falcon®3.0: Operation Fighting Tiger™ only. **MCU is compatible with Falcon 3.02 and MiG-29: D.A.F.

Keyboard Commander Corps keyboard templates end "Keyboard Confusion" and let you concentrate on winning. Our high-quality, full-color templates turn any AT101 keyboard into a realistic control panel for your favorite sim and our standardized, color-coded layout flattens the learning curve!



Template Special:
1- \$12.95, Any 2- \$21.50
Any 3- \$30.00, Any 4 or more \$9.25 each!!

CHECK SIX!!

- Keyboard Commander Templates reduce confusion and increase one's gaming pleasure. -CGW
- Falcon 3.0/3.01/MiG-29
- Strike Commander
- Tornado
- Strike Eagle III
- X-Wing
- Gunship 2000 I & I
- Comanche: Max. Overkill
- Aces of the Pacific
- Secret Weapons Luftwaffe
- MS Flight Simulator 4.0 & 5.0
- A.T.P.
- Jetfighter I & II
- B-17 Flying Fortress
- CY Air Combat
- F117A Stealth
- MegaFortress

★ High-Quality, 3-D Graphics ★ Color-Coded Layout ★ Laminated Stock ★
 ★ Fits all AT101 Keyboards ★ Standardized Format ★ Affixes to Keyboard ★

PILOT THE NAVY'S FIRST LINE OF DEFENSE.

FLEET DEFENDER

The F-14 Tomcat Simulation!

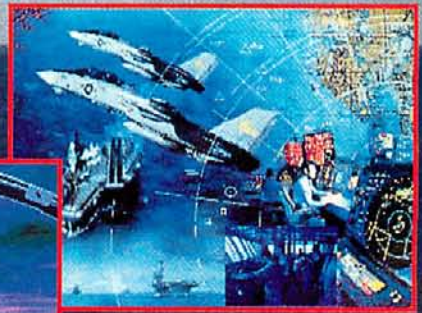

Actual screens may vary.

It's all up to you! The skies are swarming with bandits. Only you stand between the threat and your carrier battle group.

Lock on your radar and launch the Navy's advanced weapons to destroy the most sophisticated enemy targets ever developed for a MicroProse simulation. Roll, turn, climb, and dive to out-maneuver enemy aircraft using an artificial intelligence developed right out of Soviet and Third World military doctrine.

A computer-controlled wingman responds to your every command. And, you'll interact with strike packages that include F/A-18 Hornets, A-6 Intruders, A-7 Corsairs and E-2C Hawkeye AWACS.

Featuring the latest in 3-D terrain technology derived from digitized information taken from LANDSAT geological surveys, you'll pilot your F-14 through actual locations.

Fleet Defender from MicroProse. We brought you the F-15 Strike Eagle, now try the F-14 Tomcat featuring the most authentically modeled F-14 systems available anywhere outside of the Navy.

MICRO PROSE
ENTERTAINMENT • SOFTWARE

© 1993 MicroProse Software, Inc. ALL RIGHTS RESERVED.

For IBM-PC/Compatibles.

Circle Reader Service #95

To get our free catalog, call 1-800-879-PLAY Mon.-Fri., 8:30 am - 5:00 pm EST or fill out the coupon and mail it to: MicroProse Software, Inc., 180 Lakefront Drive • Dept. D10 • Hunt Valley, MD 21030-2245

Name: _____

Address: _____

City: _____ State: _____ Zip: _____

AAX

More Than Apache

New Scenarios And New Features For NovaLogic's Comanche

by Bryan Walker

Released over a year ago, NovaLogic's *Comanche Maximum Overkill (CMO)* still remains the undisputed champion of helicopter flight sims. The legions of *CMO* fans, as well as gamers who haven't yet had the pleasure of dashing through gorgeous Voxel Space graphics, will definitely be interested in two new products that expand on the original classic: the *Over the Edge* mission disk and *Comanche CD*.

Sharpening The Edge

The *Edge* expansion disk serves up 40 tough new missions and a rich variety of worthy features. Unlike *Mission Disk 1 (MD1)*, *Edge* doesn't pamper you with occasional milk



runs. Taking place in four new terrain models, the Silver Dove, Whirlwind, Over the Edge, and Terminal Velocity operations are flat-out tough from the word "go." In fact, many players are going to be banging their heads against the wall trying to get through some scenarios. Where all of the missions of *CMO* and *MD1* could be finished in a few days, completing all 40 of *Edge's* adventures will be a much lengthier affair.

Edge gives the bad guys better odds with new vehicles, including the Soviet Osa and Lebed watercraft, as well as the OH-6 Cayue light helicopter. The enemy has also been gulping down smart pills and is now capable of better tracking, more accurate fire, and the ability to actually lob rounds over obstacles onto unsuspecting Comanches. The age-old tactic of patiently "Shooting and Scooting" is the order of the day in the *Edge*. Fortunately, you now have improved cannon and rocket effectiveness, making it easier to reach out

and torch someone. *Edge* also introduces new friendlies to support and protect, including M-1 Abrams main battle tanks and Red Cross tents.

Wide-eyed gamers now faced with new terrain and deadlier enemies might overlook some of the more subtle refinements *Edge* offers. NovaLogic's attention to detail has provided graphic refinements like beautiful reflections over water and an atmospheric haze, better response to the Thrustmaster Weapon Control System, and wind effects. Arctic regions now have occasional snowstorms, and the volcanic Hawaiian scenarios feature sparks spewing from hilltops. Players with rudder-pedal accessories such as the Thrustmaster RCS will be delighted with the new ability to disengage the main rotor/tail rotor control mixing, making precise yaw maneuvers in tight "hover holes" much easier. The Altitude Hold feature can now be toggled off, giving the more experienced player manual altitude control. Gluttons for punishment can also turn the Comanche's stealth mode off, giving the enemy even better detection and engagement abilities...as if they needed it! Though these improvements may not seem significant at first glance, their effects add up quickly.

Comparing the original *CMO* to *CMO* with the *Edge* expansion clearly shows the superiority of the new features and makes for a far more enjoyable game.

Silver Worth Gold?

Comanche CD (CCD) combines every feature, mission, and improvement included in *CMO*, *MD1*, and *Edge*, along with 10 new missions and impressive splash animations. With a total of 100 scenarios, *CCD* will take even the hottest joystick jocks quite a while to finish. The new demo and over-view animations are simply stunning, and are a remarkable demonstration of the capabilities of CD-ROM. Frankly, the

10 Operation Zephyr missions available only in *CCD* aren't worth the added cost of the CD-ROM version, but when the combined cost of the mission disks are added in to the original *CMO*, *CCD* is a very good value for gamers with only the original game, or CD-ROM owners now thinking of purchasing *CMO*. Players who already own *CMO* in addition to either *MD1* or *Edge* will not get the most bang for their buck with *CCD*.

Dereliction Of Duty

While both *Edge* and *CCD* provide a great deal of challenge, many of the limitations I noted in my review of the original *CMO* are still present. These include very limited flight characteristics, small terrain models, wingmen reluctant to protect you from enemy helicopters, and the lack of a legitimate campaign game. Though the state-of-the-art Voxel Space graphics and hair-raising action make *CMO* the best helicopter simulator for the PC, it would be nice to see NovaLogic produce a chopper title on par with *Falcon 3.0* in the technical realism arena. And that's certainly within their capability.

Edge and *CCD* are the most well-rounded *CMO*-based products to date. These commendable efforts may also be NovaLogic's last *Comanche Maximum Overkill* releases. While neither title provides a complete gameplay overhaul, few fans of the original *CMO* will be able to resist the extra action these products offer. A few of the new missions might be too much for some gamers, but most sim fans are going to find that *Over the Edge* and *Comanche CD* will definitely be turning up the heat during the long, cold winter! **CGW**

Comanche Maximum Overkill: Over the Edge; Comanche CD



TITLE: Comanche Maximum Overkill: Over the Edge; Comanche CD
 PRICE: Over the Edge: \$49.95; Comanche CD: \$74.95
 SYSTEM: IBM
 REQUIREMENTS: Over the Edge: 386SX or greater, 4 MB RAM, VGA adapter, 8 MB of HD space, and original Comanche Maximum Overkill. Comanche CD: 1 MB HD space, CD-ROM drive
 PROTECTION: None
 DESIGNERS: Kyle Freeman, John Garcia
 PUBLISHER: NovaLogic, Inc. Tarzana, CA (818) 774-0600

Connect A Joystick To Your Notebook With The Parallel Game Port.



▶ Notebook computers are great — except when it comes to playing simulation and action games. That's because they don't come equipped with a game port.

▶ Introducing the Parallel Game Port™ from Genovation. The PGP software turns your notebook into a gamebook by converting the computer's printer port into a "virtual game port". A part of the PGP package is an adapter which lets you connect a joystick, yoke or rudder pedals to any portable or desktop DOS computer. A port doubler cable is also available from Genovation, allowing the connection of two devices to the same adapter. ▶ The Parallel Game Port is an indispensable accessory for today's serious gamer.

Whether you fly combat, race a car, play football or wing along at 100 knots, the PGP's software features will enhance your play action. You

can now take control of the game as the PGP allows you to program the joystick's keys and customize them for your specific needs. What's more, the Parallel Game Port eliminates the computer speed dependencies of some game ports. And it's easy to install, so you can be up and running in minutes.

▶ The Parallel Game Port is now compatible and comes with interfaces to more than **60** games. Including, most likely, every one of your favorites. And every month we add many more games to this list. Because we write our own game interfaces, they become available as soon as new games come to market — and may be downloaded free of charge from our own BBS. ▶ Look for the

Parallel Game Port in the software section of your nearest computer dealer. Or call us at Genovation **(800) 822-4333**.



Compatible
with
more than
60 games!



GENOVATION^{INC}

Genovation, Inc. ▶ 17741 Mitchell North ▶ Irvine, CA 92714
(714) 833-3355 ▶ FAX (714) 833-0322 ▶ Sales: (800) 822-4333
Copyright ©1993 Genovation, Inc. All product names are trademarks of their respective companies.

Circle Reader Service #68

The Expanding Universe Of X-Wing

The Saga Continues With Imperial Pursuit And B-wing Add-ons

by Jeff James

After destroying the Death Star and beating the pixelated stuffing out of the Empire in *X-Wing*, what does a self-respecting rebel fighter jock do next? Retire to a lush planet with his metals and android servants? Not while there's Ultimate Badness about, he won't! And more battles with Ultimate Badness is what we have in LucasArts' two new expansion diskettes *Imperial Pursuit* and *B-wing*. Together they provide a collection of new missions and animated cut scenes continuing the *X-Wing* saga. Both expansion disks require *X-Wing* to operate, although they do not require each

somewhat, but the utmost of skill and lots of luck are the only things that will get you through the tougher missions.

B-Wing picks up where *Imperial Pursuit* leaves off, with the rebels still looking for a new rebel base. *B-Wing* also introduces yet another alphabetic rebel starfighter: the B-Wing. In addition to a new, 20-mission Tour of Duty, *B-Wing* gives players the opportunity to put this new heavy assault fighter through its paces on the training grounds and to fly the B-Wing in six historical missions. The historical missions are a trifle disappointing; roughly half of them simply insert the B-Wing into older Y-Wing or X-Wing missions.

In flight, the B-Wing is a bizarre looking beast. Beneath its eccentric exterior, the B-Wing proves to be a potent vessel with impressive offensive capabilities. In addition to three laser cannons and three ion cannons, the B-Wing can carry up to 12 proton torpedoes, making it the ideal craft to take out Imperial capital ships. When in flight, the B-Wing handles much like a quicker, more nimble Y-Wing, even though the B-Wing has heavier weaponry, shields and armor. I found the third ion cannon on the B-Wing (located at the end of the S-foil under the cockpit) extremely difficult to target accurately, making it nearly impossible to hit small, fast-moving craft with any consistency. Dog fighting daredevils

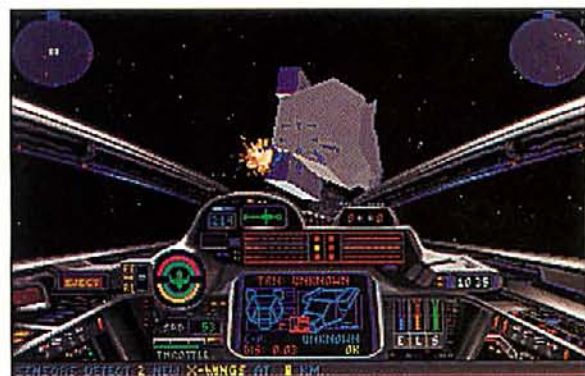

will prefer the A-Wing or X-Wing; the B-Wing performs best when allowed to fire linked weapons at the broadside of an Imperial capital ship.

To the avid *X-Wing* disciple, both expansion disks should be considered must-buy products. If you can only afford one expansion disk, *B-Wing* is the better value. It offers more Tour of Duty missions (20 as opposed to *Imperial Pursuit's* 15), includes a new starfighter, and offers additional historical and training missions. *Star Wars* mavens hoping for the chance to pilot the Millennium Falcon through an asteroid field or to blast Imperial AT-AT Walkers on the icy tundra of Hoth in a rebel snowspeeder will have to wait and hope—neither craft is available for use in either expansion disk, and *B-wing* is the last of the planned *X-wing* add-ons. It seems that the *Star Wars* baton will be passed to LucasArt's next project, the forthcoming *Tie Fighter*. So, the next time we meet, we'll have ducked under the curtain and emerged on the Dark Side. And I'm sure the Emperor has some expansion plans of his own...

EGW



other to function (i.e., playing *B-Wing* does not require that you already have *Imperial Pursuit* installed).

In addition to new missions and animated sequences, both expansion disks include an on-line hint system to help you through the more difficult missions and a Top Ace pilot that can be used to play any mission in the original game, or as an experienced wingman in the add-ons.

The first of the *X-Wing* expansion disks, *Imperial Pursuit*, picks up the story after the destruction of the Death Star. Fifteen additional missions are included, beginning with the player flying escort duty for rebel transports fleeing an Imperial armada heading towards the rebel base on the Yavin. In terms of mission difficulty, *Imperial Pursuit* appears to share the same inconsistency of mission difficulty found in *X-Wing*, with some missions being exceedingly easy and others virtually impossible. The mission hints seems to help

Imperial Pursuit and B-Wing



TITLE: X-Wing Tour of Duty: Imperial Pursuit
X-Wing Tour of Duty: B-Wing
PRICE: \$29.95 each
SYSTEM: IBM
REQUIREMENTS: Original X-Wing game
PROTECTION: Documentation look up
DESIGNERS: Lawrence Holland and Edward Kilham
PUBLISHER: LucasArts
San Rafael, CA
1-800-STAR-WARS



Introducing FLIGHTSTICK PRO™ Flying The Best . . .

Just Got Better.

Look for CH
Products' VIRTUAL
PILOT,
FLIGHTSTICK,
GAMECARD 3
AUTOMATIC, and
our MACH series
where you buy
FLIGHTSTICK
PRO.

FLIGHTSTICK PRO is the ultimate combat stick for total command of the skies. Made to endure the toughest missions, FLIGHTSTICK PRO gives you the winning edge to take on even the worst enemy. With top gun precision, you can view your surroundings, activate radar, blast missiles, thrust into mach speed . . . all at your fingertips. FLIGHTSTICK PRO includes a four-way switch to control weapons, radar, and viewing for more advanced games plus all the best features of FLIGHTSTICK. Great with flight simulation, auto racing, and any game that uses a joystick. For all IBM compatible computers.

FLIGHTSTICK PRO. The most intense joystick you'll ever fly.



Fly The Best!



970 Park Center Drive • Vista, CA 92083 • Phone: 619 598-2518 • FAX: 619-598-2524

Circle Reader Service #45



F-117 Stealth Cockpit. Photo Courtesy: Department of Defense

Peripherals for Power Players

by H.E. Dille

Whether playing the latest scrolling, shoot-em-up, or a state of the art combat simulator, computer gamers want their input to be taken seriously. The keyboard is no way for a Prince of Persia to rescue fair maidens, and a scrawny two-button joystick does no justice to the sophisticated fly-by-wire control of an F-15. Gamers want *control*, and control specialized to their gaming needs. Here, then, is a look at some of the various peripheral options available.

One of the most innovative and thoughtful new additions to the joystick arena is undoubtedly Suncom's *My Joystick*. Realizing that most pre-school and primary age children have difficulty in manipulating a full size joystick, they designed a half-size

stick that really fills a gap in the market. The unit features a down-sized base



My Joystick

that can either be held in the off hand or used on a desktop. Three over-sized control buttons are color coded for easy distinction between them, and located for equal access by right or left handed players. A signal selector switch also allows parents to change the functions of the various buttons to suit their child's preferences for the software in use. Rounding out the design is a short and stout control stick that is perfect for small hands to maneuver. (Suncom Technologies, (708) 647-4040).

Triax Controls offers a PC version of their unique line of *Turbo Touch* video game pads. Unlike conventional pads that use mechanical rocker arms for directional control, the *Turbo Touch* uses capacitance to register motion. Underneath the blue

Man Enough™

MATURE LEVEL

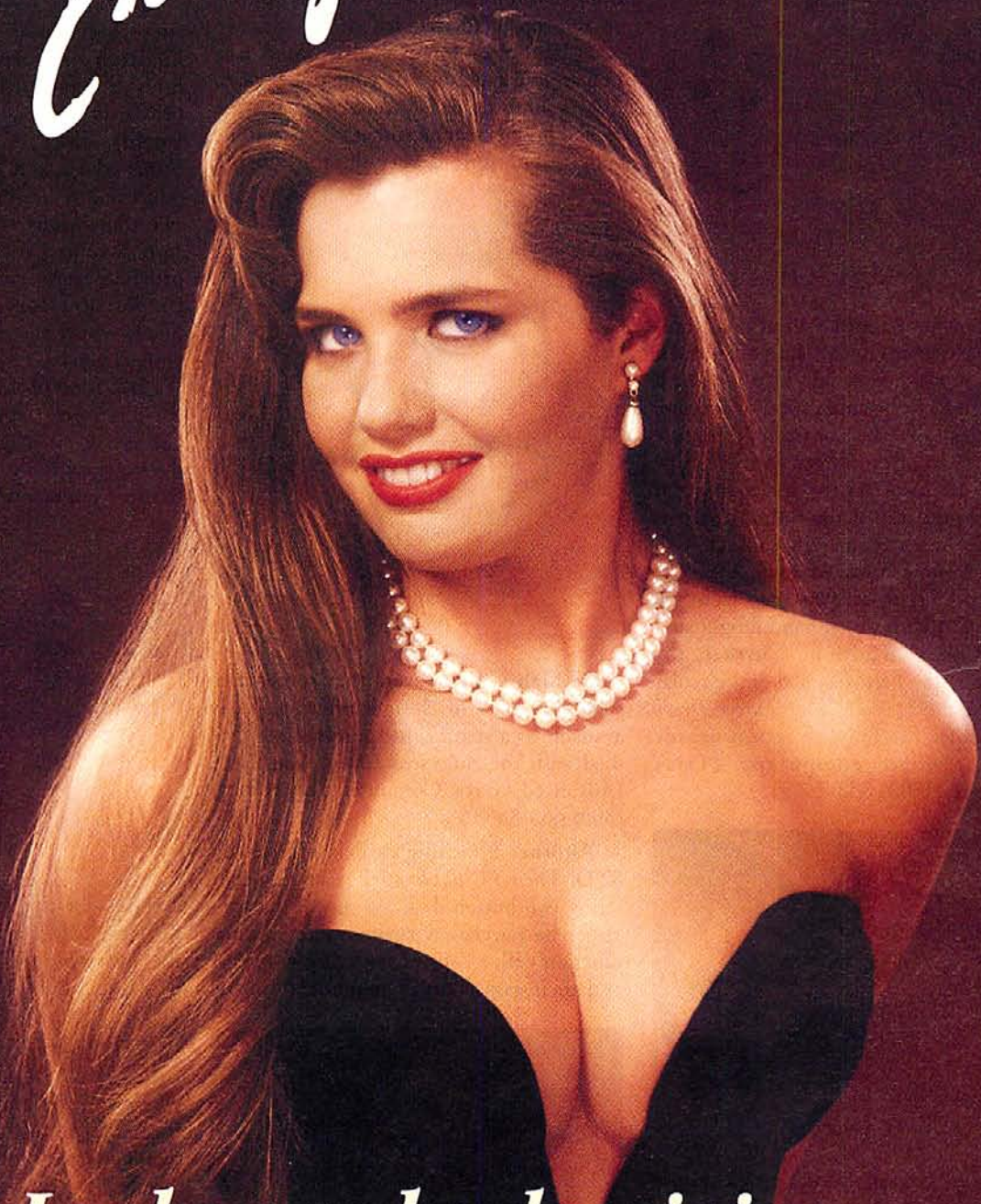

Looks can be deceiving...



Blair the Rich Girl



Erin the Lawyer



Fawn the Sales Rep



Quinn the Anchorwoman



Kellie the Psychologist

An interactive CD-ROM social adventure.

Circle Reader Service #137

Available at your local software dealer or order direct 1.800.644.9283

Man Enough is a trademark of Tsunami Media, Inc. © Tsunami Media, Inc. 1993



octagonal touch plate are a series of sensors that register a change in capacitance when the player's finger passes over them. This



Turbo Touch 360

signal is transmitted into a directional command. The sensitivity of the pad is such that little pressure is required to register a response. In fact, the application of pressure actually degrades the controller's performance, because if the finger (yes it is now possible to control via the index finger if desired, instead of just the thumb) flattens under pressure, it comes in contact with more than one sensor. As such, the controller actually trains players away from the "death grip" that leads to hand fatigue and "numb thumb" syndrome. Further, the design offers the best diagonal and circular control on the market. The *Turbo Touch PC* is a must for fans of action/arcade games for home computers. (Triax Technologies, (800) 858-7429).



PC Gamepad

Advanced Gravis also has an entry into the PC pad market. The *Gravis PC Gamepad* features a diamond shaped four button control face and a conventional rocker arm pad. The latter also boasts a removable joystick handle for precise fingertip control. Other features include a selector switch for right or left hand control and independent single shot or turbo-fire options for the button array. Included in the purchase price is a premium coupon for a free copy of one of seven PC titles, such as *Prince of Persia* or *Lakers vs. Celtics*.

The *Gravis Analog Pro* is a conventional, full size stick with several nice features. The unit is most suited to flight simulations, featuring a recessed throttle control dial, three stick mounted buttons (a front trigger and two thumb controlled weapons buttons on the top of the padded stick), and two other buttons on top of the base. Stick tension is adjustable to suit your preferences. Also, a "throttle off" feature eliminates the second joystick conflicts that occur in some games. The unit is very durable during



Analog Pro

those high-G maneuvers that sometimes snap the yokes of cheaper offerings. It is available as a stand alone purchase or bundled with the *Advanced Gravis Gamecard*. (Advanced Gravis Computer Technology, (800) 663-8558).

Another bundling deal is offered by STD. Their *PC Raider* stick is an auto-centering two button desk top model that can either be purchased separately or in conjunction with a copy of *F-19 Stealth Fighter* and their game port. Though less capable



PC Raider

than some of the other products discussed here, the *PC Raider* should be viewed as an excellent starter stick for players who don't require some of the other special features. (STD Entertainment, (410) 785-5661).

One of the boldest attempts to advance the state of the art in peripherals is Logitech's *Cyberman*. This odd-looking, multi-dimensional controller is designed primarily for use with free-scrolling 3-D worlds like *Ultima Underworld*, *Shadowcaster*, and *Doom*. Its unique design offers mouse-like "proportional control" in two dimensions and yaw, pitch, roll, and vertical control in three dimensions. It also provides tactical feedback in the form of simple vibrations, so that in games like *Shadowcaster* the device will vibrate when your character takes a hit. Unfortunately, the execution of this great idea falls short of expectations. Control in 3-space can be clumsy, even in games that support the device specifically, the acrobatics required to use it can be tiring to the hand and wrist,



Cyberman

and the vibrating feedback quickly loses its novelty. While a noble attempt, it seems the *Cyberman* will need to go back to the drawing board. (Logitech, (800) 732-2935).

CH Products offers two designs of interest to flight simulator fans, the *Flightstick Pro* and the *Virtual Pilot*. The former is a multi-button stick with independent trim controls and a top mounted "coolie" switch. You can eliminate a lot of keyboard interaction with these features, which allow you to view the surroundings, activate radar, arm and disarm weapons and so on, without ever having to take your hand off the stick. The unit is shipped with special drivers for Microsoft's *Flight Simulator 4.0*, which provide flaps, gear, brake and trim controls. All games may be played with the stick, but some of the special features in each may not be controllable without specific driver programs which must be obtained from CH Products.

With All the Games

ONLY ONE HAS

Knocking at Your Door...

THE POWER TO

RIP YOU APART!



Lock the doors, roll up the windows and hold onto your seat—Jurassic Park for the PC has arrived.

Ocean's exclusive 3D texture-mapping process puts you in intimate contact with more than 100 tons of REAL dinosaur meat—in two nerve-splitting perspectives.

Scope out the island and let razor-sharp overhead graphics drop you in the

middle of stampeding Brachiosaurus and Triceratops. Then strap on your "Night Vision" goggles and venture 3D-deep into the maze-filled corridors of the Visitor's Center, where you'll come eyeball-to-eyeball with both Raptors and Spitters.

And if that's not enough to make you sweat, remember...somewhere out there a famished T-Rex awaits—eager to show you a rip-roarin' good time.



Ocean of America, Inc.
1855 O' Toole Ave. Suite D-102
San Jose, CA 95131
(408) 954-0201



TM & © 1992 Universal City Studios, Inc. & Amblin Entertainment Inc. All rights reserved. Ocean Software Authorized User. Ocean is a registered trademark of Ocean Software Limited.





Flightstick Pro

Their second unit, the *Virtual Pilot*, is a desk-mounted flight yoke that precisely controls ailerons and elevators, plus features a self-centering response that simulates actual flying conditions. For example, if you are flying straight and level at proper trim and change the pitch, roll or both, you need simply release the yoke to cause the plane to attempt to regain it's previous level flying position (provided, of course, the maneuver did not exceed the flight envelope and put the plane into a stall or spin). On the front face of the yoke is an elevator trim tab that may be used to trim the plane



Virtual Pilot

to climb, fly wings level, or glide when the fuel gage shows empty. Again, this feature has greater applicability to "civilian" flight simulators like the Microsoft line than afterburner-based dogfighting products. The throttle control is a conventional "T" stick on top of the unit, but is not supported by all games. The unit is also very good for driving simulations. (CH Products, (800) 624-5804).

The closest competitor to the *Virtual Pilot* is the *G-Force Yoke* from Suncom. Also best suited for driving and flying simulations, the unit features a spring loaded self-centering yoke with both horizontal and vertical trimmer switches. Though the

latter are not specifically designed to do so, they can be used to replicate the functions of the elevator and aileron trim tabs discussed previously. A column mounted linear potentiometer acts as the throttle control. The *G-Force Yoke* is also equipped with dual fire buttons for left or right hand operation, as well as trigger-finger and thumb tip control. A center mounted selector switch allows the user to vary button functions for personal taste.



Weapons Control System

Thrustmaster Control Systems has recently released the Mark II versions of their venerable flight and weapons control systems (*Flight Control System* and *Weapons Control System* respectively). When operated in conjunction with their rugged rudder control pedals, the Thrustmaster system remains one of the most versatile, dependable series of flight simulation accessories on the market. (ThrustMaster, (503) 639-3200).



Pro Flight Control System

At the high end of specialization, **Thunderseat Technologies** is marketing an entire line of controllers and accessories that approach professional flight simulator quality, but do so at a corresponding price point. You won't find these products in stores, because each is built only when

ordered directly from the manufacturer.

The *Thunderseat Multimedia Chair* is of general interest to all players. In essence, it is a padded cockpit seat mounted over a massive subwoofer. The unit may be used in conjunction with existing speakers for enhanced performance or hooked up directly to the output of any source, from a sound card to a VCR. The intent of the design is to translate sound, such as the whine and rumble of a high performance aircraft, to vibrations which increase the player's suspension of disbelief. Side consoles are available that allow convenient mounting of Thrustmaster's *FCS* and *WCS*, or any other sticks. A swing out keyboard holder is also available and, for those who want the full effect, rudder pedals and a strap-in harness may be had.

For those whose interest in aviation extends beyond casual game play to include the pursuit of a private pilot license, Thunderseat Technologies is ready to meet your needs as well. The *YM-2 Thunderflight Control* is built with the same precision yoke ATC used in their 610 model, the



YM-2 Thunderflight Control

largest selling FAA approved IFR simulator in the world. The unit is heavy-duty steel construction and capable of supporting a monitor within the outer frame. An optional power grid mounts to the right side of the console for control of auxiliary functions like fuel mixture, cowl flaps, carburetor heat and others. Even more capable is the *King Air Style Yoke*, featuring an actual Beechcraft layout with functional dials and switches, as well as a separate radio stack. Though these designs may seem like overkill to a lot of players, the company's intent is to obtain FAA approval for the first home-based flight simulators at a cost of under \$3000. If any of these high-end items are a "must have" purchase, contact

NO MORE GAMES

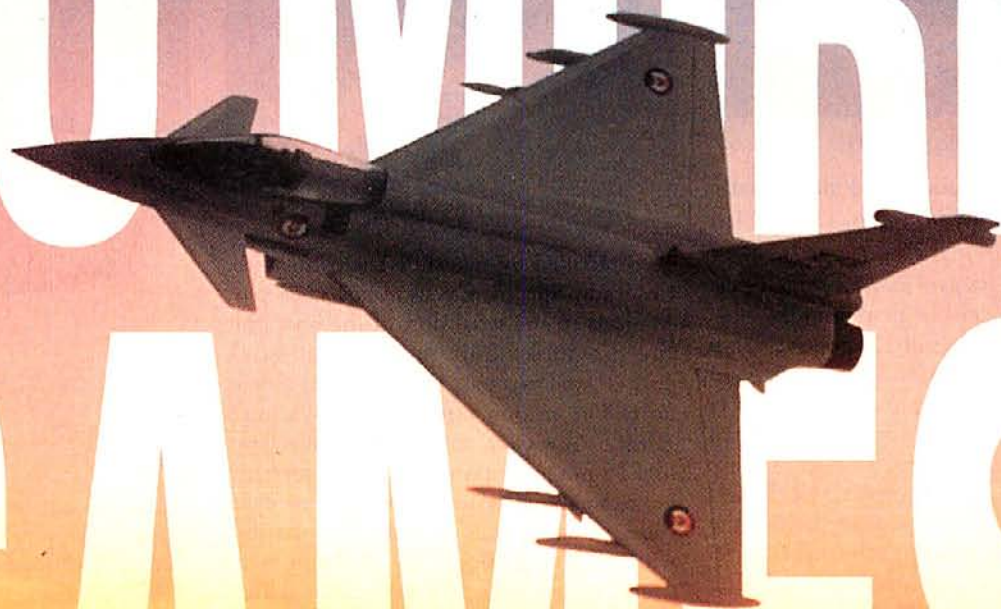

TFX
TACTICAL FIGHTER EXPERIMENT

in the most sophisticated aerial combat simulation ever created for your PC—TFX: Tactical Fighter Experiment.

Grab the controls of any of three USAF-spec flight models and spread democracy over five million square miles of topographically accurate landscape.

You're finished with training... Had your fun and games. Now it's time to face reality

Equipped with ASRAAMs, Mavericks, M61s, laser-guided GBUs...you're fully loaded to tackle more than 200 "real-world" campaigns, based on today's geopolitical realities. And to keep you sweating bullets, from Somalia to Sarajevo, the skies are swarming with AI-programmed bogeys that'll make you pay for your mistakes...with your life.

Log on and engage in TFX. This time, you're not just playing games.



ocean

Ocean of America
1855 O'Toole Avenue, Suite D-102
San Jose, CA 95131
(408) 954-0201

TFX © 1993 Ocean of America. All rights reserved.
Ocean is a registered trademark of Ocean Software Limited.

**WIN the TFX
Contest.
See Package
for Details.**

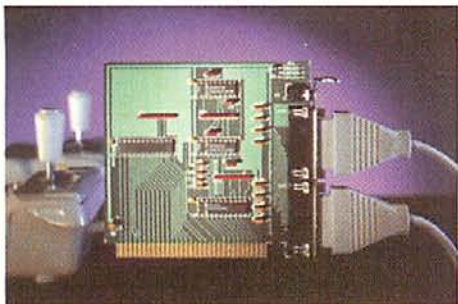

Gameport 2000

Thunderseat for a catalog and more details. (Thunderseat Technologies, (310) 410-0022).

Suncom's *Gameport 2000* is a high performance peripheral for its diminutive asking price. First, it is fully responsive in all speed ranges, from low end 286s to Pentium based 586s running at 80 MHz and beyond. In addition, it has a dedicated audio port that improves base PC sound. Although you shouldn't expect MIDI quality from this add on, it does represent the least expensive way on the market to improve sound quality while still enjoying the benefits of a premium game port.

Speaking of game ports, notebook and laptop users have suffered without them for too long. Fortunately, this situation has



Notebook Gameport

been rectified by two different companies. Colorado Spectrum's *Notebook Gameport* connects to the serial port of the host unit and provides a fully functional joystick port, as well as a pass through serial mouse port. The second offering, Genovation's *Parallel Gameport*, converts a parallel port to a 15-pin game port for use by a joystick, yoke, weapons system controller or even rudder pedals (it is currently compatible with more than 60 games). They also manufacture a separate port doubler which allows the connection of two such devices. Both of these peripherals might also appeal to desktop owners who need a gameport but don't want to install a card or lack the



Parallel Gameport

available slots. (Genovation, (714) 833-3355).

As you can see, the preceding group of products has something to offer to virtually everybody. Fortunately, it is also the tip of an iceberg that gets bigger and better all the time. Expect to see expanded coverage of even newer products after the January Consumer Electronics Show. **EGW**

What Do PC Jet Jockeys Want?

Hair-Raising Sorties
Death Defying Maneuvers
Heroics
Victory
Realism
HOTAS™
And...

ThrustMaster® Controls

10150 SW Nimbus Ave. Portland, OR. 97223-4337 PHONE (503)639-3200 FAX (503)620-8094

NEW PRODUCT



The Mark II WCS™ (Programmable Throttle; Also Allows you to Program your Joystick)



FCS™ (Joystick)



RCS™ (Rudder Pedals)

Circle Reader Service #135

THE HOTTEST 3-D ACTION SINCE WOLFENSTEIN!

BLAKE STONE

ALIENS OF GOLD

Terror has been unleashed!

And now...the violence that plagues a distant research colony threatens the planet Earth.

As British military agent Blake Stone you're thrust into deadly combat against the malevolence of a mad scientist and the insidious mutant army under his command. Dr. Goldstern, driven by his insanity and bent on the annihilation of mankind, won't rest until he rules the known universe.

The forces of heroic good and villainous evil collide in this life-or-death struggle to control Earth's future.

Sign up to fight as Agent Blake Stone. The fate of humanity is in your hands!

**Call Toll Free
1-800-GAME123**

For the cost of shipping and handling, only \$5.00, you'll receive Episode One, *The Star Institute*. Or download Episode One and pay no shipping and handling. Call the Software Creations BBS and check out the FREE Apogee file section. The BBS phone lines are:

- (508) 365-2359: 2400 BAUD
- (508) 368-7036: 9600-14.4K
- (508) 368-4137: 14.4-16.8K

Episodes two through six are sold separately and can be purchased by calling Apogee's toll-free number, shown above.

CREATED BY



JAM PRODUCTIONS

PUBLISHED BY



SOFTWARE
P. O. BOX 496389 GARLAND, TX 75049

APOGEE SOFTWARE • THE HEIGHT OF GAMING EXCITEMENT

Blake Stone: Aliens of Gold requires an IBM or 100% compatible computer with 640K RAM, a VGA graphics card, and a hard disk drive. Extended memory (XMS), expanded memory (EMS), joystick, mouse, AdLib, Sound Blaster or compatible cards are optional.

Trademarks belong to their respective owners.

Circle Reader Service #38



Not Recommended for Younger Viewers Due to Realistic Depictions of Violence.

Engaging AdLib™ music; Intense Sound Blaster™ sound effects



3-D texture mapping virtual reality in 256 colors



Take on dozens of vicious opponents in combat



Battle through 60 levels of heart-pounding terror!

A001CGW



Hackin' The Nights Away

SSI's *Dungeon Hack* Slashes Role-Playing Down To Its Roots

Every once in a while, even the most dedicated role-players long for something simple. They long for a game that doesn't require months of playing time, reams of notes, pages of hand-drawn maps; a game where they can just go out and let loose with some primordial bloodlust hack-n-slash, never mind any convoluted plots or story lines.

Until now, a game like that was hard to find. Especially one that you'd want to play more than once. Now, however, there is SSI's *Dungeon Hack*.

Dungeon Hack is a single-player game that uses the same engine and graphics as *Eye of the Beholder III*, only the graphics here are much better, especially the monster images. The "plot" is simple: wade through a dungeon full of nasty critters to retrieve a magical orb. That's really all there is to it.

That doesn't sound like a whole lot, and ordinarily it wouldn't be a whole lot. What makes *Dungeon Hack* interesting is that you can customize the dungeon to your own specific tastes. You have control over a majority of the physical and play factors, and you can create a dungeon however you want.

The size of the dungeons can range from 10 to 25 levels. Monster strength varies from wimp to supercritter. Treasure can be everywhere or hardly anywhere. Food can be readily available or difficult to find. Magical traps can be all over the place or nowhere. Character magic spells can be potent or weak. Enemies can lurk behind every door or they can be out to lunch. Undead can be turned off so they don't appear at all (Yes! My favorite feature!). The same is true for enemy spellcasters. Most of these controls have ranges, so you can really fine-tune the dungeon exactly to your tastes.

Death In The Afternoon

Perhaps the most interesting feature of all is "Character Death Real." This dungeon

setting is for the truly hardy (or suicidal), because once your character dies, that's it. The save games go away, too, and there is NO restore for this one. Your character has adventured for the last time. It's one way to add a nail-biting thrill to the game play.

For the first time, all the character classes from *Advanced Dungeons & Dragons* 2nd edition—including the bard class—are available here. The only option missing is dual class for humans; human characters must be single class, but as usual they can choose any profession.



Character creation is a simple process: pick gender, race, class and alignment. Stats can be modified up to their maximums (always advisable), including 18/00 Strength for both male and female fighters of all races except Halfling. Choose a picture for your character and enter a name. Most beginning characters start at level 3, except triple-classed Half-Elves, who start as 3rd level clerics and 2nd level in the other professions, pure Mages who begin at 5th, and pure Clerics who come in at 4th.

When that's finished, you move to the main dungeon creation screen. Here you can choose easy, moderate, hard or custom. The first three are automatic settings; custom is where you make what you will of the dungeon and is likely to be your preference when you start up.

The important thing to keep in mind here is that each dungeon is created for a specific character, and once you move on from the dungeon creation screen, nothing can be changed again. This is the one and only dungeon for that character, and if you don't like it, you must create a new character and a new dungeon.

There are no puzzles, as such, in the dungeons. The closest thing might be finding keys for certain locks, discovering where the illusory walls are (if you have that feature turned on), and looking for buttons to open apparent dead-ends. Otherwise, the levels, however many there may be, are pretty straightforward.

You can make it a bit more difficult by turning multi-level puzzles on, which means an item you need on level 5 will be found on some other level. That means dragging a lot of extra stuff with you, and while the inventory slots are generous (you can carry up to 54 items!), they can fill up rather quickly, especially if the treasure level is set high.

I preferred the high treasure setting, since most of the goodies you find are randomly generated each game, and there is no telling what will show up. A high treasure setting, however, doesn't mean Monty Haul. If you set it high and expect to find swords +5 and plate mail +3 all over the place, you will be sorely disappointed. Really good items are rare, whatever the setting.

TITLE:	Dungeon Hack
PRICE:	\$60.00
SYSTEM:	IBM
REQUIREMENTS:	386 or better, 2MB RAM, VGA graphics, 12MB hard drive space; supports Ad Lib, Roland and Sound Blaster sound cards
PROTECTION:	Documentation look up
DESIGNERS:	Thomas Holmes, Chris Straka
PUBLISHER:	Strategic Simulations, Inc. Sunnyvale, CA (408) 737-6800

A rift in the fabric of time and space, a deadly foe from the past and the judgment of all humanity await the crew of the Starship Enterprise™.

... the five year mission continues.



Join Captain James T. Kirk and the crew of the U.S.S. Enterprise™ in all new episodes that place *you* in command. Beam down to alien worlds, communicate with new life forms and take the helm as you join the legendary crew of the Starship Enterprise™ in their continuing five year mission to explore the final frontier.

Software © 1993 Interplay Productions, Inc. All rights reserved. Star Trek™ and © 1993 Paramount Pictures. All rights reserved. Star Trek is a registered trademark of Paramount Pictures.



17922 Fitch Ave.
Irvine, CA 92714
(714) 553-6678

Also, the treasure generator skews some of the items toward character class. For example, my Paladin never came across any mage scrolls, but for the Cleric/Mage and the Fighter/Mage, they showed up often. Similarly, blade weapons appeared for the Paladin and Fight/Magic User, but not for the Cleric/Mage, except for daggers.

This makes sense. Fighters can't use mage scrolls, and mages can't wield swords, so why put them in the game? Typically then, anything you find will be usable by your character as one class or another (except perhaps those Bracers of Archery, which show up everywhere, even for pure Mages!).

That doesn't mean you would want to use it, as a fair number of items happen to be cursed. A certain amount of care is necessary when handling newly-found objects (keys and key-like objects are always safe, though). Saving the game is always a good idea before trying on that new armor you just picked up.

Mages and multi-classed mages have an easier time of it. They come with Improved Identify in their spellbooks, which tells you exactly what an item is. Non-mages, however, must rely either on trial-and-error experiments, or finding the scrying glass that acts as an Identify spell. The glass is a random item, and may or may not show up. It has a limited number of charges, so it needs to be used with some discretion. Typically, it is best used to identify rings and potions first, weapons second.

Getting Around Underground

The game has a very nice auto-mapping feature, with dual maps. A small one in the left-hand corner is always on, showing your immediate location and changing as you move around the level. Clicking on this brings up the level map, showing the entire area. Naturally, those places you haven't seen yet are blank.

Also detailed on the map are the locations of monsters (shown as red squares), stairs up and down, pits, illusory walls, doors, teleporters, and treasures lying on the floor (black squares). Of course, these are only visible in areas you've already visited. In addition, the level map can be sent to your printer for a hard copy of the map.

The only flaw in this otherwise excellent mapping system is that it doesn't show the locations of alcoves. These are small niches set into the walls at random places, usually hallways. It is all too easy to walk right by one and

never see it. Using a different color on the map for that section of wall would have been a great help in finding missed alcoves.

Having gone through *Dungeon Hack* four times to completion, twice to level 10, once to level 15, and once to the 25th level (whew!), plus running other characters to varying depths, I have concluded that a 10-15 level dungeon is probably the best.



For one thing, 25 levels is a *long* way to go when you're just hacking through critters with no other objective than wiping them out. Sooner or later, the monsters begin to repeat, and you end up fighting "the same old stuff" as you go further down. And let's face it, 25 levels of plain killing can get boring after a while.



The generators for monsters and treasure exhibit some anomalies. For example, in the 25-level dungeon I fully expected to run across all the monsters (except undead, which I had turned off). However, there were five types that never appeared at all, including, oddly enough, hobgoblins, which are staple monsters for the second and third levels, and had appeared in every other dungeon I created.

A Measure Of Treasure

Armor was often hard to come by in the dungeons, even mundane stuff (this at high treasure level, too). That's important for fighter types who start off with nothing better than ring mail (another good reason to max

out dexterity). Most of my fighters had to go down a fair way before something better than leather showed up, and even shields were often in short supply. Eventually, you do get your hands on some good armor, but it usually takes longer than it should.

Mage scrolls seem weighted towards the more powerful showing up early. More than once, high-level scrolls such as Death Spell, Power Word, and Stun appeared on the first and second levels, while the more-useful (at that point) 2nd and 3rd level spells were hard to come by. My Fighter/Magic User who went the 25 levels, for example, never happened across a fireball scroll (she did have Lightning Bolt, though). As these scrolls are the only way for mages to learn new spells (no training halls in these dungeons), running a pure mage can be a difficult undertaking.

Sad to relate, SSI decided to invoke the "no mage spells in armor" rule of the 2nd edition AD&D rules. This really hampers spellcasting for multi-classed characters. Running around without armor is an excellent way to die an early death, especially once you get down to around level 4 where the monsters take a decided turn for the nasty. Until you have a decent selection of robe, bracers and protective devices, spellcasting will be either limited or dangerous in combat. Armor restrictions do not apply to Clerics, who can wear anything, nor to full Elves in Elven Chain Mail.

On a positive note, I'm happy to say that the game ran very cleanly. No crashes, freezes or lockups; no weird things happened with the graphics. That's really quite amazing when you consider that the dungeon, and everything in it, is created anew each time you generate a character.

The manual is good, providing all the necessary details on play and dungeon generation. Read the races section carefully so you know how far any race can advance in a given profession. There is, however, one omission in the list of monsters: somehow, the Living Muck was overlooked. This is a nasty critter that likes to eat metal weapons.

Overall, in spite of some weak points, *Dungeon Hack* delivers what it promises: the chance to create your own, specially-designed, hack-n-slash paradise. Whatever you want, be it killer dungeon or easy romp or something in between, it can be yours with this program. So the next time that bloodlust urge strikes, don't take it out on the loved ones. *Dungeon Hack* it out of your system.

CGW

Play the best for less



Legends OF FUTURE PAST™

*"...A remarkably rich playground for
modem-owning role-players."*

(Computer Gaming World, Aug. 1992)

*"...no other game... captures the true
essence of roleplaying like this one."*

(Computer Game Review, Oct. 1992)

**Now you can play the award-winning
multi-player online game
Legends of Future Past
for as little as \$1.80 per hour!**

Create your character and visit Andor, a world created solely through artistic prose and colored by shared imagination. Meet the exciting, intrepid and interesting people who populate these ever-expanding lands. Become part of the community of adventurers who have found reward, riches — even romance — in the fantastic land of the Shattered Realms.

Live Game Masters: You'll explore a living world where professional game designers introduce new adventures and lands to explore on a continuing basis. Delve into the politics of the City-State of Fayd, or take up a noble quest. Become a Champion of Justice — or a Force for Darkness. Andor itself will change around you as you are drawn into the never ending plot of Legends of Future Past.

Full Character Development: In Legends, you can assume the role of any character imaginable. Our skill-based system will enable you to develop the persona of your dreams. Be a powerful wizard, sly thief or valiant knight — or even a gentle weaver, a skilled weaponsmith or a miner. The possibilities for profession and character development are endless.

Advanced Interactive Fiction: Legends was designed as a monumental work of fantasy and artificial intelligence. Not only will you interact with people just like yourself — you will be in a realm that responds to your every action. There are no graphics, because only the power of the English language could capture the beauty of this world. Come try it for yourself.

New Lower Rates:

\$9.95 a month includes five (5) hours online time.

Additional hours charged at \$1.80 hour total via direct dial and Internet, or \$3.60 hour total fee via CNS local dial-ups. No surcharge for connecting at 9600 baud or during daytime hours.

If you are on Internet: telnet to *novalink.com*, or write *info@novalink.com*.

- **No special software required.**
- **Toll free number customer service and technical support.**
- **All adult: You must be eighteen (18) or older to use NovaLink.**
- **American Express, Visa, MasterCard, Discover and Diners Club.**

...and you can try it free!

NovaLinkSM
MAKING THE WORLD A BIT SMALLER

800-274-2814 Voice

800-937-7644 Sign-up/Info

P.O. Box 11, Shrewsbury, MA 01545



Scorpio Offers Aid To Afflicted Adventurers

Dark Sun ■ Lands of Lore ■ Ultima VII: Black Gate ■ Ultima VII: Serpent Isle
Hand of Fate ■ Return to Zork ■ Darkside of Xeen ■ Ultima Underworld II
Crusaders of the Dark Savant

So here we are in the mail room, which is overflowing as usual. What with the holidays, new games, and distracting screams from the dungeon, we just haven't had the chance to do any cleaning up. The dump trucks are supposed to arrive soon; I sure hope they come, because I can barely fit all of you in here. Meanwhile, hold your breath and think thin thoughts.

Before we get to the good stuff, I have to say a few words about that dread condition, Selective Dyslexia. It can strike anyone, anywhere, anytime. Among *CGW* readers, it generally manifests as "Dear Scorpio, I read your column in *CGW* every month and think it's great. Now I need help with...." and that's all that's in the envelope; there is no all-important self-addressed, stamped envelope.

Somehow, people manage to read my entire column, right down to the address...but that part about "If you live in the US, enclose a SASE" doesn't come through. I get about five letters per month from SD-stricken individuals, so it's not a rare problem. Don't become a victim of Selective Dyslexia! Pur that SASE in there! And now, on to the mail!

Dark Sun: From Kevin C. in Malaysia (the mail seems to be working again) comes important news about the endgame freeze after the final battle. If you hit the ESC key while the post-battle graphics are being displayed, you can bypass the whole thing (avoiding the hang entirely) and get back to the game. Hitting the ESC key must be done *before* the sequence reaches the "picking up the sword" section. This has been tested at SSI, and it works. If your game freezes after the final fight (or if you want to make sure that it doesn't), just use the ESC key and you'll be okay.

Lands of Lore: In my article a few issues back, I mentioned that it was possible to endlessly duplicate the Vaalen's cube. It turned out later that this was (ahem) a bug, and you weren't supposed to be able to do that. This has been fixed in subsequent releases, and you can't do it anymore. A pity, since those cubes came in very handy on level three of the White Tower, where a lot of

people have trouble, especially with the Spirit Snakes. The snakes are a spell cast by the ghosts, so the quicker you kill off the ghosts, the less snakes you'll have to face (and there is no way to kill the serpents themselves). Remember ghosts can walk through walls, so keep moving while you're on the third level.

Ultima VII—The Black Gate: Letters still show up from people having a hard time in the final dungeon on Avatar Isle—specifically, in the area with the cells to the north and the locked door to the east. As you go up the northern corridor, the second door is supposed to retract into the floor, while the first door rises behind, sealing off the corridor and "trapping" the party in the cell area. This entire sequence is triggered only by reading the scroll in the Shrine of the Codex *before* you enter the dungeon at all (yes, it's bizarre, but that's how it is). If the door is not retracting as you approach it, restore to a save before you went into the dungeon, read the scroll in the shrine, and then enter the dungeon. If that still doesn't help you, get in touch with **Origin** for additional assistance.

Ultima VII—Serpent Isle: Some readers have had strange things happen to them while trying to use the serpent jawbone to travel via the serpent gates. The characters start to freeze or the game hangs. This is usually the result of using an *empty* jawbone on the gate. Never do that. Every time you obtain a tooth, put it into the jaw right away, because the thing only works properly when the teeth are in place.

Hand of Fate: Although the review for this game is only showing up this issue, questions have been coming in about it already. The con-man octopus and his shell game seem to be giving some people a hard time. Well, of course. Didn't your mother ever tell you not to gamble with strangers? Heh. Anyway, you have to be more than quick-eyed to win this game; you have to be lucky. With the right item, you'll be a real shoe-in.

Return To Zork: Having made it down river to West Shanbar, a number of players are having a hard time getting any further. Some of them have figured out that the door

under the mill leads to other places, but finding the key to it, that's another matter. Actually, getting the key isn't hard at all, if you give it some thought. I'll drink a toast to your success (third time's the charm!).

Darkside of Xeen: It wasn't too long ago that I gave a hint about getting the Chalice from the Tower of the Vowelless Knights, but people still keep asking about this one (hey, ya gotta re-read those old back issues!). It's such a simple answer, most tend to overlook the obvious. Remember the lessons from the lower level? Remember what you typed in as answers? That's what you need to do here, and you don't have to be elaborate; three letters are enough.

Ultima Underworld II: It's not too hard to make a bottle of gin...ah, a Djinn bottle for yourself. There's someone in the Pits of Carnage who can give you complete directions about accomplishing that. And Nystul can tell you whether or not you've done it right (that hysterical laughter is a dead giveaway, heh). But filling the bottle with spirits, as it were, that's the tricky part. You don't want to go breaking anything until you're well-protected and up close.

Crusaders of the Dark Savant: Summoning demons for fun and profit is always an interesting experience. Of course, it helps if you have all the right ingredients before you make the attempt (kids, don't try this at home). Some players may find themselves without an essential part. It's usually the part from the basement of Orkogre Castle. Rations, anyone? (ick!)

That's it for this look into the mailbag. Remember if you need help with an adventure, you can reach me in the following ways:

On Delphi: Stop by the GameSIG (under the Groups and Clubs menu).

On GEnie: Visit the Games RoundTable (type: Scorpio to reach the Games RT).

By US Mail (enclose a self-addressed, stamped envelope if you live in the US):

Scorpio, PO Box 338, Gracie Station,
New York, NY 10028.

Until next time, happy adventuring! **cgw**

Disciples OF STEEL



The Ultimate in Classical Fantasy Role-Playing...

Help save a richly detailed land from self-destruction. Unite the people of this ancient land and together you can defeat the evil horde that is gathering... growing... waiting...

- Animated and detailed VGA graphics
- 3D "first person" view of dark dungeons and musty towers
- Turn based overhead tactical combat
- Original musical compositions and sound effects to get your heart pounding!
- Open ended non-linear game play
- Eight disciples to control and develop
- Over a hundred quests to complete
- Conquer towns and cities, tax the people and raise vast armies.

Available for IBM PC and compatibles (VGA, 80386 or better, 2 MB of Ram or more, sound support for Sound Blaster and compatibles.)



137 West Bay Area - Webster, TX 77598

1-713-554-7137

Circle Reader Service #87

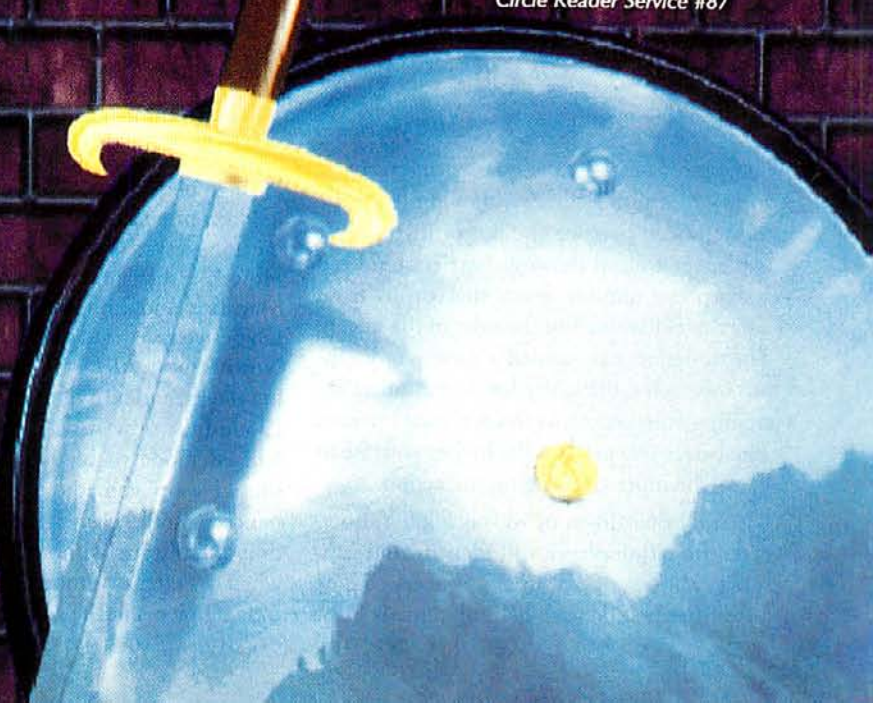

GLOW, LITTLE FIREWORM...

Inline Designs Turns On The Bug Light At The *Firefall Arcade*

by Richard Mulligan

Normally, I am unimpressed with "twitch" games of the arcade variety; they just don't hold my interest anymore. But as my rictus grin and beat-up fingers will attest, *Firefall Arcade*, Inline Software's latest release for the color Macintosh family, is a rare and welcome exception to the action game realm. Designed and developed by Dave Triplett and Brian Greenstone, *Firefall* is a masterful blend of 256-color graphics, animation, sound effects and music that creates an exciting playing environment. The game is near flawlessly executed and quite addictive.

"Bugs, Mr. Rico! Zillions of 'em!"

Taking its cue from the old *Centipede* arcade game, the objective is to shoot and destroy each body segment of crawling nasties

Seekers, Shields, Double Shots for the guns, Ghosters that allow movement through barriers, and the ever present Extra Lives. The trick is to destroy enough barriers to allow room to maneuver and shoot the Fireworm while dodging the nasties and grabbing the goodies.

As each level of difficulty is completed, there's a Bonus Round. Here, you are challenged with the task of destroying three complete Fireworms, with the bonus growing larger with each Fireworm destroyed.

"Zounds, I missed!"

The interface is intuitive and trouble-free. You can use the mouse, keyboard or Gravis GamePad to move and fire. The player icon is intentionally designed with a smooth-scroll delay between movement of the mouse or arrow key and reaction by the icon, but this is easily adjusted to and seamlessly adds to the challenge.

There are two play modes, Normal and Enhanced. The difference between the two is in the quality of the graphic animation and effects; in Enhanced mode, the sounds and music seem sharper, and the destruction of a barrier or nasty creates an interesting "firefall" effect (hence the name of the game). However, the graphics, animation and sound are excellent in both modes.

The Enhanced mode is designed for high performance Macintoshes; the manual recommends a Centris 610 or better, meaning a system speed of 20 MHz or better. However, the game was tested on a 16 MHz Mac IIcx and Enhanced mode ran perfectly, if a tad slower than Normal mode. In fact, for learning the ins and outs of the game, I found the slower speed of Enhanced mode to be a boon. I should warn you, though: Enhanced mode play speeds up dramatically and without notice when a certain number of the moving pieces in the game have

been destroyed. Be on the lookout for that; you'll either be quick or dead.

With such a simple and intuitive interface, Inline has wisely refused to load the game box down with a lot of unnecessary manuals. The documentation consists of one three-panel reference card that lists the keyboard commands, point values of the game objects, and color pictures of the powerups with a short description of the function each performs. Nothing more is needed.

"WARNING!!!
Danger, Will Robinson!"

When *Firefall* was first installed on the Mac IIcx test machine, it conflicted with Fifth Generation Systems' *AutoDoubler* compression program. It conflicted so badly, in fact, that the game installation failed and the *AutoDoubler* control panel device was trashed and had to be reinstalled. If you use this compression program, boot the control panel device for *AutoDoubler* and turn it off *before* installing the game. On the test machine, *AutoDoubler* was turned back on after the *Firefall* installation and no other problems were experienced. The *AutoDoubler* problem was the only control panel or INIT conflict experienced, out of over 30 installed on the test computer.

Firefall Arcade is a simple, elegantly rendered and enjoyable arcade game. The action ranges from the sedate to the furious and the animation and sound are excellent. So, if you enjoy a good arcade interlude or have kids that do, *Firefall Arcade* is a must-have for your household.

CGW



called Fireworms. As the Fireworms creep left and right around barriers, moving from the top of screen towards the bottom, you must maneuver around the same barriers and keep a sharp eye out for death that drops from above or rolls out from the sides of the screen. The designers have added a variety of weapons, obstacles, difficulty levels and other intriguing enhancements to keep your interest. The better you get and the higher you rise in score, the more challenging the action.

Not all that drops or rolls is a killer, however; the astute player will identify and capture a variety of advantage makers. These powerups include such helpful items as Heat

Firefall Arcade



TITLE: Firefall Arcade
 PRICE: \$49.95
 SYSTEM: Mac
 REQUIREMENTS: Mac LC or better, 256 colors, 3MB RAM, 3.7MB hard drive space
 PROTECTION: None
 DESIGNERS: Dave Triplett, Brian Greenstone
 PUBLISHER: Inline Software, Inc., Lakeville, CT 06039 203-435-4995

At the Summer Consumer Electronics Show, an incredible new game beat all the rest...

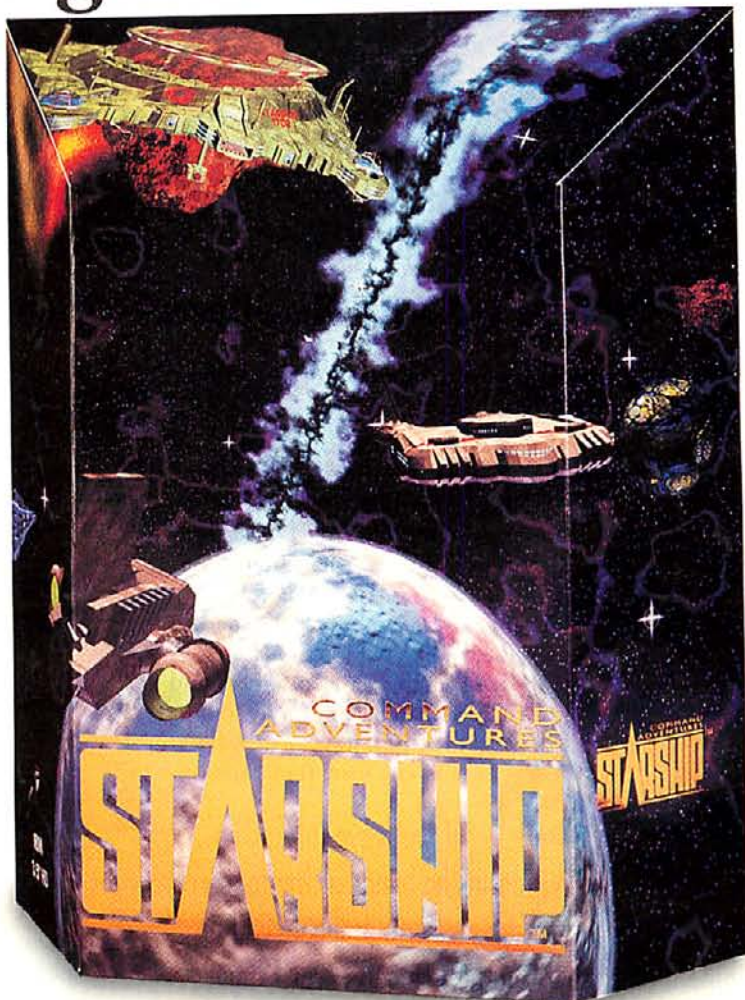

Take off on the adventure everyone's talking about: *Command Adventures: STARSHIP*. You'll wage war in space and on planets of every description. Outwit devious pirates and bloodthirsty aliens. And amass wealth, weapons and glory. All while revelling in bone-chilling sound effects, an incredible CD-quality soundtrack, and what *PC Entertainment* called the "tremendous visual appeal of

ray-traced graphics and beautiful cinematic sequences." No wonder *Computer Game Review* said *STARSHIP* "must be seen to be believed!"

It's never the same game twice. And with over 50 worlds to conquer, isn't it time you got started? To order or for the name of your nearest dealer, call today!

1-800-238-4277

 Merit Software™

 FUTURE VISION

13707 Gamma Road • Dallas, Texas 75244 • 214-385-2353

MINIMUM REQUIREMENTS: 386SX-33 PC or 100% compatible, 2MB RAM with 575K Free Low RAM, Hard Drive, VGA Graphics Adapter with 256K Video Memory, Microsoft or 100% Compatible Mouse
SOUND SUPPORT: PC Internal Speaker, AdLib, AdLib Gold, Sound Blaster, Sound Blaster Pro, ProAudio Spectrum 16, Roland MT-32, and Roland Sound Canvas
©1993 Merit Software ©1993 Future Visionary, Inc. Future Vision, Command Adventures Starship, and Masters of the Imagination™ are registered trademarks of Future Visionary, Inc. ALL RIGHTS RESERVED

The Tour Book for the Future of Interactive Entertainment



by Johnny L. Wilson

All Teched Up And Nowhere To Go

At the recent InterTainment '93 conference in Santa Monica, California, there was a jarring juxtaposition of the present and future of interactive entertainment. Many companies are currently involved in providing interactive television games, location-based amusement park experiences and on-line network games in the here and now. Other companies represented were speaking about an industry that is yet to happen: widespread video-on-demand, interactive movies and multiplayer gaming experiences via cable television. Conflicts between the present reality and visions of the potential future were inevitable, so the conference served as something of a reality check to people like myself.

You see, I spend so much time looking at the games and technologies that are "on their way" that I sometimes fail to look at the landscape around me. As a result, the session on "Interactive Television Today" threw a lot of cold water on my hopes for the future. The speakers who are involved in this business are certainly willing to settle

for a much lower threshold of interactivity than I am.

For example, Sami Saad of Info Telecom, a provider of interactive quiz shows in three European countries, demonstrated his LUDICS controller. This \$20 handheld controller has four buttons for input and a serial number encoded in the chip. Would-be trivia masters register the serial numbers and are able to play in up to 16 quiz games per day. The player sends encoded transmissions



"If we leave interactive television in the hands of the merger experts and media pundits, we will probably end up with something that will surpass Orwell's worst nightmare. If we leave it in the hands of the creative people, we might end up with something that will surpass Shakespeare's greatest vision."

—Paul McKellips

Director of Corporate Communications,
Interactive Systems

of his or her answers by telephone. The system works. The company is making money, but every interaction is limited to four menued choices. In contrast, joysticks and video game controllers have more directional choices than four. So, the potential for interactive experience seems entirely too limited.

However, if I thought LUDICS was too limited, I was really shocked by the new "interactive" device from Interactive Systems. Now, from the inventors of "Sabre Rider and the Star Sheriffs," the animated series developed for Mattel Toys and Merv Griffin Enterprises, comes Toby Terrier toys. The toy dogs are electronic and respond to an invisible VEIL (Visually Encoded Intelligent Light) source which is broadcast along with the images and sounds of a television show. When the on-screen Toby asks if children and their simulated pets are ready to sing or play, the VEIL causes the dogs to yip, bark or nod. When the songs and dances are taking place on-screen, the dogs are signalled to bark in time with the music. Frankly, such a design seems to be moving the wrong direction in interactivity. Indeed, we could almost call it simulated interactivity.

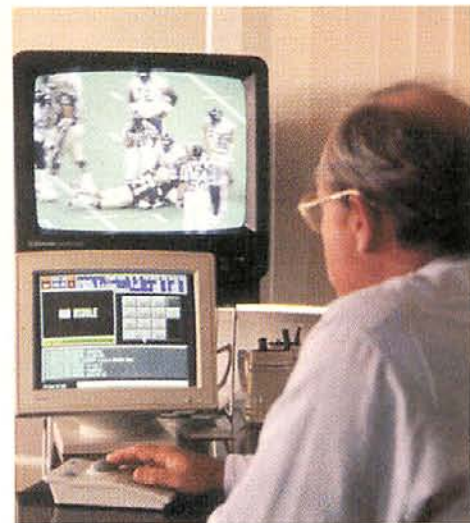

NTN's football play-calling game QB-1 foreshadows the future of interactive TV.

GET REAL.



Upgrade up to a Sound Blaster™ 16, and you've got PC audio as real as it gets.

Real CD-quality, 16-bit stereophonic sound. Real built-in upgradability. And best of all, real 100% Sound Blaster compatibility.

All of which may just be why we're the 16-bit PC audio standard. And why those other manufacturers spend so much time comparing themselves to Sound Blaster.

But like the man says, Get Real. Because there's only one card that's "as good as a Sound Blaster 16." And that's a Sound Blaster 16. For information, call 1-800-998-5227.



THE 16-BIT SOUND STANDARD.

CREATIVE™
CREATIVE LABS, INC.



U.S. Inquiries: Creative Labs, Inc., Tel: 1-800-998-5227 or 1-408-428-6600. International Inquiries: Creative Technology Ltd., Singapore, Tel: 65-773-0233, Fax: 65-773-0353. Sound Blaster, and the Sound Blaster and Creative logos are trademarks of Creative Technology Ltd. All other trademarks are the property of their respective holders. © Copyright 1993 Creative Technology Ltd. All rights reserved.

One approach to interactivity that seems to hold a lot of promise, however, is that being taken by NTN Communications. NTN operates the trivia games that are available in hotels, bars and restaurants across the country. Competitors compete against players all over the country in their quest for high scores. Currently, NTN Trivia is not only available in these location-based venues, but is also offered via GEnie and soon, The Imagination Network. NTN also operates a football play-calling game called QB-1. Although the latter

game requires a special input device called a Playmaker, it shows how interactivity can be piggybacked to existing programming. In this case, a football game is broadcast normally, but viewers who have the special input device can compete against other players (usually in sports bars, but occasionally on cable television networks).

The installed base of Playmaker units is currently 1.5 million and the company translates that into 5 million gamers, since there are usually three persons gathered around each Playmaker. NTN expects to introduce a new sports application based on pari-mutual racing in the near future. The racing game will be for cable television and touches on another consideration—, gambling. One service that could feasibly cause demand for the interactive highway to skyrocket is on-line gambling. Of course, given existing state-by-state jurisdiction over gambling, this will have some interesting obstacles for the cable industry or telephone companies providing interactivity to surmount.

"General purpose computers will cease to exist." — Howard Postman, President, Ideal Point, Inc.

It's The Interface, Stupid!

At the InterTainment '93 conference, as at most conferences on the new interactive frontier, there was much talk about the interface issue. Gary Louder of ICTV, a Silicon Valley corporation that specializes in interface development for interactive television, believes that the answer is in the software and not in the so-called set-top box. His ideal is to build systems which use existing platforms and boxes. The guiding principle of his company is that "Services have to look more like television than computers."

Howard Postman, President of consulting firm Ideal Point, Inc., went further. He insisted that interactive television will pave

the way for services far beyond movies and shopping. He even presented the vision of a computerless society where the smart interfaces of the future will meet each individual's needs. However, he warned, "There is no way that a common interface is going to meet everyone's needs. Anything that is not an adaptive interface is not going to work."

Obviously, I think Postman's vision of the computerless society is about as unrealistic as the vision of a paperless office that was so prevalent a little over a decade ago. Still, just as software drives today's hardware platforms, it will be the smart filters and intuitive interfaces of the future that will empower "everyman's" computer, whether that computer be keyboardless and voice-actuated through a fiber-optic network or a keyboard/mouse configuration tied into the home LAN and outside gateways.

FINANCIAL KINGPINS



Sometimes said to be the most powerful man in Silicon Valley, Arjun Gupta (center) of venture capitalist giant Kleiner, Perkins, Caufield and Byers, spoke on the panel concerning finance for interactive ventures. He predicted that the interactive software business would end up in the hands of five or six big publishers, much like the half-dozen book publishers that presently control that market. He believes Hollywood will continue to partner in interactive entertainment rather than purchase the market, since "Everything in Hollywood is twenty times the return of either the best-selling CD or cartridge products." More ominously, he predicted a future bloodbath in specialized hardware systems before the market stabilizes on a standard.

How Do They Do That? (Video On Demand)

Bellcore Labs has been working on a delivery system for video-on-demand (or, more accurately, near video-on-demand, since there will always be a time lag) for some time. Currently, they are experimenting with a system that incorporates Philips CD-I (with the digital

video cartridge) as the set-top box/player. According to this system, a huge file of digitized film is stored on a tape drive. When a film is requested, it finds the file and downloads the movie at 1.5 MB per second to a disk array capable of holding up to 12 full length movies. From the disk

array, the data is buffered to an intelligent line card which, in turn, moves the movie data down to the viewer's individual CD-I boxes. In turn, the CD-I's interface allows editing, windowing and multi-lingual features which have not been available in pay-per-view until now.



Lucky's CASINO ADVENTURE

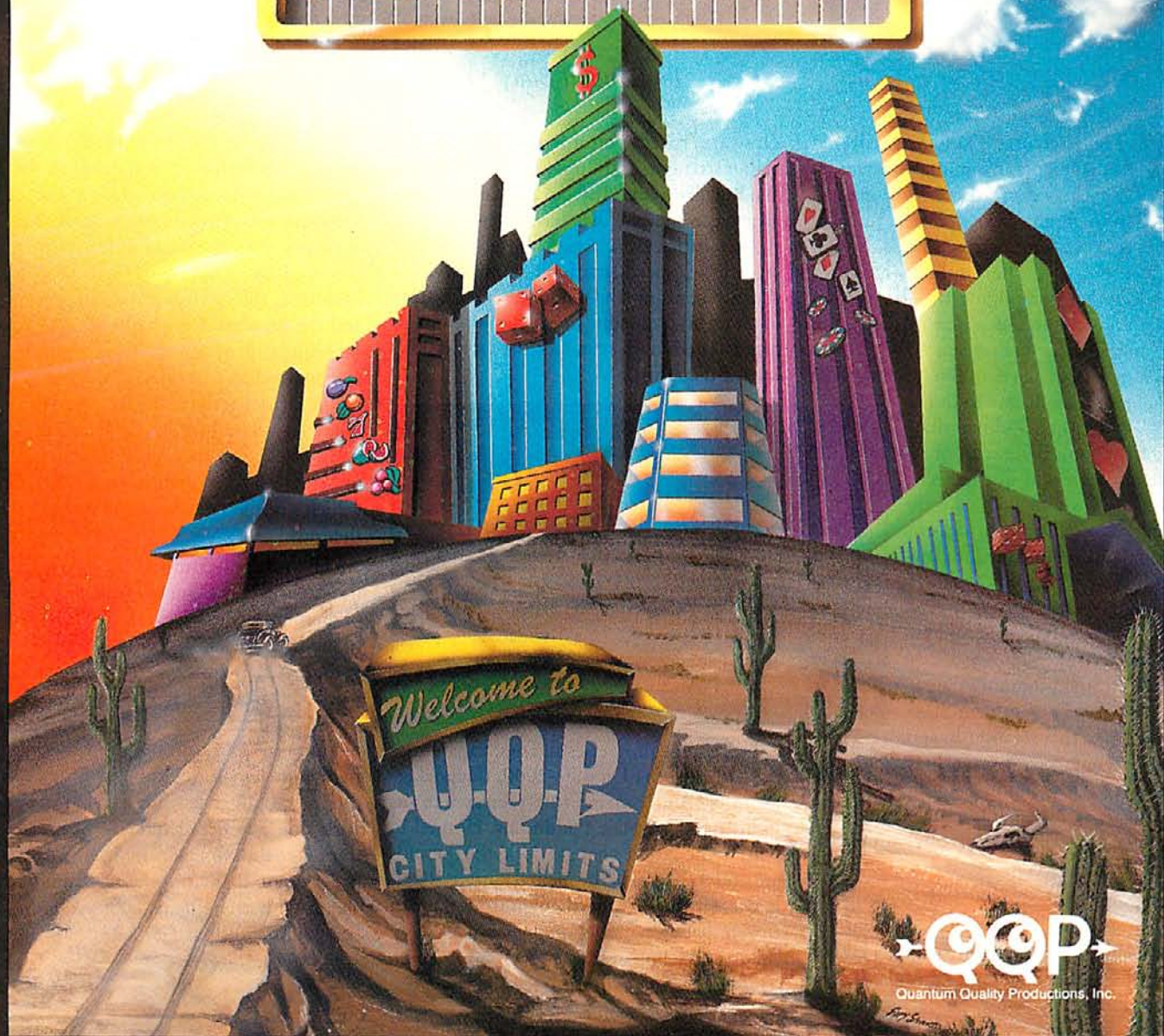

QQP
Quantum Quality Productions, Inc.

It is vacation time . . . you can sit at home watching the grass grow or enter our world . . . LUCKY'S CASINO ADVENTURE. This could just be your lucky break. Everyone can "win", but only the best can hold out for the full three weeks. Travel between the many casinos, have a bite to eat and rest in the hotels. Nothing has been left out in this state of the art experience of a lifetime.

- **Games Included: 5 Different Pokers, 8 Different Slots (all completely different), Palgow, Blingo, Keno, Baccarat, 3 Different Video Pokers, Money Wheel, Blackjack, Casino, Craps, Red Dog, Roulette, Caribbean Stud (ALL REAL CASINO QUALITY)**
- **Supports All Major Sound Cards**
- **256 Spectacular Colors**
- **Tournament Play**
- **Scoring History**
- **640 x 400 VESA VBE 1.2 Compatible**
- **Three Week Adventures to experience**

The "Lucky's Casino Adventure" computer game is for IBM PC. It can be obtained through your favorite retailer or call:

1-908-788-2799

or by writing to:
QQP—495 Highway 202
Flemington, NJ 08822

Copyright 1993 Q.Q.P. All rights reserved. IBM is a trademark of International Business Machines.

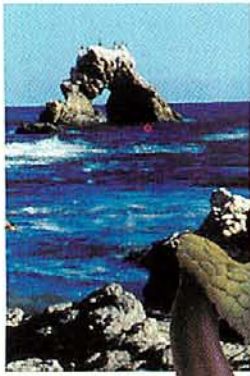

The Galapagos Were Never Like This!

Maxis' *UnNatural Selection* Sends *SimLife* to Boot Camp

by Randall Black

When Charles Darwin discovered that plants and animals owed their existence to a process he named "evolution by natural selection," he revealed that life is a competition that awards survival only to the fittest. The SimFolks at Maxis have succeeded in bringing the intensity of the evolutionary contest, "red in tooth and claw," to the computer screen.

UnNatural Selection combines the intricate simulation of life forms found in *SimLife* with a knock-down drag-out strategy game. The heart of the action can be found in the Secret Missions, in which you take the role of scientist Dr. Ted Jackson. Jackson has been recruited to combat ferocious "theroids," genetically engineered beasts that have overrun nine islands. He and co-researchers originally began the theroid research program in an attempt to relieve world hunger. Now we learn that six months ago, Jackson's fellow scientist, Dr. Ingrid Skinner, disappeared with a number of theroid specimens that have mutated into monsters. Jackson's job is to breed even tougher animals to take the islands back.

Using digitized speech and a computer "movie," the game introduces most of the plot by way of one Franklin Griggs, a crusty, loud-mouthed colonel who ramrods the operation and heaps abuse on Jackson when things aren't going well. The game begins when Jackson and Colonel Griggs arrive by helicopter aboard an aircraft carrier that will serve as Jackson's laboratory during the island-hopping campaign against the theroids. Central to Jackson's lab and still being assembled by Dr. Andy Anderson, a third scientist and consummate nerd, the DigiLife AL-2000 console controls the unnatural selection of three types of theroids: zips, hulks and slugs.

Zips are speedy creatures, hulks possess higher strength, and slugs have greater stamina. But all three body types are really variants of a basic theroid that has genes for eight characteristics. By selecting for fighting, mating, eating, speed, strength, stamina, vision and momentum (the tendency of a creature to travel in a straight line), you attempt to breed a theroid that can kick the tar out of its wayward cousins.



As the game progresses and new capabilities are added to the DigiLife-2000, the pocket-protected Anderson interrupts research to announce the lab's latest additions. Housed in pens in the carrier's hangar deck, the theroids are under control of the Neural Pattern Regulator, which can put them into a state of frozen paralysis. The original theroid breeding stock is, to put it politely, genetically challenged. Jackson's job is to whip these chromosomal weaklings into fighting trim. Using yet another device, the Synthetic Neural Injector, you can create new, slightly less pathetic individuals and plunge them into the gene pool.

The console also comes equipped with controls for the

level of radiation, which produces genetic diversity by inducing mutations in the animals' genes. Alas, the radiation also causes harmless viruses to mutate into nasty X, Y and Z viruses that are spread during mating and inherited by offspring. The Y virus causes blindness, the Z virus lowers the birth rate, and the dreaded X gradually saps stamina in subsequent generations. In general, it's important to eliminate infected theroids quickly before viruses get a chance to spread throughout your entire breeding population. However, virus-laden theroids can be sequestered in a pen of their own to later serve as the vehicles of biological warfare against enemy theroids.

The most powerful tool on the DigiLife is the database. The database can sort hundreds of theroids according to one or a combination of many traits, allowing you to select the best and move them to a separate pen, or grab the worst and zap them into oblivion. Although they reproduce sexually, all theroids are hermaphrodites, creatures equipped with both male and female reproductive organs. The different body types are capable of mating with one another. Eventually zips seem to dominate the population simply because they get around to mating faster, but they can acquire the strength and stamina of even the best hulks and slugs.

UnNatural Selection

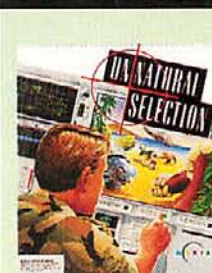

Title: UnNatural Selection
SYSTEM: IBM
PRICE: \$49.95
REQUIREMENTS: 386SX or higher, 330K EMS RAM for sound, 15MB hard drive space, mouse; supports Sound Source and Sound Blaster sound cards
PROTECTION: None
DESIGNER: Jim Simmons, Peter Fokos, Nick Corea
PUBLISHER: Maxis
Orinda, CA
(510) 254-9700



MECHAMANDER™

FUTURISTIC STRATEGY
COMBAT SIMULATION

FROM



MINDCRAFT

For a free, playable demo of MECHAMANDER,
Dial 885 310-320-5196.

Circle Reader Service #98

As you take the role of Jackson, feverishly trying to breed a batch of theroids tough enough to take on Dr. Skinner's runaways, the clock is ticking. At 0700 hours, Colonel Griggs comes on the horn and announces in his warmly dictatorial tone, "It's showtime, Jackson! Are you ready to go to battle stations, now?" You can delay the attack, but at great cost: Skinner's theroids get tougher in the meantime. Stalling, in effect, sets the game to expert level, significantly boosting the numerical values of the enemy theroids' genes. Even if you have a theroid deficiency, it's better to go paw-to-paw with the opposition sooner rather than later.



As Jackson, you oversee the loading of theroids into three fast Sea Stallion helicopters, each holding up to 17 critters, and three slower Sea Knight choppers with room for 36. In addition to theroids, the helicopters can carry boxes of cargo, a mixed armamentarium of materiel to support the assault. Cargo includes regular food along with special red "rage" chow and pink "lust" that increase fighting or mating behavior. Another kind of food, "bran," can be dumped on enemy theroids to use up their eating drive without providing nutrition (and presumably giving "regular" army a whole new meaning). A limited number of noisemakers let you temporarily clear areas of creatures by frightening friend and enemy alike. Another type of cargo, "decoys," serve as combination punching bags and inflatable party dolls to sap enemy fighting and mating drives. In addition to the chopper fleet, a C-130 Hercules transport plane orbits the island, prepared to lay down a swath of regular food to hungry troops.

Once Jackson's theroids are dropped on the island, it's possible to aim a "satellite beam" at individual animals to increase stamina, strength, speed, fighting, eating or mating. Like the proverbial horseshoe nail that lost the war, the beam can make the difference between victory and defeat. Yet another control is the NPR button, which puts every one

of your theroids into stasis, rendering them invulnerable to attack. Since theroids often hit the ground in a shockingly low state of stamina, a valuable strategy is to freeze them *en masse* with the NPR and then zap the weak sisters to boost stamina before turning off the NPR to unleash your scaly horde.

Once Jackson's theroids take over the island, it's back to the lab to continue refining the remaining theroids before the next port of call and Colonel Grigg's mellifluous call to battle stations. The smart player will have reserved the highest quality breeding stock for the next round of mutation and selection. In fact, the relative calm of the aircraft loading

deck turns out to be an ideal place to continue selecting for stronger traits by shipping misfits off to their new island home. While Jackson sweats to crank up his babies' genes, the enemy theroids continue to mutate, and each island is more challenging than the last. Through judicious mutation and selection, the true champions, body types called "beasts," begin to emerge. The combative beast is difficult to breed because these hard-fighting theroids have trouble mating. Although it's relatively easy to mutate a maximum gene value for fighting, the trait quickly becomes extinguished because theroids maxed out for fighting are too busy tangling to tango. Even beasts at less than maximum levels of fighting make poor mothers and reproduce very slowly, making them poor candidates for colonizing and holding territory. To take over an island it helps to have an ample supply of better breeders. Still, by the time you reach the ninth island, you also had better have some really bad mothers on board.

UnNatural Selection is actually two products rolled into one. To practice breeding and assault tactics for the secret missions and explore the incredible sophistication of the lab and theroid variables, the game includes an "Independent Research" section with 15 bizarre islands of its own. The designers have provided a mind-boggling depth of control over virtually every feature of laboratory settings and theroid bodies. Also included are 16 "textbook experiments" that explore everything from cannibalism and carrion-eating to theroid "intelligence." As do the Secret Mis-

sions, the Independent Research lab provides a number of visualization options, including two levels of close-up viewing and numerous ways to examine genetic make-up and watch behavior. In the extreme close-up you can actually see the creatures fight, mate, eat, and die in claymation action. These animated bits add a cute dash of splash, but they become irrelevant after the first few viewings.

Despite some creative departures from real science, *UnNatural Selection* offers a vivid demonstration of several key principles underlying Darwinian evolution. And, like other rule-governed life simulators, the program gives rise to surprising "emergent behaviors" in which the organisms display unexpected trends in the ways they evolve. In the bargain, *UnNatural Selection's* database provides unprecedented control and insight into the forces driving its particular brand of artificial evolution. Given the intuitive grasp of genetic selection *UnNatural Selection* provides, not to mention its entertaining format, it would not be surprising if instructors began assigning the game as homework for college-level courses in evolutionary biology.

As a game, *UnNatural Selection* supplies a set of increasingly difficult challenges that will drive the obsessive personality to go without sleep. The last two Secret Missions require the toughest beasts, every trick in the book, and significant stamina on your part. The movie sequences, especially the friction



between Griggs and Jackson, and the plot itself, stimulate interest without intruding on the game. The Secret Missions offer closure to the plot and an interesting surprise with the conquest of the ninth and final island: Dr. Skinner's breeding pens. Overall, *UnNatural Selection* offers up a slick, funny and memorable game combined with a fascinating artificial life laboratory.

A science writer for more than a decade, Randall Black has written for such publications as Smithsonian Air & Space, Wildlife Conservation, Science Digest and OMNI. CGW



How
long can you
survive in a constantly
changing world of
alliance and intrigue?

Will
you be a minor player
in the politics
of the age,
or push the limits
of empire and
dominance?

Coming soon from Mindcraft.

Circle Reader Service #99

The Elder Scrolls

ARENA



"I've played role-playing games since they first appeared on mainframes a decade ago. The Elder Scrolls: Arena is quite simply the most captivating, well-designed, realistic world available on home computers."

*—Russ Ceccola, Associate Editor,
Electronic Games*

"The most impressive showing by any company...Bethesda's Fall line-up is one of the best going."

—Computer Game Review

Circle Reader Service #41

BETHESDA SOFTWORKS

THE TERMINATOR™

KAMFAGE



He's back.
He's made a few friends ...
... and they're angry.

Circle Reader Service #42

BETHESDA SOFTWORKS™

MERCHANT PRINCE

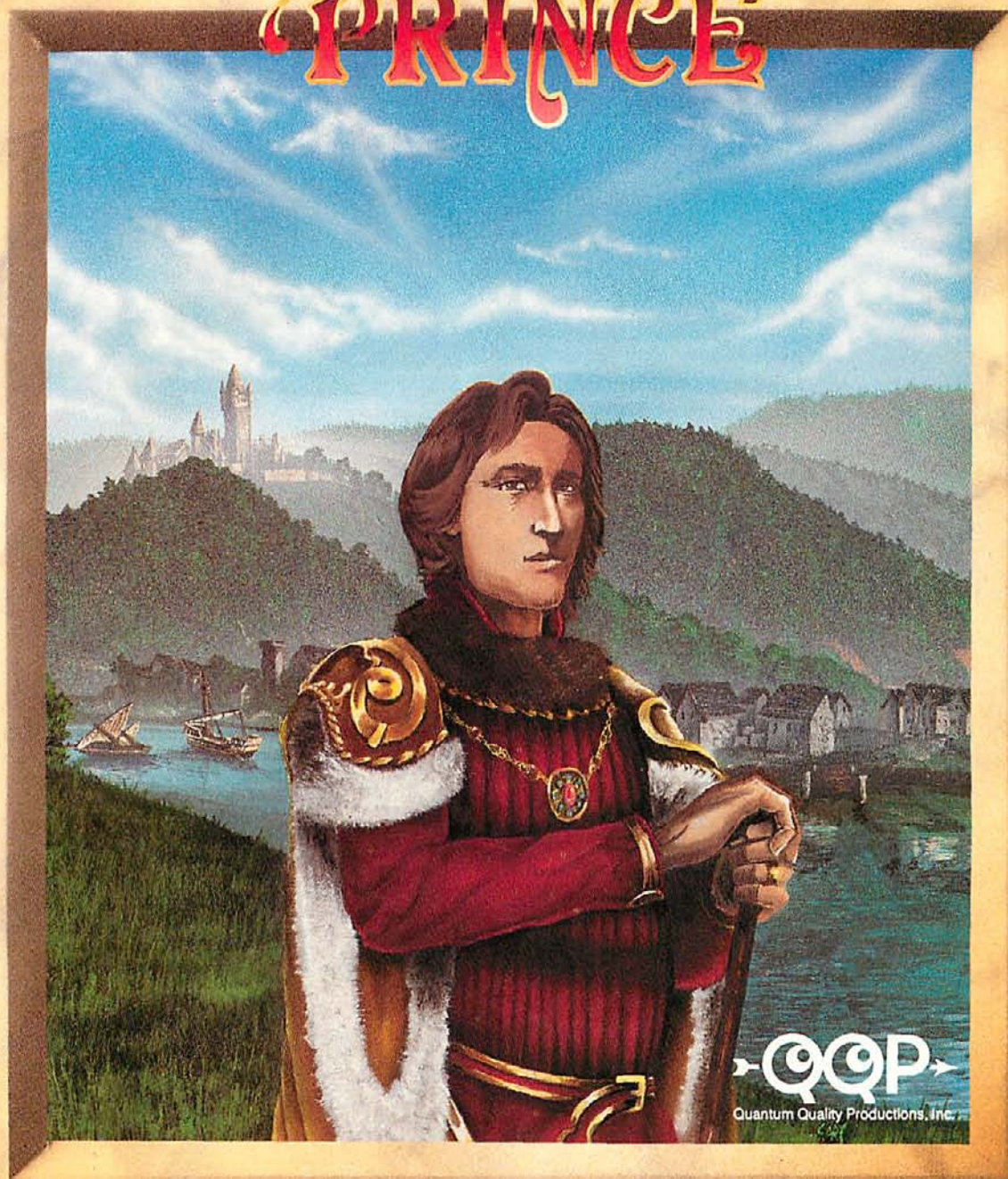

EXPLORE THE WORLD!! Your family can rule the high seas, and crush the competition in this all out, global conquest game. You embark from your center of power, Venice, to seek your fortune. Find the hidden treasures in far off lands and establish trade routes. But, this is only the beginning. Your popularity is at stake as you involve yourself with the church and state. The others in power say you can't do it. . . . Do you have the strength??

Delve into the political power struggle, entrench yourself in the ruling establishment of the church, and trade in exotic commerce to become the master of the world
"THE MERCHANT PRINCE."

Masters of the World

- Historical and Random World Maps (Billions)
- Four Players
- Modem Play
- Complete Scoring History
- Strong Artificial Intelligence
- Both Land and Naval Trade Routes
- Build Your Own Road System—Worldwide!
- Manipulate the Local Politicians
- Inspire the Church and People

The "Merchant Prince" computer game for IBM PC. It can be obtained through your favorite retailer or call:
(908) 788-2799

or by writing to:
QQP—495 Highway 202
Flemington, NJ 08822
Copyright 1993 Q.Q.P. All rights reserved.
IBM is a trademark of International Business Machines.

THE RED CRYSTAL

“The Seven Secrets
of Life”

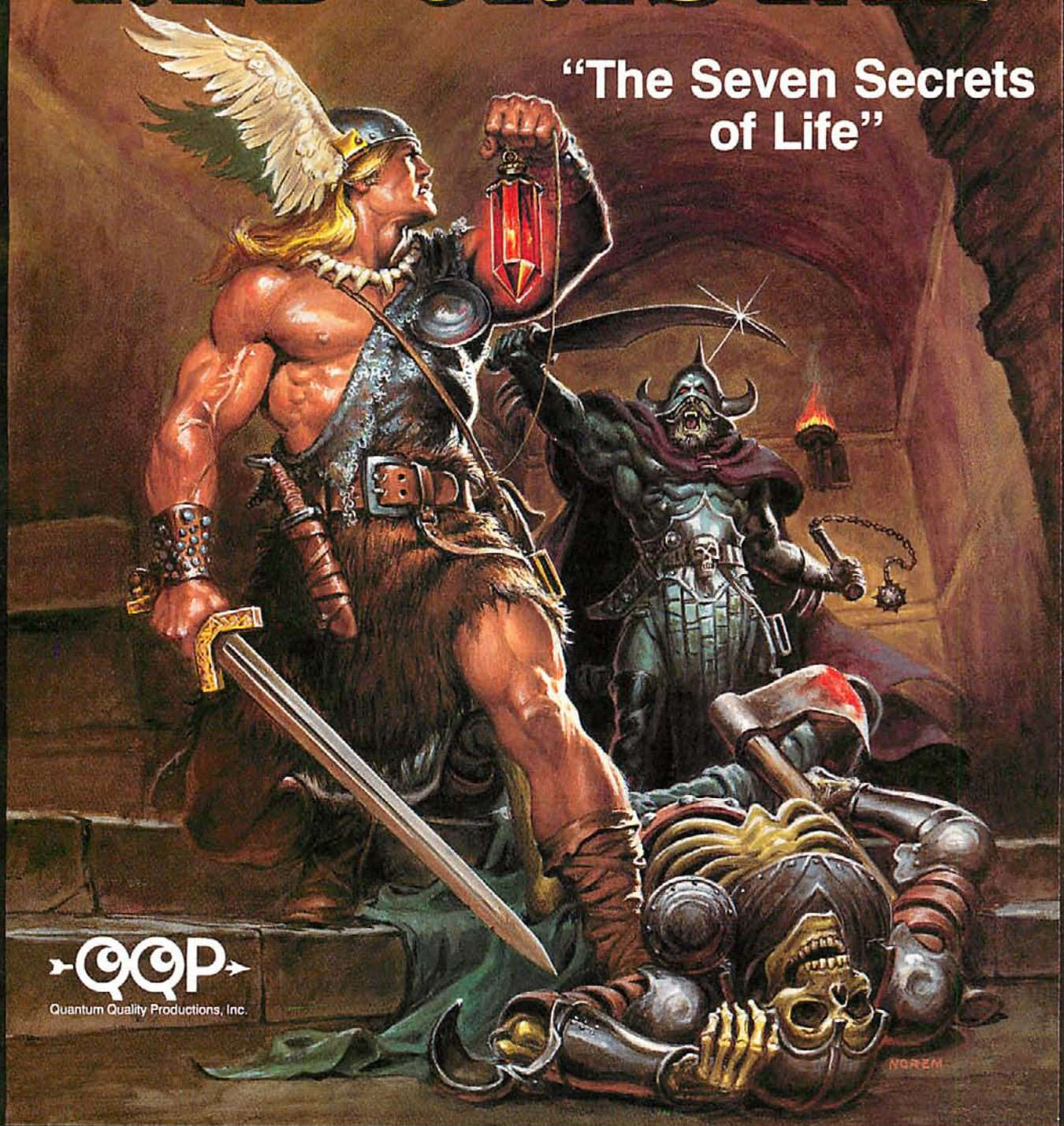

→ QQP →

Quantum Quality Productions, Inc.

Seek out the seven secrets of life . . . Can you forge through the evil that lurks in the depths of the eerie dungeons, the ominous castle towers and the savage countryside? Play alone or with a partner. Simply, one fine adventure and role playing endeavor.

- **MODEM PLAY**
- **1 OR 2 PLAYERS WORKING TOGETHER OR IN HEAD TO HEAD COMPETITION**
- **BREATH TAKING GRAPHICS**
- **FASCINATING ECONOMIC SYSTEM**
- **LARGE VARIETY OF MONSTER TYPES**
- **OVER 50 DUNGEON LEVELS**
- **AUTO-MAPPING FEATURE**

The “Red Crystal: Seven Secrets of Life” is for the IBM PC. It can be obtained through your favorite retailer or ordered directly by calling:

908-788-2799

1993© Q.Q.P. All rights reserved. IBM is a trademark of International Business Machines.

A Thayler For Your Thoughts

Or How To Buy Friends and Influence People In *The Patrician*

by Tim Carter

Ah, to be rich. To acquire great fame and fortune, marry a beautiful wife, and buy one's way into political office. The dream, as we all know, of every medieval European merchant. That's right, medieval Europe. Sorry, no knights in armor, no large wars of conquest, only hoards of money and political power. So take off those general's stars and put on your best Donald Trump smile and take a look at *The Patrician*, a German design distributed in North America by Readysoft.

The Patrician is a game of medieval trade and political power. The game is set in 14th century Europe, along the Baltic and North

League's military ventures, but the overriding priority is money.

While only a successful political campaign will win the game, political campaigns cost money. An unsuccessful merchant will never succeed in politics; an ample purse is vital, and this can only be obtained through a clever economic strategy.

Aristocratic Appeal

The Patrician is presented in an attractive and pleasing manner. While not quite state of the art, the graphics are very good, particularly for a strategy game. On my 486-50 the scrolling map was smoother than any I have ever seen. On slower machines it was not quite as smooth, but it was still impressive. More importantly, the screen was attractive and easy to understand, even on the black and white monitor of a laptop.

The game interface is clean and logical. The game shifts from town to town as ships arrive and depart. Each town has the a similar layout: a commercial screen (the waterfront), a political screen (the town square), and a construction screen (the ship-

yard). Clicking on the various buildings provides access to the offices inside, where most of the activities take place. All commands may be given by mouse, although a combination of mouse and keyboard commands works best, particularly when entering numbers.

The ease and accessibility of the interface is particularly important for *The Patrician*, as the manual is somewhat

less than helpful. To be fair, it is probably very informative in its original German, but the English translation leaves much to be desired. The history that constitutes about half of the total manual is difficult to read and provides little assistance to aspiring merchants. The actual instructions range from clear to completely obtuse, depending upon the topic. In some cases the manual is wrong, as in the names and descriptions of the various ships available. It also discusses commodities that do not exist and fails to accurately describe the steps necessary to win the game.

Surprisingly, however, this does not really detract from the play value of the game. The manual is not so bad that the mechanics of the game are obscured, and the interface is easy enough that, once I got going, I was able to do just about everything without referring to the instructions.

Merchant Manners

At the heart of *The Patrician* is a trading simulation. The game revolves around the buying and selling of 18 commodities in 16 towns stretching from London to Novgorod. You can buy and sell anything from corn and fish to furs and pepper. With one exception (noted below) the commodities are transported from town to town by ship, and so a large, well organized fleet is vital to commercial success. Ships may be purchased at any town, however the supply of wood and other raw materials



Sea trade routes. You take the position of a lowly merchant in one of the towns that formed the Hanseatic League. The League was a powerful alliance of merchants in the 14th century that dominated trade in the Baltic for almost 200 years. The objective of the game is to rise through trade and politics to the head of the League.

While there is some conflict in *The Patrician*, the central focus is definitely economic. You are required to fend off pirate attacks from time to time, and status and political power can be gained from participating in the

The Patrician



TITLE: *The Patrician*
 PRICE: \$59.95
 SYSTEM: Amiga, Atari ST, IBM (IBM reviewed)
 REQUIREMENTS: Amiga: 1MB RAM, hard drive, mouse; supports RAM expansion; IBM: 286 or better, VGA graphics
 DESIGNER: Triptychon
 PUBLISHER: Readysoft
 Richmond Hill, Ontario, Canada
 (416) 731-4175

CHIPS & BITS

PO Box 234
 Rochester VT 05767
 Call 800-699-4263
 Int'l 802-767-3033
 Fax 802-767-3382
 Source-10027

Visa & MC Accepted. Checks Held 4 Weeks.
 Money Orders Treated as Cash. COD \$8.
 Compatibility guaranteed. Shipping charges non-
 refundable. Shipping times not guaranteed. Most
 items shipped same day. Price and availability
 subject to change.

OVERNIGHT SHIPPING IN US \$4 PER ORDER.
 Mail to Canada, PR, HI, AK, APO, FPO \$4 per
 order. 4-8 day Worldwide shipping \$6 per item.
 Including Kuala Lumpur.

HANDLING \$2 PER SHIPMENT



'THRUSTMASTER'S FORMULA T1' is the most realistic control for all of today's driving simulators. Features fully functional steering wheel, brake and gas pedals and turbo boost gauge used in supporting games. \$129



'DREAM GIRL' Let your dream girl ask you intimate questions. The more you reveal to her, the more she reveals to you! This movie like video game features live video display, popular music, stunning effects and amazing graphics. \$32



'AD LIB', the music synthesizer card that made the PC game industry stand up and listen, is here to make your favorite action, adventure, role playing, arcade and simulation games come alive with sound. Features 11 different FM synthesized voices and the greatest level of software support in the industry. \$34



'MAN ENOUGH' Five women and you. They want it all. But its not going to be easy. An interactive social adventure, **Man Enough** features almost an hour of live-action video, stimulating dialogue, which comes to life through digitized speech and 320 x400 enhanced VGA graphics. \$45

IBM HARDWARE

- Acoustic Research P22 \$79
- Acoustic Research P42S \$159
- Acoustic Resrch P570 \$319
- Acoustic Resrch P622 \$239
- AdLib Sound Card \$34
- AdLib Gold Sound Card \$99
- Adv Gravis Ultrasound \$129
- CH Weapons Cntrl Sys \$44
- Command Control Pad \$17
- Fighter Stick \$79
- Flight Stick \$36
- Flight Stick Pro \$57
- Game Card 3 Automatic \$28
- Labtec CS-150 Spkrs \$17
- Labtec CS-550 Spkrs \$24
- Labtec CS-700 Spkrs \$28
- Maxx Cobra Flightstick \$54
- Maxx Control Yoke \$54
- Maxx Rudder Pedal FLT \$38
- Pilot Control Stand \$22
- Pro Audio 16 Basic \$118
- Pro Audio Spectrum 16 \$149
- Pro Audio Spect Plus \$129
- Pro Audio Studio 16 \$205
- Reel Mag Mltimd Upgrd \$399
- Rudder Pedals Driving \$39
- Sony SRS7 Speakers \$9
- Sony SRS9 Speakers \$14
- Sound Blaster 16 ASP \$214
- Sound Blaster 16 Basic \$129
- Sound Blaster Deluxe \$82
- Sound Blst Discov CD 16 \$399
- Sound Blst CD ROM Drv \$299
- Sound Blstr Pwrld Spkrs \$24
- Sound Blstr Pro Deluxe \$124
- Sound Blstr Voice Assist \$54
- Sound Galaxy BX2 WSpkr \$65
- Sound Galaxy NX2 WSpkrs \$79
- Sound Galaxy NXPRO \$109
- Sound Galaxy NXPPO 16 \$499
- Sound Glyx NXP16wSCSI \$139
- Sound Machine \$94

IBM HARDWARE

- Thrustmaster FCS Pro \$99
- Thrustmstr Flight Cntrl Sys \$59
- Thrustmstr Game Card \$27
- Tmastr Rudder Cntrl Sys \$99
- Tmastr Weapn Cntrl Sys \$94
- Video Blaster \$349
- Virtual Pilot \$61
- Voice Blaster \$52

IBM ADULT

- 101 Sex Postions 2 CD \$44
- Adult Reference CD \$24
- Advs of Brad Stallion CDS \$39
- Animated Fant 1 or 2 CDS \$34
- Busting Out CD \$38
- Busty Babes CD \$32
- Centerfold Squares \$21
- Creme de la Creme CD \$29
- Debby Does Dallas CD \$38
- Deep Throat CD \$42
- Digital Dancing \$38
- Dreamgirl \$32
- Extreme Delight CD \$22
- Femme Fatale \$26
- Femme Fatal Dsk 1-6 ea \$18
- Girlfriend Suzie Or Teri \$36
- Hidden Obsessions CD \$38
- Insatiable CD \$32
- Jigsaw Pinups \$19
- Kama Sutra CD \$44
- Legends of Porn 2 CD \$29
- Lovely Ladies II CD \$39
- Metal & Lace NR13 \$29
- Mystic of Orient CD \$29
- Nightwatch Interact CD \$36
- Paradise Club CD \$46
- Penthouse Jigsaw PG \$21
- Penthouse Jigsaw XXX \$24
- Physical Therapy CD \$19
- Plyboy Electronic Dabtk \$42
- Southern Beauties CD \$26

IBM ADULT

- Strip Poker 3 \$29
- Strip Poker Professional \$34
- Strip Pker 3 Disk 1-6 ea \$16
- Strp Pker Pro Dsk 1-6 ea \$16
- The Devil Mis Jones CD \$34
- The Sexiest Women CD \$22
- Wick Q-Time Movie CD \$42
- Women Who Love Mn CD \$26
- Women of Venus CD \$27

IBM ADVENTURE

- Adv Willie Beamish \$19
- Alone in the Dark \$33
- Alone in the Dark 2 \$36
- Altered Destiny \$29
- Amazon \$19
- Animation Classics \$39
- Award Bundle \$46
- Beverly Hillbillies \$19
- Bioforge \$52
- Bloodnet \$42
- Blue Force: Next of Kin \$39
- Cstle Wolfst-Spear Dest \$32
- Companion of Xanth \$34
- Dark Seed \$19
- Day of the Tentacle \$34
- Dracula \$34
- Dragon Knight 3 \$49
- Dragon's Sphere \$42
- Dreamweb \$36
- Elf \$24
- Epic \$32
- Eric the Unready \$21
- Flashback \$32
- Fourplay WIN \$19
- Frd Phrkas Front Pharm \$38
- Gabriel Knight \$36
- Gateway \$32
- Gateway 2: Homeworld \$34
- Hand of Fate \$34
- Heimdall \$17

IBM ADVENTURE

- Hired Guns \$32
- Hook \$32
- Inca \$34
- Inca 2 \$42
- Indy Jnes 4 Fate Atlantis \$36
- Innocent Until Caught \$36
- Isle of the Dead \$38
- Jack the Ripper \$39
- Jagged Alliance \$48
- Jonny Quest \$26
- King's Quest 5 VGA \$36
- King's Quest 6 VGA \$42
- King's Ransom \$38
- Kronolog: Nazi Paradox \$42
- Laura Bow 2 \$39
- Leather Goddesses 2 \$39
- Legend of Kyrandia \$32
- Leisure Suit Larry 1 VGA \$19
- Leisure Suit Larry 5 \$24
- Leisure Suit Larry 6 \$42
- Loom \$19
- Lost Files Sherl Holmes \$26
- Merchant Prince \$39
- Metal Mutant \$32
- Mixed-Up Mother Goose \$29
- Out of this World \$36
- Police Quest 1 VGA \$19
- Police Quest 3 VGA \$36
- Police Quest 4 \$42
- Prince of Persia \$25
- Prince of Persia 2 \$39
- Quest for Glory 1 \$18
- Return of the Phantom \$34
- Return to Zork \$40
- Rex Neb Master Ed \$32
- Rex Neb Cos Gen Ben \$36
- Riftwar Legacy VGA \$37
- Ringworld \$35
- Robocop 3 \$32
- Sam & Max Hit Road \$38
- Screen Antics WIN \$19
- Secret Monkey Island 2 \$21
- Secret Monkey Isle VGA \$25

IBM ADVENTURE

- Secret of 7th Labyrinth \$42
- Shadow Caster \$45
- Shadowgate WIN \$34
- Simon the Sorcerer \$32
- Space Quest 1 VGA \$16
- Space Quest 4 VGA \$24
- Space Quest 5 VGA \$36
- Spellcasting 101 \$19
- Spellcasting 201 \$36
- Spellcast 301 Sprng Brk \$34
- Star Reach \$36
- Star Trek 25th Anniv \$35
- Star Trek: Judge Rites \$38
- Starship \$38
- Stellar \$21
- System Shock \$54
- Teen Mutant Ninja Turt \$25
- Terminator 2029 \$37
- Term 2029 Oper Scour \$19
- Terminator Rampage \$38
- Terror of the Deep \$36
- The Dig \$45
- Under a Killing Moon \$43
- Where Spce Carmen Dix \$44
- Where Time Carmen \$32
- Where USA Carmen Dix \$45
- Where Wrld Carmen Dix \$52
- Yserbius \$36

IBM ARCADE

- 500 CC Race Bike \$29
- Aliens Ate My Babysitter \$19
- Aracnaphobia W Sound \$19
- Brt Simpson's Hse Weird \$31
- Cogito Windows \$34
- Drag L Esc Singe's Cast \$34
- Dragon's Lair \$22
- Dragon's Lair 2 or 3 \$34
- Eagle's Rider \$29
- Eight Ball Deluxe \$38
- Fire & Forget \$24

IBM ARCADE

- Galactic Conqueror \$31
- Galactic Empire \$27
- Geekwad Gmes Glyx CDS \$21
- Goblins VGA \$18
- Goblins 3 \$29
- Guy Spy \$24
- Highway Patrol 2 \$29
- Incred Machine VGA \$27
- Incredible Machine 2 \$27
- Incredible Toons \$29
- Infestation \$19
- Innocent \$38
- Metal & Lace \$29
- Night Breed \$26
- Pick'n Pile \$19
- Silverball \$29
- Simpsons: Arcade Games \$31
- Space Ace \$32
- Space Ace 2 \$34
- Street Fighter 2 \$39
- Swamp Gas WIN \$38
- Take-A-Break Pinball \$28
- Teenage MNT Man Miss \$31
- Teen Mut N Turtles Adv \$32
- Teen Mutant Ninja Turtle \$25
- The Incr Machine 2 WIN \$30
- The Tinies \$29
- Titan \$29
- Titus Fox \$25
- Tristan Pinball \$19
- Volfied \$24
- Wild Streets \$24

IBM BUNDLES

- ADD Collector's Ed 2 \$46
- ADD Starter Kit \$35
- Air Combat Classics \$42
- Capstone CD Game Col \$45
- Combat Classics \$24
- Dynamix Bundle 1 \$39
- Eye of the Beholder Col \$52

will greatly affect the price as well as the time of construction. For those in a hurry, ships may also be purchased at periodic auctions, although the condition of most auctioned ships is not good, to say the least.

The one exception to this system is the caravan route between Hamburg and Lubeck. These are two of the richest towns in the League, and players are well advised to consider either for their home. The caravan route allows you to ship large amounts of commodities by road between the two cities. Goods should be sent via the caravan route whenever possible as it reduces the wear and tear on ships and allows merchants to safely send very large quantities of goods in a single shipment.

Trade revolves around the prices of the different commodities in each of the cities. Obviously, the aim is to buy goods low and sell high. Prices are determined by supply and demand, and the difference in prices between towns can be great. This provides structural advantages that should be exploited regularly. For instance, furs will always be cheap in Novgorod and expensive in the West. At the same time, Fish Oil is usually very cheap in Scandinavia and scarce everywhere else. Prices also fluctuate according to the season (naturally, the supply of some goods declines over the winter) and according to the stocks each town has built up through trade.

Because prices are sensitive to the activity of traders, a diverse trading strategy is necessary. Trading only in high value goods, such as pepper and furs, will quickly deplete the cash of your home town, leading to economic (and thus political) ruin. In general, it is a good idea to buy more from your home town than you sell there. This will keep the local merchants and citizens happy and the town prosperous.

A smart trade strategy will benefit from the use of warehouses. These can be built in any town on the map and provide a number of advantages. If left empty, they supply rent and can be considered a form of long-term investment. More importantly, warehouses can be used to stock up on seasonal commodities during the harvest when prices are cheap.

In addition, merchants can hire workers to develop raw materials into more valuable finished products. This is done by retraining workers in a particular town and then stocking raw materials in a warehouse in the same town. For instance, wool can be converted to more valuable cloth, greatly increasing its

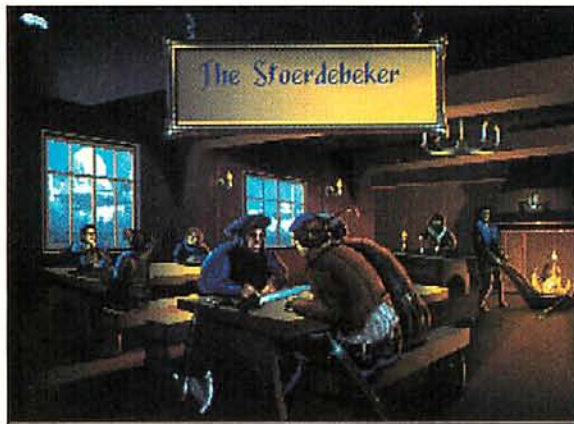

value, even if it is never shipped to another location.

Becoming Pious And Mighty

Once an effective trade network is established and a number of ships are in operation, a political campaign can (and must) be mounted. To compete for the leadership of the League, it is necessary first to be elected mayor of one of the towns that make up the league.

Election is based upon popularity with the townspeople, which can be increased in a number of ways. First, one needs to be a successful and prosperous merchant. Second, it is important to be sufficiently pious; there are church constructions to finance, poor people to support, and, of course, indulgences to pay. Third, social status can be increased through membership in trade guilds, through public feasts, and through a socially successful marriage, including a prestigious and sufficiently grandiose wedding.

Finally, contributions to the defense of your home town and the military expeditions of the league are crucial to the success of a merchant's rise to power. They are also the most expensive. Not only do military expenses draw cash away from trade, expeditions usually require heavily armed ships, which are then not able to ply the trade routes.

All in all, a political career is an immensely

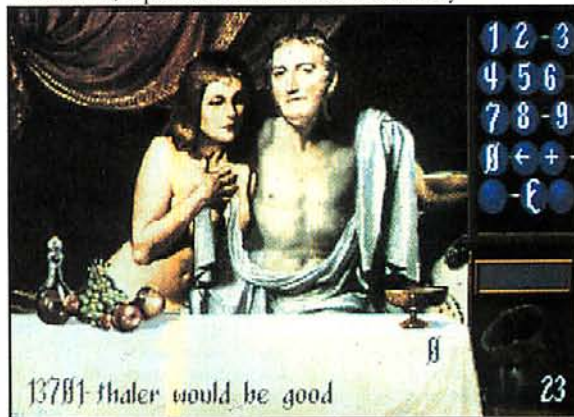

expensive undertaking. The nature of the economic model is such that expenses do not level off either, so that with increased expansion comes increased costs. Artisans and crew members must be paid, warehouses and ships maintained, and new ships purchased. Ships deteriorate over time, particularly if they carry heavy loads in rough seas. Every time a ship is repaired it loses carrying capacity. A well used ship will, over time, lose the ability to carry enough cargo to pay for itself. Therefore, there is no such thing as a complete fleet or a capital expense plateau: new investment is required constantly.

Traders In Training

While the interface is easy to learn, this does not altogether compensate for the failings of the manual. Almost no numbers or formulae are provided to explain how the economic model works. Absolute control freaks will not be able to stomach such an omission, while the rest of us would just like to know how much we are paying the crews of our ships and the staff at our warehouses.

Furthermore, the number of commodities (18) and the number of different buying and selling prices for each (16) makes for a bookkeeping nightmare the first few times you play the game. An experienced player will come to know where each good can be obtained for the best price and where each can find the best market; however, for beginners, an on-line bookkeeping system would have been appreciated.

Once the pricing system is understood, the trading element of the game becomes somewhat repetitive. As prices change constantly and special events alter the regular supply of a particular commodity there is still plenty to do, but a smart merchant is virtually guaranteed to make money.

Finally, there are no levels of difficulty or options for an altered start. While it is possible to begin the game in a number of different towns, this does not alter the basic price structure that underpins the game.

These limitations are unfortunate because underneath them is a solid program and a fun game to boot. It has a limited scope, but what it does it does well. The lack of options will ultimately reduce its replayability, but the game is sufficiently long that this shouldn't be a huge problem for casual strategists. Players looking for a strategy game with an interesting and less combat-oriented approach will find that *The Patrician* fits the bill nicely. **cgw**

CHIPS & BITS

PO Box 234
Rochester VT 05767
Call 800-699-4263
Int'l 802-767-3033
Fax 802-767-3382
Source-10027



'SAM & MAX HIT THE ROAD'
Freelance animal police partners Sam and Max team up to solve the mystery of the missing Bigfoot, Bruno. Explore America in a comic book world styled for adults. Contains full screen graphics, full talkie introduction, over 12 US locals, a free activity book & built in mini games. \$38



'THE C.H.A.O.S. CONTINUUM' is a fully interactive movie experience containing spectacular animation, and special effects. Titan Colony is being held captive by a vast, orbiting computer. Only you can find a way to stop it. Features innovative image control & random events to improve playability. \$42

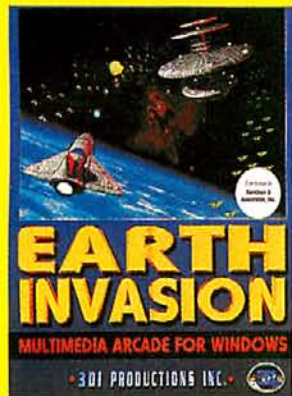

'EARTH INVASION' For Windows. On patrol in earth orbit you hear the first reports of a giant Cyborg Mothership. Only a few thousand miles from the planet, it has launched an attack on ground defense systems. Total surprise has rendered the planet helpless. You're civilization's only hope. \$24



'IRON HELIX CD'
You are out-gunned and on the run from a deadly defender robot with only your wits to prevent intergalactic war. Your mission: destroy the doomsday weapon on board a derelict spaceship. Iron Helix combines fluid nonstop action with stunning photo realistic 3-D graphics and a dynamite soundtrack. \$56



'UNDER A KILLING MOON' transports you to the virtual world of the feisty detective Tex Murphy. New feature allows you to save and splice scenes together. Digitized voices & sound effects and amazing level of detail & freedom of movement make this game visually and aurally stunning. \$43 or CDS\$48

IBM BUNDLES

Eye Beholder Trilogy CDS\$52
Inch 3.0 Wtmaster FCSS\$99
Game Pak 1 \$19
Gateway Collection 1&2 \$32
Land Sea Air 2 \$29
Lost Treas Infocom or CDS\$39
Lost Treas Infocom 2 or CD \$29
Lucas Classic Advts \$36
Max Pac \$19
Max Overkill W Disk \$45
Megafortress Mega-Pak \$38
Perfect General Trilogy \$34
Quarterdeck Game Bund\$62
Secret Weap Luftwaffe CD \$42
Space Quest Bundle 1-4 \$42
Spellcasting Bundle \$34
Spellcasting Bundle CD \$32
Strike Force '42/Red Storm \$35
The Victory Pack \$45
Ultima Trilogy \$39
Ultima Trilogy 2 \$48
Wing Com 1 Dlx or CD \$48
Wizardry Trilogy \$32
Wizardry Trilogy 2 \$32

IBM CD ROM

1st Guest \$48
1st Guest 2: 11th Hour \$65
1st Gst OEM Jewel Case \$35
Advs of Willie Beamish \$39
Legis: Guardian of Fleet \$54
Jone in the Dark \$48
Arctic Baron \$29
17 Flying Forts w SS2 \$37
Backroad Racers \$43
Barn Bear Goes to Schl \$23
Barn Bear Goes to Spce \$23
Battle Chess WIN&DOS \$19
Bloodnet \$45
Blue Force: Next of Kin \$39
Buzz Aldrin Rce Space \$59

IBM CD ROM

Campaign \$35
Castles 2 \$49
Chaos Continuum \$42
Chessmaniac 5 Bill & 1 \$35
Chessmaster 3000 \$46
Chopper Pack \$37
Conan \$26
Conq Robin Hood WIN \$42
Conspiracy \$44
Curse of Enchantia \$26
Cyber Space \$38
Dark Seed \$48
Darksun \$52
Day of the Tentacle \$45
Dinosaurs \$42
Dracula \$48
Dracula Unleashed \$49
Dragon's Lair \$39
Dune \$54
Dune OEM Jewel Case \$34
EcoQuest Search Cetus\$42
Eric The Unready \$36
European Racers \$41
Eye of the Beholder 3 \$48
Eye Behldr 3 Jewel Cse\$24
F117&F15 SE 2 Jwl Cse\$28
F15 Strike Eagle 3 \$46
FA 18 Hornet \$54
Fantasy Empires \$45
Fascination \$39
Fatty Bear's Funpack \$34
Fatty Bear's Wrld Games\$44
Fatty's Bears Bday Surp \$38
Gabriel Knight \$45
Gateway 2 \$34
Gobliins 1 or 2 \$30
Great Naval Battles \$55
Gunship 2000 Jwl Cse \$26
Guy Spy \$29
Hard Day's Night \$29
Harrier Assault SVGA \$44
Hell Cab \$49
Hi-Tech Aircraft \$43

IBM CD ROM

Hypnotic Harp \$36
Inca \$39
Inca 2 \$42
Indy Jones Fate Atlantis \$42
Interplay's 10 Yr Anthly \$49
Iron Helix \$56
Jet Pack \$46
Jungle Book WIN \$24
Jutland \$48
King's Quest 5 WIN \$41
King's Quest 6 \$45
King's Quest 6 Upgrade \$24
King's Ransom \$38
Koshan Conspiracy \$48
Labyrinth of Time \$48
Lands of Lore \$44
Laura Bow 2 \$39
Lawn Mower Man \$45
Legend of Kyrandia \$39
Leg Kyrandia Jewel Cse\$24
Leisure Suit Larry 6 \$46
Loom \$39
Lord of the Rings \$45
Lost in Time \$39
Mad Dog Mcree \$32
Magic Death \$26
Mantis Exp Fighter \$46
Mario Teaches Typing \$48
Mario is Missing \$44
Microcosm \$49
Microsoft Golf \$48
Mosaic Magic \$34
Multimedia: Vivaldi WIN \$24
Myst \$64
NFL Coaches Club Fball \$32
Omar Sharif Bridge DLX\$46
Patrician \$38
Phantasmagoria \$59
Police Qust 4: Opn Seas\$42
Protostar \$44
Putt Putt Goes to Moon \$44
Putt Putt Joins Parade \$48
Putt Putt's Funpack \$34

IBM CD ROM

Quest for Glory 1 VGA \$39
Return To Zork \$48
Retrn Zork OEM Jwl Cse\$32
Ringworld \$38
Scrabble Deluxe \$25
Secret Monkey Island \$39
Shadow of the Comet \$48
S Holmes Con Det 1or2 \$36
Sherl Holmes Con Det 3 \$51
Shuttle \$29
Sim Ant/City/Earth ea \$48
Slater & Charlie \$42
Sftwre Toolwrks Refernc \$79
Space Quest 4 \$37
Spce Qust 4 Jewel Cse \$16
Spirit of Excalibur \$26
Star Trek 25 Anniversary\$55
Star Wars Chess \$49
StarTrek Nxt Generation \$46
Stellar 7 \$42
Storm Troop \$54
Stronghold \$36
System Shock \$54
Team Yankee 2 \$29
T2 Chesswars \$27
Terror of the Deep \$36
Tetris Gold \$32
The Journeyman Projct \$48
Tony La Russa BB 2 \$46
Tornado \$42
Trump Castle Collection \$14
Ultima 9 or 10 \$54
Ultima Underworld 1 & 2 \$59
Under a Killing Moon \$48
Video Cube \$45
Where in World Deluxe \$59
Where Wrld is Dlx OEM\$24
Who Killed Sam Rupert \$21
Wing Commander 3 \$54
Wing Command Ultima 6\$57
Wing Command Ult UW \$55
Wolf Pack \$42
World Circuit \$34

IBM CD ROM

World of Xeen \$42
Wrath of the Demon \$29

IBM EDUCATIONAL

Ancient Empire \$25
Auto Map \$39
AutoWorks \$49
Boom Box \$19
Castle of Dr Brain EGA \$25
Castle of Dr Brain VGA \$19
Children's Write & Publ \$42
Civil War \$57
Clock Works \$19
Cuckoo Zoo \$32
Discoveries of the Deep \$37
Dyno-Quest \$36
Eagle Eye Mysteries \$32
Easy Street \$36
EcoQuest 2 Lst Sct Rain\$34
EcoQuest VGA \$32
Fatty Bear's Bday Surp \$32
Island Of Dr. Brain VGA \$29
Mario Teaches Typing \$26
Marvin the Moose Vol 1 \$30
Mavis Beacon Typing 35 \$29
M Beacon Typing WIN35\$34
Metrognomes Music \$26
Mozart Magic Mus Mchn\$18
Munchers Bundle \$29
Orbits: Voyage Solar Sys \$39
Pet Pan Story Paint Adv \$34
Play Room \$35
Print Shop Deluxe \$49
Print Shp Dlx Bus Graph \$29
Putt Putt Goes to Moon \$42
Putt Putt Joins Parade \$32
Putt Putts Fun Pak \$19
Quarky Quaysoo Trb Sci\$29
Read Rab 1: Erly Read\$35\$32
Reader Rabbit 2 \$37
Reader Rabbit 2 WIN \$29

IBM EDUCATIONAL

Reader Rabbit 3 \$32
Read Rab Rdy Letrs 35 \$37
Rodney's Funscreen \$32
Scooter's Magic Castle \$32
Secret Isle Dr. Quandy \$38
Slater&Charlie Camping \$29
Snapdragon \$29
Speedreader WIN \$30
Stickybear Opposites \$23
Stickybear Parts Speech\$32
Stickybear Reading \$24
Stickybear Read Comp \$30
Stickybear Read Tutor \$31
Stickybear Shapes \$29
Stickybear Spellgrabber \$32
Stickybear Spell Tutor \$32
Stdent Writing Cntr WIN \$32
Super Munchers \$29
Spr Solver: Mid Resc 35 \$30
Spr Silver: Gizm&Gadge \$26
Treasure Cove \$29
Treas Math Storm WIN \$32
Treasure Mountain \$39
TreeHouse \$39
Under Sea Adventure \$39
Video Jam \$34
Wacky Funster \$18

IBM HINT BOOKS

A-Train \$16
Advent Willie Beamish \$10
Bard's Tale 1,2 or 3 ea \$10
Blue Force: Next of Kin \$10
Buck Rogers Countdown\$10
Castle Wolfenstein 3D \$10
Castle of Dr Brain \$10
Champions of Krynn \$10
Civilization \$16
Codename Iceman \$10
Colonel's Bequest \$10
Conquests Robin Hood \$10

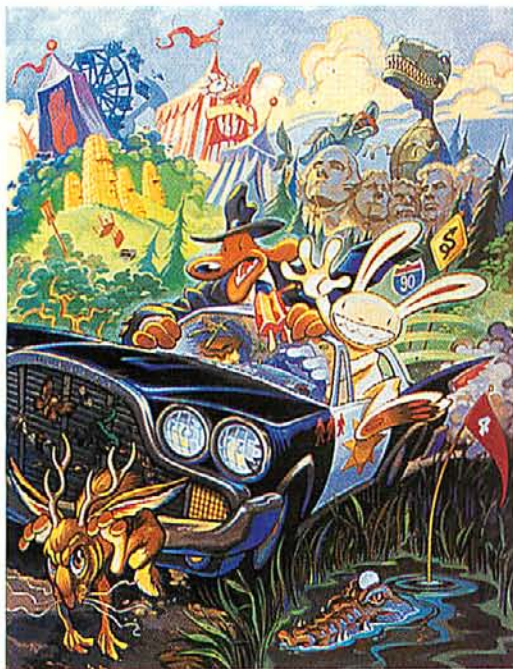

HIT the ROAD, MAX

LucasArts Takes To The Highway With Sam & Max

by Charles Ardai

Sam and Max, readers of Steve Purcell's comic strips will know, are a couple of weird-looking, sarcastic, gleefully subversive guys who have roughly as much respect for cows of the sacred variety as Beefsteak Charlie has for the ordinary sort. They delight in puncturing pomposity, exposing the tacky underbelly of our fine nation to the ridicule it both invites and deserves, and generally behaving like a pair of willfully malicious imps. They remind me of my friends.

They are *also*, respectively, a laconic, suit-wearing dog and a hyperactive, misshapen rabbit. In this regard they do not resemble my friends. My friends are not laconic.

If I like my friends, it would seem to follow that I must also like Sam and Max, and probably the new LucasArts game in which they make their software debut, *Sam & Max Hit the Road*—and, in fact, I do. However, I have to admit to liking it measurably less than LucasArts' previous foray into cartoon-inspired comedy, *Day of the Tentacle*.

Tentacle felt like an old Looney Tunes short, complete with pratfalls, goofy gags, and scads of silliness. *Sam & Max* has its share of pratfalls, too, but it feels less like a Warner Brothers cartoon and more like an underground comic book. To begin with, the art is more edgy and raw. (Sam is a closer cousin to Matt Groening's "Bongo" from the "Life In Hell" strip than to Bugs Bunny.) The music is quietly unnerving jazz instead of rousing calliope schtick. Some of the plot material the

game introduces is chancier than a mainstream cartoon would permit, the images more scabrous, the jokes more adult. ("Every time I catch enough fish to fill my net," one character complains, "a helicopter swoops



down and carries the fish off...It's like being stuck in a Norman Mailer novel.")

While, on the whole, I believe that the designers should be commended for taking a chance with material that is certain to appeal to a smaller audience than they might have reached with something easier or more accessible, it is a gamble that does not always pay off. There is a reason that mainstream is more popular than underground, no matter what field you are discussing: it is more fun and less "in your face"; it's

calculated to entertain rather than to disconcert.

For the sake of comparison, consider the field of professional magic. More people like David Copperfield than Penn & Teller, a duo who resemble Sam and Max in many ways. Why? Because even if you enjoy their style and appreciate that they are less conservative and predictable than Copperfield, Penn & Teller can be hard to take after a while.

Self-referential jokes, sneering remarks, deadpan derision, sarcasm, and ridicule can all be funny, but only to a point. Push the point too far and you can give the impression of the party guest trying too hard to be "on," the comedian who doesn't know when to let up, or the teenage boor with a wisecrack for every situation.

It is probably not very useful to psychoanalyze cartoon characters, but Sam and Max are a pair of aggressive little buggers who vent

Sam & Max Hit the Road

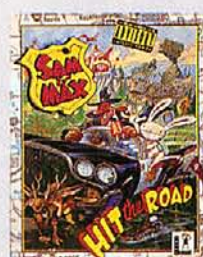

TITLE: Sam & Max Hit the Road
 PRICE: \$59.95
 SYSTEM: IBM
 REQUIREMENTS: 386-33MHz or better recommended, 2MB RAM recommended, VGA graphics, 16MB hard drive space; supports Ad Lib, Sound Blaster (Pro/16), PAS, Roland and General MIDI sound cards
 PROTECTION: Documentation look up
 DESIGNERS: Sean Clark, Mike Stemmler, Steve Purcell, and Collette Michaud
 PUBLISHER: LucasArts
 San Rafael, CA
 (800) 782-7927

CHIPS & BITS

PO Box 234
Rochester VT 05767
Call 800-699-4263
Int'l 802-767-3033
Fax 802-767-3382
Source-10027



'JACK THE RIPPER' A mystery 100 years in the making with multiple solutions that offer new challenges replay after replay. Features a unique windowing system and supports Ad-Lib, Soundblaster and Gravis UltraSound boards. \$39



'THE MERCHANT PRINCE' Explore the world! Can you seek & explore the old world and find new worlds with their own prospering ports of call? Find advantageous trade routes. Historical & random maps. Up to 4 players. Modern play \$39



'GABRIEL KNIGHT: SINS OF THE FATHER' Gabriel Knight is a horror writer and rookie private investigator. Your skill, logic and and courage will help him solve a series of ritual voodoo murders. Includes 'Gabriel Knight' graphic novel and features 3-D high-resolution graphics. CD \$45



'STAR WARS: REBEL ASSAULT' Take control of a Star Wars vehicle in challenging piloting & combat scenarios. Hone flight & combat skills to defend Tatooine against Imperial attack, challenge the menacing walkers of planet of Hoth and combat the Empire in intense deep space battles. CD \$48



'AMAZON' recaptures the fun of the 1950's drive-in movies. Travel to regions of the Amazon, fight 10 foot ants, and find emeralds stolen by Cortez. Amazing cinematic effects such as multiple camera angles, flashbacks, pans, and fades. Features fully digitized voices & sound effects. \$19

IBM HINT BOOKS

Conquests of Camelot \$10
Curse of Azure Bonds \$10
Dark Queen of Krynn \$10
Darklands \$14
Death Knights of Krynn \$10
Dungeon Master \$10
Dynamix Grt War Planes \$16
Elvira 2 Jaws Cerberus \$10
Elvira Mistress Dark \$10
Eye of Beholder 1 or 3 \$10
Eye of the Beholder 2 \$12
Frd Pharkas Fron Pharm \$8
Gateway Savage Fron \$10
Globe Conq Book w/disk \$21
Goblins \$10
Gold Rush \$10
Sunship 2000 \$16
Harpoon \$16
Heart of China \$10
Hero's Quest \$10
Immortal \$10
Indi Jnes 4 Fate Atlantis \$10
King's Quest 1-6 ea \$10
Laura Bow 2 HintBook \$10
Les Suit Larry 1,2,or3ea \$10
Leisure Suit Larry 5 \$9
Lemmings /disk \$18
Loom \$10
Lord of the Rings V1 \$10
Lord of the Rings V2 \$6
Lost Files Sherl Holmes \$10
LucasArts Adv Book \$16
LucasArts Air Comb Gde \$16
Magic Candle 2 \$10
Magic Candle 3 \$10
Manhunter NY or SFran \$10
Maniac Mansion \$10
Martian Dreams \$13
Matrix Cubed \$10
Might & Magic 1 & 2 \$10
Might & Magic 2 \$12
Might & Magic 3 \$16
Mgt&Mag 4 Clouds Xeen \$16

IBM HINT BOOKS

Might & Magic 5 \$16
Off Bk Leis Suit Larry 2 \$14
Off Book Ultima 2nd Ed \$16
Off Gd Rog Wilc Spc Ad \$14
Off Gde King Quest 3 ed \$16
Off book of Police Quest \$12
Pepper's Adventure Time \$8
Planet's Edge \$16
Police Quest 1,2 or3 ea \$10
Pool of Radiance \$10
Pools of Darkness \$12
Populous 1&2 Strat Bk \$16
Power Monger Strategy \$16
Powermonger \$10
Protostar \$8
Quest Clues 2,3or4 ea \$21
Quest Clues 5 Bk Orbs \$16
Quest Clue 6 Man Swrds \$16
Quest for Glory 3or4 ea \$10
Quest Glory Strat Gde \$19
Questbusters: Bk Clues \$18
Railroad Tycoon \$12
Realms of Arkania \$14
Return to Zork \$9
Return to Zork Adv Gde \$16
Rex Nebrl Cos Gen Ben \$14
Rise of the Dragon \$10
Savage Empire \$10
Secret Monkey Isle 1or2 \$10
Secret Silver Blades \$10
Shadow Caster \$18
Shadow Sorcerer \$10
Simlife Official Strategy \$16
Space Quest 1-4 ea \$10
Spellcasting 101: Off Bk \$14
Spellcasting 201 Bk \$10
Star Trek 25th Aniv \$9
Starflight 1or 2 ea \$10
Strike Commnder Off Bk \$14
Summoning \$16
Tales Magic: Proph Shad \$12
Treasures Savage Fron \$10
Tunnels & Trolls \$16

IBM HINT BOOKS

Ultima 4-6 ea \$10
Ultima 7 \$12
Ultima 7 & Underworld Bk \$16
Ultima 7.5 Balnce Scales \$16
Ultima Avatar Advs Book \$16
Ultima U Stygian Abyss \$12
Ult Underworld Lab Book \$12
Warriors Etern Sun H Bk \$14
Wizardry 6 Cos Forge \$12
Wizardry 7 \$16
Yeager Air Comb Hndbk \$16
Yserbius \$10

IBM ROLE PLAYING

Access Super Bundle \$40
Amberstar \$19
Arborea Journ Inn Sanct \$34
Arena: Elder Scrolls \$44
Bard's Tale 3 \$32
Bard's Tale Construction \$27
Black Crypt \$32
Bloodstone \$27
Bloodwych \$15
Celtic Legends \$32
Challenge of 5 Realms \$39
Champions \$37
Champions of Krynn \$19
CHARACTER EDs \$16
Cobra Mission \$39
Conan \$16
Corporation \$14
Curse Azure Bonds \$15
Cyber Empire \$16
Cyber Space \$39
Dark Queen of Krynn \$32
Dark Sun \$47
Drk Sun Grey Isle Ex Pk \$34
Darklands \$39
Darklands Mster Ed wbk \$51
Daughter of Serpents \$19
Death Knights of Krynn \$21

IBM ROLE PLAYING

Disciples of Steel \$29
Dungeon Hack \$42
Dungeon Master \$31
Dungeon Master 2 \$36
Dusk of the Gods \$16
Elvira 2 Jaws Cerberus \$29
Eternam \$19
Eye of Beholder 1 or 2 \$19
Eye of the Beholder 2 \$38
Eye of the Beholder 3 \$21
Forgotten Castle \$48
Gateway Savage Front \$32
Gods \$26
Interactive Movie 1 \$52
Lands of Lore \$34
Legacy: Realm Of Terror \$39
Legend \$31
Legend of Valor \$39
Lord of the Rings V1 \$32
Lord of the Rings V2 \$37
Loremaster \$39
Lost Tribe \$29
Lure of the Temptress \$37
Magic Candle 1 \$24
Magic Candle 2 or 3 \$19
Martian Dreams \$37
MegaTraveller: Zhodani \$19
MegaTraveller \$24
Might & Magic 3 \$36
Mght&Mag 4 Clids Xeen \$39
Mght&Mag 5 D Sd Xeen \$39
Mines of Titan \$9
Pirates \$19
Pirates Gold \$39
Planet's Edge \$22
Pool of Radiance \$15
Pools of Darkness \$38
Protostar \$39
Quest for Glory 3 \$38
Quest for Glory 4 \$42
Realms of Arkania \$35
Red Crystal \$34
Rome: Pathway Power \$29

IBM ROLE PLAYING

Savage Empire \$34
SpelJam: Pirate Rlm Spc \$16
Spellcraft: Aspects Valor \$38
Star Saga 2 \$28
Stonekeep \$52
Stronghold \$36
Summoning \$38
Tales Magic: Prop Shad \$16
The Genies Curse \$45
Ultima 4 Quest of Avatar \$35
Ultima 5 Warriors Dest \$35
Ultima 5 Warriors Dest \$38
Ultima 6 False Prophet \$19
Ultima 7 Black Gate \$48
Ultima 7 Forge of Virtue \$18
Ultima 7.5 Part 2 Silv Sd \$20
Ult 7.5 Serp Isle Spc Pk \$18
Ultima 7.5 Serpent Isle \$48
Ultima 8: Pagan \$48
Ult 8: Pagan Spc Acc Pk \$17
Ultima 9: Ascension \$52
Ult Uworld 2 Labyrinth \$46
Ult Uwrld Stygian Abyss \$19
Uncharted Waters \$42
Unlimited Adventures \$37
Veil of Darkness \$37
Vengeance of Excalibur \$16
Waxworks \$29
Wizardry 5 ODCP \$26
Wizard 6 Cosmic Forge \$34
Wizardry 7 Crusaders \$39

IBM SIMULATIONS

A T P 2.0 \$29
A T P Flight Simulator \$19
A T P Flight Sim 1.00 \$29
A.T.A.C \$30
A10 Avenger \$46
A320 Airbus \$44
AH-64 B Longbow \$54
AH-64 Helicopter \$46

IBM SIMULATIONS

Aces Europe Miss 1 or 2 \$27
Aces Over Europe \$39
Aces Pacific Mission \$19
Aces of the Deep \$42
Aces of the Pacific \$42
Air Warrior SVGA \$35
Armoured Fist \$45
Art of the Kill \$24
Assignment Miami \$26
Attack Pack \$42
B17 Flying Fort Classic \$19
Car and Driver \$26
Combat Classics 2 \$29
Cyber Race \$42
Delta V \$48
Design Own Railroad \$19
Elite 2 \$38
Elite Plus \$19
Eye of the Storm Fit Sim \$29
F117A Stealth Fighter \$47
F15 Strike Eagle 2 Scen \$12
F15 Strike Eagle 3 Ace Pk \$52
F15 Strike Eagle III \$42
F19 Stealth Fighter \$18
F40 Pursuit Simulator \$29
FA 18 Hornet \$54
Falcon 3 Scen1 Fight Tgr \$24
Falc 3 Scen3 FA 18 Horn \$32
Falcon 3 Scen 2 MiG 29 \$32
Falcon 3.0 \$46
Falcon 4.0 \$59
Fire & Forget 2 \$30
Flat Top \$48
Fit Defend F14 Tomcat \$48
Flight Sim Toolkit \$58
Flight of the Intruder \$16
Fly the Grand Canyon \$39
Grand Canyon Scenery \$18
Grandest Fleet \$36
Great Nav Bat Am in Atl \$21
Grt Nav Bat Sp Ships Atl \$19
Great Naval Battles \$44
Great Naval Battles 2 \$39



gobs of latent hostility and alienation in their obnoxious running commentary on everything they encounter. They are constantly egging each other on, trying to top each other in cleverness and sang-froid, and it tries one's patience. Not that the obnoxious remarks aren't funny, if you go for that sort of thing—they often made me laugh out loud, but enough is enough, and what is funny for the duration of a ten-panel comic strip starts to grate after a few hours of gameplay.

Play It Again, Sam

The gameplay itself is solid. LucasArts has renovated its SCUMM game engine by removing the inventory and command icons from the screen, allowing the whole space to be occupied by graphics. The result is that there is room for the characters to be drawn large and in detail; this, plus the elimination of the "interface frame" surrounding the graphics, helps break down the barrier between the player and the action. It's one more step, and not a negligible one, toward allowing gamers to "play a cartoon."

Players still select from the usual command icons (Walk, Talk, Use, Take, Look), which they cycle through by clicking the right mouse button. Clicking on a cardboard box stowed in one corner of the screen calls up one's inventory; any of the objects one has collected can then be picked up and used as command icons themselves. (It is worth mentioning that, once again, LucasArts has come up with some of the cleverest and best-drawn icons in the business. What these guys can conjure up in less than a half-inch of space is incredible.)

Perhaps the most novel element of the gameplay is the way in which conversations are handled. When the player clicks the "clacking teeth" icon on a character, a row of dialogue and subject icons appears across the bottom of the screen. Instead of choosing

from lines of dialogue, as in *Tentacle*, the player selects a type of speech act—question, exclamation, non sequitur—or else chooses icons representing characters and events in the game. This allows the game's writers to continually surprise the player with their context-sensitive witticisms, rather than displaying a list of gag lines in a bland menu format. The technique adds spice already in the floppy-disk version of the game; when the inevitable CD-ROM version comes out, replacing printed text with speech, the degree to which the new system improves interactive conversations should be even more apparent.

Extensive use of spoken-word audio will also help in a less obvious way. Some of the dialogue text, which is color coded to indicate who is speaking, is hard to read against some

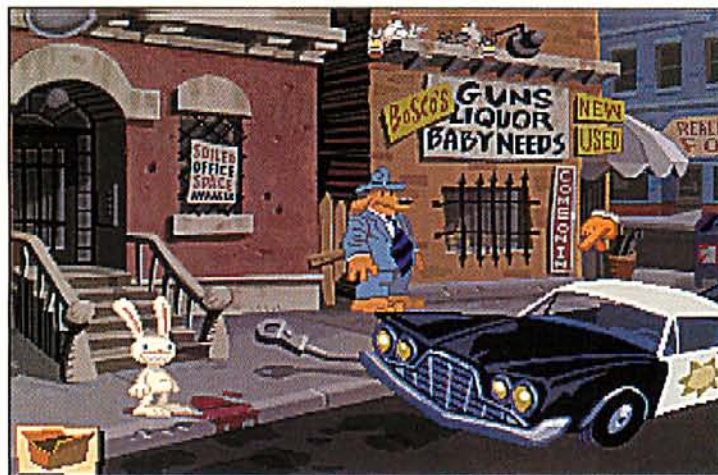

backgrounds. Sam's brown text is especially prone to illegibility, while Max's white letters can be eye-searing if your monitor's brightness is turned a notch too high. Replacing text with audio should eliminate the problem.

Of course, different color schemes or some kind of letter shadowing could also have eliminated the problem, and the fact that they weren't used suggests (mildly) inadequate forethought on LucasArts' part. There are other examples, too. Consider one quirk of cycling through icons rather than selecting them from a menu: if one attempts to use an object on someone or something inappropriate, the computer jumps the cycle back to the default "walk" icon, requiring the player to click several times in order to bring up the object again for another try. Or consider the peculiarities of icon placement: sometimes, if you want to look at Max (for instance),

placing the "eye" icon right on top of Max will not work, while placing it above Max's head will.

None of the above interferes with gameplay to a serious extent, but it is needlessly annoying. The new interface would need some tweaking, therefore, before I could recommend it unreservedly.

Hare Of The Dog

Less easily tweakable is the game's storyline, a rambling, picaresque mishmash centered around the pursuit of an AWOL sasquatch who has vanished from a New England freak show. Sam and Max, "freelance police" by trade, are called upon to track down Bruno the Bigfoot and, while they are at it, Trixie the Giraffe-Necked Girl, who vanished on the same day. They undertake this mission by poking around the freak show's various tents and trailers and (for no apparent reason) a chain of discount grub-huts called "Snuckey's." Their investigation leads them to a series of tourist traps around the country such as "The World's Largest Ball of Twine" (where they have to chat up a psychic and steal a mood ring) and "The World of Fish" (where they have to pilfer a painful of fish and then disguise themselves as a giant trout).

Along the way there are lots of weird characters to talk with (my favorite being the painfully loquacious Doug the Mole Man) and puzzles to solve. The latter tend not to be very hard, particularly since the characters periodically give the player a nudge in the right direction. ("I'm sure this is somehow useful," Sam says at one point, pointing to a set of binoculars. "I think we're supposed to do something in there," says Max at another, as they exit the carnival's Tunnel of Love ride.) The hardest puzzles are the ones that require the player to use Max as a tool, since it is not obvious just what he is useful for. At various times, you

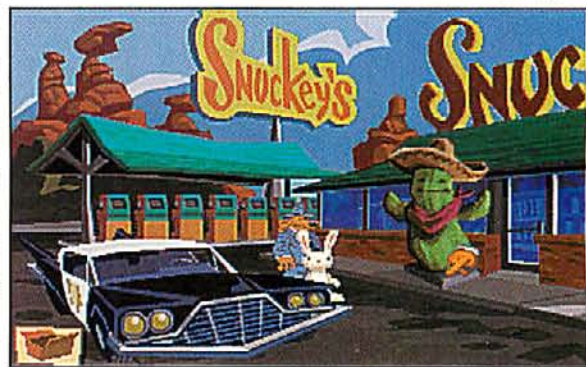

CHIPS & BITS

PO Box 234
 Rochester VT 05767
 Call 800-699-4263
 Int'l 802-767-3033
 Fax 802-767-3382
 Source-10027



'LANDS OF LORE'
 The dark army encroaches. King Richard falls and Scotia beckons you... laughing. In her mad quest for power, Scotia has ravaged the Kingdom. She seeks the throne yet it eludes her. She's getting desperate and mean. Can you stop her? Do you even dare to? **CDS44**



'PACIFIC STRIKE'
 is a World War II flight simulation that allows you to change the course of the war in the Pacific Theater. Fly a wide variety of expertly modeled aircraft in all the major theatres, including Pearl Harbor and Midway. Plan your own missions and earn promotions. Features VGA Graphics. **\$52**

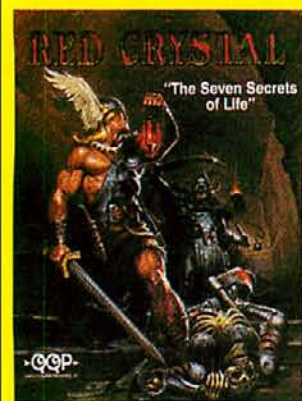

'RED CRYSTAL'
 Seek out the 7 secrets of life. Can you forge through the evil that lurks in the depths of the eerie dungeons, the ominous castle towers and the savage countryside? Play alone or modem it. Features over 50 levels, breathtaking graphics and an auto mapping feature. **\$34**



'DUSK OF THE GODS'
 Become an Einherjor, one of Odin's champions, & travel throughout the lands of Norse Mythology. Battling hostile creatures will be one of many challenges you must face on your journey. Alter events so the gods may defeat the minions of Loke at the Battle of Ragnarok. **\$16**



'MECHWARRIOR 2'
 Climb into one of 16 Battle Mechs and prepare to set your imagination on fire. You're strapped into a 100-ton machine that can annihilate a squadron of F-15s in a heartbeat. And you're about to battle your way across the planetary terrain. From ice to desert to urban land. **\$42**

IBM SIMULATIONS

Great Nav Bat Scen Bld \$28
 Gunship 2000 Scen Disk \$24
 Gunship 2000 VGA \$37
 Harrier Assault \$32
 Harrier Assault SVGA \$48
 Indy Car Racing \$39
 Jet Fighter 2.0 \$39
 Jet Fighter 2.0 Mis Disk \$19
 Jump Jet \$39
 Jump Jet Aces Pack \$50
 Life and Death \$19
 Life and Death 2 \$24
 Lunar Command \$26
 M1 Tank Platoon Classic \$19
 M4 Sherman Tank Sim \$34
 Mantis Exp Speech Pak \$19
 Mantis Exp Ftr VGA \$28
 Mantis Exp Ftr VGA \$34
 Maximum Overkill \$43
 Max Overkill Mis Disk 1 \$24
 Max Overkill Mis Disk 2 \$29
 Mechwarrior 2 \$42
 Megafortress Miss Dsk \$26
 MiG 29 \$48
 Microsoft Flight Sim 5.0 \$42
 Microsoft Flight Sim 5 SF \$32
 Microsoft Flight Sim 5 DC \$29
 Microsoft Spce Sim 1.0 \$44
 MiG 29 Fulcrum \$32
 New Facilities Locator \$18
 Pacific Strike \$52
 Pacific Strike Spch Pak \$18
 Power Boat Simulator \$39
 Power Politics WIN \$19
 Privateer \$47
 Privateer Special Op \$22
 Privateer Speech Pack \$17
 Rally \$34
 Rd Baron Mis Dsk Bldr \$18
 Red Baron VGA \$36
 Red Storm Rising ODCP \$18
 Rd&Trk Grnd Prix Unlim \$34
 Sailing Instrctr Pk VGA \$239

IBM SIMULATIONS

Sail Sm 3 Est or Wst Cst \$32
 Sailing Simulator 3 \$42
 Scenery Collect Set A \$19
 Scenery Collect Set B \$34
 Scen Col Calif or Gr Brit \$19
 Scenery Enhance Ed \$21
 Scen: Hawaii or Tahiti \$16
 Sea Wolf \$48
 Seal Team \$42
 Secret Weap Luftwaffe \$34
 Sec Weap Exp 3 He162 \$21
 Secret Weap Exp P38 \$21
 Shuttle \$26
 Silent Service 2 \$19
 Speed Racer \$34
 Strike Commander \$41
 Strike Comnd Spec Op1 \$20
 Strike Comnd Spch Pk \$16
 Strom Troop \$54
 Stunt Island \$37
 Sub War 2025 \$42
 Syndicate \$36
 Task Force Adm Pack \$52
 Team Yankee 2 \$24
 Test Drive 2 \$30
 Test Drive 2:Collection \$19
 Test Drve 2:Euro Change \$6
 Test Drive 3 \$29
 Test Drive 3: Passion \$19
 Test Drive 3:Road & Car \$16
 Thunderhawk \$16
 Tie Fighter \$48
 Tornado \$48
 Tracon WIN \$28
 Ultrabots Sanction Earth \$39
 Voice Command F117A \$18
 Voice Comnd F15SE3 \$18
 W C 2 Operation 1 \$22
 W C 2 Operation 2 \$22
 W C 2 Speech Mod \$13
 W C Secret Mission \$20
 W C Sec Mis1&2 Bundle \$20
 W C Secret Mis 2 HD \$20

IBM SIMULATIONS

Wing Armada \$54
 Wing Commander \$19
 Wing Commander 2 \$29
 Wing Commander 3 \$52
 Wing Commander Acad \$32
 Wolfpack \$15
 World Circuit \$35
 X-Wing \$38
 X-Wing Mis Disk 1or 2 \$18
 Yeager's Air Combat \$21

IBM SPORTS

APBA Baseball \$24
 APBA Bsbl Statmstr 2.0 \$29
 APBA Bowling \$14
 APBA Football \$34
 APBA Hockey \$32
 APBA Micro Manager \$32
 Action Sports Soccer \$19
 American Gladiators \$21
 Baseball for Windows \$46
 Dave Robinson NBA Act \$44
 Front Page Football Pro \$42
 GREENS \$34
 Hardball 3 Collection \$39
 Hardball 3 Players Disk \$16
 Internat Sports Chall \$21
 Jack Nicklaus Crs1-5 ea \$15
 J Nicklaus Signature Ed \$27
 Joe Montana Football \$31
 Joe Montana Football 2 \$42
 LH Boxing Contenders \$16
 LH Football Utilities \$16
 LH Pro Bball 91 Tm Dsk \$16
 LH Pro Bball Utilities \$16
 LH Pro Basketball \$36
 LH Pro Bball 74-83 Tms \$16
 LH Pro Bball 8990 Tms \$16
 LH Pro Bball L Leaders \$16
 LH Pro Bball Utilities \$16

IBM SPORTS

Lance Haffner Baseball \$36
 Lance Haffner Boxing \$36
 Lance Haffner Coll Bball \$36
 Lance Haffner Football \$36
 Lance Haffner Hockey \$36
 Links Courses:Firestone \$17
 Links Courses: Bay Hill \$17
 Links Courses:Pinehurst \$17
 Links Courses: Dorado \$17
 Links Crses:Troon North \$17
 Links Pro 386 Golf \$32
 Links Pro: Mauna Kea \$19
 Links Pro: Pinehurst \$19
 Links Pro: Banff Spr \$19
 Links Pro: Belfry \$19
 Links Pro: Innsbrook \$19
 Links Pro: 6 Firestone \$20
 Links Pro: 7 Peb Bch \$20
 ML 1950s World Series \$17
 ML 1960s World Series \$17
 ML 1970s World Series \$17
 ML 1980s World Series \$17
 ML Bsbl 4 Fantasy Mngr \$25
 ML Bsbl 4 Gen Mngr \$19
 ML Bsbl All Teams ea \$20
 ML Football 2 \$39
 ML Personal Pro Golf \$28
 Madden Football 2 \$17
 Michael Jordan Flgt Sim \$21
 ML 83-88 Bbsal Seas ea \$17
 Microleague 89 FB Seas \$17
 Microleague Bsbl 4 USTod \$31
 Microleague Bsbl 4 USTod \$28
 Microleague Basketball \$28
 Microsoft Golf WIN \$48
 Mike Ditka Pwr Ftball \$34
 NFL Challenge \$60
 NFL Chal Premium Ed \$59
 NFL Coaches Club \$36
 NFL Football \$19
 NFL Video Football \$39
 NHL Hockey \$44

IBM SPORTS

Nascar Challenge \$29
 PGA Tour Golf \$21
 Pro Tennis Tour 2 \$32
 QuarterPole \$30
 Road to the Final Four \$37
 Summer Challenge \$34
 The Games Winter Chal \$29
 Tom Landry Football Dix \$29
 Tny LRussa Class Stad \$15
 Tny LRussa Bsb2 92 Tm \$14
 T LRssa Bsb2 Fnt Mng3 \$14
 Tny LRussa2 Bsbll Stad \$18
 Tny LRussa AL Stad \$15
 Tony LaRussa BB 1990 \$15
 Tony LaRussa BB 1991 \$15
 Tony LaRussa Baseball \$19
 Tony LaRussa Bsbll 2 \$36
 Team Disk 1992 \$16
 Tony LRussa Fant Mngr \$15
 Tony LRussa NL Stads \$15
 T LRussa Tms 1901-68 \$15
 Unneces Roughness \$34
 W Gretsky Lgue Sim 2 \$29
 W Gretsky Hockey 3 \$36
 Weaver Baseball 2.0 \$17
 Weaver Commis Disk 2 \$16
 Wilson Pro Staff Golf \$23

IBM STRATEGY

A Train \$34
 A Train Construction Set \$23
 A Train W Const Set \$44
 Air Force Commander \$16
 Airbucks 1.2 \$24
 Ambush at Sorinor \$42
 Arctic Baron \$29
 Armada \$22
 Armada 2525 \$29
 Ashes of Empire \$34
 Battles of Destiny \$36
 Big Business \$29

IBM STRATEGY

Breach 2 \$24
 Breach 2 Scenario Disk \$15
 Breach 3 \$36
 Buzz Aldrin Race Space \$38
 Caesar \$36
 Campaign 2 \$36
 Capitalist Pig WIN \$19
 Carriers at War \$24
 Carriers at War 2 \$39
 Carriers War Const Kit \$29
 Castles \$18
 Castles 2 \$36
 Chesmstr 4000 Trb WIN \$36
 Civilization \$41
 Civilization WIN \$42
 Clash of Steel \$39
 Cohort 2 \$18
 Command HQ Classic \$18
 Conquer for Windows \$36
 Conquered Kingdoms \$36
 Conq Kingdoms Scen 1 \$24
 Conquest of Japan \$36
 Crisis in the Kremlin \$39
 Dark Star \$36
 Detroit \$36
 Discovery Stp Columb \$34
 Dominion: 1 King's Life \$41
 Dominus \$39
 Dune \$16
 Dune 2 \$34
 El Fish \$34
 Empire Deluxe \$36
 Empire DLX Scenario 1 \$21
 Empire Deluxe WIN \$35
 Railroad Tycoon \$34
 Fantasy Empires \$39
 Fields of Glory \$34
 Final Conflict \$17
 Fort Apache \$24
 Gemfire \$37
 Genghis Khan 2 \$36
 Genghis Khan ODCP \$37
 Gettysburg \$29

have to use him as an interrogator, a circuit breaker, and a knife; the best heuristic to keep in mind is, "When all else fails, try using Max."

Other sequences that some players may find difficult include the two action sequences that must be completed successfully to finish the game, "Wak-A-Rat" and "Gator Golf." The former has Sam pounding rats with a hammer at the carnival; quick and accurate placement of the mouse is key to passing this hurdle. The latter has Sam whacking fish into a gator-infested swamp in order to build a bridge between the shore and the island on which Max is imprisoned. Dexterity is less crucial here, but it takes a while to figure out how to get the gators to move where you want them to.

Sam & Max also contains a handful of optional sub-games, including a version of "Battleship" called "CarBomb," a coloring book, a set of Sam and Max dress-up dolls, and a simple driving/jumping game called "Highway Surfing." Of these, only the last (in which the player can get up to Level 7 or thereabouts just by sitting back and doing

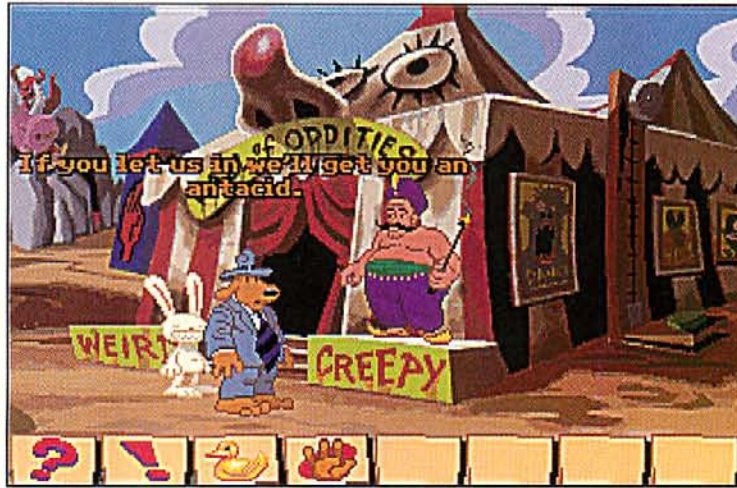

nothing) is weak. None of them have anything to do with the game's story, however, and their presence (along with that of a bunch of screen savers that kick in if you don't do anything for a few minutes) contribute to the feeling that *Sam & Max* is more a computerized busybox—not unlike the very road trip "activity books" the designers satirize at every turn—than a unified, focused piece of fiction.

To The Max

However gonzo *Day of the Tentacle* got, it was always grounded in a very clear and well-

developed storyline and it made sure we cared about the characters and their plight. *Sam & Max* is all over the map, literally; its main characters are basically jerks; and the quest they are on is of no significance even to them. So, although individual scenes in the game can be quite funny, the whole is rather less than the sum of its parts.

Day of the Tentacle was that rarest of all creations, one in which everything came together perfectly. *Sam & Max* is fine, but lesser. It's like the difference between *Raiders of the Lost Ark* and *Indiana Jones and the Temple of Doom*—or between the original *Maniac Mansion* and its lackluster follow-up, *Zak McKracken and the Alien Mindbenders*.

Gamers ravenous for a LucasArts fix after finishing *Tentacle* will find that *Sam & Max* affords a couple of hours of somewhat similar amusement. Endlessly sarcastic New York intellectuals like my friends will find its tone wholly agreeable, but whether it plays in Peoria remains to be seen. *Sam & Max* marches to a different drummer. You'll have to decide if you can dance to its irregular beat. **CGW**

MIDI MAN
BECAUSE IT'S NOT JUST A GAME!

A service organization developed to integrate technology and creativity to deliver a package of uncompromising high quality.

DEPENDABLE, SEASONED PROFESSIONALS WITH THE FLEXIBILITY TO HANDLE ALL OF YOUR NEEDS. **VERSATILITY IS OUR BUSINESS!**
AUDIO PRODUCTION? **WE DELIVER EVERYTHING!**
RESULTS? **WHAT DO YOU THINK?**

Certified developers for:



- **Composition, Arrangement, & Full Orchestration** •
- **Film Scoring • Sound Design • MIDI/SMPTE • Voice Over & ADR Service**

We offer complete audio production for Film, Video, & Multimedia.
• *Programming • Writing • Game Design/Consulting Services also available •*

Extensive list of credits in the Multimedia and Film/Video Industries.
For More Information Call (512) 834-8325
12330 Metric Blvd., Ste. 7202 • Austin, TX 78758-2524

Circle Reader Service #96

CHIPS & BITS

PO Box 234
Rochester VT 05767
Call 800-699-4263
Int'l 802-767-3033
Fax 802-767-3382
Source-10027

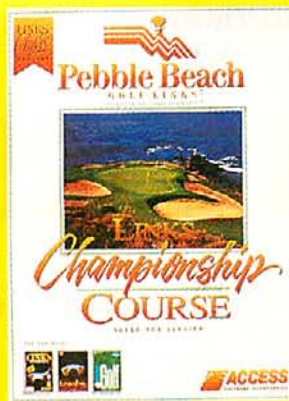

'PEBBLE BEACH GOLF LINKS' is the first in a series of LINKS CLASSIC EDITION courses made for the LINKS 386 PRO with VGA graphics. Designers and programmers spent more than a year reproducing every nuance of Pebble Beach. Users will feel like they've actually played the course! \$24



'THE PATRICIAN' is a trading game based in Germany. Become a member of the social elite and begin to trade your way to the top. But, beware, the road to the top is bumpy. Set against spectacular backdrops & covering 16 towns across medieval Europe, The Patrician is a complex & involved strategy game. \$34

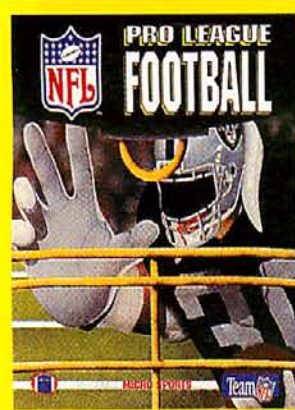

'NFL PRO LEAGUE FOOTBALL' hits you like a 240 pound full-back with the goal line in sight. Coach your favorite team. Choose from 198 plays or create your own. Features full detailed, color animation, NFL teams, players & stats, full rosters with substitutions, instant replay and true modern play. \$39



'FLEET DEFENDER F14' Whether on routine Fleet defense duties, air to air combat engagements or special intercept missions, the F-14 Tomcat leads the field. Features state of the art 3D visuals, accurate flight modeling of all planes, authentic radar and weapons system, & campaigns. \$48



'DRAGON FORCE' They're armed, dangerous, and ready for action. They're the Drastic Response Assault Group Operations Network Force - an elite international strike force against terrorism. Lead your team of top secret trouble shooters on special operations to the hottest spots world wide. \$12

IBM STRATEGY

Gtysbrg: Intract Bat Sim	\$34
Global Domination	\$29
Goblins 2 Princes Buffn	\$24
Gold of the Americas	\$24
Gr Nav Battles Adm Pak	\$48
HUMANS	\$24
Harpoon 2	\$48
Harpoon 2 Battle Set 1	\$26
Heirs to the Throne	\$36
Humans: Insult to Injury	\$14
Kingdoms of France	\$34
Kingdoms of Germany	\$34
Koshan Conspiracy	\$32
Kye Deluxe WIN	\$33
L'Empereur	\$37
Laser Squad	\$16
Lemmings 2: The Tribes	\$35
Lemmings Datadisk	\$19
Lemmings ODCP	\$19
Liberty or Death	\$37
Lost Admiral	\$19
Lost Admiral Enhanced	\$44
Lost Admiral Scen Disk	\$23
Lost Vikings	\$24
Maelstrom	\$38
Master of Orion	\$39
Mega Lo Mania	\$31
Merchant Colony	\$17
Napoleonics	\$34
New World Order	\$38
Nuclear War	\$19
Outpost	\$48
Overlord	\$21
Paladin 2	\$24
Patrician	\$34
Perfect General	\$36
Perfect General 2	\$44
Perfect Gen Scen 2 20th	\$23
Perf Gen Scen WW2	\$21
Populous	\$17
Populous 2	\$28
Populous Promise Lnds	\$14
Powermonger	\$34

IBM STRATEGY

Rags to Riches	\$36
Railroad Tycoon Classic	\$19
Railroad Tycoon 2	\$40
Rampart	\$17
Reach for the Stars	\$24
Realms	\$16
Red Zone	\$32
Renegade Leg Intercept	\$21
Riders of Rohan	\$19
Robo Sport WIN	\$34
Romance 3 Kingdoms	\$42
Romance 3 Kingdoms 2	\$39
Romance 3 Kingdoms 3	\$36
Rules of Engagement 2	\$38
Second Conflict WIN	\$34
Seven Cities Gold 2	\$36
Shadow President	\$39
ShadowGate WIN	\$32
Sid Meir's Civil War	\$58
Siege With Exp Disk	\$24
Sim Ant	\$32
Sim Ant Windows	\$34
Sim City Classic	\$27
SimCity Classic Win	\$29
Sim City 2000	\$42
Simcity 2000 Windows	\$42
Simcity Graphic Set 1or2	\$23
Simcity WIN	\$34
Simearth	\$34
Simearth WIN	\$34
Simfarm	\$41
Simhealth	\$29
Simlife	\$39
Simlife WIN	\$39
Smokin' Gun WIN	\$28
Space Hulk	\$36
Spaceward Hol	\$38
Spaceward Hol WIN	\$36
Special Forces	\$39
Star Control	\$29
Str Cntl 2:Ur-Quan Mstrs	\$34
Star Legions	\$24
Strike Squad	\$41

IBM STRATEGY

Sub Version	\$36
Task Force 1942	\$39
Tegel's Mercenaries	\$18
Tegel's Mercenaries 2	\$44
The Complete UMS	\$44
Theatre of War	\$16
Theatre of War Set 1	\$21
Traders	\$15
Unnatural Selection	\$38
Utopia	\$29
Vikings Fields Conquest	\$19
Visions of Aftermath	\$16
Walls of Rome	\$39
War in the Gulf	\$34
Warlords 2	\$42
When Two Worlds War	\$42
Worlds at War	\$19

IBM TRADITIONAL

An AmTail Coloring BK	\$19
Animat Wrkshp	\$29
Batt Chess 4000 SVGA	\$36
Battle Chess WIN	\$18
Beat the House	\$29
Casino Game Pak WIN	\$32
Casino Mstr Gold WIN	\$43
Checkmate	\$36
Checkmate WIN	\$36
ChessManiac 5 Bil & 1	\$42
Chessmaster 2000	\$27
Chessmaster 3000	\$29
Chessmaster 3000 WIN	\$35
Classic 5	\$32
Classic 5 WIN	\$30
Clue Master Detective	\$16
Cribbage Master	\$29
Dealer's Choice	\$19
Doodlemation Windows	\$19
Dr Floyds Desktop Toys	\$14

IBM TRADITIONAL

Dr Thorp's Blackjack	\$32
Gambit	\$36
Game-Maker Ver 2.0	\$49
Go Master Dix Ver 4or5	\$89
Go Mstr Dix 5 WIN 53	\$79
Go Master Jr Ver 4or 5	\$19
Go Mstr Jr Ver 5 WIN 53	\$19
Go Master Tool Kit	\$39
Go Mstr Tool Kit WIN 53	\$79
Go Master Ver 4	\$34
Go Master Ver 4or5 WIN	\$39
Go Master Ver 5	\$39
Grand Slam Bridge 2	\$27
GrandMaster Chess	\$19
GrndMaster Chess Dix	\$37
Home Alone 2	\$26
Hng Kng Mah Jong Pro	\$32
Hoyle's Bk Gmes Class	\$29
Jeopardy 25th Aniv	\$15
Jeopardy Sports Edition	\$7
Jeopardy, Super Talking	\$16
Joseki Genius	\$39
King's Table	\$24
Laffer Utilities WIN	\$21
Lucky's Casino Adv	\$39
Monopoly Deluxe	\$29
Monopoly Deluxe WIN	\$29
Origamo	\$39
Pinball Dreams	\$29
Pool Shark	\$18
Positronic Bridge	\$30
Positron Bidge CompSE	\$60
Price is Right	\$15
Risk	\$19
Russian Six Pack	\$39
Scrabble Deluxe	\$26
Shanghai 2	\$29
Solitaire Royale	\$19
Solitaire WIN	\$28
Solitaire's Journey WIN	\$38
Solitaires Journey	\$34
Star Wars Chess	\$38
Super Jeopardy	\$19

IBM TRADITIONAL

Take Break Crsswrld WINS	\$24
Terminator Chess	\$34
Terminator 2 Chess Wars	\$37
Tesseract WIN	\$16
Trmp Cst 2 Cas Rst Bay	\$16
Trump Castle 3	\$34
Virtual Reality Studio 2	\$64

IBM WAR GAMES

Across the Rhine	\$45
Action North Atlantic	\$26
Action off River Platte	\$26
Air Raid Pearl Harbour	\$22
Am Civil War 1, 2, or 3	\$24
Banzai	\$26
Battle Stations	\$22
Battle Tank Barbarossa	\$36
Battle Tank Kursk	\$39
Battle of Austerlitz	\$26
Battle of Leyte Gulf	\$24
Battle of the Atlantic	\$36
Battles of Napoleon	\$24
Battleship Bismark	\$26
Blitzkrieg Ardennes	\$19
Blood & Iron	\$48
Blue and the Grey	\$36
Borodino Napoleon Inv	\$29
Bravo Romeo Delta	\$29
Campaign	\$32
Campaign Mission 1	\$18
Carrier Strike	\$39
Carrier Strike Exp Pak	\$19
Charge of Light Brigade	\$18
Decision at Gettysburg	\$18
Dreadnoughts	\$34
Dreadnoughts Bismark	\$29
Dreadnoughts Deluxe	\$89
Dreadnoughts Ironclads	\$29
Drums of Glory	\$44
Fall Gelb	\$36
Fifth Eskadra	\$36

IBM WAR GAMES

Fleet Med	\$27
Gary Grigsby Pacif War	\$45
Gary Grigsby's War Rus	\$45
German Raider Atlantis	\$26
Gettysburg:Turning Point	\$36
Golan Front	\$36
Grand Fleet	\$36
Grey Seas, Grey Skies	\$36
Halls of Montezuma	\$24
High Command	\$45
In Harms Way	\$36
Kriegsmarine	\$36
Kursk Campaign	\$36
Long Lance	\$39
Main Battle Tank C Germ	\$36
Main Batt Tank MidEast	\$36
Main Battle Tank N Germ	\$36
Malta Storm	\$36
Man of War	\$36
Mare Nostrum	\$26
Marianas Turkey Shoot	\$14
Midway	\$26
Moscow Campaign	\$36
Northern Fleet	\$36
Operation Overlord	\$36
Pac Storm Midway Cpgn	\$36
Pac Strm Solomn Camp	\$36
Panzer Battles	\$24
Patrol	\$23
Patton Strikes Back	\$14
Prelude to Julland	\$26
Red Sky Morning	\$36
Return to Falklands	\$28
Rising Sun	\$26
Rd Sumter to Appomax	\$45
Rommel Bat For N Africa	\$24
Rommel at El Alamein	\$36
Rommel at Gazala	\$36
Second Front	\$21
Squad Leader	\$48
Stalingrad Campaign	\$36
The Great War	\$39
Third Reich	\$34

Mortar Combat!

Battling With BRIX In MicroLeague's Latest

by Allen L. Greenberg

The secret to the success of the rubber band and the paper clip in the office environments of the world is twofold: they are simple, useful and cheap. And, perhaps more importantly, they are cleverly disguised toys for bored executives and secretaries. This may be the best explanation for their ubiquity in desks throughout the world, especially those mahogany desks generally lacking in papers to be clipped or objects to be rubber-banded.

With the invention of the desktop dartboard, the executive fly-swatter and *Tetris*, the demand for office toys has been brought out into the open, and such toys need no longer masquerade as marginally useful pieces of office equipment. Now, proudly and without false pretense, a pastime based on the common household building brick becomes an object of recreation in *BRIX*, a new abstract strategy game from MicroLeague Interactive.



Each of *BRIX*'s two-dimensional screens contains a maze, the walls and borders of which may not be altered during the game. The bricks in *BRIX* are inscribed with a variety of patterns and are scattered throughout each maze. The object is to manipulate the bricks so that two or more touch each other. When they do, look out. Call it love, call it hate—either way, the brief affair ends explosively. Each patterned brick must "meet its match," so to speak, in order for the level to be complete.

BRIX is played using only the keyboard, and neither the mouse nor the joystick are supported. A brick-shaped cursor is manipulated about the screen using the four directional keys. Once the cursor is on a brick, it may be

highlighted using the space bar, at which point that brick may then be moved in whichever direction is open. Those familiar with the classic computer and arcade game *Boulder Dash* will probably feel at home with the action here.

The game is divided into *BRIX 1* and *BRIX 2*, which probably reflects its shareware origin. Both games contain seven levels, each of which are divided into a variety of sub-levels, difficulties, and sub-sub-levels so that the package boasts a total of 224 different challenges. Each puzzle is tagged with its own secret code so that you can return to the puzzle in the future without playing through the earlier portion of the game.

As long as they are adjacent to each other either horizontally or vertically, any number of matching bricks will cause an explosion. Several different brick patterns appear in each maze, and there is a varying number of bricks that bear the same pattern. An even number of matching bricks is usually easier to eliminate, since these may be taken out in pairs. An odd number of matching bricks means that, at some point, the three bricks must be brought together at the same instant.

The mazes can be quite complex and therefore require some careful study. Unfortunately, careful study is a luxury you cannot afford due to a countdown timer that restricts each round to a small number of fleeting minutes. An option to pause the game is not available, and although each round of the game may be reset to the beginning as many as two times, this option does not reset the timer. Players who enjoy tackling these types of challenges at a leisurely, crossword-puzzle manner may be unhappy with this panicked pace.

Making *BRIX* somewhat more interesting than the average brain teaser are a variety of



gadgets appearing in some of the mazes. Automatic laser guns destroy everything in their path and are set to fire every few seconds. You may destroy bricks by dropping them into an acid or water bath, although using the acid bath will cause the round to end. Transporters beam bricks from one portion of the maze to another. There are elevators that carry bricks up or down, as well as crumbling bricks that turn to dust within several seconds of supporting another brick. The most interesting of these gadgets is an hourglass that causes the entire screen to do a vertical flip every few seconds.

BRIX includes a "level solver" which will, mid-game, demonstrate the solution to a particular puzzle, provided you have earned enough game points to pay for this service. There is also a puzzle editor that allows you to alter an existing puzzle or to wipe it out in favor of one of your own design.

BRIX is certainly an entertaining little exercise, although its potential for desktop-based addiction is not quite as high as its package would lead you to believe. It may, however, prove more engaging, and certainly more challenging, than creating paper clip chains and shooting rubber bands into coffee mugs.

CGW



TITLE: BRIX
PRICE: \$34.95
SYSTEM: IBM
REQUIREMENTS: 286 or better, VGA graphics, 1.5MB hard drive space; supports Sound Blaster sound card
PROTECTION: None
DEVELOPER: Epic MegaGames
PUBLISHER: MicroLeague Software
 Newark, DE
 (800) 334-6572

CHIPS & BITS

PO Box 234
 Rochester VT 05767
 Call 800-699-4263
 Int'l 802-767-3033
 Fax 802-767-3382
 Source-10027

Second Conflict™



'SECOND CONFLICT' is a game of interstellar strategy & conquest for windows. Control all aspects of the economy, military, and civilian population. Allocate resources to produce battleships, stealth ships, transports and missiles. Features multiple human & computer players & a scenario editor. \$34



'ARCTIC BARON' Your mission is vital: free the planet from perpetual winter and economic slavery. You command a giant steam powered train, but as your journey unfolds your need for fresh supplies becomes essential. Featuring 3-D maps, exquisite graphics, excellent sound effects & music. \$29



'UNNATURAL SELECTION' is a game that combines artificial life and animation to create simulation with plot & intrigue. You must selectively breed & mutate artificial creatures to outwit your mad scientist opponent. \$38
 6 FREE Issues of 'Strategy Plus' w/ Unnatural Selection Purchase.



'THE COMPLETE UNIVERSAL MILITARY SIMULATOR' UMS, UMS II: Nations at War, the UMS II: Planet Edit, American Civil War Scenarios, Desert Storm Scenarios, over 500 pages of dox all together in a 3 ring binder and slipcase. \$44

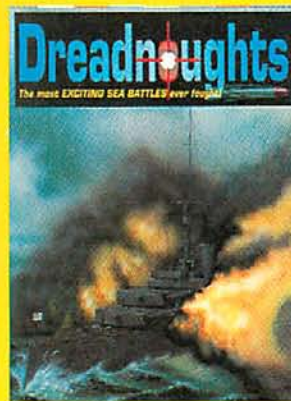

'DREADNOUGHTS' models the looks and tactics of fighting fleets during the great age of the battleship. Includes 7 scenarios such as: Falklands (1914), Jutland (1916) and Bank (1915). Features menu interface for entering commands, external 3D view & hidden movement. 1 or 2 players. \$34

IBM WAR GAMES

- To The Rhine \$36
- V Vic: Gold, Juno, Sword \$44
- Victory at Sea \$46
- War in the Falklands \$26
- Warship Changed Histry \$26
- Waterloo \$19
- White Death \$19
- WW 2 Battles S Pacific \$34

IBM BUDGET

- Covert Action \$12
- Crime City \$12
- Crime Does Not Pay \$12
- Dark Half \$9
- Das Boot Submarine \$12
- Diplomacy \$12
- Dr Thorp's mini Bclckjck \$12
- Dr Doom's Revenge \$9
- D Wng Jcks&Vid Pker 5 \$12
- Dragon Force \$12
- Dragon Lord \$9
- Dragon Strike \$12
- Dragons of Flame \$9
- Electric Jigsaw \$12
- F15 Strike Eagle 1 \$7
- Fighting for Rome \$12
- Free DC \$9
- Games Master WIN \$6
- Gauntlet 2 \$9
- Global Effect \$8
- Gunship \$12
- Harmony \$5
- Hearts \$12
- Hole in 1 Mini Golf Deluxe \$12
- Interact Adlt Sampler CDS \$12
- Jack Nicklaus Clip Art \$9
- J Nicklaus SE Course 1 \$9
- Jeopardy 1 or 2 \$9
- Jeopardy Junior \$9
- John Elway Quarterback \$6
- Land Sea Air Trilogy \$12
- Leather Goddesses \$12
- Lexicross \$12
- Lightspeed \$9
- Lnks Crses:Barton Creek \$9
- M U D S \$12
- ML Baseball All Stars \$12
- Madden Football \$12
- Marvel Trilogy \$12
- Matrix Cubed \$12
- Medieval Lords \$9
- MegaFortress \$12
- MegaTraveller 2 \$12

IBM BUDGET

- Metal & Lace Upgrade \$5
- Micro league bsbl Sea I3 \$12
- Millenium \$6
- Obliterator \$6
- Oligopoly \$9
- On Target \$12
- Operation Combat \$12
- Penthouse Jigsaw XXX \$12
- Pictionary \$12
- Pirates a must \$6
- Playmaker Football \$12
- Power Dome \$9
- Predator 2 \$12
- Punisher \$9
- Puzzle Gallery 1 \$9
- Puzzle Master \$6
- RR Tycoon W Strat Pls \$12
- Red Storm Rising \$9
- Rings of Medusa \$12
- Ruckus Poker \$12
- Ruckus Roulette \$12
- Savage \$9
- Sentinel Worlds 1 \$9
- Seventh Fleet \$3
- Shadow Sorcerer \$12
- Siege \$12
- Snoopy's Fun Pack \$12
- Sony SRS7 Speakers \$9
- Sony SRS9 Speakers \$14
- Spot \$9
- Storm Across Europe \$12
- Strategic Forces \$9
- Street Ball \$12
- Taking of Beverly Hills \$12
- Team Yankee \$12
- Test Drive2: Supercars \$12
- Tie Break Tennis \$9
- Trmp Cst 2 Cas Rsr Bay \$6
- Trmp Cst 2 DD1 Lts Slts \$4
- Trmp Cst 2 DD2 Pker 2 \$4
- Turn-n-Burn \$12
- Typhoon of Steel \$12
- Under Fire \$12

IBM BUDGET

- Vaxine \$12
- Video Poker Villa Crespo \$9
- Video Poker Win \$12
- Video Poker by Masque \$9
- Warlords \$12
- Wheel of Fortune 2 \$9
- Wver Tm & Play Stats 89 \$6
- X-Men \$9

AMIGA

- American Civil War Vol 3 \$24
- Atomino \$3
- Batt Chess Enhance CD \$19
- Black Crypt \$26
- Bridge 7 \$19
- Dark Queen of Krynyn \$6
- Das Boot Submarine \$9
- Dick Tracy \$10
- Dreadnoughts Ironclads \$12
- Dragon's Lair 1 or 2 \$19
- Fast Break \$3
- Go Master Dix Ver 5 \$49
- Harpoon Battle Set 4 \$19
- Harpoon Scenario Editor \$14
- Heatwave \$3
- Heaven & Earth \$19
- Jck Nicklaus Crse 1-5 ea \$6
- Leisure Suit Larry 1 \$9
- Lexicross \$19
- Mean 18 Golf \$3
- Menacer \$3
- Monopoly \$14
- Night Shift \$6
- Omar Sharif Bridge Dix \$19
- Out This World COLOR \$19
- Police Quest 1 \$10
- Reach for the Stars \$19
- Risk \$14
- Robo Sport \$24
- Secret Monkey Isle \$19
- ShadowGate \$19

AMIGA

- Shanghai 2 \$19
- Shark Attack Ult Golf \$6
- S Holmes Con Det 3 CD \$19
- S Holmes Con Detec CDS \$19
- Sim Ant \$19
- Simcity \$29
- Simcity Terrain Editor \$9
- Space Ace 2 MONO \$19
- Spirit Excalibur COLOR \$14
- Star Trek 25th Anniv \$19
- Starlight 1 \$19
- Super Tetris \$19
- Treasure Trap \$9
- Test Drive 2 \$19
- Test Drive 2:CA Chal \$6
- Test Drive 2:Muscle Cars \$3
- Test Drive 2:Supercars \$6
- UMS 2 \$19
- Vette \$19
- Where Europe Carmen \$19
- Wordtris \$19
- Yeager's AFT \$19

JAGUAR

- Jaguar CD System \$299
- Jaguar Controller \$24
- Jaguar System \$249
- Alien Vs Predator \$54
- Baseball \$54
- Basketball \$54
- Battle Zone 2000 \$54
- Checkered Flag 2 \$54
- Club Drive \$44
- Crescent Galaxy \$44
- Evolution:Dino Dudes \$44
- Jaguar Form 1 Racing \$54
- Kasumi Ninja \$54
- NFL Football \$54
- Raiden \$44
- Tempest 2000 \$44
- Tiny Toon Adventures \$44

FREE GAME OFFER

Send the specified amount on any in stock software and choose a free IBM game from the corresponding list below. Offer subject to change or cancellation without notice. Valid from Jan 1st through Feb 28th or while supplies last.

SPEND \$100

- Backgammon by George Blackjack
- Blackjack for Windows
- Chessnet
- Covert Action 3.5
- Dragons of Flame 5.25
- Dragon Force 5.25
- Earth Rise 5.25
- Free D.C. 5.25
- John Elway Quarterback 5.25
- MacArthur's War 5.25
- S.C. Out
- Trump Castle 2 5.25
- Video Poker Windows
- Video Poker By Masque

SPEND \$200

- Acquire 3.5
- Amazon 3.5
- Breach 2 5.25
- Lost Admiral
- Magic Candle 2 5.25
- Megatraveler Zhodani 5.25
- Mercenaries 5.25
- Playmaker Football
- Rules of Engagement 5.25
- Star Legions 5.25
- Warlords 5.25

THE YEAR THE STARS FELL

An Overview of 1993's
Space War Titles

by Martin E. Cirulis

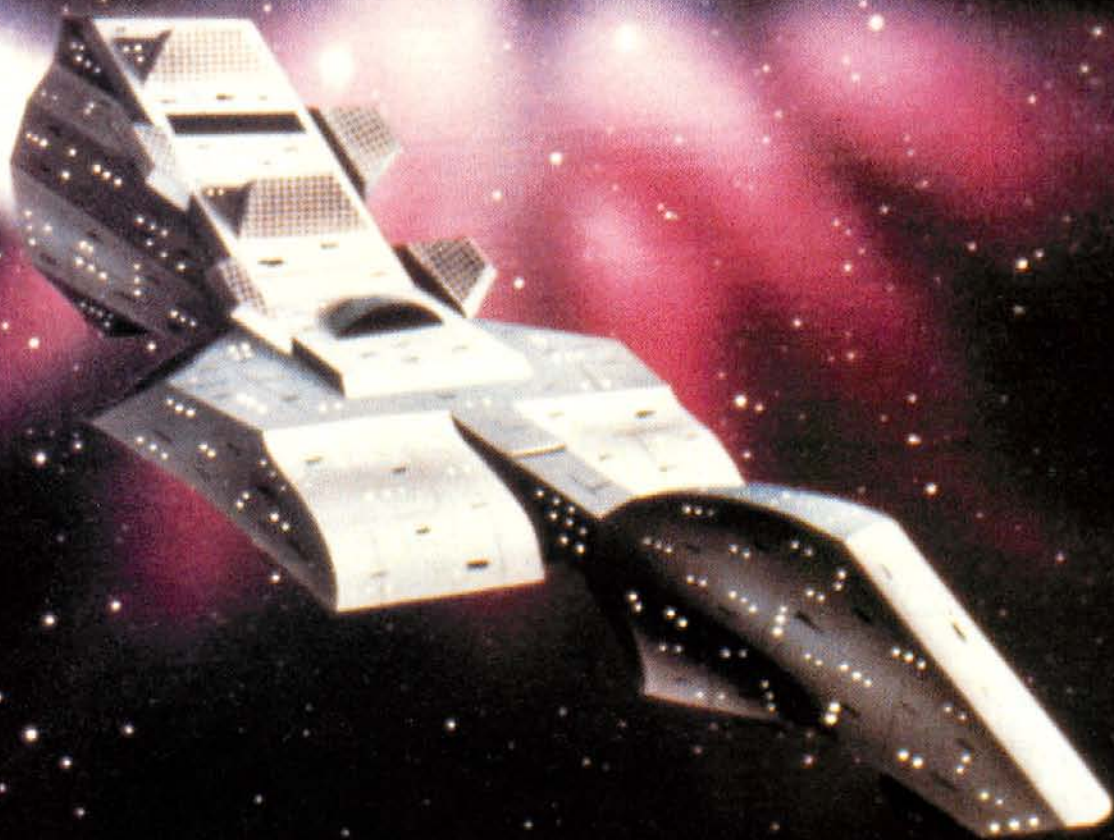

Illustration by N. Taylor Blanchard

© N.T.B.
1998

It could have something to do with the latest crop of TV science fiction, good and bad, or a reflection of the newest plague of brush-fire wars on our own little world; or maybe it's just that time of decade again. Whatever the cause, 1993 produced a hoard of software titles with science fictional elements, revolving around various aspects of tactical and strategic warfare in the depths of space and across the surface of alien worlds.

Over the past year, I have had the occasionally dubious pleasure of playing most of the science fiction wargames to hit the shelves. The pack was large and competitive, including the epic but light-hearted *StarControl II* by Accolade; the much buzzed *Master of Orion* from MicroProse; the repetitive *Star Legions* and the Siamese twins of the software world, *Tegel's Mercenaries* and *Strike Squad*, all brought to you by the busy kids at Mindcraft; a fast-paced tribute to Frank Herbert's dream, *Dune II* from Virgin; the wacky cowboy frontier of *Spaceward HO!* marketed by New World Computing; a game that just couldn't live up to its box-top brags, *Maelstrom* by Merit Software; the gory child of Games Workshops' boardgame, *SpaceHulk* distributed by Electronic Arts, the uninspired *When Two Worlds War* and the complex and innovative ship-to-ship wargame, *Rules of Engagement 2*, both given life by Impressions; and last but far from least, a dedicated and evolving shareware spaceploitation game, *VGA Planets 3.0*, distributed by its designer, Tim Wisseman. As you can probably imagine, with a field as extensive as this, there was very little time this year for me to play much of any other genre, never mind getting enough sleep.

SPACEPLOITATION HO!

With an attitude that would strike terror and rage into any aboriginal heart, the colo-

nization and exploitation of alien worlds was the major facet of the three games that were closest to the traditional model of SF wargames. *Spaceward HO!*, *Master of Orion* and *VGA Planets* are all based on the

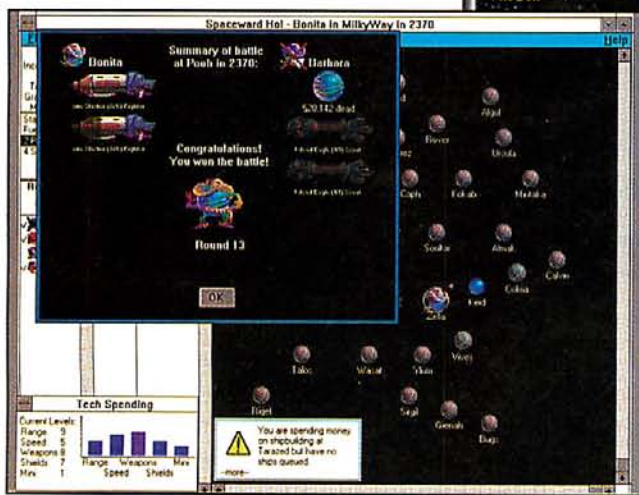

Spaceward HO!: the wild, wild Western spiral arm of the galaxy.

explore/conquer/build fleets template which has been with us since the days of SSI's *Imperium Galactium* on the old C-64 (nearly a decade ago!). Still, this new crop of spaceploitation titles has re-invented itself in a variety of distinctive ways.

Spaceward HO! was the most notable because it presented the spaceploitation concept with a hybrid sci-fi/wild west theme and played the colonization of space for laughs. Its simple economics and development were all controlled by convenient slider bars and, most importantly, it did away with the ago-



Master of Orion: the Civ-ilized space game.

nizing hotseat of most multi-player games with its networking capability. With space for 20 players, human and computerized, *HO!* brought a cheer from most social gamers and drew in many non-wargamer types with the use of clever bells and whistles.

Master Of Orion came out in the second half of the year and turned out, by coincidence or design, to incorporate many of *HO!*'s user-friendly aspects into a more traditional, serious clash of empire. The game involves 10 races with distinct traits and advantages; any particular scenario involves five races randomly selected from the pool. *Master Of Orion* has the kind of attention to detail that keeps you coming back to try new strategies. The only drawback was the fact that it was a single player game; *MOO* could have made a brilliant multi-player platform. Instead it is another in a disturbing trend of non-social wargames from MicroProse.

The most traditional spaceploitation game of the year, *VGA Planets*, still managed to break new ground; it is a shareware game that runs on a computer Bulletin Board System. Up to 11 players can carve up and exploit a

500 world universe in the comfort of their own homes, and when they have finished a round of managing their worlds and fleets, they simply order the software to pack the turn into a convenient single file that can then be uploaded to the BBS. The BBS host program integrates the turns, resolves conflict, and updates the galaxy. Diplomacy, treaties, and Jihads abound in this game, which is very similar in feel to a play-by-mail system but without the cost and wait. A new version, *Planets 4.0*, will support up to 20 races, a workable AI, and offer even more refinements to the hosts, allowing them to fine tune games to their own taste. *VGA Planets* can be found as shareware on an ever-growing list of BBSs.

"This World Must Be Mine!"

This year also brought a narrowing of the Space War focus down to battles over the surface of worlds. *Star Legions*, *When Two Worlds War* and *Dune II* all revolved around the trials and tribulations of invading and securing a single world. Economics and politics were either sacrificed or dealt with very superficially in order to concentrate on individual structures and military units as the focus moved from strategic to tactical. It seems that reaction time was also considered important on this smaller stage as all three of these titles were based on a system of real-time continuous action instead of the more relaxed and pensive turn-based simulations most wargamers are used to.

StarLegions came out early this year and tried to present the gobbling of worlds by a giant empire, not from the Admiral's lofty perch, but from the up-close perspective of the General in charge of securing a world once the flash and glory space combat is over. *SL* examined many interesting points of planetary invasion. Bombardments could cost you the destruction of the very prize you sought, and you are always gambling glory against disgrace as you try to "bid low" on the ships and troops you will requisition from your Empire to get the job done. Unfortunately, the game suffered from a high tedium factor. World after world offered fewer surprises and more sheer numbers. Over-simplification of game mechanics that reduced your options and undermined the futuristic premise of the game did little to help.

Impressions narrowed the focus even further with *When Two Worlds War*, a head-to-head conflict either against the AI or a human via modem. You have to protect your own

world and its Military Industrial Complex while journeying to your foe's world and paving it with lasers and bombs. Of course the enemy has the identical set of priorities, and with the game running in real time, a prospective warlord has to think fast and react faster. *W2WW* incorporated a basic research and development system along the lines of that found in *HO!* and gave you a multitude of options, but all this work on the designer's part was almost for naught; the simplification of mechanics demon struck again and rendered most of the game's tactical options moot. A weak AI opponent was also a fault, but the modem capability helped get around this and make for an enjoyable two player game.

Dune II was generally lauded as a great improvement over the first computer game version of this legendary SF series. Only a token nod was given to the elegant and treacherous politics of Frank Herbert's immortal books, but *Virgin* still managed to capture the feel of fighting across this strange



Dune II: Sand worms, spice, and many a gamer's vice.

and arid world. You must contend against one, two or even three rival houses in a scenario while trying to gather up enough precious Spice to support your war efforts. In addition, there are the awesome Sandworms wandering the landscape, gobbling up assault tanks like popcorn. To capture Dune, you must battle over individual provinces, conquering one before being allowed to move on to another, very much like *Bullfrog's Powermonger* from last year. The AI for the opponents' Houses is tenacious and tough most of the time. In the final analysis though, *Dune* is but a single world and, from a wargamer's point of view, once you have captured her in the role of each different Noble House offered to you, there is very little reason to go back. Modem support could have made a world of difference to the lifetime of this game.

Roll The Dice, Move Your Mice

With the wargaming microscope turned to its highest power, we venture into the world of conflict where a player controls only a handful of dynamic units. In *Tegel's Mercenaries*, and its unofficial sequel, *Strike Squad*, you are controlling small squads of troops by ordering each person individually. In *Rules of Engagement II*, your job is to captain a single starship while giving orders to other ships in your fleet. Real-time combat is a big part of all three of these titles, and they trade heavily on the concept that you are a being with a mission.

Tegel's Mercenaries and *Strike Squad* from *Mindcraft* are in the tradition of squad level wargames that can be traced back to *Avalon Hill's* boardgame, *Squad Leader*. In these games you are the commander of a group of mercenaries who find themselves in the unenviable position of trying to save the civilized galaxy while maintaining a healthy profit margin. Commanding these characters is a

matter of guiding them around a skewed 3-D landscape while issuing very basic fire/grab/drop/move orders. Characters not under your direct control possess a rudimentary intelligence; enough to shoot at any enemy in range, but not enough to come in out of the laser rain on their own. Among other problems, the linear storyline of *Tegel's Mercenaries* reduced its replay value almost to nil. *Strike Squad*, while keeping an almost identical graphic and control engine, added permanent locations that could be revisited and an *Ultima*-style "go-there-talk-to-that" storyline. Unfortunately, the setting of a broken leg did little to alleviate the patient's heart condition, and *Mindcraft* seems to have declined to advertise the

fact that *Strike Squad* is *Tegel's 1.5*.

Space Hulk is not a game about a big green muscleman in a spacesuit. It's actually the first of what I am sure will be many computer conversions of the extensive and nihilistic *WarHammer 40K* series of games from England's *Games Workshop*. Distributed by *Electronic Arts*, this software package is extremely faithful to its boardgame incarnation. Squads of Imperial Marines, a military branch that has evolved into a neo-religious order, must root out the dark and twisted enemies of humanity in the bowels of ancient dreadnoughts and the subterranean caverns of shattered worlds. Game play is relatively simple and easy to get the hang of. You face a hostile world through a first person point-of-view similar to *Wolfenstein 3-D*, but lacking the fluidity of motion found in that title.

All Pros. No Cons.

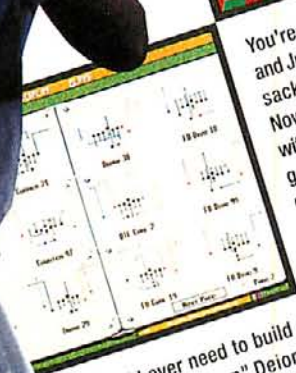
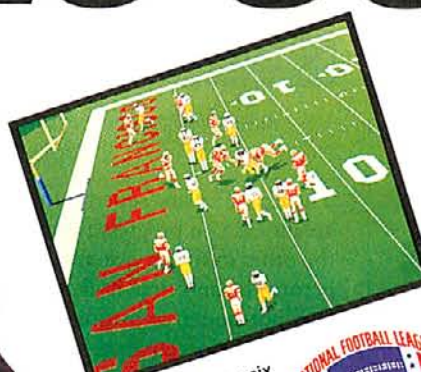
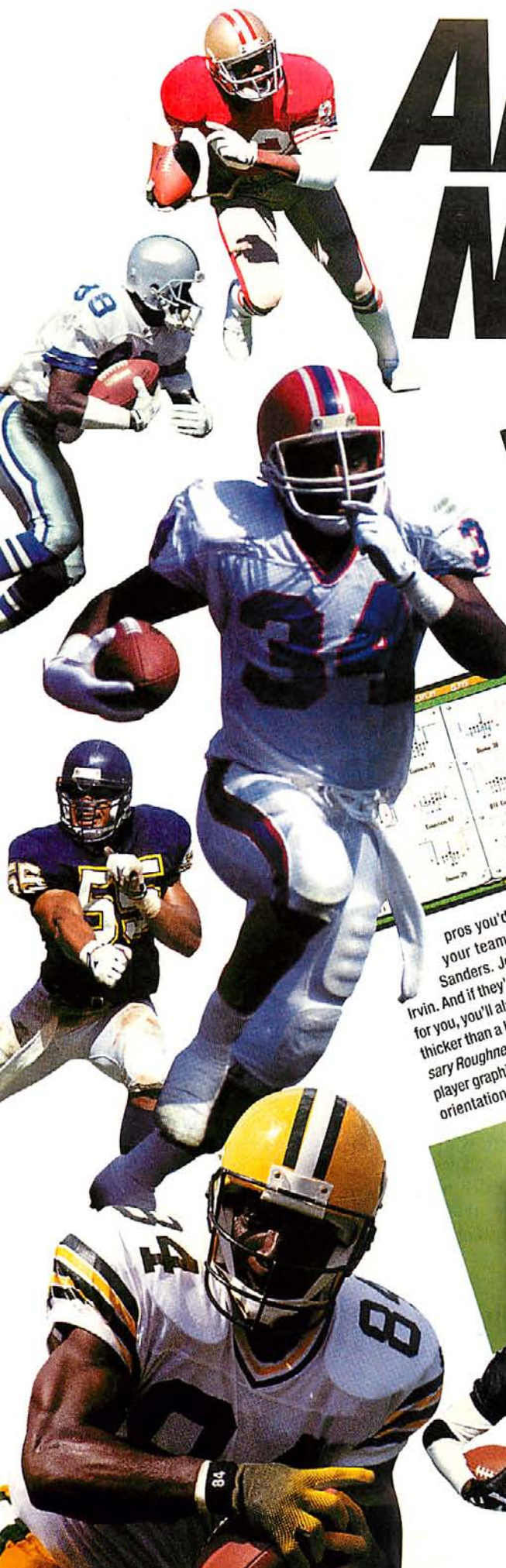

NATIONAL FOOTBALL LEAGUE PLAYERS

You're down by six and Junior Seau just sacked you again. Now it's 4th and 18 with only a minute to go. Should you go long to Sterling Sharpe, or dump it in the flat to Thurman Thomas? In *Unnecessary Roughness*, it's your call. But don't worry. You've got all the NFLPA™

pros you'd ever need to build your team. Like "Neon" Deion Sanders. John Taylor. Or Michael Irvin. And if they're not enough weapons for you, you'll also have a playbook that's thicker than a lineman's head. *Unnecessary Roughness* also features roto-scoped player graphics. Plus a rotating 3-D game orientation with infinite camera views

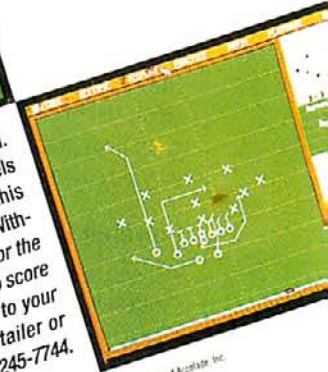
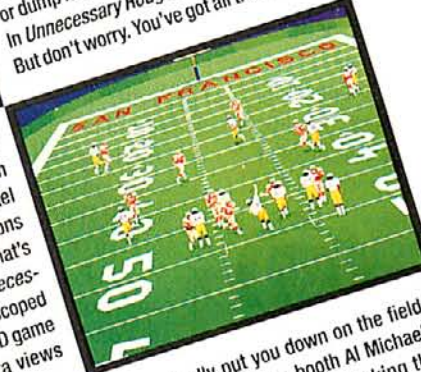

that actually put you down on the field. Meanwhile, up in the booth Al Michaels handles the play-by-play, making this football game as real as you can get. Without getting hit, at least. Available for the IBM PC and 100% compatibles. To score yours, rush to your favorite retailer or call 1-800-245-7744.

AL MICHAELS CALLS THE SHOTS

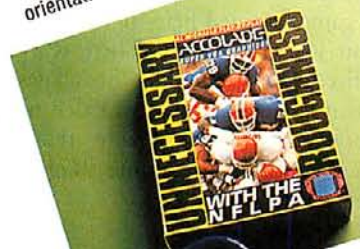

© 1993 Accolade, Inc. All rights reserved. NFLPA is a trademark of the National Football League Players Association and is used under license. Accolade, Inc. Logo and name © NFLPA 1993. Unnecessary Roughness is a trademark of Accolade, Inc. and is officially licensed by the National Football League Players Association. IBM is a registered trademark of International Business Machines. All other trademarks and registered trademarks are properties of their respective owners.



DON'T WASTE YOUR SOUND CARD ON INFERIOR SPEAKERS.

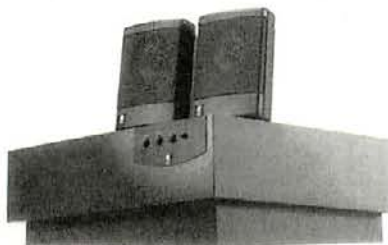

The Powered Partner 622

Powered Partners are the perfect complement to your multimedia computer system. They are the only speakers to be named a 1992 Windows Winner by Windows magazine. They were also nominated for a Readers' Choice award by Multimedia Magazine. But the best reason to use Powered Partners is the sound. Listen to the experts: "They (Powered Partner 622) set the standard for all the other speakers" (David Ranada—"Windows" recommended) and "If you want the best, look no further... the (Powered Partner) 570s are the Rolls Royce of sound" (Rich Heimlich). With such high praise, why buy anything else.



Powered Partner 622 Features

- Sophisticated 3-piece system with separate powered sub-woofer
- Fully shielded, even the sub-woofer
- Perfect for all computer and video applications
- Electronic crossover and 3 power amplifiers

For a dealer near you,
call 1-800-969-AR4U.

In Canada, call Precor at 1-800-268-1172.



Superior Sound Simplified

© 1993 Acoustic Research, a division of IJI

Circle Reader Service #34

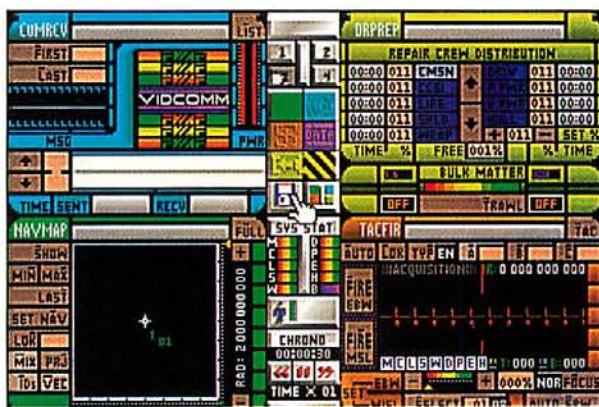

Rules Of Engagement 2: Underneath all those buttons is a great game.

The graphics are superb, and there is gore aplenty as you progress from one scenario to the other in the service of your undying Emperor. The only drawback is that squad members not under your direct control have the same life expectancy as those old *Star Trek* guys in red shirts.

Rules of Engagement 2 seems proud to acknowledge its sequelism and is a great refinement of its previous incarnation. As part of Omnitrend's *Interlocking Game System*, *RoE2* is meant to be linked to *Breach 2* or, preferably, the upcoming *Breach 3*. With the games interlocked, the boarding of enemy ships and installations is resolved at the squad level of control. *RoE2* is actually more like a starship simulator but without the arcade qualities marking other titles in this category. Here, your decisions are tactical in nature, and quick thinking combined with fluid tactics are far more important than lightning reflexes. Personnel have their own personalities and motivations that affect how they respond in combat, so you need to choose your ship captains wisely. Make no mistake; it uses a polished ship-panel interface, but *RoE2* is a complex game—definitely the most complex of the games covered here. It rewards every moment you put into it. There is even a magnificent scenario builder that allows you to construct entire campaigns based on the success/failure branching paths that have been so successful in Origin's *Wing Commander* series.

Adventure Is My Middle Name!

With all these bombs going off across the galaxy there were bound to be a few mutants around, and sure enough, there were a couple of hybrids in the genre this year. *StarControl II* and *Maelstrom* are both wargames at heart, but they are driven by adventure game plots. Yes, you must still collect material, make ships, and blow up other people's ships, but

there is a developing storyline that evolves around you and demands your participation. If you play the narrow military commander and pay attention only to battles while the universe goes by outside your viewport, you've found a sure way to lose these games. Unfortunately the genre splice brought with it the flaw of the adventure game genre: the end of the story brings the end of gameplay, and the software graveyard gains another played-out hulk.

Maelstrom came on the scene

early in the year claiming to be the final word in clash of empires simulations. At this point in the sales curve it seems *Maelstrom* was about as successful at fulfilling this claim as Idi Amin was at being President for Life. The general idea was good: you are a renegade military commander trying to keep your former empire from crushing the entire civilized galaxy in its mailed fist. You control a fairly large network of ships, operatives, research teams and mines that support precarious revolt. It's a great idea that falls short in the details. Unfortunately, the combat system makes most of your neat research gadgets moot, and most of the plot devices stretch the credulity of the player much too far. *Maelstrom* touts itself as having a high degree of replayability because the turning points of the plot occur different times in different games, but no matter when you dip, it's still the same old dance.

Somewhere between the pretension of *Maelstrom* and the wackiness of *Spaceward HO!* is Accolade's *StarControl II*. This game is the fruit of a marriage between the action game *StarControl* and the very popular *StarFlight* adventure game. As a sequel to the wars fought in the original *StarControl*, *SCII* brings you the same bunch of friends and enemies, but in much closer detail. Now you can talk to them, reform alliances, and intimidate old enemies. In fact, the first half of the game plays much like an interstellar "Where are they now?" episode. Combat is a series of single ship combats in high arcade style, each race having a special ship type with its own tactical profile. There is enough humor in the story to keep you from minding the thin parts of the plot, and the only drawback to the wargame aspect is the fact the computer fights too efficiently to make any ship but your human dreadnought worth using. As an adventure game it must come to an end, but to keep you from pulling *SCII* off your hard drive too soon, the designers have included a ship-to-ship melee sub-game that allows you

Officially Licensed by

INDYCAR

From the Creators of
Indianapolis 500®: The Simulation™

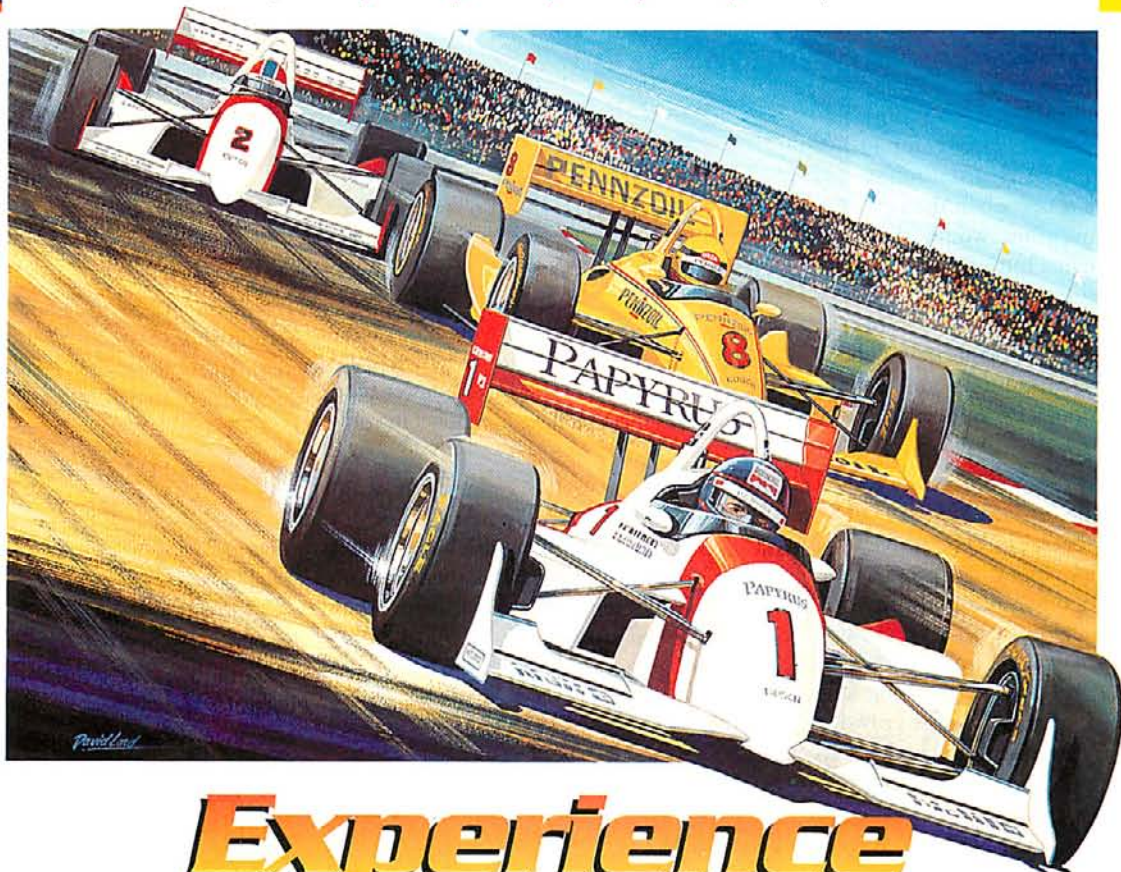

Experience IndyCar Racing!



The Official Game of IndyCar Racing

The one and only PC simulation officially licensed by IndyCar. Now you can challenge the world's leading racers wheel to wheel. Plus, see the actual drivers, their teams and cars in lifelike detail.

Complete Car Setup, Infinite Control

You call the shots - front and rear wing adjustments, brake bias, anti-roll, turbo boost, gearing, camber, stagger shocks, tire pressure and compound. Choose from 6 different engines and 5 different chassis for the ultimate race machine.

Accurate Tracks

Experience the IndyCar season as the real drivers do. Every turn, bank, straight and hill is painstakingly accurate. Race the short ovals, super speedways, road courses and city street circuits. This is **the** IndyCar simulation!

Overall Game Play

Feel the pressure. Make the same critical decisions the IndyCar teams make every race. Tune your car to the real track, qualify on the pole, develop your pit strategy, fine tune your race plans and more!



Circle Reader Service #108

Installment One of the
Papyrus Racing Series!

Indianapolis 500®: The Simulation™ is a trademark of Electronic Arts Inc. Indianapolis 500 is a registered trademark of the Indianapolis Motor Speedway. IndyCar™ and helmet logo are under exclusive license to Championship Auto Racing Team, Inc. Papyrus Racing Series is a trademark of Papyrus Publishing Inc.

PAPYRUS
PUBLISHING, INC.

to slug it out with any ship available in the game, either against the computer or a friend.

THE MANHATTAN PROJECT

If there was a trend in SF wargames this year it was that of scientific research. It should be easy to see how fascinating technology advancements are, and what an involving dynamic they add to a computer game. Let's face it, a large component of those 4:30 AM *Civilization* games was waiting to see when the new and wonderful invention would slide out of the wise man's hut and finding out how quickly you could put it to use in smiting your enemies. The lesson of this incredibly popular wargame has not been lost on the software community, and technological research popped up all over the place in 1993.

The forms this research capability took were part of what defined this new crop of SF wargames. For example, in *HO!* or *W2WW*, research is a quick and dirty proposition: invest so much of your economy into research, decide what ratio of that research money is going into what discipline, get a new technology level and a cooler looking ship icon. Get one tech level behind the crowd—that's bad. Get two down, you better start shopping for mausoleum space.

In a more complex game like *Master of Orion*, the arrival of new technologies took on a more random aspect: after a certain amount of basic research on a topic you could make a breakthrough next month or ten years from now. Also, instead of simply researching generic levels of technology, you could choose specific devices to research, from weapons to computers, and each one of these advancements had a name and unique effect in the game. This is a quantum leap in realism, giving a person's virtual empire a sense of identity that reflects his or her own personality; the more attached a person becomes to something they feel they are creating, the more involved they become in the simulation.

Maelstrom further refined this process by allowing you to decide which characters to hire and place in charge of what projects. Even games with no research model, like *VGAP* or *Dune II*, still let you spend more money on facilities that would build you a better arsenal. I think it's safe to say that new technology modeling and SF wargames are safely joined at the hip now, but there are still dangerous complications, especially for designers trying to get a product out without paying attention to detail. The more intricate your technology modeling gets, the more op-

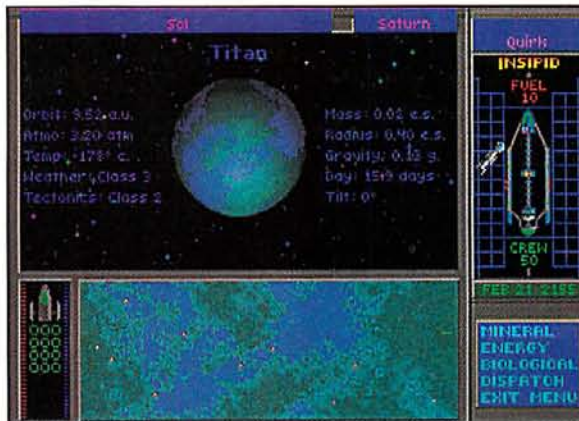

Star Control 2: It's got graphics, it's got story, who could ask for anything more?

tions are given to the player, which is usually a good thing; but beware: nothing will bring out the limitations of a wargame faster than tactical decisions that have no impact in combat.

For example, suppose I think the Zappotron cannon looks really neat, so I invest my empire's tremendous wealth in creating it and re-arming my fleets. If I then find no noticeable difference in combat from when my ships were armed with the old Goober gun, I am going to realize that what should

NOTHING WILL BRING OUT
THE LIMITATIONS OF A
WARGAME FASTER THAN
TACTICAL DECISIONS THAT
HAVE NO IMPACT
IN COMBAT.

have been a tactical decision has been reduced to irrelevant chrome and gradually lose interest in the game. On the other hand if there is a difference, or better still, if I find out later that there are subtleties—i.e., though the Zappotron is far more effective in open space, it fails to function at all in a Nebula where the old reliable Goober Gun did—not only will I feel the grim satisfaction of having learned something I didn't suspect, but the illusion that I am playing a dynamic, evolving simulation will be strengthened and I will be far less likely to pull it off my hard drive in a week and tell my friends to avoid it.

The same general problem occurs with AIs. Weak ones will appear far weaker in an envi-

ronment with many choices that they never utilize. The AI for *W2WW* was purported to be as strong as the one in QQP's *The Lost Admiral*, and it very well may have been, but an AI that shines in an enjoyable but relatively simple game like *Admiral* is severely intellectually-challenged in a game like *W2WW* where it is presented with a palette of sophisticated choices that it is simply not up to manipulating. This makes the game easy to beat and thus, pretty dull. On the other hand, an AI designed to take full advantage of a game from the design stage up, as appears to be the case in *Master of Orion*, is enjoyable to play again and again. The moral here is that a multitude of gadgets looks great in the manual, but the game's AI had better have the subtleties to match them.

"MR. CHECKOV, SET PLOTS ON REPETITIVE!"

While the worst of these games still held a few moments of enjoyment for me, the most common disappointment I had was discovering how much SF wargaming has come to resemble bland SF television and movies. The premises and plots of some of these games are extremely weak and would not be tolerated for a moment in historical wargaming, but are here acceptable because, "Hey, what do you want? It's all made up stuff anyway." Unfortunately, in a big media world no one ever learns from a mistake. Studios produce turkeys like *Last Action Hero*, which die at the box office despite their desperate hype, and in our little corner we have soulless drones like *When 2 Worlds War* or the tritely plotted *Maelstrom*. When they do badly, it's because "The SF wargame market is tiny and dying." Right.

SF wargames are in the same state that fantasy adventure and role-playing games were a few years ago: Fun, but mired in derivative plots from books, TV and D&D. "Go out, kill something and get its stuff." Spaceploitation is in the same hole now, but hopefully, a few designers will start complicating these tired plots with real world concepts; i.e., people are generally afraid of players who rape and pillage as a hobby and will tend to hunt them down instead of giving them the game winning doohickey. SF wargames need a Lord British-type designer to drag them kicking and screaming out of the galaxy of Space War pastiches and into the light of other more respected gaming forms. If I was invading Russia, I would be expected to have to deal with partisans, and if I am raping an entire world I should have to dedi-

PICK-UP THE PHONE



AND PICK TWO GAMES FREE!

1-800-795-5979



Choose Any Two Sierra MAC Games FREE When You Switch to Sprint!*

Sprint® long-distance service just became more valuable - up to \$159.90** more! Now, when you switch your home long-distance service to Sprint, you can select any Sierra game, free! After enjoying six months of high-quality long-distance, you may qualify for a second free Sierra game.***

Only Sprint can offer you a nationwide 100% digital, fiber optic network that provides the long-distance quality and reliability you need. Experience for yourself Sprint's "fiber-optic" clarity that makes both your long-distance calls and PC data transmissions crystal clear and virtually error free.

Unsurpassed call and data clarity is just one of the many benefits you will enjoy as a Sprint customer.

The Most® A Unique Calling Plan

Sprint offers an unprecedented long-distance calling plan called The Most available now for all customers. The Most will save Sprint Customers 20 percent off already low rates on calls each month to whomever you talk to

the most, including international calls—even if the called person is with a competitive long-distance carrier.

The Most will also provide an automatic 20 percent discount off all calls to Sprint's millions of dial 1 customers, anytime and anywhere.

When the person you talk to the most in a given month is a Sprint Customer, Sprint will combine both discounts for an effective overall savings of 36 percent on calls to that number.****

Save on Long-Distance When You're away from home too!

Sprint's FONCARD™ lets you continue to take advantage of long-distance calling and savings even when you're away from home. The FONCARD is free, with cards available for every member of your family.

The Service You Deserve

At Sprint, we make no compromises when it comes to dependable, personal service - we do it all; operator services,

directory assistance, customer service, even instant credit for wrong numbers. And we do it 24 hours a day!

No Risk Guarantee

Your satisfaction is guaranteed: we'll pick up the cost of switching your long distance to Sprint, and will even pay to switch you back if you are not completely satisfied. (Some restrictions apply.)

So why not sign up for Sprint and receive the clarity, savings and service you want while getting two Sierra games you enjoy?



* Offer valid only in the U.S. and for new Sprint customers. Not valid for FONCARD-only orders. One offer per household. Certain restrictions apply.

** Retail value of Sierra Games.

*** To qualify for a second game, the customer must bill \$20 per month in 3 of the first 6 months.

**** THE MOST discounts apply to in-state/intraLATA calls only where authorized.

IT'S ALL IN

► Sources indicate that a rival syndicate has developed a dangerous new computer program, and our research boys want it. Your mission: build Company Agents using cybernetic implants and hi-tech weaponry. Utilizing action, strategy

or a lethal mix of the two, you can infiltrate fifty remarkably de-



tailed futuristic cities, each 'alive' in real-time.

SYNDICATE

► To confiscate a copy of Syndicate, visit your local software retailer, or call toll free

1-800-245-4525.

Available for the IBM

PC and compatibles.



Eliminate the Hooligans. Take control of the city. But expect maximum resistance.

YOUR HEAD.

DATADISK

Datadisk now available!
Syndicate: American Revolt.
New missions. New Weapons.
New World Order. Features
Network Play!

AVAILABLE

A
T
E

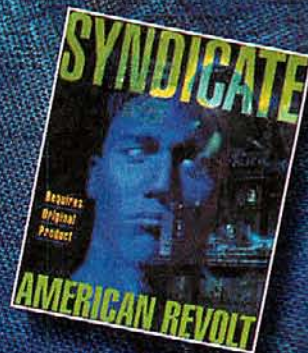

Game Attributes Summary

Title	# of Players	Focus	Scale	Motivation	Economic model	Complexity ¹	Windows? ²
Star Control II	1	Exploration, Warfare	Single Ships	Plot Driven	Very Simple	5	without sound
Tegel's Mercs	1	Mercenary Missions	Squad Level	Connected Scenarios	Very Simple	6	no
Strike Squad	1-2	Mercenary Missions	Squad Level	Plot Driven	Very Simple	6	no
Master of Orion	1	Exploration, Exploitation	Fleets	Conquest	Good	6	yes
Dune II	1	World Domination	Individual Vehicles	Conquest	Simple	5	yes ³
Spaceward HO!	1-20	Exploration, Exploitation	Fleets	Conquest	Good	3	yes ³
Maelstrom	1	Politics, Warfare	Fleets	Plot Driven	Simple	5	no
VGA Planets 3.0	2-11	Exploration, Exploitation	Fleets	Conquest	Good	7	no
Star Legions	1	World Domination	Divisional	Conquest	None	4	yes
Rules of Engagement 2	1	Fleet Command	Single Ships	Connected Scenarios	None	8	yes ³
When 2 Worlds War	1-2	World Domination	Individual Vehicles	Conquest	Simple	6	no
Space Hulk	1	Extermination	Squad Level	Connected Scenarios	None	4	no

1) Complexity is rated on a scale with 1 being comparable to Snakes 'n Ladders and 10 being a game with a game manual the size of a New York phone book.

2) This criterion is a very loose one and my .PIF file creation skills are nowhere near good enough to make these definitive or bug free statements.

3) Indicates designed Windows compatibility.

The Cirulis Scorecard

Title	User Friendliness	Replay Value	A.I.	Graphics	Premise / Execution	Overall
Star Control II	B+	C	A	A	B/A	B+
Tegel's / StrikeSquad	C+	D	D	C+	E/C	C-
Master of Orion	B	A	A	B	B/A	A-
Dune II	C	C	B	B+	A/B	B+
Spaceward HO!	A+	A	B+	B	A/A+	A
Maelstrom	C	C-	C	C	B+/D	C
Star Legions	C+	C+	C	C-	B/C-	C
Rules of Engagement 2	C	A+	A	B+	A/A	A-
When 2 Worlds War	C+	C+	C	C-	B/C	C+
Space Hulk	C-	B	A	C	B/A	B

cate some resources to quelling the inevitable revolution.

There were steps in some more interesting directions in 1993. In *MOO*, the Orion of the title is a lost world full of technologies but guarded by a dreadnought older than mankind. It's still conquest, but it's conquest that begins to have an interesting point to it. Further, in Tim Wisseman's *VGA Planets*, at least populations will grow angry and riot if you tax them too much or over-mine their world.

IN THE YEAR 2525...

What will 1994 bring? I'm not really the

right being to ask, but I can tell you what would be nice to see. It would be nice to see connectivity becoming a more important option. I think we can safely assume that at least a couple of computer gamers have friends and more of these friends are getting network cards at home or work every year. A few more titles taking advantage of this hardware would be nice—space war has always been an ideal, multi-player arena. Finally, more interlocking games like *Rules of Engagement/Breach* would be appreciated, perhaps a planetary invasion game that links with a fleet battle system.

As for what we are *sure* to see in the next

year: there will be things like *Breach 3* from Impressions, and two giant robot games, but it remains to be seen how much wargame there will be mixed in with the sheer arcade simulation of the cockpit. The grand strategy front seems quiet, and other than the 4.0 version of *VGAP* there is not much else in sight. I think *MOO* will safely reign supreme well into the new year. But even as I write, a new game from Merit Software has crossed my desk; It's called *Command Adventures: Starship* and it seems to have my name on it. So if you'll excuse me, I have many stars to cross and worlds to conquer before I sleep.

CGW

RETRACING THE MISSIONS
OF WORLD WAR II FLYING
ACES IS FASCINATING,
BUT REWRITING HISTORY IS
THE ULTIMATE CHALLENGE . . .

PACIFIC

★ STRIKE ★™

In Pacific Strike, you cruise into all major battles of the Pacific theatre — Pearl Harbor, The Coral Sea, Midway, Guadalcanal, the Solomon Islands, the Marianas, Leyte Gulf, Iwo Jima and Okinawa. Now you can change the outcome of each battle and the entire war through your own successes and failures. Can you force an end to the war before the bomb is dropped on Hiroshima?

- ✦ Fly the **Wildcat**, **Corsair**, **Hellcat**, **Devastator**, **Dauntless**, **Avenger** and **Helldiver**, enjoying the astounding realism of their fully instrumented cockpits. You'll do more than practice!
- ✦ Hone your skills as you face relentless enemy pilots in **Zeros**, **Kates**, **Vals**, **Bakas**, **Betties** and more — so graphically detailed that you can even see enemy pilots and insignia.
- ✦ Prove those skills in a stunning variety of missions — grueling dogfights over the Pacific, dive-bombing runs against carriers and warships (including the **Yamato!**) and challenging rocket attacks on pillboxes, airfields and other ground installations.

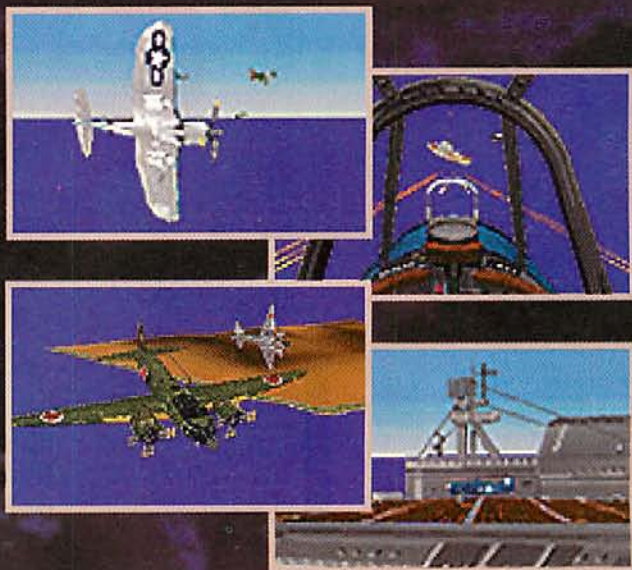

ORIGIN
We create worlds.®

An Electronic Arts® Company
P.O. BOX 161750 AUSTIN, TX 78716

©Copyright 1993, ORIGIN Systems, Inc. Pacific Strike is a trademark of ORIGIN Systems, Inc. Origin and We create worlds are registered trademarks of ORIGIN Systems, Inc. Electronic Arts is a registered trademark of Electronic Arts. Available at a software retailer near you or call 1-800-245-4525 for MC/Visa/Discover orders. • Actual screens may vary. • A Stand-Alone Game • Made in the USA

COMPUTER Express

Since
1985

800-228-7449 EXT. 328

TOLL FREE ORDER LINE

OMNI CD UPGRADE KIT



Multimedia Upgrade Kit includes Double-Speed CD-ROM drive, Aldus PhotoStyler SE, and QuickCD. Double-speed CD-ROM drive is multi-session photo CD compatible, fully MPC level 2 compatible.

CD ROM XA ready and features a 300KB/sec transfer rate, 350ms access time and a 64KB RAM buffer. For use in systems with or without sound cards. Motorized tray-loading, doesn't require a caddy. Supports all PCs and sound cards.

PUBLISHER: Access

\$56

AUDIO MAGICIAN PLUS 16



A 16-bit stereo sound card which is 100% Sound Blaster and AdLib compatible and features a built-in joystick port/MIDI interface. Includes a 20-voice FM music synthesizer (Yamaha OPL3). Record, compress, store and playback sound, voice and music at 16 bits-per-sample. Programmable sample rate from 4,000-44,000KHz. PCM, ADPCM, ESPCM, compression. Bundled software includes Audio ClipLibrary, Audio Recorder, Audio Reminder, Chime, Stopwatch, Timer and Calculator.

PUBLISHER: Calypso

\$66

AEGIS CD



Guardian of the Fleet naval simulation. Pushes you to the limit of real-time strategic and tactical combat simulation. Puts the latest in military technology and the ultimate high-tech warship at your fingertips. Features historically accurate battle sequences. Based on newly declassified military information and historical accounts of actual battles. Challenges you to use the arts of deception, intelligence and warfare in this high-tech, high-thrill military simulation.

PUBLISHER: Time Warner

\$54

HAND OF FATE: KRYANDIA II



Rejoin the adventure in Kryandia II, the long-awaited second title in the Fables and Friends series. You are the alibi, young mystic who must voyage to the center of the world to break the spell. Travel through swamps, farms, coastal towns and previously uncharted

lands of Kryandia. Enables you and over 500 characters to change your mind, mood and maybe based on preceding events. Hours of fun and awesome graphics. Features far-reaching lands infused with mysteries to decipher and puzzles to solve. Extensive sound effects and a musical score.

PUBLISHER: Virgin Games

\$31

STAR TREK: JUDGEMENT RITES



The 5-year mission continues. Encounter strange adversaries in situations that simply defy logic. True episodic format beams eight original missions into your computer. As Captain Kirk, you and your entire crew: Spock, Dr. McCoy, Uhura,

Sulu, Chekov and Scott, bring the original unique TV series' humor on board. Digitized, original painted backgrounds and detailed, computer-rendered starships pull you into the missions. Original series' sound effects and music take you back to the action.

PUBLISHER: Interplay

\$33

LAWNMOWER MAN CD



Truly an impressive blend of 3D and blockbuster action. There are 10 different varieties of gameplay, from puzzles through "cinematic" style platforms to fly through scenarios which are true to the feel and quality of the film.

Who spends his hours cutting neighborhood lawns, it used as a guinea pig by Dr. Angelo, and attains super-human powers with the help of a unique Virtual Reality system. Entered into a Virtual Reality world within the Earth's computer network, he seeks revenge against Dr. Angelo for the injustice carried out against him.

PUBLISHER: Sony Imagesoft

\$39

LAWNMOWER MAN CD

JOYSTICKS/GAMECARDS

Flight Stick.....	18
Flight Stick.....	37
Flight Stick Pro.....	57
G-Force Flight Yoke.....	53
GameCard Autoset.....	21
GameCard III Automatic.....	25
GameCard III MCA Automatic.....	40
Notebook Gameport.....	39
Thrustmaster ACM Game Card.....	24
Thrustmaster Driving Control.....	CALL
Thrustmaster Flight Control.....	60
Thrustmaster Pro Flight.....	CALL
Thrustmaster Rudder Pedals.....	104
Thrustmaster Weapon UPROM.....	29
Thunderstick.....	25
Virtual Pilot.....	66

CS-3000 SPEAKER PAIR/SUBWOOFER

AR Partner 22 Speaker Sys. Gray.....	66
AR Partner 42 Speaker Sys. Gray.....	CALL
AR Partner 570 Speaker System.....	259
AR Partner 622 Speaker System.....	198
Altec ACS100 Speakers.....	127
Altec ACS200 Speakers.....	211
Koss HD-1 Speakers.....	23
Koss HD-4 Speakers.....	39
Koss HD-6 MPC Speakers.....	65
Labtec CS-1000 Speakers.....	75
Labtec CS-150 Speakers.....	19
Labtec CS-180 Shielded Speaker.....	22
Labtec CS-550 Speakers.....	26
Labtec CS-800 Speakers.....	31
Labtec CS-900 Speakers.....	63
Labtec SS-100 Stereo Speakers.....	17
Labtec SS-700 Speakers.....	27

DIGITAL/CD MULTIMEDIA KIT

DigitalEdge CD Mult. Kit.....	666
Discovery Int. Dbl. 16-bit Kit.....	453
Fusion CD 16 External.....	475
Fusion CD 16E Internal.....	546
Fusion Double CD Internal Kit.....	497

MEMPHIS MULTIMEDIA UPGRADE KIT

MultiSpin 3XE Ext. 195ms.....	629
MultiSpin 3XI Int. 195ms.....	529
MultiSpin 3XP Portable 195ms.....	480
OmniCD Upgrade Kit.....	299
PAS 16 II Multimedia Kit.....	863
Sony CDU-31A LL/L Mult. Kit.....	459
Sony CDU-7305 Ext. Mult. Kit.....	580
Sound System W/Microphone 2.0.....	54
Sound System W/Sound Card 2.0.....	186
Texel DM302B Int. 240ms.....	366
Texel DM502B Ext. 240ms.....	488
Texel Ext. Bare Drive.....	463
Texel Ext. Business CD Kit.....	769
Texel Ext. Education CD Kit.....	733
Texel Ext. Home CD Kit.....	672
Texel Ext. w/PAS-16 & Cable.....	714
Texel Int. Bare Drive.....	371
Texel Int. Business CD Kit.....	684
Texel Int. Education CD Kit.....	610
Texel Int. Home Bundle.....	573
Texel Int. Home CD Kit.....	573
Texel Int. w/PAS-16 & Cable.....	573

AUDIO MAN

Gravis UltraSound.....	138
Port-A-Sound Plus.....	150
Pro Audio 16 Basic.....	135
Pro Audio Studio 16.....	212

PRO AUDIO STUDIO 16 XL

Pro AudioStudio 16 XL.....	337
Pro AudioSpectrum 16.....	173
RealMagic Multimedia Playback.....	395
Sound Blaster 16 MCD.....	155
Sound Blaster 16 MCD ASP.....	200
Sound Blaster 16 SCSI-2.....	168
Sound Blaster 16 SCSI-2 ASP.....	222
SoundMan 16.....	100

FAN CARD VERSION II

FanCard Version II.....	24
IPS-360 GPS Navigation.....	505
Microsoft Bus.....	80
Microsoft PS/2 Serial Mouse 2.0.....	81
Microsoft PS/2 Mouse 2.0.....	81
Practical PM14400FXMT EXT F.M.....	227
Pro Movie Studio.....	319
Sony PIX-100 CD-ROM XA Player.....	880
Spartarst 1.4.4 EXT Fax/Modem.....	186
Spartarst 1.4.4 INT-Fax/Modem.....	163
Star LS-5 Laser Printer.....	690
Star NX 1040 Rainbow 180CPS.....	161
Star Starjet SJ-4B Ink Jet.....	275
VGA TV Elite.....	275

CD-ROM

20th Cent. 7th Guest.....	112
AD&D Eye 1.....	51
AD&D: Dark.....	49
AD&D: Dungeon.....	40
Adventures.....	29
Adventures of Willy Beamish.....	39
Air Warrior.....	34
Aladdin and His Lair.....	32
Animals in the Dark.....	46
Animals MPC VERSION.....	56
Arthur's Teacher Trouble.....	40
B17 & Silent Service II.....	34
Backroad Racer.....	46
Battle Chess MPC & DOS.....	45

FAN CARD VERSION II

FanCard Version II.....	24
IPS-360 GPS Navigation System.....	505
Microsoft Bus Mouse 2.0.....	80
Microsoft PS/2 Serial Mouse 2.0.....	81
Microsoft PS/2 Mouse 2.0.....	81
Practical PM14400FXMT EXT F.M.....	227
Pro Movie Studio.....	319
Sony PIX-100 CD-ROM XA Player.....	880
Spartarst 1.4.4 EXT Fax/Modem.....	186
Spartarst 1.4.4 INT-Fax/Modem.....	163
Star LS-5 Laser Printer.....	690
Star NX 1040 Rainbow 180CPS.....	161
Star Starjet SJ-4B Ink Jet.....	275
VGA TV Elite.....	275

20th CENTURY VIDEO ALMANAC

20th Century Video Almanac.....	112
7th Guest.....	50
AD&D Eye Beholder Trilogy.....	51
AD&D: Dark Sun Shattered Lands.....	49
AD&D: Dungeon Hack.....	40
AD&D: Dungeon.....	29
Adventures.....	39
Adventures of Willy Beamish.....	39
Air Warrior.....	34
Aladdin and His Lair.....	32
Animals in the Dark.....	46
Animals MPC VERSION.....	56
Arthur's Teacher Trouble.....	40
B17 & Silent Service II.....	34
Backroad Racer.....	46

CD-ROM TITLES

Battle Chess MPC & DOS.....	45
Berlitz Japan Alive.....	112
Berlitz Think & Talk French.....	99
Better Homes Healthy Cooking.....	51
Bibles & Religion.....	11
Blood Net.....	43
Blue Force.....	39
Budget Guide USA 1993.....	20
Campaign.....	34
Capitol Hill.....	28
Castles.....	29
Celebrity.....	56
Ch... ..	10
Ch... ..	44
Ch... ..	63
Ch... ..	11
Ch... ..	23
Ch... ..	92
Ch... ..	43
Ch... ..	17
Ch... ..	23
Ch... ..	39
Ch... ..	36
Ch... ..	38
Ch... ..	39
Ch... ..	39
Ch... ..	11
Ch... ..	93
Ch... ..	43
Ch... ..	45
Ch... ..	91
Ch... ..	47
Ch... ..	35
Ch... ..	35
Ch... ..	39
Ch... ..	34
Ch... ..	39
Ch... ..	11
Ch... ..	93
Ch... ..	43
Ch... ..	45
Ch... ..	39
Ch... ..	47
Ch... ..	35
Ch... ..	51
Ch... ..	39
Ch... ..	3
Ch... ..	CALL
Ch... ..	99

CD-ROM TITLES

European Racers.....	43
F-15 Strike Eagle III.....	48
Family Doctor MPC WIN.....	45
Fractal Ecstasy.....	25
FreePhone.....	25
Galiliah Knight.....	46
Gateway II.....	34
Global Explorer.....	89
Goblins.....	29
Goblins 2.....	29
Great Naval Battles Pack.....	51
Guinness Disk Records '93.....	37
Gunship 2000 w/Scenario.....	37
HAM Radio.....	11
Hell Cab.....	61
Hi-Tech Aircraft.....	46
INCA.....	39
INCA 2.....	39
Indiana Boy of Atlantis.....	39
Iron Felix.....	57
Journeyman Project.....	44
Just Grandma & Me.....	34
Juliana.....	50
Key HomeDesigner WIN.....	23
King James Elect. Bible.....	18
King's Quest VI.....	44
King's Quest VI Upgrade.....	44
Labyrinth of Time.....	47
Land of Lore.....	41
Laura Bow II.....	39
Legend of Kryandia.....	33
Leisure Suit Larry VI.....	45
Lightning.....	55
Loom.....	46
Lord of the Rings.....	44
Lost Treasures Infocom.....	33
Lost in Time.....	40
Lytic Language French MPC.....	38
Lytic Language Spanish MPC.....	23
MPC Music Mozart.....	23
MPC Wizard Diagnostic.....	11
MS Beethoven for WIN.....	51
Macmillan Kids Dictionary.....	37
Mad Dog McCree.....	45
Man Enough.....	40
Manix Experimental.....	40
Map Expert.....	264
Mario Early Years Collection.....	29
Mario is Missing Deluxe.....	33
Mayo Clinic Family Health.....	39
Mega Race.....	34
Mightsoft Golf Windows MPC.....	42
Miracle & Magic World of Xeen.....	40
Monopoly Deluxe.....	23
Multimedia Dinosaur WIN.....	51
Multimedia Mozart WIN.....	51
Multimedia Stravinsky WIN.....	51
Musical Instruments.....	51
National Lampoons Chess.....	35
Naval Pack.....	37
Newsweek Interactive #1.....	29
Oceans Below.....	29
Our Solar System.....	10
Oxford English Reference.....	94
Penthouse Interactive.....	79
Photo CD Access DOS.....	28
Photo CD Access WIN.....	28
PhotoEdge Color WIN.....	99
Pill Book.....	25
Police Quest IV.....	46

Request Your America Online Membership Kit (Includes 10 Hours Online) With Any Purchase **FREE**

CD-ROM TITLES

Encarta Encyclopedia '94.....	99
Challenge CD Pack.....	29
Chessmaster 3000 WIN.....	56
Cinematic Movie Guide '94.....	51
Clipart Gallery.....	10
College Break CD Collection.....	34
Company of Whales w/Video.....	44
Complete Battles.....	63
Complete Bookshop.....	11
Complete House.....	23
Compton's Encyclopedia Upg.....	92
Conspiracy.....	43
Cookbook Heaven.....	17
Curse of Enchantment.....	23
CyberRace.....	39
D&D: Fantasy Empires.....	36
Daemonsgate.....	38
Dark Seed.....	39
Day of the Tentacle.....	39
Deathstar Arcade Battles.....	11
Dictionary of Living World.....	93
Dinosaur Adventure.....	43
Dinosaur! Multimedia Ency.....	45
DirectPhone.....	91
Dracula Unleashed.....	47
Dragon's Lair.....	35
Dune.....	51
Eco Quest Search for Cetus.....	39
Electronic Arts Sampler.....	3
Eleventh Hour.....	CALL
Encarta Encyclopedia '94.....	99

GIGA GAMES CD



Thousands of the finest shareware MS-DOS and MS-Windows games are now on one CD-ROM. Features 280 classic arcade games to the latest window simulations over 3,000 files in all. Features an assortment of educational programs to target all ages: 135 programs for younger children, and 240 programs for older students. Games include 130 card games, 135 adventure games and 160 utilities and cheat sheets for commercial and shareware games. Also includes 130 Mah Jongg Tile sets, sports, trivia, word, war, and sports games, demos, BBS doors and more!

PUBLISHER: Walnut Creek

\$19

SOUND BLASTER 16 BASIC



Professional CD-quality 16-bit stereo sound at a great value. Offers advanced audio technology to enhance business and recreational applications. True 16-bit stereo sound. 16-bit and 8-bit stereo sampling and playback—from 4kHz to 44.1 kHz. 20-voice, 4-operator FM music synthesizer. CD-ROM interface for Creative Labs CDROM drives. Includes a joystick port, Manalogue for Windows, Creative Wave Studio, Creative SoundLE™, Creative Talking Scheduler and Creative Music.

PUBLISHER: Creative Labs
PART #: 32529

\$130

METAL & LACE



The battle of the Robo Babes. Looking for a game to play? Something fun and exciting, yet sexier than munching dots or pudgy little pointers? Look no further. The gorgeous Robo Babes are expecting you! You can find them on McChita Island soaking up the tropical sunshine. They'll give you a welcome you won't soon forget. The Robo Babes even talk! Yeah! Hi-Fi stereo voice. Recommended for mature game players only.

PUBLISHER: Megatech
PART #: 31594

\$27

INDY CAR RACING



Experience the thrill of racing against the world's best drivers in the world's fastest race cars. Gives you 800-horsepower IndyCar driving. Detail even includes the paint schemes and decals of actual IndyCars and the skid marks through the groove at every turn. Select wing angles, fire tyre and pressure, suspension stiffness, camber, gearing and much more. Adjust turbo boost, brake bias and roll bar settings from the cockpit. Custom-tune your engine in the dyna room!

PUBLISHER: Virgin Games

\$37

BLOODNET



A Cyberpunk Gothic. Projects you into cyberspace, a virtual reality world where consciousness meets computer. Two popular, dark adventure genres combine to create an exciting new role-playing experience. Transformed into a vampire, you must brave the streets of Manhattan 2094, where cyberpunks and urban mercenaries rule. Immerse into a global data network where a character can download his consciousness to do battle with vampires and "rage gangers". Contains over 150 digitized voices with 3-D rendered Hallelucinographic art. IBM CD version \$44.

PUBLISHER: Microprose

\$40

UNDER A KILLING MOON CD



Interactive movie goes lightyears beyond any other! Takes you to the streets of post World War III San Francisco, into a Virtual World full of people and places so richly detailed you'll feel like you're actually there, Hollywood stars add credibility and the necessary talent. Create your own personalized Tex Murphy movie which can be replayed at any time. Rich, original music, high quality digitized voices and sound effects make this Interactive Movie as exciting as it is visually stunning.

PUBLISHER: Access

\$56

NFL PRO LEAGUE FOOTBALL

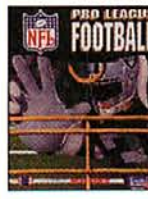

Brace yourself for impact. Strategy, graphics and Pro League play so real, it's licensed by the NFL, the NFLPA, and chosen by USA TODAY to simulate Super Bowl play. Full-field detailed color animation with actual NFL logos, NFL players, teams, uniforms and statistics. Design plays from scratch, or choose from 198 offensive and defensive plays. Coach your favorite team using the Pro Draft, Pro Trader and Team Editor modules. Full rosters with injuries and substitutions. True modern play with chat mode.

PUBLISHER: Micro Sports

\$34

WARLORDS II

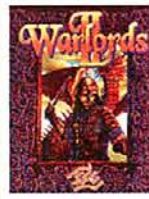

The sequel to the highly addictive, highly successful, award-winning Warlords. Now you have more worlds to conquer, more mighty armies to make, and more enemies to vanquish. New magical items and abilities. Hires graphics and backed by a full sound track. Features include random worlds for infinite playability, mysterious hidden maps, exciting and dangerous quests, and exotic army types. Contains 640x480 VGA graphics and sound board support.

PUBLISHER: 55G
PART #: 31521

\$38

CD-ROM TITLES

ROMIX Comics Freex #1	18
ROMIX Comics Hardcore #1	18
ROMIX Comics Prime #1	18
Rebel Assault	44
Return of the Phantom	39
Return to Zork	44
SVGA Harrier	47
Sam & Max Hit the Road	34
Scrabble Deluxe	23
Secret Weapons Luftwaffe	46
Secret of Monkey Island	46
SelectPhone	164
Seven Days in August	34
Shadow of the Camel	CALL
SimAnt Enhanced	47
SimCity Enhanced	46
Sound Sensations	12
Space Quest IV	40
Space Shuttle MPC	28
Space Shuttle MPC	28
Spellcasting Party Pak	34
Spirit of Excalibur	22
Sporting News Pro Football	25
Ster Trek 25th Enhanced	46
Street Allies 2.0 USA WIN	92
Strike Commander/Tactical	48
Technicals	11
Tetris Gold	31
Tony LaRussa Baseball II	47
Too Many Typelants!	11
Total Distortion	69
Typecase	40
U.S. Atlas 4.0	34
UFO Close Guide WIN	35
USA Today: The 90's Vol. 1	44
Ultima I-VI	55
Ultima Underworld I & II	55
Vocation Planner Gold	29
Where in World Deluxe	54
WinCD Professional 1.1	29
Wines of the World	41
Wing II/Ultima UnderWorld	55
World Pack	47
World Atlas 4.0	45
World Circuit Grand Prix	34
Managing Your Money 10	35
Quicken 3.0 WIN	44
Quicken 7.0	44
Quicken Deluxe CD WIN	63
Taxcut Federal Final DOS '93	32
TurboTax Final 1040 DOS '93	40
TurboTax Final 1040 WIN '93	40
TurboTax Savings Guide DOS '93	15
TurboTax Savings Guide WIN	15
TurboTax Tax Business DOS	105
TurboTax Tax Planner DOS	22
TurboTax Tax Planner WIN	22
Access 1.1 WIN	327
Access Comp. Upgrade 1.1	129
After Dark	28
After Dark 2.0 WIN	28
AutoMap 3.0	56
AutoMap 3.0 WIN	56
AutoMap Europe WIN	35
AutoMap Ski Resorts WIN	24
AutoMap Upgrade 3.0	26
AutoMap Upgrade 3.0 WIN	25

IBM FINANCE/TAX

IBM PRODUCTIVITY

IBM PRODUCTIVITY

Betty Crocker Cookbook WIN	23
CA Clipper Comp. Upgrade 5.2	145
Calendar Creations Baseball	40
Calendar Creations Days & Cats	40
Calendar Creations Exotic Cars	37
Calendar Creations Impressions	40
Calendar Creations Nature	37
Calendar Creations Oceans	40
Coaster Screen Saver WIN	34
Coin Keeper	29
Comic Keeper	29
Corel Draw 4.0 WIN	408
DeskView 306 2.6	97
Disney Collection Screen Saver	27
DoodleMation WIN	19
Draft & Print	71
FoxPro 2.5 WIN	324
FoxPro Comp. Upgrade 2.5 WIN	188
FoxPro Ver Upgrade 2.5 WIN	99
Holy Bible King James Version	28
Home Survival Toolkit	32
Key CAD Complete	35
Lotus 123 Rel 4 Upg WIN	102
Lotus 123 Release 4 WIN	319
Lotus Improv 2.0 WIN	98
MS-DOS Upgrade 6.2	50
MS-DOS Upgrade for Dummies 6.2	50
Morph WIN	103
Norton Utilities 7.0	119
Office Professional 4.0	576
Office Standard 4.0	480
Office Standard Comp. Upg. 4.0	284
Office Standard Vers. 4.0	246
Paradox 4.5 WIN	150
Photo CD Alaska	41
Photo CD Animals	41
Photo CD Auto Racing	41
Photo CD Butterflies	41
Photo CD Fireworks	41
Photo CD Japan	41
Photo CD Parachute Racing	41
Photo CD Sailboats	41
Photo CD Underwater	41
Photo CD WWII Aircraft	41
Print Shop Deluxe	46
Print Shop Deluxe WIN	46
Prococom Plus WIN	100
Publisher 2.0 WIN	89
Q&A 4.0 WIN	168
QEMM 386 7.01	59
Quattro Pro 5.0	41
Quattro Pro 5.0 WIN	41
Rosemary West's House Fortune	28
Scenes Impressionists Collect	23
Scenes Outer Space Collection	23
Scenes Sierra Club Collection	23
Shoobox Image Manager WIN	99
Stamp Keeper	84
Voice Assist	95
WinFax Pro 3.0 WIN	95
Windows 3.1	84
Windows NT 3.1	319
Windows NT Upgrade 3.1	280
Windows Upgrade 3.1	50
Word 6.0 WIN	315
Word Windows 6.0 Comp. Upg.	122
Word Windows 6.0 Vers. Upg	93
WordPerfect Vers Upg Windows	290
WordPerfect Windows 6.0	290
WordPerfect Windows 6.0 Comp	

IBM DEMONSTRATION VALUES

IBM ADULT

IBM RECREATION

Wordperfect DOS 6.0	293
Wordperfect DOS 6.0 Comp. Upg.	125
Wordperfect DOS 6.0 Vers. Upg.	108
AD&D: Eye of Beholder Trilogy	49
Adventure Pack	24
Air Combat Classics	39
Archie/Barbarians Fun LunchPak	25
Comanche & Mission Disk #1	42
Great Naval Battles Pack	49
HardBall III Diamond Collect.	39
Jet Pack	40
Lucas Arts Classic Collection	34
MachWarrior/BattleTech I & II	19
Micro Kitchen/Betty Bundle DOS	43
Micro Kitchen/Betty Bundle WIN	43
Perfect General Trilogy	34
GEMM 386 Game Pack 7.0	69
Sierra Dynamics Bundle - VGA	40
Strike Commander/Tactical	48
WWII Pack	34
Wing Commander II w/Speech	24
Wizardry Trilogy II	33
Bare Assets CD	55
Penthouse Interactive CD	79
Playboy Elect. DanceBook	34
Strip Poker Pro #1 Data Disk	16
Strip Poker Pro #2 Data Disk	16
Strip Poker Pro #3 Data Disk	16
Strip Poker Pro #4 Data Disk	16
Strip Poker Pro #5 Data Disk	16
Strip Poker Pro #6 Data Disk	16
Strip Poker Professional	27
A-10 Tank Killer Enhanced 1.5	25
A320 Airbus US Edition	40
AD&D: Dark Sun Hint Book	10
AD&D: Dark Sun Shattered Lands	48
AD&D: Dungeon Hack	39
AD&D: Eye of Beholder III	43
AD&D: Eye of Beholder Trilogy	49
APBA Baseball for Windows	40
Acas of Pacific 1946 WWII Miss.	19
Acas of the Deep	CALL
Acas of the Pacific - VGA	46
Acas over Europe	39
Acas over Europe: Mission #1	CALL
Acas over Europe: Mission #2	CALL

IBM RECREATION

IBM RECREATION

Adven. of Willy Beamish	26
Adventure Pack	24
Air Combat Classics	39
Air Warrior SVGA	34
Alone in the Dark	34
Ancient Art of War in Skies	34
Arborea 2	39
Archie Ultra	26
Arena	CALL
Art of the Kill	25
Ashes of Empire	35
B-17 Flying Fortress - VGA	21
Baseball Card Collector Windows	26
Battle Chess 4000 - Super VGA	34
Battle Chess 4000 WIN	33
Battle Chess WIN	28
Battles of Destiny	38
Beethoven II	19
Betrayal at Kronrod	39
Blood Net	40
Blue & the Gray	39
Blue Force: The Next of Kin	39
Bram Stoker's Dracula	31
Buzz Algrin's Race into Space	40
CD-San Francisco Scenery	28
CD-Washington D.C. Scenery	28
Caesar	37
Caesars Palace WIN	14
Campaign II	34
Card Shop Plus	29
Carrier Strike	40
Carriers at War II	40
Castle of Dr. Brain - VGA	19
Castles II: Siege & Conquest	34
Challenge of the 5 Realms	40
Chessmaster 4 WIN	36
Civilization	45
Civilization Hint Book	17
Civilization Master Player Ed.	52
Civilization WIN	45
Clash of Steel: WWII 1939-45	40
Classic 5 WIN	29
Coaster	16
Cobra Mission	33
Cognito WIN	34
CoHort II	19
Comanche & Mission Disk #1	42
Comanche: Mission Disk I	24
Comanche: Mission Disk II	24

800-228-7449 EXT. VOICE:508-443-6125
328 FAX:508-443-5645
31 Union Ave., Sudbury, MA 01776

日本の皆様よりのオーダー大歓迎！日本語で FAX:0011-508-443-5645
 又は、CompServeID:70007,1534で見積りをお願い合わせ下さい。
 迅速に、如何なる御要望にも誠意をもってお応え致します。

FREE UPS GROUND SHIPPING
10,000 IN STOCK ITEMS

COMPUTER Express

Since 1985

800-228-7449 EXT. 328
TOLL FREE ORDER LINE

THRUSTMASTER WEAPONS MARK II



User programmable throttle and weapons functions. Compatible with 5-pin keyboard connectors. Program your joystick for any current or future game. Your gaming peripherals (joystick and WCS) will be instantly compatible with current or future games. Features: LED lighting system indicates when certain functions are activated; Screw-down connector; Handle moves fore and aft for throttle control; Study seven-foot cables; Allows joystick programmability through joystick interface; Digital/Analog mode toggle switch; User-programmable functions; One year warranty.

PUBLISHER: Thrustmaster
PART #: 31258 **\$90**

GAME BLASTER



Converts the VGA output from your PC to a video signal so you can play all your favorite PC games on any TV set. Display on-line services like Prodigy, America Online, and CompuServe. Includes \$150 worth of FREE games: Prince of Persia, Jettfighter II, and Spectre Challenger! Supports 640x480 VGA resolution in 256 colors, outputs NTSC video in RCA composite and S-VHS super video standards. Includes A/C Power Supply, 6-foot RCA cable, 6-foot S-VHS cable and a VGA Y-cable. Supports TV Auto Blanking, toggling between VGA monitor and TV display.

PUBLISHER: ADS
PART #: 32333 **\$99**

UNNATURAL SELECTION



You are a brilliant scientist, happily working to end world hunger by designing Theroids. Theroids are large, docile animals with the potential to be a cheap, efficient food source. Then things start to go wrong, and one of your colleagues disappears with the genetic samples. Unstoppable mutant Theroids go on the rampage and the military is holding you responsible. A high-tech, genetic battle/strategy game with incredible sound effects and speech. Features actual digitized film footage of real actors. Ultimate, super "beasts" are yours for the making.

PUBLISHER: Maxis **\$27**

PEBBLE BEACH GOLF COURSE



FOR USE WITH LINKS, LINKS 386 PRO, or MICROSOFT GOLF. Located on the Monterey Peninsula in California. The only course of its stature open to public play. Along the shores of Carmel Bay, professional and recreational players alike have experienced firsthand the wonders of this seaside layout, rich with tradition and natural beauty. Nine national championships have unfolded at Pebble Beach. Super VGA version features real sound with all major sound boards. Enjoy becoming a part of history!

PUBLISHER: Access Software
PART #: 32479 DOS **\$19**

MOTORMOUSE RED CORVETTE

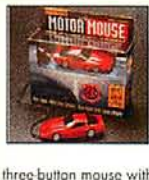

A serial mouse styled as an exact replica of a 1985 Chevrolet Corvette. A sporty alternative to your dull grey "mouse". A high-quality three-button mouse with buttons on the hood. Gives you the same quick access to on-screen functions. Simply plug it into your computer's serial port. Includes a special Windows driver that turns the cursor into an animated version of the car, including sound support to rev the "engine" and sound the horn. FOR IBM PC AND COMPATIBLES ONLY.

PUBLISHER: MotorMouse
PART #: 32941 **\$35**

NHL HOCKEY '94



Combines hot arcade action with in-depth simulation and stats and a full season mode. NHL and NHLPA licenses allow inclusion of player names and faces as well as team names and logos (including the Stanley Cup!). Simulate the actual 1993 84-game NHL season. Compile team and player stats throughout the season. Ron Barr's digitized voice sets up every game of the season. Digitized rink announcer voice reports goal summaries and penalties. Realistic organ music brings rink to life. Each rink features individual music, over 50 pieces in all. Supports Sound Blaster, Ad Lib and Roland MT-32 sound.

PUBLISHER: Electronic Arts
PART #: 31741 DOS **\$40**

Comanche: Maximum Overkill	42
Command HQ Classic	19
Command Starship	37
Companions of Xenith	33
Conquered Kingdoms	34
Conquered Kingdoms Scenario	26
Crossroads Deluxe WIN	23
CyberRacer	39
CyberSpace	34
D&D: Fantasy Empires	36
D&D: Stronghold	36
Doom	28
Darklands Hint Book	14
Darklands	40
Day of the Tentacle Hint Book	9
Day of the Tentacle: Maniac II	33
Delta V	CALL
Detroit	34
Doom	46
Dragon Knight III	46
DreamWeb	34
Dune	25
Dune II	29
Dungeon Master	34
Earth Invasion Arcade WIN	26
Eco Quest II: Rainforest	28
Eight Ball Deluxe	29
ElFish	34
Empire Deluxe	34
Empire Deluxe Scenario	22
Empire Deluxe Strategy Guide	13
Empire Deluxe WIN	34
Eternam	34
Evasive Action	29
Even More Incredible Machines	28
F-15 Strike Eagle II Classic	19
F-15 Strike Eagle III	46
F-19 Stealth Fighter Classic	21
F/A Hornet Naval Fighter	31
Falcon 3.0	47
Falcon: Mig 29/Deadly Adversary	24
Falcons: Operation Fight Tiger	30
FlashBack	30
Fleet Defender	46
Flight Light	19
Flight Sim: Las Vegas	27
Flight Sim: New York Scenery	27
Flight Sim: Paris Scenery	26
Flight Sim: San Francisco	27
Flight Sim: Washington D.C.	27
Flight Simulator 3.0	41
Flight Simulator Toolkit	60
Forgotten Castle	49
Four Play	20
Freddy Pharkas	39
Freddy Pharkas Hint Book	7
Front Page Sports: Football Pro	45
Frontier: Elite II	39
Gabriel Knight	39
Gary Grigsby's War in Russia	46
Gateway II	34
Geekwad Games of the Galaxy	23
Global Dominations	34
Goblins	20
Goblins II	24
Goblins III: The Prince Buffoon	24
Grandest Fleet	CALL
Great Naval Battles Pack	49
Great War	39

Hand of Fate - Kyrandia II	31
HardBall III	34
HardBall III Big League Parks	16
HardBall III Diamond Collect	39
HardBall III Player Disk	16
Harpoon II	42
Heirs to the Throne	33
High Command	42
Hoyle's Book of Game I Classic	28
Human's Like You've Never Seen	26
Human's: Insult to Injury	14
INCA	34
INCA 2	34
INCA Hint Book	7
Incredible Machine	28
Incredible Toons	28
Indiana Jones Fate of Atlantis	34
Jack Nicklaus Signature Golf	25
Jack Nicklaus Signature Tour 1	16
Jack Nicklaus Signature Tour 2	16
Jagged Alliance	CALL
Jeopardy Deluxe WIN	34
Jeopardy with Alex	25
Jet Fighter II	24
Jet Pack	40
Joe Montana Football	CALL

Jump Jet	40
Kasparov's Gambit	36
Kid Pix	35
King's Quest V - VGA	25
King's Quest VI	44
King's Quest VI Hint Book	7
King's Ransom	29
Kingdoms of Germany	34
Kings Table	25
Kronology	40
Kye Deluxe	26
Lands of Lore	31
Lands of Lore Hint Book	7
Laura Beth	20
Legendary Heroes of Phobos II	22
Letter from the Emperor	39
Links - Kyrandia	22
Links - Kyrandia II	8
Links - Larry I	19
Links - Larry V	19
Links - Larry VI	8
Links - Larry VII	9
Lemmings	31
Lemmings II	31
Links 386 Pro	39
Links: Banff Springs SVGA	19
Links: Balfrey Course SVGA	19
Links: Firestone Course SVGA	19

Links: Innsbrook Course SVGA	19
Links: Mauna Kea Course SVGA	19
Links: Pinehurst Country SVGA	19
Lost Treasures of Infocom I	27
Lost Treasures of Infocom II	25
Lost Vikings	25
Lost in Time	34
Lucas Arts Classic Collection	34
Lucky's Casino Adventure	36
Lure of the Temptress	29
Master of Orion	37
MechWarrior II	46
Merchant Prince	37
Metal & Lace Upgrade Disk NR18	6
Michael Jordan Flight	20
Microleague Baseball/Football	29
Microsoft Arcade WIN	26
Microsoft Space Simulator	43
Might & Magic Clouds of Xeen	40
Might & Magic DarkSide of Xeen	39
Mike Ditka Football	16
Monopoly Deluxe	34
More Incredible Machines	28
More Vegas Games WIN	19
Montal Kombat	34
NFL '94 WIN	29
NFL Coaches Football	34
Nano Tank	24
Operation Combat 2	19
Outpost	CALL
Pacific Strike	49
Pacific Strike Speech Disk	17
Pacific War	44
Patriot	45
Perfect General Great Battles	25
Perfect General Trilogy	34
Perfect General WWII Scenario	23
Pinball Dreams	29
Pirates! Gold	39
Police Quest III	39
Police Quest IV	38
Pool Shark	20
Populous II	28
Power Game II	25
Powermonger	17
Prince of Persia II	40
Privateer	49
Privateer Speech Pack	17
Prophecy	26
Quarter Pale	19
Quest for Glory I	39
Quest for Glory II	39
Quest for Glory IV	40
Quiz Show WIN	10
Roags to Riches	33
Railroad Tycoon Classic	19
Railroad Tycoon Deluxe	39
Railroad Tycoon Master Hint	39
Rally: The Final Round	34
Reclaim for Skies	19
Reclams of Arkansas	34
Reclams of Arkansas Hint Book	14
Red Baron	39
Red Baron Mission Builder	19
Red Crystal	34
Red Storm Rising Classic	19
Remind Me	34
Return of the Phantom	34
Return to Zork	44

THE SOFTWARE TOOLWORKS

MIRACLE PIANO TEACHING SYSTEM
(w/ 2 FREE SONG LIBRARY'S)

\$269.00

IBM RECREATION

IBM RECREATION

IBM RECREATION

IBM RECREATION

IBM RECREATION

IBM RECREATION

IBM RECREATION

IBM RECREATION

SIMCITY 2000

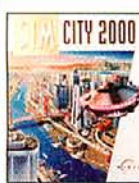

The ultimate city simulator. This morning, you approved a new solar power plant, designed an underground transportation system, and jumped five points in the polls. Then you raised taxes, read two local newspapers, built a zoo, and pushed your education bill through the city council. It's time for lunch—unless, of course, there's a fire, tornado, earthquake or alien invasion. Scenario challenges include the 1991 Oakland fire, unemployment in Flint, Michigan and more. Import saved cities from SimCity and SimCity Classic.

PUBLISHER: Maxis
PART #: 31457 DOS
PART #: 32616 MAC

\$39

GABRIEL KNIGHT



Gabriel Knight is the last in a long line of Shadow Hunters, those fated to fight the dark forces of the supernatural. Haunted by a centuries-old curse, he's tormented by terrifying nightmares. Now he must spend every waking moment scouring

the side streets and back alleys of New Orleans for the key to his dark past. Features more conversation, more clues, more game options, and more dark secrets to discover. Includes a bound and illustrated graphic novel. IBM CD version \$46.

PUBLISHER: Sierra
DOS/WIN

\$39

THE HUMANS



You've never seen anything like them! Inside every Human is a small but usable brain. Humans must learn to cooperate throughout all 160 levels by using and sharing tools that are "discovered" along the way. Cooperation

is the key in this world of dinosaurs and enemy tribes. It's a naive struggle against extinction, where you score points by finishing levels with as many of your tribesman intact as HUMANLY possible. Features eight original sound tracks, colorful animations and three levels of difficulty.

PUBLISHER: Gametek
DOS, IBM CD

\$25

UNNECESSARY ROUGHNESS



Suit up and go head-to-head against real NFLPA pros in a ferocious battle of outrageous tackles, impossible one-handed catches, brutal head-butts, and flying helmets, in a graphically intense PC football game. Design your

own plays, routes and logos. Take the field as TV sportscaster Al Michaels and call every exciting play. Filled with intense graphics, realistic animation and high-impact gameplay. Import and export teams from all 28 NFL cities. Features 1:2 player competition, or 2 player cooperative game play. Supports all major sound boards.

PUBLISHER: Accolade

\$34

KEYBOARD COMMANDER TEMPLATES



High-quality, full-color keyboard overlays for flight simulators will turn any AT101 keyboard into a 3-D looking "control panel". Includes all key commands in a logical layout, and legend boxes for cockpit displays. Available for

MS FS 5.0, FALCON 3.0, WING 29, STRIKE COMMANDER, ATR, X-WING, COMANCHE, F-15 II, ACES OF PACIFIC, JETFIIGHTER, SECRET WEAPONS, B-17, GUNSHIP, ACES OVER EUROPE, TORNA-DO and more! Ask about Falcon 3.0's Keyboard & Utility bundles! Quantity Pricing: 2 @ \$21.50, 3 @ \$30.00, any 4 or more only \$9.25 each!

Publisher: Keyboard Commander Corp.

\$13

EIGHT BALL DELUXE PINBALL



Experience real pinball on your PC. Features a country and western pool table theme with great graphics, sound and realistic ball motion. Three flippers control the action as players go for the 8-ball and then the Deluxe. Play along speech and background sounds encourage you to "Quit talking and start chalking". Features detailed 256 color graphics and real-time animation. Includes tilt, 3-way nudge, 3 flippers and multi-channel digital sounds.

PUBLISHER: Broderbund
DOS, MAC

\$29

LANWORDS FOR WINDOWS



Fast-paced, challenging, entertainment value that's fun for all ages. Seven word game variations, or create your own version. Change the look of your games with a choice of colorful

tile patterns. Offers 20 different computer opponents with increasingly sophisticated vocabulary and skill, ranging from beginner to expert levels, containing 160,000 words. On-line help, "best plays", anagram finders, and word finders are also included. If you've got network support, you can receive and send messages to your opponents via a chat windows screen.

PUBLISHER: Saber Software
PART #: 32743 WIN

\$23

BEAT THE HOUSE



Prepare yourself for a casino gaming experience! Includes the 160-page study guide, "Beat the House Companion." Featuring slot machines, blackjack, roulette, video poker and craps. Beginners will learn the rules, odds and terminology of casino play. Seasoned gamblers are schooled in strategic counting techniques as well as profitable betting strategies. One to four people can play against each other, or computer players will fill the empty seats. Anyone can be a High Roller when they know how to "Beat the House!"

Publisher: Spirit of Discovery
Part #30343

\$27

800-228-7449 EXT. VOICE:508-443-6125
3 28 FAX:508-443-5645
31 Union Ave., Sudbury, MA 01776

日本の皆様よりのオーダー大歓迎!日本語で FAX:0011-508-443-5645、
又は、CompuServeID:70007,1534で見取りをお問い合わせ下さい。
迅速に、如何なる御要望にも誠意をもってお応え致します。

FREE UPS GROUND SHIPPING
10,000 IN STOCK ITEMS

IBM RECREATION	
Rex Nebular.....	40
Rox Nebular Clue Book.....	12
Road & Track Grand Prix.....	34
Road to the Final Four 2.....	40
Romance Three Kingdoms III.....	40
Rome: Pathway to Power.....	19
Royal Flush.....	37
Rules of Engagement II.....	39
SSN-21: Sea Wolf.....	36
SVGA Harrier.....	17
Sam & Max Hint Book.....	12
Sam & Max Hit the Road.....	33
Sea Wolf.....	42
Seal Team.....	36
Secret of Monkey Island II.....	22
Seven Cities of Gold Comm.....	30
Shadow Caster.....	43
Shadow Caster Hint Book.....	11
Sid Meier's Trilogy.....	79
Silent Service II Classic.....	19
SimAnt WIN.....	28
SimCity 2000.....	39
SimCity Classic.....	26
SimCity Classic WIN.....	25
SimEarth WIN.....	29
SimFarm.....	29
SimLife WIN.....	29
Smokin' Guns.....	24
Solitaire WIN.....	25
Soltano's Journey WIN.....	35
Space Hulk.....	36
Space Quest IV.....	26
Space Quest V.....	39
Space Quest V Hint Book.....	7
Spear of Destiny.....	29
Spear of Destiny Hint Book.....	13
Spectre FC.....	24
Spectre VR.....	CALL
Speed Racer Challenge Racer X.....	33
Spellingcasting Party Pak.....	39
SportsWorks.....	28
Star Trek: 25th Anniv. Hint Bk.....	7
Star Trek: 25th Anniversary.....	34
Star Trek: The Next Generation.....	46
Star Trek: Judgment Rites.....	33
Star Wars Chess.....	31
Stonekeep.....	46
Street Fighter II.....	34
Strike Commander.....	36
Strike Commander Players Guide.....	11
Strike Commander Speech Book.....	17
Strike Commander Tactical #1.....	21
Strike Squad.....	36
Subwar 2050.....	CALL
Summoning.....	36
Syndicate.....	36
T2 The Arcade Game.....	29
Task Force 1942.....	39
Terminator 2029.....	40
Tesserae WIN.....	16
Test Drive III: The Passion.....	19
Tetris Trio.....	29
The Dig.....	40
The Games: Winter Challenge.....	19
Third Reich.....	34
The Fighter Space Combat.....	40
Tony LaRussa Baseball II.....	36
Tony LaRussa II: A&N Stadiums.....	19
Tony LaRussa II: Fantasy Draft.....	14
Tornado.....	50

IBM RECREATION		
Tower.....	43	
Ultima Underworld.....	21	
Ultima Underworld II Hint Book.....	12	
Ultima Underworld II: Labyrinth.....	49	
Ultima VII Part 2: Serpent Isle.....	47	
Ultima VII Part 2: Siphon Seed.....	21	
Ultima VIII: Forge Virtue Add On.....	17	
Ultima VIII: The Black Gate.....	48	
Ultima VIII: Pagan.....	47	
Ultimate.....	36	
Urnatural Selection.....	27	
V for Victory Market Garden.....	43	
V for Victory Utah Beach.....	42	
V for Victory Velikiye Luki.....	43	
Vegas Games WIN.....	19	
Veil of Darkness.....	17	
Victory Pak.....	42	
Victory of Sea.....	34	
Vikings: Fields of Conquest.....	19	
WWII Battles of S. Pacific.....	34	
WWII Pack.....	34	
Warriors of Legend.....	20	
Wheel of Fortune Deluxe WIN.....	23	
When Two Worlds War.....	34	
Wing Commander Academy.....	30	
Wing Commander II w/Speech.....	24	
Wizardry Trilogy II.....	33	
Wizardry: Crusader Dark Savant.....	40	
World Circuit Grand Prix.....	34	
World War II: Battle S. Pacific.....	34	
X-Wing.....	39	
X-Wing: B-Wing Tour of Duty.....	19	
X-Wing: Imperial Pursuit.....	19	
Ysarius.....	26	
7th Guest CD.....		29
A Hard Days Night Beatles CD.....	45	
American Civil War III.....	29	
Battle of Britain 2.....	34	
BestBooks.....	34	
Better Homes Health Cooking CD.....	47	
Bomber 2.....	29	
Caesar.....	34	
Caesars Palace.....	19	
Carriers At War.....	40	
Castles II.....	35	
Chuck Yeager Air Combat.....	36	
Civilization.....	45	
Conqitd.....	34	
Dark Seed.....	38	
Disney Collection Screen Saver.....	28	
Dracula Unleashed CD.....	55	
Falcon MC.....	41	
Flight Simulator.....	42	
Freddy Pharkas.....	39	
Golf Companion.....	26	
Hell Cab CD.....	61	
Indiana Jones Fate of Atlantis.....	34	
Iron Helix CD.....	59	
Johnny Man Project CD.....	44	
King's Quest VI.....	44	
Legend of Kyrandia.....	35	
M4 Sherman Tank.....	34	
Mac Attack.....	23	
Mac Full of Humans.....	23	
Mania Teaches Typing.....	29	
Mario Is Missing.....	29	
Micro Kitchen Companion '94.....	19	
Monopoly.....	28	
Myst CD.....	48	

MACINTOSH TITLES	
Oceans Below CD.....	28
Pathway into Darkness.....	37
Pax Imperia.....	40
Photo CD Access.....	28
Print Shop Deluxe.....	48
Print Shop Deluxe Business.....	24
Print Shop Deluxe Comics.....	24
Print Shop Deluxe Sampler.....	23
Quicken 4.0.....	44
Ready, Set, Read.....	28
Rex Nebular.....	40
Royal Flush.....	37
Sierra Award Winning Bundle.....	46
SimAnt.....	29
SimCity Classic.....	26
SimEarth.....	29
SimLife.....	29
Spectre.....	26
Spotstar 14.4 EXT MAC&FAX.....	205
Star Trek 25th Anniversary.....	34
Star Trek Screen Saver.....	34
Stellar 7.....	22
Street Atlas USA CD.....	89
Strip Poker Professional.....	29
Taxcut Federal Final '93.....	32
Thunderbolt ADB.....	52
Tristan MAC I/C/MAC II.....	17
V for Victory III: Mt. Garden.....	43

SEGA/SNES/3DO		
V for Victory Velikiye Luki.....	43	
Victory Pak.....	43	
Victory of Sea.....	41	
Wheel of Fortune w/Vanna White.....	29	
4 Way Play Adapter SEGA.....		28
Bubsy in Claws SEGA.....	32	
Bubsy in Claws SNES.....	34	
Cool Spot SEGA.....	52	
Dungeons Master SNES.....	66	
Final Fight 2 SNES.....	66	
John Madden NFL '94 SEGA.....	47	
John Madden NFL '94 SNES.....	50	
Jungle Strike SEGA.....	43	
Jurassic Park SEGA.....	43	
Mad Dog McCree 3DO.....	51	
Megadrive Adapter SEGA.....	19	
Mortal Combat SNES.....	62	
National League Football SEGA.....	43	
NHL '94 SEGA.....	45	
NHL '94 SNES.....	48	
RoboCop vs. Terminator.....	52	
Shining Force SEGA.....	45	
Street Fighter II SEGA.....	64	
Street Fighter II SNES.....	63	
Super Off Road Bubsy SNES.....	53	
WWF Royal Rumble SNES.....	64	
X-Men SEGA.....	44	

800-228-7449 - Orders Only, 508 443-6125 - all other business Sales Dept. Hours - Monday - Friday - 9AM - 5PM, Saturday 9AM to 5PM. All other Business - Monday - Friday - 9AM to 5PM. Most orders ship within 24 hours. Temporary shortages are normally filled within 10 days. Books, Memory chips, and some electronic components are not returnable. We ship only to verified billing addresses. International orders welcome. Airborne Express Shipping charges \$7 per order up to 6 lbs. \$1 per lb. above 6 lbs. UPS Ground service charge \$3 per order. Actual freight charges apply for computers, hard disks, Bernoulli's, tape back-ups, print drivers, Multimedia kits, monitors, etc. Alaska, Hawaii, outside continental U.S., APO/FPO call for information. Prices subject to change without notice. Some product not available outside the U.S. Please call for more information. Not responsible for errors or omissions. Mastercard, Visa, Discover, prepaid orders, purchase orders, wire transfer, cash, and cashiers check accepted. Personal and Company checks allow 14 days to clear. No surcharge for credit card orders. Your credit card is not charged until the merchandise is shipped. We check for stolen credit cards. All returns for credit, repair, or exchange must have a return authorization number. Returned orders or ordered wrong items are subject to a 15% restocking fee. We ship latest versions of software available. Over nine years of service. Thousands of satisfied customers. Send your Fax today! All quotes answered immediately. Product covered by manufacturer's warranty. Defective items replaced immediately. Educational, government, and corporate purchase orders welcome. All item numbers represent 3 1/2" floppy, except where noted.



Adventures in Cynicism

A Review Of Merit Software's *Command Adventures: Starship*

by Martin E. Cirulis

I can appreciate irony of almost any kind, but there are times when it gets a bit thick, even for me. As I was finishing my overview of the year in science fiction wargaming, a new piece of genre software arrived, *Command Adventures: Starship* (CAS) from Merit Software. After pawing happily through the contents of the bright shiny box I ended my article on the hopeful note that perhaps this new game would avoid some of the pitfalls that had plagued at least half of the previous year's crop, and start the new year well. As I installed this new beastie (a big'un, weighing in at 25 megs of hard drive) I was even more pleased. Great sound and graphics washed over me during the intro, and the manual, though sparse, promised a profusion of equipment and options that reminded me of fine games like *SunDog*, *Elite* or *Privateer*.

Then, the chrome faded and game play began.

Into the V.O.I.D.

Contrary to first impressions, CAS only pays lip service to the four X's (Xplore, Xpand, Xploit, Xterminate). This game is really dedicated to the 4X's evil cousin, the VOID, Varying Only In Degree. VOID games are games that do not offer actual exploration and discovery or even new challenges; instead, they give you an initial battle involving one or two enemy pieces. Now, this is a great learning scenario, but you begin to get suspicious when the next battle has three of the same basic foe, and the next has four and so on and so on. No surprises, no variation in play; you need only craft a strategy for an ever growing number of identical enemy units.

CAS boils down, with barely any heat at all, to this premise: Capture all 50 worlds on the map. You have a space combat system similar

to the arcade action of Accolade's *Star Control II*, and a ground combat/boarding party combat system refined somewhat from Mindcraft's *Tegel's Mercenaries/Strike Squad*. Your mission is exactly that of another Mindcraft release, *Star Legions*, except that you are expected to conquer worlds not with fleets and troops, but with a handful of good ol' aliens with sidearms.



You travel across vast distances of space using a grand starmap, which is blank to begin with. As you travel from point to point in hyperspace, portions of the map are revealed to uncover planets or starbases. Starbases are all identical, and planets come in five basic graphic types that seems to have no effect on gameplay other than varying the obstructive terrain. When you are on top of your map target you exit the starmap and enter the bridge of the ship. Here, you must switch to the tactical map that displays your ship and allows you to maneuver and fight in action-intensive battles as in *Star Control II*.

All action on the space and ground tactical maps proceeds in real-time. Starbases, planets and derelict ships appear on this screen as well and may be boarded or landed on with personnel once your ship matches speed and bearing with the target.

Propaganda Alert

Before you disembark, however, your tactical area must be cleared of hostile ships. Note that, contrary to the manual's propaganda about the types of ships you will encounter and their likely behavior, *all* of them will attack you without parley, no matter *what* your race or behavior is. If you cripple an alien ship, it becomes a derelict; you may board it with personnel and use the ground combat system to kill the remaining crew and take the weapons they leave lying on the floor.

All ship scenes are featureless, a maze of fairly random hallways and rooms about half the size of the planetary battle map. Once depopulated you receive a dollar-value reward for the enemy ship (from whom or what, I have no idea) and your prize disappears.

Command Adventures: Starship



TITLE: Command Adventures: Starship
 PRICE: \$69.95
 SYSTEM: IBM
 REQUIREMENTS: 386SX or better, 2MB RAM, 25MB hard drive space; supports AdLib (Gold), Sound Blaster (Pro), PAS-16, Roland MT-32 and Sound Canvas sound cards
 PROTECTION: Code look up on non-reproducible paper
 DESIGNER: Tom Lima
 PUBLISHER: Merit Software
 Dallas, TX
 (214) 385-2353

HELL CAB.

ONE RIDE AND YOU'LL
KNOW WHY
EVERYONE WALKS IN N.Y.

Welcome to the cab ride from Hell. This cabby wants more than your money—he wants your soul! All he has to do is get you to the worst hellholes in history and see you try to survive. Sound fun?

This is *Hell Cab*, an interactive epic adventure in the devil's time machine. Get ready to face ravenous dinosaurs, fight blood-thirsty gladiators and duck for cover in the WWI trenches of Verdun. To survive, you'll have to overcome countless dangers and resist the irresistible. Think you can beat the devil? Climb in!

• Dazzling animation, music and bone-rattling sound effects
• Multiple environments, complex strategies
• Real-life, first-person interaction

Visit your local gaming store or call 800-482-3766.



Explore the Empire State Building in all its splendor. It's virtually yours, courtesy of the devil's technology!



Will your last stop be the devil's favorite sun spot... Hell itself?



**TIME WARNER
INTERACTIVE GROUP**

2210 Olive Avenue, Burbank, CA 91506
(800) 482-3766

Circle Reader Service #1

R3M1 08P1



You are given over 30 ship weapons to choose from, but don't expect a cornucopia of graphic affects and damage characteristics. All weapons, be they lasers, missiles, or mines, fire a little colored ball that travels across the screen and explodes where you had the cursor target placed when you pressed the mouse button. There is no variation in speed, and the only difference is in the damage they cause; and you can only tell this is true because the enemy blows up with fewer hits. Sadly, the thirty-odd exotic ground weapons work exactly the same generic way.

When space is clear of enemy vessels, you may shuttle your landing party to the surface of the neutral world and conquer it. There are two objectives: eliminate all enemy troops, and use your engineers to build and activate "Isolation Grid Units" in all four corners of the tactical map. If you satisfy both requirements, an energy fence springs up, sealing you off from the 99.98 percent of the planetary surface left unconquered, and the world is declared yours. Once again, a monetary reward wings your way from the ether and you can go on to another world or back to a starbase for repairs, ship upgrades and new personnel.

As I said previously, personal combat is handled by an engine almost identical to the one used by Mindcraft in their *Tegel's Mers/Strike Squad* series. Except for slightly



slicker graphics in its few details, it is executed even more poorly in *CAS*. You can only control one player at a time using basic fire, move, and pickup commands, and you can leave an individual with basic attack/defend instructions when you switch to another figure, but when these units are under computer control, they are

painfully stupid. They're fully capable of shooting an ally standing in the way of an enemy trooper and, in defense mode, will empty a clip at a wall while the enemy on the other side also blazes away at the very same wall.

A Universe of Illusion

Usually, the marketing of a piece of software is beyond the scope of a reviewer, but in this case an exception has to be made. First, a couple of clarifications: *Command Adventure: Starship*, regardless of the strong impression given by the documentation and the box, is *not* a role-playing game. There are no characters, skills, or names involved. Also, the only "Adventure" going on here is in the title. There is no plot line to be followed, no mystery to be uncovered—just simple, repetitious action gaming. Vague allowances are made for these aspects, but they are nothing more than camouflage for a bare-boned game.

Now, it is true that sometimes a game's reach is beyond its grasp and falls short. These things happen, and a disappointing game is just a fact of life—at least the effort has been made to make the game the best it could be. But here, I suspect, is a game at least six months short on development time that has been hurriedly thrown into a glossy package to catch the holiday buying frenzy.

The number of "in-

consistencies" between the manual and the actual game are amazing. For example, the manual refers to some danger involved in the hiring of crew members, hinting that there were assassins about. Wrong! The crew you hire don't even have names, never mind personalities or divergent loyalties! There are also references to the four different kind of missions you will find other ships performing, giving you the idea that there is some kind of coherent backdrop for this game. Wrong again. There is no context for the action in this game, no beings to talk to, nothing to interact with.

The box's picture of reality is even further skewed. Careful consumers have learned to spot screen shots on a box that are probably just animation sequences, not really a play shot. However, on the *CAS* box, Merit has spliced control panels along the bottom of the animation screen shots to give the impression that you actually play against that kind of graphic splendor. While crowing about the number of weapons you can use, the box fails to mention they can only be distinguished



from each other with a calculator. The term "strategic" is bandied about to give you an impression of a big space game, even though all your decisions are purely tactical. Perhaps we can attribute these inconsistencies to boyish enthusiasm, perhaps to intentions less innocent, but either way I was left with a very sour taste in my mouth.

Sadly enough, I haven't hit on half the things badly done or omitted in this game. There were times when I was truly convinced that I had gotten hold of some half-finished pre-release version by accident, or that a blood vessel had burst in my brain and I was somehow missing the point. A long list of disgruntlements would be brutal and pointless. Let it stand at this: the graphics are great and the sounds are stunning, but even the moderately experienced gamer will experience disappointment on a galactic scale. **CGW**

Give Your Joystick a Thrill.

In the early 21st century, staged fighting has become a lucrative profession for female hardbodies, with dozens of legal arenas in the city. But for the leanest, meanest warriors, the real money comes from the illegal bouts held outside the city. It's the hottest day of the summer and you're baking inside a dilapidated warehouse. You — and your opponent — wear the latest in MECHA armor. The best fighting armor in the world.

METAL & LACE

THE BATTLE OF THE ROBO BABES

This won't be any picnic. With the intense heat and action, you'll both end up in less than full body dress.

It's dream babes in heavy armor battling for prize money — action packed, arcade style fun for your PC. But be warned — with its intense violence and voluptuous women, Metal & Lace: Battle Of The Robo Babes is for mature audiences only. And not for the faint hearted. Available now at your nearest dealer or call 1-800-258-MEGA. Or write Megatech, P.O. Box 11333, Torrance, CA 90510. Visa, Mastercard, checks accepted.

System requirements: 286-20 or faster machine (386 recommended) with 640K RAM, hard disk, joystick recommended. Operating Sys.: MS DOS 3.3 or above, Windows 3.1. Graphics compatible with VGA. Sound support: Sound Blaster, Sound Blaster Pro, Thunder Board, Pro Audio Spectrum, Adlib Gold and Speed Master.



NR-13

This game is not for the faint-hearted. Contains violence and some material inappropriate for minors.

NOT RECOMMENDED FOR PLAYERS UNDER 13.

For a free demo, call our 24hr. BBS at 310-539-7739. (8N1)

MEGATECH

Circle Reader Service #88

All companies and product names mentioned are trademarks or registered trademarks of the respective owners.



Letters from Paradise



Digital Deja Vu

I live about 200 miles away from the nearest city with a population of more than 30,000 and *CGW* is basically my primary source of information on the gaming world. It is for this reason, and that of your close association with game developers, that I write to you. My question concerns games on CD.

Like all addicted, sorry, *dedicated* gamers, you know that when a hot new game is released you can't wait to get stuck into it and with truly challenging games you play it to death, until there are no surprises left and all the puzzles have been solved. When this game is a success, the producers may then decide that with the right voices and possibly some better graphics, they could release the game on CD. Sounds great—NOT!

How many people are going to turn around and pay an even higher price for the same game with the same objectives and puzzles? There is no anticipation (which is a big part of CRPGs and adventure games. There is also no sense of accomplishment in solving any puzzles.

One example which comes to mind is *Indiana Jones and the Fate of Atlantis*. My wife and I enjoyed the game immensely and would have snapped up the CD version in a minute, but having played the floppy disk version of the game, there is no point, even if the voices are great.

From what I have read in your magazine, I can appreciate the financial constraints placed on some software companies which would restrict them from producing first-run games on CD as opposed to or as well as on floppies, given the relatively small number of CD-ROM owners, the extra expense and the fact that the game may be a turkey on any format. But, is it at all possible for the software companies to announce at the time the

floppy version of a game is released that a CD version of the same game MAY follow?

David Bisman
Bathurst, NSW, AUSTRALIA

In the earliest days of CD games, the re-releases of floppy-disk games were primarily a laboratory for developing and refining the production skills

and technological capacity for creating solid CD entertainment software. In order to lose the least amount of money on said experiments, it was necessary to have a game prove itself in the market first and try to market an enhanced version later. Now, the economics of scale are shifting. It is becoming more and more feasible

The 5th Wave

By Rich Tennant



"THE MANUFACTURERS OF A DATA ENCRYPTION PROGRAM THAT SCRAMBLES MESSAGES INTO A BRAINLESS MORASS OF INDECIPHERABLE CODE, HAS JUST FILED A 'LOOK AND FEEL' COPYRIGHT SUIT AGAINST OUR GAME MANUAL DIVISION."

to have stand-alone CD titles because of the expansion of the installed base of CD-ROM drives. Hence, more and more titles are being released simultaneously (or near simultaneously) in floppy disk and CD formats. As the installed base of CD-equipped computers increases, we believe that CDs will become the dominant shipping medium of computer game software. In fact, we predict that this shift will have occurred by the Spring of 1995 and that it will require the same type of disk exchange then to get 3.5" disk versions of games as it currently requires to get 5.25" disk versions of games. In short, the answer to your question is that companies will not only announce their CD products at an earlier time, but CD products are beginning to take the point in their marketing plans. Within six months, it is likely that your question will become moot.

Agent Orange

I am writing to say that I am happy with the recent acquisition of CGW by Ziff-Davis. The additional pages of articles and advertisements are greatly appreciated (and your magazine is the only media outlet where I appreciate *more* advertisements). However, I have run into a problem with the magazine.

While reading CGW and eating an orange, I noticed the print smearing. I cleaned my hands and ran a test on the ink. The print did not smear with dry skin or with water, but it came right off with juice from the orange. I am enclosing the page for your reference. Obviously, I will be avoiding citrus fruit while reading your fine magazine.

Robert M. McLearen, Jr.
Des Moines, IA

Does this mean we should print a disclaimer? Maybe it could read, "While CGW readers are advised not to eat citrus fruit while reading the magazine, we are not liable for cases of scurvy or insufficient vitamin protection against the common cold." Seriously, we pass along the word about citric acid and our ink in order for others to avoid both damage to the magazine and accidental ingestion.

Hall Of Blame

I believe that your magazine, while certainly the finest in the industry, consistently makes one mistake. You admit too many games into the CGW Hall of Fame.

When I first began to read your magazine, there were very few games in the Hall of Fame—certainly not more than 10 or 12. However, in the December 1993 issue, it was announced that *The Secret of Monkey Island* was being added, for a total of 31 games. How could the number of games in the Hall of Fame have doubled in the three years since I had started reading the magazine, if it origi-



nally took eight years to get the first 12 or so in?

I believe that your magazine has become much too lenient in which games it admits to the Hall of Fame. The Hall of Fame should be a great honor, and not made so easily available. It seems to me that most of the games were inducted for either their popularity or the fact that the members of the CGW staff inducted them as their favorite games. I do not understand this! Of the 31 games on the list, only three or four have made what I consider to be a worthwhile contribution to the industry, with three to four others as possible second choices. That's a total of six-to-eight games. Where did the other 22 games come from?

While I realize that the primary judge of a game being entered into the Hall of Fame is how popular the game is among CGW readers, that is not a fair criterion. Don't assume that just because a game is popular means it deserves to be in the Hall of Fame. Sure, *King's Quest V: Absence Makes The Heart Go Yonder!* was a popular game, but I doubt very much that it had a positive impact on the industry. I have only seen it have a negative impact. Every game created after it has required ridiculous hardware requirements,

and while most have sported VGA graphics and stereo sound, very few of them have been worthwhile to play, because they are so easy and not catered to anyone with real gaming experience. And Zork, perhaps the most influential game ever was left off the list until the Prodigy Infocomrades [Ed: led by Mr. Murray] got it on in the summer of 1992, because of a mistake. When you started the Hall of Fame, it wasn't rated high enough.

I really believe that you need to rethink and reorganize the criteria and entry requirements for the games in the Hall of Fame. It should be reserved for the most influential and important games in the industry, and not just the ones that have been highly rated by the readers. Set an example for the rest of the industry and admit only the most worthy games. You used to do that and I hope you will again.

Matthew Murray
Bellingham, WA

The original CGW Hall of Fame was unveiled in CGW #45 (March, 1988). The charter inductees were: Ultima III, Ultima IV, Wizardry, The Bard's Tale, Chessmaster 2000, Kampfgruppe, Mech Brigade, M.U.L.E., and the original War in Russia. Of the original nine, only Mech Brigade seems a

questionable choice, even in light of today's games. Mech Brigade was included because it fixed some design flaws in Kampfgruppe, a tactical game of WWII armored combat that still brings flutters to the hearts of dedicated wargamers, today. We felt that it would be inconsistent to induct Kampfgruppe into the Hall of Fame without inducting its successor and superior design. Unfortunately, Mech Brigade was never actually as popular as Kampfgruppe and it is the most difficult of the charter members to defend.

At its inception, the criteria for inclusion in the Hall of Fame were: 1) quality of the game as perceived by the editorial staff; 2) quality of the game as demonstrated in reader ratings; and 3) contribution of the game to the computer gaming hobby as a whole and the genre to which the game was specific. We still hold to those criteria. Indeed, the rotating descriptions of Hall of Fame members which we print in the magazine each month are intended to highlight those reasons which we believe meet requirements #1 and #3.

We relaxed the criteria to induct Zork. Zork was never rated high enough to meet qualification #2, but there is no doubt that it was worthy of inclusion. As for the two specific games whose inclusion you considered unworthy, let me remind you that KQV was inducted

because it represented: a) new technology in using the scanning process to make backgrounds and animation look more fluid and realistic; b) the entire series as a whole (the most commercially successful adventure game series in history); and c) a watershed in the work of a designer who defined the graphic adventure genre (Roberta Williams has worked with co-authors and co-designers since that point.) from its inception. Further, The Secret of Monkey Island may well have been the apex of the SCUMM system at LucasArts (nee' Lucasfilm) Games. The system has evolved in some areas and devolved in others, BUT it is rare to find anyone who hasn't played and enjoyed Monkey Island to the extent that they treat it as a reference point in the genre.

Finally, another reason for the proliferation of titles in the Hall of Fame is that the number of genres represented have expanded. Simulation games, as represented in this issue, have advanced gigantic leaps past the technology that was in play when the charter members were inducted. Indeed, the number of titles available have increased. Remember, the number of athletes represented in their respective Hall of Fame museums and the number of films listed in the National Registry of Film increases with each calendar year. We have averaged less than five

additions to the Hall of Fame per year. We believe that is responsible growth.

Heavy Duty Crimefighter

I felt compelled to forward this letter in response to a comment made by Johnny Wilson in the December issue's editorial regarding the new "record size" of your magazine. The following is an absolutely, positively, unquestionably true story (well...just a few minor liberties were taken).

I was out buying some clothes one cold and windy evening in late November at an area shopping mall. Following a couple of hours of unbridled spending, I exited the establishment and began walking towards my car. It was at this time that a hoodlum came literally out of nowhere to grab the largest bag that I was carrying. He immediately proceeded to run off with his new prize, which included a pair of pants, a shirt, some socks and, as fortune would have it, the latest copy of CGW that I had happened to purchase at my favorite bookstore on the way out of the mall. Against better judgment and not wanting to throw away my hard won currency in these tough times, I gave chase. He bolted across the parking lot and down an adjoining street. Though it was quite dark out and the robber wore similarly dark clothing, I man-

THE ULTIMATE Play-By-Mail Offer... ...JUST GOT BETTER!

Another five major play-by-mail games have joined our unique offer: **Cluster Lords** (rules and 10 free turns in this deep space opera), **Death and Sorrow** (rules and 10 free turns in this introductory fast-moving wargame), **Perseus Arm** (the 170-page rulebook and 3 turns in a massive new space opera), **St Valentine's Day Massacre** (rules and five turns in PBM's most challenging crime game), **World Conquest** (rules and 4 turns in this clean strategic wargame). And now all subscriptions are processed by first class mail, ensuring you get the hottest news in the hobby.

Play by mail is America's most exciting form of gaming, pitting you against crack players across the country and abroad. (Call (216) 673-2117 for news of the big national PBM convention.) Our offer gives you the chance to sample it and decide if it's for you.

For those who haven't seen our guaranteed offer before, here it is:

Take a \$20 (4-issue) subscription to FLAGSHIP, the leading international play-by-mail magazine, and let our reviews, features and player comments help you pick the best of the latest games. We think you'll enjoy our frank, irreverent style. With your first issue we'll send you a \$20 coupon for any of the above games and 19 others, with a description of each so you can decide which of these intriguing designs to try. The only condition: that you've not played with the chosen moderator before.

But what if you *don't* like FLAGSHIP? What if you're *not* intrigued by the game you write for? Haven't you wasted \$20?

No! Write us within a month of getting your first FLAGSHIP to tell us you were disappointed, and we'll refund you the entire \$20. (You can still use the coupon.)

So: either you've enhanced your gaming with an exciting new dimension for \$20. Or you've explored it and decided it's not for you - at a cost of zero!

Why not try it? Send \$19.99 to FLAGSHIP, CGW offer, PO Box 454, Fair Lawn, NJ 07401-0454.

[European readers: Send £9.99 to FLAGSHIP, CGW offer, PO Box 1733, Handsworth, Birmingham B20 2PP for the equivalent European offer!]

"Never before has there been a game so movie-like in its construction."

— Computer Gaming World

"Graphics, music and sound effects are all exceptionally strong."

— Questbusters

TSUNAMI

(pronounced soo-nah'-mee)

n. A powerful vision

and a fresh approach

to an almost forgotten

art...the ancient art

of storytelling.

RINGWORLD™

Revenge of the Patriarch™

Based on the award winning book series by celebrated author

LARRY NIVEN

Look for these premium TSUNAMI titles:

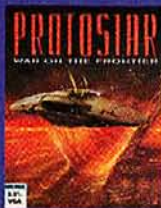
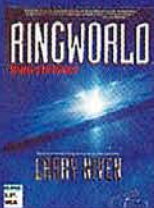

NOVICE LEVEL

Actual VGA screens

THE INFODISK SAID YOU WERE TO DELIVER A WARNING...

It never mentioned an insane Patriarch, Kzinti assassins, or the fact that the only hope for the future of the universe might be found on a world so immense it could hold a million earths. Ringworld holds the answers — if only you can find it in time...

Circle Reader Service #138

Experience Larry Niven's universe like never before!

Available from your local dealer in 3.5" disk or CD-ROM FORMAT.

TSUNAMI™

™ designates a trademark of Tsunami Media, Inc.
©Tsunami Media, Inc. 1993. All rights reserved.

Tsunami Media, Inc. is an independent publisher, distributed exclusively by Accolade, Inc.

aged to maintain the pursuit beneath a trail of dim street lamps. The remembrance of years of high school track surely carried me relentlessly forward.

After a few minutes of running, an unbelievable thing happened—the thief started to slow down! I couldn't believe it. I began to rapidly gain ground. By the time he'd reached Webster Square, some half mile away from the scene of the crime, the crook had slowed to a complete stop and ultimately collapsed in a heap on the sidewalk against a wrought iron railing.

I came up beside him and, before I could say or do anything, the breathless burglar thrust the bag containing the stolen goods in my direction and, with face flushed and chest heaving, bellowed, "Go ahead and take it back!" At that precise moment, I realized that it wasn't the pants, shirt or socks—it was the near telephone book-like magnitude of *CGW* that had completely and utterly worn down this svelte and doubtless seasoned pilferer. The pages upon pages of advertisements, the *Holiday Buyer's Guide*, the truly incarcerating interview with Daryl Gates, the *Kids & Computers* section and the additional pages and pages of advertisements had all concerted and, indeed, conspired to weight down and ultimately defeat this mighty purloiner! Who would've imagined that such new-found bulk would have served so lofty a purpose?

Well done, *CGW*! Well done!

*Jim Corbin
Lowell, MA*

*Not only do we need the screen rights to this story for a Made-For-*CGW* movie, but this may cause us to open up a new division to sell "The Sub" as an anti-theft device.*

Why is there no news of Sierra's first CD-only game, *Phantasmagoria*? What has happened to it? How come we never get a look at this, presumably technological, breakthrough of a game?

*Raymond Port
Santa Rosa, CA*

CGW has not published any material on this game because it is too early to even publish a "Behind The Screens" on the product. Roberta Williams is following a "closed set" philosophy on the product because they are trying a lot of new techniques in this huge game, and they don't want competitors technologically stealing a march on them by using such techniques in smaller projects. Hence, security is tighter than usual. We will cooperate with Sierra in publishing a "Behind The Screens" as soon as it is practical from both their perspective and ours.

CGW

Holiday Carols for Computer Gamers

We received a lot of interesting verses for our computer caroling competition. The two best were from Charlton Sun in Amherst, OH, and Bill DiMartino in Newburn, NC. We will be sending a one-year subscription to both Bill and Charlton.

ULTIMA HAILED (To be sung to the tune of "Jingle Bells")

BRANDISHING MY BOW,
ON A HOT BRITANIAN DAY.
O'ER THE LANDS WE KNOW,
GOING OUT TO SLAY.
CHAMPIONS OF OUR KING,
ON A QUEST THAT NEVER CEASED.
MAKING PEACE BY VANQUISHING,
EVERY HORRID, EVIL BEAST.

Oh!

ULTIMA! ULTIMA!
THAT'S MY FAVORITE GAME.
UNDERWORLD OR SERPENT ISLE,
I LIKE IT JUST THE SAME.

Oh!

ULTIMA! ULTIMA!
THAT'S MY FAVORITE GAME.
I THINK RICHARD GARRIOT
DESERVES ALL OF HIS FAME.

*Charlton Sun
Amherst, OH*

GOD REST YE MERRY AEROPLANES

(to the tune of "God Rest Ye Merry, Gentlemen")

DOES ANYBODY WANT TO BUY MY
COPY OF S.C.?
I WISH I HADN'T GONE AND WASTED
ALL OF MY MONEY!
TO MAKE IT WORSE I ALSO BOUGHT
THE SPEECH PACK,
DISKS ALL THREE.
OH WHY, DIDN'T I WAIT FOR THE
REVIEW, WAIT FOR THE REVIEW!
OH WHY, DIDN'T I WAIT FOR THE
REVIEW?

*Bill DiMartino
Newburn, NC*

THE 12 Ks OF CHRISTMAS (to the tune of "The Twelve Days of Christmas")

ON THE TWELFTH DAY OF CHRISTMAS,
MY TRUE LOVE GAVE TO ME:
TWELVE HARD DRIVES HUMMING,
ELEVEN NETWORKS LINKING,
TEN MONITORS GLEAMING,
NINE MODEMS CALLING,
EIGHT K A CACHING,
SEVEN FAN CARDS COOLING,
SIX SOUND CARDS BLASTING,
FIVE MULTIMEDIA GAMES!
FOUR MEG OF RAM,
THREE NEW MICE,
TWO LOCAL BUS,

AND A PENTIUM CHIP THAT DOESN'T
MELT DOWN.

*David McGirth
Las Vegas, NV*

D & D (WITH APOLOGIES TO SSI AND TSR) (to the tune of "Jingle Bells")

DASHING THROUGH MYTH DRANNOR,
WITH DARK SUN IN A SACK,
WISH I WAS AT HOME RIGHT NOW,
PLAYING DUNGEON HACK.
DARK MOON AND HILLSFAR
MAKE MY SPIRITS BRIGHT.
WHAT FUN IT IS TO SIT AND PLAY
D AND D TONIGHT!

D & D! D & D!
I'LL PLAY IT ALL THE DAY!
AND I'LL CONTINUE INTO THE NIGHT,
THEN SAY:
D & D! D & D!

I'LL PLAY IT ALL THE DAY!
OH, WHAT FUN IT IS TO SCREAM AND
SHOUT,
"I WON THE GAME IN ONLY A DAY!"

*Ted Dawes
Melrose, MA*

WINTER UNDERGROUND (to the tune of "Winter Wonderland")

GRUIES ARE HOWLING, ARE YOUR
LISTENING?
THAT GOLD'S APPEALING, THAT IS
GLISTENING!
BUT CAN YOU FIGURE OUT THE ROOM
THAT IS ROUND
WHILE WALKING IN THE WINTER
UNDERGROUND?
CLINKITY-CLANKITY GO THE FALLING
ZORKMIDS
AS INTO A TROPHY CASE THEY GO.
THEN IT'S BACK THROUGH THE TRAP
DOOR FOR MORE TREASURE
AS BACK INTO THE G.U.E. WE GO.
CAN YOU GET, PAST THE BA-AT?
CAN YOU FIX THE FLOOD CONTROL
DAM?
OR CAN YOU FIGURE OUT THE ROOM
THAT IS ROUND
WHILE WALKING IN THE WINTER
UNDERGROUND?

*Matthew Murray
Bellingham, WA*

.....

TSUNAMI

(pronounced soo-nah'-mee)

n. A powerful vision

and a fresh approach

to an almost forgotten

art...the ancient art

of storytelling.

.....

BLUE

F O R C E

Look for these premium
TSUNAMI titles:

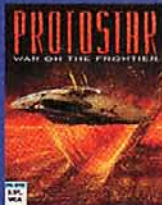

Circle Reader Service #139

.....

The Tsunami logo is a stylized, white, hand-drawn wave or scribble that forms the word 'TSUNAMI' in a jagged, irregular font.

TSUNAMI™

™ designates a trademark of Tsunami Media, Inc.
©Tsunami Media, Inc. 1993. All rights reserved.

CREATED BY
BEST SELLING
GAME DESIGNER

JIM WALLS

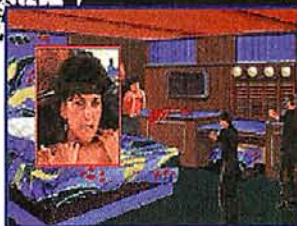

Actual VGA screens

YOU'RE JAKE RYAN, rookie motorcycle officer. Ten years have passed since the unsolved murders of your parents, but a twisted trail of evidence still exists. While patrolling your beat, pieces from the past begin to link with the present. You're treading where you're not wanted and someone wants you to know it!

BLUE FORCE...Realize your destiny.

Available from your local dealer in 3.5" disk or CD-ROM FORMAT.

Tsunami Media, Inc. is an independent publisher, distributed exclusively by Accolade, Inc.

Anime Mine

MegaTech's *Metal & Lace: The Battle of the Robo Babes*

by Charles Ar dai

Warning: The following review is a frank discussion of a game that features elements which may be offensive to some readers. Hence, even the review may include references which could be offensive. Let the reader beware.

It is easy to pick on a game like *Metal & Lace*. Anything that willingly subtitles itself "The Battle of the Robo Babes" is asking to have fun poked at it. I assume the designers know that (although since English is obviously not their first language, we can't be sure), and I also assume they don't mind.

If that's so, I say, "Bravo!" It's nice, once in a while, to see a game that is what it is and makes no bones about it. *Pac-Man* was a game about munching dots in a maze. *Lemmings* is a game about moving critters from one end of the screen to the other. *Metal & Lace* is a game about beating people up and seeing pretty, naked girls. That's all it is. If nobody wants what it has to offer, it won't sell. But since (to paraphrase H.L. Mencken) no one has ever gone broke overestimating the bloodlust or libido of the American public, if I were MegaTech I wouldn't worry. It will sell. People may blush when they bring it to the cash register, but that's never stopped *Playboy* from selling a million copies of every issue.

No, the problem with *Metal & Lace* is not that it's embarrassing or silly, or, for that matter, excessively prurient. The problem with *Metal & Lace* is that the game, merely a side-view human-punching-bag extravaganza modeled after games like *Street Fighter* and *Mortal Kombat* at its core, is not particularly good. There is nothing wrong, in my opinion, with a little wholesome T&A, but the T&A is only a small (indeed, optional) part of the game. Since the player spends more time clobbering the mech-suited babes than ogling once he's beaten the pants off them, MegaTech ought to have put more effort into making sure that their combat sequences compared favorably with those designed by their competitors.

Mano-a-Womano

T&A games have a history of misguidedly emphasizing the T&A factor over the game factor. *Artworx*, one of the earliest purveyors, forced gamers to go through endless rounds of so-so poker to unwrap their opponents in

Strip Poker and endless rounds of *Othello* to uncover an ankle here and an elbow there in *Centerfold Squares*, where it could take up to a dozen games to get to the good stuff. (The year *Squares* came out, I learned to play *Othello* really well—but, by God, I never want to play *Othello* again as long as I live.)

Metal & Lace suffers from the same flaws. The full-screen Anime graphics of scantily clad women are doled out as rewards for beating the same women two times apiece in the combat sessions. There are seven different

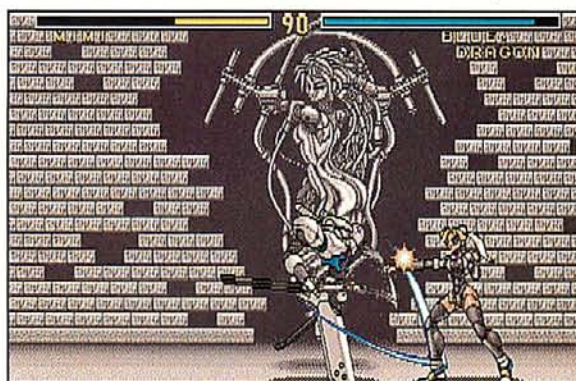

women, each depicted in four graphics that degrade in order from L.L. Bean to Victoria's Secret, to (if one installs the "NR-18" upgrade files) demurely topless, to "Sure, my panties are dangling, but are you ready for the ultimate challenge?" That makes 56 battles, plus the fights between rounds with the "super champions" who have to be beaten three times each—almost 70 fights in all, and that's assuming that the player wins every battle, which he won't.

Anything a player has to do 100 times or more had better be spectacular fun in order not to become boring quickly and then maddening as time drags on. The combat in *Metal & Lace* is, alas, a far cry from spectacular fun. The designers try to spice things up by giving the player seven different types of armor to choose from, a half dozen bits of machinery (shields, boosters, neural amplifiers) to upgrade the armor,

and a handful of different background scenes against which to fight, but while this does help keep the player interested, it only does so for an extra dozen fights or so. In the end it all cancels out since most players will spend the first dozen fights being beaten to a pulp while simply trying to learn the controls.

The player starts with too little money to buy the really good hardware and too little experience to use the hardware he does buy proficiently. By contrast, the robo-babes are proficient from the start, in addition to which they don't have to deal with a set of inscrutable keyboard commands. (Not to mention the paralyzing fear that banging the appropriate keys rapidly and frequently enough to vanquish a foe will shortly necessitate the purchase of a new keyboard.) First-order punches and kicks are easy enough for the player to accomplish, but the more complex moves, which are the only techniques that can win a fight, take a great deal of practice to pull off.

Wise players will go into two-player mode and try all the moves out on a stationary opponent; even so, the complex combinations of key-presses are likely to flee one's mind in the heat of battle.

The game does have its share of secret tricks which, once discovered, make the game much easier. Poke around on the barroom screen to which one returns between fights and you find that all the room's objects, when clicked on, can disgorge valuable treasures as well as snide remarks. Click on the floor often enough and it will let you have a suit of armor it has been hiding; click on the Schwarzeneg-

Metal & Lace: The Battle of the Robo Babes



TITLE: Metal & Lace: The Battle of the Robo Babes
 PRICE: \$49.95
 SYSTEM: IBM
 REQUIREMENTS: 386 or better, VGA graphics, 16MB hard drive space; supports Adlib (Gold), PAS, Sound Blaster (Pro)
 PROTECTION: Code wheel
 DESIGNERS: Erwin Mab, Hideki Masuko, David S. Moskowitz, Kenny Wu
 PUBLISHER: MegaTech
 Torrance, CA
 (310) 539-9177

"I hope there will be a sequel...I will gladly buy it after this one!"

— Computer Game Review

"...the graphics in PROTOSTAR are incredible!"

— Computer Gaming World

TSUNAMI

(pronounced soo-nah'-mee)

n. A powerful vision

and a fresh approach

to an almost forgotten

art...the ancient art

of storytelling.

PROTOSTAR

WAR ON THE FRONTIER



Look for these premium
TSUNAMI titles:

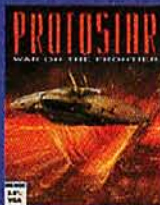
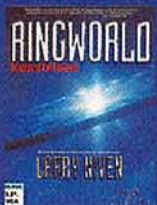

ADVANCED LEVEL



Actual VGA screens

MANKIND IS IRRESISTIBLE PREY...

The Sketch Empire has viewed Human prosperity as an invitation for conquest. Now they have sealed the borders of Human space. YOU are enlisted to serve as the PROTOSTAR Agent for an operation of grave importance. Your objective is to disrupt Sketch supply lines along the Galactic Frontier. You must assemble your team and win the support of the critical alien factions.

Your *War on the Frontier* may prove that mankind is more predator than prey!
Available from your local dealer in 3.5" disk or CD-ROM FORMAT.

Circle Reader Service #140

TSUNAMI™

™ designates a trademark of Tsunami Media, Inc.
©Tsunami Media, Inc. 1993. All rights reserved.

Tsunami Media, Inc. is an independent publisher, distributed exclusively by Accolade, Inc.

GAMERS

Can your Computer
Handle the newest games?
Let us help, We specialize
in gamer's needs...

IDE Hard Drives

Seagate	130meg drive	\$210
Seagate	261meg drive	\$263
Samsung	252meg drive	\$238
Seagate	341meg drive	\$345
Western Digital	340meg	\$326

Mother Boards

486DX2/ 66 VLB 256k Cache	\$675
486DX/ 33 VLB 128k Cache	\$462
486/40 DLC	\$173
System RAM	\$43

Complete System

486DX/ 33 Vesa Local 128K Cache	
255meg Hard drive, 1.2 & 1.44 floppy	
1meg VLB Video, 4 meg Ram	
.28 SVGA Monitor, VLB Multi I/O	
Mini Tower Case	
101 Keyboard, 3 button Mouse	
	\$1789

Large Inventory,
Software and other Hardware
Sound and Video, CD ROM

Computer System Solutions
1-800-666-5590

*Prices Subject to change without Notice

Circle Reader Service #52

MIDNIGHT GAMES

FINEST IN INTERACTIVE ENTERTAINMENT
SINCE 1984

LEGENDS

A RICHLY DETAILED AND
REALISTIC COMPUTER
MODERATED PLAY-BY-MAIL
GAME SIMULATION COMBINING
THE FINEST ELEMENTS OF
FANTASY ROLE-PLAYING
AND EMPIRE BUILDING!
RULES BOOKS - \$15.00
CAMPAIGN MODULE - \$15.00
(INCLUDES SET-UP AND MAP)

MIDNIGHT GAMES

PO BOX 280 DEPT G
MEDFORD OR 97501-0019
BBS# 503-857-8537
PHONE# 503-772-7872
FAX# 503-772-0636
COMPUSERVE# 71241,455

GIVE OUR MULTI-LINE BBS A
CALL AND CHECK OUT THE
LATEST IN WINDOWS AND
OS/2 SHAREWARE, OR VISIT
OUR GAMING SECTION!

Circle Reader Service #97

gerian bouncer a dozen times and he'll give you some batteries.

Each source of goodies will also, occasionally, dispense a malediction—an armor-damaging kidney punch, a pocket picked of \$1000—but the clever player will use a simple scheme of saving the game immediately after receiving each blessing and restoring the game after each curse to eliminate all risk. By carrying out this scheme for a few hours (since the barroom never runs out of treasures to dispense), the player can rack up enough bucks to buy all the hardware he needs, including unlimited supplies of “AI chips” which, when called upon in battle, turn the player's character over to computer control.

AI autopilot is, I found, the best way to play the game—insofar as it can be called “playing”—since it gets one past all the interminable battles with minimal damage to one's keyboard or temper. However, playing the game in this fashion is utterly mechanical: one goes to the barroom; one clicks on everything, saving and restoring as necessary; one buys up enough machinery to guarantee a win; and then one has the computer fight itself. It's not the worst way I can think of to spend some time, but when the minutes start turning into hours and you've just heard the barroom ashtray say “Oy!” for the thousandth time, you start to feel that you are wasting your life.

Add in combat graphics that are hardly better than Epyx's *World Karate Championship* for the Commodore 64, sluggish keyboard response, and the endless, painful repetition of everything (for instance, there is no way to shut off the useless “Mia the towel girl has a tip for you” feature that delays the beginning of each fight), and you end up with a game that starts out weak and ends up unbearable.

What About the Babes?

After all is said and done, *Metal & Lace* does have a saving grace. The odds are that more people will buy it for its sex than for its violence, and it is here that the game performs best. Though there are some slovenly moments—one babe calls herself “Kathleen” though the text on the screen identifies her as “Cristina”; another says, “There's not a drop of silicon in these,” referring to body parts that are sometimes augmented by silicone—most players will be too pleased with the quality of the art to care.

Anyone new to Japanese Anime art will need to get used to the odd and somewhat disturbing combination of doe-eyed little girl faces and sexy, adult bodies. Anime fans, however, are in for a treat. The thirty-or-so

images the game contains (half as many without the nudity upgrade) are prime examples of the style.

In deliciously Japanese-flavored English, the package promises “flashy eyes, fine noses, and spunky hair colors” and there's no denying that's what it provides. The noses are fine, the hair is spunky, there is a nice variety of body types and voices, and there is even some animation, though nothing to get too excited about (a finger moves, eyes blink, hot oil drips). Typical Japanese avoidance of all things pubic means that the artists carefully selected poses which keep the babes, even at their barest, a notch more modest than Sharon Stone. Though this feels like a bit of a cheat—like those old skin flicks where the naked women were always carrying a purse, or a plant, or something at crotch level—gamers so inclined will find sufficient fodder for no end of licentious fantasy.

Hits & Misogyny

I regret that the game is also typically Japanese in some rather less charming ways: the backstory in the manual is bloodier and cruder than anything an American publisher would release, for instance, and the game often invokes uncomfortable stereotypes. The final villain is a caricature Jewish American Princess named Rachel Saperstein (“the only one in her Bar (sic) Mitzvah class that has not gone under the knife...Rachel loves to listen to Wagner”). As a Jew, I find this mildly offensive. If I were black, I might bridle at the “Jamaal Wilkerson” character; if Scottish, at the designers giving a Scots burr to the drunken, burping beer barrel.

There is also the more pervasive problem of misogyny: the babes constantly taunt the player, impugning his manhood, until he beats them soundly, kicks them out of the fighting business, and makes them strip and pose for his pleasure. (“You can spank me,” one says, underwear around her knees.) Poorly adjusted adolescent males who play this game will not exactly come away from the experience with a healthier attitude toward women.

Sensitivity, of course, is more than one should expect from a game called “The Battle of the Robo Babes,” so there may be no point in complaining; but good gameplay is not, and there is equally little of that to be found. The babes are hot—true enough—but all in, if that's what you want, you'd be better off buying a CD wrapped in plain brown paper.

CGW

DISK-COUNT SOFTWARE

Lowest delivered prices with great customer service.

800-448-6658

HOURS: M-F 9 AM-8 PM SAT 10 AM-3 PM EST

PRODUCT INFO & OTHER BUSINESS: 908-396-8880



NO SURCHARGE
SHIPPING IS ONLY \$4.00
PER ORDER, NOT PER
ITEM
HARDWARE INCLUDED!!!



CD ROM	SOFTWARE	CD ROM	SOFTWARE
Aesop's Fables 33	Library of Art:Renaiss 65	Comanche 42 ⁹⁹	Great Britain 37
Aircraft Encyclopa 45	Loom 39	Mission Disk 25 ⁹⁹	Hawaii 19
Amer Bus. Phnbk. 39	Lost Treasure 49	Comic Bk Creator 17	Instant Facit Loc. 19
Amer Hert Pict Dict 75	MacMillan Child Dict 49	Compan of Xanth 35 ⁹⁹	Japan Scenery 19 ⁹⁹
Arthur Teacher Trbl 41	Manhole 49	Computer Works 46 ⁹⁹	New York 29 ⁹⁹
Autodesk Explorer 119	Maniac Mansion 39 ⁹⁹	Cohort 2 19 ⁹⁹	Paris 29 ⁹⁹
Barney Bear Goes	Mantis 45 ⁹⁹	Conquest of Japan 35 ⁹⁹	Pilots Pwr Tools 24 ⁹⁹
to School 26	Mario is Missing 47 ⁹⁹	Contrapuzak 25 ⁹⁹	Rescue Air 911 17
into Space 26	Mavis Beacon 39	Crusader Drk Savn 39 ⁹⁹	San Francisco 29 ⁹⁹
Battlechess 34	Mayo Clinic 49	Cuckoo Zoo 31 ⁹⁹	Scenery SI A or B 37
Beauty & Beast 49	Mixed Up Moth Gs 39	Cyber Space 34 ⁹⁹	Scenery Enh Ed 25
Beethoven Ninth 59	Monarch Notes 75	Daemongate 35 ⁹⁹	Sound & Graphic 25
Berlitz Think & Talk	Monkey Island 39	Darklands 37 ⁹⁹	Tahiti 19
French 105	MM Music: Mozart 33	Darkseed 39	Washington DC 29 ⁹⁹
Spanish 105	MM Music: Vivaldi 33	Darkside of Xeen 39 ⁹⁹	West USA Scnry 39 ⁹⁹
Bloodnet 41 ⁹⁹	Our Solar System 29	Dark Sun 47 ⁹⁹	West Europe 19
Blue Force 39 ⁹⁹	Pool Shark 19 ⁹⁹	Daughter of Serpnt 31 ⁹⁹	Freddy Pharkas 39 ⁹⁹
Bookshelf 129	Precision Map 84 ⁹⁹	Deja Vu 1 & 2 37 ⁹⁹	Front Page Pro 45 ⁹⁹
Britanica Family Choc 49	Protostar 39 ⁹⁹	Design your Railroad 35	Fun School: Fred Frog 39
Buzz Aldrin Race 59	Publish Ill 69	Diet Pro DOS/Win 25/36	Sam Spy, Teddy Br 17
Carmen World Dix 65	Reference Library 59	Dino Park 35 ⁹⁹	G-Force 19 ⁹⁹
Cautious Condo 45	Return of Phantom 37 ⁹⁹	Dino Quest 31 ⁹⁹	Gateway II 35 ⁹⁹
C D Game Pack 55	Rotor/Airball/Time 25	Dinosaur Adventure 34	Gearworks 29 ⁹⁹
C D Speedway 57	San Diego Zoo 49	Discovering Amer 35 ⁹⁹	Geekwad Games 22 ⁹⁹
Chess Maniac 34 ⁹⁹	Secret Weapons 59	Distant Sun 39 ⁹⁹	Goblins 1 or 2* 22
Christmas Carol 33	Seventh Guest 59	Doc Fight 37 ⁹⁹	Grand Slam Bridg II 32
CIA World Fact 39	Sherlock Holmes 39	Dr Floyd Desktop 19 ⁹⁹	Great Naval Admt 48 ⁹⁹
Clipart Goliath 30	Sherlock Holmes 3 49	Dr Jay Window 59 ⁹⁹	Super Ships 20 ⁹⁹
Conan Cimerion 36	Sleeping Beauty 37	Dr. Quandy 31	Great Works 30 ⁹⁹
Creative Kids 36 ⁹⁹	Sound Works 35	Dragon Sphere 39	Gunship 2000 29 ⁹⁹
Curse of Enchantia 25 ⁹⁹	Space Quest 4 37	Dragon Lair 3 39 ⁹⁹	Scenario Disk 24
Deathstar Arcade 30	Space Series-Apollo 49	Dreadnoughts 40 ⁹⁹	Hardb 3 35
Dictionaries & Lang 30	Space Shuttle 29 ⁹⁹	Dune 2 36	Data Disk (ea.) 17 ⁹⁹
Dune 45 ⁹⁹	Spirit of Excalibur 37	Dungeon Master 29 ⁹⁹	Harnier Assault 34 ⁹⁹
Education Master 32	Stellar 7 37	Dynamix Bundle 42	Headline Harry 37
Electronic Cookbk 75	Strange Deadfellow 39	Eagle Eye Mystery 31 ⁹⁹	Health & Diet Pro 26
Elect. Home Library 49	Star Trek Enhanced 49	EO-Quest 1 or 2 29 ⁹⁹	High Command 42 ⁹⁹
Electr Traveler: Calif 33	Street Atlas 99	Eight Ball Delx 35 ⁹⁹	Hong Kong Mahjong 32
Encarta Encyclop 249 ⁹⁹	Talking Classic Tale 75	EI Fish 35	Hoyle Bk Game 1/3 30
European Monarchs 49	Talking Jungle Safari 75	Empire Deluxe 35 ⁹⁹	Humans 25
F-15 39 ⁹⁹	Table Science 59	Scenario Disk 19 ⁹⁹	Inca 34 ⁹⁹
F-117A 43 ⁹⁹	Ultimate Shareware 59	Entrmt Pak Win (ea.) 28	Incredible Machine 29 ⁹⁹
Family Doctor 39	US Atlas w/Atomap 49	Eric the Unready 35 ⁹⁹	Indiana Jones 4 37
Fatty Bear 43 ⁹⁹	US History 39	Eternam 35 ⁹⁹	Inspector Gadget 35 ⁹⁹
Font Master 39	US Presidents 49	Eye of Beholder 2 38	Island of Dr. Brain 29 ⁹⁹
G Force 19 ⁹⁹	USA Wars: Civil War 49	Eye of Beholder 3 42	Jettifighter 2 39
Gateway II 35 ⁹⁹	USA Wars: Korea 49	EZ Cosmos 42	Ad Mission Disk 19
Gettysburg: MM Hist 43	USA Wars: Vietnam 49	Ez Language Series 47 ⁹⁹	John Madden 2 31 ⁹⁹
Gofer Winkles Adv 33	USA Wars: WW II 49	F14 Fleet Defend 44 ⁹⁹	Johnny Quest 29 ⁹⁹
Golden Immortal 28	Voyage Planet ea 69	F 15 III 44	Jump Jet 38 ⁹⁹
Great Cities Vol 1 49	Who Killd Sam Rup 25	Master Edition 49 ⁹⁹	MPE Version 48 ⁹⁹
Gunship 2000 37 ⁹⁹	Wily Beamish 37	F17a Stealth 29 ⁹⁹	Kye Deluxe 30 ⁹⁹
Guy Spy 32	Win CD 32	Falcon 3.0 45	Kid Cad 29 ⁹⁹
Humans 25 ⁹⁹	Wing Com & Miss 45	Oper Fight Tiger 25	Kid Cuts 35 ⁹⁹
Inca 35 ⁹⁹	Wing Com/Ultima 6 45	Mig 29 Data Disk 34 ⁹⁹	Kid Pix 35 ⁹⁹
Inspector Ga - Aet 37 ⁹⁹	Wing Comm 2 57	Family Tree Maker 42	Kid Pix Companion 25
Interactive Vd Old Test 52	Wing Comm 2 57	Fantasy Empire 42 ⁹⁹	Kid Works 2 35 ⁹⁹
Interactive Storytime 45	W C 2/Ulti. Undrwld 57	Farm Creativity Kit 18	Kids Zoo 33 ⁹⁹
Intro Games Fr/Sp 79	World Atlas 42	Fatty Bear Birthday 31 ⁹⁹	Kids Ransom 34 ⁹⁹
Its a Wonderful Life 48	World War II Pak 37 ⁹⁹	Fields of Glory 33 ⁹⁹	King's Quest 6 45
Jazz: Multimedia Hist 69	Adults Only-Must be 21	Flashback 32 ⁹⁹	Land of Lore 34 ⁹⁹
Jets & Props 55	Animation Fantasy 65	Flight Simul ATP 28	Legacy 39
Jones in Fast Lane 37	PC Pix Vol 1 or 2 65	Flight Simulator 5 43 ⁹⁹	Princ of Persia 2 39 ⁹⁹
Just Grandma & Me 36	Porkware 65	Arf Trc Cntrlr 34 ⁹⁹	Print Shop Deluxe 45
Jutland 44 ⁹⁹	Private Collection 65	Arcl/Soen Dsgn 28	Graphic Coll. (ea) 30
Kings Quest 5 42	Private Pictures 1 or 2 65	Aircraft Adv Factory 25	Print Shop, New 35
King Quest 6 Up 26 ⁹⁹	Seedy Vol 1-7 ea. 65	# 685 17	Graphics (ea) 22
Land Of Lore 34 ⁹⁹	Storm 1 or 2 65	# 701 17	Print Shp Compion 31
Languages of World 99	Storm 1 or 2 65	Links 25	Privateer 47 ⁹⁹
Learn to Speak Spn 59	Visual Fantasy 65	Links 386 Pro 39	Prophecy 25 ⁹⁹
Leisure Suit Larry 42	Caddies 7.95ea. 3/\$ 19	Coastal 35 ⁹⁹	Protostar 39 ⁹⁹
		Cobra Mission 39 ⁹⁹	Putt Putt Parade 32
			Speech Disk 17
			Zoo Keeper 36
			Strip Poker 3 32
			Zug's Spelling Adv 22
			Data Disk (ea) 17
			Adv of Eco Island 22

Sound Cards	MIDI Software	CD DRIVES	Joysticks	Multimedia
ATI Stereo FX 131	Ballade Windows 79	Toshiba	CH Flightstick 37 ⁹⁹	Aitech
Stereo FX CD 147 ⁹⁹	Band in a Box 69	3041 Internal 489 ⁹⁹	CH Game Card 3 31	Audio Show 369
Covox Voice Blstr 64 ⁹⁹	Cadenza 125	3041 External 594 ⁹⁹	CH Mach 3 28 ⁹⁹	Pro 256 280
Gravis Ultra Sound 129	Cakewalk 95	Texel America	CH Virtual Pilot 65	Pro Color Plus 529
CD-ROM Kit 298 ⁹⁹	Cakewalk Win 129 ⁹⁹	3021 Internal 349	Eliminator Card 26	ProVGA TV 459
Media Vision	Cakewalk Pro 169	3024 Dbl Spd 390	Gravis Analog Pro 39	Pro PC/TV Plus 249 ⁹⁹
Audio Port 139	Cakewalk Win Pro 240	3024 Business 679	Gravis Joystick 32	Pro VEGA/TV + 659
CDCP 959	Encore 379	3024 Education 604	Gravis PC Game Pad 21	VideoSurge 659
CDCPXL 1159	Jammer Pro 125	3024 Home 569	Kidz Mouse 30 ⁹⁹	VideoSurg SVHS 729
Pro Audio 16 179 ⁹⁹	Laser Music Procs 79	3024 Multimedia 844	Kraft KC3 Joystick 28	Wave Watcher 419
Pro Audio Studio 224 ⁹⁹	Master Tracks Pro 249	5024 Dbl Spd 495	Maxx Flight Yoke 69	TV/GRX TV 269
Pro 16 Multimedia	MCS Stereo 55	5024 Business 769	Maxx Pedal 39	
Upgrade Kit 2 935	Midiscan 269 ⁹⁹	5024 Education 729	Quickshot Game Cd 14	
Pro Movie Audio 339 ⁹⁹	Midisoft Studio 159	5024 Multimedia 969	Quickshot Warrior 18	
Logitech Audioport 134	Music Bytes Vol 1 65	US Robotic Sportster	Suncom Command 19 ⁹⁹	
Soundman 132 ⁹⁹	Music Printer 79	2400 Int. 99 ⁹⁹	Thrustmaster	
Sound Blaster 85	Music Printer Plus 419	14.4 v.42bs 162 ⁹⁹	FCS 69	
SB Midi Kit 59 ⁹⁹	Music Time 169	w/ S/R Fax 183 ⁹⁹	FCS Pro 109	
Snd Blast/ Pro MCA 259	Piano Works 99	14.4 v.42bis Ext 183 ⁹⁹	Game Card 29 ⁹⁹	
Sound Blaster DICE 132	Quick Score Deluxe 99	w/ S/R Fax 213 ⁹⁹	Weapons 2 95 ⁹⁹	
SB Pro 16 164 ⁹⁹	Songwright 5 89 ⁹⁹		Rudder Pedal 109	
SB Pro 16 ASP 209 ⁹⁹	The Miracle 325		UPROM Chip 29 ⁹⁹	
SB Discovery 161 459				
SB Edutainment 16 549 ⁹⁹				

Store: 1060 Randolph Ave. Rahway N.J.

TERMS AND CONDITIONS

Master Card, Visa, American Express & Discover Accepted. No Surcharge on Credit Cards. By mail: P.O. Box 3, Carteret, N.J. 07008. All Sales Are Final. NO REFUNDS! Exchange on defective merchandise with the same item only. No exceptions. All Products are new from manufacturer. All claims and guarantees are from the manufacturer. Call for current price and availability. GOVERNMENT AND SCHOOL P.O.'s WELCOMED. For your protection, we will only ship to the address the credit card company has on file, therefore shipping to AK., HI., PR., P.O. Boxes, APO/FPO extra. International orders call for shipping charges. N.J. Resident add 6% sales tax. 20% restocking fee for all returned items.

JUST GOT LUCKY

Gamblers May Hit The Jackpot In QQP's *Lucky's Casino Adventure*

by Chris Lombardi

There are certain categories of computer games that make a rush-hour elevator seem spacious by comparison. Chess is the most notorious example. You could build a court-yard monument to The Unknown Programmer with all of the chess game boxes created over the last ten years. Gambling games, too, enjoy this over-populous distinction. You can almost bet on a dozen new gambling games being created every year.

These categories spawn so many off-spring because they have the broadest possible appeal, and they are relatively easy to produce. The difficult part for publishers has been boosting their games above the throng so that gamers take notice. The push in Chess has been toward more multi-media eye-candy, but with gambling it's not so easy. You can only do so much graphically with a deck of cards.

QQP's solution is too add...brace yourselves...added play value! It's a concept foreign to some marketers, but one that is very familiar to the gamers at QQP. Witness their card game *Solitaire's Journey*. Solitaire is another flooded area of gaming, but QQP made their product a success (made it a Top 10 game for god-sake!) by adding an incredible number of play options (100 different types of Solitaire!) and inventing clever ways to make the package add up to more than the sum of its individual games. *Lucky's Casino Adventure*, QQP's new gambling game, finds them applying the same technique.

Full House, Options High

It's no empty marketing hyperbole to say that *Lucky's Casino Adventure* offers the largest selection of gambling games ever collected under one roof—18 games of chance, including five styles of Poker. Gamblers can now sample like hors d'oeuvres the less popular

and less accessible games like Red Dog, Pai Gow Poker, and Caribbean Stud, in addition to dining comfortably on the staples of the gamblers diet: Blackjack, Craps, Roulette and Poker. (For a description of each game in *Lucky's*, see the sidebar, QQP's Book of Games.)

Before placing their first bets, gamblers will have to choose a persona to represent them in *Lucky's* world. The stock in *Lucky's* stable of cartoonish faces includes a dozen or so char-

charm. There are seven tournaments available, each a collection of games arranged in a branching structure. In each game of the tournament, the player is given a certain number of hands, or dice rolls, or slot machine pulls to rack up the bucks. When the turns are over, the player moves on to the next node of the tourney and chooses the next game to play. In the end, the player is given a score based upon the cash won or lost and the average size of the bet. Each Tournament is designed to have its own flavor, from Short & Sweet to the Poker Player's Delight and the Strategist's Holiday. These tournaments are a great way for friends to compete, and offer a challenge unavailable anywhere else.

If It's Tuesday, It Must Be Quantum City

The Three Week Vacation mode is the true test of gambling skill and endurance. The player arrives at the Quantum City limits with a wad of cash totaling 2500 bucks, a book of gambling coupons, and a nasty case of the gambler's itch. The goal is to make it through a three week gambling frenzy without going broke.

QQP has done a great job in developing the character of Quantum City. It is a city of 14 casinos (and one pawn shop), each with its own style. Each has a unique selection of games, betting limits, and prices for rooms and eats. They even attract different types of gamblers. As in reality, the Poker rooms of



acters with a healthy variety of racial and facial types. Mixed with the mostly middle aged ladies and gents are a broad-labeled and -sideburned cat that pays homage to The King, and a couple of characters that are dead-ringers for Jerry Garcia of The Grateful Dead. Once characters are assigned names and faces, the game will keep track of their performance, rank them according to a rating system, and display the rankings for multiple players. Though it does support multiple characters, the game can only be played by one player at a time.

Lucky's can be played three different ways. While Single Game mode offers no surprises (pick any of the 18 games and have at it), Tournament mode is a classic touch of QQP

Lucky's Casino Adventure

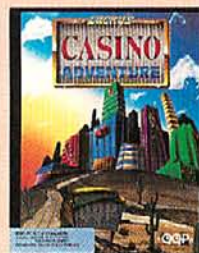

TITLE: Lucky's Casino Adventure
 PRICE: \$64.95
 SYSTEM: IBM
 REQUIREMENTS: 386 or better, VESA compatible SVGA graphics card, 5MB hard drive space, mouse
 PROTECTION: None
 DESIGNERS: Destiny Software
 PUBLISHER: Quantum Quality Productions
 Flemington, NJ
 (908) 788-2799

The Labyrinth of Time

(o n c. d.)



The Labyrinth of Time. An epic fantasy of time travel and adventure, possible only on CD-ROM. The legendary King Minos has commissioned a labyrinth bridging time and space.

You must overcome the power of Minos and destroy the labyrinth by manipulating the very fabric of history. But beware, the future may not unfold in quite the way you planned.



ELECTRONIC ARTS WHITE HOTLINE
1-900-288-HINT
PINT.CD99-288-4444 4842

Available for PC CD. Coming soon for Macintosh® CD. Macintosh is a registered trademark of Apple Computer.

ELECTRONIC ARTS®

95¢ for the first minute, 75¢ for each additional minute. If under 18, get parents permission before calling. Requires a touch-tone telephone. Messages subject to change without notice.

Circle Reader Service #60

some clubs will have a preponderance of casual gamblers who play sloppy and unpredictable hands; others will draw old timers who play very tight, disciplined hands. In *Lucky's* you can tell the difference from one club to the next.

In addition to money, a character's energy level is an important consideration while Vacationing. An energy indicator bar will slowly tick down as the player whiles away the hours on the casino floor. The player can walk from casino to casino, using up energy and time, but saving cash, or he can take a cab and spare the legs but spoil the wallet. Energy depletion can be slowed by eating regularly at nicer restaurants and sleeping at more expensive hotels. A coupon book offers several hundred dollars in free stakes, and free steaks may come to the high-stakes gambler in the form of food "comps" from generous pit bosses. In addition, silly random events will occur, temporarily closing a club and forcing the player to seek out other stomping grounds. Like the "Bus Trips" in *Solitaire's Journey*, the Vaca-

tion mode adds a unique dimension to the staid conventions of computer card games.

Sights & Sounds

The world of *Lucky's*, as far as its graphics, sound, and interface go, is of an erratic consistency. The game requires a VESA compatible video card and makes good use of it in the beautiful digitized photos of the Vegas neon jungle that lie behind the main menus. In jolting contrast, the rest of the game is depicted in cartoonish simplicity, and in a resolution reminiscent of the EGA graphics days. The interface, too, has its quirks. The resolution of the mouse control is chunky, giving the cursor a noticeable jerkiness. To its credit, the game has keyboard equivalents for most of the commands, but not all. I found myself using an uncomfortable combination of both mouse and keyboard.

Lucky's also plays a full hand of music and sound effects, though they didn't do a whole lot for me. Aside from one mild rock tune, it plays a half-dozen or so insipid melodies that tend to bore into the brain and lodge themselves there for the rest of the day. The game also has a full complement of spoken dialogue for the dealers and players. Most of the voices are pleasant enough, but the main male voice for the player's character, with his "Ah, man!" and exclamations of joy, sounds more



like a college kid on a Spring Break junker than a wizened veteran of the felt.

Aside from small problems with the look and feel of the package, the only major problem is the documentation. It's clear that it was done in a rush. It fails to explain how to use the Blackjack card counting feature and the vacation coupons, makes reference to tables that aren't there, and while it fails to discuss even the slightest bit of gambling strategy (the on-line docs give *some*), it insists on printing the rankings of poker hands six times.

Let The Chips Fall

Still, in spite of its lack of polish, *Lucky's Casino Adventure* is, without doubt, the best, most complete gambling package available. While other programs will entice gamers with more eye candy, and others will offer the serious student better instruction and play analysis tools, none can surpass *Lucky's Casino Adventure* in its selection of games and its clever ways of uniting these games into competitive tournaments and adventures.



QQP's Book Of Games

Baccarat: Baccarat is usually played at the finest casinos in special rooms where the players are waited upon by a retinue of tuxedoed attendants. The environs create an air of elegance and exclusivity that allows the mistresses of tycoons to lose their money in style, away from the unwashed masses. The game itself isn't a very interesting one. The players and the dealer are dealt a hand of two cards. Before the hands are dealt, the players choose to bet on either their hand, the dealer's, or a tie. The hand that is nearest a total of 9, after a third card is dealt in certain situations, wins. The odds and the level of skill involved are equivalent to choosing red or black at the roulette table.

Big Six Wheel: Wheel of Fortune fans, and those who enjoy flushing money down the loo, might get a thrill out of this. It's essentially a dumbed-down version of rou-

lette, with a wheel marked with six different numbers. Plunk your money down on a number, watch the animated wheel spin, and, more often than not, watch your money go away. Probably included by QQP for the sake of completeness—certainly not as a selling point.

Bingo: That's the name-o of this game-o. Not exactly what you think of when you think gambling; nonetheless, Bingo has its following, and those followers will find a nice simulation here. You can play one to six cards with all of the Bingo game variations: Postage Stamp, Letter-T, -H, -U, -L, -X, Large and Small Picture Frame, and the granddaddy of them all—Blackout. The chunky mouse interface really shows its weakness here, as you have to use precise movements to mark your numbers.

Blackjack: All of the standard conventions

are here: Splits, Double-Downs, Insurance, and the choice to play with 1, 2, 4 or 6 decks. The Help file contains a small chart of Doubling and Splitting strategies, which is nice, but a chart for basic Hit-Stand decisions would have served the novice gambler better. The game does have a card counting feature that will track the number of Aces, Face Cards, and Other cards that have been played from the current deck, and will even give you a Hit-Stand Index. Sadly, the documentation—both on-line and hard copy—doesn't explain how to use it.

Caribbean Stud: This combination of Blackjack and Poker is coming into vogue at certain casinos. The player places an initial bet and is dealt five cards which are treated as a poker hand. If the player chooses to play the hand, he must match the initial bet. If the dealer's hand is not an Ace-King high

Arriving soon...

TOWER!

Tower cab simulator.

Photo-realistic graphics and features like a 360° scrollable view and easy access information displays put you right in the middle of all of the action.



Tower puts you in the controller's chair high atop the tower cab of a major airport to choreograph the movement of the incoming and outgoing air traffic.

You control runway activity, ground crews and terminal traffic through a 360° scrollable out-the-window view with your keyboard or mouse. Local radar displays and easy-access information displays give you crash reports, news stories and more. You can also link, via modem, with Microsoft's® Flight Simulator® and Mallard's Air Traffic Controller™.

Character-style game play allows you to work your way up the 'corporate ladder' of each airport gaining perks, acquiring passwords to new levels and getting promoted accordingly. Points are scored depending on varying levels of traffic at different airports, types of pilots, time of day, weather conditions and the problems and emergencies that face the controller on the job every day.

So if you think you're up to the challenge of directing traffic of a 'big league' international airport, get to your local software retailer for the arrival of **Tower!** From the publisher of today's hottest flight simulation enhancement products, Mallard Software. Who else?



Mallard™

See your software retailer or, for ordering information, call

1-800-WEB-FEET

© 1993 Mallard Software, Inc.
© 1993 Aviation Simulations, Inc.

hand or better, the dealer can't play, and the player is given even money on the initial bet. If the dealer can play, and the player's hand is a better poker hand than the dealer's, then the player is paid on a scale according to the value of his hand (3 of a Kind pays 3 to 1, Full House pays 7 to 1, up to a Royal Flush which pays 100 to 1).

Casino: A trip to a gambling encyclopedia informed me that Casino was once a popular 2-4 player gambling game. It never made it into modern gambling institutions because it is a game of more skill than chance, and a good player can consistently win with or without Lady Luck on his arm. Explaining the rules of this unfamiliar game would take too long, so suffice it to say that it is a simple, moderately interesting game. With the low betting limits enforced by *Lucky's*, even the most skillful player won't earn much money playing it.

Craps: In the real clubs, the Craps table is the most exciting place to be. While QQP's version doesn't capture that high energy, it does have all of the standard betting options and odds (there are no odds on craps). An animated hand shakes the dice and lets 'em roll.

Keno: Keno is like a mini-state lottery held every 15 minutes, with similarly bleak odds and a terrible pay-off. Mark one to fifteen numbers on a card, and keep your eyes peeled on the board. While it might be fun to fill in a card while eating a buffet dinner in Vegas, I can't see anyone spending more than a few minutes with this game.

Pai Gow Poker: The money tends to move slowly in this game due to frequent "pushes." The player is dealt seven cards with which he must make two poker hands:

a five card hand and a two card hand, with the only restriction being that the five-card hand must be higher than the two-card. If both of the player's hands beat the dealer's hand (according to standard poker conventions), the player wins even money. If only one hand wins, the hand is a push. Otherwise, the player loses.

Poker: Poker is the meat of any gambling package, and the hardest to program correctly. QQP has done a fairly good job with its five poker variants: straight Seven- and Five-Card Stud, Jacks or Better and Lowball Five-Card Draw, and Texas Hold'em. The betting system struck me as being rigid at first, since you can only bet a pre-set amount each round, but the limitation serves to speed up the game.

Poker is, of course, the only game where you play against fellow gamblers, and not the house, and it is very much a game of psychology as much as luck. QQP has captured something of this psychological aspect in the computer players' individual personalities. You'll find your basic types around this table: timorous gamblers who will only play when they've "got the nuts," "chasers" who will throw their money away running after an improbable hand, and testosterone-fueled players who will try to scare people away with an early raise, and who will continue to raise in a fit of machismo when challenged. And, as in real life, each of the casinos in Vacation mode has its own character. There are some tables that don't know the word "check," while others play as tight as a cocktail waitress's bodice.

The computer players play solid poker for the most part, though they are predictable in a few situations. For instance, in Seven-

Card Draw, I've never seen a computer player that has four spades showing try to bluff a flush; if he bets the hand, you can be sure he's got the goods. The same seems to hold true when the computer player is showing four cards to a straight.

Red Dog: Two cards are dealt in this simplistic game. The player can bet on whether or not the third card dealt will lie between the two previous cards. If the player bets and wins, he is paid-off according to an odds table. In the case that the first two cards are of the same value and the third card matches them (3 of a Kind), then the player is paid 11 to 1 on his bet.

Roulette: The upscale gambler's game of choice before such games as Baccarat came along. Place your bet and let the spinning wheel spin.

Slot Machines: The bandits of yore are simulated here in all their glory. *Lucky's* recreates eight different machines of three to five reels and with 1 to 3 pay-off lines. Their silly themes are an appropriate parody of the real McCoy. There's Diablo Dollars, where three 6's reap a nice reward, and Buggy Bucks with its insectoid characters, and so on. Some machines even claim to have a progressive jackpot, but there's no way of knowing how things are progressing. On the whole, it seems that *Lucky's* machines are much looser than most.

Video Poker: A vile and addictive invention, the Video Poker machine has become the bread and butter for most modern casinos. *Lucky's* has three varieties of machines: standard Jacks or Better, Deuces Wild, and Jokers Wild. All of the standard devices are supported, all with keyboard equivalents.

CGW

The Gamers' Guide To Quantum City

Quantum City is a big place with a lot to offer the simulated gambler. Here is a quick chart to help you find the gaming environment you're looking for, and at the right price.

Casino	Room Rate	Meals	Baccarat	Big 6	Bingo	Blackjack	Caribbean	Casino	Craps	Keno	Pai Gow	Poker	Red Dog	Roulette
Arms	\$175	\$12/24/32	—	—	8-10pm	\$5-1000	\$5-1000	—	\$1-500	—	—	\$20-40	\$5-500	\$1-500
Bump's	\$122	\$14/22/32	\$20-10K	\$1-500	—	\$5-1000	—	\$5-200	\$1-500	Yes	\$5-200	\$20-40	\$5-500	\$1-500
Coral Reef	\$24	\$8/12/18	—	\$1-100	—	\$2-50	—	—	—	Yes	—	\$5-10	—	—
Destiny	\$68	\$5/12/15	\$10-5000	\$1-500	—	\$4-1000	\$4-1000	—	—	—	\$5-200	\$15-30	—	—
Empress	\$73	\$6/10/12	\$10-5000	—	—	\$4-500	—	—	\$1-500	—	—	\$10-20	—	\$1-500
Flamingo	\$138	\$5/9/13	—	—	—	\$25-5000	—	—	\$5-1000	—	\$10-500	\$25-50	\$5-500	\$5-1000
Hassle's	\$22	\$8/12/118	—	\$1-100	—	\$2-50	—	—	\$1-100	—	—	\$5-10	—	\$1-100
Jester's	\$82	\$6/8/12	\$10-5000	\$1-500	—	\$4-1000	—	—	\$1-500	—	\$5-200	\$15-30	\$5-500	\$1-500
Cactus Klub	\$38	\$5/9/14	—	\$1-100	—	\$2-20	—	—	\$1-100	—	—	\$10-20	—	—
The King	\$78	\$3/7/20	\$10-5000	\$1-500	—	\$4-500	—	—	\$1-500	Yes	\$5-200	\$10-20	\$5-500	\$1-500
Nero's	\$154	\$12/16/25	\$20-10K	\$1-500	10-12pm	\$25-5000	—	—	\$5-1000	Yes	\$10-500	\$25-50	\$5-500	\$5-1000
The Pits	\$18	\$3/9/11	—	—	12-2am	\$1-25	—	\$1-25	—	—	—	—	—	—
Quantum	\$30	\$5/10/15	\$5-500	\$1-100	4-6pm	\$2-200	—	\$3.50	\$1-100	—	\$2-50	\$10-20	\$2-50	\$1-100
The Ranch	\$42	\$5/10/15	\$5-500	—	—	\$2-200	—	—	\$1-100	—	\$2-50	\$10-20	—	\$1-100

FOR WINDOWS!

Limited-time offer

\$39.95

Incredible Value!

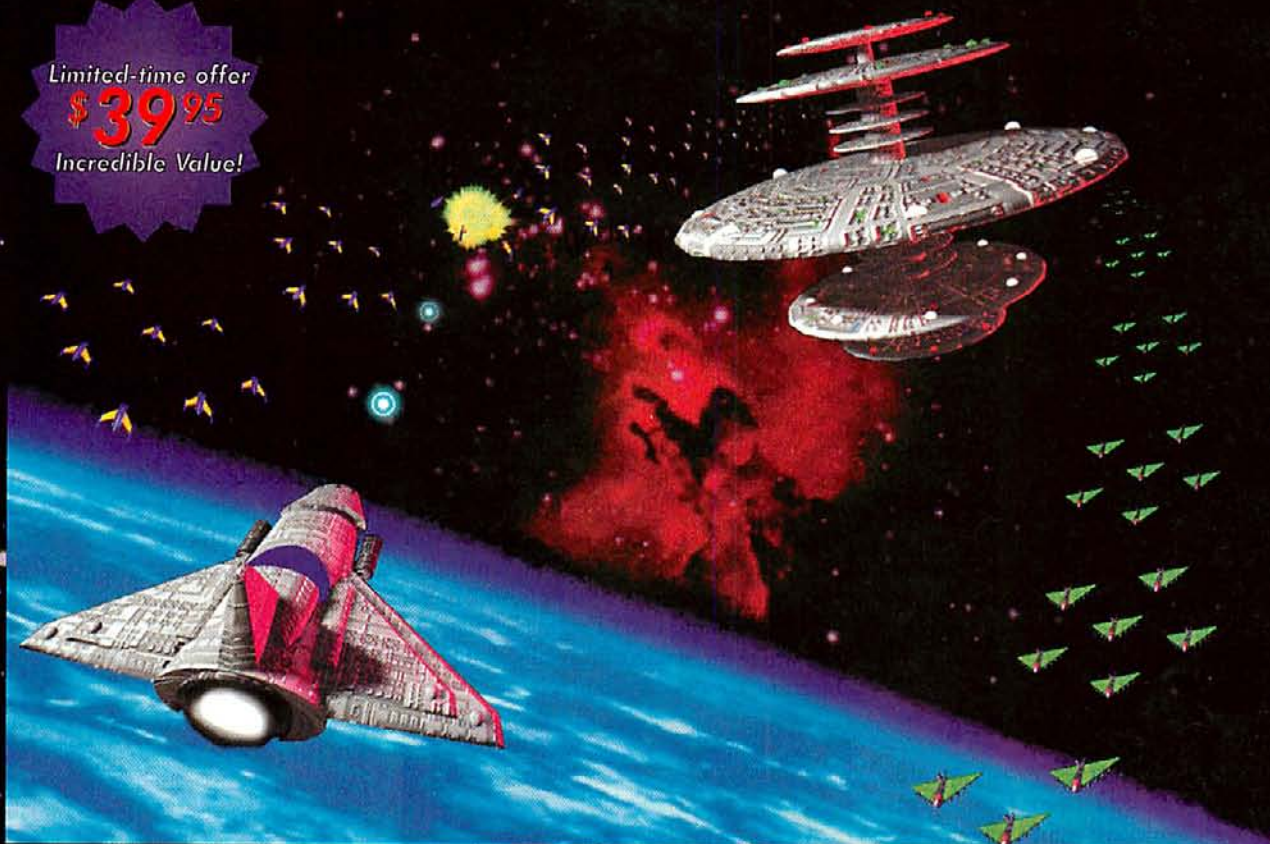

HIGH SPEED 3D ARCADE ACTION FOR WINDOWS!

EARTH INVASION



THREE COMPLETE GAMES IN ONE!

- INCREDIBLE PHOTOREALISTIC 3D GRAPHICS
- STEREO SOUND EFFECTS AND MIDI MUSIC
- OVER 30 LEVELS OF PLAY AND 5 DEGREES OF DIFFICULTY

NOW AVAILABLE AT SOFTWARE RESELLERS THROUGHOUT AMERICA
OR CALL 800-545-7677 or 310-793-0600 TO ORDER



• 3DI PRODUCTIONS INC. •

BEST OF THE REST

Shaking Those Winter Blues

Shareware Action To Combat The Season's Chill

by Chuck Miller

February is usually accompanied by the Winter doldrums, a time when most people need a little pick-me-up to carry them through until Spring. While this is especially true in the more frigid climates, the cool temperatures and slower pace of the season seems to affect almost everyone—even those in more temperate locales. Well, not to let Winter get the best of us, here are some shareware games guaranteed to shake the icicles from your eyelids and get your reflexes out of hibernation.

Due For A Good Paddling

The first of two games examined this month is *Epic Pinball* from Epic MegaGames, a compilation of eight different pinball machines available in two separate packs of four tables each. Those familiar with *Silverball* from MicroLeague Interactive will know the quality to expect from *Epic Pinball*. Programmed by the same team, this collection of pinball tables is even better than that offered in the previously released commercial package.

Sporting VGA graphics and support for Sound Blaster, Sound Blaster Pro and Gravis Ultrasound sound boards, *Epic Pinball* requires a 386 or faster processor. Installation is quick and easy; overall quality is very high. Graphics are attractively rendered and smoothly animated. Screen scrolling (each table is approximately two screens high) is smooth as glass. The only major failing I detected concerned audio quality. When played with regular Sound Blaster emulation on a Sound Blaster 16, the digitized effects and music sound a little muffled. Apart from this shortcoming, I can find little else to fault in the game's design or execution.

As mentioned, eight boards are available. "Android" offers fast action as you strive to activate a robot. It's the only playable table provided in the shareware version of the game. The rest of the first Pinball Pack is comprised of "Pot of Gold," a machine of

shamrocks, leprechauns, and bonus points at the end of its rainbow; "Excalibur," an Arthurian table based on the famous sword; and "Crash and Burn," shifting gears on a grand prix playfield, pit stops and all. The second Pinball Pack contains "Magic," slight of hand pinball style in a 1950's magic shop; "Pinball Jungle," a trip through the Amazon with Epic's *Jill of the Jungle*; "Deep Sea," an underwater aquatic challenge with reefs, sink holes, and sunken ships; and "Enigma," an empty table where the action continually changes as objects materialize as you play.

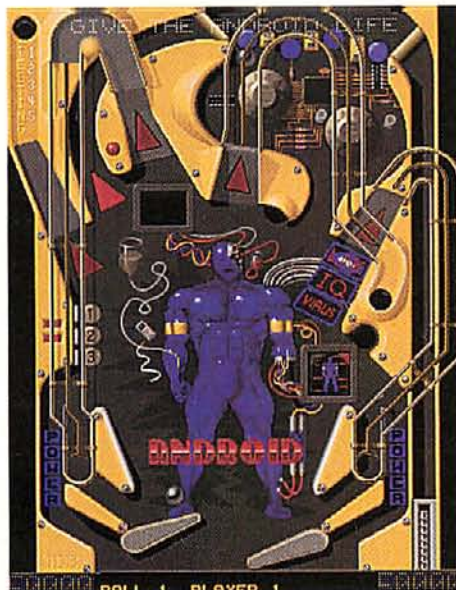

Save your quarters and warm your fingers on the commercial-quality Epic Pinball (two screens shown).

With registration, you receive printed documentation that includes a description of game options, plus a complete explanation of each pinball table. Target values, awarded points, skill shots, powerups, bonuses, timed events, ramps and jackpots are all clearly explained. In addition, individual table menus provide on-line assistance in the form of a brief synopsis of each table's rules. Additionally, you can select the number of balls to play

(either 3, 5 or 6), the table angle (the degree of table slope) and whether sound effects and music are on or off. Shift keys activate the flippers, the space bar acts as plunger and "nudge" (when a ball is in play), "Z" and "I" nudge the table left and right respectively, "P" pauses the game, and "M" and "S" toggle music and sound.

Overall, *Epic Pinball* comes with enough bells and whistles to make play an enjoyable proposition and an addictive pleasure. Ball action is realistic, and the options allow sufficient configurability to tune play to your own liking. At a shareware registration fee of \$29 per pack or \$45 for all eight boards, *Epic Pinball* rings up a high score. Very few commercial alternatives offer as much without causing your wallet to Tilt! *Epic Pinball* is available from Epic MegaGames, 10406 Holbrook Drive, Potomac MD 20854, (800) 972-7434. On CompuServe just type GO EPIC.

Not Quite Spinal Extraction

For those who would rather tilt their opponent than a pinball machine, Panda Entertainment and Accend Inc. has a body basher guaranteed to provide hours of bone crushing, spine jarring, visceral action—*Sango Fighter*. Though the scenes have changed from that of city streets to the hills and valleys of ancient China, it is apparent that *Sango Fighter* is a clone of the ever popular *Street Fighter*. It makes no pretense at being anything else. In many ways, *Sango Fighter* does parallel its role model, but the change of local to a China of the past somehow makes this game more interesting, at least to this novice street warrior.

The story goes something like this.... The frail and incompetent emperor of the Eastern Han Dynasty, Han-Ling, has left his country in a state of disarray, managed by a group of corrupt eunuchs. The result? Rebellion has spread throughout the country. After a great period of unrest and fighting, Dong Zhuo

ON TARGET

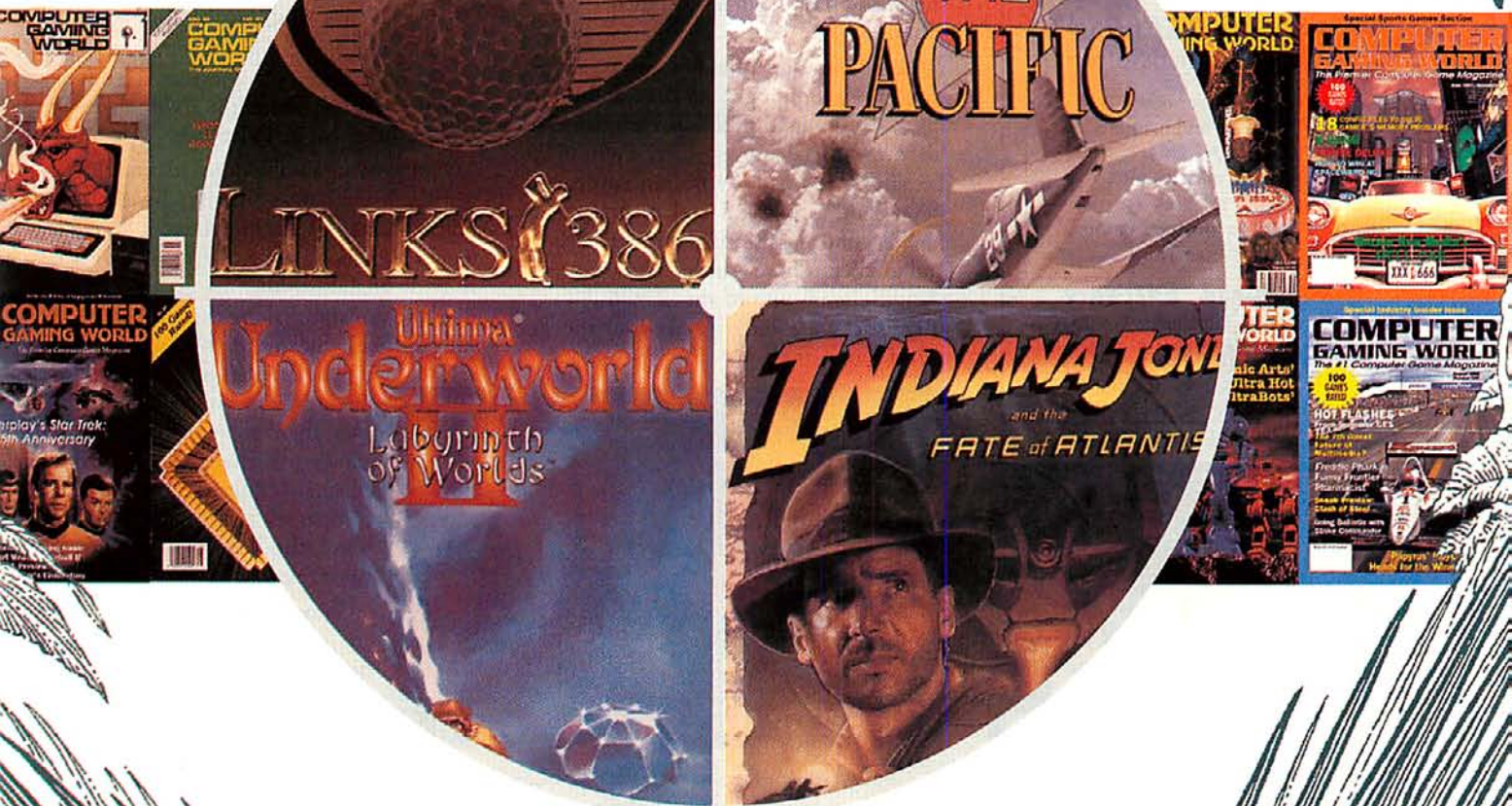

Don't go unarmed to the software store. For more than 12 years, *Computer Gaming World* has provided game hunters with the best information in the field. *CGW* is the magazine for gamers who want *more* than quick overviews of the latest games.

We're loaded with the most complete reviews, new strategies, and the best hints for the discerning hunter.

Take aim now with *Computer Gaming World* and save almost \$20 off the newsstand price.

Only \$28 per year (12 issues).

Lock and load with your
Visa or MasterCard and call



1-800-827-4450

rose to military power and usurped the throne. Though he was quickly defeated, the eunuchs, ten allied generals, continued to fight among themselves for power. Finally, after ten years of bitter struggle, Cao Cao eliminated his opponents and took control. Now, many years later, Liu Bei, the legitimate heir to the throne, and his forces must regain power from Cao Cao. You are enlisted for this battle.

Game play in *Sango Fighter* is very good, on par with the PC version of *Street Fighter*. While the shareware version offers two fighting characters for trial purposes, the registered

version includes 12 warriors, each with their own special attacks. Three modes of play are supported: Story, Battle and Two Player. In Story mode, the events of the conflict are told between fighting segments, weaving combat into the chronicle of territorial reclamation. You represent the five top generals in this scenario. Selecting Battle mode pits you as a single fighter throughout the conflict as you face the opposition's 11 top generals. Finally, Two Player mode, lets you and a friend bash, smash and slash it out against each other.

All the traditional fighting moves are provided from jumping to kicking, and punching to slamming. In addition, each fighter has his own special moves: Fatal Palm, Fling, Lethal Fist, Tornado, Whirling Sweep, and a slew of other physical and mental attacks. Fighter control is provided through keyboard and joystick. Those wanting to use a joystick should choose one of the gamepad variety (flightsticks are out). Otherwise, the keyboard is preferred.



Sango Fighter weaves an illustrated storyline between fighting segments.

\$5 postage and handling, *Sango Fighter* is a good value, and comes recommended. To order your copy direct, contact: Accend Inc., PO Box 23958, Suite 289, Milwaukee WI 53223-0958, (414) 354-6038.

Well, once again this concludes our look at the best in shareware entertainment. Of late, both the quality and quantity of shareware games have been escalating at a rapid pace, roughly matching that of the commercial marketplace and making the job here all the more difficult due to space restraints. As such,

only the highest quality titles have made it into this column. However, there are many more worthy games out there. So, be sure to check for additional titles from the companies represented here, and watch the bulletin boards for the latest releases.

Games reviewed in this column are available through numerous distributors of shareware and public domain software, as well as on many national and private on-line services. If you do not have access to these services, you can usually write or call the game developer for an evaluation copy. And remember, if you find a shareware program enjoyable, please register it with the author.

Send Us Your Best

If you have authored a shareware or public domain game for MS-DOS compatible, Macintosh or Amiga computers and would like to have it considered for review in this column, please send two complete copies on 3.5" disks with documentation and a cover letter to:

Best of the Rest
Computer Gaming World
130 Chaparral Court, Suite 260
Anaheim Hills, CA 92808.

CGW

Games Too Expensive? Consider Pre-owned Software

- Save big \$\$\$ over new
- Original disks and manuals
- IBM - AMIGA - C64
- Hard-to-find classics plus all the latest releases
- Call or write for free catalog (specify computer)

Bare Bones Software

940 4th Ave #222 Huntington WV 25701

1-800-638-1123

Customer Service: 304-529-0461
BBS for complete list: 304-529-7050

Circle Reader Service #39



BASED ON BRAM STOKER'S ORIGINAL NOVEL

For Windows. Excellent graphics, interface, sounds!

Count Dracula is somewhere in London. Use your wits to track down the bloodthirsty vampire and put an end to his evil menace. Assume the role of Prof. Van Helsing, the renowned metaphysician or Mina Harker, the alluring young schoolmistress. Learn the secrets of Renfield, the madman. Explore haunted mansions and much more...



\$29 each. Mail check, cash or money order to:
SDJ Enterprises, Inc.
1551 Fawn Valley Dr.
St. Louis, MO 63131
(314) 966-5602 (Evenings Only)

World Renowned

Requires:
Windows 3.1
VGA graphics
386 25Mhz or faster
Supports Sound Blaster
Easy to Install

Not available in stores. Satisfaction guaranteed or your money back.



Street Fighter-esque action is the core of game play in Sango Fighter.

From a presentation viewpoint, *Sango Fighter* is a quality product. Graphics, VGA only, are pleasing. Animated combat actions are smooth and reasonably lifelike in movement. Audio, if you have MIDI or Roland compatibility, is excellent, though AdLib, Sound Blaster and compatible cards are supported. Music and sound effects (mostly grunts, groans, and the sound of body parts being mashed) are reproduced well. The overall quality of this release is equivalent to any commercial offering.

Though I don't usually find myself drawn to this genre of action titles, I discovered *Sango Fighter* to be an entertaining and addictive game. *Street Fighter* fans are bound to battle over it. At a registration fee of \$30, plus

Circle Reader Service #123

HOLY CHEAT!

THE
WORLD'S FIRST
GAME UTILITY



Axis the Gamecheater gives you a few new tricks in your favorite games — special powers, enhanced weapons, and extra lives. So now you can get on with the adventure, past that nasty spiked pit, without burning your last life in a bad Super Dave imitation. Or you can loose your vengeance with that out-law turbo laser cannon you've always wanted. With *Axis the Gamecheater*, you get the little boost you need to keep the game fun! Superpowers are yours on demand — with just the press of a key!

Axis the Gamecheater provides custom cheats for dozens of the most popular games, on PCs or Macs, and we're adding new games all the time. Ask for it at your favorite software source!

For more information, call

800-926-9677

or 901-682-9676, Fax: 901-682-9691

Baseline
PUBLISHING

Circle Reader Service #40

Over There

How To Make Dinosaurs And Jet Fighters In Three Easy Steps

by Robin Matthews

This month is very much a best-of-British show, with a closer than normal look at two PC products from Ocean Software destined to do pretty well. One is their cracking flight sim *T.F.X.*, the other is based on a best-selling book, that became a very, very big film, and has resulted in an even bigger marketing opportunity! Thanks to the revival caused by young Spielberg, almost every conceivable dinosaur product has been fed into the insatiable mass-market appetite for our prehistoric friends. Ocean, a Manchester-based UK software house, launches another of their film tie-ins with the PC version of *Jurassic Park*, loosely based on the plot of the book.

All too often, a successful film, TV or cartoon character has been an excuse to loosely associate a weak product that is sold purely on the basis of its marketable "label." The history of such relationships are often tenuous and mostly insulting. We are still waiting for a decent Disney tie-in, and games like *Moonwalker*, *Platoon* and some of the James Bond games have been absolutely awful. Ocean has released its share of turkeys, *Platoon* in particular, but seems nowadays to be a well-focused company, determined to establish a more quality-driven product range.

Jurassic Park (JP) is probably the most expensive license purchased by Ocean, and is a combat-oriented adventure divided into two differently presented environments. The basic game plot follows Michael Crichton's best-selling book, as a combination of cloning

and palaeontology brings dinosaurs to life. The island of Isla Nublar, a tiny islet off the coast of Central America, is home to a custom-built dinosaur "safari park," and you as a world-renowned '-assaurus' expert have been invited to examine the cloned inhabitants.



Jurassic Park

The dinosaurs are monitored and controlled by a huge super computer (probably a 486DX66 with local bus, VESA and Roland soundcard and a 5.25" floppy disk drive) that maintains discreet enclosures, paddocks and all the island's security and feeding systems. Dennis Nedry, the park's computer guru, has sabotaged the security systems. With the electrified fences down, hundreds of prehistoric predators, including Vicious Velociraptors (raptors), Dangerous Dilophosaurs (spitters) and Terrifying T-Rex's are marauding around and you are on the menu!

Part one of *JP* is an exterior shoot-em-up with very high quality graphics and limited sound support. You start off in the Tyranno-

saur paddock and nearby are the two grandchildren of the owner, John Hammond (played by Dickie Attenborough in the film, dahlings...). Combat is fast, furious and frequent. You must find the kids and then lead them to the visitors centre, negotiating a large game world in the process. The interface is smooth, with the only occasional difficulty being lining up exactly right to hit your opponent. Initial weapons include a re-chargeable 'phaser' which throws out bolts of electricity and a submachine gun.

More ammo and first aid kits that restore health points are found in caches over the landscape, almost in *Operation Wolf* style. Picking things up is easy and inventory management is nice and basic. The graphic display is always busy, but not overly so, and the screen update and scrolling is smooth and quick.

Having found the children and escaped successfully, *JP* then moves into its second reel, a completely different first-person perspective 3-D adventure where you come across the raptors and other dinosaurs literally face to face. Looking a bit like Bethesda's *Terminator 3-D* games, the second half is still combat-oriented but there are some straightforward object-manipulation puzzles.

The graphics are very good and the speed of screen update and sound effects all contribute to a product that is atmospheric and full of pace. The objective here is to get to the generator and turn on the power. Once accomplished, the final chapter requires a trip through the caves, meeting up with the other survivors and escaping via helicopter.

ARCTIC BARON

The year is 2022 and global warming is threatening the very existence of mankind. Scientists put "Operation Blind" into effect to reverse the process, but something goes seriously wrong! The Earth is plunged into a nuclear winter and the sun becomes permanently eclipsed.

Centuries after the disaster, a new world order has been established and the Viking Union hold the power. They dominate the rail network and the only source of money – coal – and aren't going to easily give up their monopoly.

You command a gigantic steam powered train and use it to journey to towns to trade in supplies, slaves and mammoths. Your raw instincts will help you pull your survival plan together from the information you obtain along the way. Your mission is vital: free the planet from perpetual winter and economic slavery.

Your quest for the sun is one of danger and excitement... become the Arctic Baron... free your people!



Available for IBM PC and Amiga

ReadySoft Incorporated
30 Wertheim Court, Suite 2
Richmond Hill, Ontario, Canada L4B 1B9
Tel: (905) 731-4175 Fax: (905) 764-8867

 Silmarils

 READYSOFT

© 1992 Silmarils – All rights reserved. Distributed by ReadySoft Incorporated.

Circle Reader Service #118

PAPER MAYHEM

"The Informative PBM Magazine"

Do you know what PBM (Play-By-Mail) gaming is? If you don't, we can help you explore the world of PBM gaming. Paper Mayhem has been leading the way for over 10 years by informing people about PBM gaming. Articles, reviews, biographies and more fill each issue. Not to mention the ratings of PBM games and companies that our readers participate in.

Paper Mayhem has been improving with the ever expanding hobby of PBM gaming since 1983. Each bimonthly issue brings you the latest on PBM news.

So why delay and miss out on all the fun? Read Paper Mayhem and take advantage of PBM gaming.

Send subscriptions to:
PAPER MAYHEM
 Dept CG, 1518 Adams St.
 Ottawa, IL 61350-4770

US Subscriptions:
 Single issue \$5.00
 1 year \$24.00 - 2 year \$42.00

FOREIGN SUBSCRIPTIONS: 1 year Canada \$31.00; 1 year to Europe \$51.00; 1 year to Australia \$57.00. All Subscriptions to PAPER MAYHEM are to be paid in US funds and drawn from US banks. Foreign subscriptions are asked to use International Money Order in US funds.

Circle Reader Service #107

Statement of Ownership, Management and Circulation

Title of Publication:	Computer Gaming World
Publication No.:	672910
Date of Filing:	11/16/93
Frequency:	Monthly
No. Issues Published Annually:	12
Annual Subscription Price:	\$28.00
Publication Mailing Address:	130 Chaparral Ct., #260 Anahaim Hills, CA 92808
Headquarters Mailing Address:	One Park Ave. New York, NY 10016
Publisher:	Russell Sipe 130 Chaparral Ct., #260 Anahaim Hills, CA 92808
Editor:	Johnny Wilson (Same address as above)
Managing Editor:	Ken Brown (Same address as above)
Owner:	Ziff Communications Company One Park Ave. New York, NY 10016

Bondholders, mortgages and other security holders owning or holding one percent or more of total amount of bonds, mortgages, or other securities: None

Extent and Nature of Circ	Avg. No. Copies Ea. Iss During Preceding 12 Mo's	Actual No. Copies Of Single Iss. Published Nearest Filing Date
Total No. Copies:	117,075	122,600
Paid and/or requested Circ:	52,494	54,753
Mail Subscription:	18,735	20,041
Total Paid and/or Requested Circ.:	71,229	75,394
Free Distribution by Mail, Carrier or other means:	1,829	1,583
Total Distribution:	73,058	76,977
Copies Not Distributed:	1,068	826
Return from News Agents:	42,949	44,797
Total:	117,075	122,600



Jurassic Park

Overall, Ocean has done an excellent job with *Jurassic Park*. Even though the game only picks up on one or two aspects of the film (which didn't have the deepest plot in the world anyway), this is a respectable film tie-in. As it says on the packaging, are you ready to play in the park?

Hardware-wise, *JP* requires an IBM-compatible system running an 80386 or 80486 processor. VGA graphics with at least 256k ram, 2 MB of system memory with at least 588k free and 800k EMS and 9Mb of hard disk space. Controls are joystick, mouse, keyboard or combinations thereof. While Soundblaster, AdLib and Roland sound cards are supported, *JP's* appetite was incompatible with Gravis Ultrasound.

On a higher plane, Ocean's long awaited flight sim *Tactical Fighter Experiment* features three hi-tech aircraft. One is already a veteran of the Gulf War, the Lockheed F117A Stealth fighter and two are yet to enter active service, the Lockheed F-22 Superstar and the will-it-fly, won't-it-fly European Fighter Aircraft, the EFA. Designed by Digital Image Design, *T.F.X.* claims to combine the technical accuracy of Spectrum HoloByte's *Falcon* with some genuine arcade performance. Four basic flight models vary from the simple arcade model, through simple, realistic and finally the military simulator.

The arcade model is forgiving and lets you hurtle across the skies ignoring most of the basic rules of advanced flight. The military simulator could be the most advanced flight model yet—it takes into account weather, temperature and weapon/wing distribution. This is the real purist's sim and involves so many calculations a second that a 486 is minimum spec. The other two flight models fall between the extremes and give a good learning curve.

You take the role of a pilot for a United Nations air force acting as the world's police force. *T.F.X.* has five separate scenarios, the first set in Libya against a bonkers Arab general (almost history), the second in Yugoslavia during a civil war (could be the present), the third in Columbia versus a drug baron (next year?) and finally a real hypothetical in the south atlantic and the islands of South Georgia (very close to the bone, as the British Press has been reporting the possibility of a huge oil find there!).

A full and detailed review of *T.F.X.* is being prepared by fellow 'limey' and ace pilot Paul Rigby, but suffice it to say that just for a change *T.F.X.* might live up to the hype....



Tactical Fighter Experiment

So life on the Ocean wave looks rosy at the moment. That's all for this month, next time *Gremlin's Liril Divil* and a look at what's happening this side of the pond.

The above games and any of the other games mentioned in past "Over There's can be obtained from:

Strategic Plus Software,
 28 D&E The Courtyard, High Street, Hampton Hill, Middlesex. TW12 1PD,
 Tel 01144819778088,
 Fax 01144819774822,
 or on CompuServe on 1000014,3466

Computer Adventure World has now moved (it took a reader from Canada to spot it—whoops and sorry!). Their correct address details are:

Computer Adventure World,
 Bank Buildings, Charing Cross,
 Birkenhead England, L41 6EJ
 Tel: 01144516661132

Robin Matthews can be contacted on CompuServe on 76004,3456 and welcomes comments and requests (within reason!). CGW

"LET THERE BE PAX!"

Play PAX IMPERIA, the strategic, multi-player simulation of intergalactic empire building. DOS, Mac and network versions available. along with full color posters of this *Great Moment From The Future.*



*Imperial Stardate 2407...
Melina Pariknova Lands The
Fleet In The Vega System.*

Circle Reader Service #58



"totally engaging throughout"

-Computer Gaming World

"a definite must for Mac gamers"

- Dragon Magazine



"strategically elegant"

- Mac Home Journal



PAX IMPERIA.. lets you live like a King and play like an Emperor!
Available now at your nearest dealer or call 800-769-2768.
CompuServe, GO: GAMEPUBC
Visa, Mastercard, check or money orders accepted.

Changeling Software, Inc
596 Elm Street
Windsor Locks, CT 06096



A Fate Worse Than Debt

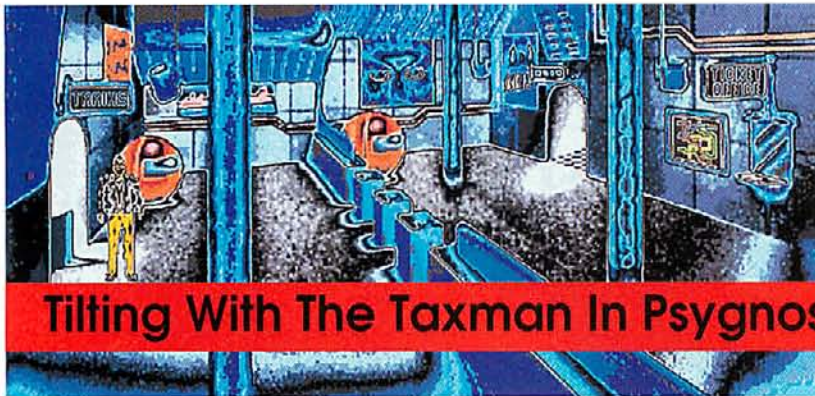

Tilting With The Taxman In Psygnosis' *Innocent Until Caught*

by Charles Arday

If it is indeed true that nothing in life is certain except death and taxes, then *Innocent Until Caught*, which puts the player in the position of having to evade both, is best described as a fantasy game. Yet this is fantasy of a uniquely adult sort. Combine a steady stream of sly sexual references, a casual attitude toward crime, scenes and suggestions of graphic violence, and some small and grainy, but nevertheless full-frontal, nudity, and "uniquely adult fantasy" emerges as perhaps the only apt description for this sometimes disappointing but never dull import from the U.K.

Before the morally upright among you run screaming from the room, let me note that the risqué material is presented in the context of a science fiction plot and with all the good, elbow-in-the-ribs humor of (and many tips of the hat to) classic science fiction comedies such as Harry Harrison's *Stainless Steel Rat* and Douglas Adams' *Hitchhiker's Guide to the Galaxy*. Does this make it more palatable? As a rule, yes. Bare breasts are bare breasts whatever the century, but at least a fatal shot with a death ray spills less gore on the screen than the equivalent shot with a bullet would.

Still, you should know what you're getting into. Though hardly "R-rated," *Innocent Until Caught* easily merits a PG-13. Anyone expecting it to be *Space Quest VI* is in for a rude awakening.

Presumptions Of Innocence

Innocent casts your character as a small-time adventurer with a big-time ego, an intergalactic thief who owes most of his attitude and

not a little of his backstory to Harry Harrison's famous "Slippery Jim" DiGriz. Jack T. Ladd—self-styled connoisseur, raconteur, and all around bad egg—will gladly heist any property he can get his hot little hands on, evading the corrupt and lazy cops of the 21st century through ingenuity, resourcefulness, and (in a pinch) running really fast.

As the game starts, Jack comes up against

first carrying out a minor act of pilfering for the owner of a house of prostitution, then undertaking several increasingly larcenous assignments for a crime syndicate. Completing three of these assignments successfully gets Jack off the backwater planet where he starts out, but that's a far cry from solving his problems. In all, he has to steal his way across two more planets and a spaceship before settling matters to his satisfaction.

You put Jack through his paces with a point-and-click interface that is less conventional than it appears at first glance. All the commonplaces of the genre are there—the large graphic window in which the action takes place, the menu of command icons (Walk, Talk, Look At, Get, Use), the inventory window crammed with sundry junk—but there are also a number of features we don't generally see.

Some are minor but nice: the inventory window is a free-form space in which objects can be manipulated, combined and overlapped, rather than a set of discrete compartments; all text appears in shaded speech bubbles, ensuring that legibility is never a problem; the game allows up to 99 saved games and automatically labels each with the percentage of the game that you have com-

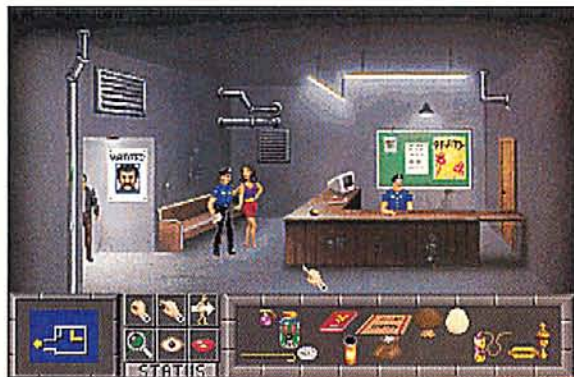

the one nemesis he can neither out-talk nor out-run: the Interstellar Revenue Decimation Service. It seems that our high-flying (anti)hero has neglected to pay taxes on a lifetime of ill-gotten gains. The IRDS gives him 28 days to come up with the cash. The penalty for failure is what you might call severe: torture, execution, the sale of Jack's internal organs, and the seizure of all property owned by Jack's descendants for the next 15 generations.

Making matters worse, Jack currently has no money to his name and no way to earn any, except by going back to his life of crime. So, go back he does,

Innocent Until Caught



TITLE: *Innocent Until Caught*
 PRICE: \$59.99
 SYSTEMS: Amiga, IBM (IBM reviewed)
 REQUIREMENTS: 386 or better, VGA graphics, 18MB hard drive space; supports Ad Lib, Sound Blaster, and Roland sound cards
 PROTECTION: Documentation look up
 DESIGNERS: Divide By Zero
 PUBLISHER: Psygnosis
 Cambridge, MA
 (617) 497-7794

BLAST COMPUTER GAMES INTO ANOTHER DIMENSION FOR ONLY \$169!



GAME BLASTER™

BLASTS COMPUTER GAMES FROM PCs TO BIG-SCREEN TVs!

SPECIAL OFFER! FREE GAMES—a \$150 value—INSIDE EVERY GAME BLASTER PACKAGE!

These sensational computer games are FREE with every package!

Prince of Persia®

JetFighter II™

Spectre Challenger™



by Bröderbund



by Velocity



by Velocity

GAME BLASTER turns your living room into a virtual reality gameroom by boosting your favorite PC games from your VGA monitor onto your big-screen TV.

GAME BLASTER converts your PC's VGA output to a video signal and supports 640x480 VGA resolution. So take off today with GAME BLASTER—and blast your computer into the next dimension.



Circle Reader Service #35



ADVANCED DIGITAL SYSTEMS 20204 State Rd. Cerritos, CA 90701 (310)865-1432 (310)809-6144 (Fax) (800)888-5244

Available from leading computer products suppliers, such as: • Babbage's • Best Buy • CompUSA • Computability • Computer City • Computer Express • Egghead Software • Insight • PC Zone • Tiger Software • USA Flex

© Suggested Retail Price

• All brand and product names are trademarks or registered trademarks of their respective owners.



pleted. Other features are more substantial—for instance, the lower left corner of the screen is devoted to an overhead map of your current surroundings and, as a navigational convenience, you can click on exits on the map as well as those shown in the graphic window. (Since many screens in the game scroll, one or more exits often get pushed off-screen. Being able to use the map for navigation saves a lot of time.)

Also convenient is the distinction the game draws between the “Look At” icon, which produces a description when clicked on a particular item, and the “Scan” icon, which you can sweep around the screen to search for items you might otherwise have missed. Since several of the key objects in the game are roughly the size of a parentheses and a few are the size of a comma (this is one of the game’s main weaknesses, actually), the “Scan” function makes the difference between nerve-racking gameplay and gameplay that gives minimal cause for complaint.

Where the gameplay does fall down, in fact, it is rarely because of poor design and usually because of what appears to be poor coding. I have played few final versions of games that have displayed more bugs per hour than *Innocent Until Caught*. Starting with an installation procedure I had to run twice before it “took” and a sound card configuration procedure that is less than user friendly, *Innocent* broke down at least once every half dozen screens.

At one point a quarter of the screen went



black, only to return, bit by bit, when I brushed the cursor over it repeatedly. At another point, after saving the game, I found myself unable to change icons. At still another, I encountered a more traditional error message: “ILL Error 29/(Item)/Room 2.” In fairness, none of the bugs caused a total system crash—I was always able to fiddle around until the game came back on-line. However, there is no reason I should have had to.

Innocence And Experience

I suppose it is a good sign that even with all the bugs, I never felt inclined to stop playing. Jack’s story is interesting enough (the stage is set by a startlingly well-written 27-page personal history included with the game), the puzzles clever enough, and most of the graphics and sound good enough to make up for the undeniable shortcomings the game has in other respects.



For instance, though the package art and some of the close-ups used during dialogue sequences are truly awful, most of the visuals are great. This does not necessarily mean they are attractive: the look is generally quite seedy. However, assuming that seedy is the look the artists were after, *Innocent* succeeds marvelously at conveying a future caught somewhere between cyberpunk and New York City circa 1994. The bars still have neon signs, but the subways let out into a spaceport—it is a tense and atmospheric near-future mix.

Punchy, peculiar music does its part in supporting this atmosphere. Synthesizer rags, low-down blues, and spicy adventure melodies play side by side with outer-space themes that echo John Williams. More sound ef-

fects would have been nice, as would voices to go with the crackling repartee between Jack and the various lowlifes he meets, but seven floppy disks can only hold so much. (One of the particularly impressive things they hold is an opening sequence so slick that it could be an outtake from *Wing Commander*.)

The game’s puzzles are a mixed bag: all are well conceived, but a few have the disadvantage of not making a lot of sense. Why exactly would a circuit board from a waiter droid, when combined with a boombox, create a remote control that would allow you to steer a different robot away from a ship? Why would Jack be allowed to keep the fake subway token he makes after he has used it once? Why would a pawnshop owner notice if Jack takes a vase and walks out with it, but not notice if Jack takes the vase (still right under his nose), puts it in a bag, and then walks out?

Other puzzles depend on your noticing objects so minuscule—a ticket stub poking out of a character’s back pocket, a “power point” hidden in a junkyard, a pellet in an art gallery—that they might easily escape the attention even of a player who uses the Scan function religiously. As a reviewer, I had the benefit of a cheat-sheet provided by *Psychosis*; without it, I am not sure I would have found all the microscopic objects you need to finish the game.

Innocent Verdict

Good designers take care of their players, making sure that all puzzles, however difficult to solve, are logical and that all events, however strange, are explicable—also that their game makes no unreasonable demands on the player in terms of eyesight, manual precision or the like. *Innocent Until Caught* displays too little of that sort of TLC. Like the world it depicts, *Innocent* is a little more cold and unfriendly than I either am accustomed to or enjoy.

Still, it is rare that a game startles me in the way this one did, because of both the quality of its writing and the unusual candor of some of its grittier and raunchier sequences. (“Hi,” Jack says to a hooker. “No,” she replies, “but I can be if you want.”) Unusual games earn points in my book, as do daring ones, and *Innocent* is both. It’s not for all tastes, heaven knows, but for those who like their adventures a little raw—in more senses than one—*Innocent Until Caught* delivers. **CGW**

The Patrician

My precious A. Scon

Heavy winds and pirate attacks keep me from you longer than planned. Fear not about D. Arblay, I know many things about him he would rather were left unsaid... The town council shall elect me Mayor, from where I shall rise to Alderman of the whole Hanseatic League! With this letter is a picture of a ship I bid successfully for. Enough of politics and business! I count the days until our marriage. I return from Flougoed bearing a gift of beautiful furs that you might wrap them round your slender, smooth young body.

With Passion Patrician

My beloved Patrician
 Since I saw you last, we hear rumours that you meet in darkened backrooms of alehouses frequented by pirates who call arms. Are you mad? Do you know not of my father, is so upset for bidding trade in arms? You won't the wedding, the council will not support a man who breaks the laws of God, no matter how much aid you have given the church and the poor.
 I am so vexed - I must see you soon.
 With concern
 A. Scon

My beloved Patrician
 I write with urgency to tell you which is stricken with the Plague. already your trading must have gained you a ship full of riches, make haste back to me that we might celebrate the heat of our passion and advance the marriage plans. My father had news... recently, a certain D. Arblay has begun business in the town and claims he will be Mayor, not you! The miserable cur! On your return you should be advised to throw a huge feast for the townsfolk.
 With Love
 A. Scon

The Patrician is an epic saga of power and money set in medieval Europe. Trading and strategy are key to taking your rightful place in the Hanseatic League - the most powerful group of highly organized traders who transformed international trading in the middle ages.

In your pursuit to become a member of this social elite, you begin your climb to the top maneuvering your status from humble merchant to elected Mayor and ultimately Alderman. But the road to the top won't come easily, with bribery, blackmail, lavish feasts and financial "donations" becoming your tools.

As the Patrician (an ancient roman aristocrat) you'll travel the high seas visiting sixteen seaport towns, each with different trading potential. Be careful though, your expedition will find you confronting pirates and using the primitive but devastating weapons of the time. Every decision you make has a bearing on what happens later, so you must be a skilled strategist in all aspects of your life, including personal relationships.

Complex, involving and addictive, you'll find The Patrician is in a league of its own!

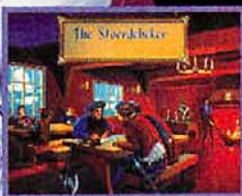
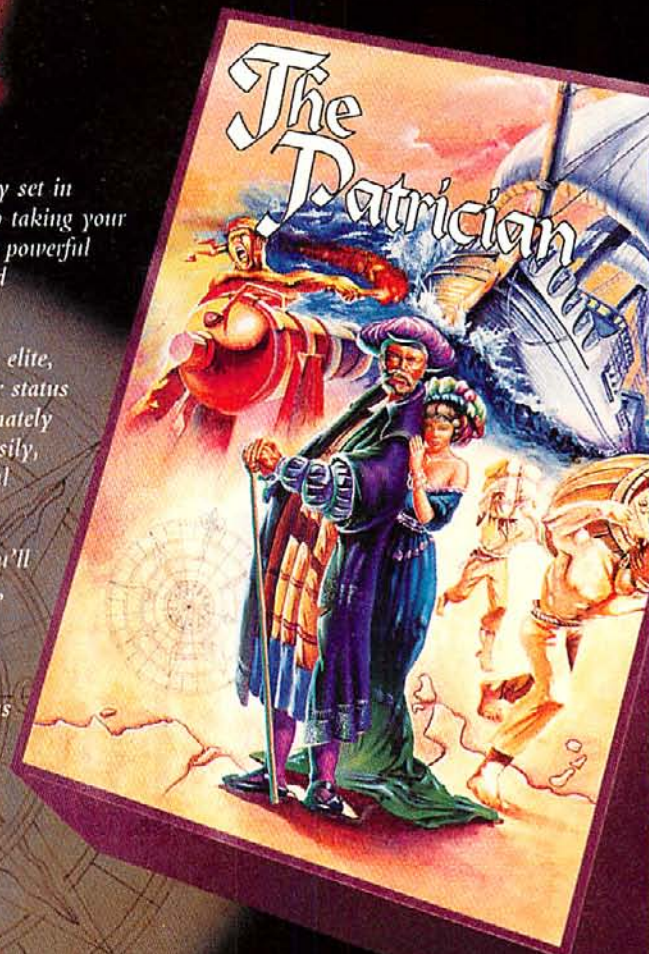

ReadySoft Incorporated
 30 Wertheim Court, Suite 2
 Richmond Hill, Ontario, Canada L4B 1B9
 Tel: (905) 731-4175 Fax: (905) 764-8867

Available for IBM PC, Amiga & PC CD-ROM

©1993 Ascon Ltd.
 Distributed by ReadySoft Incorporated



FABLES & FRIENDS: THE HAND OF FACE IS A TRADEMARK OF WESTWOOD STUDIOS, INC. © 1993 WESTWOOD STUDIOS, INC. VIRGIL IS A REGISTERED TRADEMARK OF VIRGIN ENTERPRISES, LTD. ALL RIGHTS RESERVED.

KISS CONVENTIONAL LOGIC GOODBYE

Now you see it. Now you don't. The land of Kyrandia is disappearing piece by piece and all the evidence points

conclusion: a curse. Thus second in the *Fables & Fiends*



toward one perilous conclusion: a curse. Thus second in the *Fables & Fiends*

the offbeat, young mystic who must voyage to the center of the world to break the spell. Out of sync and out on foot, your aberrant journey reveals nothing

is what it isn't. And one hand,



seems. Everything is what it you can count your friends on

Literally. Conspiring to push



the twisted edge of cinemagraphic entertainment, Westwood Studios has designed more puzzles and gameplay in the first few chapters of

The Hand of Fate

The Legend of Kyrandia

advanced graphics



than in all of

The most



on the market are first pencil tested, then painted on-screen to surrealistic perfection. Breakthrough

Trulight technology ically for a fuller, fourth



Shadow



Sunlight

illuminates each scene more cinematically dimensional picture. The new

State of Mind System, along with superior intuitive interfacing, enables you and



over 50 characters to change your mind, mood and mayhem based on preceding events. Don't just

play with your mind. Change the way your mind plays.

Grasp *The Hand of Fate* and kiss conventional logic goodbye.

THE HAND OF FATE

Westwood
STUDIOS



ROLE-PLAYING REVERSAL

Yserbius and Fates of Twinion Go From On-Line Games To Boxed Set

by Bernie Yee



When Sierra On-line's subsidiary, Dynamix, published what is perhaps the best fantasy role-playing game of the year in *Betrayal at Krondor*, it seemed that the stalwart adventure gamers at Sierra might be interested in testing the role-playing waters. With the *Quest for Glory* (QFG) series, Sierra was clearly no stranger to the conventions of the genre, but QFG has grown to be less of a pure hybrid adven-

Medieval Land, is not so much a sequel to *Yserbius* as a parallel game. There appears to be no plot relation between the two, except for the fact that both will suck up your on-line dollars and time. As for the stand-alone versions, that's a different story altogether.

The "boxed set" is a solo version of the on-line success. While TIN's *Yserbius* showed excellent on-line gameplay, with some puzzles solvable only by group cooperation, the boxed set is a hollow shell of its vibrant on-line self. Both *Yserbius* and *Twinion* are essentially the same games with different dungeon layouts and different monsters. Playing *Yserbius* without fellow on-line gamers is like being in an amusement park after hours, one in which the rides aren't all that fun to begin with.

Yserbius is no technological achievement in game design. In many ways, it is a throwback to the original *Bard's Tale* game, with a first-person view on your display and character statistics taking up your VGA screen, which is understandable since Joe Ybarra, a *Bard's Tale* implementor, contributed to the *Yserbius* design. Aside from the VGA niceties and the point-and-click interface, there really is nothing that truly distinguishes *Yserbius* from its 8-bit predecessor, other than the TIN gateway.

The appealing part of *Yserbius* is that you can start developing your hero or heroine off-line, then take him or her on-line where *Yserbius* really shines. This feature saves on-line time

and dollars by allowing you to become familiar with the environs, interface, and game mechanics before your modem gets that "ATDT" code and starts dialing your local TIN access number. As if to reinforce this off-line "proving grounds" marketing plan, *Yserbius* boxed sets come with 30 hours of free on-line time to TIN. That alone may make *Yserbius* stand-alone worth the price of admission for gamers who want to venture on-line.

Guide to Dining Alone

Yserbius and *Twinion* are examples of minimalist game design. The perspective is a simple, first person view that moves you through the dungeon in discrete 10' steps and 90 degree turns; it's the same system first done in *Wizardry I*, brought into color by *Bard's Tale*, and institutionalized by *Dungeonmaster* and *Eye of the Beholder*. The graphics are nice, though not up to par of the intricate walls found in *Eye of the Beholder*. Like *Eye of the Beholder*, you are limited to exploring underground settings, but unlike *Eye*, *Yserbius* has a very nice little auto-mapping function that keeps tabs on where you've been and where you should be going. Sound is adequate, and while there is a running musical score, the repetition can become tedious. As in *Ultima Underworld*, you play a



Shadow of Yserbius

ture/role-playing game than an adventure game with role-playing elements. Sierra conservatively opted to stick a toe in the pool rather than jump in with their new role-playing releases, *Shadow of Yserbius* and the *Fates of Twinion*. If these names sound familiar to you, that's because they are, far and away, the most popular gaming areas on The Imagination Network, formerly The Sierra Network, which is now run by Sierra and AT&T.

The game engine for *Yserbius* originally appeared on TSN installation disks, and the game was written specifically for multiplayer, on-line play. In a little role-reversal, the TIN interface now comes with the stand-alone versions of *Yserbius* and *Twinion*. *Twinion*, a recently opened section in TIN's

Shadow of Yserbius

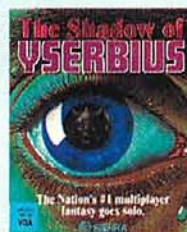

TITLE: Shadow of Yserbius
 PRICE: \$59.95
 SYSTEM: IBM
 REQUIREMENTS: 386-16MHz or better, VGA graphics, mouse; supports AdLib, PAS, Roland and Sound Blaster sound cards; Yserbius-9MB HD space
 Twinion-4.5MB HD space
 PROTECTION: None
 DESIGNER: Ybarra Productions
 PUBLISHER: Sierra On-line
 Coarsegold, CA
 (800) SIERRA1

THE FIRST SUPER-VGA FLIGHT SIMULATOR

SUPER-VGA HARRIER

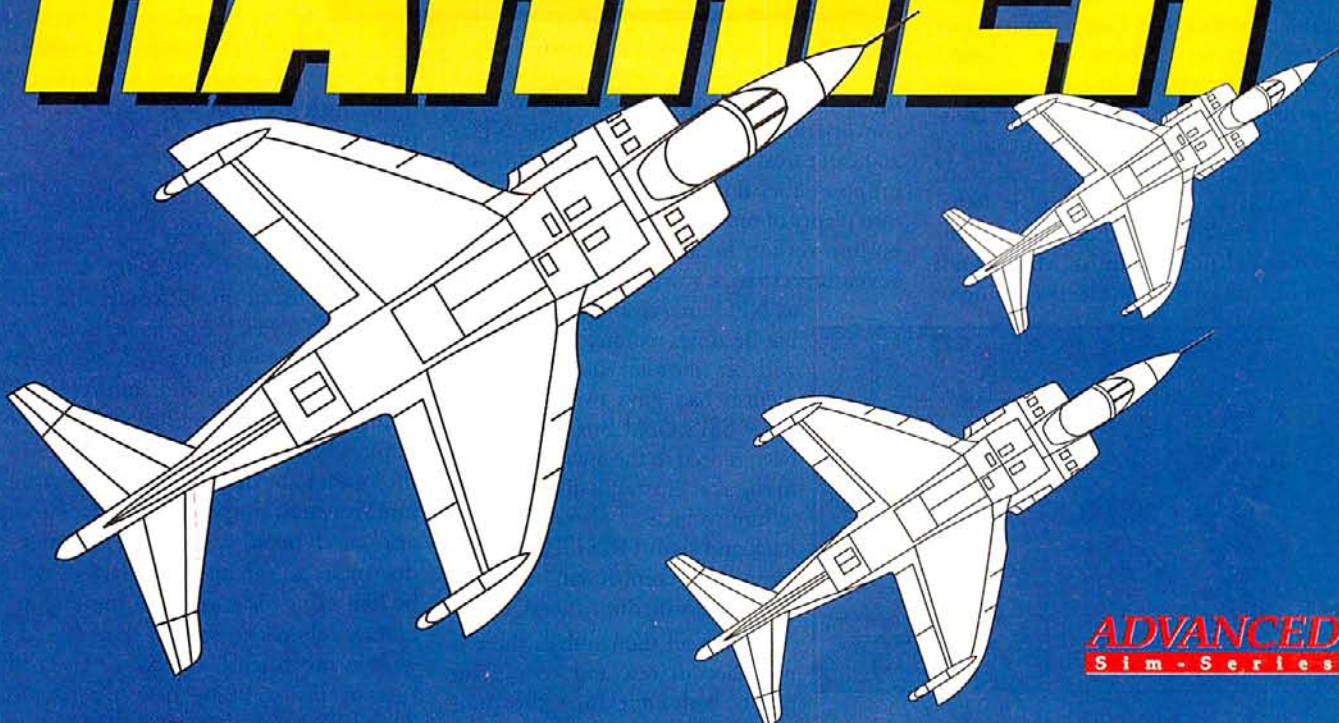

ADVANCED
Sim-Series

From the flight fanatics at Domark comes the first-ever strategic flight simulator designed for full-screen SVGA graphics technology. *This is not a typical flight sim.* SUPER-VGA HARRIER blows the competition out of the sky with super-fast, silky-smooth screen update — *at twice the resolution!* Now you can experience a much larger

visual world, where objects are sharper, cleaner and can be seen for miles.

"Harrier receives extremely high marks for graphics which are the best I've ever seen — BETTER THAN FALCON. The explosions and ground detail are really great."

— PC SOURCES MAGAZINE

"After playing Harrier in SVGA, all other flight-sims look like they are being played through a telescope... Not so long ago, a few glimpses at multi-million dollar serious flight simulators produced memories of images not far from those present in Harrier; very simply, it's that good."

— STRATEGY PLUS MAGAZINE

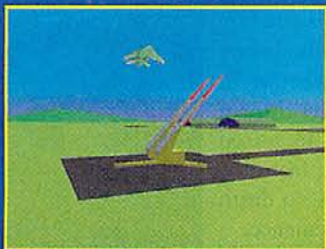

Screens shown: 640 x 480 256-color SVGA resolution.

IBM PC/COMPATIBLES: Available October 1993

Super-VGA Harrier ©1993 Domark Group Ltd.
Published by Domark Software Ltd.
Programmed by Simis Ltd. Graphics by the Kremlin.
Sound by Martin Walker. Produced by Jim Tripp.
Falcon is a trademark of Spectrum HoloByte.

DOMARK™

1900 S. Norfolk St., Suite, 202, San Mateo, CA 94403 415/513-8929

DISTRIBUTED BY
Spectrum
HoloByte

Visa/MC orders:
call 24 hrs a day,
7 days a week:
1-800-695-GAME
(orders only).

Circle Reader Service #227

solo adventurer with no one lending a hand or a sword. In the TIN version of *Yserbius* and *Twinion*, the whole point is to join a party of adventurers to recreate the feeling of sitting around the dining room table with a group of friends, rolling dice and mapping your latest adventure in the pen-and-paper variety of role-playing games.

Combat is also simple and straightforward, resembling the system used in *Dungeonmaster* or *Eye of the Beholder*. It lacks some of the tactical nuances in the SSI Gold Box series (including America On-Line's multiplayer Gold Box game, *Neverwinter Nights*), *Darklands* and *Riftwar*—which is a pity, considering that *Yserbius* is really a game of combat. You face off with one or more groups of baddies (some of which can be out of sword range), and if your sword swipe is lethal enough, you can kill two, three or four monsters with one round of combat. Magic is not really an offensive factor in the beginning of



Fates of Twinion

the game, though certain scrolls (like the Scroll of Protection) and potions (the Elixir of Healing) are necessary for surviving the tougher encounters. Luckily, you can also buy these items in the local store.

The magic system is also familiar. Your character is allotted a certain amount of Mana, or spell points, which increases with experience to enable you to cast more spells with greater effectiveness. Offensive spells, such as lightning, and defensive spells like Energy Field, are matched with information spells that find secret doors, reveal set monster encounters (but not random ones), and more. *Twinion* starts the adventurer off with no spells, while *Yserbius* gives you a starter set of enchantments.

In between casting spells and killing creatures, don't expect much conversation. There is no non-player character interaction in the boxed set of *Yserbius*. Nor is there any in the on-line version, but people are too busy talking with each other and having fun to notice. The NPC interaction is of the "step on the



Shadow of Yserbius

square, get a message" variety. There's no conversation, and you can't fight the NPCs and can't steal from them; for all intents and purposes, they don't exist. Although you run into plenty of monsters (scaled back from the on-line version because there are no other adventurers to back you up), they don't count as NPC interaction. In fact, combat becomes tedious after a while, with set "monster squares" that replenish bad guys over and over. Since SSI's Gold Box games have been retired to the great hard drive in the sky, the stand-alone *Yserbius* is sure to take its place as the big hack and slash FRPG. Unless you are a pure combat fan, this is a dubious distinction, at best.

Despite all the combat, there is no place to rest and restore hit points without exiting the dungeon, unless you find a magical fountain. Luckily, Mana and Heal potions are often found as booty, and you will use them up quickly. And in a bit of idiosyncrasy left over from on-line play, adventurers can leave the dungeon and head back to the "inn" while in the middle of exploring a level. There are two entrances into the dungeon, the main entrance and the "resume" entrance. The "resume" entrance puts you back where you left, and the main entrance puts you at the beginning. But you can still go to the store, sell off items and buy more potions and scrolls, before "resuming" your last adventure. If you die, however, you get thrown back to the inn and you are forced to start your spelunking from the main entrance. There is no death in *Yserbius*, only inconvenience.

Everlasting God Stompers

Character development lacks the subtlety of other great FRPGs like *Riftwar*, *Darklands* or *Ultima*. Pretty soon, your *Yserbius* or *Twinion*

hero will have hundreds, if not thousands of hit points, and he or she will be tossing around spells that not only reduce your opponents to cinders, but should be covered by the latest nuclear non-proliferation agreement. Much as the *Bard's Tale* series was reduced to megalomaniacal idiocy with characters and villains that resembled gods more than Merlin or Arthur, *Yserbius* will give you that feeling of gods among men, as your character stomps on enemies like you would crush an ant. Obviously, little thought was given to character progression and development.

Obviously, little thought was given to character progression and development.

Despite these flaws, there is something to be said for *Yserbius* as a stand-alone game. It is refreshingly simple to play—no complex notes to keep, no changing conversation branches, just go in, kick butt and take the treasure. With a few puzzles in the diet to give you some fiber with your hack and slash meal, you have a diverting and amusing FRPG to occupy your time for a little while. Problem is, most FRPGers don't want to be amused—they want to be thrown into a real world, with rare treasures, unspeakable horrors and, like any good book, a gripping storyline that doesn't let go. That's a good RPG—it should be like *being there*. If Sierra is going to do a fantasy role-playing game, they should do it with as much relish as a *King's Quest* adventure or the stunning new *Gabriel Knight*. There is no way that, in the age of *Lands of Lore*, *Riftwar*, and *Ultima VIII: Pagan*, you can take an FRPG like *Yserbius* seriously as a stand-alone game. As an introduction to TIN, *The Shadows of Yserbius* and *The Fates of Twinion* succeed nicely. No doubt that it will gently introduce many gamers to the joys of multi-player gaming. But if you want to be captivated and lose track of time while playing a stand-alone game, pass by the *Yserbius* and *Twinion* for greener pastures. There's a lot of them. **CGW**



Fates of Twinion

OTHER GAMES MAY TALK. THIS ONE HAS A VOICE.

Star Trek: The Next Generation's

PATRICK STEWART

in

LANDS OF LORE: *The Throne of Chaos*

With Patrick Stewart as the voice of King Richard, *Lands of Lore* has a royal advantage over other fantasy games: An actor of real authority in a role of authority, at the head of a huge cast of heroes and villains who speak, rant and roar their way through the most vocally interac-



tive role-playing adventure yet devised. (A mammoth 130 MB of digitized speech makes it possible.)



The Dark Army is on the move, led by the shape-shifting sorceress Scotia—and each time you meet her she'll be more powerful and terrifying than the last. But your powers can grow, too. Experienced-based character development makes great warriors of those who take arms (in real-time combat) against a sea of indescribable monsters



and makes mighty wizards of those who cast Larger-Than-Life spells. Explore ancient castles, living

forests, hidden lairs, bustling towns, haunted caverns, through 30 enchanted levels made vividly real by more than 20 MB of compressed art and special effects.

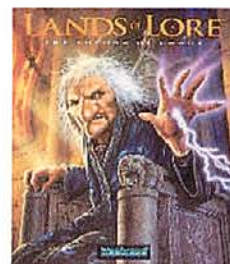

For the PC CD-ROM

Westwood™
STUDIOS

DISTRIBUTED
EXCLUSIVELY BY

Virgin

Saturday Morning Fever!

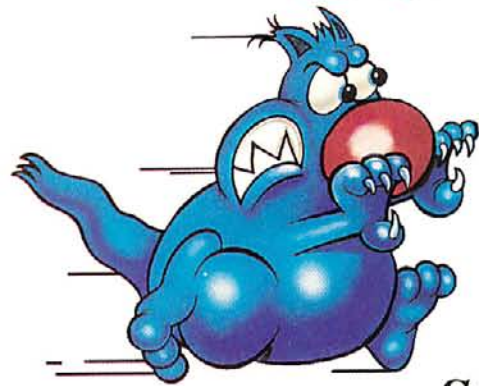

Sid & Al's Incredible Toons Will Drive You Looney Tunes

by Neil Harris

Back in the early part of the century, artist Rube Goldberg created newspaper cartoons diagramming machines of fantastic complexity. His machines were typically "time-saving devices" that accomplished their goals through an outlandishly circuitous chain of events. It might start with an anvil dropping on a seesaw which propelled a mouse through the air onto a platform with some cheese which released a balloon which triggered a switch...all ending in the completion of a menial household task. Rube Goldberg's machines became part of American folklore, leading to one of the stereotypes of the mad inventor—the father in "Honey, I Shrank the Kids," for example.

In Dynamix' recent puzzle game, *The Incredible Machine*, the goal was to create incredible machines in the Goldbergen vein and to solve mechanical puzzles. In the puzzles, an item or group of items was missing from a machine, and it was the player's task to figure out which item was missing from where. I showed this game to an engineer friend who immediately became addicted. He bought a copy and showed it to all his friends, leading to a chain reaction that brought productive work to a halt at a major naval yard. I wouldn't be a bit

surprised if the next propulsion system for battleships is just a wee bit more complex than it might have been otherwise.

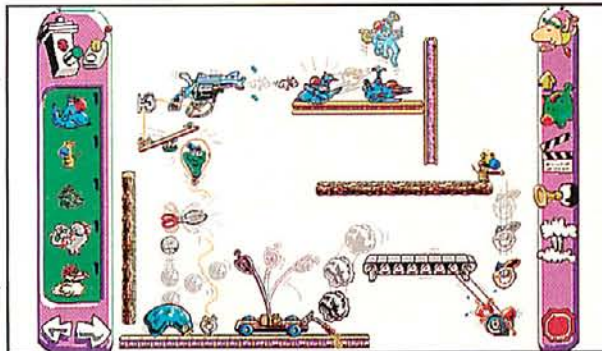

Sid & Al's Incredible Toons is the sequel to the *Incredible Machine*—and boy what a sequel! I'll be up front and admit my unabashed love for this game. It's exactly what I wanted from a sequel to *The Incredible Machine*. The puzzles are more challenging, the animation and sound effects are hysterically funny, and there are a host of small improvements.

A Game With Character

Like *The Incredible Machine*, *Sid & Al* is a series of puzzles that begins with a goal and with some of the parts needed to complete the goal. The object is to choose from the pieces available and produce the desired result. The difference is that the machine "parts" are wonderfully drawn and animated cartoon characters. Whereas we were dealing with mostly inanimate and mundane machine

parts in *The Incredible Machine*, we are now working with Sid Mouse and Al E. Cat, two animated creatures who look like washed up rejects of a by-gone cartoon era, each having the stereotyped animosity for the other's species. In the puzzles, perhaps Al will have to catch Sid, or Sid will have to destroy Al. By placing the pieces together just so and pushing the "on" switch, a series of animated steps play out on the screen until the goal is reached, in its action looking like something Wile E. Coyote had ordered from ACME, though hopefully performing more effectively.

So where *Sid & Al's Incredible Toons* bounds past the original game is in its character, or rather, its characters. Along with the titular stars, Sid and Al, is a supporting cast of toons including Bik Dragon, Eunice Elephant, and Hildegard Hen. Each character has a set of actions him, her, or it will take under different circumstances. If Al sees a dead fish, he'll lurch his overfed self over to it and scarf it down and spit out the bones. Al will also eat bananas and bubble gum. If he sees Sid, he'll chase him. Dropping things on Al's head get different reactions. Something heavy will make a small flock of birds circle his head, tweeting merrily. An egg will crack and he'll do a slow burn, frying the egg. The variety of

reactions and animations is a real treat. I'm sure there are many animations still lurking in this game that I haven't seen yet because I haven't put together the right combination of circumstances so far.

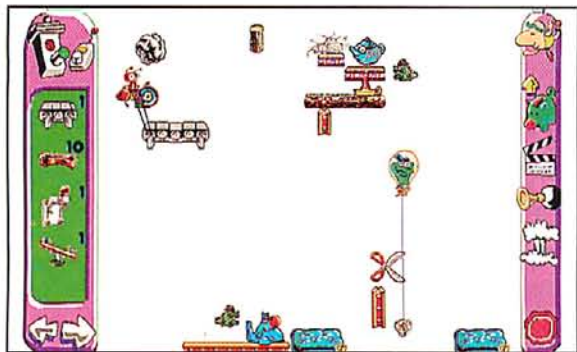

The supporting characters have a lot simpler reactions than Sid and Al. Bik Dragon spews fire when bumped, useful in lighting bomb fuses, heating teapots, or toasting one of the other characters. Eunice the Elephant vacuums up peanuts and anything else in the vicinity of her favorite snack, and she also tosses objects and, of course, runs away from Sid the Mouse in terror. Hildegard Hen lays an egg if she's bumped, and the egg drops down onto something or someone.

Most of the reactions are logical and internally consistent within the game, and will be familiar to those of us reared on Saturday morning cartoon shows. There are a few that I have trouble with, mainly the fact that some characters and objects are

arbitrarily immune to the effects of gravity. I mean really, an *elephant* is not affected by gravity but a mouse is? It's only a quibble really, because you get used to the rules in a hurry. If you care to read the manual, it's all there, but most of us will learn more from trial and error. It's more fun that way.

More Objects Than Carter Has Liver Pills

One major improvement over *The Incredible Machine* is in the variety of the objects you have available. I counted 66 different objects, not counting the characters already discussed. Some of them are only slight variations of each other, like the five types of

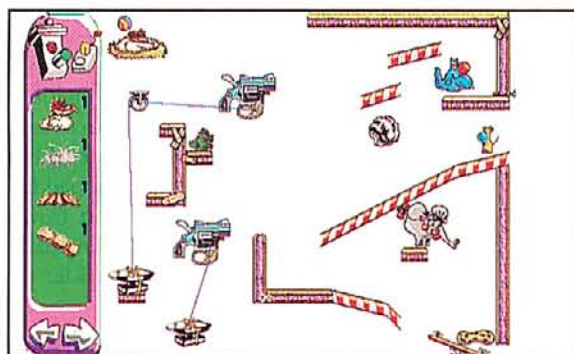

inclines and six types of walls, which vary in appearance and in how slick they are when something is sliding along them. Some items are unique. And some, like the gears, pulleys, conveyor belts, rope, electric switch and outlet, and teeter-totter are pretty much identical to the parts available in *The Incredible Machine*.

Some of the objects have interesting properties that can be adjusted. The Rataput can be set to fire off one or multiple boulders. The timer can be set to go off immediately or to delay until a later time. Generally you have to adjust these just right in order to bring off the desired result. One of my favorite new objects is the Chow-Man Motor. If some food drops into his tray, the Chow-Man scarfs it up, his chest puffs out, and he jogs along his treadmill. Sid ought to consider getting this kind of exercise.

The tunnel is another handy item. It comes in two identical parts, and a character going in one part will come out the other before long. I keep expecting a train to come out of one of them. Maybe I haven't hit a high enough level yet, or maybe the designers are

saving that for the next sequel. A nice touch is that Sid puts on a mining helmet before going into the tunnel, and when he comes out the first thing that becomes visible is the beam of light from the helmet.

Nobody Said This Would Be Easy

While the previous game was a challenge, with a little perseverance (and maybe a few friends kibitzing over a few shoulders) it could be solved completely.

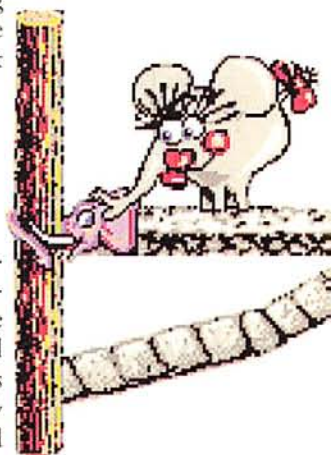

I find this game to be *much* tougher.

It's divided into levels. The first is called Cake Walk, and it's very simple, designed to demonstrate the basics of the different parts and get you used to the game. The next section, called All Brawn, No Brains, are about at the level of the puzzles in the prior game, requiring a lot of trial and error along with a good dose of inspiration.

From then on, it's time to sweat. The third level is called Really, Really Hard, and it's not named that way to make you feel good. On the earlier levels I had the stamina to solve many puzzles in each sitting. On this level, it's all I can do to get through one, after which it's time for a hot toddy and a good night's rest.

That's not all. There is an even tougher level—Looney Bin!, which might just send me there. After a while I get the feeling that this level was created just so Dynamix can sell hint books. Ten of the puzzles in this level can't even be attempted until all 90 of the other puzzles in all the levels have been solved. At the end of all 100 puzzles there is some kind of spectacular show, or so the documentation says. I may never see it myself.



Toon It Yourself Kit

The designers would have been severely remiss if they didn't let players design their own puzzles using all these wonderful characters and gizmos. Of course they knew better. The HomeToons section gives you a blank slate and a full selection of all the pieces to play with. You can even save your puzzles to disk and trade them with your friends or, as the manual suggests, upload them to your favorite on-line service for the rest of us to try—especially those of us still stuck on the Looney Bin! level.

The only shortcoming in the HomeToons section is that the game can't be programmed to understand when the puzzle has been completed successfully. That's a shame. Perhaps the designers can take this on as their own puzzle for the inevitable next generation game.

More Improvements

I mentioned earlier that there are many small improvements to *Sid & Al's Incredible Toons* compared to its predecessor. This

game automatically saves your progress and eliminates the strange set of codes that saved your score in the older game. A score system with points based on speed of solving the puzzles was apparently judged superfluous—solving the puzzles is certainly reward enough for me.

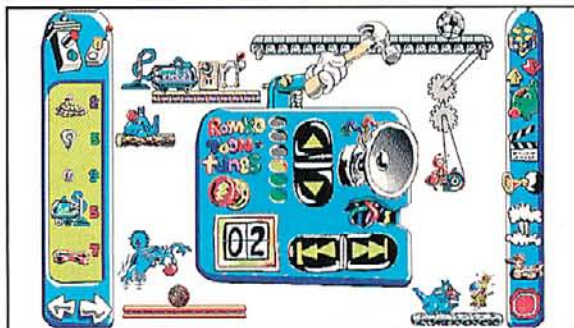

The other improvement I'm very fond of is the screen dump feature. The game creates a disk file containing a screen dump when you hit the ALT-S key combination: a handy feature if you want to analyze a screen away from the computer. This would be very handy from inside a padded cell, although the psychiatrist might frown on it. On the other hand, solving the puzzle that sent me there might be therapeutic.

Finally, a special mention should go to the folks who put together the manual, Michael Waite and Richard Tunnell. The manual is well organized, fun to read and, with its cover parody of TV Guide and frenetic layout, in the spirit of the game.

Kudos Deserved

Jeff Tunnell and his co-designers, Chris Cole and Brian Hahn, have pulled off a winner here. *Sid & Al's Incredible Toons* deserves a place on your computer and will certainly show up on best game of the year lists. It's challenging to solve, fun to play, and great to just watch the animations and listen to the sounds. **cgw**



the FASTEST CD DRIVE ON THE MARKET

Q DRIVE CD \$599⁹⁵

MAC/PC

SPECIAL BUNDLE

- Chessmaster 3000
- Loom
- Secret of Monkey Island
- Stellar 7

\$799⁹⁵

Call for a FREE CD-ROM catalog filled with our complete line of CD's & Multimedia accessories!

1-800-777-3642

Quality Computers™

Features:

- RCA stereo jacks
- Front head phone jack
- Personal head phone set
- Two stereo speakers
- Double enclosure door
- Automatic lens cleaner
- Plays audio CDs
- Fast 200ms access time
- 330 KB/sec transfer rate
- Multi-spin technology
- Photo CD capability
- MTBF 50,000 hr's
- Two CD-Roms

SPECTRUM ELECTRONICS

P.O. BOX 6295
SALINAS, CA
93912-6295

1-800-983-4321
CALL US TODAY!!
ask for catalog

CD	Price	CD	Price	CD	Price
7th Guest	\$54	Armored Fist	\$52	Sim City 2000	\$46
AD&D Dark Sun	\$56	Bloodnet	\$45	Star Control II	\$38
AD&D Dungeon Hack	\$40	Blue and the Gray	\$46	Spaced Hulk	\$45
AD&D Eye of the Beholder Tri	\$56	Clash of Steel	\$45	SSN-21 Seawolf	\$55
AD&D Fantasy Empires	\$46	Commande & Mission Disk #1	\$52	The Great War 1914-1918	\$48
Blue Force	\$42	Command Adventures: Starship	\$43	Tie Fighter	\$48
Dracula Unleashed	\$51	D&D Stronghold	\$45	Ultima VIII: Pagan	\$59
Dune	\$45	Domination	\$45	V for Victory Gold Juno Sword	\$46
Eric the Unready	\$37	Dune II	\$40	Victory at Sea	\$52
Great Naval Battles	\$58	Eye of the Beholder I or II	\$16	War in Russia	\$53
Iron Helix	\$59	Eye of the Beholder III	\$48	Warlord II	\$42
Journeyman Project	\$52	Falcon 3.0	\$50	When Two Worlds War	\$40
Labyrinth of Time	\$50	Forgotten Castle	\$59	Wing Commander Academy	\$41
Legend of Kyrandia	\$48	Front Page F.B.Pro	\$46	CD ROM DRIVES	
Robot Assault	\$45	Global Domination	\$39	Creative Omni CD	\$379
Return to Zork	\$48	Harpoon II	\$52	Sound Blaster Discover CD	\$479
Sherlock Holmes, Cons I or II	\$39	High Command	\$50	16 Multimedia Kit	\$479
Sherlock Holmes, Consulting III	\$51	Inca 2	\$46	Sound Blaster Education CD	\$539
Strike Commander	\$59	Isle of the Dead	\$37	16 Multimedia Kit	\$539
Tony La Russa Baseball II	\$56	Kasparov's Gambit	\$46	Texel CD ROM	\$439
Ultima I-VI	\$59	Master of Orion	\$39	WE SELL:	
Ultima Underworld I & II	\$59	Police Quest 4	\$46	IBM	SEGA
Wing Commander 2 Deluxe	\$40	Prince of Persia 2	\$45	MAC	SNES
Wing Commander I Deluxe	\$40	Privateer	\$57	3DO	
Wing Commander I/Ultima VI	\$40	Quest for Glory 4	\$46	ATARI JAGUAR	
Wolfpack	\$42	Return to Zork	\$48	WE SELL	
IBM		Sea Team	\$45	ALL COMPUTER & VIDEO	
AD&D: Dark Sun	\$56	7 Cities of Gold (commem.)	\$39	ENTERTAINMENT PRODUCTS	
AD&D: Dungeon Hack	\$46	Shadowcaster	\$52		

ALL SALES FINAL, NO REFUNDS

PRICES SUBJECT TO CHANGE. CONTACT PUBLISHERS FOR DEFECTS
20% RESTOCKING FEE ON RETURNED & REFUSED ITEMS

PAYMENT: CHECKS (ORDERS SHIPPED WHEN CHECK CLEARS)

MONEY ORDERS (TREATED AS CASH)

CA residents add \$7.25 sales tax

FREE SHIPPING WITH \$100 PURCHASE, UNDER \$100

ADD \$5 PER ORDER, 2ND DAY AIR ADD \$7

OTHER SHIPPING TERMS ARRANGED. COD ADD \$5

EXPERIENCE LIVE-VIDEO · HIT SONGS · SOUND EFFECTS · AMAZING GRAPHICS · CHALLENGING GAMES

NEW!

EXPERIENCE LIVE-VIDEO · HIT SONGS · SOUND EFFECTS · AMAZING GRAPHICS · CHALLENGING & ENTERTAINING GAMES

The Ultimate Interactive Video Dating Game

Dream Girl

Live...ON CD!

HIT SONGS INCLUDED!
 DREAM GIRL, DREAM BOY
 ONE MISTAKE
 BEST OF LOVERS, BEST OF FRIENDS
 HOLDING ON - ENDLESS NIGHTS
 THIEF OF HEARTS
IN 8-BIT AND 16-BIT STEREO SOUND

Do you have what it takes to be with the most beautiful models around? Now you can find out thanks to the latest in computer technology! This advanced interactive multimedia game places you in the action with live-video, sound effects, amazing graphics and hit songs! You determine what happens next as your Dream Date asks you questions! The better your response the further you get! At last you have a chance to spend time with beautiful models and win their hearts!



SUPER BONUS!
Windows Screens Saver Included!
 Protect your computer screen with Live Video, Songs and Super Graphics! (\$29.00 value)

ONE OF THE FUNNIEST GAMES OF THE YEAR!

Sold at better computer stores, everywhere! Or to order direct call:

1-800-465-CDCD

Call (416)656-6406 for technical information or support.



by **Microforum**

EXPERIENCE LIVE-VIDEO · HIT SONGS · SOUND EFFECTS · AMAZING GRAPHICS · CHALLENGING & ENTERTAINING GAMES

EXPERIENCE LIVE-VIDEO · HIT SONGS · SOUND EFFECTS · AMAZING GRAPHICS · CHALLENGING & ENTERTAINING GAMES

To receive a **FREE** catalogue of Microforum CD titles or for **DEALER** inquiries please call (416)656-6406 or fax us at (416)656-6368

Palm Reading The Hand of Fate



Hands On Experience With Westwood's Latest Adventure

by Scorpia, Adventure Games Editor

The *Hand of Fate* is the second in Westwood Studio's *Fables & Fiends* series, a sort-of sequel to *Legend of Kyrandia*. Sort-of, since the main character is Zanthia the alchemist, a supporting character in the first game, rather than Brandon.

The land of Kyrandia, as usual, is in trouble, but this time the trouble is more than a megalomaniac jester: slowly, piece by piece, Kyrandia is disappearing. If this goes on much longer, there won't be any Kyrandia left at all. Not a pleasant prospect to contemplate.

Naturally, all the mages and sages paw frantically through musty old volumes hoping to find a solution. Naturally, they don't find anything. The outlook is pretty grim until Marko (a wannabe mage) shows up with his new assistant, a hand. The hand, through diagrams, explains that they need an anchor stone from the center of the world to keep Kyrandia together. Zanthia is unanimously chosen to go get it. Lucky Zanthia!

The task would seem to be a simple one, until Zanthia returns home to find all her equipment smashed and supplies stolen. Obviously, someone doesn't want her fixing up the problem, and now she has to get to the center of the world the hard way. This is where the game actually begins.

Hand of Fate is a linear adventure, divided into sections, that begins with the swamplands around Zanthia's house. Each time a section is completed, you move on to the next one, and there is no going back to a previous area. Usually, this makes players nervous, as linear games often require that some obscure item from the beginning be used at the end.

Happily, this is not the case here. Every time Zanthia moves on, she tends to lose

most or all of her inventory. Thus, each new section provides everything necessary to solve the puzzles in it, and there is no need to worry about having overlooked some crucial item back in the swamps, or anywhere else for that matter.



Graphically, and in terms of the interface, the game is similar to *Legend of Kyrandia*. So *Hand of Fate* is visually pretty and the point-and-click system easy to use. Clicking on an item picks it up to become the cursor; the item can then be placed in the inventory or clicked on something or someone else to "use" it.

Conversations are handled in a similar manner, but they are automatic sequences. Clicking on people usually starts them talking, with Zanthia making pre-determined responses; there are no choices to make as to what she will say. Then again, conversations are not a main item here, although it is important to talk to everyone you meet at least once.

It was nice to see a female lead character for a change. Too many adventures these days are still male-oriented as far as the main character is concerned. Featuring Zanthia in this one earns Westwood a point on my scorecard.

There has been a definite improvement in puzzle construction over *Kyrandia*, where too many solutions depended solely on trial-and-error. You can, of course, solve almost any puzzle in any adventure with that method, but it is often time-consuming and tedious. Most players prefer situations where there is a logical connection between the item(s) and the solution, even if it takes them a while to figure out what it is.

So it's good to see that many of the puzzles in *Hand of Fate* can be thought out, if you take the time to think about what needs to be done. Naturally, some answers are going to be a little obscure, but games that are too easy usually aren't all that satisfying.

However, Westwood is still a little too fond of red herrings (misleading items), which can be found all over the place. One or two are traditional in adventures, but *Hand of Fate* has more than its share of them. This can become frustrating, with players wasting time over things that really aren't

The Hand of Fate



TITLE: The Hand of Fate
 PRICE: \$62.99
 SYSTEM: IBM
 REQUIREMENTS: 386-20MHz or better, DOS 5.0 or higher, 2MB RAM (1MB XMS or EMS), VGA/MCGA graphics, 20MB hard drive space, 3.5" HD floppy drive, Mouse; supports AdLib, AdLib Gold, Sound Blaster (SB Pro), Roland MT-32/LAPC-1 and General MIDI
 PROTECTION: None
 DESIGNERS: Westwood Studios
 PUBLISHER: Virgin Games
 Irvine, CA
 (800)874-4607

TORTURED
SCREAMS.
EAR PIERCING
SHRIEKS.
ANGUISHED
CRIES.

NOISES FROM THE
SOUND CARD YOU
JUST BOUGHT?

NO.

FROM YOUR
WALLET.

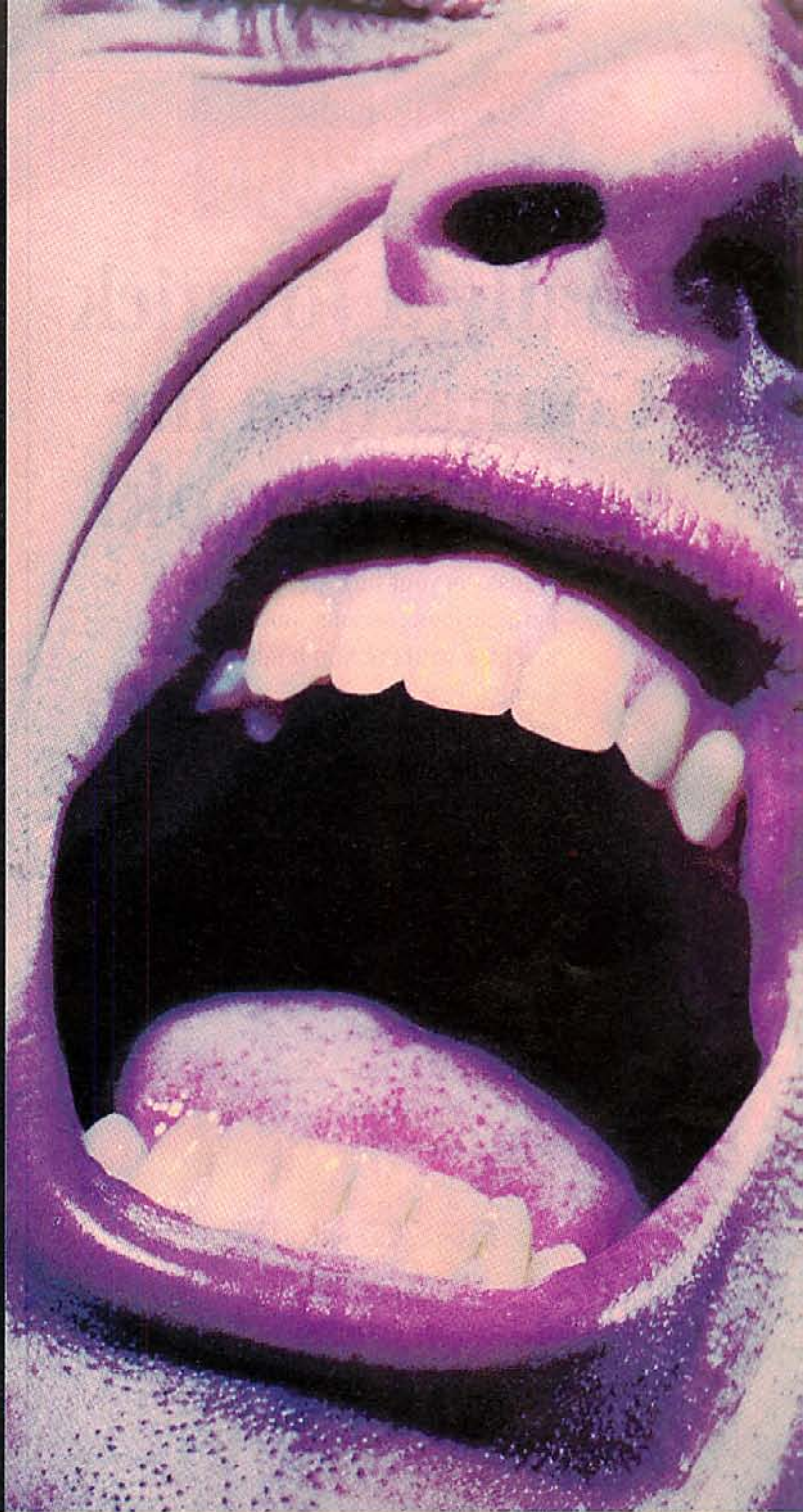

Must a 16-bit state-of-the-art sound card cost an arm, a leg and several other appendages? Must you raid your children's college fund to get the CD-quality audio supplied by 32 Operator Wavetable Synthesis? Must you fork out a sum equal to the GNP of a small European nation for Sound Blaster™ compatibility and a MIDI interface? In a word, no. The new ARIA 16 offers all of this, plus easy installation and a Digital Signal Processor that allows

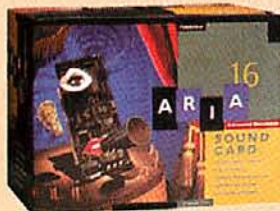

you to upgrade to speech recognition, for the oddly level-headed price of \$99. Or, for a bit more, there's the ARIA 16se, featuring a SCSI-2 interface, a mic/headset, and Interplay's *Star Trek®: 25th Anniversary™*: 3 Episode Edition with ARIA speech recognition.

To learn more, call us at 1-800-477-3473. And give your ears the sound they want. Without ticking off your wallet.

Prometheus®

Circle Reader Service #109

©1994 Prometheus Products Inc. All trademarks are property of their respective companies. © & © 1993 Paramount Pictures. All Rights Reserved.

STAR TREK is a Registered Trademark of Paramount Pictures, Prometheus Authorized User.

Finally, a Joystick Connection for Your Notebook!

Transform your high-performance portable into a serious simulation machine with the Notebook Gameport™. Connect an IBM-compatible joystick or yoke and rudder pedals.

The Notebook Gameport™ not only maximizes the entertainment potential of your notebook computer, it's also the quickest, easiest joystick connection for your desktop! Ask your local retailer for the Notebook Gameport™ or call Colorado Spectrum to place your order.



COLORADO SPECTRUM

748 Whalers Way, E-201, Fort Collins, CO 80525
International Telephone: (303) 225-1687

(800) 238-5983

9-Pin Connector to Computer's Serial Port

Easily connects to all IBM compatible notebook and desktop computers.

Four-axis Gameport

Supports joystick & rudder pedals simultaneously. No calibration, jumpers or manual speed adjustments necessary.

Pass-through Serial Mouse Port

Mouse remains fully operational while gameport is in use.



important at all. Mustard Island is a case in point. You can easily spend hours trying to deal with the cannibals, when in fact the real puzzle is to avoid the island completely in the first place.

There is also a certain amount of subtle misdirection that can lead you down the garden path if you aren't careful. For instance, throughout the game Zanthia concocts little potions to help in different situations. The trick is that she won't be making *all* the potions listed in her recipe book. So it's easy to get caught in a mindset that looks to magic instead of logic for a solution to a particular problem.

The best way to approach *Hand of Fate* is to keep in mind that everything you need in a section of the game can be found in that section. If one or more ingredients for a potion can't be found, it's a good bet that magic isn't the answer to the puzzle you're trying to solve. Look for another way of doing it.



One of the surprising things about *Hand of Fate* is that it's really a rather short adventure. There are only about seven sections to it, all of them fairly small. Some areas may be more difficult than others, but in general experienced gamers are likely to finish this one quickly.

If the game has one really sore point, it's the ending. Having gone through the game using your head, you are suddenly thrust into what is a type of mini action sequence, which is done in real time. The only "puzzle" here is figuring out which ways Zanthia should jump to avoid an unpleasant demise. The use of what is basically an arcade sequence is a jarring note, and really doesn't fit in with the rest of the game as a whole. A less active, and more puzzle-oriented, endgame would have been better.

Overall, *Hand of Fate* is a humorous, moderate-level adventure game. Much of what was wrong with *Legend of Kyrandia* has been cleaned up, although Westwood's technique still needs a little more polish (and a few less red herrings). Anyone looking for a short-term adventure workout is likely to enjoy this one. **CGW**

"THE GRANDEST FLEET"

IS COMING !!

FROM Q.Q.P. INC

"OUR FINEST GAME YET"

Also Look Out For
The Perfect General II
And The Lost Admiral II

(908) 788-2799
495 Hwy 202
Flemington, NJ 08822

Can Larry Keep It Up?

Leisure Suit Larry Lands His Sixth Sexy Sequel

by Allen L. Greenberg

As ludicrous as it may seem, there was once a time when leisure suits were not only regarded as fashionable, but even quite attractive. Leisure Suit Larry, on the other hand, has never been considered either fashionable or attractive. In fact, this sex-conscious fictional character (along with his creator, Al Lowe) may have even contributed to the justifiable death of leisure suit popularity. Larry, whom one might describe as a Saturday morning cartoon character let loose in a whorehouse, appears to have

recently call "the Land of the Lounge Lizards" one's roots) the hero is once again alone and desperate for female companionship. This time, however, Larry has stumbled onto the palatial facilities of "La Costa Lotta" health spa. In one of Sierra's famous mega-introductory sequences, we discover that Larry has won two weeks at the place as consolation prize after appearing on a television dating show. (First prize winners, according to one staff member, need only remain for a single weekend.) From the moment he steps up to the reception window, Larry finds himself facing some of the most beautiful women he could ever hope for. To bed even one of them, Larry would fulfill any quest or satisfy any need. In order to succeed in *LSL6*, Larry finds himself striving to fulfill the requests of nine different women, so that they, in turn, might satisfy his.

The alluring inmates at "La Costa Lotta" include a thunder-thighed receptionist whose only hope is that Larry will manage to repair the facility's liposuction apparatus—a machine that, when functional, appears capable of draining Lake Michigan. A sadistic exercise trainer named "Thunderbird" tries to entice the hero with the joys of leather, chains and handcuffs. Rose, who specializes in colonic treatments, wants only a small gift (certainly within Larry's capabilities). The lilting Burgundy might notice Larry if she could only set aside her guitar for a moment. Merrily is in the mood for love only when she is bungee jumping, and Char claims to be in desperate need of batteries for her "friend." The hard-bodied Cav would be willing to double date,

while Shablee wishes only for a new dress, yet hides a secret behind her romantic eyes. Finally, Shamara keeps herself, as well as her inner thoughts, hidden from the rest of the spa.

As is usual with Larry, though he works hard to meet the needs of women, he rarely receives what he has earned, and moments of romantic climax quickly turn to painfully comical punch-lines. It is easy to imagine yourself sitting on a stool in Lefty's bar, listening to Al Lowe as he tells Larry's funny, sad story, punctuated by frequent elbow-jabs to the rib cage. It is only through Larry's luck, as well as your perseverance, that the hero will finally experience the night of his dreams. There are additional game points to be earned, provided you are willing to endure several of Larry's less glamorous bodily functions.

In addition to Larry's prospective conquests, there are several innocent bystanders with whom he will have to deal. One of the spa's employees carries a wrench, without



learned all about life either in a schoolyard alcove, or by repeated viewings of teen hormone movies.

To know Larry is to become familiar with a wealth of sexual puns and double entendres previously unworthy of human awareness. To date, Larry has appeared in five adventures, only four of which have been published. (Al Lowe has casually stated that he has no intention of issuing Larry's fourth adventure, and we can only assume that it was just too vulgar for public viewing.) *Leisure Suit Larry 6: Shape Up Or Slip Out!* (*LSL6*) has now been released by Sierra, and it manages to live down to the same seamy moral standards set by the previous four.

Gone, for this outing, is Larry's former partner Passionate Patti, with whom Larry was forced to share equal screen time in his previous adventure. In what may be a "back-to-the-roots" move for Larry, (if one can hon-

Leisure Suit Larry 6: Shape Up Or Slip Out!

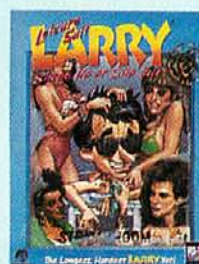

TITLE: Leisure Suit Larry 6: Shape Up Or Slip Out!
 PRICE: \$69.95
 SYSTEM: IBM (DOS and Windows)
 REQUIREMENTS: DOS Version—286-16MHz or better, 10MB hard drive space, mouse. Windows Version—386SX or better, 2MB RAM, Windows 3.1; supports AdLib, General MIDI, PAS-16, Roland, Sound Blaster and Ultrasound sound cards
 PROTECTION: None
 DESIGNER: Al Lowe
 PUBLISHER: Sierra On-Line Coarsegold, CA (800) SIERRA1

Psychotic Killers.

Hand-To-Hand
Combat.

High Explosives.

Acid Baths.

Then It
Gets
Bad.

CRITICAL PATH

Kat, chopper pilot—turned survivalist, has only one hope for escape from Generalissimo Minh's maximum security facility...You. Guide Kat along the Critical Path, through scene after scene of killers, mutants, traps and high-explosive surprises. It's a gritty, realistic cinematic experience!

"This isn't a game...they're going to KILL me!"

From your fully-equipped control center, you share Kat's view via a camera mounted on her headset. Action bursts forth on your screen with lifelike 3D motion video, explosive sound effects and music soundtrack! Warn Kat of fast-approaching dangers. But if you slip up... it's "Game Over"! Sign up for combat duty at a software dealer near you.



MEDIA VISION

WINDOWS™
CD-ROM

Call 1-800-845-5870 for information on a dealer near you. © 1993 Media Vision, Inc., 47300 Bayside Parkway, Fremont, CA 94538. Fax (510) 770-9592.
Media Vision, the Media Vision logo and Critical Path are trademarks of Media Vision, Inc. All other trademarks are those of their respective companies. All rights reserved.

Circle Reader Service #150

which all is lost. The most unusual tram service ever devised becomes the source of some important items and will require the hero to provide some quick, on the spot distraction in order to obtain them. A "secret agent" security guard keeps a careful eye on the spa, unless Larry can provide him with an even greater eyeful. Finally, a mercenary life-guard must be made to look in another direction at precisely the right moment.

Like Larry's earlier adventures, *LSL6* is not particularly difficult, and experienced players might be disappointed to find that they can complete it within two or three evenings. Larry, whose lust-crazed mind would probably not be able to focus on a more challenging adventure, should have few problems uncovering most of the items that are necessary to complete his tasks. Certain key objects, however, are only to be acquired through trickery and theft. Often, the game's sly, cynical narration will provide a nudge in the right direction. Managing the large number of objects that Larry eventually must carry around with him is not a problem in *LSL6*. There seems to be no limit to the number of objects he is able to

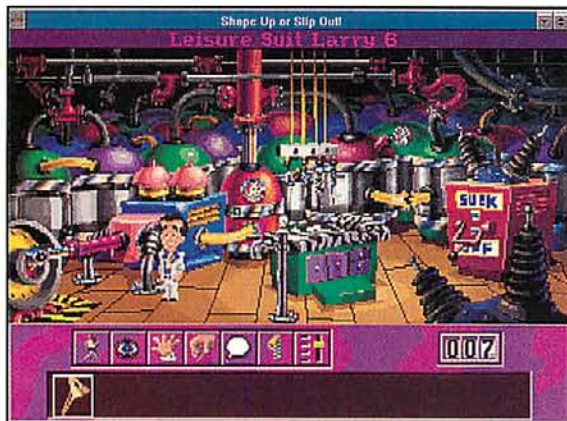

stuff into his multi-pocketed leisure suit, and nearly every item he discovers in the spa is worth some points with the typical Sierra scoring system, not to mention the women.

The Clicker Picker-Upper

In addition to puzzles, which are appropriate for the beginning player, *LSL6* also features an adventure gaming interface that is remarkably easy to use. Larry's actions are confined to six icons: walk, see, manipulate, take, speak and...zipper. The zipper is reserved for special occasions that occur far less often than Larry would like. In general, the cursor becomes whichever icon has been selected, so that it may be placed somewhere on

the graphic screen. This way, you can construct commands like "take key," "move door," or "have intimate relations with Char" with a single mouse-click.

Once Larry has acquired an object, there is no risk that it will be lost through incorrect usage. The spa provides its guests with certain amenities, including towels, soap and matches, which may be replaced as needed; Larry need only learn how to summon room service. A scrolling pictorial list of objects held in inventory is always displayed along the bottom of the screen. Once selected, an object may be examined, put to use or combined with another of the objects in inventory.

In the continuing effort to "idiot-proof" games (which makes one wonder how Larry has lasted so long), each action icon is now equipped with a "hot spot," which is, appropriately, a small red dot on some part of the icon. The dot represents the active, or sensitive part of the icon and allows you to more accurately place that icon on an object. This is a valuable device for any graphic adventure, and particularly appropriate for a game featuring Leisure Suit Larry—who is always looking for the hot spot. Also, this will be helpful to those who will consume large quantities of alcohol in an attempt to improve

THE MOST COMPLETE ADVENTURE MANAGEMENT SYSTEM ON THE MARKET TODAY!

INTRODUCING...THE TRIAD CAMPAIGN SYSTEM™ FOR GAMEMASTERS

SYSTEM REQUIREMENTS

IBM/Comp with Windows 3.1* • Minimum 2 megs hard drive space • 4 megs RAM

RULES

Designed to implement detailed campaign backgrounds and scenarios • Adaptable to multiple campaign backgrounds or worlds

MAPS

World size to tactical • Markers display key locations, characters and creatures • Sizeable display windows • Zoom • Applicable sound, graphics and text with map markers

SPELLCASTING

Adjustable parameters to create different effects • System calculates spell characteristics and appropriate level, area and range

SYSTEM FEATURES

Example adventure included • Formula calculator • Rules documented in context sensitive help files with cross-references • Encounter generator loads all data, no need to consult charts or books • Game clock and calendar • Player's Guide • Gamemaster's Guide

COMBAT

Damage calculated and subtracted from target • Combat results returned in text form suitable to read to your players • Spell effects applied automatically to all creatures in effect area • Set character destinations and targets and let the system perform the movements and attacks

CHARACTERS

Character creation quick and easy or as detailed as desired • Detailed skills, professions, stats and abilities

ORDER NOW! Mail check or money order for \$39.95.
Add \$4.00 for shipping and handling

Call or write for more information

(904) 494-3165

GAMEMASTER'S Clip Art and Sound Clips Disks
Available - \$12.00 ea; \$10.00 with TCS order.
(Specify 8 Bit Mono or 8 Bit Stereo for Sound Clips)

Additional Player's Guides available, 3 for \$10.00

Nawu Triad Institute

P.O. Box 11246 • Pensacola, FL 32524-1246 Florida residents add applicable sales tax

USES Windows 3.1*

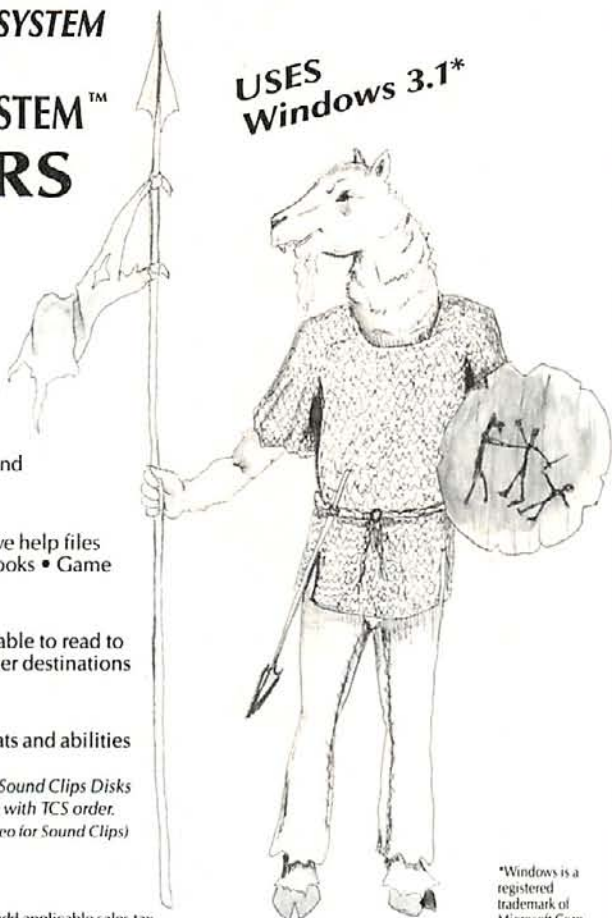

*Windows is a registered trademark of Microsoft Corp.

COBRA

MISSION

The sexy role-playing
adventure game

You stumble back to your office after a long, hard day of detective work. You can't wait to get cozy with a bottle of whiskey, but your answering machine has an urgent message. "This is a life and death emergency. Women are disappearing. Donna's missing. Please, come quickly." Donna's rescue is only the beginning of an adventure that indulges your wildest fantasies as it plunges you into fun and danger. While on screen you're dazzled by innova-

WANTED: Private Investigator to Rescue Desperate Beauty.

tive and original Japanese animation that's taking other countries by storm, and is now available in the U.S.

"Cobra Mission is unique."
Computer Game Review

"...quite an original."
Strategy Plus

"I have to admit I enjoyed it."
"Game Bytes"

Available now at your nearest dealer or call 1-800-258-MEGA. Or write: Megatech, P.O. Box 11333, Torrance, CA 90510 Visa, MasterCard, checks accepted.



System requirements: 386 or faster machine with 640K RAM hard disk with min. 11 megabytes of available space required, mouse recommended. Graphics compatible with EGA, MCGA and VGA (VGA highly recommended). Sound support: Sound Blaster, Thunder Board, Pro Audio Spectrum and Adlib.

Circle Reader Service #151

NR-18

This game is not for the faint-hearted. Contains violence and some material inappropriate for minors.

NOT RECOMMENDED FOR PLAYERS UNDER 18.

None of the games developed by Megatech Software have been rated by the MPAA.

MEGATECH

the game's jokes, and will need as much help as possible with their motor and visual coordination.

Larry is able to move, without hindrance, from one portion of the screen to another. He need no longer be brought to a complete halt due to some pixel-sized impediment. Further, there is no longer any confusion as to which pathways on the screen lead to dead ends, as opposed to those which lead to other locations. Larry may be made to travel to any door or object simply by clicking on his objective.

Players will also appreciate the presence of two game-saving aids. The first, when selected, reminds you to save after each major game sequence. The second allows you to set up a system that periodically reminds you to save the game.

Pixelated Playmates

While many adventure games have attempted to use graphics that appear painted or even photographed, *LSL6* is still very much a cartoon. The pictures are still highly detailed, however, and Larry's hideous features have never been more obvious. His "babes," of course, have all been rendered in achingly



seductive detail, although some players might wish for some revealing photographs rather than drawings. The game's finale is, quite naturally, a "climactic" sequence that involves some very impressive video sequences and makes the game well worth finishing.

The sound effects and background music are very enjoyable, with the possible exception of Larry's flatulence. Music ranges from Larry's familiar honky-tonk theme to the Bolero-like music that accompanies the game's most romantic moments. Each room and its occupants are colored by their own musical theme.

As though it were some kinky sex product,

a particularly modest or shy purchaser can only hope that no one in line at the software store notices that *LSL6*'s package promises a product which is "longer and harder." This is clearly labeled as a game not for minors. The program uses some mildly offensive language, although it stops short of what is euphemistically referred to by thousands of radio stations across the United States as the "s-word" and the "f-word." However, players with young children nearby should also be aware that the program will cause their computer to scream in feminine ecstasy each time a point is scored. The program also includes several non-interactive sequences which, through references to unconventional sex, may also be considered offensive by some users. These may be "fast-forwarded" without loss of points or game-play.

The obvious conclusion regarding *LSL6* is that it is a very clever game that will easily offend the puritan-minded, just as it might offend the experienced gamer looking for a serious puzzle challenge. For the novice who enjoys a touch of risqué entertainment and good, off-color jokes, *LSL6* is a very novel and enjoyable source of Titillation and Amusement. **CGW**

SIDELINE SOFTWARE

ORDERS 1-800-888-9273 ONLY
YOUR PC IMPORT & CLOSEOUT CONNECTION

NEW PC TITLES	TYPE	\$
Alien Breed	Arcade	38
Battle Isle '93	War Simulation	40
Body Blows	Arcade	40
Brutal Sports Football	Arcade Simulation	40
Daemongate	Role Playing Game	45
Elite 2	Space Strategy	40
Fields of Glory	Arcade Simulation	45
Fire and Ice	Arcade	40
Fury of the Furries	Arcade	40
Ishar 2	Role Playing Game	45
Jurassic Park	Arcade Strategy	45
Kisley's Fun House	Arcade	40
Ryder Cup Golf	Sports Simulation	40
Simon the Sorcerer	Graphic Adventure	40
Sub War 2050 (Microprose)	Simulation	50
T.F.X.	Simulation	50
T-2 The Coin-Op	Arcade	40

PC EUROMAGS
Get the latest news on the best PC titles from Europe! These high gloss, full color magazines also feature demo-packed playable cover DISKS with each issue!
PC Format, PC Review, PC Zone, PC Player, PC Plus, PC Power, PC Action, or PC Games each only \$10

SHIPPING (UPS Ground) For up to 3 pieces, by payment: Mastercard & Visa \$5.00 • C.O.D. (Cash Only) \$10.00
Next day & second day air available! Call for prices on special shipping.
Shipping times not guaranteed. Price & Availability subject to change!
No refunds or exchanges. Defective products exchanged with same item.
Products warrantied through Sideline.
FAX ORDERS CALL (305) 491-6134
Need Info? Call (305) 491-9519 DEALER INQUIRIES INVITED!
840 N.W. 57th Court, Ft. Lauderdale, FL 33309

DON'T MISS THESE DISCOUNT PC DEALS!

4-D Sports Boxing	18.95	Carriers at War	21.95
688 Attack Sub	18.95	Centurion Defender of Rome	18.95
A-Train	26.95	Chuck Yeager's Adv. Combat	21.95
Action Stations	18.95	Colossus Bridge 4	16.95
Ancient Art of War in Siege	24.95	Command HQ	18.95
Aztec (Microprose)	24.95	Creepers	18.95
B-17 Bomber (Microprose)	24.95	Deluxe Strip Poker 2	18.95
Bard's Tale 3	18.95	El-Fish	21.95
BAT 2	21.95	F16 Falcon	14.95
Battle Isle	18.95	Fire Team 2200	16.95
Battlehess	18.95	First Samurai	18.95
Blindwych	14.95	Four Crystals of Trazzar	21.95
Carrier Command	14.95	Flight of the Intruder	18.95

DISCOUNT PRICES

Global Conquest (Microprose)	21.95
GP Unlimited Road & Track	21.95
Greg Norman Golf	18.95
Harpoon	14.95
Heart of China	18.95
Hero Quest	18.95
Hook	16.95
Il Came From the Desert	14.95
Jack Nicholas Greatest 18	16.95
Joe and Mac Caveman	18.95
King of Chicago	14.95
Legend of Kyrandia	21.95
Lemmings 2	28.95
Links 386	29.95
Lure of the Temptress	18.95
Mantis	24.95
Mavis Beacon Typing Tutor	18.95
Mega Lo Mania	21.95
Microprose Greens	26.95
Mike Ditka Football	18.95
Mig 29 Jetcrum	18.95
Nigel Mansell's Grand Prix	21.95
Obitus	18.95
Pacific Islands	21.95
Paperboy 2	16.95
Pit Fighter	18.95
Populous & Promised Lands	24.95
Power Monger	21.95
Prince of Persia	16.95
Pushover	18.95
RBI Baseball 2	14.95
Rex Nebular	24.95
RoboCop 3	19.95
Rocket Ranger	16.95
Sargon 5	18.95
Shadowlands	18.95
Sim Ant	21.95
Sim City Terrain Editor	21.95
Sleazebiter	9.95
Sleeping Gods Lie	14.95
Spacewrecked	16.95
Special Forces	24.95
Spell Casting 101	18.95
Spoils of War (HAW)	18.95
Storm Masters	18.95
Strike Fleet	19.95
Super Off Road	16.95
Super Space Invaders	18.95
Super Teles	19.95
Team Yankee	21.95
The Immortal	19.95
The Lost Admiral	21.95
The Simpsons	16.95
T.V. Sports Baseball	21.95
T.V. Sports Boxing	21.95
T.V. Sports Football	14.95
Trump Casino 2	18.95
Ultima 6	21.95
Vette	14.95
Waxworks	24.95
White Death (RAW)	18.95
Wizard	18.95
Wotpack	18.95
W.W.F. 2	24.95
Zool	21.95

THE ULTIMATE ROLE-PLAYING AID

Introducing **The Ultimate Character Editor**. This exciting new product features full mouse and keyboard support, online context sensitive help and a complete windowing system (does not require MS Windows to run). This editor allows you to edit 30 of the games listed below (including Might and Magic 1-4, Ultima 4-7, all SSI AD&D games, Bard's Tale 1-3, Wizardry 6-7 and more). The price for this editor is \$59.95. So, for the price of 3 editors, you will be getting 30 editors. Upgrades will be available to handle new games as they are released for only \$9.95 per game.

• **CHARACTER EDITORS - \$19.95 each**
Might and Magic (1,2,3, 4 or 5), Pool of Radiance, Hard Nova, Bard's Tale (1, 2 or 3), Wasteland, Dragon Wars, Space Rogue, Wizardry (Edits 1-3), Wizardry 4, Wizardry 5, Bane of Cosmic Forge, Crusaders of the Dark Savant, Treasurers of the Savage Frontier, Sentinel Worlds I, Knights of Legend, Secret of the Silver Blades, Curse of the Azure Bonds, Champions of Krynn, Space 1889, Drakkhen, Keys to Maramon, MegaTraveller (1 or 2), Keef the Thief, Darklands, Escape from Hell, Ultima (3, 4, 5, 6, 7 or 7 pt. 2), Savage Empire, Dark Heart of Uukrul, Tunnels and Trolls, Lord of the Rings (1 or 2), Countdown to Doomsday, Eye of the Beholder (1, 2 or 3), Darklands, Death Knights of Krynn, Fountain of Dreams, Magic Candle (1, 2 or 3), Pools of Darkness, Ultima Underworld (1 or 2), Twilight 2000, Planets' Edge, Dark Queen of Krynn, Prophecy of the Shadow, Martian Dreams, Realms of Arkania.

• **HINT BOOKS - \$9.95 each except where noted**
Might and Magic 1, Knights of Legend, Curse of the Azure Bonds, Champions of Krynn, Legacy of Ancients, Dark Heart of Uukrul, Wizardry (1, 2, 3, 4, 5, Bane or Crusaders (\$12.95)), Eye of the Beholder 2, Might and Magic 3 (\$12.95).

IBM listed. Apple and C64 versions also available.
Please add \$4.00 for shipping and handling.
Open from 9 AM - 9 PM every day for your convenience.



GOSELIN COMPUTER CONSULTANTS
P.O. Box 1083 • Brighton, MI 48116 • (313) 229-2453



For information and release dates 1 (404) 840-7906
 To place orders in U.S. and Canada 1 (800) 852-6187
 Fax 1 (404) 840-7925
 2980 Lake Colony Drive, Suite 3, Norcross GA 30071
 Please have credit card ready! Open Saturdays 10-5.

SAME DAY SHIPPING UNTIL 8:00 PM EASTERN TIME!

Past

AD&D AI Quadim	IBM Feb
AD&D Stronghold	38
AD&D Unlimited Adven.	38
Betrayal at Kronder	42
Clouds of Xeen	44
Companions of Xanth	37
Darkside of Xeen	44
Dark Sun	49
Grey Isles Camp.	Nov
Dungeon Hack	38
Fantasy Empires	38
Gryphon Mastr Hylar	Nov
Hand of Fate, The	38
Kings Quest 6	47
Kings Ransom	37
Legacy	39
Legends of Drakka	Nov
Lost Vikings	25
Magic Candle 3	37
Platreal Gold	39
Quest for Glory 3	42
Realms of Arkania	38
Red Crystal	47
Return to Zork	38
Shadowcaster	43
Simon the Sorcerer	32
Ultima 7	49

Cyber Race	IBM 42
Dominion	39
Dune 2	37
Gateway 2:Homeworld	38
Masters of Orion	39
Mechwarrior 2	Feb
Out of This World	37
Privateer	48
Speech Pack	17
Space Hulk	39
Star Control 2	37
Star Trek:Next Gnrtn	Jan
Strike Commander	48
Speech Pack	19
Tactical Disk	20
Syndicate	38
Terminator/Rampage	43
Wing Commander 2	26
Wing Commandr Academy	32
X-Wing	42
Imperial Pursuit	19
B-Wing	18

Pre-WWII

Ambush at Sorinor	38
Archon Ultra	32
Blue & the Gray	43
Caesar	38
Cohort 2	19

High Command	44
Pacific War	47
Red Sky at Morning	39
Third Reich	37
V for Victory Series	
Gold, Juno, Sword	39
Victory Pack	44
Victory at Sea	43
WWII: Battles of Pacific	37

Modern

A-10 Warthog	94'
Comanche:Max Ovrkll & Expansion Dsk. #1	43
Expansion Dsk. #2	25
Empire Deluxe Scenario Disk	20
Empire Deluxe(WIN)	38
F-14 Fleet Defender	46
F-15 III	29
Falcon 3.0	45
Mig-29	33
Op. Fighting Tiger	25
Flight Sim 6.0	45
Gunship 2000	32
Campaign Disk #1	29
Harpoon 2	49
Mig 29	60
Red Sky at Morning	39
Seal Team	38

Sci-Fi

Mechamander	Dec
Mercenaries 2	Dec
Pax Imperia	Mar
Reach for the Stars	26
Rules of Engagement 2	25
Spaceward HOI(WIN)	37
Spaceward HOI(DOS)	37
Star Legions 2	38
Strike Squad	38
When Two World's War	38

General

Civilization	44
Civilization Windows	49
Empire Deluxe	38
Global Domination	37
Incredible Machine 2	32
Lemmings 2	37
Lost Admiral Enhanced	Dec
Perfect General Enhanc	Dec
R.R. Tycoon Deluxe	40
SIMCity 2000	42
SIMEarth(Win/Dos/Mac)	42
SIMFarm	42
SIMLife	32
SIMLife (Windows)	47
Socrates V 3.0 Chess	Dec
Unnatural Selection	32

Sports

APBA Baseball/WIN	44
Front Page Football Pro	48
Hockey League Sim2	29
Indy Car Racing	43
Links 386 Pro	42
Banff Springs	19
Belfry	19
Innisbruck	19
Mauna Kea	19
Pebble Beach	26
Pinehurst	19
NFL Pro League Football	38
NHL Hockey	43
Stratomatic Baseball	34
Tony Larussa Baseball 2	37
92' Stats Disk	12
AL/NL Stadium's Fantasy Draft	12
Wayne Gretzky 3	37

Hint Books

Civilization/Rome 640k	IBM 13
Clouds of Xeen	15



Logitech Cyberman
 The most advanced way to master 3D games.
 Cyberman is the revolutionary input device for hardcore gamers. It offers you tactile feedback that lets you feel all the action.

Darkside of Xeen	13
Darksun	10
F-15 III	18
Falcon 3.0	17
Lands of Lore	10
Lemmings Companion	17
Might & Magic Off. Guide	12
Might & Magic 3 or 4	13 ea
Privateer	11
Protostar	10
Realms of Arkania	14
Return to Zork	8
Run 5 Magazines 1-19	6ea
Sam and Max	10
SIMEarth: Strategy Guide	12
SIMLife: Strategy Guide	12
Simon the Sorcerer	8
Star Control 2	11
Strike Commander	10
Ultima: Official Book	12
Ultima 7	10
Ultima 7 Part 2	11
Ultima 7/Underworld 1	15
Ultima Underworld 1 or 2/1ea	
Windows Shopper Guide	30
Wizards 7 (Crusaders)	13

Hardware

CH-Flightstick Pro	63
CH-Virtual Pilot	66
Gravis Eliminator Card	29
Pilot Control Stand	26
Soundblaster ASP 16	140
Soundblaster Pro Detx	119
ThrustMaster Series	
Flight Stick	86
Flight Stick Pro	102
Game Card	28
Rudder Pedals	106
Weapons Control	69
Weapons Control 2	95

CDROM

7th Guest	IBM 67
AD&D Fantasy Empires	39
Aegis: Guardian Fleet	Dec
Blade	57
Bloodnet	40
Comanche & Missns	47
Cyber Race	42
Dark Sun	Jan
Day of the Tentacle	42
Discovers of the Deep	34
Dracula Unleashed	49 49
Dune	66
Dungeon Hack	32
Eye of Beholder Trilogy	49
F-15 III	48
Great Naval Battles	50
Helicab	64
Inca	43 43
Iron Helix	61 61
Journeymen Project	47
Kings Quest 6	47

Kings Ransom	37
Labrynth of Time	49
Legend of Kyrandia	42
Mad Dog McCree	35
Myst	50

Dagger of Amn Ra	Mac 42
Deja Vu 1&2	25
Falcon MC	45
Harpoon 2	43
Indy Jones/Fate Atlantis	37
Kings Quest 5	42
Kings Quest 6	Jan
Leisure Suit Larry 5	42
Leisure Suit Larry 6	Jan
Lost Treasures Intcom	42
Might & Magic 3	39
Might & Magic 4	Jan
Out of This World	37
Panzer Battles	29
Pax Imperia	43
Reach for the Stars	28
Red Baron	42
Rommel North Africa	29
Secret of Monkey Island 1	37
Secret of Monkey Island 2	37
SIMCity 2000	46
SIMFarm	42
SIMLife	42
Victory Pack	43
V 4 Vctry/Gold,Jun,Swr	39
Victory at Sea	43

Viking Ratings

Hands of Fate	A
Indy	A

Victory at Sea
 Designed by Jim Dunning, Victory at Sea will be the premiere grand strategy Pacific Theater game on the market due to its game depth and ease of play.

IBM \$45

SIM CITY 2000



IBM \$42

Sim City 2000

New sim stuff including schools, hospitals, univer cities, sewers, subways, and complete water main system. Your city view is rotatable and allows for zooming in or out. A MAJOR upgrade!

Forge of Virtue	19
Ultima 7 Part 2	49
The Silver Seed	49
Ultima Underworld 2	49
Wizardry 7 Crusader	42

Present

Alone in the Dark	38
Amazon	38
Blue Force:Next of Kin	42
Champions	Dec
Dagger of Amn Ra	42
Day of the Tentacle	37
Freddy Pharkas	42
Gabriel Knight	42
Labrynth of Time	49
Maniac Mansion 2	37
Metal and Lace	32
Return of the Phantom	38
Sam & Max Hit Road	38
Speed Racer	37

Future

Bloodnet	40
Command Starship	38

Conquered Kingdoms	37
Add on Disk #1	25
D&D Fantasy Empires	38
Battles of Civil War Series	
Vol.1	26
Vol.2	26
Vol.3	26
Great War, The	42
Heirs to the Throne	37
Man of War	39
Paladin 2	25
Platreal Gold	39
Railroad Tycoon Deluxe	42
Seven Cities of Gold	32
Siege:Walls of Rome	39
Warlords 2	42

World War II

Aces Over Europe	42
Campaign Dsk #1	Feb
Across the Rhine	46
Battle of South Pacific	37
Carriers at War	42
Construction Kit	37
Clash of Steel	43
Great Naval Batt/Admiral Bundle	49
Grigsby's War in Russia	47

Aces Over Europe
 Over 20 meticulously modeled aircraft. Fly for the Luftwaffe, RAF, or USAAF in historical campaigns. The sharpest and smoothest 3-D graphics with a Gourard shading in a new Tall Res Mode.

IBM \$42

Shipping Rates/Hours

UPS Rates: Ground: \$5.00 3-day air:\$6.00
 2-day air: 7.00 AK & HI:12.50
 COD add: 5.00 Overseas:Call

Mail Rates:AK & HI: 6.00 Canada: 6.00
 Overseas: Call

Prices subject to change, so call first!
 Hours:Mon-Fri 10am-8pm(EST)
 7am-5pm(Pacific)

KIDS & COMPUTERS

Reviews



Oceans Below

Suspended weightless, floating between the bottom of the ocean and the door to the other world populated with air breathers, the diver observes, through the crystal clear liquid, the vast variety of multicolored marine creatures. While shadows of the surface waves pass across the reef landscape filled with many forms of multicolored life, the diver now belongs to the world of water. If your kids want to follow in the wake of Jacques Cousteau, *Oceans Below* will take them diving without the risk.



Oceans Below

Price: \$49.95

In Brief: An undersea nature show-type program that will take adults and children to 17 world-famous dive sites

Requirements: IBM compatible 386SX/25 or better with 4MB RAM, hard disk with 5MB free space; SVGA display with VESA driver; mouse; CD-ROM drive; DOS 5.0 or higher; Windows 3.1 or higher, MS-, MSCDEX Version 2.21 or higher.

Audio Support: Sound Blaster compatible cards; MPC-compliant audio cards.

Other Versions: DOS CD-ROM (\$49.95); Macintosh CD-ROM (\$49.95)

The Software Toolworks
60 Leveroni Court
Novato, CA 94949
(415) 883-3000
Circle Inquiry #170

Use the program to simulate a dive along Australia's Great Barrier Reef, or in Hawaii, the Red Sea, the South Pacific, the Sea of Cortez, the Galapagos, or 11 other dive sites. Kids and parents can learn about undersea plane wrecks in Truk Lagoon, shipwrecks, underwater animal and plant life. More than 68 sunken treasures hidden in the game help to reproduce the sensation of diving.

This isn't a virtual reality program, where a simulated dive would take one through three-dimensional ocean settings. At each of the 17 dive sites, a description of the location, the diving conditions, the water conditions, and the most notable sea life can be obtained from the icons along the bottom of the screen. During the dive, the only option one has is to swim down to a digitized scene of the reef area containing the indigenous animal life. Clicking on the features shown in the picture will pop-up a full-motion video describing the fish, crustaceans, coral, and other interesting objects, accompanied by a short speech segment describing the item selected.

For the best results, the computer's video card will have to support the VESA standard. Parents should check the manual that accompanies the computer at home to make sure this won't be a problem. Standard VGA boards without VESA drivers result in muddy displays. A double-spin CD-ROM drive would also help, but at the least the CD-ROM drive on the computer should have a speed of 150KB/second. Again, check the manual.

Oceans Below simulates the diving experience, which is pretty unique among software programs. It can be quite informative and entertaining, but it is not able to give the feeling of weightlessness, excitement, and pressure that comes with a real diving experience. As

an interactive educational program, it is similar to watching a documentary about scuba diving — with the added benefit of moving through the material at will.

— Alfred C. Giovetti

My Paint

Crayons have saved more than one Mom and Dad from the loony bin during foul weather. With *My Paint*, your children won't wait for stormy weather to break out the colors. They get the same chance to nurture their artistic talents, but their fingers will be on the mouse instead of on the crayons.



My Paint

Price: \$49.95

In Brief: An electronic coloring book with sound and animated icons.

Requirements: IBM PC or compatible with 512K RAM; EGA or VGA display; mouse; hard disk.

Audio Support: Sound Blaster, Sound Blaster Pro, Ad Lib, Disney Sound Source, ProAudio Spectrum, Echo II, and Tandy.

For ages: 2 to 12

Saddleback Graphics
12812 Garden Grove Blvd. Unit P
Garden Grove, CA 92643
(714) 741-7093
Circle Inquiry #171

The program's animated paint palette springs to life, unlike the stagnant icons

FutureVision

Expanding Educational Frontiers
Through Technology



NOW APPEARING!

FutureVision

YOU'VE SEEN THEM IN COMPUTER SHOPPER... YOU'VE SEEN THEM IN PC SOURCES!... HERE FOR AN EXTENDED ENGAGEMENT IN COMPUTER GAMING WORLD!

STARRING THE EDUCATIONAL CURRICULUM CONSULTANTS WITH A CAST OF THOUSANDS OF BLOCKBUSTER SOFTWARE TITLES!



ADVENTURE	SIMULATORS	WAR GAMES	EDUCATION	CD-ROM
A08D Unlimited Adventure.....34.00	Acas Over Europe.....41.50	A-Train.....33.50	Alge-Blaster 3.....31.00	Jehand.....52.00
Alone in the Dark.....35.50	ATAIC.....33.50	Caesar.....35.50	Dinosaur Adventure.....31.00	King's Quest VI.....49.00
Betrayal at Kronor.....41.50	B-17 Flying Fortress.....38.50	Civilization NPE.....47.00	Eagle Eye Mystery.....31.00	Legend of Kyranfia.....49.00
Cobra Mission.....48.00	Car & Driver.....37.50	Conquered Kingdoms.....36.00	Fatty Bear's B-day Surprise.....31.00	Loom.....34.00
Dark Side of Xen.....41.50	Commander: Maxim. Overkill.....43.50	Empire Deluxe.....36.00	Foreign Language.....CALL	Mantis Experimental Fighter.....45.00
Darklands.....38.50	F-15 Strike Eagle 3.....41.50	High Command.....41.00	Kid Pix.....35.00	Mamo is Missing.....24.00
Day of the Tentacle.....34.50	Iron Helix.....49.00	Populus II.....38.00	Kid Works 2.....35.00	Mixed up Mother Goose.....24.00
Eric the Unready.....36.50	Road & Track.....35.50	Powermonger.....32.00	Metropolis Music.....27.00	Monkey Island I.....27.00
Eye of the Beholder III.....41.50	Strike Commander.....47.00	Railroad Tycoon Deluxe.....47.00	Stickyphear Preschool.....31.00	Peter and the Wolf.....22.00
Flashback.....32.50	Syndicate.....47.00	Rome.....31.00	Supersolvers Midnight Rescue.....31.00	Putt Putt Joins the Parade.....39.00
Kings Quest VI.....44.50	Tomaso.....49.00	Seven Cities of Gold II.....36.00	Talking Spell-it Plus.....31.00	Right College.....27.00
Last Tribe.....27.50	Ultrabots.....37.00	Sim Life.....39.50	Think Quick.....31.00	Secret Weapons/Luftwaffe.....24.00
Pirates Gold.....41.50	X-Wing.....39.00	Star Trek 25th.....36.00	Treasurehouse.....39.00	Seventh Sonet.....55.00
Police Quest IV.....46.50		Stronghold.....39.50	Writer Rabbit.....31.00	Shakespeare.....16.00
Prince of Persia 2.....44.50				Sherlock Holmes.....44.00
Protostar.....41.50				Space Adventure.....29.00
Quest for Glory IV.....38.50				Space Quest IV.....19.00
Ringworld.....35.50				Stellar 7.....20.00
Space Quest V.....38.50				Ultima Bundle (1-6).....59.00
Star Control 2.....34.50				Where in the World CSD.....29.00
Ultima Underworld II.....46.50				Willie Beamish.....27.00
Ultima VII Part I or II.....46.50				Wing Commander & Ultima 6.....21.00

ALL PRODUCTS SOLD CARRY MANUFACTURER'S FULL WARRANTIES AND DOCUMENTATION!

ORDERING

- Phone orders accepted M-F from 8:00am - 5:00pm PST
- Fax orders accepted 24 hours a day 7 days a week
- Ask for a catalog of our complete software selections

SHIPPING

- Orders received before 2:00PM will be shipped same day for product in stock.
- \$5.00 shipping charge per order.

PAYMENT

- No surcharge for Visa or MasterCard orders
- C.O.D. orders welcome with a \$3.00 charge
- School, government and corporate purchase orders accepted.

CALL YOUR PERSONAL EDUCATIONAL CURRICULUM CONSULTANT

1.800.995.4661

Many other titles available. - Prices subject to change without notice.



FAX - 1-800-995-4669

INTERNATIONAL CUSTOMERS:
Voice-408-370-4650 • Fax-408-370-9466

FutureVision - 644 N Santa Cruz Ave - Suite 12 - Los Gatos CA 95030

found in traditional paint programs. In *My Paint*, icons dance, flash, and move side to side. Kids will be held in rapt attention.

Although children can create and color their own pictures, an assortment of 28 coloring book pictures, or templates, are also included. The idea here is for kids to master the advanced tools of the paint program. Each one of the coloring book pictures comes to life with its own sound effect, such as dinosaurs roaring, trains chug-chugging, and cats meowing.

As a bonus, the publisher bundles an additional Video Coloring Book Disk called *Alphabet Fun* with *My Paint*. It's the first in a planned series of five add-on disks that can be installed by way of a special Parent Menu. Each add-on disk brings more than 25 new drawings and sounds into the *My Paint* program. It's refreshing to see a software company back up such a quality effort by adding so much to the original product. Rain or shine, *My Paint* is sure to brighten up any child's day.

— Jeff Kingston

Scary Poems For Rotten Kids

You don't have to be rotten or a kid to enjoy this interactive CD-ROM storybook. Eerie sights and sounds abound on this program designed to enhance reading skills.

Scary Poems for Rotten Kids opens with a screen that looks like a real book. In its simplest form, this electronic book can narrate any or all of its 13 poems. Even the youngest kids can sit back and enjoy the language, without having to read it — a real plus when it comes to the art of poetry.

But the publisher has adapted the program for the different skills and abilities of its users. With a click of the mouse button, the program can be configured to read each poem sentence by sentence, word by word, syllable by syllable, in English and/or Spanish, and with or without sound effects or narration. It will provide definitions and explanations for every word and phrase contained in the poems.

Using the Bookmark option, parents or teachers can modify each of these settings to match each child's particular reading skills and/or deficiencies. For



Scary Poems for Rotten Kids

Price: \$29.95

In Brief: An interactive CD-ROM storybook filled with hair-raising reading adventures.

Requirements: IBM compatible with 2MB RAM; VGA display; hard disk; CD-ROM drive; DOS 5.0 or higher; Windows 3.1 or higher.

Audio Support: Sound Blaster compatible

For Ages: 7 and up

Other Versions: Macintosh CD-ROM (\$29.95)

Discis Knowledge Research
PO Box 66
Buffalo, NY 14223-0066
(800) 567-4321
Circle Inquiry #172

example, one child might click on a word and hear it pronounced first in Spanish, then in English. Another child might click on a word; hear the word pronounced, hear a definition of the word, and then hear the word pronounced again. Each word is highlighted as it is read by the narrator so users can follow along word for word. A unique Recall tool allows teachers or parents to print or display words that a child selected for extra help. These lists can then be used to develop future review or vocabulary lists.

The poems, based on the original text by Sean O Huigin, range from the light-hearted "The Day the Mosquitoes Ate Angela Jane" to the rappin' "The Munchies," to the skin-crawling "The Body." Each work is accompanied by unearthly sound effects and clear narration in character-appropriate voices. Lines like *It slips beneath your doors at night... and sucks up everything in its sight* (from "The Body"), are sure to capture and hold the reader's attention. Each text is accompanied by original, interactive illustrations. Words pop up and are pronounced when clicked on and hidden sound effects are triggered by clicking on certain objects. Many of the illustrations are multi-layered — a first click on a hand will produce the word

hand while a second click might produce palm.

Because of its ability to be so tightly customized, this program would be especially suited to children with special reading needs, although any child aged seven on up will enjoy hearing these ghoulish tales. *Scary Poems for Rotten Kids* is just one of many excellent offerings in the publisher's Kids Can Read program series.

— Felicia Donovan

Mathology

This bit of edutainment presents math concepts within the storybook world of Greek mythological figures. New games begin with an overview of ancient Greece and its people's thirst for knowledge. Zeus asks the players' help in regaining lost skills with numbers. Players can save unfinished games and can bypass the legend. One or two can play. The game will keep track of each player's turn. Players can select warrior type and the degree of game difficulty.

As a warrior, kids move around the screen by pressing various keys. Before solving number problems, players must find their way through the city. They can gain bonus points by being a skilled fighter. The warrior only fights those opposed to knowledge. Concerned par-

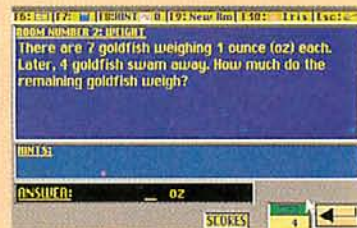

Mathology

Price: \$59.95

In Brief: An arcade-action math adventure game set in Greek mythology.

Requirements: IBM compatible with 640K RAM; VGA display; hard disk with 4MB free space; DOS 3.3 or higher.

Audio Support: Adlib and Sound Blaster compatible sound devices.

For Ages: 8 and up

Lawrence Productions
1800 South 35th St.
Galesburg, MI 49053-9687
(616) 665-7075
Circle Inquiry #173

Purple Car Lands on Moon!

Due to a freak accident at the Fireworks Factory, Putt-Putt is blasted to the moon. There he meets Rover, a vehicle left behind by the astronauts. Putt-Putt and Rover must work together to rebuild a rocket, and decide for the Man in the Moon. Putt-Putt fits in with the Man in the Moon's fits of cooperation.

lonely little lunar terrain astronauts. Putt-Putt and Rover together to rebuild a rocket, and accomplish a few good deeds for the Moon People before they head home. Putt-Putt Goes to the Moon teaches the benefits and the lasting value of friendship.

For a FREE Demo
IBM-PC or Color Macintosh
Call (206) 485-1212
*Offer good while supplies last.

PUTT-PUTT GOES TO THE MOON

Ages
3-8

IT
TALKS!



Wow! You were here with the astronauts?!!?



Want to buy our rocket? It's for sale. Only 10 glowing moon crystals.



Hello! I'm Governor Moonbeam. And you must be?



ents should know that this is not a heavy battle action game. No guns and knives here — the weapons of choice are rocks and spears. Kids gain rewards from skillfully moving about the screen, not by performing combat heroics.

Kids first master addition and subtraction skills. Then they advance to multiplication and division skills through 24 levels of difficulty. The highest levels involve using decimals in all four of these math functions. Students progress from solving word problems that require only one computation to problems needing multiple steps.

Some problems require that students separate key facts from extra information in the problem. For example, a question may state that a person drinks four ounces of milk, then go on to list other menu items. But the question to answer only concerns the amount of milk consumed. Defining useful information from unnecessary facts is key to building comprehensive math knowledge, and for shaping critical thinking skills.

The game presents 240 separate math problems randomly. Each one is seen within its own picture. Players can opt to see up to six hits, depending on the question. The game includes a calculator and list of formulas.

Although the reason for setting the game within the historical context of ancient Greece remains vague, *Mathology* provides basic instruction in math concepts and practice in computation.

— Jack M. Germain

Rusty and Rosy Read With Me

Finally, here's a series of programs that address the many complicated processes involved in learning to read. *Rusty and Rosy Read to Me (Volumes 1 and 2)* have a wealth of sophisticated features enhanced by an excellent design that keeps the game concepts simple. Through it all it maintains a depth that's hard to find in early-reader programs.

Kids start *Rusty and Rosy Read With Me* by selecting their names from a pre-assigned list created during installation. Parents use the installation process to configure the program to their child's skill level.

Catch-A-Match, one of two deceptively simple activities in Volume 1, provides three scenes: Sea Match, Space

Match and Sky Match; in which kids fight through fish, space aliens or air balloons to match a chosen letter, number, color or shape before their air tanks run empty. Other learning concepts include Big versus Little, Same versus Different, Order of the Alphabet, Number Sets or All Concepts. Each concept is pronounced as the cursor passes over it, so pre-readers can make their own choices. Parents can set which concepts will appear for kids to choose from; so, if parents want to reinforce only letter recognition for example, they simply select *Letters* — no other game concepts will appear.

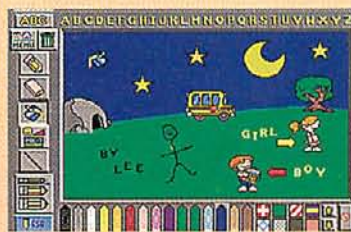

Rusty & Rosy, Read With Me (Volumes 1 & 2)

Price: \$49.95 for each volume

In Brief: Excellent pre-reading programs that focus on letter and letter sound recognition.

Requirements: IBM compatible with 4MB RAM; VGA display; hard disk; DOS 3.1 or higher; Windows 3.1 or higher.

Audio Support: SoundBlaster, Disney Sound Source, Adlib, Covox

For Ages: 3 to 7

Waterford Institute
1590 East 9400 South
Sandy, UT 84093
800-767-9976
Circle Inquiry #174

Keeping the program open, however, keeps the many learning opportunities this program provides available at all times. One of the nicest features of this program is that it is self-adjusting in difficulty levels according to the performance. For example, if a child begins at Level Two and misses several matches, the program will automatically drop to Level One. Once the child demonstrates proficiency at that level, the program returns to Level Two. This ensures that kids truly understand each concept before moving on to new material.

Occasionally, an ear will be displayed in the Item-to-be-Matched box, but no

visual cue is given; kids must listen to hear the cue — a wonderful way to reinforce listening skills. Electronic bookmarks can mark the concepts a child has already mastered and place them at the next level each time they play the program. Catch A Match offers lots of rewards each time a child succeeds and is varied enough to keep kids interested for a long time.

Volume 1's Coloring Box is a full-featured paint program with freeform or pre-designed scenes that provide an unstructured environment in which children can explore lines, colors, shapes and letters. Parents can set some of the mechanical options, such as mouse control, to make it easier for kids to use. This allows even very young children with undeveloped motor skills to play. The background scenes, objects, patterns and letters provide for a wealth of creativity which can easily be printed out to create storybooks.

Volume Two of *Rusty and Rosy's Read With Me* is equally rich. It also contains two deceptively simple games: Treasure Hunt and The Word Traveler.

Treasure Hunt is a matching game that reinforces shapes, upper- and lower-case letters, simple words and rhymes. Other concepts include colors, word-to-picture, letters-to-picture and signs. Signs is a wonderful introduction to real-life signs like Stop and Handicapped. Kids can play Treasure Hunt alone, with a friend, or against the computer. Each item or object is clearly pronounced as it is flipped. For very young players, cards can be placed face up. Kids earn treasures for every correctly matched pair, and each set of matched cards reveals more and more of an interactive island scene with hot spots that trigger animation and reveal the next set of cards. The number of cards used in the game can be set ahead of time by parents, adjusted by kids during the game, or be automatically increased by the program every three games.

Perhaps the most interesting and unique game of all is The Word Traveler, which allows children to explore words, letters and individual letter sounds (*phonemes*). The use of phonics is considered by many educators to be the second major step (after letter recognition) in mastering reading. The Word Traveler can be played in Easy, Medium or Hard mode. Using text-to-speech technology, an animated robot pro-

Fatty BEAR'S FUNPACK™



Mix away! Dozens of pictures and thousands of colors await!



Have any fours? Go Fish with Fatty Bear.

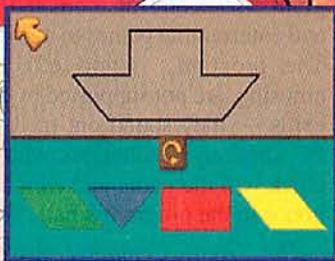

Experience the ancient Chinese game of Tangrams.



Your child will flip over Reversi's multiple skill levels.

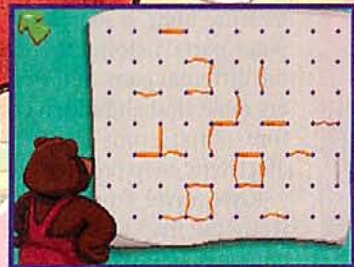

Lines and Boxes. It's Fatty Bear's favorite game.

Includes **Reversi, Tangrams, Go Fish, Lines and Boxes, and Fatty Bear's Paint Set.**

- Develops logic and strategy skills
- Enhances pattern recognition and spatial thinking abilities
 - Junior Adventure quality speech and animation
 - Four skill levels
- Challenging enough for everyone, even grown-ups!
- **Only \$29.95! To order, call 206-485-1212**



Ages
3-8

IT
TALKS!

nounces any word the child makes, real or invented. Real words are encouraged through pictures and a pop-up Word Zapper that lets children know they've created a real word. (The program's 60,000-word dictionary ensures many hits and can be customized.) Kids get rewards for creating real words, which can then be sent into a child's personal dictionary to be recalled, reviewed or printed out.

Each of these volumes comes with a companion videocassette that reinforces letter recognition, letter formation (Volume 1); and vocabulary and print concepts (Volume 2) through songs, animation and nursery rhymes. Another handy feature is the KidMode option, which prevents kids from leaving Read With Me to get to other programs. On-screen help, sound effects, and instructional sound may be toggled on or off.

Rusty and Rosy Read With Me should be on the shelf of every home learning center. Parents will find it extremely useful in helping to develop the basic concepts that create new readers.

— Felicia Donovan

The Great Computer Adventure

Computer proficiency in many schools means knowing the parts of a computer and how they work. This computer adventure sends children on a treasure hunt in search of missing computer parts, helping them to learn about the different parts of the computer. Players must find all hidden components before time runs out. An encoded electronic map provides location clues.

Kids travel from one site to another using the map as a guide. Each location contains an envelope. Once kids locate the envelope, they receive a clue in the form of a riddle or rhyme. If they unravel the identity of the computer part referenced in the clue, a door opens onto a puzzle.

Contestants must solve the puzzle before they can take the uncovered part. Some puzzles involve memory skills. Others build vocabulary and reading skills. A few involve math. All exercises draw on critical thinking skills.

The look of *The Great Computer Adventure* will be familiar to any kid or parent who has played the games in the Carmen Sandiego series. Kids use but-



The Great Computer Adventure

Price: \$39.95

In Brief: This adventure game introduces and explains the components that make up a computer.

Requirements: IBM compatible with 640K RAM; VGA display; hard disk with 3MB free space; mouse.

For Ages: 7 to 12

American Training International
12638 Beatrice St.
Los Angeles, CA 90066
(800) 955-5284; (310) 823-1129
Circle Inquiry #175

tons to manipulate a high-tech gadget to obtain information about missing computer parts. A small video window, called the VolcanoMeter, keeps players posted on the game's elapsed time. Information on sites visited, parts found, and parts taken display on screen when players press a Notes button.

Only a limited amount of time is allowed to solve puzzles and retrieve parts. This makes the adventure more exciting. As challengers play, they learn interesting facts about eight computer components, including: disk drives, keyboard, memory, modem, monitor, mouse, printer, and processor. The program uses colorful animated graphics and entertaining games to motivate play. The program's sound effects, while amusing, are not supported by any audio cards — they sound out of date on the PC speaker. Challengers who beat the clock win the game and earn a place of honor in the program's hall of fame.

The Great Computer Adventure is both entertaining and educational. However, some children will have only a limited interest in the program. Challengers who go on the treasure hunt a second time may encounter different clues, but occasionally they will discover identical game puzzles and clue locations. Nevertheless, for a first time player, this package does a wonderful job of teaching computer literacy in a very engaging way.

— Carol Holzberg, PhD

Thinkin' Things

To help your child develop problem solving and analytical skills, Edmark brings another winner to the computer. *Thinkin' Things* joins *Millie's Math House* and *Kid Desk* as an excellent example of educational software. But this isn't dry stuff — there's plenty of room for youngsters to display their creative side.

Children as young as four years old should be able to jump right into this program. The publisher has designed a difficulty scale, called a Grow Slide, into the program. Parents can easily change the settings to provide a challenge appropriate for their child's abilities.



Thinkin' Things

Price: \$59.95

In Brief: Six modules stimulate creativity and analytical skills.

Requirements: IBM compatible with 640K RAM; VGA display; hard disk; mouse.

Audio Support: Sound Blaster and other sound devices.

For Ages: 4 to 8

Other Versions: Macintosh (\$59.95)

Edmark
P.O. Box 3218
Redmond, WA 98073-3218
(206) 556-8484
Circle Inquiry #176

Kids learn comparison and problem-solving skills in the Fripple Shop as they fill orders for delightfully wacky pets. Requests arrive by phone, fax, or in person. Fripple customers are very specific about what they want. The young Fripple merchant will need to evaluate his or her inventory with a careful eye. When a customer says she likes "straight hair, big eyes, but no spots" the child must pick the right Fripple from the shelf. A correct answer sends the Fripple bouncing happily out the door to its new owner. Should a child stumble, the pro-



Help Kids Key Into Computers.

The Computer Learning Foundation.[®]
We're here to help you.

Kids are the key to America's future.

And computers are the tools of their times. By the year 2010, virtually every job in America will require some use of technology. That means we must prepare all of our youth today to take on technology tomorrow.

Computers benefit children today.

Computers can enhance children's learning and unlock their creativity. They can help children be more productive and develop better communication skills. Computers make learning come alive and create learning experiences that weren't possible before. Plus, children love using computers, so children maintain a positive attitude toward learning.

The Computer Learning Foundation is here to help parents and educators

The Computer Learning Foundation is an international non-profit foundation taking the lead in computer literacy efforts. We are here to help parents and educators with the information and resources they need to help our children.

We have involved millions in discovering the benefits of technology. Our lesson plan and resource guides help parents and educators use technology with children. Our Computer Learning Month[®] each October is a focus for thousands of community and school programs. And we award thousands of dollars in technology products each year in our Computer Learning Month contests.

The Computer Learning Foundation is helping schools obtain more computers.

In our new *Computer Learning Dollars[™]* program, schools* can earn free computers, software and other technology products by saving Tetra Pak *Tetra Brik[®]* aseptic symbols from fruit, juice, milk and other non-carbonated drink boxes and by saving receipts from North Carolina Office Depot stores.

Write to us today.

We're here to help you.

Help kids key into computers.

You Won't Believe What You'll Achieve!

For more information, write to:



Computer Learning Foundation
P.O. Box 60007, Dept KC
Palo Alto, CA 94306-0007

* Available only in Massachusetts, New Jersey and North Carolina during the 1993-1994 school year.

The Computer Learning Foundation[®] is a non-profit educational foundation funded by corporations.

Corporate Partners: Sega Youth Foundation
Tetra Pak Inc.
Office Depot, Inc.

Corporate Associate: IBM/EduQuest[™]

Principal Sponsors:
Kids & Computers
Microsoft Corporation
T.H.E. Journal
MAC Home Journal

Teaching K-8
Curriculum Product News
Media & Methods
Technology & Learning

gram provides gentle hints to help reach the goal.

Two music-oriented modules stimulate pattern recognition, as well as visual and auditory discrimination skills. Kids will get a kick jamming along with a funky ape named Oranga Banga on drums, or tapping out melodies on a xylophone with a tuneful chicken named Toony Loon.

Add to this a pair of visually-stunning segments that let young artists create futuristic images on their own digital canvas. Kids can drag spheres or geometric shapes onto a workspace with a background design they have selected. They can even set the objects in motion, accompanied by the music of their choice. The effect is really quite impressive, especially to adults watching a preschooler create original designs within a short time. The only skill required for success is an ability to use a mouse, which most youngsters pick up readily.

Parents will appreciate the clever devices *Thinkin' Things* uses to stimulate their child's thinking. It's a well-designed and creative program that really enhances learning. And the kids? They'll be having too much fun learning to be thinking of such things.

— Dennis McCauley

Americans in Space

Boasting over 500 photographic images and an hour plus of video with narration, *Americans in Space* comprehensively traces the history of America's manned space flights. Kids who only know the space shuttle will marvel at how we came so far, so fast.

At its beginning, the program presents what looks like the foyer of space center. To the left is an elevator marked Express Tours. Straight ahead is a door marked Mission Control, and to the right is the Exit. In the center of the room is a podium with a book on it labeled Pilot's Manual.

The Express Tours icon opens up a narrated slide show. The topics covered are Race to the Moon, Turning Points, Disasters, Living in Space, and Cruising the Planets. The slide show can be run in a window or take advantage of the entire screen. (The show runs faster when displayed in a window.) The publisher made a good selection of pictures, although some of the detail and contrast

is not up to photographic quality. The narration accompanying the pictures is interesting and well paced.

The Mission Control door opens up explorations in various American space projects. Beginning with a Prologue, it moves through Mercury, Gemini, Apollo, Sky Lab, Apollo-Soyuz, Space Shuttle, and Space Station. Each project is further divided into missions, most of which include specific text entries, video clips and narrated slide shows. Kids can also get information about the goal of each mission and examine crew photos.



Americans in Space

Price: \$69.95 (Macintosh and Windows version ship in same package.)

In Brief:

Requirements: Macintosh with 3.5MB RAM; 256-color display; CD-ROM drive; System 6.05 or higher. IBM PC (386SX or better) with 2MB RAM; SVGA display; hard drive; CD-ROM drive; Windows 3.1 or higher.

Audio Support: Sound Blaster compatible

Multicom Publishing
1100 Olive Way Suite 1250
Seattle, WA 98101
(206) 622-5530
Circle Inquiry #177

Double clicking on the Pilots Manual opens the program's help feature. This feature helps parents and kids navigate smoothly through the program. Overall, this program is highly recommended for families interested in exploring America's role in the exploration of space, particularly manned space flight.

— Joel Schwartz, M.D.

Kid Keys

This musical typing tutor combines keyboarding and early reading skills with speech and song. It's an effective combination. The program has just enough animation to keep preschoolers and elementary school kids interested,

and its entertaining approach makes learning to type easier to take.

Kid Keys offers three variations on the typing theme. All three have various options easily set through a picture menu bar across the top of the screen. The learning modules can be selected from the menu bar and by pressing a large symbol on the wall of Keystone's Playroom. Keystone is a friendly dragon who greets youngsters at the opening screen.

With the Magic Keyboard, children become familiar with key and letter locations. Keys make sounds and music when pressed. Letter combinations make sounds when pressed, and a group of lively characters repeat the letters and the words they form.

The second variation, Dragon Tunes, combines the teaching of finger position with music. Each letter plays a note to a familiar song. When the letter sequence is finished, the tune plays back. For advanced learning, children create their own songs in timed practice sessions. There are 26 tunes, one for each letter in the alphabet. Players select the song they want to use from the Dragon Songbook.



Kid Keys

Price: \$49.95

In Brief: Children build keyboarding and early reading skills.

Requirements: IBM compatible with 640K RAM; VGA display; hard disk with 6MB free space; mouse; audio device; DOS 3.3 or higher.

Audio Support: Sound Blaster compatible sound devices; Disney Sound Source; Covox Speech Thing; IBM PS1 Audio; others.

For Ages: 4 to 8

Davidson & Associates
P.O. Box 2961
Torrance, CA 90509
(800) 545-7677
Circle Inquiry #178

Monster Rescue, the third game in the program, challenges players to use keyboarding skills to help the keyboard monsters get out of Keystone's castle. A



Join your kids on
an adventure they'll
never forget!



Take them to Tuneland™, a magical place of fun, music and laughter!

Tuneland stars Howie Mandel as Lil' Howie, a loveable, animated playmate, in the first fully-animated interactive cartoon. Join your child and Lil' Howie for hour after hour of playing, singing and learning that computers can be fun. Oh! By the way, Mom and Dad, when you play with Tuneland by yourself, Lil' Howie promises not to tell! See your nearest software dealer today!

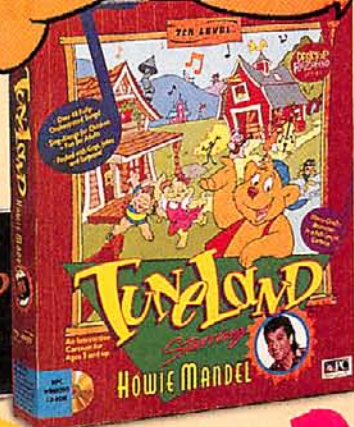

"The best product of its kind I've seen all year."

Gina Smith
Editor-in-Chief,
Electronic
Entertainment
Magazine



7th LEVEL

7th Level, Inc., 5225 San Fernando Road West, Los Angeles, CA 90039 ©1993 7th Level, Inc. Tuneland, Desktop Playground and 7th Level are trademarks of 7th Level, Inc. All rights reserved. • SYSTEM REQUIREMENTS: IBM: Tandy® or compatible 386 25 MHz or better with a minimum of 4MB of RAM, SVGA display and CD-ROM drive with CD audio connector, MPC compatible sound card, MS-DOS® 3.3 w/Windows™ 3.1 or later. Optional: amplified speakers, headphones.

Circle Reader Service #32

COMPUTER Express

Since 1985

800-228-7449 EXT. 601

TOLL FREE ORDER LINE

ROCK & BACH STUDIO



Ages 7-14. Produce your own action-packed music video! Assemble a band from a large cast of outrageous characters with their own individual music styles. Teach them your songs, or choose from a funky collection of programmed selections. Conduct, lead the jam, or let them go wild on their own. You control the sound and light mixer. Put it all together and create videos for your friends to play! See how sound is related to music. Try out the instruments in a symphony orchestra. Travel through music history with Bach, Mozart and others. Features SVGA graphics and digitized sound.

PUBLISHER: Binary Zoo

\$21

KID KEYS



Ages 4-8. A magical typing program that builds skills for young children. A friendly dragon named Keystone guides children through three exciting activities that familiarize them with basic keyboard functions. Kids can explore the keyboard with unique and animated imagery in the Magic keyboard. As they type, different animations appear that reinforce letters and key positions. Once children are familiar with the keyboard, they can play Dragon Tunes and the Alphabet Song Game. Features easy-to-read type, digitized speech, music and sound effects.

PUBLISHER: Davidson

\$28

BODYWORKS 3.0



All new 1994 edition! The human body is the ultimate machine. Explore its systems, structures, and functions in fascinating detail. An adventure in anatomy. Colorful, comprehensive graphics guide you on a journey

through the body. Advanced "speech back" sound lets you hear the correct pronunciation. Detailed animation bring the intricate functions of the body to life. Includes both DOS and Windows versions. Discover the miracle of the human machine!

PUBLISHER: Software Marketing DOS/WIN

\$38

STUDYWARE SAT I

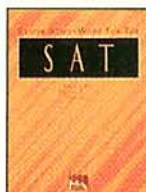

Prepare yourself for the new SAT I in four simple steps. Complies with the new SAT format and covers all the new question types. Covers all the topics included on the SAT. Contains thousands of questions, answers and on-screen explanations.

four full tests; complete on-screen glossary and dictionary; useful hints and test-taking strategies; pull-down menus; mouse compatibility. Explains all correct and incorrect answers. Scores and analyzes Test Prep Guide practice exams as well as on-screen StudyWare exams. Review and prepare at your own pace!

PUBLISHER: Cliffs

\$34

THINKIN' THINGS



Six thought-provoking activities build problem solving, creativity, critical thinking and memory skills that will give your child a solid foundation for a lifetime of successful learning. Varying levels of difficulty to allow for different ages and abilities to learn and be challenged. Instructions are spoken or graphical, so even pre-readers can build their thinking skills. Gives kids the tools they need to think analytically, solve problems creatively, and have fun learning to learn!

PUBLISHER: Edmark DOS, MAC

\$34

MATH ACE



Ages 8-14. Turns your kids on to math. Includes captivating arcade-style game, essential skill-building exercises, and an introduction to 70 major math concepts. Features engaging graphics,

MIDI music, and sound effects. Hundreds of real-world challenges with Bit Bot, your animated math navigator. More than 3000 math problems with a visual math function generator. Also features Smart Lab, an interactive math workshop.

PUBLISHER: Magic Quest DOS, MAC

\$28

SCIENCE & HISTORY

Body Illustrated.....	45
ComputerWorks.....	26
Dandy Dinosaurs CD.....	47
DinoPark Tycoon.....	33
Discover Space.....	34
EZ Cosmos 4.0.....	42
Earth Treks.....	29
Eco Quest Search for Cetus CD.....	39
Ecology Treks.....	29
Jurassic Dinosaurs CD.....	29
Jurassic Dinosaurs WIN.....	29
Kid's Zoo CD.....	50
Kid's Zoo DOS/WIN.....	34
Oceans Below CD.....	29
Odell Down Under WIN.....	34
Oregon Trail Deluxe.....	33
Pepper's Adventures in Time.....	29
Quark & Quaysoo's Science.....	29
Science Adventure 2.0.....	35
Space Adventure.....	34
Space Adventure CD.....	50
Space Adventure II CD.....	50
Time Riders-American History.....	34
Time Treks.....	29
Undersea Adventure WIN.....	46
Webster's Dictionary WIN.....	62
Where in America's Past Carmen.....	29
Where in Space Carmen Deluxe.....	40
Where in Time is Carmen?.....	29
Where in World Deluxe CD.....	54
Where in the USA Deluxe.....	40
Where in the USA is Carmen?.....	29
Where in the World Deluxe.....	40
Where in the World is Carmen?.....	29
Wild Science Arcade w/T-SHIRT.....	22
ZooKeeper.....	34
Zugs Race Through Space.....	23
Alge Blaster Plus.....	28
Algebra.....	52
Algebra By Example.....	24
Calculus WIN.....	51
Chemistry Works DOS/WIN.....	26
Dinosoft Addition & Subtract.....	14
Dinosoft Math Flashcards.....	12
Dinosoft Multiply & Divide.....	14
Early Math WIN.....	29
Geometry Concepts.....	34
Kid Cad WIN.....	29
Learn About Fractions.....	16
Line & Shape Eater CD.....	25
Math Blaster Spot/Kid Works II.....	43

MATH

Math Blaster WIN.....	34
Math Rabbit Enhanced.....	28
Mathology.....	28
Mega Math.....	29
Mental Math Games 2.0.....	28
Millie's Math House.....	28
Operation Neptune.....	34
StickyBear Math Tutor.....	25
Super Solvers:Midnight Rescue.....	28
Super Solvers:Out Numbered.....	28
Aladdin and His Lamp CD.....	32
Amanda Stories CD.....	20
Arthur's Teacher Trouble.....	40
Bailey's Book House.....	28
Beauty and the Beast CD.....	25
BookMaster for Speed Reading.....	34
Cinderella CD.....	20
Dinosoft Phonics.....	10
Follow the Reader.....	29
Heather Hits Homerun CD.....	20
Jr High Grade Builder 3 Pack.....	22
Just Grandma & Me CD.....	34
Long Hard Day at the Ranch CD.....	20
Mind Castle.....	34
Moving Gives A Stomach Ache CD20.....	20
Mud Pubble CD.....	20
Once Upon A Time II.....	30
StickyBear Math Tutor.....	25
Super Solvers:Midnight Rescue.....	28
Super Solvers:Out Numbered.....	28
Treasure MathStorm!.....	34
Treasure MathStorm! WIN.....	34
Treasure Mountain.....	33
What's My Angle.....	28
Aesop's Fables CD.....	20
Aladdin and His Lamp CD.....	32
Amanda Stories CD.....	20
Arthur's Teacher Trouble CD.....	40

MATH

READING

Bailey's Book House.....	28
Beauty and the Beast CD.....	25
BookMaster for Speed Reading.....	34
Cinderella CD.....	20
Dinosoft Phonics.....	10
Follow the Reader.....	29
Heather Hits Homerun CD.....	20
Jr High Grade Builder 3 Pack.....	22
Just Grandma & Me CD.....	34
Long Hard Day at the Ranch CD.....	20
Moving Gives A Stomach Ache CD20.....	20
Mud Pubble CD.....	20
Once Upon A Time II.....	30
Paper Bag Princess CD.....	20
Peter and the Wolf CD.....	25
Reader Rabbit I Enhanced.....	34
Reader Rabbit II.....	34
Reader Rabbit III.....	34
Reader Rabbit Ready for Letter.....	34
Reading Adventures in Oz.....	34
Reading and Me Talking.....	25
Ready, Set, Read WIN.....	29
Rusty & Rosy Volume 1 WIN.....	29
Rusty & Rosy Volume 2 WIN.....	29
Scary Poems for Rotten Kids CD.....	20
School House: 30 Programs.....	18
Sleeping Beauty Storybook CD.....	25
Speed.....	45
StickyBear Reading Tutor.....	29
Super Solvers: Ancient Empires.....	27
Tale of Benjamin Bunny CD.....	20
Heather Hits Homerun CD.....	20
Jr High Grade Builder 3 Pack.....	22
Just Grandma & Me CD.....	34
Long Hard Day at the Ranch CD.....	20
Mind Castle.....	34
Moving Gives A Stomach Ache CD20.....	20
Mud Pubble CD.....	20
Once Upon A Time II.....	30
Paper Bag Princess CD.....	20
Peter and the Wolf CD.....	25
Reader Rabbit I Enhanced.....	34
Reader Rabbit II.....	34
Reader Rabbit III.....	34
Reader Rabbit Ready for Letter.....	34
Reading Adventures in Oz.....	34
Reading and Me Talking.....	25
Ready, Set, Read WIN.....	29
Rusty & Rosy Volume 1 WIN.....	29

READING

READING

Rusty & Rosy Volume 2 WIN.....	29
Scary Poems for Rotten Kids CD.....	20
School House: 30 Programs.....	18
Sleeping Beauty Storybook CD.....	25
Speed.....	45
StickyBear Reading Tutor.....	29
StickyBear Reading Tutor.....	29
Super Solvers: Ancient Empires.....	27
Tale of Benjamin Bunny CD.....	20
Tale of Peter Rabbit CD.....	20
Talking Classic Tales CD.....	55
Talking Classic Tales CD.....	55
Talking Jungle Safari CD.....	49
Talking Phonics Plus.....	26
Tell Tale Heart CD.....	34
Thomas' Snowsuit CD.....	20
Tortoise & The Hare CD.....	34
Treasure Cove.....	34
Ugly Duckling CD.....	39
Zugs Dinosaur World.....	23
Aladdin Print Kit.....	14
Animation Studio WIN.....	75
Betty Crocker Boys & Girls.....	18
Creation Stories CD.....	32
Creative Writer WIN.....	39
Fine Artist.....	45
Kid Cuts.....	23
Kid Doodle WIN.....	20
Kid Pictures.....	19
Kid Pix.....	35
Kid Rhymes.....	20
Lenny's Music Toons CD.....	34
Lenny's Music Toons WIN.....	34
Logo Writer.....	56
MetroGnomes' Music.....	28
Miracle Piano w/FREE Songs.....	269
My Own Stories.....	29
Peter Pan:Story Painting Adv.....	31
Print Shop Deluxe 1.2.....	46
Print Shop Deluxe 1.2 WIN.....	46
Print Shop Deluxe Comic WIN.....	24
Print Shop Deluxe Comics.....	24
Print Shop Deluxe Companion.....	34
Print Shop Deluxe Companion WIN34.....	34
Print Shop Deluxe Sampler.....	26
Print Shop Deluxe Sampler WIN.....	26
Show & Tell for Kids.....	28
Sound Source.....	27
Story Book Weaver.....	29
Wild Learning Safari.....	23
Alphabet Blocks WIN.....	28

CREATIVITY

Request your Free T-Shirt with purchase of Rock 'n' Bach, Mystery at the Museums, or Wild Science Arcade.



BEGINNING READING



The unique Dream Team talking characters have emerged as an absolutely remarkable teaching tool. Using proven learning methods, Yobi, Bananas, Jack, Spooky and Irid establish a one-on-one relationship

with your child while giving positive reinforcement. Challenging puzzles and exciting story lines are skillfully blended with music, sound effects and articulate characters to create an extraordinary learning experience. Leads your child through the process of learning to read.

PUBLISHER: Sierra \$28

BIG GREEN DISC



An interactive documentary on the future of our planet. Informs you of the environmental issues threatening our planet and what you can do to help solve them. Looks at problems including global warming, pollution, ozone depletion, acid rain, and the potential solutions: recycling, alternative energy sources and conservation. After examining the facts, enter into an environmental debate. Fully narrated with stunning photography throughout. Features specially filmed video sequences, in-depth photo stores, and animated diagrams.

PUBLISHER: Sony Imagesoft IBM CD \$55

ALGE BLASTER 3

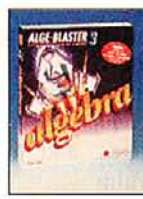

Ages 12 to adult. Newest version of the world's best-selling algebra program. Guides you through an entire year's algebra curriculum, using an interactive tutorial approach. Four unique activities with all-new SVGA graphics, animations and sound will help you develop a better understanding of the algebraic process. Learn how to solve equations and translate word problems into algebraic expressions. Two challenging new graphic games will ensure that you become a graphing expert. Covers all subject areas and features on-screen hints.

PUBLISHER: Davidson WIN \$33

MARIO'S TIME MACHINE



Join the Mario Brothers on a wild ride through time as they relive great moments in history in this new series. Take a romp with the dinosaurs during the Jurassic period, stop off in ancient Egypt to meet Cleopatra, and arrive just in time to witness the first successful powered flight of the 20th Century—all in a day's work for the popular plumbers. See Mario visit the workshop of Thomas Edison, ride along with Neil Armstrong and cheer for Babe Ruth, in addition to witnessing scores of other historic events. Entertaining and educational for the whole family.

PUBLISHER: Software Toolworks \$28

MAVIS BEACON TEACHES TYPING 3.0



Learn to type with the world's best-selling program. Now it's better than ever! Provides all the features of version 2, like personalized practice lessons and witty conversational explanations. New exciting features include practice text from the

New Grailier's Multimedia Encyclopedia and Newsweek Magazine, lesson tracking ability, and amazing games that take a fresh approach to making learning even more fun. Features 256-color graphics and new MIDI music. Mavis will have you typing like an expert in no time. For users of all ages.

PUBLISHER: Software Toolworks \$27

SOFT KARAOKE



So much fun for the holidays! Totally amazing! Turns your PC or MAC into a full-fledged home Karaoke machine. A breakthrough in entertainment! Lyrics light up to the right beat directly on a monitor. Instantly access your own personal song bank. Countless hours of fun for music lovers and professional musicians. Tempo and Key are fully adjustable. Includes five legally licensed top Billboard hits and hundreds of optional songs available. Guaranteed to run on Windows 3.1 with your sound board. **REQUIRES A SOUND BOARD.**

PUBLISHER: Tune 1000 DOS, MAC \$26

EAGLE EYE MYSTERIES IN LONDON



Match wits with the world's smartest junior detectives! Jake and Jennifer Eagle run the hottest detective agency, and they are looking for 8-14 year-old volunteers to help them solve their latest series of cases. Solve over 50 new progressively challenging cases. Use your deductive reasoning and reading comprehension skills. **FREE** poster size map of London included. Use the map for clues to solve the cases. Keeps children enthralled while strengthening their deductive reasoning skills. **MAC version: \$35.**

PUBLISHER: Electronic Arts \$30

AMAZON TRAIL



Journey through time from the mouth of the Amazon to its lofty sources in the Andes high country. Find the medicinal plant that will save the ancient Incas from extinction and deliver it to the Inca King. Meet as many as 30 other historic explorers, naturalists, scientists, and natives. Exercise problem-solving and reading-comprehension skills. Develop navigational abilities. Introduces ecosystems and provides insights into South American history from the time of the Spanish Conquistadors to present.

PUBLISHER: MECC DOS, MAC \$33

SPELLING

- Mario's Fun with Letters26
- Mickey's ABC's Enhanced.....19
- Spell It Plus.....29
- Super Solvers:Spellbound.....29
- Word Attack 329
- Word Munchers.....19
- Word Tunes CD.....31
- Yobi's Spelling Tricks WIN.....29

GEOGRAPHY

- Discovering America34
- Expert Maps12
- Last Tribe26
- My First World Atlas29
- Mystery at Museums w/T-SHIRT23
- Nigel's World26
- PC Globe Maps & Facts26
- PC Globe Maps & Facts CD40
- PC USA 3.027
- World Atlas 4.0 WIN45

EARLY LEARNING

- AJ World of Discovery29
- Berenstein Bears Fun LunchPak25
- Berenstein Bears Junior Jigsaw18
- Berenstein Bears Learn At Home25
- Cuckoo Zoo31
- Fatty Bears B-Day Surprise CD39
- Fatty Bears Birthday Surprise30
- First Letters & Words.....12
- First Shoppes.....9
- Fisher Price Classics26
- Kid Pix Companion WIN29
- Kid Pix WIN.....36
- KidDesk25
- Mario Early Years Collection CD29
- Meggie Series Bundle.....29
- Mickey's 123's Enhanced.....20
- Mickey's ABC's Enhanced.....20
- Mickey's Jigsaw Puzzles16
- Mixed Up Fairy Tales20
- Mixed Up Mother Goose CD.....40
- Number Munchers20
- Peanuts: Yearn to Learn WIN37
- Playroom 2.029
- Power Hits CD.....29
- Putt Putt Goes to the Moon29
- Putt-Putt Fun Pack.....21
- Putt-Putt Joins the Parade30
- Scooter's Magic Castle31
- Slater & Charlie Go Camping29
- Snoopy's Game Club23
- Stickybear Preschool CD.....32
- Stickybear Preschool28

TYPING

- TreeHouse.....34
- Word Munchers.....20
- Easy Working Typing WIN20
- Mario Teaches Typing26
- Mavis Beacon Typing 3.024
- Mavis Beacon Typing CD56
- Typing Tutor V Plus.....29

LANGUAGE

- Berlitz Think & Talk Italian CD99
- Berlitz Think/Talk Spanish CD99
- Language Assistant:French 5.056
- Language Assistant:French WIN56
- Language Assistant:German WIN56
- Language Assistant:Italian 5.055
- Language Assistant:Spanish 5.056
- Learn to Speak Spanish CD49
- VocabLearn French I34
- VocabLearn French I WIN40
- VocabLearn Italian I34
- VocabLearn Japanese I WIN40
- VocabLearn Spanish I34
- VocabLearn Spanish I WIN40

TEST PREPARATION

- ACT w/Cliff Notes26
- Biology Studyware23
- Calculus Studyware25
- Chemistry Studyware25
- GMAT w/Cliff Notes29
- GRE w/Cliff Notes29
- LSAT w/Cliff Notes34
- Physics Studyware26
- SAT NEW Personal Trainer WIN34
- Score RX for ACT at Home61
- Score RX for GRE at Home61
- Score RX for LSAT at Home79
- Score RX for SAT at Home.....61

REFERENCE

- American Heritage Dictionary34
- Americans in Space CD.....47
- Animals: San Diego Zoo CD56
- Barron's Book Notes WIN46
- BodyWorks 3.039
- Creep Crawlies CD.....41
- Cute 'n' Cuddlies39
- Dictionary of Living World CD.....93
- Dinosaur Adventure CD43
- Dinosaur! MPC Encyclopedia CD.....45
- Greatest Book Collection CD31
- MS Dinosaurs Multimedia CD.....51
- Orbits:Voyage the Solar System.....32
- Addition & Subtraction16

MACINTOSH TITLES

- Algebra52
- Algebra Blaster Plus32
- Backyard28
- Calculus Studyware23
- Dinosaur Adventure25
- Early Math29
- Kid's Studio34
- Kid's Typing29
- KidDesk25
- Mac Globe34
- Mac USA 2.029
- Mario Teaches Typing29
- Math Blaster Plus34
- Math Flashcards14
- Math Rabbit 2.035
- Millie's Math House28
- Mind Castle34
- Multiply & Divide16
- My First World Atlas29
- My Own Stories29
- Odell Down Under34

MACINTOSH TITLES

- Oregon Trail28
- Phonics16
- Playroom 2.029
- Principles of Chemistry.....26
- Reader Rabbit I34
- Reader Rabbit Ready for Letter.....34
- Spell It Plus30
- StickyBear Reading Room29
- Super Solvers:Out Numbered34
- Super Solvers:Spellbound34
- Treasure MathStorm!34
- TreeHouse34
- USA Geography29
- VocabLearn French I34
- VocabLearn Italian I34
- VocabLearn Spanish I30
- Where in America's Past ???29
- Where in Time is Carmen?29
- Where in the World - Deluxe46
- Where in the World is Carmen??29
- ZooKeeper34

800-228-7449 EXT. VOICE:508-443-6125
601 FAX:508-443-5645
31 Union Ave., Sudbury, MA 01776

日本の皆様よりのオーダー大歓迎！日本語で FAX:0011-508-443-5645、
 又は、CompuServe ID:70007, 1534で見積りをお問い合わせ下さい。
 迅速に、如何なる御要望にも誠意をもってお応え致します。

FREE UPS GROUND SHIPPING
10,000 IN STOCK ITEMS

800 228-7449 - Orders Only, 508 443-6125 - all other business. Sales Dept. Hours - Monday - Friday - 8AM till 8PM, Saturday 9AM till 5PM. All other Business - Monday - Friday - 9AM till 5PM. Most orders ship within 24 hours. Temporary shortages are normally filled within 10 days. Books, Memory chips, and some electronic components are not returnable. We ship only to verified billing addresses. International orders welcome. Airborne Express Shipping charges \$7 per order up to 6 lbs. \$1 per lb. above 6 lbs. UPS Ground service charge \$3 per order. Actual freight charges apply for computers, hard disks, Bernoulli's, tape back-ups, printers, Multimedia kits, monitors, etc. Alaska, Hawaii, outside continental U.S. APO/FPO call for information. Prices subject to change without notice. Some product not available outside the U.S. Please call for more information. Not responsible for errors or omissions. Mastercard, Visa, Discover, prepaid orders, purchase orders, wire transfer, cash, and cashiers check accepted. Personal and Company checks allow 14 days to clear. No surcharge for credit card orders. Your credit card is not charged until the merchandise is shipped. We check for stolen credit cards. All returns for credit, repair, or exchange must have a return authorization number. Returned orders or ordered wrong items are subject to a 15% restocking fee. We ship latest versions of software available. Over nine years of service. Thousands of satisfied customers. Send your Fax today! All quotes answered immediately. Product covered by manufacturer's warranty. Defective items replaced immediately. Educational, government, and corporate purchase orders welcome. All item numbers represent 3.5" floppy, except where noted.



set of hands with moving fingers shows which fingers to press as letters pop onto the screen. This game introduces the use of uppercase and lowercase letters.

The program's print option activates when players reach various score ranges based on accurate typing. This feature prints thank you notes from the various friendly monsters with the player's name on it. That's a great incentive for young kids learning the essential keyboarding skills that will help them with their future computer instruction.

— Jack M. Germain

The Complete Annotated Alice

Lewis Carroll's classic children's books *Alice's Adventures in Wonderland* and *Through the Looking Glass* come alive in *The Complete Annotated Alice*, a multimedia CD-ROM from Voyager. This well-produced Hypercard stack contains the full text and pictures from both books. In addition, the program includes extensive annotations, comments, and analysis of the stories and, as a bonus for Carroll fans, "The Wasp In a Wig," a lost chapter that didn't make it to print in either book.



The Complete Annotated Alice

Price: \$19.95

In Brief: A captivating, multimedia romp through the looking glass and beyond.

Requirements: Macintosh LC or better with 2MB RAM; hard disk; System 6.0.7 or higher; Hypercard 2.1.

The Voyager Company
578 Broadway, Suite 460
New York, NY 10027
(800) 446-2001; (212) 431-5199
Circle Inquiry #180

Using *The Annotated Alice* is very much like thumbing through a traditional book. Readers can page back and

forth, skip ahead or back, mark favorite passages, even make notes in the margin. However, the software offers tools a traditional book does not, allowing the reader to instantly find text, export passages, and jump to annotations on a whim.

The book is simple for a child to navigate, the mouse isn't even necessary to turn the page. Adults will enjoy Alice for its extensive annotations, which give new insights to the book (the annotations make a book all by themselves).

To keep it simple for the little ones, parents can switch off the annotations, the toolbar and other gimmickry. Throughout, the book includes familiar drawings of Alice on her underground escapades. As a nice touch, a click of the mouse switches between normal text and large print.

The Complete Annotated Alice is a joy to peruse, or read from cover to cover. Despite a few minor cosmetic problems, this program provides a rewarding experience for both young children and adults.

— Kevin Savetz

European Racer

Every kid wishes for the chance to jump behind the wheel of a Porsche 911 S, but most of them settle for building the model. Revell-Monogram turns model building into model driving. Young model makers receive a 1/24th scale model Porsche 911 Slant Nose and a CD-ROM disk in this program bundle. The software assists in the construction of the model with step-by-step instructions, and three-dimensional views over which kids have control. Video clips show model-making tips — how to glue, paint, and detail the model Porsche. A painting option lets modelers see how each car looks in different colors before painting. An on-line glossary of automotive terms enhances the program's educational aspects.

The driving simulation begins on the showroom floor, where a female voice describes the model and its capabilities. From here, the game accelerates through the backroads of Europe. Young drivers must dodge obstacles, outrun the police, and sustain as little damage as possible (and finish with fuel in the tank). If successful, drivers will arrive at one of four tracks: the Zurich Switchback, the Sicilian

Jackknife, the Barcelona Corkscrew, or the Stuttgart Screamer. Here they will go against five computer competitors in a five-lap race.



European Racer

Price: \$70

In Brief: A plastic car model and CD-ROM disk combination allows youngsters to build and drive an authentic European sports car.

Requirements: IBM PC or compatible (386SX or better) with 4 MB RAM; hard disk with 13MB free space; Super VGA display; CD-ROM drive; mouse; DOS 5.0 or higher.

Audio Support: Sound Blaster compatible

Revell-Monogram
8601 Waukegan Rd.
Morton Grove, IL 60053
(708) 966-3500
Circle Inquiry #179

Random road and weather conditions means players must modify their cars before or during each race. Drivers may choose from a selection of five different wing spoilers, three tire options, and between an automatic or manual transmission. This sophisticated software product brings with it sophisticated hardware requirements. One major warning: The installation program modifies the system's CONFIG.SYS file without first saving the original file.

The multimedia effects of interactive 3-D graphics, digitized sound effects, and video will have kids glued to the computer screen for hours. Model building has come to the MTV generation.

— Jeff Kingston

CGW



My son and I love this game!!!

Great work!!

Robert Strauss, Burbank



My daughter (11 years old) and I have become "Oxyd" addicts. We cannot wait to begin exploring the many other levels. Thanks for creating such an excellent product. R. S., Germantown

This is, without question, the most impressive game I have ever seen. I am amazed at the audio, visual and action. George L. Tanty, Arlington Heights

Outstanding program!!!! John Bernauer, Los Gatos

Wow! That's all I can say about Oxyd. What an incredible game! Hurry! I can't wait to play!!

This game is highly addictive. Stuart Ritchie, Canada

One of the nicest games I have seen in a long time.

Thanks for creating such a challenging piece of software. Steve Brannan, Canada

I'm completely hooked! Patricia B. Smith, NH

The game is a blast! Excellent graphics, extremely well done. Interesting challenges in each landscape also. I look forward to the next 90 landscapes. David Mangini, CT

The game is really slick, well designed. Those first 10 levels alone were worth paying for!

One of the most elegant games I've played. Thanks a lot for a great game. Jeffrey Jondahl, San Diego

OK so we got hooked!

I enjoy this game a great deal and so do my children and their friends. It is just what I have been looking for !!

Jerome Wescott, Minneapolis

My whole family enjoyed your game a great deal.

Michael C. Moore, Columbia

Oxyd has to be the most artistically superb piece of programming that I have seen. From my position of having completed about one third of the single-player levels, the landscapes have been continuously varied with a marvelous attention to graphic and audible detail that makes each new one a continuing delight. I especially appreciate how the marble interacts in seemingly realistic but different ways when rolling over or bouncing against different "natural" (or unnatural) substances like stone, wood, swamp, freefall etc. At this point, I'm already worrying that I'll run out of levels (assuming I keep solving the puzzles). Jeffrey R. Harrow

Even our 3yr old enjoys the game.

I just had to write to tell you how much fun I've had playing Oxyd. The attention to detail - the sounds, the textures of the surfaces - really adds to the fun of the game. It invites the imagination for a ride.

Thanks also for making all of the landscapes challenging but not impossible. At first I thought that landscape 76 was unfairly difficult, but when I found the way through it, I really admired the ingenuity. Tom Phoenix, Portland

It is rare to find such a visually appealing, addictive and playable game. Kathryn Wilson, Australia

I'm really impressed with your game, Oxyd. Congratulations on a unique and fun product, and best luck to you all. John M. Dodd, Thousand Oaks



Oxyd® magnum! for PC, Mac,

A500 - A2000, ST, TT or Falcon Computers.

Sequel of the award winning Oxyd,
now at a store near you!

Mac: 1MB RAM, color or monochrome!
PC: 386 or above, 2.5MB RAM, EGA or VGA, Soundbl.a. or Adl. optional.



Oxyd Credits:

Best Brain Game

MacWorld Game Hall of Fame 1993

Game of the Year

Computer 8 Pädagogik 06/93

Score this game a solid 10

Current Notes 06/93

**"A" rating - Wow! Exquisite.
A must for your games library.**

AmigaWorld 06/93

Game of the Month.

MacWelt 02/93

Top of the Charts

Brain Teaser Category, PC Games German edition.



100 new landscapes.
New objects and game
elements to explore.

Oxyd magnum! is an entirely new and riveting
challenge for Oxyd experts and beginners alike.

Call 617-497-1130

for the Oxyd magnum! retailer nearest you

Get a free appetizer for PC, Mac, Amiga or ST:

Send \$ 4.00 for shipping & handling for 10 challenging landscapes
of Oxyd to Dangleware, 35 Howard Street, Cambridge, MA 02139.
Send \$ 4.00 for a 5 level teaser of Oxyd magnum! (PC or Mac only)

Beggar's Canyon, Anyone?

LucasArts' *Rebel Alliance* Wants You

by Paul C. Schuytema

Don your blaster helmet and prick up your synapses to receive the all-encompassing waves of the Force. Once again, it's time to jump back in time, back to a galaxy far, far away to do battle against the evil Empire and their dreaded Death Star. Lucas Arts has brought the struggle of *Star Wars* to life in an arcade shooter entitled *Rebel Assault*, a game that takes full advantage of a CD-ROM disc to cram into its 15 chapters all the pomp and circumstance we've come to expect from the pulp science fiction saga. It is a fresh experience, a melding of arcade action and cinema that showcases the possibilities of a CD-ROM game. In some ways, *Rebel Assault* is a breathtaking game, yet it comes up a few light sabers short in some key areas.

The game is composed of a series of 15 chapters, beginning with basic flight training, screaming down the infamous Beggar's Canyon on Tatooine (the subject of many of Luke Skywalker's boasts) and ending with the archetypal assault on the Death Star. The central character is not Luke Skywalker, but an amazing facsimile, a rebel rookie who must prove himself (or herself, since the game can represent either gender) through a hail of fire.

The chapters consist of "mini games" all threaded together in a linear, cinematic plot. While the goal and presentation of each chapter is varied, the basic skill—hand-eye coordination—is all that's needed. Most chapters are "aim and shoot" games, while a few others test your flight and maneuvering skills. It should be noted that *Rebel Assault* is in no way a flight simulator, or in any way remotely related to Lucas Arts' *X-wing*.

The two qualities that stand out in *Rebel Assault* are the media experience (the video, animations and sound) and the hyper-intense level of action. Make no mistake, the quality of the graphics and the cut scenes is the best yet delivered in a PC action game. Screaming

your X-Wing down a river bed or weaving an A-Wing through the stalactites of an ice cave add up to one of the most visually intense experiences you can imagine.

In the cut scenes between chapters, the plot unfolds through a blending of video clips (taken from the first two *Star Wars* movies) and computer-generated animations. The video segments are full screen, although the video quality has been compromised to allow for the screen size, a decent frame rate, and a CD-quality soundtrack.



The action level in *Rebel Assault* is unrelenting. You must blast, swerve and aim constantly, testing the mettle of your trigger finger and the endurance of your joystick control skills. At times, it seems like luck (or perhaps the Force) is the only thing keeping you from tumbling into a ball of flames at the bottom of some godforsaken riverbed. "Fast" and "frantic" are keywords in *Rebel Assault*, and you should be prepared to lean on the fire button constantly.

The graphics are an interesting blend of traditional graphics and video clips. Some levels, such as the ice cave shoot-out and the asteroid field, feature video scenery flying past, and you are allowed limited movement with which to dodge and fly through the obstacles. It is an interesting way to present a game, since the level of detail can far surpass any

"calculate on the fly" technology, and the limited movement is very acceptable for game play purposes. It creates the effective illusion of flight control. In other levels, such as the Imperial Walker shoot-outs, the flight path is pre-recorded. In these levels you may manipulate the aiming reticule and achieve a very minor level of left-right/up-down variation, but you are constrained to the established flight path.

Although the game does not offer a disk-based save-game feature, *Rebel Assault* will provide a password to use when you return to the more advanced levels. The only problem is that the passwords are granted only after the completion of several levels of play, and not after each level. This can add up to frustration when you have to battle through three levels just to get back to where you lost the game the last time.

The plot seems to fold certain elements of *The Empire Strikes Back* (such as the Imperial raid on the snowbound Rebel base) into the plot to destroy the Death Star. As an exercise in story telling, I can't help feeling slightly disappointed in the game, as it essentially replays several scenes from the movie, adding precious little fresh substance. The plot is flimsy enough in that it requires a knowledge of the movies to make sense of it, and so it seems foolish to replay some of the scenes exactly (such as the briefing of the stolen Death Star plans). I wish that Lucas Arts had taken a little more creative license with the game and offered up a fresh plot thread to make it a new cinematic experience, not just a point and shoot replay of the original movie.

Rebel Assault



TITLE:	Rebel Assault
PRICE:	\$69.95
SYSTEM:	IBM
REQUIREMENTS:	386-33MHz, 4MB RAM, VGA graphics, MPC Level 1 CD-ROM drive; supports Pro Audio Spectrum, Sound Blaster, and Ultrasound sound cards
PROTECTION:	None
DESIGNER:	Vince Lee
PUBLISHER:	LucasArts San Rafael, CA (800) 782-7927

IMAGINE A GAMING DEVICE
SO INTUITIVE IT'S LIKE
NOT HAVING ONE
AT ALL.

CYBERMAN™

THE MOST ADVANCED
WAY TO MASTER
3-D GAMES.

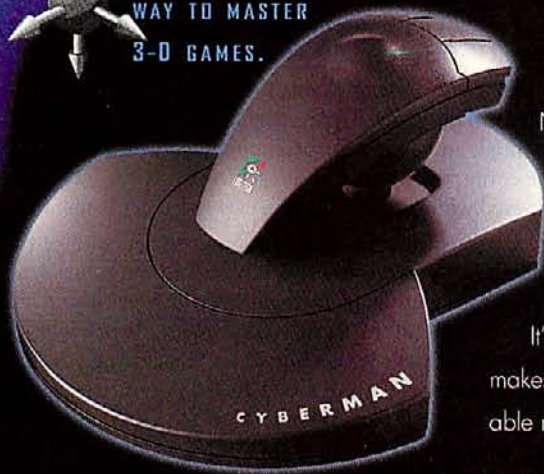

Now moving in a game is as easy as thinking about it. Only CyberMan moves in three directions (x, y, and z) and three rotations (pitch, yaw, and roll), which correlate directly to your moves inside a 3-D game; your intuitive movements translate literally to the screen.

It's also the only controller with tactile feedback that makes you a physical part of the game. CyberMan is available now at your local dealer, or call **1-800-732-2928**



The Senseware™ Company

™ Trademarks belong to their registered owners.

Circle Reader Service #81

NOTEBOOK
GAMEPORT™

Finally, a Joystick Connection for Your Notebook!

Transform your high-performance portable into a serious simulation machine with the Notebook Gameport™. Connect an IBM-compatible joystick or yoke and rudder pedals.

The Notebook Gameport™ not only maximizes the entertainment potential of your notebook computer, it's also the quickest, easiest joystick connection for your desktop! Ask your local retailer for the Notebook Gameport™ or call Colorado Spectrum to place your order.



COLORADO
SPECTRUM

748 Whalers Way, E-201, Fort Collins, CO 80525
International Telephone: (303)225-1687

(800) 238-5983

9-Pin Connector to Computer's Serial Port

Easily connects to all IBM compatible notebook and desktop computers.

Four-axis Gameport

Supports joystick & rudder pedals simultaneously. No calibration, jumpers or manual speed adjustments necessary.

Pass-through Serial Mouse Port

Mouse remains fully operational while gameport is in use.



In all, I would say that *Rebel Assault* is an odd mix of challenging and mindless levels, offering very little continuity in the difficulty scale. If I had one overarching bone to pick with the game, it would be the "sameness" of the levels. Each replay of any chapter offers the same fare, with TIE fighters approaching in exactly the same patterns and Imperial Storm Troopers showing up in the same places. With the exception of a very few levels, where so much is going on that an entire pattern is hard to grasp (such as the asteroid field dogfight), a level is fairly easy to memorize, making the repeated-play challenge diminish logarithmically. In one level, where your alter-ego has to blast Imperial Storm Troopers in a series of ice-cave locales, the patterns were so easy to anticipate that I had figured it out on my first run through, and actually came out of the encounter undamaged. If one could "record" the joystick and trigger actions of a successful game, then that recording could win the game time after time.

Rebel Assault is also peppered with more than a few bugs, the most irritating of which is the constantly decaying calibration of the joystick. It is not uncommon to have to recalibrate the joystick up to a dozen times during a single game. Also, some of the branching paths in the Beggar's Canyon and cave scenarios are implemented very poorly, with visual jerks, frozen screens, and movement to the left when you want to go right.

One thing that *Rebel Assault* does do is to herald in a new era of CD-ROM games. The game is played entirely off the disk with no installation required, and except for beginning load time, it is fast, fluid and furious the entire way through. It is exciting to see the level of detail that can be achieved while still keeping the play speed at the manic levels.

Rebel Assault is a gorgeous, fast-paced shooter that is a lot of fun to play. The problem is, the fun is too short lived, and the game certainly doesn't lure us back to play again and again. If you love the old arcade style of frantic aim and shoot games, then *Rebel Assault* will be an experience not to be missed. If you live to see the cutting edge of PC entertainment technology, then this CD-ROM is a must have. But if you want hours of in-depth play, then perhaps the Force should guide you elsewhere. **CGW**

THIS IS YOUR BRAIN.

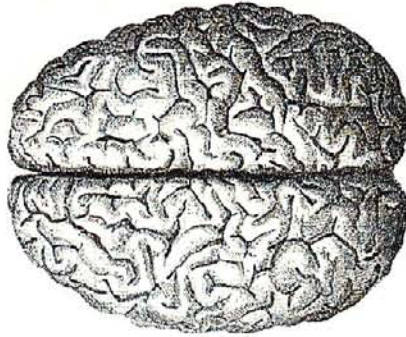

THIS IS YOUR BRAIN NEUROJACKED INTO CYBERNET IN SPECTRE VR.™

FULL MOTION VIDEO FROM CD-ROM: THINK OF IT AS AN INTERMEDIATE STEP BETWEEN CYBERSPACE AND LIFE AS YOU'VE KNOWN IT.

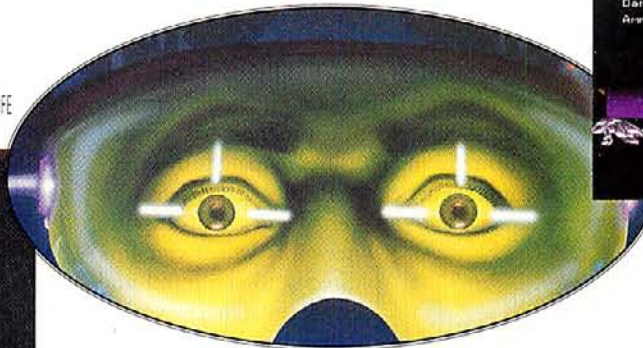

SMART WALLS ARE COVERED WITH LIVE ACTION VIDEO. ACID POOLS WILL TRY TO TRAP YOU. MAYBE YOUR SCATTER SHOTS CAN HELP UNTRAP YOU.

ANY QUESTIONS?

GO AHEAD, JACK INTO A WHOLE OTHER WORLD.  THAT IS, IF YOU THINK YOU'RE READY TO HANDLE NANOSECOND PRESSURE FROM

SMART-WEAPON ENEMIES THAT LEARN YOUR EVERY MOVE THEN STRIKE FROM ANY DIRECTION.  THE CYBERWORLD HAS NEVER BEEN SO FRIGHTENINGLY REAL. BUT THERE'S

HOPE: AT LEAST YOU'LL HAVE AN ARSENAL THAT'S JUST AS SMART AND POWERFUL AS THAT OF YOUR OPPONENTS.  THE QUESTION: CAN YOU NAVIGATE THE MATRIX.

AS QUICKLY AS YOUR BRAIN PROCESSES THE STIMULATION ON YOUR SCREEN!  THE ANSWER: FIND OUT AS YOU HOVER ABOVE THE CYBERARENA, OR SUBMERGE

INTO NEGATIVE CYBERSPACE.  YOU CAN EVEN ALTER THE LANDSCAPE, YOUR OPPONENTS AND YOUR WEAPONS WITH VRCHITECT.™ 

 SO, JACK INTO SPECTRE VR WITH ONE PLAYER, A NETWORK OF UP TO EIGHT, OR EVEN MODEM PLAY ON THE PC. AND GET READY FOR A WHITE

HOT ELECTRONIC ADRENALINE RUSH, BUT BE FOREWARNED: REALITY WILL NEVER BE QUITE THE SAME AGAIN.   VELOCITY.™

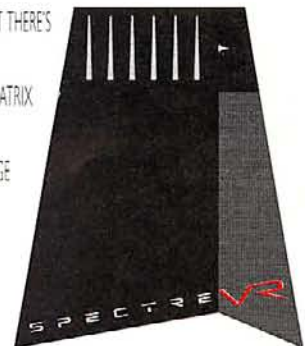

AVAILABLE FOR YOUR IBM PC, MAC AND CD-ROM.

Circle Reader Service #142

HEY, YOU WITH THE CPU: GET A CYBERLIFE. GET SPECTRE VR.™

© 1993 VELOCITY. ALL RIGHTS RESERVED. VELOCITY, SPECTRE VR AND VRCHITECT ARE TRADEMARKS OF VELOCITY DEVELOPMENT CORPORATION. PENNACIA GAMESHES IS A TRADEMARK OF PENNACIA CORPORATION.

TO ORDER, SEE YOUR LOCAL RETAILER, OR CALL 1-800-VELOCITY.

NIGHTSIDE WITH A CYBER-LEECH

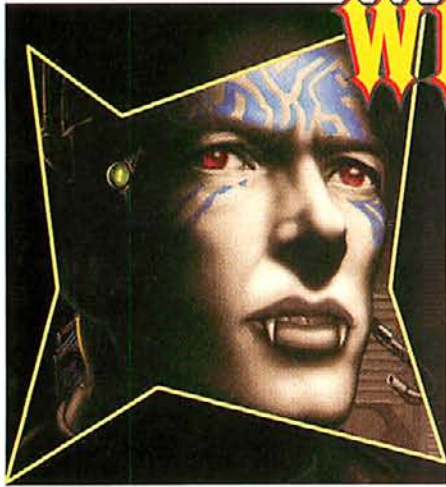

Dig Your Fangs Into The Dark Future of *Bloodnet*

by Douglas Seacat

Dark genres have become very popular. We are experiencing another age of the Film Noir, where the shadows are more alluring than the light. In particular, we have come to enjoy the concept of the moldering urban landscape, where technology provides an escape, not a solution, to

creatures who are losing their connections to life.

Cyberpunk is a much different genre. It is a futuristic mythos of computers and technology, where scientific progress has created nightmares and pleasures to match any supernatural experience. Reality has been subverted by computer networks which can link directly to the mind and create imaginary worlds. There would seem to be little room in this hard-edged universe for mystical creatures of the night.

Despite this, *BloodNet* proves the two genres complement each other. Both rely on the darkness of a crowded city where the population is inured to violence and despair. In the Cyberpunk world, the

mega-corporations leech money and information as greedily as any blood-sucker. Why shouldn't vampires adapt to the world of the future? The passing of time means nothing to such creatures. Cyberspace becomes simply another avenue of exploitation, another means with which to quench their thirst for blood and power.

Forcibly Inducted

It is in this rich background that *BloodNet's* story takes place. The player takes

the role of Ransom Stark, a man who has been victimized and must strike back at his persecutors. Like many residents of 2094 Manhattan, Ransom was first victimized by TransTech, his former employer. This megacorporation controls cyberspace with an iron hand, monopolizing the technology of the information network. TransTech is notorious for abusing its workers. In *BloodNet*, the "Virtual Reality" of Cyberspace is stressful on the mind. Merging one's thoughts with the computer is hardly a natural process and overexposure can cause severe mental unbalance. A disease known as Hopkins-Brie Syndrome can end the career of the best cyber-jockey, since victims can no longer separate reality from fiction. Instead of treating such victims, TransTech fires them, leaving them both unemployed and mentally unstable.

This was the fate of Ransom Stark, before he was given a neural implant that helps suppress his hallucinations. No longer working for TransTech, Ransom was forced to become a cyberspace pirate, illegally hacking into the system on a mercenary basis for the highest bidder. Such a criminal profession has been taken up by increasing numbers of the underworld, all of whom need the



problems and where life is a struggle for survival in an overpopulated rat-warren. Two literary genres have taken these themes to great popularity: Cyberpunk and the Modern Gothic. *BloodNet* is the bold attempt by MicroProse to combine these fictional environments into a better, darker, more morbid whole.

What does a vampire have to do with cyberspace? A difficult question. On one hand we have a dark metropolis dominated by hidden supernatural forces, creatures who have lived for centuries in secrecy, hunting upon humans in the hours of darkness. The modern Gothic is designed to stress our own humanity as we sympathize with undead

Bloodnet

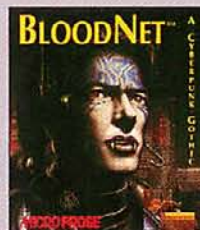

TITLE: Bloodnet
 PRICE: \$69.95
 SYSTEM: IBM
 REQUIREMENTS: 386-16Mhz or better, 2MB RAM, VGA graphics, 9MB hard drive space, mouse; supports AdLib, PAS, Roland, Sound Blaster (Pro), Sound Master and Wave Blaster sound cards.
 PROTECTION: None
 DESIGNERS: John Antinori, Laura Kampo
 PUBLISHER: MicroProse
 Hunt Valley, MD
 (410) 771-1151

PEAK PERFORMANCE

INTRODUCING SPEED BUMPS LIKE YOU'VE NEVER SEEN.

A CD-ROM game with some serious highs and lows.

Your challenge—drive like mad to reach the highest point in each of the continental 48 United States! Whip out the map, plan your strategy and try to beat the world record! Blow past campy

roadside attractions, answer bizarre questions and chat with the locals.

But don't dilly-dally, get into high gear and hitch a ride to your local software dealer.



MEDIA VISION

Circle Reader Service #85



Media Vision, Inc., 47300 Bayside Parkway, Fremont, CA 94538 (510) 770-8600 Fax: (510) 770-9592. Media Vision and the Media Vision logo are trademarks of Media Vision, Inc. Peak Performance is a trademark of Ken Bell Productions. © 1993 Ken Bell Productions. All other trademarks and registered trademarks are those of their respective owners. All rights reserved.

information TransTech hoards within their network. Rage gangs have sprouted throughout Manhattan. These punks and former employees of TransTech wage a war of survival by any means possible. Such gangs have no solidarity, and are as likely to kill each other as hurt TransTech. There are worse dangers than the rage gangs, however: vampires have begun to plague the city.

Ransom discovered this danger first-hand, when his payment for a job turned out to be the bite of a vampire. Ransom feels himself changing, becoming a monster thirsting for blood. Only his neural implant keeps Ransom from completing the transformation to an undead. Now partially human, he strives for a way to turn himself back to normal.

Stalking Manhattan

The player takes control of Ransom Stark, exploring the dark future of New York. To become human again, Stark needs much information, most of which must be gained from the myriad residents of the city. He has to get back in touch with old friends, make some new ones, always fearing discovery by TransTech or the vampires who turned him. Along the way, he becomes embroiled in conflict with TransTech, which he discovers (unsurprisingly) has ties to the vampires.

Despite the fact that the player is always Ransom Stark, it is possible to create a customized version of the down-and-out hacker. Through a series of questions (similar to the famous *Ultima IV* process), each person can develop their own unique "Ransom Stark." The list of skills and attributes is extensive and interesting, ranging from combat related skills to cyberskills and personality attributes.

The game's interface is designed to make Stark's quest as easy as possible.

The controls are relatively simple. The bulk of the game takes place in the "real" world of 2094 Manhattan. Movement around the city takes place on a nicely drawn overhead map, where arrows indicate possible locations of interest. Such travel is conveniently instantaneous, but adds time to the game clock, depending upon the distance traveled.

Ransom's hunger grows as the game continues, and can only be satisfied by drinking blood, usually killing a victim and lowering Ransom's humanity. When Ransom loses all his humanity, the game is lost. Such hunger

cannot be ignored. When Ransom is too hungry, he will lose control and kill randomly. Several creative alternatives to killing can be found in the game (such as the use of blood-producing nanotechs) but none are permanent, and Ransom's hunger always re-



turns. The player must marshal his time, developing a course of action and following up clues.

As the game progresses, new locations become available, giving the game a sense of progress. However, in general, the game is quite non-linear. Stark begins the story with a list of contacts and friends, but is free to explore to his heart's content. The designers have done an excellent job of providing an



interesting cast of characters whose dialogues not only help develop the atmosphere, but provide leads to continue the game. Some people won't cooperate until Stark has done them favors, while others are willing to help directly. The game begins as a solo quest, but up to five individuals can be added to the group. Some people need to be hired to join, while others are willing to help Stark out of friendship. One of the major decisions in the game is deciding which characters to bring along on particular missions.

Conversation is the most important game activity, but occasionally combat cannot be

avoided. The vampires of Manhattan are a singularly vicious breed, and some rage gangs express their dissatisfaction best through violence. Reflecting the dangerous nature of both the Gothic and Cyberpunk genres, death is a distinct possibility whenever combat is entered. Each side is allowed to place characters on the board, and then melee ensues. If left to their own devices, the characters will fight the entire combat automatically, without any intervention by the player.

Otherwise, a player can take a hands-on approach and attempt to turn the tide of battle with specific commands. Characters can maneuver for better positioning, target different foes, use items, and switch weapons. There are a few vampire specific options, like "biting" a foe, or "exerting will" to confuse the enemy. In general, however, combat is a simple affair. Furniture doesn't provide cover, and moving about isn't generally helpful unless one happens to be using a melee weapon. The best strategy is often to scatter the characters evenly among the opponents, make sure they have heavy firepower, then sit back until all foes drop. This quick approach lets one get back to the story as rapidly as possible.

Naturally, no Cyberpunk game would be complete without cyberspace. Some of the puzzles in the game can't be solved until one finds a cyberspace port, decks in, and traverses this alternate computer realm. To a net-runner, no possession is more important than his computer deck. *BloodNet* allows one to upgrade the deck's hardware as the game progresses. Cloak chips can be found which reduce the chance of TransTech security noticing intrusion, memory can be upgraded, as can the "Soul Box" (an important deck component which ensures mental integrity in the cyberspace realm).

When transported to cyberspace, the player begins on the General Plane, a digital highway between different computer realms. Here one occasionally bumps into other "Data Angels" (characters similarly decked into the net), with whom one can talk. Otherwise, it is necessary to know an active address of a WELL, where all manner of interesting programs and information can be discovered.

As the game progresses, Stark gains increased access to locations in both the "real

NOW PLAYING AT A CD-ROM DRIVE NEAR YOU.

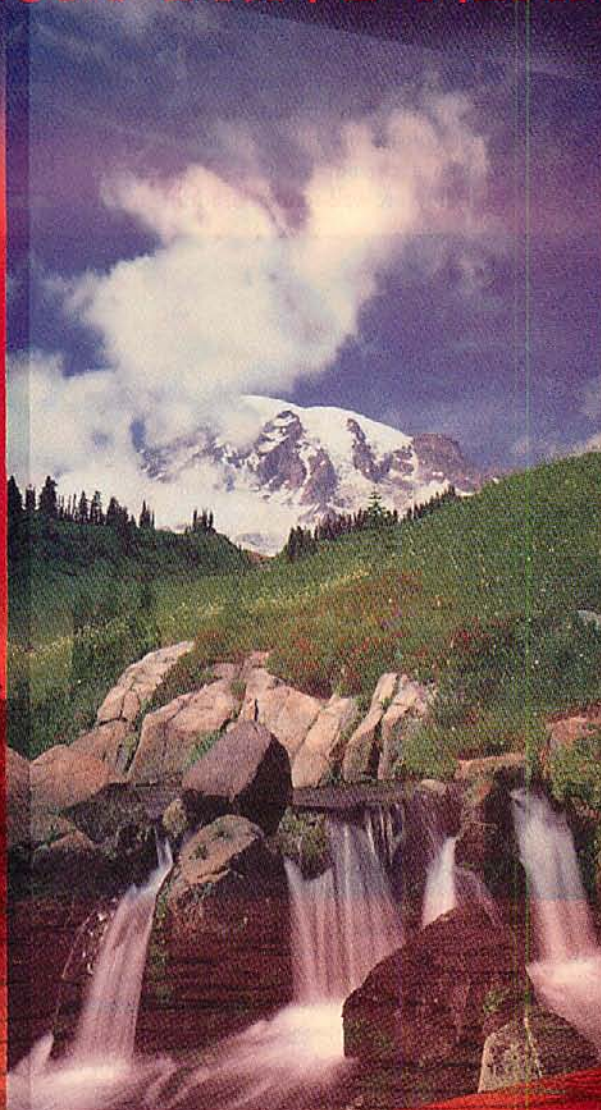

ENTER QUANTUM GATE, THE FIRST VIRTUALCINEMA™ EXPERIENCE.

**How you interact makes the difference...
between life and death!**

The year is 2057. Earth will only support life for another decade. You've enlisted to help conquer Tar-Palantire, possibly Earth's only salvation. Explore a detail-filled virtual environment, navigating both interactive and arcade-style action scenarios that test your skill at space-age combat and role-playing.

High Adventure In VirtualCinema!

VirtualCinema makes you the main character in this

full-length, cinematic adventure experience! How you interact with real on-screen actors determines how the story unfolds...all the clues you need await your discovery. Six different action segments challenge you with new situations and constant danger. All presented in realistic video, with 16-bit CD-quality sound. The challenge awaits at a software dealer near you.



MEDIA VISION

Call 1-800-845-5870 for information or a dealer near you. Media Vision, Inc., 47300 Bayside Parkway, Fremont, CA 94538. Fax (510) 770-9592. Quantum Gate and VirtualCinema are trademarks of Hyperbole Studios. Media Vision and the Media Vision logo are trademarks of Media Vision, Inc. © 1993 Hyperbole. All other trademarks are those of their respective owners.

world” and cyberspace, uncovering both more characters to interact with and more information about TransTech and the vampires of Manhattan. Similarly, the danger increases as he becomes hunted by both factions. Stark has to walk a narrow path to maintain his humanity while also using his vampiric gifts to best advantage.

Pumped Full Of Vasopressin

MicroProse is to be commended for showing that a Gothic-Cyberpunk synthesis is possible. Thematically, the game has a lot to offer. The designers could have chosen to slap down an easy action/adventure game drawing on two popular genres. Instead, they made the story the centerpiece, including a huge amount of dialogue to bring the plot to life. The conversations are hard-edged and filled with enough futuristic lingo and jargon to match any literary effort.

As the game progresses, the parallels between the two genres become increasingly clear, building mood. TransTech has developed the link between mind and computer so strongly that they have begun to leech valuable information from the minds of users, becoming a vampiric entity. Reversing this paradigm, Ransom Stark’s hunger for blood grows with ravenous intensity, checked only by a complex piece of technology, the neural implant.

On the gaming side, the programmers have included several convenient options. Stark’s neural implant allows him to remember all the conversations he’s had throughout the game, which can be re-read as needed. While taking some notes is advised, the player need never despair missing something important.

The movement system is also convenient. Using the map allows one to journey throughout the city without the tedium of some CRPGs; travel between areas only takes up game-time, not real-time. Once in locations, it is unnecessary to walk near to characters to speak to them, another welcome decision. Objects can also be picked up anywhere on the screen, or dropped with equal liberty. Further, when speaking with someone who desires a particular item, it isn’t necessary to dig through the inventory to find it since this is handled automatically. All these features help both to streamline game play and reduce CRPG Frustration Syndrome (a most persistent disease).

BloodNet delivers nicely on Cyberpunk technology. There is a wide and interesting variety of gadgets and weaponry in the game, including nanotech weapons, circuitry frying

grenades, and holographic technology. The gamer has the opportunity to cyber-up with enhanced legs, hands, arms, and even eyes and ears. An interesting feature is the “Jury Rig” option which allows fabrication of items or drugs from base components. All these features help imbue the dark atmosphere with a decidedly science fiction edge.

Unlike some modern games that require the cutting edge of hardware, *BloodNet* delivers decent graphics without the computing strain. Animation is limited, and most of the graphics consist of still-shots of the background in a current location. These background shots are well-rendered, adding to the



dark mood of the game without becoming distracting. In Cyberspace, strange morphing data structures float about within the computer web. These efforts provide an excellent backdrop for the story without demanding cutting-edge computing power.

Access Denied

In spite of praise-worthy efforts, *BloodNet* is flawed in several respects. Although based upon a most interesting premise, the game as a whole left me vaguely dissatisfied. A major reason for this is the game’s pacing. I greatly prefer non-linear plots to restrictive ones, but sometimes *BloodNet* seems to bend too far the other way. Leaving options open is great, but often the player seems to be left with no sense of direction whatsoever. The protagonist becomes like a witless errand-boy, running around for others with little appreciable reason.

While there can be no doubt that the idea of a Cyber-Gothic is a good one, the game fails to deliver on some of the features of these genres. The story, atmosphere, and themes are all solid, but the details are lacking. This is particularly true in cyberspace, which was a great disappointment for me. In *BloodNet*, cyberspace takes on none of the depth of the “real world” characters and places. Occasion-

ally a Data Angel will be found wandering the general plane, but this is a relatively rare occurrence, making the net seem vast and empty. The excitement of updating one’s Soul Box was reduced when I noticed no negative side effect of staying for prolonged time in Cyberspace, even with a simple Tin Soldier Soul Box. On the vampire side, hunting is handled extremely loosely. To hunt, one can simply click a victim, who will immediately disappear with the message “Stark has disposed of the body.” This works no matter how many other people might happen to be watching. Further, despite the manual’s assertion to the contrary, Stark’s humanity does not lower for acts of violence, only killing victims for blood.

Several aspects of the game are technically sloppy. The largest example of this is combat, which has few redeeming qualities. Combat graphics are markedly inferior to the rest of the game, and the entire combat sequence is both confusing and frustrating. Having most of the combat automated by the computer is a good idea, but only if computer supervision actually works. Sometimes characters will refuse to follow new orders, sitting uselessly in the combat rather than doing what they’ve been told.

Exacerbating the combat problem is one particular flaw in game design. There is an event in the game which causes a group of thugs, led by “Buzz” to attack the player frequently in the subway. No matter how many times Buzz and his men are killed, they will continue to attack at random intervals in the game. Worse, the event which makes them attack is virtually unavoidable. Similarly, certain characters can disappear permanently if they are “dismissed” from the party even if they are needed later.

ICEing The BloodNet

BloodNet has much to recommend it. As yet, there are no other games which combine these two game-worthy genres in this way. Perhaps Cyberpunk needs a little Gothic infusion to bolster its lagging popularity, and vampires are certainly a strong current fascination. The game is to be lauded for emphasizing the story line, something many recent games have forgotten, but the story is couched in game elements that are less than ideal. *BloodNet* can be compared to an uncut gem; it is a dark and wonderful gem of an idea, but a gem without polish. **CGW**



Strategy, graphics and Pro League play so real it's licensed by the NFL, the NFLPA, and chosen by USA TODAY to simulate Super Bowl play.

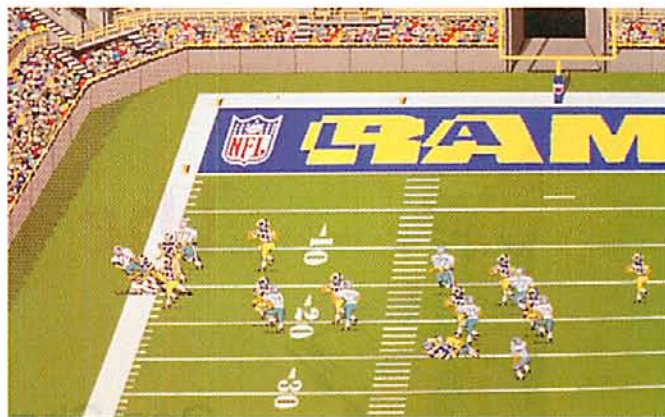

BRACE YOURSELF FOR IMPACT

NFL Pro League Football hits you like a 240 pound fullback with the goal line in his eyes.

🏈 NFL Pro League Football has full field detailed color animation with actual NFL logos, NFL players, teams, uniforms and statistics.

🏈 Design plays from scratch or choose from 198 offensive and defensive plays. 🏈 Coach your favorite team using the Pro Draft, Pro

Trader and Team Editor modules. 🏈 Full rosters with injuries and substitutions. Instant replay. 🏈 True modem play with chat mode. 🏈 Stats Keeper and League Leaders modules, provide pages of the most complete statistical reports found in any computer game! So go ahead *Brace Yourself for Impact* with the best in the NFL.

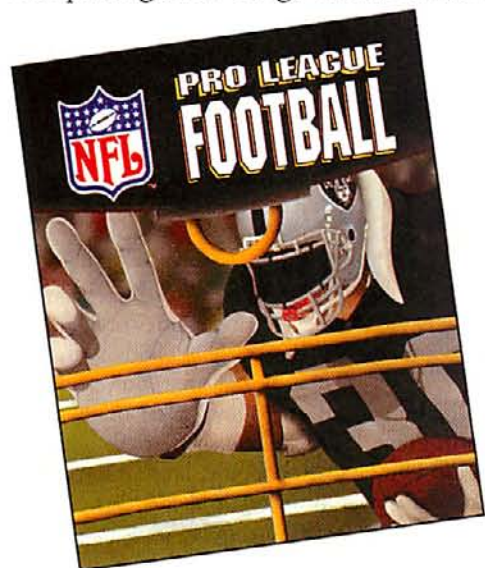

“NFL Pro League Football is a landmark product for Micro Sports....the most powerful football simulation available today.”

Mark Cohen
The Sports Game Review

Circle Reader Service #75

MICRO SPORTS
800-937-7737



Can't find NFL Pro League Football? Call directly to place your order or for the name of your nearest retailer. NFL Pro League Football is a registered trademark of Micro Sports, Inc. © Micro Sports, Inc. ALL RIGHTS RESERVED.

The Tale Of Mustafa

One Character's Rise to Glory in SSI's Fantasy Empires

by H.E. Dille

Today, fellow warriors, we hear the tale of Mustafa, a young dwarven noble who rescued his kingdom through diplomatic cunning and brilliant maneuvering on the field of battle. Pay attention, brave fighters, that when your call to battle comes, you shall be prepared.

In the summer of his thirty-fifth year, Mustafa the Noble received some rather unexpected news. He and a small band of adventurers, some of whom he dared to call friends, were returning to Northern Rockhome when a messenger came stumbling up to the party, somewhat weather beaten from his travels. The messenger gasped and wheezed his way through the news, glancing over his shoulder periodically, as though he could scarcely wait to get home. Mustafa learned of the passing of his Uncle, the Baron of Murkits, and the subsequent summoning of his presence by the Baron's advisors.

The news was troublesome, and not simply because of the grief it conveyed. Mustafa felt unprepared for the responsibilities laid before him and shared his feelings with his friends. The land was facing perilous times, and they were all too aware of the risks and opportunities conveyed in the inheritance. His duty seemed clear, however, and he forced himself to cast his doubts aside. He was, nevertheless, quite relieved when his friends offered to join him.

Upon arrival in Murkits, Mustafa found that the situation was grave indeed. In the time since his Uncle's passing, much of the fief's wealth had been carted off and the country of Ethengar Khanate divided into nine separate provinces. Further, the once proud castle of Murkits had been ravaged, leaving only a keep, an armory and some rather insignificant fortifications. There wasn't even a remnant of the Baron's Guard or any other standing militia. All of these once loyal retainers had apparently pursued more mercenary objectives in the absence of central leadership. The months ahead would be long and arduous, but Mustafa knew what he must do. Gathering his party of adventurers, Mustafa laid out his plan.

"Friends, my first task must be to train and re-organize the once

proud army of my homeland. I will round up groups of 100 strong fighters and, when they are ready, I will send them off into one of the nine provinces. Every third month, I will look for one among them who can be a leader like ourselves. I will train this one personally. As each of the provinces of Ethengar Khanate are subdued back into lawfulness, I will build new keeps for the collection of taxes and to maintain order. I am confident that I can do all this without your aid. Wait...before you protest, I did not mean that you were not needed at all. Word has come to me about Eol, Magdel, Dauros and Nightspawn, the other powers that had challenged my Uncle in the past. Each are restless and seeking to expand their base of power. They are already fighting amongst themselves. If we are to have any hope of meeting this threat, we must be prepared. I charge each of you to a quest: Search the lands for magical items that can aid our common goal. Return to me when each is found, and I will have units available for your command."

Thus began the tale of the one who unified all Mystara under a single banner. Mustafa's plan to consolidate the Ethengar Khanate was sound, and by the time he had done so, all but one of his friends had come and gone many times, building experience and gathering magical larder for the Imperial Vault. The missing friend, an Elf of some stature, had perished inexplicably.

Mustafa mourned his loss, not only from a personal standpoint, but also because he had hoped to use this hero to gather support in the Elven Kingdom of Alfheim. The elves were powerful warriors, and the Leader who developed their trust would likely prevail in the coming conflict. Mustafa coveted their lands, but opted to expand into the Principalities of Glantri and the Broken Lands first. It was rumored that powerful magic

users and clerics could be trained there and none of his current provinces could support them. He had skirmished briefly with Eol in the mountainous region known as Rockhome, land of the dwarves, and had seen firsthand the power of magic on the battle field.

Nightspawn, the foulest of all the opposing Lords, had established

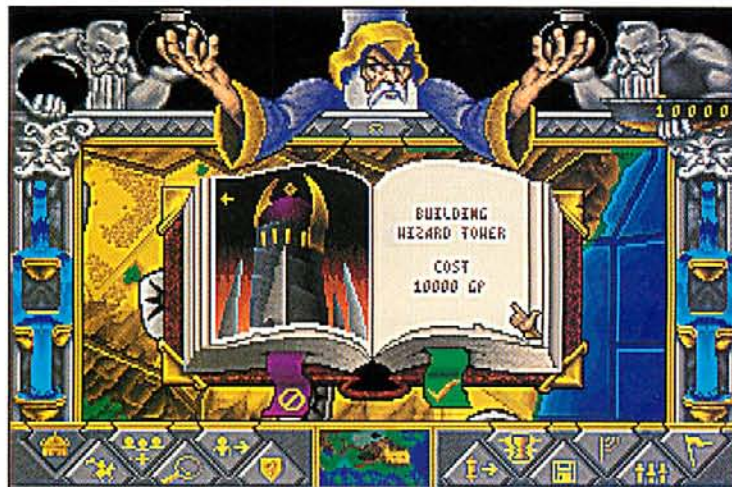

*A long time ago
in a galaxy far, far away...
good and evil clashed.*

Now, the Force is with you.

THE SOFTWARE TOOLWORKS' STAR WARS CHESS

Now available in this galaxy
for IBM® PC and compatibles
and MPC CD-ROM

Combine Star Wars characters with one of the oldest strategy games in the world and you get **The Software Toolworks' Star Wars Chess**



The Force is with you

Star Wars Chess - the most thrilling animated chess game in the galaxy!

Relive battles between the Rebel Alliance and the evil Empire through astounding original artwork and a powerful chess program.



Up to 72 animated 3-D capture sequences!

It's like making your own Star Wars movie on a chessboard! Through dazzling animation, Leia, Luke, C-3PO, Darth Vader and other characters you love come to life in brilliant 3-D sequences. Up to 72 unique capture moves and authentic Star Wars music and sound effects make this a chess program like no other in the universe.

It's your turn to pit yourself against the dark side... and may the Force be with you!



For the store nearest you or to buy, call

1-800-234-3088



months, rising from regulars to veterans in the process. In the wake of their wrath, keeps and armories were constructed in the mountains to begin training dwarven warriors. Any excess monies collected were invested in more cleric and wizard towers, scattering them among all the provinces that would support them to prevent mass destruction from any magical attack on one province.

All was proceeding well until Mustafa's warriors attacked the Makkres Mountains, where Eol had built a huge castle to withstand the assault. Lacking catapults or battering rams to breach the heavy gates, over 200 battle hardened veterans were cut down in the fields surrounding the castle by barrages of javelin sized arrows fired from ballista on the battlements. A second period of consolidation was necessary.

Mustafa felt that Eol had his back to the wall, but he needed to buy time to construct the siege engines necessary to reduce the fortress. Magdel and Dauros were as yet uncontacted, but one or both of them had surely come in contact with Eol. In the hopes of spurring their campaigns against Eol, Mustafa sent both leaders aid. If the plan succeeded, Eol would be caught between the narrowing jaws of a vise.

While fortifying the eastern and southern borders with a steady stream of fighters and dwarves, Mustafa had sufficient reserve force to renew the offensive in the west. The objective would be to drive through the Broken Lands and solidify control of Allheim and the Republic of Darokin. The initial going was easier than expected, because Nightspawn had used the preceding period of peace to

a presence in the Broken Lands. For Mustafa's plan to work, he needed to appease Eol from attacking his eastern borders while he massed troops in the west. The rate of his expansion thusfar had precluded the construction of castles or siege engines, both of which would have eased his burden. He proposed a treaty for six months (turns), adding 2500 gold pieces for enticement, which Eol gleefully accepted.

Mustafa massed three armies of 200 fighters in separate western provinces, each lead by one of his original party. Other Fighter leaders that had risen from the ranks were left with token forces on the eastern border to guard against treachery. To the south, Mustafa's underbelly was soft and weak. Fortunately, no sign of trouble had appeared in this area.

The three armies swept quickly through Glantri, conquering three neutral provinces each month without encountering Nightspawn. The entire resources of the treasury were devoted to building keeps in the wake of their passage. By the end of the third month, the armies were depleted to a quarter of their original strength from nothing more than quelling the local populace. It was time to consolidate the new acquisitions.

Two Armories were constructed behind the front lines to replenish the western armies. Other revenue was expended in the construction of a wizard tower in the principality of Boldavia. As plans were contemplated for the coming months, a dark specter arose over the province of Kiyats. In the guise of the Grim Reaper, the visage struck our coat of arms thrice, and 70 of Mustafa's stalwart defenders fell to the ground, dead. Eol was suspected of the deed, though none could prove it. Treachery was in the air.

The prophecy was fulfilled shortly thereafter when Eol broke the treaty two months early, taking Kiyats without casualty and defeating the defenders of Bor with minor losses. To counter this offense, Mustafa hastily constructed two more armories in Murkits, which brought his total troop concentration in the home province to 240. These were split and sent to reclaim the contested provinces the next turn. Nightspawn would have to wait for now, and a treaty was struck with him immediately.

With four armories fully employed, Murkits turned out a steady stream of 240 warriors a month. These forces continued the counter-offensive through Eol's scattered forces in Rockhome for the next six



expand southward into the Five Shires and the Grand Duchy of Karamaikos. He possessed a lot of warriors, but had foolishly garrisoned them in small groups throughout his lands, as opposed to concentrating force where necessary.

As this campaign progressed, the forces of Dauros mounted a surprise amphibious invasion of Bor, and threatened Murkits with a large force. Fortunately, Mustafa had used magic sparingly up to that point, allowing the globe of power to glow a brighter red with

each passing month. Death was cast on Dauros's legions, weakening them for the coming slaughter. Concurrently, a meteor storm was summoned to wreck havoc in the Makkres Mountains. The catapults and ballista were ready, and Mustafa did not want to lose too many



IBM - CD-ROM - AMIGA - CD32

SOFTWARE EXPRESS

P.O. Box 324
Jefferson, WI 53549-0324

Save 20-50% On Software
HOT! NEW RELEASES! FAST!
HUNDREDS To Choose From!

IBM AMIGA CD-ROM CD32
DISK CATALOG - FREE!
SHIPPING - *FREE!
JOIN AND SAVE!

Land's of Lore ** (Virgin) \$29.95 300001	Space Shuttle (Virgin) \$24.95 300023
Ultima VIII: Pagan ** (Origin) \$47.95 300159	Lord Of The Rings ** (Interplay) \$26.95 300024
Rules Of Engagement II (Impressions) \$37.95 300002	Lost Admiral ** (QQP) \$31.95 300055
When Two Worlds War (Impressions) \$29.95 300003	7 Cities Of Gold (Comm) ** (Elec Arts) \$34.95 300056
Return Of The Phantom ** (MicroProse) \$31.95 300004	Aegis: Guardian Of Fleet ** (Soft Sorcery) \$44.95 300061
Betrayal At Klondor ** (Sierra) \$34.95 300005	Strike Squad ** (Mindcraft) \$34.95 300048
Goblins II ** (Sierra) \$19.95 300006	Stunt Island ** (Disney) \$29.95 300073
Crusaders Of The Drk Savant (Sir Tech) \$34.95 300013	Blue Force: Next Of Kin ** (Tsunami) \$34.95 300032
Privateer ** (Origin) \$45.95 300014	Grandmaster Chess Dix Ed ** (Capstone) \$29.95 300026
Day Of The Tentacle ** (Lucas Arts) \$31.95 300015	Eight-Ball Deluxe ** (Amtek) \$29.95 300027
Armour-Geddon ** (Psygnosis) \$24.95 300016	Innisbrook - Links Course ** (Access) \$14.95 300028
Silver Seed ** (Origin) \$14.95 300017	Empire Deluxe Scenarios ** (New World) \$14.95 300029
Metal & Lace: Robo Babes ** (Megatech) \$26.95 300018	Blue And The Gray (Impressions) \$34.95 300030
Third Reich (Avalon Hill) \$20.95 300019	Wing Commander Acdy ** (Origin) \$29.95 300031
Warlords II ** (SSG) \$34.95 300020	Protostar: War On Frontier ** (Tsunami) \$34.95 300033
Cobra Mission ** (Megatech) \$41.95 300008	Dune II (Virgin) \$29.95 300036
Prince Of Persia 2 ** (Broderbund) \$34.95 300011	Links 386 Pro ** (Access) \$34.95 300037
Mig-29: Deadly Adversary ** (Spect Halo) \$44.95 300034	Humans ** (Gametek) \$22.95 300038
Comanche: Max Overkill ** (Nova Logic) \$39.95 300046	Beat The House ** (Spirit Disc) \$24.95 300039
Railroad Tycoon Dix ** (MicroProse) \$34.95 300042	Empire Deluxe ** (New World) \$29.95 300040
Aces Over Europe ** (Sierra) \$34.95 300021	Gateway II: Homeworld ** (Legend) \$31.95 300041
V For Victory IV ** (Elec Arts) \$39.95 300022	Wayne's World ** (Capstone) \$21.95 300043
Freddy Pharkas: Frontier ** (Sierra) \$34.95 300007	Simon The Sorcerer ** (Infocom) \$26.95 300044
Lampoon's Chess Maniac ** (Spect Halo) \$34.95 300009	Rags To Riches ** (Interplay) \$29.95 300045
Creepers (Psygnosis) \$24.95 300010	Earth Invasion ** (3DI Prod) \$20.95 300046
Michael Jordan In Flight ** (Elec Arts) \$39.95 300012	Dominion ** (Mindcraft) \$39.95 300049

Strike Squad ** (Mindcraft) \$34.95 300050	Street Fighter II ** (Capcom) \$24.95 300071
Bloodstone ** (Mindcraft) \$21.95 300051	Air Support * (Psygnosis) \$24.95 300193
Lost Admiral ** (QQP) \$31.95 300055	Leander * (Psygnosis) \$24.95 300194
Master Of Orion ** (MicroProse) \$29.95 300057	Animation Classics Pack * (Readysoft) \$39.95 300195
Carriers At War II ** (SSG) \$34.95 300058	Pinehurst - Links Course ** (Access) \$10.95 300090
Tom Landry Football Deluxe (Merit) \$24.95 300060	SimEarth (Maxis) \$24.95 300096
Red Crystal: 7 Secrets Life ** (QQP) \$29.95 300062	Legacy: Realm Of Terror ** (MicroProse) \$34.95 300118
X-Wing ** (Lucas Arts) \$34.95 300077	Ultima VII: Serpent Isle ** (Origin) \$45.95 300133
Imperial Pursuit ** (Lucas Arts) \$14.95 300078	USA East Scenery ** (SubLogic) \$34.95 300139
Seal Team ** (Elec Arts) \$34.95 300067	Speed Racer ** (Accolade) \$19.95 300072
Mechwarrior 2: The Clans ** (Activision) \$37.95 300068	Hole-In-One Min Golf Dix! ** (DigiTek) \$18.95 300075
NFL Coach Club Football ** (MicroProse) \$34.95 300069	B-Wing ** (Lucas Arts) \$14.95 300079
Spear Of Destiny ** (Id Software) \$34.95 300063	Indiana Jones:Fate Of Atlant (Lucas Arts) \$31.95 300081
Coaster ** (Disney) \$24.95 300074	Lucky's Casino Adventure ** (QQP) \$35.95 300083
World War II: South Pacific ** (QQP) \$29.95 300082	Challenge Of Five Realms ** (MicroPlay) \$34.95 300085
F-15 Strike Eagle III ** (MicroProse) \$39.95 300084	Band Of The Cosmic Forge (Sir Tech) \$29.95 300197
Great War 1914-1918 ** (SSI) \$37.95 300088	Heirs To The Throne ** (QQP) \$31.95 300086
Bountiful - Links Course ** (Access) \$10.95 300089	Fantasy Empires ** (SSI) \$34.95 300125
SimFarm ** (Maxis) \$29.95 300054	Desert Strike * (Elec Arts) \$29.95 300128
SimCity 2000 ** (Maxis) \$36.95 300059	Mario Is Missing ** (Soft Toolwks) \$29.95 300129
SimAnt (Maxis) \$30.95 300190	Strike Commander ** (Origin) \$45.95 300130
SimLife ** (SSI) \$34.95 300141	Fmt Pg Spts: Football Pro ** (Dynamix) \$41.95 300134
El-Fish ** (Maxis) \$29.95 300142	Syndicate (Elec Arts) \$34.95 300135
A-Train (Maxis) \$34.95 300143	Dark Sun: Shatter Lands ** (SSI) \$46.95 300087
SimCity Classic (Maxis) \$24.95 300145	Space Hulk (Elec Arts) \$34.95 300082
Return To Zork ** (Infocom) \$34.95 300064	Spaceward Hol ** (New World) \$29.95 300093
Star Trek: Judgment Rites ** (Interplay) \$31.95 300065	Lemmings (Psygnosis) \$24.95 300094
Sam & Max Hit The Road ** (Lucas Arts) \$31.95 300066	Lemmings II: The Tribes (Psygnosis) \$29.95 300106
Kings Ransom ** (Readysoft) \$29.95 300070	Wing Commander Deluxe ** (Origin) \$45.95 300095

Microsoft Flight Sim 5.0 ** (Microsoft) \$39.95 300097	Detroit ** (Impressions) \$29.95 300105
Walker * (Psygnosis) \$21.95 300100	Flashback ** (SSI) \$29.95 300115
King's Quest VI ** (Sierra) \$39.95 300102	SSN-21 Seawolf ** (Elec Arts) \$41.95 300155
Quarter Pole ** (MicroLeague) \$24.95 300119	Eye Beholder III Drannor ** (Sir Tech) \$41.95 300156
Silverball ** (MicroLeague) \$27.95 300120	BloodNet: Cyberpnk Gothic ** (MicroProse) \$34.95 300157
Pirates Gold ** (MicroProse) \$34.95 300121	Dragon Knight III ** (Megatech) \$39.95 300158
Cohort II (Impressions) \$15.95 300122	Azagon ** (Access) \$34.95 300160
Humans - Insult To Injury ** (Gametek) \$09.95 300136	Dracula ** (Psygnosis) \$32.95 300161
Air Combat Classics ** (Lucas Arts) \$39.95 300137	Civilization (MicroProse) \$39.95 300162
MicroLeague Pro Pack ** (MicroLeague) \$26.95 300138	Fleet Defender: The F-14 ** (MicroProse) \$44.95 300164
Flight Assignment: A.T.P ** (SubLogic) \$29.95 300140	NHL Hockey ** (Elec Arts) \$41.95 300166
Pinball Dreams (21st Century) \$24.95 300147	Lost In Time ** (Coktel) \$34.95 300168
Pinball Fantasies * (21st Century) \$24.95 300148	Shadow Of Yserbius ** (Sierra) \$21.95 300169
Clash Of Steel ** (SSI) \$37.95 300116	Unnecessary Roughness ** (Accolade) \$32.95 300165
Belfry: Links Course ** (Access) \$14.95 300149	More Incredible Machines ** (Sierra) \$26.95 300170
Star Control II ** (Accolade) \$29.95 300150	Forgot Castle:Awakening** (Twin Dolphin) \$49.95 300172
Jonny Quest: Mayan Warriors ** (Hollyware) \$24.95 300108	Inca ** (Sierra) \$34.95 300196
Dungeon Hack ** (SSI) \$34.95 300110	Eric The Unready ** (Accolade) \$29.95 300174
Brix ** (MicroLeague) \$19.95 300111	Ringworld ** (Accolade) \$32.95 300175
Lost Vikings (Interplay) \$24.95 300113	Wacky Funsters ** (Accolade) \$16.95 300176
Elder Scrolls: The Arena ** (Batheza) \$39.95 300152	Alone In The Dark ** (Interplay) \$29.95 300177
IndyCar Racing ** (Papyrus) \$37.95 300153	Battle Chess (Interplay) \$24.95 300178
Trump Castle III ** (Capstone) \$29.95 300154	Chessmaster 3000 ** (Soft Toolwks) \$24.95 300182
Global Domination ** (Impressions) \$29.95 300103	DarkSeed (Merit) \$34.95 300185
A-Train Const Set ** (Maxis) \$18.95 300144	Dune (Virgin) \$29.95 300186
War In Russia ** (SSI) \$49.95 300171	Legend Of Kyrandia: Fables (Virgin) \$29.95 300187
Stronghold ** (SSI) \$35.95 300173	Scrabble Deluxe Comp Ed (Virgin) \$19.95 300189
Star Trek: 25th Anniversary * (Interplay) \$32.95 300179	Robo Sport (Broderbund) \$20.95 300191
Hired Guns (Psygnosis) \$31.95 300109	Agony * (Psygnosis) \$24.95 300192

* = Not Available For The IBM

** = Not Available For The Amiga

SEE HOW EASY IT IS TO SAVE UP TO 50% ON YOUR SOFTWARE PURCHASES.

- Just fill in and mail the coupon in this ad (Select payment method) and we'll send you your introductory package along with a copy of your first disk catalog.
- You agree to buy just ONE more selection from us in the next year (Priced \$19.95 or above) - you may decide to discontinue receiving our catalog at any time thereafter. Our regular prices are normally at least 20% lower than the suggested retail price. (A shipping and handling charge will be added to all orders of \$100 or less, FREE shipping for orders over \$100, excluding tax).
- FREE Disk magazine each month. Each magazine contains 250 items and can be saved to your hard drive to keep an archive of up to 4 months of items. This will give you up to 1,000 different items to choose from. Each item is described in detail and most items also have a picture description. If an item is not in your catalog and you are looking for a specific title you can request it in our REQUEST section of the catalog software program.
- YOU control what you want and what you don't want. Use our Easy-Order method of placing your order via your computer modem if you are paying with a credit card or C.O.D. (The call is FREE) or use our convenient order card which will be included in each mailing. Orders are usually shipped out within 1 week of your order.
- Our BONUS plan is designed to save you 20%-50% on many of your purchases through our company. Once you have fulfilled your agreement with us you will be entitled to take a selection at 20%-50% off our regular price with each selection you purchase at full price. Depending on your purchasing habits, you can save 100's of dollars on your annual software purchases.
- You always have the option to purchase your software in any format that the selection is available in. (CD-ROM, CD32, 5 1/4" or 3 1/2" Floppy Disk). Our company supports IBM & AMIGA computer systems only.
- Use your Credit Card to place your order. (No Surcharge on Credit Cards) You may also Pre-Pay with a personal check only by sending us your check with your order (Using our order cards) but please allow 14 days for the check to clear. We also accept C.O.D. Orders - C.O.D. order must add \$5.00 to their order total.
- GOVERNMENT AND SCHOOL P.O.'s WELCOMED. We will also have special interest issues full of educational and productivity software.
- If the Application is missing, write to: Software Express, P.O. Box 324, Jefferson, WI 53549-0324.

NOTE: All items in This Ad Are For 3.5" Disks Only. Once you join, you can select from any available formats.
* Shipping is FREE with an order over \$100.

YES! Count me IN! Send me my INTRODUCTORY selection listed below (Which I am already receiving at up to 50% off) and I agree to purchase at least one more selection at your full price within the next year.

Selection Number: _____ Price: _____ Selection Format (check one)
 IBM AMIGA
Note: The Selections in This Ad Are For 3.5" Disks Only

Please Send Me Future Catalogs IBM (Requires Windows 3.11 Or Greater) AMIGA (Requires Workbench 2.0 Or Greater)
 In The Following Format 3.5" Disk 5.25" Disk

Check method of payment: Charge this purchase to my Credit Card
 Payment Is Enclosed And Selection Price Plus \$4.95 Shipping Plus Tax (if applicable) VISA MASTERCARD
 C.O.D. Add Selection Price Plus \$4.95 Shipping Plus \$5.00 C.O.D. Charge Plus Tax (if applicable) Acct. No. _____

WI Residents Add 5.5% Tax (Including shipping) Signature _____

Name _____ Apt. _____
 Address _____
 City _____ State _____ Zip _____
 Phone Number () _____

Send To:
 Software Express
 P.O. Box 324
 Jefferson, WI 53549-0324

WE DO NOT SHIP TO P.O. BOXES

of them in eliminating Eol, for now he knew that Magdel was crouched like a snake in Sodderford and Ylaruam.

With two-thirds of Mystara in his grasp, Mustafa had sufficient resources to build concentrations of armories in Alfheim, massing deadly armies of Archers that could swing to any front in a few short months. Using a Rod of True Sight brought back from one of the hero quests, Mustafa sought out the largest concentrations of troops in the enemy lands. Wizard and Cleric towers were targeted in the same manner. Tornados and Lightning Storms were wrested from the magical orbs and sent where they could do the most damage. Structures crumbled under the onslaught, and even elite troops were destroyed in the ensuing chaos.

Despite the aid that was given, Dauros did not prove much of a threat. His center of power was in the island Kingdom of Ostland, and he had already been driven from the mainland by Magdel. Eol fell swiftly before the assembled siege engines, though he did outlast Dauros. Nightspawn proved elusive, as he mounted a campaign of cat and mouse through the archipelago of island fortresses that ran along the southern expanse of Mystara. Magdel proved to be an entirely different proposition.

By the time Mustafa had succeeded in eliminating the other oppo-

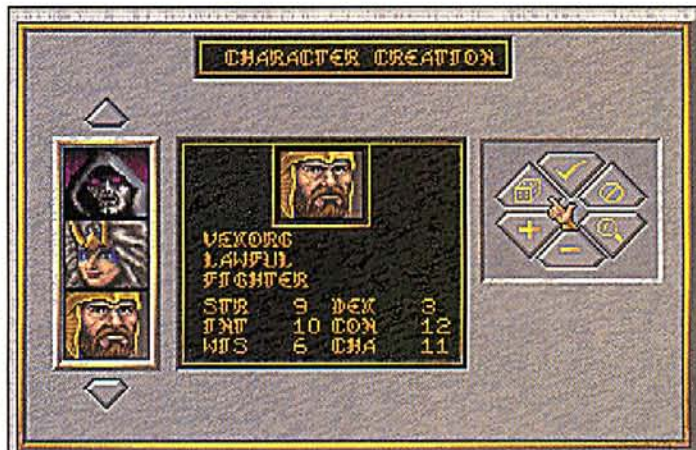

nents, his forces were scattered all over the land. This made them easy targets, despite their experience. Further, Mustafa had expended all of his accumulated Magical energy, and lost a good number of heroes to dangerous quests and ill-fated attacks. Magdel capitalized on the weak borders and began an across-the-board offensive, ignoring all requests for a treaty.

With each passing month, Mustafa's base of power shrank, while Magdel's grew. The heroes that lead her forces were indeed powerful, and Mustafa saw the need to

personally coordinate attacks against them in each battle. In the end, he succeeded in turning back her offensive when she controlled fully 40% of the land. Mustafa's Elves deserved the most credit for changing the tide of events, though the ability of his many clerics to turn Magdel's undead legions could not be discounted.

At the feast of celebration that marked the war's end, Mustafa reflected on the lessons of his campaign. He vowed to never discount the affects of magic. Also, to further his skill as a diplomat, using this refined art of gentlemen to obtain his true objectives. Finally, he learned not to underestimate the presence of heroes on the field, and to husband well the men under their command, as one elite unit is worth five of fresh recruits. These things he now knew well, and would not forget the next time the Empire is threatened. **CGW**

COMPUTER BASKETBALL

IBM • APPLE II • C-64

3 IN 1 FOOTBALL

Unmatched statistical accuracy • Stats compiler • Full team and player statistical breakdown • You call the plays and timeouts • Compare scouting reports • Use the two-minute rule • 766 total teams included, NFL, WFL, USFL, WFLA & College from 1925 to present • Trade, draft or input teams • Standings and League Leaders!

BASKETBALL - THE PRO GAME

You're the coach and you choose line-ups, shot selection, style of play and much more • Stats compiler • Full team and individual player stats kept for up to an 82 game schedule • All players rated by actual statistics and tendencies • 27 current teams and over 190 great teams from the past included • Standings and League Leaders!

ORDER TODAY!
 Mail check or money order for **\$39.95** each.
 You may call in and order with VISA or Master Card.
 Please add \$3.00 for shipping and handling.

For more information, call or write for a free brochure.
1-800-477-7032

© LANCE HAFFNER GAMES

P.O. BOX 100594 • NASHVILLE, TN 37224 615/366-8088

SOFTWARE CLOSEOUTS

>>>COMMERCIAL SOFTWARE FOR IBM AT BARGAIN PRICES<<<

IBM STEALS, YOUR CHOICE \$5

CROSSBOW, 1st COURIER, T.K.O., EYE OF HORUS, ARCHIPLAGOS, POCKET ROCKETS, GHOSTS & GOBLINS, PRESIDENT IS MISSING, SUPER JULY 2, BALL GAME, IMPOSSIBLE MISSION 2, CALIFORNIA GAMES, SUB BATTLE 1, A CRACKDOWN, WORLD GAMES, WINTER GAMES, DEATH SWORD, STREET FIGHTING MAN, TURBO CHAMPIONS, OUTRUN, SILENT SERVICE, SPITFIRE ACE, SHADOWGATE, CONCENTRATION, WELLTRIS, STARQUAKE, FACES, NIGHT HUNTER, MONTY PYTHON, VEGAS CASINO, BARBARIAN, SPORT OF KINGS, MAGIC JOHNSON, SPACE HARRIER, THUD RIDGE, GAUNTLET 2.

\$10 SPECIALS FOR IBM

DON'T GO ALONE, TEST DRIVE, DRAGON WARS, VEGAS VIDEO POKER, BEATING THE HOUSE AT BLACKJACK, CRIBBAGE, STRATEGIC CRAPS, CHAMPIONSHIP POKER, REVOLUTION '76, B.A.T. HUSHBUCK, BOPARDY 25th ANNIVERSARY, WHEEL OF FORTUNE GOLD, MID WINTER, DR. DOOM'S REVENGE, GUNSHIP, PALCON, AMAZING SPIDERMAN, COLONEL'S BEQUEST, HOSTAGE RESCUE MISSION, DEJAVU 2, HARRIER COMBAT SIMULATOR, CONQUEST OF CAMELOT, MANHUNTER NEW YORK, ROTOFX, ARKANOID 2, POLICE QUEST 2, HEROES OF THE LANCE, 7 SPIRITS OF ICE, STARGOOSE WARRIOR, DRAGONS OF FLAME, MIDWINTER LORDS, HARPICON, SCENARIO EDITOR, MOSDU'S FIGHT PALACE.

SIERRA SUPER SPECIAL
 \$20 each, 3 or more \$15 each

QUEST FOR GLORY 1 to 2, KINGS QUEST 1, 2, 3 or 4, SPACE QUEST 1, 2, 3 or 4, RISE OF THE DRAGON, TREASURE ISLAND, LARRY 1, 2, 3 or 4, ZELIARD, HOYLES BOOK OF GAMES I, POLICE QUEST 1 to 3, B.A.R.T. OF CHINA.

PREMIUM \$25 BLOWOUTS

F-117A STEALTH FIGHTER, GUNSHIP 2000, MANTIS, DARKLANDS, GREENS, ULTIMA SAVAGE EMPIRE.

TONS OF IBM HITS...\$15 EACH

WORLD CLASS LEADERBOARD, ECHELON, GUNBOAT, GRAND PRIX CIRCUIT, HOVERFORCE, TEST DRIVE 2, STRATEGIC CRAPS, STREET ROD, FREE D.C., POWER POLITICS, HILL STREET BLUES, BIG BUSINESS, ARMADA 2525, DUSK OF THE GODS, MOONSHINE RACERS, KILLING CLOUD, MISSION IMPOSSIBLE, SPEEDBALL 2, TEENAGE MUTANT NINJA TURTLES, VIDEO POKER FOR WINDOWS, CHESSNET FOR WINDOWS, BLACKJACK FOR WINDOWS, REVELATION KNIGHTS OF THE SKY, FLAMES OF FREEDOM, SPECIAL FORCES, GREENS UPGRADE, LIGHTSPEED, COVERT ACTION, F-15 STRIKE EAGLE 2, MEGATRAVELLER 1, DAYS OF THUNDER, FOUR CRYSTALS OF TRAZERE, CASINO CHALLENGE, BAD BLOOD, PUNISHER, MILLENIUM, TROKA, TWILIGHT 2000, CODENAME ICEMAN, THEXDR, FIREHAWK, HOYLES BOOK OF GAMES 2, OIL 'S WELL, MANHUNTER SAN FRANCISCO, PAPERBOY 2, SARGON 4, HIDDEN AGENDA, WARLORDS, MACARTHUR'S WAR, SECRET OF THE SILVER BLADES, BUCK ROGERS 2, MATRIX CUBED, DARK QUEEN OF KRYNN, CONFLICT KOREA, GATEWAY TO THE SAVAGE FRONTIER, TREASURES OF THE SAVAGE FRONTIER, DEATH KNIGHTS OF KRYNN, SUPER SPACE INVADERS, MEGAFORTRESS, AMARILLO SLIM'S REAL POKER, VENGEANCE OF EXCALIBUR, COUNTDOWN TO DOOMSDAY, MAGNETIC SCROLLS, K.G.B., CLUE.

SPECIAL \$20 DEALS

HARD'S TALE CONSTRUCTION SET, KNOWLEDGE ADVENTURE, SPELLCASTING 101, HYPERSPEED, LAND SEA & AIR TRILOGY, SILENT SERVICE 2, RED STORM RISING, ALLIED FORCES BUNDLE, F-19 STEALTH FIGHTER, PRO LEAGUE BASEBALL, SAVAGE EMPIRE, REALMS, LOST ADMIRAL, HUNT FOR RED OCTOBER, CRISIS IN THE KREMLIN, PROPHECY OF THE SHADOW, SHADOW SORCERER, V FOR VICTORY, D-DAY or RUSSIAN FRONT or MARKET GARDEN.

VISAMC ORDERS CALL TOLL-FREE
1-800-676-6616
 Credit Card Orders Only!!! (\$25 minimum)

COMPUSULT
 P.O. BOX 5160
 SAN LUIS OBISPO
 CA 93403

TO ORDER: Send check or money order including shipping charges of \$5 for U.S.A., \$8 for Canada, \$16 all others. Californians must include 7.25% sales tax. To receive our catalog with 1000's of closeouts for all computer types, send \$2 in cash or U.S. postage stamps... DO NOT CALL FOR A CATALOG!!! A catalog is free with any order from this ad. To check for an item not listed here, call (805) 544-6616.

1000's more items for all different computers... Apple, Atari, Amiga, C64/128, MAC, & lots more IBM/MS-DOS!!

Guess what's coming for dinner...

ALIEN BREED



All hell just broke loose in the heavens.

Your mission: Kick some mean, green Alien butt! Overcome 18 labyrinth levels of the most ferocious creatures ever to terrorize the cosmos. Then set the Intex Space Station for self-destruct and face the biggest challenge of all: get out quick or die! Alien Breed is not for those who are afraid of the dark.

- 18 levels of Alien encounters and deadly missions
- Simultaneous 2 player option
- 256 color graphics with ultra-smooth screen scrolling
- Powerful sound effects and digitized speech.



TEAM 17

Developed by Team 17 Ltd.
Published by **MICROLEAGUE interactive software**
U.O.P., 201 Bellevue Building, Newark, DE 19702
1-800-334-6572

Circle Reader Service #92

MICROLEAGUE
M
interactive software

"I Came, I Played, I Conquered"



Art by Rodger MacGowan; Copyright 1994 RBM Graphics

COMPUTER WARGAMING WORLD

In this issue . . .

**Flight Commander Review
A Paper Chase
by Alan Emrich 194**

**Inspecting the
Walls of Rome
by Emperor
"Hadrian" E. Dille 200**

**The Global Domination
Review Gathers
Chuck Moss 206**

Italian Commander: "If you are a great general, come down and fight me."

Marius: "If you are a great general, come and make me fight you."

Gaius Marius (c. 157BC - 86BC),
Adcock, *The Roman Art of War
Under the Republic*, 1940

Call Me A Dreamer

(Just Don't Call Me Late For The Game)

by Alan Emrich

The Data Highway as a Military Objective

While at the Western Cable Show back in December, I attended a panel where the likes of Rupert Murdoch, Ted Turner, John Malone and Trip Hawkins discussed the future of 500-channel and interactive TV. The possibilities of the future were on the lips of every attendee at show.

Wandering through the various booths, I noticed one for The History Channel, coming soon to a cable station near you. Since many of us see the world through simulated field glasses (i.e., "wargamer's eyes"), putting The History Channel together with the interactive television that is rapidly approaching would make any wargamer smile. When the networks finally achieve *interactive history*, we'll probably be fighting each other to be first in line — and then we'll be fighting each other *on-line*, big time.

Why end this daydream here? Imagine the *Interactive History Channel* of the future — While scanning your listing of favorite programs, you notice that Wednesday night at 8:00 PM is *The Age of Napoleon*. The show's concept is that each week, a group of veteran wargamers (and amateur historians) would get together to maneuver units and issue commands within the game's structure through their interactive TV system. Meanwhile, some entertaining commentator/historian (David Chandler?) follows the game, presents the history of the age (complete with anecdotes) and interviews some of the players. All the while, information is coming in on the forging and breaking of alliances, military maneuvers, battles being fought, etc. Professional actors in period costume could do cameos of prominent individuals from the era to help bring it all to life. Wow!

Reality Check

Sure, the ratings might not be that great, but with 500 channels, who is going to no-

tion? In the meantime, we must consider the more immediate future of our hobby.

First, the bad news. After finishing his work on *CPU Bach*, Sid Meier is finding it tough to get motivated to go back to his Civil War game. It has been sitting on his back burner for a while, so we're watching closely to see what toy Sid will pick up and start playing with next.

Among the good news, there are several random dispatches. Another inter-network *CHQ* tournament has been launched. This one is featuring the new 2.x version of the game and involves several players from the *CompuServe* and *Prodigy* networks.

Computer-enabled board wargamers will be pleased to hear that more boardgame titles are appearing for the *Aide de Camp* system all the time. The Gamers have released their *Perryville*, *Barren Victory* and *Stalingrad Pocket* for the *ADC* system, among others. Scott Hamilton, who is presently busy preparing his WWII East Front tactical armor game (*Tigers on the Prowl*), will be working on a major 2.0 revision for the popular *Aide de Camp* kit.

Aide de CGW?

It's no secret that we like wargaming strategy articles, but we also like tables, outlines, indexes and other "game aids." Allow me to put before you, the talented grognards among our readers, an open solicitation for supplemental wargaming material that would be considered game aids. If you see the need for a popular computer wargame to have supplemental material, and you're up to the task of creating them, give me a call here at *CGW* and let's see if we can work an article out of it. You can reach me from 8 AM to 5 PM Pacific Time at (714) 283-3000 x25. Take this to your hearts, and give me your charts. If you're able, give us a table. You get the idea.

From the bunker, Alan Emrich **CGW**

50 YEARS OF GLOBAL CONFLICT

Campaign II heralds a new generation of War Simulations

Campaign II heralds a new generation of War Simulations with more depth than ever before and fabulous real-time 3D action.

The depth to Campaign II is provided by the all new strategy. Expert Military consultant, Wilf Owen, from recent conflicts has

brought his knowledge to bear on computer gaming with an end result that looks and feels more realistic than ever before. All aspects involved in the running of an army have been considered, so that now you can place yourself in command of either side, at any level in the chain of command. Over 130

templates of the most significant military forces from 56 different nations of the last 50 years have been included to gain an insight into real conflicts such as Korea, Vietnam and Operation Desert Storm.

The action takes the form of fast 3D graphics if you choose to

enter the battlefield in one of the 152 types of military vehicles. APCs and Mobile Artillery, utilise weapons ranging from wire-guided missiles, rockets, homing missiles, and machine-guns supported by laser rangefinders to tracer rangefinders, night vision, and gun stabilizers.

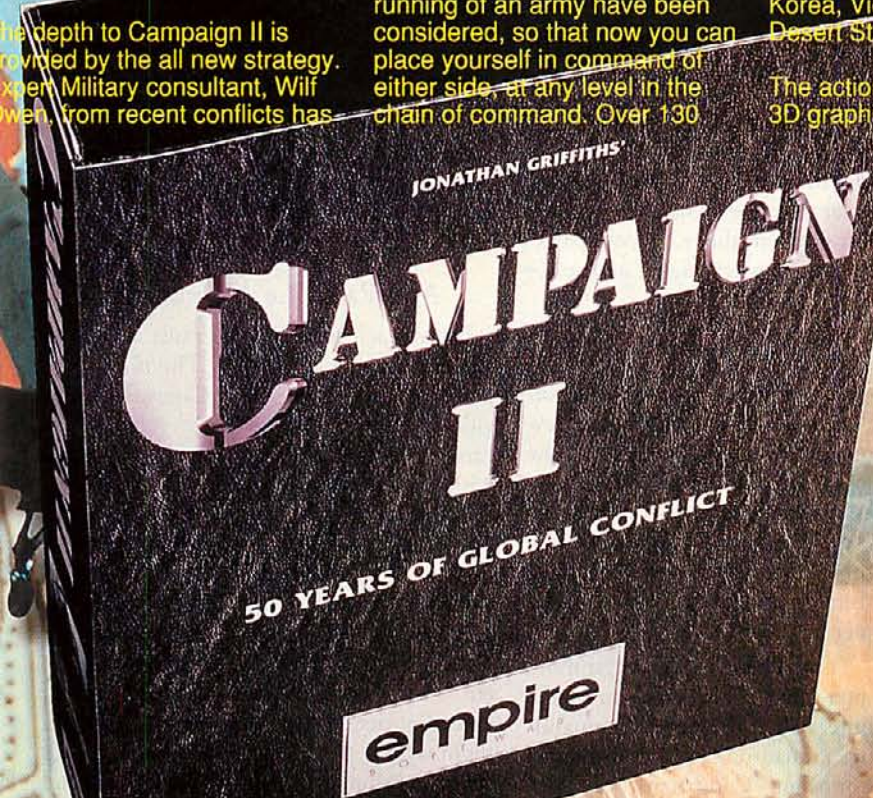

- Campaign II has emerged as the most comprehensive simulation with new improved strategy, at any level in the Chain of Command (C.O.C.), closely resembling that of a real military situation.
- Hands-on action as you fly helicopters in air-to-ground or air-to-air attacks.
- Deploy the animated infantry during fierce battlefield action in a new improved 3D environment.
- Featuring all the modern weapons systems: guided missiles, rockets, homing missiles, laser rangefinders, gun stabilizers and night sights.

**CAMPAIGN WAS BIG CAMPAIGN WAS GOOD
CAMPAIGN II IS BIGGER, BETTER AND QUITE SIMPLY
THE MILITARY SIMULATION OF THE YEAR!**



Air-to-Air Combat For The Reflex Impaired

A Review of Big Time Software's *Flight Commander*

by Alan Emrich

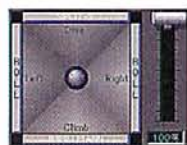

Believe it or not, there were "flight sims" long before there were computers to fly them on. In the glory days of board wargaming (during the 1970s and early 80s), cardboard counters representing individual aircraft flew across gridded paper maps. Supporting each counter was a separate sheet of paper used to simulate its cockpit control panel. Upon this cockpit sheet were more cardboard chits to designate speed, altitude, bank, incline, weapons, performance ability, damage, etc. Although we had to envision much of what was going on with our mind's eye, we were flying dogfights with planes of every era back in those days—and it was great!

as a boardgame, but with the computer keeping track of all the number crunching and "boring parts" of air combat in the jet age. (I can almost hear the voice of Sid Meier saying, "Charles, just give 'em the really cool parts" because that's exactly what *Flight Commander* has.)

Flight School

The well designed manual starts you off with a quick tutorial lesson, blowing up a few ground targets in a cakewalk mission. The game includes many such single mission scenarios. These cover the era from Korea to the near future of jet combat. While there are some historical encounters, most seem to be hypothetical engagements.

Tutorial number two is far more interesting. This takes you to the other half of the game, commanding a squadron of planes through a campaign. Campaigns are connected missions fought over a series of days, where one or two missions per day might be conducted. With about a dozen planes and pilots, keeping pilots rested and damaged planes repaired adds a new dimension to *Flight Commander*.

Since the screen includes an overview map for "telescrolling," several zoom levels to play on, plus smooth scrolling buttons, managing large air battles is about as easy as can be.

Praise The Lord And Pass The Ammunition

Before each mission, you must arm all of the airplanes on your side. The number of planes is up to you; *Flight Commander* provides the freedom to vary force levels, and you can create large squadron level engagements with the click of a mouse. Since *Flight Commander* covers the entire span of jet aircraft history, the quality of heat and radar homing missiles, "dumb" and laser guided bombs and such, all vary with the epoch played. Here, you can decide if you want more radar or heat seeking missiles, bombs or extra fuel capacity, etc.—whatever your plane can carry without exceeding its hard points and still maintain flight weight. Honestly, I had more fun with the old "clunkers" from the Vietnam and Arab-Israeli wars of the 70s than with the newer stuff. I learned a new respect for pilots who flew during my formative years with those old weapons. For other players, however, it is easy enough to suit one's own tastes from the wide selection of mission and armament options to choose from, although I would urge players to try every era.

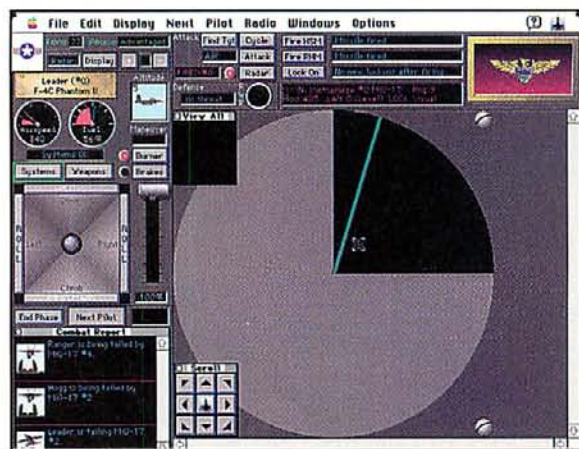

Clearly, Charles Moylan cherished those days as well. He has created a one-man computer game company, Big Time Software, Inc., and produced what is, essentially, a computerized flight combat boardgame. Though an admitted computer joystick jock, Charles wanted to create a computer game in which his tactical skills and knowledge of air combat techniques would determine the outcome of engagements, *not* his hand-eye coordination. Taking a page from those cumbersome paper wargames of yesteryear, he created *Flight Commander* to be as detailed

Flight Commander is played on a square grid, with each square and each level of altitude representing 1/3 of a mile. Each game turn simulates 7.5 seconds of real time. Aircraft can face in any of 8 directions (the square's four sides and corners) and maneuvers are conducted in 45 degree increments. The map will either be a pale blue and white for air-to-air duels or brown for bombing missions.

Flight Commander



TITLE: Flight Commander
 PRICE: \$69.95
 SYSTEM: Macintosh
 REQUIREMENTS: Mac Plus or better, System 6.0.5 or higher, Monochrome: 1MB RAM, Color, System 6: 2MB RAM, Color, System 7: 3MB RAM
 PROTECTION: None
 DESIGNER: Charles Moylan
 PUBLISHER: Big Time Software, Inc., P.O. Box 39444, Baltimore, MD 21212-6444 (410) 366-8984

Stop playing with yourself.

Get 15 hours of gut-stomping fun for less than \$20.

No more figuring out in one day how to beat the puny A.I. of a computer game. Oh, no; I'm afraid you're up against something just a *little* more difficult this time: the nastiest, meanest, smartest, most cunning opponents in the game world—other humans. With a computer and modem, you can team with—or against—some of the best gamers in the Known World. Take your place as a European vassal lord in *The Hundred Years' War™* and try your Machiavellian mettle in the epic battle for empire and prestige.... Don the hauberk of a warrior and travel dangerous lands in the color graphics role-playing world of *Drakkar™* or the *Island of Kesmai™*. Play the latest version of the very first true multi-player game, *MUD II: The Quest For Immortality™*... or test your strategy against dozens of other would-be Galactic Emperors in *Galaxy II: Expanding Empires™*.

So stop playing with yourself! Membership is just \$8.95 a month and includes 4 hours of non-prime access in standard services. Or, for \$19.95 a month you can have 15 hours of access in standard services during non-prime time. Thereafter, access rates are as low as \$2.50 an hour after 6pm local time and all day weekends. Isn't that a small price to pay to get your butt waxed?

How to register for an NVN subscription:

To register on-line, set your comm software to 1200, 2400 or 9600 bps, N-8-1, and full duplex. Dial 1-800-336-9092. When connected, enter CG94PL and press <RETURN>. Then enter name, address and Visa,® Discover Card,® American Express,® MasterCard® number or EFT information. Your Starter Kit will be mailed right away.

For more information, call 1-800-336-9096.

Internet mail
ASK ABOUT OUR
OTHER INTERNET
SERVICES



NVN—Good stuff. Good price.

Subscription fee is \$8.95 per month, which includes 4 hours of non-prime time access in standard services. 9600 bps access available at no surcharge. Standard services are \$2.50/hour during non-prime (6pm - 7am weekdays, and all day weekends); and \$7.50/hour during prime-time (7am - 6pm, Monday - Friday). Premium services carry additional charges. Unused portions of monthly hours provided by subscription may not be carried forward or transferred. Hourly rates and service content are subject to change without notice. NVN is a service mark of National Videotex Network, Corp. All others are for identification purposes only and belong to their respective companies or organizations.

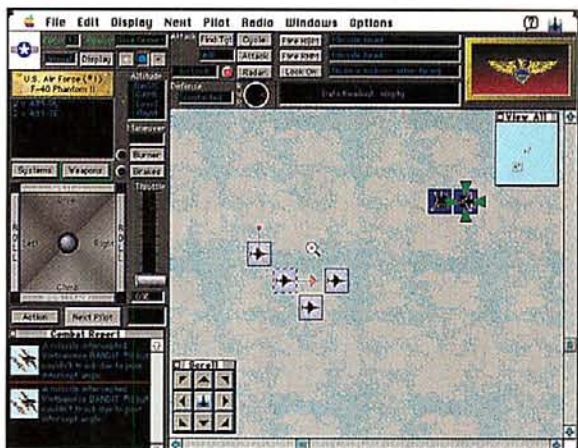

After a few mouse clicks, your aircraft are armed and the mission begins. If you are fortunate enough to have area radar (when using that advanced rule), you'll know where your enemy is on the map at all times (just like a boardgame). Players without EWACS or ground based radar to paint the sky must find their targets with either aircraft radar or get within eyeball distance (and with long range missiles, planes can be dead before they'll ever make visual contact). The enemy might begin in your sights or on your tail, but usually they are at some relative position in-between.

Planes paths are plotted individually by way of a simulated joystick to the left of the main playing area. By clicking on and repositioning this joystick, you alter the distance, altitude and direction of that plane's next move for the current game turn. Effects of acceleration and deceleration will not kick in until the following turn, however. Diving for the second consecutive turn allows the option of performing a Split-S maneuver, while climbing two turns in a row affords the opportunity to perform an Immelmann. Barrel Rolls and High-G maneuvers can also be plotted, although the latter has only a chance of success (based upon the airplane type and pilot skill). I found this interface to be so intuitive, quick and easy that my turns were plotted in only a

minute or two, which kept things moving quickly and maintained my interest level like boardgames on this subject never could.

"Bandits! Bandits!"

Flight Commander comes with a plethora of sound effects and many digitized voices to liven up play, both at appropriate times and randomly. Each turn begins with an audio cue of a jet passing overhead and the beeps, chatter and explosions progress from there. The audio atmosphere is terrific, although it can be toggled off when you need to play in "stealth mode."

After individually plotting your aircraft's course, pressing the Next Turn button simultaneously executes every plane's plotted ma-



neuvers. Cannon fire is automatically resolved whenever the opportunity presents itself during this execution phase. The firing of all other weapons actually occurs during planning phase. Bombs will score their hits (if any) immediately when fired, as will missiles unless the advanced rule is switched on that moves missiles during the execution phase concurrently with aircraft. This latter option can create some real nail biting as missiles might take two or three turns to close with an enemy—two to three turns that they can fire back!

Chaffing At The Hit

Defenses are handled by probability tables within the program. Certainly pilot skills, plane types, and technology levels are all factored into the equations. Missiles and cannons might miss for any of a number of reasons, and the player(s) are notified of the reasons *why* they missed when they do. I found myself quickly learning to

get better attack angles from this useful feedback, and learning the minimum and maximum ranges (in squares) for firing certain radar homing missiles. Players will also get a feel when they're up against superior technology. Sometimes ECM can protect a plane from everything but a cannon's gunsights.

What I found so striking about *Flight Commander* was how fast the game moved along. I finished most scenarios in about 15-20 minutes once I got the hang of the system (which was pretty quick). Setting up another mission or campaign takes less than five minutes, so my verdict is that *Flight Commander* has got "replay value" written all over it for those who can handle a strategy game on tactical jet combat, rather than a real time sim.

Flight Commander is not only a fine solitaire wargame (the AI is better than I am at its best levels, but in modern aerial duels, that's not saying much, I'm afraid), but two human players can play on the same machine with ease, quickly taking turns entering their moves and then watching together as they are resolved. There is no play-by-email or play-by-modem feature supported, but I have a feeling that these will come if the game catches on.

Presently, *Flight Commander* is only available for the Macintosh, but I found out that Big Time Software is already investigating a Windows version of the game. Frankly, *Flight Commander* would be a perfect Windows wargame due to its quick, simple and exciting play. It is easy to envision it as a "10 minute break" game.

DYOB (Design Your Own Battles)

The glory of *Flight Commander* would have to be in its flexible design-your-own scenario features. From a simple display, you can select offensive and defensive combatants, the mission objective for the offensive player (bomb-



**The NEW
CAPE COD CONNECTION
ELECTRONIC SHOPPING MALL**

Our BBS is back - 24 HOUR Electronic On-Line Shopping is available. • Download our complete new & used Software, Tabletop & Sports Apparel Catalogs, updated daily with new products. • On-Line Ordering 24 Hours • One of the largest used software listing available today. Have us sell your used software on consignment.

Robert Berry, Proprietor
21 PLEASANT VIEW AVENUE • FALMOUTH, MA 02540

**BBS 508-548-2908 ■ HELP 508-457-0738
24 HOUR FAX 508-457-4558**

ZERO'S & ONE'S

ASK FOR PRICE LIST AND TAKE A LOOK AT OUR SALE ITEM
(800) 788-2193

Sample Listing of Products

HARDWARE

CREATIVE LABS:	
CD 16 Kit (Business)	635.00
Discovery 8 CDRom Kit	399.00
Discovery 16 CDRom Kit	469.00
EduLnmnt 8 CDRom Kit	449.00
EduLnmnt 16 CDRom Kit	519.00
Snd Blaster 16	218.95
Snd Blaster Pro Dlx	119.95
Video Blaster	299.00
Video Spigot	399.00
MEDIA VISION:	
Fusion 16 CDRom Kit	499.95
PAS 16 Snd Cd	165.95
Pro Aud Studio 16	189.00
Pro Audio Spectrum	
16 MM Kit	899.00
TOSHIBA 3401 200ms	
Int w/Pas Cable	495.00
AI TECH:	
Pro PC/TV Plus	309.95
Wave Watcher-TV	419.00
Video Surge	615.95
OTHER SND, MM, & VIDEO:	
Computer Eyes RT	434.95
Gravis Ultra Sound	129.00
TelevEyes VGA-TV	199.00
WIN TV	399.95

STICKS & YOKES

CH PRODUCTS:	
Auto III Game Card	27.00
Flight Stick	35.95
Mach II	22.00
Mach III+	27.00
Virtual Pilot Yoke	62.95
GRAVIS	
Analog Pro	37.95
Game Card Hi Speed	29.95
THRUSTMASTER:	
ACM HiSpd Game Card	26.95
Weapons Control Mark II	99.95
U-Prom for WCS Mark I	27.95
Flight Control	59.95
Flight Control Pro	99.95
Rudder Pedals	99.95
COLORADO SPECTRUM:	
Mouse Wheel	call

MODEMS

Prices too Low to Print:
Boca, Sportster, Supra,
Zolltrix, Zoom and others

FLT SIM/WAR

A Line in Sand	26.95
Aces over Europe	44.95
Air Warrior SVGA	35.95
Ambush at Sorinor	35.95
Armored Fist	42.95
ATAC	34.95

B-17 Flying Fortress	41.95
Birds of Prey	31.95
Campaign	35.95
Comanche:Maximm Ovrrkl	43.95
Carrier Strike	41.95
Carriers at War	34.95
Conquer Kingdoms	35.95
Conquest Japan	35.95
Empire Deluxe	35.95
F-15 Stirke Eagle III	43.95
Falcon 3.0/Mig 29	call
Flight Sim 4.0	37.95
Flight Sim Add-Ons	call
Flt Sim Scen USA East	41.95
Flight Sim 5.0	call
High Command	41.95
Jetfighter II bundle	44.95
Jump Jet	41.95
Liberty or Death	35.95
Lost Admiral	35.95
Pacific War	47.95
Patriot	43.95
Palton Strikes Back	14.95
Perfect General	35.95
Rebel Assault	tba
Secret Weapons Luftwffe	29.95
Special Forces	29.95
Strike Commander	47.95
Task Force 1942	38.95
Theater of War	19.95
Tornado	44.95
V Victory 1, 2, or 3 ea	43.95

ENTERTAINMENT

A-Train	41.95
ADD:Unltd Adventure	34.95
Action 5-5 Sierra Gms	24.95
Adventure Starter-Sierra	19.95
Air Bucks	35.95
Alone in the Dark	35.95
Amazons	36.95
Arcade Hits	24.95
Armourgeddon	39.95
Ashes of Empire	34.95
Back to Future II	26.95
Bart Simpson-Wierdnes	29.95
Batman Returns	41.95
Betrayal at Kronдор	39.95
Blue Force	39.95
Caesar	35.95
Carmen SD-Space Dlux	47.95
Castles II	35.95
Challenge of 5 Realms	39.95
Civilization:Master Playr	49.95
Classic Adventure-Lucas	35.95
Conquered Kingdoms	35.95
Creepers	29.95
Dagger Amon Ra	41.95
Dark Half	34.95
Dark Seed	41.95
Darklands	41.95
Daughter of Serpents	32.95
Day of Tenacle	34.95

Design Your Railroad	34.95
Discovery:Columbus	35.95
Dragon Lair III	35.95
Dune II	35.95
El Fish	35.95
Eric The Unready	35.95
Flashback	31.95
Freddy Pharkas	41.95
Global Effect	19.95
Goblins 2	24.95
Heimdall	21.95
Home Alone 2	27.95
Humans	25.95
Inca	34.95
Indy Jones 4	35.95
Kings Quest VI	44.95
Kyrandia (Legend)	34.95
Legacy:Realm of Terror	36.95
Legends Valour	37.95
Leis, Suit Larry 5	41.95
Lemmings 2	35.95
Lost Treas Infocorn II	29.95
Lost Treas. of Rain Forest	29.95
Magic Candle III	37.95
Maniac Mansion	14.95
Mantis	31.95
Mario Is Missing!	34.95
Mercenaries (Tege!s)	37.95
Might & Magic V	41.95
Monkey Island 2	25.95
Out of This World	36.95
Paladin II	35.95
Pirates! Gold	41.95
Police Quest 3	39.95
Prophecy by Sierra	24.95
Populous II	37.95
Prince of Persia II	41.95
Quest for Glory III	41.95
Return of the Phantom	41.95
Ringworld	35.95
Romance 3 Kingdoms	39.95
Rome:Pathway to Pwr	29.95
Rules of Engagement II	41.95
SciFi:5 Actvion Games	26.95
Shadow President	41.95
Shadowlands	29.95
Sherlock Hims:Lst Files	42.95
Siege	22.95
Sim Ant	35.95
Sim City	29.95
Sim Earth	42.95
Sim Life	41.95
Simpson's Arcade	29.95
Space Hulk	34.95
Space Quest V	41.95
Spear of Dstiny:Wlfnstn	35.95
Star Control II	35.95
Star Trek 25th Anniv.	35.95
Stunt Island	33.95
Syndicate	36.95
Terminator 2029	41.95
Ultima Underworld II	47.95
Ultima VII Part 2	45.95
Ultrabots	36.95

Veil of Darkness	35.95
Wing Commander II	47.95
Wizardary VII:Craders	41.95
X-Wing	41.95
X-Wing Misson Dsk	19.95

CD ROM

7th Guest	52.95
Arthur's Teacher Trbls	41.95
Chess Maniac-Natl Lampn	34.95
Clip Art Haven-jewel	16.95
Composer's Qst MPC	54.95
Compton Interact. Encyc.	249.95
Curse of Enchantia	24.95
Daggar of Amon Ra	41.95
Day of Tenacle	41.95
Dinosaur Adventures	41.95
Dune	56.95
Eco-Quest 1	41.95
Encarta MM Encycl.	269.95
F-15 Strike Eagle III	47.95
Fontmaster 2	18.95
Games 1993-Jewel	21.95
Global Explr-DeLorme	89.95
Indy Jones:Fate Atlantis	41.95
Inspector Gadget	35.95
Iron Helix	call
King's Quest VI	44.95
Jutland	52.95
Just Grandma & Me	38.95
Kodak Photo CD	29.95
Legend of Kyrandia	41.95
Map Expert by DeLorme	299.95
Mayo Clinic (jewel box)	29.95
Midi Music Shop-jewel box	22.95
MS Cinemania MPC	54.95
Monarch Notes	61.95
Old Testmanet Interact	49.95
PC Karaoke	77.95
Playing with Language	29.95
Prophone 1993 Ed	129.95
Pub.Paradise-Clip Art	22.95
Putt Putt Fun Pack	26.95
Rodney's Fun Screen	39.95
RoMaterial:Vis/Snd Effect	19.95
Shareware Studio V.C	18.95
Sherlock Holmes 3	43.95
Space Adventure 2.0	61.95
Space Quest IV	41.95
Ultima Underworld I&II	58.95
Who Killed Sam Rupert	24.95
Willy Beamish	41.95
Wing Commander II Dlx	52.95
WCmdr II/Ult Undrwrld	52.95
World Fact Book '92	59.95

WINDOWS

Alphabet Blocks	29.95
Audio:Star Trek V.I	34.95
Conquered for Windows	44.95
MS Golf	42.95
Origin FX Screen Svr	24.95
Star Trek Screen Svr	44.95

Take Break:Pinball	29.95
Yobl Magic Spell Tricks	29.95

SPORTS

Car & Driver	call
Front Page Sports Ftbl	41.95
Jack Nicklaus Sig Golf	41.95
Jordan in Flight	36.95
Links 386 Pro	39.95
NFL Pro Football 1992	35.95
NFL Video Pro Football	35.95
Sports Adventure	47.95
Tony LaRussa Bsbl II	37.95
Trouble Shooting Golf	29.95
Wayne Grtzky Hockey 3	35.95
Wilson Pro Golf	24.95
World Circuit Grnd Prix	35.95
World Tour Tennis	31.95

EDUCATIONAL

ACT Studyware	29.95
Alge-Blaster	29.95
Amazon Trail	34.95
Auto Works	44.95
Calculus	24.95
Castle of Dr. Brain	29.95
Cuckoo Zoo	31.95
Dinosaur Adventure	32.95
Discover Space	37.95
Eagle Eye Mysteries	31.95
Inspector Gadget	34.95
Island Dr. Brain	29.95
Kid Cad 3-D	29.95
Lost Tribes (Soc. Stdy)	24.95
Mario Teacher Typing	24.95
Math Rabbit (New)	29.95
Mickey's ABC's Ench.	19.95
Millie's Math House	29.95
Operation Neptune	34.95
Oregon Trail Dlx	35.95
Peter Pan Print Kit	31.95
Playroom ver 2.0	29.95
Putt-Putt Fun Pak	25.95
Ready for Letters	34.95
Rock & Bach	34.95
Scooters Magic Castle	31.95
Time Treks	29.95
Treasure Math Storm	34.95
What'sMy Angle-Geom	29.95

**AND A WIDE
RANGE OF OTHER
PRODUCTS
FROM A...TO Z...!**
AAAAAAAAA

**MANY SALE ITEMS IN
OUR FULL PRICE LIST**

ALL IBM COMPATIBLE

ZERO'S & ONE'S

ORDER: 800-788-2193

3315 E RUSSELL RD, #H-177

FAX: 702-897-1571

TECH/INFO: 702-897-2797

LAS VEGAS, NV 89120

INTL: 702-897-2797

Prices and availability subject to change. All sales final. We do not guarantee compatability. All software is factory fresh and unopened. We are not responsible for manufacturer's defects. Contact publisher regarding defects. Any return subject to 20% restocking fee. Shipping: 1st game \$5; add'l games add \$1 each in Continental US. 2nd Day Air \$6 1st game, add'l games add \$1 each in Continental US. COD add \$5.00. All prices are US Dollars. WE ACCEPT M/C & VISA.



add even more to *Flight Commander's* replay value and drew me back to the game again and again.

What's Not To Like?

I found one minuscule bug in the game (my tutorial airplane had no bombs, so I had to destroy the ground targets with missiles and strafe them). When I called Charles Moylan to report this, he said that it would be fixed in a wink. When queried what I didn't like about *Flight Commander*, I had to admit that I found it tedious to

ing any number of target types, including ships, or going for air superiority), and the general weather conditions. Aircraft on each side can be automatically or manually selected, and these selections can be either based on point values or simply numbers of aircraft per side (and some very *large* furballs can be constructed!). It's a breeze to create, say, two groups of four strike aircraft, support by a third group of three fighters and have them encounter a dozen enemy bogies and a target with SAM support. Even the process of arming these aircraft can be handled by the computer, if desired. These instant scenarios

every plane in a group that I wanted to keep formation. Charles promised that I could have a patch that afternoon with that feature in if I wanted it, and that it would certainly be in the game's next revision. Honestly, I got the feeling that he was doing this just because I was a fellow wargamer who liked his game, not because of any special "reviewer's clout." This sort of dedication and attention to customers is the beauty of the one-man game company.



Flight Commander is for any Mac Plus or newer system (and, yes, it even plays all right in black & white). The manual is written in a friendly, informative manner that will quickly get you started and have you mastering all of the advanced options in no time. It even includes an extensive reference section. With customizable missions and woolly campaign games, this board-cum-computer war-game gets a big thumb's up from this fly boy. I have to admit, I really enjoyed having the time to think about my flight tactics, rather than rely on my sorry old reflexes. **CGW**



Watch me come alive in your computer!

Girlfriend Teri™
Shown Here

NOT A CARTOON

The World's First Artificially Intelligent Virtual Woman!

- ▶ Revolutionary new game for PC compatibles
- ▶ Artificial intelligence, Interactive Conversation
- ▶ 3000+ word vocabulary, synonyms, idioms
- ▶ She lives in your computer, and talks to you on the screen
- ▶ VGA video of a *REAL* woman - no cartoons!
- ▶ Runs on any 286, 386, 486 (12MHz min.)
- ▶ Requires 640K RAM and 10Mb hard disk
- ▶ No nudity, possible mature situations
- ▶ Also available Girlfriend Lisa,™ now only \$59.95

Order from your favorite dealer or send check or M.O. for \$69.95 Plus \$4 shipping. Add \$4 if C.O.D. Specify 3.5" or 5.25" disk

"If your dealer doesn't carry Girlfriend,™ show them this ad and they can order it from us!"

AldeaLabs
709 Lingco, Suite #106
Dept. #CGW
Richardson, TX 75081
(214) 235-4999
FAX 235-4992

BECOME THE ULTIMATE GAMER

THE

Infinity

MACHINE

From **REM** Software

With the Infinity Machine™, you can make virtually **any** game bow to your every whim! With our easy to use real-time editing technology, you can add lives, edit character specs, and change weapons & abilities - all without ever leaving your game. With our **Infinity Code** system, you can generate your own codes for easier access to game features! And when you're in a tough situation, Infinity Machine's **slow motion** feature gets the action back under **your** control.

\$34.95 U.S.



TO ORDER, CALL 313-457-1161

Cao Cao

Genghis Khan

It took 1400 years,
but we finally
got them together!

Picture this, two of history's most ruthless and ambitious leaders in the same room. Now, throw in the fact that both are looking towards world domination with massive armies following their every command. Sounds interesting, doesn't it. This winter, Koei's bringing Genghis Khan and Cao Cao together to a store near you, and it's going to be exciting. After all, Genghis Khan is out to lead his Mongol hordes victoriously across Asia and Europe in **GENGHIS KHAN II: CLAN OF THE GRAY WOLF** and Cao Cao's devising new ways to reunite China after the collapse of the Second Han Dynasty in **ROMANCE OF THE THREE KINGDOMS III: DRAGON OF DESTINY**. The contest for world domination is about to begin. Are you ready?

Genghis KHAN II

CLAN OF THE GRAY WOLF



CONQUER THE WORLD!



SEIZE THE BATTLE ADVANTAGE.

Romance III of the Three Kingdoms III DRAGON OF DESTINY



SEAL AN ALLIANCE.



PREPARE FOR
DISEASE & DISASTER!

KOEI

KOEI Corporation, 1350 Bayshore Highway, Suite 540
Burlingame, CA 94010

Genghis Khan II and Romance of the Three Kingdoms III are trademarks of KOEI Corporation.

Circle Reader Service #78

ALSO AVAILABLE FOR
SNES & SEGA.

KOEI Games are available for all systems in retail outlets nationwide! If you can't find the KOEI product you are looking for, call us at (415)348-0500 (9am to 5pm PST).

PC
Compatible



And The Walls Come Tumbling Down

Mindcraft's Siege Engine Comes of Age in *Walls of Rome*

by H.E. Dille

"The origin and rise of fortification is undoubtedly due to the degeneracy of mankind."

J. Muller, Professor of Fortification
Royal Military Academy, Woolwich, 1746

The statement of our esteemed Prof. Muller doesn't speak well of the moral character of the folks at Mindcraft. Fortifications and more fortifications have been their business for over a year now, between their original *Siege* game, their *Dogs of War* extension, and now their latest siege game, *Walls of Rome*. If the Professor's suggestion is correct, it sure doesn't show in Mindcraft's product. The *Siege* series of games has done anything but degenerate. It has, in fact, improved quite a bit.

Walls of Rome (*WOR*) pulls the *Siege* gaming engine out of the Dark Ages into more classical times, literally and figuratively. In the literal sense, this release has abandoned the Medieval fantasy setting of its predecessors in favor of the historical battles of antiquity. Figuratively speaking, *WOR* corrects many of the AI problems of prior releases, breaking down the artificial wall that had inhibited player satisfaction up to this point. The computer opponent is much more aggressive, logical and methodical than before. The result is a well executed treatise on the sieges of the Romans, Celts, Carthaginians and Parthians, which introduces you to the soldiers of the time, but doesn't require you to feed them, house them, and give them time off for the Holidays.

WOR allows you to pursue a single battle in which you may take either side, or a campaign focusing on the expansion of one of the aforementioned empires. The campaigns are played out as a series of linked battles without strategic maneuver between each one.

Man The Battlements!

At the beginning of an engagement, the defensive side will have a limited number of troops already manning the walls of the castle.

The remainder of the force is in reserve within the barracks. By clicking on the barracks, you can see a display of the troops and equipment available for deployment. Double clicking on a troop type will bring up a window providing additional information about that unit, including offensive and defensive strength, weapon types and speed of movement. Mindcraft has even done a little homework and dressed the troops in authentic period apparel.

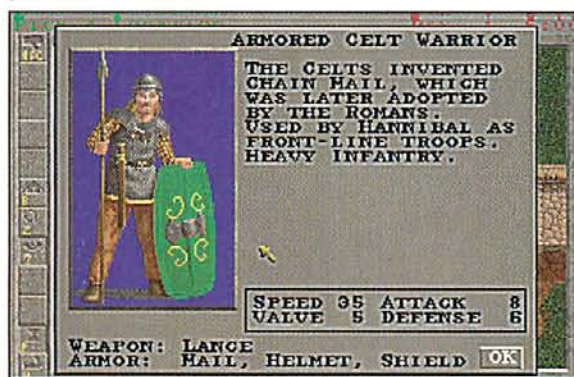

To deploy troops, click on the unit, then click on the up arrow at the top of the barracks display. This will form a group. Additional clicks on the arrow will add to that group in accordance with the multiplier option set on the left side of the display. The default setting is the Roman numeral ten (X), and it is adequate for most situations. The maximum size of any given group is 50 soldiers, and they may be deployed in conjunction with an equivalent amount of equipment; 50 Roman slingers can carry 50 ladders to raise along the castle walls. Also, 50 archers can carry 50 pots of Greek fire to conduct a barrage of flaming arrows. When Cavalry is sent to the field, the maximum group size is reduced to 25 because the horses count into the total. Also,

there is a maximum number of 40 groups per side at any given time, regardless of the number of troops in each group.

To the right of the troop window is a similar display for equipment, which might include ladders, bridges, catapults, ballistae and Greek fire, among others. This equipment is available for immediate use, but if you wish to supplement these figures for an extended barrage or some other strategy, it is possible to construct more equipment using the Engineer function. The engineering options are one of the finer points of *WOR* and supplement the base combat model nicely.

Used To Couldn't Spell Engineer, Now I Are One

Beyond knocking politely at the front gate, placing ladders under crennels (the openings at the top of a wall) is the fastest way to get into a castle, but it is also very dangerous. Troops who carry the ladders are burdened and very vulnerable to attack, although the survivors of such a group can immediately scale the walls. With proper timing, defenders may pour Greek fire down on the ascending warriors and push the ladders back off the walls. Because of this, it is always best to have at least one archer group supporting the raising of the ladders via barrage and two large

Walls of Rome: Siege Warfare in Classical Times

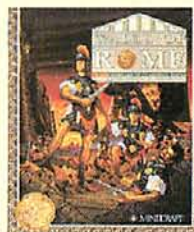

TITLE: Walls of Rome: Siege Warfare in Classical Times
 PRICE: \$59.95
 SYSTEM: IBM
 REQUIREMENTS: 286-12MHz or better, VGA graphics, mouse
 PROTECTION: Documentation look up
 DESIGNERS: Ali Atabek, Scott Baker, Paul Kellner, James Thomas
 PUBLISHER: Mindcraft
 Torrance, CA
 (310) 320-5215

TIGERS

ON THE PROWL



**HPS Simulations,
the WARGAMER'S
Computer Company,
and designer Scott Hamilton,
bring you the ULTIMATE WWII tactical combat simulation.**

Covering the ENTIRE Eastern Front from 1939-45, *Tigers On The Prowl* includes a detailed database of hundreds of fighting vehicles, weapons, and force structures for the Axis, Allied and Soviet forces. Likewise, combat is resolved by precise calculations of armor thickness and round penetration at the instant of impact.

It also features morale, hidden movement, communications, airstrikes, night fighting, forest fires, and much more. Designed for all levels of wargamers, *Tigers On The Prowl* includes 5 scenarios, a flexible scenario builder, and three levels of complexity. Orders are given to platoons or sec-

tions, with a maximum of a supported combat brigade on each side. Can be played solitaire against the computer, or by two players - either face to face or by mail/e-mail. *Tigers On The Prowl* can use maps and symbols created with Aide De Camp. *Tigers On The Prowl* is as real as you can get without being there.

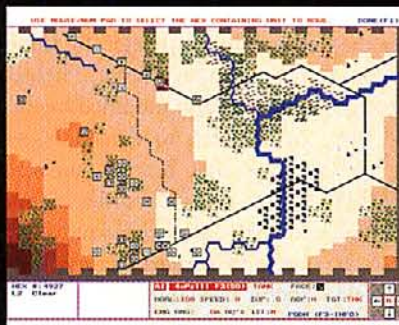

Requires VGA,
570KB free RAM
and 2 MB hard disk
space. Mouse optional.
For IBM and compatibles.

VISA/MC: CALL
(408) 554-8381
Dealer Inquiries
Welcome

HPS
SIMULATIONS

HPS Simulations
P.O. Box 3245
Santa Clara, CA 95055-3245

infantry groups behind the engineering unit to flood the breach created. Casualties will be high in such an assault, but if properly executed, a "beachhead" can be established on one of the castle walls and supplemented with further troops as the attack continues.

Another classic method of breaching the enemy defenses is through mining. Undermining the castle walls so that they collapse is much more time consuming than a ladder assault, but it is usually not as costly in terms of men and equipment. Tunnels appear as green squares on the terrain display and do not impede troop movement on the surface.

Siege towers, when properly constructed and placed against a castle wall, provide immediate access for large numbers of troops. Although initially harder to erect than ladders, siege towers are preferable for their durability and the increased safety they afford assaulting troops. The construction of siege towers should be done far from the castle, out of range of enemy archers, catapults and ballistae. Once completed, the tower is pushed to the desired location, acting as a shield in the process for the troops who are moving it.

Other engineering functions include the laying of bridges and the construction of battering rams, catapults, ballistae and ramparts behind which "artillery" can hide while bombarding. If troops are encountering too much resistance while performing a given function, you may also have them drop their equipment and mount a defense or a hasty retreat. Other troops can later gather the equipment that has been dropped.

Taking Tactical Command

Once troops are deployed in the field, they can be given orders to advance, occupy a given area, conduct a barrage of an area, target a single group, conduct patrols in an area, even chase and fight a specific enemy unit. As you can see, this is a much more diverse command structure than was present in prior Mindcraft titles. Further, when units are given movement orders—say, move from an attacking barracks to one of the critical locations within a castle—the AI recognizes the closest access point to the interior (ladders, tower or whatever), vectors the unit directly to that point, and automatically plots the zig-zag path necessary within the castle. This alleviates user frustration over trying to obtain exact tactical point to point movement and frees the mind for tactical thought.

On the field of battle, there are three levels

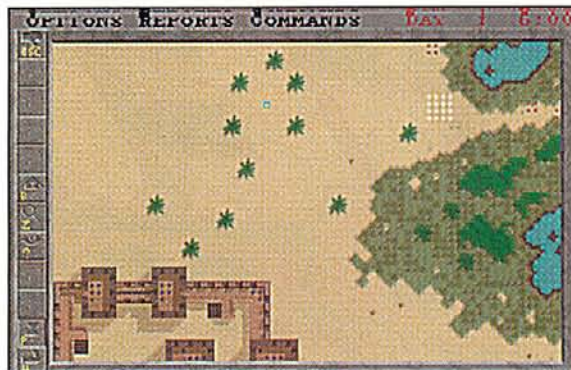

of zoom available to view the clashing troops. At the widest view, the entire field is depicted, and the user can control area functions like bombardment and troop movement. Zooming in a level, the overview shows roughly a third of the entire area, with each group now depicted as a mass of individual dots as opposed to a block of color. Dots that turn dark in a group are casualties, so this view is a good one to quickly monitor the progress of several groups at once. Clicking the magnifying glass a third time reveals individual soldiers in combat, and only a portion of an entire group may be visible on the single screen. At this



level, arrows whiz back and forth, and the corpses of the fallen litter the landscape. This level of magnification allows minute control of individual troop movements if desired.

Deployed groups may be relieved on station by other units or released from their current activity. These units return to the barracks to recover from their fatigue and allow wounded soldiers to recuperate in the hospital. These soldiers become available for redeployment after their wounds have healed (the exact number of days varies).

Victory in *WOR* centers around controlling strategically important regions in each castle. These conditions are also modified by the ratio of attackers to defenders, so that games that become un-winnable due to heavy casualties are not prolonged unduly. To monitor your progress toward victory, the main menu bar contains reports on re-

gions controlled, casualties for the day and the battle, and other reports of interest to the astute commander.

For those who are willing to invest the time, Mindcraft has included a fully functional system editor with *WOR*. This feature allows you to edit existing battles or create entirely new ones of your own, which may be subsequently uploaded to the Mindcraft BBS for other *WOR* players to enjoy. Separate editor functions include map alteration and construction, troop composition and numbers, location of the battle, days allowed for the siege, even the number of hours of daylight allotted.

Chinks In The Armor

WOR's gaming engine, though vastly improved as noted, still requires some minor tweaking. Units on the move still tend to elongate into weak columns as opposed to retaining more classic fighting formations. Also, when defending, you must keep group size small to get each deployed unit positioned correctly on the wall. As such, with the limitations imposed on the total number of groups, the defender will generally have fewer troops in the field than the attacker at any given time.

Some players have also reported a bug that allows no more than 23 groups to be deployed at any given time. This anomaly only appears with certain hardware configurations, but Mindcraft is working on a patch if you are experiencing the problem. The patch can be obtained directly from Mindcraft or through the major networks.

Despite these minor flaws, I could not help but be impressed with the amount of improvement that has occurred. *WOR* is not only a solid extension of the original *Siege* engine, it offers loads of replay value as well. If you have yet to experience Mindcraft's *Siege* system, it may be time to go back in time and assault the *Walls of Rome*. **EGW**

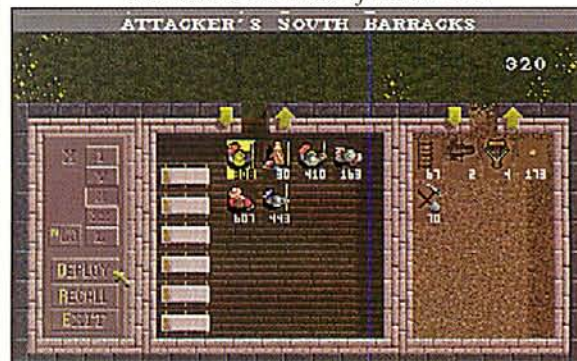

GREAT NAVAL BATTLES™ Vol. II

GUADALCANAL

1942-1943

***This one
will blow
you away!***

Get ready for the second volume in SSI's hugely successful ADVANCED SIMULATOR SERIES!

GREAT NAVAL BATTLES VOLUME II: GUADALCANAL sends you to the South Pacific for the monumental conflict that rocked these remote islands. Five tactical battles, three carrier battles, and one full campaign provide limitless hours of cutting-edge World War II naval combat simulation. *All in crisply detailed Super-VGA!*

Build your forces from 100 ship types and 20 plane types as you engage enemy forces on land, at sea, and in the air. Sophisticated command and control features let the computer handle the details while you make the big decisions. Or, micro-manage every detail — right down to the targeting of individual guns!

GREAT NAVAL BATTLES VOL. II: GUADALCANAL

**THE PREMIUM
NAVAL COMBAT
SIMULATOR.**

**IBM &
COMPATIBLES**

Available on
3.5" disks

and
CD-ROM.

To order:
Visit your
retailer or call:
1-800-245-4525
with VISA/MC (U.S.
and Canada only).

**IN
SUPER
VGA!**

IBM 256-COLOR SVGA DISPLAYS

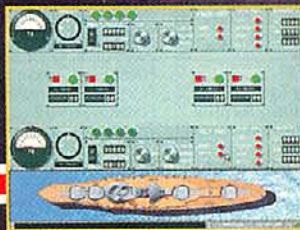
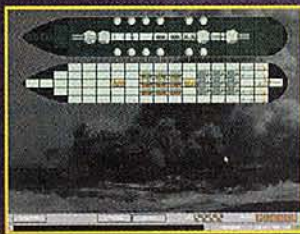

©1993 Strategic Simulations, Inc. All rights reserved.

Circle Reader Service #133

FREE SHIPPING!

ON ALL U.S. ORDERS OVER \$50. VIA UPS GROUND WITH COUPON.

**F
E
A
T
U
R
E
D
P
R
O
D
U
C
T
S**

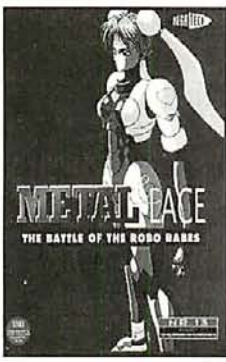

METAL & LACE
By Megatech
In the 21st century, staged fighting has become a lucrative profession for female hardbodies. But the real money comes from the illegal bouts held outside the city. It's dream babes in heavy armor battling for prize money. Action packed, arcade style fun for your PC. But be warned Metal and Lace is for mature audiences only.
\$34. R Rated
\$39. Mature

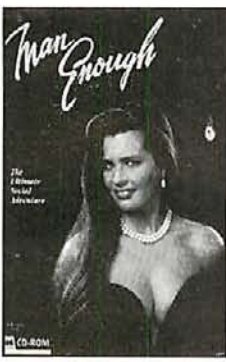

MAN ENOUGH CD
by Accolade
If you want a shot at the ultimate date, you'll have to earn it. Jeri's the kind of woman every man dreams about but she demands more from a man than a clever line. If you're going to date Jeri, you'll have to pass her test. She has five girlfriends. You'll like all of them. The question is, will they like you?
\$50.



AXIS GAMECHEATER
by Baseline Software
Be Immortal in all of your favorite computer games. AXIS The Gamecheater is the world's first game utility that will allow you to cheat at your favorite games. With AXIS, you can override predefined game functions with assignable hot keys. You can add time, lives, money, extra ammo or fuel, or whatever it takes for you to win.
\$43.



BRIDGE FOR WINDOWS
by Meadowlark Software
Great bidding and extensive help available make Bridge for Windows the ideal choice for any bridge player seeking to bid and play better. We have tested Meadowlark Bridge with the 128 hands in Ron Klinger's Guide to Better Bridge. Meadowlark Bridge reached the recommended contract on 104 of the hands. Microbridge Companion reached 62 correctly bid hands, Grand Slam Bridge II correctly bid 57. Can play over thirty conventions with a detailed explanation of each convention. Many, many more features!
\$52.



SCISSORS N STONES CD ROM
by Pixis Interactive
Beautiful women engage you in an all or nothing, head-to-head competition of high stakes, the stakes are not for money but rather for articles of clothing. Your goal is to make your opponents bare all without having to expose yourself.
Scissors N Stones is the first interactive erotic game that features full motion video merged with 3D generated animation that adds an extra dimension of realism, never before available. Includes, Realistic 3D walk through sequences, Full person point-of-view, Addictive game-play, multiple opponents. **\$99.**



ADULT SAMPLER CD ROM
By New Machine
This super hot CD Rom Sampler contains tasty tidbits from the most popular adult CD Roms available. This includes clips from the following: Night Watch, J. Stephen Hicks picture disks, Seymore Butts, Dream Machine, Legends Night Trips, Secrets, Hidden Obsessions, Dirty Dancing, Future Sex Magazine.
\$14.

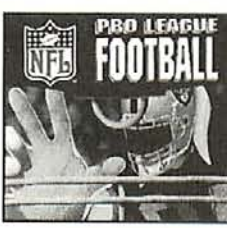

PRO LEAGUE FOOTBALL
by Micro Sports
Play by yourself or with friends and travel the road to the Super Bowl. Season replays in less than 20 minutes. True modem play with Chat mode. 5 years of teams in their official NFL home and away Jerseys. Create your own league or use preset leagues with NFL schedules from the last 30 years. Choose 198 preset plays or design your own. Computer determines playoff schedule using NFL tie-breaking procedures.
\$37.

LOCAL GIRLS
By Pacific Data
Volume #1 in the local girl series. Shot in Hawaii. Over 1000 pictures of girls on the beach, on the stage and in the bedroom.
\$39.



Also available:
Exotic Girls \$39.
Hawaii Girls \$39.
Tropical Girls \$39.

IBM DISK GAMES

A.T.P.: Flight Commander	37
Aces of Pacific:WW2 1946	22
Aces of the Deep	43
Aces of the Pacific	47
Aces Over Europe	43
AD&D Al Qadim Genie's Curse	45
AD&D Dungeon Hack	40
AD&D Fantasy Empire	40
Adventures of Willie Bemish 2	43
After Dark Screen Saver DOS	35
Air Dual Flight Simulator	42
Air Warrior	37
Airport & Facilities Directory	20
Ambush at Sorinor	40
Animation Studio Windows	79
Archon Ultra	40
Armored Fist	45
Ashes of Empire	37
Axis The GameCheater	43
Baseball Windows	43
Beat the House	32
Betrayal at Kronidor	43
Blood Net	43
Bloodstone	30
Bodyworks 3.0	43
Bram Stoker's Dracula	37
Brix	24
Caesar	37
Carrier Strike	43
Carriers at War	43
Carriers at War 2	43
Chess Maniac 5 PC	45
ChessMaster 4000 Windows	37
Civilization	47
Civilization Windows	54
Clash of Steel	43
Classic Funpack for Windows	20
Coaster	20
Cobra Mission	47
Cohort II	22
Comanche Bundle	45
Comanche Mission Disk 1	28
Comanche Mission Disk 2	35
Command Advent. Starship	43
Companions of Xanth	37
Conquer Windows	43
Conquered Kingdoms	37
Conquered Kingdoms Data 1	27
Cuckoo Zoo	33
Cyber Race	34
Daemongate	43
Dark Sun Shattered Lands	52
Delta V	43
Detroit	37
Discovery:Steps of Columbus	37
Dominion	40
Doom	47
Dragon Knight 3	43
Dune 2: Building of a Dynasty	37
Dyno Quest	27
Eagle Eye Mysteries	34
Eagle Eye Mysteries London	35
Earth Invasion Windows	27
Eight Ball Deluxe	32
Empire Deluxe	37
Empire Dix. Scenario Builder	22
Empire Deluxe Windows	37
Eric the Unready	37
Eternam	37
Eye of Beholder 1,2,3 Bundle	52
Eye of the Beholder 3	37
Falcon 3.0	50
Falcon 3.0 Mig 29	37
Falcon Fighting Tiger	30
Fatty Bear Birthday Surprise	35
Fatty Bear's Fun Pack	24
Flashback	35
Fleet Defender F-14 Tomcat	50
Flight Light	22
Flight Sim Toolkit	57
Forgotten Castle Awakening	50
Front Pg. Sports Football Pro	47
Gabriel Knight	43
Gary Grigsby's Pacific War	47
Gary Grigsby's War in Russia	47
Gateway 2	37
Geekwad Games of Galaxy	25
Gizmos & Gadgets	37
Global Domination	37
Goblins 3	27
Grand Slam Bridge 2	33
Great Naval Bat Admiral's Pk	54
Hardball 3	37
Hardball 3 Stadium Disk	19
Hardball III Players Disk	19
Harpoon 2	45
Harpoon 2 Battle#2 WESTPAC	30
Harpoon 2 Scenario Editor	30
Head Coach Football Windows	27
Heirs to the Throne	37
High Command	47
Hong Kong Mahjong Pro	33
Hoyle's Book of Games 3	32
Incredible Toons	32
IndyCar Racing	42
Isle of the Dead	37
Italy Scenery Disk	52
Jagged Alliance	47
Jeopardy Alex Windows	27
Jump Jet	43
Kasparov's Gambit	39
Kid Pix	37
King's Quest 6	47
King's Quest 7	47
King's Ransom	37
King's Table	47
Kronolog The Nazi Paradox	23
Krusty's Super Funhouse	32
Lands of Lore	37
Leasure Suit Larry 6	43
Legacy Realm of Terror	43
Legend Kyrandia 2 Hand Fate	40
Leisure Suit Larry 5	27
Links 386 Pro	42
Links Course Banff Springs	22
Links Course Pebble Beach	29
Lost in Time	37
Lucky's Casino	40
Masters of Orion	45
Matinee Screen Saver	32
Meadowlark Bridge Windows	59
Metal and Lace	34
Metal and Lace Upgrade	5
Microsoft Arcade Windows	34
Microsoft Flight Sim. 5.0	49
MM 2 Day of Tentacle	40
MM4: Clouds of Xeen	43
MM4: Dark Side of Xeen	45
More Incredible Machine	32
More Vegas Games Windows	22
Mortal Kombat	40
NanoTank Windows	30
New York Scenery Disk	34
NFL Coaches Club Football	43
NHL Hockey '94	43
Out of This World	37
Pacific Strike	50
Pacific Strike Speech Pack	22
Paris Scenery Disk	34
Perfect General	37
Perfect General Bundle	37
Peter Pan Story Painting	35
Pinball Dreams	32
Pirates Gold	43
Police Quest 4	43
Power Game Bundle 2	32
Powerboating Simulator III	49
Prince of Persia 2	45
Privateer	25
Privateer Mission Disk 1	25
Privateer Speech Pack	22
Pro League Football	37
Putt Putt Goes to the Moon	35

Putt Putt Joins the Parade	33
Putt Putt's Fun Pack	25
Quarterpole	35
Quest Glory 4 Shad Darkness	43
Quest for Glory III	43
Railroad Tycoon Classic	22
Railroad Tycoon Deluxe	43
Real Weather Pilot	27
Realms of Arkania	37
Red Baron	43
Red Crystal	37
Return to Zork	47
Rules of Engagement 2	43
Sailing Simulator III VGA	49
Sam & Max Hit The Road	37
San Francisco Scenery Disk	32
Scenery Enhancement Editor	27
Scenery Grand Canyon	22
Scenery Tokyo Japan	22
Sea Team	40
Shadwaster	45
Sharif on Bridge	32
Shuttle Space Flight	35
Siege Walls of Rome	40
Silent Service 2 Classic	22
Silverball	34
Sim Ant	37
Sim Ant Windows	37
Sim City 2000	43
Sim City Classic DOS	27
Sim City Windows	37
Sim Earth Windows	37
Sim Farm	35
Sim Life	32
Simon the Sorcerer	34
Slater & Charlie Go Camping	32
Smokin' Gun Windows	30
Solitaire's Journey	37
Space Quest 5	37
Spectre VR	37
Speed Racer Challenging Racer X37	37
Spoils of War 5.25	29
SSN-21 Seawolf	45
Star Reach	37
Star Trek Judgement Rights	37
Star Wars Chess	45
Stonekeep	47
Street Fighter II	37
Strike Command Mission 1	22
Strike Comm Speech Pack	20
Strike Squad	40
Strip Poker Professional	35
Stronghold	40
Super Tetris Windows	35
SVGA Harrier	52
Syndicate	37
Syndicate American Revolt	25
T2 Arcade Game	30
Take a Break Pinball Windows	32
Terminator 2029	43
Terminator 2029 Op Scour	22
Terminator Rampage	43
Tetris Classic	32

C D R O M C E N T R A L

7th Guest	54	Global Explorer	89	Protostar War on Frontier	43	US History	34	Southern Beauties	44
AD&D Dungeon Hack	37	Goblins 2	35	Putt Putt Goes to the Moon	47	USA East/West/ATP	62	Storm 1, 2, 3 or 4	69
AD&D Fantasy Empires	45	Goblins	35	Putt Putt Joins The Parade	39	USA Wars: Civil War	39	Super Smutware	44
Aegis Guardian of the Fleet	53	Great Naval Battles	54	Putt Putt's Fun Pack	39	USA Wars: Civil War	39	Swimware 1993	39
Alone in the Dark	52	Grollers Encyclopedia 6	79	Rebel Assault	52	Video Cube	43	Tropical Girls	39
Animals	34	Gunship 2000	37	Return of the Phantom	47	Virtual Reality Starter Kit 1	42	Wild Women	44
Arthur's Teacher Trouble	40	Hell Gab	67	Return to Zork	50	Where World Carmen Deluxe	39	Women of Venus	39
Astrology Source	52	House of Games	34	Rodney's Fun Screen	37	Wild Places	29		
B17 & Silent Service Combo	39	Inca	45	Sol-Fi Fantasy	29	Willie Beamish	29		
Barney Bear Goes to Space	29	Intro to Wordperfect 5.2	37	Secret of Monkey Island	29	Windowmaster	32	ADULT INTERACTIVE CD'S	
Basics Electronic Cookbook	39	Iron Helix	62	Shareware 1993 2	39	Windows 1993	34	Adult Movie Almanac	99
Bible Library	39	Jets & Props	44	Shareware 1993	44	Wing Comm & Ultima 6	30	Adventures Seymore Butts	99
Blood Net	50	Just Grandma and Me	37	Shareware Explorer	50	Wing Commander 2 Deluxe	30	Cat and Mouse	69
Blue Force	43	Jutland	53	Shareware Overload 3 Pack	29	Wing Commander Deluxe	30	Combo Cuddles	44
Campaign	40	KGB/CIA World Factbook	40	Shareware Overload	19	WolfPack	45	Digital Dancin'	69
Caddie	47	King's Quest 6 Upgrade	27	Sharif on Bridge	32	World Circuit Grand Prix	45	Doors of Passion	69
Chess Maniac	43	King's Ransom	37	Sherlock Holmes Detective 2	57			Dream Machine	69
ChessMaster 3000	29	Kings Quest 6	47	Sherlock Holmes Detective I	32	ADULT CD ROM (21+ TO ORDER)		L.A. Strippers	69
Gomanche	62	Kings Quest V	43	Sherlock Holmes III	49	101 Sexual Postions 1 OR 2	69	Night Watch	69
Conspiracy	47	Labyrinth of Time	52	Shuttle Flight Simulator	34	Adult Palate Vol. 1 or Vol. 2	69	Paradise Club	69
Creepy Crawflies	49	Lawnmower Man	37	Sleeping Beauty	35	Adult Sampler	14	Scissors N Stones	99
Cute & Cuddles	45	Learn Fly Fishing	37	Small Blue Planet	59	American Girls	39		
Cyber Race	45	Library Europ & American Art	57	Software Vault: Games		Animation Fantasies 1 or 2	69	ADULT CD'S (MOVIES)	
Daemonsgate	34	Library of the Future	49	Collection	34	Busty Babes 2	44	After Dark Trilogy	69
Dark Sun Shattered Lands	54	Loom	34	Software Vault: Gold	34	Creme De Le Crema	44	Betrayal	69
Dracula Unleashed	52	Lord of the Rings	47	Software Windows Collection	34	Cyborgasm (Voice Only)	29	Busting Out	69
Dragon's Lair	40	Lost in Time	45	Space Quest 4	29	Digital Dreams	44	Cafe Flesh	44
Dune	59	Lost Treasures of Infocom 2	47	Space Quest 4	43	Exotic Girls	39	College Girls	44
Encyclopedia of Clip Art	34	Lost Treasures of Infocom 4	47	Sports Illustrated Almanac	39	Girls In Vivid 2	69	Debbie Does Dallas	44
Eric the Unready	37	Mad Dog McCree	42	Star Trek 25th Anniversary	60	Girls of J. Stephen Hicks II	29	Deep Throat	69
European Racer's	47	Majestic Places	29	Star Trek Collectibles	47	Girls of Mardi Gras	44	Devil & Miss Jones	44
Eye of Beholder 1,2,3 Bundle	54	Mammals National Geo.	29	Star Wars Chess	45	Girls, Girls, Girls, Girls	44	Hidden Obsessions	69
Eye of the Beholder 3	32	Mantis: Experimental	47	Strike Commander	58	Hawaii Girls	39	Insatiable	44
F117A/F15 Strike 2	40	Mayo Clinic	43	Terrorist Group Profiles	44	High Volume Nudes	39	Legends of Porn II	44
F15 Strike Eagle 3	59	Mayo Clinic Total Heart	40	The Journeyman Project	47	Hot Pix 2, 3 or 4	44	Moving Fantasies	44
Family Doctor	35	Mitsumi Double Speed Drive 245	245	The Tortoise & The Hare	40	Island Girls 3 in 1	39	New Wave Hookers II	44
Fate of Atlantis	42	Mixed up Mother Goose	24	The Tiegler	43	Kama Sutra	69	Night Trips	69
Fatty Bear's Birthday Surpr.	45	MM 2 Day of Tentacle	45	Timetable Science & Innov.	39	King Dong	59	Princess of Persia	44
Fatty Bear's Fun Pack	30	North American Indians	44	Tony LaRussa 2	54	Local Girls 2	44	Rimfire Pacific	69
Fingers for Windows	30	Oregon Trail	40	Tony LaRussa 2	54	Local Girls	39	Secrets	69
Fractal Ecstasy	45	Our Solar System	22	Tornado	45	Men Who Love Women	44	Traci I Love You	44
Gabriel Knight	50	Phoenix 3.0	15	Total Baseball '93 Ed.	49	Mystique of Orient	59	Visual Fantasies	69
Geekwad Games of the Galaxy 25	25	PhoneDisc Residential USA	59	U.S. Presidents	39	PC Pix Vol. 1, 2 or 3	69	Wicked	69
Gifs Galore	22	Private Eye Mysteries	45	Ultima Under/Wing Comm 2	60	Smutware	44		
				US Atlas & Autopam	57	So Much Stareware	69		

The Blue and The Gray	43	Ultima Underworld II	52	SOUNDCARDS	
The Elder Scrolls The Arena	43	Ultima VII Silver Seed	22	Ad Lib Gold 1000	79
The Great War 1914-18	47	Ultima VIII Pagan	52	Digital Edge CD ROM Kit	695
The Merchant Prince	40	Ultima VIII Speech Pack	22	Discovery CD 16 bit Internal	595
Third Reich	37	Undersea Adventure	37	Edutainment 16 Internal	595
Tom Landry Football Deluxe	32	Uninvited Windows	40	Pro Audio Spectrum 16	189
Tony Larussa Baseball 2	40	Unlimited Adventures	37	Sound Blaster 16	138
Tornado	52	Unnatural Selection	35	Sound Blaster 16 ASP	219
Tower	43	USA East Scenery Disk	43	Sound Blaster Deluxe	79
U.S. Atlas for Windows	54	V. Victory 4: Gold Juno Sword	43	Sound Blaster Pro Deluxe	122
Ultima 7: Forge of Virtue	22	Victory at Sea	45	Sound Blaster Pro MCA	258
Ultima 7: The Serpent Isle	50	Victory Pak	47	Sound Galaxy NX Pro 16	159
Ultima Pt 1: Stygian Abyss	25	Video Jam	35	Sound Machine Sound Kit	99
		Warlords 2	43	Soundman 16	129
		Warriors of Legend	22	UltraSound	129
		Washington Scenery	34	Voice Blaster	72
		WC 2 & Speech Pak	27	Wave Blaster	190
		WC 2 Special Ops 1&2	27		
		When Two Worlds War	37		
		Where in Space Carmen	43		
		Where in the World Deluxe	48		
		Winball Windows	30		
		Wing Commander & Ultima 6	39		
		Wing Commander Academy	35		
		Wing Commander Deluxe Ed	50		
		Wizardry Trilogy 2	37		
		World Circuit Grand Prix	37		
		WW II Battles of South Pacific	37		
		X-Wing MD 2 B Wing	22		
		X-Wing	42		
		X-Wing Mission Disk 1	22		

JOYSTICKS	
ACM Game Card	35
Analog Plus	27
Flight Control Pro	115
Flight Control System	69
Flight Control Yoke	69
Flight Stick	39
Flight Stick Pro	65
Formula 11	129
G Force Yoke	59
Gameport III Automatic	34
Mach I	17
PC Command Control	19
PC Gamepad	23
Rudder Pedals	115
Virtual Pilot	65
Weapons Controller Mark 2	99

Mitsumi Double Speed CD Rom Drive. High Performance Operation, 250 ms access time, powered tray loading, double shell dust-sealed mechanism.	
On Sale! \$235.00	

Bachelor Pad \$16.
Major League Baseball
Mouse Mat All 28 Teams \$12

Get the facts via FaxBack...
Call 201.676.7454 from your fax machine. Receive information on new releases, Adult CD rom, specials, and more.
24 HOURS A DAY • 7 DAYS A WEEK

Our New *Mission Control Communique* is here!
Order our color catalogue filled with new items, CD Rom, Adult CD Rom, Discount Coupons, Complete Listings and more! FREE with your order, otherwise send \$2.00. (Outside of US and Canada send \$5.00)



MISSION CONTROL

FREE SHIPPING
On All US Orders over \$50 via UPS Ground
Simply send in coupon with your order!
Offer expires 02/28/94

Methods of Payment
We accept Visa, MC, Discover Card & Money orders. Personal checks allow 14 days to clear. School, State & City purchase orders accepted.

Shipping
UPS Ground (\$5 minimum)/UPS Blue (\$7 minimum); APO & FPO (\$7 minimum); Overseas minimum \$30 shipping (please fax orders) Send money orders or checks to:

MISSION CONTROL
551 Valley Road, Suite 211
Dept. CGW0294
Upper Montclair, NJ 07043
Overseas & Military Orders given special attention!

The Last Dictator

Grabbing The Global Reins In *Global Domination*

by Chuck Moss

Underneath our civilized veneer, underneath our day-to-day submissiveness to demands of family, job, and country, we strategy gamers all possess a common drive: we want to rule the world. Fortunately for family, job, and country, we have lots of socially acceptable outlets for this lust to conquest.

The most recent outlet for our will to power is *Global Domination* from Impressions. Part of a full-court press of Impressions game releases, *Global Domination* attempts to be

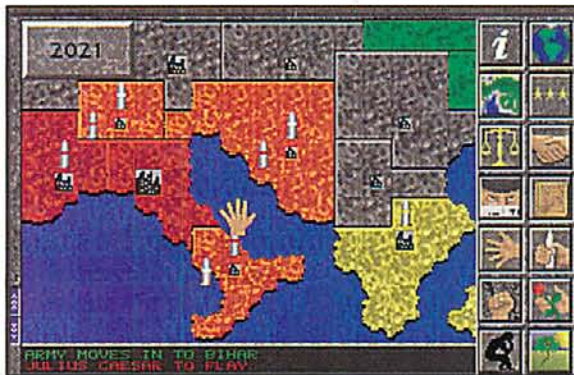

both a grand-strategic game à la *Command HQ* and a tactical game in the *Dune II* or *Perfect General* mode. The resulting game is at once both a failure and a surprising success.

Global Domination is actually a successor of sorts to an earlier Impressions conquest game called *The Final Conflict*. *The Final Conflict* attempted to marry logistics, strategy, economics, and the arcade-style action that Euro-audiences seem to love. It flopped miserably, myself being one of the perhaps five yanks who actually bought and played it. *Global Domination* has narrowed its scope and concentrated on two areas: a simple strategic world conquest game and a detailed tactical simulation for the action-oriented conqueror.

The game allows five human or computer players to slug it out for world dominion, either on our world or a randomly generated one. The computer players have personalities chosen from a list of nine historical worthies—from Queen Victoria and Abe Lincoln to Gengis Khan, Henry V, and a drooling Caveman for novices. (Bismarck stands in for Adolf Hitler—the documentation shows Der

Fuhrer's puss, but political sensitivity, or just plain common sense, prevailed.) The personalities resemble characters in *Sid Meier's Civilization*: each favors his or her own strategy and trustworthiness level, but their graphic depictions pale against those of Sid's Civ.

The strategic game runs just fine, albeit slowly, on an old 286, but getting the most of the tactical game requires a 386. The "learning curve" of the game can hardly be called a curve at all: you boot it up, you make some mistakes in the first game or two, and you're ready to conquer the world. The documentation is adequate, and the game's icon-driven menus are largely self-explanatory. The manual has a little tutorial exercise that explains everything you need to know.

The interface is mouse-driven, with menu buttons selected by a pointing finger cursor. While the graphics are sharp and clear, one longs for the ability to select some of the more common commands via keyboard. Many operations must be done repeatedly, and constant clicking of the same buttons gets tiresome.

The global map is clear and sharp and very colorful. Split up into territories with different "cities" or point levels for each province, the world begins just like the old board game *Risk*, with players holding a few regions amidst a lot of unclaimed space. Indeed, the strategic game is very reminiscent of *Risk*, with players taking turns, spending income on armies, attacking, garrisoning and defending.

Each turn represents a month and is not divided into phases. You can perform any action in any order you choose. Typically, one goes to the logistics screen, buys armies, places them, moves, attacks, and conducts covert operations. Typical turns last 10 to 15 minutes.

Purchasing armies is not a totally abstract exercise as in *Risk*. Players assemble forces of different components—from in-

fantry and light armor to strike aircraft and air mobile troops. There are six settings for forces, and you can tweak your units around, adding or subtracting as cash flow merits. This "unit mix" seems irrelevant from the strategic purview, but is actually vital to the tactical game.

Movement logistics are handled very abstractly. You buy "movement points" and use the mouse to manipulate a little hand to pick up your armies—shown as bullets of varying sizes—and place them somewhere else. If the new territory is unoccupied, it changes to the attacker's color. If defended, a conflict ensues that can rage for months. Sea movement is handled through fleet points—and little ships that sail *very* slowly between continents. There is no naval combat.

One non-*Risk* wrinkle is the addition of covert operations. You can purchase intelligence points that enable you to spy on other players, learn about force compositions, leadership qualities, and offer alliances and pacts. It also allows you to build "special forces" that try to "destabilize" (i.e. drive mad) other leaders, buy loyalty, and incite territories to revolt.

Revolution is an integral part of the game, as a territory in revolt changes color to a vivid purple and cannot be invaded or traversed for an indeterminate—usually lengthy—period of time. Indeed, fomenting revolution is the best way to tie your enemy up in knots. The revolution command is a little fist, and one of the game's most amusing features is sailing your fist above the world, capriciously dropping down to cause trouble. Like those two young reprobates on MTV would say: "Heh, heh—revolution is cool!"



Global Domination

GLOBAL DOMINATION

The Ultimate Multi-Player Conquest Simulation
Impressions

TITLE: Global Domination
PRICE: \$59.95
SYSTEM: IBM
REQUIREMENTS: 286 or higher (386-16MHz recommended), VGA graphics, 8MB hard drive space, mouse; supports Ad lib (Gold), Aria, Roland, Sound Blaster sound cards
PROTECTION: None
DESIGNER: David Lester
PUBLISHER: Impressions
Cambridge, MA 02142
(203) 676-9002

USED IBM GAMES
COMPLETE & VIRUS FREE
WITH THE ORIGINAL BOX,
DOCUMENTATION AND DISKS

4D BOXING	7
688 ATTACK SUB	10
7TH QUEST - CD	37
A-TRAIN	21
A.T.A.C.	19
A10 TANK KILLER 1.5	19
ABC BOXING	13
ABC MONDAY NIGHT FB	9
ACES OF THE PACIFIC	21
ACTION SPORTS SOCCER	11
ACTION STATIONS	15
ADV OF WILLY BEAMISH	16
AIR BUCKS	15
AIR BUCKS VBR 1.2	19
AIR FORCE COMMANDER	11
ALL AMERICAN COLLEGE	17
ALONE IN THE DARK	24
ALTERED DESTINY	22
AMAZON	21
AMBUSH	19
ANCIENT ART WAR - SEA	11
ANCIENT ART WAR - SKY	15
APBA FOOTBALL	17
ARE WE THERE YET?	11
ARMADA 2525	16
ARMOUR ALLEY	8
B.A.T.	4
B17 FLYING FORTRESS	19
BAD BLOOD	13
BALANCE OF POWER 1990	9
BALANCE OF THE PLANE	13
BARO'S TALE 1	7
BARO'S TALE 2	10
BARO'S TALE 3	19
BARO'S TALE CONST SET	13
BATTLE CHESS	9
BATTLE CHESS - CD	26
BATTLE ISLE	14
BATTLES OF DESTINY	22
BATTLETECH 1	5
BATTLETECH 2	9
BETRAYAL AT KRONDOR	29
BIG BUSINESS	7
BLITZKRIEG ARDENNES	13
BLOODSTONE	27
BLOODWYCH	9
BLUE ANGELS	9
BLUE FORCE/NEXT OF KIN	25
BO JACKSON BASEBALL	9
BRAIN BLASTER	6
BREACH 2	6
BREACH 2 SCEN DISK	8
BUCK ROGERS 1	5
BUZZ ALDRIN RACE INT	28
CAESAR	26
CAESARS PALACE	6
CAMPAIGN	17
CAR DRIVER	21
CARRIER COMMAND	21
CARRIER STRIKE	21
CARRIERS AT WAR	13
CASTLE DR BRAIN - VGA	11
CASTLE 2	19
CASTLES-ARTHRN CMPN	5
CENTERION DINDR ROME	9
CHALLENGE OF 5 REALM	21
CHAMBER SCI MUT PRST	12
CHAMPIONS OF KRYNN	9
CHESSMASTER 3000 WIN	19
CIVILIZATION	24
CLASH OF STEEL	29
CLUE MASTER DETECTIV	9
COASTER	15
CODE NAME: ICEMAN	6
COLONEL'S BEQUEST	10
COMMAND HQ	9
CONAN	9
CONFLICT: KOREA	7
CONFLICT: MIDDLE EAST	8
CONQUERED KINGDOMS	25
CONQUESTS OF JAPAN	19
CONQUESTS OF LONGBO	15
CONTINUUM	12
CORPORATION	8
COUNTDOWN	12
COVERT ACTION	6
CRACK DOWN	6
CRIBBAGE GIN KING	19
CRIME WAVE	13
CRISIS IN THE KREMLIN	15
CRUISE FOR A CORPSE	14
CURSE OF AZURE BONDS	9
CYBER EMPIRES	14
CYBERGENIC RANGER	4
DAGGER OF AMMON RA	24
DARK CENTURY	18
DARK QUEEN OF KRYNN	15
DARK SUN	29
DARKLANDS	29
DARKLANDS MASTER ED	29
DARKSEED	18
DARKSPYRE	9
DAVID WOLF: SECRET AG	10
DAY OF THE VIPER	4
DEATH WU 2 LOST IN LV	7
DEATH KNIGHT OF KRYN	14
DICK TRACY	7
DON'T GO ALONE	3
DOUBLE DRAGON 2	3
DRAGON FORCE	8
DRAGON LORD	6
DRAGON WARS	6
DRAGONS OF FLAME	5
DRAKKHEN	8
DUNE	10
DUNE 2	30
DUSK OF THE GODS	12
EARTHRAISE	4
ELVIRA 1	16
ELVIRA 2	21
EPIC	13

ERIC THE UNREADY	17
ESCAPE FROM HELL	7
ETERNAM	16
EYE OF THE BEHOLDER	9
EYE OF BEHOLDER 2	16
EYE OF BEHOLDER 3	19
EYE OF BEHOLDER 3-CD	35
F-117A STEALTH FIGHTER	24
F15 STRIKE EAGLE 2	11
F15 STRIKE EAGLE 3	32
F19 STEALTH FIGHTER	9
FALCON 3 SCEN FIGHTR	16
FALCON 3.0	32
FALCON AT	11
FANTASY EMPIRE	26
FIGHTING FOR ROME	6
FINAL CONFLICT	9
FIRETEAM 2200	7
FLAMES OF FREEDOM	8
FLASHBACK	22
FLIGHT OF INTRUDER	8
FLIGHT PLANNER	16
FLIGHT SIM AIRCRAFT	9
FLIGHT SIMULATOR 4.0	18
FLIGHT SIMULATOR 5.0	32
FLOOR 13	10
FOUNTAIN OF DREAMS	5
FOUR CRYSTALS TRAZER	12
FREDDY PHARKAS FRTR	27
FREE DC	5
FRONT PAGE FOOTBALL	23

HOYLE'S BK GAMES VOL 3	16
HUMANS	7
HUNT RED OCTOBER	14
HYPERSPEED	8
IMMORTAL	11
INCA	19
INCREDIBLE MACHINE VGA	18
INDIANAPOLIS 500	24
INDY JONES FATE ATLA	11
INDY JONES: LAST CRUS	16
ISHIDO	9
ISLAND OF DR BRAIN VGA	19
JACK NICKLAUS GRIST 18	32
JACK NICKLAUS SE CRS	6
JACK NICKLAUS UNIL GOLF	6
JAMES ROND STEALTH	9
JET FIGHTER 2 MISSION	9
JET FIGHTER 2.0	26
JET MONTANA FOOTBALL	14
JUMP JET	26
JUST GRANDMA & ME-CD	25
KEYS TO MARAMON	9
KGB	11
KILLING CLOUD	13
KING'S QUEST 4 - EGA	13
KING'S QUEST 5 - VGA	12
KING'S QUEST 6 - VGA	23
KNIGHTS OF THE SKY	12
KOSHAN CONSPIRACY	21
KRISTAL	4

MERCHANT COLONY	8
MICHAEL JORDAN FLT SIM	25
MICKEY'S 123'S	17
MICKEY'S ABC'S	8
MICKEY'S JIGSAW PUZZLE	17
MIDWINTER	5
MIG 29 FLURUM	19
MIGHT & MAGIC 1	8
MIGHT & MAGIC 2	7
MIGHT & MAGIC 3	8
MIGHT & MAGIC 4	26
MIGHT & MAGIC 5	32
MIKE DITKA FOOTBALL	11
MILLENNIUM	4
MINES OF TITAN	5
MISSION: IMPOSSIBLE	5
ML BASEBALL 4 USA 1	9
ML BASEBALL GM/OWNER	10
ML BASEBALL MANAGERS	4
ML FOOTBALL 2	9
ML FOOTBALL DELUXE	26
MONKEY ISLAND 2	21
MONKEY ISLAND VGA	16
MOONBASE	10
MURDER	19
NASCAR CHALLENGE	14
NFL COACH'S CLUB	25
NFL FOOTBALL	9
NFL PRO LEAGUE FB '91	12
NFL PRO LEAGUE FB '92	16
NIGHTBREED	9

RIDERS OF ROHAN	12
RISE OF DRAGON-VGA	19
ROAD & TRACK GRAN PR	24
ROAD TO FINAL FOUR	23
ROBOSPORT - WIN	21
ROCKETEER	18
ROMANCE 3 KINGDOMS	14
ROMANCE 3 KINGDOMS 2	19
ROME: PATHWAY TO POW	19
ROMMEL AT N. AFRICA	12
RULES OF ENGAGEMENT	6
RULES OF ENGAGEMENT 2	24
S.C. OUF	12
S.AVAGE EMPIRE	19
TANK	12
SEA DOGUE	11
SEAL TEAM	29
SEARCH FOR THE KING	10
SECOND FRONT	12
SECRET OF SILVER BLADE	6
SECRET WEAPONS LUFTW	19
SENTINEL WORLDS	4
SHADOW GASTER	35
SHADOW OF YSERBIUS	25
SHADOW PRESIDENT	18
SHADOW SORCERER	6
SHADOWGATE - WIN	22
SHADOWLANDS	17
SHERLOCK HOLMES -CD	24
SHUTTLE	15
SIERGE	8

STREET FIGHTER 2	22
STREET ROD 2	9
STRIKE ACES	13
STRIKE COMMANDER	28
STRIKE COMMANDER SP	10
STUNT DRIVER	10
STUNT DRIVER	24
STUNTS	10
SUMMONING	11
SUPER OFF ROAD	8
SUPER TRUIS	17
SWORD OF ARAGON	13
SYNDICATE	26
TANGLED TALES	19
TANK	12
TASK FORCE 1942	12
TEAM YAAJEE	15
TEENAGE MNT ARCADE	11
TEENAGE MNT MANH MIS	19
TEGEL'S MERCENARIES	13
TERMINATOR	22
TERMINATOR 2029	24
TEST DRIVE 2	15
TEST DRIVE 3	19
TEST DRIVE 3:ROAD&CAR	9
THE PROPHECY	21
THEATRE OF WAR	8
THEIR FINEST HOUR	14
THEXDER 1	10
THUNDER HAWK	6
THUNDERSTRIKE	18
TIME QUEST	6
TIMES OF LORE	11
TOM LANDRY FOOTBALL	11
TONY LARUSSA BB	13
TONY LARUSSA ULT BB	6
TOP GUN DANGER ZONE	10
TORNADO	30
TRACON	10
TRACON 2	15
TREASURE TRAP	7
TREASURES SAVAGE FR	9
TRILOGY	10
TRISTAN PINBALL	9
TUNNELS & TROLLS	6
TWILIGHT 2000 - VGA	16
TYPHOON OF STEEL	6
ULTIMA 4 - QUEST AVAT	15
ULTIMA 5 WARRIORS DE	19
ULTIMA 6 FALCK PROPH	11
ULTIMA 7 BLACK GATE	29
ULTIMA 7 FORGE OF VIRT	14
ULTIMA 7.5 SERPENT ISLE	29
ULTIMA 7.5 SILVER SE	16
ULTIMA TRILLOGY 1	15
ULTIMA TRILLOGY 2	16
ULTIMA UNDERWORLD 1	27
ULTIMA UNDERWORLD 2	26
ULTRABOTS SANCTION E	28
UMS 2	23
UNCHARTED WATERS	6
UNDER FIRE	21
UNLIMITED ADVENTURES	8
UTOPIA	21
V VICTORY: UTAH BEACH	14
VEIL OF DARKNESS	29
VENGEANCE OF EXCALIB	25
VIKING CHILD	8
VISIONS OF AFTERMATH	16
WACKY FUNSTERS	13
WAR IN MIDDLE EARTH	14
WAR IN THE FALKLANDS	6
WAR IN THE GULF	13
WARLORDS	6
WARLORDS 2	31
WATERLOO	8
WAXWORKS	16
WC 2 SPEC OPERATION 1	15
WC 2 SPEC OPERATION 2	15
WC 2 SPEECH PACK	8
WC SECRET MISSION 1	5
WC SECRET MISSION 2	5
WCULTIMA 6 - CD	32
WEAVER BASEBALL 2	9
WEAVER COMMISSIONERS	7
WEAVER MLBPA PLS ST	4
WESTERN FRONT	15
WHEN TWO WORLDS WR	28
WHERE IN WORLD GSD	10
WHERE IN WORLD GSD-CD	29
WING COMMANDER 1	9
WING COMMANDER 2	26
WING COMM ACADEMY	26
WIZARDY 4	11
WIZARDY 5	15
WIZARDY 6-COSMIC FOR	15
WIZARDY 7-CRUSADERS	29
WOLFENSTEIN 3D	16
WOLFPACK	9
WONDERLAND	24
WORLD CIRCUIT	9
WORLDS AT WAR	9
X-WING	29
X-WING B WING	15
X-WING IMPERIAL PURS	15
XIPHOS	6
YEAGER'S AFT	4
YEAGER'S AIR COMBAT	16
CD-ROM Games	CALL

GAMER'S GOLD

WE PAY CASH FOR USED GAMES

We want your current used games

1-800-377-8578

call for authorization before shipping or
FAX list for current quotes to 605-334-8766

In Canada, call 605-339-2060

WE SELL USED GAMES

All games are tested & IBM disks virus checked

games are in original box with original documentation

Call for current title availability

WE ACCEPT
VISA/MasterCard/Discover

Most items shipped same day. \$5 UPS/\$7 2nd Day Air

GAMER'S GOLD • 1008 W. 41st Street • Sioux Falls • South Dakota • 57105

WE'RE BUYING!

IBM & MAC GAMES

Got Something To Sell?
Follow these Easy Steps

1. Prepare a list of the games you are selling. Specify IBM or MAC. Call, fax, or mail your list to **GAMER'S GOLD.**
2. **GAMER'S GOLD** will quote the current buying prices & issue an authorization number for your shipment. Games will not be accepted without an authorization no. Price quotes are good for 14 days.
3. Pack games in box. Write authorization no. clearly on outside of box. Mail to **GAMER'S GOLD.**
4. If you would like to use your money or credit to purchase games, include a "wish list" of titles you are interested in.
5. Your check will usually be mailed within 5-7 working days of receiving your games.

Games will be checked for viruses & completeness. Games must be complete with all disks, printed materials, & in original box. Incomplete games will be returned at your expense.

FRONT PAGE FB PRO	29
FULL METAL PLANET	9
FUTURE WARS	5
GARY GRIGSBY PACIFIC	29
GATEWAY	11
GATEWAY 2: HOMEWORLD	29
GATEWAY SAVAGE FRTR	19
GENGHIS KHAN	19
GHOSTS & GOBLINS	5
GLOBAL CONQUEST	19
GLOBAL EFFECT	9
GOBLIINS 2 - VGA	19
GOBLIINS - VGA	14
GODFATHER	18
GOLD OF AZTECS	9
GOLD OF THE AMERICAS	9
GRAIL QUEST	9
GRANDSLAM BRIDGE	7
GREAT NAVAL BATTLES	20
GREAT NAVAL BATT - CD	33
GREAT NA AMERICA ATL	12
GREAT NB SUPER SHIPS	12
GREENS	22
G GRIGSBY'S PAC WAR	29
GUNBOAT	5
GUNSHIP	5
GUNSHIP 2000 SCEN DSK	16
GUNSHIP 2000 VGA	19
HALLS OF MONTEZUMA	16
HARD NOVA	9
HARDBALL 3	19
HARDBALL 3 PLAYERS D	8
HARDBALL 3 STADIUM D	8
HARPOON	14
HARPOON DESIGNER SER	10
HARPOON EDITOR	14
HARRIER ASSAULT	25
HEART OF CHINA - VGA	10
HEAVEN & EARTH	12
HEAVY METAL	13
HEROES OF THE 357TH	11
HEROES OF THE LANCE	9
HIGH COMMAND	29
HILLSFAR	9
HOOK	15
HOVERFORCE	20
HOYLE'S BK GAMES VOL 1	12
HOYLE'S BK GAMES VOL 2	12

L'EMPEREUR	19
LAKERS VS CELTICS	8
"LAND SEA AIR TRILOGY"	9
LANDS OF LORE	29
LASER SQUAD	19
LEATHER GODDESSES 2	24
LEGACY:REALM OF TERR	17
LEGEND OF FAERGHAIL	25
LEGEND OF KYRANDIA	23
LEMMINGS OF VALOR	15
LEMMINGS	15
LEMMINGS 2	21
LEXICROSS	12
LHX ATTACK CHOPPER	6
LIGHTSPEED	5
LINE IN THE SAND	9
LINKS 386 PRO	26
LINKS GOLF	16
LORD OF THE RINGS 2	19
LOST ADVENTURE ENHANCE2	22
LOST FILES SHERLOCK	21
LOST IN LA	15
LOST PATROL	4
MADDEN FOOTBALL 1	15
MADDEN FOOTBALL 2	5
MAGELSTRUM	25
MAGIC CANDLE 1	9
MAGIC CANDLE 3	14
MAGIC-JOHNSON MVP	9
MANHOLE	5
MANHUNTER SE	18
MANTIS EXP FIGHTER-VGA	16
MANTIS EXP SPEECH PA	12
MARTIAN DREAMS	15
MARTIAN MEMORANDUM	13
MATRIX CUBED	5
MAXIMUM OVERKILL	32
MAXIMUM OVERKILL MISS	15
MEAN STREETS	5
MECHWARRIOR	13
MEDIAVAL LORDS	7
MEDIAVAL WARRIORS	3
MEGAFORTRESS	8
MEGAFORTRESS MISS DK	8
MEGATRAVELLER 1 ZHOD	4
MEGATRAVELLER 2	7
MEGATRAVELLER 3	26

NO GREATER GLORY	18
NOVA 9 VGA	16
OBITUUS	16
OIL'S WELL	8
OPERATION COMBAT	8
OUT OF THIS WORLD	19
PALADIN 2	22
PAPERBOY 2	13
PATRIOT	23
PERFECT GENERAL	6
PGA TOUR GOLF TOURN	23
PIRATES	4
PLANET'S EDGE	19
PLAYMAKER FOOTBALL	9
POLICE QUEST 1 - VGA	9
POLICE QUEST 3 - VGA	9
POLICE QUEST 4	35
POOL OF RADIANCE	10
PPOOLS OF DARKNESS	19
POPULOUS	8
POPULOUS 2	21
POWER HITS: MOVIES	13
POWER HITS: SCI / FI	16
POWER HITS: SPORTS	13
POWERHITS: BATTELEC	21
POWERMONGER	19
PRINCE OF PERSIA	12
PRINCE OF PERSIA 2	25
PRIVATEER	35
PRO LEAGUE BASEBALL	12
PROPHECY 1	5
PROPHECY OF SHADOW	5
PROTOSTAR	26
PSYCHIC WAR	6
QUEST FOR GLORY 1-EGA	6
QUEST FOR GLORY 1-VGA	12
QUEST FOR GLORY 2-EGA	12
QUEST FOR GLORY3-VGA	19
RAILROAD TYCOON	32
RAILROAD TYCOON 2	14
RAMPART	9
REALMS	11
REALMS OF ARKANIAN	29
RED LIGHTNING	5
RETURN OF PHANTOM	25
RETURN TO ZORK	29
REVOLUTION '76	9
REX NEBULAR COS GEN	22

SIERGE EXP-DOGS OF WAR	8
SIERRA ADV BUNDLE	24
SIERRA FAMILY FUN PK	19
SILENT SERVICE 2	12
SILPHEED	14
SIM CITY	17
SIM CITY GRAPHICS SET 1	10
SIM CITY GRAPHICS SET 2	12
SIM CITY TERRAIN EDIT	10

So...you buy armies, attack, try to beat the other guys, and stir up mischief at home. Is that all? Not by a long shot. *Global Domination* has a detailed tactical game, called "satellite battles." Briefly, those units you buy in the logistics screen are placed on a detailed map of varying terrain, and you must either attack or defend certain objectives like headquarters, airfields and supply depots.

You have mouse-driven command of your units, which can vary from one infantry soldier to fleets of tanks, helicopters and jets. Command is much like *Dune II* and *The Perfect General*, with individual units selected and objectives chosen. The graphics and sounds of this portion of the game are stunning.

However, the tactical game does not measure up to the standard of the other games mentioned. The command system is clunky, lacking the fluidity and ease of the other games' controls. The command options are too few to efficiently handle large numbers of units. I spent too much time fighting the interface and watching those beautiful jets and tanks go somewhere else than ordered, or miss the target by one "square" because the

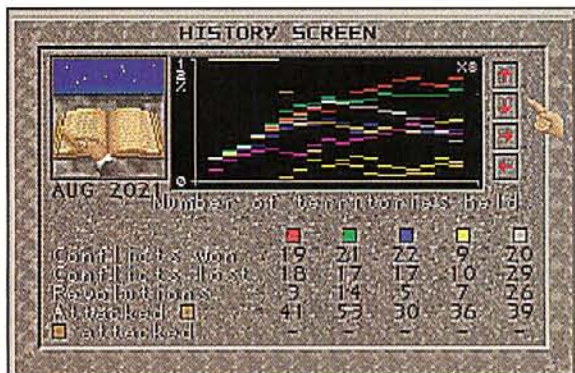

prey moved. Also, it's very slow on low-end (286/386) machines.

In short, the tactical game, while visually gorgeous, is simply not up to current standards. After a couple of tedious battles, I longed for the quick, easy, resolution of the strategic game. The other bells and whistles—conflict watching, physical maps—add little to the game and remind one of *Final Conflict's* Euro-style chrome. So the much-ballyhooed tactical simulation is, in my opinion, not quite enough. Maybe in arcade-mad Europe, it would work, but the US market has segmented this type of game and dealt with it in a far more detailed fashion.

So take away the tactical wargame and what's left? A simple, workmanlike, interme-

diante-level, conquer-the-world game that's surprisingly enjoyable and addictive. Imagine a jazzed-up *Risk* with computer players and nasty revolution! *Global Domination* neatly fills the niche between simple games like *Risk* and more involved products like *Command H.Q.* and *Empire Deluxe*.

While the game does come with a modem feature, attempts to tele-play floundered on slow conflict resolution, which may have been due to my buddy's slow machine. However, *Global Domination* makes a great solitaire game. I lost much sleep and marital accord ("I know it's 1:30 but I'm besieging New Jersey!"). It's fast, fun, and sneaky. It is not too complicated, but neither is it overly simple-minded. Replay value? All I can say is that this article was delayed by frequent "fact checks" that took up to four hours each!

So give *Global Domination* an unexpected thumbs up. Its ambitious challenge to *The Perfect General* falls flat, but what's left makes a perfect addition to the global conqueror's hard drive. It's a pleasant and entertaining little game allowing you to match wits with history's greatest warlords and sweep them before you like digitized chaff. Now, if you'll excuse me...I've got to drive Napoleon out of Africa. **CGW**

Precision analog joystick with an unsurpassed 5-year limited warranty. Compatible with all flight simulation software, including Microsoft Flight Simulator 5.0.

Announcing O.T.C.

When that enemy MIG is bearing down on you, HUNT and PECK are not the first two responses that come to mind. If you agree, consider the advanced Thunderstick with OTC—One Touch Command. Touch a button to look left. Release it and you're automatically looking forward into your heads-up display. A single touch could select a weapon, target, and fire all at once. Eight dual-programmable buttons on the front panel let you replace multiple keystrokes with One Touch Commands. Comes with a selection of predefined command sets. A simple display lets you set up your own to suit your aircraft or mission parameters.

For over 30 years, Kraft has delivered Speed, Power, and Control to earth-bound pilots. When it's time for reflex responsive flight, reach for the Thunderstick with One Touch Command. We wouldn't give you the power if we didn't think you could handle it.

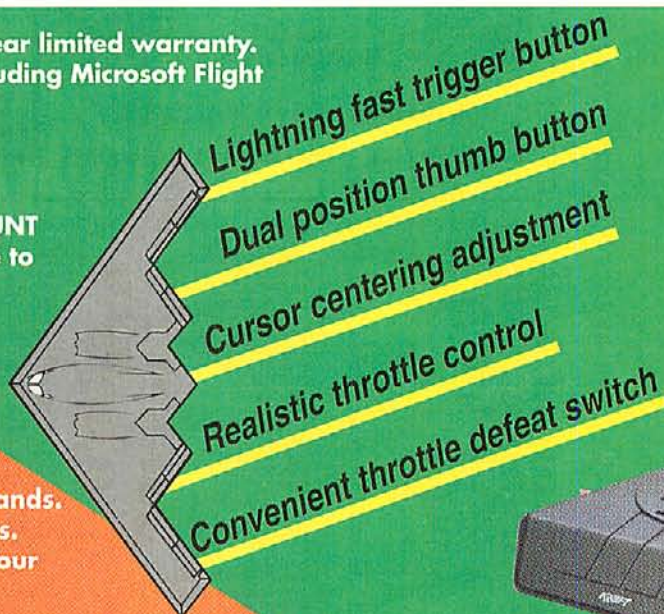

KRAFT

THUNDERSTICK®



Kraft Systems, Inc. ♦ 450 W. California Ave. ♦ Vista, CA 92083 ♦ Tel: (619) 724-7146 ♦ Fax: (619) 941-1770

Brian Vodnik's Kingdoms of Germany™

Available in
Stores NOW!

The BEST Medieval Strategy Game Series made. Period.

Features

- 1-6 Players, 196 Territories
- 7 Troop types and catapults
- 5 Difficulty levels with handicapping
- Control of up to 20 armies and 5 flotillas per kingdom, 5 Castle types
- Toggle each kingdom between human, computer, and off
- Resource management of food, wood, stone, iron
- Beautifully HAND-DRAWN graphics
- Huge 832 X 711 pixel map that you actually play on!
- Simple point and click interface to an intricate and detailed game

New Additions

- Artificial intelligence (AI) that makes extremely tough computer opponents at the higher difficulty levels (even tough enough to beat the game designer, Brian Vodnik!)
- Quickmove™ and Double Quickmove™ which greatly speeds up the computer's turn
- Quick and easy food shortage/crop increase notification for faster turns
- Quick siege
- Dispatch/Gather troops to or from castle garrisons to adjacent territories
- Immediate/Delayed catapult construction option
- End of turn checking for movable armies



Available NOW!



REDUCED!!

Actual IBM Screen Shots



Call or send \$4.00 for a 7-turn playable demo or download it FREE from our BBS @ (708) 545-1410 and get hooked!

Save \$20 off of the list price of \$59.95 and get Kingdoms of Germany™ for only \$39.95 + \$3.50 S&H

Reduced! Get Vikings™ for only \$29.95 + \$3.50 S&H. Registered users can upgrade to Vikings™ Enhanced for \$10. Call for Details. Buy Vikings™ and Kingdoms of Germany™ for \$64.95 + 3.50 S&H and get the Vikings™ Enhanced upgrade (a \$10.00 value) FREE! Check, Money Order, and Visa/Mastercard accepted. Call Realism Entertainment™ for more details on all offers at (708) 595-7487.

Realism
Entertainment™
The video game perfectionists... details, details, details™

Vikings™ is available for Amiga and IBM.
Kingdoms of Germany™ available for IBM.
Coming soon for Color Macintosh.
Realism Entertainment™
6N522 Pine Street
Bensenville, IL 60106
(708) 595-7487



VIKINGS™, Fields of Conquest™
Kingdoms of Germany™ and
TRUE 32-BIT™, are trademarks of
Realism Entertainment™

© 1993 Realism Entertainment™
All Rights Reserved Worldwide.

Opponents Wanted

Those wishing to place their own free ads need only send us a postcard (or use the Notes section of the RID card), letter, FAX [714-283-3444] or E-Mail (Prodigy [EXPT40B], CompuServe [76703,622], The Sierra Network at Box 1048, GENie and America On-Line [CGW]). Generally, we run them only once, so send another each time if you want to keep your name listed! The ads themselves should serve as reasonable examples as to how to write your own. However,

- Include a brief description of the types of opponents and games you are interested in playing. Games being played other than direct by modem can be listed (trading save game disks or even face-to-face).
- At least one (possibly more) telephone number(s) must be included. *Do not forget the area code* and mention whether they are Home, Work or Modem numbers.
- Include your city and state so that people who call you will both: a) have a clue as to what time zone you are in and b) recognize it when they see it on their phone bill.

The Networks

The following are voice contact numbers for many of the various on-line network services that connect gamers. Call them for more information on these networks.

America On-Line: (800) 827-6364

CompuServe Information Service: (800) 848-8990

Novalink (formally Digital Dreams) Network: (800) 274-2814

GENie: (800) 638-9636

The ImagiNation Network: (800) IMAGIN-1

Multi-Player Games Network: (800) GET-GAME

National Videotex (NVtel): (800) 336-9096

Prodigy: (800) 822-6922 x556

USA Today Sports Network: (800) 826-9688

Bulletin Board Systems

Wargamers unite! Looking for an opponent for *War in Russia*, *Empire Deluxe*, *Falcon 3.0* or others? Look no more! Cybersystems BBS has an Opponents Wanted and wargame discussion message bases. Sysop moderated wargames, tournaments and more. Large *War in Russia* tournament in progress. Play FT, swap saved games, play-by-modem. 24 hours a day, hassle free! Funning Sychronet, 3 Gigs, 3 Lines, 30+ on-line games. Settings: 8-N-1, 2400/9600/38.4 (USR Duals). No fee. Call (908) 654-1290.

The Dakota Central Telenet BBS in Carrington, ND (58421) is a BBS with many challenging on-line games and over 30,000 files available to download free of charge. On-line games include the massive *Land of Devastation* post-nuclear war RPG with an available EGA graphic user interface, plus you can battle other traders and aliens in *TradeWars 2002* (tournaments start frequently). Explore with your character in the combat-happy RPG *Wizard's Arena*, and make big booms with others like *Nuke War* and *Naval Battle*. Trivia and card games are also on-line. Huge games file area. Free access, with a small fee for total access. 3 nodes; 300-14,400 Baud, 8-N-1. Call (701) 674-8115, 24 hours a day, 7 days a week.

The Informer BBS under SYSOP John Custer is running flight sim updates, Cracks, flight sim conferences. This is the home of SIMNET, the flight sim network of the 510 Tactical Fighter Wing (sponsors of SIM CON 93). We also have a direct link to Thrustmaster tech support and many pilots to answer your questions. (415) 468-6713, 6714 or 6715.

Call Little Caesar's Nightclub at (416) 238-8238. All wargamers should check out message base #13 for discussions on computer wargaming. Find an opponent or leave a review. All computer platforms welcome.

The Elfspire Tome is a Fantasy Role-Playing Game Master's resource bulletin board. We feature role-playing echoes, on-line games, fantasy clip art and much more. 1200-9600 Baud. (415) 595-2387.

The Electronic Estates BBS in Oak Lawn, IL invites you to join their *Tradewars 2002*, *Global War* and *Chess* games. Many files available for download, Netmail, instant access and more. "A world class, American BBS" (pmc 11/93). Call (708) 424-6136.

Will you hack and slash your way through a real-time, multi-user dungeon (MUD) or attempt to conquer an entire galaxy? It's your choice when you call The Batboard BBS in Columbia, MO. Enjoy the true AD&D action of *Legends* and the professional e-mail game *VGA Planets* (with an off-line VGA interface) or tackle over 30 other on-line challenges, including *ANSI Pro Football*, *Chat Roulette*, *BandWars*, role-playing, strategy, trivia and casino games. Prizes awarded for highest monthly scores, with full access on your first call (and it's free)! Two CD-ROMs on-line, with the latest in quality shareware games! FidoNet echoes (including GAMING), multiline chat, the adult role-playing game *Wild Side* — visit today for the best in multiline diversions! We're always open 24 hours at (314) 446-0475 with 14400 bps supported.

The Delphic Oracle is an all-gaming BBS. Play RPGs (*AD&D*, *GURPS*), play-by-email games (*Diplomacy*, *ASL*), *Empires at War* (a Napoleonic on-line game) and other games on-line. Find modem game players. Gamemasters and players wanted. Simi Valley, California (805) 582-9004 [2400 8-N-1] Free access.

The Gaming Connection BBS in Everett, WA specializes in connecting modem-to-modem players. Give it a call at (206) 742-4044, twenty-four hours a day. Join a Gaming Ladder and make new friends to challenge. *Empire Deluxe* and *Harpoon* scenarios, plus access to everything (including over 5,000 files) available on your first call!

The Ho-Down BBS wants you to "test your metal" in multi-player games of *Spaceward*, *Ho! Are you tired of beating 19 smart computer players in a small galaxy? Want a real challenge? Try competing against the most deadly, devious, dastardly, dangerous, diabolical, double-crossing dealers of death and destruction this side of Deneb. In other words, against players just like you! Call with modem set at 8-N-1, up to 14400 bps. (206) 577-8868.*

The Imperium BBS is looking for modem gamers like you! Tournaments are run for *Knights of the Sky*, *Command HQ*, *The Perfect General* and *Global Conquest* (just to name a few!). We have on-line games, message base and 3 gigs of files, too. Call one of our three nodes in Middleton, NJ at either: 1200/2400 (908) 706-0342; 9600 v.32 (908) 706-0305; HST Dual Standard 38.4 (908) 706-0321.

The Mac Commonwealth BBS in metro New Orleans, LA is sponsored by the National Home & School Mac User Group, a nonprofit organization promoting leisure and learning on the Mac. Our multi-line system features over 1 gigabyte of downloadable files, with emphasis on games and educational material. On-line magazines, Usenet newsgroups, OneNet conferences and Internet e-mail. Support file sections for over 60 commercial games! FirstClass graphic user interface. All lines support 1200 - v.32bis 14,400 access. For information on BBS and group activities, send inquiries to NHSMUG, P.O. Box 640641, Kenner, LA 70064. BBS line 1: (504) 837-7984.

By Area Code

Grognaards, unite! Rather mature gamer (who confesses to remembering initial release of Avalon Hill's *Gettysburg*) is stranded in the wilderness of LaGrange Park, IL and wants to find other wargamers familiar with *Aide de Camp*. Hopefully, we can play some *Flat Top*—electronic, double-blind. Also looking for a good, long session of *Grigsby's Pacific War* to play by file transfer (I'm not only willing, but *eager* to be the next Nagumo). Byron Inglesh, CompuServe [73322,203].

Miami, FL player throws down his gauntlet to anyone who challenges him in a game of *Battlechess* (either disk or CD-ROM). If you have a network with Internet access, respond at CJHM22A@PRODIGY.COM or call Stephen Hertz at H-(305) 448-8425.

Seeking local opponents for modem gaming. Will play *The Perfect General*, *F-15 III* and many others. Call me in Syracuse, NY at H-(315) 622-2204. Ask for Jerry any time between 8am and 10pm.

Looking for a local opponent to meet for face-to-face game of *Clash of Steel*, *Warlords II* or other board and computer wargames. I'm in Harford County, MD. Call Josh at H-(410) 939-1021.

Opponents sought for *Empire Deluxe*, *Conquered Kingdoms*, *The Perfect General* and *Global Conquest*. Will also play other modem capable games (I have a PPI 14.4 modem). I can't afford long distance, but will consider PC Pursuit. Contact Gene Goolby between 12pm and 10pm any day at H-(410) 923-6188 in Anne Arundel County, MD.

Local modem opponent wanted for almost any flight sim or *Robosport*. Call Al (The Cheesy) at H-(415) 593-1989 in the San Francisco bay area.

Wanted in the San Francisco area: Head-to-head *Falcon 3.02.1/IMiG 29.1.01* players. Will also play *F-15 III/Tornado*. I can play at speeds up to 14400 Baud and am a member of the 510 Tactical Fighter Wing. All challengers welcome. Call H-(415) 468-2021.

Local (Contra Costa County, CA) modem opponents wanted for *Falcon 3.01* (or allied) and *The Perfect General*. Contact Joseph "Joe Cruise" in Concord, CA at H-(510) 827-0283 anytime. Beginners are more than welcome! I have lots of free time, so if you are interested in another game, or want to play face-to-face in any game of your choice, please call.

Seeking local opponents for *Command HQ*, *688 Attack Sub*, *The Perfect General* or any other game of your choice. Please, call David in the Vancouver/Lower Mainland area and let's do battle. Phone me at H-(604) 264-7998.

Brigadier General "Shifty" Pierre challenges you to battle in *The Perfect General*. The battle "Stuck in the Middle Again," short game, partial sighting, random hit. It doesn't matter where you live, I have PC Pursuit and I'll phone you. Or, what about a war for control of the planet in *Empire Deluxe*? CGW Tournament rules, Wrap on. I live near Chicago. Voice: H-(708) 479-4344; BBS: (815) 886-0109.

Local opponents sought for *The Perfect General*, *Falcon 3.02* and other games in the NYC area. Contact Lorenzo "Wren" Lamberty at H-(718) 597-3588 anytime after 4pm.

Seeking opponents for modem play in the Colorado Springs, CO area. I would love to play *The Perfect General*, *Empire Deluxe*, *Modem Wars*, *Knights of the Sky* or anything you've got a hankering to lose at (hehehe). Contact Steven Woodcock at either of the following: H-(719) 392-2975 or by email via the InterNet at: swoococ@oldcolo.com

Local opponents wanted for *Falcon*, *F-15 III* or *Tornado*. Call Rod in Memphis, TN at H-(901) 527-8764 or W-(901) 525-2557.

Opponents wanted in the Longview, TX area for *Conquered Kingdoms* by modem. I am also interested in any type of modem strategy game. Call Bill Anderson at H-(903) 663-2120.

Looking for PBEM opponents for *Second Front*, *Carrier Strike* or just about any other wargame. Contact Ernest Calridge in the Toronto area after 6pm at H-(905) 238-8238.

Mediocre *Empire Deluxe* player seeks same for modem or e-mail contest. Ask for Johnny at H-(909) 676-7251. **CGW**

ADVERTISERS' INDEX

RS#	ADVERTISER	PAGE	RS#	ADVERTISER	PAGE	RS#	ADVERTISER	PAGE
31	3DI Productions	129	71	High Tech Expressions	27	108	Papyrus Publishing	99
32	7th Level	171	147	Humongous Adventure	165	109	Promethius	153
33	Accolade	97	148	Humongous Adventure	167	113	QQP	73
34	Accoustic Research	98	50	Imagination Network	17	115	QQP	80
35	Advanced Digital Sys.	139	72	Impressions	3	116	QQP	81
36	AI Tech Internation	219	73	Impressions	5	114	OOP	155
37	Aldealabs	198	74	Inner Circle Technology	65	17	Quality Computers	150
38	Apogee Software	61	75	Innerprise Software	185	118	Readysoft	135
39	Bare Bones Software	132	76	Interplay	63	119	Readysoft	141
40	Baseline Publishing	133	77	Keyboard Commander	48	120	Readysoft	217
41	Bethesda Softworks	78	78	Koei	199	121	Realism	209
42	Bethesda Softworks	79	79	Kraft Systems Inc.	208	122	REM Software	198
45	CH Products	53	80	Lance Haffner Games	190	123	SDJ Enterprises	132
44	Cape Cod Connection	196	81	Logitech	177	124	Sideline Software	160
46	Chips & Bits	83	84	Mallard	41	125	Sierra On-Line	101
46	Chips & Bits	85	83	Maxis Software	39	126	Sigma Designs	21
46	Chips & Bits	87	84	Maxis Software	41	127	Sir Tec Software	9
46	Chips & Bits	89	150	Mediavision	157	128	Software Express	189
46	Chips & Bits	91	85	Mediavision	181	129	Software Toolworks	187
46	Chips & Bits	93	86	Mediavision	183	130	Spectrum Electronics	150
47	Colorado Spectrum	154	88	Mega Tech	113	132	Spectrum HoloByte	30-31
48	Colorado Spectrum	178	151	Mega Tech	159	131	Spectrum HoloByte	44-45
49	Compsult	190	89	Merit Software	69	*	Strategic Simulations	203
51	Computer Express	109	90	Microform	151	134	Suncom Technology	38
149	Computer Express	172-173	91	Microform	213	135	Thrustmaster Inc.	60
52	Computer Sys. Solutions	122	92	MicroLeague	191	136	Time Warner I. Group	111
53	Creative Labs, Inc.	71	93	MicroLeague	215	137	Tsunami	55
55	Disk-Count Software	123	94	MicroProse Software	35	138	Tsunami	117
56	Domark	227	95	MicroProse Software	49	139	Tsunami	119
58	Dongleware Publishing	137	96	Midian Software	90	140	Tsunami	121
57	Dongleware Publishing	175	97	Midnight Games	122	141	Twin Dolphin Games	145
60	Electronic Arts	125	98	Mindcraft	75	142	Velocity Development	179
59	Electronic Arts	102-103	99	Mindcraft	77	144	Viking Software	161
61	Entertainment Internat'l.	193	100	Mission Control	204-205	143	Virgin Games	142-143
62	Falcon Northwest	7	101	National Videotext	195	145	Virgin Games	147
63	Flagship Magazine	116	102	Nawru Triad Inc.	158	146	Zero's and One's	197
64	Formgen	2	103	Nova Logic	12			
65	Future Vision	163	104	Nova Logic	13			
66	GE Information System	37	*	Ocean of America	57			
67	Gamer's Gold	207	*	Ocean of America	59			
68	Genovation	51	106	Origin Systems	105			
69	Gosselin Comp. Consult.	160	105	Origin Systems	228			
*	HPS Simulations	201	107	Paper Mayhem	136			

* No Reader Service number. Please call advertiser for information.

Taking A PEEK

A quick look at titles now appearing on a store shelf near you.

Activision
11601 Wilshire Blvd.
Los Angeles, CA 90025
(800) 477-3650

SIMON THE SORCERER: Begin with a spellbook and a large cauldron. Fill it with swamp water; mix in a dash of *Altered Destiny*; and add a smidgen of *Legend of Kyrandia*. Then, blend in a large portion of *The Secret of Monkey Island* topped off with a just a hint of *Waxworks* and mix well. The result? *Simon the Sorcerer*, a wacky, tongue-in-cheek interactive fantasy with an attitude about an adolescent destined to save a magical dimension from the archetypal evil wizard. With humor closely resembling that of LucasArts' *Monkey Island*, this tale of a dimension-crossing boy and his dog features a rich world of tasty puzzles designed to test the wits of the most astute adventurer while keeping the humor dial turned up to the max. IBM (\$49.95). Circle Reader Service #1.

Apple Computer, Inc.
20525 Mariani Ave.
Cupertino, CA 95014
(800) 708 STAR

WACKY JACKS: Not quite live, from Cupertino, it's Don Pardo! Yes, the voice of *Saturday Night Live* provides the vocal counterpoint for this simple multimedia game show. Up to four players switch back and forth in the "hot seat" in front of the computer in order to play games similar to Concentration, Hangman, Tic-Tac-Toe, and scrambled pocket puzzles. All of the games draw from a large library of pictures from around the world and feature the vocal stylings of the golden-throated Pardo. Though the CD access time means occasional "dead air," which would horrify the legendary TV announcer, *Wacky Jacks'* three difficulty levels make it easy for families to play the games together. Macintosh CD-ROM (\$39.95). Circle Reader Service #2.

Bethesda Softworks
PO Box 7877
Gaithersburg, MD 20898-7877
(301) 963-2002

THE TERMINATOR: RAMPAGE: Just when you thought it was safe to hang up your



Simon the Sorcerer



Wacky Jacks



The Terminator: Rampage



The Magic Death

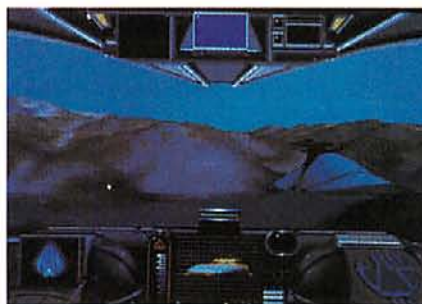

CyberRace

M-30 Grenade Launcher, SKYNET reappears. It seems that prior to its destruction SKYNET sent a core dump of all its vital data back to 1984, housed in a specially modified T-800 Terminator. The result: SKYNET became fully functional much sooner than planned and used the knowledge of its future destruction in an alternate timeline to bring about the annihilation of mankind before the resistance could be formed. Fortunately, just enough resistance fighters survived the timeline shift to send a resistance commando into the past to defeat SKYNET. The player, of course, becomes said commando. With enhanced features over the previous *Terminator* release, *Terminator Rampage* offers a look similar to id Software's *Doom*, though the gameplay doesn't compare. Action, regardless of difficulty, is intense. The faint of heart need not apply. IBM (\$69.95). Circle Reader Service #3.

Creative Multimedia
514 NW 11th Ave., Suite 203
Portland, OR 97209
(503) 241-1530

THE MAGIC DEATH: Digital detectives in search of murders to solve may want to investigate this new offering from Creative Multimedia. Bearing strong resemblance to Viacom's *Sherlock Holmes* titles and built on the engine of CMC's earlier *Who Killed Sam Rupert?*, *The Magic Death* brings criminology into the 90s with more technology-based means of aiding the sleuth in determining the culprit(s) involved in a crime. Blood tests, fabric analysis, autopsies and the like are now at your disposal. Examine the crime scene, question the suspects, check your sources, review the evidence, verify alibis and hold your press conference. Watch your time, though; you only have six hours of game time in which to solve the case. IBM CD-ROM with Windows-ROM (\$49.99). Circle Reader Service #4.

Cyberdreams, Inc.
21243 Ventura Blvd., Suite 230
Woodland Hills, CA 91364
(818) 348-4560

CYBERRACE: Designed by the renowned futurist Syd Mead (*Blade Runner*, *Tron*, *2010*, *Star Trek: The Motion Picture*), *CyberRace* brings futuristic 3D combat and racing to the PC. A front runner in concept, *CyberRace* also benefits from improvements in VOXEL graphics that allow Cyberdreams to render detailed landscapes at amazingly fast speeds. Though some role-playing elements fill the intermediary scenes between race segments, game play is primarily action intensive. Most playing time is spent in the CyberSled, jockeying for position and eliminating your opponents. Certainly, having the talents of Syd Mead in the development of the storyline is



THE ULTIMATE
CD DISK
FOR
VIDEO GAMES

SUPER
ARCADE
Games

Incredible Graphics, Super Sound Effects & Fast Action ! These are only some of the features that you will find on this CD ! Each game has been carefully selected as one of the best in it's category. Have hours of fun with Super Arcade Games. Some of the games included are: GOTCHA, HELUS, KEN'S LABYRINTH, XERIX, LLAMATRON, MAJOR STRYKER, DEFENDER, MEGATRON, VGA LEAPER, GATEWORLD, PROTEC HEAVY WATER JOGGER, STELLAR DEFENSE FLUX STARFIRE JETPACK 3D CATABOMBS SEA QUEST

SPECIAL OFFER

\$29.00

OVER 150 OF THE LATEST GAMES !

ALL UNDER AN EASY TO USE MENU SYSTEM

SOLD AT BETTER COMPUTER STORES

For support call 416 - 656 - 6406

To order direct call 1-800-465-CDCD



Microforum

Circle Reader Service #91

ALL TO RECEIVE A FREE CATALOG OF ALL THE MICROFORUM TITLES

the strength behind *CyberRace*, and the story itself may actually eclipse game play. Nonetheless, it appears that *CyberRace* will find a strong appeal among sci-fi fans and racing enthusiasts. IBM and IBM CD-ROM (\$69.95). Circle Reader Service #5.

Dynamic Dimensions Development, Inc.
512 Main St., Suite 1014
Ft. Worth, TX 76102
(817) 336-1105

MORPHMAN: THE CHALLENGE OF THE QUEAXMAR EXPERIMENTS! Look! Up in the sky! It's a bird. It's a plane. Actually, it's both. It's Morphman! Combining 3D animations with Microsoft's *Video for Windows*, *Morphman* provides an interesting concept, but generally lacks more than minimal interaction. As superhero Morphman, you must rescue Professor Roberts from a group of evil military scientists who have kidnapped and imprisoned him in their fortress. Using your wits and molecular sampler, you must infiltrate and destroy the structure, freeing the professor in the process. Under normal use, your molecular sampler allows you to "sample" creatures you meet and alter your molecular structure to match them (like a fish, bat, etc.). Used in reverse, the sampler becomes a powerful energy weapon. Unfortunately, the interaction seems rather too limited for those attuned to more traditional quests. IBM CD-ROM with Windows (\$49.95). Circle Reader Service #6.

Frogman Software
PO Box 144506
Miami, FL 33114-9776
(305) 567-1363

LETHAL TENDER: Remember when your mother told you not to put money in your mouth because you didn't know where it had been? In *Lethal Tender*, Frogman's version of a *Wolfenstein 3D* game, Nick Hunter infiltrates a secret underground manufacturing plant where the criminal mastermind, Thorne Devereaux, is producing a high explosive called PAID (Particle Accelerated Incendiary Device). The plan is to impregnate coins with PAID; hence, creating millions of monetary time bombs jingling in peoples' pockets all across America. When the protective coating wears off—BOOM! Hunter's task, of course, is to foil Devereaux's plans by destroying his operation. *Lethal Tender* is not exactly in the same league with *Wolfenstein 3D*, but it is a good value for its low retail price. With ten action-filled levels to explore, *Lethal Tender* offers a full clip of excitement for the money. IBM (\$14.95). Circle Reader Service #7.

TERROR OF THE CATACOMBS: Following on their popular *Catacomb* adventures, Frogman has just shipped their newest title in the series. As the 3D adventure con-



Morphman: The Challenge of the Queaxmar Experiments!

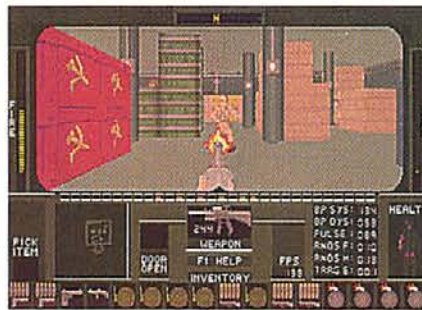

Lethal Tender

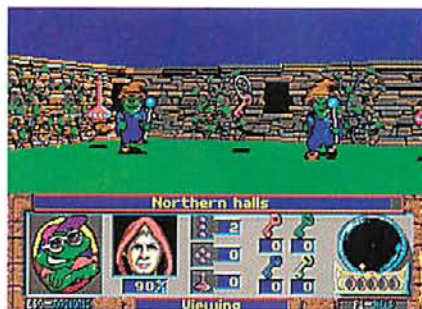

Terror of the Catacombs



Classics Fun Pack for Windows



Doom

tinues, Nemesis once again threatens life as we know it, resulting in your call back to action. Unfortunately, he has gained control of the Time Gates and must be stopped before he can unleash any more high-tech monsters from the distant future or decaying beasts from the ancient past. As it stands, this continuation of the *Catacomb* games looks and plays exactly like the former releases. Unfortunately, this means the graphics are still only 16-color EGA (though VGA and SVGA compatible). Playability is good, almost addictive, and offers bang for the buck in spite of its lackluster visuals. IBM (\$14.95). Circle Reader Service #8

Id Software, Inc.
(800) 434-2637

DOOM: If *Wolfenstein 3-D* kept you happily awake each night, look forward to a delight of insomnia with *Doom*. Instead of nasty Nazis, this time you may gleefully blow away space aliens with a variety of weapons, including rocket launchers, mega-machine guns, and even space-age brass knuckles (with appropriate spikes, of course). The player is a space marine, rooting through the treacherous depths of our local space station for the "Ultimate Evil," which gives the usual level-to-level crash and bash some semblance of a plot. Game controls are similar to *Wolf 3-D*, but also include a strategic map of the space station levels for planning one's Rambo-like assaults. Be sure to have at least a 386SX, but for those wishing the full thrill of carnage, only a 486 will do. Since networking is supported, bring along a friend to share in the visceral delights. *Doom* is a stand-alone product, not requiring *Wolf 3-D*, and the first episode of *Doom* is shareware from Id Software. IBM (Registered version: \$40). Circle Reader Service #9.

Impressions Software, Inc.
222 Third Street, Suite 0234
Cambridge, MA 02142
(203) 676-9002

CLASSICS FUN PACK FOR WINDOWS: This collection of seven Windows games is definitely FUN! *Classics Addiction Pack* might have been a better title for the package. Included are Peg Jump, Code Breaker, Word Search, Puzzle Game, and three solitaire card games. Most need no introduction as they are self-explanatory. All, though, are just as brain teasing as the original table games on which they are based. Those who like a good game of solitaire will surely gravitate to Klondike, Lady Louise or Canfield. Logic lovers will be drawn to Peg Jump and Code Breaker. Gamers with a penchant for word puzzles will find Word Search worthwhile. Whether you have only 15 minutes or hours to play, this little collection of classics is worth the low admission price. IBM

You can play war games or you can make history.

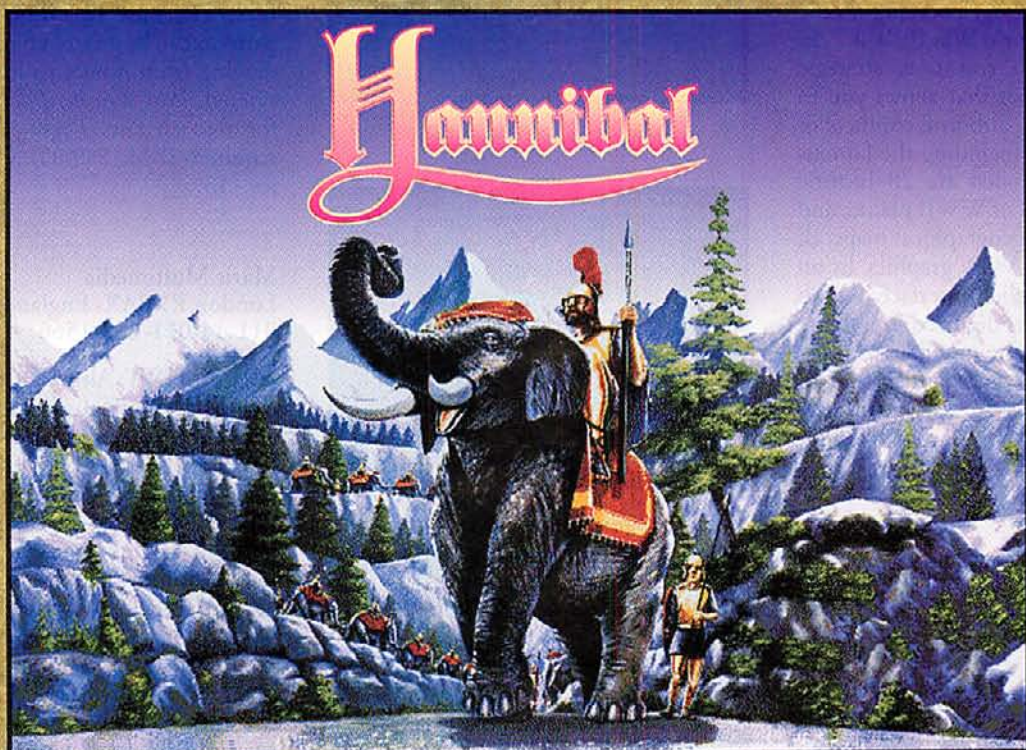

Hannibal takes history out of the books and into your PC. Experience the life and times of one of history's most controversial heroes. You are Hannibal. Think his thoughts, fight his battles, befriend his allies and negotiate his treaties. Do everything as he did, or dare to do more.

- ✦ Based upon the actual history of Roman and Carthagian campaigns.
- ✦ 700 towns, each a possible friend or foe.
- ✦ Go to market to equip your army with horses, ships, mercenaries and elephants.
- ✦ Keep tabs on the political situation: don't raise tax rates too high or you may suffer the consequences.
- ✦ Negotiate peace or siege and destroy to increase your finances.
- ✦ Includes historical survey of Hannibal and his times.



Can you conquer the powerful Roman Empire?

Suggested Retail Price: \$49.95

UPC Code: 037523-84113-1

Format: IBM/PC Compatible

System Requirements: 640K RAM, 286/16mhz or faster, hard drive, DOS 3.3 or higher, VGA, supports SoundBlaster and SoundBlaster compatible, mouse recommended.

Developed by



U.O.P., 201 Bellevue Building
Newark, DE 19702

1-800-334-6572

Published by



with Windows (\$24.95). Circle Reader Service #10.

WW2 AIR FORCE COMMANDER: At the bargain price, one can hardly expect Impressions' second title in their *Air Force Commander* series to be "Their Finest Hour," but it is still worth considering. Focusing on the European theater of World War II, *WW2 Air Force Commander* is a real-time, strategic simulation of air combat that allows you to recreate the large-scale, airborne conflicts of the second world war, including the famous Battle of Britain. Included are 28 historic scenarios, a wide variety of WWII planes, and reasonable selection of geographical maps, all featured in 256-color VGA graphics in an easy-to-use point-and-click interface. AdLib music and Sound Blaster digitized sounds are supported. Owners of the original *Air Force Commander* who have eagerly anticipated an add-on "mission disk" can purchase *WW2AFC* directly for \$9.95, plus \$5 shipping and handling. IBM (\$19.95). Circle Reader Service #11.



WW2 Air Force Commander



Companions of Xanth

Legend Entertainment Company
PO Box 10810
Chantilly, VA 22021-0810
(800) 658-8891

COMPANIONS OF XANTH: Previewed in our July 1993 issue (*CGW* #108), this graphic adventure breaks some new ground for Legend Entertainment. It is their first release to use a parserless, icon-based interface (there is a parser, but it is nearly transparent to the user). Plus, it's a very funny game based on an interesting literary license. When Piers Anthony wrote *A Spell for Chameleon*, the first Xanth novel, he certainly couldn't have expected the number of forthcoming titles it would generate. Even less would he have expected that the competition described in one of those Xanth novels would appear as a computer adventure game. Based on Anthony's novel *Demons Don't Dream*, *Companions of Xanth* offers traditional adventure game puzzles, though it also has some that cannot be solved without the help of the titular Companions. IBM (\$59.95). Circle Reader Service #12.

Mallard Software, Inc.
3207 Justin Rd.
Flower Mound, TX 75028
(214) 539-2575

REAL WEATHER PILOT: Storm clouds are looming on the horizon with the release of Mallard's *Real Weather Pilot*, which generates weather for *Flight Simulator 4* or *5*. Capable of dialing up the DUATS weather reporting system and downloading actual weather reports, *Real Weather Pilot* lets you experience the actual weather conditions between any two U.S. airports. Of course, simulated

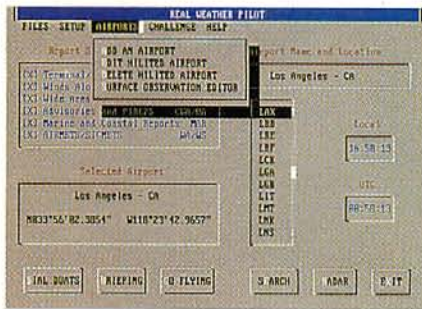

Real Weather Pilot



Red Shift



Multimedia Kaleidosonics

weather conditions are also available. So, you can land at LAX in the middle of a snow storm if flying into L.A. isn't unreal enough for you. Weather reports can be grouped for providing comprehensive preflight briefings and can be printed out for inflight reference. You can also save interesting weather patterns in archive files for later use. In addition, random weather patterns can be generated with difficulty levels ranging from novice to impossible. All considered, *Real Weather Pilot* is a first-class tool for a coach fare. *Flight Simulator 4* or *5* is required. IBM (\$39.95). Circle Reader Service #13.

Maris Multimedia
London E1 8AX, England
011-44-071-488-1566

RED SHIFT: Although it is not a game, *Red Shift* is a powerful astronomy program that allows amateur astronomers to print visibility reports on deep sky objects to determine when and where such phenomena can be observed. One simply selects a location on the map and tells the program to calculate with regard to that location. Then, it's easy to find the Andromeda Galaxy, Horsehead Nebula and a host of comets. There are 250,000 stars and 40,000 deep sky objects catalogued in this program, and the algorithms were executed by scientists from Space Mission Control in Russia. Combined with this astronomy program is a multimedia library of both still pictures and about a half dozen film clips. Macintosh CD-ROM (69£ British plus Value Added Tax). Circle Reader Service #14.

Masque Publishing, Inc.
PO Box 5223
Englewood, CO 80155
(303) 290-9853

MULTIMEDIA KALEIDOSONICS: This interactive art toy combines 38 attractive photographs of natural wonders, from the desert to the mountains to outer space with a jazz/fusion soundtrack. Designer John Ratcliff (*688 Attack Sub*, *Seawolf*) uses a variety of special effects to play with the images, while floating 2-D and 3-D texture wrapped objects like liberated parade floats. Where this program differs from a screen saver is in its endlessly customizable options and relaxing New Age audio. Users may change—and save—2-D and 3-D settings, object movement and rotation, mirroring, warping, background shatters, speed and brightness. Rob Wallace created the soothing 48 minute score for the program in a MIDI studio using his computer. If you want to up the technological ante on nature-scape videos such as those seen in The Nature Company, *Kaleidosonics* may be your cup of tea. IBM CD-ROM (\$24.99). Circle Reader Service #15.

ReadySoft Incorporated & Epicenter Interactive Present

DRAGON'S LAIR[®]

CD-ROM



You're in for the adventure of your life...

Dragon's Lair is back and better than ever on CD-ROM!

This full arcade version is packed with spectacular animation and digitized sound, bringing Dragon's Lair to life like never before!

You control the actions of Dirk the Daring, a valiant knight, on a quest to rescue the fair Princess from the clutches of an evil dragon. Fight your way through the castle of the dark wizard who has enchanted it with treacherous monsters and obstacles.

Lead on brave adventurer... your quest awaits!



also available for
IBM PC & Macintosh



ReadySoft Incorporated
30 Wertheim Court, Suite 2
Richmond Hill, Ontario, Canada L4B 1B9
Tel: (905) 731-4175 Fax: (905) 764-8867

Licensed by Sega Enterprises Ltd. for play on the Sega CD™ system. Sega and Sega CD are trademarks of Sega Enterprises Ltd. ALL RIGHTS RESERVED. 3DO, the 3DO logos, and Interactive Multiplayer are trademarks of The 3DO Company

"REELMAGIC" is a trademark of Sigma Designs, Inc.

"Dragon's Lair" is a registered trademark of Bluth Group, Ltd. ©1993. Character Designs ©1993 Don Bluth. ©1993 all audio, visual and concept - used under the exclusive license of Epicenter Interactive Inc. Programming ©1993 ReadySoft Incorporated. ALL RIGHTS RESERVED

Media Vision Multimedia Publishing
47300 Bayside Parkway
Fremont, CA 94538
(510) 770-8600

CRITICAL PATH: It's Cinemaware Meets Digitized Video when Media Vision, manufacturer of multimedia hardware (read: sound and video cards), enters the multimedia publishing fray with their first interactive action-adventure. In this new CD-ROM title combining motion picture, video game, and computer generated animation elements, Kat, a 24-year-old renegade chopper pilot, must be safely guided through a post-apocalyptic setting with your help. Pursued by mutant thugs and dogged at every turn by an insane dictator, Kat is forced to face one life threatening event after another in an effort to escape her captor's "fortress." During the course of the game, you must anticipate the various threats to Kat's life and help her avoid danger by aiding her from a remote control station. Extensive use of video and sound effects makes the game intense and creates a fast-paced and captivating experience. However, expect a good deal of trial and error in the process of securing Kat's safety. IBM CD-ROM with Windows (\$79.95). Circle Reader Service #16.

Merit Software
13707 Gamma Rd.
Dallas, TX 75244
(800) 238-4277

KRONOLOG: THE NAZI PARADOX: In *Kronolog's* version of history, Germany won World War II through a German monopoly on the atomic bomb. The result of this revisionist past is a plausible future of a world on the brink of ecological disaster. It is now 2020 and America is under the cultural and intellectual chokehold of the Nazi German Empire. To make matters worse, the Nazis have invented a workable time machine. Meanwhile, American society is involved in a surrogate war in the Far East and is on the edge of complete environmental devastation. Some Nazi collaborators and a secret underground movement soon raise the tensions to apocalyptic levels. You are, of course, thrown into this milieu, with your goal being to stop the environmental destruction and bring the Nazi government to its knees. This puzzle-based, icon-operated animated adventure features a more interesting premise than execution. IBM (\$69.95). Circle Reader Service #17.

Microsoft Corporation
One Microsoft Way
Redmond, WA 98052-6399
(206) 882-8080

ISAAC ASIMOV'S THE ULTIMATE ROBOT: One of the first releases in the new *Microsoft HomeLine* is this combination photo gallery, short story library, robot paper doll



Critical Path



Kronolog: The Nazi Paradox

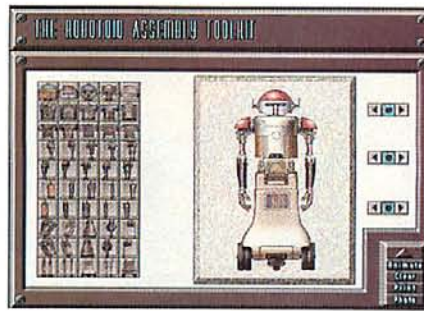

Isaac Asimov's The Ultimate Robot



Wolfpack CD-ROM



Heirs to the Throne

print shop, and film clip vault. Not only does this product provide short, succinct *Quick-Time* film clips from some classic science fiction films, but it also provides the text for more than 50 of Isaac Asimov's robot stories. Unfortunately, the robot assembly portion of the program isn't as sophisticated as one would hope. It is essentially *Designasaurus* for robots, with the user assembling paper doll robots that can be printed to hard copy or animated on screen. Though somewhat interesting, there isn't any real game to it. Also, the advertised screen savers require *After Dark* to function. Still, it is definitely the type of product that has something for every robot fiction fan. Macintosh CD-ROM (\$79.95). Circle Reader Service #18.

NovaLogic
19510 Ventura Blvd. #200
Tarzana, CA 91356
(818) 774-0812

WOLFPACK CD: This is a reworking of the original *Wolfpack* released in 1989, packed onto a CD with a fabulous new introduction sequence and sound track. While not the definitive work on the subject, *Wolfpack CD* is more like a "Fun Pack" for burgeoning submariners. Using a fairly easy point-and-click interface, players can jump from ship-to-ship on their side (commanding either the submarines or convoys) as they close for a fateful engagement, leaving every unattended ship under the AI's guidance. Instead of running from room-to-room or ship-to-ship, as in some simulations, commands can be entered from a single control panel in this simulation. What makes *Wolfpack CD* compelling is its intriguing soundtrack and mission construction set. New captains will also appreciate its short learning curve, which will have them at periscope depth before they can say "Heil What's-His-Name." IBM CD-ROM (\$39.95). Circle Reader Service #19.

QQP, Inc.
1046 River Avenue
Flemington, NJ 08822
(908) 788-2799

HEIRS TO THE THRONE: A decisively German import (you can almost hear the accent when reading the roughly translated docs), this is one speedy strategy game! The king has died and you, as one of the land's Barons, must step in to fill the vacuum. Naturally, the other Barons are also vying for control of the kingdom, so the stage is set for a classic multi-player strategy game (for up to four players at the same machine). With clean systems and an intuitive interface, the game offers a bunch of options and random maps that serve to give it depth and variety. Strategists will quickly find themselves mastering the interface to the point where they will be clicking off turns as fast as their wetware can

Do it on the big screen...with gamePlayerTV



Play PC games on TV!

The new AItech gamePlayerTV lets you do this. Instead of playing games on your PC monitor, you can maximize your game-playing excitement by playing them on a larger TV screen. Imagine sitting in front of your 20" TV playing your favorite computer game and for the first time, seeing and hearing the power of 24-bit computer graphics. WOW! Sit down Sega; this is real power!

gamePlayerTV is well-suited for game, business presentation, video recording, and all home and business audio applications. It includes high-quality digital audio record

and playback capabilities for all your Windows Sound System, SoundBlaster and AdLib games and educational and business software. And, whether your TV accepts NTSC or PAL signals, gamePlayerTV provides 24-bit, 16.7 million color resolution and S-Video output for enhanced TV viewing and video tape recording.

An easy and user-friendly on-line TV adjustment screen puts all the controls for TV output right at your fingertips. The sound editing software included with gamePlayerTV makes recording and playback of digital sound fun and exciting. AItech's enhanced Windows-installed software makes the set up of gamePlayerTV easy and effortless.

AItech can assist with your other desktop video and multimedia needs too. We offer a complete line of fully compatible DTV and multimedia products, including integrated

full-motion video/audio capture, compression, and professional audio/video output to TV and video.

So, don't settle for small-time pleasure when you can achieve the ultimate in game-playing excitement with gamePlayerTV. For more information on this and our other products, contact your local dealer or call us at 1-800-882-8184 or 1-510-226-8960, or fax 1-510-226-8996.

AItech International
47971 Fremont Blvd., Fremont, CA 94538

AItech

Audio/VideoBlender



VideoSurge



WaveWatcherTV



audioSHOW



gamePlayerTV



ProPC/TV Plus



V i s i o n f o r M u l t i m e d i a

© AItech International, 1993. Audio/VideoBlender, VideoBlender, VideoSurge, WaveWatcherTV, audioSHOW, gamePlayerTV and ProPC/TV Plus are trademarks of AItech International. Star WING Wars is a product of Lucas Arts. All other trademarks are the property of their respective holders. Specifications are subject to change without notice.

Circle Reader Service #36

process. IBM (\$59.95). Circle Reader Service #20.

Sierra On-Line, Inc.
P.O. Box 485
Coarsegold, CA 93614
(800) 757-7707

POLICE QUEST: OPEN SEASON: This latest offering in the *Police Quest* series draws from the expertise of former L.A. Police Chief Daryl Gates. Beginning with a brutal murder of one of L.A.'s finest, you don the badge of a detective working on a bizarre murder case. Life as an L.A.P.D. homicide detective is no picnic: as if the bad guys weren't tough enough, you must also deal with the press, and must follow strict police procedures at all times. From the manual that reads like "the book" that officers must go by when enforcing the law, through mandatory weapon qualifications, to visiting actual police hang outs, *Police Quest: Open Season* evinces a remarkable degree of work-a-day police realism as a result of Gates' contributions. Set in a new, enhanced game engine with marvelous digitized backgrounds, this game may be more appealing than True Crime television. IBM and IBM CD-ROM (\$69.95 and \$79.95 respectively). Circle Reader Service #21.

TAKE A BREAK! CROSSWORDS, VOLUMES I & II: Provided courtesy of Sierra and Dynamix, and designed for use in the Windows environment, this exercise in alphabetic aerobics offers over 750 puzzles broken down into several sizes and complexity levels. With an animated fairy for a host, *Take A Break! Crosswords'* animations and digitized voices make their contributions to what is, essentially, a digitized version of a crossword puzzle book (however, since these puzzles can be printed out, you can still solve them in the paper and pencil medium if you desire). The intuitive interface comes in particularly handy when playing against the clock for bonus points, and the inclusion of an auto-check feature and on-line hints will help serve the crossword-impaired among us. IBM with Windows (\$49.95). Circle Reader Service #22.

Tsunami Media, Inc.
PO Box 790
Coarsegold, CA 93614-9983
(800) 644-9283

MAN ENOUGH: In this dating simulation, the object is to win and *not* to "score." The gamer as Mr. Right (or Mr. Wrong, as the case may be) has to interact with six beautiful and, more importantly, different women in order to be successful in his simulated social life. Interaction occurs mostly via menued conversation trees that are numerically weighted for each computer date's pro-



Police Quest: Open Season



Take A Break! Crosswords, Volumes I & II

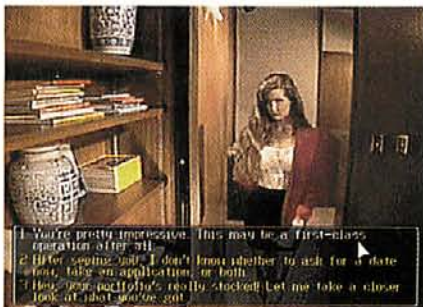

Man Enough

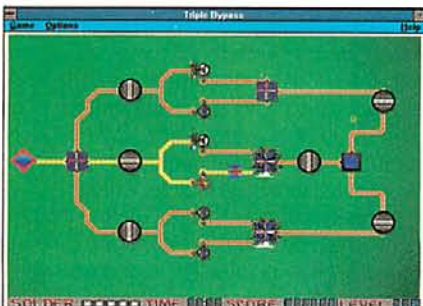

Nanotank

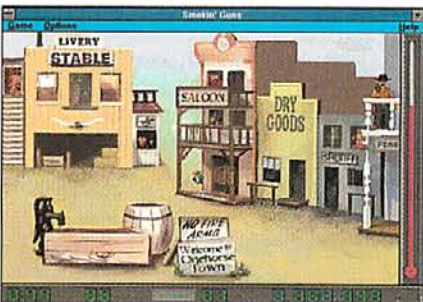

Smokin' Guns

file. Too many strikes and the gamer is out. Enough fast pitches and the date may be on. There are some interactive video sequences such as a paintball game and parachute drop that add garnish to play. The spice of the game, however, is provided by the witty repartee replete with sexual innuendo and the bouidoir pictures provided during encounters with each of the six lovelies. There is nothing X-rated about these film clips and slide shows, but those who think *Victoria's Secret* catalogs are too risqué will want to steer clear of this product. IBM CD-ROM (\$79.95). Circle Reader Service #23.

Twin Dolphin Games, Inc.
220 Twin Dolphin Dr., Suite B
Redwood Shores, CA 94065
(415) 637-9300

NANOTANK: If Mr. Wizard couldn't help you understand electronics, *Nanotank* may offer some clues. In this bizarre Windows puzzle game, *Nanotank* allows you to control a microscopic probe as it traverses the treacherous innards of a computer system in search of an evil virus. The 100 puzzling levels are set up like circuit boards, with an entry point and an exit. The Nanotank must cross the board and reach the exit without losing contact with a powered "trace." The pathway is littered with odd components—switches, diodes, capacitors, relays, optocouplers, teleporters—that must be manipulated or repaired with solder to make clear the pathway to victory. You don't need a degree in Electrical Engineering to play *Nanotank*, but that kind of problem-solving smarts would certainly help. IBM with Windows (\$39.95). Circle Reader Service #24.

SMOKIN' GUNS: Ready! Aim! Click! Trigger-happy gamers now have six venues of rapid-fire carnage under Windows with *Smokin' Guns*. Scenarios include: Gangsterland, for shootin' it out against the mob; House on the Hill, for a Haunted House ecto-blast of ghost-busting fun; County Fair, a more traditional shooting gallery with no return fire; Neptune Six, offering outer space alien popping; Silicon Gulch, a wild west six-gun slinger; and Terminal Flight, for Bruce Willis types. With mouse cursor as gunsight, your task is to dispense with the bad guys while avoiding blasting innocent bystanders. Though killing bad guys increases your score, hitting bystanders lowers it 1000 points each. Multiple rounds are provided in each scenario with each round offering increased difficulty. Survive long enough without your life meter running out and get your name on the sharpshooter list. With oodles of configuration options and great visual and audible enhancements, *Smokin' Guns* hits the bull's-eye. IBM with Windows (\$39.95). Circle Reader Service #25. **CGW**

COMPUTER GAMING WORLD HALL OF FAME

The games in *Computer Gaming World's* Hall of Fame have been highly rated by our readers over time. They have been rated for their impact on the computer gaming hobby during their peak period of influence and acceptance by our readership. Note that the dates listed for each game are the copyright dates and may precede the actual release dates. Specific formats listed are those which *CGW* has in its possession.

- The Bard's Tale* (Electronic Arts, 1985)
Many Formats
- Chessmaster* (The Software Toolworks, 1986)
Many Formats
- Civilization* (MicroProse, Inc., 1991)
Amiga, IBM, Macintosh
- Dungeon Master* (FTL Software, 1987)
Amiga, Atari ST, IBM
- Earl Weaver Baseball* (Electronic Arts, 1986)
Amiga, IBM, Macintosh
- Empire* (Interstel, 1978)
Amiga, Atari ST, C-64, IBM
- F-19 Stealth Fighter* (MicroProse, Inc., 1988)
IBM
- Gettysburg: The Turning Point* (Strategic Simulations, Inc., 1986)
Amiga, Apple, C-64, IBM
- Gunship* (MicroProse, Inc., 1989)
Amiga, C-64, IBM
- Harpoon* (Three-Sixty Pacific, 1989)
Amiga, IBM, Macintosh
- Kampfgruppe* (Strategic Simulations, Inc., 1985)
Many Formats
- King's Quest V* (Sierra On-Line, Inc., 1990)
Amiga, IBM, Macintosh
- M-1 Tank Platoon* (MicroProse, Inc., 1989)
Amiga, IBM
- Mech Brigade* (Strategic Simulations, Inc., 1985)
Many Formats
- Might & Magic* (New World Computing, 1986)
Amiga, Apple, C-64, IBM, Macintosh
- M.U.L.E.* (Electronic Arts, 1983)
Atari 8-bit, C-64
- Pirates* (MicroProse, Inc., 1987)
Many Formats
- Railroad Tycoon* (MicroProse, Inc., 1990)
Amiga, IBM, Macintosh
- Red Baron* (Dynamix 1990)
Amiga, IBM, Macintosh
- SimCity* (Maxis, 1987)
Many Formats
- Starflight* (Electronic Arts, 1986)
Amiga, C-64, IBM, Mac, Sega
- The Secret of Monkey Island* (LucasArts Entertainment Company, 1990)
Many Formats
- Their Finest Hour* (LucasArts Entertainment Company, 1989)
Amiga, Atari ST, IBM
- Ultima III* (Origin Systems, Inc., 1983)
Amiga, Apple, Atari ST, C-64, IBM
- Ultima IV* (Origin Systems, Inc., 1985)
Amiga, Apple, Atari ST, IBM
- Ultima VI* (Origin Systems, Inc., 1990)
C64, IBM
- War in Russia* (Strategic Simulations, Inc., 1984)
Apple
- Wasteland* (Interplay Productions, Inc., 1986)
Apple, C-64, IBM
- Wing Commander* (Origin Systems, Inc., 1991)
Amiga, IBM, Sega
- Wizardry* (Sir-Tech Software, 1981)
Many Formats
- Zork* (Infocom, 1981)
Many Formats

Their Finest Hour LucasArts Entertainment Co., 1989 Amiga, Atari ST, IBM



Lucasfilm, (now LucasArts) electrified the gaming world with Larry Holland's second action game/combat flight simulator. The realistic bit-mapped graphics were a big hit with gamers who were tired of the polygon-filled look of other flight simulators, and the flight model was more realistic than that used in its predecessor (*Battlehawks 1942*). In addition, gamers loved the ability to fly on both sides of the conflict and to take on the role of a crew member, as well as a pilot.

Ultima III Origin Systems, Inc., 1983 Amiga, Apple, Atari ST, C64, IBM

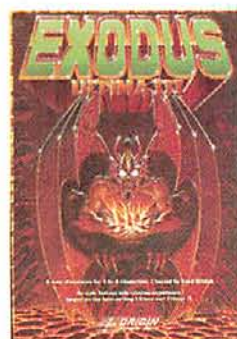

Although Lord British often refers to the first three Ultimas as a trilogy (and they are marketed as such), *Ultima III* was really the first one to have a coherent plot beyond the typical dungeon romp. It set the tone for the future series and encouraged Lord British to try to accomplish more, in terms of role-playing, in the next trilogy of releases. Also, when the Ultima series was converted to the Nintendo platform, *Ultima III* was the game which became known as *Ultima* to hundreds of thousands of cartridge gamers.

Top Adventure Games

GAME	COMPANY	SCORE
1 Day of the Tentacle	LucasArts	10.19
2 Monkey Island 2: Le Chuck's	LucasArts	9.91
3 Indiana Jones: Fate of Atlantis	LucasArts	9.79
4 Quest for Glory III	Sierra	9.56
5 Sherlock Holmes CD	Viacom	9.55
6 The Seventh Guest	Virgin	9.42
7 Star Control II	Accolade	9.36
8 Les Manly in: Lost in L.A.	Accolade	9.28
9 Lost Files of Sherlock Holmes	Electronic Arts	9.20
10 King's Quest VI: Heir Today...	Sierra	9.17

Top Role Playing Games

GAME	COMPANY	SCORE
1 Ultima Underworld	Origin	10.29
2 Betrayal at Krondor	Dynamix	9.98
3 Lands of Lore	Virgin	9.65
4 Might & Magic: Darkside of Xeen	New World Computing	9.46
5 Ultima Underworld II	Origin	9.42
6 Might & Magic III	New World Computing	9.41
7 Ultima VII	Origin	9.34
8 Eye of the Beholder II	SSI	9.34
9 Might & Magic: Clouds of Xeen	New World Computing	9.34
10 Wizardry VII: Crusaders of Savant	Str-Tech	9.10

Top Simulation Games

GAME	COMPANY	SCORE
1 X-Wing	LucasArts	9.78
2 World Circuit	MicroProse	9.66
3 Falcon 3.0	Spectrum HoloByte	9.59
4 Comanche: Maximum Overkill	Novalogic	9.39
5 Aces of the Pacific	Dynamix	9.38
6 Secret Weapons of the Luftwaffe	LucasArts	9.19
7 Red Storm Rising	MicroProse	9.04
8 Stunt Island	Disney	9.04
9 Silent Service II	MicroProse	9.03
10 Gunship 2000	MicroProse	9.02

Top Strategy Games

GAME	COMPANY	SCORE
1 Master of Orion	MicroProse	10.20
2 Solitaire's Journey	QQP	9.97
3 Dune II	Virgin	9.87
4 Syndicate	Electronic Arts	9.37
5 Chessmaster 3000	Software Toolsworks	9.32
6 Hong Kong Mahjong Pro	Electronic Arts	9.13
7 The Lost Admiral	QQP	9.05
8 Mech Warrior	Activision	8.94
9 The Incredible Machine	Dynamix	8.92
10 The Island of Dr. Brain	Sierra	8.91



Reader Poll #113

Top 100 Games

Rank	Game	Company	Type	Score
1	Links 386 Pro	Access	SP	10.41
2	Ultima Underworld	Origin	RP	10.29
3	Master of Orion	MicroProse	ST	10.20
4	Day of the Tentacle	LucasArts	AD	10.19
5	Warlords II	SSG	WG	10.16
6	Wing Commander II	Origin	AC	10.00
7	Betrayal at Krondor	Dynamix	RP	9.98
8	Solitaire's Journey	QQP	ST	9.97
9	V for Victory: Velikiye Luki	Three-Sixty Pacific	WG	9.93
10	Monkey Island 2: Le Chuck's Revenge	LucasArts	AD	9.91
11	Dune II	Virgin	ST	9.87
12	Indiana Jones: Fate of Atlantis	LucasArts	AD	9.79
13	X-Wing	LucasArts	SI	9.78
14	The Perfect General	QQP	WG	9.75
15	Front Page Sports Football	Dynamix	SP	9.72
16	Carriers at War Construction Kit	SSG	WG	9.68
17	World Circuit	MicroProse	SI	9.66
18	Lands of Lore	Virgin	RP	9.65
19	V for Victory: Utah Beach	Three-Sixty Pacific	WG	9.63
20	Falcon 3.0	Spectrum HoloByte	SI	9.59
22	Wolfenstein 3-D	Id Software	AC	9.58
23	V For Victory: Market Garden	Three-Sixty Pacific	WG	9.56
24	Sherlock Holmes CD	Viacom	AD,RP	9.55
26	V for Victory: Gold Juno Sword	Three-Sixty Pacific	WG,ST	9.53
27	Privateer	QQP	AC	9.50
28	Links	Access	SP	9.47
29	Might & Magic: Darkside of Xeen	New World Computing	RP	9.46
30	NHLPA Hockey	Electronic Arts	SP	9.45
31	Warlords	SSG	WG,ST	9.43
32	Ultima Underworld II	Origin	RP	9.42
34	The Seventh Guest	Virgin	AD	9.42
35	Might & Magic III	New World Computing	RP	9.41
36	War in Russia	SSI	WG	9.40
37	Comanche: Maximum Overkill	NovaLogic	SI	9.39
38	Aces of the Pacific	Dynamix	SI	9.38
40	Syndicate	Electronic Arts	ST,AC	9.37
41	Hardball III	Accolade	SP	9.36
42	Pacific War	Accolade	AD,AC	9.34
43	Might & Magic: Clouds of Xeen	SSI	WG	9.34
44	Eye of the Beholder II	SSI	RP	9.34
45	Ultima VII	SSI	RP	9.34
46	Chessmaster 3000	Origin	RP	9.32
47	Les Manly in: Lost in L.A.	Software Toolsworks	ST	9.32
48	Jack Nicklaus Signature Golf	Accolade	AD	9.28
49	Lemmings	Accolade	SP	9.27
50	Lost Files of Sherlock Holmes	Psychosis	AC,ST	9.21
51	Secret Weapons of the Luftwaffe	Electronic Arts	AD	9.20
52		LucasArts	SI	9.19

Top Wargames

RANK	GAME	COMPANY	SCORE
1	Warlords II	SSG	10.16
2	V for Victory: Veilikya Luki	Three-Sixty Pacific	9.93
3	The Perfect General	QQP	9.75
4	Carriers at War Construction Kit	SSG	9.68
5	V for Victory: Utah Beach	Three-Sixty Pacific	9.63
6	V for Victory: Market Garden	Three-Sixty Pacific	9.58
7	V for Victory: Gold Juno Sword	QQP	9.55
8	Conquered Kingdoms	SSG	9.53
9	Warlords	SSI	9.43
10	War in Russia	SSI	9.40



Top Action Games

RANK	GAME	COMPANY	SCORE
1	Wing Commander II	Origin	10.00
2	Wolfenstein 3-D	Id Software	9.59
3	Privateer	Origin	9.50
4	Lemmings	Psygnosis	9.21
5	Tetris Classic	Spectrum HoloByte	9.14
6	Oh, No! More Lemmings	Psygnosis	8.92
7	Prince of Persia 2	Broderbund	8.60
8	Out of this World	Interplay	8.57
9	Flashback	SSI	8.38
10	Lemmings 2: The Tribes	Psygnosis	8.33



Top Sports Games

RANK	GAME	COMPANY	SCORE
1	Links 386 Pro	Access	10.41
2	Front Page Sports Football	Dynamix	9.72
3	Links	Access	9.47
4	NHLPA Hockey	Electronic Arts	9.45
5	Hardball III	Accolade	9.37
6	Jack Nicklaus Signature Golf	Accolade	9.27
7	Tony La Russa Baseball II	SSI	8.78
8	NFL Pro League Football	Micro Sports	8.54
9	The Games: Winter Challenge	Accolade	8.50
10	PGA Tour Golf	Electronic Arts	8.49



Poll is based on reader survey cards in each issue of CGW and published two issues subsequent. Data on more than 100 games is archived and top ten lists may contain games which scored below the Top 100 cutoff.

51	Clash of Steel	SSI	9.18
52	Second Front	WG	9.17
	King's Quest VI: Heir Today...	Sierra	9.17
54	Tetris Classic	Spectrum HoloByte	9.14
55	Hong Kong Mahjong Pro	Electronic Arts	9.13
56	The Castle of Dr. Brain	Sierra	9.11
57	Eye of the Beholder	SSI	9.10
	Wizardry VII: Crusaders of Savant	Sir-Tech	9.10
59	The Dagger of Amon Ra	Sierra	9.09
	Conflict: Korea	SSI	9.09
61	Ultima VII: Part Two Serpent Isle	Origin	9.08
62	Empire Deluxe	New World Computing	9.07
63	Bane of the Cosmic Forge	Sir-Tech	9.05
	Quest for Glory I (VGA)	Sierra	9.05
	The Lost Admiral	QQP	9.05
66	Stunt Island	Disney	9.04
	Red Storm Rising	MicroProse	9.04
	Eric the Unready	Legend	9.04
	Conquests of the Longbow	Sierra	9.04
70	Silent Service II	MicroProse	9.03
71	Quest for Glory II	Sierra	9.02
	Gunship 2000	MicroProse	9.02
73	Police Quest 3	Sierra	9.01
74	Ultima V	Origin	9.00
	Battles of Destiny	WG,ST	9.00
76	Space Quest IV	AD	8.98
	Western Front	WG	8.98
78	Carriers At War	SSI	8.97
79	The Adventures of Willy Beamish	SSG	8.96
	Freddy Pharkas Frontier Pharmacist	Dynamix	8.96
81	Alone in the Dark	Sierra	8.95
82	Mech Warrior	I-Motion	8.95
83	The Incredible Machine	Activation	8.94
	F-117A	Dynamix	8.92
	Oh, No! More Lemmings	MicroProse	8.92
86	The Island of Dr. Brain	PSygnosis	8.92
87	Rise of the Dragon	ST	8.91
	Martian Memorandum	AD	8.89
89	F-15 Strike Eagle III	Access	8.89
90	Chuck Yeager's Air Combat	MicroProse	8.88
91	Indianapolis 500	Electronic Arts	8.87
92	Elvira	Electronic Arts	8.83
	MiG-29	Accolade	8.82
94	Command HQ	Spectrum HoloByte	8.82
	Spellcasting 301: Spring Break	MicroPlay	8.81
96	Rex Nebular	Legend	8.81
97	Gateway to the Savage Frontier	AD	8.80
98	Tony La Russa Baseball II	MicroProse	8.80
	Populous II	SSI	8.78
	Hoyle Book of Games, Vol. 3	SSI	8.78
		Electronic Arts	8.78
		Sierra	8.78

Games on unnumbered lines have scores equal to the line above. = Top game of type. **Magenta**=New Game
AD=Adventure, RP=Role Playing, SI=Simulation, ST=Strategy, WG=Wargame, AC=Action, SP=Sports

The Computer Gaming World Poll

A monthly survey of the readers of Computer Gaming World Magazine.

PC Research Hits List Of Top-Selling Software

October, 1993

PC Games (MS-DOS/Windows)

Rank	Title and Source
1.	Microsoft Flight Simulator 5.0 (Microsoft Corporation)
2.	Privateer (Origin Systems, Inc.)
3.	AD&D Dark Sun (Strategic Simulations, Inc.)
4.	Return to Zork (Activision)
5.	Scenery Disk: San Francisco (Mallard Software, Inc.)
6.	Masters of Orion (MicroProse, Inc.)
7.	Microsoft Arcade (Microsoft Corporation)
8.	Street Fighter II (Hi Tech Expressions)
9.	X-Wing (LucasArts Entertainment) SimCity
10.	The Blue & The Gray (Impressions)
11.	Front Page Sports Football Pro (Sierra On-Line, Inc.)
12.	Return to Zork CD-ROM (Activision)
13.	The 7th Guest (Virgin Interactive Entertainment)
14.	NHL Hockey (Electronic Arts)
15.	Chessmaster 4000 (The Software Toolworks)
16.	SimCity (Maxis Software)
17.	SEAL Team (Electronic Arts)
18.	Lands of Lore (Virgin Interactive Entertainment)
19.	Links 386 Pro (Access Software, Inc.)
20.	X-Wing: Imperial Pursuit (LucasArts Entertainment)

Amiga Games

Rank	Title and Source
1.	Overlord (Virgin Interactive Entertainment)
2.	688 Attack Sub (Electronic Arts)
3.	Hoyle's Book of Games (Sierra On-Line, Inc.)
4.	Oh No! More Lemmings (Psygnosis)
5.	John Madden Football (Electronic Arts)

Macintosh Games

Rank	Title and Source
1.	Chuck Yeager's Air Combat (Electronic Arts)
2.	SimCity (Maxis Software)
3.	Prince of Persia (Broderbund Software, Inc.)
4.	Star Trek: 25th Anniversary (Interplay Productions, Inc.)
5.	Microsoft Flight Simulator (Microsoft Corporation)

CD-ROM Products

Rank	Title and Source
1.	Return to Zork (Activision)
2.	The 7th Guest (Virgin Interactive Entertainment)
3.	King's Quest VI (Sierra On-Line, Inc.)
4.	ROMaterial (Moon Valley)
5.	MPC Wizard (Aris Entertainment)
6.	Dracula Unleashed (Viacom New Media)
7.	Mad Dog McCree (American Laser Games)
8.	Day of the Tentacle (LucasArts Entertainment)
9.	Just Grandma and Me (Broderbund Software, Inc.)
10.	Wing Commander Deluxe Edition (Origin Systems, Inc.)

This list is based on units sold by ten retail chains, representing over 1300 stores. For more information please contact PC Data at (703) 435-1025.

What You've Been Playing Lately

Every month our mailbox bulges with hundreds of Reader Input Cards from our most loyal and outspoken readers. Over the years we've found these cards to be an invaluable source of feedback. Within 10 days of releasing our latest issue we can expect to see cards pouring in with suggestions, encouragements, tirades and many good laughs, in addition to the data for our Top 100 poll. Through your efforts, we know *exactly* where we stand with our readers (you don't mince words!), and we are treated to well-articulated opinions on anything and everything related to gaming. This column is a forum for these responses and for the results of our "Playing Lately?" query on the Reader Input Card. Thanks for taking the time to fill them out...keep 'em coming!

Playing Lately? Results For CGW #113, November 1993

1	Master of Orion (MicroProse, Inc.)
2	Front Page Sports Football Pro (Dynamix, Inc.)
3	Warlords II (Strategic Studies Group)
4	X-Wing (LucasArts Entertainment)
5	Aces Over Europe (Dynamix, Inc.)
6	Privateer (Origin Systems, Inc.)
7	Betrayal at Krondor (Dynamix, Inc.)
8	Lands of Lore (Westwood Studios)
9	Empire Deluxe (New World Computing)
10	Civilization (MicroProse, Inc.)

Notable Quotables

"I think *FPS: Football Pro* is as close to a perfect game as has ever been made, computer or otherwise!"
S. Morze, Alhambra CA

"Mastering *Orion* has taken all my time. *Orion* has mastered me!"
Leominster, MA

"To those who make strategic military wargames, let us make new units!"
Kuan, New York City

"Great 'zine in December—it's always fun. However, my mailing label is covering the *second-best part* of the young lady (an Amazon?). You didn't do that on purpose, did you?"
John Laton

"I saw a picture of Johnny Wilson the other day and he looks just like the man who mugged me last Friday. Do you know if he was in Kansas City recently?"
Stephen L. Click, Kansas City, KS

"I don't think *Strike Commander* gets the credit it deserves. Granted, it requires a fast machine to run on—I had an older 386/33 and boy was it slow, totally unplayable. I recently purchased a REAL computer, DX2/66 VESA 16MB, etc., and I tell you, *Strike* is hands down the best sim on the market. It is unfortunate that more gamers don't own faster machines so that they could really enjoy flight simulation at its best."
Randy Heiting, Ranama City, FL

"I know this might be too much to ask of you folks, but one issue of *CGW* a month simply isn't enough for me!! Ever think about going weekly, since now you have the muscle of Ziff-Davis behind you?"
Byron Hamilton, Palm Springs, CA

"First there was *Empire*.
Then there was *Civilization*.
Now there is *Orion*."
(mystery conqueror, address unknown)



The Patch File

Computer game programs have grown so massive and the number of possible configurations has become so huge that incompatibilities and glitches seem to be breeding at an exponential rate. Consumers and publishers are both frustrated at the need for adding patches into "buggy" programs, but they seem to be an interim solution that is going to be with the hobby for a while (presumably, until a standard platform configuration is agreed upon). So, until the golden age of standardized platforms and bug-free programs, *Computer Gaming World* will publish a regular list of the latest updates of which we are aware.

These patches can usually be downloaded from most major networks (e.g., CompuServe or GENie), but can also be obtained from individual software publisher's own BBSs or direct from the publisher with proof of purchase. We continue to urge publishers to keep us updated on the latest versions/patches to their games.

(***) indicates new files)

Blue And The Gray Update V1.01 Update: With this patch, poor quality units will now rout at 15% rather than 10%, transporting troops will not "pop" back into a train or ship, and the AI will now be tougher and quicker in battle. 10/23/93

**** Clash of Steel V1.1 Update:** Fixes a number of small bugs. 11/18/93

Darksun V1.1 Update: Fixes problems with Wave Blaster and Sound Blaster + LAPC/SCC1. Eliminates the crash that may occur after the final battle, and random crashes when changing regions. 10/26/93

**** Empire Deluxe V3.11a Upgrade:** Updates Version 3.11 to Version 3.11a. Corrects a number of minor bugs and extends the sound card support. 12/02/93

Even More Incredible Machine Windows Patch: Corrects several problems including these specific errors: "You cannot run more than one copy of this program" error message when in 256-color mode, and "RunTime Error: Stack Overflow" error message when Windows MIDI Mapper is not configured correctly. 10/19/93

**** Fantasy Empires V1.1 Update:** Fixes the Multiplying Siege Engine Bug, the Disappearing Hero Bug, and eliminates most random crashes. 11/25/93

**** IndyCar Racing V1.02 Update:** Fixes random crashes/hangs and low memory problems. 11/25/93

**** Kasparov's Gambit Version 1.1:** In addition to restoring the chess engine to the full strength of the original 32-bit Socrates II program, this patch also improves driver setups, low-memory detection, time controls, ratings and much more. 12/3/93

Lands of Lore Version 1.11A Patch: Fixes a number of small bugs including the inability to retrieve Dawn's second key. 9/08/93

**** Leisure Suit Larry 6 Update:** Fixes the "Oops errors" that occur while playing. Also contains the bonus sound effects for 8-bit sound cards. 11/24/93

Links 386 Complete V1.11 Update: Contains both the Link 386 Pro EXE version 1.11 and a collection of new VESA drivers for various video cards. 9/03/93

NFL Coaches Club Football Update: Corrects some rare problems, improves the AI, and adds some new features. 10/21/93

Omar Sharif on Bridge Upgrade (IBM/Windows): The latest version of Interplay's bridge game for Windows. 9/03/93

Railroad Tycoon Deluxe Version 2: Fixes a few problems and adds some features. 11/23/93

Red Sky At Morning V1.33: The latest version SimCan's new wargame. 9/18/93

Return of the Phantom CD-ROM Speech Fix: Fixes digital speech repeat and echo due to an odd EMS configuration. 9/14/93

Rules of Engagement 2 V1.05 to 1.06 Update: Patch for those having problems running the game with a Viper graphics cards. 10/09/93

**** Rules of Engagement 2 V1.07 Update (Amiga):** Update to the Amiga version of Impression's game. 12/02/93

Solitaire's Journey For Windows Patch: Corrects minor bugs in the Windows version of SJ. 11/11/93

Strike Commander/Tactical Operations 1 Fix: Converts old Strike Commander save games to the Tactical Operations format. Only needed if you wish to run Strike Commander saves create prior to Tactical Operations installation. 9/30/93

**** Tony LaRussa II Version 1.2 Update:** . 11/5/93

Tornado 1.0 to 1.0c Upgrade: An update for the US version of the game. 10/29/93

V For Victory 3.1 Upgrade (IBM): Upgrades Velikiye Luki and Market Garden Versions 2.0 to Version 3.1. 8/19/93

V For Victory Utah Beach 2.0 Data Upgrade (IBM): Upgrades Utah Beach to Version 3.1 8/19/93

V For Victory 3.11 Upgrade (Mac): Upgrades Velikiye Luki and Market Garden to Version 3.11. 8/19/93

V For Victory Utah Beach 2.0 Data Upgrade (Mac): Upgrades Utah Beach to Version 3.11. 8/19/93

V For Victory: Gold Juno Sword Version 4.01 (Mac): Upgrades the Macintosh version 4.0 to 4.01. 8/28/93

War In Russia 1.1 Upgrade: Fixes three bugs and adds an enhancement. 10/04/93

Warlords Version 1.1.5 Update (Macintosh): Updates any version of Warlords Mac to V1.1.5. 10/09/93

Warlords II e1.02 to v1.02a Update: Fixes a bug with certain VGA cards (Diamond) and updates a few sound drivers, including PAS 16. 10/26/93

WW2: Battles of the South Pacific: Corrects a problem with the ranking system. 9/21/93

The PRODIGY Weekly Top Ten

Computer Gaming World is Prodigy's on-line games expert. Look for us in their Game Center, a forum where users read articles posted on-line by *CGW* and exchange messages on the bulletin boards (we can be reached there at EXPT40B). The Prodigy Game Poll is run by Prodigy based on a list of games provided by *CGW* and is updated weekly. Note that it is not a cumulative rating over time (like the *CGW* Top 100 Poll). Instead, the Prodigy Game Poll is a weekly "Snapshot" of game popularity with gamers rating their favorites on a 1 - 10 scale. The highest total point earners make their Top 10. We provide this data to our readers as another barometer of "what's hot" in computer gaming.

GAME POLL

TOP TEN RANKED GAMES
Week of December 3 to December 9

RANK	SCORE	TITLE	RANK	SCORE	TITLE
1	2503	Wolfenstein-3D	6	1347	Wing Commander 2
2	1897	X-Wing	7	1202	SimCity 2000
3	1751	Civilization	8	1200	Front Pg Football
4	1710	Kings Quest VI	9	1118	Falcon 3.0
5	1373	Seventh Guest	10	1010	Links 386 Pro

BALANCE YOUR BUDGET OR ZIFFNET FOR PRODIGY HAS
ZAP A MARTIAN! OVER 3,000 SOFTWARE TITLES
YOU CAN DOWNLOAD TO YOUR PC

Menu Jump Path A-Z Xref Copy Tools ? Exit **Look**



The Rumor Bag

In Search Of Nessie

by Sir Ian Bain Macintosh

It was raining in Inverness. To those who are familiar with the area, such a statement is tantamount to stating that Apple II games are a rarity. Nonetheless, I was not about to let a Scottish squall spoil my great adventure. I stood on the deck of a tourist ship that was sending its exhaust smoke behind us in such a way as to emulate the famous fog on the moors. Still, I kept my eyes glued to the surface of the loch in hopes that the most famous resident of Inverness might welcome me to his or her world.

The friendly native guide, her blonde hair darkening as it peeked out from under her tam and became soaked with the rain, kept delivering her spiel about the monster as though it were a warm spring day instead of a wet, rainy one. I might ha' believed the wee lass, but her dimple kept showing so I realized it was all a game to her. As she finished her tale, I told her there was another set of Celtic tales that was about to find its way to civilization. After all, Koei Corporation is hard at work on a title called *Celtic Tales: Balor of the Evil Eye*. It is expected to be the first in a series of fantasy/strategy games in the Koei tradition.

She seemed genuinely intrigued by my rumor, but as the boat pulled up to a dock next to the ruins of Uruquhart Castle, she told us how the English had destroyed the castle in order to strengthen their rule of the highlands. I briefly pictured the destruction and wondered aloud if any computer games would ever be based on the Jacobite Rebellion. "Not really," my guide surprised me by answering what I had intended as a purely rhetorical question, "my friends and I at the wargaming club usually prefer games with nukes or Nazis." She really surprised me by

stating that they were testing a new game from QQP.

"It's called *The Pure Wargame Volume 1: Death From Above*," she said and the dimple was lost in her most thoughtful expression. "It's supposed to have eight scenarios, but we've only played the Arnhem, Kanev, Maleme and Ste. Mere-Eglise Carentan (6/5/44) scenarios. I guess it's obvious that it emphasizes paratroopers, but the bonny part is that you can have the troops drop into their historical locales or face random drift. In fact, the random weather option can make your plans gang agley faster than you can quote a Robbie Burns poem." By the time she explained about the way the score takes into account the objectives and area controlled, as well as the number of prisoners taken and casualties inflicted, we had reached the keep of the old castle.

By now, the rest of the tour was getting restless. They didn't like a fellow with a tartan bag on his head getting that much special attention from their tour guide. We were down in the dungeon and, as a bekilted Scotsman came toward me with a menacing gleam in his eye, I felt like I was right in the middle of Capstone's new *Corridor 7*, a new game using the *Wolfenstein 3-D* engine with full-screen graphics and diminished lighting.

The Scotsman didn't have real violence on his mind, though. He had simply heard me discussing QQP with our native guide and wondered what was new about *The Perfect General II*. I told him that the art was more detailed and that animated shells zip across the map whenever the tanks or anti-tank weapons fire. I also told him that the most important difference was the addition of aircraft. In fact, I told him that they had a really

interesting method of plotting air attacks and even included an anti-aircraft calculation based on a 1/3 chance of hitting the aircraft if a machine gun is present within two hexes of the target.

He thanked me, but proceeded to throw a brief scare into me. He reached down and pulled out his dirk. Fortunately, he handed the dirk to me with the bone handle blade first. I accepted the knife and noticed the word *Adanac* on the handle. When I asked him why the game company's name was on his dirk handle, he quickly explained, "Laddie, in my wargame club we play Nukes, Nazis and *Napoleonics*. I just thought ye might be interested in the fact that *Adanac* is working on a new game called, *The Road from Marengo to Waterloo*."

I handed back his dirk and assured him I was interested. Then, as we trudged up the stone stairs to an upper story where we could look out over the loch, I told him that the winding stair wells reminded me of a new puzzle game from QQP. Called *Origamo*, it is essentially *Tetris* meets anagrams. Artistically, the real-time shaped puzzle game features oriental, pyramid, Native American, and Alice in Wonderland themes, among others.

I looked out over the loch and strained my eyes for even one view of the sea monster. The drizzle had moderated by this point and the sun had begun to shine. I kept finding that I was less and less interested in seeing Nessie than I was in viewing the bonny face of our tour guide. So, I kept turning my back to the loch as my eyes took in the lovely. After all, if I wanted to see a monster, all I had to do was wait for *The Evolver* from Trimark. *The Evolver* can easily be described as "Terminator meets Child's Play," but the most interesting prospect for the film is that the game and film are to be produced concurrently. So, filming for the game will be accomplished at the same time as filming for the theatrical release. I was just about to inform our lovely docent that production was set to begin in mid-January of 1994 when a little girl pointed to the loch behind me and covered her mouth to stifle a scream.

There was an audible intake of breath from the entire group as I turned around, only to see the bubbles where some large creature had been scant moments before. Had I really missed seeing the legendary monster or, as so many readers have written in to tell me, had I merely missed the mark? Ah, well, I could always have purchased a picture of the monster from one of the local residents. You don't suppose the pixelation means anything, do you? **CGW**

FIRST-EVER COMPREHENSIVE FLIGHT MODELING SOFTWARE

FLIGHT SIMULATOR TOOLKIT



ADVANCED
Sim-Series

CREATE YOUR OWN PLANES, OBJECTS & BATTLEFIELDS — IN SUPER-VGA!

Domark set the standard with SUPER-VGA HARRIER, the first-ever SVGA strategic flight simulator. Now, we're pushing that standard to new heights! FLIGHT SIMULATOR TOOLKIT,

the first 3-D flight modeling software ever produced for your PC, is Domark's second offering in its ADVANCED SIM-SERIES™ state-of-the-art flight simulator product line.

FST is revolutionary. It's powerful, sophisticated, and easy to use. Technophiles will appreciate the attention to detail — cockpits include modern instrumentation, such as OBI, DME, and Glidescope — as well as the ability to build every detail of their sim world.

In a hurry? Not interested in building every last plane,

tree, truck, valley or skyscraper? No problem. Just check out the extensive library of clip-art imagery: aircraft, ground targets, landscapes and objects. You'll be streaking through the heavens in no time!

FLIGHT SIMULATOR TOOLKIT.
YOUR AIRCRAFT. YOUR LANDSCAPES. YOUR MISSIONS — YOUR WORLD.

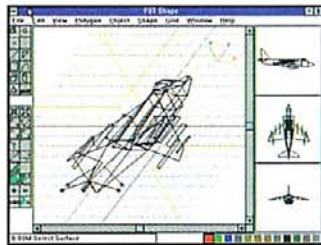

Screens shown: IBM 256-color SVGA displays.

IBM PC/COMPATIBLES: Available November 1993

Requires Windows™ 3.1

Flight Simulator Toolkit ©1993 Domark Group Ltd.

Published by Domark Software Ltd.

Programmed by Simis Ltd.

Graphics by the Kremlin.

DOMARK™

1900 S. Norfolk St., Suite. 202, San Mateo, CA 94403 415/513-8929

Circle Reader Service #152

DISTRIBUTED BY
Spectrum
HoloByte

Visa/MC orders:
call 24 hrs a day,
7 days a week:
1-800-695-GAME
(orders only).

PAGAN

Ultima VIII



**AVATAR,TM
YOU'RE NOT
IN BRITANNIA[®]
ANymore!**

Foiled by your defense of Britannia, the evil Guardian transports you to a world already under his dominion. Now you must confront alien realms and powerful new enemies in a battle without allies. But wait! Perhaps more has changed than just the battlefield . . . ?

- Incredibly smooth and lifelike animation — 400 frames of art per character (1200 frames for the Avatar) and 10 times the art of any previous Ultima!
- A new, more natural perspective.
- Compatibility with EMS, XMS and all other common memory management systems.
- Twice as many frames per second, producing a richer, faster story in this luxuriously detailed world!

VOLUNTARILY
RATED MP-13
(For Mature Players)

Look for the new *Pagan* Clue Book!

ORIGIN[®]
We create worlds.[®]

An Electronic Arts[®] Company
P.O. BOX 161750 AUSTIN, TX

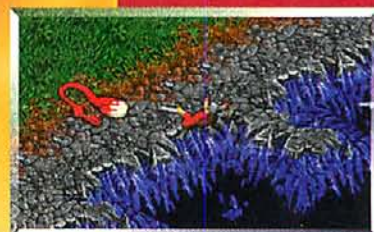

Actual screens may vary.

Pagan and Avatar are trademarks of ORIGIN Systems, Inc. Ultima, Origin, and We create worlds are registered trademarks of ORIGIN Systems, Inc. Copyright © 1993 ORIGIN Systems, Inc. Electronic Arts is a registered trademark of Electronic Arts. For IBM PC and 100% compatible systems.

Available at a software retailer near you, or call 1-800-245-4525 for MC/Visa/Discover orders.

Circle Reader Service #105