

US Army Order of Battle 1919–1941

Volume 3

The Services: Air Service, Engineers, and Special Troops, 1919–41

by

Lieutenant Colonel (Retired) Steven E. Clay



Combat Studies Institute Press
US Army Combined Arms Center
Fort Leavenworth, KS

Library of Congress Cataloging-in-Publication Data

Clay, Steven E., 1957-

US Army order of battle, 1919-1941 / Steven E. Clay.

p. cm.

Includes bibliographical references.

1. United States. Army--Organization--History--20th century--Encyclopedias. I. Title. II. Title: United States Army order of battle, 1919-1941.

UA25.C59 2010

355.30973'09041--dc22

2010022326



CSI Press publications cover a variety of military history topics. The views expressed in this CSI Press publication are those of the author and not necessarily those of the Department of the Army or the Department of Defense. A full list of CSI Press publications, many of them available for downloading, can be found at <http://usacac.army.mil/CAC2/CSI/>.

The seal of the Combat Studies Institute authenticates this document as an official publication of the CSI. It is prohibited to use CSI's official seal on any republication of this material without the written permission of the Director of CSI.

Contents

	<i>Page</i>
Explanatory Notes	v
Key to Abbreviations	xiii
Map and Illustration Symbols	xvii

Volume 3. The Services: Air Service, Engineers, and Special Troops, 1919–41

Part VI. Air Service and Air Corps Organizations

Chapter 28. Air Service and Air Corps Major Commands	1233
Chapter 29. Headquarters, Air Service	1261
Chapter 30. Groups	1289
Chapter 31. Squadrons, Heavier Than Air	1359
Chapter 32. Squadrons, Lighter Than Air	1553
Chapter 33. Squadrons, Non-Flying	1623

Part VII. Engineer Organizations

Chapter 34. Engineer Major Commands	1673
Chapter 35. Engineer Regiments	1691
Chapter 36. Engineer Battalions/Squadrons	1763

Part VIII. Special Troops Organizations

Chapter 37. Special Troops	1863
---	-------------

Previous volumes include –

Volume 1. The Arms: Major Commands and Infantry Organizations, 1919–41

Part I. Organization of the US Army

Chapter 1. Genesis of the Modern American Army	3
Chapter 2. Geographical Organization and Tactical Commands of the US Army, 1898–1920	7
Chapter 3. Corps Areas and Departments	11
Chapter 4. General Headquarters and Field Armies	95
Chapter 5. Corps	137
Chapter 6. Corps Area Training Centers	187

Part II. Infantry Organizations

Chapter 7. Infantry Divisions	195
Chapter 8. Infantry Brigades	291
Chapter 9. Infantry Regiments	351
Chapter 10. Infantry Battalions	519
Chapter 11. Tank Organizations	539

Volume 2. The Arms: Cavalry, Field Artillery, and Coast Artillery, 1919–41

Part III. Cavalry Organizations

Chapter 12. Cavalry Divisions	557
Chapter 13. Cavalry Brigades	593
Chapter 14. Cavalry Regiments	611
Chapter 15. Cavalry Squadrons	655

Chapter 16. Machine Gun Squadrons	665
Chapter 17. Armored Car Squadrons	677
Part IV. Field Artillery Organizations	
Chapter 18. Field Artillery Major Commands	685
Chapter 19. Field Artillery Brigades	697
Chapter 20. Field Artillery Regiments	749
Chapter 21. Field Artillery Battalions	927
Chapter 22. Field Artillery Observation Battalions	941
Chapter 23. Ammunition Trains	951
Part V. Coast Artillery Organizations	
Chapter 24. Coast Artillery Major Commands	985
Chapter 25. Coast Artillery Brigades	1037
Chapter 26. Coast Artillery Regiments and Battalions	1051
Chapter 27. Army Mine Planters	1175

Follow-on volume includes—

Volume 4. The Services: Quartermaster, Medical, Military Police, Signal Corps, Chemical Warfare, and Miscellaneous Organizations, 1919–41

Part IX. Quartermaster Corps Organizations	
Chapter 38. Quartermaster Trains	
Chapter 39. Field Remount Depots	
Chapter 40. Motor Repair Battalions, Quartermaster Corps	
Chapter 41. Service Battalions, Quartermaster Corps	
Chapter 42. Wagon Trains	
Chapter 43. Quartermaster Regiments and Squadrons	
Chapter 44. Port and Embarkation Units	
Chapter 45. US Army Transport Service	
Part X. Medical Corps Organizations	
Chapter 46. Medical Headquarters	
Chapter 47. Medical Regiments, Battalions, and Squadrons	
Chapter 48. Hospitals, Hospital Centers, and Surgical Groups	
Part XI. Military Police Organizations	
Chapter 49. Military Police Battalions	
Part XII. Signal Corps Organizations	
Chapter 50. Signal Corps Battalions	
Part XIII. Chemical Warfare Service Organizations	
Chapter 51. Chemical Regiments/Battalions	
Part XIV. Miscellaneous Organizations	
Chapter 52. Border Commands	
Chapter 53. ROTC Units	

Appendixes

Appendix A. Glossary of Terms	
Appendix B. Major Events of the US Army, 1919–41	
Appendix C. US Army Statistics, 1919–41	
Appendix D. Civilian Conservation Corps Organization, 1933–41	
Appendix E. Branch and Department Chiefs, 1917–41	
Appendix F. Annual Summer Training Camp Locations	

Explanatory Notes

Example Unit Entry (battalions, regiments, brigades)

<i>Unit Title and Type</i>	<i>Parenthetical</i>	<i>Component and Geographic Allotment</i>
↓	↓	↓
308th Cavalry Regiment (62d Cavalry Division)		Organized Reserve Maryland/Pennsylvania
HQ—Cumberland, MD, 1921–22; Pittsburgh, PA, 1923–41 ← <i>Headquarters Location</i>		

Demobilized 22 December 1918 at Camp Kearny, CA, as the 65th and 66th Field Artillery Regiments, and on 21 December 1918 as the 22d Trench Mortar Battery. All elements reconstituted in the Organized Reserves on 15 October 1921 and consolidated as the 308th Cavalry, assigned to the 62d Cavalry Division, and allotted to the Third Corps Area. Organized 10 November 1921 with regimental headquarters at Cumberland, MD. Regiment relocated about October 1922 to western Pennsylvania. Regimental headquarters concurrently organized at Pittsburgh. Reorganized 1 July 1929 as a three-squadron regiment. Concurrently, entire regiment relocated to Pittsburgh, PA. Typically conducted its Inactive Training Period meetings at the 107th Field Artillery’s Hunt Armory at the Post Office Building in Pittsburgh. Members built the 308th Cavalry Club in 1928 on property owned by the Aspinwall Hospital in Aspinwall, PA, and conducted some Inactive Training there. Facilities included equestrian, pistol, and saber training areas. Conducted regular equestrian training with the horses of the 107th Field Artillery. Conducted summer training with the 3d Cavalry Regiment at Fort Myer, VA, and at Fort Belvoir, VA. Trained with the units of the 52d Cavalry Brigade at Mount Gretna, PA, in July 1928. Conducted cavalry Citizens Military Training Camp (CMTC) training at Fort Myer as an alternate form of training. Designated mobilization training station was the York Concentration Area, PA. Location 7 December 1941—Pittsburgh, PA.

Unit Service Narrative

Organization Day: 24 February. Chosen to commemorate the regiment’s organization on 24 February 1918.

Status: Disbanded 11 November 1944 as the 66th Tank Destroyer Battalion. ← *Unit status as of 2001*

Events: 301 ← *Events in which the unit participated 1919–41 (see appendix B).*

Commanders, 308th Cavalry Regiment

Col. John J. Boniface	24 February 1918–25 April 1918	Col. Jean H.A. Day	15 September 1926–ao October 1926
Col. Hugh D. Berkeley	26 April 1918–24 September 1918	Col. Josiah L. Reese	ao March 1927–25 February 1930
<i>Demobilized/Inactive</i>	21 December 1918–10 November 1921	Col. George H. Cherrington	25 February 1930–January 1941
Lt. Col. Elmer J. Kingsbury	10 November 1921–October 1922	Unknown	January 1941–5 May 1941
Col. Josiah L. Reese	October 1922–15 September 1926	Lt. Col. John H. Schenkel	5 May 1941–6 November 1941

Purposes and Scope

The purposes of *US Army Order of Battle 1919–1941* are threefold. The first is to fill a void in the published record of US Army units documented by *Order of Battle of the United States Land Forces in the World War* published by the Center of Military History and Mr. Shelby L. Stanton’s *Order of Battle, U.S. Army World War II*. The second is to provide Army command historians, unit historians, and other individuals who are trying to research specific unit histories a basic overview of what these units were doing in the interwar period, where the units were located, and who commanded them. The third is to provide a private individual who had a relative who served during this period, and who wishes to know what that service may have consisted of, an account of the major activities in which the relative’s unit was involved. The scope of the work covers units from the size of separate battalions from all arms and services to field armies, as well as the actual order of battle of each as applicable.

Each unit is represented by a unit entry block. The entries contain a host of information that is standardized in its presentation as far as possible. Each entry includes the unit title and type, the headquarters to which the unit was assigned, the geographical area to which the unit was allotted (if National Guard or

Organized Reserve), the unit's headquarters location, the unit's physical location (or the unit's headquarters location if dispersed) on 7 December 1941, a unit service narrative, the unit's organization day, the unit's status as of 2001, and a chronological listing of the unit's commanding officers. Depending on the type of unit, additional information may include a listing of subordinate units and their years of assignment; "snapshot" orders of battle for divisions, corps, and armies for selected years; and the subordinate components of nonstandard units such as harbor defense commands. Also included in this work are the headquarters, a unit service narrative, commanders, and a "Major posts, camps, stations, airfields, and National Guard and Organized Reserve training facilities" section for each of the nine corps areas and three overseas departments. Though these were not tactical headquarters in the traditional sense, their importance to this period, and to this project, were such that I felt compelled to add their information.

Unit Title and Type

The unit title, in most cases, is the designation by which the unit was known for most of the 1919–41 period. In some cases, most notably the Air Service/Air Corps units, several unit titles followed by dates are given due to numerous redesignations.

Parentheticals

Titles are often followed by parenthetical information. Typically, the first of these will be the unit type or weapon, such as **(Antiaircraft)** or **(75-mm G)**. These designations will always be in boldface type. The notation (C) will follow some units. This indicates the unit was designated as a "Colored" unit and manned by African American personnel. The term "Colored" and the designation (C) were the standard usage of the period in mobilization documents and elsewhere and are used here for historical purposes. These designations too will always be in boldface type. Some units held the same designation at different times, but are not the same organization. These titles will be followed by a Roman numeral in parentheses, e.g., (I), (II), etc., to clearly differentiate the separate units. These designations will always be in standard type. The final example of parenthetical information is the major headquarters to which the unit was assigned, for example: (1st Division). This is typically the brigade, division, corps, or army to which the unit was assigned. For National Guard units, these reflect planned mobilization assignments for wartime and do not necessarily reflect actual peacetime command and control relationships. In some cases, again most often Air Service/Air Corps units, the organization was assigned to several different headquarters from 1919 to 1941. In those cases, I have attempted to designate that headquarters to which the unit was assigned for the longest period or, in some instances, the headquarters to which it was assigned in the initial mobilization plans of 1921–23. Admittedly, there are a few instances where these two examples will not apply, but in each of these exceptional cases, the rationale was different and it is not feasible to explain every reason. The headquarters designations will also be in standard type.

Component and Geographic Allotment

National Guard and Organized Reserve units are identified in this section of the unit entry. The state or states of allotment are also identified. In some cases, the unit was allotted for organization to more than one state. In those instances, the states of allotment will be identified with the conjunction "and" as such: **Alabama, Mississippi, and Louisiana National Guard**. Typically, the state to which the headquarters was allotted will appear first. In other cases, usually Organized Reserve units, the organization was withdrawn from allotment to one state or geographical area, and reallocated to another. In those instances, the initial state or states of allotment and the follow-on state or states will be differentiated with a slash "/", indicating the first, second, etc., areas of allotment as such: **Organized Reserve Missouri and Kansas/South Dakota**. In some cases for National Guard or Organized Reserve units, an organization was constituted but never allotted to a given state. In those instances, only the component (i.e., **National Guard** or **Organized Reserve**) is listed. Regular Army units that were generally in an inactive status between 1921 and 1939 are shown as **Regular Army Inactive (RAI)**. The vast majority of RAI units were organized with Reserve personnel during this period and thus are differentiated in this manner from Organized Reserve units and active Regular Army units. Many Organized Reserve units were withdrawn from the Reserve and allotted

to the Regular Army between 1927 and 1940. These units are all listed herein as Organized Reserve units as that is the component in which they were originally allotted. Active Regular Army units below division level and which headquarters were active for the majority of 1919 to 1941 will have no component listed.

Headquarters Location

The city or post and state or overseas location where the unit's headquarters was physically and permanently located, roughly between January 1919 and 7 December 1941, is listed here. Generally speaking, temporary locations are not included unless the absence from the permanent location was for 6 months or longer. The location and relocation dates for Regular Army and National Guard units are generally accurate, having been determined from unit data cards for the Regular Army and state annual or biennial reports and various other documents for National Guard units. While the majority of the initial organization dates and locations for Organized Reserve (O.R.) units are generally accurate, the relocation dates were somewhat problematic for these units. The primary document used to determine O.R. headquarters locations are 3"x5" index cards located at the Center of Military History at Fort McNair in Washington, DC. These cards were the methodology by which the Army tracked O.R. units in the interwar period. They usually (though not always) contain dates and headquarters location for the relocation of the units, but the relocation dates themselves are often that of the actual document that notified the individual who kept the cards rather than the actual date of the relocation. The date provided on the index card has typically been used as the date of relocation in the absence of the actual date. Those dates, however, while generally accurate, can be as much as a year off. In those instances where the actual relocation date has been located in other kinds of documents, the actual date has been used.

Unit Service Narrative

The service narrative generally provides an overview of the unit's permanent changes of station, assignment and reassignment to major commands, allotment to and withdrawal from component (Regular Army [R.A.], National Guard [N.G.], O.R.), allotment to corps area or overseas department, initial organization date and location, training activities and locations, activation and inactivation, and the location of the unit (or of the unit headquarters if the unit was dispersed) on 7 December 1941. Special events and activities, awards, and deployments are also covered. For R.A. units, support to the Civilian Conservation Corps and training support to O.R. units are covered. For N.G. units, callups for state emergencies of battalion-size or larger, dates of Federal recognition, dates of induction into Federal service, summer training camp locations, and mobilization training stations are covered. For O.R. units, locations for Inactive Training Period meetings, summer training camp locations, mobilization training stations, and Reserve Officers' Training Corps (ROTC) feeder units are covered. Regular Army Inactive (RAI) units are covered similarly to O.R. units with the addition of information on Active Associate units and affiliation with ROTC units. Dates provided for unit movements are generally the dates of arrival at the new location by the unit headquarters, unless specifically given as a departure date from the losing duty station. Subordinate elements of the unit may have arrived before or after that date.

Organization Day

The War Department's General Order #24, dated 10 June 1922, established the concept of "Organization Day" (sometimes referred to as "Regimental Day") for US Army units. The Organization Day was not necessarily the date on which the unit was organized. It could also be a special date in its history such as its baptism of fire in combat. In instances where an Organization Day had been adopted, the unit's chosen date for Organization Day, an explanation of the date's significance, and the date of adoption are given, if known.

Status

The unit's status (active, inactive, disbanded, etc.) and designation as of 2001 is given if known.

Events

The numbers represent events of significance in which the unit participated between 1919 and 1941. The details of each event number are located in appendix B.

Commanders

Where known, the unit's commanders and their inclusive dates of command are provided for regiment-size units and above, and selected battalion-size units. The dates of command are for the period 1 January 1919 to 7 December 1941, or the end date of command for the last pre-World War II commander, whichever is later. For infantry, cavalry, field artillery, coast artillery, and engineer regiments, the commanders for the World War I period are also provided if known, because those commander lists were not previously provided in the Center of Military History's *Order of Battle of the United States Land Forces in the World War*. For some N.G. units, the commanders will have a state abbreviation in parentheses following their name (e.g., (GA) for the state of Georgia) in those instances where the unit was a multistate organization to identify from which state the commander was assigned. If the commander of a N.G. or O.R. unit was an R.A. officer, the name will be followed by the abbreviation (R.A.). If the commander of a N.G. or R.A. unit was an O.R. officer, the name will be followed by the abbreviation (O.R.). If the name is not followed by an abbreviation, the commander is of the component or state to which the unit headquarters was allotted. If a commander is not known for a given period, the entry "Unknown" and the inclusive dates (at least month and year) are provided. In some instances, especially for O.R. units, the inclusive dates for a given commander are not known. In those cases, the entry "ao" (for "as of") followed by a month and year indicates the earliest or latest date known for that commander to be in command of the unit indicated. The example below indicates that Colonel William J. Smith was known to be in command from at least July 1937 to at least April 1940.

Example: Col. William J. Smith

ao July 1937–ao April 1940

Additionally, a single asterisk (*) beside a commander's name indicates he was an R.A. officer in command of an RAI unit. Two asterisks (**) indicates a Reserve officer who was in command of an RAI unit. Note that relatively few O.R. brigades and no RAI brigades were assigned a brigadier general as commanding general. These headquarters functioned as such on few occasions, usually at a command post exercise or occasionally during annual training. The brigade was strictly a tactical command during this period and exercised no administrative duties or responsibilities. Those duties were performed at the division and regimental levels. For that reason, O.R. and RAI brigades were generally "commanded" by majors or lieutenant colonels whose duties were primarily limited to planning, conducting, or supervising training in the brigade headquarters during the inactive training period. More often than not, personnel assigned to brigade headquarters simply conducted their inactive training with one of the subordinate regiments. At summer training, the senior regimental commander often served as the brigade commander when the brigade headquarters was intended to function as such. When assignment of Reserve officers to RAI regiments began in 1926, only a single reserve major (later changed to a lieutenant colonel) was authorized as the commander though the regiment could acquire its full quota of captains and lieutenants from the officer's Reserve Corps. In 1927, the command of these regiments was, in many cases, passed to selected Active Duty R.A. colonels and lieutenant colonels who, for the most part, were the professors of Military Science and Tactics at the college or university with which the RAI unit was affiliated. This practice seems to have effectively ended on 1 October 1933, though in some instances it was ended earlier, after which command was exercised by the senior Reserve officer assigned. Most units not affiliated with an educational institution were commanded by Reserve officers, though in a few cases they were commanded by R.A. officers who were assigned as an additional duty. This practice also seems to have ended on 1 October 1933. In many instances, brigades and regiments were commanded by captains and even lieutenants. Those organizations seem to have served more as Reserve pool units for mobilization assignment purposes than actual functional units. This was usually because the assigned personnel were geographically dispersed so as to prevent regular assembly for inactive training periods. Nonetheless, the senior officer assigned acted as the commanding officer during summer training unless a higher ranking officer was temporarily attached to assume command for the camp period.

Example Major Command Unit Entry (divisions, corps, armies)

Major command unit entries generally follow the same pattern as those for smaller unit entries with the exceptions detailed below.

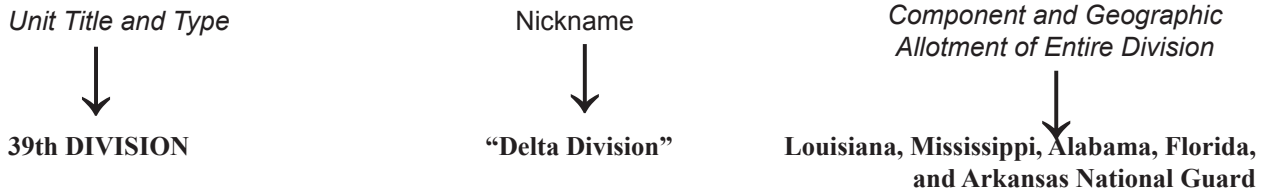

HQ—*Not organized, 1921–23* ← *Headquarters Location*

The 39th Division headquarters arrived at Newport News, VA, aboard the S.S. *Matoika* on 31 December 1918 after 4 months of overseas service and was demobilized 23 January 1919 at Camp Beauregard, LA. In accordance with the National Defense Act of 1920, the division was allotted to the states of Louisiana, Alabama, Mississippi, Florida, and Arkansas and assigned to the IV Corps in 1921. The division’s designated mobilization training station was Camp McClellan, AL. The division headquarters was not reorganized before the adjutants general of the several states from which the division was drawn petitioned the War Department to change the designation of the division to be formed as the 31st Division as that was the organization in which most of the states’ units served in World War I. The request was approved and the subordinate elements assigned to the 39th Division were withdrawn and assigned to the 31st Division, less the Arkansas elements, effective 1 July 1923.

Unit Service Narrative

Status: Headquarters and Headquarters Company currently active at Little Rock, AR, as HHC, 39th Infantry Brigade.

Division Commanders

No commanders assigned

**39th DIVISION
Organization 1923**

UNIT:	HQ LOCATION:
<i>Headquarters</i>	<i>Alabama N.G.*</i>
<i>Headquarters, Special Troops</i>	<i>Alabama N.G.*</i>
<i>Headquarters Company</i>	<i>Mobile, AL</i>
<i>39th Military Police Company</i>	<i>Florida N.G.*</i>
<i>39th Signal Company</i>	<i>Alabama N.G.*</i>
<i>114th Ordnance Company (M)</i>	<i>Jacksonville, FL</i>
<i>39th Tank Company (L)</i>	<i>Ozark, AL</i>
<i>Motorcycle Company No. 114</i>	<i>Florida N.G.*</i>
77th Infantry Brigade	<i>Montgomery, AL</i>
<i>154th Infantry Regiment</i>	<i>Jacksonville, FL</i>
<i>167th Infantry Regiment</i>	<i>Gadsden, AL</i>
78th Infantry Brigade	<i>New Orleans, LA</i>
<i>155th Infantry Regiment</i>	<i>Vicksburg, MS</i>
<i>156th Infantry Regiment</i>	<i>New Orleans, LA</i>
64th Field Artillery Brigade	<i>Louisiana N.G.*</i>
<i>114th Ammunition Train</i>	<i>Elba, AL</i>
<i>116th Field Artillery Regiment</i>	<i>Florida N.G.*</i>
<i>141st Field Artillery Regiment</i>	<i>Alabama N.G.*</i>
<i>114th Engineer Regiment</i>	<i>Mississippi N.G.*</i>
<i>114th Medical Regiment</i>	<i>Louisiana N.G.*</i>
<i>39th Division Train, Q.M.C.</i>	<i>Mississippi N.G.*</i>
<i>39th Division Air Service</i>	<i>Birmingham, AL</i>

*Organization/
Order of Battle*

*Indicates state of headquarters allocation; headquarters not organized or inactive.

Nickname

Many divisions adopted nicknames in the World War I period or, in a few cases, the nickname was adopted after the division was constituted or reconstituted in 1921. The nicknames are shown as illustrated.

Component and Geographic Allotment

For corps and armies, only the state to which the headquarters was allotted are listed. For divisions, every state that was allotted a unit in the division's order of battle is listed. The state to which the headquarters was originally allotted and organized will be listed first.

Organization/Order of Battle

Each division, corps, and field army has one or two "snapshot" orders of battle provided to illustrate how the command was organized at the time indicated. The 1939 order of battle provided for the R.A.'s 1st through 9th Divisions represent those divisions' final organization before the change to the "triangular" tables of organization in October 1939. Unit designations in italics indicate an inactive unit or a "not organized" or "not initiated" unit. Unit headquarters locations in italics represent the state of allotment for National Guard Inactive (NGI) units and the corps area of allotment for RAI and Organized Reserve Inactive (ORI) units. Partially active units (i.e., the headquarters was inactive, but some subordinate elements were active) are also shown in italics. For partially active units, the unit headquarters mobilization station/post is also shown in italics.

Division Commanders and Chiefs of Staff

Note that about half of the O.R. divisions actually had at least one general officer assigned as division commander sometime during this period, and none had a general assigned for the entire period. In most cases, one of the R.A. brigade commanders in the corps area was assigned as the commanding general of one of the three O.R. divisions as an additional duty. This practice seems to have been most widely used in the Second, Fourth, Fifth, and Seventh Corps Areas. In some cases, the corps area commander assigned that duty to himself. In two instances, those of the 77th and 95th Divisions, Reserve divisions were actually commanded by a Reserve officer. Generally speaking, the division's chief of staff exercised routine command in the name of the corps area commander or the assigned division commander. Thus, the names of the R.A. chiefs of staff assigned to O.R. divisions have been included in this *Order of Battle*.

Terminology and Abbreviations

The military and ethnic terminology and abbreviations used in this work are those that were used from 1919 to 1941; therefore, at the beginning of each volume is a Key to Abbreviations. See Appendix A, "Glossary of Terms," for definitions of the terminology used in this *Order of Battle*.

The National Guard

The N.G. poses several problems in preparing a work such as this because the rules by which the Center of Military History (and the states themselves) trace each unit's lineage do not always mirror those for the R.A. and O.R./US Army Reserve. For example, when a unit in the O.R. was relocated from one community to another, the unit retained its history and designation. In the case of the N.G., however, when a unit designation was relocated to a unit in another community, the history of the unit was retained in the organization located in the first community. Also, if a unit was demobilized (i.e., disbanded) in one community, and then in another community a unit is organized with the same designation, there was, in theory, no relation between the two units other than the fact that they happened to have shared the same designation. For example, the 120th Ammunition Train was organized at Bristow, OK, in May 1923. The unit in Bristow was disbanded in May 1924. A new 120th Ammunition Train was organized at Sperry, OK, in June 1924 and later reorganized as Headquarters Battery, 160th Field Artillery in June 1926. Another new 120th Ammunition Train was organized at Haskell, OK, also in June 1926, and later reorganized as Battery B,

160th Field Artillery in January 1927. In theory, there were three different organizations with the designation “120th Ammunition Train” and as such, each should merit a separate Unit Entry in this *Order of Battle*. To complicate matters, regimental, brigade, and division headquarters appear not to have been considered state- or community-specific units. For example, the Headquarters, 108th Cavalry at New Orleans, LA, was withdrawn from the state of Louisiana on 15 March 1929 and allotted to the state of Georgia and reorganized at Hinesville, GA. There appears to have been no loss of identity or history in the transfer of that unit designation between states, much less between communities in the same state. It is the same unit with the same lineage. Additionally, the Center of Military History does not consider N.G. units “constituted,” even though the Federal designations of those units were clearly “placed on the rolls of the army” (this is especially pertinent since the vast majority of N.G. units used Federal designations and not state designations during the period) and allotted to the various states in 1920–21 in accordance with the guidelines laid out in the 1920 amendment to the National Defense Act of 1916. The methodology appears to assume that the designation does not exist (at least on the rolls of the Army) until the day the unit is organized and federally recognized, even though letters and memorandums allotting the unit designation to a state, mobilization plans, and numerous other documents clearly refer to the existence of the unit designation before it was actually organized. In light of these pre-existing designations, for the purposes of this *Order of Battle*, I have chosen to consider the designation of N.G. units to have been constituted in the same manner as R.A. and O.R. units (i.e., when the designation of a unit was placed on the rolls of the Army). Therefore, those units that have a clearly differentiated identity (in other words, separate battalions, regiments, divisions, etc.) are treated as one and the same organization in the Unit Entries. Only in rare instances are two (or more) N.G. units with the same designation treated as separate and distinctly different organizations. The Unit Entries for these units generally makes the purpose for differentiation self-evident.

Key to Abbreviations

(AA)	antiaircraft	Aux	auxiliary
(C)	Colored	Avn.	aviation
(CA)	civilian airfield	AZ	Arizona
(CC)	civilian college	B.A.G.	Branch Assignment Group
(H)	heavy	Bkry	bakery
(HD)	horse drawn	Bln.	balloon
(HP)	heavy ponton	Bn.	battalion
(HT)	heavy tractor	Bomb.	bombardment
(HTA)	heavier-than-air	Brig.	brigade
(L)	light	Brig. Gen.	brigadier general
(LP)	light ponton	Btry	battery
(LT)	light tank	C.A.	coast artillery
(LTA)	lighter-than-air	C.A.C.	Coast Artillery Corps
(M&H)	medium & heavy	C.G.	commanding general
(M)	medium	C.O.	commanding officer
(MA)	military airfield	C.S.A.	Confederate States of America
(MC)	military college	C.W.S.	Chemical Warfare Service
(Mecz)	mechanized	C.Z.	Communications Zone
(MI)	military institute	CA	California
(MT)	medium tank	Camo	camouflage
(Mtd)	mounted	Capt.	Captain
(Mtzd)	motorized	CARL	Combined Arms Research Library
(NGF)	National Guard Aviation Facility	CARS	Combat Arms Regimental System
(PS)	Philippine Scouts	CASC	Corps Area Service Command
(RO)	railway operating	CASU	Corps Area Service Unit
(RY)	railway	Cav.	cavalry
(S&F)	sound and flash	Cbt	combat
(TD)	tractor/truck drawn	CCC	Civilian Conservation Corps
(Topo)	topographic	CCX	Command and Communications Exercise
(WS)	water supply	CD	Coast Defenses
A.A.	Active Associate	Chem.	Chemical
AAB	Army Air Base	CIA	Central Intelligence Agency
Abn	airborne	CM	civilian master
AC	Air Corps	Cmd	command
Adj.	adjutant	Cmpl.	Complement
Adm.	airdrome	CMTC	Citizens Military Training Camp
Admin	administration	CO	Colorado
AEF	American Expeditionary Force	Co.	company
AFG	American Forces, Germany	Col.	colonel
AFHRA	Air Force Historical Research Agency	Coll	collecting
AIT	advanced individual training	Commo	communications
AK	Alaska	Comp.	composite
AL	Alabama	Conv	convalescent
amb.	ambulance	Cos.	companies
ammo.	ammunition	Cpl.	Corporal
ao	as of	CPX	command post exercise
AP	airport	CST	common skills training
AR	Arkansas	CT	Connecticut
Armd.	armored	Ctr.	Center
Armt	armament	CZ	Canal Zone
Ars.	arsenal	DC	District of Columbia
Arty.	Artillery	DE	Delaware
AS	air service	Dent	dental
Ash.	airship	Dep	depot
Atk.	attack	Dept.	department
ATS	army transport service	Det.	detachment













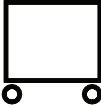



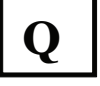

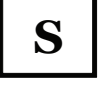

Disch.	Discharge	Instr.	Instructor
Dispry.	Dispensary	Intel	intelligence
Dist.	District	KKK	Ku Klux Klan
Div. Arty.	division artillery	KS	Kansas
Div.	division	KY	Kentucky
DNG	Deferred National Guard	LA	Louisiana
Doc	document	Lab	laboratory
DT	dump truck	LB	light bridge
e.g.	for example	LM	light maintenance
EEN&T	eyes, ears, nose & throat	Lt.	lieutenant
elmts	elements	Lt. Col.	lieutenant colonel
Engr.	engineer	Lt. Gen.	lieutenant general
Engrs.	engineers	LUTC	Local Unit Training Camp
ERC	Enlisted Reserve Corps	M. Rep. Bn.	Motor Repair Battalion
etc.	and so forth	M. Rep. Sec	Motor Repair Section
Evac	evacuation	M. Rep.	motor repair
F.A.	field artillery	M.C.	Medical Corps
Fin.	Finance	M.P.	military police
FL	Florida	M.T. Cmd.	motor transport command
Fld	field	M.T. Co.	motor transport company
G	gun	M.T.	motor transport
G.O.	General Order	M.T.C.	Motor Transport Corps
G.P.F.	Grande Puissance Filloux	MA	Massachusetts
GA	Georgia	Maint	maintenance
Gen.	General	Maj.	major
G-H	gun, horse drawn	Maj. Gen.	major general
GHQ	General Headquarters	Man'g	maneuvering
GHQR	General Headquarters Reserve	Max-Fac	maxillo-facial
Gonio	goniological	MD	Maryland
G-P	gun, portee	ME	Maine
Gp.	group	mecz	mechanized
GS	general support	Med.	Medical
GUTC	General Unit Training Camp	Met	meteorology
H	howitzer	MG	machine gun
Haw Div	Hawaiian Division	MGM	Metro-Goldwyn Mayer
HB	heavy bridge	MI	Michigan
HD	Harbor Defenses	Mil.	Military
HHB	headquarters and headquarters battery	Misc	miscellaneous
HHC	headquarters and headquarters company	MN	Minnesota
HHD	headquarters and headquarters detachment	MO	Missouri
HHS	headquarters and headquarters squadron	mob.	Mobilization
HHSC	headquarters and headquarters and service company	MR	military reservation
HHT	headquarters and headquarters troop	MS	Mississippi
HI	Hawaii	MT	Montana
HM	heavy maintenance	Mt cyl	motorcycle
Hosp.	hospital	mtz	motorized
Hosp Ctr	hospital center	N.G.	National Guard
HQ	headquarters	NC	North Carolina
Hv	heavy	NCO	noncommissioned officer
i.e.	that is	ND	North Dakota
I.G.	inspector general	NE	Nebraska
IA	Iowa	NGI	National Guard Inactive
ID	Idaho	NGR	National Guard Reserve
IL	Illinois	NH	New Hampshire
IN	Indiana	NJ	New Jersey
Induct.	Induction	NM	New Mexico
Inf.	Infantry	No.	number
		NV	Nevada

NY	New York	S.S.	steam ship
NYPOE	New York Port of Embarkation	San.	sanitary
O.R.	Organized Reserve	SC	South Carolina
Obsn.	observation	SCF	Southern Coastal Frontier
Ofc.	Office	Sch. B&C	School for Bakers and Cooks
OH	Ohio	Sch.	School
OK	Oklahoma	SD	South Dakota
Opns	operations	sec	section
OR	Oregon	Secr	secret
ORC	Officers Reserve Corps	Sect.	sector
Ord.	ordnance	Sel	selective
Org.	organization	Sep.	separate
ORI	Organized Reserve Inactive	SFPOE	San Francisco Port of Embarkation
OV	overseas	Sig.	signal
P.M.O.	Provost Marshal Office	Sp. Tps.	special troops
P2D	Provisional 2d Division	Sp.	Special
PA	Pennsylvania	Sq.	squadron
PC Div.	Panama Canal Division	SSD	Selective Service Detachment
Pers	personnel	Sta.	station
PG	Proving Ground	Sup	supply
Ph Div.	Philippine Division	Sup Dep	supply depot
PI	Philippine Islands	Surg.	surgeon/surgical
PID	Provisional Infantry Division	Sv	service
PL	Public Law	T/O	table of organization
Plt.	Platoon	TA	Territory of Alaska
PMS&T	Professor of Military Science and Tactics	Tact.	Tactical
POE	port of embarkation	TH	Territory of Hawaii
Port	portee	Tm	team
PR	Peurto Rico	TN	Tennessee
Prof Sv	professional services	Tn.	train
Prov.	provisional	Tng.	Training
Purs.	pursuit	Trp.	troop
Q.M.	quartermaster	Tr Mtr	trench mortar
Q.M.C.	quartermaster corps	Trans	transportation
R&I	Reception and Integration	Trk	truck
R.A.	Regular Army	TX	Texas
R.A.T.C.	Regular Army Training Center	U.S.A.C.S.	U.S. Army Cable Ship
Rad.	radio	U.S.A.J.M.P.	U.S. Army Junior Mine Planter
RAI	Regular Army Inactive	U.S.A.M.P.	U.S. Army Mine Planter
RAR	Regular Army Reserve	U.S.A.T.	U.S. Army Transport
Rcn.	reconnaissance	U.S.A.T.S.	U.S. Army Transport Service
Rct.	Recruit	U.S.C.G.C.	U.S. Coast Guard Cutter
Rctg.	Recruiting	U.S.C.G.T.	U.S. Coast Guard Tender
Rec'g	receiving	U.S.D.B.	United States Disciplinary Barracks
Recep.	Reception	U.S.L.H.T.	U.S. Light House Tender
Recr.	Recreation	U.S.M.C.	United States Marine Corps
Regt.	regiment	U.S.S.	United States Ship
Repl.	Replacement	U.S.V.	United States Volunteers
Res	reserve	US	United States
RI	Rhode Island	USARS	United States Army Regimental System
Rmt	remount	USN	United States Navy
Roent	roentgenology	UT	Utah
ROK	Republic of Korea	V.C.	Veterinary Corps
ROTC	Reserve Officers' Training Corps	VA	Virginia
RP	Republic of Panama	VI	Virgin Islands
Rpr	repair	VM	Vickers-Maxim
S.C.	Signal Corps	VT	Vermont
S.R.	sound ranging	WA	Washington

Wag	wagon
WDGMP	War Department General Mobilization Plan
WDGS	War Department General Staff
WI	Wisconsin
WPD	War Plans Division
WV	West Virginia
WX	weather
WY	Wyoming
XC	cross-country
Z.I.	Zone of the Interior

Military Map and Illustration Symbols

These symbols are used in the maps, tables of organization, and other illustrations presented in this *Order of Battle*. They reflect the common symbols in use from 1919 to 1941.

	Unit		Engineer unit
	Train or motorized unit		Special Troops unit
	Railway unit		Mine Planter
	Infantry unit		Quartermaster unit
	Cavalry unit		Transport unit
	Artillery unit		Military Police unit
	Ammunition unit		Signal Corps unit
	Tank unit		Ordnance unit
	Air service/air corps unit		Chemical Warfare unit
	Airship unit		Medical unit
	Balloon unit		Veterinary unit

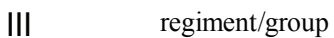
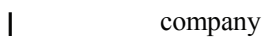
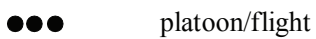
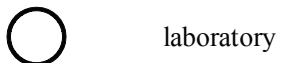
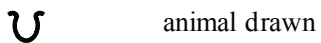
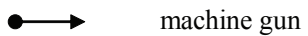
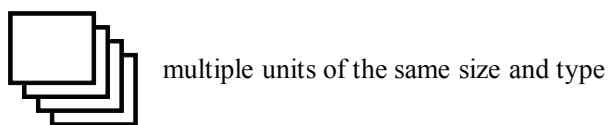

Part VI

Air Service and Air Corps Organizations

1919-41

Chapter 28

Air Service and Air Corps Major Commands

Coast Artillery Journal



Aircraft of the 1st Air Division assembled at March Field, CA, for maneuvers, May 1933.

Initially, the major commands for the Air Service consisted of the General Headquarters Air Service (redesignated as the General Headquarters Aviation in 1928), air divisions, air brigades, and wings. The latter three, with one exception, were intended to provide the subordinate command structure for the General Headquarters Air Service. The wing, the one exception, could also be a component of an army air service as well.

The General Headquarters Air Service was intended to be the command and control headquarters for all air service units in the General Headquarters Reserve. This included all air service units less those assigned to army, corps, and division air service headquarters. This command eventually evolved into the General Headquarters Air Force which was partially organized in 1933 and redesignated as the Air Force Combat Command in 1941.

Air divisions were composed of two or more air brigades. These commands were tailored for specific missions such as aerial defense of a given geographic area and thus had no standardized organization. Five air divisions were constituted in the Organized Reserve in the interwar period. One division, designated as the "1st Air Division," was organized provisionally for the 1931 air corps maneuvers that took place across the eastern United States, but was discontinued after only two weeks of active service. The actual 1st Air Division, constituted in 1921, for some reason was demobilized in 1933, then another of the same designation immediately constituted. The new division was initiated in 1935 only for a short period, but never functioned as an actual headquarters.

Air brigades were composed of two or more wings plus additional air and ground assets as required for a specific mission. Air brigades were generally mission- or equipment-specific such as bombardment, airship, balloon, and training or school brigades. Twelve air brigades were constituted or organized in the Army during this period—three in the Regular Army and nine in the Organized Reserve. Two brigades (both designated “1st”) were active during various periods in the interwar period. The first was Billy Mitchell’s 1st Air Brigade that won some notoriety for sinking obsolete battleships off the coast of Virginia in 1921. Several of the Reserve brigades were initiated as well, but all were inactivated by 1933.

Wings consisted of two or more groups plus additional air and ground assets as required for the mission. Wings were designated as airship, attack, balloon, bombardment, pursuit, or transport, though in the case of heavier-than-air wings (i.e., fixed wing aircraft), the wing was at times composed of a mixture of groups which created a composite wing. A total of fifty-eight wings of various types were constituted between 1919 and 1941. Twenty-three of these wings saw active service in this period, most of them only briefly prior to the attack on Pearl Harbor. Many of the others were initiated at some point as Reserve units, but none of those wings functioned as actual headquarters.

HQ, General Headquarters Air Service (1924-28)

Organized Reserve New York/Massachusetts

HQ, General Headquarters Aviation (1928-29)

HQ-Manhattan, NY, 1922-25; *Inactive* 1925-29

Subordinate units: 517th Headquarters Squadron 1921-29

Organized provisionally at Manhattan, NY, in March 1922 as General Headquarters Air Service in accordance with Second Corps Area General Orders. Formally constituted in the Organized Reserve on 31 March 1924 as Headquarters, General Headquarters Air Service, allotted to the Second Corps Area, and initiated with personnel from the existing unit in Manhattan. Inactivated in 1925 at Manhattan by relief of personnel. Relieved from the Second Corps Area in 1925 and allotted to the First Corps Area. Boston, MA, designated by November 1925 as headquarters on reorganization, but the unit was never organized at that location. This unit functioned as a reserve pool for the assignment of officers only. It did not function as an actual headquarters. Redesignated Headquarters, General Headquarters Aviation 3 March 1928. Discontinued in 1929.

HQ, General Headquarters Air Force (1933-36)

HHS, General Headquarters Air Force (1936-41)

HQ-Langley Field, VA, 1933-34; Bolling Field, DC, 1934-35; Langley Field, VA, 1935-41; Bolling Field, DC, 1941.

Subordinate units: 1st Pursuit Wing 1935-41, 2nd Bombardment Wing 1935-41, 3rd Attack Wing 1935-41, 21st Airship Group 1935-37

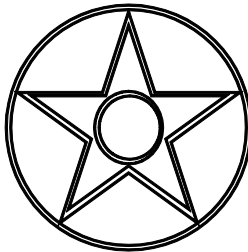

Constituted in the Regular Army on 1 October 1933 as Headquarters, General Headquarters Air Force and partially organized at Langley Field, VA, with personnel and assets from the demobilized 1st Bombardment Brigade Headquarters. Transferred on 28 February 1934 to Bolling Field, DC. Transferred on 28 February 1935 to Langley Field, VA. Redesignated Headquarters and Headquarters Squadron, General Headquarters Air Force on 1 March 1935 and fully activated. Transferred on 29 March 1941 to Bolling Field, DC. Redesignated Headquarters and Headquarters Squadron, Air Force Combat Command on 1 July 1941.

Events: 174, 197, 200, 227, 249, 252, 268

Commanders, G.H.Q. Air Force

Brig. Gen. Oscar Westover

1 Oct 33-1 Mar 35
Lt. Gen. Delos C. Emmo

Brig. Gen. Frank M. Andrews
10 Mar 39-30 Jun 41

1 Mar 35-10 Mar 39

DIVISIONS, BRIGADES, WINGS

HQ, 1st Air Division (I) (GHQR)

Organized Reserve Nebraska

HQ-*Not initiated* 1921-24; Omaha, NE, 1924-28; *Inactive* 1928-33

Constituted in the Organized Reserve on 15 October 1921, assigned to the General Headquarters Reserve, and allotted to the Seventh Corps Area. Headquarters initiated in November 1924 at Omaha, NE. Inactivated on 28 November 1928 and withdrawn from the Seventh Corps Area. Withdrawn from the Organized Reserve on 8 May 1929, allotted to the Regular Army, and further allotted to the Eighth Corps Area. Kelly Field, TX, designated as headquarters on reorganization, but the unit was never organized at that location. Designated mobilization training station was the Air Corps Training Center, Kelly Field. Demobilized on 1 October 1933.

Commanders, 1st Air Division (I)

Unknown

Nov 24-28 Nov 28

Inactive

28 Nov 28-1 Oct 33

HQ, 1st Air Division (II) (GHQR)**Organized Reserve Texas/New York****HQ-Not initiated** 1933-35; Kelly Field, TX, 1935-36; *Inactive* 1936-41

Constituted in the Organized Reserve on 1 October 1933, assigned to the General Headquarters Reserve, and allotted to the Eighth Corps Area. Initiated 20 June 1935 at Kelly Field, TX. Withdrawn from the Eighth Corps Area on 5 June 1936 and allotted to the Second Corps Area. Inactivated on 31 October 1936 at Kelly Field by relief of personnel. Mitchel Field, NY, designated on 15 April 1937 as headquarters on reorganization, but unit was never organized at that location. Designated mobilization training station was the Air Corps Training Center, Kelly Field. Location 7 December 1941—*Inactive*.

Status: Disbanded on 31 May 1942.**Commanders, 1st Air Division (II)**

Maj. Ralph W. Stone

20 Jun 35-31 Oct 36

Inactive

1 Oct 36-7 Dec 41

HQ, 2nd Air Division (GHQR)**Organized Reserve****HQ-Not initiated** 1933-41

Constituted in the Organized Reserve on 1 October 1933 and allotted to the Third Corps Area. Location 7 December 1941—*Not initiated*.

Status: Disbanded on 31 May 1942.**HQ, 3rd Air Division (GHQR)****Organized Reserve California****HQ-Not initiated** 1933-41

Constituted in the Organized Reserve on 1 October 1933 and allotted to the Ninth Corps Area. Los Angeles, CA, designated on 20 February 1934 as headquarters on organization, but the unit was never organized at that location. Location 7 December 1941—*Not initiated*.

Status: Disbanded on 31 May 1942.**HQ, 4th Air Division (GHQR)****Organized Reserve New York****HQ-Not initiated** 1933-41

Constituted in the Organized Reserve on 1 October 1933 and allotted to the Second Corps Area. Mitchel Field, NY, designated on 5 January 1934 as headquarters on organization, but unit was never organized at that location. Location 7 December 1941—*Not initiated*.

Status: Disbanded on 31 May 1942.**HQ, 1st Air Brigade (Provisional)****HQ-Langley Field, VA, 1921****Subordinate units:** 1st Pursuit Group; 2nd Bombardment Group; 258th Heavy Bombardment Squadron; 19th Balloon Squadron

Organized in the Regular Army on 27 May 1921 at Langley Field, VA, with personnel and assets from Langley Field Station Complement and the 258th Heavy Bombardment Squadron. Organized for the purposes of conducting aerial bombing tests against ex-German and decommissioned U.S. Navy warships off the coast of the Chesapeake Bay area. Discontinued on 30 September 1921 at Langley Field.

Events: 22, 23

Commanders, 1st Air Brigade (Provisional)

Brig. Gen. William Mitchell 27 May 21-30 Sep 21

HQ, 1st Air Brigade (Bombardment) (1924-26)

Organized Reserve New York

HQ, 1st Bombardment Brigade (I) (1926-29) (GHQR)

HQ, 21st Bombardment Brigade (1929-33) (GHQR)

HQ-Not initiated 1924-33

Constituted in the Organized Reserve on 21 Mar 1924 as Headquarters, 1st Air Brigade (Bombardment) and allotted to the Second Corps Area. Mineola, Long Island, NY, designated as headquarters on organization, but the unit was never organized at that location. Redesignated 28 April 1926 as Headquarters, 1st Bombardment Brigade. Withdrawn from the Organized Reserve on 8 May 1929 and allotted to the Regular Army. Concurrently withdrawn from the Second Corps Area and allotted to the Eighth Corps Area. Kelly Field, TX, designated as headquarters on organization, but the unit was never organized at that location. Designated mobilization training station was the Air Corps Training Center, Kelly Field. Redesignated 18 June 1929 as Headquarters, 21st Bombardment Brigade. Demobilized on 1 October 1933.

HQ, 1st Bombardment Brigade (II) (GHQR)

HQ-Not organized 1929-32; Langley Field, VA, 1932-33

Constituted in the Regular Army on 8 May 1929 as Headquarters, 1st Bombardment Brigade and allotted to the Eighth Corps Area. Kelly Field, TX, designated as headquarters on organization, but the unit was never organized at that location. Designated mobilization training station was the Air Corps Training Center. Activated on 25 June 1932 at Langley Field, VA. Inactivated on 30 September 1933 at Langley Field, VA, by transfer of personnel and assets to the partially activated Headquarters, General Headquarters Air Force. Demobilized on 1 October 1933.

Commanders, 1st Bombardment Brigade

Col. Roy T. Kirtland	25 Jun 32-30 Jun 32	Col. Clarence C. Culver	12 Aug 32-22 Aug 33
Maj. Leo G. Hefferman	30 Jun 32-12 Aug 32	Lt. Col. Albert L. Sneed	22 Aug 33-30 Sep 33

HQ, 2nd Air Brigade (Bombardment) (1924-26)

Organized Reserve Wisconsin

HQ, 2nd Bombardment Brigade (I) (1926-29) (GHQR)

HQ, 20th Bombardment Brigade (1929-33) (GHQR)

HQ-Milwaukee, WI, 1924-29; Kelly Field, TX, 1929; Inactive 1929-33

Constituted in the Organized Reserve on 21 March 1924 as Headquarters, 2nd Air Brigade (Bombardment) and allotted to the Sixth Corps Area. Headquarters initiated in 1924 at Milwaukee, WI. Redesignated 28 April 1926 as Headquarters, 2nd Bombardment Brigade. Withdrawn from the Organized Reserve on 8 May 1929 and allotted to the Regular Army. Concurrently withdrawn from the Sixth Corps Area and allotted to the Eighth Corps Area. Kelly Field, TX, designated as headquarters on organization, but the unit was never organized at that location. Redesignated 18 June 1929 as Headquarters, 20th Bombardment Brigade. Inactivated on 1 December 1929 at Milwaukee by relief of personnel. Designated mobilization training station was the Air Corps Training Center, Kelly Field. Demobilized on 1 Oct 1933.

Commanders, 20th Bombardment Brigade

Unknown	ao Dec 24-30 Mar 29	Maj. Herman J. Woeltjen	30 Mar 29-1 Dec 29
	<i>Inactive</i>	1 Dec 29-1 Oct 33	

HQ, 2nd Bombardment Brigade (II) (GHQR)

Regular Army Inactive

HQ—*Not organized* 1929-42

Constituted in the Regular Army on 8 May 1929 as Headquarters, 2nd Bombardment Brigade and allotted to the Eighth Corps Area. Kelly Field, TX, designated as headquarters on organization, but the unit was never organized at that location. Designated mobilization training station was the Air Corps Training Center, Kelly Field. Location 7 December 1941—*Inactive*.

Status: Disbanded on 31 May 1942.

HQ, 3rd Air Brigade (Bombardment) (1924-26)

Organized Reserve Nebraska

HQ, 3rd Bombardment Brigade (1926-41) (GHQR)

HQ—Omaha, NE, 1924-28; *Inactive* 1928-41

Constituted in the Organized Reserve on 21 March 1924 as Headquarters, 3rd Air Brigade (Bombardment) and allotted to the Seventh Corps Area. Headquarters initiated by Aug 1924 at Omaha, NE. Redesignated 28 April 1926 as Headquarters, 3rd Bombardment Brigade. Withdrawn from the Seventh Corps Area on 5 September 1928. Location 7 December 1941—*Inactive*.

Status: Disbanded on 31 May 1942.

Commanders, 3rd Bombardment Brigade

Unknown Aug 24-5 Sep 28

HQ, 4th Air Brigade (Airship) (1924-26)

Organized Reserve Nebraska

HQ, 4th Airship Brigade (1926-33) (GHQR)

HQ—Omaha, NE, 1924-33

Subordinate units: 4th Airship Wing, 5th Airship Wing.

Constituted in the Organized Reserve on 21 March 1924 as Headquarters, 4th Air Brigade (Airship) and allotted to the Seventh Corps Area. Headquarters initiated by August 1924 at Omaha, NE. Redesignated 28 April 1926 as Headquarters, 4th Airship Brigade. Demobilized on 1 October 1933.

Commanders, 4th Airship Brigade

Unknown Aug 24-1 Oct 33

HQ, 5th Air Brigade (Airship) (1924-26)

Organized Reserve Nebraska/Kansas

HQ, 5th Balloon Brigade (1926-33) (GHQR)

HQ—Omaha, NE, 1924-26; Kansas City, KS, 1926-33

Subordinate units: 10th Balloon Wing, 12th Balloon Wing.

Constituted in the Organized Reserve on 21 March 1924 as Headquarters, 5th Air Brigade (Balloon) and allotted to the Seventh Corps Area. Headquarters initiated by August 1924 at Omaha, NE. Redesignated 28 April 1926 as Headquarters, 5th Balloon Brigade. Headquarters relocated on 26 May 1926 to Kansas City, KS. Demobilized on 1 October 1933.

Commanders, 5th Balloon Brigade

Unknown Aug 24-1 Oct 33

HQ, 11th Air Brigade (School) (1926)

Organized Reserve

HQ, 11th School Brigade (1926-41) (ZI)

HQ-Not initiated 1926-41

Subordinate units: 21st School Wing, 22nd School Wing, 23rd School Wing

Constituted in the Organized Reserve on 19 March 1926 as Headquarters, 11th Air Brigade (School) and allotted to the Fifth Corps Area. Redesignated 28 April 1926 as Headquarters, 11th School Brigade. Withdrawn from the Fifth Corps Area on 5 September 1928. Location 7 December 1941—*Not initiated*.

Status: Disbanded on 31 May 1942.

HQ, 12th Air Brigade (School) (1926)

Organized Reserve Texas

HQ, 12th School Brigade (1926-41) (ZI)

HQ-Not initiated 1926-41

Subordinate units: 24th School Wing, 25th School Wing, 26th School Wing.

Constituted in the Organized Reserve on 19 March 1926 as Headquarters, 12th Air Brigade (School) and allotted to the Eighth Corps Area. Redesignated 28 April 1926 as Headquarters, 12th School Brigade. San Antonio, TX, designated on 22 August 1927 as headquarters on organization, but the unit was never organized at that location. Withdrawn from the Eighth Corps Area on 5 September 1928. Location 7 December 1941—*Not initiated*.

Status: Disbanded on 31 May 1942.

HQ, 13th Air Brigade (School) (1926)

Organized Reserve

HQ, 13th School Brigade (1926-41) (ZI)

HQ-Not initiated 1926-42

Subordinate units: 27th School Wing, 28th School Wing, 29th School Wing

Constituted in the Organized Reserve on 19 March 1926 as Headquarters, 13th Air Brigade (School) and allotted to the Ninth Corps Area. Redesignated 28 April 1926 as Headquarters, 13th School Brigade. Withdrawn from the Ninth Corps Area on 5 September 1928. Location 7 December 1941—*Not initiated*.

Status: Disbanded on 31 May 1942

HQ, 14th Air Brigade (School) (1926)

Organized Reserve

HQ, 14th School Brigade (1926-42) (ZI)

HQ-Not initiated 1926-42

Subordinate units: 30th School Wing, 31st School Wing, 32nd School Wing

Constituted in the Organized Reserve on 19 March 1926 as Headquarters, 14th Air Brigade (School) and allotted to the Second Corps Area. Redesignated 28 April 1926 as Headquarters, 14th School Brigade. Withdrawn from the Second Corps Area on 5 September 1928. Location 7 December 1941—*Not initiated*.

Status: Disbanded on 31 May 1942

1st Wing Headquarters (1919-29) (GHQ)

HQ, 1st Bombardment Wing (1929-33)

HQ, 1st Pursuit Wing (1933-35)

HHS, 1st Wing (1935-40) (GHQAF)

HHS, 1st Bombardment Wing (1940-41)

HQ-Kelley Field, TX, 1919-24; *Inactive* 1924-31; March Field, CA, 1931-41; Davis-Monthan Field, AZ, 1941

Subordinate units: 1st Pursuit Group 1919-22 and 1933-35, 2nd Bombardment Group 1919-22, 3rd Attack Group 1919-29, 7th Bombardment Group 1924, 1929-33 and 1935-41, 8th Pursuit Group 1933-35, 10th School Group 1922-29, *14th School Group* 1923-29, 17th Pursuit Group 1929-35, 17th Attack Group 1935-39, 17th Bombardment Group 1939-41, 19th Bombardment Group 1935-41, 20th Pursuit Group 1939-41, 35th Pursuit Group 1940-41, 41st Bombardment Group 1941, 6th Reconnaissance Squadron 1941, 38th Observation Squadron 1935-40, 38th Reconnaissance Squadron 1940-41, 88th Observation Squadron 1935-40, 89th Observation Squadron 1935-38, Base Headquarters and 4th Air Base Squadron 1936-40, Base Headquarters and 5th Air Base Squadron 1936-40.



Authorized in the Regular Army on 15 August 1919 as the 1st Wing Headquarters. Organized on 16 August 1919 at Kelley Field, TX. Provided command and control of all units conducting patrol duties 1919-22 along the Mexican Border from Brownsville, TX, to the California-Arizona border. Assigned to the General Headquarters in 1921. Reorganized 19 July 1922 as 1st Wing (Provisional) Headquarters and assigned responsibility to perform duties as the headquarters for the Advanced Flying School. Inactivated on 26 June 1924 at Kelley Field and 10th School Group designated as Active Associate. Allotted to the Eighth Corps Area on 29 February 1927. Fort Sam Houston, TX, designated as headquarters on organization, but the unit was never organized at that location. Designated headquarters location changed on 14 September 1928 to Kelly Field, TX. Redesignated as Headquarters, 1st Bombardment

Wing on 8 May 1929. Activated on 1 April 1931 at March Field, CA. Redesignated as Headquarters, 1st Pursuit Wing on 18 August 1933. Responsible for the supervision and administration of twenty-five camps in the southern California C.C.C. District, 1933-34. Redesignated Headquarters, 1st Wing on 1 March 1935 and assigned to the General Headquarters Air Force. Redesignated as Headquarters and Headquarters Squadron, 1st Wing on 1 September 1936. Consolidated on 14 October 1936 with the 1st Pursuit Wing (a WWI unit organized on 6 July 1918 at Toul, France; demobilized in December 1918 in France; reconstituted on 14 October 1936). Redesignated as Headquarters and Headquarters Squadron, 1st Bombardment Wing on 19 October 1940. Transferred on 27 May 1941 to Tucson, AZ. Location 7 December 1941—Tucson, AZ.

Organization Day: 16 Aug. Chosen to commemorate the wing's original date of organization on 16 Aug 1919.

Status: Disbanded 15 June 1983.

Events: 104, 142, 164, 174, 182, 195, 197, 200, 201, 227, 231, 235, 249, 252, 257, 279, 289

Commanders, 1st Wing

Col. Thomas D. Milling	6 Jul 18-Dec 18	1st Lt. Charles G. Brenneman	1 Apr 31-1 May 31
<i>Demobilized</i>	Dec 18-19 Aug 19	Maj. Joseph T. McNarney	1 May 31-20 Oct 31
Lt. Col. Davenport Johnson	28 Aug 19-10 Mar 20	Maj. Carl Spaatz	20 Oct 31-4 Jan 33
Col. Archie Miller	10 Mar 20-4 Aug 20	Brig. Gen. Henry H. Arnold	4 Jan 33-11 Jan 36
Capt. Emerson E. Swanson	17 Sep 20-18 Feb 21	Lt. Col. Hubert H. Harmon	11 Jan 36-29 Feb 36
Maj. John N. Reynolds	18 Feb 21-1 Feb 22	Brig. Gen. Henry B. Clagett	29 Feb 36-16 Jul 36
Lt. Col. John N. Howard	1 Feb 22-26 Jun 24	Brig. Gen. Delos C. Emmons	16 Jul 36-1 Mar 39
<i>Inactive</i>	26 Jun 24-1 Apr 31	Brig. Gen. Jacob E. Fickel	31 Mar 39-31 Dec 39
	Brig. Gen. Frank D. Lackland	1 Jan 40-Dec 41	

1st Balloon Wing Headquarters (1921-23) (GHQR)

Organized Reserve Connecticut

10th Balloon Wing Headquarters (1923-33) (GHQR)

HQ-New Haven, CT, 1922-33

Subordinate units: 561st Balloon Group 1921-33, 562nd Balloon Group 1921-33, 563rd Balloon Group 1921-33, 564th Balloon Group 1921-33.

Constituted in the Organized Reserve on 15 October 1921 as 1st Balloon Wing Headquarters, assigned to the General Headquarters Reserve and allotted to the First Corps Area. Organized by December 1922 with headquarters at New Haven, CT. Redesignated as 10th Balloon Wing Headquarters on 25 January 1923. Withdrawn from the First Corps Area and demobilized on 1 October 1933.

Commanders, 10th Balloon Wing

Unknown Dec 22-1 Oct 33

2nd Wing Headquarters (1919-29) (GHQ)

HQ, 2nd Bombardment Wing (1929-35)

HHS, 2nd Wing (1935-40) (GHQAF)

HHS, 2nd Bombardment Wing (1940-41)

HQ-Langley Field, VA, 1919-21; *Inactive* 1921-22; Langley Field, VA, 1922-41

Subordinate units: 1st Pursuit Group 1935-41, 2nd Bombardment Group 1919-41, 7th Bombardment Group 1933-35, 8th Pursuit Group 1929-41, 9th Bombardment Group 1935-40, 15th School Group 1925-28, 22nd Bombardment Group 1940-41, 31st Pursuit Group 1940-41, 50th Observation Squadron 1922-27; 18th Reconnaissance Squadron 1940-41, Base Headquarters and 1st Air Base Squadron, Base Headquarters and 2nd Air Base Squadron.



Authorized in the Regular Army on 15 August 1919 as the 2nd Observation Wing Headquarters. Organized on 4 September 1919 at Langley Field, VA. Assumed control of all Air Service units on the Atlantic Coast. Redesignated as 2nd Wing Headquarters on 14 March 1921. Assigned to the General Headquarters in 1921. Inactivated on 30 September 1921 at Langley Field and most personnel transferred to Air Park No. 3. Activated on 8 August 1922 at Langley Field. Redesignated as Headquarters, 2nd Bombardment Wing on 8 May 1929. Redesignated as Headquarters, 2nd Wing on 1 March 1935 and assigned to the General Headquarters Air Force. Redesignated as Headquarters and Headquarters Squadron, 2nd Wing on 1 September 1936. Redesignated as Headquarters and Headquarters Squadron, 2nd Bombardment Wing on 19 October 1940. Inactivated on 5 September 1941 at Langley

Field. Location 7 December 1941—*Inactive*.

Status: Disbanded 15 June 1983.

Events: 71, 164, 174, 178, 196, 197, 200, 213, 227, 234, 249, 252, 268, 283, 328, 330

Commanders, 2nd Wing

Col. Townsend F. Dodd	4 Sep 19-5 Oct 19	Lt. Col. Clarence C. Culver	5 Jul 27-29 Jun 29
Lt. Col. John N. Reynolds	5 Oct 19-18 Apr 20	Lt. Col. Jacob W. S. Wuest	1 Jul 29-16 Jun 30
Col. William N. Hensley, jr.	18 Apr 20-30 Jun 21	Capt. George L. Usher	16 Jun 30-1 Jul 30
Lt. Col. Charles H. Danforth	30 Jun 21-8 Sep 21	Col. Roy T. Kirtland	1 Jul 30-30 Jun 32
<i>Inactive</i>	30 Sep 21-8 Aug 22	Col. Clarence C. Culver	15 Jul 32-31 Aug 33
Lt. Col. Charles H. Danforth	8 Aug 22-2 Jun 24	Lt. Col. Herbert A. Dargue	31 Aug 33-17 May 34
Capt. Lynwood B. Jacobs	2 Jun 24-1 Jul 24	Lt. Col. Albert L. Sneed	17 May 34-13 Oct 34
Capt. Paul J. Mathis	1 Jul 24-1 Jan 25	Maj. Byron Q. Jones	13 Oct 34-18 Feb 35
Maj. Thomas D. Milling	1 Jan 25-7 Feb 25	1st Lt. Richard E. Nugent	18 Feb 35-2 Mar 35
Maj. Harold Geiger	7 Feb 25-28 Sep 25	Brig. Gen. Henry C. Pratt	2 Mar 35-12 Mar 37
Maj. Lawrence S. Churchill	29 Sep 25-27 Jul 26	Brig. Gen. Gerald C. Brant	18 Mar 37-28 Feb 38
Maj. Robert R. M. Goolrick	27 Jul 26-25 Sep 26	Col. Henry B. Claggett	1 Mar 38-31 Mar 38
Maj. Lawrence S. Churchill	25 Sep 26-5 Jul 27	Brig. Gen. Arnold N. Krogstad	31 Mar 38-5 Sep 41

2nd Balloon Wing Headquarters (GHQR)**Organized Reserve Oregon****12th Balloon Wing Headquarters (1923-33) (GHQR)****HQ**-Portland, OR, 1922-28; *Inactive* 1928-30; Los Angeles, CA, 1930-33**Subordinate units:** *31st Balloon Group* 1921-27, 559th Balloon Group 1921-33, 565th Balloon Group 1921-33, 566th Balloon Group 1921-33, 567th Balloon Group 1921-33.

Constituted in the Organized Reserve on 15 October 1921 as 2nd Balloon Wing Headquarters and allotted to the Ninth Corps Area. Headquarters initiated 17 October 1922 at Portland, OR. Redesignated as 12th Balloon Wing Headquarters on 25 January 1923. Inactivated on 1 September 1928 at Portland by relief of personnel. Headquarters reorganized 28 January 1930 at Los Angeles, CA. Withdrawn from the Ninth Corps Area and demobilized on 1 October 1933.

**Commanders, 2nd Balloon Wing Headquarters
12th Balloon Wing**

Lt. Col. George E. Houck	17 Oct 22-1 Jan 28	<i>Inactive</i>	1 Sep 28-28 Jan 30
Unknown	1 Jan 28-1 Sep 28	Unknown	28 Jan 30-1 Oct 33

3rd Wing Headquarters (1923-29) (First Army)**HQ, 3rd Attack Wing (1929-35)****HHS, 3rd Wing (1935-40) (GHQAF)****HHS, 3rd Bombardment Wing (1940-41)****HQ**-*Not organized* 1923-32; Fort Crockett, TX, 1932-35; Barksdale Field, LA, 1935-40; MacDill Field, FL, 1940-41; Drew Field, FL, 1941**Subordinate units:** 1st Pursuit Group 1924-28, 3rd Attack Group 1924-39, 3rd Bombardment Group 1939-40, 9th Observation Group 1923-29, 13th Bombardment Group 1940-41, 16th Pursuit Group 1923-33, 20th Pursuit Group 1933-39, 29th Bombardment Group 1940-41, 44th Bombardment Group 1940-41, 313th Pursuit Group 1923-24, 314th Pursuit Group 1923-24, 315th Observation Group 1921-23; 3rd Reconnaissance Squadron 1940-41, 14th Reconnaissance Squadron 1940-41, 21st Reconnaissance Squadron 1940-41, Base Headquarters and 6th Air Base Squadron.

Constituted in the Regular Army on 24 March 1923 as 3rd Wing Headquarters and assigned to the First Army. Concurrently, 2nd Wing Headquarters designated Active Associate. Allotted to the Second Corps Area on 28 February 1927. Withdrawn from the Second Corps Area on 14 January 1929 and allotted to the Eighth Corps Area. Redesignated as Headquarters, 3rd Attack Wing on 8 May 1929, relieved from the First Army, and assigned to the General Headquarters Reserve. Activated on 15 June 1932 at Fort Crockett, TX. Transferred on 27 February 1935 to Barksdale Field, LA. Redesignated as Headquarters, 3rd Wing on 1 March 1935 and assigned to the General Headquarters Air Force. Redesignated as Headquarters and Headquarters Squadron, 3rd Wing on 1 September 1936. Awarded the Columbian Trophy for 1936. Transferred on 2 October 1940 to MacDill Field, FL. Redesignated as Headquarters and Headquarters Squadron, 3rd Bombardment Wing on 19 October 1940. Transferred on 5

September 1941 to Drew Field, FL, and inactivated on the same date. Location 7 December 1941—*Inactive*.**Status:** Disbanded 15 June 1983.**Events:** 174, 193, 194, 197, 200, 217, 227, 243, 249, 252, 264

Commanders, 3rd Wing

Capt. Charles A. Chauncey	15 Jun 32-29 Jun 32	Brig. Gen. Gerald C. Brant	2 Mar 35-15 Mar 37
Lt. Col. Horace M. Hickam	29 Jun 32-5 Nov 34	Col. Robert E. M. Goolrick	15 Mar 37-1 Apr 37
Capt. Alfred Lindeberg	5 Nov 34-26 Feb 35	Brig. Gen. Frederick L. Martin	1 Apr 37-Dec 40

Capt. Angier H. Foster

26 Feb 35-2 Mar 35
Brig. Gen. Follett Bradley

Brig. Gen. Clarence L. Tinker
Jul 41-5 Sep 41

Dec 40-Jul 41

4th Airship Wing Headquarters (GHQR)

Organized Reserve Minnesota/Kansas

HQ-Minneapolis, MN, 1922-26; Duluth, MN, 1926-31; Winfield, KS, 1931-33

Subordinate units: 342nd Airship Group 1921-33, 343rd Airship Group 1921-33, 344th Airship Group 1921-33.

Constituted in the Organized Reserve on 31 March 1924 as 4th Airship Wing Headquarters and allotted to the Seventh Corps Area. Headquarters initiated in December 1924 at Minneapolis, MN. Relocated 26 May 1926 to Duluth, MN. Relocated on 12 October 1931 to Winfield, KS. Demobilized on 1 October 1933.

Commanders, 4th Airship Wing

Unknown Dec 24-1 Oct 33

HQ, 4th Pursuit Wing (1929-36) (GHQR)

Regular Army Inactive

HHS, 4th Pursuit Wing (1936-38)

HQ-*Not organized* 1929-38

Subordinate units: 17th Pursuit Group 1933-35, 20th Pursuit Group 1933-38.

Constituted in the Regular Army on 8 May 1929 as Headquarters, 4th Pursuit Wing and allotted to the Eighth Corps Area. Kelly Field, TX, designated as headquarters on organization, but the unit was never organized at that location. Designated mobilization training station was the Air Corps Training Center, Kelly Field. Withdrawn from the Eighth Corps Area on 1 October 1933 and allotted to the Fourth Corps Area. Redesignated as Headquarters and Headquarters Squadron, 4th Pursuit Wing on 1 September 1936. Disbanded on 1 January 1938.

HHS, 4th Bombardment Wing

HQ-Mitchel Field, NY, 1940-41; Westover Field, MA 1941

Subordinate units: 34th Bombardment Group 1941, 43rd Bombardment Group 1941.

Constituted in the Regular Army on 19 October 1940. Activated on 18 December 1940 at Mitchel Field, NY. Transferred 10 March 1941 to Westover Field, MA. Inactivated on 1 October 1941 at Westover Field. Location 7 December 1941—*Inactive*.

Commanders, 4th Bombardment Wing

Col. Richard H. Ballard

18 Dec 40-Jan 41
Unknown

Brig. Gen. John B. Brooks
23 Jul 41-1 Oct 41

Jan 41-23 Jul 41

5th Airship Wing Headquarters (GHQR)

Organized Reserve Missouri/Nebraska

HQ-St. Louis, MO, 1925-31; Omaha, NE, 1931-33

Subordinate units: 23rd Airship Group 1921-33, 345th Airship Group 1921-33, 346th Airship Group 1921-33.

Constituted in the Organized Reserve on 31 March 1924 as 5th Airship Wing Headquarters and allotted to the Seventh Corps Area. Headquarters initiated in January 1925 at St. Louis, MO. Relocated 12 October 1931 to Omaha, NE. Demobilized on 1 October 1933.

Commanders, 5th Airship Wing

Unknown Jan 25-1 Oct 33

HQ, 5th Pursuit Wing (1929-33)

Regular Army Inactive

HHS, 5th Attack Wing (1933-38)

HQ-*Not organized* 1929-35; Kelly Field , TX, 1935-36; *Inactive* 1936-38

Subordinate units: 32nd Attack Group 1933-38, 33rd Attack Group 1933-38.

Constituted in the Regular Army on 8 May 1929 as Headquarters, 5th Pursuit Wing and allotted to the Eighth Corps Area. Redesignated as Headquarters, 5th Attack Wing on 1 October 1933. Organized on 17 June 1935 with O.R. personnel as an RAI unit at Kelly Field, TX. Withdrawn from the Eighth Corps Area on 5 June 1936 and allotted to the Sixth Corps Area. Inactivated on 31 October 1936 at Kelly Field by relief of personnel. Chicago, IL, designated as headquarters on reorganization, but the unit was never organized at that location. Redesignated as Headquarters and Headquarters Squadron, 5th Attack Wing on 1 September 1936. Designated mobilization training station was the Air Corps Training Center, Kelly Field 1929-36 and San Angelo, TX, 1936-38. Disbanded on 1 January 1938.

Commanders, 5th Attack Wing

Capt. Clarence E. Shankle** 17 Jun 35-31 Oct 36

** RAI Commanders: Organized Reserve officer.

HHS, 5th Bombardment Wing

HQ-McChord Field, WA, 1940-41; Fort George Wright, WA, 1941.

Subordinate units: 17th Bombardment Group 1941, 39th Bombardment Group 1941.

Constituted in the Regular Army on 19 October 1940. Activated on 18 December 1940 at McChord Field, WA. Transferred on 5 January 1941 to Fort George Wright, WA. Inactivated on 5 September 1941 at Fort George Wright, WA. Concurrently, personnel transferred to the staff of the II Bomber Command. Location 7 December 1941—*Inactive*.

Commanders, 5th Bombardment Wing

Brig. Gen. Carlyle H. Wash 17 Dec 40-23 Apr 41 Maj. Nathan B. Forrest 23 Apr 41-1 Oct 41

6th Wing Headquarters (Attack) (1921-29) (Fourth Army)

Organized Reserve Pennsylvania

HQ, 6th Attack Wing (1929-36)

HHS, 6th Attack Wing (1936-41)

HQ-Franklin, PA, 1922-26; *Inactive* 1926-41

Subordinate units: 302nd Pursuit Group 1923-33, 307th Observation Group 1923-29, 303rd Attack Group 1923-33.

Constituted in the Organized Reserve on 15 October 1921 as 6th Wing Headquarters (Attack), assigned to the Fourth Army, and allotted to the Third Corps Area. Headquarters initiated on 1 March 1922 at Franklin, PA. Redesignated as Headquarters, 6th Attack Wing on 8 May 1929. Inactivated on 3 December 1926 at Franklin by relief of personnel. Redesignated as Headquarters and Headquarters Squadron, 6th Attack Wing on 1 September 1936. Location 7 December 1941—*Inactive*.

Status: Disbanded on 31 May 1942.

Commanders, 6th Attack Wing

Capt. Frank C. Hendry 1 Mar 22-20 Mar 23 1st Lt. Ernest F. Caldwell ao Jan 24-3 Dec 26
Inactive 20 Mar 23-ao Jan 24 *Inactive* 3 Dec 26-7 Dec 41

HQ, 6th Pursuit Wing (I) (1929-33)

Regular Army Inactive

HQ, 6th Transport Wing (1933-36)

HHS, 6th Transport Wing (1936-41)

HQ—*Not organized* 1929-35; Kelly Field, TX, 1935-36; *Inactive* 1936-41

Subordinate units: 1st Transport Group 1933-39, 2nd Transport Group 1933-39.

Constituted in the Regular Army on 8 May 1929 as Headquarters, 6th Pursuit Wing, and allotted to the Eighth Corps Area. Kelly Field, TX, designated as headquarters on organization, but the unit was never organized at that location. Redesignated as Headquarters, 6th Transport Wing on 1 October 1933. Organized on 17 June 1935 with O.R. personnel as an RAI unit at Kelly Field, TX. Withdrawn from the Eighth Corps Area on 5 June 1936 and allotted to the Sixth Corps Area. Inactivated on 31 October 1936 at Kelly Field by relief of personnel. Redesignated as Headquarters and Headquarters Squadron, 6th Transport Wing on 1 September 1936. Chicago, IL, designated as headquarters on reorganization, but the unit was never organized at that location. Designated mobilization training station was the Air Corps Training Center, Kelly Field. Location 7 December 1941—*Inactive*.

Status: Disbanded on 31 May 1942.

Events: 328, 330

Commanders, 6th Transport Wing

2nd Lt. James M. Allison ** 17 Jun 35-31 Oct 36

** RAI Commanders: Organized Reserve officers.

HHS, 6th Pursuit Wing (II)

HQ—Selfridge Field, MI, 1940-41

Subordinate units: 1st Pursuit Group 1940-41; 31st Pursuit Group 1940-41.

Constituted in the Regular Army on 19 October 1940. Activated on 18 December 1940 at Selfridge Field, MI. Inactivated on 7 December 1941 at Selfridge Field, MI. Location 7 December 1941—Selfridge Field, MI.

Commanders, 6th Pursuit Wing

Brig. Gen. Henry B. Clagett

Jan 41-Apr 41

Col. Lawrence P. Hickey

Apr 41-15 Sep 41

Brig. Gen. Carlyle H. Wash

15 Sep 41-7 Dec 41

7th Wing Headquarters (Attack) (1921-29) (Fifth Army)

Organized Reserve Ohio

HQ, 7th Attack Wing (1929-36)

HHS, 7th Attack Wing (1936-41)

HQ—Cincinnati, OH, 1922-33; Port Columbus Airfield, OH, 1933-30; *Inactive* 1930-41

Subordinate units: 1st Pursuit Group 1923-24, 308th Pursuit Group 1923-33, 315th Observation Group 1923-33, 305th Attack Group 1923-33.

Constituted in the Organized Reserve on 15 October 1921 as 7th Wing Headquarters (Attack), assigned to the Fifth Army and allotted to the Fifth Corps Area. Headquarters initiated in June 1922 at Cincinnati, OH. Redesignated as Headquarters, 7th Attack Wing on 8 May 1929. Inactivated by March 1930 at Cincinnati by relief of personnel. Relieved from assignment to Fifth Army on 1 October 1933. Port Columbus Airfield, OH, designated on 21 December

1933 as headquarters on organization, but the unit was never organized at that location. Redesignated as Headquarters and Headquarters Squadron, 7th Attack Wing on 1 September 1936. Location 7 December 1941—*Inactive*.

Status: Disbanded on 31 May 1942.

Commanders, 7th Attack Wing

1st Lt. Earl L. Wright	Jun 22-21 Nov 22	Unknown	ao Mar 23- ao Mar 30
2nd Lt. Robert J. Owen	21 Nov 22-ao Mar 23	<i>Inactive</i>	ao Mar 30-7 Dec 41

HQ, 7th Pursuit Wing

HQ-Mitchel Field, NY, 1940-41

Subordinate units:

Constituted in the Regular Army on 19 October 1940. Activated on 18 December 1940 at Mitchel Field, NY. Inactivated on 31 August 1941 at Mitchel Field, NY. Location 7 December 1941—*Inactive*.

Commanders, 7th Pursuit Wing

Brig. Gen. John C. McDonnell	18 Dec 40-Apr 41	Col. Thomas L. Handley	Apr 41-31 Aug 41
------------------------------	------------------	------------------------	------------------

8th Wing Headquarters (Attack) (1921-29) (Sixth Army)

Organized Reserve Missouri

HQ, 8th Attack Wing (1929-33)

HQ-Richards Field, Kansas City, MO, 1922-29; *Inactive* 1929-33

Subordinate units: 304th Pursuit Group 1923-33, 322nd Pursuit Group 1923-24, 320th Observation Group 1923-33, 321st Attack Group 1923-33.

Constituted in the Organized Reserve on 15 October 1921 as 8th Wing Headquarters (Attack), assigned to the Third Army and allotted to the Seventh Corps Area. Headquarters initiated in February 1922 at Richards Field, Kansas City, MO. Redesignated as Headquarters, 8th Attack Wing on 8 May 1929. Inactivated on 18 October 1929 at Richards Field by relief of personnel. Withdrawn from the Seventh Corps Area and demobilized on 1 October 1933.

Commanders, 8th Attack Wing

Maj. Guy V. Head	Feb 22-13 Sep 22	Unknown	ao Jun 27-18 Oct 29
Capt. Richard E. Wiles	13 Sep 22-ao Jun 27	<i>Inactive</i>	18 Oct 29-1 Oct 33

HHS, 8th Pursuit Wing

HQ-Maxwell Field, AL, 1940-41; Morrison Field, FL, 1941

Subordinate units:

Constituted in the Regular Army on 19 October 1940. Activated on 6 November 1940 at Maxwell Field, AL. Transferred on 16 May 1941 to Morrison Field, FL. Inactivated on 1 November 1941 at Morrison Field, FL. Location 7 Dec 1941—*Inactive*.

Commanders, 8th Pursuit Wing

Capt. Harold H. Fulk	6 Nov 40-1 Mar 41	Lt. Col. John W. Monahan	1 Mar 41-1 Nov 41
----------------------	-------------------	--------------------------	-------------------

9th Wing Headquarters (Attack) (1921-29) (Second Army)

Organized Reserve Illinois

HQ, 9th Attack Wing (1929-33)

HQ-Chicago, IL, 1922-29; *Inactive* 1929-33

Subordinate units: 302nd Pursuit Group 1923-24, 306th Pursuit Group 1923-33, 317th Observation Group 1923-33, 319th Attack Group 1923-33.

Constituted in the Organized Reserve on 15 October 1921 as 9th Wing Headquarters (Attack), assigned to the Second Army, and allotted to the Sixth Corps Area. Headquarters initiated on 4 May 1922 at Chicago, IL. Redesignated as Headquarters, 9th Attack Wing on 8 May 1929. Inactivated on 1 December 1929 at Chicago by relief of personnel. Withdrawn from the Sixth Corps Area and demobilized on 1 October 1933.

Commanders, 9th Attack Wing

1st Lt. Benjamin H. Roberts

4 May 22-19 Oct 22

Capt. Albert S. Cummins

20 Oct 22-8 Dec 24

Maj. Philip G. Kemp

8 Dec 24-1 Dec 29

HHS, 9th Pursuit Wing

HQ-March Field, CA, 1940-41

Subordinate units: 14th Pursuit Group, 51st Pursuit Group.

Constituted in the Regular Army on 19 October 1940. Activated on 18 December 1940 at March Field, CA. Inactivated on 1 October 1941 at March Field, CA. Location 7 December 1941—*Inactive*.

Commanders, 9th Pursuit Wing

Unknown

18 Dec 40-1 Oct 41

10th Wing Headquarters (Attack) (1921-29)

Organized Reserve

HQ, 10th Attack Wing (1929-33)

HQ-*Not initiated* 1921-33

Constituted in the Organized Reserve on 15 October 1921 as 10th Wing Headquarters (Attack), assigned to the General Headquarters Reserve, and allotted to the First Corps Area. Redesignated as Headquarters, 10th Attack Wing on 8 May 1929. Demobilized on 1 October 1933.

HHS, 10th Pursuit Wing

HQ-Hamilton Field, CA, 1940-41

Constituted in the Regular Army on 19 October 1940. Activated on 18 December 1940 at Hamilton Field, CA. Inactivated on 7 December 1941 at Hamilton Field, CA. Location 7 December 1941—*Inactive*.

Events: 328, 330

Commanders, 10th Pursuit Wing

Brig. Gen. Millard F. Harmon, Jr.

18 Dec 40-19 Jul 41

Brig. Gen. William O. Ryan

19 Jul 41-5 Aug 41

Col. Michael F. Davis

6 Aug 41-7 Dec 41

11th Wing Headquarters (Attack) (1921-29) (Sixth Army)

Organized Reserve Washington/California

HQ, 11th Attack Wing (1929-33)

HQ-Seattle, WA, 1922-28; *Inactive* 1928-30; San Francisco, CA, 1930-33

Subordinate units: 310th Pursuit Group 1923-33, 311th Pursuit Group 1923-24, 312th Observation Group 1923-33, 309th Attack Group 1923-33.

Constituted in the Organized Reserve on 15 October 1921 as 11th Wing Headquarters (Attack), assigned to the General

Headquarters Reserve, and allotted to the Ninth Corps Area. Headquarters initiated on 17 October 1922 at Seattle, WA. Relieved from the General Headquarters Reserve on 31 March 1924 and assigned to the Sixth Army. Inactivated on 1 September 1928 at Seattle by relief of personnel. Redesignated as Headquarters, 11th Attack Wing on 8 May 1929. San Francisco, CA, designated on 28 January 1930 as headquarters on reorganization, but the unit was never organized at that location. Withdrawn from the Ninth Corps Area on 1 October 1933 and demobilized.

Commanders, 11th Attack Wing

Lt. Col. Frank H. Patterson 31 Oct 22-1 Sep 28

HHS, 11th Pursuit Wing

HQ-Hamilton Field, CA, 1940-41; Portland, OR, 1941

Subordinate units: 54th Pursuit Group 1940-41, 55th Pursuit Group 1940-41.

Constituted in the Regular Army on 19 October 1940. Activated on 18 December 1940 at Hamilton Field, CA. Transferred in June 1941 to Portland, OR. Inactivated on 1 October 1941 at Hamilton Field, CA. Location 7 December 1941—*Inactive*.

Commanders, 11th Pursuit Wing

Brig. Gen. Millard F. Harmon, Jr. 18 Dec 40-Apr 41 Brig. Gen. Carlyle H. Wash 23 Apr 41-14 Sep 41

HHS, 12th Pursuit Wing

HQ-Quarry Heights, CZ, 1940-41

Subordinate units: 16th Pursuit Group 1940-41, 32nd Pursuit Group 1940-41, 37th Pursuit Group 1940-41.

Constituted in the Regular Army on 19 October 1940. Activated on 20 November 1940 at Quarry Heights, CZ. Wing mission was to provide command and control of pursuit aviation operations in the Panama Canal Department. Location 7 December 1941—Albrook Field, CZ.

Events: 292, 333

Commanders, 12th Pursuit Wing

Brig. Gen. Adlai H. Gilkeson 20 Nov 40-17 Feb 42

13th Wing Headquarters (Bombardment) (1924-29) (GHQR)

Organized Reserve Maryland

HQ, 13th Bombardment Wing (1929-36)

HHS, 13th Bombardment Wing (1936-41)

HQ-Baltimore, MD, 1925-29; *Inactive* 1929-33

Subordinate units: 347th Bombardment Group 1923-33

Constituted in the Organized Reserve on 31 March 1924 as 13th Wing Headquarters (Bombardment), assigned to the General Headquarters Reserve and allotted to the Third Corps Area. Headquarters initiated in February 1925 at Baltimore, MD. Redesignated as Headquarters, 13th Bombardment Wing on 8 May 1929. Inactivated on 23 July 1929 at Baltimore by relief of personnel. Redesignated as Headquarters and Headquarters Squadron, 13th Bombardment Wing on 1 September 1936. Location 7 December 1941—*Inactive*.

Status: Disbanded on 31 May 1942.

Commanders, 13th Bombardment Wing

Capt. Harold G. Slauson Feb 25-23 Jul 29

HHS, 13th Composite Wing

HQ-Langley Field, VA, 1940; Borinquen Field, PR, 1940-41

Subordinate units: 25th Bombardment Group 1940-41, 36th Pursuit Group 1941, 40th Bombardment Group 1941.

Constituted in the Regular Army on 2 October 1940. Activated on 10 October 1940 at Langley Field, VA. Departed the port of Newport News, VA, 25 October 1940 on the U.S.A.T. *Hunter Liggett* en route to Puerto Rico. Arrived on 1 November 1940 at Borinquen Field, PR. Organized to be the Air Corps component command of the Puerto Rican Department. Inactivated on 25 October 1941 at Borinquen Field, PR. Location 7 December 1941—*Inactive*.

Commanders, 13th Composite Wing

2nd Lt. Paul Hinds	10 Oct 40-1 Nov 40	Brig. Gen. Follett Bradley	Nov 40-Aug 41
Capt. Kenneth O. Sanborn	1 Nov 40-Nov 40	Lt. Col. Robert V. Ignico	Aug 41-Sep 41
	Brig. Gen. Douglas B. Netherwood	Sep 41-25 Oct 41	

14th Wing Headquarters (Bombardment) (1924-29) (GHQR)

Organized Reserve Indiana

HQ, 14th Bombardment Wing (1929-36)

HHS, 14th Bombardment Wing (1936-41)

HQ-*Not initiated* 1924-41

Subordinate units: 348th Bombardment Group 1923-33

Constituted in the Organized Reserve on 31 March 1924 as 14th Bombardment Wing Headquarters, assigned to the General Headquarters Reserve and allotted to the Seventh Corps Area. Redesignated as Headquarters, 14th Bombardment Wing on 8 May 1929. South Bend, IN, designated on 21 December 1933 as headquarters on organization, but the unit was never organized at that location. Redesignated as Headquarters and Headquarters Squadron, 14th Bombardment Wing on 1 September 1936. Location 7 Dec 1941—*Not initiated*.

Status: Disbanded on 31 May 1942.

HHS, 14th Pursuit Wing

HQ-Fort Shafter, TH, 1940-41

Subordinate units: 15th Pursuit Group 1940-41, 18th Pursuit Group 1940-41.

Constituted in the Regular Army on 19 October 1940 and assigned to the Hawaiian Department. Activated on 1 November 1940 at Fort Shafter, TH, and further assigned to the Hawaiian Air Force. Wing mission was to provide command and control of pursuit aviation operations in the Hawaiian Department. Location 7 December 1941—Fort Shafter, TH.

Events: 297, 312

Commanders, 14th Pursuit Wing

Col. Harvey S. Burwell	1 Nov 40-7 Apr 41	Brig. Gen. Howard C. Davidson	7 Apr 41-15 Oct 42
------------------------	-------------------	-------------------------------	--------------------

15th Wing Headquarters (Bombardment) (1921-29) (GHQR)

Organized Reserve Washington

HQ, 15th Bombardment Wing (I) (1929-33)

HQ, 15th Transport Wing (1933-36) (GHQR)

HHS, 15th Transport Wing (1936-41)

HQ—*Not initiated* 1924-30; Boeing Field, Seattle, WA, 1930-37; *Inactive* 1937-41

Subordinate units: 349th Bombardment Group 1923-33

Constituted in the Organized Reserve on 31 March 1924 as 15th Bombardment Wing Headquarters, assigned to the General Headquarters Reserve, and allotted to the Ninth Corps Area. Redesignated as Headquarters, 15th Bombardment Wing on 8 May 1929. Headquarters initiated by April 1930 at Boeing Field, Seattle, WA. Redesignated as Headquarters, 15th Transport Wing on 1 October 1933. Redesignated as Headquarters and Headquarters Squadron, 15th Transport Wing on 1 September 1936. Inactivated on 2 March 1937 at Seattle by relief of personnel. Location 7 December 1941—*Inactive*.

Status: Disbanded on 31 May 1942.

Commanders, 15th Wing

Unknown Apr 30-2 Mar 37

HHS, 15th Bombardment Wing (II)

HQ—March Field, CA, 1940-41; Fresno, CA, 1941

Subordinate units: 47th Bombardment Group 1940-41, 48th Bombardment Group 1940-41.

Constituted in the Regular Army on 19 October 1940. Activated on 18 December 1940 at March Field, CA. Transferred on 2 August 1941 to Fresno, CA. Inactivated on 3 September 1941 at Fresno, CA. Location 7 December 1941—*Inactive*.

Commanders, 15th Bombardment Wing

Unknown 18 Dec 40-Jun 41 Col. Robert F. Travis Jun 41-3 Sep 41

16th Wing Headquarters (Bombardment) (1921-29) (GHQR)

Organized Reserve Illinois

HQ, 16th Bombardment Wing (1929-36)

HHS, 16th Bombardment Wing (I) (1929-41)

HQ—*Not initiated* 1924-27; Chicago, IL, 1927-33; Evanston, IL, 1933-41

Subordinate units: 350th Bombardment Group 1923-33

Constituted in the Organized Reserve on 31 March 1924 as 16th Wing Headquarters (Bombardment), assigned to the General Headquarters Reserve and allotted to the Ninth Corps Area. Organized about January 1927 at Chicago, IL. Redesignated as Headquarters, 16th Bombardment Wing on 8 May 1929. Inactivated on by June 1929 at Chicago by relief of personnel. Evanston, IL, designated on 7 October 1933 as headquarters on reorganization. Redesignated as Headquarters and Headquarters Squadron, 16th Bombardment Wing on 1 September 1936. Reorganized about June 1937 at Evanston. Location 7 December 1941—Chicago, IL.

Status: Disbanded on 31 May 1942.

Commanders, 16th Bombardment Wing

Unknown Jan 27-Jun 29 1st Lt. Cassius H. Thomas Jun 37-23 Jun 39
Inactive Jun 29-Jun 37 Col. Fred W. Sizer 23 Jun 39-ao Jan 40
Unknown ao Jan 40-7 Dec 41

HHS, 16th Bombardment Wing (II)

HQ—Langley Field, VA, 1940-41; Bowman Field, KY 1941

Subordinate units: 45th Bombardment Group 1941, 46th Bombardment Group 1941.

Constituted in the Regular Army on 19 October 1940. Activated on 18 December 1940 at Langley Field, VA. Transferred in March 1941 to Bowman Field, KY. Inactivated on 1 September 1941 at Bowman Field, KY. Location 7 December 1941—*Inactive*.

Commanders, 16th Bombardment Wing

Unknown

18 Dec 40-3 Apr 41

Brig. Gen. Junius W. Jones

3 Apr 41-1 Sep 41

17th Wing Headquarters (Pursuit) (1924-29) (GHQR)

Organized Reserve Minnesota

HQ, 17th Pursuit Wing (1929-36)

HHS, 17th Pursuit Wing (1926-41)

HQ-Minneapolis, MN, 1924-26; St. Paul, MN, 1926-41

Subordinate units: 354th Pursuit Group 1924-33; 355th Pursuit Group 1924-33; 356th Pursuit Group 1924-33.

Constituted in the Organized Reserve on 31 March 1924 as 17th Wing Headquarters (Pursuit), assigned to the General Headquarters Reserve, and allotted to the Seventh Corps Area. Headquarters initiated in December 1924 at Minneapolis, MN. Relocated 26 May 1926 to St. Paul, MN. Redesignated as Headquarters, 17th Pursuit Wing on 8 May 1929. Inactivated by June 1929 at St. Paul by relief of personnel. Redesignated as Headquarters and Headquarters Squadron, 17th Pursuit Wing on 1 September 1936. Location 7 December 1941—*Inactive*.

Status: Disbanded on 31 May 1942.

Commanders, 17th Pursuit Wing

Unknown

Dec 24-Jun 29

17th Bombardment Wing

HQ-Savannah, GA 1940-41

Subordinate units: 3rd Bombardment Group 1940-41, 27th Bombardment Group 1940-41.

Constituted in the Regular Army 3 October 1940. Activated on 18 December 1940 at Savannah Field, GA. Inactivated on 1 September 1941 at Savannah Field, GA. Location 7 December 1941—*Inactive*.

Events: 310, 328

Commanders, 17th Bombardment Wing

Brig. Gen. Louis H. Brereton

18 Dec 40-1 Aug 41

Col. Asa N. Duncan

1 Aug 41-1 Sep 41

18th Wing Headquarters (Pursuit) (1924-29) (GHQR)

Organized Reserve Texas

HQ, 18th Pursuit Wing (1929-36)

HHS, 18th Pursuit Wing (1936-41)

HQ-*Not initiated* 1924-41

Constituted in the Organized Reserve on 31 March 1924 as 18th Pursuit Wing Headquarters, assigned to the General Headquarters Reserve, and allotted to the Eighth Corps Area. Dallas, TX, designated on 12 October 1928 as headquarters on organization, but the unit was never organized at that location. Redesignated as Headquarters, 18th

Pursuit Wing on 8 May 1929. Redesignated as Headquarters and Headquarters Squadron, 18th Pursuit Wing on 1 September 1936. Location 7 December 1941—*Not initiated*.

Status: Disbanded on 31 May 1942.

HQ, 18th Composite Wing (1929-37) (Hawaiian Department)

HHS, 18th Wing (1937-40)

HHS, 18th Bombardment Wing (1940-41)

HQ-Not organized 1929-31; Fort Shafter, TH, 1931-37; Hickam Field, TH, 1937-41

Subordinate units: 5th Composite Group 1929-39, 5th Bombardment Group 1939-41, 18th Pursuit Group 1929-41, Base Headquarters and 17th Air Base Squadron 1936-41, Base Headquarters and 18th Air Base Squadron 1936-41.

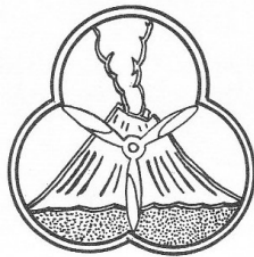

Constituted in the Regular Army on 8 May 1929 as Headquarters, 18th Composite Wing, assigned to the Hawaiian Department, and allotted to the Eighth Corps Area. Kelly Field, TX, designated as headquarters on organization, but the unit was never organized at that location. Designated mobilization training station was the Air Corps Training Center, Kelly Field. Activated on 1 May 1931 at Fort Shafter, TH. Redesignated as Headquarters and Headquarters Squadron, 18th Wing on 1 September 1937. Transferred on 30 October 1937 to Hickam Field. Redesignated as Headquarters and Headquarters Squadron, 18th Bombardment Wing on 19 October 1940. As such, the wing mission was to provide command and control of bombardment aviation operations in the Hawaiian Department. Assigned to the Hawaiian Air Force on 2 Nov 1940. Location 7 December 1941—Hickam Field, TH.

Events: 141, 158, 211, 225, 248, 276, 291, 297, 312

Commanders, 18th Wing

Lt. Col. Gerald C. Brant	1 May 31-17 Aug 34	Lt. Col. Robert C. Candee	18 Jul 38-30 Sep 38
Lt. Col. Delos C. Emmons	17 Aug 34-7 Jul 36	Brig. Gen. Walter H. Frank	30 Sep 38-Jul 40
Lt. Col. John C. McDonnell	7 Jul 36-9 Jul 36	Col. Shepler W. FitzGerald	Jul 40-Oct 40
Lt. Col. Hume Peabody	9 Jul 36-24 Jul 36	Col. Howard C. Davidson	Oct 40-Oct 40
Lt. Col. John C. McDonnell	24 Jul 36-9 Sep 36	Brig. Gen. Walter H. Frank	Oct 40-Nov 40
Brig. Gen. Barton K. Yount	12 Sep 36-18 Jul 28	Brig. Gen. Jacob W. Rudolf	Nov 40-Dec 41

19th Wing Headquarters (Pursuit) (1928-29) (GHQR)

Organized Reserve Texas

HQ, 19th Pursuit Wing (1929-33)

HQ-Not initiated 1928-41

Constituted in the Organized Reserve on 5 September 1928 as 19th Wing Headquarters (Pursuit), assigned to the General Headquarters Reserve, and allotted to the Eighth Corps Area. Houston, TX, designated on 12 October 1928 as headquarters on organization, but unit was never organized at that location. Redesignated as Headquarters, 19th Pursuit Wing on 8 May 1929. Withdrawn from the Eighth Corps Area on 1 October 1933 and demobilized.

HQ, 19th Composite Wing (1929-37) (Panama Canal Department)

HHS, 19th Wing (1937-40)

HHS, 19th Bombardment Wing (1940-41)

HQ-Not organized 1929-31; Mitchel Field, NY, 1931-33; Albrook Field, CZ, 1933-41

Subordinate units: 6th Composite Group 1929-39, 6th Bombardment Group 1939-41, 16th Pursuit Group 1929-41, 20th Pursuit Group 1929-33, Base Headquarters and 15th Air Base Squadron 1936-41, Base Headquarters and 16th Air Base Squadron 1936-41.



Constituted in the Regular Army on 8 May 1929 as Headquarters, 19th Composite Wing, assigned to the Panama Canal Department, and allotted to the Eighth Corps Area. Kelly Field, TX, designated as headquarters on organization, but the unit was never organized at that location. Designated mobilization training station was the Air Corps Training Center, Kelly Field. Activated on 1 April 1931 at Mitchel Field, NY. The headquarters was apparently maintained in a cadre status during 1 Apr 1931-2 September 1933. Transferred to Albrook Field, CZ, and arrived there 25 January 1933. Headquarters Flight participated in a "Goodwill Flight" to San Juan, Costa Rica in May 1935. Redesignated as Headquarters and Headquarters Squadron, 19th Wing on 1 September 1937.

Redesignated as Headquarters and Headquarters Squadron, 19th Bombardment Wing on 19 October 1940. Wing mission was to provide command and control of bombardment aviation operations in the Panama Canal Department. Inactivated on 25 October 1941 at Albrook Field, CZ. Personnel and assets transferred to the concurrently activated VI Bomber Command.

Events: 202, 224, 245, 270, 292, 308, 333

Commanders, 19th Wing

2nd Lt. Jared V. Crabb	1 Apr 31-15 Mar 33	Lt. Col. Benjamin G. Weir	9 Sep 36-13 Oct 38
2nd Lt. Roland O. S. Akre	15 Mar 33-28 Mar 33	Lt. Col. Junius H. Houghton	10 Mar 36-18 Jul 36
2nd Lt. Neal E. Ausman	28 Mar 33-8 Apr 33	Lt. Col. Charles T. Phillips	18 Jul 36-20 Aug 36
2nd Lt. Jared V. Crabb	8 Apr 33-2 Sep 33	Brig. Gen. George H. Brett	20 Aug 36-9 Sep 38
Col. William C. McChord	2 Sep 33-11 Oct 35	Brig. Gen. Herbert A. Dargue	13 Oct 38-18 Oct 40
Lt. Col. John M. Reynolds	11 Oct 35-15 Dec 35	Brig. Gen. Douglas B. Netherwood	18 Oct 40-Aug 41
Lt. Col. Donald P. Muse	15 Dec 35-10 Mar 36	Brig. Gen. Edwin B. Lyon	Aug 41-25 Oct 41

20th Wing Headquarters (Pursuit) (1928-29) (GHQR)

Organized Reserve Oklahoma/New York

HQ, 20th Pursuit Wing (1929-36)

HHS, 20th Pursuit Wing (1936-41)

HQ-Not initiated 1928-35; Lawton, OK, 1935-36; *Inactive* 1936-41

Constituted in the Organized Reserve on 5 September 1928 as 20th Wing Headquarters (Pursuit), assigned to the General Headquarters Reserve, and allotted to the Eighth Corps Area. Post Field, OK, designated on 12 October 1928 as headquarters on organization. Redesignated as Headquarters, 20th Pursuit Wing on 8 May 1929. Headquarters initiated on 20 June 1935 at Lawton, OK. Withdrawn from the Eighth Corps Area on 5 June 1936 and allotted to the Second Corps Area. Inactivated on 31 October 1936 at Lawton by relief of personnel. Redesignated as Headquarters and Headquarters Squadron, 20th Pursuit Wing on 1 September 1936. Mitchel Field, NY, designated on 5 April 1937 as headquarters on reorganization, but the unit was never organized at that location. Location 7 December 1941—*Inactive*.

Status: Disbanded on 31 May 1942.

Commanders, 20th Pursuit Wing

Maj. Hugh R. Gilchrist	20 Jun 35-31 Oct 36	<i>Inactive</i>	31 Oct 36-7 Dec 41
------------------------	---------------------	-----------------	--------------------

HHS, 20th Bombardment Wing

HQ-Fort Douglas, UT 1940-41

Subordinate units: 7th Bombardment Group 1940-41, 42nd Bombardment Group 1941.

Constituted in the Regular Army on 19 October 1940. Activated on 18 December 1940 at Fort Douglas, UT. Inactivated on 1 September 1941 at Fort Douglas, UT. Location 7 December 1941—*Inactive*.

Commanders, 20th Bombardment Wing

Col. Shepler W. FitzGerald	Jan 41-7 Apr 41	Brig. Gen. Ralph Royce	7 Apr 41-12 May 41
	Col. Lowell W. Smith	12 May 41-1 Sep 41	

21st Air Wing Headquarters (School) (1924-28) (ZI)

Organized Reserve

HQ, 21st Wing (School) (1928-29)

HQ-Not initiated 1924-41

Constituted in the Organized Reserve on 23 March 1924 as the 21st Air Wing Headquarters (School), assigned to the 12th Air Brigade (School), and allotted to the Fifth Corps Area. Redesignated in July 1928 as Headquarters, 21st Wing (School). Withdrawn from the Eighth Corps Area on 5 September 1928. Location 7 December 1941—*Not initiated*.

Status: Disbanded on 31 May 1942.

HHS, 21st Bombardment Wing

HQ-New Orleans, LA, 1940-41; Barksdale Field, LA, 1941

Subordinate units: 30th Bombardment Group 1940-41, 38th Bombardment Group 1940-41, 2nd Reconnaissance Squadron 1935-40, 15th Reconnaissance Squadron 1940-41.

Constituted in the Regular Army on 19 October 1940. Activated on 1 November 1940 at New Orleans, LA. Transferred on 2 April 1941 to Barksdale Field, LA. Inactivated on 1 October 1941 at Barksdale Field, LA. Location 7 December 1941—*Inactive*.

Status: Disbanded 15 December 1942.

Commanders, 21st Bombardment Wing

Brig. Gen. Walter H. Frank

1 Nov 40-8 Apr 41
Col. Junius H. Houghton

Lt. Col. Clarence H. Welch
19 Jun 41-1 Oct 41

8 Apr 41-19 Jun 41

22nd Air Wing Headquarters (School) (1924-28) (ZI)

Organized Reserve Texas

HQ, 22nd Wing (School) (1928-29)

HQ-Not initiated 1924-41

Constituted in the Organized Reserve on 23 March 1924 as the 22nd Air Wing Headquarters (School), assigned to the 12th Air Brigade (School), and allotted to the Eighth Corps Area. San Antonio, TX, designated on 22 August 1927 as headquarters on organization, but the unit was never organized at that location. Redesignated in July 1928 as Headquarters, 22nd Wing (School). Withdrawn from the Eighth Corps Area on 5 September 1928. Location 7 December 1941—*Inactive*.

Status: Disbanded on 31 May 1942.

HHS, 22nd Pursuit Wing

HQ-Savannah, GA 1940-41

Constituted in the Regular Army on 19 October 1940. Activated about November 1940 at Savannah, GA. Inactivated in October 1941 at Savannah. Location 7 December 1941—*Inactive*.

Status: Disbanded 15 December 1942.

23rd Air Wing Headquarters (School) (1924-28) (ZI)

Organized Reserve

HQ, 23rd Wing (School) (1928-29)

HQ-Not initiated 1924-41

Constituted in the Organized Reserve on 23 March 1924 as the 23rd Air Wing Headquarters (School), assigned to the 12th Air Brigade (School), and allotted to the Eighth Corps Area. Redesignated in July 1928 as Headquarters, 23rd Wing (School). Withdrawn from the Eighth Corps Area on 5 September 1928. Location 7 December 1941—*Not initiated*.

Status: Disbanded on 31 May 1942.

24th Air Wing Headquarters (School) (1924-28) (ZI)

HQ, 24th Wing (School) (1928-29)

HQ, 24th School Wing (1929-31)

HQ-Not organized 1924-27; Kelly Field, TX, 1927-31

Subordinate units: 10th School Group 1927-31, 11th School Group 1927-31, 13th School Group 1927-31.

Constituted in the Organized Reserve on 23 March 1924 as the 24th Wing Headquarters (School), assigned to the 12th Air Brigade (School), and allotted to the Eighth Corps Area. Withdrawn from the Organized Reserve 1 August 1927 and allotted to the Regular Army. Concurrently activated at Kelly Field, TX, with personnel transferred from the 10th School Group. Performed duties as the headquarters for the Air Corps Flying Schools in the San Antonio area. Redesignated in Jul 1928 as Headquarters, 24th Wing (School). Redesignated 8 March 1929 as Headquarters, 24th School Wing. Demobilized on 1 October 1931 at Kelly Field, TX, and personnel transferred to the 10th School Group.

Commanders, 24th School Wing

Maj. James E. Chaney

31 Aug 27-6 Aug 30
Maj. Max F. Schneider

Maj. Frederick L. Martin
22 Sep 31-1 Oct 31

6 Aug 30-22 Sep 31

25th Air Wing Headquarters (School) (1924-28) (ZI)

Organized Reserve Texas

HQ, 25th Wing (School) (1928-41)

HQ-Not initiated 1924-41

Constituted in the Organized Reserve on 23 March 1924 as the 25th Air Wing Headquarters (School), assigned to the 12th Air Brigade (School), and allotted to the Eighth Corps Area. San Antonio, TX, designated on 22 August 1927 as headquarters on organization, but unit was never organized at that location. Redesignated in July 1928 as Headquarters, 25th Wing (School). Withdrawn from the Eighth Corps Area on 5 September 1928. Location 7 December 1941—*Not initiated*.

Status: Disbanded on 31 May 1942.

26th Air Wing Headquarters (School) (1924-28) (ZI)

Organized Reserve Texas

HQ, 26th Wing (School) (1928-41)

HQ-Not initiated 1924-41

Constituted in the Organized Reserve on 23 March 1924 as the 26th Air Wing Headquarters (School), assigned to the 12th Air Brigade (School), and allotted to the Eighth Corps Area. San Antonio, TX, designated on 22 August 1927 as headquarters on organization, but unit was never organized at that location. Redesignated in July 1928 as Headquarters, 26th Wing (School). Withdrawn from the Eighth Corps Area on 5 September 1928. Location 7 December 1941—*Not initiated*.

Status: Disbanded on 31 May 1942.

27th Air Wing Headquarters (School) (1924-28) (ZI)

Organized Reserve

HQ, 27th Wing (School) (1928-41)

HQ-Not initiated 1924-41

Constituted in the Organized Reserve on 23 March 1924 as the 27th Air Wing Headquarters (School), assigned to the 13th Air Brigade (School), and allotted to the Ninth Corps Area. Redesignated in July 1928 as Headquarters, 27th Wing (School). Withdrawn from the Ninth Corps Area on 5 September 1928. Location 7 December 1941—*Not initiated*.

Status: Disbanded on 31 May 1942.

28th Air Wing Headquarters (School) (1924-28) (ZI)

Organized Reserve

HQ, 28th Wing (School) (1928-41)

HQ-Not initiated 1924-41

Constituted in the Organized Reserve on 23 March 1924 as the 28th Air Wing Headquarters (School), assigned to the 13th Air Brigade (School), and allotted to the Ninth Corps Area. Redesignated in July 1928 as Headquarters, 28th Wing (School). Withdrawn from the Ninth Corps Area on 5 September 1928. Location 7 December 1941—*Not initiated*.

Status: Disbanded on 31 May 1942.

29th Air Wing Headquarters (School) (1924-28) (ZI)

Organized Reserve

HQ, 29th Wing (School) (1928-41)

HQ-Not initiated 1924-41

Constituted in the Organized Reserve on 23 March 1924 as the 29th Air Wing Headquarters (School), assigned to the 13th Air Brigade (School), and allotted to the Ninth Corps Area. Redesignated in July 1928 as Headquarters, 29th Wing (School). Withdrawn from the Ninth Corps Area on 5 September 1928. Location 7 December 1941—*Not initiated*.

Status: Disbanded on 31 May 1942.

30th Air Wing Headquarters (School) (1924-28) (ZI)

Organized Reserve

HQ, 30th Wing (School) (1928-41)

HQ-Not initiated 1924-41

Constituted in the Organized Reserve on 23 March 1924 as the 30th Air Wing Headquarters (School), assigned to the 14th Air Brigade (School), and allotted to the Second Corps Area. Redesignated in July 1928 as Headquarters, 30th Wing (School). Withdrawn from the Second Corps Area on 5 September 1928. Location 7 December 1941—*Not initiated*.

Status: Disbanded on 31 May 1942.

31st Air Wing Headquarters (School) (1924-28) (ZI)

Organized Reserve

HQ, 31st Wing (School) (1928-41)

HQ-Not initiated 1924-41

Constituted in the Organized Reserve on 23 March 1924 as the 31st Air Wing Headquarters (School), assigned to the 14th Air Brigade (School), and allotted to the Second Corps Area. Redesignated in July 1928 as Headquarters, 31st Wing (School). Withdrawn from the Second Corps Area on 5 September 1928. Location 7 December 1941—*Not initiated*.

Status: Disbanded on 31 May 1942.

32nd Air Wing Headquarters (School) (1924-28) (ZI)

Organized Reserve

HQ, 32nd Wing (School) (1928-41)

HQ-Not initiated 1924-41

Constituted in the Organized Reserve on 23 March 1924 as the 32nd Air Wing Headquarters (School), assigned to the 14th Air Brigade (School), and allotted to the Second Corps Area. Redesignated in July 1928 as Headquarters, 32nd Wing (School). Withdrawn from the Second Corps Area on 5 September 1928. Location 7 December 1941—*Not initiated*.

Status: Disbanded on 31 May 1942.

33rd Airship Wing Headquarters (School) (1924-28) (ZI)

Organized Reserve

HQ, 33rd Airship Wing (School) (1928-41)

HQ-Not initiated 1924-41

Subordinate units: 21st Airship Group 1924-28

Constituted in the Organized Reserve on 23 March 1924 as the 33rd Air Wing Headquarters (School) and allotted to the Sixth Corps Area. Redesignated in July 1928 as Headquarters, 33rd Wing (School). Withdrawn from the Sixth Corps Area on 5 September 1928. Location 7 December 1941—*Not initiated*.

Status: Disbanded on 31 May 1942.

34th Airship Wing Headquarters (School) (1924-28) (ZI)

Organized Reserve

HQ, 34th Airship Wing (School) (1928-41)

HQ-Not initiated 1924-41

Subordinate units: 432nd Airship Group 1924-28

Constituted in the Organized Reserve on 23 March 1924 as the 34th Air Wing Headquarters (School) and allotted to the Sixth Corps Area. Redesignated in July 1928 as Headquarters, 34th Wing (School). Withdrawn from the Sixth Corps Area on 5 September 1928. Location 7 December 1941—*Not initiated*.

Status: Disbanded on 31 May 1942

Chapter 29

Headquarters, Air Service and Aviation



A Curtiss O-11 from the 101st Observation Squadron undergoes inspection circa 1928.

Headquarters, Air Service (redesignated Headquarters, Aviation in 1928) were authorized at three command levels: army, corps, and division. These commands provided command and control for assigned or attached army air service and air corps units.

Organization

The army air service possessed all assets required for conducting tactical operations in support of the field army. The service's mission was to achieve air supremacy over the field army's airspace to allow the service's attack squadrons the freedom to attack enemy formations and key installations as well as cooperate with ground units as they maneuvered to engage enemy forces. The army air service consisted of a headquarters and an attack wing of one attack group and two pursuit groups. Separate from the wing, but part of the air service, were an observation group, a communications section, three airdrome companies, an ordnance maintenance company, and a headquarters squadron. All six of the field army air service headquarters were constituted in the Organized Reserve and initiated. All six were inactive by 1929.

The corps air service possessed assets required for selected tactical operations in support of the corps. The service performed visual and photographic reconnaissance missions, command observation missions, spotting for the adjustment of artillery fire, and maintained contact with wide-spread infantry and supporting cavalry formations. The service could supplement divisions for various operations and attach balloon companies to both the corps and division artillery to perform spotting services. The corps air service consisted of a headquarters, one observation group, and one balloon group. Six of the corps air service headquarters were constituted in the National Guard and twelve in the Organized Reserve. None of the National Guard corps air service headquarters were ever organized; all twelve of those in the

Organized Reserve were initiated during 1921-22. As with the army level headquarters, all corps air service headquarters were inactivated by 1929.

The division air service possessed assets required for conducting selected tactical operations in support of the division and performed missions similar to those of the corps air service. The service consisted of a headquarters, and observation squadron, an air intelligence section, and a photographic section. A division air service was provided for each of the National Guard and Organized Reserve infantry divisions in 1921. For some reason, the Regular Army divisions were not authorized an air service until 1923. Cavalry divisions were authorized a division air service in 1927, but the units were eliminated from all types of divisions less than two years later in 1929. All division air service headquarters were demobilized that year and their subordinate elements were reassigned to corps observation groups.

None of the air service headquarters at army and corps level were functional units, and therefore, none ever functioned as actual headquarters. The divisional air service headquarters—RA, NG, and OR—were almost always collocated with the observation squadrons that were assigned to them. In fact, more often than not, the observation squadron commander also functioned as the air service commander (though that arrangement was not intended for wartime operations). Therefore, most RA and NG division air services did function as command headquarters, though as a command level, they often seemed to be indistinguishable from their subordinate observation squadron due to the dual command functions of the squadron commander. The OR headquarters were functional only as far as their participation in the Inactive Training Period activities and summer camps. They did not exercise command functions as a separate headquarters except perhaps during CPXs.

Training

Since none of the army and corps level air service headquarters were functional units, the Inactive Training Period activities of the personnel assigned to those units were generally limited to training attendance with other units, troop schools, or correspondence courses. None of these units attended camps as organizations.

The Regular Army division air services generally supported the training of their respective divisions. They performed reconnaissance missions for the ground units and often played the role of enemy attack and observation aircraft to help train the ground units in reacting to aircraft attacks and camouflaging against aerial observation. These units also participated in many of the various air corps maneuvers in the 1920s and 30s as well. Additionally, Regular Army units assisted the summer training of various RAI and OR air service units as well.

The National Guard division air service units were also frequently integrated into their division's summer training and performed a number of other types of training missions as well. In addition to normal flight training operations, National Guard air services were employed in search and rescue missions, forest fire patrols, aerial photography and mapping missions, and aerial observation support to assist field and coast artillery organizations during live-fire exercises.

Since most OR division air service headquarters did not function as separate and distinct units from their subordinate observation squadrons, they did not have training activities separate from their subordinate units. However, because many of the divisional observation squadrons were some of the best-equipped and most active flying units in the OR, the few personnel assigned to an air service headquarters benefited from the training held by those squadrons during the Inactive Training Period. The headquarters typically attended summer training with the squadron as well.

Headquarters, First Army Air Service**Organized Reserve New Hampshire**

HQ—*Not initiated* 1921-22; Dover, NH, 1922-29; *Inactive* 1929-41

Subordinate units: 3rd Attack Wing 1923-28; 3rd Attack Group 1923-28; 1st Pursuit Group 1923-28; 9th Observation Group 1923-28; 446th Headquarters Squadron 1923-28; 410th Airdrome Company; 412th Airdrome Company; 381st Ordnance Company (M)

Constituted in the Organized Reserve 15 October 1921 as Headquarters, First Army Air Service, assigned to the First Army and allotted to the First Corps Area. Headquarters initiated in November 1922 at Dover, NH. Withdrawn from the Organized Reserve and First Corps Area on 5 September 1928 and allotted to the Regular Army. Inactivated on 9 December 1929 at Dover by relief of personnel. Location 7 December 1941—*Inactive*.

Commanders, First Army Air Service Headquarters

1st Lt. John T. Murtha
Unknown

9 Feb 23-ao Mar 23
ao Mar 23-ao Jul 24

Capt. George W. Snow
Unknown

ao Jul 24-ao Jul 26
ao Jul 26-9 Dec 29

Headquarters, Second Army Air Service**Organized Reserve Ohio**

HQ—*Not initiated* 1921-22; Dayton, OH, 1922-28; *Inactive* 1928-41

Subordinate units: 9th Attack Wing 1923-28, 319th Attack Group 1923-28; 306th Pursuit Group 1923-28; 317th Observation Group 1923-28; 413th Headquarters Squadron 1923-28; 405th Airdrome Company; 415th Airdrome Company; 402nd Ordnance Company (M)

Constituted in the Organized Reserve 15 October 1921 as Headquarters, Second Army Air Service, assigned to the Second Army and allotted to the Fifth Corps Area. Headquarters initiated in April 1922 at Dayton, OH. Withdrawn from the Organized Reserve on 5 September 1928 and inactivated at Dayton. Location 7 December 1941—*Inactive*.

Commanders, Second Army Air Service Headquarters

Capt. John V. Kampman

Apr 22-12 Sep 24

Lt. Col. William F. Long

12 Sep 24-5 Sep 28

Headquarters, Third Army Air Service**Organized Reserve California**

HQ—*Not initiated* 1921-22; San Francisco, CA, 1922-28; *Inactive* 1928-41

Subordinate units: 8th Attack Wing 1923-28, 321st Attack Group 1923-28; 304th Pursuit Group 1923-28; 320th Observation Group 1923-28; 480th Headquarters Squadron 1923-28; 417th Airdrome Company; 418th Airdrome Company; 383rd Ordnance Company (M)

Constituted in the Organized Reserve 15 October 1921 as Headquarters, Third Army Air Service, assigned to the Third Army and allotted to the Ninth Corps Area. Headquarters initiated in October 1922 at San Francisco, CA. Withdrawn from the Organized Reserve on 5 September 1928 and inactivated at San Francisco. Location 7 December 1941—*Inactive*.

Commanders, Third Army Air Service Headquarters

Maj. Edgar G. Tobin

Oct 22-23 Feb 23

Unknown

23 Feb 23-5 Sep 28

Headquarters, Fourth Army Air Service**Organized Reserve New York**

HQ—*Not initiated* 1921-22; Governors Island, NY, 1922-29; *Inactive* 1929-41

Subordinate units: 6th Attack Wing 1923-28; 303rd Attack Group 1923-28; 302nd Pursuit Group 1923-28; 307th Observation Group 1923-28; 394th Headquarters Squadron 1923-28; 402nd Airdrome Company; 403rd Airdrome Company; 366th Ordnance Company (M)

Constituted in the Organized Reserve 15 October 1921 as Headquarters, Fourth Army Air Service, assigned to the Fourth Army and allotted to the Second Corps Area. Headquarters initiated on 17 February 1922 at Governors Island, NY. Withdrawn from the Organized Reserve on 5 September 1928. Inactivated on 4 March 1929 at Governors Island by relief of personnel. Location 7 December 1941—*Inactive*.

Commanders, Fourth Army Air Service Headquarters

Maj. Henry Abby, Jr.	17 Feb 22-30 Mar 22	Col. Halsey Dunwoody	30 Mar 22-4 Mar 29
----------------------	---------------------	----------------------	--------------------

Headquarters, Fifth Army Air Service

Organized Reserve Kentucky

HQ-*Not initiated* 1921-22; Henderson, KY, 1922-28; *Inactive* 1928-41

Subordinate units: 7th Attack Wing 1923-28; 305th Attack Group 1923-28; 308th Pursuit Group 1923-28; 315th Observation Group 1923-28; 466th Headquarters Squadron 1923-28; 406th Airdrome Company; 416th Airdrome Company; 385th Ordnance Company (M)

Constituted in the Organized Reserve 15 October 1921 as Headquarters, Fifth Army Air Service, assigned to the Fifth Army and allotted to the Fifth Corps Area. Headquarters initiated in January 1922 at Henderson, KY. Withdrawn from the Organized Reserve on 5 September 1928 and inactivated at Henderson. Location 7 December 1941—*Inactive*.

Commanders, Fifth Army Air Service Headquarters

Maj. Jack Doublin	Jan 22-ao Jan 23	Unknown	ao Jan 23-5 Sep 28
-------------------	------------------	---------	--------------------

Headquarters, Sixth Army Air Service

Organized Reserve Texas/California

HQ-*Not initiated* 1921-23; San Antonio, TX, 1923-24; San Francisco, CA, 1924-28; *Inactive* 1928-41

Subordinate units: 11th Attack Wing 1923-28; 309th Attack Group 1923-28; 310th Pursuit Group 1923-28; 312th Observation Group 1923-28; 439th Headquarters Squadron 1923-28; 407th Airdrome Company; 411th Airdrome Company; 379th Ordnance Company (M)

Constituted in the Organized Reserve 15 October 1921 as Headquarters, Sixth Army Air Service, assigned to the Sixth Army and allotted to the Eighth Corps Area. Headquarters initiated on 26 February 1923 at San Antonio, TX. Withdrawn from the Eighth Corps Area 13 June 1924 and allotted to the Ninth Corps Area. Headquarters reorganized in 1924 at San Francisco, CA. Withdrawn from the Organized Reserve on 5 September 1928 and inactivated at San Francisco. Location 7 December 1941—*Inactive*.

Commanders, Sixth Army Air Service Headquarters

Capt. Raymond A. Tolbert	26 Feb 23-13 Jun 24	Unknown	13 Jun 24-5 Sep 28
--------------------------	---------------------	---------	--------------------

Headquarters, I Corps Air Service

Massachusetts National Guard

HQ-*Not organized* 1921-41

Subordinate units: 323rd Observation Group 1923-28; 11th Balloon Group 1921-23; 132nd Balloon Group 1923; 552nd Balloon Group 1923-28

Constituted in the National Guard in 1921 as Headquarters, I Corps Air Service, assigned to the I Corps and allotted to the state of Massachusetts. Withdrawn from the state of Massachusetts 1 January 1927 and allotted to the Fifth Corps Area as an Organized Reserve unit. Withdrawn from the Organized Reserve 18 October 1927 and allotted to the Regular Army. Withdrawn from the Fifth Corps Area on 5 September 1928. Location 7 December 1941—*Not organized*.

Headquarters, II Corps Air Service**Organized Reserve New York****HQ**-Manhattan, NY, 1921-28; *Inactive* 1928-41**Subordinate units:** 325th Observation Group 1921-28; 50th Balloon Group 1921-23; 550th Balloon Group 1923-28

Constituted in the Organized Reserve 15 October 1921 as Headquarters, II Corps Air Service, assigned to the II Corps and allotted to the Second Corps Area. Headquarters initiated on 2 November 1921 at Manhattan, NY. Withdrawn from the Organized Reserve 18 October 1927 and allotted to the Regular Army. Withdrawn from the Second Corps Area on 5 September 1928 and inactivated at Manhattan. Location 7 Dec 1941—*Inactive*.

Commanders, II Corps Air Service Headquarters

Capt. Robert G. Macks
 Capt. Robert W. Carroll

2 Nov 21-21 Oct 22
 21 Oct 22-1 Mar 23

Maj. Grover O' Neill
 Maj. Alfred P. Grimm

1 Mar 23-21 Apr 25
 21 Apr 25-31 Aug 28

Headquarters, III Corps Air Service**Pennsylvania National Guard****HQ**-*Not organized* 1921-41**Subordinate units:** 328th Observation Group 1923-28; 12th Balloon Group 1921-23; 133rd Balloon Group 1923; 553rd Balloon Group 1923-28

Constituted in the National Guard in 1921 as Headquarters, III Corps Air Service, assigned to the III Corps and allotted to the state of Pennsylvania. Withdrawn from the National Guard 1 January 1927 and allotted to the Third Corps Area as an Organized Reserve unit but was never organized. Withdrawn from the Organized Reserve 18 October 1927 and allotted to the Regular Army. Withdrawn from the Third Corps Area on 5 September 1928. Location 7 December 1941—*Not organized*.

Headquarters, IV Corps Air Service**Alabama/Louisiana National Guard****HQ**-*Not organized* 1921-41**Subordinate units:** 12th Observation Group 1923-27; 13th Balloon Group 1921-23; 134th Balloon Group 1923; 554th Balloon Group 1923-27

Constituted in the National Guard in 1921 as Headquarters, IV Corps Air Service, assigned to the IV Corps and allotted to the state of Alabama. Birmingham, AL, designated as headquarters upon organization, but the unit was never organized at that location. Withdrawn from the Alabama National Guard 2 September 1925 and allotted to the Louisiana National Guard. Withdrawn from the Louisiana National Guard 22 June 1927 and allotted to the Fourth Corps Area as an Organized Reserve unit. Atlanta, GA, designated as the headquarters upon organization, but the unit was never organized at that location. Withdrawn from the Fourth Corps Area on 5 September 1928. Location 7 December 1941—*Not organized*.

Headquarters, V Corps Air Service**Indiana National Guard****HQ**-*Not organized* 1921-41**Subordinate units:** 333rd Observation Group 1923-27; 14th Balloon Group 1921-23; 135th Balloon Group 1923; 555th Balloon Group 1923-27

Constituted in the National Guard in 1921 as Headquarters, V Corps Air Service, assigned to the V Corps and allotted to the state of Indiana. Withdrawn from the Indiana National Guard and from the Fifth Corps Area 22 June 1927. Location 7 December 1941—*Not organized*.

Headquarters, VI Corps Air Service**Illinois National Guard****HQ**-*Not organized* 1921-41**Subordinate units:** 335th Observation Group 1923-27; 15th Balloon Group 1921-23; 136th Balloon Group 1923; 556th Balloon Group 1923-27Constituted in the National Guard in 1921 as Headquarters, VI Corps Air Service, assigned to the VI Corps and allotted to the state of Illinois. Withdrawn from the Illinois National Guard and from the Sixth Corps Area 22 June 1927. Location 7 December 1941—*Not organized*.**Headquarters, VII Corps Air Service****Missouri National Guard****HQ**-*Not organized* 1921-27**Subordinate units:** 336th Observation Group 1923-27; 16th Balloon Group 1921-23; 137th Balloon Group 1923; 557th Balloon Group 1923-27Constituted in the National Guard in 1921 as Headquarters, VII Corps Air Service, assigned to the VII Corps and allotted to the state of Missouri. Placed on the deferred list 2 July 1923, and unit requirement transferred to the Organized Reserve as a Deferred National Guard unit. Omaha, NE, designated as headquarters upon activation as an Organized Reserve unit, but the unit was never organized. Withdrawn from the Missouri National Guard and from the Seventh Corps Area 22 June 1927. Location 7 December 1941—*Not organized*.**Headquarters, VIII Corps Air Service****Organized Reserve Texas****HQ**-*Not initiated* 1921-22; Fort Sam Houston, TX, 1922-28; *Inactive* 1928-41**Subordinate units:** 338th Observation Group 1923-28; 51st Balloon Group 1921-23; 548th Balloon Group 1923-28Constituted in the Organized Reserve 15 October 1921 as Headquarters, VIII Corps Air Service, assigned to the VIII Corps and allotted to the Eighth Corps Area. Headquarters initiated on 26 July 1922 at Fort Sam Houston, TX. Withdrawn from the Eighth Corps Area on 5 September 1928 and inactivated at Fort Sam Houston. Location 7 December 1941—*Inactive*.**Commanders, VIII Corps Air Service Headquarters**

Maj. Edgar G. Tobin

26 Jul 22-23 Feb 23
UnknownCapt. Penrose B. Metcalf
ao Mar 25-5 Sep 28

23 Feb 23-ao Mar 26

Headquarters, IX Corps Air Service**Organized Reserve California****HQ**-*Not initiated* 1921-22; San Francisco, CA, 1922-28; *Inactive* 1928-41**Subordinate units:** 341st Observation Group 1923-28; 15th Balloon Group 1921-23; 138th Balloon Group 1923; 549th Balloon Group 1923-28Constituted in the Organized Reserve 15 October 1921 as Headquarters, IX Corps Air Service, assigned to the IX Corps and allotted to the Ninth Corps Area. Headquarters initiated on 5 September 1922 at San Francisco, CA. Withdrawn from the Ninth Corps Area on 5 September 1928 and inactivated at San Francisco. Location 7 December 1941—*Inactive*.**Commanders, IX Corps Air Service Headquarters**

Capt. Stephen S. Barrows

5 Sep 22-ao Jan 23

Unknown

ao Jan 23-5 Sep 28

Headquarters, XI Corps Air Service**Organized Reserve Massachusetts****HQ**-*Not initiated* 1921-22; Boston, MA, 1922-28; *Inactive* 1928-41

Subordinate units: 301st Observation Group 1923-28; 41st Balloon Group 1921-23; 541st Balloon Group 1923-28
 Constituted in the Organized Reserve 15 October 1921 as Headquarters, XI Corps Air Service, assigned to the XI Corps and allotted to the First Corps Area. Headquarters initiated in March 1922 at Boston, MA. Withdrawn from the First Corps Area on 5 September 1928 and inactivated at Boston. Location 7 December 1941—*Inactive*.

Commanders, XI Corps Air Service Headquarters

Col. Arthur D. Butterfield	Mar 22-ao Feb 24	Unknown	ao Feb 24-ao Apr 26
	Capt. Howard W. Nestor	ao Apr 26-5 Sep 28	

Headquarters, XII Corps Air Service

Organized Reserve New York

HQ-Albany, NY, 1921-28; *Inactive* 1928-41

Subordinate units: 324th Observation Group 1921-28; 42nd Balloon Group 1921-23; 542nd Balloon Group 1923-28
 Constituted in the Organized Reserve 15 October 1921 as Headquarters, XII Corps Air Service, assigned to the XII Corps and allotted to the Second Corps Area. Headquarters initiated on 2 November 1921 at Albany, NY. Withdrawn from the Second Corps Area on 5 September 1928 and inactivated at Albany. Location 7 December 1941—*Inactive*.

Commanders, XII Corps Air Service Headquarters

Unknown	2 Nov 21-21 Oct 22	Maj. Robert G. Thach	1 Mar 23-27 Nov 23
Maj. Edward L. Hazeltine	21 Oct 22-1 Mar 23	Unknown	27 Nov 23-5 Sep 28

Headquarters, XIII Corps Air Service

Organized Reserve Pennsylvania

HQ-*Not initiated* 1921-22; Pittsburgh, PA, 1922-28

Subordinate units: 330th Observation Group 1921-28; 43rd Balloon Group 1921-23; 543rd Balloon Group 1923-28
 Constituted in the Organized Reserve 15 October 1921 as Headquarters, XIII Corps Air Service, assigned to the XIII Corps and allotted to the Third Corps Area. Headquarters initiated on 24 August 1922 at Pittsburgh, PA. Withdrawn from the Third Corps Area on 5 September 1928 and inactivated at Pittsburgh. Location 7 December 1941—*Inactive*.

Commanders, XIII Corps Air Service Headquarters

Col. Robert L. Montgomery	24 Aug 22-31 Jan 25	Unknown	31 Jan 25-5 Sep 28
---------------------------	---------------------	---------	--------------------

Headquarters, XIV Corps Air Service

Organized Reserve Georgia

HQ-*Not initiated* 1921-22; Atlanta, GA, 1922-28; *Inactive* 1928-41

Subordinate units: 331st Observation Group 1921-28; 44th Balloon Group 1921-23; 554th Balloon Group 1923-28
 Constituted in the Organized Reserve 15 October 1921 as Headquarters, XIV Corps Air Service, assigned to the XIV Corps and allotted to the Fourth Corps Area. Headquarters initiated on 31 August 1922 at Atlanta, GA. Withdrawn from the Fourth Corps Area on 5 September 1928 and inactivated at Atlanta. Location 7 December 1941—*Inactive*.

Commanders, XIV Corps Air Service Headquarters

Maj. Robert B. Stephens	31 Aug 22-ao Sep 22	Unknown	ao Sep 22-5 Sep 28
-------------------------	---------------------	---------	--------------------

Headquarters, XV Corps Air Service

Organized Reserve Ohio

HQ-*Not initiated* 1921-22; Wilmington, OH, 1922-28; *Inactive* 1928-41

Subordinate units: 332nd Observation Group 1921-28; 45th Balloon Group 1921-23; 555th Balloon Group 1923-28

Constituted in the Organized Reserve 15 October 1921 as Headquarters, XV Corps Air Service, assigned to the XV Corps and allotted to the Fifth Corps Area. Headquarters initiated in September 1922 at Wilmington, OH. Withdrawn from the Fifth Corps Area on 5 September 1928 and inactivated at Wilmington. Location 7 December 1941—*Inactive*.

Commanders, XV Corps Air Service Headquarters

1st Lt. Russell S. Haines	Sep 22-8 Jan 23 Unknown	1st Lt. Francis J. Gaynor ao Apr 23-5 Sep 28	15 Mar 23-ao Apr 23
---------------------------	----------------------------	---	---------------------

Headquarters, XVI Corps Air Service

Organized Reserve Wisconsin

HQ-*Not initiated* 1921-23; Milwaukee, WI, 1923-28; *Inactive* 1928-41

Subordinate units: 334th Observation Group 1921-28; 46th Balloon Group 1921-23; 546th Balloon Group 1923-28

Constituted in the Organized Reserve 15 October 1921 as Headquarters, XVI Corps Air Service, assigned to the XVI Corps and allotted to the Sixth Corps Area. Headquarters initiated on 2 April 1923 at Milwaukee, WI. Withdrawn from the Sixth Corps Area on 5 September 1928 and inactivated at Milwaukee. Location 7 December 1941—*Inactive*.

Commanders, XVI Corps Air Service Headquarters

Maj. Emil F. Schwab	2 Apr 23-20 Apr 23 Unknown	Maj. Vivian A. C. Henman ao May 23-5 Sep 28	20 Apr 23-ao May 23
---------------------	-------------------------------	--	---------------------

Headquarters, XVII Corps Air Service

Organized Reserve Kansas

HQ-*Not initiated* 1921-22; Topeka, KS, 1922-28; *Inactive* 1928-41

Subordinate units: 337th Observation Group 1921-28; 47th Balloon Group 1921-23; 547th Balloon Group 1923-28

Constituted in the Organized Reserve 15 October 1921 as Headquarters, XVII Corps Air Service, assigned to the XVII Corps and allotted to the Seventh Corps Area. Headquarters initiated in June 1922 at Topeka, KS. Withdrawn from the Seventh Corps Area on 5 September 1928 and inactivated at Topeka. Location 7 December 1941—*Inactive*.

Commanders, XVII Corps Air Service Headquarters

Unknown	Jun 22-5 Sep 28
---------	-----------------

Headquarters, XVIII Corps Air Service

Organized Reserve Texas

HQ-*Not initiated* 1921-22; San Antonio, TX, 1922-28; *Inactive* 1928-41

Subordinate units: 339th Observation Group 1921-28; 48th Balloon Group 1921-23; 551st Balloon Group 1923-28

Constituted in the Organized Reserve 15 October 1921 as Headquarters, XVIII Corps Air Service, assigned to the XVIII Corps and allotted to the Eighth Corps Area. Headquarters initiated on 23 April 1922 at San Antonio, TX. Withdrawn from the Eighth Corps Area on 5 September 1928 and inactivated at San Antonio. Location 7 December 1941—*Inactive*.

Commanders, XVIII Corps Air Service Headquarters

Capt. Malcolm J. Buchanan	23 Apr 22-Mar 23	Unknown	ao Apr 23-ao Nov 25
Maj. Benjamin Chilton	Mar 23-ao Apr 23 Unknown	Maj. Malcolm J. Buchanan Jan 28-5 Sep 28	ao Nov 25-Jan 28

Headquarters, XIX Corps Air Service

Organized Reserve California

HQ-*Not initiated* 1921-22; Los Angeles, CA, 1922-28; *Inactive* 1928-41

Subordinate units: 340th Observation Group 1921-28; 49th Balloon Group 1921-23; 558th Balloon Group 1923-28

Constituted in the Organized Reserve 15 October 1921 as Headquarters, XIX Corps Air Service, assigned to the XIX Corps and allotted to the Ninth Corps Area. Headquarters initiated in February 1922 at Los Angeles, CA. Withdrawn

from the Ninth Corps Area on 5 September 1928 and inactivated at Los Angeles. Location 7 December 1941—*Inactive*.

Commanders, XIX Corps Air Service Headquarters

Unknown	Feb 22-5 Sep 22 Unknown	Lt. Col. Fred J. Martel ao Jan 23-5 Sep 28	5 Sep 22-ao Jan 23
---------	----------------------------	---	--------------------

Headquarters, 1st Division Air Service

HQ-Mitchel Field, NY, 1923-29

Subordinate units: 5th Observation Squadron 1923-29; 14th Photo Section 1923-29

Constituted in the Regular Army 24 March 1923, assigned to the 1st Division, and allotted to the Second Corps Area. Headquarters organized on 5 May 23 at Mitchel Field, NY. Redesignated as Headquarters, 1st Division Aviation on 10 March 1928. Demobilized on 15 February 1929.

Organization Day: 5 May. Chosen to commemorate the unit's date of organization, 5 May 1923.

Events: 60, 71

Commanders, 1st Division Air Service Headquarters

Capt. Ira C. Eaker	1 Jun 23-19 Sep 23	1st Lt. Marion L. Elliott	21 Jul 26-7 Jan 27
1st Lt. Samuel M. Connell	19 Sep 23-1 Oct 24	1st Lt. Charles P. Prime	7 Jan 27-22 Mar 28
Capt. Harold M. McClelland	1 Oct 24-5 Sep 25	Capt. Walcott P. Hayes	22 Mar 28-28 Jun 28
1st Lt. Samuel M. Connell	5 Sep 25-21 Jul 26	1st Lt. Byron E. Gates	28 Jun 28-15 Feb 29

Headquarters, 1st Cavalry Division Air Service

HQ-Mitchel Field, NY, 1927-29

Subordinate units: 1st Observation Squadron 1927-29; 8th Photo Section 1927-29

Constituted in the Regular Army 15 August 1927, assigned to the 1st Cavalry Division, and allotted to the Second Corps Area. Headquarters organized on 15 August 1927 at Mitchel Field, NY. Redesignated as Headquarters, 1st Cavalry Division Aviation on 10 March 1928. Demobilized on 15 February 1929.

Commanders, 1st Cavalry Division Air Service Headquarters

1st Lt. Newton Longfellow	15 Aug 27-27 Feb 28	1st Lt. Newman R. Laughinghouse	27 Feb 28-15 Feb 29
---------------------------	---------------------	---------------------------------	---------------------

Headquarters, 2nd Division Air Service

HQ-Biggs Field, TX, 1923-26; Dodd Field, TX, 1926-29

Subordinate units: 12th Observation Squadron 1924-29; 1st Photo Section 1923-29

Constituted in the Regular Army 24 March 1923, assigned to the 2nd Division, and allotted to the Eighth Corps Area. Headquarters organized on 31 March 1923 at Biggs Field, Fort Bliss, TX. Attached to the 1st Cavalry Division in June 1924. Relieved from attachment to the 1st Cavalry Division 22 June 1926 and transferred to Dodd Field, Fort Sam Houston, TX. Redesignated as Headquarters, 2nd Division Aviation on 10 March 1928. Demobilized on 15 February 1929.

Commanders, 2nd Division Air Service Headquarters

Maj. Leo G. Heffernan	1 Mar 23-29 Jun 25	Capt. Clearton N. Reynolds	6 Jan 28-20 Aug 29
Maj. John N. Reynolds	29 Jun 25-6 Jan 28	Maj. Eugene L. Lohman	20 Aug 28-15 Feb 29

Headquarters, 2nd Cavalry Division Air Service

HQ-Marshall Field, KS, 1927-29

Subordinate units: 16th Observation Squadron 1927-29; 9th Photo Section 1927-29

Constituted in the Regular Army 15 August 1927, assigned to the 2nd Cavalry Division, and allotted to the Seventh Corps Area. Headquarters organized on 15 August 1927 at Marshall Field, KS. Redesignated as Headquarters, 2nd Cavalry Division Aviation on 10 March 1928. Demobilized on 15 February 1929.

Commanders, 2nd Cavalry Division Air Service Headquarters

Maj. Henry H. Arnold	15 Aug 27-Aug 28	Unknown	Aug 28-15 Feb 29
----------------------	------------------	---------	------------------

Headquarters, 3rd Division Air Service

HQ-Crissy Field, CA, 1923-29

Subordinate units: 91st Observation Squadron 1923-29; 15th Photo Section 1923-29

Constituted in the Regular Army 24 March 1923, assigned to the 3rd Division, and allotted to the Ninth Corps Area. Headquarters organized on 1 July 1923 at Crissy Field, CA. Redesignated as Headquarters, 3rd Division Aviation on 10 March 1928. Demobilized on 15 February 1929.

Events: 34, 84

Commanders, 3rd Division Air Service Headquarters

Capt. John W. Signer	1 Jul 23-17 Feb 25	Maj. Albert L. Sneed	3 Aug 27-10 Nov 27
Maj. Delos C. Emmons	17 Feb 25-3 Aug 27	Lt. Col. Gerald C. Brant	10 Nov 27-15 Feb 29

Headquarters, 3rd Cavalry Division Air Service

Regular Army Inactive

HQ-Not organized 1927; Lawton, OK, 1927-29

Subordinate units: 44th Observation Squadron 1927-29; 24th Photo Section 1927-29

Constituted in the Regular Army 15 August 1927, assigned to the 3rd Cavalry Division, and allotted to the Eighth Corps Area. Headquarters organized by December 1927 with Reserve personnel as a RAI unit with headquarters at Lawton, OK. Redesignated as Headquarters, 3rd Cavalry Division Aviation on 10 March 1928. Demobilized on 15 February 1929.

Commanders, 3rd Cavalry Division Air Service Headquarters

Unknown	ao Dec 27-15 Feb 29
---------	---------------------

Headquarters, 4th Division Air Service

HQ-Maxwell Field, AL, 1923-29

Subordinate units: 22nd Observation Squadron 1923-29; 4th Photo Section 1923-29

Constituted in the Regular Army 24 March 1923, assigned to the 4th Division, and allotted to the Fourth Corps Area. Headquarters organized on 1 December 1923 at Maxwell Field, AL. Redesignated as Headquarters, 4th Division Aviation on 10 March 1928. Demobilized on 15 February 1929.

Commanders, 4th Division Air Service Headquarters

Maj. Roy S. Brown	1 Dec 23-24 Jun 25	1st Lt. Russell C. Mac Donald	6 Apr 28-2 May 28
Maj. Harrison H. C. Richards	24 Jun 25-4 Aug 27	1st Lt. Mervin E. Gross	2 May 28-13 Jul 28
1st Lt. Mervin E. Gross	4 Aug 27-6 Apr 28	Capt. Alfred F. King, Jr.	13 Jul 28-15 Feb 29

Headquarters, 5th Division Air Service

HQ-Wright Field, OH, 1923-27; *Inactive* 1927-29

Subordinate units: 88th Observation Squadron 1923-29; 7th Photo Section 1923-29

Constituted in the Regular Army 24 March 1923, assigned to the 5th Division, and allotted to the Fifth Corps Area. Headquarters organized on 1 July 1923 at Wright Field, OH. Inactivated on 7 May 1927 at Wright Field. Redesignated as Headquarters, 5th Division Aviation on 10 March 1928. Demobilized on 15 February 1929.

Commanders, 5th Division Air Service Headquarters

Maj. Hugh J. Knerr	1 Jul 23-13 Jul 25	1st Lt. Clifford C. Nutt	27 Apr 27-1 Jul 27
Capt. John C. Colgan	13 Jul 25-1 Oct 25	1st Lt. John C. Kennedy	1 Jul 27-1 Aug 27
Capt. Henry Pascale	1 Oct 25-8 Feb 26	<i>Inactive</i>	1 Aug 27-1 Jun 28
Maj. John C. McDonnell	8 Feb 26-15 May 26	1st Lt. Thomas L. Gilbert	1 Jun 28-1 Jul 28
Capt. John C. Colgan	15 May 26-27 Apr 27	1st Lt. William E. Beakley	1 Jul 28-15 Aug 28
	Maj. Louis H. Brereton	15 Aug 28-15 Feb 29	

Headquarters, 6th Division Air Service

HQ-Chanute Field, IL, 1923-29

Subordinate units: 15th Observation Squadron 1923-29; 5th Photo Section 1923-29

Constituted in the Regular Army 24 March 1923, assigned to the 6th Division, and allotted to the Sixth Corps Area. Headquarters organized on 1 June 1923 at Chanute Field, IL. Inactivated in June 1927 at Chanute Field. Redesignated as Headquarters, 6th Division Aviation on 10 March 1928. Demobilized on 15 February 1929.

Commanders, 6th Division Air Service Headquarters

Capt. Ernest Clark	1 Jun 23-Aug 24	<i>Inactive</i>	21 Jun 27-15 May 28
1st Lt. Owen E. Spruance	Aug 24-25 Feb 25	1st Lt. Arthur G. Hamilton	15 May 28-26 Nov 28
Capt. Ernest Clark	25 Feb 25-21 Jun 27	Capt. Clearton H. Reynolds	26 Nov 28-15 Feb 29

Headquarters, 7th Division Air Service

HQ-Marshall Field, KS, 1923-27

Subordinate units: 16th Observation Squadron 1923-27; 10th Observation Squadron 1927-29; 9th Photo Section 1923-27; 18th Photo Section 1923-29

Constituted in the Regular Army 24 March 1923, assigned to the 7th Division, and allotted to the Seventh Corps Area. Headquarters organized on 1 June 1923 at Marshall Field, KS. For the period 1923-27, the 7th Division Air Service performed the duties of aviation support and demonstration unit for the Cavalry School. Inactivated on 15 August 1927 at Marshall Field. Redesignated as Headquarters, 7th Division Aviation on 10 March 1928. Demobilized on 15 February 1929.

Commanders, 7th Division Air Service Headquarters

Maj. Clarence L. Tinker	1 Jun 23-5 Oct 24	Maj. Benjamin G. Weir	6 Nov 24-1 Nov 25
1st Lt. Benjamin F. Griffin	5 Oct 24-6 Nov 24	Capt. Thomas Bolend	1 Nov 25-22 Mar 26
Maj. Henry H. Arnold	22 Mar 26-15 Aug 27	<i>Inactive</i>	15 Aug 27-15 Feb 29

Headquarters, 8th Division Air Service

HQ-Bolling Field, DC, 1923-27; *Inactive* 1927-29

Subordinate units: 99th Observation Squadron 1923-27; 21st Observation Squadron 1927-29; 3rd Photo Section 1923-29; 19th Photo Section 1927-29

Constituted in the Regular Army 24 March 1923, assigned to the 8th Division, and allotted to the Third Corps Area. Headquarters organized on 1 May 23 at Bolling Field, DC. Inactivated on 31 July 1927 at Bolling Field. Redesignated as Headquarters, 8th Division Aviation on 10 March 1928. Demobilized 15 February 1929.

Commanders, 8th Division Air Service Headquarters

Capt. Clearton N. Reynolds	1 May 23-28 Jul 26	Capt. Byrne V. Baucom	1 May 27-4 Jun 27
Capt. William H. Crom	28 Jul 26-1 May 27	1st Lt. James A. Healy	4 Jun 27-31 Jul 27

Headquarters, 9th Division Air Service

HQ-Mitchel Field, NY, 1923-27; *Inactive* 1927-29

Subordinate units: 1st Observation Squadron 1923-27; 45th Observation Squadron 1927-29; 8th Photo Section 1923-29; 13th Photo Section 1927-29

Constituted in the Regular Army 24 March 1923, assigned to the 9th Division, and allotted to the First Corps Area. Headquarters organized on 1 June 1923 at Mitchel Field, NY. Inactivated on 15 August 1927 at Mitchel Field. Redesignated as Headquarters, 9th Division Aviation on 10 March 1928. Demobilized on 15 February 1929.

Commanders, 9th Division Air Service Headquarters

Maj. Davenport Johnson	1 Jun 23-27 Aug 25	Capt. Harry C. Drayton	27 Aug 25-4 Nov 25
	1st Lt. Newton Longfellow	4 Nov 25-15 Aug 27	

Headquarters, Panama Canal Division Air Service

HQ-*Not organized* 1922-28

Subordinate units: 7th Observation Squadron 1922-27; 12th Photo Section 1922-27; 10th Branch Intelligence Office 1922-23; 40th Air Intelligence Section 1923-25

Constituted in April 1922 in the Regular Army, assigned to the Panama Canal Division, and allotted to the Panama Canal Department. Demobilized about February 1928.

Headquarters, Hawaiian Division Air Service

HQ-Wheeler Field, TH, 1922-27 ; *Inactive* 1927-28

Subordinate units: 4th Observation Squadron 1922-27; 11th Photo Section 1922-27; 11th Branch Intelligence Office 1922-23; 41st Air Intelligence Section 1923-25

Constituted in January 1922 in the Regular Army, assigned to the Hawaiian Division, and allotted to the Hawaiian Department. Headquarters organized in January 1922 at Wheeler Field, TH. Inactivated on 31 August 1927 at Wheeler Field. Demobilized about February 1928.

Commanders, Hawaiian Division Air Service Headquarters

Maj. George E. Stratemeyer	20 Dec 21-11 Mar 22	1st Lt. George W. McEntire	17 Mar 26-1 May 26
Maj. Karl H. Gorman	11 Mar 22-5 Apr 23	Capt. John W. Signer	1 May 26-1 Aug 27
Capt. Alfred F. King, Jr.	5 Apr 23-Jan 25	Capt. Lester T. Miller	1 Aug 27-31 Aug 27
	Capt. Chilion F. Wheeler	Jan 25-17 Mar 26	

Headquarters, Philippine Division Air Service

HQ-*Not organized* 1922-28

Subordinate units: 2nd Observation Squadron 1922-27; 6th Photo Section 1922-27; 12th Branch Intelligence Office 1922-23; 42nd Air Intelligence Section 1923-25

Constituted in April 1922 in the Regular Army, assigned to the Philippine Division, and allotted to the Philippine Department. Demobilized about February 1928.

Headquarters, 21st Cavalry Division Aviation

National Guard

HQ-*Not organized 1928-29*

Constituted in the National Guard 19 December 1928, assigned to the 21st Cavalry Division, but never allotted to a state. Demobilized on 1 July 1929.

Headquarters, 22nd Cavalry Division Aviation

National Guard

HQ-*Not organized 1928-29*

Constituted in the National Guard 19 December 1928, assigned to the 22nd Cavalry Division, but never allotted to a state. Demobilized on 1 July 1929.

Headquarters, 23rd Cavalry Division Aviation

National Guard

HQ-*Not organized 1928-29*

Constituted in the National Guard 19 December 1928, assigned to the 23rd Cavalry Division, but never allotted to a state. Demobilized on 1 July 1929.

Headquarters, 24th Cavalry Division Aviation

National Guard

HQ-*Not organized 1928-29*

Constituted in the National Guard 19 December 1928, assigned to the 24th Cavalry Division, but never allotted to a state. Demobilized on 1 July 1929.

Headquarters, 26th Division Air Service

Massachusetts National Guard

HQ-Boston Airport, Boston, MA, 1921-29

Subordinate units: 101st Observation Squadron 1921-29; 101st Photo Section 1921-29; 101st Branch Intelligence Office 1921-22; 161st Air Intelligence Section 1922-25



Constituted in the National Guard in 1921, assigned to the 26th Division, and allotted to the state of Massachusetts. Headquarters organized and Federally recognized on 18 November 1921 at Boston, MA. Redesignated as Headquarters, 26th Division Aviation on 10 March 1928. Demobilized on 15 February 1929.

Headquarters, 27th Division Air Service

New York National Guard

HQ-Hempstead, LI, NY, 1921-22; Miller Field, SI, NY, 1922-29

Subordinate units: 102nd Observation Squadron 1921-29; 102nd Photo Section 1921-29; 102nd Branch Intelligence Office 1921-22; 162nd Air Intelligence Section 1922-25



Constituted in the National Guard in 1921, assigned to the 27th Division, and allotted to the state of New York. Headquarters organized on 22 March 1921 at Hempstead, LI, NY. Inactivated on 3 September 1922 at Hempstead. Reorganized and Federally recognized on 4 November 1922 at Miller Field, Staten Island, NY. Redesignated as Headquarters, 27th Division Aviation on 10 March 1928. Demobilized on 15 February 1929.

Commanders, 27th Division Air Service

Maj. Kenneth P. Littauer

17 Nov 21-20 Oct 23

Maj. George A. Vaughn

29 Oct 23-15 Feb 29

Headquarters, 28th Division Air Service

Pennsylvania National Guard

HQ-Not organized 1921-24; Philadelphia Airport, Philadelphia, PA, 1924-29

Subordinate units: 103rd Observation Squadron 1921-29; 103rd Photo Section 1921-29; 103rd Branch Intelligence Office 1921-22; 103rd Air Intelligence Section 1922-25



Constituted in the National Guard in 1921, assigned to the 28th Division, and allotted to the state of Pennsylvania. Headquarters organized and Federally recognized on 27 June 1924 at the Philadelphia Airport, Philadelphia, PA. Redesignated as Headquarters, 28th Division Aviation on 10 March 1928. Demobilized on 15 February 1929.

Commanders, 28th Division Air Service

Maj. John S. Owens

27 Jun 24-15 Feb 29

Headquarters, 29th Division Air Service

Maryland National Guard

HQ-Logan Field, Baltimore, MD, 1921-29

Subordinate units: 104th Observation Squadron 1921-29; 104th Photo Section 1921-29; 104th Branch Intelligence Office 1921-22; 164th Air Intelligence Section 1922-25



Constituted in the National Guard in 1921, assigned to the 29th Division, and allotted to the state of Maryland. Headquarters organized and Federally recognized on 29 June 1921 at Logan Field in Baltimore, MD. Redesignated as Headquarters, 29th Division Aviation on 10 March 1928. Demobilized on 15 February 1929.

Commanders, 29th Division Air Service

Maj. George L. Jones

29 Jun 21-Feb 22

Maj. Paul V. Burwell

Feb 22-15 Sep 24

Maj. William D. Tipton

15 Sep 24-15 Feb 29

Headquarters, 30th Division Air Service

Tennessee National Guard

HQ-Blackwood Field, Nashville, TN, 1921-29

Subordinate units: 105th Observation Squadron 1921-29; 105th Photo Section 1921-29; 105th Branch Intelligence Office 1921-22; 165th Air Intelligence Section 1922-25

Constituted in the National Guard in 1921, assigned to the 30th Division, and allotted to the state of Tennessee. Headquarters organized and Federally recognized on 4 December 1921 at Blackwood Field, Nashville, TN. Redesignated as Headquarters, 30th Division Aviation on 10 March 1928. Demobilized on 15 February 1929

Commanders, 30th Division Air Service

Maj. John C. Bennett, Jr. 4 Dec 21-15 Feb 29

Headquarters, 31st Division Air Service

Alabama National Guard

HQ-Not organized 1921-22; Roberts Field, Birmingham, AL, 1922-29

Subordinate units: 106th Observation Squadron 1921-29; 106th Photo Section 1921-29; 106th Branch Intelligence Office 1921-22; 166th Air Intelligence Section 1922-25



Constituted in the National Guard in 1921, assigned to the 31st Division, and allotted to the state of Alabama. Headquarters organized and Federally recognized on 21 January 1922 at Roberts Field, Birmingham, AL. Redesignated as Headquarters, 31st Division Aviation on 10 March 1928. Demobilized on 15 February 1929.

Commanders, 31st Division Air Service

Maj. James A. Meissner

16 Jan 24-ao Feb 24
Maj. Sumpter Smith

Maj. W. V. M. Robertson
15 May 25-15 Sep 29

ao Apr 24-15 May 25

Headquarters, 32nd Division Air Service

Michigan National Guard

HQ-Not organized 1921-26; Detroit, MI, 1926-29

Subordinate units: 107th Observation Squadron 1921-29; 107th Photo Section 1921-29; 107th Branch Intelligence Office 1921-22; 107th Air Intelligence Section 1922-25



Constituted in the National Guard in 1921, assigned to the 32nd Division, and allotted to the state of Michigan. Headquarters organized and Federally recognized on 7 May 26 at Detroit, MI. Redesignated as Headquarters, 32nd Division Aviation on 10 March 1928. Demobilized on 15 February 1929.

Commanders, 32nd Division Air Service

Maj. Frederick R. Anderson

7 May 26-15 Feb 29

Headquarters, 33rd Division Air Service

Illinois National Guard

HQ-*Not organized* 1921-27; Municipal Airport, Chicago, IL, 1927-29

Subordinate units: 108th Observation Squadron 1921-29; 108th Photo Section 1921-29; 108th Branch Intelligence Office 1921-22; 108th Air Intelligence Section 1922-25



Constituted in the National Guard in 1921, assigned to the 33rd Division, and allotted to the state of Illinois. Headquarters organized and Federally recognized on 1 July 1927 at the Municipal Airport, Chicago, IL. Redesignated as Headquarters, 33rd Division Aviation on 10 March 1928. Demobilized on 15 February 1929.

Commanders, 33rd Division Air Service

Maj. Merrill D. Mann, Jr. (R.A.) 1 Jul 27-15 Feb 29

Headquarters, 34th Division Air Service

Minnesota National Guard

HQ-Holman Municipal Airport, St. Paul, MN, 1921-29

Subordinate units: 109th Observation Squadron 1921-29; 109th Photo Section 1921-29; 109th Branch Intelligence Office 1921-22; 169th Air Intelligence Section 1922-25



Constituted in the National Guard in 1921, assigned to the 34th Division, and allotted to the state of Minnesota. Headquarters organized and Federally recognized on 21 November 1921 at Holman Municipal Airport in St. Paul, MN. Redesignated as Headquarters, 34th Division Aviation on 10 March 1928. Demobilized on 15 February 1929.

Commanders, 34th Division Air Service

Maj. Ray S. Miller 17 Jan 21-15 Feb 29

Headquarters, 35th Division Air Service

Missouri National Guard

HQ-*Not organized* 1921-26; Anglum Field, St. Louis, MO, 1926-29

Subordinate units: 110th Observation Squadron 1921-29; 110th Photo Section 1921-29; 110th Branch Intelligence Office 1921-22; 170th Air Intelligence Section 1922-25

Constituted in the National Guard in 1921, assigned to the 35th Division, and allotted to the state of Missouri. Headquarters organized and Federally recognized on 23 June 1923 at Anglum Field, St. Louis, MO. Redesignated as Headquarters, 35th Division Aviation on 10 March 1928. Demobilized on 15 February 1929.

Commanders, 35th Division Air Service

Maj. William M. Robertson	23 Jun 23-16 Sep 24	Capt. William H. Leininger	21 May 25-14 Oct 25
Capt. Charles R. Wassell	16 Sep 24-21 May 25	Maj. Charles R. Wassell	14 Oct 25-15 Feb 29

Headquarters, 36th Division Air Service**Texas National Guard**

HQ-*Not organized* 1921-23; Ellington Field, Houston, TX, 1923-27; Houston Municipal Airport, Houston, TX, 1927-29

Subordinate units: 111th Observation Squadron 1921-29; 111th Photo Section 1921-29; 111th Branch Intelligence Office 1921-22; 171st Air Intelligence Section 1922-25

Constituted in the National Guard in 1921, assigned to the 36th Division, and allotted to the state of Texas. Headquarters organized and Federally recognized on 29 June 1923 at Ellington Field, Houston, TX. Redesignated as Headquarters, 36th Division Aviation on 10 March 1928. Demobilized on 15 February 1929.

Commanders, 36th Division Air Service

Maj. Bernard A. Law

29 Jun 23-1 Jan 26

Maj. Walter H. Reid (R.A.)

1 Jan 26-15 Feb 29

Headquarters, 37th Division Air Service**Ohio National Guard**

HQ-*Not organized* 1921-27; Cleveland Airport, Cleveland, OH, 1927-29

Subordinate units: 112th Observation Squadron 1921-29; 112th Photo Section 1921-29; 112th Branch Intelligence Office 1921-22; 172nd Air Intelligence Section 1922-25



Constituted in the National Guard in 1921, assigned to the 37th Division, and allotted to the state of Ohio. Headquarters organized and Federally recognized on 20 June 1927 at Cleveland Airport, Cleveland, OH. Redesignated as Headquarters, 37th Division Aviation on 10 March 1928. Demobilized on 15 February 1929.

Commanders, 37th Division Air Service

Maj. Thomas J. Herbert

20 Jun 27-15 Feb 29

Headquarters, 38th Division Air Service**Indiana National Guard**

HQ-Kokomo, IN, 1921-26; Stout Field, Indianapolis, IN, 1926-29

Subordinate units: 113th Observation Squadron 1921-29; 113th Photo Section 1921-29; 113th Branch Intelligence Office 1921-22; 173rd Air Intelligence Section 1922-25

Constituted in the National Guard in 1921, assigned to the 38th Division, and allotted to the state of Indiana. Headquarters organized and Federally recognized on 1 August 1921 at Kokomo, IN. Redesignated as Headquarters, 38th Division Aviation on 10 March 1928. Demobilized on 15 February 1929.

Commanders, 38th Division Air Service

Maj. Wilbur Fagley

1 Aug 21-30 Jun 22

Maj. James C. Patten

1 Jul 22-9 Jun 26

Maj. Richard F. Taylor

10 Jun 26-15 Feb 29

Headquarters, 39th Division Air Service**Louisiana/Alabama National Guard**

HQ-*Not organized* 1921-23; Roberts Field, Birmingham, AL, 1923

Subordinate units: 114th Observation Squadron 1921-23; 114th Photo Section 1921-23; 114th Branch Intelligence Office 1921-22



Constituted in the National Guard in 1921, assigned to the 43rd Division, and allotted to the state of Connecticut. Headquarters organized and Federally recognized on 1 November 1923 at Brainard Field, Hartford, CT. Redesignated as Headquarters, 43rd Division Aviation on 10 March 1928. Demobilized on 15 February 1929.

Commanders, 43rd Division Air Service

Maj. Talbot O. Freeman

1 Nov 23-31 Dec 25 Maj. William F. Ladd

31 Dec 25-15 Feb 29

Headquarters, 44th Division Air Service

New Jersey National Guard

HQ-*Not organized* 1921-29

Subordinate units: 119th Observation Squadron 1921-29; 119th Photo Section 1921-29; 119th Branch Intelligence Office 1921-22; 119th Air Intelligence Section 1922-25



Constituted in the National Guard in 1921, assigned to the 44th Division, and allotted to the state of New Jersey. Redesignated as Headquarters, 44th Division Aviation on 10 March 1928. Demobilized on 15 February 1929.

Headquarters, 45th Division Air Service

Colorado National Guard

HQ-*Not organized* 1921-23; Denver Municipal Airport, Denver, CO, 1923-29

Subordinate units: 120th Observation Squadron 1921-29; 120th Photo Section 1921-29; 120th Branch Intelligence Office 1921-22; 120th Air Intelligence Section 1922-25

Constituted in the National Guard in 1921, assigned to the 45th Division, and allotted to the state of Colorado. Headquarters organized and Federally recognized on 27 January 1923 at Denver Municipal Airport, Denver, CO. Redesignated as Headquarters, 45th Division Aviation on 10 March 1928. Demobilized on 15 February 1929.

Commanders, 45th Division Air Service

Maj. William H. Dayton

6 Mar 24-16 May 27

Maj. Bruce Kistler

16 May 27-15 Feb 29

Headquarters, 61st Cavalry Division Aviation

Organized Reserve New York

HQ-*Not initiated* 1928-29

Subordinate units: 861st Observation Squadron 1928-29

Constituted in the Organized Reserve 28 December 1928, assigned to the 61st Cavalry Division, and allotted to the Second Corps Area. Demobilized on 15 February 1929.

Headquarters, 62nd Cavalry Division Aviation

Organized Reserve District of Columbia

HQ-*Not initiated* 1928-29

Subordinate units: 862nd Observation Squadron 1928-29

Constituted in the Organized Reserve 28 December 1928, assigned to the 62nd Cavalry Division, and allotted to the Third Corps Area. Washington, DC, designated as the headquarters upon organization, but the unit was never organized. Demobilized on 15 February 1929.

Headquarters, 63rd Cavalry Division Aviation

Organized Reserve North Carolina

HQ-*Not initiated* 1928-29

Subordinate units: 863rd Observation Squadron 1928-29

Constituted in the Organized Reserve 28 December 1928, assigned to the 63rd Cavalry Division, and allotted to the Fourth Corps Area. Demobilized on 15 February 1929.

Headquarters, 64th Cavalry Division Aviation

Organized Reserve Ohio

HQ-*Not initiated* 1928-29

Subordinate units: 864th Observation Squadron 1928-29

Constituted in the Organized Reserve 28 December 1928, assigned to the 64th Cavalry Division, and allotted to the Fifth Corps Area. Demobilized on 15 February 1929.

Headquarters, 65th Cavalry Division Aviation

Organized Reserve Illinois

HQ-*Not initiated* 1928-29

Subordinate units: 865th Observation Squadron 1928-29

Constituted in the Organized Reserve 28 December 1928, assigned to the 65th Cavalry Division, and allotted to the Sixth Corps Area. Demobilized on 15 February 1929.

Headquarters, 66th Cavalry Division Aviation

Organized Reserve Kansas

HQ-*Not initiated* 1928-29

Subordinate units: 866th Observation Squadron 1928-29

Constituted in the Organized Reserve 28 December 1928, assigned to the 66th Cavalry Division, and allotted to the Ninth Corps Area. Demobilized on 15 February 1929.

Headquarters, 76th Division Air Service

Organized Reserve Connecticut

HQ-*Not initiated* 1921-22; Hartford, CT, 1922-24; *Inactive* 1924-29

Subordinate units: 301st Observation Squadron 1921-29; 301st Photo Section 1921-29; 301st Branch Intelligence Office 1921-22; 301st Air Intelligence Section 1922-25

Constituted in the Organized Reserve 24 June 1921, assigned to the 76th Division, and allotted to the First Corps Area. Headquarters initiated in January 1923 at Hartford CT. Inactivated by August 1924 at Hartford by relief of personnel. Redesignated as Headquarters, 76th Division Aviation on 10 March 1928. Demobilized on 15 February 1929.

Commanders, 76th Division Air Service

Unknown Jan 23-Aug 24

Headquarters, 77th Division Air Service

Organized Reserve New York

HQ-Garden City, NY, 1921-29

Subordinate units: 302nd Observation Squadron 1921-29; 302nd Photo Section 1921-29; 302nd Air Intelligence Office 1921-22; 302nd Branch Intelligence Office 1921-22; 302nd Air Intelligence Section 1922-25

Constituted in the Organized Reserve 24 June 1921, assigned to the 77th Division, and allotted to the Second Corps Area. Headquarters initiated on 1 October 1921 at Garden City, NY. Redesignated as Headquarters, 77th Division Aviation on 10 March 1928. Demobilized on 15 February 1929.

Commanders, 77th Division Air Service

Maj. George Peabody	1 Oct 21-9 Jan 24	Maj. Stedman S. Hanks	9 Jan 24-16 May 25
	Unknown	16 May 25-15 Feb 29	

Headquarters, 78th Division Air Service

Organized Reserve New Jersey

HQ-Atlantic City, NJ, 1921-25; Newark, NJ, 1925-29

Subordinate units: 303rd Observation Squadron 1921-29; 303rd Photo Section 1921-29; 303rd Air Intelligence Office 1921-25

Constituted in the Organized Reserve 24 June 1921, assigned to the 78th Division, and allotted to the Second Corps Area. Headquarters initiated on 17 August 1921 at Atlantic City, NJ. Relocated on 8 September 1925 to Newark, NJ. Redesignated as Headquarters, 78th Division Aviation on 10 March 1928. Demobilized on 15 February 1929.

Commanders, 78th Division Air Service

1st Lt. George Rockwell, Jr.	17 Aug 21-17 Feb 22	Unknown	ao Mar 22-24 Jun 28
Maj. Harrison H. C. Richards	17 Feb 22-ao Mar 22	Maj. Edward M. Urband	24 Jun 28-15 Feb 29

Headquarters, 79th Division Air Service

Organized Reserve Pennsylvania

HQ-Philadelphia, PA, 1921-29

Subordinate units: 304th Observation Squadron 1921-29; 304th Photo Section 1921-29; 304th Air Intelligence Office 1921-25

Constituted in the Organized Reserve 24 June 1921, assigned to the 79th Division, and allotted to the Third Corps Area. Headquarters initiated on 15 November 1921 at Philadelphia, PA. Redesignated as Headquarters, 79th Division Aviation on 10 March 1928. Demobilized on 15 February 1929.

Commanders, 79th Division Air Service

Capt. Guy W. Rogers	15 Nov 21-28 Aug 23	Unknown	ao Sep 25-ao Jun 27
Maj. William D. Grant	28 Aug 23-ao Sep 25	Maj. William A. Reading	ao Jun 27-15 Feb 29

Headquarters, 80th Division Air Service

Organized Reserve Virginia

HQ-Richmond, VA, 1921-29

Subordinate units: 305th Observation Squadron 1921-29; 305th Photo Section 1921-29; 305th Air Intelligence Office 1921-25

Constituted in the Organized Reserve 24 June 1921, assigned to the 80th Division, and allotted to the Third Corps Area. Headquarters initiated on 27 October 1921 at Richmond, VA. Redesignated as Headquarters, 80th Division Aviation on 10 March 1928. Demobilized on 15 February 1929.

Commanders, 80th Division Air Service

Capt. Douglas C. Fithian	27 Oct 21-30 Apr 23	Maj. William A. Coleman	30 Apr 23-15 Feb 29
--------------------------	---------------------	-------------------------	---------------------

Headquarters, 81st Division Air Service

Organized Reserve Tennessee

HQ-Not initiated 1921-22; Knoxville, TN, 1922-29

Subordinate units: 306th Observation Squadron 1921-29; 306th Photo Section 1921-29; 306th Air Intelligence Office 1921-25

Constituted in the Organized Reserve 24 June 1921, assigned to the 81st Division, and allotted to the Fourth Corps Area. Headquarters initiated in February 1922 at Knoxville, TN. Redesignated as Headquarters, 81st Division Aviation on 10 March 1928. Demobilized on 15 February 1929.

Commanders, 81st Division Air Service

Unknown	Feb 22-ao Dec 23	Unknown	ao Sep 25-ao Feb 28
Maj. Edward C. Landon	ao Dec 23-ao Sep 25	Maj. George A. Wiggs	ao Feb 28-25 Mar 28
	Unknown	25 Mar 28-15 Feb 29	

Headquarters, 82nd Division Air Service

Organized Reserve Georgia

HQ-Not initiated 1921-22; Macon, GA, 1922-29

Subordinate units: 307th Observation Squadron 1921-29; 307th Photo Section 1921-29; 307th Air Intelligence Office 1921-25

Constituted in the Organized Reserve 24 June 1921, assigned to the 82nd Division, and allotted to the Fourth Corps Area. Headquarters initiated on 14 January 1922 at Macon, GA. Redesignated as Headquarters, 82nd Division Aviation on 10 March 1928. Demobilized on 15 February 1929.

Commanders, 82nd Division Air Service

Maj. Raymond H. Harrell	14 Jan 22-ao Mar 22	Unknown	ao Mar 22-15 Feb 29
-------------------------	---------------------	---------	---------------------

Headquarters, 83rd Division Air Service

Organized Reserve Ohio

HQ-Not initiated 1921-22; Dayton, OH, 1922; Columbus, OH, 1922-29

Subordinate units: 308th Observation Squadron 1921-29; 308th Photo Section 1921-29; 308th Air Intelligence Office 1921-25

Constituted in the Organized Reserve 24 June 1921, assigned to the 83rd Division, and allotted to the Fifth Corps Area. Headquarters initiated in March 1922 at Dayton, OH. Relocated on 21 November 1922 to Columbus, OH. Redesignated as Headquarters, 83rd Division Aviation on 10 March 1928. Demobilized on 15 February 1929.

Commanders, 83rd Division Air Service

Unknown	Mar 22-23 Jul 22	Unknown	ao Sep 22-1 Jul 24
Capt. Charles C. Cleary	23 Jul 22-ao Sep 22	Maj. Lyman R. Walker	1 Jul 24-ao Nov 27
	Unknown	ao Nov 27-15 Feb 29	

Headquarters, 84th Division Air Service**Organized Reserve Ohio/Indiana****HQ**-Cleveland, OH, 1921-22; Schoen Field, Fort Benjamin Harrison, IN, 1922-29**Subordinate units:** 309th Observation Squadron 1921-29; 309th Photo Section 1921-29; 309th Air Intelligence Office 1921-25

Constituted in the Organized Reserve 24 June 1921, assigned to the 84th Division, and allotted to the Fifth Corps Area. Headquarters initiated in December 1921 at Cleveland, OH. Inactivated on 11 August 1922 at Cleveland. Reorganized on 13 November 1922 at Schoen Field, Fort Benjamin Harrison, IN. Redesignated as Headquarters, 84th Division Aviation on 10 March 1928. Demobilized on 15 February 1929.

Commanders, 84th Division Air Service

1st Lt. John N. Joyce	Dec 21-1 May 22	<i>Inactive</i>	11 Aug 22-13 Nov 22
Maj. William F. Long	1 May 22-11 Aug 22	Maj. Harry E. Cross	13 Nov 22-ao Sep 24
	Unknown	ao Sep 24-15 Feb 29	

Headquarters, 85th Division Air Service**Organized Reserve Michigan****HQ**-*Not initiated* 1921-22; Detroit, MI, 1922-25; *Inactive* 1925-29**Subordinate units:** 310th Observation Squadron 1921-29; 310th Photo Section 1921-29; 310th Air Intelligence Office 1921-25

Constituted in the Organized Reserve 24 June 1921, assigned to the 85th Division, and allotted to the Sixth Corps Area. Headquarters initiated in October 1922 at Detroit, MI. Inactivated by September 1925 at Detroit. Redesignated as Headquarters, 85th Division Aviation on 10 March 1928. Demobilized on 15 February 1929.

Commanders, 85th Division Air Service

Unknown	Oct 22-Aug 25	<i>Inactive</i>	Aug 25-15 Feb 29
---------	---------------	-----------------	------------------

Headquarters, 86th Division Air Service**Organized Reserve Illinois****HQ**-*Not initiated* 1921-22; Chicago, IL, 1922-29**Subordinate units:** 311th Observation Squadron 1921-29; 311th Photo Section 1921-29; 311th Air Intelligence Office 1921-25

Constituted in the Organized Reserve 24 June 1921, assigned to the 86th Division, and allotted to the Sixth Corps Area. Headquarters initiated on 10 March 1922 at Chicago, IL. Redesignated as Headquarters, 86th Division Aviation on 10 March 1928. Demobilized on 15 February 1929.

Commanders, 86th Division Air Service

Maj. George F. Lee	10 Mar 22-ao Jun 22	Unknown	ao Jun 22-15 Feb 29
--------------------	---------------------	---------	---------------------

Headquarters, 87th Division Air Service**Organized Reserve Alabama****HQ**-*Not initiated* 1921-22; Montgomery, AL, 1922-29**Subordinate units:** 312th Observation Squadron 1921-29; 312th Photo Section 1921-29; 312th Air Intelligence Office 1921-25

Constituted in the Organized Reserve 24 June 1921, assigned to the 87th Division, and allotted to the Fourth Corps Area. Headquarters initiated in July 1922 at Montgomery, AL. Redesignated as Headquarters, 87th Division Aviation on 10 March 1928. Demobilized on 15 February 1929.

Commanders, 87th Division Air Service

Unknown	Jul 22-Apr 24	Maj. James A. Meissner	Apr 24-22 Feb 26
	Unknown	22 Feb 26-15 Feb 29	

Headquarters, 88th Division Air Service**Organized Reserve Iowa**

HQ-Not initiated 1921-22; Des Moines, IA, 1922-26; Sioux City, IA, 1926-29

Subordinate units: 313th Observation Squadron 1921-29; 313th Photo Section 1921-29; 313th Air Intelligence Office 1921-25

Constituted in the Organized Reserve 24 June 1921, assigned to the 88th Division, and allotted to the Seventh Corps Area. Headquarters initiated in March 1922 at Des Moines, IA. Relocated on 26 May 26 to Sioux City, IA. Redesignated as Headquarters, 88th Division Aviation on 10 March 1928. Demobilized on 15 February 1929.

Commanders, 88th Division Air Service

Capt. Herbert O. Koehler	Mar 22-13 Sep 22	Maj. Arthur J. Neubauer	1 Jun 26-ao Jun 27
Maj. Lauritz G. Haugen	13 Sep 22-ao Oct 22	Unknown	ao Jun 27-ao Dec 28
Unknown	ao Oct 22-1 Jun 26	Maj. Egbert D. Brown	ao Dec 28-15 Feb 29

Headquarters, 89th Division Air Service**Organized Reserve Nebraska**

HQ-Not initiated 1921-22; Omaha, NE, 1922-29

Subordinate units: 314th Observation Squadron 1921-29; 314th Photo Section 1921-29; 314th Air Intelligence Office 1921-25

Constituted in the Organized Reserve 24 June 1921, assigned to the 89th Division, and allotted to the Seventh Corps Area. Headquarters initiated in March 1922 at Omaha, NE. Redesignated as Headquarters, 89th Division Aviation on 10 March 1928. Demobilized on 15 February 1929.

Commanders, 89th Division Air Service

Capt. Harry B. Coffee	Mar 22-17 Mar 22	Maj. Lyle S. Powell	13 Sep 22-ao Oct 22
Maj. Lauritz C. Haugen	17 Mar 22-13 Sep 22	Unknown	ao Oct 22-15 Feb 29

Headquarters, 90th Division Air Service**Organized Reserve Texas**

HQ-Not initiated 1921-22; El Paso, TX, 1922-25; Dallas, TX, 1925-29

Subordinate units: 315th Observation Squadron 1921-29; 315th Photo Section 1921-29; 315th Air Intelligence Office 1921-25

Constituted in the Organized Reserve 24 June 1921, assigned to the 90th Division, and allotted to the Eighth Corps Area. Headquarters initiated on 9 January 1922 at El Paso, TX. Relocated on 4 April 1925 to Dallas, TX. Redesignated as Headquarters, 90th Division Aviation on 10 March 1928. Typically conducted Inactive Training Period meetings on Sundays at Biggs Field 1922-25. Personnel used the aircraft of the 12th Observation Squadron at Biggs Field for flying training. Typically conducted Inactive Training Period meetings at Hensley Field 1925-29. Demobilized on 15 February 1929.

Commanders, 90th Division Air Service

Capt. Maurice Blumenthal	9 Jan 22-3 May 22	Capt. Sylvanus C. Coon	3 May 22-23 Feb 23
	Maj. Alva W. Snyder	22 Feb 23-15 Feb 29	

Headquarters, 91st Division Air Service**Organized Reserve California**

HQ-Los Angeles, CA, 1921-29

Subordinate units: 316th Observation Squadron 1921-29; 316th Photo Section 1921-29; 316th Air Intelligence Office 1921-25

Constituted in the Organized Reserve 24 June 1921, assigned to the 91st Division, and allotted to the Ninth Corps Area. Headquarters initiated in November 1921 at Los Angeles, CA. Redesignated as Headquarters, 91st Division Aviation on 10 March 1928. Demobilized on 15 February 1929.

Commanders, 91st Division Air Service

Maj. Roy J. Heffner	Nov 21-ao Oct 22	Maj. Edward P. Howard	ao Oct 24-1 Feb 28
Unknown	ao Oct 22-ao Oct 24	Maj. Livingston G. Irving	1 Feb 28-15 Feb 29

Headquarters, 94th Division Air Service

Organized Reserve Massachusetts

HQ-Boston, MA, 1921-29

Subordinate units: 319th Observation Squadron 1921-29; 319th Photo Section 1921-29; 319th Air Intelligence Office 1921-25

Constituted in the Organized Reserve 24 June 1921, assigned to the 94th Division, and allotted to the First Corps Area. Headquarters initiated on 23 December 1921 at Boston, MA. Redesignated as Headquarters, 94th Division Aviation on 10 March 1928. Demobilized on 15 February 1929.

Commanders, 94th Division Air Service

Maj. Arthur L. Richmond	23 Dec 21-ao Apr 26	Unknown	ao Apr 26-15 Feb 29
-------------------------	---------------------	---------	---------------------

Headquarters, 95th Division Air Service

Organized Reserve Oklahoma

HQ-*Not initiated* 1921-22; Hatbox Field, Muskogee, OK, 1922-25; Tulsa, OK, 1925-29

Subordinate units: 320th Observation Squadron 1921-29; 320th Photo Section 1921-29; 320th Air Intelligence Office 1921-25

Constituted in the Organized Reserve 24 June 1921, assigned to the 95th Division, and allotted to the Eighth Corps Area. Headquarters initiated on 20 November 1922 at Hatbox Field, Muskogee, OK. Inactivated in March 1925 at Muskogee. Reorganized on 10 July 1925 at Tulsa, OK. Redesignated as Headquarters, 95th Division Aviation on 10 March 1928. Demobilized on 15 February 1929.

Commanders, 95th Division Air Service

Capt. Charles B. Oldfield	20 Nov 22-Mar 25	Capt. Frank D. McSherry	10 Jul 25-12 May 28
<i>Inactive</i>	Mar 25-10 Jul 25	Unknown	12 May 28-15 Feb 29

Headquarters, 96th Division Air Service

Organized Reserve Oregon

HQ-*Not initiated* 1921-23; Portland, OR, 1923-29

Subordinate units: 321st Observation Squadron 1921-29; 321st Photo Section 1921-29; 321st Air Intelligence Office 1921-25

Constituted in the Organized Reserve 24 June 1921, assigned to the 96th Division, and allotted to the Ninth Corps Area. Headquarters initiated in December 1922 at Portland, OR. Redesignated as Headquarters, 96th Division Aviation on 10 March 1928. Typically conducted Inactive Training Period meetings at Pearson Field, Vancouver Barracks, WA. Demobilized on 15 February 1929.

Commanders, 96th Division Air Service

Unknown	Dec 22-ao Dec 24	Maj. Howard C. French	ao Nov 24-15 Feb 29
---------	------------------	-----------------------	---------------------

Headquarters, 97th Division Air Service

Organized Reserve Maine/New Hampshire

HQ-*Not initiated* 1921-23; Bangor, ME, 1923-24; *Inactive* 1924-27; Concord, NH, 1927-29

Subordinate units: 322nd Observation Squadron 1921-29; 322nd Photo Section 1921-29; 322nd Air Intelligence Office 1921-25

Constituted in the Organized Reserve 24 June 1921, assigned to the 97th Division, and allotted to the First Corps Area. Headquarters initiated in January 1923 at Bangor, ME. Inactivated by August 1924 at Bangor by relief of personnel. Reorganized on 14 February 1927 at Concord, NH. Typically conducted Inactive Training Period meetings at 51 North Main Street in Concord. Redesignated as Headquarters, 97th Division Aviation on 10 March 1928. Demobilized on 15 February 1929.

Commanders, 97th Division Air Service

Unknown	Jan 23-Aug 24 Unknown	<i>Inactive</i> 14 Feb 27-15 Feb 29	Aug 24-14 Feb 27
---------	--------------------------	--	------------------

Headquarters, 98th Division Air Service

Organized Reserve New York

HQ-Syracuse, NY, 1921-29

Subordinate units: 323rd Observation Squadron 1921-29; 323rd Photo Section 1921-29; 323rd Air Intelligence Office 1921-25

Constituted in the Organized Reserve 24 June 1921, assigned to the 98th Division, and allotted to the Second Corps Area. Headquarters initiated on 15 December 1921 at Syracuse, NY. Redesignated as Headquarters, 98th Division Aviation on 10 March 1928. Demobilized on 15 February 1929.

Commanders, 98th Division Air Service

Maj. Allan G. White	15 Dec 21-16 Mar 24	Unknown	16 Mar 24-15 Feb 29
---------------------	---------------------	---------	---------------------

Headquarters, 99th Division Air Service

Organized Reserve Pennsylvania

HQ-*Not initiated* 1921-23; Pittsburgh, PA, 1923-29

Subordinate units: 324th Observation Squadron 1921-29; 324th Photo Section 1921-29; 324th Air Intelligence Office 1921-25

Constituted in the Organized Reserve 24 June 1921, assigned to the 99th Division, and allotted to the Third Corps Area. Headquarters initiated in June 1923 at Pittsburgh, PA. Redesignated as Headquarters, 99th Division Aviation on 10 March 1928. Demobilized on 15 February 1929.

Commanders, 99th Division Air Service

Unknown	Jun 23-ao Sep 25 Unknown	Maj. James B. McCally 28 Feb 27-15 Feb 29	ao Sep 25-28 Feb 27
---------	-----------------------------	--	---------------------

Headquarters, 100th Division Air Service

Organized Reserve Ohio

HQ-Cincinnati, OH, 1921-29

Subordinate units: 325th Observation Squadron 1921-29; 325th Photo Section 1921-29; 325th Air Intelligence Office 1921-25

Constituted in the Organized Reserve 24 June 1921, assigned to the 100th Division, and allotted to the Fifth Corps Area. Headquarters initiated on 21 December 1921 at Cincinnati, OH. Redesignated as Headquarters, 100th Division Aviation on 10 March 1928. Demobilized on 15 February 1929.

Commanders, 100th Division Air Service

1st Lt. M. H. Snodgrass	21 Dec 21-ao Jan 22	Unknown	ao Jan 22-15 Feb 29
-------------------------	---------------------	---------	---------------------

Headquarters, 101st Division Air Service**Organized Reserve Wisconsin**

HQ-Not initiated 1921-22; Ashland, WI, 1922-25; Milwaukee, WI, 1925-29

Subordinate units: 326th Observation Squadron 1921-29; 326th Photo Section 1921-29; 326th Air Intelligence Office 1921-25

Constituted in the Organized Reserve 24 June 1921, assigned to the 101st Division, and allotted to the Sixth Corps Area. Headquarters initiated in October 1922 at Ashland, WI. Relocated on 2 June 1925 to Milwaukee, WI. Redesignated as Headquarters, 101st Division Aviation on 10 March 1928. Demobilized on 15 February 1929.

Commanders, 101st Division Air Service

Unknown	Oct 22-15 Feb 29
---------	------------------

Headquarters, 102nd Division Air Service**Organized Reserve Arkansas**

HQ-Not initiated 1921-22; Little Rock, AR, 1922-26; Pine Bluff, AR, 1926-29

Subordinate units: 327th Observation Squadron 1921-29; 327th Photo Section 1921-29; 327th Air Intelligence Office 1921-25

Constituted in the Organized Reserve 24 June 1921, assigned to the 102nd Division, and allotted to the Seventh Corps Area. Headquarters initiated in January 1922 at Little Rock, AR. Relocated on 11 February 1926 to Pine Bluff, AR. Redesignated as Headquarters, 102nd Division Aviation on 10 March 1928. Demobilized on 15 February 1929.

Commanders, 102nd Division Air Service

Unknown	Jan 22-15 Feb 29
---------	------------------

Headquarters, 103rd Division Air Service**Organized Reserve Colorado**

HQ-Colorado Springs, CO, 1921-24; Denver, CO, 1924-29

Subordinate units: 328th Observation Squadron 1921-29; 328th Photo Section 1921-29; 328th Air Intelligence Office 1921-25

Constituted in the Organized Reserve 24 June 1921, assigned to the 103rd Division, and allotted to the Seventh Corps Area. Headquarters initiated on 29 November 1921 at the Federal Building in Colorado Springs, CO. Relocated on on 26 July 1924 to Denver, CO. Redesignated as Headquarters, 103rd Division Aviation on 10 March 1928. Demobilized on 15 February 1929.

Commanders, 103rd Division Air Service

Capt. C. G. Mitchell	29 Nov 21-9 Jan 22	Unknown	ao Nov 26-ao Apr 28
Maj. Richard D. Gile	9 Jan 22-Dec 24	Maj. Charles W. Keene	ao Apr 28-12 May 28
Maj. Lilburn V. Chambers	Dec 24-ao Nov 26	Maj. James O. Nabors	13 May 28-15 Feb 29

Headquarters, 104th Division Air Service**Organized Reserve Utah**

HQ-Not initiated 1921-22; Salt Lake City, UT, 1922-29

Subordinate units: 329th Observation Squadron 1921-29; 329th Photo Section 1921-29; 329th Air Intelligence Office 1921-25

Constituted in the Organized Reserve 24 June 1921, assigned to the 104th Division, and allotted to the Ninth Corps Area. Headquarters initiated in January 1922 at Salt Lake City, UT. Redesignated as Headquarters, 104th Division Aviation on 10 March 1928. Demobilized on 15 February 1929.

Commanders, 104th Division Air Service

Capt. H. H. George	Jan 22-ao Oct 22	Unknown	ao Oct 22-ao Dec 28
	Maj. Doyen P. Wardwell	ao Dec 28-15 Feb 29	

Chapter 30

Groups



USAF Photo

YB-17s of the 2nd Bombardment Group intercept the S.S. *Rex* at sea, 12 May 1938.

Groups provided command and control for assigned or attached army air service and air corps units.

Organization

There were nine types of group headquarters in the interwar era—six heavier than air (HTA), two lighter than air (LTA), and one special group. The HTA groups included attack, bombardment, observation (some later Redesignated as reconnaissance groups), pursuit, transport, and composite units. The LTA groups included airship and balloon organizations. The special headquarters was the school group, which could be HTA, LTA, or non-flying organizations. Many of these group headquarters underwent one or more conversions or redesignations so it is difficult to illustrate how many types of groups were in each category. The following table, however, shows the allotment of those types of units as they were originally organized as of 1921 or as originally constituted and in the component to which they were originally allotted. The table includes only those units organized or constituted prior to December 1939 in the case of Regular Army units and as of December 1940 for National Guard and Organized Reserve units.

Units organized or constituted.

	Atk	Bomb	Obsn	Purs	Trans	Ash	Bln	Comp	Sch
RA	1	4	4	8	1	1	0	3	2
RAI	2	0	11	0	2	1	4	1	3
NG	0	0	0	0	0	0	8	0	0
OR	6	4	23	19	0	6	26	0	31
Totals	9	8	39	27	3	8	38	4	36

With two exceptions, all HTA groups consisted of four squadrons, one service squadron (designated as an “air park” until 1923), and a photo section. The pursuit and transportation groups were the exceptions and neither had a photo section. The two LTA groups were similarly organized except that they were composed originally of four airship or balloon companies. The companies were redesignated as squadrons in 1933. As their name suggests, composite groups consisted of a mixture of squadrons. Typically, a composite group would have at least one bombardment, one observation, one pursuit, and a service squadron each. The mix might not have included one or more of the squadrons, but would always include the service squadron. School groups were also generally composed of four school squadrons, but could consist of more or less as well. A school group could also be either a flying or non-flying unit depending on the mission it was assigned. The group’s basic structure held steady until 1936 when the service squadrons were eliminated from the organizational scheme. The structure remained the same thereafter until World War II.

Attack Group, 1926

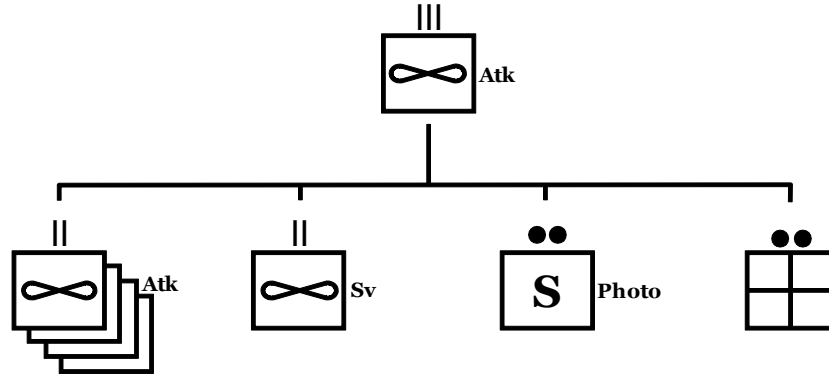

T/O: 278
 Approved: 3 June 1926
 Commander Lt. Col.
 Officers: 251
 W. O. --
 Enlisted 1,214
 Total 1,465

Key Equipment:
 Airplanes, various 112
 Cars, various 6
 Trucks, various 81
 Machine guns, AA 15
 Machine guns, aerial 416

Bombardment Group (Dual Engine), 1921

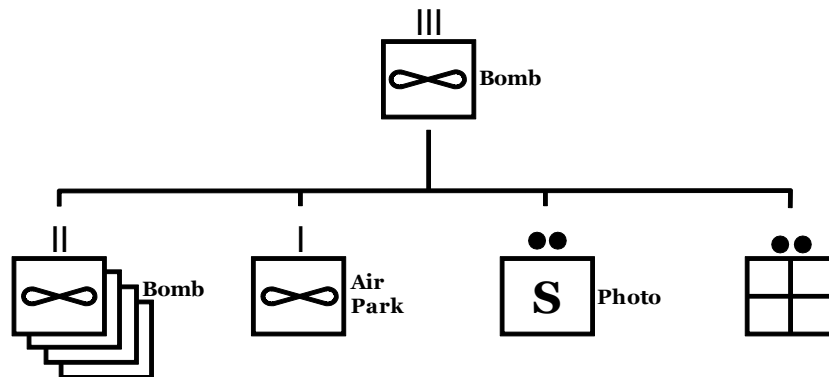

T/O: 575W
 Effective: 31 August 1921
 Commander: Col. or Lt. Col.
 Officers: 248
 W. O. 1
 Enlisted: 1,277
 Total: 1,526

Key Equipment:
 Airplanes, various 58
 Cars, various 11
 Trucks, various 124
 Machine guns, AA 18
 Machine guns, aerial 224

TOEs for attack and bomb group.

Observation Group, 1926

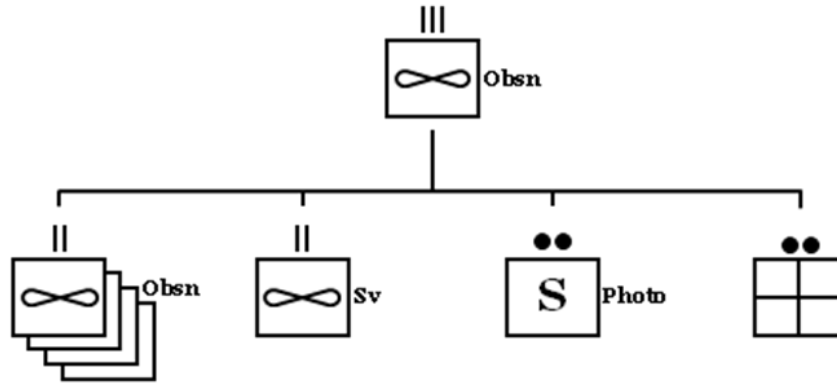

T/O: 275W
 Approved: 3 June 1926
 Commander: Lt. Col.
 Officers: 167
 W. O. —
 Enlisted: 970
 Total: 1,137

Key Equipment:
 Airplanes, various 64
 Cars, various 6
 Trucks, various 79
 Machine guns, AA 15
 Machine guns, aerial 224

Pursuit Group, 1921

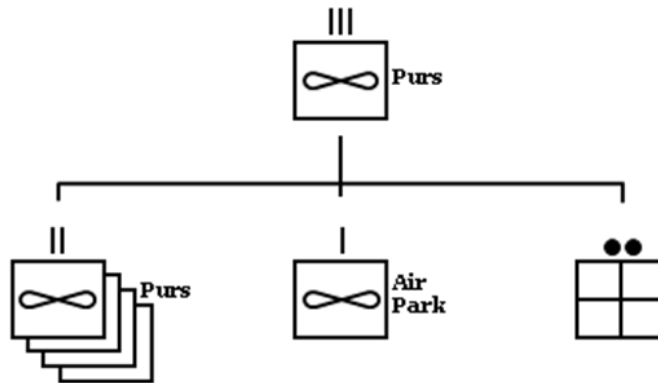

T/O: 276W
 Effective: 19 August 1921
 Commander: Col. Or Lt. Col.
 Officers: 151
 W. O. 1
 Enlisted: 1,150
 Total: 1,302

Key Equipment:
 Airplanes, various 106
 Cars, various 11
 Trucks, various 121
 Machine guns, AA 18
 Machine guns, aerial 216

TOEs observation and pursuit groups.

Airship Group, 1926

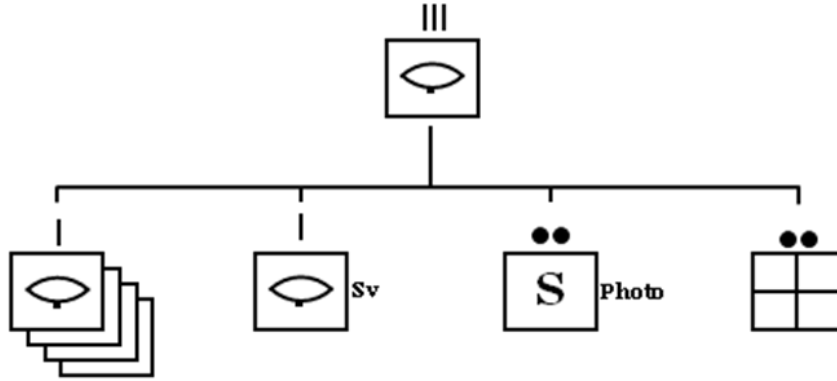

T/O: 576W
 Approved: 29 June 1926
 Commander: Lt. Col.
 Officers: 52
 W. O.: -
 Enlisted: 931
 Total: 983

Key Equipment:
 Airships: Indef
 Cars, various: 6
 Trucks, various: 67
 Machine guns, AA: 27

Balloon Group, 1926

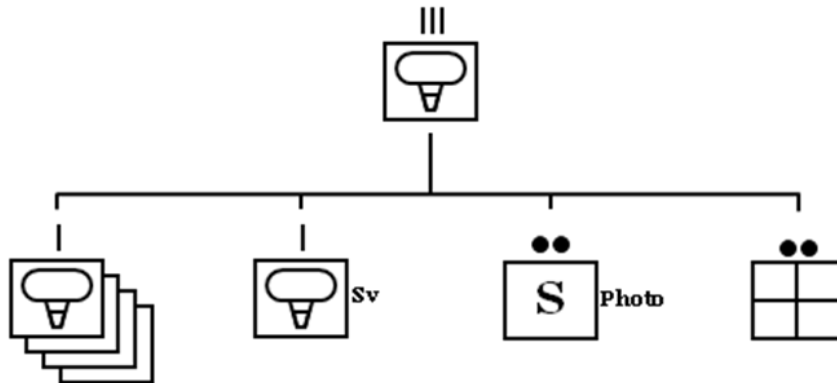

T/O: 175W
 Effective: 30 April 1926
 Commander: Maj.
 Officers: 51
 W. O.: -
 Enlisted: 911
 Total: 962

Key Equipment:
 Cars, various: 7
 Trucks, various: 57
 Balloons: 4
 Guns, 37 mm: 8
 Machine guns, AA: 48

TOEs for airship and balloon groups.

None of the National Guard balloon groups were ever organized and all were demobilized in 1927. Additionally, none of the Regular Army Inactive or Organized Reserve groups were functional units and therefore did not function as headquarters. At the time of Pearl Harbor, all active air corps groups were Regular Army organizations and none of the OR groups were activated for World War II service.

Training

Given the nature of the flying service, air corps units tended to be very active in terms of actual training. This was particularly true of the Regular Army. These groups not only participated in many of the ground units' training exercises, they conducted many of their own maneuvers as well. Particularly after 1929, many of these groups participated in rather large-scale air maneuvers two or three times a year. The groups also participated in a number of demonstrations and events that were primarily designed for public relations both nationally and internationally. For example, contingents of the 2nd Bombardment Group flew to Argentina in 1937 on a "Goodwill Flight" for the purposes of creating better relations with South American countries.

Since OR group headquarters were pool units, they did not conduct training activities during the Inactive Training Period. The headquarters personnel participated in the training activities of their subordinate squadrons or with other units. They also typically attended summer training as individuals or with one of the group's squadrons that was ordered to camp.

1st Airship Group Headquarters (See 21st Airship Group)

1st Army Observation Group (See 7th Observation Group)

1st Day Bombardment Group (See 2nd Bombardment Group)

1st Group Headquarters (Observation) (See 4th Composite Group)

HQ, 1st Pursuit Group (1919-33)

HHS, 1st Pursuit Group (1933-41)

HQ-Selfridge Field, MI, 1919; Kelly Field, TX, 1919-21; Ellington Field, TX, 1921-22; Selfridge Field, MI, 1922-41

Subordinate Squadrons: 17th Pursuit Squadron 1919-40; 27th Pursuit Squadron 1919-41; 71st Pursuit Squadron 1941; 94th Pursuit Squadron 1919-41; 95th Pursuit Squadron 1919-27; 57th Service Squadron 1919-36

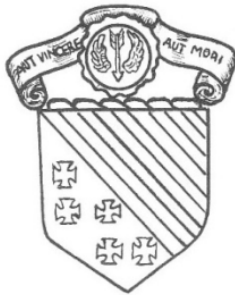

Organized in the Regular Army on 22 August 1919 at Selfridge Field, MI, as the 1st Pursuit Group Headquarters. Transferred on 31 August 19 to Kelly Field, TX. Transferred on 1 July 1921 to Ellington Field, TX. Transferred on 1 July 1922 to Selfridge Field, MI. Redesignated as Headquarters, 1st Pursuit Group on 12 February 1923. Consolidated on 8 April 1924 with the 1st Pursuit Group (a WWI unit organized on 5 May 1918 in Toul, France; demobilized on 24 December 1918 at Colombay-les Bolles, France; reconstituted on 8 April 1924). Reorganized and redesignated as Headquarters and Headquarters Squadron, 1st Pursuit Group on 1 October 1933. Redesignated as Headquarters and Headquarters Squadron, 1st Pursuit Group (Interceptor) on 1 December 1939. Redesignated as Headquarters and Headquarters Squadron, 1st Pursuit Group (Fighter) on 12 March 1941. Location 7 December 1941—

Selfridge Field, MI.

Organization Day: 5 May. Chosen to commemorate the group's initial organization in France on 5 May 1918.

Status: Active in the U. S. Air Force as the 1st Operations Group at Langley A.F.B., VA.

Events: 39, 46, 55, 71, 85, 104, 107, 126, 164, 165, 174, 197, 213, 214, 227, 249, 252

Commanders, 1st Pursuit Group

Lt. Col. Davenport Johnson	9 Jun 19-28 Aug 19	Maj. Thomas G. Lanphier	6 Oct 24-25 Aug 28
Maj. Reed M. Chambers	28 Aug 19-3 May 20	Maj. Ralph Royce	25 Aug 28-15 May 30
Capt. Arthur R. Brooks	3 May 20-18 Feb 21	Maj. Gerald E. Brower	15 May 30-18 Jul 32
Maj. Carl A. Spatz	18 Feb 21-Jun 21	Maj. Adlai H. Gilkeson	18 Jul 32-27 Oct 32
Capt. Arthur R. Brooks	Jun 21-Jul 21	Maj. George H. Brett	27 Oct 32-11 Jul 33
1st Lt. Roy B. Mosher	Jul 21-18 Aug 21	Lt. Col. Frank M. Andrews	11 Jul 33-4 Oct 34
Capt. William E. Farthing	27 Aug 21-21 Nov 21	Maj. Ralph Royce	4 Oct 34-29 Apr 37
Maj. Carl A. Spatz	21 Nov 21-6 Oct 24	Maj. Edwin J. House	29 Apr 37-7 Jul 38
	Lt. Col. Lawrence P. Hickey		7 Jul 38-30 Apr 42

1st Surveillance Group Headquarters (See 3rd Attack Group)

HHS, 1st Transport Group

HQ-Not organized 1933-34; Columbus, OH, 1934-37

Subordinate Squadrons: 1st Transport Squadron 1937-41; 2nd Transport Squadron 1937-41; 3rd Transport Squadron 1937-41; 4th Transport Squadron 1937-41; 5th *Transport Squadron* 1937-41; 1st Service Squadron 1933-36

Constituted in the Regular Army on 1 October 1933 as Headquarters and Headquarters Squadron, 1st Transport Group, assigned to the 6th Transport Wing, and allotted to the Fifth Corps Area. Organized in early 1934 with Organized Reserve personnel as a RAI unit at Columbus, OH. Organized provisionally 14 February 1934 as an active unit, less Reserve personnel, at Columbus, OH. Discontinued on 11 May 1934 as an active provisional organization. Consolidated on with the 10th Observation Group on 20 May 1937. Concurrently redesignated as Headquarters and Headquarters Squadron, 10th Transport Group, and activated at Patterson Field, OH.

Commanders, 1st Transport Group

Maj. Leo A. Walton 14 Feb 34-11 May 34

HQ, 2nd Bombardment Group (1919-33)

HHS, 2nd Bombardment Group (1933-41)

HQ-Ellington Field, TX, 1919-22; Langley Field, VA, 1922-41

Subordinate Squadrons: 11th Bombardment Squadron 1919-27; 20th Bombardment Squadron 1919-41; 49th Bombardment Squadron 1919-41; 54th Bombardment Squadron 1936-39; 96th Bombardment Squadron 1919-41; 59th Service Squadron 1919-36; 2nd Photo Section 1922-35



Organized in the Regular Army on 18 September 1919 at Ellington Field, TX, as 1st Day Bombardment Group Headquarters. Redesignated as 2nd Bombardment Group Headquarters on 14 March 1921. Transferred on 1 June 1922 to Langley Field, VA, and assigned to the 2nd Wing. Redesignated as Headquarters, 2nd Bombardment Group on 12 February 1923. Consolidated on 8 April 1924 with the 1st Day Bombardment Group (a WWI unit organized on 10 September 1918 in Amantz, France; demobilized in November 1918 at Maulan, France; reconstituted on 8 April 1924). Group and subordinate units participated in the bombing tests of Brig. Gen. Billy Mitchell against obsolete target battleships off the coast of Virginia in September 1923. Conducted the bombing of the Pee Dee River bridge in North Carolina 17-24 December 1927. Group and subordinate units participated in the bombing tests on the S.S. *Mount Shasta* 11-12 August 1931. Reorganized and redesignated as Headquarters and

Headquarters Squadron, 2nd Bombardment Group on 1 October 1933. Supported relief efforts during the Pennsylvania floods in the spring of 1936. Participated in the South American "Goodwill Flights" to Argentina in February 1938. Supported relief efforts of the Chilean earthquake in January 1939. Awarded the Columbian Trophy for 1939. Redesignated as 2nd Bombardment Group (Heavy) on 1 December 1939. Location 7 December 1941—Langley Field, VA.

Status: Active in the U. S. Air Force as the 2nd Operations Group at Barksdale A.F.B., LA.

Events: 23, 29, 39, 46, 55, 71, 85, 104, 107, 126, 131, 155, 164, 165, 174, 176, 178, 196, 200, 213, 214, 227, 249, 252, 268, 283

Commanders, 2nd Bombardment Group

Maj. Ralph P. Cousins	15 Jun 19-Sep 20	Maj. Hugh J. Knerr	2 Jul 27-5 Aug 30
Maj. Jenner Y. Chisum	Sep 20-28 Mar 21	1st Lt. James W. Hammond	5 Aug 30-24 Sep 30
Lt. Col. Charles H. Danforth	28 Mar 21-20 Jul 21	Maj. Herbert A. Dargue	24 Sep 30-13 Sep 33
Maj. Henry J. F. Miller	20 Jul 21-7 Mar 22	Capt. Eugene L. Eubank	21 Sep 33-9 May 34
Maj. Blackburn Hall	7 Mar 22-5 Sep 22	Capt. Edward C. Black	9 May 34-21 Jun 34
Capt. Walter R. Lawson	6 Sep 22-15 Feb 23	Maj. Willis H. Hale	21 Jun 34-11 Mar 35
Maj. John N. Reynolds	16 Feb 23-10 Oct 23	Lt. Col. Charles B. Oldfield	11 Mar 35-6 Mar 37
Maj. John H. Pirie	20 Oct 23-4 Jun 25	Lt. Col. Robert Olds	6 Mar 37-1 Jan 40
Maj. Louis H. Brereton	4 Jun 25-27 Jun 27	Maj. Clyde V. Finter	1 Jan 40-1 Feb 40
Capt. Willis H. Hale	27 Jun 27-2 Jul 27	Lt. Col. Harold L. George	1 Feb 40-Jul 41
	Col. Darr H. Alekire	Jul 41-Sep 42	

2nd Group Headquarters (Observation) (See 5th Composite Group)

HHS, 2nd Transport Group

HQ—*Not organized* 1933-34; Shreveport, LA, 1934-36; Cleveland, OH, 1936-38; *Inactive* 1938-40

Subordinate Squadrons: 6th Transport Squadron; 7th Transport Squadron; 8th Transport Squadron; 2nd Service Squadron

Constituted in the Regular Army on 1 October 1933 as Headquarters and Headquarters Squadron, 2nd Transport Group, assigned to the 6th Transport Wing, and allotted to the Fourth Corps Area. Organized by July 1934 with Organized Reserve personnel as a RAI unit at Shreveport, LA. Withdrawn from the Fourth Corps Area 5 June 1936 and allotted to the Fifth Corps Area. Reorganized by December 1936 with Organized Reserve personnel as a RAI unit at Cleveland, OH. Withdrawn from the Fifth Corps Area 1 January 1938 and allotted to the Sixth Corps Area. Redesignated as 39th Transport Group on 1 June 1940. Location 7 December 1941—*Inactive*.

Commanders, 2nd Transport Group

Unknown	Jul 34-5 Jun 36	Capt. Lawrence E. Eyer**	ao Dec 36-1 Jan 38
---------	-----------------	--------------------------	--------------------

** RAI Commanders: Organized Reserve officers.

HQ, 3rd Attack Group (1921-33)

HHS, 3rd Attack Group (1933-39)

HHS, 3rd Bombardment Group (1939-41)

HQ—Fort Bliss, TX, 1919-21; Kelly Field, TX, 1921-26; Fort Crockett, TX, 1926-35; Barksdale Field, LA, 1935-40; Savannah, GA, 1940-41

Subordinate Squadrons: 8th Attack Squadron 1919-41; 10th Reconnaissance Squadron 1941; 13th Attack Squadron 1919-41; 26th Attack Squadron 1919-29; 51st Attack Squadron 1935-36; 90th Attack Squadron 1919-41; 60th Service Squadron 1919-36; 16th Photo Section 1927-29; 1st Photo Section 1929-31; 5th Photo Section 1931-33



Organized in the Regular Army on 1 July 1919 at Kelly Field, TX, as Army Surveillance Group Headquarters. Redesignated as 1st Surveillance Group Headquarters 15 August 1919. Transferred on 12 November 1919 to Fort Bliss, TX. Transferred on 2 July 1921 to Kelly Field, TX. Redesignated as 3rd Attack Group Headquarters 30 August 1921. Assigned to the First Army about October 1921. Attached 1 July 1922 to the 1st Wing. Redesignated as Headquarters, 3rd Attack Group on 12 February 1923. Assigned in 1924 to the 3rd Attack Wing (First Army). Group and subordinate units participated in the border patrols along the Texas and New Mexico borders with Mexico 1919-21 and during the 1929 Escobar-Topete revolution. Transferred on 1 July 1926 to Fort Crockett, TX. Relieved from assignment in 1929 to the 3rd Attack Wing (First Army). Participated 20 May 1930 in the Independence Day celebrations in Havana, Cuba. Reorganized

and redesignated as Headquarters and Headquarters Squadron, 3rd Attack Group on 1 October 1933. Supported emergency air mail efforts in 1934. Transferred on 28 February 1935 to Barksdale Field, LA. Assigned to the 1st Wing on 1 March 1935. Awarded the Columbian Trophy for 1936 and 1937. Redesignated as Headquarters and Headquarters Squadron, 3rd Bombardment Group (Light) on 1 December 1939. Transferred on 6 October 1940 to Savannah, GA. Relieved from the 1st Wing on 16 January 1941 and assigned to the 17th Bombardment Wing. Relieved from the 17th Bombardment Wing on 1 September 1941 and assigned to the III Air Support Command. Location 7 December 1941—Savannah, GA.

Status: Active in the U. S. Air Force as the 3rd Operations Group at Elmendorf A.F.B., AK.

Events: 39, 46, 55, 85, 104, 105, 125, 126, 146, 164, 165, 174, 194, 197, 200, 213, 214, 217, 227, 243, 249, 252, 310, 330

**Commanders, 3rd Attack Group
3rd Bombardment Group**

Maj. B. B. Butler	1 Jul 19-1 Sep 19	Maj. Davenport Johnson	4 Mar 30-29 Jun 32
Maj. William G. Schauffler	1 Sep 19-27 Sep 19	Lt. Col. Horace M. Hickam	29 Jun 32-14 Feb 34
Lt. Col. Henry B. Clagett	27 Sep 19-18 Nov 19	Maj. Earl L. Naiden	14 Feb 34-15 Jul 34
Maj. Leo A. Walton	18 Nov 19-7 Dec 20	Lt. Col. Horace M. Hickam	15 Jul 34-5 Nov 34
Maj. Leo G. Heffernan	7 Dec 20-1 Aug 22	Lt. Col. Earl L. Naiden	5 Nov 34-12 Jul 37
Lt. Col. Seth W. Cook	1 Aug 22-5 Sep 23	Maj. Oliver S. Ferson	12 Jul 37-15 Aug 37
Maj. Louis H. Brereton	5 Sep 23-25 Jun 24	Col. Ira A. Rader	15 Aug 37-15 Aug 38
Maj. Harvey B. S. Burwell	25 Jun 24-22 Jan 26	Col. John C. McDonnell	15 Aug 38-1 Dec 40
Maj. Frank D. Lackland	22 Jan 26-14 Aug 28	Lt. Col. Paul L. Williams	2 Dec 40-17 Aug 41
Maj. John H. Jouett	14 Aug 28-4 Mar 30	Lt. Col. Phillips Melville	18 Aug 41-18 Jan 42

3rd Group Headquarters (Observation) (See 6th Composite Group)

HQ, 4th Composite Group (Philippine Department)

HQ-Nichols Field, PI, 1921-41

Subordinate Squadrons: 2nd Observation Squadron 1920-41; 3rd Pursuit Squadron 1920-41; 17th Pursuit Squadron 1940-41; 20th Pursuit Squadron 1940-41; 28th Bombardment Squadron 1922-41; 66th Service Squadron 1921-38; 6th Photo Section 1922-35



Organized in the Regular Army 15 August 1919 at Nichols Field, PI, as the 1st Group Headquarters (Observation) and assigned to the Philippine Department. Redesignated as 4th Group Headquarters (Observation) on 14 March 1921. Redesignated as 4th Group Headquarters (Pursuit & Bombardment) on 29 June 1922. Redesignated as 4th Composite Group Headquarters in July 1922. Redesignated as Headquarters, 4th Composite Group on 12 February 1923. Reorganized and redesignated as Headquarters and Headquarters Squadron, 4th Composite Group on 9 September 1937. Disbanded on 1 November 1941 at Nichols Field.

Events: 44, 51, 68, 139, 245, 270

Commanders, 4th Composite Group

Maj. Roy S. Brown	ao Jan 21-Apr 21	Maj. Henry W. Harms	3 Mar 30-15 May 31
1st Lt. John Blaney	Apr 21-10 Dec 21	Maj. John B. Brooks	15 May 31-1 Jun 33
1st Lt. Cyrus Bettis	10 Dec 21-3 Apr 22	Maj. Douglas B. Netherwood	1 Jun 33-17 Sep 34
1st Lt. Charles M. Leonard	3 Apr 22-15 Nov 22	Maj. Gerald E. Brower	17 Sep 34-1 Dec 34
1st Lt. Cyrus Bettis	15 Nov 22-26 Mar 23	Capt. Thomas W. Hastey	1 Dec 34-17 Apr 35
Maj. Benjamin G. Wier	26 Mar 23-2 Sep 24	Maj. Gerald E. Brower	17 Apr 35-1 Aug 35
Maj. George E. A. Reinberg	2 Sep 24-9 Nov 24	Maj. Thomas W. Hastey	1 Aug 35-8 Jun 36
Maj. Charles L. Brown	9 Nov 24-10 Jul 25	Col. Albert L. Sneed	8 Jun 36-16 Apr 37
Maj. John C. McDonnell	10 Jul 25-2 Dec 25	Lt. Col. Thomas S. Voss	16 Apr 37-22 Dec 37
Maj. Clinton W. Howard	2 Dec 25-6 Dec 27	Lt. Col. William H. Crom	22 Dec 37-27 Oct 39
Maj. Walter G. Kilner	6 Dec 27-15 Feb 30	Col. Lawrence C. Churchill	27 Oct 39-9 May 41
Maj. Ralph Cousins	15 Feb 30-3 Mar 30	Maj. Kirtley J. Gregg	9 May 41-5 Aug 41
	Maj. Orren Grover	Maj. Orren Grover	5 Aug 41-1 Nov 41

HQ, 5th Composite Group (1922-33) (Hawaiian Department)

HHS, 5th Composite Group (1933-39)

HHS, 5th Bombardment Group (1939-41)

HQ-Luke Field, TH, 1919-39; Hickam Field, TH, 1939-41

Subordinate Squadrons: 4th Observation Squadron 1919-22 and 1930-38; 4th Reconnaissance Squadron (attached) on 1938-41; 6th Pursuit Squadron 1919-27; 19th Pursuit Squadron 1924-27; 23rd Bombardment Squadron 1922-28 and 1938-41; 26th Attack Squadron 1930-38; 26th Bombardment Squadron 1939-41; 31st Bombardment Squadron 1938-41; 50th Observation Squadron 1930-38; 50th Reconnaissance Squadron (attached) on 1938-41; 72nd Bombardment Squadron 1923-41; 65th Service Squadron 1923-38; 11th Photo Section 1922-35



Organized in the Regular Army on 15 August 1919 at Luke Field, TH, as the 2nd Group Headquarters (Observation) and assigned to the Hawaiian Department. Redesignated as 5th Group Headquarters (Observation) on 14 March 1921. Redesignated as 5th Group Headquarters (Pursuit & Bombardment) on 11 June 1922. Redesignated as Headquarters, 5th Composite Group on 12 February 1923. Participated in the aerial sowing of tree seeds provided by the Territorial Forestry Division for the islands of Oahu, Kauai, and Maui 1922-37. Assigned to the 18th Composite Wing on 8 May 1929. Reorganized and redesignated as Headquarters and Headquarters Squadron, 5th Composite Group on 1 October 1933. Elements conducted bombing of a lava flow from Mauna Loa volcano in December 1935 to divert it from the city of Hilo, TH. Redesignated as Headquarters and Headquarters Squadron, 5th Bombardment Group on 25 March 1938. Transferred on 1 January 1939 to Hickam Field, TH. Redesignated as Headquarters and Headquarters Squadron, 5th Bombardment Group (Medium) on 1 December 1939. Redesignated as Headquarters and Headquarters Squadron, 5th Bombardment Group (Heavy) on 20 November 1940. Location 7 December 1941—Hickam Field, TH.

Status: Active in the U. S. Air Force as the 5th Operations Group at Minot A.F.B., ND.

Events: 33, 75, 88, 120, 138, 141, 158, 160, 189, 211, 225, 248, 276, 297, 312

**Commanders, 5th Composite Group
5th Bombardment Group**

Capt. George C. Furrow	19 Aug 19-18 Sep 19	Maj. Henry J. F. Miller	26 May 26-26 Aug 26
Maj. Hugh H. Knerr	19 Sep 19-25 Oct 19	Maj. Percy E. Van Nostrand	26 Aug 26-31 May 29
Maj. Sheldon H. Wheeler	26 Oct 19-13 Jul 21	Capt. Raymond E. O'Neill	31 May 29-21 Aug 29
Maj. John B. Brooks	13 Jul 21-12 Apr 22	Maj. Maxwell Kirby	21 Aug 29-17 Jun 32
Capt. Robert Oldys	12 Apr 22-20 May 22	Capt. James F. Powell	17 Jun 32-23 Sep 32
Maj. George E. Stratemeyer	20 May 22-15 Jul 22	Maj. Vincent B. Dixon	23 Sep 32-26 Oct 34
Maj. George H. Peabody	15 Jul 22-10 Nov 22	Capt. Walcott P. Hayes	26 Oct 34-12 Jan 35
Capt. Robert Oldys	10 Nov 22-13 Apr 23	Lt. Col. Asa N. Duncan	12 Jan 35-1 Dec 36
Maj. Karl H. Gorman	13 Apr 23-10 Aug 23	Lt. Col. Millard F. Harmon, Jr.	1 Dec 36-18 Jul 38
Maj. George E. Lovell, Jr.	10 Aug 23-7 Apr 24	Maj. John I. Moore	18 Jul 38-30 Sep 38
Maj. Arnold N. Krogstad	7 Apr 24-9 Jan 26	Col. Shepler W. FitzGerald	20 Sep 38-1 Jan 39
Maj. George E. Lovell, Jr.	9 Jan 26-26 May 26	Lt. Col. Walter F. Kruse	1 Jan 39-Aug 41
	Lt. Col. Edwin B. Bobzien	Aug 41-ao Jan 42	

HQ, 6th Composite Group (1922-33) (Panama Canal Department)

HHS, 6th Composite Group (1933-37)

HHS, 6th Bombardment Group (1937-41)

HQ-France Field, CZ, 1919-41

Subordinate Squadrons: 3rd Bombardment Squadron 1938-41; 5th Observation Squadron 1919-21; 7th Observation Squadron 1919-37; 7th Reconnaissance Squadron 1937-40; 24th Pursuit Squadron 1922-29; 25th Bombardment Squadron 1922-41; 44th Observation Squadron 1930-37; 44th Reconnaissance Squadron 1937-41; 63rd Service Squadron 1924-36; 12th Photo Section 1922-35



Organized in the Regular Army on 30 September 1919 at France Field, CZ, as the 3rd Group Headquarters (Observation) and assigned to the Panama Canal Department. Redesignated as 6th Group (Observation) Headquarters 14 March 1921. Redesignated as 6th Composite Group Headquarters on 3 July 1922. Redesignated as Headquarters, 6th Composite Group on 12 February 1923. Assigned to the 19th Composite Wing on 8 May 1929. Reorganized and redesignated as Headquarters and Headquarters Squadron,

6th Composite Group on 1 October 1933. Redesignated as Headquarters and Headquarters Squadron, 6th Bombardment Group on 1 September 1937. Flew mercy missions to support earthquake relief efforts in and near Santiago, Chile, 28 January-13 February 1939. Redesignated as Headquarters and Headquarters Squadron, 6th Bombardment Group (Medium) on 1 December 1939. Redesignated as Headquarters and Headquarters Squadron, 6th Bombardment Group (Heavy) on 12 December 1940. Assigned to the VI Bomber Command on 25 October 1941. Location 7 December 1941—France Field, CZ.

Status: Active in the U. S. Air Force as the 6th Operations Group at MacDill A.F.B., FL.

Events: 26, 31, 36, 40, 43, 58, 69, 81, 101, 102, 119, 140, 167, 170, 181, 223, 271, 292, 308, 333

Commanders, 6th Composite Group

Maj. Raycroft Walsh	14 Mar 21-Apr 22	Maj. Leo G. Heffernan	4 Jul 31-7 Dec 31
Maj. Norman J. Boots	Apr 22-19 Aug 22	Maj. Louis H. Brereton	7 Dec 31-20 Jun 35
1st Lt. Perry Wainer	19 Aug 22-2 Oct 22	Lt. Col. Junius H. Houghton	20 Jun 35-18 Jul 36
Maj. Follett Bradley	2 Oct 22-14 Jul 26	Lt. Col. William O. Butler	18 Jul 36-7 Jun 39
Maj. Roy M. Jones	14 Jul 26-24 Aug 26	Lt. Col. Vernon L. Burge	7 Jun 39-30 Aug 39
Lt. Col. Arthur G. Fisher	24 Aug 26-5 Jun 29	Lt. Col. Edwin J. House	30 Aug 39-Feb 41
Maj. Edwin B. Lyon	5 Jun 29-20 Jul 29	Lt. Col. Samuel M. Connell	Feb 41-14 Sep 41
Lt. Col. James A. Mars	20 Jul 29-4 Jul 31	Lt. Col. Henry K. Mooney	15 Sep 41-20 Jan 43

HQ, 7th Observation Group (1921-23)

HQ, 7th Bombardment Group (1923-33)

HHS, 7th Bombardment Group (1933-41)

HQ-Park Field, TN, 1919; Langley Field, VA, 1919-21; *Inactive* 1921-28; Rockwell Field, CA, 1928-31; March Field, CA, 1931-34; Hamilton Field, CA, 1934-35; March Field, CA, 1935-37; Hamilton Field, CA, 1937-40; Fort Douglas, UT, 1940-41

Subordinate Squadrons: 1st Observation Squadron 1919-23; 9th Bombardment Squadron 1923-41; 11th Bombardment Squadron 1928-41; 12th Aero Squadron 1919-20; 22nd Bombardment Squadron 1939-41; 30th Bombardment Squadron 1923-31; 31st Bombardment Squadron 1923-28 & 1931-38; 32nd Bombardment Squadron (RAI) on 1923-32; 50th Observation Squadron 1920-22; 88th Aero Squadron 1919-21; *64th Service Squadron* 1923-31; 70th Service Squadron 1931-35; *17th Photo Section* 1923-32; 23rd Photo Section 1932-33

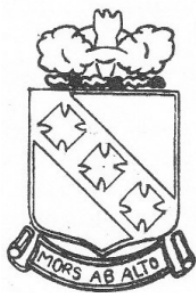

Organized in the Regular Army on 1 October 1919 at Park Field, TN, as the 1st Army Observation Group. Transferred on 28 October 1919 to Langley Field, VA. Redesignated as 7th Observation Group Headquarters 14 March 1921. Inactivated 30 August 1921 and 1st Pursuit Group designated Active Associate. Redesignated as Headquarters, 7th Bombardment Group on 24 March 1923. Allotted to the Ninth Corps Area 28 February 1927. Activated on 1 June 1928 at Rockwell Field, CA. Assigned to the 1st Bombardment Wing on 8 May 1929. Transferred on 29 October 1931 to March Field, CA. Reorganized and redesignated as Headquarters and Headquarters Squadron, 7th Bombardment Group on 1 October 1933. Transferred on 4 December 1934 to Hamilton Field, CA. Transferred on 5 November 1935 to March Field. Transferred on 22 May 1937 to Hamilton Field. Redesignated as Headquarters and Headquarters Squadron, 7th Bombardment Group (Heavy) on 1 December 1939. Transferred on 1 September 1940 to Fort Douglas/Salt Lake City Municipal

Airport. Relieved from the 1st Bombardment Wing on 18 December 1940 and assigned to the 20th Bombardment Wing. Ground elements departed from Fort Douglas 13 November 1941 and sailed from the port of San Francisco on 21 November on an army transport en route to the Philippines. Aircraft and crews began departing Muroc Field, CA, on 6 December en route to Hawaii. Elements of the group flew their B-17s into Hickam Field at the height of the Japanese attack on Pearl Harbor. Location 7 December 1941—En route to the Philippines.

Status: Consolidated 13 January 1994 with the First Army Observation Group (a WWI unit organized on 6 September 1918; demobilized in April 1919; reconstituted on 13 January 1994); active in the U. S. Air Force as the 7th Operations Group at Dyess A.F.B., TX.

Events: 85, 104, 108, 116, 126, 142, 165, 182, 197, 201, 227, 235, 249, 252, 289

Commanders, 7th Bombardment Group

1st Lt. Harry J. Martin	17 Mar 21-5 May 21	Maj. Charles T. Phillips	11 May 34-8 Oct 34
1st Lt. Bernard S. Thompson	6 May 21-6 Jun 21	Capt. Lewis R. P. Reese	8 Oct 34-5 Nov 34
1st Lt. Harry J. Martin	6 Jun 21-30 Aug 21	Lt. Col. Clarence L. Tinker	5 Nov 34-31 Aug 36
<i>Inactive</i>	1 Sep 21-1 Jun 28	Col. Davenport Johnson	31 Aug 36-17 Nov 36
Maj. Albert L. Sneed	1 Jun 28-10 Jul 28	Lt. Col. George E. Stratemeyer	17 Nov 36-15 Aug 38
Capt. Frank H. Pritchard	10 Jul 28-5 May 29	Lt. Col. Joseph T. McNarney	15 Aug 38-5 Mar 39
Maj. Carl A. Spatz	6 May 29-29 Oct 31	Maj. Earl H. DeFord	5 Mar 39-26 Aug 39
Maj. Joseph T. McNarney	29 Oct 31-3 Jul 33	Lt. Col. Ralph Royce	26 Aug 39-7 Apr 41
Maj. Leo A. Walton	3 Jul 33-11 May 34	Maj. Earl H. DeFord	7 Apr 41-5 Oct 41
	Maj. Stanley K. Robinson	6 Oct 41-29 Jan 42	

HQ, 8th Pursuit Group (1923-33)

HHS, 8th Pursuit Group (1933-41)

HQ-Not organized 1923-31; Langley Field, VA, 1931-40; Mitchel Field, NY, 1940-41

Subordinate Squadrons: 33rd Pursuit Squadron 1923-28 and 1932-41; 34th Pursuit Squadron 1923-28; 35th Pursuit Squadron 1923-41; 36th Pursuit Squadron 1923-41; 55th Pursuit Squadron 1928-32; 67th Service Squadron 1923-31; 58th Service Squadron 1932-36; 71st Service Squadron 1931-32

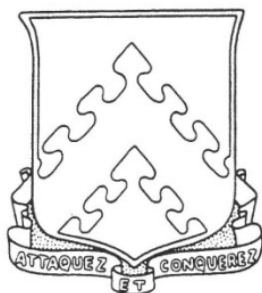

Constituted in the Regular Army on 24 March 1923 as Headquarters, 8th Pursuit Group. Designated Active Associate was the 1st Pursuit Group. Allotted to the Ninth Corps Area 28 February 1927. Assigned to the 2nd Bombardment Wing on 8 May 1929. Activated on 1 April 1931 at Langley Field, VA. Reorganized and redesignated as Headquarters and Headquarters Squadron, 8th Pursuit Group on 1 October 1933. Consolidated on with the 58th Service Squadron 1 September 1936, and reorganized and redesignated as Headquarters and Headquarters Squadron, 8th Pursuit Group. Redesignated as Headquarters and Headquarters Squadron, 8th Pursuit Group (Fighter) on 1 December 1939. Transferred on 5 November 1940 to Mitchel Field, NY. Relieved from the 2nd Bombardment Wing on 18 December 1940 and assigned to the 7th Pursuit Wing. Redesignated as Headquarters and

Headquarters Squadron, 8th Pursuit Group (Interceptor) on 12 March 1941. Location 7 December 1941—Mitchel Field, NY.

Status: Active in the U. S. Air Force as the 8th Operations Group at Kunsan A.B., Republic of Korea.

Events: 174, 176, 178, 196, 200, 227, 249, 252, 268, 283, 301, 330

Commanders, 8th Pursuit Group

1st Lt. Corley P. McDarment	1 Apr 31-10 Aug 31	Capt. Albert M. Guidera	2 Feb 34-18 Feb 35
Capt. George L. Usher	10 Aug 31-18 Mar 32	Maj. Byron Q. Jones	18 Feb 35-1 Mar 35
Capt. Harold E. George	18 Mar 32-23 Apr 32	Lt. Col. Adlai H. Gilkeson	1 Mar 35-5 Sep 38
Capt. George L. Usher	23 Apr 32-3 May 32	Lt. Col. William E. Kepner	5 Sep 38-1 Feb 40
Capt. Harold E. George	3 May 32-1 Jun 32	Maj. Edward M. Morris	1 Feb 40-23 Dec 40
Maj. Byron Q. Jones	1 Jun 32-2 Feb 34	Lt. Col. Frederic H. Smith, Jr.	17 Jan 41-21 May 42

HQ, 9th Observation Group (1922-35)

HQ, 9th Bombardment Group (1933-41)

HHS, 9th Bombardment Group (1933-41)

HQ-Mitchel Field, NY, 1922-40; Rio Hato Airfield, Panama, 1940-41; Waller Field, Trinidad, 1941

Subordinate Squadrons: 1st Observation Squadron 1922-23 and 1929-35; 1st Bombardment Squadron 1935-41; 5th Observation Squadron 1922-23 and 1929-35; 5th Bombardment Squadron 1935-41; 21st Observation Squadron 1923-29; 44th Observation Squadron 1923-29; 45th Observation Squadron (RAI) on 1923-29; 50th Observation Squadron 1923-29; 99th Observation Squadron 1929-35; 99th Bombardment Squadron 1935-41; 61st Service Squadron 1923-36; 8th Photo Section 1922-27 & 1929-35; 13th Photo Section 1927-28; 14th Photo Section 1922-27 & 1929-35; 19th Photo Section 1927-28; 31st Air Intelligence Section 1922-25.



Constituted in the Regular Army on 19 July 1922 as the 9th Group Headquarters (Observation). Organized on 1 August 1922 at Mitchel Field, NY. Redesignated as Headquarters, 9th Observation Group on 24 March 1923. Reorganized and redesignated as Headquarters and Headquarters Squadron, 9th Bombardment Group on 1 October 1933. Participated in the American Day Exercises at the New York World's Fair in September 1939. Redesignated as Headquarters and Headquarters Squadron, 9th Bombardment Group (Medium) on 1 December 1939. Ground elements departed from the port of New York 5 November 1940 on the U.S.A.T. *Chateau Thierry* and arrived 12 November 1940 at Rio Hato Airfield in Panama. Aircraft and crews departed Mitchel Field on 17 November 1940 for Rio Hato and arrived several days later. Transferred on 30 October 1941 to Waller Field, Trinidad. Location 7 December 1941—Waller Field, Trinidad.

Status: Active in the U. S. Air Force as the 9th Operations Group at Beale A.F.B., CA.

Events: 85, 103, 107, 115, 164, 168, 174, 249, 268, 283

**Commanders, 9th Observation Group
9th Bombardment Group**

Maj. Walter R. Weaver	23 Aug 22-17 Jul 23	Lt. Col. John H. Howard	2 Sep 29-4 May 33
Maj. William N. Hensley, Jr.	17 Jul 23-22 Jul 25	Maj. Carlyle H. Wash	4 May 33-1 Jun 33
Lt. Col. Benjamin D. Foulis	22 Jul 25-20 Dec 27	Maj. Follett Bradley	1 Jun 33-23 Aug 34
Maj. Howard C. Davidson	20 Dec 27-1 Jan 28	Col. Walter H. Frank	23 Aug 34-1 Aug 37
Maj. John N. Reynolds	1 Jan 28-1 Jun 28	Lt. Col. Carl W. Connell	1 Aug 37-Apr 40
Lt. Col. Henry C. Pratt	1 Jun 28-23 Jul 29	Col. Ross F. Cole	Apr 40-Aug 41
Maj. William O. Ryan	23 Jul 29-4 Sep 29	Maj. Charles F. Born	Aug 41-May 42

10th Balloon Group Headquarters (GHQR) (1921-23)

Nebraska National Guard

HQ, 31st Balloon Group (GHQR) (1923-24)

HQ, 151st Balloon Group (GHQR) (1924-27)

HQ-Not organized 1921-27

Subordinate Squadrons: *141st Balloon Company 1921-27; 142nd Balloon Company 1921-27; 143rd Balloon Company 1921-27; 144th Balloon Company 1921-27; 145th Balloon Company 1921-27; 146th Balloon Company 1921-27; 139th Balloon Service Company 1923-27*

Constituted in the National Guard in 1921 as 10th Balloon Group Headquarters, assigned to the 2nd Balloon Wing (Redesignated as 12th Balloon Wing on 25 January 1923), and allotted to the state of Nebraska. Redesignated as Headquarters, 31st Balloon Group on 25 January 1923. Unit placed on the deferred list 2 July 1923. Redesignated as Headquarters, 151st Balloon Group in 1924. Withdrawn from the National Guard on 17 September 1927 and demobilized.

10th Group Headquarters (School) (1922-23)

HQ, 10th School Group (1923-31)

HQ-Kelly Field, TX, 1922-31

Subordinate Squadrons: 39th School Squadron 1922, 1927-31; 40th School Squadron 1923-31; 41st School Squadron 1923-31; 42nd School Squadron 1923-31; 43rd School Squadron 1923-31; 48th School Squadron 1923-31; 68th Service Squadron 1923-31; Air Park No. 13 1922-23; 22nd Photo Section 1922-31



Organized in the Regular Army on 22 June 1922 at Kelley Field, TX, as 10th Group Headquarters (School). Assigned to the 1st Wing (Provisional) on 19 July 1922. Redesignated as Headquarters, 10th School Group 25 January 1923. Assigned to the 1st Wing 6 February 1923. Designated as Zone of the Interior Troops 13 June 1924. Relieved from the 1st Wing on 8 July 1927 and assigned to the 24th School Wing. Operated the Air Corps Advanced Flying School 1922-31. Demobilized on 15 July 1931 at Kelly Field, TX, and personnel transferred to the Air Corps Advanced Flying School.

Commanders, 10th School Group

Maj. John N. Reynolds	22 Jun 22-1 Sep 22	Maj. Frank M. Andrews	15 Sep 25-1 Sep 27
Maj. Louis H. Brereton	1 Sep 22-Nov 22	Capt. Raymond E. O'Neill	26 Apr 27-3 Jun 28
Lt. Col. John H. Howard	Nov 22-16 Jan 23	Maj. James E. Chaney	4 Jun 28-1 Jul 30
Maj. Horace M. Hickam	16 Jan 23-1 Aug 25	Maj. Clarence L. Tinker	1 Jul 30-6 Aug 30
	Maj. Frederick L. Martin	6 Aug 30-15 Jul 31	

HHS, 10th Observation Group

HQ-*Not organized 1933-37*

Subordinate Squadrons: 69th Service Squadron 1933-36

Constituted in the Regular Army on 1 October 1933 as Headquarters and Headquarters Squadron, 10th Observation Group, assigned to the First Army, and allotted to the Second Corps Area. Mitchel Field, NY, designated as headquarters on organization, but the unit was never organized at that location. Consolidated on with the 1st Transport Group on 20 May 1937, Redesignated as Headquarters and Headquarters Squadron, 10th Transport Group, and activated at Patterson Field, OH. Concurrently relieved from First Army.

HHS, 10th Transport Group

HQ-*Not organized 1933-37; Patterson Field, OH, 1937-38; Wright Field, OH, 1938-41; Patterson Field, OH, 1941*

Subordinate Squadrons: 1st Transport Squadron 1937-41; 2nd Transport Squadron 1937-41; 3rd Transport Squadron 1937-41; 4th Transport Squadron 1937-41; 5th Transport Squadron 1937-41



Constituted in the Regular Army on 1 October 1933 as Headquarters and Headquarters Squadron, 1st Transport Group. Consolidated on with the 10th Observation Group on 20 May 1937, Redesignated as Headquarters and Headquarters Squadron, 10th Transport Group, and activated at Patterson Field, OH. Transferred on 20 June 1938 to Wright Field, OH. Transferred on 17 January 1941 to Patterson Field, OH. Location 7 December 1941—Patterson Field, OH.

Status: Inactive in the U. S. Air Force as the 370th Air Expeditionary Group.

Events: 234

Commanders, 10th Transport Group

Maj. Hugh A. Bivins	15 Jun 37-Oct 39	Maj. Murray E. Woodbury	Jan 41-2 Sep 41
Maj. Fred H. Borum	Oct 39-Jan 41	Capt. Theodore Q. Graff	2 Sep 41-31 Mar 42

11th Balloon Group Headquarters (I Corps) (1921-23)

New Hampshire National Guard

HQ, 32nd Balloon Group (I Corps) (1923-24)

HQ, 132nd Balloon Group (I Corps) (1924-27)

HQ-Not organized 1921-27

Subordinate Squadrons: 101st Balloon Company 1921-27; 102nd Balloon Company 1921-27; 103rd Balloon Company 1921-27; 104th Balloon Company 1921-27; 11th Balloon Park 1921-23; 131st Balloon Service Company 1923-27

Constituted in the National Guard in 1921 as 11th Balloon Group Headquarters, assigned to the I Corps, and allotted to the state of New Hampshire. Redesignated as Headquarters, 32nd Balloon Group on 25 January 1923. Unit placed on the deferred list 2 July 1923 as a Deferred National Guard (DNG) unit, and replaced in the mobilization plan by the 52nd Balloon Group (DNG). Redesignated as Headquarters, 132nd Balloon Group in 1924. Withdrawn as a Deferred National Guard unit 11 January 1927 and allotted permanently to the Organized Reserve as the 552nd Balloon Group.

11th Group Headquarters (School) (1922-23)

HQ, 11th School Group (1923-31)

HQ-Brooks Field, TX, 1922-31

Subordinate Squadrons: 46th School Squadron 1923-27; 47th School Squadron 1923-27; 48th School Squadron 1924-27; 51st School Squadron 1927-31; 52nd School Squadron 1927-31; 62nd Service Squadron 1923-31; 24th Photo Section 1922-27 & 1929-31; 20th Photo Section 1927-29

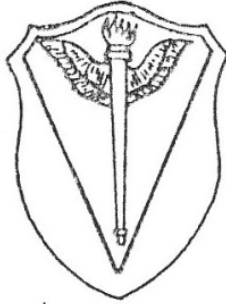

Organized in the Regular Army on 1 September 1922 at Brooks Field, TX, as 11th Group Headquarters (School). Redesignated as Headquarters, 11th School Group 25 January 1923. Assigned to the 24th School Wing on 8 July 1927. Functioned as the headquarters for the Air Corps Primary Flying School 1922-31. Demobilized on 31 December 1931 at Brooks Field, TX.

Commanders, 11th School Group

Maj. Ralph Royce
Maj. James E. Chaney

1 Sep 22-26 Jun 26
26 Jun 26-16 Jul 27

Maj. Shepler W. FitzGerald
Lt. Col. Henry B. Clagett

16 Jul 27-25 Aug 30
25 Aug 30-1 Oct 31

HHS, 11th Observation Group (1933-38)

HHS, 11th Bombardment Group (1938-41)

HQ-Not organized 1933-40; Hickam Field, TH, 1940-41

Subordinate Squadrons: 14th Bombardment Squadron 1940-41; 15th Observation Squadron 1933-37; 26th Bombardment Squadron 1940-41; 42nd Bombardment Squadron 1940-41; 865th Observation Squadron 1933-40; 84th Service Squadron 1933-36

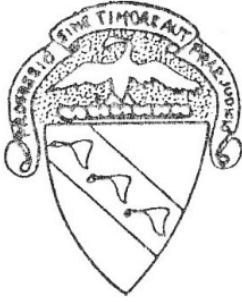

Constituted in the Regular Army on 1 October 1933 as Headquarters and Headquarters Squadron, 11th Observation Group, assigned to the Second Army, and allotted to the Sixth Corps Area. Redesignated as Headquarters and Headquarters Squadron, 11th Bombardment Group (Medium) on 1 January 1938 and relieved from the Second Army. Activated on 1 February 1940 at Hickam Field, TH, and assigned to the 18th Wing. Redesignated as Headquarters and Headquarters Squadron, 11th Bombardment Group (Heavy) on 1 December 1940. Location 7 December 1941—Hickam Field, TH.

Status: Active in the U. S. Air Force as the 11th Wing at Bolling A.F.B., DC.

Events: 297, 312

Commanders, 11th Bombardment Group

Lt. Col. Walter F. Kraus

1 Feb 40-14 Jun 40

Lt. Col. St. Clair Streett

15 Jun 40-Apr 41

Lt. Col. Albert F. Hegenberger

Apr 41-Mar 42

12th Balloon Group Headquarters (III Corps) (1921-23)

Pennsylvania National Guard

HQ, 33rd Balloon Group (III Corps) (1923-24)

HQ, 133rd Balloon Group (III Corps) (1924-27)

HQ-Not organized 1921-27

Subordinate Squadrons: *105th Balloon Company* 1921-27; *106th Balloon Company* 1921-27; *107th Balloon Company* 1921-27; *108th Balloon Company* 1921-27; *12th Balloon Park* 1921-23; *132nd Balloon Service Company* 1923-27

Constituted in the National Guard in 1921 as 12th Balloon Group Headquarters, assigned to the III Corps, and allotted to the state of Pennsylvania. Redesignated as Headquarters, 33rd Balloon Group on 25 January 1923. Unit placed on the deferred list 2 July 1923 as a Deferred National Guard (DNG) unit, and replaced in the mobilization plan by the 53rd Balloon Group (DNG). Redesignated as Headquarters, 133rd Balloon Group in 1924. Withdrawn from the National Guard on 17 September 1927 and demobilized.

12th Group Headquarters (Composite) (1923-24)

HQ, 12th Observation Group (1924-36)

HHS, 12th Observation Group (1936-38)

HHS, 12th Reconnaissance Group (1938-41)

HQ-Not organized 1923-30; Dodd Field, TX, 1930-31; Brooks Field, TX, 1931-37

Subordinate Squadrons: *10th Observation Squadron* 1927-31; *12th Observation Squadron* 1927-37; *15th Observation Squadron* 1937-38; *16th Observation Squadron* 1927-31; *22nd Observation Squadron* 1931-38; *82nd Observation Squadron* 1937-38; *88th Observation Squadron* 1931-35; *91st Observation Squadron* 1927-31 and 1937-38; *554th Observation Squadron* 1927-31; *56th Service Squadron* 1923-29; *58th Service Squadron* 1929-31; *62nd Service Squadron* 1931-36; *18th Photo Section* 1923-29; *1st Photo Section* 1931-35; *9th Photo Section* 1929-31; *15th Photo Section* 1929-31



Constituted in the Regular Army on 6 February 1923 as the 12th Group Headquarters (Composite) and assigned to the IV Corps. Designated mobilization station was Langley Field, VA, 1923-28, Carlstrom Field, FL, 1928, and Maxwell Field, AL, 1928-30. Redesignated as Headquarters, 12th Observation Group in 1924. The 2nd Wing designated as Active Associate 22 December 1924. Allotted to the Fourth Corps Area 28 February 1927. Withdrawn from the Fourth Corps Area 14 January 1929 and allotted to the Eighth Corps Area. Withdrawn from the Eighth Corps Area 8 May 1929 and allotted to the Ninth Corps Area. Activated on 1 October 1930 at Dodd Field, TX. Transferred on 31 October 1931 to Brooks Field, TX. Reorganized and redesignated as Headquarters and Headquarters Squadron, 12th Observation Group on 1 September 1936. Concurrently, consolidated with the 62nd Service Squadron. Consolidated on 1 December 1936 with the 62nd Aero Squadron (a WWI unit organized in August 1917 at Kelly Field, TX; redesignated as the 474th Aero Squadron in February 1918; demobilized in January 1919 at Garden City, NY; reconstituted on 1 December 1936). Inactivated 1 June 1937 and allotted to the Eighth Corps Area. Personnel concurrently transferred to the 82nd Observation Squadron. Redesignated as Headquarters and Headquarters Squadron, 12th Reconnaissance Group on 1 January 1938. Concurrently, withdrawn from the Ninth Corps Area and allotted to the Third Corps Area. Location 7 December 1941—*Inactive*.

Status: Disbanded 15 June 1983.

Events: 164, 174

Commanders, 12th Observation Group

Maj. Eugene A. Lohman	1 Oct 30-7 Jun 31	Lt. Col. Gerald C. Brant	20 Nov 34-25 Feb 35
Maj. William B. Mayer	7 Jun 31-11 Aug 31	Maj. William C. Ocker	25 Feb 35-27 Mar 35
Maj. Frank D. Lackland	11 Aug 31-21 May 34	Lt. Col. Edward L. Hoffman	27 Mar 35-2 Sep 35
Maj. Charles B. Oldfield	21 May 34-20 Nov 34	Maj. Robert Kauch	2 Sep 35-29 Oct 35
	Lt. Col. Henry J. F. Miller	29 Oct 35-1 Jun 37	

13th Balloon Group Headquarters (IV Corps) (1921-23)

Georgia National Guard

HQ, 34th Balloon Group (IV Corps) (1923-24)

HQ, 134th Balloon Group (IV Corps) (1924-27)

HQ—Not organized 1921-27

Subordinate Squadrons: *109th Balloon Company* 1921-27; *110th Balloon Company* 1921-27; *111th Balloon Company* 1921-27; *112th Balloon Company* 1921-27; *13th Balloon Park* 1921-23; *133rd Balloon Service Company* 1923-27

Constituted in the National Guard in 1921 as 13th Balloon Group Headquarters, assigned to the IV Corps, and allotted to the state of Georgia. Savannah, GA, designated as headquarters on organization, but the unit was never organized at that location. Redesignated as Headquarters, 34th Balloon Group on 25 January 1923. Unit placed on the deferred list 2 July 1923 as a Deferred National Guard (DNG) unit, and replaced in the mobilization plan by the 54th Balloon Group (DNG). Redesignated as Headquarters, 134th Balloon Group in 1924. Withdrawn from the National Guard on 17 September 1927 and demobilized.

13th Group Headquarters (School) (1923)

HQ, 13th School Group (1923-31)

HQ—Not organized 1923-27; March Field, CA, 1927-31

Subordinate Squadrons: 47th School Squadron 1927-31; 51st School Squadron 1923-27; 53rd School Squadron 1927-31; 54th School Squadron 1927-31; *69th Service Squadron* 1923-27; 70th Service Squadron 1927-31; 23rd Photo Section 1927-31; *25th Photo Section* 1925-27; *26th Photo Section* 1925-27

Constituted in the Regular Army on 6 February 1923 as the 13th Group Headquarters (School). Designated Active Associate was the Air Service Technical School. Redesignated as Headquarters, 13th School Group in 1923. Designated mobilization station was Chanute Field, IL, 1923-27. Allotted to the Eighth Corps Area 28 February 1927. Assigned to the 24th School Wing on 8 July 1927. Activated on 31 July 1927 at March Field, CA. Demobilized on 30 April 1931.

Commanders, 13th School Group

Capt. Rosenham Beam	31 Jul 27-22 Aug 27	Maj. Floyd N. Keesling	29 Jul 30-5 Aug 30
Maj. Millard F. Harmon	22 Aug 27-29 Jul 30	Maj. Joseph T. McNamey	5 Aug 30-30 Apr 31

14th Balloon Group Headquarters (V Corps) (1921-23)

Indiana National Guard

HQ, 35th Balloon Group (V Corps) (1923-24)

HQ, 135th Balloon Group (V Corps) (1924-27)

HQ-Not organized 1921-27

Subordinate Squadrons: *113th Balloon Company 1921-27; 114th Balloon Company 1921-27; 115th Balloon Company 1921-27; 116th Balloon Company 1921-27; 14th Balloon Park 1921-23; 134th Balloon Service Company 1923-27*

Constituted in the National Guard in 1921 as 14th Balloon Group Headquarters, assigned to the V Corps, and allotted to the state of Indiana. Redesignated as Headquarters, 35th Balloon Group on 25 January 1923. Unit placed on the deferred list 2 July 1923 as a Deferred National Guard (DNG) unit, and replaced in the mobilization plan by the 54th Balloon Group (DNG). Redesignated as Headquarters, 135th Balloon Group in 1924. Withdrawn from the National Guard on 17 September 1927 and demobilized.

HQ, 14th School Group (1923-29)

HQ, 14th Observation Group (1929-33)

HHS, 14th Observation Group (1933-38)

HHS, 14th Reconnaissance Group (1938-41)

HQ-Not organized 1923-29; Sixth Corps Area 1929-38; Inactive 1938-41

Subordinate Squadrons: *15th Observation Squadron 1929-33; 16th Observation Squadron 1933-37; 22nd Observation Squadron 1929-31; 39th School Squadron 1923-27; 52nd School Squadron 1923-27; 56th Service Squadron 1929-36; 88th Observation Squadron 1929-31; 91st Observation Squadron 1931-33; 56th Service Squadron 1929-35; 70th Service Squadron 1923-27; 27th Photo Section 1925-27; 4th Photo Section 1929-31; 5th Photo Section 1929-38*

Constituted in the Regular Army on 6 February 1923 as Headquarters, 14th School Group and assigned to the 1st Wing. Designated Active Associate was the Air Service Technical School 1923-25 and the 10th School Group on 1925-27. Designated as Zone of the Interior Troops 13 June 1924. Allotted to the Eighth Corps Area 28 February 1927. Brooks Field, TX, designated as headquarters on organization, but the unit was never organized at that location. Redesignated as Headquarters, 14th Observation Group on 8 May 1929, withdrawn from the Eighth Corps Area, and allotted to the Sixth Corps Area. Concurrently relieved from the 1st Wing and assigned to the Third Army. Organized on 31 May 1929 with Organized Reserve personnel as a RAI unit in the Sixth Corps Area. Redesignated as Headquarters and Headquarters Squadron, 14th Observation Group on 1 October 1933. Redesignated as Headquarters and Headquarters Squadron, 14th Reconnaissance Group on 1 January 1938. Concurrently withdrawn from the Sixth Corps Area allotted to the Fourth Corps Area. New Orleans, LA, designated as headquarters on reorganization, but the unit was never organized at that location. Designated mobilization station was Selfridge Field, MI, 1929-38. Location 7 December 1941—*Inactive*.

Status: Disbanded 15 June 1983.

Commanders, 14th Observation Group

Capt. Clearton H. Reynolds*	31 May 29-15 Feb 30	Unknown**	15 Feb 30-1 Jan 38
-----------------------------	---------------------	-----------	--------------------

* Regular Army officers who were designated as commander for mobilization purposes.

** RAI Commanders: Organized Reserve officers.

15th Balloon Group Headquarters (VI Corps) (1921-23)

Illinois National Guard

HQ, 36th Balloon Group (VI Corps) (1923-24)

HQ, 136th Balloon Group (VI Corps) (1924-27)

HQ-Not organized 1921-27

Subordinate Squadrons: *117th Balloon Company* 1921-27; *118th Balloon Company* 1921-27; *119th Balloon Company* 1921-27; *120th Balloon Company* 1921-27; *15th Balloon Park* 1921-23; *135th Balloon Service Company* 1923-27

Constituted in the National Guard in 1921 as 15th Balloon Group Headquarters, assigned to the VI Corps, and allotted to the state of Illinois. Chicago, IL, designated as headquarters on organization, but the unit was never organized at that location. Redesignated as Headquarters, 36th Balloon Group on 25 January 1923. Unit placed on the deferred list 2 July 1923 as a Deferred National Guard (DNG) unit, and replaced in the mobilization plan by the 56th Balloon Group (DNG). Redesignated as Headquarters, 136th Balloon Group in 1924. Withdrawn from the National Guard on 17 September 1927 and demobilized.

HQ, 15th School Group

HQ-Not organized 1923-29

Subordinate Squadrons: 50th Observation Squadron 1923-24; 54th School Squadron 1923-29; 58th Service Squadron 1923-24; 19th Airship Company 1923-24; 20th Photo Section 1923-25

Constituted in the Regular Army on 6 February 1923 as Headquarters, 15th School Group, and assigned to the 2nd Wing. Relieved from the 2nd Wing on 13 June 1924 and designated Zone of the Interior Troops. Designated Active Associate was the Air Service Technical School 1923-25 and the 10th School Group on 1925-27. Designated mobilization station was Langley Field, VA, 1923-27. Allotted to the Eighth Corps Area 28 February 1927. Demobilized on 5 March 1929.

Commanders, 15th School Group

Maj. Louis H. Brereton*	31 Dec 25-29 Jun 26	Maj. Oscar Westover*	30 Jun 26-30 Dec 26
-------------------------	---------------------	----------------------	---------------------

* Regular Army officers who were designated as commander for mobilization purposes only.

HQ, 15th Observation Group (1929-33)

HHS, 15th Observation Group (1933-41)

HQ-San Antonio, TX, 1929-33; Los Angeles, CA, 1933-36; Inactive 1936-41

Subordinate Squadrons: 91st Observation Squadron 1933-37; 89th Service Squadron 1929-35; 15th Photo Section 1933-35; 561st Observation Squadron 1936-41

Constituted in the Regular Army on 8 May 1929 as Headquarters, 15th Observation Group and allotted to the Eighth Corps Area. Organized on 8 October 1929 with Organized Reserve personnel as a RAI unit at San Antonio, TX. Designated mobilization training station was the Air Corps Training Center, Kelly Field, TX. Withdrawn from the Eighth Corps Area 1 October 1933, allotted to the Ninth Corps Area, and assigned to the Fourth Army. Concurrently, redesignated as Headquarters and Headquarters Squadron, 15th Observation Group. Organized by December 1933 with Organized Reserve personnel as a RAI unit at Los Angeles, CA. Designated mobilization training station was Crissy Field, CA, 1933-36. Withdrawn from the Ninth Corps Area 5 June 1936 and allotted to the Seventh Corps Area. Location 7 December 1941-*Inactive*.

Commanders, 15th Observation Group

Unknown**	8 Oct 29-1 Oct 33	Unknown**	Dec 33-5 Jun 36
<i>Inactive</i>	1 Oct 33-Dec 33	<i>Inactive</i>	5 Jun 36-7 Dec 41

** RAI Commanders: Organized Reserve officers.

16th Balloon Group Headquarters (VII Corps) (1921-23)

Minnesota National Guard

HQ, 37th Balloon Group (VII Corps) (1923-24)

HQ, 137th Balloon Group (VII Corps) (1924-27)

HQ-Not organized 1921-27

Subordinate Squadrons: *121st Balloon Company* 1921-27; *122nd Balloon Company* 1921-27; *123rd Balloon Company* 1921-27; *124th Balloon Company* 1921-27; *16th Balloon Park* 1921-23; *136th Balloon Service Company* 1923-27

Constituted in the National Guard in 1921 as 16th Balloon Group Headquarters, assigned to the VII Corps, and allotted to the state of Minnesota. Redesignated as Headquarters, 37th Balloon Group on 25 January 1923. Unit placed on the deferred list 2 July 1923 as a Deferred National Guard (DNG) unit, and replaced in the mobilization plan by the 52nd Balloon Group (DNG). Redesignated as Headquarters, 137th Balloon Group in 1924. Withdrawn from the National Guard on 17 September 1927 and demobilized.

HQ, 16th Pursuit Group (1923-33)

HHS, 16th Pursuit Group (1933-41)

HQ-Not organized 1923-27; New York City, NY, 1927-29; San Antonio, TX, 1929-32; Albrook Field, CZ, 1932-41

Subordinate Squadrons: 24th Pursuit Squadron 1932-41; 29th Pursuit Squadron 1923-41; *37th Pursuit Squadron* 1923-32; *38th Pursuit Squadron* 1923-32; *55th Pursuit Squadron* 1923-28; 43rd Pursuit Squadron 1940-41; 44th Reconnaissance Squadron 1937-40; 74th Pursuit Squadron 1932-37; 74th Attack Squadron 1937-39; 74th Bombardment Squadron 1939-40; 78th Pursuit Squadron 1932-40; 58th Service Squadron 1930-32; 71st Service Squadron 1923-30; 80th Service Squadron 1932-36



Constituted in the Regular Army on 24 March 1923 as Headquarters, 16th Pursuit Group and assigned to the General Headquarters Reserve. Designated Active Associate was the 9th Observation Group on 1923-27. Designated mobilization station was Mitchel Field, NY, 1923-30. Assigned to the 3rd Attack Wing in 1924. Allotted to the Second Corps Area 28 February 1927. Organized on 7 September 1927 with Organized Reserve personnel as a RAI unit at New York City, NY. Withdrawn from the Second Corps Area 14 January 1929 and allotted to the Eighth Corps Area. Organized on 2 December 1929 with Organized Reserve personnel as a RAI unit at San Antonio, TX. Activated on 1 December 1932, less Reserve personnel, at Albrook Field, CZ. Relieved from the 3rd Attack Wing on 15 June 1933 and assigned to the 19th Composite Wing. Reorganized and redesignated as Headquarters and Headquarters Squadron, 16th Pursuit Group on 1 October 1933. Redesignated as Headquarters and Headquarters Squadron, 16th Pursuit Group (Interceptor) on 1 December 1939. Relieved from the 19th Wing on 20 November 1940 and assigned to the 12th Pursuit Wing. Location 7 December 1941—Albrook Field, CZ.

Status: Active in the U. S. Air Force as the 16th Special Operations Wing at Eglin A.F.B., FL.

Events: 308

Commanders, 16th Pursuit Group

Capt. Rex F. Gilmartin**	7 Sep 27-14 Jan 29	Lt. Col. Robert L. Walsh	24 Jun 33-14 Aug 35
<i>Inactive</i>	14 Jan 29-2 Dec 29	Lt. Col. Charles T. Phillips	14 Aug 35-15 Sep 36
Unknown	2 Dec 29-1 Dec 32	Maj. Gilbert T. Collar	15 Sep 36-23 Sep 36
Maj. Eugene A. Lohman	1 Dec 32-16 May 33	Lt. Col. Benjamin G. Weir	23 Sep 36-11 Jul 38
Maj. Robert A. Candee	16 May 33-24 Jun 33	Lt. Col. Willis H. Hale	11 Jul 38-14 Aug 39
	Col. Adlai H. Gilkeson	14 Aug 39-24 Dec 41	

** RAI Commanders: Organized Reserve officers.

17th Balloon Group Headquarters (IX Corps) (1921-23)

California National Guard

HQ, 38th Balloon Group (IX Corps) (1923-24)

HQ, 138th Balloon Group (IX Corps) (1924-27)

HQ-Not organized 1921-27

Subordinate Squadrons: *127th Balloon Company* 1921-27; *128th Balloon Company* 1921-27; *129th Balloon Company* 1921-27; *130th Balloon Company* 1921-27; *17th Balloon Park* 1921-23; *137th Balloon Service Company* 1923-27

Constituted in the National Guard in 1921 as 17th Balloon Group Headquarters, assigned to the IX Corps, and allotted to the state of California. Redesignated as Headquarters, 38th Balloon Group on 25 January 1923. Unit placed on the deferred list 2 July 1923 as a Deferred National Guard (DNG) unit, and replaced in the mobilization plan by the 52nd Balloon Group (DNG). Redesignated as Headquarters, 138th Balloon Group in 1924. Withdrawn from the National Guard on 17 September 1927 and demobilized.

HQ, 17th Composite Group (Hawaiian Department)

HQ-Schofield Barracks, TH, 1923-24; *Inactive* 1924-27

Subordinate Squadrons: 4th Observation Squadron 1923-24; 19th Pursuit Squadron 1923-24

Organized in the Regular Army on 1 May 1923 at Schofield Barracks, TH, as Headquarters, 17th Composite Group. Assigned to the Hawaiian Department. Inactivated 15 Jan 24 at Schofield Barracks. Designated mobilization station was Schofield Barracks 1924-27. Demobilized in 1927.

Commanders, 17th Composite Group

Capt. Alfred F. King, Jr.

31 May 23-10 Aug 23

Maj. Robert E. M. Goolrick

10 Aug 23-31 Dec 23

HQ, 17th Observation Group (1927-29)

HQ, 17th Pursuit Group (1929-33)

HHS, 17th Attack Group (1933-39)

HHS, 17th Bombardment Group (1939-41)

HQ-Not organized 1927-28; Fort Worth, TX, 1928-29; *Inactive* 1929-31; March Field, CA, 1931-40; McChord Field, WA, 1940-41; Pendleton, OR, 1941

Subordinate Squadrons: 17th Pursuit Squadron 1929-30; 27th Pursuit Squadron 1929-30; 33rd Pursuit Squadron 1930-31; 34th Pursuit Squadron 1930-35; 34th Attack Squadron 1935-39; 34th Bombardment Squadron 1939-41; 37th Bombardment Squadron 1939-40; 73rd Pursuit Squadron 1931-35; 73rd Attack Squadron 1935-39; 73rd Bombardment Squadron 1939-41; 95th Pursuit Squadron 1929-35; 95th Attack Squadron 1935-39; 95th Bombardment Squadron 1939-41; 57th Service Squadron 1929-30; 64th Service Squadron 1931-36; 69th Service Squadron 1930-31



Constituted in the Regular Army on 18 October 1927 as Headquarters, 17th Observation Group and allotted to the Eighth Corps Area. Organized about Jan 28 with Organized Reserve personnel as a RAI unit at Fort Worth, TX. Redesignated as Headquarters, 17th Pursuit Group on 8 May 1929 and assigned to the 1st Bombardment Wing. Inactivated 1 October 1929 at Fort Worth by relief of Reserve personnel. Designated mobilization training station was Dodd Field, TX, 1927-31. Activated on 15 July 1931 at March Field, CA. Reorganized and redesignated as Headquarters and Headquarters Squadron, 17h Pursuit Group on 1 October 1933 and assigned to the 4th Pursuit Wing. Reorganized and redesignated as Headquarters and Headquarters Squadron, 17th Attack Group on 1 March 1935 and relieved from the 4th Pursuit Wing. Awarded the Frank Luke Trophy for 1935. Participated

in flood relief efforts in southern California 3-15 March 1938. Reorganized and redesignated as Headquarters and Headquarters Squadron, 17th Bombardment Group (Medium) on 1 December 1939. Transferred on 24 June 1940 to McChord Field, WA. Transferred on 29 June 1941 to Pendleton, OR. Location 7 December 1941—Pendleton, OR.

Status: Inactive in the U. S. Air Force as the 17th Bombardment Group (Tactical).

Events: 195, 201, 227, 231, 249, 252, 257, 289, 290, 330

**Commanders, 17th Observation Group
17th Pursuit Group
17th Attack Group
17th Bombardment Group**

Maj. Malcolm J. Buchanan**	Jan 28-1 Oct 29	Capt. Ira C. Eaker	1 Nov 34-10 Apr 35
<i>Inactive</i>	1 Oct 29-29 Oct 31	Lt. Col. John H. Pirie	10 Apr 35-18 Jul 36
Capt. Frank O'D. Hunter	29 Oct 31-26 Jan 33	Lt. Col. Carlyle H. Wash	19 Jul 36-16 Mar 40
Capt. Charles Douglas	26 Jan 33-14 Jun 33	Lt. Col. William H. Crom	17 Mar 40-12 Feb 41
Maj. Clarence L. Tinker	14 Jun 33-1 Nov 34	Lt. Col. Walter R. Peck	12 Feb 41-Feb 42

** RAI Commanders: Organized Reserve officers.

HQ, 18th Pursuit Group (1927-33)

HHS, 18th Pursuit Group (1933-41)

HQ-Wheeler Field, TH, 1927-30; Schofield Barracks, TH, 1930-39; Wheeler Field, TH, 1939-41

Subordinate Squadrons: 6th Pursuit Squadron 1927-41; 19th Pursuit Squadron 1927-41; 26th Attack Squadron (attached) on 1930-40; 36th Pursuit Squadron 1931-32; 37th Pursuit Squadron 1932-36; 38th Pursuit Squadron 1932-36; 73rd Pursuit Squadron 1928-31; 74th Pursuit Squadron 1928-31; 77th Pursuit Squadron 1931-32; 78th Pursuit Squadron 1936-41; 75th Service Squadron 1930-38



Organized in the Regular Army on 5 January 1927 at Wheeler Field, TH, as Headquarters, Provisional Pursuit Group and assigned to the Hawaiian Department. Redesignated as Headquarters, 18th Pursuit Group on 24 Jan 27. Assigned to the 18th Composite Wing on 8 May 1929. Reorganized and redesignated as Headquarters and Headquarters Squadron, 18th Pursuit Group on 1 October 1933. Redesignated as Headquarters and Headquarters Squadron, 18th Pursuit Group (Interceptor) on 1 December 1939. Relieved from the 18th Wing on 1 November 1940 and assigned to the 14th Pursuit Wing. Elements participated in the interception of Japanese aircraft at Pearl Harbor 7 December 1941. Location 7 December 1941—Wheeler Field, TH.

Status: Active in the U. S. Air Force as the 18th Operations Group at Kadena A.B., Japan.

Events: 141, 142, 158, 160, 248, 276, 297, 312

Commanders, 18th Pursuit Group

Maj. Henry J. F. Miller	24 Jan 27-6 Apr 29	Lt. Col. John C. McDonnell	3 Sep 35-10 Sep 37
Maj. Carlyle H. Wash	6 Apr 29-16 May 31	Maj. Clayton L. Bissell	10 Sep 37-2 May 38
Capt. Horace N. Heisen	16 May 31-23 Jun 31	Maj. Bernard J. Toohar	2 May 38-30 Sep 38
Lt. Col. Ernest Clark	23 Jun 31-3 Sep 35	Lt. Col. William E. Lynd	30 Sep 38-22 Mar 40
	Maj. Kenneth M. Walker	22 Mar 40-7 Dec 41	

HQ, 19th Observation Group (1927-29)

HQ, 19th Bombardment Group (1929-33)

HHS, 19th Bombardment Group (1933-41)

HQ-*Not organized* 1927-28; Phoenix, AZ, 1928-29; *Inactive* 1929-32; Rockwell Field, CA, 1932-35; March Field, CA, 1935-41; Albuquerque, NM, 1941; Clark Field, PI, 1941

Subordinate Squadrons: 23rd Bombardment Squadron 1929-38; 30th Bombardment Squadron 1932-41; 31st Bombardment Squadron 1928-33; 32nd Bombardment Squadron 1932-41; 72nd Bombardment Squadron 1932-38; 93rd Attack Squadron 1935-39; 93rd Bombardment Squadron 1939-41; 76th Service Squadron 1928-36



Constituted in the Regular Army on 18 October 1927 as Headquarters, 19th Observation Group and allotted to the Hawaiian Department. Organized by June 1928 with Organized Reserve personnel as a RAI unit at Phoenix, AZ. Redesignated as Headquarters, 19th Bombardment Group on 8 May 1929 and assigned to the 18th Composite Wing. Inactivated 1 October 1929 at Phoenix by relief of Reserve personnel. Designated mobilization training station was Dodd Field, TX, 1927-32. Activated on 24 June 1932 at Rockwell Field, CA, and assigned to the 18th Composite Wing. Though assigned to the 18th Composite Wing, only two squadrons of the group, the 23rd and 72nd Bombardment Squadrons, were stationed in Hawaii. Reorganized and redesignated as Headquarters and Headquarters Squadron, 19th Bombardment Group on 1 October 1933. Relieved from the 18th Composite Wing on 2 March 1935 and assigned to the 1st Wing. Transferred on 25 October 1935 to

March Field, CA. Awarded the Columbian Trophy for 1938. Redesignated as 19th Bombardment Group (Heavy) on 1 December 1939. Transferred on 7 June 1941 to Albuquerque, NM. Departed from the port of San Francisco on 4 October 1941 on the U.S.A.T. *Willard A. Holbrook* and arrived at Manila, PI, on 23 October 1941. Transferred to Clark Field, PI, the same day, and assigned to the U. S. Air Forces, Far East. Location 7 December 1941—Clark Field, PI.

Status: Active in the U. S. Air Force as the 19th Air Refueling Group at Warner-Robins A.F.B., GA.

Events: 182, 195, 235, 252, 257, 289, 290

**Commanders, 19th Observation Group
19th Bombardment Group**

Maj. Carlyle L. Nelson**	ao Jun 28-1 Oct 29	Maj. James L. Grisham	22 Jul 35-10 Aug 35
<i>Inactive</i>	2 Oct 29-23 Jun 32	Lt. Col. Howard C. Davidson	10 Aug 35-17 Aug 36
Capt. Harold M. McClelland	24 Jun 32-12 Feb 34	Lt. Col. Hubert R. Harmon	18 Aug 36-22 Jun 37
Capt. James L. Grisham	12 Feb 34-1 May 35	Lt. Col. Harvey S. Burwell	22 Jun 37-1 Nov 40
Lt. Col. Harold M. McClelland	1 May 35-22 Jul 35	Lt. Col. Eugene L. Eubank	1 Nov 40-10 Dec 41

** RAI Commanders: Organized Reserve officers.

HQ, 20th Balloon Group (1927-29)

HQ, 20th Pursuit Group (1929-33)

HHS, 20th Pursuit Group (1933-41)

HQ-Not organized 1927-30; Mather Field, CA, 1930-32; Barksdale Field, LA, 1932-39; Moffett Field, CA, 1939-40; Hamilton Field, CA, 1939-41

Subordinate Squadrons: 24th Pursuit Squadron 1929-32; 55th Pursuit Squadron 1930-31 and 1932-41; 77th Pursuit Squadron 1930-41; 78th Pursuit Squadron 1931-32; 79th Pursuit Squadron 1933-41; 87th Pursuit Squadron 1935-36; 71st Service Squadron 1931-36; 80th Service Squadron 1929-31



Constituted in the Regular Army on 18 October 1927 as Headquarters, 20th Balloon Group and allotted to the Eighth Corps Area. Fort Sam Houston, TX, designated as headquarters on organization, but the unit was never organized at that location. Withdrawn from the Eighth Corps Area 1 September 1928 and allotted to the Sixth Corps Area. Redesignated as Headquarters, 20th Pursuit Group on 8 May 1929 and assigned to the 19th Composite Wing. Activated on 15 November 1930 at Mather Field, CA. Transferred on 14 October 1932 to Barksdale Field, LA. Reorganized and redesignated as Headquarters and Headquarters Squadron, 20th Pursuit Group on 1 October 1933 and assigned to the 4th Pursuit Wing. Relieved from the 4th Pursuit Wing on 1 January 1938. Transferred on 15 November 1939 to Moffett Field, CA. Redesignated as Headquarters and Headquarters

Squadron, 20th Pursuit Group (Fighter) on 1 December 1939. Transferred on 1 September 1940 to Hamilton Field, CA. Redesignated as Headquarters and Headquarters Squadron, 20th Pursuit Group (Interceptor) on 12 March 1941. Location 7 December 1941—Hamilton Field, CA.

Status: Active in the U. S. Air Force as the 20th Operations Group at Shaw A.F.B., SC.

Events: 194, 197, 200, 227, 243, 249, 252, 289, 304

Commanders, 20th Pursuit Group

Maj. Clarence L. Tinker	15 Nov 30-14 Oct 32	Maj. Armin F. Harold	7 Oct 36-14 Sep 37
Capt. John M. Clark	14 Oct 32-1 Nov 32	Lt. Col. Ross G. Hoyt	14 Sep 37-1 Nov 40
Lt. Col. Millard F. Harmon	1 Nov 32-7 Oct 36	Lt. Col. Ira C. Eaker	1 Nov 40-1 Jan 42

HQ, 21st Airship Group (1923-37)

HQ, 21st Balloon Group (1937-39)

HQ-Brooks Field, TX, 1921-22; Scott Field, IL, 1921-39; *Inactive* 1939-41

Subordinate Squadrons: 8th Airship Company 1921-33; 9th Airship Company 1921-33; 9th Airship Squadron 1933-37; 12th Airship Company 1921-33; 16th Airship Company 1921-33; 19th Airship Squadron 1933-37; 24th Airship Service Company 1921-33; 24th Airship Service Squadron 1933-37; 24th Service Squadron 1937-39; 1st Balloon Squadron 1937-39; 2nd Balloon Squadron 1937-39; 3rd Balloon Squadron 1937-39; 8th Balloon Squadron (RAI) on 1937-39; 12th Balloon Squadron (RAI) on 1937-39; 21st Photo Section 1922-37

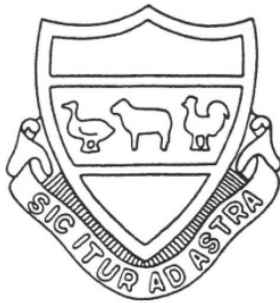

Constituted in the Regular Army on 13 September 1921 as 1st Balloon Group Headquarters, and assigned to the Zone of the Interior. Concurrently activated at Brooks Field, TX. Redesignated as 1st Airship Group Headquarters 3 January 1922. Transferred on 1 July 1922 to Scott Field, IL, to perform duties as support troops for the Air Service Balloon and Airship School. Redesignated as Headquarters, 21st Airship Group on 1 January 1923. Assigned to the General Headquarters Reserve 8 May 1929. Assigned to the General Headquarters Air Force 1 October 1933. Relieved from control of the General Headquarters Air Force 12 August 1936 and placed under control of the Commanding General, Sixth Corps Area. Consolidated on 20 November 1936 with Headquarters, 1st Balloon Group (a WWI unit organized on 16 October 1917 as Headquarters Company, 2nd Balloon Squadron at Fort Omaha, NE; redesignated as Headquarters Company, Balloon Group, I Army Corps 8 October 1918; demobilized in December 1918 at Colombey-les-Belles, France; reconstituted on 20 November 1936). Reorganized and redesignated as Headquarters and Headquarters Squadron, 21st Balloon Group on 1 June 1937. Relieved from the Sixth Corps Area 19 February 1939 and assigned to the 3rd Wing. Inactivated 1 June 1939 at Scott Field. Location 7 December 1941—*Inactive*.

**Commanders, 21st Airship Group
21st Balloon Group**

Lt. Col. John A. Paegelow	13 Sep 21-1 Jun 33	Col. Frank M. Kennedy	3 Aug 33-1 Mar 37
Capt. Ira R. Koenig	1 Jun 33-3 Aug 33	Col. Arthur G. Fisher	1 Mar 37-1 Jun 39

HQ, 22nd Balloon Group (School)

Regular Army Inactive

HQ-*Not organized* 1923-26; Belleville, IL, 1926-32; Chicago, IL, 1932-33

Subordinate Squadrons: 15th Balloon Company 1927-33; 20th Balloon Company 1923-33; 22nd Balloon Company (RAI) on 1923-33; 23rd Balloon Company (RAI) on 1927-33; 34th Balloon Service Company 1927-33; 16th Photo Section 1929-33

Constituted in the Regular Army on 6 February 1923 as Headquarters, 22nd Balloon Group (School). Designated Active Associate was the 12th Airship Company 1923-27. Organized on 14 July 1926 with Organized Reserve personnel as a RAI unit at Belleville, IL. Designated mobilization training station was Scott Field, IL, 1923-33. On organization the group was to perform duties as support troops for the Air Service Balloon and Airship School. Allotted to the Sixth Corps Area 28 February 1927. Relocated on 26 February 1932 to Chicago, IL. Demobilized on 1 October 1933.

Commanders, 22nd Balloon Group (School)

Unknown*	14 Jul 26-1 Oct 33
----------	--------------------

** RAI Commanders: Organized Reserve officers.

HHS, 22nd Bombardment Group

HQ-Langley Field, VA, 1939-41

Subordinate Squadrons: 2nd Bombardment Squadron 1940-41; 18th Reconnaissance Squadron 1940-41; 19th Bombardment Squadron 1940-41; 33rd Bombardment Squadron 1940-41



Constituted in the Regular Army on 1 December 1939 as Headquarters and Headquarters Squadron, 22nd Bombardment Group (Medium). Activated on 22 December 1939 at Langley Field, VA. Location 7 December 1941—Langley Field, VA.

Status: Active in the U. S. Air Force as the 22nd Operations Group at McConnell A.F.B., KS.

Commanders, 22nd Bombardment Group

Maj. Ross F. Cole	1 Feb 40-1 Apr 40	Maj. Lewis M. Merrick	20 Feb 41-11 Aug 41
Lt. Col. John I. Moore	2 Apr 40-20 Feb 41	Maj. Percival E. Gabel	11 Aug 41-3 Nov 41
	Maj. Mark K. Lewis, Jr.	3 Nov 41-9 Dec 41	

HQ, 23rd Airship Group

Regular Army Inactive

HQ-*Not organized* 1923-32; Chicago, IL, 1932-33

Subordinate Squadrons: 1st Airship Company (RAI) on 1923-33; 13th Airship Company (RAI) on 1923-33; 18th Airship Company 1927-33; 19th Airship Company 1927-33; 25th Airship Service Company 1927-33; 7th Photo Section 1929-33

Constituted in the Regular Army on 24 March 1923 as the Headquarters, 23rd Airship Group. Designated Active Associate was the 21st Airship Group on 1923-27. Allotted to the Ninth Corps Area 28 February 1927. Withdrawn from the Ninth Corps Area 1 September 1928 and allotted to the Sixth Corps Area. Organized by June 1932 with Organized Reserve personnel as a RAI unit with headquarters at Chicago, IL. Designated mobilization training station was Scott Field, IL, 1923-33. Demobilized on 1 October 1933.

Commanders, 23rd Airship Group

Unknown**	ao Jun 32-1 Oct 33
-----------	--------------------

** RAI Commanders: Organized Reserve officers.

HHS, 23rd Composite Group

HQ-Maxwell Field, AL, 1939-40; Orlando, FL, 1940-41

Subordinate Squadrons: 1st Pursuit Squadron 1939-41; 24th Bombardment Squadron 1939-41; 54th Bombardment Squadron 1939-41



Constituted in the Regular Army on 1 August 1939 as Headquarters and Headquarters Squadron, 23rd Composite Group. Activated on 1 August 1939 at Maxwell Field, AL. The group mission was to develop and test new theories of aerial combat and tactics for the Air Corps Tactical School. Transferred on 1 September 1940 to Orlando, FL. Redesignated as Headquarters, Air Corps Proving Ground Detachment 1 July 1941. Location 7 December 1941—Orlando, FL.

Status: Inactive in the U. S. Air Force as the 550th Tactical Missile Wing.

Events: 301

Commanders, 23rd Composite Group

Maj. Frank O'D. Hunter 1 Aug 39-1 Apr 42

HQ, 24th Balloon Group (1923-33)

Regular Army Inactive

HHS, 24th Balloon Group (1933-41)

HQ-Not organized 1923-26; Chicago, IL, 1926-33; *Inactive* 1933-41

Subordinate Squadrons: 2nd Balloon Squadron 1933-37; 5th Balloon Company (RAI) on 1929-33; *5th Balloon Squadron* 1933-41; 6th Balloon Company (RAI) on 1923-33; *6th Balloon Squadron* 1933-41; 7th Balloon Company (RAI) on 1923-33; *8th Balloon Company* 1929-33; 32nd Balloon Service Company (RAI) on 1929-33; *32nd Balloon Service Squadron* 1933-36; *10th Photo Section* 1929-33

Constituted in the Regular Army on 6 February 1923 as Headquarters, 24th Balloon Group and assigned to the Zone of the Interior as a coast defense balloon group. Designated Active Associate was the 9th Airship Company 1923-26. Designated mobilization training station was Scott Field, IL, 1923-33. Organized on 19 August 1926 with Organized Reserve personnel as a RAI unit at Chicago, IL. Relieved as a Zone of the Interior organization by the 1926 General Mobilization Plan and assigned to the VI Corps. Withdrawn from the Sixth Corps Area 1 October 1933, allotted to the Fourth Corps Area, and assigned to the IV Corps. Concurrently, Redesignated as Headquarters and Headquarters Squadron, 24th Balloon Group. Charlotte, NC, designated as headquarters on reorganization, but the unit was never organized at that location. Designated mobilization training station was Pope Field, NC, 1933-41. Location 7 December 1941—*Inactive*.

Commanders, 24th Balloon Group

Unknown** 19 Aug 26-1 Oct 33

** RAI Commanders: Organized Reserve officers.

HQ, 25th Balloon Group (Panama Canal Department)

Regular Army Inactive

HQ-Not organized 1923-29; Chicago, IL, 1929-33

Subordinate Squadrons: *4th Balloon Company* 1923-29; *5th Balloon Company* 1923-29; 9th Balloon Company (RAI) on 1929-33; 10th Balloon Company (RAI) on 1929-33; 11th Balloon Company (RAI) on 1929-33; 14th Balloon Company (RAI) on 1929-33; 33rd Balloon Service Company (RAI) on 1929-33; *13th Photo Section* 1929-33

Constituted in the Regular Army on 6 February 1923 as Headquarters, 25th Balloon Group and assigned to the Panama Canal Department. Designated Active Associate was the 6th Composite Group. Designated mobilization training station was France Field, CZ, 1923-27. Demobilized on 28 February 1927. Reconstituted 18 October 1927 and allotted to the Eighth Corps Area. Fort Sam Houston, TX, designated as headquarters on organization, but the unit was never organized at that location. Withdrawn from the Eighth Corps Area 1 September 1928 and allotted to the Sixth Corps Area. Organized by June 1929 with Organized Reserve personnel as a RAI unit at Chicago, IL. Designated mobilization training station was Scott Field, IL, 1927-33. Demobilized on 1 October 1933.

Commanders, 25th Balloon Group

Unknown** ao Jun 29-1 Oct 33

** RAI Commanders: Organized Reserve officers.

HHS, 25th Bombardment Group

HQ-Not organized 1939-40; Langley Field, VA, 1940; Borinquen Field, PR 1940-41

Subordinate Squadrons: 10th Bombardment Squadron 1940-41; 12th Bombardment Squadron 1940-41; 35th Bombardment Squadron 1940-41; 27th Reconnaissance Squadron 1940-41



Constituted in the Regular Army on 22 December 1939 as Headquarters and Headquarters Squadron, 25th Bombardment Group (Heavy). Activated on 1 February 1940 at Langley Field, VA. Ground elements departed from Fort Monroe, VA, on 27 October 1940 on an army transport and arrived 2 November 1940 at San Juan, PR. Aircraft and crews departed Langley Field on 1 November 1940 for Borinquen Field, PR, and arrived several days later. Location 7 December 1941—Borinquen Field, PR.

Status: Inactive in the U. S. Air Force as the 25th Tactical Reconnaissance Wing.

Events: 329

Commanders, 25th Bombardment Group

Lt. Col. Theodore J. Koenig	1 Feb 40-1 Oct 40	Lt. Col. Caleb V. Haynes	7 Jan 41-1 Jun 41
Maj. William B. Souza	1 Oct 40-6 Jan 41	Maj. Alva L. Harvey	1 Jun 41-10 Sep 41
	Maj. Neil B. Harding	10 Sep 41-ao Jan 42	

HQ, 26th Balloon Group (1923-33) (Hawaiian Department)

Regular Army Inactive

HHS, 26th Balloon Group (1933-41)

HQ-Not organized 1923-26; Chicago, IL, 1926-33; *Inactive* 1933-36; Oklahoma City, OK, 1936-41

Subordinate Squadrons: 1st Balloon Company 1929-33; 1st Balloon Squadron 1933-37; 2nd Balloon Company 1930-33; 3rd Balloon Company (RAI) on 1923-33; 3rd Balloon Squadron 1933-37; 4th Balloon Company (RAI) on 1929-33; *4th Balloon Squadron* 1933-41; *21st Balloon Company* 1923-27; *26th Balloon Service Squadron* 1933-36; *31st Balloon Service Squadron* 1929-33 & 1936-41; *3rd Photo Section* 1929-33

Constituted in the Regular Army on 6 February 1923 as Headquarters, 26th Balloon Group and assigned to the Hawaiian Department. Designated Active Associate was the 5th Composite Group. Designated mobilization training station was Luke Field, TH, 1923-27 and Scott Field, IL, 1927-33. Organized on 14 July 1926 with Organized Reserve personnel as a RAI unit with headquarters at Chicago, IL. Demobilized on 28 February 1927. Reconstituted 18 October 1927, allotted to the Sixth Corps Area, and concurrently reorganized as a RAI unit with headquarters at Chicago. Inactivated by June 1933 in the Sixth Corps Area by relief of personnel. Withdrawn from the Sixth Corps Area 1 October 1933 and allotted to the Eighth Corps Area. Concurrently, redesignated as Headquarters and Headquarters Squadron, 26th Balloon Group and assigned to the VIII Corps. Organized on 14 December 1936 with Organized Reserve personnel as a RAI unit with headquarters at the Municipal Airport, Oklahoma City, OK. Location 7 December 1941—Oklahoma City, OK.

Commanders, 26th Balloon Group

<i>Medical officers only</i>	14 Jul 26-28 Feb 27	Capt. John H. Engelbrecht**	14 Dec 36-ao Feb 36
<i>Demobilized</i>	28 Feb 27-18 Oct 27	Unknown**	ao Feb 36-ao Jun 37
Unknown**	18 Oct 27-1 Oct 33	Capt. Elmer R. Norris**	ao Jun 37-ao Aug 37
<i>Inactive</i>	1 Oct 33-14 Dec 36	Unknown**	ao Aug 37-7 Dec 41

** RAI Commanders: Organized Reserve officers.

HQ, 27th Balloon Group (Philippine Department)

HQ-Not organized 1923-27

Subordinate Squadrons: *17th Balloon Company* 1923-27; *27th Balloon Company* 1923-27

Constituted in the Regular Army on 6 February 1923 as Headquarters, 27th Balloon Group and assigned to the Philippine Department. Designated Active Associate was the 4th Composite Group on 1923-27. Designated mobilization training station was Camp Nichols, PI, 1923-27. Demobilized on 28 February 1927.

HHS, 27th Bombardment Group

HQ-*Not organized* 1939-40; Barksdale Field, LA, 1940; Hunter Field, GA, 1940-41; Clark Field, PI, 1941

Subordinate Squadrons: 15th Bombardment Squadron 1940-41; 16th Bombardment Squadron 1940-41; 17th Bombardment Squadron 1940-41; 91st Bombardment Squadron 1940-41



Constituted in the Regular Army on 22 December 1939 as Headquarters and Headquarters Squadron, 27th Bombardment Group (Light). Activated on 1 February 1940 at Barksdale Field, LA, and assigned to the Southeast Air District. Transferred on 7 October 1940 to Hunter Field, GA. Assigned to the III Air Support Command 1 September 1941. Departed from the port of San Francisco on the U.S.A.T. *President Coolidge* and arrived at Manila, PI, 20 November 1941. Transferred to Clark Field, PI, on the same day. Location 7 December 1941—Clark Field, PI.

Status: Active in the U. S. Air Force as the 27th Operations Group at Cannon A.F.B., NM.

Events: 310

Commanders, 27th Bombardment Group

Col. Clarence L. Tinker	1 Feb 40-Mar 41	Col. Guy McNeil	5 Jul 41-Nov 41
Lt. Col. William B. Wright	Mar 41-5 Jul 41	Col. John H. Davies	Nov 41-17 Dec 41

HHS, 28th Composite Group

HQ-*Not organized* 1939-40; March Field, CA, 1940; Moffett Field, CA, 1940-41; Elmendorf Field, TA, 1941

Subordinate Squadrons: 18th Pursuit Squadron 1941; 34th Pursuit Squadron 1940; 36th Pursuit Squadron 1940-41; 73rd Pursuit Squadron 1941



Constituted in the Regular Army on 22 December 1939 as Headquarters and Headquarters Squadron, 28th Composite Group. Activated on 1 February 1940 at March Field, CA. Transferred on 7 October 1940 to Moffett Field, CA. Departed from the port of San Francisco on the U.S.A.T. *St. Mihiel* for duty stations in Alaska. Arrived 23 February 1941 at Elmendorf Field, TA. Location 7 December 1941—Elmendorf Field, TA.

Status: Active in the U. S. Air Force as the 28th Operations Group at Ellsworth A.F.B., SD.

Commanders, 28th Composite Group

Col. William H. Crom	1 Feb 40-12 Feb 40	Maj. Donlad W. Titus	20 Oct 40-25 May 41
Lt. Col. Lotha A. Smith	12 Feb 40-1 Sep 40	Lt. Col. William O. Eareckson	26 May 41-7 Nov 41
Maj. William O. Eareckson	1 Sep 40-20 Oct 40	Maj. Norman D. Sillin	7 Nov 41-23 Jan 43

HHS, 29th Bombardment Group

HQ-*Not organized* 1939-40; Langley Field, VA, 1940; MacDill Field, FL, 1940-41

Subordinate Squadrons: 6th Bombardment Squadron 1940-41; 29th Bombardment Squadron 1940-41; 52nd Bombardment Squadron 1940-41



Constituted in the Regular Army on 22 December 1939 as Headquarters and Headquarters Squadron, 29th Bombardment Group (Heavy). Activated on 1 February 1940 at Langley Field, VA. Transferred on 21 May 1940 to MacDill Field, FL. Location 7 December 1941—MacDill Field, FL.

Status: Inactive in the U. S. Air Force as the 29th Flying Training Wing.

Events: 302

Commanders, 29th Bombardment Group

Maj. Vincent J. Meloy	1 Feb 40-15 Jan 41	Lt. Col. James P. Hodges	1 Feb 41-1 Oct 41
Maj. Charles W. Lawrence	15 Jan 41-1 Feb 41	Maj. Frank H. Robinson	1 Oct 41-1 Dec 41
	Lt. Col. James M. Fitzmaurice	1 Dec 41-29 Mar 42	

HHS, 31st Pursuit Group

HQ-*Not organized* 1939-40; Selfridge Field, MI, 1940-41; Baer Field, IN, 1941

Subordinate Squadrons: 39th Pursuit Squadron 1940-41; 40th Pursuit Squadron 1940-41; 41st Pursuit Squadron 1940-41



Constituted in the Regular Army on 22 December 1939 as Headquarters and Headquarters Squadron, 31st Pursuit Group (Interceptor). Activated on 1 February 1940 at Selfridge Field, MI. Transferred on 6 December 1941 to Baer Field, IN. Location 7 December 1941—Baer Field, IN.

Status: Active in the U. S. Air Force as the 31st Operations Group at Aviano A.B., Italy.

Events: 330

Commanders, 31st Pursuit Group

Lt. Col. Harold H. George	1 Feb 40-1 Jul 41	Col. John R. Hawkins	1 Jul 41-4 Dec 42
---------------------------	-------------------	----------------------	-------------------

HHS, 32nd Attack Group (1933-38)

Regular Army Inactive

HHS, 32nd Observation Group (1938-42)

HQ-*Not organized* 1933-38; Atlanta, GA, 1938-41

Subordinate Squadrons: 6th Attack Squadron 1933-38; 7th Attack Squadron 1933-38; 22nd Service Squadron 1933-36; 16th Observation Squadron 1938-40

Constituted in the Regular Army on 1 October 1933 as Headquarters and Headquarters Squadron, 32nd Pursuit Group, assigned to the 5th Attack Wing, and allotted to the Fourth Corps Area. Redesignated as Headquarters and Headquarters Squadron, 32nd Observation Group on 1 January 1938 and assigned to the Third Army. Organized by December 1938 with Organized Reserve personnel as a RAI unit at Atlanta, GA. Designated mobilization training station was Pope Field, NC. Location 7 December 1941—Atlanta, GA.

Commanders, 32nd Attack Group

Unknown** ao Dec 38-7 Dec 41

** RAI Commanders: Organized Reserve officers.

HHS, 33rd Attack Group (1933-38)

Regular Army Inactive

HHS, 33rd Observation Group (1938-42)

HQ-Not organized 1933-38; Chicago, IL, 1938-41

Subordinate Squadrons: *14th Attack Squadron* 1933-38; *93rd Attack Squadron* 1929-35; *97th Attack Squadron* 1933-38; *23rd Service Squadron* 1933-36

Constituted in the Regular Army on 1 October 1933 as Headquarters and Headquarters Squadron, 33rd Pursuit Group, assigned to the 5th Attack Wing, and allotted to the Eighth Corps Area. Designated mobilization training station was San Angelo, TX. Withdrawn from the Eighth Corps Area 5 June 1936 and allotted to the Sixth Corps Area. Redesignated as Headquarters and Headquarters Squadron, 33rd Observation Group on 1 January 1938. Organized by July 1938 with Organized Reserve personnel as a RAI unit at Chicago, IL. Location 7 December 1941—Chicago, IL.

Events: 264

Commanders, 32nd Attack Group

Unknown** ao Jul 38-7 Dec 41

** RAI Commanders: Organized Reserve officers.

HHS, 35th Pursuit Group

HQ-Not organized 1939-40; Moffett Field, CA, 1940; Hamilton Field, CA, 1940-41

Subordinate Squadrons: 18th Pursuit Squadron 1940-41; 20th Pursuit Squadron 1940-41; 21st Pursuit Squadron 1940-41



Constituted in the Regular Army on 22 December 1939 as Headquarters and Headquarters Squadron, 35th Pursuit Group (Interceptor). Activated on 1 February 1940 at Moffett Field, CA. Transferred on 10 September 1940 to Hamilton Field, CA. Location 7 December 1941—Hamilton Field, CA.

Status: Active in the U. S. Air Force as the 35th Operations Group at Misawa A.B., Japan.

Commanders, 35th Pursuit Group

Maj. Aubrey C. Strickland

1 Feb 40-1 Jul 41

Col. George P. Tourtellot

1 Jul 41-11 Mar 42

HHS, 36th Pursuit Group (Puerto Rican Department)

HQ-Not organized 1939-40; Langley Field, VA, 1940-41; Losey Field, PR 1941

Subordinate Squadrons: 22nd Pursuit Squadron 1940-41; 23rd Pursuit Squadron 1940-41; 32nd Pursuit Squadron 1940-41



Constituted in the Regular Army on 22 December 1939 as Headquarters and Headquarters Squadron, 36th Pursuit Group (Interceptor). Activated on 1 February 1940 at Langley Field, VA. Departed 2 January 1941 from the port of Newport News on the U.S.A.T. *Chateau Thierry* for duty stations in Puerto Rico. Arrived 6 January 1941 at Ponce, PR. Transferred to Losey Field, PR, and assigned to the Caribbean Defense Command. Further assigned to the Caribbean Interceptor Command 3 June 1941 (redesignated as VI interceptor Command 25 October 1941). Location 7 December 1941—Losey Field, PR.

Status: Active in the U. S. Air Force as the 36th Operations Group at Anderson A.F.B., Guam.

Commanders, 36th Pursuit Group

Maj. Ned Schramm	1 Feb 40-15 Jul 41	Maj. Charles A. Harrington	15 Jul 41-1 Nov 41
	Lt. Col. Glenn O. Barcus	1 Nov 41-19 Feb 42	

HHS, 37th Pursuit Group (Panama Canal Department)

HQ-*Not organized* 1939-40; Albrook Field, CZ, 1940-41

Subordinate Squadrons: 28th Pursuit Squadron 1940-41; 30th Pursuit Squadron 1940-41; 31st Pursuit Squadron 1940-41



Constituted in the Regular Army on 22 December 1939 as Headquarters and Headquarters Squadron, 37th Pursuit Group (Interceptor). Activated on 1 February 1940 at Albrook Field, CZ. Location 7 December 1941—Albrook Field, CZ.

Status: Inactive in the U. S. Air Force as the 37th Fighter-Bomber Group.

Events: 292, 333

Commanders, 37th Pursuit Group

Capt. Russell E. Randall	1 Feb 40-27 May 40	Maj. Milo N. Clark	27 May 40-ao Jan 42
--------------------------	--------------------	--------------------	---------------------

HHS, 41st Observation Group (I Corps)

Regular Army Inactive

HQ-*Not organized* 1933-34; Rhode Island at large 1934-41

Subordinate Squadrons: 101st Observation Squadron 1933-40; 118th Observation Squadron 1933-40; 301st Observation Squadron 1933-40; 41st Service Squadron (RAI) on 1933-36

Constituted in the Regular Army on 1 October 1933, assigned to the I Corps, and allotted to the First Corps Area. Organized by December 1934 with Organized Reserve personnel as a RAI unit in Rhode Island. Relieved from the I Corps in 1941 and disbanded.

Commanders, 41st Observation Group

Unknown**	ao Dec 34-Jan 41
-----------	------------------

** RAI Commanders: Organized Reserve officers.

HHS, 42nd Observation Group (II Corps)

Regular Army Inactive

HQ-Mitchel Field, NY, 1933-41

Subordinate Squadrons: 97th Observation Squadron 1935-37; 102nd Observation Squadron 1933-40; 119th Observation Squadron 1933-40; 302nd Observation Squadron 1933-40; 42nd Service Squadron (RAI) on 1933-36

Constituted in the Regular Army on 1 October 1933, assigned to the II Corps, and allotted to the Second Corps Area. Organized on 7 November 1933 with Organized Reserve personnel as a RAI unit at Mitchel Field, NY. Relieved from the II Corps in 1941 and disbanded.

Commanders, 42nd Observation Group

Capt. Roy A. Mullen**	7 Nov 33-ao Jan 34	Unknown**	ao Jan 34-Jan 41
-----------------------	--------------------	-----------	------------------

** RAI Commanders: Organized Reserve officers.

HHS, 43rd Observation Group (III Corps)

HQ-*Not organized* 1933-41

Subordinate Squadrons: 3rd Observation Squadron 1937-40; 97th Observation Squadron 1937-40; 103rd Observation Squadron 1933-40; 104th Observation Squadron 1933-40; *43rd Service Squadron* 1933-36

Constituted in the Regular Army on 1 October 1933, assigned to the III Corps, and allotted to the Third Corps Area. Designated mobilization training station was Langley Field, VA. Relieved from the III Corps in 1941 and disbanded.

HHS, 44th Observation Group (IV Corps)

Regular Army Inactive

HQ-*Not organized* 1933-34; Nashville, TN, 1934-41

Subordinate Squadrons: 16th Observation Squadron 1937-38; 105th Observation Squadron 1933-40; 106th Observation Squadron 1933-40; *44th Service Squadron* 1933-36

Constituted in the Regular Army on 1 October 1933, assigned to the IV Corps and allotted to the Fourth Corps Area. Organized by 1934 with Organized Reserve personnel as a RAI unit at Nashville, TN. Relieved from the IV Corps in 1941 and disbanded.

Commanders, 44th Observation Group

Unknown**	ao Dec 34-Jan 41
-----------	------------------

** RAI Commanders: Organized Reserve officers.

HHS, 45th Observation Group (V Corps)

Regular Army Inactive

HQ-*Not organized* 1933-34; Cleveland, OH, 1934-41

Subordinate Squadrons: 12th Observation Squadron 1937-40; 112th Observation Squadron 1933-40; 113th Observation Squadron 1933-40; 325th Observation Squadron 1933-40; 864th Observation Squadron 1933-40; 45th Service Squadron (RAI) on 1933-36

Constituted in the Regular Army on 1 October 1933, assigned to the V Corps, and allotted to the Fifth Corps Area. Organized by December 1934 with Organized Reserve personnel as a RAI unit at Cleveland, OH. Relieved from the V Corps in 1941 and disbanded.

Commanders, 45th Observation Group

Unknown**	ao Dec 34-ao Jul 38	Maj. James L. Zimmerman**	ao Jul 38-ao Aug 38
	Unknown**	ao Aug 38-Jan 41	

** RAI Commanders: Organized Reserve officers.

HHS, 46th Observation Group (VI Corps)

Regular Army Inactive

HQ-*Not organized* 1933-34; Detroit, MI, 1934-41

Subordinate Squadrons: 107th Observation Squadron 1933-40; 108th Observation Squadron 1933-40; 46th Service Squadron (RAI) on 1933-36

Constituted in the Regular Army on 1 October 1933, assigned to the VI Corps, and allotted to the Sixth Corps Area.

Organized by June 1934 with Organized Reserve personnel as a RAI unit at Detroit, MI. Relieved from the VI Corps in 1941 and disbanded.

Events: 264

Commanders, 46th Observation Group

Unknown** ao Jun34-Jan 41

** RAI Commanders: Organized Reserve officers.

HHS, 47th Observation Group (VII Corps)

Regular Army Inactive

HQ-*Not organized* 1933-37; Seventh Corps Area 1937-41

Subordinate Squadrons: 1st Observation Squadron 1937-40; 109th Observation Squadron 1933-40; 110th Observation Squadron 1933-40; 154th Observation Squadron 1933-40; *47th Service Squadron* 1933-36



Constituted in the Regular Army on 1 October 1933, assigned to the VII Corps, and allotted to the Seventh Corps Area. Organized by January 1937 with Organized Reserve personnel as a RAI unit in the Seventh Corps Area. Designated mobilization station was Marshall Field, KS. Relieved from the VII Corps in 1941 and disbanded.

Commanders, 47th Observation Group

1st. Lt. James E. Darby** ao Jan 37-14 Mar 37 Unknown** 17 Mar 37-Jan 41

** RAI Commanders: Organized Reserve officers.

HHS, 48th Observation Group (VIII Corps)

Regular Army Inactive

HQ-*Not organized* 1933-35; Fort Worth, TX, 1935-41

Subordinate Squadrons: 22nd Observation Squadron 1937-40; 111th Observation Squadron 1933-40; 120th Observation Squadron 1933-40; *48th Service Squadron* 1933-36

Constituted in the Regular Army on 1 October 1933, assigned to the VIII Corps, and allotted to the Eighth Corps Area. Organized on 17 June 1935 with Organized Reserve personnel as a RAI unit at Hensley Field, Fort Worth, TX. Relieved from the VIII Corps in 1941 and disbanded.

Commanders, 48th Observation Group

1st Lt. Frank C. Merrill** 17 Jun 35-15 Jan 37 Maj. Frank C. Cawthon** 15 Jan 37-

Jan 41

** RAI Commanders: Organized Reserve officers.

HHS, 49th Observation Group (IX Corps)**Regular Army Inactive****HQ**-*Not organized* 1933-36; Long Beach, CA, 1936-37; Inglewood, CA, 1937; *Inactive* 1937-39; Inglewood, CA, 1939-41**Subordinate Squadrons:** 115th Observation Squadron 1933-40; 116th Observation Squadron 1933-40; 49th Service Squadron (RAI) on 1933-38

Constituted in the Regular Army on 1 October 1933, assigned to the IX Corps, and allotted to the Ninth Corps Area. Organized 29 July 1936 with Organized Reserve personnel as a RAI unit at the Municipal Airport, Long Beach, CA. Transferred on 18 March 1937 to Inglewood, CA. Inactivated 2 September 1937 at Inglewood by relief of Reserve personnel. Reorganized by June 1939 at Inglewood. Relieved from the IX Corps in 1941. Location 7 December 1941—Inglewood, CA.

Status: Disbanded 31 May 1942.**Commanders, 49th Observation Group**

Capt. Robert M. Lloyd**	29 Jul 36-11 Aug 37	<i>Inactive</i>	2 Sep 37-Jun 39
Unknown**	11 Aug 37-2 Sep 37	Unknown**	Jun 39-7 Dec 41

** RAI Commanders: Organized Reserve officers.

HQ, 301st Observation Group (1921-33) (Fourth Army)**Organized Reserve Massachusetts****HHS, 301st Observation Group (1933-41)****HQ**-Springfield, MA, 1921-24; Worcester, MA, 1924-28; *Inactive* 1928-41**Subordinate squadrons:** 301st Observation Squadron 1933-41, 319th Observation Squadron 1933-41, 322nd Observation Squadron 1933-41, 351st Observation Squadron 1924-33, 352nd Observation Squadron 1924-33, 391st Observation Squadron 1921-24, 392nd Observation Squadron 1921-24, 393rd Observation Squadron 1921-24, Air Park No. 301 1921-23, 331st Service Squadron 1923-24, 330th Service Squadron 1924-33, 343rd Service Squadron 1933-36

Constituted in the Organized Reserve on 15 October 1921, assigned to the Fourth Army, and allotted to the First Corps Area. Initiated on 1 December 1921 with headquarters at Springfield, MA. Relieved from the Fourth Army 31 March 1924 and assigned to the XI Corps. Relocated on 4 December 1924 to Worcester, MA. Inactivated by June 1928 at Worcester by relief of personnel. Reorganized and redesignated as Headquarters and Headquarters Squadron, 301st Observation Group on 1 October 1933. Location 7 December 1941—*Inactive*.

Status: Disbanded 31 May 1942.**Commanders, 301st Observation Group**

Capt. Ralph H. Cram	1 Dec 21-11 Jun 23	Unknown	ao May 26-Jun 28
2nd Lt. Everette W. Chandler	11 Jun 23-ao May 26	<i>Inactive</i>	Jun 28-7 Dec 41

HQ, 302nd Pursuit Group (1921-33) (Fourth Army)**Organized Reserve New York****HHS, 302nd Pursuit Group (1933-41)****HQ**-*Not initiated* 1921-22; Buffalo, NY, 1922-29; *Inactive* 1929-41**Subordinate squadrons:** 395th Pursuit Squadron 1921-33, 396th Pursuit Squadron 1921-33, 397th Pursuit Squadron 1921-33, 398th Pursuit Squadron 1921-33, 447th Pursuit Squadron 1933-41, 448th Pursuit Squadron 1933-41, 449th Pursuit Squadron 1933-41, Air Park No. 332 1921-23, 332nd Service Squadron 1923-33

Constituted in the Organized Reserve on 15 October 1921, assigned to the 6th Attack Wing (Fourth Army), and allotted to the Second Corps Area. Initiated on 30 March 1922 with headquarters at Buffalo, NY. Inactivated 9 December 1929 at Buffalo by relief of personnel. Reorganized and redesignated as Headquarters and Headquarters Squadron, 302nd Pursuit Group on 1 October 1933. Location 7 December 1941—*Inactive*.

Status: Disbanded 31 May 1942.

Commanders, 302nd Pursuit Group

2nd Lt. Clement G. Geisler	21 Jan 22-15 Mar 22	Lt. Col. Clinton B. Amorous	26 Jan 23-9 Feb 23
1st Lt. William H. Phillips	15 Mar 22-30 Mar 22	Maj. William S. Calkins	9 Feb 23-3 Aug 26
Capt. William J. Dunn, Jr.	30 Mar 22-21 Oct 22	Maj. Grover O' Neill	3 Aug 26-9 Dec 29
Maj. Gorman DeF. Lerner	21 Oct 22-26 Jan 23	<i>Inactive</i>	9 Dec 29-7 Dec 41

HQ, 303rd Attack Group (1921-33) (Fourth Army)

Organized Reserve New York

HHS, 303rd Attack Group (1933-41)

HQ-Not initiated 1921-22; New Dorp, Staten Island, NY, 1922-30; *Inactive* 1930-41

Subordinate squadrons: 399th Attack Squadron 1921-41, 400th Attack Squadron 1921-41, 401st Attack Squadron 1921-41, 402nd Attack Squadron 1921-41, Air Park No. 333 1921-23, 333rd Service Squadron 1923-33

Constituted in the Organized Reserve on 15 October 1921, assigned to the 6th Attack Wing (Fourth Army), and allotted to the Second Corps Area. Initiated on 21 March 1922 with headquarters at New Dorp, NY. Typically conducted Inactive Training Period meetings at Miller Field, NY. Inactivated 30 January 1930 at New Dorp by relief of personnel. Reorganized and redesignated as Headquarters and Headquarters Squadron, 303rd Attack Group on 1 October 1933. Designated mobilization training station was Mitchel Field, NY. Location 7 December 1941—*Inactive*.

Status: Disbanded 31 May 1942.

Commanders, 303rd Attack Group

Capt. Gerard B. Lambert	12 Jun 22-26 Jan 23	Capt. Frank P. Gillick	Mar 23-22 Dec 24
2nd Lt. Perry A. Hull	26 Jan 23-Mar 23	Maj. Kenneth P. Littauer	22 Dec 24-30 Jan 30
	<i>Inactive</i>	30 Jan 30-7 Dec 41	

HQ, 304th Pursuit Group (1921-33) (Third Army)

Organized Reserve Pennsylvania/Maryland

HQ-Not initiated 1921-22; Franklin, PA, 1922-23; Baltimore, MD, 1923-29; *Inactive* 1929-33

Subordinate squadrons: 403rd Pursuit Squadron 1921-33, 404th Pursuit Squadron 1921-33, 405th Pursuit Squadron 1921-33, 406th Pursuit Squadron 1921-33, Air Park No. 334 1921-23, 334th Service Squadron 1923-33

Constituted in the Organized Reserve on 15 October 1921, assigned to the 8th Attack Wing (Third Army), and allotted to the Third Corps Area. Initiated in April 1922 with headquarters at Franklin, PA. Relocated by April 1923 to Baltimore, MD. Inactivated 2 August 1929 at Baltimore by relief of personnel. Withdrawn from the Third Corps Area 1 October 1933 and demobilized.

Commanders, 304th Pursuit Group

Capt. Thomas Munroe	Apr 22-ao Jan 23	1st Lt. Alfred S. Koch	ao Jun 29-25 Jul 29
Lt. Col. William G. Schauffler	31 Oct 23-24 Jun 27	<i>Medical officers only</i>	25 Jul 29-2 Aug 29
Unknown	24 Jun 27-ao Jun 29	<i>Inactive</i>	2 Aug 29-1 Oct 33

HQ, 305th Attack Group (1921-33) (Fifth Army)

Organized Reserve Pennsylvania/Virginia

HHS, 305th Attack Group (1933-41)

HQ-Not initiated 1921-22; Franklin, PA, 1922-23; Richmond, VA, 1923-29; *Inactive* 1929-41

Subordinate squadrons: 406th Attack Squadron 1933-41, 407th Attack Squadron 1921-41, 408th Attack Squadron 1921-41, 409th Attack Squadron 1921-41, 410th Attack Squadron 1921-41, Air Park No. 335 1921-23, 335th Service Squadron 1923-33

Constituted in the Organized Reserve on 15 October 1921, assigned to the 7th Attack Wing (Fifth Army), and allotted to the Third Corps Area. Initiated in April 1922 with headquarters at Franklin, PA. Relocated by April 1923 to Richmond, VA. Inactivated 14 August 1929 at Richmond by relief of personnel. Reorganized and redesignated as Headquarters and Headquarters Squadron, 305th Attack Group on 1 October 1933. Location 7 December 1941—*Inactive*.

Status: Disbanded 31 May 1942.

Commanders, 305th Attack Group

Capt. Harmar D. Denny, Jr.	Apr 22-30 Jan 23	Lt. Col. Joseph F. Randall	22 May 23-14 Aug 29
Maj. Louis A. McAbee	30 Jan 23-22 May 23	<i>Inactive</i>	14 Aug 29-7 Dec 41

HQ, 306th Pursuit Group (1921-33) (Second Army)

Organized Reserve Indiana/Ohio

HHS, 306th Pursuit Group (1933-41)

HQ-Not initiated 1921-22; Fort Wayne, IN, 1922; Toledo, OH, 1922-30; *Inactive* 1930-34; Toledo, OH, 1934-37; *Inactive* 1937-41

Subordinate squadrons: 414th Pursuit Squadron 1921-41, 415th Pursuit Squadron 1921-33, 416th Pursuit Squadron 1921-33, 417th Pursuit Squadron 1921-33, 464th Pursuit Squadron 1933-41, Air Park No. 336 1921-23, 336th Service Squadron 1923-36

Constituted in the Organized Reserve on 15 October 1921, assigned to the 9th Attack Wing (Second Army), and allotted to the Fifth Corps Area. Initiated in May 1922 with headquarters at Fort Wayne, IN. Relocated on 27 July 1922 to Toledo, OH. Inactivated by March 1930 at Toledo by relief of personnel. Reorganized and redesignated as Headquarters and Headquarters Squadron, 306th Pursuit Group on 1 October 1933. Reorganized by June 1934 with headquarters at Toledo. Inactivated by June 1937 at Toledo by relief of personnel. Location 7 December 1941—*Inactive*.

Status: Disbanded 31 May 1942.

Commanders, 306th Pursuit Group

Unknown	May 22-27 Jul 22	<i>Inactive</i>	Mar 30-ao Jun 34
Capt. Earl W. Moss	27 Jul 22-ao Jan 23	Unknown	ao Jun 34-ao Jun 37
Unknown	ao Jan 23-Mar 30	<i>Inactive</i>	ao Jun 37-7 Dec 41

HQ, 307th Observation Group (1921-33) (Fourth Army)

Organized Reserve Illinois/New York

HHS, 307th Observation Group (1933-41)

HQ-Not initiated 1921-22; Chicago, IL, 1922-24; *Inactive* 1924-25; Manhattan, NY, 1925-28; Mitchel Field, NY, 1937-41

Subordinate squadrons: 391st Observation Squadron 1924-33, 391st Observation Squadron 1924-33, 393rd Observation Squadron 1924-33, 412th Observation Squadron 1921-24, 418th Observation Squadron 1921-24, 419th Observation Squadron 1921-24, 420th Observation Squadron 1921-24, 451st Observation Squadron 1924-33, 452nd Observation Squadron 1924-33, 302nd Observation Squadron 1933-41, 303rd Observation Squadron 1933-41, 353rd Observation Squadron 1933-37, 369th Observation Squadron 1937-41, 861st Observation Squadron 1937-41, Air Park No. 337 1921-23, 331st Service Squadron 1924-33; 337th Service Squadron 1923-24; 344th Service Squadron 1933-36

Constituted in the Organized Reserve on 15 October 1921, assigned to the Fourth Army, and allotted to the Sixth Corps Area. Initiated on 21 January 1922 with headquarters at Chicago, IL. Withdrawn from the Sixth Corps Area 13 June 1924 and allotted to the Second Corps Area. Initiated on 21 April 1925 with headquarters at Manhattan, NY. Inactivated 9 October 1928 at Manhattan by relief of personnel. Reorganized and redesignated as Headquarters and Headquarters Squadron, 307th Observation Group on 1 October 1933. Concurrently relieved from the Fourth Army and assigned to the XII Corps. Reorganized 10 March 1937 at Mitchel Field, NY. Location 7 December 1941—Mitchel Field, NY.

Status: Disbanded 31 May 1942.

Commanders, 307th Observation Group

Capt. Charles A. Reid	21 Jan 22-13 Jun 24	Lt. Col. Stedman S. Hanks	15 May 25-21 Sep 26
<i>Inactive</i>	13 Jun 24-21 Apr 25	Maj. John S. N. Eley	21 Sep 26-9 Oct 28
Capt. Samuel H. Mapes	21 Apr 25-15 May 25	<i>Inactive</i>	9 Oct 28-10 Mar 37
	Unknown	10 Mar 37-7 Dec 41	

HQ, 308th Pursuit Group (1921-33) (Fifth Army)**Organized Reserve Illinois****HHS, 308th Transport Group (1933-41) (GHQR)****HQ**-*Not initiated* 1921-22; Peoria, IL, 1922-25; Bloomington, IL, 1925-29; *Inactive* 1929-41**Subordinate squadrons:** 421st Pursuit Squadron 1921-33, 422nd Pursuit Squadron 1921-33, 423rd Pursuit Squadron 1921-33, 424th Pursuit Squadron 1921-33, Air Park No. 338, 338th Service Squadron 1923-33, 349th Service Squadron 1933-36Constituted in the Organized Reserve on 15 October 1921 as Headquarters, 308th Pursuit Group,, assigned to the 7th Attack Wing (Fifth Army), and allotted to the Sixth Corps Area. Initiated on 4 May 1922 with headquarters at Peoria, IL. Relocated on 2 June 1925 to Bloomington, IL. Inactivated 1 December 1929 at Bloomington by relief of personnel. Reorganized and redesignated as Headquarters and Headquarters Squadron, 308th Transport Group on 1 October 1933, relieved from the Fifth Army, and assigned to the General Headquarters Reserve. Conducted summer training most years with units of the 1st Pursuit Group at Chanute Field, IL, 1923-29. Location 7 December 1941—*Inactive*.**Status:** Disbanded 31 May 1942.**Commanders, 308th Pursuit Group**

Maj. Joseph T. Woodward	4 May 22-23 Jan 23	Maj. Theodore P. Walker	20 Jun 24-11 Mar 26
Maj. Joseph B. Jiskra	23 Jan 23-1 Nov 23	Capt. John M. Schroeder	11 Mar 26-1 Dec 29
	<i>Inactive</i>	1 Dec 29-7 Dec 41	

HQ, 309th Attack Group (1921-33) (Sixth Army)**Organized Reserve Illinois****HHS, 309th Attack Group (1933-41)****HQ**-*Not initiated* 1921-22; Municipal Airport, Chicago, IL, 1922-29; *Inactive* 1929-41**Subordinate squadrons:** 425th Attack Squadron 1921-41, 426th Attack Squadron 1921-41, 427th Attack Squadron 1921-41, 428th Attack Squadron 1921-41, Air Park No. 339 1921-23, 339th Service Squadron 1923-36Constituted in the Organized Reserve on 15 October 1921, assigned to the 11th Attack Wing (Sixth Army), and allotted to the Sixth Corps Area. Initiated on 21 January 1922 with headquarters at the Municipal Airport, Chicago, IL. Inactivated 1 December 1929 at Chicago by relief of personnel. Reorganized and redesignated as Headquarters and Headquarters Squadron, 309th Attack Group on 1 October 1933. Conducted summer training most years with units of the 1st Pursuit Group at Chanute Field, IL. Location 7 December 1941—*Inactive*.**Status:** Disbanded 31 May 1942.**Commanders, 309th Attack Group**

2nd Lt. Kent A. Alcorn	21 Jan 22-19 May 22	Capt. John N. Thorpe, Jr.	1 Apr 25-ao May 25
Capt. Stephen D. Day	19 May 22-10 Feb 23	Maj. Charles A. Reid	ao Dec 25-11 Mar 26
Unknown	10 Feb 23-1 Apr 25	Maj. John N. Thorpe, Jr.	11 Mar 26-1 Dec 29
	<i>Inactive</i>	1 Dec 29-7 Dec 41	

HQ, 310th Pursuit Group (1921-33) (Sixth Army)**Organized Reserve Missouri****HHS, 310th Pursuit Group (1933-41)****HQ**-Richards Field, Kansas City, MO, 1921-41**Subordinate squadrons:** 429th Pursuit Squadron 1921-33, 430th Pursuit Squadron 1921-41, 431st Pursuit Squadron 1921-33, 432nd Pursuit Squadron 1921-33, 479th Pursuit Squadron 1933-41, 526th Pursuit Squadron 1933-41, Air Park No. 340 1921-23, 340th Service Squadron 1923-33, 542nd Service Squadron 1933-36

Constituted in the Organized Reserve on 15 October 1921, assigned to the 11th Attack Wing (Sixth Army), and allotted to the Seventh Corps Area. Initiated on 16 December 1921 with headquarters at Richards Field, Kansas City, MO. Reorganized and redesignated as Headquarters and Headquarters Squadron, 310th Pursuit Group on 1 October 1933. Location 7 December 1941—Kansas City, MO.

Status: Disbanded 31 May 1942.

Commanders, 310th Pursuit Group

Capt. Glenn R. Miller

16 Dec 21-13 Sep 22
Unknown

Capt. Walter G. DeSteiger
ao Oct 22-7 Dec 41

13 Sep 22-ao Oct 22

HQ, 311th Pursuit Group (1921-33) (Sixth Army)

Organized Reserve Texas/New Jersey

HHS, 311th Pursuit Group (1933-41)

HQ-Not initiated 1921-23; Galveston, TX, 1923-36; *Inactive* 1936-41

Subordinate squadrons: 435th Pursuit Squadron 1921-41, 436th Pursuit Squadron 1921-41, 437th Pursuit Squadron 1921-33, 438th Pursuit Squadron 1921-33, Air Park No. 341 1921-23, 341st Service Squadron 1923-36

Constituted in the Organized Reserve on 15 October 1921, assigned to the 11th Attack Wing (Sixth Army), and allotted to the Eighth Corps Area. Initiated on 26 February 1923 with headquarters at Galveston, TX, and stationed at the Fort Crockett U.S. Army Airdrome. Relieved from the Sixth Army 13 June 1924 and assigned to the General Headquarters Reserve. Reorganized and redesignated as Headquarters and Headquarters Squadron, 311th Pursuit Group on 1 October 1933. Withdrawn from the Eighth Corps Area 5 June 1936 and allotted to the Second Corps Area. Inactivated 3 November 1936 at Galveston by relief of personnel. Newark, NJ, designated as headquarters on reorganization, but the unit was never organized at that location. Conducted summer training most years with units of the 3rd Attack Group at Fort Crockett, TX. Location 7 December 1941—*Inactive*.

Status: Disbanded 31 May 1942.

Commanders, 311th Pursuit Group

Unknown
Capt. David C. Procter
Capt. Joseph M. Davidson

26 Feb 23-ao Jan 24
ao Jan 24-ao Nov 26
ao Jul 27-16 May 28
Inactive

Unknown
1st Lt. Quinn M. Corley
Maj. Charles W. Childress, Jr.
31 Oct 36-7 Dec 41

16 May 28-20 Jun 35
20 Jun 35-ao Jul 35
ao May 36-31 Oct 36

HQ, 312th Observation Group (1921-33) (Sixth Army)

Organized Reserve California

HHS, 312th Observation Group (1933-41)

HQ-Not initiated 1921-22; Crissy Field, San Francisco, CA, 1922-28; *Inactive* 1928-41

Subordinate squadrons: 316th Observation Squadron 1933-41, 321st Observation Squadron 1933-41, 420th Observation Squadron 1921-33, 434th Observation Squadron 1921-33, 440th Observation Squadron 1921-33, 441st Observation Squadron 1921-33, 561st Observation Squadron 1933-41, Air Park No. 342 1921-23, 342nd Service Squadron 1923-33, 381st Service Squadron 1933-36

Constituted in the Organized Reserve on 15 October 1921, assigned to the Sixth Army, and allotted to the Ninth Corps Area. Initiated by May 1922 with headquarters at Crissy Field, San Francisco, CA. Inactivated 1 September 1928 at San Francisco by relief of personnel. Redesignated as Headquarters and Headquarters Squadron, 312th Observation Group on 1 October 1933. Location 7 December 1941—*Inactive*.

Status: Disbanded 31 May 1942.

Commanders, 312th Observation Group

Capt. George D. Kinsland
Capt. Charles J. McElhiney

ao May 22-14 Jun 22
14 Jun 22-ao Aug 22
Inactive

1st Lt. Stanley C. Kerk
Unknown
1 Sep 28-7 Dec 41

ao Oct 22-ao Sep 25
ao Sep 25-1 Sep 28

HQ, 313th Pursuit Group (GHQR)

Organized Reserve Massachusetts

HQ-Boston, MA, 1921-33

Subordinate squadrons: 442nd Pursuit Squadron 1921-33, 443rd Pursuit Squadron 1921-33, 444th Pursuit Squadron 1921-33, 445th Pursuit Squadron 1921-33, Air Park No. 343 1921-23, 343rd Service Squadron 1923-33

Constituted in the Organized Reserve on 15 October 1921, assigned to the General Headquarters Reserve, and allotted to the First Corps Area. Initiated on 1 December 1921 with headquarters at Boston Airport, Boston, MA. Withdrawn from the First Corps Area 1 October 1933 and demobilized.

Commanders, 313th Pursuit Group

Unknown	1 Dec 21-3 Jan 22	Capt. Rutledge B. Barry	28 Dec 26-13 Jan 27
1st Lt. Harold D. Wilson	3 Jan 22-Mar 22	Capt. Edward W. Killgore	13 Jan 27-May 28
Capt. Gordon C. Price	Mar 22-ao Dec 22	<i>Medical officers only</i>	May 28-Jul 28
Unknown	ao Mar 22-ao May 26	1st Lt. Lynn F. Howard	Jul 28-ao Sep 28
1st Lt. William W. Batchelder	ao May 26-28 Dec 26	Unknown	ao Sep 28-1 Oct 33

HQ, 314th Pursuit Group (First Army)

Organized Reserve New York

HQ-Mineola, Long Island, NY, 1921-33

Subordinate squadrons: 447th Pursuit Squadron 1921-33, 448th Pursuit Squadron 1921-33, 449th Pursuit Squadron 1921-33, 450th Pursuit Squadron 1921-33, Air Park No. 344 1921-23, 344th Service Squadron 1923-33

Constituted in the Organized Reserve on 15 October 1921, assigned to the 3rd Attack Wing (First Army), and allotted to the Second Corps Area. Initiated on 12 December 1921 with headquarters at Mineola, Long Island, NY. Relieved from the First Army 31 March 1924 and assigned to the General Headquarters Reserve. Inactivated 19 March 1930 at Mineola by relief of personnel. Conducted summer training most years with units of the 9th Observation Group at Mitchel Field, NY. Withdrawn from the Second Corps Area 1 October 1933 and demobilized.

Commanders, 314th Pursuit Group

Col. Benjamin F. Castle	12 Dec 21-Jul 25	Maj. Gorman De F. Lerner	Jul 25-19 Mar 30
	<i>Inactive</i>	19 Mar 30-1 Oct 33	

HQ, 315th Observation Group (1921-33) (First Army)

Organized Reserve Pennsylvania

HHS, 315th Observation Group (1933-41)

HQ-Harrisburg, PA, 1921-29; *Inactive* 1929-41

Subordinate squadrons: 411th Observation Squadron 1921-33, 412th Observation Squadron 1921-33, 453rd Observation Squadron 1921-33, 454th Observation Squadron 1921-33, 304th Observation Squadron 1933-41, 305th Observation Squadron 1933-41, 324th Observation Squadron 1933-41, Air Park No. 345 1921-23, 335th Service Squadron 1933-36, 345th Service Squadron 1923-33

Constituted in the Organized Reserve on 15 October 1921, assigned to the First Army, and allotted to the Third Corps Area. Initiated on 18 November 1921 with headquarters at Harrisburg, PA. Relieved from the First Army 2 July 1923 and assigned to the Fifth Army. Inactivated 2 August 1929 at Harrisburg by relief of personnel. Reorganized and redesignated as Headquarters and Headquarters Squadron, 315th Observation Group on 1 October 1933. Location 7 December 1941—*Inactive*.

Status: Disbanded 31 May 1942.

Commanders, 315th Observation Group

1st Lt. Frederick L. Simonin	18 Nov 21-3 Apr 22	Maj. William D. Grant	20 May 25-15 Apr 29
Maj. Robert C. Disque	3 Apr 22-ao Oct 22	<i>Medical officers only</i>	15 Apr 29-2 Aug 29
1st Lt. Frederick L. Simonin	20 Sep 23-20 May 25	<i>Inactive</i>	2 Aug 29-7 Dec 41

HQ, 316th Pursuit Group (1921-33) (Second Army)

Organized Reserve Georgia

HHS, 316th Bombardment Group (1933-41)

HQ-Not initiated 1921-22; Atlanta, GA, 1922-29; *Inactive* 1929-41

Subordinate squadrons: 455th Pursuit Squadron 1921-33, 455th Bombardment Squadron 1933-41, 456th Pursuit Squadron 1921-41, 457th Pursuit Squadron 1921-41, 458th Pursuit Squadron 1921-33, 458th Bombardment Squadron 1933-41, Air Park No. 346 1921-23, 346th Service Squadron 1923-36

Constituted in the Organized Reserve on 15 October 1921 as Headquarters, 316th Pursuit Group, assigned to the 9th Attack Wing (Second Army), and allotted to the Fourth Corps Area. Initiated on 12 May 1922 with headquarters at Atlanta, GA. Relieved from the Second Army 31 March 1924 and assigned to the General Headquarters Reserve. Relocated in February 1926 to Candler Field in Atlanta. Inactivated 19 September 1929 at Atlanta by relief of personnel. Redesignated as Headquarters and Headquarters Squadron, 316th Bombardment Group on 1 October 1933. Designated mobilization training station was Camp Joseph E. Johnston, FL, (later redesignated as Camp J. Clifford R. Foster) on 1922-30 and Maxwell Field, AL, 1930-41. Location 7 December 1941—*Inactive*.

Status: Disbanded 31 May 1942.

Commanders, 316th Pursuit Group

<i>Medical officers only</i>	12 May 22-25 Sep 22	Maj. Robert G. Stephens	ao Sep 24-ao Dec 24
1st Lt. Ellis C. Lindsey	25 Sep 22-ao Jan 23	Unknown	ao Dec 24-ao Jul 28
Unknown	ao Jan 23-ao Sep 24	1st Lt. Edgar C. Nilson	ao Jul 28-19 Sep 29
	<i>Inactive</i>	19 Sep 29-7 Dec 41	

HQ, 317th Observation Group (1921-33) (Second Army)

Organized Reserve Ohio

HHS, 317th Observation Group (1933-41)

HQ—Not initiated 1921-22; Dayton, OH, 1922-25; Mansfield, OH, 1925-30; *Inactive* 1930-34; Mansfield, OH, 1934-37; *Inactive* 1937-41

Subordinate squadrons: 418th Observation Squadron 1921-33, 459th Observation Squadron 1921-33, 460th Observation Squadron 1921-33, 461st Observation Squadron 1921-33, 308th Observation Squadron 1933-41, 309th Observation Squadron 1933-41, 360th Observation Squadron 1933-41, 336th Service Squadron 1933-36, Air Park No. 337 1921-23, 337th Service Squadron 1923-33

Constituted in the Organized Reserve on 15 October 1921, assigned to the Second Army, and allotted to the Fifth Corps Area. Initiated in April 1922 with headquarters at Dayton, OH. Relocated on 15 April 1925 to Mansfield, OH. Inactivated by March 1930 at Mansfield by relief of personnel. Reorganized and redesignated as Headquarters and Headquarters Squadron, 317th Observation Group on 1 October 1933. Reorganized by June 1934 at Mansfield. Inactivated by June 1937 at Mansfield by relief of personnel. Location 7 December 1941—*Inactive*.

Status: Disbanded 31 May 1942.

Commanders, 317th Observation Group

Capt. Harold A. Wise	Apr 22-ao Sep 24	Maj. James L. Zimmerman	ao Jun 34-ao Aug 35
Unknown	ao Sep 24-Mar 30	Unknown	ao Aug 35- ao Jun 37
<i>Inactive</i>	Mar 30-ao Jun 34	<i>Inactive</i>	ao Jun 37-7 Dec 41

HQ, 318th Pursuit Group (1921-33) (GHQR)

**Organized Reserve Indiana/
Kentucky/Ohio**

HHS, 318th Attack Group (1933-41) (GHQR)

HQ—Not initiated 1921-22; Danville, IN, 1922-25; Louisville, KY, 1925-30; *Inactive* 1930-41

Subordinate squadrons: 462nd Pursuit Squadron 1921-33, 463rd Pursuit Squadron 1921-33, 464th Pursuit Squadron 1921-33, 465th Pursuit Squadron 1921-33, 463rd Attack Squadron 1933-41, 464th Attack Squadron 1933-41, 465th Attack Squadron 1933-41, Air Park No. 348 1921-23, 348th Service Squadron 1923-33

Constituted in the Organized Reserve on 15 October 1921 as Headquarters, 318th Pursuit Group, assigned to the General Headquarters Reserve, and allotted to the Fifth Corps Area. Initiated in May 1922 with headquarters at Danville, IN. Relocated on 15 April 1925 to Louisville, KY. Inactivated by March 1930 at Louisville by relief of personnel. Reorganized and redesignated as Headquarters and Headquarters Squadron, 318th Attack Group on 1 October 1933. Lima, OH, designated 21 December 1933 as headquarters on reorganization, but the unit was never organized at that location. Location 7 December 1941—*Inactive*.

Status: Disbanded 31 May 1942.

Commanders, 318th Pursuit Group

1st Lt. Harvey Hadley	May 22-22 Nov 22	Unknown	ao Sep 24- Mar 30
Capt. Winfield E. Sisson	22 Nov 22-ao Sep 24	<i>Inactive</i>	Mar 30-7 Dec 41

HQ, 319th Attack Group (1921-33) (Second Army)

Organized Reserve Illinois

HHS, 319th Attack Group (1933-41)

HQ-*Not initiated* 1921-22; Municipal Airport, Chicago, IL, 1922-29; *Inactive* 1929-41

Subordinate squadrons: 423rd Attack Squadron 1933-41, 467th Attack Squadron 1921-41, 468th Attack Squadron 1921-41, 469th Attack Squadron 1921-33, 470th Attack Squadron 1921-33, Air Park No. 349 1921-23, 349th Service Squadron 1923-33; 378th Service Squadron 1933-36

Constituted in the Organized Reserve on 15 October 1921, assigned to the 9th Attack Wing (Second Army), and allotted to the Sixth Corps Area. Initiated on 21 January 1922 with headquarters at the Municipal Airport, Chicago, IL. Inactivated 22 June 1929 at Chicago by relief of personnel. Reorganized and redesignated as Headquarters and Headquarters Squadron, 319th Attack Group on 1 October 1933. Conducted summer training most years with units of the 1st Pursuit Group at Chanute Field, IL. Location 7 December 1941—*Inactive*.

Status: Disbanded 31 May 1942.

Commanders, 319th Attack Group

Maj. Philip G. Kemp	21 Jan 22-8 Dec 24	Unknown	ao Sep 25-ao Jan 27
Capt. Kenneth T. Prince	8 Dec 24-ao Sep 25	Maj. Joseph L. Whitney	ao Jan 27-22 Jun 29
	<i>Inactive</i>	22 Jun 29-7 Dec 41	

HQ, 320th Observation Group (1921-33) (Third Army)

Organized Reserve Missouri/Iowa

HHS, 320th Observation Group (1933-41)

HQ-St. Louis, MO, 1921-26; Davenport, IA, 1926-41

Subordinate squadrons: 154th Observation Squadron 1921-23 and 1929-33, 419th Observation Squadron 1921-33, 433rd Observation Squadron 1921-33, 471st Observation Squadron 1921-33, 313th Observation Squadron 1933-41, 314th Observation Squadron 1933-41, 327th Observation Squadron 1933-41, 564th Observation Squadron 1923-24, 570th Service Squadron 1923-33

Constituted in the Organized Reserve on 15 October 1921, assigned to the Third Army, and allotted to the Seventh Corps Area. Initiated on 23 November 1921 with headquarters at St. Louis, MO. Relocated on 26 May 1926 to Davenport, IA. Reorganized and redesignated as Headquarters and Headquarters Squadron, 320th Observation Group on 1 October 1933. Designated mobilization training station was Camp Dodge, IA. Location 7 December 1941—Davenport, IA.

Status: Disbanded 31 May 1942.

Commanders, 320th Observation Group

Col. G. H. Shields, Jr.	23 Nov 21-19 Dec 21	Maj. B. J. Saunders	19 Dec 21-ao Jan 22
	Unknown	ao Jan 22-7 Dec 41	

HQ, 321st Attack Group (1921-33) (Third Army)

**Organized Reserve Oklahoma/
Texas/New Jersey**

HHS, 321st Attack Group (1933-41)

HQ-*Not initiated* 1921-23; Tulsa, OK, 1923-25; Houston, TX, 1925-36; *Inactive* 1936-41

Subordinate squadrons: 472nd Attack Squadron 1921-41, 473rd Attack Squadron 1921-41, 474th Attack Squadron 1921-41, 475th Attack Squadron 1921-41, Air Park No. 350 1921-23, 350th Service Squadron 1923-36

Constituted in the Organized Reserve on 15 October 1921, assigned to the 8th Attack Wing (Third Army), and allotted to the Eighth Corps Area. Enid, OK, designated as headquarters on organization, but the unit was never organized at that location. Initiated on 12 May 1923 with headquarters at Tulsa, OK. Relocated on 15 April 1925 to Houston, TX. Reorganized and redesignated as Headquarters and Headquarters Squadron, 321st Attack Group on 1 October 1933. Withdrawn from the Eighth Corps Area 5 June 1936 and allotted to the Second Corps Area. Inactivated 31 October 1936 at Houston by relief of personnel. Elizabeth, NJ, designated as headquarters on reorganization, but the unit was never organized at that location. Location 7 December 1941—*Inactive*.

Status: Disbanded 31 May 1942.

Commanders, 321st Attack Group

1st Lt. Frederick L. Knoblick	12 May 23-ao Mar 26	1st Lt. Henry C. Kristopherson	20 Jan 35-16 Sep 35
Capt. Raymond A. Tolbert	ao Nov 26-14 May 28	Lt. Col. Fred Feasel	16 Sep 35-31 Oct 36
Unknown	14 May 28-20 Jan 35	<i>Inactive</i>	31 Oct 36-7 Dec 41

HQ, 322nd Pursuit Group (Third Army)

Organized Reserve California

HQ-Not initiated 1921-22; San Diego, CA, 1922-29; *Inactive* 1929-30; Los Angeles, CA, 1930-33

Subordinate squadrons: 476th Pursuit Squadron 1921-33, 477th Pursuit Squadron 1921-33, 478th Pursuit Squadron 1921-33, 479th Pursuit Squadron 1921-33, Air Park No. 351 1921-23; 385th Service Squadron 1923-33

Constituted in the Organized Reserve on 15 October 1921, assigned to the 8th Attack Wing (Third Army), and allotted to the Ninth Corps Area. Initiated in May 1922 with headquarters at San Diego, CA. Relieved from the Third Army 13 June 1924 and assigned to the General Headquarters Reserve. Inactivated 20 October 1929 at San Diego by relief of personnel. Reorganized 28 January 1930 with headquarters at Los Angeles, CA. Withdrawn from the Ninth Corps Area 1 October 1933 and demobilized.

Commanders, 322nd Pursuit Group

Maj. Arthur J. Davis	May 22-ao Oct 22	Maj. Kenneth Decker	Aug 26-20 Oct 29
Capt. Herbert G. Partridge	ao Jun 23-Jul 25	<i>Inactive</i>	20 Oct 29-28 Jan 30
Capt. Edwin C. Moore	Jul 25-Aug 26	Unknown	28 Jan 30-1 Oct 33

HQ, 323rd Observation Group (I Corps)

Organized Reserve Massachusetts

HQ-Not initiated 1924-25; Fitchburg, MA, 1925-33

Subordinate squadrons: 550th Observation Squadron 1924-33, 551st Observation Squadron 1924-33; 566th Service Squadron 1924-33

Constituted in the Organized Reserve on 31 March 1924, assigned to the I Corps, and allotted to the First Corps Area. Initiated in November 1925 with headquarters at Fitchburg, MA. Withdrawn from the First Corps Area 1 October 1933 and demobilized.

Commanders, 323rd Observation Group

1st Lt. Walter J. Klein	Nov 25-ao Jun 28	Unknown	ao Jun 28-1 Oct 33
-------------------------	------------------	---------	--------------------

HQ, 324th Observation Group (1924-33) (XII Corps)

Organized Reserve New York

HHS, 324th Observation Group (1933-41)

HQ-Not initiated 1924-41

Subordinate squadrons: 353rd Observation Squadron 1924-33, 354th Observation Squadron 1924-33; 323rd Observation Squadron 1933-41, 369th Observation Squadron 1924-33; 861st Observation Squadron 1933-41; 375th Service Squadron 1924-36

Constituted in the Organized Reserve on 31 March 1924, assigned to the XII Corps, and allotted to the Second Corps Area. Poughkeepsie, NY, designated as headquarters on organization, but the unit was never organized at that location. Designated mobilization training station was Mitchel Field, NY. Reorganized and redesignated as Headquarters and Headquarters Squadron, 324th Observation Group on 1 October 1933. Location 7 December 1941—*Not initiated*.

Status: Disbanded 31 May 1942.

HQ, 325th Observation Group (II Corps)

Organized Reserve New York

HQ-*Not initiated* 1924-25; New Dorp, NY, 1925-29; *Inactive* 1929-33

Subordinate squadrons: 369th Observation Squadron 1924-33, 370th Observation Squadron 1924-33, 382nd Service Squadron 1924-33

Constituted in the Organized Reserve on 31 March 1924, assigned to the II Corps, and allotted to the Second Corps Area. Initiated on 2 December 1925 with headquarters at Miller Field, New Dorp, NY. Inactivated 2 December 1929 at New Dorp by relief of personnel. Withdrawn from the Second Corps Area 1 October 1933 and demobilized.

Commanders, 325th Observation Group

Capt. Charles F. Littlejohn Unknown	2 Dec 25-ao Jan 26 ao Jan 26-12 Mar 29	Capt. Charles F. Littlejohn <i>Inactive</i>	12 Mar 29-2 Dec 29 2 Dec 29-7 Dec 41
--	---	--	---

HQ, 326th Pursuit Group (Third Army)

Organized Reserve Pennsylvania

HQ-Philadelphia, PA, 1921-29; *Inactive* 1929-33

Subordinate squadrons: 501st Pursuit Squadron 1921-33, 502nd Pursuit Squadron 1921-33, 503rd Pursuit Squadron 1921-33, 504th Pursuit Squadron 1921-33, Air Park No. 371 1921-23, 386th Service Squadron 1923-33

Constituted in the Organized Reserve on 15 October 1921, assigned to the 8th Attack Wing (Third Army), and allotted to the Third Corps Area. Initiated on 2 November 1921 with headquarters at Philadelphia, PA. Relieved from the Third Army 31 March 1924 and assigned to the General Headquarters Reserve. Inactivated 23 July 1929 at Philadelphia by relief of personnel. Withdrawn from the Third Corps Area 1 October 1933 and demobilized.

Commanders, 326th Pursuit Group

1st Lt. William H. Francisco Maj. Charles J. Biddle	2 Nov 21-24 Aug 22 24 Aug 22-9 Feb 26	Capt. William H. Francisco <i>Inactive</i>	9 Feb 26-23 Jul 29 23 Jul 29-1 Oct 33
--	--	---	--

HQ, 327th Pursuit Group (GHQR)

Organized Reserve Texas

HQ-*Not initiated* 1921-23; San Antonio, TX, 1923-25; Beaumont, TX, 1925-33

Subordinate squadrons: 505th Pursuit Squadron 1921-33, 506th Pursuit Squadron 1921-33, 507th Pursuit Squadron 1921-33, 508th Pursuit Squadron 1921-33, Air Park No. 372 1921-23, 387th Service Squadron 1923-33

Constituted in the Organized Reserve on 15 October 1921, assigned to the General Headquarters Reserve, and allotted to the Eighth Corps Area. Initiated on 23 February 1923 with headquarters at San Antonio, TX. Relocated on 15 April 1925 to Beaumont, TX. Withdrawn from the Eighth Corps Area 1 October 1933 and demobilized.

Commanders, 327th Observation Group

Maj. Edgar C. Tobin	23 Feb 23-12 May 28	Unknown	12 May 28-1 Oct 33
---------------------	---------------------	---------	--------------------

HQ, 328th Attack Group (GHQR)

Organized Reserve Washington

HQ-*Not initiated* 1921-22; Seattle, WA, 1922-24

Subordinate squadrons: 509th Attack Squadron 1921-24, 510th Attack Squadron 1921-24; 511th Attack Squadron 1921-24; 512th Attack Squadron 1921-24; Air Park No. 373 1921-23

Constituted in the Organized Reserve on 15 October 1921, assigned to the General Headquarters Reserve, and allotted to the Ninth Corps Area. Initiated on 17 October 1922 with headquarters at Seattle, WA. Inactivated in April 1924 at Seattle by relief of personnel. Withdrawn from the Ninth Corps Area 13 June 1924 and demobilized.

Commanders, 328th Attack Group

Maj. William G. Parker 17 Oct 22-Apr 24

HQ, 328th Observation Group (III Corps)

Organized Reserve Pennsylvania

HQ-Not initiated 1924-25; Reading, PA, 1925-29; *Inactive* 1929-33

Subordinate squadrons: 552nd Observation Squadron 1924-33, 553rd Observation Squadron 1924-33; 56th Service Squadron 1929-33

Constituted in the Organized Reserve on 31 March 1924, assigned to the III Corps, and allotted to the Third Corps Area. Initiated by December 1925 with headquarters at Reading, PA. Inactivated by June 1929 at Reading by relief of personnel. Withdrawn from the Third Corps Area 1 October 1933 and demobilized.

Commanders, 328th Observation Group

Unknown ao Dec 25-Jun 29

HQ, 329th Observation Group (1921-33) (GHQR)

Organized Reserve California

HHS, 329th Observation Group (1933-41)

HQ-Not initiated 1921-22; Los Angeles, CA, 1922-29; *Inactive* 1929-30; San Diego, CA, 1930-41

Subordinate squadrons: 329th Observation Squadron 1933-41, 367th Observation Squadron 1933-41, 513th Observation Squadron 1921-33, 514th Observation Squadron 1921-41, 515th Observation Squadron 1921-33, 516th Observation Squadron 1921-33, 805th Observation Squadron 1933-41, Air Park No. 374 1921-23, 374th Service Squadron 1923-36

Constituted in the Organized Reserve on 15 October 1921, assigned to the General Headquarters Reserve, and allotted to the Ninth Corps Area. Initiated in February 1922 with headquarters at Los Angeles, CA. Inactivated 20 October 1929 at Los Angeles by relief of personnel. Reorganized 28 January 1930 with headquarters at San Diego, CA. Typically conducted Inactive Training Period meetings at Clover Field in Santa Monica, CA. Reorganized and redesignated as Headquarters and Headquarters Squadron, 329th Observation Group on 1 October 1933. Location 7 December 1941—San Diego, CA.

Status: Disbanded 31 May 1942.

Commanders, 329th Observation Group

2nd Lt. Charles E. Brubaker	Feb 22-ao Mar 22	Lt. Col. Fred J. Martel	ao Aug 24-ao Sep 25
Capt. Lamar Nelson	ao Jul 22-ao Oct 22	Unknown	ao Sep 25-20 Oct 29
Unknown	ao Oct 22-ao Aug 24	<i>Inactive</i>	20 Oct 29-30 Jan 30
	Unknown	30 Jan 30-7 Dec 41	

HQ, 330th Observation Group (XIII Corps)

Organized Reserve Virginia

HQ-Not initiated 1924-27; Richmond, VA, 1928-29; *Inactive* 1929-33

Subordinate squadrons: 355th Observation Squadron 1924-33, 356th Observation Squadron 1924-33, 376th Service Squadron 1924-33

Constituted in the Organized Reserve on 31 March 1924, assigned to the XIII Corps, and allotted to the Third Corps Area. Initiated by June 1927 with headquarters at Richmond, VA. Inactivated 14 August 1929 at Richmond by relief of personnel. Withdrawn from the Third Corps Area 1 October 1933 and demobilized.

Commanders, 330th Observation Group

Unknown

ao Jun 27-15 Apr 29
Inactive

Lt. Col. William D. Grant
14 Aug 29-1 Oct 33

15 Apr 29-14 Aug 29

HQ, 331st Observation Group (XIV Corps)

Organized Reserve Georgia

HQ-Not initiated 1924-41

Subordinate squadrons: 306th Observation Squadron 1933-41, 307th Observation Squadron 1933-41, 312th Observation Squadron 1933-41, 357th Observation Squadron 1924-33, 358th Observation Squadron 1924-33, 388th Service Squadron 1924-36

Constituted in the Organized Reserve on 31 March 1924, assigned to the XIV Corps, and allotted to the Fourth Corps Area. Atlanta, GA, designated as headquarters on organization, but the unit was never organized at that location. Designated mobilization training station was Maxwell Field, AL. Redesignated as Headquarters and Headquarters Squadron, 331st Observation Group on 1 October 1933. Location 7 December 1941—*Not initiated*.

Status: Disbanded 31 May 1942.

HQ, 332nd Observation Group (1924-33) (XV Corps)

Organized Reserve Ohio/Illinois

HHS, 332nd Observation Group (1933-41)

HQ-Not initiated 1924-26; Cincinnati, OH, 1926-33; *Inactive* 1933-36; Champaign, IL, 1936-41

Subordinate squadrons: 310th Observation Squadron 1933-41, 311th Observation Squadron 1933-41, 865th Observation Squadron 1933-41, 359th Observation Squadron 1924-33, 360th Observation Squadron 1924-33; 337th Service Squadron 1933-36, 377th Service Squadron 1924-33

Constituted in the Organized Reserve on 31 March 1924, assigned to the XV Corps, and allotted to the Fifth Corps Area. Initiated in January 1926 with headquarters at Cincinnati, OH. Withdrawn from the Fifth Corps Area and allotted to the Sixth Corps Area 1 October 1933. Concurrently, Redesignated as Headquarters and Headquarters Squadron, 332nd Observation Group. Chicago, IL, designated as headquarters on reorganization, but the unit was never organized at that location. Reorganized by September 1936 with headquarters at Champaign, IL. Location 7 December 1941—Champaign, IL.

Status: Disbanded 31 May 1942.

Commanders, 332nd Observation Group

Unknown

Jan 26-1 Oct 33
Unknown

Inactive
ao Sep 36-7 Dec 41

1 Oct 33-ao Sep 36

HQ, 333rd Observation Group (1924-33) (V Corps)

Organized Reserve Indiana

HHS, 333rd Observation Group (1933-41)

HQ-Schoen Field, Fort Benjamin Harrison, IN, 1924-30; Inactive 1930-41

Subordinate squadrons: 555th Observation Squadron 1924-41, 556th Observation Squadron 1924-41; 539th Service Squadron 1933-36

Constituted in the Organized Reserve on 31 March 1924, assigned to the V Corps, and allotted to the Fifth Corps Area. Initiated in September 1924 with headquarters at Schoen Field, Fort Benjamin Harrison, IN. Designated mobilization training station was Schoen Field. Reorganized and redesignated as Headquarters and Headquarters Squadron, 333rd Observation Group on 1 October 1933. Inactivated by March 1930 at Schoen Field by relief of personnel. Typically conducted Inactive Training Period meetings at Schoen Field. Location 7 December 1941—*Inactive*.

Status: Disbanded 31 May 1942.

Commanders, 333rd Observation Group

Unknown

Sep 24-ao Mar 30

Inactive

ao Mar 30-7 Dec 41

HQ, 334th Observation Group (1924-33) (XVI Corps)

Organized Reserve Illinois

HHS, 334th Observation Group (1933-41)

HQ-Not initiated 1924-26; Evanston, IL, 1926-29; *Inactive* 1929-41

Subordinate squadrons: 361st Observation Squadron 1924-41, 362nd Observation Squadron 1924-41; 378th Service Squadron 1924-41

Constituted in the Organized Reserve on 31 March 1924, assigned to the XVI Corps, and allotted to the Sixth Corps Area. Initiated on 8 May 1926 with headquarters at Evanston, IL. Inactivated 30 March 1929 at Evanston by relief of personnel. Chicago, IL, designated as headquarters on reorganization, but the unit was never organized at that location. Reorganized and redesignated as Headquarters and Headquarters Squadron, 334th Observation Group on 1 October 1933. Location 7 December 1941—*Inactive*.

Status: Disbanded 31 May 1942.

Commanders, 334th Observation Group

Medical officers only

8 May 26-ao Jun 26
Inactive

Maj. Leslie H. Ross
30 Mar 29-7 Dec 41

12 Apr 27-30 Mar 29

HQ, 335th Observation Group (1924-33) (VI Corps)

Organized Reserve Michigan

HHS, 335th Observation Group (1933-41)

HQ-Not initiated 1924-26; Detroit, MI, 1926-41

Subordinate squadrons: 557th Observation Squadron 1924-41, 558th Observation Squadron 1924-41; 567th Service Squadron 1924-36

Constituted in the Organized Reserve on 31 March 1924, assigned to the VI Corps, and allotted to the Sixth Corps Area. Initiated on 8 May 1926 with headquarters at Detroit, MI. Reorganized and redesignated as Headquarters and Headquarters Squadron, 335th Observation Group on 1 October 1933. Location 7 December 1941—Detroit, MI.

Status: Disbanded 31 May 1942.

Commanders, 335th Observation Group

Medical officers only

8 May 26-ao Jun 26

Unknown

ao Jun 26-7 Dec 41

HQ, 336th Observation Group (VII Corps)

Organized Reserve Nebraska

HQ-Not initiated 1924-25; Omaha, NE, 1925-26; Grand Island, NE, 1926-33

Subordinate squadrons: 559th Observation Squadron 1924-33, 560th Observation Squadron 1924-33; 568th Service Squadron 1924-33

Constituted in the Organized Reserve on 31 March 1924, assigned to the VII Corps, and allotted to the Seventh Corps Area. Initiated in March 1924 with headquarters at Omaha, NE. Relocated on 26 May 1926 to Grand Island, NE. Withdrawn from the Seventh Corps Area 1 October 1933 and demobilized.

Commanders, 337th Observation Group

Unknown

Mar 24-1 Oct 33

HQ, 337th Observation Group (XVII Corps)

Organized Reserve Missouri

HQ-Not initiated 1924-25; St. Louis, MO, 1925-33

Subordinate squadrons: 363rd Observation Squadron 1924-33, 364th Observation Squadron 1924-33; 379th Service Squadron 1924-33

Constituted in the Organized Reserve on 31 March 1924, assigned to the XVII Corps, and allotted to the Seventh Corps Area. Initiated in January 1925 with headquarters at St. Louis, MO. Withdrawn from the Seventh Corps Area 1 October 1933 and demobilized.

Commanders, 337th Observation Group

Unknown Jan 25-1 Oct 33

HQ, 338th Observation Group (1924-33) (VIII Corps)

Organized Reserve Texas

HHS, 338th Observation Group (1933-41)

HQ-Not initiated 1924-25; Temple, TX, 1925-29; *Inactive* 1929-35; Temple, TX, 1935-41

Subordinate squadrons: 315th Observation Squadron 1933-41, 320th Observation Squadron 1933-41, 328th Observation Squadron 1933-41, 365th Observation Squadron 1924-33, 366th Observation Squadron 1924-33, 350th Service Squadron 1933-36, 380th Service Squadron 1924-33

Constituted in the Organized Reserve on 31 March 1924, assigned to the VIII Corps, and allotted to the Eighth Corps Area. Initiated on 6 April 1925 with headquarters at Temple, TX. Inactivated 1 October 1929 at Temple by relief of personnel. Reorganized and redesignated as Headquarters and Headquarters Squadron, 338th Observation Group on 1 October 1933. Reorganized by August 1935 at Temple. Location 7 December 1941—Temple, TX.

Status: Disbanded 31 May 1942.

Commanders, 338th Observation Group

Unknown	6 Apr 25-ao Apr 27	<i>Inactive</i>	1 Oct 29-ao Aug 35
Capt. Ralph W. Stone	ao Apr 27-16 May 28	Capt. Ben W. Barclay	ao Aug 35-10 Dec 36
Lt. Col. Barnard Cummings	16 May 28-1 Oct 29	Lt. Col. Charles W. Mason	10 Dec 36-ao Jul 37
	Unknown	ao Jul 37-7 Dec 41	

HQ, 339th Observation Group (1924-33) (XVIII Corps)

Organized Reserve Texas/New Jersey

HHS, 339th Observation Group (1933-41)

HQ-Not initiated 1924-26; Temple, TX, 1926-28; *Inactive* 1928-35; Temple, TX, 1935-36; *Inactive* 1936-41

Subordinate squadrons: 371st Observation Squadron 1924-33, 561st Observation Squadron 1924-33, 365th Observation Squadron 1933-41, 366th Observation Squadron 1933-41, 569th Service Squadron 1924-36

Constituted in the Organized Reserve on 31 March 1924, assigned to the XVIII Corps, and allotted to the Eighth Corps Area. Initiated in May 1926 with headquarters at Temple, TX. Inactivated 19 May 1928 at Temple by relief of personnel. Reorganized and redesignated as Headquarters and Headquarters Squadron, 339th Observation Group on 1 October 1933. Reorganized 20 June 1935 at Temple, TX. Designated mobilization training station was Kelly Field, TX. Withdrawn from the Eighth Corps Area 5 June 1936 and allotted to the Second Corps Area. Inactivated 3 November 1936 at Temple by relief of personnel. Englewood, NJ, designated as headquarters on reorganization, but the unit was never organized at that location. Location 7 December 1941—*Inactive*.

Status: Disbanded 31 May 1942.

Commanders, 339th Observation Group

Unknown	May 26-19 Apr 27	<i>Inactive</i>	19 May 28-20 Jun 35
1st Lt. Clarence L. Solomon	19 Apr 27-ao May 27	Maj. William C. Lewis	20 Jun 35-3 Nov 36
Capt. Joe Thurmond	ao Jan 28-19 May 28	<i>Inactive</i>	3 Nov 36-7 Dec 41

HQ, 340th Observation Group (XIX Corps)**Organized Reserve California**

HQ-Not initiated 1924-25; Crissy Field, San Francisco, CA, 1925-29; *Inactive* 1929-33

Subordinate squadrons: 367th Observation Squadron 1924-33, 368th Observation Squadron 1924-33; 381st Service Squadron 1924-33

Constituted in the Organized Reserve on 31 March 1924, assigned to the XIX Corps, and allotted to the Ninth Corps Area. Initiated in November 1925 with headquarters at Crissy Field, San Francisco, CA. Inactivated 20 October 1929 at Crissy Field by relief of personnel. Withdrawn from the Ninth Corps Area 1 October 1933 and demobilized.

Commanders, 340th Observation Group

Capt. B. A. Palmer

Nov 25-ao Jan 26
*Inactive*Unknown
20 Oct 29-7 Dec 41

ao Jan 26-20 Oct 29

HQ, 341st Observation Group (IX Corps)**Organized Reserve Oregon/Washington**

HQ-Not initiated 1924-33

Subordinate squadrons: 321st Observation Squadron 1929-33, 372nd Observation Squadron 1924-33, 562nd Observation Squadron 1924-30, 805th Observation Squadron 1930-33; 384th Service Squadron 1924-33

Constituted in the Organized Reserve on 31 March 1924, assigned to the IX Corps, and allotted to the Ninth Corps Area. Portland, OR, designated as headquarters on organization, but the unit was never organized at that location. Designated headquarters location changed in 1930 to Spokane, WA. Withdrawn from the Ninth Corps Area 1 October 1933 and demobilized.

HQ, 342nd Airship Group (GHQR)**Organized Reserve Pennsylvania**

HQ-Not initiated 1924-27; Philadelphia, PA, 1927-28

Subordinate squadrons: 379th Airship Company 1924-28, 380th Airship Company 1924-28, 381st Airship Company 1924-28, 382nd Airship Company 1924-28, 509th Airship Service Company 1924-28

Constituted in the Organized Reserve on 31 March 1924, assigned to the General Headquarters Reserve, and allotted to the Third Corps Area. Initiated on 14 June 1926 at Philadelphia, PA. Withdrawn from the Third Corps Area 5 September 1928 and demobilized.

Commanders, 342nd Airship Group

Capt. William F. Boecker

14 Jun 26-5 Sep 28

HQ, 343rd Airship Group (GHQR)**Organized Reserve Ohio**

HQ-Not initiated 1924-25; Norton Field, Cincinnati, OH, 1925-30; *Inactive* 1930-33

Subordinate squadrons: 385th Airship Company 1924-33, 386th Airship Company 1924-33, 387th Airship Company 1924-33, 388th Airship Company 1924-33, 510th Airship Service Company 1924-33

Constituted in the Organized Reserve on 31 March 1924, assigned to the General Headquarters Reserve, and allotted to the Fifth Corps Area. Initiated by December 1925, with headquarters at Norton Field, Cincinnati, OH. Inactivated by March 1930 at Norton Field by relief of personnel. Withdrawn from the Fifth Corps Area 1 October 1933 and demobilized.

Commanders, 343rd Airship Group

Unknown

ao Dec 25- Mar 30

Inactive

Mar 30-1 Oct 33

HQ, 344th Airship Group (GHQR)**Organized Reserve Alabama/Illinois****HQ-Not initiated** 1924-41**Subordinate squadrons:** 377th Airship Company 1924-33, 378th Airship Company 1924-33, 383rd Airship Company 1924-33, 384th Airship Company 1924-33, 389th Airship Squadron 1933-41, 390th Airship Squadron 1933-41, 511th Airship Service Company 1924-33Constituted in the Organized Reserve on 31 March 1924, assigned to the General Headquarters Reserve, and allotted to the Fourth Corps Area. Maxwell Field, AL, designated as headquarters on organization, but the unit was never organized at that location. Withdrawn from the Fourth Corps Area 5 September 1928 and allotted to the Sixth Corps Area. Evanston, IL, designated as headquarters on organization, but the unit was never organized at that location. Location 7 December 1941—*Inactive*.**HQ, 345th Airship Group (GHQR)****Organized Reserve Minnesota/Kansas****HQ-St. Paul, MN, 1924-26; Wichita, KS, 1926-33****Subordinate squadrons:** 389th Airship Company 1924-33, 390th Airship Company 1924-33, 391st Airship Company 1924-33, 392nd Airship Company 1924-33, 512th Airship Service Company 1924-33

Constituted in the Organized Reserve on 31 March 1924, assigned to the General Headquarters Reserve, and allotted to the Seventh Corps Area. Initiated in August 1924 with headquarters at St. Paul, MN. Relocated on 26 May 1926 to Wichita, KS. Withdrawn from the Seventh Corps Area 1 October 1933 and demobilized.

Commanders, 345th Airship Group

Unknown Aug 24-1 Oct 33

HQ, 346th Airship Group (GHQR)**Organized Reserve California/Washington****HQ-Not initiated** 1924-25; Los Angeles, CA, 1925-29; Seattle, WA, 1929-33**Subordinate squadrons:** 393rd Airship Company, 394th Airship Company, 395th Airship Company, 396th Airship Company, 514th Airship Service Company

Constituted in the Organized Reserve on 31 March 1924, assigned to the General Headquarters Reserve, and allotted to the Ninth Corps Area. Initiated by 1925 with headquarters at Los Angeles, CA. Inactivated by June 1929 at Los Angeles by relief of personnel. Reorganized 16 October 1929 with headquarters at Seattle, WA. Designated mobilization station was Boeing Field at Seattle. Conducted summer training at Sand Point Airdrome or Boeing Field, WA. Withdrawn from the Ninth Corps Area 1 October 1933 and demobilized.

Commanders, 346th Airship GroupUnknown ao Dec 25-Jun 29 *Inactive* Jun 29-16 Oct 29
Unknown 16 Oct 29-1 Oct 33**HQ, 347th Bombardment Group (GHQR)****Organized Reserve Maryland****HQ, 347th Bombardment Group****HQ-Not initiated** 1924-26; Baltimore, MD, 1926-29; *Inactive* 1929-41**Subordinate squadrons:** 481st Bombardment Squadron 1924-41, 482nd Bombardment Squadron 1924-41, 483rd Bombardment Squadron 1924-41, 484th Bombardment Squadron 1924-33, 389th Service Squadron 1924-33Constituted in the Organized Reserve on 31 March 1924, assigned to the General Headquarters Reserve, and allotted to the Third Corps Area. Initiated by September 1925 with headquarters at Baltimore, MD. Inactivated 2 August 1929 at Baltimore by relief of personnel. Reorganized and redesignated as Headquarters and Headquarters Squadron, 347th Bombardment Group on 1 October 1933. Concurrently, withdrawn from the Third Corps Area. Location 7 December 1941—*Inactive*.

Status: Disbanded 31 May 1942.

Commanders, 347th Bombardment Group

Unknown

ao Sep 25-2 Aug 29

Inactive

2 Aug 29-7 Dec 41

HQ, 348th Bombardment Group (GHQR)

Organized Reserve Illinois

HQ, 348th Bombardment Group

HQ-Not initiated 1924-33; Springfield, OH, 1933-37; *Inactive* 1937-41

Subordinate squadrons: 485th Bombardment Squadron 1924-41, 486th Bombardment Squadron 1924-41, 487th Bombardment Squadron 1924-41, 488th Bombardment Squadron 1924-41, 347th Service Squadron 1924-36

Constituted in the Organized Reserve on 31 March 1924, assigned to the General Headquarters Reserve, and allotted to the Fifth Corps Area. Initiated by December 1933 with headquarters at Springfield, OH. Reorganized and redesignated as Headquarters and Headquarters Squadron, 348th Bombardment Group on 1 October 1933. Inactivated by June 1937 at Springfield by relief of personnel. Location 7 December 1941—*Inactive*.

Status: Disbanded 31 May 1942.

Commanders, 348th Bombardment Group

Unknown

ao Dec 33-ao Jun 37

Inactive

ao Jun 37-7 Dec 41

HQ, 349th Bombardment Group (GHQR)

Organized Reserve Washington

HQ, 349th Bombardment Group

HQ-Not initiated 1924-25; Seattle, WA, 1924-29; *Inactive* 1929-41

Subordinate squadrons: 489th Bombardment Squadron 1924-41, 490th Bombardment Squadron 1924-41, 491st Bombardment Squadron 1924-41, 492nd Bombardment Squadron 1924-41, 373rd Service Squadron 1924-36

Constituted in the Organized Reserve on 31 March 1924, assigned to the General Headquarters Reserve, and allotted to the Ninth Corps Area. Initiated on 22 October 1925 with headquarters at Seattle, WA. Boeing Field designated as mobilization training station. Inactivated by June 1929 at Seattle by relief of personnel. Reorganized and redesignated as Headquarters and Headquarters Squadron, 349th Bombardment Group on 1 October 1933. Location 7 December 1941—*Inactive*.

Status: Disbanded 31 May 1942.

Commanders, 349th Bombardment Group

Maj. Mott Sawyer

22 Oct 25-ao Jan 26
Inactive

Maj. Gilbert H. Eckerson
Jun 29-7 Dec 41

ao Jun 26-Jun 29

HQ, 350th Bombardment Group (GHQR)

Organized Reserve Wisconsin/Illinois

HQ, 350th Bombardment Group

HQ-Not initiated 1924-26; Milwaukee, WI, 1926-27; Chicago, IL, 1927-29; *Inactive* 1929-37; Chicago, IL, 1937-41

Subordinate squadrons: 493rd Bombardment Squadron 1924-41, 494th Bombardment Squadron 1924-41, 495th Bombardment Squadron 1924-41, 496th Bombardment Squadron 1924-33, 390th Service Squadron 1924-33

Constituted in the Organized Reserve on 31 March 1924, assigned to the General Headquarters Reserve, and allotted to the Sixth Corps Area. Initiated on 8 May 1926 with headquarters at Milwaukee, IL. Relocated on 7 January 1927 to Chicago, IL. Reorganized and redesignated as Headquarters and Headquarters Squadron, 350th Bombardment Group on 1 October 1933. Inactivated 1 December 1929 at Chicago by relief of personnel. Reorganized by June 1937 with headquarters at Chicago. Location 7 December 1941—*Inactive*.

Status: Disbanded 31 May 1942.

Commanders, 350th Bombardment Group

Unknown	8 May 26-20 Mar 29	<i>Inactive</i>	1 Dec 29-ao Jun 37
Capt. Frederick H. Chetlain	20 Mar 29-1 Dec 29	Unknown	ao Jun 37-7 Dec 41

HQ, 351st Pursuit Group (1924-33) (GHQR)

Organized Reserve Illinois/Wisconsin

HHS, 351st Bombardment Group (1933-41) (GHQR)

HQ-Not initiated 1924-26; Decatur, IL, 1926-27; Milwaukee, WI, 1927-29; *Inactive* 1929-41

Subordinate squadrons: 493rd Bombardment Squadron 1933-41, 494th Bombardment Squadron 1933-41, 495th Bombardment Squadron 1933-41, 497th Pursuit Squadron 1924-33, 498th Pursuit Squadron 1924-33, 499th Pursuit Squadron 1924-33, 500th Pursuit Squadron 1924-33, 538th Service Squadron 1924-33

Constituted in the Organized Reserve on 31 March 1924 as Headquarters, 351st Pursuit Group, assigned to the General Headquarters Reserve, and allotted to the Sixth Corps Area. Initiated on 8 May 1926 with headquarters at Decatur, IL. Relocated on 7 January 1927 to Milwaukee, WI. Inactivated 20 March 1929 at Milwaukee by relief of personnel. Reorganized and redesignated as Headquarters and Headquarters Squadron, 351st Bombardment Group on 1 October 1933. Location 7 December 1941—*Inactive*.

Status: Disbanded 31 May 1942.

Commanders, 351st Pursuit Group

Unknown	8 May 26-20 Mar 29	<i>Inactive</i>	20 Mar 29-7 Dec 41
---------	--------------------	-----------------	--------------------

HQ, 352nd Pursuit Group (1924-33) (GHQR)

Organized Reserve Kentucky

HHS, 352nd Bombardment Group (1933-41) (GHQR)

HQ-Not initiated 1924-41

Subordinate squadrons: 509th Pursuit Squadron 1924-33, 510th Pursuit Squadron 1924-33, 511th Pursuit Squadron 1924-33, 512th Pursuit Squadron 1924-33, 539th Service Squadron 1924-33; 486th Bomb Squadron 1933-41, 487th Bomb Squadron 1933-41, 488th Bomb Squadron 1933-41, 539th Service Squadron 1924-33, 377th Service Squadron 1933-36

Constituted in the Organized Reserve on 31 March 1924 as Headquarters, 352nd Pursuit Group, assigned to the General Headquarters Reserve, and allotted to the Fifth Corps Area. Bowman Field, KY, designated as headquarters on organization, but the unit was never organized at that location. Designated mobilization training station was Bowman Field. Redesignated as Headquarters and Headquarters Squadron, 352nd Bombardment Group on 1 October 1933. Location 7 December 1941—*Not initiated*.

Status: Disbanded 31 May 1942.

HQ, 353rd Pursuit Group (1924-33) (GHQR)

Organized Reserve New York

HHS, 353rd Attack Group (1933-41) (GHQR)

HQ-Not initiated 1924-41

Subordinate squadrons: 522nd Pursuit Squadron 1924-33, 523rd Pursuit Squadron 1924-33, 524th Pursuit Squadron 1924-33, 525th Pursuit Squadron 1924-33, 540th Service Squadron 1924-33

Constituted in the Organized Reserve on 31 March 1924 as Headquarters, 353rd Pursuit Group, assigned to the General Headquarters Reserve, and allotted to the Second Corps Area. Manhattan, NY, designated as headquarters on organization, but the unit was never organized at that location. Redesignated as Headquarters and Headquarters Squadron, 353rd Attack Group on 1 October 1933. Location 7 December 1941—*Not initiated*.

Status: Disbanded 31 May 1942.

HQ, 354th Pursuit Group (1924-33) (GHQR)

Organized Reserve Minnesota

HHS, 354th Attack Group (1933-41) (GHQR)

HQ-St. Paul, MN, 1924-26; Minneapolis, MN, 1926-41

Subordinate squadrons: 526th Pursuit Squadron 1924-33, 527th Pursuit Squadron 1924-33, 528th Pursuit Squadron 1924-33, 529th Pursuit Squadron 1924-33, 541st Service Squadron 1924-33

Constituted in the Organized Reserve on 31 March 1924 as Headquarters, 354th Pursuit Group, assigned to the General Headquarters Reserve, and allotted to the Seventh Corps Area. Initiated in December 1924 with headquarters at St. Paul, MN. Relocated on 26 May 1926 to Minneapolis, MN. Reorganized and redesignated as Headquarters and Headquarters Squadron, 354th Attack Group on 1 October 1933. Location 7 December 1941—Minneapolis, MN.

Status: Disbanded 31 May 1942.

Commanders, 354th Pursuit Group

Unknown Dec 24-7 Dec 41

HQ, 355th Pursuit Group (1924-33) (GHQR)

Organized Reserve Missouri/Arkansas

HHS, 355th Transport Group (1933-41) (GHQR)

HQ-St. Louis, MO, 1924-28; Fort Smith, AR, 1928-41

Subordinate squadrons: 530th Pursuit Squadron 1924-33, 531st Pursuit Squadron 1924-33, 532nd Pursuit Squadron 1924-33, 533rd Pursuit Squadron 1924-33, 542nd Service Squadron 1924-33, 531st Transport Squadron 1933-41, 687th Service Squadron 1933-36

Constituted in the Organized Reserve on 31 March 1924 as Headquarters, 355th Pursuit Group, assigned to the General Headquarters Reserve, and allotted to the Seventh Corps Area. Initiated in August 1924 with headquarters at St. Louis, MO. Relocated on 3 April 1928 to Fort Smith, AR. Reorganized and redesignated as Headquarters and Headquarters Squadron, 355th Transport Group on 1 October 1933. Location 7 December 1941—Fort Smith, AR

Status: Disbanded 31 May 1942.

Commanders, 355th Pursuit Group

Unknown Aug 24-7 Dec 41

HQ, 356th Pursuit Group (1924-33) (GHQR)

Organized Reserve Minnesota

HHS, 356th Transport Group (1933-41) (GHQR)

HQ-Minneapolis, MN, 1924-31; St. Paul, MN, 1931-41

Subordinate squadrons: 534th Pursuit Squadron 1924-33, 535th Pursuit Squadron 1924-33, 536th Pursuit Squadron 1924-33, 537th Pursuit Squadron 1924-33, 543rd Service Squadron 1924-33, 527th Transport Squadron 1933-41, 528th Transport Squadron 1933-41, 529th Transport Squadron 1933-41, 384th Service Squadron 1933-36

Constituted in the Organized Reserve on 31 March 1924 as Headquarters, 356th Pursuit Group, assigned to the General Headquarters Reserve, and allotted to the Seventh Corps Area. Initiated in August 1924 with headquarters at Minneapolis, MN. Relocated on 12 October 1931 to St. Paul, MN. Reorganized and redesignated as Headquarters and Headquarters Squadron, 356th Transport Group on 1 October 1933. Location 7 December 1941—St. Paul, MN.

Status: Disbanded 31 May 1942.

Commanders, 356th Pursuit Group

Unknown Aug 24-7 Dec 41

HQ, 401st School Group (ZI)**Organized Reserve New York/Vermont****HQ-Not initiated** 1924-26; Middlebury, VT, 1926-28

Constituted in the Organized Reserve on 13 June 1924, assigned to the Zone of the Interior and allotted to the Second Corps Area. Brooklyn, NY, designated as headquarters on organization, but the unit was never organized at that location. Withdrawn from the Second Corps Area 19 March 1926 and allotted to the First Corps Area. Initiated by December 1926 with headquarters at Middlebury, VT. Withdrawn from the Organized Reserve 5 September 1928 and demobilized.

Commanders, 401st School Group

Unknown ao Dec 26-5 Sep 28

HQ, 402nd School Group (ZI)**Organized Reserve New York****HQ-Not initiated** 1924-28

Constituted in the Organized Reserve on 13 June 1924, assigned to the Zone of the Interior and allotted to the Second Corps Area. Manhattan, NY, designated as headquarters on organization, but the unit was never organized at that location. Withdrawn from the Second Corps Area 19 March 1926 and allotted to the Fifth Corps Area. Withdrawn from the Organized Reserve 5 September 1928 and demobilized.

HQ, 403rd School Group (ZI)**Organized Reserve****HQ-Not initiated** 1924-28

Constituted in the Organized Reserve on 13 June 1924, assigned to the Zone of the Interior and allotted to the Second Corps Area. Withdrawn from the Second Corps Area 19 March 1926 and allotted to the Fifth Corps Area. Withdrawn from the Organized Reserve 5 September 1928 and demobilized.

HQ, 404th School Group (ZI)**Organized Reserve****HQ-Not initiated** 1924-28

Constituted in the Organized Reserve on 13 June 1924, assigned to the Zone of the Interior and allotted to the Third Corps Area. Withdrawn from the Second Corps Area 19 March 1926 and allotted to the Fifth Corps Area. Withdrawn from the Organized Reserve 5 September 1928 and demobilized.

HQ, 405th School Group (ZI)**Organized Reserve****HQ-Not initiated** 1924-28

Constituted in the Organized Reserve on 13 June 1924, assigned to the Zone of the Interior and allotted to the Third Corps Area. Withdrawn from the Second Corps Area 19 March 1926 and allotted to the Fifth Corps Area. Withdrawn from the Organized Reserve 5 September 1928 and demobilized.

HQ, 406th School Group (ZI)**Organized Reserve****HQ-Not initiated** 1924-28

Constituted in the Organized Reserve on 13 June 1924, assigned to the Zone of the Interior and allotted to the Third Corps Area. Withdrawn from the Second Corps Area 19 March 1926 and allotted to the Fifth Corps Area. Withdrawn from the Organized Reserve 5 September 1928 and demobilized.

HQ, 407th School Group (ZI)**Organized Reserve****HQ-Not initiated** 1924-28

Constituted in the Organized Reserve on 13 June 1924, assigned to the Zone of the Interior and allotted to the Third Corps Area. Withdrawn from the Second Corps Area 19 March 1926 and allotted to the Fifth Corps Area. Withdrawn from the Organized Reserve 5 September 1928 and demobilized.

HQ, 408th School Group (ZI)**Organized Reserve****HQ-Not initiated** 1924-28

Constituted in the Organized Reserve on 13 June 1924, assigned to the Zone of the Interior and allotted to the Third Corps Area. Withdrawn from the Second Corps Area 19 March 1926 and allotted to the Fifth Corps Area. Withdrawn from the Organized Reserve 5 September 1928 and demobilized.

HQ, 409th School Group (ZI)**Organized Reserve****HQ-Not initiated** 1924-28

Constituted in the Organized Reserve on 13 June 1924, assigned to the Zone of the Interior and allotted to the Third Corps Area. Withdrawn from the Second Corps Area 19 March 1926 and allotted to the Fifth Corps Area. Withdrawn from the Organized Reserve 5 September 1928 and demobilized.

HQ, 410th School Group (ZI)**Organized Reserve Texas****HQ-Not initiated** 1924-27; San Antonio, TX, 1927-28

Constituted in the Organized Reserve on 13 June 1924, assigned to the Zone of the Interior and allotted to the Fifth Corps Area. Withdrawn from the Fifth Corps Area 19 March 1926 and allotted to the Eighth Corps Area. Initiated on 22 August 1927 with headquarters at San Antonio, TX. Designated mobilization station was Brooks Field Flying School and Replacement Center. Withdrawn from the Organized Reserve 5 September 1928 and demobilized.

Commanders, 410th School Group

Unknown 22 Aug 27-5 Sep 28

HQ, 411th School Group (ZI)**Organized Reserve Missouri/Texas****HQ-Kansas City, MO, 1924-26; Inactive** 1926-27; San Antonio, TX, 1927-28

Constituted in the Organized Reserve on 13 June 1924, assigned to the Zone of the Interior and allotted to the Seventh Corps Area. Initiated about December 1924 with headquarters at Kansas City, MO. Withdrawn from the Seventh Corps Area 19 March 1926 and allotted to the Eighth Corps Area. Reorganized 22 August 1927 with headquarters at San Antonio, TX. Designated mobilization station was Brooks Field Flying School and Replacement Center. Withdrawn from the Organized Reserve 5 September 1928 and demobilized.

Commanders, 411th School Group

Unknown ao Dec 24-5 Sep 28

HQ, 412th School Group (ZI)**Organized Reserve Kansas/Texas****HQ**-Salina, KS, 1924-26; *Inactive* 1926-28

Constituted in the Organized Reserve on 13 June 1924, assigned to the Zone of the Interior and allotted to the Seventh Corps Area. Initiated by December 1924 with headquarters in Kansas. Withdrawn from the Seventh Corps Area 19 March 1926 and allotted to the Eighth Corps Area. Designated mobilization station was Brooks Field Flying School and Replacement Center. Withdrawn from the Organized Reserve 5 September 1928 and demobilized.

Commanders, 412th School Group

Unknown ao Dec 24-19 Mar 26

HQ, 413th School Group (ZI)**Organized Reserve Arkansas/Texas****HQ**-Fort Smith, AR, 1924-26; *Inactive* 1926-28

Constituted in the Organized Reserve on 13 June 1924, assigned to the Zone of the Interior and allotted to the Seventh Corps Area. Initiated about 1924 with headquarters at Fort Smith, AR. Withdrawn from the Seventh Corps Area 19 March 1926 and allotted to the Eighth Corps Area. Designated mobilization station was Brooks Field Flying School and Replacement Center. Withdrawn from the Organized Reserve 5 September 1928 and demobilized.

Commanders, 413th School Group

Unknown ao Dec 24-19 Mar 26

HQ, 414th School Group (ZI)**Organized Reserve Missouri/Texas****HQ**-St. Louis, MO, 1924-26; *Inactive* 1926-28

Constituted in the Organized Reserve on 13 June 1924, assigned to the Zone of the Interior and allotted to the Seventh Corps Area. Initiated about 1924 with headquarters at St. Louis, MO. Withdrawn from the Seventh Corps Area 19 March 1926 and allotted to the Eighth Corps Area. Designated mobilization station was Brooks Field Flying School and Replacement Center. Withdrawn from the Organized Reserve 5 September 1928 and demobilized.

Commanders, 414th School Group

Unknown ao Dec 24-19 Mar 26

HQ, 415th School Group (ZI)**Organized Reserve Minnesota/North Dakota****HQ**-St. Paul, MN, 1925-26; New Rockford, ND 1926-28**Subordinate squadrons:** 747th School Squadron, 748th School Squadron, 749th School Squadron, 750th School Squadron, 751st School Squadron, 752nd School Squadron

Constituted in the Organized Reserve on 13 June 1924, assigned to the Zone of the Interior and allotted to the Seventh Corps Area. Initiated in January 1925 with headquarters at St. Paul, MN. Designated mobilization station was San Diego Field Flying School and Replacement Center. Relocated on 26 May 1926 to New Rockford, ND. Withdrawn from the Seventh Corps Area 5 September 1928 and demobilized.

Commanders, 415th School Group

Unknown Jan 25-5 Sep 28

HQ, 416th School Group (ZI)**Organized Reserve Missouri/Iowa****HQ**-St. Louis, MO, 1925-26; Des Moines, IA, 1926-28**Subordinate squadrons:** 753rd School Squadron, 754th School Squadron, 755th School Squadron, 756th School Squadron, 757th School Squadron, 758th School Squadron

Constituted in the Organized Reserve on 13 June 1924, assigned to the Zone of the Interior and allotted to the Seventh Corps Area. Initiated in January 1925 with headquarters at St. Louis, MO. Designated mobilization station was San Diego Field Flying School and Replacement Center. Relocated on 26 May 1926 to Des Moines, IA. Withdrawn from the Organized Reserve 5 September 1928 and demobilized.

Commanders, 416th School Group

Unknown Jan 25-5 Sep 28

HQ, 417th School Group (ZI)

Organized Reserve Missouri

HQ-Kansas City, MO, 1925-26; St. Joseph, MO, 1926-28

Subordinate squadrons: 759th School Squadron, 760th School Squadron, 761st School Squadron, 762nd School Squadron, 763rd School Squadron, 764th School Squadron

Constituted in the Organized Reserve on 13 June 1924, assigned to the Zone of the Interior and allotted to the Seventh Corps Area. Initiated in January 1925 with headquarters at Kansas City, MO. Designated mobilization station was San Diego Field Flying School and Replacement Center. Relocated on 26 May 1926 to St. Joseph, MO. Withdrawn from the Organized Reserve 5 September 1928 and demobilized.

Commanders, 417th School Group

Unknown Jan 25-5 Sep 28

HQ, 418th School Group (ZI)

Organized Reserve Missouri/Minnesota

HQ-St. Joseph, MO, 1922-26; St. Paul, MN, 1926-28

Subordinate squadrons: 765th School Squadron, 766th School Squadron, 767th School Squadron, 768th School Squadron, 769th School Squadron, 770th School Squadron

Constituted in the Organized Reserve on 13 June 1924, assigned to the Zone of the Interior and allotted to the Seventh Corps Area. Initiated in January 1925 with headquarters at St. Joseph, MO. Designated mobilization station was San Diego Field Flying School and Replacement Center. Relocated on 26 May 1926 to St. Paul, MN. Withdrawn from the Organized Reserve 5 September 1928 and demobilized.

Commanders, 418th School Group

Unknown Jan 25-5 Sep 28

HQ, 419th School Group (ZI)

Organized Reserve Iowa

HQ-*Not initiated* 1924-28

Constituted in the Organized Reserve on 13 June 1924, assigned to the Zone of the Interior and allotted to the Ninth Corps Area. Designated mobilization station was San Diego Field Flying School and Replacement Center. Withdrawn from the Ninth Corps Area 19 March 1926 and allotted to the Seventh Corps Area. Withdrawn from the Organized Reserve 5 September 1928 and demobilized.

HQ, 420th School Group (ZI)

Organized Reserve Iowa

HQ-*Not initiated* 1924-28

Constituted in the Organized Reserve on 13 June 1924, assigned to the Zone of the Interior and allotted to the Ninth Corps Area. Designated mobilization station was San Diego Field Flying School and Replacement Center. Withdrawn from the Ninth Corps Area 19 March 1926 and allotted to the Seventh Corps Area. Withdrawn from the Organized Reserve 5 September 1928 and demobilized.

HQ, 421st School Group (ZI)**Organized Reserve Wisconsin****HQ-Not initiated** 1924-28

Constituted in the Organized Reserve on 13 June 1924, assigned to the Zone of the Interior and allotted to the Ninth Corps Area. Designated mobilization station was San Diego Field Flying School and Replacement Center. Withdrawn from the Ninth Corps Area 19 March 1926 and allotted to the Sixth Corps Area. Withdrawn from the Organized Reserve 5 September 1928 and demobilized.

HQ, 422nd School Group (ZI)**Organized Reserve South Dakota****HQ-Not initiated** 1924-26; Sioux Falls, SD 1926-28

Constituted in the Organized Reserve on 13 June 1924, assigned to the Zone of the Interior and allotted to the Ninth Corps Area. Designated mobilization station was San Diego Field Flying School and Replacement Center. Withdrawn from the Ninth Corps Area 19 March 1926 and allotted to the Seventh Corps Area. Initiated about 1926 with headquarters at Sioux Falls, SD. Withdrawn from the Organized Reserve 5 September 1928 and demobilized.

Commanders, 422nd School Group

Unknown ao Dec 26-5 Sep 28

HQ, 423rd School Group (ZI)**Organized Reserve Kentucky****HQ-Not initiated** 1924-26; Louisville, KY, 1926-28

Constituted in the Organized Reserve on 13 June 1924, assigned to the Zone of the Interior and allotted to the Ninth Corps Area. Designated mobilization station was San Diego Field Flying School and Replacement Center. Withdrawn from the Ninth Corps Area 19 March 1926 and allotted to the Fifth Corps Area. Initiated about 1926 with headquarters at Louisville, KY. Withdrawn from the Organized Reserve 5 September 1928 and demobilized.

Commanders, 423rd School Group

Unknown ao Dec 26-5 Sep 28

HQ, 424th School Group (ZI)**Organized Reserve Kentucky****HQ-Not initiated** 1924-28

Constituted in the Organized Reserve on 13 June 1924, assigned to the Zone of the Interior and allotted to the Second Corps Area. Designated mobilization station was Langley Field Flying School and Replacement Center. Withdrawn from the Ninth Corps Area 19 March 1926 and allotted to the Fifth Corps Area. Withdrawn from the Organized Reserve 5 September 1928.

Status: Disbanded 31 May 1942.**HQ, 425th School Group (ZI)****Organized Reserve New York****HQ-Not initiated** 1924-28

Constituted in the Organized Reserve on 13 June 1924, assigned to the Zone of the Interior and allotted to the Second Corps Area. New York City, NY, designated as headquarters on organization, but the unit was never organized at that location. Designated mobilization station was Langley Field Flying School and Replacement Center. Withdrawn from the Organized Reserve 5 September 1928.

Status: Disbanded 31 May 1942.

HQ, 426th School Group (ZI)

Organized Reserve Illinois

HQ-Not initiated 1924-28

Constituted in the Organized Reserve on 13 June 1924, assigned to the Zone of the Interior and allotted to the Second Corps Area. Designated mobilization station was Langley Field Flying School and Replacement Center. Withdrawn from the Organized Reserve 5 September 1928.

Status: Disbanded 31 May 1942.

HQ, 427th School Group(ZI)

Organized Reserve

HQ-Not initiated 1924-28

Constituted in the Organized Reserve on 13 June 1924, assigned to the Zone of the Interior and allotted to the Second Corps Area. Designated mobilization station was Langley Field Flying School and Replacement Center. Withdrawn from the Organized Reserve 5 September 1928.

Status: Disbanded 31 May 1942.

HQ, 428th School Group (ZI)

Organized Reserve

HQ-Not initiated 1924-28

Constituted in the Organized Reserve on 13 June 1924, assigned to the Zone of the Interior and allotted to the Second Corps Area. Designated mobilization station was Langley Field Flying School and Replacement Center. Withdrawn from the Organized Reserve 5 September 1928.

Status: Disbanded 31 May 1942.

HQ, 429th School Group (ZI)

Organized Reserve Illinois

HQ-Not initiated 1924-28

Constituted in the Organized Reserve on 13 June 1924, assigned to the Zone of the Interior and allotted to the Second Corps Area. Designated mobilization station was Langley Field Flying School and Replacement Center. Withdrawn from the Organized Reserve 5 September 1928.

Status: Disbanded 31 May 1942.

HQ, 430th School Group (ZI)

Organized Reserve Nebraska

HQ-Not initiated 1924-28

Constituted in the Organized Reserve on 13 June 1924, assigned to the Zone of the Interior and allotted to the Second Corps Area. Lincoln, NE, designated as headquarters on organization, but the unit was never organized at that location. Designated mobilization station was Langley Field Flying School and Replacement Center. Withdrawn from the Organized Reserve 5 September 1928.

Status: Disbanded 31 May 1942.

HQ, 431st School Group (ZI)**Organized Reserve New York****HQ-Not initiated** 1924-28

Constituted in the Organized Reserve on 13 June 1924, assigned to the Zone of the Interior and allotted to the Second Corps Area. New Brighton, NY, designated as headquarters on organization, but the unit was never organized at that location. Designated mobilization station was Langley Field Flying School and Replacement Center. Withdrawn from the Organized Reserve 5 September 1928.

Status: Disbanded 31 May 1942.**HQ, 432nd Airship Group (ZI)****Organized Reserve Illinois****HQ-Not initiated** 1924-33

Subordinate squadrons: 389th Airship Company 1924-33, 390th Airship Company 1924-33, 391st Airship Company 1924-33, 392nd Airship Company 1924-33, 512th Airship Service Company 1924-33

Constituted in the Organized Reserve on 13 June 1924, assigned to the Zone of the Interior and allotted to the Sixth Corps Area. Monroe, IL, designated as headquarters on organization, but the unit was never organized at that location. Designated mobilization assignment was the Scott Field Balloon and Airship School. Withdrawn from the Sixth Corps Area 1 October 1933 and demobilized.

HQ, 541st Balloon Group (1924-38) (XI Corps)**Organized Reserve Maine/Connecticut****HQ, 41st Balloon Group (1921-24)****HHS, 60th Balloon Group (1938-42)****HQ-Not initiated** 1921-22; Bangor, ME, 1922-27; New Haven, CT, 1927-41

Subordinate squadrons: 301st Balloon Company 1921-33, 302nd Balloon Company 1921-33, 303rd Balloon Company 1921-33, 304th Balloon Company 1921-33, Balloon Park No. 31 1921-23, 338th Balloon Service Company 1923-33, 301st Balloon Squadron 1933-41, 302nd Balloon Squadron 1933-41, 303rd Balloon Squadron 1933-41, 338th Balloon Service Squadron 1933-41

Constituted in the Organized Reserve on 29 July 1921 as Headquarters, 41st Balloon Group, assigned to the XI Corps, and allotted to the First Corps Area. Initiated in October 1922 with headquarters at Bangor, ME. Redesignated as HQ, 541st Balloon Group on 20 February 1924. Relocated on 29 January 1927 to New Haven, CT. Relieved from assignment to the XI Corps 1 October 1933 and assigned to the I Corps. Concurrently, reorganized and redesignated as Headquarters and Headquarters Squadron, 541st Balloon Group. Redesignated as HHS, 60th Balloon Group on 1 January 1938. Concurrently withdrawn from the Organized Reserve and allotted to the Regular Army. Location 7 December 1941—New Haven, CT.

Status: Disbanded 31 May 1942.**Commanders, 541st Balloon Group**

Unknown Oct 22-7 Dec 41

HQ, 542nd Balloon Group (1924-38) (XII Corps)**Organized Reserve New York****HQ, 42nd Balloon Group (1921-24)****HHS, 61st Balloon Group (1938-42)****HQ-Buffalo, NY, 1921-29; Inactive** 1929-41

Subordinate squadrons: 305th Balloon Company 1921-33, 306th Balloon Company 1921-33, 307th Balloon Company 1921-33, 308th Balloon Company 1921-33, Balloon Park No. 32 1921-23, 339th Balloon Service Company 1923-33; 305th Balloon Squadron 1933-41, 306th Balloon Squadron 1933-41, 307th Balloon Squadron 1933-41, 339th Balloon Service Squadron 1933-41

Constituted in the Organized Reserve on 29 July 1921 as Headquarters, 42nd Balloon Group, assigned to the XI Corps, and allotted to the Second Corps Area. Initiated on 4 November 1921 with headquarters at Buffalo, NY. Redesignated as HQ, 542nd Balloon Group on 20 February 1924. Inactivated by June 1929 at Buffalo by relief of personnel. Relieved from assignment to the XII Corps 1 October 1933 and assigned to the II Corps. Concurrently, reorganized and redesignated as Headquarters and Headquarters Squadron, 542nd Balloon Group. Redesignated as HHS, 61st Balloon Group on 1 January 1938. Concurrently withdrawn from the Organized Reserve and allotted to the Regular Army. Location 7 December 1941—Buffalo, NY.

Status: Disbanded 31 May 1942.

Commanders, 542nd Balloon Group

Capt. Guy W. Brookhauser	4 Nov 21-10 Jun 23	Maj. William J. Dunn	19 Aug 26-6 Jan 27
Capt. John M. Galt	10 Jun 23-ao Sep 23	Maj. Archibald K. Benedict	6 Jan 27-Jun 29
Unknown	ao Sep 23-19 Aug 26	<i>Inactive</i>	Jun 29-7 Dec 41

HQ, 543rd Balloon Group (1924-38) (XIII Corps)

Organized Reserve Pennsylvania

HQ, 43rd Balloon Group (1921-24)

HHS, 62nd Balloon Group (1938-42)

HQ-Pittsburgh, PA, 1921-29; *Inactive* 1929-41

Subordinate squadrons: 309th Balloon Company 1921-33, 310th Balloon Company 1921-33, 311th Balloon Company 1921-33, 312th Balloon Company 1921-33, Balloon Park No. 33 1921-23, 340th Balloon Service Company 1923-33, 309th Balloon Squadron 1933-41, 310th Balloon Squadron 1933-41, 311th Balloon Squadron 1933-41, 357th Balloon Squadron 1933-41, 340th Balloon Service Squadron 1933-41

Constituted in the Organized Reserve on 29 July 1921 as Headquarters, 43rd Balloon Group, assigned to the XIII Corps, and allotted to the Third Corps Area. Initiated on 9 December 1921 with headquarters at Pittsburgh, PA. Redesignated as HQ, 543rd Balloon Group on 20 February 1924. Inactivated 14 August 1929 at Pittsburgh by relief of personnel. Reorganized and redesignated as Headquarters and Headquarters Squadron, 543rd Balloon Group on 1 October 1933. Redesignated as HHS, 62nd Balloon Group on 1 January 1938. Concurrently withdrawn from the Organized Reserve and allotted to the Regular Army. Location 7 December 1941—*Inactive*.

Status: Disbanded 31 May 1942.

Commanders, 543rd Balloon Group

Maj. Samuel S. McCahill	9 Dec 21-31 Jan 25	Capt. Leo J. Griffin	10 Jan 28-2 Aug 29
Capt. Sheridan Talbot	21 Jan 25-ao Feb 25	Capt. Harry Weber	2 Aug 29-14 Aug 29
Maj. William L. Carbine	ao May 25-10 Jan 28	<i>Inactive</i>	14 Aug 29-7 Dec 41

HQ, 544th Balloon Group (1924-41) (XIV Corps)

Organized Reserve South Carolina

HQ, 44th Balloon Group (1921-24)

HQ-Not initiated 1921-22; Charleston, SC, 1922-29; *Inactive* 1929-41

Subordinate squadrons: 313th Balloon Company 1921-33, 314th Balloon Company 1921-33, 315th Balloon Company 1921-33, 316th Balloon Company 1921-33, Balloon Park No. 34 1921-23; 341st Balloon Service Company 1923-33, 313th Balloon Squadron 1933-41, 314th Balloon Squadron 1933-41, 315th Balloon Squadron 1933-41, 341st Balloon Service Squadron 1933-41

Constituted in the Organized Reserve on 29 July 1921 as Headquarters, 44th Balloon Group, assigned to the XIV Corps, and allotted to the Fourth Corps Area. Initiated on 25 April 1922 with headquarters at Charleston, SC. Relieved from the XIV Corps 2 July 1923 and assigned to the IV Corps. Redesignated as HQ, 544th Balloon Group on 20 February 1924. Inactivated 19 September 1929 at Charleston by relief of personnel. Relieved from assignment to the IV Corps 1 October 1933 and assigned to the XIV Corps. Concurrently, Redesignated as Headquarters and Headquarters Squadron, 544th Balloon Group. Designated mobilization station was Camp Joseph E. Johnston, FL, (later Redesignated as Camp J. Clifford R. Foster). Location 7 December 1941—*Inactive*.

Status: Disbanded 31 May 1942.

Commanders, 544th Balloon Group

Capt. Harold F. Semple

25 Apr 22-ao Sep 25
Inactive

Unknown
19 Sep 29-& Dec 41

ao Sep 25-19 Sep 29

HQ, 545th Balloon Group (1924-38) (XV Corps)

Organized Reserve Ohio

HQ, 45th Balloon Group (1921-24)

HHS, 63rd Balloon Group (1938-42)

HQ-Akron, OH, 1921-30; *Inactive* 1930-41

Subordinate squadrons: 317th Balloon Company 1921-33, 318th Balloon Company 1921-33, 319th Balloon Company 1921-33, 320th Balloon Company 1921-33, Balloon Park No. 35 1921-23, 342nd Balloon Service Company, 317th Balloon Squadron 1933-41, 318th Balloon Squadron 1933-41, 319th Balloon Squadron 1933-41, 320th Balloon Squadron 1933-41, 342nd Balloon Service Squadron 1933-41

Constituted in the Organized Reserve on 29 July 1921 as Headquarters, 45th Balloon Group, assigned to the XV Corps, and allotted to the Fifth Corps Area. Initiated on 8 November 1921 with headquarters at Akron, OH. Relieved from the XV Corps 2 July 1923 and assigned to the V Corps. Redesignated as HQ, 545th Balloon Group on 20 February 1924. Inactivated by March 1930 at Akron by relief of personnel. Reorganized and redesignated as Headquarters and Headquarters Squadron, 545th Balloon Group on 1 October 1933. Redesignated as HHS, 63rd Balloon Group on 1 January 1938. Concurrently withdrawn from the Organized Reserve and allotted to the Regular Army. Location 7 December 1941—*Inactive*.

Status: Disbanded 31 May 1942.

Commanders, 545th Balloon Group

Unknown

8 Nov 21-Mar 30

Inactive

Mar 30-7 Dec 41

HQ, 546th Balloon Group (1924-41) (XVI Corps)

Organized Reserve Wisconsin

HQ, 46th Balloon Group (1921-24)

HHS, 64th Balloon Group (1938-42)

HQ-Not initiated 1921-22; Fond du Lac, WI, 1922-27; *Inactive* 1927-41

Subordinate squadrons: 321st Balloon Company 1921-33, 322nd Balloon Company 1921-33, 323rd Balloon Company 1921-33, 324th Balloon Company 1921-33, Balloon Park No. 36 1921-23, 343rd Balloon Service Company 1921-33, 321st Balloon Squadron 1933-41, 322nd Balloon Squadron 1933-41, 323rd Balloon Squadron 1933-41, 324th Balloon Squadron 1933-41, 343rd Balloon Service Squadron 1933-41

Constituted in the Organized Reserve on 29 July 1921 as Headquarters, 46th Balloon Group, assigned to the XVI Corps, and allotted to the Sixth Corps Area. Initiated on 24 November 1922 with headquarters at Fond du Lac, WI. Redesignated as HQ, 546th Balloon Group on 20 February 1924. Inactivated 15 January 1927 at Fond du Lac by relief of personnel. Relieved from assignment to the XVI Corps 1 October 1933 and assigned to the VI Corps. Concurrently, reorganized and redesignated as Headquarters and Headquarters Squadron, 546th Balloon Group. Redesignated as HHS, 64th Balloon Group on 1 January 1938. Concurrently withdrawn from the Organized Reserve and allotted to the Regular Army. Location 7 December 1941—*Inactive*.

Status: Disbanded 31 May 1942.

Commanders, 546th Balloon Group

1st Lt. Eugene N. Berglund
Unknown

24 Nov 22-ao Jan 23
ao Jan 23-23 Dec 24

Maj. Leslie H. Ross
Inactive

23 Dec 24-15 Jan 27
15 Jan 27-7 Dec 41

HQ, 547th Balloon Group (1924-41) (XVII Corps)

Organized Reserve Missouri

HQ, 47th Balloon Group (1921-24)

HHS, 65th Balloon Group (1938-42)

HQ-Not initiated 1921-22; St. Louis, MO, 1922-41

Subordinate squadrons: 325th Balloon Company 1921-33, 326th Balloon Company 1921-33, 327th Balloon Company 1921-33, Balloon Park No. 37 1921-23, 344th Balloon Service Company 1921-33, 325th Balloon Squadron 1933-41, 326th Balloon Squadron 1933-41, 327th Balloon Squadron 1933-41, 328th Balloon Squadron 1933-41, 344th Service Squadron 1933-41

Constituted in the Organized Reserve on 29 July 1921 as Headquarters, 47th Balloon Group, assigned to the XVII Corps, and allotted to the Seventh Corps Area. Initiated in April 1922 with headquarters at St. Louis, MO. Redesignated as HQ, 547th Balloon Group on 20 February 1924. Relieved from assignment to the XVII Corps 1 October 1933 and assigned to the VII Corps. Concurrently, reorganized and redesignated as Headquarters and Headquarters Squadron, 547th Balloon Group. Redesignated as HHS, 65th Balloon Group on 1 January 1938. Concurrently withdrawn from the Organized Reserve and allotted to the Regular Army. Location 7 December 1941—St. Louis, MO.

Status: Disbanded 31 May 1942.

Commanders, 547th Balloon Group

Unknown	Apr 22-7 Dec 41
---------	-----------------

HQ, 548th Balloon Group (1924-41) (XVIII Corps)

Organized Reserve Texas

HQ, 48th Balloon Group (1921-24)

HQ-Not initiated 1921-22; Austin, TX, 1922-25; Temple, TX, 1925-41

Subordinate squadrons: 329th Balloon Company 1921-33, 330th Balloon Company 1921-33, 331st Balloon Company 1921-33, 332nd Balloon Company 1921-33, Balloon Park No. 38 1921-23, 345th Balloon Service Company 1921-33, 329th Balloon Squadron 1933-41, 330th Balloon Squadron 1933-41, 331st Balloon Squadron 1933-41, 345th Balloon Service Squadron 1933-41

Constituted in the Organized Reserve on 29 July 1921 as Headquarters, 48th Balloon Group, assigned to the XVIII Corps, and allotted to the Eighth Corps Area. Initiated in December 1922 with headquarters at Austin, TX. Relieved from the XVIII Corps 2 July 1923 and assigned to the VIII Corps. Redesignated as HQ, 548th Balloon Group on 20 February 1924. Relocated on 15 April 1925 to Temple, TX. Inactivated 14 May 1928 at Temple by relief of personnel. Relieved from assignment to the VIII Corps 1 October 1933 and assigned to the XVIII Corps. Concurrently, reorganized and redesignated as Headquarters and Headquarters Squadron, 548th Balloon Group. Reorganized on 20 June 1935 at Temple, TX. Mobilization training station was Love Field, Dallas, TX, 1922-33 and Hensley Field, Grand Prairie, TX, 1933-41. Location 7 December 1941—Temple, TX.

Status: Disbanded 31 May 1942.

Commanders, 548th Balloon Group

Capt. Byron T. Johnson	Dec 22-13 Jan 28	<i>Inactive</i>	14 May 28-20 Jun 35
Capt. Sam V. Stone	13 Jan 28-14 May 28	Maj. James L. Gartner	20 Jun 35-14 Dec 36
	Unknown	14 Dec 36-7 Dec 41	

HQ, 549th Balloon Group (1924-41) (XIX Corps)

Organized Reserve California

HQ, 49th Balloon Group (1921-24)

HHS, 66th Balloon Group (1938-42)

HQ-Not initiated 1921-22; Los Angeles, CA, 1922-28; *Inactive* 1928-38; Los Angeles, CA, 1938-41

Subordinate squadrons: 333rd Balloon Company 1921-33, 334th Balloon Company 1921-33, 335th Balloon Company 1921-33, 336th Balloon Company 1921-33, Balloon Park No. 39 1921-23, 346th Balloon Service Company 1923-33, 333rd Balloon Squadron 1933-41, 334th Balloon Squadron 1933-41, 335th Balloon Squadron 1933-41, 346th Service Squadron 1933-41

Constituted in the Organized Reserve on 29 July 1921 as Headquarters, 49th Balloon Group, assigned to the XIX Corps, and allotted to the Ninth Corps Area. Initiated on 28 August 1922 with headquarters at Los Angeles, CA. Relieved from the XIX Corps 2 July 1923 and assigned to the IX Corps. Redesignated as HQ, 549th Balloon Group on 20 February 1924. Inactivated 1 September 1928 at Los Angeles by relief of personnel. Redesignated as Headquarters and Headquarters Squadron, 549th Balloon Group on 1 October 1933. Redesignated as HHS, 66th Balloon Group on 1 January 1938. Concurrently withdrawn from the Organized Reserve and allotted to the Regular Army. Reorganized by December 1938 with headquarters at Los Angeles, CA. Conducted summer training most years at Ross Field, CA, 1923-28. Location 7 December 1941—Los Angeles, CA.

Status: Disbanded 31 May 1942.

Commanders, 549th Balloon Group

Capt. Harold B. Reed	28 Aug 22-ao Sep 25	<i>Inactive</i>	1 Sep 28-ao Dec 38
Unknown	ao Sep 25-1 Sep 28	Unknown	ao Dec 38-7 Dec 41

HQ, 550th Balloon Group (1924-41) (II Corps)

Organized Reserve New York

HQ, 50th Balloon Group (1921-24)

HQ-Not initiated 1921-22; Rochester, NY, 1922-41

Subordinate squadrons: 14th Balloon Company 1921-33, 15th Balloon Company 1921-33, 23rd Balloon Company 1921-33, 337th Balloon Company 1921-33, Balloon Park No. 40 1921-23, 347th Balloon Service Company, 308th Balloon Squadron 1933-41, 337th Balloon Squadron 1933-41, 355th Balloon Squadron 1933-41, 347th Service Squadron 1933-41

Constituted in the Organized Reserve on 29 July 1921 as Headquarters, 50th Balloon Group, assigned to the II Corps, and allotted to the Second Corps Area. Initiated on 11 March 1922 with headquarters at Rochester, NY. Redesignated as HQ, 550th Balloon Group on 20 February 1924. Relieved from assignment to the II Corps 1 October 1933 and assigned to the XI Corps. Concurrently, reorganized and redesignated as Headquarters and Headquarters Squadron, 550th Balloon Group. Location 7 December 1941—Rochester, NY.

Status: Disbanded 31 May 1942.

Commanders, 550th Balloon Group

Capt. William N. Brockway	11 Mar 22-20 Dec 23	Unknown	ao Jan 24-13 Sep 27
Capt. William H. Smith	20 Dec 23-ao Jan 24	Capt. Cornelius D. McLaughlin	13 Sep 27-ao Jan 28
	Unknown	ao Jan 28-7 Dec 41	

HQ, 551st Balloon Group (1924-41) (VIII Corps)

Organized Reserve Texas

HQ, 51st Balloon Group (1921-24)

HQ-Not initiated 1921-22; San Antonio, TX, 1922-25; Temple, TX, 1925-28; *Inactive* 1928-33

Subordinate squadrons: 125th Balloon Company 1921-23, 126th Balloon Company 1921-23, 424th Balloon Company 1921-33, 425th Balloon Company 1921-33, 475th Balloon Company 1923-33, 476th Balloon Company 1923-33, Balloon Park No. 17 1921-23, 137th Balloon Service Company 1923-24, 487th Balloon Service Company 1924-33

Constituted in the Organized Reserve on 29 July 1921 as Headquarters, 51st Balloon Group, assigned to the XVIII Corps, and allotted to the Eighth Corps Area. Initiated in December 1922 with headquarters at San Antonio, TX. Relieved from the VIII Corps 2 July 1923 and assigned to the XVIII Corps. Redesignated as HQ, 551st Balloon Group on 20 February 1924. Inactivated 14 May 1928 at Temple by relief of personnel. Withdrawn from the Eighth Corps Area 1 October 1933 and demobilized.

Commanders, 551st Balloon Group

Unknown	Dec 22-ao Dec 24	Capt. Wilson R. McComas	Nov 26-14 May 28
Capt. Thomas J. Hughes	ao Dec 24-Nov 26	<i>Inactive</i>	14 May 28-1 Oct 33

HQ, 552nd Balloon Group (1925-33) (I Corps)

Organized Reserve

HQ, 52nd Balloon Group (1923-25)

HQ-Not initiated 1923-33

Subordinate squadrons: 451st Balloon Company 1923-33, 452nd Balloon Company 1923-33, 453rd Balloon Company 1923-33, 454th Balloon Company 1923-33, 481st Balloon Service Company 1923-33

Constituted in the Organized Reserve on 2 July 1923 as Headquarters, 52nd Balloon Group (DNG), assigned to the I Corps, and allotted to the First Corps Area. Redesignated as HQ, 552nd Balloon Group (DNG) on 23 March 1925. Withdrawn as a Deferred National Guard unit 11 January 1927 and allotted permanently to the Organized Reserve as the 552nd Balloon Group. Concurrently withdrawn from the First Corps Area and allotted to the Fifth Corps Area. Demobilized on 1 October 1933.

HQ, 553rd Balloon Group (1925-41) (III Corps)

Organized Reserve Illinois

HQ, 53rd Balloon Group (1923-25)

HQ-Not initiated 1923-30; La Salle, IL, 1930-34; Inactive 1934-41

Subordinate squadrons: 455th Balloon Company 1923-33, 456th Balloon Company 1923-33, 457th Balloon Company 1923-33, 458th Balloon Company 1923-33, 482nd Balloon Service Company 1923-41

Constituted in the Organized Reserve on 2 July 1923 as Headquarters, 53rd Balloon Group (DNG), assigned to the III Corps, and allotted to the Third Corps Area. Redesignated as HQ, 553rd Balloon Group (DNG) on 23 March 1925. Withdrawn from the National Guard on 17 September 1927 and permanently allotted to the Organized Reserve. Withdrawn from the Third Corps Area 5 September 1928 and allotted to the Sixth Corps Area. Initiated in December 1930 with headquarters at La Salle, IL. Assigned to the XVI Corps 1 October 1933. Inactivated by June 1934 at La Salle by relief of personnel. Concurrently, reorganized and redesignated as Headquarters and Headquarters Squadron, 553rd Balloon Group. Location 7 December 1941—*Inactive*.

Status: Disbanded 31 May 1942.

Commanders, 553rd Balloon Group

Unknown

Dec 30-ao Jun 34

Inactive

ao Jun 34-7 Dec 41

HQ, 554th Balloon Group (1925-41) (XIV Corps)

Organized Reserve Georgia/Michigan

HQ, 54th Balloon Group (1923-25)

HQ-Not initiated 1923-30; Bay City, MI, 1930-34; Inactive 1934-41

Subordinate squadrons: 459th Balloon Company 1923-33, 460th Balloon Company 1923-33, 461st Balloon Company 1923-33, 462nd Balloon Company 1923-33, 483rd Balloon Service Company 1923-33, 365th Balloon Squadron 1933-41, 366th Balloon Squadron 1933-41, 367th Balloon Squadron 1933-41, 398th Balloon Service Squadron 1933-41

Constituted in the Organized Reserve on 2 July 1923 as Headquarters, 54th Balloon Group (DNG), assigned to the XIV Corps, and allotted to the Fourth Corps Area. Savannah, GA, designated as headquarters on organization, but the unit was never organized at that location. Redesignated as HQ, 554th Balloon Group (DNG) on 23 March 1925. Withdrawn from the National Guard on 17 September 1927 and permanently allotted to the Organized Reserve. Withdrawn from the Fourth Corps Area 5 September 1928 and allotted to the Sixth Corps Area. Initiated in December 1930 at Bay City, MI. Reorganized and redesignated as Headquarters and Headquarters Squadron, 554th Balloon Group on 1 October 1933. Inactivated by June 1934 at Bay City by relief of personnel. Detroit, MI, designated 28 July 1937 as headquarters on reorganization, but the unit was never organized at that location. Designated mobilization station was Pope Field, Fort Bragg, NC. Location 7 December 1941—*Inactive*.

Status: Disbanded 31 May 1942.

Commanders, 554th Balloon Group

Unknown

Dec 30-ao Jun 34

Inactive

ao Jun 34-7 Dec 41

HQ, 555th Balloon Group (1925-41) (XV Corps)

Organized Reserve Michigan/Illinois

HQ, 55th Balloon Group (1923-25)

HQ-Not initiated 1923-30; Muskegon, MI, 1930-34; *Inactive* 1934-41

Subordinate squadrons: 463rd Balloon Company 1923-33, 464th Balloon Company 1923-33, 465th Balloon Company 1923-33, 466th Balloon Company 1923-33, 484th Balloon Service Company 1923-33, 364th Balloon Squadron 1933-41, 368th Balloon Squadron 1933-41, 508th Balloon Service Squadron 1933-41

Constituted in the Organized Reserve on 2 July 1923 as Headquarters, 55th Balloon Group (DNG), assigned to the XV Corps, and allotted to the Fifth Corps Area. Redesignated as HQ, 555th Balloon Group (DNG) on 25 March 1925. Withdrawn from the National Guard on 17 September 1927 and permanently allotted to the Organized Reserve. Withdrawn from the Fifth Corps Area 5 September 1928 and allotted to the Sixth Corps Area. Concurrently assigned to the General Headquarters Reserve. Initiated by December 1930 with headquarters at Muskegon, MI. Reorganized and redesignated as Headquarters and Headquarters Squadron, 555th Balloon Group on 1 October 1933. Inactivated by June 1934 at Muskegon by relief of personnel. Champaign, IL, designated 28 July 1937 as headquarters on reorganization, but the unit was never organized at that location. Designated mobilization station was Schoen Field, Fort Benjamin Harrison, IN. Location 7 December 1941—*Inactive*.

Status: Disbanded 31 May 1942.

Commanders, 555th Balloon Group

Unknown

Dec 30-ao Jun 34

Inactive

ao Jun 34-7 Dec 41

HQ, 556th Balloon Group (1925-28) (VI Corps)

Organized Reserve Illinois

HQ, 56th Balloon Group (1923-25)

HQ-Not initiated 1923-28

Subordinate squadrons: 467th Balloon Company 1923-28, 468th Balloon Company 1923-28, 469th Balloon Company 1923-28, 470th Balloon Company 1923-28, 485th Balloon Service Company 1923-28

Constituted in the Organized Reserve on 2 July 1923 as Headquarters, 56th Balloon Group (DNG), assigned to the VI Corps, and allotted to the Sixth Corps Area. Redesignated as HQ, 556th Balloon Group (DNG) on 23 March 1925. Designated mobilization station was Scott Field, IL. Withdrawn from the National Guard on 17 September 1927 and permanently allotted to the Organized Reserve. Withdrawn from the Organized Reserve on 5 September 1928 and demobilized.

HQ, 557th Balloon Group (1925-28) (VII Corps)

Organized Reserve North Dakota

HQ, 57th Balloon Group (1923-25)

HQ-Not initiated 1923-24; Larimore, ND, 1924-26; Huron, SD, 1926-28

Subordinate squadrons: 471st Balloon Company 1923-28, 472nd Balloon Company 1923-28, 473rd Balloon Company 1923-28, 474th Balloon Company 1923-28, 486th Balloon Service Company 1923-28

Constituted in the Organized Reserve on 2 July 1923 as Headquarters, 57th Balloon Group (DNG), assigned to the VII Corps, and allotted to the Seventh Corps Area. Initiated in August 1924 with headquarters at Larimore, ND. Redesignated as HQ, 557th Balloon Group (DNG) on 23 March 1925. Relocated on 26 May 1926 to Huron, SD. Withdrawn from the National Guard on 17 September 1927 and permanently allotted to the Organized Reserve. Withdrawn from the Organized Reserve on 5 September 1928 and demobilized.

Commanders, 557th Balloon Group

Unknown Aug 24-5 Sep 28

HQ, 558th Balloon Group (1925-41) (XIX Corps)

Organized Reserve California

HQ, 58th Balloon Group (1923-25)

HQ-Not initiated 1923-28

Subordinate squadrons: 477th Balloon Company 1923-28, 478th Balloon Company 1923-28, 479th Balloon Company 1923-28, 480th Balloon Company 1923-28, 488th Balloon Service Company 1923-28

Constituted in the Organized Reserve on 2 July 1923 as Headquarters, 58th Balloon Group (DNG), assigned to the XIX Corps, and allotted to the Ninth Corps Area. Redesignated as HQ, 558th Balloon Group (DNG) on 23 March 1925. Los Angeles, CA, designated as headquarters on organization, but the unit was never organized at that location. Withdrawn from the National Guard on 17 September 1927 and allotted to the Organized Reserve. Withdrawn from the Organized Reserve on 5 September 1928 and demobilized.

HQ, 559th Balloon Group (1925-28) (GHQR)

Organized Reserve Minnesota/Arkansas

HQ, 59th Balloon Group (1924-25)

HQ-Not initiated 1923-24; Glenwood, MN, 1924-26; Little Rock, AR, 1926-28

Subordinate squadrons: 489th Balloon Company 1923-28, 490th Balloon Company 1923-28, 491st Balloon Company 1923-28, 492nd Balloon Company 1923-28, 495th Balloon Service Company 1923-28

Constituted in the Organized Reserve on 13 June 1924, assigned to the General Headquarters Reserve, and allotted to the Seventh Corps Area. Initiated in August 1924 with headquarters at Glenwood, MN. Redesignated as HQ, 559th Balloon Group (DNG) on 23 March 1925. Relocated on 26 May 1926 to Little Rock, AR. Withdrawn from the National Guard on 17 September 1927 and allotted to the Organized Reserve. Withdrawn from the Organized Reserve on 5 September 1928 and demobilized.

Commanders, 559th Balloon Group

Unknown Aug 24-5 Sep 28

HQ, 561st Balloon Group (GHQR)

Organized Reserve Connecticut

HQ, 61st Balloon Group (1921-23)

HQ-Not initiated 1921-22; New Haven, CT, 1922-27; *Inactive* 1927-33

Subordinate squadrons: 351st Balloon Company 1921-33, 352nd Balloon Company 1921-33, 353rd Balloon Company 1921-33, 354th Balloon Company 1921-33, 348th Balloon Service Company 1921-33

Constituted in the Organized Reserve on 15 October 1921, assigned to the 1st Balloon Wing (General Headquarters Reserve) (later redesignated as the 10th Balloon Wing), and allotted to the First Corps Area. Initiated in April 1922 with headquarters at New Haven, CT. Withdrawn from the First Corps Area 11 January 1927 and allotted to the Fifth Corps Area. Inactivated 1 February 1927 at New Haven by relief of personnel. Withdrawn from the Organized Reserve 1 October 1933 and demobilized.

Commanders, 561st Balloon Group

Capt. Ashbel R. Welles
Maj. Edward E. Ashley

Apr 22-ao Aug 22
ao Nov 22-ao Jun 25
Inactive

Unknown
Capt. Ashbel R. Welles
1 Feb 27-1 Oct 33

ao Jun 25-ao Apr 26
ao Apr 26-1 Feb 27

HQ, 562nd Balloon Group (GHQR)**Organized Reserve New Jersey****HQ, 62nd Balloon Group (1921-23)****HQ**-Trenton, NJ 1922-39; *Inactive* 1939-41

Subordinate squadrons: 355th Balloon Company 1921-33, 356th Balloon Company 1921-33, 357th Balloon Company 1921-33, 358th Balloon Company 1921-33, 355th Balloon Squadron 1933-41, 356th Balloon Squadron 1933-41, 357th Balloon Squadron 1933-41, 349th Balloon Service Company 1923-33; 349th Balloon Service Squadron 1933-41

Constituted in the Organized Reserve on 15 October 1921, assigned to the 1st Balloon Wing (General Headquarters Reserve) (later redesignated as the 10th Balloon Wing), and allotted to the Second Corps Area. Initiated on 18 May 1922 with headquarters at Trenton, NJ. Relieved from assignment to the 10th Balloon Wing on 1 October 1933 and assigned to the XII Corps. Concurrently, reorganized and redesignated as Headquarters and Headquarters Squadron, 562nd Balloon Group. Inactivated by September 1939 at Trenton by relief of personnel. Location 7 December 1941—*Inactive*.

Status: Disbanded 31 May 1942.**Commanders, 562nd Balloon Group**

Capt. Norman S. Goetz	18 May 22-20 Dec 23	Maj. Michael A. Keily	21 Apr 25-ao Jan 26
Capt. Thomas S. Dupuy	20 Dec 23-16 Dec 24	Unknown	ao Jan 26-Sep 39
Maj. Rutherford S. Pierrepont	17 Dec 24-ao May 25	<i>Inactive</i>	Sep 39-7 Dec 41

HQ, 563rd Balloon Group (GHQR)**Organized Reserve Pennsylvania/Louisiana****HQ, 63rd Balloon Group (1921-23)****HQ**-*Not initiated* 1921-22; Philadelphia, PA, 1921-27; *Inactive* 1927-41

Subordinate squadrons: 145th Balloon Company 1921-23, 146th Balloon Company 1921-23, 359th Balloon Company 1921-33, 360th Balloon Company 1921-33, 493rd Balloon Company 1924-33, 494th Balloon Company 1924-33, 350th Balloon Service Company 1923-33; 359th Balloon Squadron 1933-41, 534th Balloon Squadron 1933-41, 350th Balloon Service Squadron 1933-41

Constituted in the Organized Reserve on 15 October 1921, assigned to the 1st Balloon Wing (General Headquarters Reserve) (later redesignated as the 10th Balloon Wing), and allotted to the Third Corps Area. Initiated on 12 November 1921 with headquarters at Philadelphia, PA. Withdrawn from the Third Corps Area 11 January 1927 and allotted to the Fourth Corps Area. Shreveport, LA, designated 22 October 1929 as headquarters on reorganization, but the unit was never organized at that location. Relieved from assignment to the 10th Balloon Wing on 1 October 1933. Concurrently, reorganized and redesignated as Headquarters and Headquarters Squadron, 563rd Balloon Group. Location 7 December 1941—*Inactive*.

Status: Disbanded 31 May 1942.**Commanders, 563rd Balloon Group**

1st Lt. Charles S. Rockey	12 Nov 21-18 Nov 21	Capt. George W. Gibson	20 Sep 23-ao Jan 24
Capt. William D. Grant	18 Nov 21-26 Jan 22	Unknown	ao Jan 24-11 Jan 27
Maj. William S. Calkins	13 Feb 23-19 Sep 23	<i>Inactive</i>	11 Jan 27-7 Dec 41

HQ, 564th Balloon Group (GHQR)**Organized Reserve Ohio****HQ, 64th Balloon Group (1921-23)****HQ**-*Not initiated* 1921-22; Youngstown, OH, 1922-30; *Inactive* 1930-33

Subordinate squadrons: 361st Balloon Company 1921-33, 362nd Balloon Company 1921-33, 363rd Balloon Company 1921-33, 364th Balloon Company 1921-33, 397th Balloon Service Company 1923-33

Constituted in the Organized Reserve on 15 October 1921, assigned to the 1st Balloon Wing (General Headquarters Reserve) (later redesignated as the 10th Balloon Wing), and allotted to the Fifth Corps Area. Initiated in June 1922 with headquarters at Columbus, OH. Inactivated by March 1930 at Youngstown by relief of personnel. Withdrawn from the Organized Reserve 1 October 1933 and demobilized.

Commanders, 564th Balloon Group

Capt. Charles P. Eich	Jun 22-ao Sep 24 <i>Inactive</i>	Unknown Mar 30-1 Oct 33	ao Sep 24-Mar 30
-----------------------	-------------------------------------	----------------------------	------------------

HQ, 565th Balloon Group (GHQR)

Organized Reserve Michigan/Nebraska

HQ, 65th Balloon Group (1921-23)

HQ—Not initiated 1921-22; Grand Rapids, MI, 1922-25; Kalamazoo, MI, 1925-39; *Inactive* 1939-41

Subordinate squadrons: 365th Balloon Company 1921-33, 366th Balloon Company 1921-33, 367th Balloon Company 1921-33, 368th Balloon Company 1921-33, 365th Balloon Squadron 1933-41, 366th Balloon Squadron 1933-41, 367th Balloon Squadron 1933-41, 368th Balloon Squadron 1933-41, 398th Balloon Service Company 1921-33, 398th Balloon Service Squadron 1933-41

Constituted in the Organized Reserve on 15 October 1921, assigned to the 2nd Balloon Wing (General Headquarters Reserve) (later redesignated as the 12th Balloon Wing), and allotted to the Sixth Corps Area. Initiated in December 1922 with headquarters at Grand Rapids, MI. Relocated on 2 June 1925 to Kalamazoo, MI. Relieved from assignment to the 12th Balloon Wing on 1 October 1933. Concurrently, reorganized and redesignated as Headquarters and Headquarters Squadron, 565th Balloon Group. Inactivated 30 June 1939 at Kalamazoo by relief of personnel. Location 7 December 1941—*Inactive*.

Status: Disbanded 31 May 1942.

Commanders, 565th Balloon Group

Maj. Edward V. Vis Unknown	2 Apr 23-ao Jul 25 ao Jul 25-24 Apr 26 <i>Inactive</i>	Lt. Col. Phelps Newberry Unknown 30 Jun 39-7 Dec 41	24 Apr 26-ao Dec 26 ao Dec 26-30 Jun 39
-------------------------------	--	---	--

HQ, 566th Balloon Group (GHQR)

Organized Reserve Iowa

HQ, 66th Balloon Group (1921-23)

HQ—Not initiated 1921-22; Des Moines, IA, 1922-30; *Inactive* 1930-39; Des Moines, IA, 1939-41

Subordinate squadrons: 369th Balloon Company 1921-33, 370th Balloon Company 1921-33, 371st Balloon Company 1921-33, 372nd Balloon Company 1921-33, 399th Balloon Service Company 1921-33, 328th Balloon Squadron 1933-41, 369th Balloon Squadron 1933-41, 370th Balloon Squadron 1933-41, 371st Balloon Squadron 1933-41, 372nd Balloon Squadron 1933-41, 399th Service Squadron 1933-41

Constituted in the Organized Reserve on 15 October 1921, assigned to the 2nd Balloon Wing (General Headquarters Reserve) (later redesignated as the 12th Balloon Wing), and allotted to the Seventh Corps Area. Initiated in July 1922 with headquarters at Des Moines, IA. Inactivated by June 1930 at Des Moines by relief of personnel. Relieved from assignment to the 12th Balloon Wing on 1 October 1933 and assigned to the XVII Corps. Concurrently, reorganized and redesignated as Headquarters and Headquarters Squadron, 566th Balloon Group. Reorganized about June 1939 with headquarters at Des Moines. Location 7 December 1941—Des Moines, IA.

Status: Disbanded 31 May 1942.

Commanders, 566th Balloon Group

Unknown	Jul 22-ao Jun 30 Unknown	<i>Inactive</i> ao Jun 39-7 Dec 41	ao Jun 30-ao Jun 39
---------	-----------------------------	---------------------------------------	---------------------

HQ, 567th Balloon Group (GHQR)

Organized Reserve Oregon

HQ, 67th Balloon Group (1921-23)

HQ-Not initiated 1921-22; Portland, OR, 1922-29; *Inactive* 1929-33

Subordinate squadrons: 373rd Balloon Company 1921-33, 374th Balloon Company 1921-33, 375th Balloon Company 1921-33, 376th Balloon Company 1921-33, 400th Balloon Service Company 1921-33

Constituted in the Organized Reserve on 15 October 1921, assigned to the 2nd Balloon Wing (General Headquarters Reserve) (later redesignated as the 12th Balloon Wing), and allotted to the Ninth Corps Area. Initiated in October 1922 with headquarters at Portland, OR. Inactivated by June 1929 at Portland by relief of personnel. Designated mobilization station was Pearson Field, Vancouver Barracks, WA. Withdrawn from the Organized Reserve 1 October 1933 and demobilized.

Commanders, 567th Balloon Group

Lt. Col. Justus M. Wheate

Oct 22-ao Sep 25
Inactive

Unknown
Jun 29-7 Dec 41

ao Sep 25-Jun 29

Chapter 31

Squadrons, Heavier Than Air



USAF Photo

Curtiss P-6 Hawks of the 17th Pursuit Squadron over Selfridge Field, MI.

Heavier Than Air (HTA) squadrons provided direct or indirect support to the ground gaining arms. This could be as direct as attack and observation missions against the enemy's front forces, or as indirect as the bombing of the enemy's industries and infrastructure in order to cripple that nation's war-making capabilities. Some also provided specialized support to include aircraft maintenance and testing, personnel and equipment transportation, training, and aerial photography.

Organization

There were nine types of HTA squadrons in the interwar era. Four of these squadrons—attack, bombardment, observation (some later redesignated as reconnaissance squadrons) and pursuit—were to be employed in direct combat roles. The remaining five—transport, photographic, service, school, and headquarters squadrons—were support organizations that performed a variety of missions and functions. Like the group headquarters, many of these squadrons experienced one or more reorganizations and/or redesignations so it is difficult to illustrate how many types of squadrons were in each category. The following table, however, shows the allotment of squadron types as they were originally organized as of 1921 or as originally constituted and in the component to which they were originally allotted during 1921-40. The table includes only those units organized or constituted prior to December 1939 in the case of Regular Army units and as of December 1940 for National Guard and Organized Reserve units.

Units Organized or Constituted.

	Atk	Bomb	Obsn	Purs	Trans	Photo	Svc	Sch	HQ
RA	6	30	31	32	12	1	19	18	1
RAI	4	0	9	0	0	0	13	0	1
NG	0	0	61	0	0	0	7	0	0
OR	24	17	106	69	0	0	92	0*	15
Totals	34	47	207	101	12	1	131	18	17

* There were a number of OR school squadrons constituted in the Organized Reserve but were apparently non-flying organizations. They are listed in Chapter 33.

Squadron structure varied by type, but in general, it consisted of two to three flights, an operations section, armament section, communications section, and an engineering section. Depending on the type of squadron, it might also include a photo section, a supply section, and a transportation section. Attack, bombardment, pursuit, and transport squadrons were typically assigned four squadrons to a like group (i.e., pursuit squadrons in a pursuit group). They could also be assigned to a composite group, but that group usually consisted of only one bombardment, one observation, and one pursuit squadron each. Service squadrons were also assigned one each to a group regardless of type. Additionally, a single observation squadron could be assigned to a division air service, or in some cases were unassigned, or attached to bombardment groups. School squadrons were assigned to school groups in varying numbers. The single photographic squadron was an asset of the Office, Chief of the Air Corps and performed special missions for that command. Headquarters squadrons were assigned one to each field army air service and performed the typical support functions associated with such organizations (administration, supply, etc.)

Attack Squadron, 1926

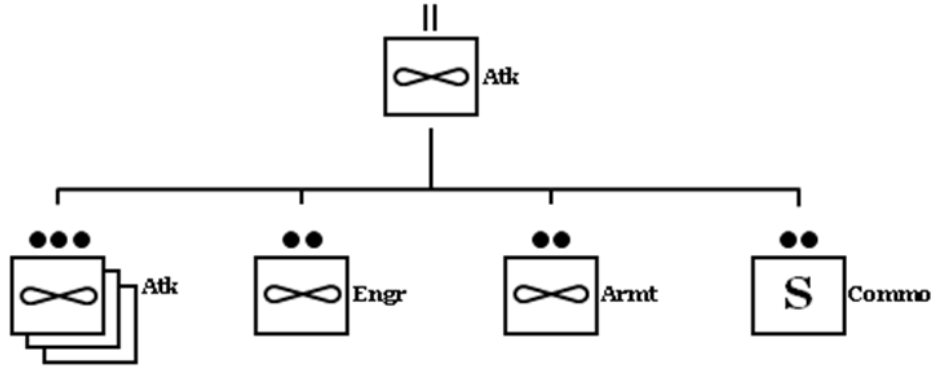

T/O: 279
 Approved: 3 June 1926
 Commander: Maj.
 Officers: 56
 W. O.: —
 Enlisted: 223
 Total: 281

Key Equipment:
 Airplanes, various 25
 Cars, various 1
 Trucks, various 14
 Machine guns, AA 3
 Machine guns, aerial 100

Bombardment Squadron (Dual Engine), 1921

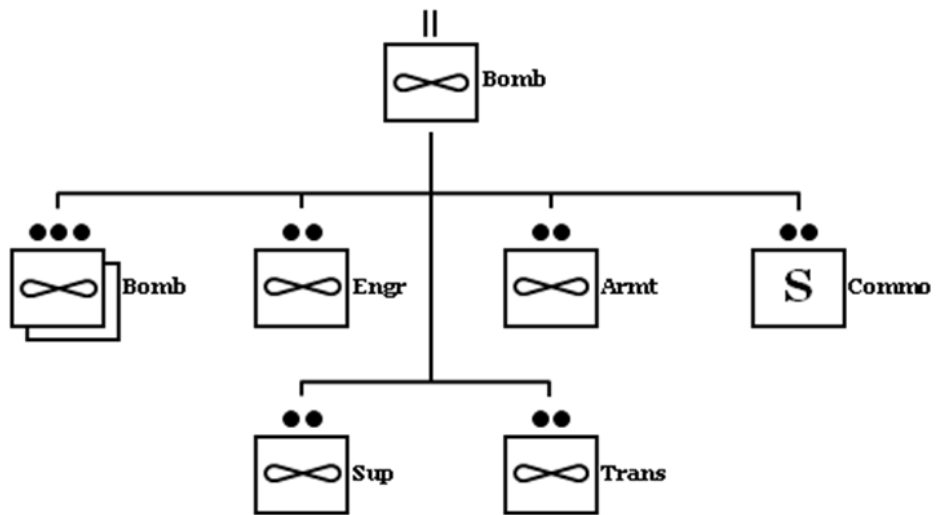

T/O: 576W
 Effective: 13 September 1921
 Commander: Maj.
 Officers: 67
 W. O.: —
 Enlisted: 247
 Total: 304

Key Equipment:
 Airplanes, various 13
 Cars, various 1
 Trucks, various 24
 Machine guns, AA 3
 Machine guns, aerial 52

TOEs for attack and bomb squadrons.

Observation Squadron, 1926

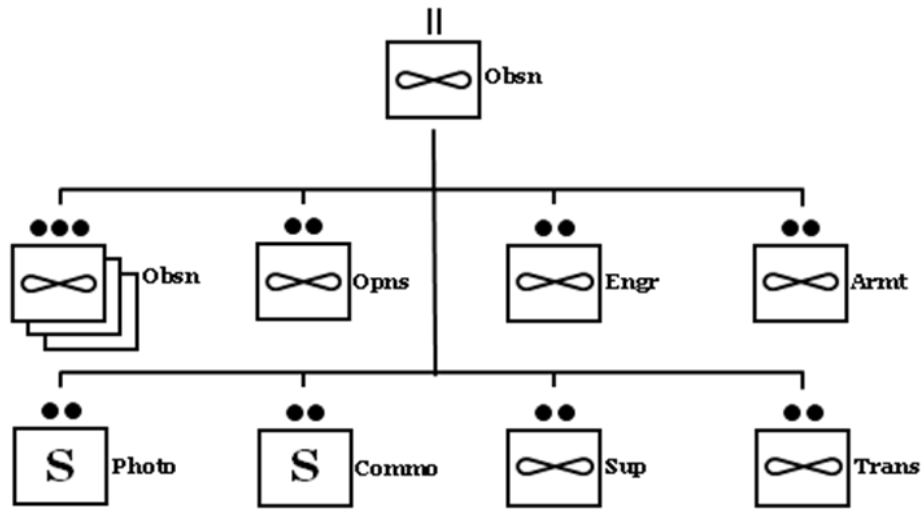

T/O: 71
 Effective: 10 June 1930
 Commander: Maj.
 Officers: 22
 W. O.: --
 Enlisted: 157
 Total: 179

Key Equipment:
 Airplanes, various 13
 Cars, various 2
 Trucks, various 24
 Machine guns, aerial 26

Pursuit Squadron, 1926

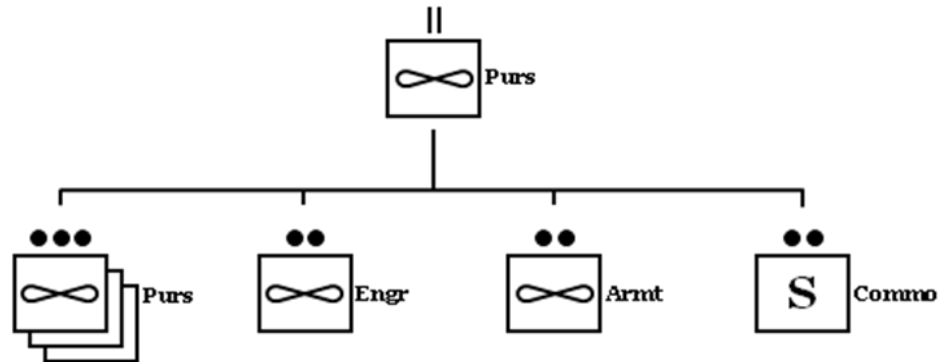

T/O: 277W
 Effective: 3 June 1926
 Commander: Maj.
 Officers: 32
 W. O.: --
 Enlisted: 215
 Total: 247

Key Equipment:
 Airplanes, various 25
 Cars, various 1
 Trucks, various 12
 Machine guns, AA 3
 Machine guns, aerial 50

TOEs for observation and pursuit squadrons.

Service Squadron, 1926

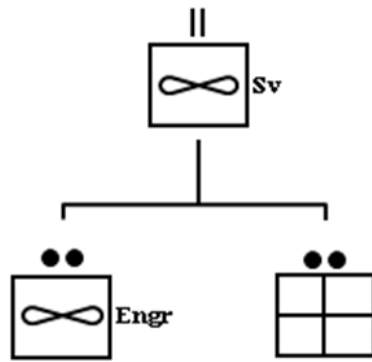

T/O:	173W
Approved:	30 April 1926
Commander	Maj.
Officers:	9
W. O.	—
Enlisted	205
Total	214

<u>Key Equipment:</u>	
Airplanes, cargo	8
Trucks, various	17
Machine guns, AA	3

TOE for service squadrons.

The T/O structure of most of these squadrons remained relatively constant throughout the interwar period. However, some were changed or eliminated. Most headquarters squadrons, for example, were reorganized and redesignated as air depot headquarters in 1933. Service squadrons were either demobilized or consolidated with existing group headquarters between 1936 and 1938. Some observation squadrons were redesignated as reconnaissance squadrons in 1936 and some in 1939. Many squadrons were also reorganized and redesignated from one type of squadron to another. Most squadrons' group assignments remained relatively constant during this time, but a sizable number were relieved from one group and assigned to another. This was especially true for the Regular Army as the number of squadrons and groups brought into active service continued to increase during the interwar years.

Of the sixty-one National Guard squadrons constituted during this time, only thirty-three were ever organized. All of the organized units were observation squadrons and none of the eight service squadrons allotted to the Guard were ever organized. Of the organized squadrons, all but four entered active duty during 1940-41

As was the norm for most types of Army units in this period, the majority of air corps squadrons were OR organizations. Over 320 of the nearly 570 HTA squadrons were Reserve units. The majority of those units were organized at some point in the interwar period, but about thirty were never initiated. Only three of the OR squadrons are known to have served in World War II (482nd, 484th, and 485th Bombardment Squadrons), and then only by being reconstituted and consolidated with an existing new organization.

Training

The Regular Army squadrons were very active organizations when compared to the rest of the Army between the wars. Of course, part of that activity was in the nature of such organizations. Pilots had to maintain proficiency in perishable flight and warfighting skills and support personnel had to ensure that the squadron's planes were ready for training, or in the case of overseas squadrons, ready for combat. These squadrons participated in a host of training exercises, both with the Army's ground units and with other air corps organizations. These training events included maneuver training with infantry and cavalry units from battalion to division-level (and later to corps and field army-level), antiaircraft exercises, coast and field artillery live-fire exercises, aerial photography and mapping missions, and exercises with naval sea and air units as well. Squadrons also participated in their own training exercises to maintain proficiency in their primary missions, whether that was bombing exercises for attack and bombardment units, resupply and air movement exercises for transportation units, or aerial gunnery and targeting exercises for pursuit units. In addition, these squadrons often supported the summer training of OR squadrons.

Most of the Regular Army Inactive units that were organized with Reserve personnel were functional units. This was primarily because these units were generally located on or near Army air fields or Organized Reserve airdromes and had easy access to army aircraft. Many of these locations also happened to be located near cities that were air hubs for major U.S. airlines. This was significant because many airline pilots were also Reserve officers.

All of the organized National Guard observation squadrons had the luxury of being situated at civilian or former military airfields on which the squadrons possessed two or three hangars and perhaps a few auxiliary buildings. The units were typically assigned about six aircraft for flight training and proficiency which were parked and maintained at the Guard unit's facilities. In addition to normal flight training operations, National Guard observation squadrons were employed in a large number of training and other missions such as search and rescue, tow-target and spotter flights for the coast and field artillery, photo missions, forest fire patrols, and any number of others. Some of these missions were performed during the unit's summer training and others were performed during the Inactive Training Period. All of these kinds of duties, however, helped make the NG observation squadrons some of the best-trained organizations in the Reserve components.

The vast number of Organized Reserve squadrons were a mixed bag. Many were functional units. Like the RAI units, the most active were those squadrons that were lucky enough to be based at an Army airfield or at a Reserve airdrome. Reserve squadrons that were located at or near Regular Army airfields were authorized the use of the aircraft from RA squadrons to maintain flying proficiency. The Organized Reserve squadrons in these situations generally held their Inactive Training Period meetings and summer training at those airfields as well. A small number of Reserve units were assigned Army aircraft that were based at their local airports. These units were typically allocated only about four to six planes and they were usually a mixture of types, mostly trainers and obsolete observation planes. There were only a handful of these units, however; usually only two or three per corps area. Other squadrons that were collocated at the same airfield were lucky as well because the pilots of those squadrons could freely use the owning squadron's aircraft based at the airport. Since there were few Reserve enlisted personnel in these squadrons, the maintenance of these aircraft was conducted by a small RA air corps detachment assigned to the field or the Reserve airdrome. Some Organized Reserve squadrons were functional units but did not have the luxury of having assigned planes or Regular Army aircraft based nearby. These units were functional only because of the assigned personnel made efforts to conduct training meetings with the sparse resources at hand, which occasionally included privately-owned aircraft. These units' Regular Army instructors were also able to arrange for Army aircraft to be flown into a local airfield for weekend training events, but this was uncommon. A sizable number of Organized Reserve squadrons were pool units made of up geographically dispersed members. These units were occasionally ordered to summer training, but usually their personnel attended camps as individuals attached to other units.

1st Observation Squadron (I) (1919-35) (9th Observation Group)

1st Bombardment Squadron (1935-41) (9th Bombardment Group)

HQ-Park Field, TN, 1919; Mitchel Field, NY, 1919-40; Rio Hato Field, Panama, 1940-41; Pianco Airport, Trinidad, 1941; Waller Field, Trinidad, 1941

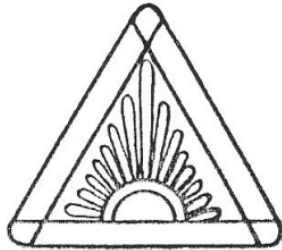

Stationed at Park Field, TN, as of August 1919 as the 1st Army Observation Squadron. Assigned on 1 October 1919 to the 1st Army Observation Group. Redesignated as the 1st Squadron (Observation) on 14 March 1921. Supported bombing tests on obsolete warships off Chesapeake Bay during June-September 1921. Relieved from assignment to the 1st Army Observation Group on 30 August 1921 and assigned to the 2nd Wing (Provisional). Relieved from assignment to the 2nd Wing (Provisional) on 30 September 1921 and assigned to the Second Corps Area. Assigned on 1 August 1922 to the 9th Observation Group. Redesignated as the 1st Observation Squadron on 15 November 1922. Relieved from assignment to the 9th Observation Group on 24 March 1923, assigned to the 9th Division, and attached to the 9th Observation Group. Relieved from

assignment to the 9th Division on 15 August 1927 and assigned to the 1st Cavalry Division. Relieved from assignment to the 1st Cavalry Division on 15 February 1929 and assigned to the 9th Observation Group. Reorganized and redesignated 1st Bombardment Squadron on 1 March 1935 and assigned to the 9th Bombardment Group. Redesignated as the 1st Bombardment Squadron (Medium) on 6 December 1939. Attached on 9 October 1940 to the 2nd Cavalry Division. Redesignated as the 1st Bombardment Squadron (Heavy) on 20 November 1940 and relieved from attachment to the 2nd Cavalry Division. Ground elements departed from the port of New York on 5 November 1940 on the U.S.A.T. *Chateau Thierry* and arrived on 12 November 1940 at Rio Hato Airfield in Panama. Aircraft and crews departed Mitchel Field on 17 November 1940 for Rio Hato and arrived several days later. Location 7 December 1941—Waller Field, Trinidad.

Status: Active in the U. S. Air Force as the 1st Reconnaissance Squadron at Beale A.F.B., CA.

Events: 66, 78, 85, 103, 107, 146, 164, 249, 268, 283

Commanders, 1st Observation Squadron (I)

1st Bombardment Squadron

Maj. Thomas G. Lanphier	ao Dec 20-28 Mar 21	1st Lt. John W. McCullough	3 Jul 30-1 Jun 32
Capt. John J. Devery	28 Mar 21-23 Jan 22	Capt. Earle J. Carpenter	1 Jun 32-5 Aug 32
Capt. Truman W. Allen	23 Jan 22-12 Feb 22	Capt. Edward J. Raley	5 Aug 32-5 Jun 34
Maj. Junius W. Jones	12 Feb 22-1 Aug 22	Capt. Earle J. Carpenter	5 Jun 34-20 Aug 34
Maj. Davenport Johnson	1 Aug 22-30 Jun 25	Maj. William E. Lynd	20 Aug 34-1 Mar 35
Capt. Harry C. Drayton	30 Jun 25-4 Nov 25	Maj. Earle J. Carpenter	1 Mar 35-6 Jun 35
1st Lt. Newton Longfellow	4 Nov 25-27 Feb 28	Maj. Charles P. Prime	6 Jun 35-20 Jul 36
1st Lt. Newman R. Laughinghouse	27 Feb 28-10 Mar 29	Maj. Claude E. Duncan	20 Jul 36-29 Jan 39
1st Lt. Charles C. Chauncey	10 Mar 29-9 Dec 29	Maj. Arthur W. Meehan	29 Jan 39-1 Jun 39
1st Lt. John A. Case	9 Dec 29-3 Jul 30	Capt. Raymond L. Winn	1 Jun 39-ao Apr 40
	Maj. Stuart P. Wright	ao Jul 40-Dec 41	

1st Observation Squadron (II) (1937-39) (47th Observation Group)

1st Reconnaissance Squadron (1939-41)

HQ-Fort Omaha, NE, 1919-21; Scott Field, IL, 1921-37; Marshall Field, KS, 1937-41



Stationed at Fort Omaha, NE, as of June 1919 as Balloon Company No. 9 and assigned to the Army Balloon School. Redesignated as the 9th Airship Company 30 August 1921. Transferred on 28 October 1921 to Scott Field, IL, and assigned to the Sixth Corps Area. Assigned on 19 July 1922 to the 21st Airship Group. Redesignated as the 9th Airship Squadron on 26 October 1933. Participated in flood relief operations in southern Illinois in January-February 1937. Transferred on 15 June 1937 to Marshall Field, KS. Reorganized and redesignated 1st Observation Squadron on 1 July 1937, assigned to the Seventh Corps Area, and attached to the Cavalry School. Assigned on 17 July 1937 to the 47th Observation Group (VII Corps).

Reorganized and redesignated 1st Reconnaissance Squadron on 6 December 1939. Relieved from assignment to the 47th Observation Group on 3 October 1940 and assigned to the Second Army. Assigned on 26 September 1941 to the 72nd Observation Group. Location 7 December 1941—Marshall Field, KS.

Organization Day: 1 July. Chosen to commemorate the squadron's redesignation 1 July 1937 as the 1st Observation Squadron.

Status: Active in the U. S. Air Force as the 41st Electronic Combat Squadron at Davis-Monthan A.F.B., AZ.

Events: 236, 256, 274, 295, 296, 303, 324

Commanders, 1st Observation Squadron (II)

Capt. Elmer T. Rundquist	1 Mar 35-17 Jun 37	Capt. Ford L. Fair	ao Oct 39-Apr 41
Maj. Jack Greer	17 Jun 37-21 Aug 38	Capt. Vernon C. Smith	Apr 41-1 Jul 41
Maj. Arthur G. Hamilton	21 Aug 38-ao Sep 39	Maj. William A. Methany	1 Jul 41- ao Jan 42

1st Photographic Squadron (OCAC)

HQ-*Not organized* 1939-40; Bolling Field, DC, 1940-41; Bradley Field, CT, 1941

Constituted in the Regular Army on 22 December 1939 and assigned to the Office of the Chief of the Air Corps. Organized on 1 February 1940 at Bolling Field, DC. Transferred on 5 December 1941 to Bradley Field, CT. Location 7 December 1941—Bradley Field, CT.

Status: Reconstituted, and consolidated 19 September 1985 with the 1st Test Squadron; active in the U. S. Air Force as the 1st Air and Space Test Squadron at Vandenberg A.F.B., CA.

Commanders, 1st Photographic Squadron

Maj. Donald G. Stitt	1 Feb 40-15 Nov 40	Maj. Minton W. Kaye	15 Nov 40-10 Jun 41
	Capt. Charles P. Hollstein	10 Jun 41-May 42	

1st Pursuit Squadron (23rd Composite Group)

HQ-Maxwell Field, AL, 1940; Orlando, FL, 1940-41; Eglin Field, FL, 1941

Constituted in the Regular Army on 1 August 1939 and assigned to the 23rd Composite Group. Redesignated as the 1st Pursuit Squadron (Interceptor) on 6 December 1939. Activated on 1 February 1940 at Maxwell Field, AL. Transferred on 2 September 1940 to Orlando, FL. Transferred on 29 June 1941 to Eglin Field, FL. Location 7 December 1941—Eglin Field, FL.

Status: Reconstituted, and consolidated 19 September 1985 with the 1st Liaison Squadron; active in the U. S. Air Force as the 1st Special Operations Squadron at Kadena A.B., Japan.

Events: 301

Commanders, 1st Pursuit Squadron

Maj. John C. Crossthaite	1 Feb 40-30 Mar 42
--------------------------	--------------------

1st Service Squadron (1st Transport Group)

HQ-*Not organized* 1933-34; Columbus, OH, 1934-38

Constituted in the Regular Army on 1 October 1933, assigned to the 1st Transport Group, and allotted to the Fifth Corps Area. Organized by March 1934 with Organized Reserve personnel as a RAI unit at Columbus, OH. Assigned on 20 May 1937 to the 10th Transport Group. Disbanded on 1 January 1938.

Commanders, 1st Service Squadron

Unknown	Mar 34-1 Jan 38
---------	-----------------

1st Staff Squadron

HQ-Bolling Field, DC, 1936-41

Constituted in the Regular Army on 1 September 1936, assigned to the General Headquarters Air Force, and allotted to the Third Corps Area. Concurrently organized at Bolling Field, DC. The squadron was responsible for flying and maintaining various types of aircraft for the flight-rated officers of Headquarters, General Headquarters Air Force in Washington DC, to maintain their flying ability. It also provided planes and crews for the Secretary of War and General Staff officers of the War Department for transportation in performance of their duties. Location 7 December 1941—Bolling Field, DC.

Status: Disbanded on 31 March 1944.

Commanders, 1st Staff Squadron

Maj. Samuel C. Eaton, Jr.	1 Sep 36-12 Nov 36	Capt. Howard M. Turner	12 Jun 38-11 Jun 38
Maj. Benjamin F. Giffin	12 Nov 36-21 Dec 36	Maj. Max F. Schneider	11 Jun 38-9 Sep 38
Capt. George W. McGregor	21 Dec 36-12 Jun 38	Capt. Lewis R. Parker	9 Sep 38-6 Aug 41
	Capt. Robert M. Stillman	6 Aug 41-20 May 42	

1st Transport Squadron (1st Transport Group)

HQ-*Not organized* 1933-35; Patterson Field, OH, 1935-41

Constituted in the Regular Army on 1 October 1933, assigned to the 1st Transport Group, and allotted to the Fifth Corps Area. Authorized to be partially organized as the 1st Provisional Transport Squadron in early 1935. Redesignated as the 1st Transport Squadron on 25 June 1935. Fully activated on 15 July 1935 at Patterson Field, OH, and attached to the Fairfield Air Depot. Assigned on 20 May 1937 to the 10th Transport Group. Location 7 December 1941—Patterson Field, OH.

Status: Inactivated on 18 December 1945 as the 1st Troop Carrier Squadron at Fort Lawton, WA.

Commanders, 1st Transport Squadron

Capt. Francis M. Zeigler	15 Jul 35-3 Dec 35	Capt. Russell H. Cooper	20 Jul 36-23 Feb 37
Capt. Clarence S. Thorpe	3 Dec 35-29 Jan 36	Capt. Signa A. Gilky	23 Feb 37-1 Aug 38
Capt. Russell H. Cooper	29 Jan 36-25 Feb 36	1st Lt. Robert W. Stewart	22 Jun 36-20 Jul 36
Capt. John W. Sessums, Jr.	25 Feb 36-22 Jun 36	Capt. Murray C. Woodbury	6 Jun 40-ao Jan 41
Capt. Raymond E. Culbertson	1 Aug 38-6 Jun 40	Capt. L.I. Sailor	ao Nov 41-ao Jan 42

2nd Bombardment Squadron (22nd Bombardment Group)

HQ-*Not organized* 1938-40; Bolling Field, DC, 1940; Langley Field, VA, 1940-41

Constituted in the Regular Army on 1 January 1938, assigned to the 22nd Bombardment Group, and allotted to the Third Corps Area. Activated on 1 February 1940 at Bolling Field, DC. Transferred on 14 November 1940 to Langley Field, VA. Location 7 December 1941—Langley Field, VA.

Status: Inactivated sometime after 1952 as the 2nd Bombardment Squadron (Heavy).

Commanders, 2nd Bombardment Squadron

Capt. Leslie P. Halcomb	1 Feb 40-ao Dec 41
-------------------------	--------------------

2nd Observation Squadron (4th Composite Group)

HQ-Rockwell Field, CA, 1919-20; Fort Mills, PI, 1920; Kindley Field, PI, 1920-29; Nichols Field, PI, 1929-41; Clark Field, PI, 1940-41; Nichols Field, PI, 1941

Organized in the Regular Army on 3 June 1919 at Rockwell Field, CA, as the 2nd Aero Squadron. Transferred on 24 December 1919 to Fort Mills, Corregidor, PI, and assigned to the Philippine Department. Assigned on 15 March 1920 to the 1st Observation Group (subsequently redesignated as the 4th Observation Group, and later the 4th Composite Group). Transferred on 15 October 1920 to Kindley Field, PI. Redesignated as the 2nd Squadron (Observation) on 14 March 1921. Consolidated on 8 April 1924 with the 2nd Aero Squadron (organized 1 December 1915 in the Regular Army as the 1st Company, 2nd Aero Squadron; redesignated as the 2nd Aero Squadron 20 July 1917; redesignated as Squadron A, Kelly Field, TX, on 23 July 1918; demobilized on 18 November 1918 at Kelly Field). Transferred in January 1929 to Nichols Field, PI. Transferred on 18 November 1940 to Clark Field, PI. Transferred in November 1941 to Nichols Field, PI. Location 7 December 1941—Nichols Field, PI.

Status: Active in the U. S. Air Force as the 2nd Air Refueling Squadron at McGuire A.F.B., NJ.

Events: 35, 41, 44, 51, 68, 139, 224, 245, 270

Commanders, 2nd Observation Squadron

Capt. R. Gilpin Ervin	ao Dec 20-15 Dec 21	Capt. Benjamin F. Giles	1 Sep 29-1 Aug 30
Capt. Junius H. Houghton	15 Dec 21-7 Mar 22	Capt. Arthur E. Easterbrook	1 Aug 30-19 Dec 31
Maj. Thomas J. Hanley, Jr.	7 Mar 22-22 Sep 22	Capt. Edgar P. Sorenson	19 Dec 31-14 Feb 34
Capt. Idwal H. Edwards	22 Sep 22-6 Oct 22	Capt. Harold R. Rivers	15 Feb 34-1 Mar 34
Maj. Benjamin G. Weir	6 Oct 22-24 Mar 23	Maj. Martinus Stenseth	1 Mar 34-6 Feb 36
Capt. Idwal H. Edwards	24 Mar 23-26 Jun 23	Capt. James F. Phillips	6 Feb 36-8 May 37
Capt. Vernon L. Burge	26 Jun 23-Apr 25	1st Lt. John W. Kirby	8 Aug 27-1 Jun 37
Capt. Morris Berman	Apr 25-16 Dec 25	Capt. Mark K. Lewis, Jr.	1 Jun 37-1 Oct 37
Maj. Leo A. Walton	16 Dec 25-26 Feb 26	1st Lt. Alfred R. Maxwell	1 Oct 37-21 Feb 38
Capt. Louis R. Knight	26 Feb 26-7 Mar 27	Capt. John P. Kirkendall	21 Feb 38-11 May 38
Capt. Elmer E. Adler	7 Mar 27-20 Jan 28	Maj. Lloyd C. Blackburn	11 May 38-ao Sep 39
1st Lt. Vincent J. Meloy	20 Jan 28-10 Apr 29	Unknown	ao Sep 39-ao Nov 40
Capt. Donald Wilson	10 Apr 29-1 Sep 29	1st Lt. John A. Goodpasture	ao Nov 40-ao Jan 41
	Capt. James Y. Parker	ao Sep 41-ao Jan 42	

2nd Service Squadron (2nd Transport Group)

HQ—Not organized 1933-37; Cleveland, OH, 1937-38

Constituted in the Regular Army on 1 October 1933, assigned to the 2nd Transport Group and allotted to the Fourth Corps Area. Withdrawn from the Fourth Corps Area on 5 June 1936 and allotted to the Fifth Corps Area. Organized by August 1937 with Organized Reserve personnel as a RAI unit at Cleveland, OH. Disbanded on 1 January 1938.

Commanders, 2nd Service Squadron

Unknown ao Aug 37-1 Jan 38

2nd Staff Squadron

HQ—Bolling Field, DC, 1936-41

Constituted in the Regular Army on 1 September 1936, assigned to the General Headquarters Air Force, and allotted to the Third Corps Area. Concurrently organized at Bolling Field, DC. The squadron was responsible for flying and maintaining various types of aircraft for the flight-rated officers of Headquarters, General Headquarters Air Force in Washington DC, to maintain their flying ability. It also provided planes and crews for the Secretary of War and General Staff officers of the War Department for transportation in performance of their duties. Location 7 December 1941—Bolling Field, DC.

Status: Disbanded on 31 May 1944.

Commanders, 2nd Staff Squadron

Capt. Herbert K. Baisley	1 Sep 36-13 Sep 36	1st Lt. Ralph Rhudy	24 Aug 38-2 May 39
Maj. Donald G. Fitz Gerald	13 Sep 36-29 Dec 36	Capt. Reginald F. C. Vance	2 May 39-ao Apr 40
Capt. Arthur L. Bump	21 Dec 36-24 Aug 38	Unknown	ao Apr 40-7 Dec 41

2nd Transport Squadron (1st Transport Group)

HQ-*Not organized* 1933-34; Columbus, OH, 1934-35; Olmsted Field, PA, 1935-41

Constituted in the Regular Army on 1 October 1933, assigned to the 1st Transport Group, and allotted to the Fifth Corps Area. Organized by March 1934 with Organized Reserve personnel as a RAI unit at Columbus, OH. Authorized to be partially organized as the 2nd Provisional Transport Squadron on 1 March 1935 and assigned to the Middletown Air Depot. Redesignated as the 2nd Transport Squadron on 25 June 1935. Fully activated on 15 July 1935 at Olmsted Field, PA. Assigned on 20 May 1937 to the 10th Transport Group. Location 7 December 1941—Olmsted Field, PA.

Status: Active in the U. S. Air Force as the 2nd Airlift Squadron at Pope A.F.B., NC.

Commanders, 2nd Transport Squadron

Capt. Charles H. Deerwester	15 Jun 37-4 Jul 37	Maj. Charles B. DeShields	18 Oct 37-1 Feb 39
Maj. George G. Lundberg	26 Jul 37-18 Oct 37	Maj. John R. Drumm	1 Feb 39-1 Feb 40
	Unknown	1 Feb 40-7 Dec 41	

3rd Bombardment Squadron

HQ-*Not organized* 1938-40; France Field, CZ, 1940-41

Constituted in the Regular Army on 1 January 1938, assigned to the 6th Composite Group and allotted to the Panama Canal Department. Redesignated as the 3rd Bombardment Squadron (Medium) on 22 December 1939. Activated on 1 February 1940 at France Field, CZ. Redesignated as the 3rd Bombardment Squadron (Heavy) on 20 November 1940. Location 7 December 1941—France Field, CZ.

Status: Inactivated on 1 January 1953 as the 129th Strategic Reconnaissance Squadron at Travis, A.F.B., CA.

Events: 292

Commanders, 3rd Bombardment Squadron

Maj. Elmer T. Rundquist	1 Feb 40-ao Jun 40	Unknown	ao Jun 40-7 Dec 41
-------------------------	--------------------	---------	--------------------

3rd Observation Squadron (Third Corps Area)

HQ-Fort Bliss, TX, 1919-21; Kelly Field, TX, 1921-22; Biggs Field, TX, 1922-26; Dodd Field, TX, 1926-31; Brooks Field, TX, 1931-37; Langley Field, VA, 1937-41

Authorized in the Regular Army on 15 August 1919 as the 1st Photo Section. Organized on 27 September 1919 at Fort Bliss, TX. Transferred on 2 July 1921 to Kelly Field, TX. Transferred on 24 June 1922 to Biggs Field, TX. Consolidated on 23 March 1924 with the 1st Photo Section (a World War I unit organized 4 April 1918 in the Regular Army at Ourches, France; demobilized 3 July 1919 at Garden City, NJ; reconstituted 23 March 1924). Transferred on 22 June 1926 to Dodd Field, TX. Transferred on 3 October 1931 to Brooks Field, TX. Reorganized and redesignated as the 3rd Observation Squadron on 1 June 1937 at Brooks Field, TX, and assigned to the Eighth Corps Area. Transferred on 14 June 1937 to Langley Field, VA, assigned to the Third Corps Area, and attached to the Coast Artillery School. Assigned on 17 July 1937 to the 43rd Observation Group (III Corps). Relieved from the 43rd Observation Group (III Corps) on 2 October 1940. Location 7 December 1941—Langley Field, VA.

Status: Active in the U. S. Air Force as the 3rd Special Operations Squadron at Nellis AFB, NV.

Events: 281, 293, 296, 301

Commanders, 3rd Observation Squadron

2nd Lt. George R. Smith	1 Jun 37-18 Jun 37	Maj. Percival E. Gabel	9 Feb 41-11 Aug 41
Maj. Glenn C. Salisbury	18 Jun 37-8 Feb 41	Unknown	11 Aug 41-7 Dec 41

3rd Pursuit Squadron (4th Composite Group)

HQ-Mitchel Field, NY, 1919; Manila, PI, 1919; Camp Stotsenburg, PI, 1919-20; Clark Field, PI, 1920-38; Fort Stotsenburg, PI, 1938-40; Nichols Field, PI, 1940-41; Iba Airfield, PI, 1941

Organized in the Regular Army on 13 May 1919 at Mitchel Field, NY, as the 3rd Aero Squadron. Transferred on 5 July 1919 to Manila, PI. Arrived at Manila 18 August 1919 and assigned to the Philippine Department. Transferred on 5 December 1919 to Camp Stotsenburg, PI. Assigned on 10 March 1920 to the 1st Observation Group (subsequently redesignated as the 4th Observation Group, and later the 4th Composite Group). Transferred on 15 October 1920 to Clark Field, PI. Redesignated as the 3rd Squadron (Pursuit) on 14 March 1921. Redesignated as the 3rd Pursuit Squadron on 25 January 1923. Consolidated on 8 April 1924 with the 3rd Aero Squadron (organized 1 November 1916 in the Regular Army and demobilized on 2 January 1919 at Post Field, OK; reconstituted on 8 April 1924). Transferred on 16 June 1938 to Nichols Field, PI. Redesignated as the 3rd Pursuit Squadron (Interceptor) on 6 December 1939. Relieved from assignment to the 4th Composite Group on 1 October 1941 and assigned to the 24th Pursuit Group. Transferred on 1 September 1941 to Iba Airfield, PI. Location 7 December 1941—Iba Airfield, PI.

Status: Active in the U. S. Air Force as the 3rd Flying Training Squadron at Moody A.F.B., GA.

Events: 35, 41, 44, 51, 68, 139, 224, 245, 270, 333

Commanders, 3rd Pursuit Squadron

Capt. Charles T. Phillips	ao Mar 21-Aug 21	Capt. Leland R. Hewitt	16 May 32-17 Oct 32
1st Lt. Raphael Baez	Aug 21-22 Oct 21	Maj. Gerald E. Brower	17 Oct 32-18 Aug 35
Maj. Adlai H. Gilkeson	22 Oct 21-19 Oct 23	Maj. Christopher W. Ford	18 Aug 35-3 Mar 37
Maj. John C. McDonnell	19 Oct 23-10 Jul 25	Maj. Lloyd Barnett	3 Mar 37-16 Jun 38
Capt. Earl H. DeFord	10 Jul 25-6 May 26	Capt. Norris B. Harbold	16 Jun 38-1 Jun 39
1st Lt. Frederick von H. Kimbel	6 May 26-22 Sep 26	Capt. Alden R. Crawford	1 Jun 39-ao Sep 39
Maj. Leo A. Walton	23 Sep 26-17 May 28	Unknown	ao Sep 39-ao Apr 41
Capt. Lawrence P. Hickey	18 May 28-1 Jul 28	Maj. Robert Patterson	ao Apr 41-9 May 41
Maj. Ralph P. Cousins	1 Jul 28-27 Jun 30	Maj. William H. Maverick	9 May 41-27 Aug 41
Maj. John B. Brooks	27 Jun 30-15 May 31	Capt. Benjamin Putnam	27 Aug 41-29 Aug 41
Capt. Aubrey Hornsby	15 May 31-16 May 32	Capt. William K. Horrigan	29 Aug 41-31 Oct 41
	1st Lt. Henry G. Thorne		31 Oct 41-ao Jan 42

3rd Staff Squadron

HQ-Sherman Field, KS, 1936-41

Constituted in the Regular Army on 1 September 1936, assigned to the General Headquarters Air Force, and allotted to the Seventh Corps Area. Concurrently organized at Sherman Field, Fort Leavenworth, KS, with personnel from the Air Corps Detachment, Fort Leavenworth. The squadron was responsible for maintaining the flight facilities and aircraft at Sherman Field. It also provided various types of aircraft for the flight-rated officers and students of the Command and General Staff School at Fort Leavenworth to maintain their flying skills. Location 7 December 1941—Fort Leavenworth, KS.

Status: Disbanded on 1 May 1944.

Commanders, 3rd Staff Squadron

Maj. Joseph A. Wilson	1 Sep 36-Jan 40	Unknown	Jan 40-7 Dec 41
-----------------------	-----------------	---------	-----------------

3rd Transport Squadron (1st Transport Group)

HQ-*Not organized* 1933-34; Indianapolis, IN, 1934-35; Duncan Field, TX, 1935-41

Constituted in the Regular Army on 1 October 1933, assigned to the 1st Transport Group, and allotted to the Fifth Corps Area. Organized by March 1934 with Organized Reserve personnel as a RAI unit at Indianapolis, IN. Authorized to be partially organized as the 3rd Provisional Transport Squadron on 1 March 1935 and assigned to the San Antonio Air Depot. Redesignated as the 3rd Transport Squadron on 25 June 1935. Fully activated on 15 July 1935, less Reserve personnel, at Duncan Field, TX. Assigned on 20 May 1937 to the 10th Transport Group. Location 7 December 1941—Duncan Field, TX.

Organization Day: 15 July. Chosen to commemorate the date of the squadron's original date of organization 15 July 1935.

Status: Inactivated on 8 December 1960 as the 3rd Troop Carrier Squadron (Heavy) at Donladson A.F.B., SC.

Commanders, 3rd Transport Squadron

Maj. John P. Richter	5 Jul 35-12 Jun 36	Lt. Col. Lester T. Miller	1 Nov 37-10 Mar 38
Maj. Elmer D. Perrin	12 Jun 36-24 Jun 37	1st Lt. Max H. Warren	10 Mar 38-23 Nov 38
1st Lt. Max H. Warren	24 Jun 37-1 Nov 37	Maj. Malcolm S. Lawton	23 Nov 38-Dec 40
	Captain Samuel V. Payne	Dec 40-ao Dec 41	

4th Observation Squadron (1919-38) (Hawaiian Division)

4th Reconnaissance Squadron (1938-41)

HQ-Hazelhurst Field, NY, 1920; Mitchel Field, NY, 1919-20; Luke Field, TH, 1920-22; Wheeler Field, TH, 1922-27; Luke Field, TH, 1927-39; Hickam Field, TH, 1939-41

Constituted in the Regular Army on 23 June 1919 as the 4th Aero Squadron, assigned to the Eastern Department, and organized at Hazelhurst Field, NY. Transferred in November 1919 to Mitchel Field, NY. Assigned on 15 December 1919 to the 2nd Observation Group (later redesignated 5th Observation Group). Transferred to Luke Field, TH, arriving there 24 January 1920. Redesignated as the 4th Squadron (Observation) on 14 March 1921. Relieved from the 5th Observation Group on 31 January 1922 and assigned to the Hawaiian Department. Assigned on 6 February 1922 to the Hawaiian Division. Concurrently transferred to Schofield Barracks, TH, (Wheeler Field). Redesignated as the 4th Observation Squadron on 25 January 1923. Consolidated on 8 April 1924 with the 4th Aero Squadron (a WWI unit organized as the 4th Aero Squadron at Post Field, OK, in May 1917; redesignated as Squadron B, Post Field in July 1918; demobilized on 2 January 1919 at Post Field, OK; reconstituted on 8 April 1924). Relieved from assignment to the Hawaiian Division on 11 January 1927, assigned to the 5th Composite Group, and transferred to Luke Field. Reorganized and redesignated 4th Reconnaissance Squadron (Medium Range) on 25 January 1938. Relieved from assignment to the 5th Composite Group on 12 October 1938 and concurrently attached. Transferred on 1 January 1939 to Hickam Field, TH. Redesignated as the 4th Reconnaissance Squadron (Medium Range) on 6 December 1939. Assigned on 1 June 1940 to the 5th Bombardment Group. Redesignated as the 4th Reconnaissance Squadron (Heavy) on 20 November 1940. Location 7 December 1941—Hickam Field, TH.

Status: Active in the U. S. Air Force as the 394th Combat Training Squadron at Whiteman A.F.B., MO.

Events: 33, 37, 75, 88, 120, 138, 141, 158, 160, 189, 211, 224, 225, 248, 276, 297, 312

Commanders, 4th Observation Squadron

4th Reconnaissance Squadron

Capt. Harry H. Young	ao Dec 20-27 Jul 22	1st Lt. Thomas L. Gilbert	13 Mar 31-9 Jun 31
Maj. Karl H. Gorman	27 Jul 22-5 Apr 23	1st Lt. Donald D. Fitzgerald	9 Jun 31-4 Apr 33
Capt. Alfred F. King, Jr.	5 Apr 23-ao May 23	1st Lt. Otto P. Weyland	4 Apr 33-10 Aug 34
Capt. Chilion F. Wheeler	ao Nov 25-17 Mar 26	1st Lt. Courtland M. Brown	10 Aug 34-23 Oct 34
1st Lt. George W. McEntire	17 Mar 26-1 May 26	Maj. Frank H. Pritchard	23 Oct 34-20 Oct 35
Capt. John W. Signer	1 May 26-1 Aug 27	Capt. Jack W. Wood	20 Oct 35-30 Oct 35
Capt. Lester T. Miller	1 Aug 27-8 Mar 28	1st Lt. Fay R. Upthegrove	30 Oct 35-7 Nov 35
1st Lt. Langhorne W. Motley	8 Mar 28-27 Jul 28	Maj. Signa A. Gilkey	7 Nov 35-14 Aug 36
Capt. Calvin E. Giffen	27 Jul 28-1 Nov 28	1st Lt. Fay R. Upthegrove	14 Aug 36-28 Jun 37
Capt. Raymond E. O'Neill	1 Nov 28-1 Jul 30	Capt. Dale D. Fisher	28 Jun 37-13 Mar 39
Capt. George P. Johnson	1 Jul 30-1 Oct 30	Capt. William E. Karnes	13 Mar 39-ao Sep 39
Capt. Ulysses G. Jones	1 Oct 30-13 Mar 31	Unknown	ao Sep 39-ao Nov 41
	Maj. Louie P. Turner	ao Nov 41-ao Feb 42	

4th Transport Squadron (1st Transport Group)

HQ-*Not organized* 1933-35; Rockwell Field, CA, 1935-38; Sacramento Air Depot, CA, 1938-41

Constituted in the Regular Army on 1 October 1933, assigned to the 1st Transport Group, and allotted to the Fifth Corps Area. Organized by March 1934 with Organized Reserve personnel as a RAI unit at Bowman Field, KY. Authorized to be partially organized as the 4th Provisional Transport Squadron on 1 March 1935 and assigned to the San Antonio Air Depot. Redesignated as the 4th Transport Squadron 25 June 1935. Fully activated, less Reserve personnel, 15 July 1935 at Rockwell Field, CA. Assigned on 20 May 1937 to the 10th Transport Group. Transferred on 1 December 1938 to Sacramento, CA. Relieved from the 10th Transport Group on 10 May 1941. Location 7 December 1941—Sacramento, CA.

Status: Active in the U. S. Air Force as the 4th Airlift Squadron at McChord A.F.B., WA.

Commanders, 4th Transport Squadron

Maj. Harold H. Carr	15 Jul 35-22 Jun 36	Maj. Lionel H. Dunlap	25 Jun 37-20 Mar 40
Capt. Charles G. Brenneman	22 Jun 36-25 Jun 37	Unknown	20 Mar 40-7 Dec 41

5th Observation Squadron (1919-36) (9th Observation Group)

5th Bombardment Squadron (1936-41) (9th Bombardment Group)

HQ—Hazelhurst Field, NY, 1919-20; Mitchel Field, NY, 1920-40; Rio Hato Airfield, Panama, 1940-41; Beane Field, St. Lucia 1941

Authorized in the Regular Army on 15 August 1919 as the 5th Aero Squadron. Organized on 24 October 1919 at Hazelhurst Field, NY, and assigned to the 3rd Observation Group. Transferred in November 1919 to Mitchel Field, NY. Attached on 20 August 1920 to the Second Corps Area. Reorganized and redesignated as the 5th Squadron (Observation) on 14 March 1921. Attached to the 1st Provisional Air Brigade 6 May-3 October 1921. Designated 3 October 1921 as an element of the 1st Division Air Service. Relieved from assignment to the 3rd Observation Group on 1 August 1922 and assigned to the 9th Observation Group. Relieved from assignment to the 9th Observation Group on 24 March 1923 and assigned to the 1st Division. Consolidated in April 1924 with the 5th Aero Squadron (organized on 5 May 1917 in the Regular Army as the 5th Aero Squadron; redesignated as the Squadron A, Souther Field on 15 July 1918; demobilized on 11 November 1918 at Souther Field, GA; reconstituted in April 1924). Participated in flood relief duty in the vicinity of Waterbury, Winooski, and Montpelier, VT, 5-21 November 1927. Participated in the operations of the Mechanized Force at Camp George G. Meade, MD, in 1928 and 1931. Relieved from assignment to the 1st Division on 15 February 1929 and assigned to the 9th Observation Group. Reorganized and redesignated 5th Bombardment Squadron on 1 March 1935 and assigned to the 9th Bombardment Group. Redesignated as the 5th Bombardment Squadron (Medium) on 6 December 1939. Ground elements departed from the port of New York 5 November 1940 on the U.S.A.T. *Chateau Thierry* and arrived 12 November 1940 at Rio Hato Airfield in Panama. Aircraft and crews departed Mitchel Field on 17 November 1940 for Rio Hato and arrived several days later. Redesignated as the 5th Bombardment Squadron (Heavy) on 20 November 1940. Transferred on 28 September 1941 to Beane Field, St. Lucia. Location 7 December 1941—Beane Field, St. Lucia.

Organization Day: 5 May. Chosen to commemorate the date of the squadron's original date of organization 5 May 1917.

Status: Active in the U. S. Air Force as the 5th Reconnaissance Squadron at Osan A.B., South Korea.

Events: 49, 63, 85, 87, 103, 107, 128, 149, 164, 187, 249

Commanders, 5th Observation Squadron

5th Bombardment Squadron

Maj. Henry Abbey, Jr.	ao Dec 20-23 Jan 22	Capt. Ernest E. Harmon	3 Oct 30-9 Sep 32
Capt. Ira C. Eaker	23 Jan 22-19 Sep 23	Capt. John G. Colgen	9 Sep 32-23 Dec 33
1st Lt. Samuel M. Connell	19 Sep 23-1 Oct 24	Capt. Willis R. Taylor	23 Dec 33-18 Feb 34
Capt. Harold M. McClelland	1 Oct 24-5 Sep 25	Capt. Leo F. Post	18 Feb 34-1 Jul 34
1st Lt. Samuel M. Connell	5 Sep 25-21 Jul 26	Capt. Willis R. Taylor	1 Jul 34-15 Sep 34
1st Lt. Marion L. Elliott	21 Jul 26-7 Jan 27	Capt. Edward W. Raley	15 Sep 34-18 Jul 36
1st Lt. Charles P. Prime	7 Jan 27-22 Mar 28	Maj. Francis B. Valentine	18 Jul 36-31 Aug 38
Capt. Walcott P. Hayes	22 Mar 28-28 Jun 28	Lt. Col. Ross F. Cole	31 Aug 38-May 40
1st Lt. Byron E. Gates	28 Jun 28-23 Aug 29	Maj. Francis B. Valentine	May 40-Aug 40
Capt. Edwin J. House	23 Aug 29-3 Oct 30	Capt. Charles F. Born	Aug 40-Aug 41

5th Transport Squadron (1st Transport Group)

HQ-Not organized 1933-34; Moundsville, WV 1934-39; Patterson Field, OH, 1939-41

Constituted in the Regular Army on 1 October 1933, assigned to the 1st Transport Group, and allotted to the Fifth Corps Area. Organized by March 1934 with Organized Reserve personnel as a RAI unit at Moundsville, WV. Activated on 14 October 1939, less Reserve personnel, at Patterson Field, OH, and assigned to the 10th Transport Group. Location 7 December 1941—Patterson Field, OH.

Status: Inactivated on 27 June 1949 as the 5th Troop Carrier Squadron at Selfridge A.F.B., MI.

Commanders, 5th Transport Squadron

Unknown	ao Mar 34-ao Mar 41	Capt. Theodore Q. Graff	ao Mar 41-ao Dec 41
---------	---------------------	-------------------------	---------------------

6th Attack Squadron (32nd Attack Group)

HQ-Not organized 1933-38

Constituted in the Regular Army on 1 October 1933, assigned to the 32nd Attack Group, and allotted to the Fourth Corps Area. Disbanded on 1 January 1938.

6th Bombardment Squadron (29th Bombardment Group)

HQ-Not organized 1939-40; Langley Field, VA, 1940; MacDill Field, FL, 1940-41

Constituted in the Regular Army on 22 December 1939 and assigned to the 29th Bombardment Group. Activated on 1 February 1940 at Langley Field, VA. Transferred on 21 May 1940 to MacDill Field, FL. Location 7 December 1941—MacDill Field, FL.

Status: Active in the U. S. Air Force as the 6th Air Refueling Squadron at Travis A.F.B., CA.

Events: 302

Commanders, 6th Bombardment Squadron

Maj. Hugo P. Rush	1 Feb 40-15 May 41	Maj. Edwin L. Tucker	15 May 41-ao Aug 41
	Unknown	ao Aug 41-7 Dec 41	

6th Pursuit Squadron (5th Composite Group)

HQ-Luke Field, TH, 1919-27; Wheeler Field, TH, 1927-41

Stationed at Luke Field, TH, as of June 1919 as the 6th Aero Squadron. Assigned on 15 September 1919 to the 2nd Observation Group (subsequently redesignated as the 5th Observation Group, and later the 5th Composite Group). Redesignated as the 6th Squadron (Pursuit) on 14 March 1921. Redesignated as the 6th Pursuit Squadron on 25 January 1923. Transferred on 11 January 1927 to Wheeler Field, TH. Concurrently relieved from assignment to the 5th Composite Group and assigned to the 18th Pursuit Group. Location 7 December 1941—Wheeler Field, TH.

Status: Inactivated on 20 February 1947 as the 6th Night Fighter Squadron at Yokota, Japan.

Events: 33, 75, 88, 120, 138, 141, 158, 189, 211, 224, 225, 248, 276, 297, 312

Commanders, 6th Pursuit Squadron

1st Lt. Walter Miller	ao Dec 20-7 Jun 21	1st Lt. Stewart W. Towle	1 May 31-1 Oct 31
1st Lt. J. Thaddeus Johnson	7 Jun 21-7 Aug 22	1st Lt. Edward H. White	1 Oct 31-1 Mar 32
Capt. Horace W. Mooney	7 Aug 22-14 Nov 22	1st Lt. Ralph E. Fisher	1 Mar 32-12 Jan 35
Capt. Edwin J. House	14 Nov 22-1 Dec 23	1st Lt. Ray H. Clark	12 Jan 35-12 Mar 35
Unknown	2 Dec 23-14 Jul 24	Maj. Early E. W. Duncan	12 Mar 35-3 Sep 35
Capt. Hugh M. Elmendorf	15 Jul 24-22 Jun 26	Maj. John C. Crosthwaite	3 Sep 35-18 Aug 36
1st Lt. Russell L. Meredith	22 Jun 26-1 Aug 26	1st Lt. Bryant L. Boatner	18 Aug 36-16 Nov 36
Capt. Clyde V. Finter	1 Aug 26-8 Mar 28	1st Lt. Homer L. Sanders	16 Nov 36-20 Nov 37
1st Lt. Bernard T. Castor	8 Mar 28-2 Oct 28	1st Lt. Paul D. Bunker, Jr.	20 Nov 37-7 Jan 38
Capt. Lotha A. Smith	2 Oct 28-19 Feb 29	1st Lt. Harry E. Wilson	7 Jan 38-7 Apr 38
1st Lt. Bernard T. Castor	19 Feb 29-1 Jul 29	Capt. Robert W. Douglass, Jr.	7 Apr 38-20 Jul 39
Capt. Frank H. Pritchard	1 Jul 29-6 Nov 29	Capt. Samuel E. Anderson	20 Jul 39-Oct 40
1st Lt. Hoyt S. Vandenburg	6 Nov 29-1 May 31	1st Lt. James R. Watt	Oct 40-ao Dec 41

6th Transport Squadron (2nd Transport Group)

HQ-*Not organized* 1933-34; Shreveport, LA, 1934-36; *Inactive* 1936-37; Columbus, OH, 1937-39; Olmsted Field, PA, 1939-41

Constituted in the Regular Army on 1 October 1933, assigned to the 2nd Transport Group, and allotted to the Fourth Corps Area. Organized by July 1934 with Organized Reserve personnel as a RAI unit at Shreveport, LA. Withdrawn from the Fourth Corps Area on 5 June 1936 and allotted to the Fifth Corps Area. Organized by August 1937 with Organized Reserve personnel as a RAI unit at Columbus, OH. Activated on 14 October 1939, less Reserve personnel, at Olmsted Field, PA, and assigned to the 10th Transport Group. Relieved from the 10th Transport Group on 1 December 1940 and assigned to the 60th Transport Group. Relieved from the 60th Transport Group on 19 May 1941 and assigned to the 61st Transport Group. Location 7 December 1941—Olmsted Field, PA.

Status: Active in the U. S. Air Force as the 6th Airlift Squadron at McGuire A.F.B., NJ.

Commanders, 6th Transport Squadron

Unknown	ao Jul 34-5 Jun 36	Maj. George J. Cressey	4 Nov 39-28 Mar 40
<i>Inactive</i>	5 Jun 36-14 Oct 39	Capt. John J. Keough	28 Mar 40-10 Jun 40
Maj. John R. Dunn	16 Oct 39-4 Nov 39	Capt. Hamish McClelland	10 Jun 40-17 Feb 42

7th Attack Squadron (32nd Attack Group)

HQ-*Not organized* 1933-38

Constituted in the Regular Army on 1 October 1933, assigned to the 32nd Attack Group, and allotted to the Fourth Corps Area. Disbanded on 1 January 1938.

7th Observation Squadron (1919-39) (6th Composite Group)

7th Reconnaissance Squadron (1939-41)

HQ-France Field, CZ, 1919-40; Howard Field, CZ, 1940-41

Stationed at France Field, CZ, as of June 1919 as the 7th Aero Squadron. Assigned on 30 September 1919 to the 3rd Observation Group (subsequently redesignated as the 6th Observation Group, and later the 6th Composite Group). Participated in the "Goodwill Flights" to El Salvador and Nicaragua 13-19 March 1935, to Columbia 14-18 December 1936, to Guatemala 8-11 February 1938 and El Salvador 19-22 April 1938. Flew mercy missions to support earthquake relief efforts in and near Santiago, Chile, 28 January-13 February 1939. Reorganized and redesignated 7th Reconnaissance Squadron (Medium Range) on 6 December 1939. Redesignated as the 7th Reconnaissance Squadron (Heavy) on 20 November 1940. Transferred on 26 November 1941 to Howard Field, CZ. Location 7 December 1941—Howard Field, CZ.

Status: Inactive in the U. S. Air Force as the 397th Bombardment Squadron.

Events: 26, 31, 36, 40, 43, 58, 69, 81, 101, 102, 119, 140, 167, 170, 181, 223, 271, 292, 308, 333

Commanders, 7th Observation Squadron

7th Reconnaissance Squadron

Capt. Alfred O. George	ao Dec 20-18 Oct 21	Capt. Robert D. Knapp	23 Dec 31-23 Oct 33
1st Lt. Arthur L. Foster	18 Oct 21-19 Jul 22	Capt. Alvin C. Kincaid	23 Oct 33-22 May 34
Capt. Orlo H. Quinn	19 Jul 22-17 Dec 23	1st Lt. Clifford P. Bradley	22 May 34-8 Sep 34
Capt. Charles E. Rust	17 Dec 23-29 Nov 25	Capt. Homer B. Chandler	8 Sep 34-8 Aug 36
1st Lt. Roderick N. Ott	29 Nov 25-10 Sep 26	Maj. Willis R. Taylor	8 Aug 36-15 Apr 37
1st Lt. Samuel C. Skemp	10 Sep 26-4 May 27	Capt. Thurston H. Baxter	15 Apr 37-ao Jun 39
Capt. Armin F. Harold	4 May 27-15 Sep 27	Capt. Guy F. Hix	ao Dec 39-11 Jun 40
Capt. Samuel C. Skemp	15 Sep 27-14 May 30	Capt. Henry K. Mooney	11 Jun 40-Sep 41
Capt. Harold H. George	14 May 30-23 Dec 31	Unknown	Sep 41-7 Dec 41

7th Transport Squadron (2nd Transport Group)

HQ-*Not organized* 1933-39; Sacramento, CA, 1939-41

Constituted in the Regular Army on 1 October 1933, assigned to the 2nd Transport Group, and allotted to the Fourth Corps Area. Activated on 14 October 1939 at Sacramento, CA, and assigned to the 10th Transport Group. Relieved from the 10th Transport Group on 11 December 1940 and assigned to the 62nd Transport Group. Location 7 December 1941—Sacramento, CA.

Status: Active in the U. S. Air Force as the 7th Airlift Squadron at McChord A.F.B., WA.

Commanders, 7th Transport Squadron

Unknown 14 Oct 39-7 Dec 41

8th Attack Squadron (1921-39) (3rd Attack Group)

8th Bombardment Squadron (1939-41) (3rd Bombardment Group)

HQ-Kelly Field, TX, 1919; McAllen, TX, 1919-20; Pope Field, NC, 1920-21; Kelly Field, TX, 1921-27; Fort Crockett, TX, 1927-35; Barksdale Field, LA, 1935-40; Savannah, GA, 1940-41

Stationed at Kelly Field, TX, as of June 1919 as the 8th Surveillance Squadron. Assigned on 1 July 1919 to the Army Surveillance Group (subsequently redesignated as the 1st Surveillance Group, and later the 3rd Attack Group). Transferred on 13 August 1919, less Flight B, to the U. S. Army Airdrome, McAllen, TX. Participated in the Mexican Border Patrol operations August 1919-June 1921 and flood relief operations in the Rio Grande Valley in June 1922. Flight B transferred 13 August 1920 to Pope Field, NC. Redesignated as the 8th Squadron (Attack) on 14 March 1921. Entire squadron transferred 2 July 1921 to Kelly Field, TX. Redesignated as the 8th Attack Squadron 25 March 1923. Transferred on 30 June 1926 to Fort Crockett, TX. Transferred on 27 February 1935 to Barksdale Field, LA. Reorganized and redesignated 8th Bombardment Squadron on 1 December 1939 and assigned to the 3rd Bombardment Group. Transferred on 8 October 1940 to Savannah, GA. Location 7 December 1941—Savannah, GA.

Status: Active in the U. S. Air Force as the 8th Special Operations Squadron at Hurlburt Field, FL.

Events: 39, 46, 55, 85, 104, 105, 125, 164, 165, 194, 197, 200, 213, 214, 217, 227, 243, 249, 252

Commanders, 8th Attack Squadron

8th Bombardment Squadron

1st Lt. Charles A. Pursley	ao Dec 20-28 Mar 21	Capt. James T. Curry	2 Dec 26-31 Aug 29
1st Lt. Harrison G. Crocker	28 Mar 21-15 May 21	1st Lt. Samuel J. Simonton	31 Aug 29-6 Sep 29
1st Lt. Vincent J. Meloy	15 May 21-24 Mar 22	1st Lt. John L. Davidson	6 Sep 29-20 Jan 30
Capt. Charles B. B. Bubb	24 Mar 22-1 Jun 22	Capt. Lotha A. Smith	20 Jan 30-5 Jul 33
1st Lt. Lotha A. Smith	1 Jun 22-1 Jul 22	1st Lt. John D. Corkville	7 Jul 33-14 Feb 34
1st Lt. Peter E. Skause	1 Jul 22-10 Jun 23	1st Lt. George McCoy, Jr.	14 Feb 34-14 Apr 34
1st Lt. Edward V. Harbeck	10 Jun 23-1 Aug 23	Capt. Lloyd L. Harvey	14 Apr 34-18 May 34
Capt. Joseph H. Davidson	1 Aug 23-1 Oct 23	Capt. John D. Corkville	18 May 34-2 Jul 34
1st Lt. Lotha A. Smith	1 Oct 23-1 Jan 24	Capt. Lloyd L. Harvey	2 Jul 34-11 Feb 35
1st Lt. Harrison G. Crocker	1 Jan 24-1 Jun 24	Capt. John D. Corkville	11 Feb 35-20 Aug 35
1st Lt. James E. Duke	1 Jun 24-1 Aug 24	Maj. Lester J. Maitland	20 Aug 35-16 Jul 38

Capt. Joseph H. Davidson	1 Aug 24-1 Apr 25	Maj. Younger A. Pitts	16 Jul 38-1 Jul 39
Capt. Ross F. Cole	2 Apr 25-28 Feb 26	Capt. Richard H. Lee	1 Jul 39-28 Aug 39
1st Lt. Dwight J. Canfield	6 Mar 26-1 Jul 26	Capt. John F. Guillett	28 Aug 39-31 Jan 40
1st Lt. Ralph F. Stearly	1 Jul 26-1 Oct 26	Maj. Richard H. Lee	31 Jan 40-4 Apr 41
1st Lt. Angier H. Foster	1 Oct 26-2 Dec 26	Capt. Robert D. Gapen	4 Apr 41-1 Jul 41
	1st Lt. Robert F. Strickland	1 Jul 41-24 Jan 42	

8th Transport Squadron (2nd Transport Group)

HQ—*Not organized* 1933-38; Fifth Corps Area on 1938-40; Brooks Field, TX, 1940; Duncan Field, TX, 1940-41; Hill Field, UT, 1941

Constituted in the Regular Army on 1 October 1933, assigned to the 2nd Transport Group, and allotted to the Fifth Corps Area. Organized by June 1938 with Organized Reserve personnel as a RAI unit in the Fifth Corps Area. Activated on 1 February 1940 at Brooks Field, TX, less Reserve personnel, and assigned to the 10th Transport Group. Transferred on 5 November 1940 to Duncan Field, TX. Relieved from the 10th Transport Group on 11 December 1940 and assigned to the 62nd Transport Group. Transferred on 29 June 1941 to Hill Field, UT. Location 7 December 1941—Hill Field, UT.

Status: Active in the U. S. Air Force as the 8th Airlift Squadron at McChord A.F.B., WA.

Commanders, 8th Transport Squadron

Unknown**	ao Jun 38-1 Feb 40	Capt. Ernest S. Holmes, Jr.	1 Feb 40-Jan 42
-----------	--------------------	-----------------------------	-----------------

** RAI commanders: Organized Reserve officers.

9th Observation Squadron (1919-23)

9th Bombardment Squadron (1923-41) (7th Bombardment Group)

HQ—March Field, CA, 1919-22; *Inactive* 1922-29; Kelly Field, TX, 1929-31; March Field, CA, 1931-34; Hamilton Field, CA, 1934-40; Fort Douglas, UT, 1940-41; Salt Lake City, UT, 1941

Stationed at March Field, CA, as of June 1919 as the 9th Corps Observation Squadron and assigned to the Western Department. Assigned on 20 August 1920 to the Ninth Corps Area. Conducted forest fire patrols in California during May-October 1920. Redesignated as the 9th Squadron (Observation) on 14 March 1921. Inactivated on 29 June 1922 at March Field. Redesignated as the 9th Observation Squadron on 25 January 1923. Redesignated as the 9th Bombardment Squadron 24 March 1923 and assigned to the 7th Bombardment Group. Designated Active Associate was the 11th Bombardment Squadron 1923-27. Allotted to the Ninth Corps Area on 28 February 1927. Withdrawn from the Ninth Corps Area on 1 September 1928 and allotted to the Eighth Corps Area. Organized by June 1929 with Organized Reserve personnel as a RAI unit at Kelly Field, TX. Conducted annual summer training at Kelly Field. Activated on 1 April 1931, less Reserve personnel, at March Field, CA. Transferred on 5 December 1934 to Hamilton Field, CA. Redesignated as the 9th Bombardment Squadron (Heavy) on 6 December 1939. Transferred on 7 September 1940 to Fort Douglas, UT. Transferred on 13 January 1941 to Salt Lake City, UT. Ground elements departed from the port of San Francisco on 6 November on an army transport en route to the Philippines. Aircraft and crews began departing Muroc Field, CA, on 6 December en route to Hawaii. Elements of the squadron flew their B-17s into Hickam Field at the height of the Japanese attack on Pearl Harbor. Location 7 December 1941—En route to the Philippines.

Status: Active in the U. S. Air Force as the 9th Bomb Squadron at Dyess A.F.B., TX.

Events: 85, 108, 142, 165, 182, 197, 200, 201, 227, 235, 249, 252, 268, 283, 289, 304

Commanders, 9th Observation Squadron

9th Bombardment Squadron

Capt. Robert L. Walsh	ao Dec 20-12 Aug 21	Capt. Harold D. Smith	29 Jul 32-23 Sep 33
Capt. Albert D. Smith	12 Aug 21-25 Oct 21	Maj. Charles T. Phillips	23 Sep 33-11 May 34
Maj. D. M. Atkinson	25 Oct 21-13 Dec 21	1st Lt. John G. Moore	11 May 34-12 Dec 34
Capt. Frederick I. Eglin	13 Dec 21-9 Mar 22	Capt. John M. Davies	12 Dec 34-14 Oct 36
Capt. William M. Randolph	9 Mar 22-29 Jun 22	Capt. Kenneth N. Walker	14 Oct 36-21 Jan 38
<i>Inactive</i>	29 Jun 22-30 Jun 26	Capt. Wilfred J. Paul	21 Jan 38-1 Mar 38
1st Lt. Kenneth N. Walker**	30 Jun 26-30 Jun 27	Maj. Thad V. Foster	1 Mar 38-Sep 39
Unknown	30 Jun 27-1 Oct 31	Maj. Elmer E. Adler	Sep 39-Feb 41
Capt. Younger A. Pitts	1 Oct 31-29 Jul 32	Maj. Julius T. Flock	Feb 41-23 Jul 41
	Maj. Richard H. Carmichael	23 Jul 41-5 Oct 41	

** RAI commanders: Organized Reserve officers.

9th Transport Squadron

HQ-*Not organized* 1938-40; Patterson Field, OH, 1940-41; Brookley Field, AL, 1941

Constituted in the Regular Army on 1 January 1938. Activated on 1 December 1940 at Patterson Field, OH, and assigned to the 63rd Transport Group. Transferred on 18 September 1941 to Brookley Field, AL. Location 7 December 1941—Brookley Field, AL.

Status: Active in the U. S. Air Force as the 9th Airlift Squadron at Dover A.F.B., DE.

Commanders, 9th Transport Squadron

Unknown 1 Dec 40-7 Dec 41

10th Bombardment Squadron (25th Bombardment Group)

HQ-*Not organized* 1939-40; Langley Field, VA, 1940; Borinquen Field, PR, 1940-41

Constituted in the Regular Army on 22 December 1939 and assigned to the 25th Bombardment Group. Activated on 1 February 1940 at Langley Field, VA. Transferred to Borinquen Field, PR, arriving there 1 November 1940. Location 7 December 1941—Borinquen Field, PR.

Status: Active in the U. S. Air Force as the 10th Missile Squadron at Malmstrom AFB, MT

Events: 329

Commanders, 10th Bombardment Squadron

Maj. Alva L. Harvey 1 Feb 40-1 Jun 41 1st Lt. Maurice M. Miller 1 Jun 41-11 Dec 41

10th Observation Squadron (7th Division)

HQ-*Not organized* 1923-27; Carlstrom Field, FL, 1927-28; *Inactive* 1929-33

Reconstituted in the Regular Army on 24 March 1923 as the 10th Observation Squadron and assigned to the 7th Division. Designated Active Associate was the 22nd Observation Squadron 1923-27. Allotted to the Fourth Corps Area on 28 February 1927. Concurrently organized with Organized Reserve personnel as a RAI unit at Carlstrom Field, FL. Withdrawn from the Fourth Corps Area on 1 September 1928 and allotted to the Eighth Corps Area. Dodd Field, TX, designated as headquarters location on organization, but the unit was never organized at that location. Relieved from assignment to the 7th Division on 15 February 1929 and assigned to the 12th Observation Group. Designated mobilization training station was Dodd Field, TX, 1929-33. Demobilized on 1 October 1933.

Commanders, 10th Observation Squadron

Unknown ** 28 Feb 27-1 Sep 28 *Inactive* 1 Sep 28-1 Oct 33

** RAI commanders: Organized Reserve officers.

10th Transport Squadron

HQ-*Not organized* 1938-40; Olmsted Field, PA, 1940-41; Westover Field, MA, 1941

Constituted in the Regular Army on 1 January 1938, and allotted to the Eighth Corps Area. Activated on 1 December 1940 at Olmsted Field, PA, and assigned to the 60th Transport Group. Transferred on 21 May 1941 to Westover Field, MA. Location 7 December 1941—Westover Field, MA.

Status: Active in the U. S. Air Force as the 10th Airlift Squadron at McChord A.F.B., WA.

Commanders, 10th Transport Squadron

1st Lt. Arthur Anderson	1 Dec 40-ao Jun 41	Unknown	ao Jun 41-7 Dec 41
-------------------------	--------------------	---------	--------------------

11th Bombardment Squadron (2nd Bombardment Group)

HQ-Fort Bliss, TX, 1919; Kelly Field, TX, 1919-22; Langley Field, VA, 1922-27; *Inactive* 1927-28;

Rockwell Field, CA, 1928-31; March Field, CA, 1931-34; Hamilton Field, CA, 1934-40; Fort Douglas, UT, 1940-41; Salt Lake City, UT, 1941

Stationed at Fort Bliss, TX, as of 22 June 1919 as the 11th Aero Squadron and assigned to the Southern Department. Participated in the Mexican Border Patrol August-November 1919. Assigned on 18 September 1919 to the 1st Day Bombardment Group (later redesignated as the 2nd Bombardment Group). Transferred on 8 November 1919 to Kelly Field, TX. Redesignated as the 11th Squadron (Bombardment) on 14 March 1921. Transferred on 30 June 1922 to Langley Field, VA. Redesignated as the 11th Bombardment Squadron on 25 January 1923. Conducted bombing tests on obsolete warships off Chesapeake Bay 5 September 1923. Transferred on 3 June 1927 to March Field, CA, relieved from the 2nd Bombardment Group, and assigned to the Air Corps Training Center. Inactivated on 31 July 1927 at March Field and personnel transferred to the 54th School Squadron. Activated on 1 June 1928 at Rockwell Field, CA, and assigned to the 7th Bombardment Group. Transferred on 29 October 1931 to March Field, CA. Conducted food relief airdrop missions to Indians snowed-in on reservations in Arizona, New Mexico, and Utah 16-21 January 1932 and for marooned miners north of Las Vegas, NM, 13 February 1933. Awarded the Mackey Trophy for 1933. Transferred on 5 December 1934 to Hamilton Field, CA. Transferred on 2 September 1940 to Fort Douglas, UT. Transferred on 18 January 1941 to Salt Lake City, UT. Ground elements departed from Salt Lake City 13 November 1941 and sailed from the port of San Francisco on 21 November on an army transport en route to the Philippines. Aircraft and crews began departing Muroc Field, CA, on 6 December en route to Hawaii. Elements of the squadron flew their B-17s into Hickam Field at the height of the Japanese attack on Pearl Harbor 7 December 1941. Location 7 December 1941—En route to the Philippines.

Organization Day: 26 June. Chosen to commemorate the squadron's initial organization on 26 June 1917.

Status: Active in the U. S. Air Force as the 11th Missile Squadron at Malmstrom A.F.B., MT.

Events: 39, 46, 55, 85, 104, 108, 116, 126, 142, 165, 182, 197, 201, 227, 235, 249, 289

Commanders, 11th Bombardment Squadron

Maj. Leo A. Walton	28 Jun 19-18 Nov 19	1st Lt. Frederick P. Kenney	28 Apr 30-1 May 30
Capt. Victor E. Parks, Jr.	18 Nov 19-4 Feb 21	1st Lt. Charles H. Howard	1 May 30-30 Jul 33
1st Lt. Benton A. Doyle	4 Feb 21-6 Dec 22	Capt. Robert E. Selff	30 Jul 33-2 Oct 34
1st Lt. Aubrey Hornsby	6 Dec 22-29 Oct 23	Maj. Arthur G. Hamilton	2 Oct 34-19 Oct 35
Capt. Early E. W. Duncan	29 Oct 23-27 Sep 25	Maj. Carlyle Ridenour	20 Oct 35-14 Jun 37
1st Lt. Wayne S. Green	27 Sep 25-22 Oct 25	Capt. Edgar T. Noyes	14 Jun 37-7 Jul 37
1st Lt. Kenneth N. Walker	22 Oct 25-15 Apr 27	Maj. Dale V. Gaffney	7 Jul 37-2 Sep 37
1st Lt. Alfred Lindeberg	15 Apr 27-26 Jul 27	Capt. Donald W. Benner	2 Sep 37-11 Jul 38
Capt. Rosenham Beam	26 Jul 27-31 Jul 27	Capt. Joseph H. Atkinson	11 Jul 38-Jan 40
<i>Inactive</i>	31 Jul 27-1 Jun 28	Unknown	Jan 40-1 May 40
Capt. Edward O. Black	1 Jun 28-20 Jul 29	Maj. John W. Warren	1 May 40-ao Jan 41
1st Lt. Francis B. Valentine	20 Jul 29-28 Apr 30	Unknown	ao Jan 41-7 Dec 41

11th Transport Squadron

HQ-Not organized 1938-40; Patterson Field, OH, 1940-41; Selfridge Field, MI, 1941

Constituted in the Regular Army on 1 January 1938. Activated on 1 December 1940 at Patterson Field, OH, and assigned to the 60th Transport Group. Transferred on 3 July 1941 to Selfridge Field, MI. Location 7 December 1941—Selfridge Field, MI.

Status: Inactivated on 8 January 1961 as the 11th Troop Carrier Squadron (Heavy) at Dreux A.B., France.

Commanders, 11th Transport Squadron

Unknown 1 Dec 40-7 Dec 41

12th Bombardment Squadron (25th Bombardment Group)

HQ-Not organized 1939-40; Langley Field, VA, 1940; Boriquen Field, PR, 1940-41; Benedict Field, St. Croix, VI, 1941

Constituted in the Regular Army on 22 December 1939 and assigned to the 25th Bombardment Group. Activated on 1 February 1940 at Langley Field, VA. Transferred to Boriquen Field, PR, and arrived there 1 November 1940. Transferred to Benedict Field, St. Croix, VI. Location 7 December 1941—Benedict Field, St. Croix, VI.

Status: Active in the U. S. Air Force as the 12th Missile Squadron at Malmstrom A.F.B., MT.

Events: 329

Commanders, 12th Bombardment Squadron

Maj. Neil B. Harding	1 Feb 40-ao Jan 41	1st Lt. Edwin H. Hawes	ao Sep 41-1 Nov 41
Unknown	ao Jan 41-ao Sep 41	1st Lt. Arthur H. Rogers	1 Nov 41-ao Jan 42

12th Observation Squadron (2nd Division)

HQ-Mitchel Field, NY, 1919; Scott Field, IL, 1919; Kelly Field, TX, 1919-20; Biggs Field, TX, 1920; Nogales, AZ, 1920-21; Biggs Field, TX, 1921-26; Dodd Field, TX, 1926-31; Brooks Field, TX, 1931-37; Godman Field, KY, 1937-41



Stationed at Mitchel Field, NY, as of 17 June 1919 as the 12th Aero Squadron. Transferred on 6 July 1919 to Scott Field, IL. Transferred on 13 October 1919 to Kelly Field, TX, and assigned to the 1st Army Observation Group. Concurrently attached to the 1st Surveillance Group. Transferred on 9 January 1920 to Biggs Field, TX. Participated in the Mexican Border Patrol January 1920-May 1921 and Forest Fire Patrol May-August 1921. Relieved from the 1st Army Observation Group on 24 March 1920 and assigned to the 1st Surveillance Group. Flight A transferred to the Army airdrome at Douglas, AZ, 12 April 1920. Concurrently, Flight B transferred to the Army airdrome at Nogales, AZ. Redesignated as the 12th Squadron (Observation) on 14 March 1921. Entire squadron transferred to Biggs Field, TX, in September 1921. Concurrently relieved from the 1st Surveillance Group and assigned to the 1st Cavalry Division. Redesignated as the 12th Observation Squadron on 25 January 1923. Relieved from assignment to the 1st Cavalry Division 1 March 1923 and assigned to the 2nd Division. Transferred on 22 June 1926 to Dodd Field, TX. One flight detached 1 July 1927 and attached to support the Field Artillery School at Fort Sill, OK, until 1 June 1928. Squadron relieved 15 February 1929 from assignment to the 2nd Division. Flew reconnaissance missions in April 1929 for the 10th Cavalry in the vicinity of Nogales, NM, during the Escobar-Topete Revolution. Assigned on 1 October 1930 to the 12th Observation Group. Transferred on 31 October 1931 to Brooks Field, TX. Flew relief missions connected with the Mississippi River Valley floods during January-February 1937. Transferred on 20 June 1937, less Flight C, to Godman Field, KY. Flight C concurrently transferred to Fort Sill, OK, to support the Field Artillery School. Relieved from the 12th Observation Group on 20 June 1937, assigned to the 45th Observation Group, and concurrently attached to the 7th Cavalry Brigade (Mech). Relieved from the 45th Observation Group on 2 October 1940 and assigned to the Armored Force. Relieved from the Armored Force 1 September 1941 and assigned to the 73rd Observation Group. Location 7 December 1941—Godman Field, KY.

Status: Active in the U. S. Air Force as the 12th Reconnaissance Squadron at Beale A.F.B., CA.

Events: 42, 45, 55, 65, 70, 74, 83, 105, 125, 147, 163, 164, 216, 230, 280, 295, 302

Commanders, 12th Observation Squadron

1st Lt. Edward D. Jones	ao Dec 20-May 21	Capt. Benjamin F. Griffin	5 Sep 31-3 Dec 32
Capt. Thomas W. Haste	May 21-19 Nov 22	1st Lt. Joseph H. Hicks	3 Dec 32-13 Jun 33
Maj. Leo G. Heffernan	19 Nov 22-20 Sep 25	Maj. Charles B. Oldfield	13 Jun 33-21 May 34
Maj. John N. Reynolds	20 Sep 25-6 Jan 28	1st Lt. Joseph H. Hicks	21 May 34-30 Jun 34
Capt. Clearton H. Reynolds	6 Jan 28-20 Aug 28	1st Lt. Rueben Kyle, Jr.	30 Jun 34-1 Aug 34
Maj. Eugene L. Lohman	20 Aug 28-6 Jul 31	1st Lt. Milton J. Smith	1 Aug 34-1 Mar 35
1st Lt. Frederick D. Lynch	28 Jul 31-5 Sep 31	Maj. Robert Kauch	1 Mar 35-17 Apr 36
	Maj. John C. Kennedy	16 Apr 36-1 Nov 41	

12th Transport Squadron

HQ-*Not organized* 1938-40; Olmsted Field, PA, 1940-41; Mitchel Field, NY, 1941

Constituted in the Regular Army on 1 January 1938. Activated on 1 December 1940 at Olmsted Field, PA, and assigned to the 60th Transport Group. Transferred on 20 May 1941 to Mitchel Field, NY. Location 7 December 1941—Mitchel Field, NY.

Status: Inactive in the U. S. Air Force as the 12th Airlift Flight.

Commanders, 12th Transport Squadron

1st Lt. Arthur L. Logan	1 Dec 40-16 May 41	Unknown	16 May 41-7 Dec 41
-------------------------	--------------------	---------	--------------------

13th Attack Squadron (3rd Attack Group)

13th Bombardment Squadron (3rd Bombardment Group)

HQ-Kelly Field, TX, 1919; Scott Field, IL, 1919; Biggs Field, TX, 1919-21; Kelly Field, TX, 1921-24; *Inactive* 1924-29; Barksdale Field, LA, 1929-40; Savannah, GA, 1940-41

Stationed at Kelly Field, TX, as of June 1919 as the 104th Aero Squadron. Assigned on 1 July 1919 to the 1st Surveillance Group (redesignated 3rd Attack Group on 14 March 1921). Transferred on 6 July 1919 to Scott Field, IL. Transferred on 6 November 1919, less one flight, to Biggs Field, TX. One flight operated from Camp Marfa, TX, until 3 September 1920. Another flight operated from Post Field, OK, 10 September-4 November 1920. Participated in the Mexican Border Patrol November 1920-June 1921. Redesignated as the 13th Squadron (Attack) on 14 March 1921. Transferred on 2 July 1921 to Kelly Field. Redesignated as the 13th Attack Squadron on 25 January 1923. Inactivated on 27 June 1924 at Kelly Field. Designated Active Associate was the 8th Attack Squadron 1924-27. Allotted to the Eighth Corps Area on 28 February 1927. Organized about May 1928 with Organized Reserve personnel as a RAI unit in the Eighth Corps Area. Conducted summer training at Fort Crockett, TX, with units of the 3rd Attack Group. Activated on 1 November 1929, less Reserve personnel, at Barksdale Field, LA, and assigned to the 3rd Attack Group. Reorganized and redesignated 13th Bombardment Squadron on 1 December 1939 and assigned to the 3rd Bombardment Group. Transferred on 10 October 1940 to Savannah, GA. Location 7 December 1941—Savannah, GA.

Status: Active in the U. S. Air Force as the 13th Bomb Squadron at Dyess A.F.B., TX.

Events: 39, 46, 55, 85, 104, 105, 125, 164, 165, 194, 197, 200, 213, 214, 217, 227, 243, 249, 252, 268, 283

Commanders, 13th Attack Squadron

13th Bombardment Squadron

1st Lt. Edward W. Raley	ao Jan 20-Nov 20	Maj. Edward M. Morris	13 Aug 34-10 Jul 37
Capt. Lloyd L. Harvey	Nov 20-28 May 24	1st Lt. Richard H. Lee	10 Jul 37-22 Aug 37
1st Lt. Edward D. Jones	28 May 24-27 Jun 24	1st Lt. Frank A. Armstrong	22 Aug 37-20 Sep 37
<i>Inactive</i>	27 Jun 24-ao May 28	Maj. Auby C. Strickland	20 Sep 37-4 Apr 39
Unknown **	ao May 28-1 Nov 29	1st Lt. Richard H. Lee	4 Apr 39-7 May 39
1st Lt. George A. McHenry	1 Nov 29-9 Jun 30	Capt. Frank A. Armstrong	7 May 39-Aug 39
1st Lt. Ralph F. Stearley	9 Jun 30-16 Sep 33	1st Lt. Karl E. Baumeister	Aug 39-16 Nov 39
Maj. Earle L. Naiden	16 Sep 33-27 Feb 34	Maj. Bernard J. Thompson	16 Nov 39-Feb 40
1st Lt. Walter L. Wheeler	27 Feb 34-26 Jun 34	Capt. Frank A. Armstrong	Feb 40-5 Oct 40
1st Lt. Ralph F. Stearley	26 Jun 34-13 Aug 34	Capt Wycliffe E. Steele	5 Oct 40-ao Jan 41
	Unknown	ao Jun 41-7 Dec 41	

** RAI commanders: Organized Reserve officers.

14th Bombardment Squadron (I) (1923-33)

14th Attack Squadron (1933-38)

HQ-Rich Field, TX, 1919-21; Langley Field, VA, 1921-22; *Inactive* 1922-32; Kelly Field, TX, 1932-36; *Inactive* 1936-38

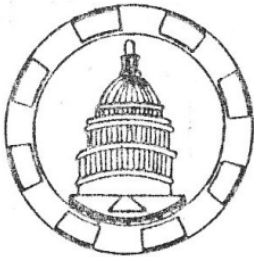

Stationed at Rich Field, TX, as of January 1919 as the 258th Aero Squadron. Redesignated as the 258th Army Artillery Squadron on 29 March 1919. Redesignated as the 258th Heavy Bombardment Squadron on 8 June 1920 and assigned to the 1st Day Bombardment Group (redesignated 2nd Bombardment Group on 14 March 1921). Transferred in 1921 to Langley Field, VA. Attached to the 1st Provisional Air Brigade 6 May-3 October 1921 while supporting the battleship bombing tests off the Virginia coast. Demobilized on 30 June 1922 at Langley Field and personnel transferred to the 11th and 20th Squadrons (Bombardment). Reconstituted in the Regular Army on 24 March 1923 as the 14th Bombardment Squadron and assigned to the General Headquarters Reserve. Designated to be assigned upon mobilization to the Chief of Ordnance to support the development of aerial bombardment munitions. Designated active associate was the 49th Bombardment Squadron 1923-27. Assigned on 13 June 1924 to the Zone of the Interior. Allotted to the Third Corps Area on 28 February 1927. Withdrawn from the Third Corps Area on 1 September 1928 and allotted to the Eighth Corps Area. Organized on 7 September 1932 with Organized Reserve personnel as a RAI unit at Kelly Field, TX. Reorganized and redesignated 14th Attack Squadron on 1 October 1933 and assigned to the 33rd Attack Group. Withdrawn from the Eighth Corps Area on 5 June 1936 and allotted to the Sixth Corps Area. Inactivated on 31 October 1936 at Kelly Field by relief of Reserve personnel. Chicago, IL, designated as headquarters location on reorganization, but the unit was never organized at that location. Disbanded on 1 January 1938.

Events: 23

Commanders, 14th Bombardment Squadron (I)

14th Attack Squadron

1st Lt. Merwyn C. Randall	ao Dec 20-Apr 21	<i>Inactive</i>	1 Jul 22-7 Sep 32
1st Lt. Phillips Melville	Apr 21-2 Sep 21	Unknown**	7 Sep 32-31 Oct 36
Capt. Walter R. Lawson	2 Sep 21-30 Jun 22	<i>Inactive</i>	31 Oct 36-7 Dec 41

** RAI Commanders: Organized Reserve officers.

14th Bombardment Squadron (II) (9th Bombardment Group)

HQ-Bolling Field, DC, 1928-36; *Inactive* 1936-37; Eighth Corps Area at large 1937-40; Hickam Field, TH, 1940-41; Clark Field, PI, 1941; Del Monte Field, PI

Organized in the Regular Army on 1 April 1928 at Bolling Field, DC, as Air Corps Detachment, Bolling Field, and assigned to the Office of Chief of the Air Corps. Relieved from assignment to OCAC on 28 August 1933 and assigned to Headquarters, Third Corps Area. Reorganized and redesignated 1 March 1935 as the 14th Bombardment Squadron and assigned to the 9th Bombardment Group. Consolidated on 8 June 1935 with the 14th Aero Squadron (a WWI unit organized as Squadron A, Rockwell Field at Rockwell Field, CA; demobilized on 28 November 1918 at Rockwell Field; reconstituted on 8 June 1935). Inactivated on 1 September 1936 at Bolling Field, DC. Organized by December 1937 with Organized Reserve personnel as a RAI unit in the Eighth Corps Area. Conducted summer training at Kelly Field, TX. Redesignated as the 14th Bombardment Squadron (Medium) on 22 December 1939. Activated on 1 February 1940, less Reserve personnel, at Hickam Field, TH, and assigned to 11th Bombardment Group. Redesignated as the 14th Bombardment Squadron (Heavy) on 20 November 1940. Transferred by flying to Clark Field, PI, completing its arrival there on 16 September 1941. Relieved from the 11th Bombardment Group on 2 December 1941 and assigned to the 7th Bombardment Group. Transferred on 6 December 1941 to Del Monte Field, PI. Location 7 December 1941—Del Monte, PI.

Status: Disbanded on 19 August 1949.

Events: 297, 312

Commanders, 14th Bombardment Squadron (II)

Maj. Donald B. Phillips	1 Mar 35-28 Aug 35	Maj. Donald D. Fitzgerald	1 Aug 36-1 Sep 36
Capt. Samuel C. Eaton, Jr.	28 Aug 35-30 Sep 35	<i>Inactive</i>	1 Sep 36-Dec 37
Maj. Hez McClellan	30 Sep 35-15 Oct 35	Unknown **	Dec 37-1 Feb 40
Maj. Samuel C. Eaton, Jr.	15 Oct 35-1 Aug 36	Maj. Emmett O'Donnell, Jr.	1 Feb 40-Jan 42

** RAI commanders: Organized Reserve officers.

15th Bombardment Squadron (Light) (27th Bombardment Group)

HQ-*Not organized* 1939-40; Barksdale Field, LA, 1940; Lawson Field, GA, 1940-41

Constituted in the Regular Army on 22 December 1939 and assigned to the 27th Bombardment Group. Activated on 1 February 1940 at Barksdale Field, LA. Transferred on 7 October 1940 to Lawson Field, GA. Location 7 December 1941—Lawson Field, GA.

Status: Disbanded on 1 October 1943 at Novvion, Sicily.

Commanders, 15th Bombardment Squadron

Unknown 1 Feb 40-7 Dec 41

15th Observation Squadron (6th Division)

HQ-Chanute Field, IL, 1921-27; Kelly Field, TX, 1927; *Inactive* 1927-28; Selfridge Field, MI, 1928-30; Scott Field, IL, 1930-40; Post Field, OK, 1940-41



Constituted in the Regular Army on 30 August 1921 as the 15th Squadron (Observation) and assigned to the Sixth Corps Area. Organized on 21 September 1921 at Chanute Field, IL. Redesignated as the 15th Observation Squadron on 25 January 1923. Assigned on 24 March 1923 to the 6th Division. Transferred on 21 June 1927 to Kelly Field, TX, and attached to the Air Corps Training Center. Inactivated on 1 August 1927 at Kelly Field and relieved from the 6th Division. Activated on 15 May 1928 at Selfridge Field, MI. Assigned on 15 February 1929 to the 14th Observation Group. Transferred in June 1930 to Scott Field, IL. Relieved from assignment to the 14th Observation Group on 1 October 1933 and assigned to the 11th Observation Group. Relieved from assignment to the 11th Observation Group on 17 July 1937 and assigned to the 12th Observation Group. Transferred on 9 October 1940 to Post Field, OK. Relieved from assignment

to the 12th Observation Group on 9 January 1941 and assigned to the Field Artillery School. Location 7 December 1941—Post Field, OK.

Status: Active in the U. S. Air Force as the 15th Reconnaissance Squadron at Indian Springs, NV.

Events: 32, 50, 85, 175, 186, 213, 214, 274, 293, 296, 302

Commanders, 15th Observation Squadron

Capt. Ernest Clark	25 Sep 21-21 Jun 27	Capt. William C. Goldsborough	4 Mar 33-16 Oct 33
Unknown	21 Jun 27-1 Aug 27	Maj. Martin F. Scanlon	17 Oct 33-13 Jan 35
<i>Inactive</i>	1 Aug 27-15 May 28	1st Lt. Leslie P. Holcomb	13 Jan 35-17 Feb 35
1st Lt. Arthur G. Hamilton	15 May 28-26 Nov 28	Maj. William C. Goldsborough	17 Feb 35-2 May 36
Capt. Clearton H. Reynolds	26 Nov 28-15 Feb 30	Maj. Raphael Baez	2 May 36-20 Aug 36
Capt. Wolcott P. Hayes	15 Feb 30-7 Aug 32	Maj. Frank H. Pritchard	20 Aug 36-15 Jan 37
1st Lt. Frederick A. Johnson	7 Aug 32-27 Jan 33	Maj. Raphael Baez	15 Jan 37-ao Oct 40
1st Lt. Leslie P. Holcomb	27 Jan 33-3 Mar 33	Unknown	ao Oct 40-7 Dec 41

16th Bombardment Squadron (Light) (27th Bombardment Group)

HQ—*Not organized* 1939-40; Barksdale Field, LA, 1940; Hunter Field, GA, 1940-41; Fort William McKinley, PI, 1941

Constituted in the Regular Army on 22 December 1939 and assigned to the 27th Bombardment Group. Activated on 1 February 1940 at Barksdale Field, LA. Transferred on 7 October 1940 to Hunter Field, GA. Sailed from San Francisco on the U.S.A.T. *President Coolidge* and arrived at Manila, PI, on 20 November 1941. Transferred to Nielson Field, PI, on the same day. Location 7 December 1941—Nielson Field, PI.

Status: Active in the U. S. Air Force as the 522nd Fighter Squadron at Cannon A.F.B., NM.

Commanders, 16th Bombardment Squadron

Maj. Bernard S. Thompson	1 Feb 40-Nov 40	Capt. William G. Hipps	Nov 40-17 Dec 41
--------------------------	-----------------	------------------------	------------------

16th Observation Squadron (7th Division)

HQ—Marshall Field, KS, 1921-31; *Inactive* 1931-37; Pope Field, NC, 1937-40; Lawson Field, GA, 1940-41

Constituted in the Regular Army on 30 August 1921 as the 16th Squadron (Observation), and allotted to the Seventh Corps Area. Organized on 7 December 1921 at Fort Riley, KS, assigned to the Seventh Corps Area, and further attached to provide aviation support to the Cavalry School. Redesignated as the 16th Observation Squadron on 25 January 1923. Assigned on 24 March 1923 to the 7th Division. Conducted bombing of ice floes on the Platte River to prevent the collapse of a Union Pacific Railroad bridge in March 1924. Consolidated on 8 April 1924 with the 16th Aero Squadron (a WWI unit organized as the 3rd Aviation School Squadron at Memphis, TN, 9 May 1917; redesignated as the 16th Aero Squadron on 31 August 1917; demobilized on 22 May 1919 at Mitchel Field, NY; reconstituted on 8 April 1924). Relieved from assignment to the 7th Division 15 August 1927 and assigned to the 2nd Cavalry Division. Flew mail from Platte City, NE, to Rapid City, SD, for President Calvin Coolidge during his stay in the Black Hills August-September 1927. Relieved from assignment to the 2nd Cavalry Division on 15 February 1929 and assigned to the 12th Observation Group. Squadron inactivated on 13 March 1931, less Flights A, B, C, and D at Marshall Field, KS. Concurrently flights posted as follows: A at Langley Field, VA, to support the Coast Artillery School; B at Fort Benning, GA, to support the Infantry School; C at Fort Bragg, NC, to support the 13th Field Artillery Brigade; D at Fort Riley, KS, to support the Cavalry School. Flight E constituted 1 October 1931 and activated on 1 November 1931 at Fort Sill, OK, to support the Field Artillery School. Entire squadron assigned 1 October 1931 to the 14th Observation Group. Relieved from assignment to the 14th Observation Group on 17 July 1937 and assigned to the 44th Observation Group (IV Corps). Concurrently, squadron headquarters activated at Pope Field, NC. All flights, less Flight B, transferred to Pope Field in July 1937. Flight B remained at Fort Benning. Relieved from assignment to the 44th Observation Group on 1 January 1938 and assigned to the 32nd Observation Group (Third Army). Relieved from assignment to the 32nd Observation Group on 3 October 1940 and assigned to the Armored Force. Entire squadron transferred to Lawson Field, GA, 24 October 1940. Attached on 15 November 1940 to the 2nd Armored Division. Relieved from the Armored Force 1 September 1941 and assigned to the 73rd Observation Group. Location 7 December 1941—Lawson Field, GA.

Status: Disbanded 12 April 1945 as the 12th Reconnaissance Squadron (Heavy, Special).

Organization Day: 31 August. Chosen to commemorate the squadron's redesignation 31 August 1917 as the 16th Aero Squadron. Adopted 25 January 1937.

Events: 55, 85, 143, 171, 188, 255, 293, 300

Commanders, 16th Observation Squadron

Capt. Thomas Bolend	7 Dec 21-9 Feb 22	Maj. Robert E. M. Goolrick	ao Aug 29-15 Mar 31
Maj. Clarence L. Tinker	9 Feb 22-5 Oct 24	<i>Inactive</i>	15 Mar 31-16 Jul 37
Maj. Benjamin G. Weir	5 Oct 24-1 Nov 25	Unknown	17 Jul 37-ao Jan 39
Capt. Thomas Bolend	1 Nov 25-22 Mar 26	Lt. Col. Vincent B. Dixon	ao Jan 39-12 Jul 40
Maj. Henry H. Arnold	22 Mar 26-1 Aug 28	Capt. Fred S. Stocks	12 Jul 40-Sep 41

17th Bombardment Squadron (27th Bombardment Group)

HQ-*Not organized* 1939-40; Barksdale Field, LA, 1940; Hunter Field, GA, 1940-41; Nielson Field, PI, 1941

Constituted in the Regular Army on 22 December 1939 and assigned to the 27th Bombardment Group. Activated on 1 February 1940 at Barksdale Field, LA. Transferred on 7 October 1940 to Hunter Field, GA. Sailed from San Francisco on the U.S.A.T. *President Coolidge* and arrived at Manila, PI, 20 November 1941. Transferred to Nielson Field, PI, on the same day. Location 7 December 1941—Nielson Field, PI.

Status: Active in the U. S. Air Force as the 523rd Fighter Squadron at Cannon A.F.B., NM.

Commanders, 17th Bombardment Squadron

Capt. Hugh A. Parker	1 Feb 40-ao Dec 40	1st Lt. Herman F. Lowery	ao Jul 41-17 Dec 41
----------------------	--------------------	--------------------------	---------------------

17th Pursuit Squadron (1st Pursuit Group)

HQ-Selfridge Field, MI, 1919-21; Ellington Field, TX, 1921-22; Selfridge Field, MI, 1922-40; Clark Field, PI, 1940; Nichols Field, PI, 1940-41

Stationed at Selfridge Field, MI, as of June 1919 as the 147th Aero Squadron. Assigned on 22 August 1919 to the 1st Pursuit Group. Transferred on 22 August 1919 to Kelly Field, TX. Redesignated as the 17th Squadron (Pursuit) on 14 March 1921. Transferred on 1 July 1921 to Ellington Field, TX. Transferred on 1 July 1922 to Selfridge Field, MI. Redesignated as the 17th Pursuit Squadron on 25 January 1923. Redesignated as the 17th Pursuit Squadron (Interceptor) on 6 December 1939. Departed from the port of San Francisco, CA, about mid-November 1940 on the U.S.A.T. *Etolin* and arrived at Manila, PI, on 23 November 1940. Transferred to Clark Field, PI, on the same day. Transferred on 5 December 1940 to Nichols Field, PI. Relieved from assignment to the 1st Pursuit Group on 14 December 1940 and assigned to the 4th Composite Group. Relieved from assignment to the 4th Composite Group on 1 October 1941 and assigned to the 24th Pursuit Group. Location 7 December 1941—Nichols Field, PI.

Status: Active in the U. S. Air Force as the 17th Weapons Squadron at Nellis A.F.B., NV.

Events: 29, 39, 46, 55, 71, 85, 104, 107, 131, 164, 165, 197, 213, 214, 227, 249

Commanders, 17th Pursuit Squadron

1st Lt. John M. Pennewell	ao Dec 20-23 Feb 21	1st Lt. Martinus Stanseth	1 Oct 28-14 Jun 29
1st Lt. Sam L. Ellis	23 Feb 21-1 Mar 21	1st Lt. Paul W. Wolf	14 Jun 29-6 Jun 30
1st Lt. Roy W. Camblin	1 Mar 21-Jun 21	1st Lt. Robert D. Moor	6 Jun 30-4 Sep 30
Capt. William F. Farthing	Jun 21-27 Aug 21	Capt. Hoyt G. Ross	4 Sep 30-1 Nov 32
1st Lt. Roy W. Camblin	27 Aug 21-20 Sep 21	Capt. Harlan T. McCormick	1 Nov 32-19 Apr 34
Capt. Guy M. Elmendorf	20 Sep 21-1 Feb 22	Maj. George P. Tourtellot	19 Apr 34-17 Aug 36
Capt. Albert M. Guidera	1 Feb 22-16 Oct 22	1st Lt. John F. Egan	17 Aug 36-3 Sep 36
Capt. Hugh M. Elmendorf	16 Oct 22-15 Sep 23	Capt. Harlan T. McCormick	3 Sep 36-2 Jul 37
1st Lt. Oliver W. Broberg	15 Sep 23-17 Jul 25	Maj. Louis N. Eller	9 Jul 37-1 Nov 37
2nd Lt. George F. Schulgen	17 Jul 25-1 Sep 25	1st Lt. John F. Egan	1 Nov 37-1 Jan 38
1st Lt. Leland C. Hurd	1 Sep 25-2 Nov 25	Capt. Dixon M. Allison	1 Jan 38-Sep 39
Capt. Frank H. Pritchard	2 Nov 25-15 Jun 28	Capt. Paul B. Wurtsmith,	Sep 39-Jul 1940
Capt. Victor H. Strahm	15 Jun 28-1 Oct 28	Maj. Kirtley J. Gregg	Jul 40-9 May 41
	Capt. Boyd Wagner	9 May 41-18 Dec 41	

18th Observation Squadron (I) (1921-25)

18th Headquarters Squadron (1925-33)

HQ-Rockwell Field, CA, 1921-22; *Inactive* 1922-25; Bolling Field, DC, 1925-28; Kelly Field, TX, 1929-33

Constituted in the Regular Army on 30 August 1921 as the 18th Squadron (Observation), and allotted to the Seventh Corps Area. Organized on 1 October 1921 at Rockwell Field, CA, and assigned to the Ninth Corps Area. Inactivated on 23 July 1922. Redesignated as the 18th Observation Squadron on 25 January 1923. Demobilized on 18 February 1925. Reconstituted and consolidated 17 March 1925 with the 18th Aero Squadron (a WWI unit organized as Squadron B, Rockwell Field; demobilized on 23 November 1918 at Rockwell Field, CA; reconstituted on 17 March 1925) and Headquarters Detachment, Bolling Field (organized 11 July 1922; redesignated as Headquarters Squadron, Bolling Field 6 October 1924) and the consolidated unit redesignated as the 18th Headquarters Squadron. Concurrently, activated at Bolling Field, DC. Inactivated on 31 March 1928 at Bolling Field, DC, and demobilized. Reconstituted 8 May 1929 and allotted to the Eighth Corps Area. Organized about June 1929 with Organized Reserve personnel as a RAI unit at Kelly Field, TX. Conducted annual summer training at Kelly Field, TX. Demobilized on 1 October 1933.

Status: Reconstituted and consolidated in 1964 with the 18th Observation Squadron; inactive in the U. S. Air Force as the 408th Bombardment Squadron.

Commanders, 18th Observation Squadron

18th Headquarters Squadron

Capt. Roscoe Fawcett	1 Oct 21-18 Nov 21	Capt. Chilion F. Wheeler	22 May 26-12 Nov 26
Capt. William M. Randolph	18 Nov 21-30 Jan 22	Capt. Byrne V. Baucom	12 Nov 26-1 May 27
Capt. R. Gilpin Ervin	30 Jan 22-23 Jul 22	1st Lt. William L. Scott, Jr.	1 May 27-22 Nov 27
<i>Inactive/demobilized</i>	24 Jul 22-16 Mar 25	Capt. Donald P. Muse	22 Nov 27-4 Feb 28
1st Lt. Lester J. Maitland	17 Mar 25-4 Jun 25	1st Lt. Devereaux M. Myers	4 Feb 28-31 Mar 28
1st Lt. Lucas V. Beau	4 Jun 25-22 May 26	<i>Inactive</i>	31 Mar 28-Jun 29
	Unknown**	Jun 29-1 Oct 33	

** RAI Commanders: Organized Reserve officers.

18th Observation Squadron (II) (1935-36)

18th Reconnaissance Squadron (1936-41)

HQ-*Not organized* 1935-36; Mitchel Field, NY, 1936-40; Langley Field, VA, 1940-41

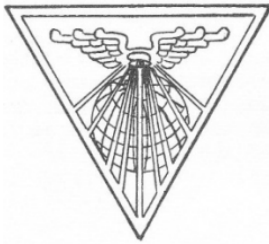

Constituted in the Regular Army on 1 March 1935 as the 18th Observation Squadron (Long Range, Light Bombardment), and allotted to the Second Corps Area. Redesignated as the 18th Reconnaissance Squadron on 1 September 1936 and assigned to the 2nd Wing. Concurrently organized at Mitchel Field, NY. Concurrently attached to the 9th Bombardment Group. Redesignated as the 18th Reconnaissance Squadron (Medium Range) on 6 December 1939. Attached in September 1940 to the 22nd Bombardment Group. Transferred on 15 November 1940 to Langley Field, VA. Location 7 December 1941—Langley Field, VA.

Status: Consolidated in 1964 with the 18th Headquarters Squadron; inactive in the U. S. Air Force as the 408th Bombardment Squadron.

Events: 252, 268, 283

Commanders, 18th Reconnaissance Squadron

Capt. John R. Doyle	1 Sep 36-26 Jan 37	Unknown	ao Sep 39-15 Jan 41
Capt. Walter C. White	26 Jan 37-25 Sep 37	Maj. Mark K. Lewis, Jr.	15 Jan 41-3 Nov 41
Maj. Phillips Melville	25 Sep 37-ao Sep 39	Unknown	3 Nov 41-7 Dec 41

18th Pursuit Squadron (35th Pursuit Group)

HQ-*Not organized* 1939-40; Moffett Field, CA, 1940; Hamilton Field, CA, 1940-41; Elmendorf Field, TA, 1941

Constituted in the Regular Army on 22 December 1939 and assigned to the 35th Pursuit Group. Activated on 1 February 1940 at Moffett Field, CA. Transferred on 10 September 1940 to Hamilton Field, CA. Transferred to Elmendorf Field, TA, arriving there 21 February 1941. Relieved from the 35th Pursuit Group on 24 February 1941 and assigned to the 28th Composite Group. Location 7 December 1941—Elmendorf Field, TA.

Status: Active in the U. S. Air Force as the 18th Fighter Squadron at Elmendorf A.F.B., AK.

Commanders, 18th Pursuit Squadron

Capt. Norman D. Sillin	1 Feb 40-5 Aug 41	1st Lt William A. Bowie	5 Aug 41-13 Feb 42
------------------------	-------------------	-------------------------	--------------------

19th Bombardment Squadron (22nd Bombardment Group)

HQ-*Not organized* 1939-40; Patterson Field, OH, 1940; Langley Field, VA, 1940-41

Constituted in the Regular Army on 22 December 1939 and assigned to the 22nd Bombardment Group. Activated on 1 February 1940 at Patterson Field, OH. Transferred on 16 November 1940 to Langley Field, VA. Location 7 December 1941—Langley Field, VA.

Status: Active in the U. S. Air Force as the 19th Special Operations Squadron at Hurlburt Field, FL.

Commanders, 19th Bombardment Squadron

1st Lt. Herman E. Hurst	1 Feb 40-16 Nov 40	Maj. David P. Laubach	19 Mar 41-10 Nov 41
Capt. Kingston K. Tibbets	16 Nov 40-19 Mar 41	Millard L. Raskin	10 Nov 41-11 Dec 41

19th Pursuit Squadron (5th Composite Group)

HQ-March Field, CA, 1921-22; *Inactive* 1922-23; Wheeler Field, TH, 1923-24; Luke Field, TH, 1924-27; Wheeler Field, TH, 1927-41

Constituted in the Regular Army on 30 August 1921 as the 19th Squadron (Pursuit) and assigned to the Ninth Corps Area. Organized on 1 October 1921 at March Field, CA. Inactivated on 29 June 1922 at March Field. Redesignated as the 19th Pursuit Squadron on 25 January 1923. Activated on 1 May 1923 at Wheeler Field, TH, and assigned to the 17th Composite Group. Consolidated on 20 December 1923 with the 19th Aero Squadron (a WWI unit organized as the 14th Aero Squadron at Kelly Field, TX, 14 June 1917; redesignated as the 19th Aero Squadron on 26 June 1917; demobilized on 14 April 1919 at Mitchel Field, NY; reconstituted on 20 December 1923). Relieved from the 17th Composite Group on 15 January 1924 and assigned to the 5th Composite Group. Concurrently transferred to Luke Field, TH. Relieved from assignment to the 5th Composite Group on 11 January 1927, assigned to the 18th Pursuit Group, and transferred to Wheeler Field. Redesignated as the 19th Pursuit Squadron (Interceptor) on 6 December 1939. Location 7 December 1941—Wheeler Field, TH.

Status: Active in the U. S. Air Force as the 19th Fighter Squadron at Elmendorf A.F.B., AK.

Events: 141, 158, 160, 248, 276, 297, 312

Commanders, 19th Pursuit Squadron

Capt. Frederick I. Eglin	30 Aug 21-1 Nov 21	Capt. Auby C. Strickland	7 Jun 29-1 Mar 32
Maj. George H. Peabody	1 Nov 21-29 Jun 22	1st Lt. Robert C. Oliver	1 Mar 32-4 Aug 32
<i>Inactive</i>	29 Jun 22-1 May 23	1st Lt. Demas T. Crow	4 Aug 32-16 Jul 34
1st Lt. Edward H. Wood	1 May 23-2 Jul 23	1st Lt. William O. Ereckson	16 Jul 34-17 Sep 34
1st Lt. Chilion F. Wheeler	2 Jul 23-10 Nov 23	1st Lt. Glenn O. Barcus	17 Sep 34-13 Feb 35
Capt. Hugh M. Elmendorf	10 Nov 23-15 Jul 24	Maj. James E. Duke, Jr.	13 Feb 35-18 Jun 35
1st Lt. Claire Chennault	15 Jul 24-1 Nov 24	Capt. Ray H. Clark	18 Jun 35-28 May 36
1st Lt. Ray A. Dunn	1 Nov 24-13 Mar 25	Capt. Russell Keillor	28 May 36-16 Nov 36
1st Lt. Claire Chennault	13 Mar 25-23 Aug 26	1st Lt. James E. Briggs	16 Nov 36-28 Jul 37
Capt. Lowell H. Smith	23 Aug 26-19 Oct 27	Capt. James A. Ellison	28 Jul 37-1 Aug 39
1st Lt. Robert S. Worthington	19 Oct 27-8 Dec 27	Capt. Roger M. Ramey	1 Aug 39-17 Mar 41
1st Lt. Carlyle H. Ridenour	8 Dec 27-6 Nov 28	1st Lt. Worley	17 Mar 41-22 Mar 41
Capt. Lowell H. Smith	6 Nov 28-7 Jun 29	Maj. Clarence H. Hagy	22 Mar 41-May 41
	Maj. Joseph A. Morris	May 41-14 Sep 42	

20th Bombardment Squadron (2nd Bombardment Group)**HQ**-Ellington Field, TX, 1919; Kelly Field, TX, 1919-22; Langley Field, VA, 1922-41

Stationed at Ellington Field, TX, as of June 1919 as the 20th Aero Squadron. Assigned on 18 September 1919 to the 1st Day Bombardment Group (later redesignated 2nd Bombardment Group). Transferred on 25 September 1919 to Kelly Field, TX. Redesignated as the 20th Squadron (Bombardment) on 14 March 1921. Transferred on 30 June 1922 to Langley Field, VA. Redesignated as the 20th Bombardment Squadron on 25 January 1923. Conducted bombing tests on obsolete warships off Chesapeake Bay 5 September 1923. Flew relief missions connected with the floods in central Pennsylvania 20-22 March 1936. Participated in the "Goodwill Flights" to Columbia 3-12 August 1938 and Brazil 10-26 November 1939. Redesignated as the 20th Bombardment Squadron (Heavy) on 6 December 1939. Location 7 December 1941—Langley Field, VA.

Status: Active in the U. S. Air Force as the 20th Bomb Squadron at Barksdale A.F.B., LA.**Events:** 39, 46, 55, 71, 85, 104, 107, 155, 164, 165, 196, 197, 200, 213, 214, 227, 249**Commanders, 20th Bombardment Squadron**

2nd Lt. William R. Maynard	ao Dec 20-23 Feb 21	Capt. Frank D. Hackett	1 Sep 29-17 Jun 31
Maj. Walter R. Weaver	23 Feb 21-1 Mar 21	1st Lt. John R. Drumm	28 Aug 28-12 Nov 28
1st Lt. Fred S. Borum	1 Mar 21-12 May 21	1st Lt. James W. Hammond	12 Nov 28-11 Dec 28
1st Lt. Thomas L. Gilbert	12 May 21-29 Aug 21	Capt. George M. Palmer	11 Dec 28-1 Sep 29
Capt. Arthur B. McDaniel	29 Aug 21-16 Sep 21	Maj. Robert T. Kronau	17 Jun 31-16 Jul 35
Capt. George S. V. Little	16 Sep 21-ao Nov 21	Maj. Barney M. Giles	16 Jul 35-6 Jul 36
Capt. Ellis Willis	ao Apr 22-20 Jun 22	Maj. Vincent J. Meloy	6 Jul 36-25 Jul 36
Capt. Walter R. Lawson	30 Jun 22-21 Apr 23	1st Lt. Frederic E. Glantzberg	25 Jul 36-14 Sep 36
1st Lt. James L. Grisham	21 Apr 23-13 Oct 23	Capt. Ward J. Davies	14 Sep 36-27 Nov 36
1st Lt. Ross F. Cole	13 Oct 23-27 Mar 24	Maj. Vincent J. Meloy	27 Nov 36-15 Jul 39
Capt. Willis H. Hale	27 Mar 24-7 Jul 27	Maj. Theodore J. Koenig	15 Jul 39-Feb 40
Capt. Cecil G. Sellers	7 Jul 27-1 Aug 27	Maj. Carl B. McDaniel	Feb 40-25 Oct 40
Capt. Asa N. Duncan	1 Aug 27- 11 Jul 28	Maj. William L. Ritchie	25 Oct 40-15 Jan 41
Capt. Ross F. Cole	11 Jul 28-28 Aug 28	Maj. Herbert K. Baisley	15 Jan 41-Apr 41
	Maj. Dale O. Smith	Apr 41-ao Jan 42	

20th Pursuit Squadron (35th Pursuit Group)**HQ**-*Not organized* 1939-40; Moffett Field, CA, 1940; Hamilton Field, CA, 1940; Nichols Field, PI, 1940-41; Clark Field, PI, 1941

Constituted in the Regular Army on 22 December 1939 and assigned to the 35th Pursuit Group. Activated on 1 February 1940 at Moffett Field, CA. Transferred on 10 September 1940 to Hamilton Field, CA. Transferred to Nichols Field, PI, arriving there 18 November 1940. Relieved from the 35th Pursuit Group on 14 December 1940 and assigned to the 4th Composite Group. Relieved from assignment to the 4th Composite Group on 1 October 1941 and assigned to the 24th Pursuit Group. Departed from San Pedro, CA, 31 October 1941 on the U.S.A.T. *Washington* and arrived at Manila, PI, about mid-November 1941. Transferred to Clark Field, PI, on the same day. Location 7 December 1941—Clark Field, PI.

Status: Active in the U. S. Air Force as the 20th Fighter Squadron at Holloman A.F.B., NM.**Commanders, 20th Pursuit Squadron**

Maj. Orrin L. Grover	1 Feb 40-9 May 41	1st Lt. Joseph H. Moore	9 May 41-ao Dec 41
----------------------	-------------------	-------------------------	--------------------

21st Observation Squadron (I) (9th Observation Group)**HQ**-*Not organized* 1923-33

Demobilized on 14 April 1919 at Hazelhurst Field, NY, as the 21st Aero Squadron. Reconstituted in the Regular Army on 24 March 1923 as the 21st Observation Squadron, assigned to the 9th Observation Group and allotted to the Sixth Corps Area. Designated Active Associate was the 15th Observation Squadron 1923-27. Designated mobilization station was Chanute Field 1924-27 and Carlstrom Field, FL, 1927-28. Relieved from assignment to the 9th Observation Group on 15 August 1927 and assigned to the 8th Division. Concurrently withdrawn from the Sixth Corps Area and allotted to the Fourth Corps Area. Withdrawn from the Fourth Corps Area on 1 September 1928 and allotted to the Eighth Corps Area. Dodd Field, TX, designated as headquarters location on organization, but the unit was never organized at that location. Relieved from the 8th Division on 15 February 1929. Designated mobilization training station was Dodd Field, TX, 1929-33. Demobilized on 1 October 1933. Reconstituted and consolidated with the 21st Observation Squadron on 2 December 1936 (see below).

21st Observation Squadron (II) (1935-36)

21st Reconnaissance Squadron (1936-41)

HQ-Bolling Field, DC, 1935-36; Langley Field, VA, 1936-39; Miami, FL, 1939-41; Newfoundland, Canada, 1941; MacDill Field, FL, 1941



Constituted in the Regular Army on 1 March 1935 as the 21st Observation Squadron (Long Range Amphibian), assigned to the 2nd Wing and organized at Bolling Field, DC. Reorganized and redesignated 21st Reconnaissance Squadron on 1 September 1936 and assigned to the 2nd Bombardment Group. Concurrently, transferred to Langley Field, VA. Consolidated on 2 December 1936 with the 21st Observation Squadron (see above). Transferred on 9 September 1939 to Miami, FL. Redesignated as the 21st Reconnaissance Squadron (Long Range) on 6 December 1939. Flew neutrality, sea search, and weather reconnaissance missions over the western Atlantic October 1939-August 1941. Relieved from assignment to the 2nd Bombardment Group on 15 November 1940 and assigned to the 3rd Bombardment Wing. Redesignated as the 21st Reconnaissance Squadron (Heavy) on 20 November 1940. Transferred on 1 May 1941 to Newfoundland, Canada. Transferred on 3

September 1941 to MacDill Field, FL. Assigned on 5 September 1941 to the 29th Bombardment Group. Location 7 December 1941—MacDill Field, FL.

Status: Active in the U. S. Air Force as the 911th Air Refueling Squadron at Seymour-Johnson, A.F.B., NC.

Events: 268, 283

Commanders, 21st Reconnaissance Squadron

Capt. William V. Andrews	1 Mar 35-1 Jun 35	Maj. Harvey H. Holland	1 Sep 36-13 Mar 37
Maj. Leslie MacDill	1 Jun 35-16 Jun 35	Maj. Hugh C. Downey	13 Mar 37-4 Jan 38
Capt. Arthur L. Bump	16 Jun 35-10 Jul 35	Maj. Roscoe C. Wriston	4 Jan 38-21 Jul 38
Maj. Leslie MacDill	10 Jul 35-18 Aug 35	Capt. James M. Fitzmaurice	21 Jul 38-6 Sep 38
Maj. William E. Farthing	18 Aug 35-12 Mar 36	Maj. Howard A. Craig	6 Sep 38-28 May 40
Maj. Jack C. Hodgson	12 Mar 36-3 Aug 36	Maj. James M. Fitzmaurice	28 May 40-15 Jul 40
Maj. Herbert M. Baisley	3 Aug 36-31 Aug 36	Maj. James P. Hodges	15 Jul 40-9 May 41
	Maj. Jarred V. Crabb	Maj. Jarred V. Crabb	9 May 41-ao Dec 41

21st Pursuit Squadron (35th Pursuit Group)

HQ-*Not organized* 1939-40; Moffett Field, CA, 1940-41; Hamilton Field, CA, 1941; Nichols Field, PI, 1941

Constituted in the Regular Army on 22 December 1939 and assigned to the 35th Pursuit Group. Activated on 1 February 1940 at Moffett Field, CA. Transferred on 10 September 1940 to Hamilton Field, CA. Relieved from the 35th Pursuit Group on 1 October 1941 and assigned to the 24th Pursuit Group. Departed from the port of San Francisco on the U.S.A.T. *President Coolidge* and arrived 20 November 1941 at Manila, PI. Transferred to Nichols Field, PI, on the same day. Location 7 December 1941—Nichols Field, PI.

Status: Active in the U. S. Air Force as the 21st Special Operations Squadron at RAF Mildenhall, UK.

Commanders, 21st Pursuit Squadron

Capt. Glenn O. Barcus	1 Feb 40-Sep 40	Maj. William E. Dyess	Sep 40-9 Apr 42
-----------------------	-----------------	-----------------------	-----------------

22nd Bombardment Squadron (7th Bombardment Group)

HQ-*Not organized* 1939-40; Hamilton Field, CA, 1940; Fort Douglas, UT, 1940-41

Constituted in the Regular Army on 22 December 1939 and assigned to the 7th Bombardment Group. Activated on 1 February 1940 at Hamilton Field, CA. Transferred on 7 September 1940 to Fort Douglas, UT. Ground elements departed from Salt Lake City 13 November 1941 and sailed from the port of San Francisco on 21 November on an army transport en route to the Philippines. Aircraft and crews began departing Muroc Field, CA, on 6 December en route to Hawaii. Elements of the squadron flew their B-17s into Hickam Field at the height of the Japanese attack on Pearl Harbor 7 December 1941. Location 7 December 1941—En route to the Philippines.

Status: Active in the U. S. Air Force as the 22nd Air Refueling Squadron at Mountain Home A.F.B., ID.

Commanders, 22nd Bombardment Squadron

Maj. John W. Warren	1 Feb 40-May 40	Capt. Joseph J. Ladd	May 40-May 41
	Capt. Kenneth B. Hobson	May 41-Sep 42	

22nd Observation Squadron (4th Division)

HQ-Post Field, OK, 1919-21; Maxwell Field, AL, 1921-31; Brooks Field, TX, 1931-41

Stationed at Post Field, OK, as of June 1919 as the 135th Aero Squadron and attached to the Field Artillery School. Assigned on 20 August 1920 to the Eighth Corps Area. Redesignated as the 22nd Squadron (Observation) on 14 March 1921. Transferred on 30 November 1921 to Maxwell Field, AL, and assigned to the Fourth Corps Area. Redesignated as the 22nd Observation Squadron on 25 January 1923. Assigned on 24 March 1923 to the 4th Division. Participated in the annual maneuvers of the 8th Infantry Brigade 1923-31. Relieved from assignment to the 4th Division on 15 February 1929 and assigned to the 14th Observation Group. Transferred on 28 June 1931 to Brooks Field, TX. Relieved from assignment to the 14th Observation Group on 30 June 1931 and assigned to the 12th Observation Group. Consolidated on 17 April 1937 with the 22nd Aero Squadron (a WWI unit organized on 16 June 1917 as the 17th Aero Squadron; redesignated as the 22nd Aero Squadron on 20 June 1917; demobilized on 16 June 1919 at Mitchel Field, NY; reconstituted on 17 April 1937). Relieved from assignment to the 12th Observation Group on 17 July 1937 and assigned to the 48th Observation Group (VIII Corps). Relieved from assignment to the 48th Observation Group on 3 October 1940 and assigned to the Third Army. Further assigned 15 November 1940 to the VIII Corps. Relieved from the VIII Corps 1 September 1941 and assigned to the 73rd Observation Group. Location 7 December 1941—Brooks Field, TX.

Status: Inactivated on 31 August 1946 as the 22nd Tactical Reconnaissance Squadron at Brooks Field, TX.

Events: 54, 94, 96, 121, 164, 184, 216, 242, 250, 258, 284, 288, 296, 299, 300

Commanders, 22nd Observation Squadron

2nd Lt. Fred H. Utley	ao Jan 20-1 Feb 20	Capt. William B. Mayer	28 Jul 31-13 Aug 31
Capt. Elmo N. Pickerill	1 Feb 20-1 Jun 20	Maj. Harry H. Young	13 Aug 31-7 Mar 32
1st Lt. Samuel M. Lunt	1 Jun 20-7 May 21	1st Lt. Armor S. Heffley	7 Mar 32-29 Jun 32
Maj. Thomas G. Lanphier	7 May 21-Oct 21	Capt. Robert Kauch	29 Jun 32-9 Oct 33
Capt. Harold M. McClelland	Oct 21-1 Nov 21	Capt. Arthur I. Ennis	9 Oct 33-1 Jan 35
Maj. Roy S. Brown	1 Nov 21-24 Jun 25	Capt. Benjamin F. Griffin	1 Jan 35-23 Sep 36
Maj. Harrison H. C. Richards	24 Jun 25-4 Aug 27	1st Lt. Joseph F. Carroll	23 Sep 36-12 Oct 36
1st Lt. Mervin E. Gross	4 Aug 27-4 Jul 28	Capt. Rueben Kyle, Jr.	12 Oct 36-10 Jul 37
Capt. Alfred F. King, Jr.	4 Jul 28-1 Oct 28	Capt. Don W. Mayhue	10 Jul 37-11 Sep 37
Capt. Donald P. Muse	1 Oct 28-25 Jun 31	Maj. Wendall B. McCoy	11 Sep 37-1 Mar 39
Capt. Calvin E. Giffin	25 Jun 31-7 Jul 31	Capt. Don W. Mayhue	1 Mar 39-ao Jul 41
Capt. Louis R. Knight	7 Jul 31-28 Jul 31	Unknown	ao Jul 41-7 Dec 41

22nd Pursuit Squadron (36th Pursuit Group)

HQ-*Not organized* 1939-40; Langley Field, VA, 1940-41; Losey Field, PR, 1941

Constituted in the Regular Army on 22 December 1939 and assigned to the 36th Pursuit Group. Activated on 1 February 1940 at Langley Field, VA. Departed 2 January 1941 from the port of Newport News on the U.S.A.T. *Chateau Thierry* for duty stations in Puerto Rico. Arrived 6 January 1941 at Ponce, PR. Transferred to Losey Field, PR, and, as part of the 36th Pursuit Group, assigned to the Caribbean Defense Command. Location 7 December 1941—Losey Field, PR.

Status: Active in the U. S. Air Force as the 22nd Fighter Squadron at Spangdahlem A.B., Germany.

Commanders, 22nd Pursuit Squadron

Unknown	1 Feb 40-Aug 40	Maj. Glenn O. Barcus	Aug 40-Jan 41
	Capt. John D. Stevenson	Jan 41-Jun 42	

22nd Service Squadron (32nd Attack Group)

HQ-*Not organized* 1933-38

Constituted in the Regular Army on 1 October 1933, assigned to the 32nd Attack Group, and allotted to the Eighth Corps Area. Disbanded on 1 January 1938.

23rd Bombardment Squadron (5th Composite Group)

HQ-March Field, CA, 1921-22; Luke Field, TH, 1922-39; Hickam Field, TH, 1939-41

Constituted in the Regular Army on 30 August 1921 and allotted to the Ninth Corps Area. Organized on 1 October 1921 at March Field, CA. Departed from the port of San Francisco 21 March 1922 on the U.S.A.T. *Buford* and arrived at Honolulu, TH, on 29 March 1922. Transferred to Luke Field, TH, the same day and assigned to the 5th Group (Observation) (later redesignated 5th Composite Group). Redesignated as the 23rd Bombardment Squadron on 25 January 1923. Consolidated on 8 April 1924 with the 23rd Aero Squadron (a WWI unit organized on 16 June 1917 as the 18th Aero Squadron at Kelly Field, TX; redesignated as the 23rd Aero Squadron (Repair) on 22 June 1917; demobilized on 23 March 1919 at Garden City, NY; reconstituted on 8 April 1924). Relieved from assignment to the 5th Composite Group on 8 May 1929 and assigned to the 19th Bombardment Group. Squadron remained attached to the 5th Composite Group for administrative purposes until December 1930. Conducted bombing missions on lava flows from the Mauna Loa volcano to divert them from the city of Hilo, TH, 27 December 1935. Relieved from assignment to the 19th Bombardment Group on 12 October 1938 and assigned to the 5th Bombardment Group. Transferred on 1 January 1939 to Hickam Field, TH. Location 7 December 1941—Hickam Field, TH.

Status: Active in the U. S. Air Force as the 23rd Bomb Squadron at Minot A.F.B., ND.

Events: 33, 75, 88, 120, 138, 141, 158, 189, 211, 225, 235, 248, 257, 276, 299, 297, 312

Commanders, 23rd Bombardment Squadron

Capt. Armin F. Herold	1 Oct 21-28 Feb 22	Capt. George P. Johnson	6 Nov 28-25 Apr 30
1st Lt. Albert B. Pitts	28 Feb 22-May 22	Capt. Frank H. Pritchard	25 Apr 30-1 Nov 30
Capt. Richard J. Kirkpatrick	May 22-16 Jan 23	1st Lt. Angier H. Foster	1 Nov 30-1 Apr 31
1st Lt. Frederick A. Johnson	16 Jan 23-13 Aug 23	1st Lt. John W. Warren	1 Apr 31-17 Feb 32
Maj. Karl H. Gorman	13 Aug 23-23 Nov 25	Capt. Raphael Baez, Jr.	17 Feb 32-12 Feb 35
Capt. Donald P. Muse	23 Nov 25-30 Nov 25	1st Lt. Jack W. Wood	12 Feb 35-1 Mar 35
1st Lt. Grandison Gardner	30 Nov 25-9 Apr 26	Maj. Arthur G. Liggett	1 Mar 35-7 Jul 36
Maj. Henry J. Miller	9 Apr 26-26 May 26	1st Lt. Maurice C. Bisson	7 Jul 36-7 Aug 36
1st Lt. Leo F. Post	26 May 26-26 Aug 26	1st Lt. Ford J. Lauer	7 Aug 36-ao Dec 36
Maj. Henry J. Miller	26 Aug 26-1 Dec 26	Unknown	ao Dec 36-ao Oct 38
Capt. Lloyd L. Harvey	1 Dec 26-1 Mar 28	Maj. Harold W. Benton	ao Oct 38-21 Dec 38
	Maj. LaVerne G. Saunders	21 Dec 38-Jan 42	

23rd Pursuit Squadron (36th Pursuit Group)

HQ-*Not organized* 1939-40; Kelly Field, TX, 1940-41; Losey Field, PR, 1941; St. Croix, VI, 1941; Losey Field, PR, 1941

Constituted in the Regular Army on 22 December 1939 and assigned to the 36th Pursuit Group. Activated on 1 February 1940 at Kelly Field, TX. Transferred on 17 November 1940 to Langley Field, VA. Departed 2 January 1941 from the port of Newport News on the U.S.A.T. *Chateau Thierry* for duty stations in Puerto Rico. Arrived 6 January 1941 at Ponce, PR. Transferred to Losey Field, PR, and, as part of the 36th Pursuit Group, assigned to the Caribbean Defense Command. Transferred on 31 May 1941 to St. Croix, VI. Transferred on 15 November 1941 to Losey Field, PR. Location 7 December 1941—Losey Field, PR.

Status: Active in the U. S. Air Force as the 23rd Fighter Squadron at Spangdahlem A.B., Germany.

Commanders, 23rd Pursuit Squadron

Capt. Joseph A. Bolger	1 Feb 40-Dec 40	1st Lt. Frederick W. Baggett	Dec 40-ao Jan 41
	Capt. Ralph E. Holmes	ao Nov 41-ao Dec 41	

23rd Service Squadron (33rd Attack Group)

HQ-*Not organized* 1933-35; Eighth Corps Area at large 1935-36; *Inactive* 1936-38

Constituted in the Regular Army on 1 October 1933, assigned to the 33rd Attack Group, and allotted to the Eighth Corps Area. Organized on 23 August 1935 with Organized Reserve personnel as a RAI unit in the Eighth Corps Area at large. Withdrawn from the Eighth Corps Area on 5 June 1936 and allotted to the Sixth Corps Area. Withdrawn from the Eighth Corps Area on 5 June 1936 and allotted to the Sixth Corps Area. Inactivated on 31 October 1936 by relief of Reserve personnel in the Eighth Corps Area. Chicago, IL, designated as headquarters location on organization, but the unit was never organized at that location. Disbanded on 1 January 1938.

Commanders, 23rd Service Squadron

Unknown **	23 Aug 35-5 Jun 36	<i>Inactive</i>	5 Jun 36-7 Dec 41
------------	--------------------	-----------------	-------------------

** RAI commanders: Organized Reserve officers.

24th Bombardment Squadron (23rd Composite Group)

HQ-Maxwell Field, FL, 1940; Orlando, FL, 1940-41; Eglin Field, FL, 1941

Constituted in the Regular Army on 1 August 1939 as the 24th Attack and Bombardment Squadron and assigned to the 23rd Composite Group. Redesignated as the 24th Bombardment Squadron on 28 September 1939. Activated on 1 December 1939 at Maxwell Field, AL. Transferred on 2 September 1940 to Orlando, FL. Transferred on 29 January 1941 to Eglin Field, FL. Location 7 December 1941—Eglin Field, FL.

Status: Inactive in the U. S. Air Force as the 24th Bombardment Squadron.

Commanders, 24th Bombardment Squadron

Maj. Joseph H. Atkinson	18 Feb 40-Sep 41	Unknown	Sep 41-7 Dec 41
-------------------------	------------------	---------	-----------------

24th Pursuit Squadron (6th Composite Group)

HQ-Mitchel Field, NY, 1921-22; France Field, CZ, 1922-32; Albrook Field, CZ, 1932-41

Constituted in the Regular Army on 30 August 1921 as the 24th Squadron (Pursuit) and assigned to the Panama Canal Department. Organized on 1 October 1921 at Mitchel Field, NY. Ground elements departed 30 April 1922 from the port of New York on the U.S.A.T. *Somme* en route to the Canal Zone. Air elements concurrently departed Mitchel Field and arrived several days later at France Field, CZ. Assigned on 27 May 1922 to the 6th Composite Group. Redesignated as the 24th Pursuit Squadron on 25 January 1923. Consolidated on 8 April 1924 with the 24th Aero Squadron (a WWI unit organized on 1 May 1917 as Company F, Provisional Aviation School Squadron; redesignated

as the 24th Aero Squadron on 23 July 1917; demobilized on 1 October 1919 at Park Field, TN; reconstituted on 8 April 1924). Relieved from assignment to the 6th Composite Group on 8 May 1928 but remained attached for command and control purposes. Assigned on 16 November 1930 to the 20th Pursuit Group. Relieved from assignment to the 20th Pursuit Group on 15 June 1932 and assigned to the 3rd Attack Wing. Transferred on 26 October 1932 to Albrook Field, CZ. Relieved from assignment to the 3rd Attack Wing 1 December 1932 and assigned to the 16th Pursuit Group. Squadron remained attached to the 6th Composite Group for administrative purposes. Participated in the “Goodwill Flights” to Guatemala 7-12 February 1938. Redesignated as the 24th Pursuit Squadron (Interceptor) on 6 December 1939. Location 7 December 1941—Albrook Field, CZ.

Status: Inactivated on 15 October 1946 as the 24th Fighter Squadron at France Field, CZ.

Events: 26, 31, 36, 40, 43, 58, 69, 81, 101, 102, 119, 140, 167, 170, 181, 223, 271, 292, 308, 333

Commanders, 24th Pursuit Squadron

Capt. Harry M. Smith	1 Oct 21-5 Nov 21	Capt. Albert M. Guidera	1 Aug 29-19 Aug 31
Capt. Truman W. Allen	5 Nov 21-17 Dec 21	Capt. Alvan C. Kincaid	19 Aug 31-1 Sep 32
Capt. Arthur E. Simonin	17 Dec 21-25 Mar 22	1st Lt. Charles E. Cabell	1 Sep 32-1 Jun 33
Capt. William E. Farthing	25 Mar 22-13 Apr 25	Maj. Allison M. Dixon	1 Jun 33-30 Apr 35
1st Lt. Walter H. Reid	13 Apr 25-7 May 25	Maj. Donald P. Muse	30 Apr 35-26 Sep 35
Capt. Thomas S. Voss	7 May 25-4 Jul 26	Maj. Guy B. Henderson	26 Sep 35-29 Oct 36
1st Lt. James T. Curry, Jr.	4 Jul 26-6 Nov 26	1st Lt. Leo W. DeRosier	29 Oct 36-21 Jul 37
1st Lt. Roderick N. Ott	10 Nov 26-14 Dec 26	1st Lt. Edward H. Underhill	21 Jul 37-15 Jul 38
Capt. Oliver W. Broberg	14 Dec 26-9 Aug 27	Capt. John J. O’ Hara	15 Jul 38-2 Jun 39
Capt. Arthur E. Simonin	9 Aug 27-13 Sep 28	1st Lt. Von R. Shores, Jr.	2 Jun 39-ao Jan 40
Maj. Paul T. Bock	13 Sep 28-1 Aug 29	Capt. Roger J. Browne	ao Apr 40-Jan 41
	Unknown		
		Jan 41-7 Dec 41	

25th Bombardment Squadron (6th Composite Group)

HQ—Mitchel Field, NY, 1921-22; France Field, CZ, 1922-41

Constituted in the Regular Army on 30 August 1921 as the 25th Squadron (Bombardment), and allotted to the Second Corps Area. Organized on 1 October 1921 at Mitchel Field, NY. Ground elements departed 30 April 1922 from the port of New York on the U.S.A.T. *Somme* en route to the Canal Zone. Air elements concurrently departed Mitchel Field and arrived several days later at France Field, CZ. Assigned to the Panama Canal Department upon arrival. Assigned on 27 May 1922 to the 6th Composite Group. Redesignated as the 25th Bombardment Squadron on 25 January 1923. Consolidated on 8 April 1924 with the 25th Aero Squadron (a WWI unit organized on 13 June 1917 as the 20th Aero Squadron; redesignated as the 25th Aero Squadron on 22 June 1917; demobilized on 17 June 1919 at Mitchel Field, NY; reconstituted on 8 April 1924). Participated in the “Goodwill Flights” to El Salvador and Nicaragua 13-19 May 1935, to Guatemala 8-11 February 1938, and to El Salvador 19-22 April 1938. Supported relief efforts for the Chilean earthquake 28 January-13 February 1939. Location 7 December 1941—France Field, CZ.

Status: Active in the U. S. Air Force as the 25th Space Control Tactics Squadron at Schriever A.F.B., CO.

Events: 26, 31, 36, 40, 43, 58, 69, 81, 101, 102, 119, 140, 167, 170, 181, 223, 271, 292, 308, 333

Commanders, 25th Bombardment Squadron

Capt. Harry M. Smith	1 Oct 21-5 Nov 21	1st Lt. Clarence F. Norton	19 Jun 29-14 Jul 29
Capt. Truman W. Allen	5 Nov 21-17 Dec 21	Capt. Albert M. Guidera	14 Jul 29-27 Jul 29
1st Lt. John E. Lynch	17 Dec 21-19 Jan 22	Maj. Edwin B. Lyon	27 Jul 29-7 Dec 30
Capt. Harry M. Smith	19 Jan 22-21 Feb 22	Capt. James A. Healy	7 Dec 30-10 Apr 31
Maj. Norman J. Boots	21 Feb 22-May 22	1st Lt. Harold D. Smith	10 Apr 31-25 Aug 31
Capt. Norbert Carolin	May 22-29 Nov 22	Capt. Roderick N. Ott	25 Aug 31-16 Mar 34
Capt. Harry M. Smith	29 Nov 22-6 Oct 24	1st Lt. William L. Scott, Jr.	16 Mar 34-28 Dec 34
1st Lt. Arthur K. Ladd	6 Oct 24-19 Mar 25	1st Lt. Bernard A. Bridget	28 Dec 34-25 Feb 35
1st Lt. Edward W. Raley	19 Mar 25-1 Sep 26	Maj. Richard H. Ballard	25 Feb 35-17 May 35
Capt. William N. Randolph	1 Sep 26-1 May 27	1st Lt. Neil B. Harding	17 May 35-13 Feb 37
Capt. Carl W. Connell	1 May 27-14 Jul 28	1st Lt. Charles G. Goodrich	13 Feb 37-8 Jul 37
1st Lt. Burton F. Lewis	14 Jul 28-13 Sep 28	Capt. Franklin C. Wolfe	8 Jul 37-9 Jul 39
Capt. Arthur E. Simonin	13 Sep 28-4 May 29	Maj. William R. Sweeley	9 Jul 39-ao Jun 40
1st Lt. William B. Souza	4 May 29-19 Jun 29	Unknown	ao Jun 40-7 Dec 41

26th Attack Squadron (1921-39) (3rd Attack Group)**26th Bombardment Squadron (1939-41)**

HQ-Kelly Field, TX, 1921-24; *Inactive* 1924-28; Galveston, TX, 1928-30; Wheeler Field, TH, 1930-40; Hickam Field, TH, 1940-41

Constituted in the Regular Army on 30 August 1921 as the 26th Squadron (Attack), and allotted to the Eighth Corps Area. Organized on 15 September 1921 at Kelly Field, TX, and assigned to the 3rd Attack Group. Redesignated as the 26th Attack Squadron on 25 January 1923. Consolidated on 8 April 1924 with the 26th Aero Squadron (a WWI unit organized on 26 May 1917 as the 1st Reserve Aero Squadron; redesignated as the 26th Aero Squadron on 1 October 1917; demobilized on 7 June 1919 at Mitchel Field, NY; reconstituted on 8 April 1924). Inactivated on 27 June 1924 at Kelly Field. Designated Active Associate was the 90th Attack Squadron 1924-27. Allotted to the Eighth Corps Area on 28 February 1927. Organized on 16 May 1928 with Organized Reserve personnel as a RAI unit at Galveston, TX. Conducted summer training at Fort Crockett, TX, with units of the 3rd Attack Group. Relieved from assignment to the 3rd Attack Group on 8 May 1929. Activated on 1 September 1930, less Reserve personnel, at Wheeler Field, TH, assigned to the 5th Composite Group, and attached to the 18th Pursuit Group. Relieved from assignment to the 5th Composite Group on 12 October 1938 and attached to the 18th Pursuit Group. Redesignated as the 26th Bombardment Squadron (Medium) on 6 December 1939. Relieved from attachment to the 18th Pursuit Group on 1 February 1940 and assigned to the 11th Bombardment Group. Concurrently, transferred to Hickam Field, TH. Redesignated as the 26th Bombardment Squadron (Heavy) on 11 December 1940. Location 7 December 1941—Hickam Field, TH.

Status: Active in the U. S. Air Force as the 26th Space Aggressor Squadron at Schriever A.F.B., CO.

Events: 39, 46, 55, 85, 141, 158, 248, 276, 297, 312

Commanders, 26th Attack Squadron

1st Lt. Lotha A. Smith	15 Sep 21-1 Nov 21	1st Lt. Nathan F. Twining	3 Sep 30-8 Mar 32
1st Lt. Byron E. Gates	1 Nov 21-6 Feb 22	1st Lt. Leonard H. Rodieck	8 Mar 32-1 Mar 34
Capt. Arthur B. McDaniel	6 Feb 22-3 Jul 22	Maj. Samuel G. Frierson	1 Mar 34-21 Sep 36
Capt. George P. Johnson	10 Jul 22-14 Sep 22	1st Lt. Richard H. Lee	21 Sep 36-16 Nov 36
1st Lt. Byron E. Gates	14 Sep 22-14 Jan 23	1st Lt. Raymond L. Winn	16 Nov 36-1 Dec 36
1st Lt. Lotha A. Smith	14 Jan 23-1 Oct 23	Maj. George A. McHenry	1 Dec 36-25 Nov 38
Capt. Joseph A. Davidson	1 Oct 23-27 Jun 24	Capt. George R. Acheson	25 Nov 38-26 Dec 39
<i>Inactive</i>	27 Jun 24-1 Sep 30	2nd Lt. Alvord Rutherford	26 Dec 39-1 May 40
1st Lt. Elmer L. Norris**	16 May 28-31 Aug 30	Maj. Richard E. Cobb	1 May 40-12 Nov 41
1st Lt. George P. Tourtellot	1 Sep 30-3 Sep 30	1st Lt. R. P. Salzarulo	12 Nov 41-13 Nov 41
	Maj. Andrew Meulenberg	13 Nov 41-20 Dec 41	

** RAI Commanders: Organized Reserve officers.

27th Pursuit Squadron (1st Pursuit Group)

HQ-Kelly Field, TX, 1919-21; Ellington Field, TX, 1921-22; Selfridge Field, MI, 1922-41

Stationed at Selfridge Field, MI, as of June 1919 as the 27th Aero Squadron. Assigned on 22 August 1919 to the 1st Pursuit Group. Transferred on 31 August 1919 to Kelly Field, TX. Redesignated as the 27th Squadron (Pursuit) on 14 March 1921. Transferred on 1 July 1921 to Ellington Field, TX. Transferred on 1 July 1922 to Selfridge Field, MI. Redesignated as the 27th Pursuit Squadron on 25 January 1923. Location 7 December 1941—Selfridge Field, MI.

Status: Active in the U. S. Air Force as the 27th Fighter Squadron at Langley A.F.B., VA.

Events: 29, 39, 46, 55, 71, 85, 104, 107, 131, 164, 165, 197, 213, 214, 227, 249, 252, 268, 283

Commanders, 27th Pursuit Squadron

1st Lt. Richard T. Aldworth	ao Dec 20-16 May 21	Capt. Lotha A. Smith	21 May 29-11 Jan 30
1st Lt. Harold A. McGinnis	16 May 21-29 Sep 21	1st Lt. Marion L. Elliot	11 Jan 30-30 Sep 30
1st Lt. Frank O' D. Hunter	29 Sep 21-3 Nov 21	Capt. Rowland C. W. Blessey	30 Sep 30-1 Jul 33
Capt. William F. Donnelly	3 Nov 21-5 Jan 22	1st Lt. Alfred A. Kessler	1 Jul 33-19 Nov 34
Capt. Burt E. Skeel	5 Jan 22-4 Oct 24	Capt. Rowland C. W. Blessey	19 Nov 34-27 Feb 35
1st Lt. Alfred J. Lyon	4 Oct 24-14 May 25	1st Lt. Alfred A. Kessler	27 Feb 35-1 Mar 35
1st Lt. Russell L. Meredith	14 May 25-14 Jul 25	Maj. James E. Parker	1 Mar 35-27 Aug 35
1st Lt. J. Thad Johnson†	14 Jul 25-2 Jul 27	Maj. Warren A. Maxwell	2 Sep 35-15 Jun 37
1st Lt. Louis C. Simon	2 Jul 27-5 Sep 27	Capt. Dixon M. Allison	15 Jun 37-5 Aug 37
1st Lt. Rex K. Stoner	5 Sep 27-23 Aug 28	Maj. Willis R. Taylor	5 Aug 37-Aug 41
1st Lt. Virgil Hine	23 Aug 28-21 May 29	Maj William E. Covington Jr.	Aug 41-Apr 42

27th Reconnaissance Squadron (25th Bombardment Group)

HQ—*Not organized* 1939-40; Langley Field, VA, 1939-40; Borinquen Field, PR, 1940-41

Constituted in the Regular Army on 16 September 1939 and assigned to the Puerto Rican Department. Concurrently, organized at Langley Field, VA. Ground elements departed from the port of Newport News on the U.S.A.T. *Chateau Thierry* on 17 November 1939 en route to Puerto Rico. Arrived 21 November 1939 at Borinquen Field, PR. The squadron was assigned to the Puerto Rican Department on arrival. Air elements departed Langley Field on 27 November and arrived at Borinquen Field on 5 December 1939. Attached to the 25th Bombardment Group in November 1940. Location 7 December 1941—Borinquen Field, PR.

Status: Inactive in the U. S. Air Force as the 417th Bombardment Squadron.

Events: 329

Commanders, 27th Reconnaissance Squadron

Maj. Delmar H. Dunton	16 Sep 39-Oct 40	Maj. Ivan M. Palmer	25 Apr 41-2 Nov 41
Maj. George W. McGregor	Oct 40-25 Apr 41	1st Lt. Norman L. Ballard	2 Nov 41-ao Jan 42

28th Bombardment Squadron (4th Composite Group)

HQ—Mather Field, CA, 1921-22 Clark Field, PI, 1922-23; Nichols Field, PI, 1923-38; Clark Field, PI, 1938-41

Constituted in the Regular Army on 30 August 1921 as the 28th Squadron (Bombardment) and assigned to the Ninth Corps Area. Organized on 20 September 1921 at Mather Field, CA. Consolidated on 9 January 1922 with the 28th Aero Squadron (a WWI unit organized on 22 June 1917 at Kelly Field, TX; demobilized on 16 June 1919 at Mitchel Field, NY; reconstituted on 9 January 1922). Inactivated on 28 June 1922 at Mather Field. Activated on 1 September 1922 at Clark Field, PI, and assigned to the Philippine Department. Assigned on 2 December 1922 to the 4th Composite Group. Redesignated as the 28th Bombardment Squadron on 25 January 1923. Transferred on 4 June 1923 to Nichols Field, PI. Transferred on 16 June 1938 to Clark Field. Redesignated as the 28th Bombardment Squadron (Medium) on 6 December 1939. Relieved from assignment to the 4th Composite Group on 16 November 1941 and assigned to the 19th Bombardment Group. Redesignated as the 28th Bombardment Squadron (Heavy) on 1 November 1941. Location 7 December 1941—Clark Field, PI.

Status: Active in the U. S. Air Force as the 28th Bomb Squadron at Dyess A.F.B., TX.

Events: 44, 51, 68, 138, 224, 245, 270, 333

Commanders, 28th Bombardment Squadron

1st Lt. George A. McHenry	20 Sep 21-26 Jan 22	Capt. Edward C. Black	1 Aug 30-15 Mar 33
1st Lt. Newman R. Laughinghouse	26 Jan 22-3 Apr 22	1st Lt. Jack Greer	15 Mar 33-21 Dec 33
1st Lt. Alfred E. Waller	3 Apr 22-6 Jun 22	1st Lt. Levi L. Beery	21 Dec 33-15 Mar 35
1st Lt. Mark R. Woodward	6 Jun 22-28 Jun 22	Maj. Thomas W. Hastey	15 Mar 35-5 Sep 35
<i>Inactive</i>	29 Jun 22-31 Aug 22	Capt. John S. Mills	5 Sep 35-29 Sep 35
Capt. Junius H. Houghton	1 Sep 22-1 May 23	Maj. Lionel H. Dunlap	29 Sep 35-6 Nov 36
Maj. Thomas J. Hanley, Jr.	1 May 23-9 Jan 24	Maj. Lloyd Barnett	6 Nov 36-1 Mar 37
Capt. Rosenham Beam	9 Jan 24-19 Apr 25	Capt. Julius T. Flock	1 Mar 37-10 Jul 37
Capt. Aubrey I. Eagle	19 Apr 25-27 Sep 26	1st Lt. Edward H. Porter	10 Jul 37-21 Feb 38
Capt. Dudley B. Howard	27 Sep 26-1 Dec 26	Maj. Guy L. McNeil	21 Feb 38-ao Sep 39
Capt. David S. Seaton	1 Dec 26-20 Apr 28	Maj. Lester Maitland	ao Jan 40-14 Mar 41
1st Lt. James A. Woodruff	20 Apr 28-21 Oct 28	Capt. Erickson S. Nichols	14 Mar 41-10 Jul 41
Capt. Arthur W. Brock	21 Oct 28-1 Aug 30	Maj. Maurice Daly	10 Jul 41-16 Nov 41
	Maj. William P. Fisher	16 Nov 41-5 Feb 42	

28th Pursuit Squadron (37th Pursuit Group)

HQ—*Not organized* 1939-40; Albrook Field, CZ, 1940-41

Constituted in the Regular Army on 22 December 1939 and assigned to the 37th Pursuit Group. Activated on 1 February 1940 at Albrook Field, CZ. Temporarily transferred to Rio Hato Field, CZ, 5 October 1940. Returned to Albrook Field 13 November 1940. Location 7 December 1941—Albrook Field, CZ.

Status: Inactivated on 25 June 1953 as the 28th Fighter-Bomber Squadron at Clovis A.F.B., NM.

Events: 292

Commanders, 28th Pursuit Squadron

1st Lt. Robert D. Gapen	1 Feb 40-May 40 Unknown	Maj. Russell E. Randall Sep 40-7 Dec 41	May 40-Sep 40
-------------------------	----------------------------	--	---------------

29th Bombardment Squadron (29th Bombardment Group)

HQ-Not organized 1939-40; Langley Field, VA, 1940-41

Constituted in the Regular Army on 22 December 1939 and assigned to the 29th Bombardment Group. Activated on 1 February 1940 at Langley Field, VA. Redesignated as the 43rd Bombardment Squadron (Heavy) on 13 March 1940.

Status: Active in the U.S. Air Force as the 43rd Flying Training Squadron at Columbus A.F.B., MS.

Events: 302

Commanders, 29th Bombardment Squadron

Capt. William D. Old	1 Feb 40-13 Mar 40
----------------------	--------------------

29th Pursuit Squadron (16th Pursuit Group)

HQ-Not organized 1923-33; Albrook Field, CZ, 1933-40; Rio Hato Airfield, CZ, 1940; Albrook Field, CZ, 1940-41

Constituted in the Regular Army on 23 March 1924, assigned to the 16th Pursuit Group, and allotted to the First Corps Area. Designated Active Associate was the 1st Pursuit Squadron 1923-27. Withdrawn from the First Corps Area on 19 February 1927 and allotted to the Second Corps Area. Withdrawn from the Second Corps Area on 1 September 1928 and allotted to the Eighth Corps Area. San Antonio, TX, designated as headquarters location on organization, but the unit was never organized at that location. Activated on 1 October 1933 at Albrook Field, CZ. Consolidated in 1935 with the 29th Aero Squadron (a WWI unit organized on 10 October 1918; demobilized on 12 September 1919 at Godman Field, KY; reconstituted in 1935). Participated in the "Goodwill Flight" to Guatemala 7-12 February 1938. Transferred on 5 October 1940 to Rio Hato Airfield, CZ. Transferred on 13 November 1940 to Albrook Field, CZ. Location 7 December 1941—Albrook Field, CZ.

Status: Inactivated on 27 April 1968 as the 29th Fighter-Interceptor Squadron.

Events: 292, 308, 333

Commanders, 29th Pursuit Squadron

1st Lt. Ernest R. Lawson	1 Oct 33-4 Dec 34	1st Lt. Norman D. Sillin	13 Feb 37-21 Apr 37
1st Lt. Joseph H. Atkinson	4 Dec 34-1 Mar 35	1st Lt. Stephen B. Mack	21 Apr 37-12 May 37
Maj. George H. Beverly	1 Mar 35-1 Oct 36	Capt. Donald B. Smith	12 May 37-15 Jun 39
1st Lt. Thayer S. Olds	1 Oct 36-13 Feb 37 Unknown	Capt. Dwight O. Montieth	15 Jun 39-May 41
		May 41-7 Dec 41	

30th Bombardment Squadron (7th Bombardment Group)

HQ-Not organized 1923-26; Third Corps Area on 1926-27; *Inactive* 1927-30; Kelly Field, TX, 1930-32; Rockwell Field, CA, 1932-35; March Field, CA, 1935-41; Albuquerque, NM, 1941; Clark Field, PI, 1941

Demobilized on 14 April 1919 at Mitchel Field, NY, as the 30th Aero Squadron. Reconstituted in the Regular Army on 24 March 1923 as the 30th Squadron (Bombardment), assigned to the 7th Bombardment Group, and allotted to the Third Corps Area. Designated Active Associate was the 20th Bombardment Squadron 1923-27. Redesignated as the 30th Bombardment Squadron on 25 January 1923. Organized on 30 June 1926 with Organized Reserve personnel as a RAI unit in the Third Corps Area. Withdrawn from the Third Corps Area on 28 February 1927 and allotted to the Ninth Corps Area. Withdrawn from the Ninth Corps Area on 1 September 1928 and allotted to the Eighth Corps Area. Organized on 15 January 1930 with Organized Reserve personnel as a RAI unit with headquarters at Kelly Field, TX. Activated on 24 June 1932, less Reserve personnel, at Rockwell Field, CA. Concurrently, relieved from assignment to the 7th Bombardment Group and assigned to the 19th Bombardment Group. Transferred on 25 October 1935 to March Field, CA. Redesignated as the 30th Bombardment Squadron (Heavy) on 6 December 1939. Transferred on 1 June 1941 to Albuquerque, NM. Departed from the port of San Francisco on 4 October 1941 on the U.S.A.T. *Willard A. Holbrook* and arrived at Manila, PI, on 23 October 1941. Transferred to Clark Field, PI, the same day. Location 7 December 1941—Clark Field, PI.

Status: Active in the U. S. Air Force as the USAF Air Demonstration Squadron (the “Thunderbirds”) at Nellis A.F.B., NV.

Events: 182, 195, 235, 252, 257, 268, 283, 289

Commanders, 30th Bombardment Squadron

Capt. Willis H. Hale**	30 Jun 26-28 Feb 27	Maj. James L. Grisham	5 May 35-1 Oct 35
<i>Inactive</i>	28 Feb 27-15 Jan 30	Maj. Albert F. Hegenberger	1 Oct 35-9 Jul 37
1st Lt. Charles B. Overacker, Jr.*	15 Jan 30-24 Jun 32	Maj. John K. Cannon	9 Jul 37-16 Aug 37
Capt. James L. Grisham	24 Jun 32-13 Apr 34	Capt. Carlyle I. Ferris	16 Aug 37-11 Sep 37
1st Lt. Walter W. Gross	13 Apr 34-23 May 34	Maj. Harry A. Halverson	11 Sep 37-17 Jul 39
1st Lt. Franklin C. Wolfe	23 May 34-9 Jul 34	Capt. Cecil E. Archer	17 Jul 39-10 Oct 40
1st Lt. Wentworth Goss	9 Jul 34-12 Sep 34	Maj. Thomas Blackburn	10 Oct 40-May 41
Capt. Carl W. Pyle	12 Sep 34-5 May 35	Maj. David R. Gibbs	May 41-10 Dec 41

* RAI Commanders: Regular Army officers.

** RAI Commanders: Organized Reserve officers.

30th Pursuit Squadron (37th Pursuit Group)

HQ-Not organized 1939-40; Albrook Field, CZ, 1940-41

Constituted in the Regular Army on 22 December 1939 and assigned to the 37th Pursuit Group. Activated on 1 February 1940 at Albrook Field, CZ. Location 7 December 1941—Albrook Field, CZ.

Status: Inactivated on 25 June 1953 as the 30th Fighter-Bomber Squadron at Clovis A.F.B., NM.

Events: 292, 333

Commanders, 30th Pursuit Squadron

1st. Lt. Carl T. Goldenberg	1 Feb 40-Oct 40	Unknown	Oct 40-7 Dec 41
-----------------------------	-----------------	---------	-----------------

31st Bombardment Squadron (7th Bombardment Group)

HQ-Not organized 1923-29; Kelly Field, TX, 1929-32; March Field, CA, 1931-34; Hamilton Field, CA, 1934-38; Hickam Field, TH, 1938-41

Demobilized on 14 April 1919 Camp Mills, LI, NY, as the 31st Aero Squadron. Reconstituted in the Regular Army on 24 March 1923 as the 31st Bombardment Squadron, assigned to the 7th Bombardment Group, and allotted to the Third Corps Area. Designated Active Associate was the 49th Bombardment Squadron 1923-27. Withdrawn from the Third Corps Area on 28 February 1927 and allotted to the Ninth Corps Area. Withdrawn from the Ninth Corps Area on 1 September 1928 and allotted to the Eighth Corps Area. Concurrently, relieved from assignment to the 7th Bombardment Group and assigned to the 19th Bombardment Group. Organized by June 1929 with Organized Reserve personnel as a RAI unit with headquarters at Kelly Field, TX. Organized Reserve officers assigned to the unit participated in summer training at Kelly Field 1929-30. Activated on 1 April 1931, less Reserve personnel, at March Field, CA. Concurrently,

relieved from assignment to the 19th Bombardment Group and assigned to the 7th Bombardment Group. Transferred on 5 December 1934 to Hamilton Field, CA. Departed from the port of San Francisco on the U.S.A.T. *Republic* on 1 February 1938 to reinforce the Hawaiian Department. Arrived at Honolulu, TH, on 8 February 1938 and transferred to Hickam Field, TH, the same day. Redesignated as the 31st Bombardment Squadron (Medium) on 6 December 1939. Location 7 December 1941—Hickam Field, TH.

Status: Active in the U. S. Air Force as the 31st Test and Evaluation Squadron at Edwards A.F.B., CA.

Events: 85, 142, 165, 182, 197, 201, 227, 235, 249, 289, 297, 312

Commanders, 31st Bombardment Squadron

Unknown**	Jun 29-1 Apr 31	1st Lt. Ralph A. Snively	29 Jun 32-6 Jan 34
Capt. Earle G. Harper	1 Apr 31-14 Oct 31	Maj. Harold D. Smith	6 Jan 34-16 Nov 36
Capt. Devereaux Myers	14 Oct 31-2 Nov 31	Maj. James G. Taylor	16 Nov 36-11 Jan 39
Capt. Earle G. Harper	2 Nov 31-1 Dec 31	Capt. Walter R. Agee	11 Jan 39-6 Mar 40
Capt. Harold W. Beaton	1 Dec 31-29 Jun 32	Capt. Hugh F. McCaffery	6 Mar 40-4 Mar 41
	Capt. Russell L. Waldron	4 Mar 41-23 Dec 41	

** RAI Commanders: Organized Reserve officers.

31st Pursuit Squadron (37th Pursuit Group)

HQ-Not organized 1939-40; Albrook Field, CZ, 1940; Rio Hato Airfield, CZ, 1940; Albrook Field, CZ, 1940-41

Constituted in the Regular Army on 22 December 1939 and assigned to the 37th Pursuit Group. Activated on 1 February 1940 at Albrook Field, CZ. Transferred on 5 October 1940 to Rio Hato Airfield, CZ. Transferred on 13 November 1940 to Albrook Field, CZ. Location 7 December 1941—Albrook Field, CZ.

Status: Inactivated on 8 October 1953 as the 31st Fighter-Interceptor Squadron at Elmendorf A.F.B., TA.

Events: 292, 333

Commanders, 31st Pursuit Squadron

1st. Lt. John R. Kelly	1 Feb 40-ao Jun 40	Unknown	ao Jun 40-7 Dec 41
------------------------	--------------------	---------	--------------------

32nd Bombardment Squadron (7th Bombardment Group)

HQ-Not organized 1923-26; Third Corps Area on 1925-27; *Inactive* 1927-29; Kelly Field, TX, 1929-32; Rockwell Field, CA, 1932-35; March Field, CA, 1935-41; Albuquerque, NM, 1941; Hamilton Field, CA, 1941

Demobilized on 14 April 1919 at Rockwell Field, CA, as the 32nd Aero Squadron. Reconstituted in the Regular Army on 24 March 1923 as the 32nd Bombardment Squadron, assigned to the 7th Bombardment Group and allotted to the Third Corps Area. Designated Active Associate was the 96th Bombardment Squadron 1923-27. Organized on 31 December 1925 with Organized Reserve personnel as a RAI unit with headquarters in the Third Corps Area. Withdrawn from the Third Corps Area on 28 February 1927 and allotted to the Ninth Corps Area. Withdrawn from the Ninth Corps Area on 1 September 1928 and allotted to the Eighth Corps Area. Organized by June 1929 with Organized Reserve personnel as a RAI unit with headquarters at Kelly Field, TX. Organized Reserve officers assigned to the unit participated in summer training at Kelly Field 1929-31. Activated on 24 June 1932, less Reserve personnel, at Rockwell Field, CA. Concurrently, relieved from assignment to the 7th Bombardment Group and assigned to the 19th Bombardment Group. Transferred on 25 October 1935 to March Field, CA. Transferred on 4 June 1941 to Albuquerque, NM. Transferred on 23 November 1941 to Hamilton Field, CA. Location 7 December 1941—Hamilton Field, CA.

Status: Active in the U. S. Air Force as the 32nd Air Refueling Squadron at McGuire A.F.B., NJ.

Events: 182, 195, 235, 257, 289

Commanders, 32nd Bombardment Squadron

Capt. Edward C. Block**	31 Dec 25-29 Jun 26	Capt. Morton H. McKinnon	1 Jul 34-1 Mar 35
Capt. Charles E. Rust**	30 Jun 26-28 Feb 27	Capt. Donald D. FitzGerald	1 Mar 35-16 Mar 35
<i>Inactive</i>	28 Feb 27-Jun 29	1st Lt. Wentworth Goss	16 Mar 35-Apr 35
Unknown**	Jun 29-24 Jun 32	Maj. Westside T. Larson	Apr 35-1 Oct 35
Capt. Horace N. Heisen	24 Jun 32-21 Apr 33	Maj. James L. Grisham	1 Oct 35-3 Sep 36
1st Lt. Donald D. FitzGerald	21 Apr 33-12 Jul 33	Maj. Walter H. Peck	3 Sep 36-9 Sep 38
Capt. Charles W. Sullivan	12 Jul 33-16 Feb 34	Maj. Eugene L. Eubank	9 Sep 38-17 Jul 39
Capt. Carlyle H. Ridenour	16 Feb 34-1 Jul 34	Capt. Archibald Y. Smith	17 Jul 39-15 Jun 40
	Capt. Leo W. DeRosier	15 Jun 40-10 Oct 41	

** RAI Commanders: Organized Reserve officers.

32nd Pursuit Squadron (36th Pursuit Group)

HQ-Not organized 1939-40; Kelly Field, TX, 1940; Langley Field, VA, 1940-41; Losey Field, PR, 1941

Constituted in the Regular Army on 22 December 1939 and assigned to the 36th Pursuit Group. Activated on 1 February 1940 at Kelly Field, TX. Transferred on 18 November 1940 to Langley Field, VA. Departed 2 January 1941 from the port of Newport News on the U.S.A.T. *Chateau Thierry* for duty stations in Puerto Rico. Arrived 6 January 1941 at Ponce, PR. Transferred to Losey Field, PR, and, as part of the 36th Pursuit Group, assigned to the Caribbean Defense Command. Location 7 December 1941—Losey Field, PR.

Status: Inactive in the U. S. Air Force as the 32nd Air Operations Squadron.

Commanders, 32nd Pursuit Squadron

Capt. T. J. Wiles	1 Feb 40-Oct 40	Capt. Charles A. Harrington	Oct 40-15 Jul 41
	Unknown	15 Jul 41-7 Dec 41	

33rd Bombardment Squadron (22nd Bombardment Group)

HQ-Not organized 1939-40; Patterson Field, OH, 1940; Langley Field, VA, 1940-41

Constituted in the Regular Army on 22 December 1939 and assigned to the 22nd Bombardment Group. Activated on 1 February 1940 at Patterson Field, OH. Transferred on 16 November 1940 to Langley Field, VA. Location 7 December 1941—Langley Field, VA.

Status: Active in the U. S. Air Force as the 33rd Flying Training Squadron at Vance A.F.B., OK.

Commanders, 33rd Bombardment Squadron

1st Lt. Theodore Q. Graff	1 Feb 40-25 Apr 40	1st Lt. Theodore Q. Graff	25 Jul 40-18 Nov 40
1st Lt. Vernet V. Poupitch	25 Apr 40-29 May 40	Maj. William Ball	18 Nov 40-15 May 41
1st Lt. Charles M. Stockdale	29 May 40-25 Jul 40	Maj. George H. Sparhawk	15 May 41-11 Aug 41
	Maj. Dwight Devine, II	11 Aug 41-12 Dec 41	

33rd Pursuit Squadron (8th Pursuit Group)

HQ-Not organized 1923-29; Kelly Field, TX, 1929-32; Langley Field, VA, 1932-40; Mitchel Field, NY, 1940-41

Demobilized on 14 April 1919 at Mitchel Field, NY, as the 33rd Aero Squadron. Reconstituted in the Regular Army on 24 March 1923 as the 33rd Pursuit Squadron, assigned to the 8th Pursuit Group, and allotted to the Sixth Corps Area. Designated Active Associate was the 17th Pursuit Squadron 1923-27. Withdrawn from the Sixth Corps Area on 28 February 1927 and allotted to the Ninth Corps Area. Withdrawn from the Ninth Corps Area on 1 September 1928 and allotted to the Eighth Corps Area. Concurrently, relieved from assignment to the 8th Pursuit Group and assigned to the 17th Pursuit Group. Organized by June 1929 with Organized Reserve personnel as a RAI unit with headquarters at Kelly Field, TX. Organized Reserve officers assigned to the unit participated in summer training at Kelly Field 1929-31. Activated on 25 June 1932, less Reserve personnel, at Langley Field, VA. Relieved from assignment to the 17th Pursuit Group on 1 March 1935 and assigned to the 8th Pursuit Group. Redesignated as the 33rd Pursuit Squadron (Fighter) on 6 December 1939. Redesignated as the 33rd Pursuit Squadron (Interceptor) on 12 March 1940.

Transferred on 14 November 1940 to Mitchel Field, NY. Ordered to Iceland and departed 27 July 1941 on the U.S.S. *Wasp*. Arrived off Iceland on 6 August 1941, and flying off the *Wasp*, landed at an airfield near Reykjavik. Assigned on arrival to the Iceland Base Command. Location 7 December 1941— Reykjavik, Iceland.

Status: Inactivated on 19 November 1956 as the 33rd Fighter-Bomber Squadron at Beach A.F.B., SC.

Events: 178, 196, 197, 200, 227, 249, 268, 283, 301

Commanders, 33rd Pursuit Squadron

Unknown**	Jun 29-1 Jun 31	Maj. Russell L. Maughn	10 Jul 37-22 Jul 37
Capt. Charles Douglas**	1 Jul 31-2 Jun 32	Capt. Allen R. Springer	22 Jul 37-5 Apr 38
Capt. Harold H. George	3 Jun 32-18 Feb 35	Maj. Russell L. Maughn	5 Apr 38-14 Aug 39
Maj. Newton Longfellow	18 Feb 35-26 Aug 35	Maj. Reuben C. Moffett	14 Aug 39-ao Apr 40
Capt. George F. Schulgen	26 Aug 35-10 Jul 37	Unknown	ao Apr 40-ao Oct 40
	Maj. Romulus W. Puryear	ao Oct 40-Feb 42	

** RAI Commanders: Organized Reserve officers.

34th Pursuit Squadron (I) (1923-35) (8th Pursuit Group)

Regular Army Inactive

34th Attack Squadron (1935-39)

34th Bombardment Squadron (1939-41)

HQ-Inactive 1923-29; Kelly Field, TX, 1929-31; March Field, CA, 1931-40; McChord Field, WA, 1940-41; Pendleton, OR, 1941

Demobilized on 10 June 1919 at Mitchel Field, NY, as the 34th Aero Squadron. Reconstituted in the Regular Army on 24 March 1923 as the 34th Pursuit Squadron, assigned to the 8th Pursuit Group and allotted to the Sixth Corps Area. Designated Active Associate was the 27th Pursuit Squadron 1923-27. Withdrawn from the Sixth Corps Area on 28 February 1927 and allotted to the Ninth Corps Area. Withdrawn from the Ninth Corps Area on 1 September 1928 and allotted to the Eighth Corps Area. Concurrently relieved from assignment to the 8th Pursuit Group and assigned to the 17th Pursuit. Organized by June 1929 with Organized Reserve personnel as a RAI unit with headquarters at Kelly Field, TX. Organized Reserve officers assigned to the unit participated in summer training at Kelly Field 1929-31. Activated on 15 July 1931, less Reserve personnel, at March Field, CA. Reorganized and redesignated as the 34th Attack Squadron on 1 March 1935 and assigned to the 17th Attack Group. Reorganized and redesignated as the 34th Bombardment Squadron on 17 October 1939 and assigned to the 17th Bombardment Group. Transferred on 24 June 1940 to McChord Field, WA. Transferred on 29 June 1941 to Pendleton, OR. Location 7 December 1941—Pendleton, OR.

Status: Active in the U. S. Air Force as the 34th Bomb Squadron at Ellsworth A.F.B., SD.

Events: 142, 195, 197, 201, 227, 231, 249, 257, 289, 290

Commanders, 34th Pursuit Squadron

34th Attack Squadron

34th Bombardment Squadron

Unknown**	Jun 29-1 Oct 31	Maj. Early E. W. Duncan	14 Mar 36-27 Jul 36
Capt. Charles Douglas	1 Oct 31-17 Jan 33	1st Lt. Nathan B. Forrest	27 Jul 36-12 Jan 37
1st Lt. John C. Crossthwaite	21 Jan 33-25 Jul 33	Maj. Albert C. Foulk	12 Jan 37-10 Jun 37
Capt. Charles Douglas	25 Jul 33-2 Sep 33	1st Lt. Robert H. Terrill	10 Jun 37-23 Aug 37
Capt. Ira C. Eaker	2 Sep 33-26 Nov 34	Maj. Emil C. Kiel	23 Aug 37-2 Aug 39
Maj. Walter R. Peck	26 Nov 34-14 Mar 36	Maj. John J. O'Hara, Jr.	2 Aug 39-14 Jan 41
	Unknown	15 Jan 41-7 Dec 41	

** RAI commanders: Organized Reserve officers.

34th Pursuit Squadron (II) (28th Composite Group)

HQ-Not organized 1939-40; Kelly Field, TX, 1940; Hamilton Field, CA, 1940-41; Del Carmen, Luzon, PI, 1941

Constituted in the Regular Army on 22 December 1939 and assigned to the 28th Composite Group. Activated on 1 February 1940 at Kelly Field, TX. Transferred on 30 November 1940 to Hamilton Field, CA. Relieved from the 28th Composite Group. Departed from the port of San Francisco on the U.S.A.T. *President Coolidge* and arrived at Manila, PI, on 20 November 1941. Transferred to Del Carmen, Luzon, PI, arriving there on 1 December 1941. Concurrently assigned to the 35th Pursuit Group. Location 7 December 1941—Del Carmen, Luzon, PI.

Status: Captured by the Japanese in April 1942 after fighting as infantry on Bataan; inactivated on 2 April 1946.

Commanders, 34th Pursuit Squadron

1st Lt. William P. Brett	1 Feb 40-ao Sep 40	Unknown	ao Sep 40-ao Nov 41
	1st Lt. Samuel W. Marrett	ao Nov 41-10 Dec 41	

35th Bombardment Squadron (25th Bombardment Group)

HQ-Not organized 1939-40; Langley Field, VA, 1940-41; Borinquen Field, PR, 1941; Coolidge Field, Antigua, 1941

Constituted in the Regular Army on 22 December 1939 and assigned to the 25th Bombardment Group. Activated on 1 February 1940 at Langley Field, VA. Ground elements departed from Fort Monroe, VA, on 27 October 1940 on an army transport and arrived 2 November 1940 at San Juan, PR. Aircraft and crews departed Langley Field on 1 November 1940 for Borinquen Field, PR, and arrived several days later. Transferred on 11 November 1941 to Coolidge Field, Antigua. Location 7 December 1941—Coolidge Field, Antigua.

Status: Inactivated on 27 June 1949 as the 35th Bombardment Squadron (Light) at Phillips Field, MD.

Commanders, 35th Bombardment Squadron

Capt. Karl Truesdell, Jr.	3 Jul 40-9 Sep 40	Unknown	9 Sep 40-7 Dec 41
---------------------------	-------------------	---------	-------------------

35th Pursuit Squadron (8th Pursuit Group)

HQ-Not organized 1923-29; Kelly Field, TX, 1929-32; Langley Field, VA, 1932-40; Mitchel Field, NY, 1940-41

Demobilized on 19 March 1919 at Garden City, NY, as the 35th Aero Squadron. Reconstituted in the Regular Army on 24 March 1923 as the 35th Pursuit Squadron, assigned to the 8th Pursuit Group, and allotted to the Sixth Corps Area. Designated Active Associate was the 94th Pursuit Squadron 1923-27. Withdrawn from the Sixth Corps Area on 28 February 1927 and allotted to the Ninth Corps Area. Withdrawn from the Ninth Corps Area on 1 September 1928 and allotted to the Eighth Corps Area. Organized by June 1929 with Organized Reserve personnel as a RAI unit with headquarters at Kelly Field, TX. Organized Reserve officers assigned to the unit participated in summer training at Kelly Field 1929-31. Activated on 25 June 1932, less Reserve personnel, at Langley Field, VA. Redesignated as the 35th Pursuit Squadron (Fighter) on 6 December 1939. Transferred on 14 November 1940 to Mitchel Field, NY. Redesignated as the 35th Pursuit Squadron (Interceptor) on 12 March 1941. Location 7 December 1941—Mitchel Field, NY.

Status: Active in the U. S. Air Force as the 35th Fighter Squadron at Kunsan A.B. South Korea.

Events: 178, 196, 197, 200, 227, 249, 301

Commanders, 35th Pursuit Squadron

Unknown**	Jun 29-25 Jun 32	1st Lt. Henry W. Dorr	31 Aug 34-4 Feb 35
Maj. Byron Q. Jones	25 Jun 32-30 Jun 32	Maj. Alfred E. Waller	4 Feb 35-10 Jul 36
Capt. Marion L. Elliott	30 Jun 32-11 Jul 32	Capt. Glenn O. Barcus	10 Jul 36-19 May 39
Capt. Albert M. Guidera	11 Jul 32-27 Jul 32	Maj. Edward M. Morris	19 May 39-1 Feb 40
Capt. Alfred E. Waller	27 Jul 32-20 Jun 34	Capt. Francis H. Griswold	1 Feb 40-Feb 41
1st Lt. Jack C. Hodgson	20 Jun 34-31 Aug 34	Capt. Charles W. Stark Jr.	Feb 41-23 Apr 41
	Maj. William H. Wise	23 Apr 41-Jan 42	

** RAI commanders: Organized Reserve officers.

36th Bombardment Squadron (28th Composite Group)

HQ-Not organized 1939-40; March Field, CA, 1940; Lowry Field, CO, 1940-41; Elmendorf Field, TA, 1941

Constituted in the Regular Army on 22 December 1939 and assigned to the 28th Composite Group. Activated on 1 February 1940 at March Field, CA. Transferred on 9 August 1940 to Lowry Field, CO. Transferred on 31 March 1941 to Elmendorf Field, TA. Location 7 December 1941—Elmendorf Field, TA.

Status: Inactivated on 15 December 1945 at Camp Kilmer, NJ.

Commanders, 36th Bombardment Squadron

Maj. William O. Eareckson 1 Feb 40-28 May 41 Unknown 29 May 41-7 Dec 41

36th Pursuit Squadron (8th Pursuit Group)

HQ-Not organized 1923-29; Kelly Field, TX, 1929-30; Selfridge Field, MI, 1930-32; Langley Field, VA, 1932-40; Mitchel Field, NY, 1940-41

Demobilized on 7 April 1919 at Garden City, NY, as the 36th Aero Squadron. Reconstituted in the Regular Army on 24 March 1923 as the 36th Pursuit Squadron, assigned to the 8th Pursuit Group and allotted to the Sixth Corps Area. Designated Active Associate was the 95th Pursuit Squadron 1923-27. Withdrawn from the Sixth Corps Area on 28 February 1927 and allotted to the Ninth Corps Area. Withdrawn from the Ninth Corps Area on 1 September 1928 and allotted to the Eighth Corps Area. Organized by June 1929 with Organized Reserve personnel as a RAI unit with headquarters at Kelly Field, TX. Organized Reserve officers assigned to the unit participated in summer training at Kelly Field 1929-31. Activated on 2 October 1930, less Reserve personnel, at Selfridge Field, MI. Relieved from assignment to the 8th Pursuit Group on 30 January 1931 and assigned to the 18th Pursuit Group. Transferred on 13 January 1932 to Langley Field, VA. Relieved from assignment to the 18th Pursuit Group on 15 June 1932 and assigned to the 8th Pursuit Group. Redesignated as the 36th Pursuit Squadron (Fighter) on 6 December 1939. Transferred on 15 November 1940 to Mitchel Field, NY. Redesignated as the 36th Pursuit Squadron (Interceptor) on 12 March 1941. Location 7 December 1941—Mitchel Field, NY.

Status: Active in the U. S. Air Force as the 36th Fighter Squadron at Osan A.B. South Korea.

Events: 141, 158, 178, 196, 197, 200, 227, 249, 252, 268, 283, 301

Commanders, 36th Pursuit Squadron

Unknown** Jun 29-1 Oct 30 Maj. Rex K. Stoner 20 Apr 35-7 Jul 36
1st Lt. Ennis C. Whitehead 2 Oct 30-25 Jun 32 Maj. Ned Schramm 7 Jul 36-1 Feb 40
2nd Lt. Henry W. Dorr 25 Jun 32-ao Jul 32 Capt. Frederic H. Smith, Jr. 1 Feb 40-Feb 41
Unknown ao Jul 32-20 Apr 35 Maj. Norman D. Sillin Feb 41-6 Nov 41

** RAI commanders: Organized Reserve officers.

37th Pursuit Squadron (1923-35) (16th Pursuit Group)

37th Attack Squadron (1935-39)

37th Bombardment Squadron (1939-41)

HQ-Not organized 1923-33; Langley Field, VA, 1933-38; *Inactive* 1938-40; Barksdale Field, LA, 1940; Lowry Field, CO, 1940-41; Pendleton, OR, 1941

Demobilized on 15 April 1919 at Mitchel Field, NY, as the 37th Aero Squadron. Reconstituted in the Regular Army on 24 March 1923 as the 37th Pursuit Squadron and assigned to the 16th Pursuit Group. Designated Active Associate was the 16th Observation Squadron 1923-27. Allotted to the Seventh Corps Area on 28 February 1927. Withdrawn from the Seventh Corps Area on 1 September 1928 and allotted to the Eighth Corps Area. Kelly Field, TX, designated as headquarters location on organization, but the unit was never organized at that location. Relieved from assignment to the 16th Pursuit Group on 15 June 1932 and assigned to the 18th Pursuit Group. Activated on 1 September 1933 at Langley Field, VA. Reorganized and redesignated 37th Attack Squadron on 1 March 1935, relieved from the 18th Pursuit Group, and attached to the 8th Pursuit Group. Inactivated on 31 January 1938 at Langley Field, VA, and

allotted to the Fourth Corps Area. Shreveport, LA, designated as headquarters location on organization, but the unit was never organized at that location. Redesignated as the 37th Bombardment Squadron (Medium) on 1 December 1939 and assigned to the 17th Bombardment Group. Relieved from assignment to the 17th Bombardment Group on 1 February 1940, activated at Barksdale Field, LA, and assigned to the 28th Composite Group. Transferred on 10 July 1940 to Lowry Field, CO. Transferred on 29 January 1941 to Pendleton, OR. Relieved from assignment to the 28th Composite Group on 23 April 1941 and assigned to the 17th Bombardment Group. Location 7 December 1941—Pendleton, OR.

Status: Active in the U. S. Air Force as the 37th Bomb Squadron at Ellsworth A.F.B., SD.

Events: 289

Commanders, 37th Pursuit Squadron

37th Attack Squadron

37th Bombardment Squadron

Maj. Caleb V. Haynes	1 Sep 33-18 Jul 35	Maj. Russell L. Maughn	16 Aug 37-31 Jan 38
Capt. Ned Schramm	18 Jul 35-7 Jul 36	<i>Inactive</i>	31 Jan 38-1 Feb 40
Maj. William C. Goldsborough	7 Jul 36-3 Aug 37	Maj. William C. Mills	1 Feb 40-ao Jun 41
Capt. David M. Ramsey	3 Aug 37-16 Aug 37	Unknown	ao Jun 41-7 Dec 41

38th Pursuit Squadron (1923-35) (16th Pursuit Group)

38th Observation Squadron (1935-36)

38th Reconnaissance Squadron (1936-41)

HQ-*Not organized* 1923-33; Selfridge Field, MI, 1933-35; *Inactive* 1935-36; March Field, CA, 1936-41; Albuquerque, NM, 1941.

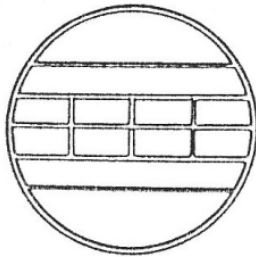

Constituted in the Regular Army on 24 March 1923 as the 38th Pursuit Squadron and assigned to the 16th Pursuit Group. Designated Active Associate was the 88th Observation Squadron 1923-27. Designated mobilization station was Wright Field, OH, 1923-33. Allotted to the Fifth Corps Area on 28 February 1927. Withdrawn from the Fifth Corps Area on 1 September 1928 and allotted to the Eighth Corps Area. Kelly Field, TX, designated as headquarters location on organization, but the unit was never organized at that location. Activated on 1 August 1933 at Selfridge Field, MI. Relieved from assignment to the 16th Pursuit Group on 15 June 1932 and assigned to the 18th Pursuit Group. Consolidated in 1933 with the 38th Aero Squadron (a WWI unit organized in July 1917 at Chanute Field, IL, ; demobilized on 1 December 1918 at Chanute Field, IL; reconstituted in 1933). Reorganized

and redesignated 38th Observation Squadron (Long Range, Light Bombardment) on 1 March 1935, assigned to the 1st Wing, and inactivated at Selfridge Field. Redesignated as the 38th Reconnaissance Squadron on 1 September 1936 and activated at March Field, CA. Conducted reconnaissance and photographic missions in connection with floods in southern California 3-15 March 1938. Transferred on 5 June 1941 to Albuquerque, NM. Transferred on 22 November 1941 to Hamilton Field, CA. Ground elements departed from the port of San Francisco on 6 December on an army transport en route to the Philippines. Aircraft and crews began departing Hamilton Field, CA, on 6 December en route to Hawaii. Elements of the squadron flew their B-17s into Hickam Field at the height of the Japanese attack on Pearl Harbor. Location 7 December 1941—Hickam Field, TH.

Status: Disbanded on 1 January 1962 as the 427th Bombardment Squadron (Medium).

Events: 257, 289

Commanders, 38th Pursuit Squadron

38th Reconnaissance Squadron

Maj. Warren A. Maxwell	1 Aug 33-1 Mar 35	Capt. Charles B. Overacker, Jr.	20 Jul 37-26 Jul 37
<i>Inactive</i>	Mar 35-1 Sep 36	Maj. Harry A. Halvorson	26 Jul 37-16 Aug 37
Maj. William S. Gravely	1 Sep 36-20 Jul 37	Maj. Paul H. Prentiss	16 Aug 37-Jan 40
	Maj. Truman H. Landon	Jan 40-Jan 42	

39th School Squadron (I) (10th School Group)

HQ-Ellington Field, TX, 1922

Authorized in the Regular Army on 10 June 1922 as the 40th Squadron (School), assigned to the 10th School Group, and allotted to the Eighth Corps Area. Organized on 27 June 1922 at Ellington Field, TX, with personnel from the 94th Squadron (Pursuit). Demobilized on 31 August 1922.

Commanders, 39th School Squadron

Capt. Byrne V. Baucom 27 Jun 22-31 Aug 22

39th School Squadron (II) (1923-35) (14th School Group)

39th Observation Squadron (1935-41)

HQ-*Not organized* 1923-27; Kelly Field, TX, 1927-36; *Inactive* 1936; Fort Worth, TX, 1936-40; France Field, CZ, 1940-41



Constituted in the Regular Army on 6 February 1923 as the 39th School Squadron and assigned to the 14th School Group. Designated Active Associate was the 40th School Squadron 1923-27. Allotted to the Eight Corps Area on 28 February 1927. Activated on 1 August 1927 at Kelly Field, TX, relieved from assignment to the 14th School Group and assigned to the 10th School Group. Relieved from assignment to the 10th School Group on 16 July 1931 and attached to the Air Corps Advanced Flying School. Consolidated in 1933 with the 39th Aero Squadron (a WWI unit organized in July 1917 at Kelly Field, TX; demobilized on 19 November 1918 at Rich Field, TX; reconstituted in 1933). Redesignated as the 39th Observation Squadron on 1 March 1935. Inactivated on 1 September 1936 at Kelly Field, TX, and allotted to the Eighth Corps Area. Organized on 25 November 1936 with Organized Reserve personnel as a RAI unit with headquarters at Fort Worth, TX.

Subordinate flights concurrently organized as follows: Flight A at Houston, TX; Flight B at El Paso, TX; Flight C at Raton, NM. Activated on 1 February 1940, less Reserve personnel, at France Field, CZ, and assigned to the Panama Canal Department. Further assigned to the Panama Canal Air Force 20 November 1940. Location 7 December 1941—France Field, CZ.

Events: 195, 292, 333

Commanders, 39th School Squadron

39th Observation Squadron

1st Lt. Robert H. Finley	1 Aug 27-4 Nov 28	Capt. George A. Whatley	11 Aug 36-1 Sep 36
2nd Lt. Harold A. Wheaton	4 Nov 28-31 Jan 29	<i>Inactive</i>	1 Sep 36-25 Nov 36
Capt. Perry Wainer	31 Jan 29-1 Nov 31	Capt. Edward V. Pettis**	25 Nov 36-1 Feb 40
1st Lt. Max F. Schneider	1 Nov 31-28 Nov 31	1st Lt. Graeme S. Bond	1 Feb 40-5 Apr 40
Maj. Ulysses G. Jones	28 Nov 31-11 Aug 36	Capt. Donald N. Wackwitz	5 Apr 40-ao Jun 40
	Unknown	ao Jun 40-7 Dec 41	

** RAI Commanders: Organized Reserve officers.

39th Pursuit Squadron (31st Pursuit Group)

HQ-*Not organized* 1939-40; Selfridge Field, MI, 1940-41; Baer Field, IN, 1941

Constituted in the Regular Army on 22 December 1939 and assigned to the 31st Pursuit Group. Activated on 1 February 1940 at Selfridge Field, MI. Transferred on 6 December 1941 to Baer Field, IN. Location 7 December 1941—Baer Field, IN.

Status: Active in the U. S. Air Force as the 39th Flying Training Squadron at Moody A.F.B., GA.

Commanders, 39th Pursuit Squadron

Capt Allen R. Springer	1 Feb 40-16 Jan 41	Capt William T. Clingerman Jr.	16 Jan 41-5 Mar 41
	1st Lt. Marvin L. McNickle	5 Mar 41-19 Jan 42	

40th Pursuit Squadron (31st Pursuit Group)

HQ-*Not organized* 1939-40; Selfridge Field, MI, 1940-41; Baer Field, IN, 1941

Constituted in the Regular Army on 22 December 1939, assigned to the 31st Pursuit Group, and allotted to the Fourth Corps Area. Activated on 1 February 1940 at Selfridge Field, MI. Transferred on 6 December 1941 to Baer Field, IN. Location 7 December 1941—Baer Field, IN.

Status: Active in the U. S. Air Force as the 40th Flight Test Squadron at Eglin A.F.B., FL.

Commanders, 40th Pursuit Squadron

Maj. John F. Egan	1 Feb 40-Dec 40	Capt. Albert P. Clark	Dec 40-ao Feb 41
	1st Lt. Fred M. Dean	ao Sep 41-ao Oct 41	

40th School Squadron (1922-35) (10th School Group)

40th Attack Squadron (1935-40)

HQ-Kelly Field, TX, 1922-36; *Inactive* 1936-37; Brownsville, TX, 1937-40

Authorized in the Regular Army on 10 June 1922 as the 40th Squadron (School), assigned to the 10th School Group, and allotted to the Eighth Corps Area. Organized on 7 July 1922 at Kelly Field, TX. Redesignated as the 40th School Squadron on 25 January 1923. Consolidated on 8 April 1924 with the 40th Aero Squadron (a WWI unit organized on 5 June 1917 at Kelly Field, TX; demobilized on 10 June 1919 at Selfridge Field, MI; reconstituted on 8 April 1924). Relieved from assignment to the 10th School Group on 16 July 1931 and assigned to the Air Corps Advanced Flying School. Reorganized and redesignated 40th Attack Squadron on 1 March 1935 and attached to the Air Corps Advanced Flying School. Relieved from the Air Corps Advanced Flying School 1 September 1936, assigned to the General Headquarters Air Force, and inactivated at Kelly Field, TX. Organized in March 1937 with Organized Reserve personnel as a RAI unit at Brownsville Municipal Airport, Brownsville, TX. Disbanded on 1 July 1940.

**Commanders, 40th School Squadron
40th Attack Squadron**

Capt. Walter F. Kraus	7 Jul 22-1 Aug 22	1st Lt. George H. Steele	24 Aug 31-15 Oct 31
1st Lt. Wallis A. Frederick	1 Aug 22-Jan 23	Capt. Thomas S. Voss	15 Oct 31-28 Feb 35
Capt. William E. Lynd	Jan 23-20 Sep 23	Maj. James A. Healy	1 Mar 35-18 Jun 36
Capt. Albert Guidera	20 Sep 23-1 Dec 24	Capt. James M. Fitzmaurice	18 Jun 36-28 Jul 36
Capt. Frederick I. Eglin	1 Dec 24-3 May 27	Maj. Leland R. Hewitt	28 Jul 36-8 Aug 36
Capt. Arthur E. Easterbrook	3 May 27-17 Apr 28	Maj. Arthur G. Liggett	8 Aug 36-1 Sep 36
Capt. William E. Lynd	17 Apr 28-12 Jun 29	<i>Inactive</i>	1 Sep 36-Mar 37
1st Lt. John W. Monahan	12 Jun 29-24 Aug 31	Maj. Daniel E. Ellis**	Mar 37-1 Jul 40

** RAI Commanders: Organized Reserve officers.

41st Pursuit Squadron (31st Pursuit Group)

HQ-*Not organized* 1939-40; Bolling Field, DC, 1940; Selfridge Field, MI, 1940-41; Baer Field, IN, 1941

Constituted in the Regular Army on 22 December 1939, assigned to the 31st Pursuit Group, and allotted to the Fourth Corps Area. Activated on 1 February 1940 at Bolling Field, DC. Transferred on 21 October 1940 to Selfridge Field, MI. Transferred on 6 December 1941 to Baer Field, IN. Location 7 December 1941—Baer Field, IN.

Status: Active in the U. S. Air Force as the 41st Flying Training Squadron at Columbus A.F.B., MS.

Commanders, 41st Pursuit Squadron

Capt. Edward W. Anderson	1 Feb 40-Jan 41	Capt. Paul B. Wurtsmith	Jan 41-7 Dec 41
--------------------------	-----------------	-------------------------	-----------------

41st School Squadron (1922-35) (10th School Group)

41st Observation Squadron (1935-36)

41st Reconnaissance Squadron (1936-41) (2nd Bombardment Group)

HQ-Kelly Field, TX, 1922-36; *Inactive* 1936-37; Love Field, Dallas, TX, 1937-38; *Inactive* 1938-40; Langley Field, VA, 1940-41; Newfoundland Air Base, Newfoundland, 1941



Authorized in the Regular Army on 10 June 1922 as the 40th Squadron (School), assigned to the 10th School Group, and allotted to the Eighth Corps Area. Organized on 7 July 1922 at Kelly Field, TX. Redesignated as the 41st School Squadron on 25 January 1923. Consolidated on 8 April 1924 with the 41st Aero Squadron (a WWI unit organized on 16 June 1917 at Kelly Field, TX; demobilized on 2 July 1919 at Camp Lee, VA; reconstituted on 8 April 1924). Relieved from assignment to the 10th School Group on 16 July 1931. Reorganized and redesignated 1 March 1935 as the 41st Observation Squadron (Long Range, Amphibian), assigned to the 2nd Wing, and attached to the Air Corps Advanced Flying School. Redesignated as the 41st Reconnaissance Squadron on 1 September 1936, inactivated at Kelly Field, TX, and allotted to the Eighth Corps Area. Organized on 20 January 1937 with Organized Reserve personnel as a RAI unit at Love Field, Dallas, TX.

Withdrawn from the Eighth Corps Area on 1 January 1938 and allotted to the Third Corps Area. Activated on 1 February 1940 at Langley Field, VA, and assigned to the 2nd Bombardment Group. Redesignated as the 41st Reconnaissance Squadron (Heavy) on 20 November 1940. Transferred on 28 August 1941 to Newfoundland Air Base, Newfoundland. Location 7 December 1941—Newfoundland Air Base, Newfoundland.

Status: Inactive in the U. S. Air Force as the 429th Bombardment Squadron.

Commanders, 41st School Squadron

41st Observation Squadron

41st Reconnaissance Squadron

Capt. Earl H. DeFord	7 Jul 22-1 Sep 22	1st Lt. Elmer D. Perrin	25 Mar 30-7 Jul 30
1st Lt. Walter D. Peck	1 Sep 22-1 Dec 22	1st Lt. Emil C. Kiel	7 Jul 30-6 Sep 31
1st Lt. Earl H. DeFord	1 Dec 22-4 Mar 23	1st Lt. Elmer D. Perrin	6 Sep 31-24 Sep 31
1st Lt. Walter D. Peck	4 Mar 23-4 May 23	1st Lt. Russell C. MacDonald	24 Sep 31-1 Oct 31
1st Lt. Earl H. DeFord	4 May 23-1 Mar 24	Capt. Christopher W. Ford	1 Oct 31-10 Aug 32
Capt. Charles B. B. Bubb	1 Mar 24-8 Aug 24	1st Lt. George H. Steele	10 Aug 32-19 Oct 32
Capt. Gilbert T. Collar	8 Aug 24-23 Oct 25	1st Lt. Russell C. MacDonald	19 Oct 32-13 Jul 33
1st Lt. George E. Rice	23 Oct 25-3 Dec 25	Maj. John A. Laird, Jr.	13 Jul 33-1 Oct 35
Capt. Rosenham Beam	3 Dec 25-7 Oct 26	Maj. William R. Sweeley	1 Oct 35-1 Sep 36
1st Lt. James G. Taylor	7 Oct 26-1 Nov 26	<i>Inactive</i>	1 Sep 36-20 Jan 37
1st Lt. Delmar H. Dunton	1 Nov 26-27 Sep 27	Capt. Joseph T. Shumate, Jr.**	20 Jan 37-1 Jan 38
1st Lt. William W. Welsh	27 Sep 27-1 Apr 28	<i>Inactive</i>	1 Jan 38-1 Feb 40
1st Lt. Arthur Thomas	1 Apr 28-5 Jul 28	Maj. Caleb V. Haynes	1 Feb 40-Mar 41
Capt. John I. Moore	5 Jul 28-1 Aug 29	Capt. Carl T. Goldenberg	Mar 41-Oct 41
1st Lt. Emil Kiel	1 Aug 29-25 Mar 30	Maj. Richard T. King, Jr.	Oct 41-Feb 42

** RAI Commanders: Organized Reserve officer.

41st Service Squadron (41st Observation Group)

Regular Army Inactive

HQ-*Not organized* 1933-34; Providence, RI, 1934-41

Constituted in the Regular Army on 1 October 1933, assigned to the 41st Observation Group (I Corps), and allotted to the First Corps Area. Organized by December 1934 with Organized Reserve personnel as a RAI unit at Providence, RI. Relieved from the 41st Observation Group on 1 January 1938. Concurrently reorganized and redesignated 41st Air Base Squadron. Disbanded on 17 January 1941.

Commanders, 41st Service Squadron

Unknown** ao Dec 34-17 Jan 41

** RAI commanders: Organized Reserve officers.

42nd School Squadron (1922-36) (10th School Group)

42nd Bombardment Squadron (1935-41) (11th Bombardment Group)

HQ-Kelly Field, TX, 1922-36; Brownsville, TX, 1936-40; Hickam Field, TH, 1940-41

Authorized in the Regular Army on 10 June 1922 as the 42nd Squadron (School), assigned to the 10th School Group, and allotted to the Eighth Corps Area. Organized on 5 July 1922 at Kelly Field, TX. Redesignated as the 42nd School Squadron on 25 January 1923. Consolidated on 8 April 1924 with the 42nd Aero Squadron (a WWI unit organized in July 1917 at Kelly Field, TX; demobilized on 21 February 1919 at Wright Field, OH; reconstituted on 8 April 1924). Relieved from assignment to the 10th School Group on 16 July 1931 and assigned to the Air Corps Advanced Flying School. Reorganized and redesignated 42nd Bombardment Squadron on 1 March 1935, assigned to the 3rd Wing, and attached to the Air Corps Advanced Flying School. Inactivated on 1 September 1936 at Kelly Field, TX, and allotted to the Eighth Corps Area. Organized on 23 November 1936 with Organized Reserve personnel as a RAI unit with headquarters at Brownsville Municipal Airport, Brownsville, TX. Redesignated as the 42nd Bombardment Squadron (Medium) on 22 December 1939, assigned to the 11th Bombardment Group, and allotted to the Third Corps Area. Activated on 1 February 1940 at Hickam Field, TH. Redesignated as the 42nd Bombardment Squadron (Medium) on 11 December 1940. Location 7 December 1941—Hickam Field, TH.

Status: Inactivated on 1 February 1963 as the 42nd Bombardment Squadron (Heavy) at Wright-Patterson A.F.B., OH.

Events: 297, 312

Commanders, 42nd School Squadron

42nd Bombardment Squadron

Capt. Frank H. Pritchard	5 Jul 22-2 Jan 23	1st Lt. William K. Moran	1 Apr 31-1 Jul 31
Capt. Joseph H. Davidson	2 Jun 23-1 Aug 23	1st Lt. Orval A. Anderson	1 Jul 31-20 Oct 31
Capt. William H. Crom	1 Aug 23-27 Sep 23	Capt. James A. Healy	20 Oct 31-1 Mar 35
1st Lt. Willis A. Frederick	27 Sep 23-9 Oct 23	Maj. Thomas S. Voss	1 Mar 35-3 Jun 36
1st Lt. Rueben D. Biggs	9 Oct 23-1 May 24	Capt. Edgar T. Selzer	7 Aug 36-1 Sep 36
1st Lt. Claude E. Duncan	1 May 24-10 Mar 26	<i>Inactive</i>	1 Sep 36-23 Nov 36
Capt. Ross F. Cole	10 Mar 26-1 Sep 27	Maj. Daniel E. Ellis**	23 Nov 36-Aug 37
Capt. John V. Hart	3 Jun 36-7 Aug 36	Maj. Ralph W. Stone**	Aug 37-31 Jan 40
Capt. William S. Gravely	1 Apr 28-7 Jul 30	2nd Lt. Niels O. Ohman	1 Feb 40-20 Mar 40
1st Lt. Howard K. Ramey	7 Jul 30-1 Apr 31	Maj. Clyde K. Rich	20 Mar 40-21 Oct 40
	Maj. Roger M. Ramey	21 Oct 40-19 Dec 41	

** RAI Commanders: Organized Reserve officers.

42nd Service Squadron (42nd Observation Group)

Regular Army Inactive

HQ-New York City, NY, 1933-41

Constituted in the Regular Army on 1 October 1933, assigned to the 42nd Observation Group (II Corps), and allotted to the Second Corps Area. Organized on 7 November 1933 with Organized Reserve personnel as a RAI unit New York City, NY. Relieved from the 42nd Observation Group on 1 January 1938. Concurrently reorganized and redesignated 42nd Air Base Squadron. Disbanded on 17 January 1941.

Commanders, 42nd Service Squadron

Unknown** 7 Nov 33-17 Jan 41

** RAI commanders: Organized Reserve officers.

43rd Bombardment Squadron (29th Bombardment Group)

HQ-*Not organized* 1939-40; Langley Field, FL, 1940; MacDill Field, FL, 1940-41

Constituted in the Regular Army on 22 December 1939 as the 29th Bombardment Squadron, assigned to the 29th Bombardment Group and allotted to the Third Corps Area. Activated on 1 February 1940 at Langley Field, VA. Redesignated as the 43rd Bombardment Squadron on 13 March 1940. Transferred on 21 May 1940 to MacDill Field, FL. Location 7 December 1941—MacDill Field, FL.

Status: Active in the U. S. Air Force as the 43rd Flying Training Squadron at Columbus A.F.B., MS.

Commanders, 43rd Bombardment Squadron

Capt. Frank H. Robinson	1 Feb 40-13 Mar 40	Maj. William D. Old	13 Mar 40-May 41
	Maj. Robert F. Travis	May 41-Dec 41	

43rd School Squadron (1922-35) (10th School Group)

43rd Pursuit Squadron (1935-38)

HQ-Kelly Field, TX, 1922-36; *Inactive* 1936-37; Eighth Corps Area at large 1937-38

Authorized in the Regular Army on 10 June 1922 as the 43rd Squadron (School), assigned to the 10th School Group, and allotted to the Eighth Corps Area. Organized on 7 July 1922 at Kelly Field, TX. Redesignated as the 43rd School Squadron on 25 January 1923. Consolidated on 8 April 1924 with the 43rd Aero Squadron (a WWI unit organized in July 1917 at Kelly Field, TX; demobilized on 17 April 1919 at Hazelhurst, NY; reconstituted on 8 April 1924). Relieved from assignment to the 10th School Group on 15 July 1931 and attached to the Air Corps Advanced Flying School. Reorganized and redesignated 43rd Pursuit Squadron on 1 March 1935 and assigned to the 3rd Wing. Inactivated on 1 September 1936 at Kelly Field, TX. Organized on 20 January 1937 with Organized Reserve personnel as a RAI unit in the Eighth Corps Area at large. Demobilized on 1 January 1938.

Commanders, 43rd School Squadron

43rd Pursuit Squadron

1st Lt. James B. Carroll	1 Jun 22-1 Aug 22	1st Lt. Alvan C. Kincaid	24 Apr 26-23 Mar 27
1st Lt. Walter D. Peck	1 Aug 22-1 Sep 22	Capt. Harold H. George	23 Mar 27-1 Aug 29
Capt. Arthur B. McDaniel	1 Sep 22-4 Oct 24	Capt. John K. Cannon	1 Aug 29-7 Jul 30
1st Lt. James A. Woodruff	4 Oct 24-1 Dec 24	1st Lt. Dale V. Gaffney	7 Jul 30-28 Jul 30
Capt. Albert Guidera	1 Dec 24-31 Aug 25	Capt. Jahn C. Cannon	28 Jul 30-27 Jul 31
1st Lt. Lotha A. Smith	1 Sep 25-24 Apr 26	Maj. Louis N. Eller	27 Jul 31-1 Sep 36
1st Lt. Alvan C. Kincaid	24 Apr 26-23 Mar 27	<i>Inactive</i>	1 Sep 36-20 Jan 37
	Maj. Richard W. Pears**	20 Jan 37-1 Jan 38	

** RAI Commanders: Organized Reserve officers.

43rd Pursuit Squadron (16th Pursuit Group)

HQ-*Not organized* 1939-40; Albrook Field, CZ, 1940-41

Constituted in the Regular Army on 22 December 1939 as the 43rd Pursuit Squadron (Interceptor). Activated on 1 February 1940 at Albrook Field, CZ, and assigned to the 16th Pursuit Group. Location 7 December 1941—Albrook Field, CZ.

Status: Active in the U. S. Air Force as the 43rd Fighter Squadron at Tyndall A.F.B., FL.

Events: 292, 333

Commanders, 43rd Pursuit Squadron

1st Lt. Robert Baseler	1 Feb 40-6 Aug 40	Capt. Walter W. Gross	6 Aug 40-Nov 40
	Capt. George H. MacIntyre	Nov 40-Dec 41	

43rd Service Squadron (43rd Observation Group)

Regular Army Inactive

HQ-*Not organized* 1933-41

Constituted in the Regular Army on 1 October 1933, assigned to the 43rd Observation Group (III Corps), and allotted to the Third Corps Area. Relieved from the 43rd Observation Group on 1 January 1938. Concurrently reorganized and redesignated 43rd Air Base Squadron. Designated mobilization station was Langley Field, VA. Disbanded on 17 January 1941.

44th Observation Squadron (1922-37) (9th Observation Group)

44th Reconnaissance Squadron (1937-41)

HQ-Post Field, OK, 1922-27; March Field, CA, 1927; *Inactive* 1927-31; France Field, CZ, 1931-32; Albrook Field, CZ, 1932-41; Atkinson Field, British Guyana, 1941

Authorized in the Regular Army on 10 June 1922 as the 44th Squadron (Observation), and allotted to the Seventh Corps Area. Organized on 26 June 1922 at Post Field, OK. Concurrently assigned to the 9th Observation Group but attached to the Field Artillery School to support training. Redesignated as the 44th Observation Squadron on 25 January 1923. Consolidated on 8 April 1924 with the 44th Aero Squadron (a WWI unit organized in July 1917 at Wright Field, OH; demobilized in October 1918 at Hazelhurst, NY; reconstituted on 8 April 1924). Relieved from assignment to the 9th Observation Group on 28 February 1927 and assigned to the 3rd Cavalry Division. Transferred on 25 June 1927 to March Field, CA. Inactivated on 31 July 1927 at March Field and allotted to the Eighth Corps Area. Post Field, OK, designated as headquarters location on organization, but the unit was never organized at that location. Designated mobilization training station was Post Field, OK, 1927-31. Relieved from to the 3rd Cavalry Division on 15 February 1929. Activated on 1 April 1931 at France Field, CZ, and assigned to the 6th Composite Group. Transferred on 13 May 1932 to Albrook Field, CZ. Attached in December 1932 to the 16th Pursuit Group. Reorganized and redesignated 44th Reconnaissance Squadron on 1 September 1937. Concurrently relieved from assignment to the 6th Composite Group and assigned to the 16th Pursuit Group. Participated in the "Goodwill Flight" to Bogota, Columbia in 1939. Relieved from assignment to the 16th Pursuit Group on 20 November 1940 and assigned to the 9th Bombardment Group. Transferred on 8 July 1941 to Howard Field, CZ. Transferred on 4 November 1941 to Atkinson Field, British Guyana. Location 7 December 1941—Atkinson Field, British Guyana.

Status: Inactivated on 15 April 1946 as the 480th Bombardment Squadron at Northwest Field, Guam.

Events: 119, 140, 167, 170, 181, 223, 271, 292, 308, 333

**Commanders, 44th Observation Squadron
44th Reconnaissance Squadron**

Maj. Thomas G. Lanphier	26 Jun 22-7 Sep 24	1st Lt. Cornelius E. O' Connor	1 Jul 34-1 Aug 34
Capt. Richard H. Ballard	7 Sep 24-1 Jun 27	1st Lt. Carl J. Crane	1 Aug 34-7 Nov 34
1st Lt. Cornelius J. Kenney	1 Jun 27-31 Jul 27	1st Lt. Guy B. Henderson	7 Nov 34-5 Feb 35
<i>Inactive</i>	31 Jul 27-1 Apr 31	Capt. George H. Beverly	5 Feb 35-1 Mar 35
1st Lt. Arnold H. Rich	1 Apr 31-22 Jul 31	Maj. Warner B. Gates	1 Mar 35-17 May 36
1st Lt. James M. Bevans	22 Jul 31-3 Sep 31	Capt. George A. Ross	17 May 36-1 Jul 36
Capt. Robert D. Knapp	3 Sep 31-25 Nov 31	1st Lt. Herbert E. Rice	1 Jul 36-29 Oct 36
Capt. Jasper K. McDuffie	25 Nov 31-17 May 32	1st Lt. Allen W. Reed	29 Oct 36-21 Apr 37
Maj. Eugene A. Lohman	17 May 32-1 Oct 32	1st Lt. Robert O. Cork	21 Apr 37-15 Apr 38
Capt. Jasper K. McDuffie	1 Oct 32-16 Mar 33	1st Lt. Trenholm J. Meyer	15 Apr 38-12 Mar 39
2nd Lt. John L. Nedwed	16 Mar 33-1 Jun 33	1st Lt. Norman B. Olsen	12 Mar 39-ao Aug 39
1st Lt. Charles P. Cabell	1 Jun 33-1 Oct 33	Capt. Forrest G. Allen	ao Feb 40-Oct 41
Capt. Jasper K. McDuffie	1 Oct 33-1 Jul 34	Maj. Richard T. King, Jr.	Oct 41-Feb 42

44th Service Squadron (44th Observation Group)

Regular Army Inactive

HQ-*Not organized* 1933-41

Constituted in the Regular Army on 1 October 1933, assigned to the 44th Observation Group (IV Corps), and allotted to the Fourth Corps Area. Relieved from the 44th Observation Group on 1 January 1938. Concurrently reorganized and redesignated 44th Air Base Squadron. Disbanded on 17 January 1941.

45th Observation Squadron (9th Observation Group)

HQ-*Not organized* 1923-28; San Antonio, TX, 1928-33

Reconstituted in the Regular Army on 24 March 1923 and assigned to the 9th Observation Group. Designated Active Associate was the 44th Observation Squadron 1923-27. Allotted to the Eighth Corps Area on 28 February 1927. Organized on 16 October 1928 with Organized Reserve personnel as a RAI unit at San Antonio, TX. Conducted annual summer training at Love Field or Hensley Field, TX, 1928-33. Relieved from assignment to the 9th Observation Group on 28 February 1927 and assigned to the 9th Division. Relieved from assignment to the 9th Division on 15 February 1929. Designated mobilization training station was Post Field, OK, 1923-27 and Dodd Field, TX, 1927-33. Demobilized on 1 October 1933.

Commanders, 45th Observation Squadron

Capt. Ralph W. Stone**	16 May 28-9 Oct 32	Unknown	9 Oct 32-1 Oct 33
------------------------	--------------------	---------	-------------------

** RAI Commanders: Organized Reserve officers.

45th Service Squadron (45th Observation Group)

Regular Army Inactive

HQ-Not organized 1933-34; Dayton, OH, 1934-41

Constituted in the Regular Army on 1 October 1933, assigned to the 45th Observation Group (V Corps), and allotted to the Fifth Corps Area. Organized by June 1934 with Organized Reserve personnel as a RAI unit at Dayton, OH. Relieved from the 45th Observation Group on 1 January 1938. Concurrently reorganized and redesignated 45th Air Base Squadron. Disbanded on 17 January 1941.

Commanders, 45th Service Squadron

Unknown** ao Jun 34-17 Jan 41

** RAI commanders: Organized Reserve officers.

46th School Squadron (11th School Group)

HQ-Brooks Field, TX, 1922-31; Randolph Field, TX, 1931-41

Authorized in the Regular Army on 10 June 1922 as the 46th Squadron (School), assigned to the 11th School Group, and allotted to the Seventh Corps Area. Organized on 1 September 1922 at Brooks Field, TX. Redesignated as the 46th School Squadron on 25 January 1923. Consolidated on 8 April 1924 with the 46th Aero Squadron (a WWI unit organized on 10 April 1918 at Kelly Field, TX; demobilized on 27 January 1919 at Garden City, NY; reconstituted on 8 April 1924). Transferred on 12 October 1931 to Randolph Field, TX. Relieved from the 11th School Group on 31 December 1931 and assigned to the Air Corps Primary Flying School. Location 7 December 1941—Randolph Field, TX.

Commanders, 46th School Squadron

Capt. Clinton F. Woolsey	1 Sep 22-23 Oct 24	Capt. Clifford C. Nutt	25 Jul 30-25 Sep 31
1st Lt. Virgil Hine	23 Oct 24-2 Jun 25	Capt. Leonidas L. Koontz	25 Sep 31-4 Mar 35
Capt. Alfred F. King, Jr.	2 Jun 25-13 Jan 27	Capt. Oakley G. Kelly	4 Mar 35-15 Jul 35
1st Lt. Samuel M. Connell	13 Jan 27-3 Jun 29	Maj. Stanton T. Smith	15 Jul 35-21 Feb 40
1st Lt. Oscar L. Rogers	3 Jun 29-Sep 29	Capt. Gerald G. Hoyle	21 Feb 40-1 May 40
Capt. William C. Ocker	Sep 29-25 Jul 30	Capt. Donald D. FitzGerald	1 May 40-7 Dec 41

46th Service Squadron (46th Observation Group)

Regular Army Inactive

HQ-Not organized 1933-34; Detroit, MI, 1934-41

Constituted in the Regular Army on 1 October 1933, assigned to the 46th Observation Group (VI Corps), and allotted to the Sixth Corps Area. Organized by December 1934 with Organized Reserve personnel as a RAI unit at Detroit, MI. Relieved from the 46th Observation Group on 1 January 1938. Concurrently reorganized and redesignated 46th Air Base Squadron. Disbanded on 17 January 1941.

Commanders, 46th Service Squadron

Unknown** ao Dec 34-17 Jan 41

** RAI commanders: Organized Reserve officers.

47th School Squadron (11th School Group)

HQ-Brooks Field, TX, 1922-27; March Field, CA, 1927-31; Randolph Field, TX, 1931-41

Authorized in the Regular Army on 10 June 1922 as the 47th Squadron (School), assigned to the 11th School Group, and allotted to the Seventh Corps Area. Organized on 1 September 1922 at Brooks Field, TX. Redesignated as the 47th School Squadron on 25 January 1923. Consolidated on 8 April 1924 with the 47th Aero Squadron (a WWI unit organized on 20 July 1917 at Kelly Field, TX; demobilized on 6 July 1919 at Camp Devens, MA; reconstituted on 8 April 1924). Transferred on 3 June 1927 to March Field, CA. Relieved from assignment to the 11th School Group on 1 August 1927 and assigned to the 13th School Group. Relieved from assignment to the 13th School Group on 30 April 1931. Transferred on 2 June 1931 to Randolph Field, TX, and assigned to the Air Corps Primary Flying School. Location 7 December 1941—Randolph Field, TX.

Status: Disbanded on 20 Apr 1944.

Commanders, 47th School Squadron

1st Lt. Fred E. Woodward	ao Jun 24-27 Oct 24	Capt. Earle G. Harper	1 Sep 28-10 Jul 30
1st Lt. Edward L. Searle, Jr.	27 Oct 24-8 Jun 25	Capt. Walter Miller	10 Jul 30-4 Mar 35
1st Lt. Elmer Perrin	8 Jun 25-10 Aug 25	Capt. Harold A. Bartron	4 Mar 35-20 Aug 36
1st Lt. Rex K. Stoner	10 Aug 25-20 Apr 26	Capt. Charles T. Myers	20 Aug 36-2 Aug 37
1st Lt. John C. Kennedy	20 Apr 26-27 Oct 26	Maj. Donald B. Phillips	2 Aug 37-Jun 40
1st Lt. Roland C. W. Blessley	27 Oct 26-3 Jun 27	1st Lt. Cordes F. Tiemann	Jun 40-Jun 40
1st Lt. William L. Boyd	3 Jun 27-25 Sep 27	Maj. Kenneth C. McGregor	Jun 40-ao Nov 40
Capt. Byrne V. Baucom	25 Sep 27-30 May 28	Unknown	ao Nov 40-ao Nov 41
1st Lt. Rowland C. W. Blessley	30 May 28-1 Sep 28	Maj. Wilbur Erickson	ao Nov 41-26 Jan 42

47th Service Squadron (47th Observation Group)

Regular Army Inactive

HQ-*Not organized* 1933-41

Constituted in the Regular Army on 1 October 1933, assigned to the 47th Observation Group (VII Corps), and allotted to the Seventh Corps Area. Relieved from the 47th Observation Group on 1 January 1938. Concurrently reorganized and redesignated 47th Air Base Squadron. Disbanded on 17 January 1941.

48th School Squadron (1922-35) (11th School Group)

48th Pursuit Squadron (1935-38)

HQ-*Not organized* 1923-27; Kelly Field, TX, 1927-31; *Inactive* 1931-33; Chanute Field, IL, 1933-36; *Inactive* 1936-38

Constituted in the Regular Army on 6 February 1923 and assigned to the 11th School Group. Designated Active Associate was the 46th School Squadron 1923-27. Allotted to the Eighth Corps Area on 28 February 1927. Activated on 1 August 1927 at Kelly Field, TX. Consolidated in 1930 with the 462nd Aero Squadron (a WWI unit organized in August 1917 at Kelly Field, TX; demobilized on 11 August 1919 at Mitchel Field, NY; reconstituted in 1930). Relieved from assignment to the 11th School Group on 8 May 1929 and assigned to the 10th School Group. Inactivated on 1 September 1931 and relieved from assignment to the 10th School Group. Kelly Field, TX, designated as headquarters location on organization, but the unit was never reorganized at that location. Activated on 1 August 1933 at Chanute Field, IL, and assigned to the Air Corps Technical School. Reorganized and redesignated 48th Pursuit Squadron on 1 March 1935. Inactivated on 1 September 1936 at Chanute Field, IL, and allotted to the Sixth Corps Area. Disbanded on 1 January 1938.

Status: Active in the U. S. Air Force as the 48th Flying Training Squadron at Columbus A.F.B., MS.

Commanders, 48th School Squadron

48th Pursuit Squadron

1st Lt. William A. Hayward	1 Aug 27-1 Mar 28	<i>Inactive</i>	1 Sep 31-1 Aug 33
1st Lt. Dale V. Gaffney	1 Mar 28-Jul 28	1st Lt. Walter K. Burgess	1 Aug 33-28 Aug 33
1st Lt. Edwin Sullivan	Jul 28-1 Oct 29	Capt. James F. Powell	28 Aug 33-1 Nov 33
1st Lt. Stanton T. Smith	1 Oct 29-12 Mar 30	Capt. William C. Farnum	1 Nov 33-1 Sep 34
1st Lt. Frederick I. Patrick	12 Mar 30-1 Jul 31	Maj. Walter K. Burgess	1 Sep 34-2 Oct 35
1st Lt. John R. Drumm	1 Jul 31-1 Sep 31	Capt. James E. Duke, Jr.	2 Oct 35-20 Jul 36
	Capt. Oscar L. Rogers	20 Jul 36-1 Sep 36	

48th Service Squadron (48th Observation Group)

Regular Army Inactive

HQ-*Not organized* 1933-35; Eighth Corps Area on 1935-41

Constituted in the Regular Army on 1 October 1933, assigned to the 48th Observation Group (VIII Corps), and allotted to the Eighth Corps Area. Organized on 17 June 1935 with Organized Reserve personnel as a RAI unit in the Eighth Corps Area. Relieved from the 48th Observation Group on 1 January 1938. Concurrently reorganized and redesignated 48th Air Base Squadron. Disbanded on 17 January 1941.

Commanders, 48th Service Squadron

Unknown** 17 Jun 35-17 Jan 41

** RAI commanders: Organized Reserve officers.

49th Bombardment Squadron (2nd Bombardment Group)

HQ-Mitchel Field, NY, 1919; Ellington Field, TX, 1919; Kelly Field, TX, 1919-22; Langley Field, VA, 1922; Phillips Field, MD, 1922-28; Langley Field, VA, 1928-41; Newfoundland Air Base, Newfoundland, 1941

Stationed at Mitchel Field, NY, as of 17 June 1919 as the 166th Aero Squadron. Transferred in July 1919 to Ellington Field, TX. Transferred on 26 September 1919 to Kelly Field, TX. Assigned on 18 September 1919 to the 1st Day Bombardment Group (later redesignated as the 2nd Bombardment Group). Attached on 1 October 1919 to the 1st Army Observation Group. Redesignated as the 49th Squadron (Bombardment) on 14 March 1921. Redesignated as the 49th Squadron (Bombardment) on 14 March 1921. Attached to the 1st Provisional Air Brigade 6 May-3 October 1921 while supporting the battleship bombing tests off the Virginia coast. Transferred on 30 June 1922 to Langley Field, VA. Transferred on 10 August 1922 to Phillips Field, MD. Attached to the Ordnance Department at Aberdeen Proving Ground to conduct tests with newly developed aerial bombs August 1922-January 1928. Redesignated as the 49th Bombardment Squadron on 25 January 1923. Transferred on 17 January 1928 to Langley Field, VA. Participated in mercy missions to provide relief to marooned inhabitants on islands isolated by the freezing of Chesapeake Bay. Consolidated on 16 October 1936 with the 49th Aero Squadron (a WWI unit organized in August 1917 at Kelly Field, TX; demobilized on 22 March 1919 at Garden City, NY; reconstituted on 16 October 1936). Participated in the "Goodwill Flights" to Argentina 15-27 February 1938, to Columbia 3-12 August 1938, to Mexico 9-15 June 1939, and to Brazil 10-28 November 1939. Unit B-17s located the Italian luxury liner S.S. *Rex* about 725 miles out to sea on the famous long range interception mission conducted on 12 May 1938. Participated in mercy missions in support of relief operations during the Chilean Earthquake at Santiago 4-14 February 1939. Redesignated as the 49th Bombardment Squadron (Heavy) on 6 December 1939. Transferred on 23 November 1941 to Newfoundland Air Base, Newfoundland. Location 7 December 1941—Newfoundland Air Base, Newfoundland.

Status: Active in the U. S. Air Force as the 49th Test and Evaluation Squadron at Barksdale, A.F.B., LA.

Events: 23, 39, 46, 55, 85, 104, 107, 155, 164, 165, 178, 196, 197, 200, 213, 214, 227, 249, 252

Commanders, 49th Bombardment Squadron

1st Lt. Fred S. Borum	ao Dec 20-4 Feb 21	Capt. Henry Pascale	10 Jul 30-3 Dec 30
Capt. Victor Parks, Jr.	4 Feb 21-12 May 21	Capt. Theodore H. Koenig	3 Dec 30-15 Aug 31
1st Lt. Harold L. George	12 May 21-30 Oct 21	Capt. Eugene L. Eubank	15 Aug 31-21 Dec 33
1st Lt. Edward W. Raley	30 Oct 21- 4 Jun 22	1st Lt. Alva L. Harvey	21 Dec 33-23 Feb 34
Capt. Asa N. Duncan	4 Jun 22-1 May 22	Capt. Henry H. Reily	23 Feb 34-9 May 34
Capt. Richard H. Ballard	1 May 22-29 Aug 22	Capt. Eugene L. Eubank	9 May 34-4 Jun 34
Capt. Romeyn B. Hough, Jr.	29 Aug 22-3 Oct 24	1st Lt. Edward A. Hillery	4 Jun 34-14 Jul 34
1st Lt. Bernard S. Thompson	3 Oct 24-18 Jun 26	1st Lt. Archibald Y. Smith	14 Jul 34-17 Dec 34
Maj. Eugene A. Lohman	18 Jun 26-22 Jul 26	Capt. Malcolm M. Lawton	17 Dec 34-20 Jul 36
Maj. Harold Geiger	22 Jul 26-16 May 27	Maj. Caleb V. Haynes	20 Jul 36-3 Jan 40
1st Lt. William H. Bleakley	16 May 27-29 Jul 27	Maj. Vincent J. Meloy	3 Jan 40-1 Feb 40
1st Lt. Mark R. Woodward	29 Jul 27-5 Aug 27	Maj. Melvin B. Asp	1 Feb 40-15 Jan 41
Maj. Fred H. Coleman	5 Aug 27-10 Jul 30	Unknown	15 Jan 41-7 Dec 41

49th Service Squadron (49th Observation Group)

Regular Army Inactive

HQ-*Not organized* 1933-36; Long Beach, CA, 1936-37; *Inactive* 1937-41

Constituted in the Regular Army on 1 October 1933, assigned to the 49th Observation Group (IX Corps), and allotted to the Ninth Corps Area. Organized on 16 September 1936 with Organized Reserve personnel as a RAI unit at the Municipal Airport, Long Beach, CA. Inactivated on 2 September 1937 at Long Beach by relief of Reserve personnel. Relieved from the 49th Observation Group on 1 January 1938. Concurrently reorganized and redesignated 49th Air Base Squadron. Disbanded on 17 January 1941.

Commanders, 49th Service Squadron

Unknown**	16 Sep 36-2 Sep 37	<i>Inactive</i>	2 Sep 37-17 Jan 41
-----------	--------------------	-----------------	--------------------

** RAI commanders: Organized Reserve officers.

50th Observation Squadron (2nd Wing)

50th Reconnaissance Squadron (1938-41)

HQ-Scott Field, IL, 1919; Langley Field, VA, 1919-27; Brooks Field, TX, 1927-29; Mitchel Field, NY, 1929-30; Luke Field, TH, 1930-39; Hickam Field, TH, 1939-41

Stationed at Scott Field, IL, as of June 1919 as the 50th Aero Squadron. Transferred in August 1919 to Langley Field, VA. Attached on 1 October 1919 to the 1st Army Observation Group. Relieved from attachment to the 1st Army Observation Group (redesignated 7th Observation Group on 14 March 1921) on 24 May 1920 and formally assigned. Redesignated as the 50th Squadron (Observation) on 14 March 1921. Attached to the 1st Provisional Air Brigade 6 May-3 October 1921 while supporting the battleship bombing tests off the Virginia coast. Assigned on 8 August 1922 to the 2nd Wing (Provisional). Redesignated as the 50th Observation Squadron on 25 January 1923. Transferred on 25 January 1927 to Brooks Field, TX. Inactivated on 1 August 1927 at Langley Field, VA, relieved from assignment to the 2nd Wing, allotted to the Eighth Corps Area, and assigned to the Office of Chief of the Air Corps. Organized in December 1927 with Organized Reserve personnel as a RAI unit at Dodd Field, TX. Relieved from assignment to OCAC 1 September 1928. Organized Reserve officers assigned to the unit participated in summer training at Kelly Field, TX, 1928. Designated mobilization training station was Dodd Field, TX, 1927-29. Withdrawn from the Eighth Corps Area on 27 October 1928 and allotted to the Second Corps Area. Assigned on 13 February 1929 to the 9th Observation Group. Relieved from assignment to the 9th Observation Group on 8 May 1929 and assigned to the 5th Composite Group. Organized on 27 May 1929 with Organized Reserve personnel as a RAI unit at Mitchel Field, NY. Activated on 1 November 1930, less Reserve personnel, at Luke Field, TH. Redesignated as the 50th Reconnaissance Squadron on 25 January 1938. Relieved from assignment to the 5th Bombardment Group on 12 October 1938 and concurrently attached to the group. Transferred on 9 October 1939 to Hickam Field, TH. Redesignated as the 50th Reconnaissance Squadron (Medium Range) on 6 December 1939. Attached on 1 June 1940 to the 11th Bombardment Group. Redesignated as the 50th Reconnaissance Squadron (Heavy) on 20 November 1940. Location 7 December 1941—Hickam Field, TH.

Events: 23, 141, 158, 160, 248, 276, 297, 312

Commanders, 50th Observation Squadron

50th Reconnaissance Squadron

1st Lt. Fraser Hale	ao Jan 20-1 Apr 21	Capt. Frank H. Pritchard	1 Nov 30-12 Mar 31
1st Lt. Isaiah Davies	1 Apr 21-15 Dec 21	Capt. Ulysses G. Jones	13 Mar 31-1 Oct 31
Capt. Arthur E. Easterbrook	15 Dec 21-7 Dec 24	1st Lt. Edgar T. Noyes	1 Oct 31-19 Oct 31
Capt. Floyd E. Galloway	7 Dec 24-23 Mar 27	Capt. Charles G. Brenneman	19 Oct 31-13 Oct 34
1st Lt. Lewis S. Webster	23 Mar 27-25 May 27	Maj. Lucas V. Beau, Jr.	13 Oct 34-17 Sep 36
1st Lt. Byron T. Ward	25 May 27-1 Aug 27	1st Lt. Charles F. Born	17 Sep 36-23 Mar 37
<i>Inactive</i>	1 Aug 27-Dec 27	1st Lt. Leland F. Stranathan	23 Mar 37-4 Sep 37
Capt. Paul S. Greene**	Dec 27-4 Apr 29	Capt. Homer W. Ferguson	4 Sep 37-1 May 40
1st Lt. Walter R. Avery**	27 May 29-1 Nov 30	Capt. Warren H. Higgins	1 May 40-ao Jan 41
	Unknown	ao Jan 41-7 Dec 41	

** RAI Commanders: Organized Reserve officers.

51st School Squadron (1923-35) (13th School Group)

51st Attack Squadron (1935-38) (3rd Attack Group)

HQ-Not organized 1923-27; Brooks Field, TX, 1927-31; Maxwell Field, AL, 1931-36; *Inactive* 1936-38

Constituted in the Regular Army on 6 February 1923 as the 51st School Squadron and assigned to the 13th School Group. Designated Active Associate was the Air Service Technical School 1923-27. Allotted to the Sixth Corps Area on 28 February 1927. Activated at Brooks Field, TX, 1 August 1927, relieved from assignment to the 13th School Group, and assigned to the 11th School Group. Relieved from assignment to the 11th School Group on 15 July 1931. Inactivated on 31 August 1931 at Brooks Field. Activated on 1 September 1931 at Maxwell Field, AL, and attached to the Air Corps Tactical School. Reorganized and redesignated 51st Attack Squadron on 1 March 1935, assigned to the 3rd Attack Group, and attached to the Air Corps Tactical School. Inactivated on 1 September 1936 at Maxwell Field, AL. Disbanded on 1 June 1938.

Commanders, 51st School Squadron

51st Attack Squadron

1st Lt. Clifford C. Nutt	1 Aug 27-1 Nov 27	1st Lt. Clarence F. Horton	26 Aug 32-2 Jun 34
Capt. Robin M. Day	1 Nov 27-11 Jun 29	1st Lt. William N. Amis	2 Jun 34-11 Sep 34
1st Lt. Russell C. McDonald	11 Jun 29-Sep 29	1st Lt. Charles D. McAllister	11 Sep 34-11 Oct 34
1st Lt. George W. Polk	Sep 29-3 Jul 30	1st Lt. Arnold H. Rich	11 Oct 34-1 Mar 35
Capt. Leonidas L. Koontz	3 Jul 30-1 Sep 31	Maj. Lloyd C. Blackburn	1 Mar 35-7 Sep 35
Capt. Floyd E. Galloway	1 Sep 31-26 Aug 32	Maj. Edward E. Hildreth	7 Sep 35-1 Sep 36
	<i>Inactive</i>	1 Sep 36-1 Jan 38	

52nd Bombardment Squadron (29th Bombardment Group)

HQ-Not organized 1939-40; Langley Field, VA, 1940; MacDill Field, FL, 1940-41

Constituted in the Regular Army on 22 December 1939, assigned to the 29th Bombardment Group, and allotted to the Third Corps Area. Activated on 1 February 1940 at Langley Field, VA. Transferred on 21 May 1940 to MacDill Field, FL. Location 7 December 1941—MacDill Field, FL.

Status: Active in the U. S. Air Force as the 52nd Flying Training Squadron at Reese A.F.B., TX.

Events: 302

Commanders, 52nd Bombardment Squadron

Capt. Frank H. Robinson	1 Feb 40-3 May 41	1st Lt. John D. Harcos	27 Oct 41-5 Nov 41
Capt. Bockman	10 May 41-27 Oct 41	Capt. James A. Walsh	5 Nov 41-14 Feb 42

52nd School Squadron (14th School Group)**HQ-Not organized** 1923-27; Brooks Field, TX, 1927-31; Randolph Field, TX, 1931-41

Constituted in the Regular Army on 6 February 1923 and assigned to the 14th School Group. Designated Active Associate was the 41st School Squadron 1923-27. Allotted to the Eighth Corps Area on 28 February 1927. Relieved from assignment to the 14th School Group on 8 July 1927 and assigned to the 11th School Group. Activated on 1 August 1927 at Brooks Field, TX. Transferred on 9 October 1931 to Randolph Field, TX, relieved from assignment to the 11th School Group, and assigned to the Air Corps Primary Flying School. Consolidated on 19 October 1932 with the 52nd Aero Squadron (a WWI unit organized in August 1917 at Kelly Field, TX; demobilized in May 1919 at Hazelhurst Field, NY; reconstituted on 19 October 1932). Location 7 December 1941—Randolph Field, TX.

Commanders, 52nd School Squadron

1st Lt. Alfred E. Waller	1 Aug 27-1 Nov 27	1st Lt. Oakley G. Kelly	11 Mar 31-1 Oct 31
1st Lt. Roderick N. Ott	1 Nov 27-17 Jul 29	Capt. Edward D. Jones	1 Oct 31-4 Mar 35
1st Lt. Roy W. Camblin	17 Jul 29-22 Apr 30	Capt. Francis P. Booker	4 Mar 35-15 Jun 36
Capt. Louis R. Knight	22 Apr 30-26 Jun 30	Capt. John F. McBlain	16 Jun 36-15 Aug 36
1st Lt. Oscar L. Rogers	26 Jun 30-16 Jul 30	Capt. Charles W. Lawrence	15 Aug 36-19 Oct 36
Capt. Clyde V. Finter	16 Jul 30-11 Mar 31	Maj. Martinus Stenseth	19 Oct 36-11 May 40
	Unknown	11 May 40-7 Dec 41	

53rd School Squadron (13th School Group)**HQ-Not organized** 1922-27; March Field, CA, 1927-31; Randolph Field, TX, 1931-41

Constituted in the Regular Army on 6 February 1923, assigned to the 13th School Group, and allotted to the Eighth Corps Area. Activated on 31 July 1927 at March Field, CA, with personnel from the 95th Pursuit Squadron and 44th Observation Squadron. Relieved from assignment to the 13th School Group on 30 April 1931. Inactivated on 4 October 1931 at March Field, CA. Activated on 12 October 1931 at Randolph Field, TX, and assigned to the Air Corps Primary Flying School. Consolidated on 14 October 1936 with the 53rd Aero Squadron (a WWI unit organized on 9 August 1917 at Kelly Field, TX; demobilized on 18 March 1919 at Hazelhurst Field, NY; reconstituted on 14 October 1936). Location 7 December 1941—Randolph Field, TX.

Status: Disbanded on 20 Apr 1944.**Commanders, 53rd School Squadron**

2nd Lt. Walter G. Plummer	31 Jul 27-10 Aug 27	Capt. Milo N. Clark	15 May 35-14 Jun 37
Capt. Lloyd N. Keesling	10 Aug 27-1 May 29	Capt. John P. Kirkendall	14 Jun 37-4 Jan 38
Capt. Idwal H. Edwards	1 May 29-2 May 30	Capt. Herbert N. Newstrom	4 Jan 38-13 Dec 38
Capt. John B. Patrick	16 May 30-20 Aug 33	Capt. Benjamin T. Starkey	13 Dec 38-1 May 40
Capt. James A. Mollison	20 Aug 33-15 May 35	Capt. Arthur L. Smith	1 May 40-7 Dec 41

54th School Squadron (1923-35) (15th School Group)**54th Bombardment Squadron (1935-41)****HQ-Not organized** 1923-27; March Field, CA, 1927-31; Maxwell Field, AL, 1931-36; *Inactive* 1936-39; 1939-40; Orlando, FL, 1940-41; Eglin Field, FL, 1941

Constituted in the Regular Army on 6 February 1923 as the 54th School Squadron, assigned to the 15th School Group, and allotted to the Eighth Corps Area. Designated Active Associate was the Air Service Tactical School 1923-27. Relieved from allotted to the Eighth Corps Area on 28 February 1927 and allotted to the Second Corps Area. Relieved from assignment to the 15th School Group on 31 July 1927, assigned to the 13th School Group, and organized at March Field, CA. Inactivated on 30 April 1931 at March Field. Activated on 15 July 1931 at Maxwell Field, AL, with personnel from the 11th Bombardment Squadron. Concurrently relieved from assignment to the 13th School Group and assigned to the Air Corps Tactical School. Reorganized and redesignated 54th Bombardment Squadron on 1 March 1935, assigned to the 2nd Bombardment Group, and attached to the Air Corps Tactical School. Inactivated on 1 September 1936 at Maxwell Field. Consolidated on 14 October 1936 with the 54th Aero Squadron (a WWI unit organized on 8 August 1917 at Kelly Field, TX; demobilized on 10 February 1919 at Mitchel Field, NY; reconstituted

on 14 October 1936). Activated on 1 October 1939 at Maxwell Field and assigned to the 23rd Composite Group. Redesignated as the 54th Bombardment Squadron (Medium) on 6 December 1939. Transferred on 2 September 1940 to Orlando, FL. Transferred on 29 June 1941 to Eglin Field, FL. Location 7 December 1941—Eglin Field, FL.

Status: Disbanded on 1 May 1942.

Events: 301

Commanders, 54th School Squadron

54th Bombardment Squadron

Maj. Louis H. Brereton	31 Dec 25-30 Jun 26	Capt. Donald P. Muse	15 Jul 31-10 Sep 31
Maj. Oscar Westover	30 Jun 26-31 Dec 26	1st Lt. Harry H. Mills	10 Sep 31-13 Aug 32
2nd Lt. Leslie F. Young	31 Dec 26-30 Jun 27	Capt. Walter H. Peck	13 Aug 32-31 Aug 33
Capt. Rosenham Beam	26 Jul 27-13 Dec 27	Maj. Rufus B. Davidson	31 Aug 33-7 Sep 35
Capt. Joseph H. Davidson	13 Dec 27-6 Sep 30	Maj. Robert T. Zane	7 Sep 35-14 Jul 36
Capt. Leo F. Post	6 Sep 30-30 Apr 31	Capt. Sigmund F. Landers	14 Jul 36-1 Sep 36
<i>Inactive</i>	30 Apr 31-15 Jul 31	<i>Inactive</i>	1 Sep 36-1 Oct 39
	Capt. Edmund F. Freeman	1 Oct 39-ao Jan 41	

55th Pursuit Squadron (16th Pursuit Group)

HQ-Not organized 1923-30; Mather Field, CA, 1930-32; Barksdale Field, LA, 1932-39; Moffett Field, CA, 1939-40; Hamilton Field, CA, 1940-41

Demobilized on 16 March 1919 at Garden City, NY, as the 467th Aero Squadron. Reconstituted in the Regular Army on 24 March 1923 as the 55th Pursuit Squadron and assigned to the 16th Pursuit Group. Designated Active Associate was the 50th Observation Squadron 1923-27. Allotted to the Third Corps Area on 28 February 1927. Withdrawn from the Third Corps Area on 1 September 1928 and allotted to the Eighth Corps Area. Concurrently, relieved from assignment to the 16th Pursuit Group and assigned to the 8th Pursuit Group. Kelly Field, TX, designated as headquarters location on organization, but the unit was never organized at that location. Activated on 15 November 1930 at Mather Field, CA. Relieved from assignment to the 8th Pursuit Group on 15 June 1932 and assigned to the 20th Pursuit Group. Transferred on 31 October 1932 to Barksdale Field, LA. Transferred on 19 November 1939 to Moffett Field, CA. Redesignated as the 55th Pursuit Squadron (Fighter) on 6 December 1939. Awarded the Frank Luke Trophy for 1940. Transferred on 9 September 1940 to Hamilton Field, CA. Redesignated as the 55th Pursuit Squadron (Interceptor) on 12 March 1941. Location 7 December 1941—Hamilton Field, CA.

Status: Active in the U. S. Air Force as the 55th Fighter Squadron at Shaw A.F.B., SC.

Events: 194, 197, 200, 227, 243, 249, 252, 289

Commanders, 55th Pursuit Squadron

1st Lt. Clarence E. Crumrine	15 Nov 30-1 Feb 33	1st Lt. Earl W. Barnes	23 Jul 34-28 Mar 35
Capt. Harold L. Cloke	1 Feb 33-24 Jun 33	Maj. Armin F. Herold	28 Mar 35-7 Oct 36
1st Lt. Clarence E. Crumrine	24 Jun 33-7 Jul 34	Capt. Morris R. Nelson	7 Oct 36-1 Jun 39
1st Lt. Hilbert M. Wittkop	7 Jul 34-23 Jul 34	Capt. Homer L. Sanders	1 Jun 39-20 Jun 41
	Unknown	20 Jun 41-7 Dec 41	

56th Service Squadron (1923-36) (12th Observation Group)

Air Park No. 1 (1921-23)

HQ-Bolling Field, DC, 1921-28; Hensley Field, TX, 1928-35; Selfridge Field, MI, 1935-36

Constituted in the Regular Army on 30 August 1921 as Air Park No. 1. Concurrently organized at Bolling Field, DC, and assigned to the III Corps Air Service. Redesignated as the 56th Service Squadron on 25 January 1923. Relieved from the III Corps Air Service on 6 February 1923 and assigned to the 12th Observation Group (IV Corps). Inactivated on 31 March 1928 at Bolling Field and allotted to the Office of Chief of the Air Corps for mobilization purposes. Relieved from assignment to the 12th Observation Group on 8 May 1928 and assigned to the 14th Observation Group. Withdrawn from the Third Corps Area on 1 September 1928 and allotted to the Eighth Corps Area. Organized in late

1928 with Organized Reserve personnel as a RAI unit at Hensley Field, TX. Organized Reserve officers assigned to the unit participated in summer training at Kelly Field, TX, 1929-34. Activated on 1 March 1935, less Reserve personnel, at Selfridge Field, MI, and assigned to the General Headquarters Air Force. Concurrently attached to the 1st Pursuit Group. Demobilized on 1 September 1936 at Selfridge Field, MI, and personnel reassigned to the 1st Pursuit Group.

Events: 71

Commanders, 56th Service Squadron

1st Lt. Talcott P. Smith	1 Oct 21-5 Nov 21	Capt. Donald P. Muse	17 May 26-1 May 27
Capt. Ray A. Dunn	5 Nov 21-1 Aug 22	1st Lt. Harry A. Dinger	1 May 27-16 Sep 27
Capt. Robert LeG. Walsh	1 Aug 22-18 Oct 23	1st Lt. Peter E. Skanse	16 Sep 27-22 Nov 27
Capt. William C. Ocker	18 Oct 23-5 Apr 24	Capt. Robert E. Ellis	22 Nov 27-9 Feb 28
1st Lt. St. Clair Streett	5 Apr 24-1 Jul 24	1st Lt. Harry A. Dinger	9 Feb 28-31 Mar 28
Capt. Lorenzo L. Snow	1 Jul 24-24 Nov 25	Unknown**	1 Apr 28-1 Mar 35
1st Lt. Thomas D. While	24 Nov 25-17 Feb 26	Maj. Warren A. Maxwell	1 Mar 35-1 Sep 35
1st Lt. Kellogg Sloan	17 Feb 26-17 May 26	Maj. Alfred A. Kessler	1 Sep 35-14 Jun 36
	1st Lt. Hanlon A. Van Auken	14 Jun 36-1 Sep 36	

** RAI Commanders: Organized Reserve officers.

57th Service Squadron (1923-36) (1st Pursuit Group)

Air Park No. 2 (1919-23)

HQ-Selfridge Field, MI, 1921-36

Stationed at Garden City, NY, as of 1 July 1919 as the 2nd Air Park. Transferred on 1 September 1919 to Ellington Field, TX. Transferred on 8 November 1919 to Kelly Field, TX. Redesignated Air Park No. 2 on 14 March 1921. Transferred on 30 June 1921 to Ellington Field, TX. Transferred on 28 June 1922 to Selfridge Field, MI, and assigned to the 1st Pursuit Group. Redesignated as the 57th Service Squadron on 25 January 1923. Relieved from assignment to the 1st Pursuit Group on 1 March 1935 and assigned to the General Headquarters Air Force. Concurrently attached to the 1st Pursuit Group. Inactivated on 1 September 1936 at Selfridge Field, MI, and personnel reassigned to the 1st Pursuit Group.

Events: 39, 46, 55, 85, 104, 107, 164, 165, 197, 213, 214

Commanders, 57th Service Squadron

Capt. Byrne V. Baucom	ao Jan 21-25 Mar 21	1st Lt. Harry A. Johnson	23 Aug 28-3 Jan 29
1st Lt. Norman D. Brophy	25 Mar 21-2 May 21	1st Lt. Walter E. Richards	3 Jan 29-20 Aug 30
Capt. John G. Colgan	2 May 21-1 Jun 21	Capt. Roderick N. Ott	20 Aug 30-17 Aug 31
1st Lt. Wesley A. Zellner	1 Jun 21-20 Aug 21	1st Lt. Harlan T. McCormick	17 Aug 31-4 Jun 32
1st Lt. Hobart R. Yeager	20 Aug 21-28 Oct 21	2nd Lt. John W. Kirby	17 Jun 32-14 Jul 32
1st Lt. Roy B. Mosher	28 Oct 21-23 Nov 21	Capt. Ennis C. Whitehead	14 Jul 32-28 Aug 32
Capt. Vincent B. Dixon	23 Nov 22-4 Aug 24	Capt. Fred C. Nelson	28 Aug 32-10 Jul 33
1st Lt. Hobart R. Yeager	4 Aug 24-15 Oct 24	1st Lt. James E. Parker	10 Jul 33-7 Dec 33
1st Lt. Ennis C. Whitehead	15 Oct 24-3 Nov 24	Capt. Fred C. Nelson	7 Dec 33-1 Mar 35
Capt. Theose E. Tillinghast	3 Nov 24-2 Dec 25	Maj. Cornelius J. Kenney	1 Mar 35-22 Jan 36
Capt. Vincent B. Dixon	2 Dec 25-23 Aug 28	Capt. Leo H. Dawson	22 Jan 36-1 Sep 36

58th Service Squadron (1923-36) (2nd Wing)

Air Park No. 3 (1921-23)

HQ-Langley Field, VA, 1921-29; Inactive 1929-30; Brooks Field, TX, 1930-32; Langley Field, VA, 1932-36

Constituted in the Regular Army on 30 August 1921 as Air Park No. 3 and assigned to the 2nd Wing (Provisional). Organized on 1 October 1921 at Langley Field, VA. Redesignated as the 58th Service Squadron on 16 January 1923. Consolidated on 8 April 1924 with Air Park No. 3 (a WWI unit organized on 6 February 1918 at Camp Waco, TX, as 255th Aero Squadron; redesignated as Air Park No. 3 on 19 October 1918; demobilized on 14 July 1919 at Hazellhurst Field, NY; reconstituted on 8 April 1924). Relieved from assignment to the 2nd Wing 8 May 1929 and assigned to the 12th Observation Group. Inactivated on 31 October 1929 at Langley Field, VA. Activated on 1 October 1930 at Brooks

Field, TX. Relieved from assignment to the 12th Observation Group on 30 June 1931 and assigned to the 16th Pursuit Group. Transferred on 11 June 1932 to Langley Field, VA. Relieved from assignment to the 16th Pursuit Group on 15 June 1932 and assigned to the 8th Pursuit Group. Relieved from assignment to the 8th Pursuit Group on 1 March 1935. Consolidated on 1 September 1936 with HHS, 8th Pursuit Group.

Events: 178, 196, 197, 200

Commanders, 58th Service Squadron

1st Lt. William B. Souza	1 Oct 21-13 Jan 22	Capt. James F. Doherty	1 Jul 28-31 Oct 29
1st Lt. Devereaux M. Myers	13 Jan 22-30 Aug 22	<i>Inactive</i>	31 Oct 29-1 Oct 30
Capt. Howard J. Houghland	30 Aug 22-12 Oct 22	1st Lt. Oscar L. Rogers	1 Oct 30-28 Sep 31
Capt. Richard H. Ballard	12 Oct 22-8 Oct 23	Capt. Louis R. Knight	28 Sep 31-11 Jan 32
1st Lt. Christopher W. Ford	8 Oct 23-5 Aug 24	1st Lt. Oscar L. Rogers	11 Jan 32-4 Apr 32
1st Lt. Charles W. Monteith	5 Aug 24-14 Oct 24	Capt. Clarence H. Welch	4 Apr 32-5 Jun 33
1st Lt. Joseph T. Morris	14 Oct 24-9 Apr 26	Capt. Albert M. Guidera	5 Jun 33-27 Dec 33
1st Lt. John R. Drumm	9 Apr 24-5 Jul 27	Capt. Clarence H. Welch	27 Dec 33-12 Mar 35
Capt. Paul J. Mathis	5 Jul 27-19 Sep 27	Maj. Howard J. Houghland	12 Mar 35-31 May 35
1st Lt. Lewis S. Webster	19 Sep 27-28 Jan 28	Maj. Orlo H. Quinn	31 May 35-30 Jan 36
1st Lt. Emile T. Kennedy	28 Jan 28-1 Jul 28	Maj. Rex K. Stoner	30 Jan 36-1 Sep 36

59th Service Squadron (1923-36) (2nd Bombardment Group)

Air Park No. 4 (1921-23)

HQ-Kelly Field, TX, 1921-22; Langley Field, VA, 1922-36

Constituted in the Regular Army on 14 March 1921 as Air Park No. 4 and assigned to the 2nd Bombardment Group. Concurrently organized at Kelly Field, TX, with personnel and equipment from the 464th Aero Squadron [Construction]. Transferred on 26 June 1922 to Langley Field, VA. Redesignated as the 59th Service Squadron on 25 January 1923. Demobilized on 1 September 1936 at Langley Field.

Events: 29, 39, 46, 55, 85, 104, 107, 131, 155, 164, 165, 178, 196, 197, 200, 213, 214

Commanders, 59th Service Squadron

1st Lt. Robin A. Day	14 Mar 21-13 Feb 22	1st Lt. William J. Hanlon	16 Jan 29-12 Mar 29
Capt. Earley E. W. Duncan	13 Feb 22-29 Oct 23	Capt. Frank D. Hackett	16 Mar 29-1 Sep 29
1st Lt. William A. Hayward	29 Oct 23-14 Nov 23	1st Lt. Clarence R. MacIver	1 Sep 29-26 Jan 31
1st Lt. Robert H. Finley	14 Nov 23-16 Jan 24	2nd Lt. Charles W. O'Connor	26 Jan 31-5 Feb 31
1st Lt. William A. Hayward	16 Jan 24-2 Jun 27	Capt. Lionel H. Dunlap	5 Feb 31-12 Sep 34
Capt. James F. Doherty	2 Jun 27-1 Jul 28	Capt. Jasper K. McDuffie	12 Sep 34-8 Mar 35
Capt. Ernest Clark	1 Jul 28-16 Jan 29	Maj. Harvey H. Holland	8 Mar 35-1 Sep 36

60th Service Squadron (1923-36) (3rd Attack Group)

Air Park No. 5 (1921-23)

HQ-Kelly Field, TX, 1921-26; Fort Crockett, TX, 1926-35; Barksdale Field, LA, 1935-36

Constituted in the Regular Army on 30 August 1921 as Air Park No. 5 and assigned to the 3rd Attack Group. Organized on 1 October 1921 at Kelly Field, TX. Redesignated as the 60th Service Squadron on 25 January 1923. Transferred on 30 June 1926 to Fort Crockett, TX. Transferred on 27 February 1935 to Barksdale Field, LA. Consolidated on 1 September 1936 with HHS, 3rd Attack Group.

Events: 39, 46, 55, 85, 104, 105, 125, 164, 165, 194, 197, 200, 213, 214, 217, 243

Commanders, 60th Service Squadron

1st Lt. Richard O. Hunnam	1 Oct 21-1 Dec 21	1st Lt. George A. McHenry	8 Jan 26-12 May 26
1st Lt. Westside T. Larsen	1 Dec 21-1 Apr 22	1st Lt. Floyd A. Lundell	12 May 26-1 Aug 26
1st Lt. Richard E. Lebrou	1 Apr 22-10 Jul 22	1st Lt. Edwin Sullivan	1 Aug 26-1 Nov 26
1st Lt. Robin A. Day	10 Jul 22-2 Jun 23	1st Lt. Angier H. Foster	1 Nov 26-1 Apr 28
1st Lt. Armor S. Huffley	2 Jun 23-9 Oct 23	1st Lt. Clarence R. MacIver	1 Apr 28-2 Jun 28
1st Lt. Westside T. Larsen	9 Oct 23-2 Jan 24	1st Lt. John G. Williams	2 Jun 28-12 Jan 29
1st Lt. Lotha A. Smith	2 Jan 24-4 Sep 24	1st Lt. John L. Davidson	12 Jan 29-1 Jun 29
1st Lt. Franklin O. Carroll	4 Sep 24-4 Jun 25	1st Lt. John F. Whiteley	1 Jun 29-22 Jul 31
1st Lt. Harrison G. Crocker	4 Jun 25-29 Sep 25	Capt. Edward M. Morris	22 Jul 31-13 Aug 34
1st Lt. Frank M. Bartlett	29 Sep 25-19 Dec 25	Maj. Oliver S. Ferson	13 Aug 34-1 Oct 35
1st Lt. Harrison G. Crocker	19 Dec 25-8 Jun 26	Maj. William N. Amis	1 Oct 35-29 Oct 35
	Maj. Lloyd C. Blackburn		
		29 Oct 35-1 Sep 36	

61st Service Squadron (1923-36) (9th Observation Group)

Air Park No. 6 (1921-23)

HQ-Mitchel Field, NY, 1921-36

Constituted in the Regular Army on 30 August 1921 as Air Park No. 6, assigned to the 9th Observation Group, and allotted to the Second Corps Area. Organized on 1 October 1921 at Mitchel Field, NY, as Air Park No. 6. Redesignated as the 61st Service Squadron on 25 January 1923. Consolidated on 8 April 1924 with the 6th Air Park (a WWI unit organized on 24 January 1918 at Waco, TX, as the 822nd Aero Squadron; demobilized on 21 July 1919 at Garden City, NY, as the 6th Air Park; reconstituted on 8 April 1924). Consolidated on 1 September 1936 with HHS, 9th Bombardment Group.

Status: Disbanded on 20 April 1944.

Events: 85, 103, 107, 164

Commanders, 61st Service Squadron

Capt. Harry M. Smith	1 Oct 21-8 Jan 22	Capt. Vernon L. Burge	2 Jun 25-20 Aug 29
Maj. Junius V. Jones	8 Jan 22-19 Apr 22	Capt. Arthur E. Simonin	20 Aug 29-26 Jun 33
1st Lt. Alonzo M. Drake	19 Apr 22-1 Jul 22	Capt. Leland W. Miller	26 Jun 33-1 Jul 34
1st Lt. Francis B. Valentine	1 Jul 22-1 Aug 22	Capt. Leo F. Post	1 Jul 34-24 Aug 24
Capt. Francis M. Brady	1 Aug 22-2 Sep 22	Capt. Leland W. Miller	24 Aug 34- 24 Jun 35
Capt. Clyde V. Finter	2 Sep 22-18 Nov 22	Capt. Vernon L. Burge	24 Jun 35-1 Feb 36
1st Lt. Alonzo M. Drake	18 Nov 22-5 Jul 24	Capt. Milton M. Towner	1 Feb 36-19 Feb 36
Capt. Harrison W. Flickenger	5 Jul 24-2 Jun 25	Capt. Joseph C. A. Denniston	19 Feb 36-1 Sep 36

61st School Squadron (Pursuit)

HQ-Kelly Field, TX, 1936-41

Constituted in the Regular Army on 1 September 1936 and assigned to the Air Corps Primary Flying School. Organized on 1 September 1936 at Kelly Field, TX. Location 7 December 1941—Kelly Field, TX.

Commanders, 61st School Squadron

Maj. Louis N. Eller	1 Sep 36-12 May 37	Capt. Elmer T. Rundquist	5 Aug 38-1 Feb 40
Capt. Howard E. Engler	12 May 37-1 Jul 37	Maj. Harvey W. Prosser	1 Feb 40-Aug 40
Maj. Clarence E. Crumrine	1 Jul 37-21 Jul 38	Capt. Robert E. L. Choate	Aug 40-Sep 40
1st Lt. Morley F. Slaght	21 Jul 38-5 Aug 38	Unknown	Sep 40-7 Dec 41

62nd Service Squadron (1923-36) (11th School Group)

Air Park No. 7 (1921-23)

HQ-Mitchel Field, NY, 1921-22; Brooks Field, TX, 1922-31; Kelly Field, TX, 1931-36

Constituted in the Regular Army on 30 August 1921 as Air Park No. 7. Organized on 2 October 1921 at Mitchel Field, NY. Transferred on 31 July 1922 to Brooks Field, TX. Assigned on 1 September 1922 to the 11th School Group. Redesignated as the 62nd Service Squadron on 25 January 1923. Relieved from assignment to the 11th School Group on 1 June 1931 and assigned to the 12th Observation Group. Transferred on 31 October 1931 to Kelly Field, TX. Consolidated with HQ, 12th Observation Group on 1 September 1936 and consolidated unit redesignated as HHS, 12th Observation Group.

Status: Disbanded on 15 June 1983.

Events: 164

Commanders, 62nd Service Squadron

Capt. Truman W. Allen	Oct 21-7 Mar 22	Capt. Thomas C. Voss	11 Sep 31-19 Oct 31
1st Lt. Arthur E. Simonin	7 Mar 22-1 Apr 22	Capt. Raphael Baez, Jr.	19 Oct 31-11 Jan 32
1st Lt. John H. Lynch	1 Apr 22-1 May 22	Capt. Louis R. Knight	11 Jan 32-28 May 32
Capt. Francis M. Brady	1 May 22-1 Aug 22	Capt. Isaac W. Ott	28 May 32-17 Jun 32
1st Lt. Clements McMullen	1 Aug 22-1 Sep 24	Capt. William B. Mayer	17 Jun 32-21 May 34
1st Lt. Kenneth B. Wolfe	1 Sep 24-23 Oct 24	Capt. Winfield S. Hamlin	21 May 34-1 Nov 34
1st Lt. Charles E. Branshaw	23 Oct 24-23 Jul 30	Capt. Raymond Morrison	1 Nov 34-1 Mar 35
1st Lt. Robert D. Knapp	23 Jul 30-23 Aug 30	Capt. Frederick D. Lynch	1 Mar 35-1 Jul 36
1st Lt. Edward W. Raley	23 Aug 30-11 Sep 31	Maj. Douglas Johnson	1 Jul 36-1 Aug 36
	1st Lt. William C. Dolan	1 Aug 36-1 Sep 36	

63rd Service Squadron (1923-36) (6th Composite Group)

Air Park No. 8 (1921-23)

HQ-Mitchel Field, NY, 1921; France Field, CZ, 1921-34; *Inactive* 1934-36

Constituted in the Regular Army on 30 August 1921 as Air Park No. 8 and assigned to the 6th Composite Group. Organized on 1 October 1921 at Mitchel Field, NY. Inactivated on 14 October 1921 at Mitchel Field in accordance with a War Department directive that ordered the air park to be allotted to and organized in the Panama Canal Department. Activated on 1 December 1921 at France Field, CZ, and assigned to the 3rd Group Headquarters (Observation) (later redesignated as the 6th Composite Group). Redesignated as the 63rd Service Squadron on 25 January 1923. Inactivated on 1 May 1934 at France Field, CZ. Demobilized on 1 September 1936.

Events: 26, 31, 36, 40, 43, 58, 69, 81, 85, 101, 102, 108, 116, 119, 140, 142, 167, 170, 181

Commanders, 63rd Service Squadron

1st Lt. Frank P. Albrook	1 Dec 21-6 Mar 22	Maj. Paul T. Bock	14 Mar 27-15 Sep 27
Capt. Harry M. Smith	6 Mar 22-26 Jun 22	Capt. Armin F. Harold	15 Sep 27-13 Mar 29
1st Lt. Frank P. Albrook	26 Jun 22-29 Jul 22	Capt. Edwin F. Carey	13 Mar 29-22 Jul 31
Capt. Harrison W. Flickenger	29 Jul 23-20 May 24	Capt. Franklin O. Carroll	22 Jul 31-30 Mar 32
Capt. William M. Randolph	20 May 24-12 Dec 24	1st Lt. George E. Rice	30 Mar 32-15 Nov 32
1st Lt. Robin A. Day	12 Dec 24-18 Jul 25	Capt. Karl S. Axtater	15 Nov 32-1 May 34
Capt. Carl W. Connell	18 Jul 25-14 Mar 27	<i>Inactive</i>	1 May 34-1 Sep 36

63rd School Squadron (Attack)

HQ-Kelly Field, TX, 1936-41

Constituted in the Regular Army on 1 September 1936 and assigned to the Air Corps Primary Flying School. Organized on 1 September 1936 at Kelly Field, TX. Location 7 December 1941—Kelly Field, TX.

Status: Disbanded on 20 Apr 1944.

Commanders, 63rd School Squadron

Maj. Arthur G. Liggett	1 Sep 36-1 Aug 37	1st Lt. Harry S. Bishop	1 Apr 40-ao Jun 40
Capt. Harvey F. Dyer	1 Aug 37-1 Apr 40	Unknown	ao Jun 40-7 Dec 41

64th Service Squadron (1923-36) (7th Bombardment Group)

Air Park No. 9 (1921-23)

HQ-*Not organized* 1921-26; Third Corps Area on 1926-27; Ninth Corps Area on 1927-28; *Inactive* 1928-30; March Field, CA, 1930-36

Constituted in the Regular Army on 30 August 1921 as Air Park No. 9, assigned to the 7th Bombardment Group, and allotted to the Third Corps Area. Redesignated as the 64th Service Squadron on 25 January 1923. Designated Active Associate was the 59th Service Squadron 1923-27. Organized on 31 December 1926 with Organized Reserve personnel as a RAI unit in the Third Corps Area at large. Withdrawn from the Third Corps Area on 28 February 1927 and allotted to the Ninth Corps Area. Organized on 12 October 1927 with Organized Reserve personnel as a RAI unit in the Ninth Corps Area at large. Withdrawn from the Ninth Corps Area on 1 September 1928 and allotted to the Eighth Corps Area. Kelly Field, TX, designated as headquarters location on organization, but the unit was never organized at that location. Activated on 19 September 1930 at March Field, CA. Relieved from assignment to the 7th Bombardment Group on 1 June 1931 and assigned to the 17th Pursuit Group. Consolidated with HHS, 17th Attack Group on 1 September 1936.

Events: 142, 197, 201, 227, 249

Commanders, 64th Service Squadron

1st Lt. William A. Hayward*	31 Dec 26-28 Feb 27	Capt. Claude E. Duncan	1 Dec 31-11 Mar 33
Maj. H. C. Kress Muhlenberg*	12 Oct 27-1 Sep 28	1st Lt. Leo H. Dawson	11 Mar 33-25 May 33
<i>Inactive</i>	1 Sep 28-19 Sep 30	2nd Lt. Alfred R. Maxwell	25 May 33-26 Jul 33
Capt. Shiras A. Blair	19 Sep 30-22 Oct 31	1st Lt. James W. Spry	26 Jul 33-27 Nov 33
Capt. Gilbert C. Collar	22 Oct 31-2 Nov 31	Capt. Bernard T. Castor	27 Nov 33-2 Apr 35
Capt. Leo F. Post	5 Nov 31-1 Dec 31	Maj. Orin J. Bushey	2 Apr 35-1 Sep 36

* RAI Commanders: Regular Army officers.

64th School Squadron (Bombardment)

HQ-Kelly Field, TX, 1936-41

Constituted in the Regular Army on 1 September 1936 and assigned to the Air Corps Primary Flying School. Concurrently organized at Kelly Field, TX. Location 7 December 1941— Kelly Field, TX.

Commanders, 64th School Squadron

Maj. Roderick N. Ott	1 Sep 36-13 Jan 37	Maj. Adolphus R. McConnell	1 Jul 38-28 Feb 39
Capt. Edgar T. Selzer	13 Jan 37-1 Jul 37	Maj. Edward H. Porter	1 Mar 39-ao Jul 41
Capt. Walter G. Bryte	1 Jul 37-1 Jul 38	Unknown	ao Jul 41-7 Dec 41

65th Service Squadron (1922-38) (5th Composite Group)

Air Park No. 10 (1921-22)

HQ-Luke Field, TH, 1921-37

Organized on 6 June 1921 in the Regular Army at Luke Field, TH, as Air Park No. 10, assigned to the 5th Composite Group, and allotted to the Hawaiian Department. Redesignated as the 65th Service Squadron on 22 December 1922. Consolidated on 16 October 1936 with the 65th Aero Squadron (a WWI unit organized on 8 April 1918 at Kelly Field, TX; demobilized on 19 July 1919 at Park Field, TN; reconstituted on 16 October 1936). Reorganized and redesignated Base Headquarters and 17th Air Base Squadron on 1 September 1937.

Status: Disbanded on 1 April 1943 as HHS, 17th Service Group.

Events: 33, 75, 88, 120, 138, 141, 158, 160, 189, 211, 225, 248

Commanders, 65th Service Squadron

Capt. Frank W. Wright	6 Jun 21-3 May 23	1st Lt. Carl W. Pyle	15 Nov 30-1 Dec 30
1st Lt. William G. Moore	3 May 23-4 Sep 23	1st Lt. Benjamin F. Griffin	1 Dec 30-1 Feb 31
Capt. Donald P. Muse	4 Sep 23-9 May 25	1st Lt. Rowland Kieburz	1 Feb 31-21 Apr 31
Capt. Lester T. Miller	9 May 25-9 Jan 26	Capt. James F. Powell	21 Apr 31-17 Jun 32
1st Lt. Bernard J. Tooher	19 Jan 26-1 Apr 26	1st Lt. Fred C. Fishback	17 Jun 32-1 Apr 33
1st Lt. Oliver P. Gothlin	1 Apr 26-10 Aug 26	Capt. Douglas Johnston	1 Apr 33-18 Jul 33
1st Lt. Lotha A. Smith	10 Aug 26-31 Jan 27	Capt. Walcott P. Hayes	18 Jul 33-26 Oct 34
Capt. Lester T. Miller	31 Jan 27-1 Aug 27	Capt. Frank L. Cook	26 Oct 34-1 Mar 35
Capt. Henry Pascale	1 Aug 27-15 Jun 28	Capt. Walcott P. Hayes	1 Mar 35-22 Jun 35
Capt. Raymond E. O'Neill	15 Jun 28-1 Nov 28	Capt. Frank L. Cook	22 Jun 35-4 Jul 35
Capt. Henry Pascale	1 Nov 28-1 Mar 29	Capt. Harold G. Peterson	4 Jul 35-28 May 36
1st Lt. Carl A. Cover	1 Mar 29-1 Jul 29	Capt. William G. Bowyer	28 May 36-16 Jun 36
Capt. Clarence B. Lober	1 Jul 29-1 Nov 29	Capt. Thomas R. Starratt	16 Jun 36-3 Aug 36
Capt. John P. Temple	1 Nov 29-8 Mar 30	Maj. Dache McC. Reeves	3 Aug 36-1 Feb 37
Capt. Lewis R. Reese	8 Mar 30-15 Nov 30	1st Lt. Lawrence H. Douthit	1 Feb 37-19 Jun 37
	Maj. Newman R. Laughinghouse		19 Jun 37-1 Sep 37

66th Service Squadron (1923-38) (4th Composite Group)

Air Park No. 11 (1921-23)

HQ-Clark Field, PI, 1921; Nichols Field, PI, 1921-38

Organized on 2 June 1921 in the Regular Army at Clark Field, PI, as Air Park No. 11, assigned to the 4th Composite Group, and allotted to the Philippine Department. Transferred on 14 December 1921 to Camp Nichols, PI, (later redesignated Nichols Field). Redesignated as the 66th Service Squadron on 25 January 1923. Consolidated in October 1936 with the 66th Aero Squadron (a WWI unit organized on 26 April 1918 at Kelly Field, TX; demobilized on 15 November 1918 at Eberts Field, AR; reconstituted in October 1936). Consolidated with Station Complement, Nichols Field 25 March 1938 and consolidated unit reorganized and redesignated as Base Headquarters and 20th Air Base Squadron.

Events: 44, 51, 68, 128, 224, 245

Commanders, 66th Service Squadron

1st Lt. Leland C. Hurd	4 Jun 21-13 Dec 21	Capt. Benjamin F. Giles	10 Apr 29-1 Sep 29
Capt. Frederick R. Lafferty	13 Dec 21-3 May 22	Capt. Charles A. Pursley	1 Sep 29-11 Mar 30
Capt. Junius H. Houghton	3 May 22-29 Sep 22	Capt. William O. Butler	11 Mar 30-27 Aug 30
Capt. George B. Patterson	29 Sep 22-18 Nov 22	Capt. Vernon L. Burge	27 Aug 30-12 Oct 32
Capt. Roland W. Wittman	18 Nov 22-1 Dec 22	Capt. John G. Whiteside	12 Oct 32-16 Mar 34
Capt. Frederick I. Eglin	1 Dec 22-31 Mar 23	1st Lt. Ivan L. Proctor	16 Mar 34-1 Dec 34
Capt. Gilbert T. Collar	31 Mar 23-1 May 23	Maj. Harvey W. Prosser	1 Dec 34-8 May 35
1st Lt. Arthur W. Vannaman	1 May 23-Dec 23	Maj. Lionel H. Dunlap	13 May 35-28 Sep 35
1st Lt. Harry Weddington	Dec 23-3 Jan 24	Maj. James W. Hammond	28 Sep 35-6 May 36
1st Lt. Harry A. Dinger	3 Jan 24-1 May 25	Maj. Shelton E. Prudhomme	6 May 36-25 Jun 36
1st Lt. Shiras A. Blair	1 May 25-13 May 26	Maj. Harold R. Wells	25 Jun 36-12 Jun 37
Capt. Robert Kauch	13 May 26-30 Apr 27	1st Lt. John P. Ryan	12 Jun 37-29 Oct 37
Capt. George L. Usher	5 May 27-10 Apr 29	Maj. Earle J. Carpenter	29 Oct 37-25 Mar 38

67th Service Squadron (8th Pursuit Group)

HQ-Not organized 1923-27; Ninth Corps Area on 1927-28; *Inactive* 1928-30; Kelly Field, TX, 1930-31; Randolph Field, TX, 1931-36

Constituted in the Regular Army on 24 March 1923, assigned to the 8th Pursuit Group, and allotted to the Third Corps Area. Designated Active Associate was the 57th Service Squadron 1923-27. Withdrawn from the Third Corps Area on 28 February 1927 and allotted to the Ninth Corps Area. Organized on 31 December 1927 with Organized Reserve personnel as a RAI unit in the Ninth Corps Area. Withdrawn from the Ninth Corps Area on 1 September 1928 and allotted to the Eighth Corps Area. Activated on 1 October 1930 at Kelly Field, TX. Transferred on 1 September 1931 to Randolph Field, TX. Relieved from the 8th Pursuit Group on 1 March 1935 and assigned to the Air Corps Primary Flying School. Inactivated on 1 September 1936 at Randolph Field, TX, and personnel transferred to the 11th Air Base Squadron.

Commanders, 67th Service Squadron

Maj. George H. Peabody*	31 Dec 27-30 Jun 28	Maj. Laurence F. Stone	18 Jul 31-27 Nov 31
<i>Inactive</i>	1 Jul 28-1 Oct 31	1st Lt. Glen L. Davasher	28 Nov 31-7 Dec 31
1st Lt. Max F. Schneider	1 Oct 30-1 Feb 31	1st Lt. Ivan L. Procter	7 Dec 31-20 Apr 32
Capt. Orlo H. Quinn	1 Feb 31-7 Jul 31	Capt. Arthur E. Easterbrook	20 Apr 32-4 Mar 35
1st Lt. Ames S. Albro	7 Jul 31-18 Aug 31	Maj. Myron R. Wood	4 Mar 35-17 Aug 36
	Maj. Eugene B. Bayley	17 Aug 36-1 Sep 36	

* RAI Commanders: Regular Army officers.

68th Service Squadron (1923-36) (10th School Group)

Air Park No. 13 (1921-23)

HQ-Not organized 1921-22; Kelly Field, TX, 1922-36

Constituted in the Regular Army on 30 August 1921 as Air Park No. 13, assigned to the 10th School Group, and allotted to the Eighth Corps Area. Organized on 5 July 1922 at Kelly Field, TX. Redesignated as the 68th Service Squadron on 25 January 1923. Relieved from assignment to the 10th School Group on 15 July 1931 and assigned to the Air Corps Advanced Flying School. Consolidated with Headquarters, Air Corps Advanced Flying School 1 September 1936 and consolidated unit reorganized and redesignated as Headquarters and Headquarters Squadron, Air Corps Advanced Flying School.

Commanders, 68th Service Squadron

Capt. Vernon L. Burge	5 Jul 22-1 Sep 22	Capt. Thomas Bolend	16 Mar 27-6 Sep 27
Capt. Earl H. DeFord	1 Sep 22-1 Dec 22	1st Lt. William M. Lanagan	6 Sep 27-3 Sep 28
Capt. Vernon L. Burge	1 Dec 22-1 Apr 23	1st Lt. John M. Clark	3 Sep 28-25 Oct 29
Capt. Walter F. Kraus	1 Apr 23-21 Jul 23	1st Lt. Ivan L. Procter	25 Oct 29-25 Sep 31
Capt. Morris Berman	21 Jul 23-29 Nov 23	Capt. Clifford C. Nutt	25 Sep 31-30 May 34
1st Lt. Ralph D. Walker	29 Nov 23-21 Jun 26	Capt. William M. Lanagan	30 May 34-11 Feb 35
1st Lt. Earle G. Harper	21 Jun 26-4 Oct 26	Capt. Louis C. Mallory	11 Feb 35-1 Mar 35
1st Lt. Ralph D. Walker	4 Oct 26-16 Mar 27	Maj. Roderick N. Ott	1 Mar 35-1 Sep 36

69th Service Squadron (13th School Group)

HQ-Not organized 1921-35; Hamilton Field, CA, 1935-36

Constituted in the Regular Army on 30 August 1921 and assigned to the 13th School Group. Designated Active Associate was the Air Service Technical School 1923-27. Allotted to the Sixth Corps Area on 28 February 1927. Relieved from assignment to the 13th School Group on 22 July 1927. Withdrawn from the Sixth Corps Area on 1 September 1928 and allotted to the Eighth Corps Area. Kelly Field, TX, designated as headquarters location on organization, but the unit was never organized at that location. Assigned on 8 May 1929 to the 17th Pursuit Group. Relieved from assignment to the 17th Pursuit Group on 1 June 1931. Withdrawn from the Eighth Corps Area on 1 October 1933 and allotted to the Second Corps Area. Activated on 19 February 1935 at Hamilton Field, CA. Assigned on 1 March 1935 to the General Headquarters Air Force. Inactivated on 1 September 1936 at Hamilton Field, CA. Personnel and equipment concurrently transferred to the Base Headquarters and 5th Air Base Squadron.

Commanders, 69th Service Squadron

Maj. Lewis R. P. Reese	19 Feb 35-28 May 35	Capt. Alvord V. P. Anderson	2 Oct 35-20 Oct 35
Maj. Guy Kirksey	28 May 35-22 Jul 35	Maj. Arthur G. Hamilton	20 Oct 35-9 Nov 35
Capt. Oliver K. Robbins	22 Jul 35-2 Oct 35	Maj. James W. Spry	10 Nov 35-20 Aug 36
	Capt. Alvord V. P. Anderson	20 Aug 36-1 Sep 36	

70th Service Squadron (14th School Group)

HQ-Not organized 1923-24; Kelly Field, TX, 1924-27; March Field, CA, 1927-33; Hamilton Field, CA, 1933-36

Constituted in the Regular Army on 6 February 1923, assigned to the 14th School Group, and allotted to the Eighth Corps Area. Designated Active Associate was the 68th Service Squadron 1923-24. Organized on 27 June 1924 at Kelly Field, TX, and attached to the 10th School Group. Transferred on 20 June 1927 to March Field, CA. Relieved from assignment to the 14th School Group on 18 July 1927 and assigned to the 13th School Group. Relieved from assignment to the 13th School Group on 30 April 1931. Assigned on 30 June 1931 to the 7th Bombardment Group. Consolidated on 27 July 1932 with the 70th Aero Squadron (a WWI unit organized on 4 March 1918 at Ellington Field, TX; demobilized on 1 September 1919 at Ellington Field, TX; reconstituted on 27 July 1932). Transferred on 2 December 1933 to Hamilton Field, CA. Relieved from the 7th Bombardment Group on 1 March 1935 and assigned to the General Headquarters Air Force. Inactivated on 1 September 1936 at Hamilton Field. Personnel and equipment concurrently transferred to the Base Headquarters and 5th Air Base Squadron.

Events: 142, 165, 182, 197, 201, 235

Commanders, 70th Service Squadron

Capt. William B. Wright	27 Jun 24-17 Nov 25	1st Lt. Carl W. Pyle	1 Oct 31-4 Nov 31
Capt. James F. Doherty	17 Nov 25-ao May 26	1st Lt. Claude E. Duncan	4 Nov 31-1 Dec 31
1st Lt. Harvey W. Prosser	ao Dec 26-21 May 27	Capt. Leo F. Post	1 Dec 31-5 May 32
1st Lt. Earle G. Harper	21 May 27-13 Oct 27	Capt. Gilbert T. Collar	5 May 32-5 Feb 33
Capt. Thomas Bolend	13 Oct 27-31 Aug 30	Capt. Robert E. Selff	5 Feb 33-26 Jul 33
Capt. Lloyd N. Keesling	31 Aug 30-30 Apr 31	Capt. John M. Davies	26 Jul 33-12 Dec 34
1st Lt. Bernard T. Castor	1 May 31-1 Oct 31	Maj. Devereaux M. Myers	12 Dec 34-1 Sep 36

71st Service Squadron (16th Pursuit Group)

HQ-*Not organized* 1923-27; New York City, NY, 1927-28; *Inactive* 1928-32; Barksdale Field, LA, 1932-36

Stationed at Love Field, TX, as of January 1919 as Flying School Detachment, Love Field. Demobilized on 17 November 1919 at Love Field. Reconstituted in the Regular Army on 24 March 1923 as the 71st Service Squadron and assigned to the 16th Pursuit Group. Designated Active Associate was the 61st Service Squadron 1923-27. Allotted to the Second Corps Area on 28 February 1927. Organized on 7 September 1927 with Organized Reserve personnel as a RAI unit at New York City, NY. Withdrawn from the Second Corps Area on 1 September 1928 and allotted to the Eighth Corps Area. Reserve personnel in the Second Corps Area concurrently relieved. Kelly Field, TX, designated as headquarters location on organization, but the unit was never organized at that location. Relieved from assignment to the 16th Pursuit Group on 1 June 1931 and assigned to the 8th Pursuit Group. Relieved from assignment to the 8th Pursuit Group on 15 June 1932 and assigned to the 16th Pursuit Group. Activated on 31 October 1932 at Barksdale Field, LA. Relieved on 14 March 1935 from the 20th Pursuit Group and concurrently attached to the group for administrative purposes. Consolidated with HQ, 20th Pursuit Group on 1 September 1936 at Barksdale Field, LA, and consolidated unit redesignated HHS, 20th Pursuit Group.

Events: 194, 197, 200, 243

Commanders, 71st Service Squadron

Unknown**	7 Sep 27-1 Sep 28	Capt. Edward V. Harbeck	3 Jun 33-16 Mar 34
<i>Inactive</i>	1 Sep 28-31 Oct 32	1st Lt. Joseph G. Hopkins	16 Mar 34-24 May 34
Capt. John P. Temple	31 Oct 32-24 Nov 32	1st Lt. Manning E. Tillery	24 May 34-31 Aug 34
Capt. Thomas Bolend	24 Nov 32-3 Jun 33	Capt. Edward V. Harbeck	31 Aug 34-14 Mar 35
	Maj. Roy W. Camblin	15 Mar 35-1 Sep 36	

** RAI Commanders: Organized Reserve officers.

72nd Bombardment Squadron (5th Composite Group)

HQ-Luke Field, TH, 1923-39; Hickam Field, TH, 1939-41

Constituted in the Regular Army on 6 February 1923, assigned to the 5th Composite Group, and allotted to the Hawaiian Department. Organized on 1 May 1923 at Luke Field, TH. Consolidated on 8 April 1924 with the 72nd Aero Squadron (a WWI unit organized in February 1918 at Waco Field, TX; demobilized on 11 July 1919 at Mitchel Field, NY; reconstituted on 8 April 1924). Relieved from assignment to the 5th Composite Group on 24 June 1932 and assigned to the 19th Bombardment Group. Squadron remained attached to the 5th Composite Group for administrative purposes. Conducted bombing missions on lava flows from the Mauna Loa volcano to divert them from the city of Hilo, TH, 27 December 1935. Relieved from assignment to the 19th Bombardment Group on 12 October 1938 and assigned to the 5th Bombardment Group. Transferred on 4 January 1939 to Hickam Field, TH. Redesignated as the 72nd Bombardment Squadron (Medium) on 6 December 1939. Redesignated as the 72nd Bombardment Squadron (Heavy) on 20 November 1940. Location 7 December 1941—Hickam Field, TH.

Status: Active in the U. S. Air Force as the 72nd Test and Evaluation Squadron at Whiteman A.F.B., MO.

Events: 141, 158, 182, 235, 248, 276, 289, 297, 312

Commanders, 72nd Bombardment Squadron

Capt. Ross G. Hoyt	1 May 23-25 Jan 24	1st Lt. William B. Clark	16 Dec 31-21 Apr 31
Capt. Richard J. Kirkpatrick	25 Jan 34-24 Oct 25	1st Lt. David M. Ramsay	21 Apr 31-2 Mar 32
1st Lt. Clyde V. Finter	24 Oct 25-13 Apr 26	Maj. John V. Hart	2 Mar 32-3 Sep 35
Capt. Lorenzo L. Snow	13 Apr 26-17 May 26	Capt. Ford J. Lauer	3 Sep 35-31 May 36
1st Lt. Clyde V. Finter	17 May 26-30 Jul 26	Maj. Idwal H. Edwards	31 May 36-3 Jul 37
Capt. Henry Pascale	30 Jul 26-1 Aug 27	1st Lt. Paul E. Ruestow	3 Jul 37-4 Sep 37
Capt. John W. Signer	1 Aug 27-2 Sep 27	Maj. Oliver P. Gothlin, Jr.	4 Sep 37-Sep 40
Capt. Harry C. Drayton	2 Sep 27-12 Jun 30	Capt. Robert F. Travis	Jul 39-Sep 40
Capt. Horace N. Heisen	12 Jun 30-28 Mar 31	Unknown	Sep 40-ao Nov 41
2nd Lt. Edgar F. Cheatle	28 Mar 31-16 Dec 31	Maj. Archibald Hanna	ao Nov 41-Jan 42

73rd Headquarters Squadron (1927-29)

73rd Pursuit Squadron (1929-35) (18th Pursuit Group)

73rd Attack Squadron (1935-39)

73rd Bombardment Squadron (1939-41)

HQ- San Antonio, TX, 1927-31; March Field, CA, 1931-41

Constituted in the Regular Army on 18 October 1927 as the 73rd Headquarters Squadron and allotted to the Eighth Corps Area. Concurrently organized with Organized Reserve personnel as a RAI unit at San Antonio, TX. Organized Reserve officers assigned to the unit participated in summer training at Kelly Field, TX, 1928-30 with the Headquarters, 3rd Attack Group. Redesignated as the 73rd Pursuit Squadron on 8 May 1929 and assigned to the 18th Pursuit Group. Designated mobilization training station was Dodd Field, TX, 1927-31. Activated on 15 July 1931, less Reserve personnel, at March Field, CA. Concurrently relieved from assignment to the 18th Pursuit Group and assigned to the 17th Pursuit Group. Reorganized and redesignated 73rd Attack Squadron on 1 March 1935 and assigned to the 17th Attack Group. Awarded the Frank Luke Trophy for 1935. Consolidated on 5 June 1936 with the 73rd Aero Squadron (a WWI unit organized in February 1918 at Waco Field, TX; demobilized on 4 July 1919 at Hazelhurst, NY; reconstituted on 5 June 1936). Participated in flood relief operations in southern California 2-5 March 1938. Reorganized and redesignated 73rd Bombardment Squadron (Medium) on 17 October 1939 and assigned to the 17th Bombardment Group. Relieved from assignment to the 17th Bombardment Group on 3 May 1941 and assigned to the 28th Composite Group. Location 7 December 1941—March Field, CA.

Status: Active in the U. S. Air Force as the 73rd Special Operations Squadron at Hurlburt Field, FL.

Events: 142, 195, 197, 201, 227, 231, 249, 257, 289

Commanders, 73rd Pursuit Squadron

73rd Attack Squadron

73rd Bombardment Squadron

Unknown**	12 Oct 27-15 Jul 31	1st Lt. Charles B. Overacker	3 Jul 35-26 Jul 35
1st Lt. Carl W. Pyle	15 Jul 31-1 Oct 31	1st Lt. Nathan B. Forrest	26 Jul 35-15 Aug 35
1st Lt. Hugh C. Minter	1 Oct 31-8 Jul 32	Maj. Louis C. Mallory	15 Aug 35-ao Sep 39
1st Lt. John H. Dulligan	8 Jul 32-6 Sep 33	Unknown	ao Sep 39-ao Jun 40
Capt. Charles Douglas	6 Sep 33-12 Jan 34	Maj. Charles B. Overacker	ao Jun 40-28 May 41
Maj. William C. Morris	12 Jan 34-3 Jul 35	Unknown	28 May 41-7 Dec 41

** RAI commanders: Organized Reserve officers.

74th Attack Squadron (1927-29)

74th Pursuit Squadron (1929-37)

74th Attack Squadron (1937-39)

74th Bombardment Squadron (1937-41)

HQ-Fort Crockett, TX, 1927-33; Albrook Field, CZ, 1933-41

Constituted in the Regular Army on 18 October 1927 as the 74th Attack Squadron and allotted to the Eighth Corps Area. Concurrently organized with Organized Reserve personnel as a RAI unit at Fort Crockett, TX. Redesignated as the 74th Pursuit Squadron on 8 May 1929 and assigned to the 18th Pursuit Group. Organized Reserve officers assigned to the unit participated in summer training at Fort Crockett, TX, 1927-33 with elements of the 3rd Attack Group. Relieved from assignment to the 18th Pursuit Group on 15 July 1931 and assigned to the 20th Pursuit Group. Relieved from assignment to the 20th Pursuit Group on 15 June 1932 and assigned to the 16th Pursuit Group. Activated on 1 October 1933, less Reserve personnel, at Albrook Field, CZ. Consolidated in October 1936 with the 74th Aero Squadron (a WWI unit organized in February 1918 at Waco Field, TX; demobilized on 28 January 1919 at Garden City, NY; reconstituted in October 1936). Reorganized and redesignated 74th Attack Squadron on 1 September 1937. Reorganized and redesignated 74th Bombardment Squadron on 1 November 1939. Redesignated as the 74th Bombardment Squadron (Medium) on 6 December 1939. Relieved from assignment to the 16th Pursuit Group on 1 February 1940 and assigned to the 6th Bombardment Group. Location 7 December 1941—Albrook Field, CZ.

Status: Inactive in the U. S. Air Force as the 135th Bombardment Squadron (Medium).

Events: 292, 308, 333

Commanders, 74th Pursuit Squadron

74th Attack Squadron

74th Bombardment Squadron

Unknown**	12 Oct 27-1 Oct 33	Capt. John T. Sprague	21 Aug 36-11 Aug 38
1st Lt. Charles P. Cabell	1 Oct 33-9 Aug 34	Capt. Edgar A. Sirmyer, Jr.	11 Aug 38-Feb 40
1st Lt. Charles H. Deerwater	9 Aug 34-4 Dec 34	Capt. Richard T. King, Jr.	Feb 40-Oct 41
Maj. Orrin L. Grover	4 Dec 34-21 Aug 36	Maj. Russell E. Randall	Sep 40-Jan 41
	Capt. Richard T. King, Jr.	Jan 41-Oct 41	

** RAI commanders: Organized Reserve officers.

75th Attack Squadron (1927-29) (18th Pursuit Group)

75th Service Squadron (1929-38)

HQ-Fort Crockett, TX, 1927-30; Wheeler Field, TH, 1930-38

Constituted in the Regular Army on 18 October 1927 as the 75th Attack Squadron, assigned to the 18th Pursuit Group, and allotted to the Eighth Corps Area. Concurrently organized with Organized Reserve personnel as a RAI unit at Fort Crockett, TX. Organized Reserve officers assigned to the unit participated in summer training at Fort Crockett, TX, 1928-30 with elements of the 3rd Attack Group. Redesignated as the 75th Service Squadron on 8 May 1929 and assigned to the 18th Pursuit Group. Activated on 15 September 1930, less Reserve personnel, at Wheeler Field, TH. Consolidated on 16 October 1936 with the 75th Aero Squadron (a WWI unit organized on 22 January 1918 at Waco Field, TX; demobilized on 17 November 1919 at Gerstner Field, LA; reconstituted on 16 October 1936). Reorganized and redesignated Base Headquarters and 18th Air Base Squadron (Single) on 1 March 1938.

Status: Disbanded on 1 April 1943.

Events: 141, 158, 248

Commanders, 75th Service Squadron

Maj. Bernard J. Tooher*	18 Oct 27-7 Feb 28	Capt. James E. Duke, Jr.	8 Jun 33-13 Feb 35
1st Archibald M. Kelley*	7 Feb 28-28 Feb 28	Capt. Early E. W. Duncan	13 Feb 35-12 Mar 35
Unknown**	1 Mar 28-15 Sep 30	Capt. Roscoe C. Wriston	12 Mar 35-1 Jun 37
1st Lt. George P. Tourtellot	15 Sep 30-2 Mar 33	1st Archibald M. Kelley	1 Jun 37-4 Sep 37
1st Lt. William O. Eareckson	2 Mar 33-8 Jun 33	Maj. Bernard J. Tooher	3 Sep 37-1 Feb 38

* RAI commanders: Regular Army officers.

** RAI commanders: Organized Reserve officers.

76th Observation Squadron (1927-29) (19th Bombardment Group)

76th Service Squadron (1929-30)

HQ-Not organized 1927-28; Kelly Field, TX, 1928-30; Rockwell Field, CA, 1930-32; March Field, CA, 1932-36

Constituted in the Regular Army on 18 October 1927 as the 76th Observation Squadron and allotted to the Eighth Corps Area. Organized by June 1928 with Organized Reserve personnel as a RAI unit at Kelly Field, TX. Organized Reserve officers assigned to the unit participated in summer training at Kelly Field 1928-30. Designated mobilization training station was Dodd Field, TX, 1927-30. Redesignated as the 76th Service Squadron on 8 May 1929 and assigned to the 20th Pursuit Group. Activated on 30 November 1930, less Reserve personnel, at Rockwell Field, CA. Relieved from assignment to the 20th Pursuit Group on 15 June 1932 and assigned to the 19th Bombardment Group. Transferred on 15 March 1932 to March Field, CA. Inactivated on 1 September 1936 at March Field, CA.

Events: 182, 235

Commanders, 76th Service Squadron

Unknown**	Jun 28-30 Nov 30	Capt. Carl W. Pyle	26 Jan 33-12 Sep 34
1st Lt. Eugene C. Batten	30 Nov 30-24 May 31	Capt. Delmar H. Dunton	12 Sep 34-1 Mar 35
1st Lt. John K. Nissley	24 May 31-25 Aug 31	Capt. Carlyle H. Ridenour	1 Mar 35-20 Apr 35
1st Lt. Claude E. Duncan	25 Aug 31-24 Sep 31	Maj. Carl W. Pyle	20 Apr 35-1 Jul 36
1st Lt. Richard K. LeBrou	24 Sep 31-26 Jan 33	1st Thomas W. Steed	1 Jul 36-31 Jul 36
	Maj. Walter R. Peck	31 Jul 36-1 Sep 36	

** RAI commanders: Organized Reserve officers.

77th Observation Squadron (1927-29)

77th Pursuit Squadron (1929-41) (20th Pursuit Group)

HQ-Not organized 1927-28; Dallas, TX, 1928-30; Mather Field, CA, 1930-32; Barksdale Field, LA, 1932-39; Moffett Field, CA, 1939-40; Hamilton Field, CA, 1940-41

Constituted in the Regular Army on 18 October 1927 as the 77th Observation Squadron and allotted to the Eighth Corps Area. Organized on 16 May 1928 as a RAI unit with Organized Reserve personnel at Dallas, TX. Conducted annual summer training at Love Field or Hensley Field, TX. Redesignated as the 77th Pursuit Squadron on 8 May 1929 and assigned to the 18th Pursuit Group. Activated on 15 November 1930, less Reserve personnel, at Mather Field, CA. Relieved from assignment to the 18th Pursuit Group on 15 June 1932 and assigned to the 20th Pursuit Group. Transferred on 14 October 1932 to Barksdale Field, LA. Consolidated in October 1936 with the 77th Aero Squadron (a WWI unit organized on 20 February 1918; redesignated as Squadron A, Barron Field, TX, 21 July 1918; demobilized on 18 November 1918 at Barron Field, TX; reconstituted in October 1936). Awarded the Frank Luke Trophy for 1937 and 1938. Transferred on 19 November 1939 to Moffett Field, CA. Redesignated as the 77th Pursuit Squadron (Fighter) on 6 December 1939. Transferred on 9 September 1940 to Hamilton Field, CA. Redesignated as the 77th Pursuit Squadron (Interceptor) on 12 March 1941. Location 7 December 1941—Hamilton Field, CA.

Status: Active in the U. S. Air Force as the 77th Fighter Squadron at Shaw A.F.B., SC.

Events: 141, 158, 194, 197, 200, 227, 243, 249, 289

Commanders, 77th Observation Squadron

77th Pursuit Squadron

Capt. Charles W. Childress**	16 May 28-14 Nov 30	Maj. Oliver P. Gothlin, Jr.	14 Sep 35-17 Aug 36
1st Lt. Walter E. Richards	15 Nov 30-13 Jun 31	Maj. Carlton F. Bond	23 Aug 36-1 Apr 37
2nd Lt. Joseph G. Hopkins	13 Jun 31-18 Aug 31	1st Lt. Orrin L. Grover	1 Apr 37-1 Jun 37
Capt. Hilbert H. Wittkop	18 Aug 31-8 Jul 32	1st Lt. Phineas K. Morrill	1 Jun 37-10 Aug 37
2nd Lt. Joseph G. Hopkins	8 Jul 32-5 Dec 32	Maj. Milo N. Clark	10 Aug 37-6 Jul 38
Capt. John M. Clark	5 Dec 32-30 Jul 35	Capt. Orrin L. Grover	18 Jul 38-Aug 39
Capt. Thomas B. McDonald	30 Jul 35-14 Sep 35	Maj. James W. McCauley	Aug 39-Feb 41
	1st Lt. Graham W. West	ao Sep 41-ao Dec 41	

** RAI Commanders: Organized Reserve officers.

78th Observation Squadron (1927-29)

78th Pursuit Squadron (1929-41) (20th Pursuit Group)

HQ-Not organized 1927-29; Kelly Field, TX, 1929-31; France Field, CZ, 1931-32; Albrook Field, CZ, 1932-37; *Inactive* 1937-40; Wheeler Field, TH, 1940-41

Constituted in the Regular Army on 18 October 1927 as the 78th Observation Squadron and allotted to the Eighth Corps Area. Redesignated as the 78th Pursuit Squadron on 8 May 1929 and assigned to the 20th Pursuit Group. Organized by June 1929 with Organized Reserve personnel as a RAI unit at Kelly Field, TX. Organized Reserve officers assigned to the unit participated in summer training at Kelly Field 1927-30. Designated mobilization training station was Dodd Field, TX, 1927-30. Activated on 1 April 1931, less Reserve personnel, at France Field, CZ, and attached to the 6th Composite Group. Transferred on 15 October 1932 to Albrook Field, CZ. Relieved from assignment to the 20th Pursuit Group on 15 June 1932 and assigned to the 16th Pursuit Group. Consolidated in 1933 with the 78th Aero Squadron (a WWI unit organized on 28 February 1918, redesignated as Squadron A, Taliaferro Field, TX, 23 July 1918, demobilized on 15 November 1918 at Taliaferro Field; reconstituted in 1933). Inactivated on 1 September 1937 at Albrook Field, CZ, and allotted to the Fourth Corps Area. Shreveport, LA, designated as headquarters location on organization, but the unit was never organized at that location. Redesignated as the 78th Pursuit Squadron (Interceptor) on 22 December 1939. Activated on 1 February 1940 at Wheeler Field, TH, and assigned to the 18th Pursuit Group. Location 7 December 1941—Wheeler Field, TH.

Status: Active in the U. S. Air Force as the 78th Fighter Squadron at Shaw A.F.B., SC.

Events: 297, 312

Commanders, 78th Pursuit Squadron

Unknown**	Jun 29-1 Apr 31	1st Lt. Frank A. Armstrong, Jr.	31 Oct 36-1 Nov 36
Capt. Louis N. Eller	1 Apr 31-6 Jun 31	Maj. Gilbert T. Collar	1 Nov 36-1 May 37
1st Lt. Patrick N. Timberlake	6 Jun 31-4 Nov 31	1st Lt. Trenholm J. Meyer	1 May 37-12 May 37
1st Lt. Earle E. Partridge	4 Nov 31-16 Dec 31	Capt. Manning E. Tillery	12 May 37-4 Aug 37
2nd Lt. Nathan B. Forrest	16 Dec 31-16 Jan 32	1st Lt. Millard A. Lewis	4 Aug 37-1 Sep 37
1st Lt. Cecil E. Henry	16 Jan 32-15 Jan 34	<i>Inactive</i>	1 Sep 37-1 Feb 40
1st Lt. James G. Pratt	15 Jan 34-12 Sep 34	Capt. Daniel W. Jenkins	1 Feb 40-20 Jul 40
Maj. Burton M. Hovey, Jr.	12 Sep 34-31 Oct 36	Capt. Archibald J. Hanna	20 Jul 40-30 Apr 41
Capt. William P. Fisher	30 Apr 41-ao Jun 41	Capt. William P. Fisher	30 Apr 41-ao May 41
	Maj. William R. Clingerman	ao Aug 41-3 Jun 42	

** RAI Commanders: Organized Reserve officers.

79th Observation Squadron (1927-29)

79th Pursuit Squadron (1929-41) (20th Pursuit Group)

HQ-*Not organized* 1929-32; San Antonio, TX, 1932-33; Barksdale Field, LA, 1933-39; Moffett Field, CA, 1939-40; Hamilton Field, CA, 1940-41

Constituted in the Regular Army on 18 October 1927 as the 79th Observation Squadron and allotted to the Eighth Corps Area. Redesignated as the 79th Pursuit Squadron on 8 May 1929 and assigned to the 20th Pursuit Group. Organized on 7 September 1932 with Organized Reserve personnel as a RAI unit at San Antonio, TX. Activated on 1 April 1933 at Barksdale Field, LA. Consolidated on 25 May 1933 with the 79th Aero Squadron (a WWI unit organized on 22 February 1918, redesignated as Squadron B, Taliaferro Field, TX, 23 July 1918, demobilized on 15 November 1919 at Taliaferro Field; reconstituted on 25 May 1933). Awarded the Frank Luke Trophy for 1936. Transferred on 19 November 1939 to Moffett Field, CA. Redesignated as the 79th Pursuit Squadron (Fighter) on 6 December 1939. Transferred on 9 September 1940 to Hamilton Field, CA. Redesignated as the 79th Pursuit Squadron (Interceptor) on 12 March 1941. Location 7 December 1941—Hamilton Field, CA.

Status: Active in the U. S. Air Force as the 79th Fighter Squadron at Shaw A.F.B., SC.

Events: 197, 197, 200, 227, 243, 249, 289

Commanders, 79th Pursuit Squadron

Unknown**	7 Sep 32-1 Apr 33	1st Lt. Robert B. Landery	26 Jul 37-13 Sep 37
Capt. Roy W. Camblin	1 Apr 33-14 Mar 35	Maj. Armin F. Herold	14 Sep 37-6 Jul 38
Maj. Charles G. Pearcy	14 Mar 35-8 Mar 36	Capt. Thayer S. Olds	6 Jul 38-1 Jun 39
Maj. Carlton F. Bond	8 Mar 36-24 Aug 36	1st Lt. Minthorne W. Reed	1 Jun 39-1 Jul 39
Maj. Charles G. Pearcy	24 Aug 36-17 Nov 36	1st Lt. Arthur F. Merewether	1 Jul 39-Mar 40
Maj. Frank O'D. Hunter	17 Nov 36-17 Jul 37	1st Lt. James Ferguson	Mar 40-Apr 42

** RAI Commanders: Organized Reserve officers.

80th Observation Squadron (1927-29)

80th Service Squadron (1929-37) (20th Pursuit Group)

HQ-*Not organized* 1927-30; San Antonio, TX, 1928-30; Mather Field, CA, 1930-32; Albrook Field, CZ, 1932-37

Constituted in the Regular Army on 18 October 1927 as the 80th Observation Squadron and allotted to the Eighth Corps Area. Organized by June 1928 with Organized Reserve personnel as a RAI unit at San Antonio, TX. Redesignated as the 80th Service Squadron on 8 May 1929 and assigned to the 20th Pursuit Group. Designated mobilization training station was Dodd Field, TX, 1927-30. Organized Reserve officers assigned to the unit participated in summer training at Kelly Field, TX, 1928-30. Activated on 15 November 1930, less Reserve personnel, at Mather Field, CA, with personnel from the Air Corps Detachment, Mather Field. Relieved from assignment to the 20th Pursuit Group on 1 March 1932 and assigned to the 19th Bombardment Group. Relieved from assignment to the 19th Bombardment Group on 15 June 1932 and assigned to the 20th Pursuit Group. Consolidated on 24 August 1932 with the 80th Aero Squadron (a WWI unit organized on 1 March 1918 at Waco Field, TX; demobilized on 22 September 1919 at Post Field, OK; reconstituted on 24 August 1932). Relieved from assignment to the 20th Pursuit Group 5 October 1932 and assigned to the 16th Pursuit Group. Sailed from San Francisco for the Panama Canal on the U.S.A.T. *U.S. Grant*

about 15 October 1932. Arrived at Balboa, CZ, on 24 October 1932 and transferred to Albrook Field, CZ, the same day. Reorganized and redesignated as Base Headquarters and 15th Air Base Squadron on 1 September 1937.

Status: Disbanded on 15 June 1983.

Events: 141, 158

Commanders, 80th Service Squadron

Unknown**	Jun 28-15 Nov 30	1st Lt. Joseph A. Bulger	1 Aug 34-15 Oct 34
Capt. John M. Clark	15 Nov 30-1 Jul 31	Capt. Leo W. DeRosier	15 Oct 34-1 Mar 35
Capt. Thomas Bolend	1 Jul 31-5 Dec 31	Maj. Alonzo M. Drake	1 Mar 35-14 Aug 35
Capt. Horace N. Heisen	5 Dec 31-18 Jun 32	Maj. Isaac J. Williams	14 Aug 35-18 Jun 36
Capt. John M. Clark	18 Jun 32-14 Oct 32	Capt. Leo W. DeRosier	18 Jun 36-1 Jul 36
1st Lt. Charles H. Deer wester	14 Oct 32-16 Mar 33	Capt. Charles A. Ross	1 Jul 36-1 Nov 36
1st Lt. Ernest H. Lawson	16 Mar 33-1 Jun 33	Maj. Gilbert T. Collar	1 Nov 36-1 May 37
Capt. Jasper K. McDuffie	1 Jun 33-14 Sep 33	1st Lt. Trenholm J. Meyer	1 May 37-12 May 37
Capt. Alonzo M. Drake	14 Sep 33-1 Aug 34	Capt. Manning E. Tillery	12 May 37-4 Aug 37
	1st Lt. Millard A. Lewis	4 Aug 37-1 Sep 37	

** RAI Commanders: Organized Reserve officers.

81st Observation Squadron

Regular Army Inactive

HQ-*Not organized* 1927-28; Galveston, TX, 1928-33

Constituted in the Regular Army on 18 October 1927 and assigned to the Air Corps Advanced Flying School. Concurrently allotted to the Eighth Corps Area. Organized on 16 May 1928 with Organized Reserve personnel as a RAI unit at Galveston, TX. Conducted summer training at Kelly Field, TX, 1928-30. Designated mobilization training station was Dodd Field, TX, 1927-31. Demobilized on 1 October 1933.

Commanders, 81st Observation Squadron

Capt. Burdette S. Graham** 16 May 28-1 Oct 33

** RAI Commanders: Organized Reserve officers.

81st Service Squadron

HQ-Kelly Field, TX, 1935-36

Constituted in the Regular Army on 1 March 1935 and assigned to the Air Corps Advanced Flying School. Concurrently organized at Kelly Field, TX. Consolidated with the Station Complement, Kelly Field on 1 September 1936 and consolidated unit redesignated as Base Headquarters and 12th Air Base Squadron.

Commanders, 81st Service Squadron

Maj. Louie C. Mallory	4 Mar 35-5 Aug 35	Maj. Wolcott P. Hayes	5 Aug 35-16 Oct 35
	Maj. George A. McHenry	16 Oct 35-1 Sep 36	

82nd Observation Squadron (I)

HQ-*Not organized* 1927-33

Constituted in the Regular Army on 18 October 1927 and allotted to the Eighth Corps Area. San Antonio, TX, designated as headquarters location on organization, but the unit was never organized at that location.

Demobilized on 1 October 1933.

82nd Observation Squadron (II) (12th Observation Group)

HQ-Moffett Field, CA, 1937-40; Hamilton Field, CA, 1940-41; Salinas, CA, 1941

Constituted in the Regular Army on 1 June 1937 and concurrently organized at Moffett Field, CA. Assigned on 17 July 1937 to the 12th Observation Group. Transferred on 12 September 1940 to Hamilton Field, CA. Assigned on 3 October 1940 to the Fourth Army. Assigned on 15 November 1940 to the III Corps. Transferred on 9 April 1941 to Salinas, CA. Assigned on 3 September 1941 to the 68th Observation Group (III Corps). Location 7 December 1941—Salinas, CA.

Status: Active in the U. S. Air Force as the 82nd Reconnaissance Squadron at Kadena A.B., Japan.

Events: 304

Commanders, 82nd Observation Squadron

Maj. Robert H. Finley	1 Jun 37-17 Jun 37	1st Lt. Robert Alan	18 Jul 38-1 Jul 39
Maj. Bushrod Hoppin	21 Jun 37-18 Jul 38	Maj. William C. Sams	1 Jul 39-7 Nov 41
	Capt. Walter C. Bass	7 Nov 41-ao Jan 42	

83rd Observation Squadron

HQ-*Not organized* 1927-33

Constituted in the Regular Army on 18 October 1927 and allotted to the Eighth Corps Area. San Antonio, TX, designated as headquarters location on organization, but the unit was never organized at that location. Designated mobilization training station was Dodd Field, TX, 1927-33. Demobilized on 1 October 1933.

84th Service Squadron (11th Observation Group)

HQ-*Not organized* 1927-28; Galveston, TX, 1928-33; *Inactive* 1933-35; Maxwell Field, AL, 1935-36

Constituted in the Regular Army on 18 October 1927, assigned to the 11th Observation Group and allotted to the Eighth Corps Area. Organized on 16 May 1928 as a RAI unit with Organized Reserve personnel at Galveston, TX. Conducted summer training at Fort Crockett, TX, with units of the 3rd Attack Group. Designated mobilization training station was Dodd Field, TX, 1927-33. Withdrawn from the Eighth Corps Area on 1 October 1933 and allotted to the Sixth Corps Area. Activated on 1 March 1935 at Maxwell Field, AL, and assigned to the Air Corps Tactical School. Inactivated on 1 September 1936 at Maxwell Field, AL.

Commanders, 84th Service Squadron

1st Lt. Carlton P. Smith**	16 May 28-1 Oct 33	Maj. Arnold H. Rich	1 Mar 35-1 Oct 35
<i>Inactive</i>	1 Oct 33-1 Mar 35	Maj. Claire L. Chennault	1 Oct 35-22 Jul 36
	Maj. Lewis A. Dayton	22 Jul 36-1 Sep 36	

** RAI Commanders: Organized Reserve officers.

85th Observation Squadron

HQ-*Not organized* 1929-33

Constituted in the Regular Army on 8 May 1929 and allotted to the Eighth Corps Area. Kelly Field, TX, designated as headquarters location on organization, but the unit was never organized at that location. Demobilized on 1 October 1933.

86th Observation Squadron (I)

HQ-*Not organized* 1929-33; Crissy Field, CA, 1933; Fort Lewis, WA, 1933; *Inactive* 1933-35; Maxwell Field, AL, 1935-36

Constituted in the Regular Army on 8 May 1929 and allotted to the Eighth Corps Area. Kelly Field, TX, designated as headquarters location on organization, but the unit was never organized at that location. Flight A organized on 1 August 1933 at Crissy Field, CA; subsequently transferred 3 October 1933 to Fort Lewis, WA. Squadron demobilized on 1 October 1933. Flight A inactivated on 17 November 1933 at Fort Lewis.

Commanders, 86th Observation Squadron (I)

Flight A

1st Lt. Fred A. Ingalls

1 Aug 33-1 Sep 33

Capt. Isaac J. Williams

1 Sep 33-17 Nov 33

86th Observation Squadron (II) (Hawaiian Department)

HQ-Maxwell Field, AL, 1935-36; *Inactive* 1936-40; Wheeler Field, TH, 1940-41

Constituted in the Regular Army on 1 March 1935, attached to the Air Corps Tactical School, and organized at Maxwell Field, AL. Inactivated on 1 September 1936 at Maxwell Field, AL. Consolidated on 1 December 1936 with the 86th Aero Squadron (a WWI unit organized on 17 August 1917 at Scott Field, IL; demobilized on 26 May 1919 at Camp Lee, VA; reconstituted on 1 December 1936). Activated on 1 February 1940 at Wheeler Field, TH, and assigned to the Hawaiian Department. Further assigned in November 1940 to the Hawaiian Air Force. Location 7 December 1941—Wheeler Field, TH.

Status: Active in the U. S. Air Force as the 43rd Electronic Combat Squadron at Davis-Montahn A.F.B., AZ.

Events: 297, 312

Commanders, 86th Observation Squadron (II)

Maj. Kenneth C. McGregor
Inactive

1 Mar 35-1 Sep 36
1 Sep 36-31 Jan 40

Maj. George R. Acheson
Maj. Charles Stewart

1 Feb 40-Aug 40
Aug 40-ao Dec 41

87th Observation Squadron

HQ-*Not organized* 1929-33

Constituted in the Regular Army on 8 May 1929 as the 87th Observation Squadron and allotted to the Eighth Corps Area. Kelly Field, TX, designated as headquarters location on organization, but the unit was never organized at that location. Demobilized on 1 October 1933.

87th Pursuit Squadron

HQ-Maxwell Field, AL, 1935-36; *Inactive* 1936-38

Constituted in the Regular Army on 1 March 1935, assigned to the 20th Pursuit Group, and organized at Maxwell Field, AL, with personnel from the 51st and 54th School Squadrons. Attached to the Air Corps Tactical School. Inactivated on 1 September 1936 at Maxwell Field, AL. Consolidated on 1 December 1936 with the 87th Aero Squadron (a WWI unit organized on 1 August 1917 at Kelly Field, TX; demobilized on 20 July 1920 at Park Field, TN; reconstituted on 1 December 1936). Demobilized on 1 January 1938.

Status: Active in the U. S. Air Force as the 87th Flying Training Squadron at Laughlin A.F.B., TX.

Events: 194, 243, 289

Commanders, 87th Pursuit Squadron

Maj. Charles D. McAllister

1 Mar 35-12 Mar 36
Inactive

Maj. Bayard Johnson
1 Sep 36-1 Jan 38

12 Mar 35-1 Sep 36

88th Observation Squadron (1919-1935) (5th Division)

88th Reconnaissance Squadron (1935-41)

HQ-Mitchel Field, NY, 1919; Scott Field, IL, 1919; Langley Field, VA, 1919-21; Godman Field, KY, 1921-22; Wright Field, OH, 1922-27; *Inactive* 1927-28; Post Field, OK, 1928-31; Brooks Field, TX, 1931-35; Hamilton Field, CA, 1935-40; Fort Douglas, UT, 1940-41; Salt Lake City, UT, 1941



Stationed at Mitchel Field, NY, as of 27 June 1919 as the 88th Aero Squadron. Transferred on 11 July 1919 to Scott Field, IL. Transferred on 5 September 1919 to Langley Field, VA. Assigned on September 1919 to the 2nd Wing. Attached on 1 October 1919 to the 1st Army Observation Group. Relieved from the 2nd Wing on 24 May 1920 and assigned to the 1st Army Observation Group. Attached to the 1st Provisional Air Brigade 6 May-3 October 1921 while supporting the battleship bombing tests off the Virginia coast. Redesignated as the 88th Squadron (Observation) on 14 March 1921. Flew missions in support of authorities engaged in quelling civil disorders in the West Virginia coal fields 2-8 September 1921. Transferred on 15 October 1921 to Godman Field, KY, and assigned to the Fifth Corps Area. Transferred on 11 October 1922 to Wright Field, OH. Redesignated

as the 88th Observation Squadron on 25 January 1923. Assigned on 24 March 1923 to the 5th Division. Transferred on 7 May 1927 to Brooks Field, TX, and attached to the Air Corps Training Center. Inactivated on 1 August 1927 at Brooks Field, TX. Activated at Post Field, OK, on 1 June 1928 and attached to the Field Artillery School. Relieved from assignment to the 5th Division on 15 February 1929 and assigned to the 14th Observation Group. Relieved from assignment to the 14th Observation Group on 30 June 1931 and assigned to the 12th Observation Group. Transferred on 5 November 1931 to Brooks Field, TX. Reorganized and redesignated 88th Reconnaissance Squadron (Long Range, Amphibian) on 1 March 1935. Concurrently relieved from the 12th Observation Group and assigned to the 1st Wing. Transferred on 24 September 1935 to Hamilton Field, CA. Redesignated as the 88th Reconnaissance Squadron on 1 September 1936 and attached to the 7th Bombardment Group. Relieved from attachment to the 7th Bombardment Group on 1 October 1937 but remained assigned to the 1st Wing. Air-dropped foodstuffs and flew reconnaissance missions in support of flood relief operations in central California 12-13 December 1937. Redesignated as the 88th Reconnaissance Squadron (Long Range) on 6 December 1939. Transferred on 7 September 1940 to Fort Douglas, UT. Redesignated as the 88th Reconnaissance Squadron (Heavy) on 20 November 1940. Transferred on 15 January 1941 to Salt Lake City, UT, and attached to the 7th Bombardment Group. Ground elements departed from Fort Douglas 13 November 1941 and sailed from the port of San Francisco on 21 November on an army transport en route to the Philippines. Aircraft and crews began departing Muroc Field, CA, on 6 December en route to Hawaii. Elements of the squadron flew their B-17s into Hickam Field at the height of the Japanese attack on Pearl Harbor. Location 7 December 1941—En route to Brisbane Australia and elements at Hickam Field, TH.

Status: Active in the U. S. Air Force as the 436th Strategic Training Squadron at Carswell A.F.B., TX.

Events: 22, 23, 164, 195, 197, 257, 289

Commanders, 88th Observation Squadron

88th Reconnaissance Squadron

Capt. Clearton H. Reynolds	ao Sep 19-1 Oct 20	1st Lt. Clifford C. Nutt	27 Apr 27-1 Jul 27
1st Lt. Raymond E. Davis	1 Oct 20- 6 Oct 21	1st Lt. John C. Kennedy	1 Jul 27-1 Aug 27
Capt. Harry H. Flounders	6 Oct 21-1 Feb 22	<i>Inactive</i>	1 Aug 27-1 Jun 28
Maj. John H. C. Williams	1 Feb 22-20 Sep 22	1st Lt. Thomas L. Gilbert	1 Jun 28-1 Jul 28
Capt. Harry H. Flounders	20 Sep 22-13 Jan 23	1st Lt. William E. Beakley	1 Jul 28-15 Aug 28
Capt. John C. Colgan	13 Jan 23-10 Feb 23	Maj. Louis H. Brereton	15 Aug 28-15 Jul 31
Maj. Hugh J. Knerr	10 Feb 23-13 Jul 25	Capt. Frank H. Pritchard	15 Jul 31-5 Nov 31
Capt. John C. Colgan	13 Jul 25-1 Oct 25	Capt. Clarence E. Shankle	5 Nov 31-3 Dec 31
Capt. Henry Pascale	1 Oct 25-8 Feb 26	Capt. Harry H. Young	3 Dec 31-1 Mar 32
Maj. John C. McDonnell	8 Feb 26-15 May 26	1st Lt. Winfield S. Hamlin	1 Mar 32-17 Mar 32
Capt. John C. Colgan	15 May 26-27 Apr 27	Maj. Calvin E. Giffin	17 Mar 32-1 Sep 36
	Maj. Newton Longfellow	6 Oct 36-1 Dec 41	

89th Observation Squadron (1929-33)**Regular Army Inactive****89th Service Squadron (1933-36)****HQ**-*Not organized* 1929-33; Los Angeles, CA, 1933-35

Constituted in the Regular Army on 8 May 1929 as the 89th Observation Squadron, assigned to the 15th Observation Group and allotted to the Eighth Corps Area. Kelly Field, TX, designated as headquarters location on organization, but the unit was never organized at that location. Redesignated as the 89th Service Squadron on 1 October 1933, relieved from the Eighth Corps Area, and allotted to the Ninth Corps Area. Organized by December 1933 with Organized Reserve personnel as a RAI unit at Los Angeles, CA. Demobilized in 1935.

Commanders, 89th Service Squadron

Unknown** ao Dec 33-ao Jan 35

** RAI Commanders: Organized Reserve officers.

89th Observation Squadron (1935-36)**89th Reconnaissance Squadron (1936-41)****HQ**-*Not organized* 1935-40; March Field, CA, 1940; McChord Field, WA, 1940-41; Pendleton, OR, 1941

Constituted in the Regular Army on 1 March 1935 as the 89th Observation Squadron, assigned to the 15th Observation Group, and allotted to the Ninth Corps Area. Relieved from the Ninth Corps Area on 1 June 1936 and allotted to the Seventh Corps Area. Consolidated in October 1936 with the 89th Aero Squadron (a WWI unit organized on 19 August 1917 at Kelly Field, TX; demobilized on 19 May 1919 at Garden City, NY; reconstituted in October 1936). Redesignated as the 89th Observation Squadron (Long Range, Light Bombardment) on 24 October 1936 and assigned to the 1st Wing. Redesignated as the 89th Reconnaissance Squadron (Medium Range) on 22 December 1939. Activated on 1 February 1940 at March Field, CA, and attached to the 17th Bombardment Group. Transferred on 26 June 1940 to McChord Field, WA. Transferred on 29 June 1941 to Pendleton, OR. Location 7 December

1941—Pendleton, OR.

Status: Inactive in the U. S. Air Force as the 432nd Bombardment Squadron (Medium).**Commanders, 89th Reconnaissance Squadron**

Maj. Robert T. Cronau

1 Feb 40-20 Mar 41

Capt. John Hilger

20 Mar 41-ao Jan 42

90th Attack Squadron (1921-39) (3rd Attack Group)**90th Bombardment Squadron (1939-41)****HQ**-Kelly Field, TX, 1919; Sanderson, TX, 1919-21; Kelly Field, TX, 1921-26; Fort Crockett, TX, 1926-35; Barksdale Field, LA, 1935-40; Savannah, GA, 1940-41

Stationed at Kelly Field, TX, as of June 1919 as the 90th Aero Squadron. Assigned on 1 July 1919 to the Army Surveillance Group (later redesignated 1st Surveillance Group in August 1919 and 3rd Attack Group in August 1921). Transferred on 29 November 1919 to Sanderson, TX. Participated in the Mexican Border Patrol operations September 1919-June 1921. Transferred on 2 July 1921 to Kelly Field. Redesignated as the 90th Squadron (Attack) on 14 March 1921. Redesignated as the 90th Attack Squadron on 25 June 1923. Transferred on 1 July 1926 to Fort Crockett, TX. Flew border reconnaissance missions from Fort Huachuca, AZ, during the Escobar-Topete Revolution 7 April-2 May 1929. Transferred on 27 February 1935 to Barksdale Field, LA. Reorganized and redesignated 90th Bombardment Squadron (Light) on 15 September 1939 and assigned to the 3rd Bombardment Group. Transferred on 10 October 1940 to Savannah, GA. Location 7 December 1941—Savannah, GA.

Status: Active in the U. S. Air Force as the 90th Fighter Squadron at Elmendorf A.F.B., AK.**Events:** 39, 46, 55, 83, 85, 104, 105, 125, 164, 165, 194, 197, 200, 213, 214, 217, 227, 243, 249, 252, 283

Commanders, 90th Attack Squadron

90th Bombardment Squadron

1st Lt. Martinus Stenseth	ao Dec 20-24 Jun 21	Capt. Horace N. Heisen	18 Mar 28-1 Oct 29
1st Lt. Edward V. Harbeck	24 Jun 21-1 Jul 21	1st Lt. Jack J. O'Connell	1 Oct 29-16 Nov 29
1st Lt. Lewis A. Dayton	1 Jul 21-Oct 21	Capt. Virgil Hine	16 Nov 29-11 Aug 32
1st Lt. Edward V. Harbeck	Oct 21-1 May 22	1st Lt. Nathan F. Twining	11 Aug 32-1 Dec 32
Capt. Wolcott P. Hayes	1 May 22-29 Aug 23	Capt. Joseph H. Davidson	1 Dec 32-24 Aug 35
1st Lt. Leland S. Andrews	29 Aug 23-23 Jun 24	Capt. George McCoy, Jr.	24 Aug 35-21 Sep 35
1st Lt. Walter R. Peck	23 Jun 24-7 Dec 25	Maj. William N. Amis	21 Sep 35-19 Jul 37
2nd Lt. Hoyt S. Vandenberg	7 Dec 25-1 Jun 26	Maj. Paul L. Williams	19 Jul 37-Sep 40
1st Lt. Edward H. Wood	1 Jun 26-18 Mar 28	Unknown	Sep 40-7 Dec 41

91st Observation Squadron (3rd Division)

HQ-Mitchell Field, NY, 1919; Park Field, TN, 1919; Rockwell Field, CA, 1919; Mather Field, CA, 1919-20; Ream Field, CA, 1920; Rockwell Field, CA, 1920; Mather Field, CA, 1920-21; Eugene, OR, 1921; Crissy Field, CA, 1921-36; Fort Lewis, WA, 1936-41; Wheeler-Sack Field, NY, 1941

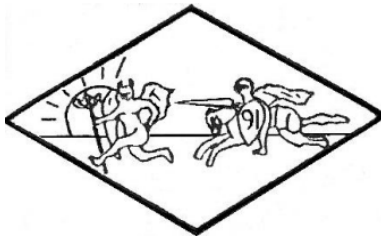

Stationed at Mitchell Field, NY, as of 17 June 1919 as the 91st Aero Squadron. Assigned on July 1919 to the Southeastern Department. Transferred on 4 July 1919 to Park Field, TN. Transferred to Rockwell Field, CA, on 29 September 1919 and assigned to the Western Department. Transferred on 3 November 1919 to Mather Field, CA. Transferred on 24 January 1920 to Ream Field, CA. Participated in Mexican Border Patrol operations January 1920-January 1921. Transferred on 30 April 1920 to Rockwell Field, CA. Participated in aerial spotter tests for coast artillery in coordination with the Harbor Defenses of San Francisco

from April to September 1920 and routine spotter missions 1921-36. Assigned on 20 August 1920 to the Ninth Corps Area. Transferred on 3 November 1920 to Mather Field, CA. Redesignated as the 91st Squadron (Observation) on 14 March 1921. Transferred on 23 May 1921 to the Municipal Field, Eugene, OR. Flew forest fire patrols in Oregon and Washington 1 July-15 September 1920, July-September 1921, and 1 August-26 September 1922. In the 1920s, flew aerial mapping and photograph missions to track the building of roads in the National Forests in the western states. Transferred on 12 October 1921 to Crissy Field, CA. Redesignated as the 91st Observation Squadron on 25 June 1923. Assigned on 24 March 1923 to the 3rd Division. Relieved from assignment to the 3rd Division on 15 February 1929. Assigned on 1 October 1930 to the 12th Observation Group. Relieved from assignment to the 12th Observation Group in 1931 and assigned to the 14th Observation Group. Relieved from the 14th Observation Group on 1 October 1933 and assigned to the 15th Observation Group. Transferred on 30 June 1936 to Gray Field, Fort Lewis, WA. Relieved from the 15th Observation Group on 17 July 1937 and assigned to the 12th Observation Group. Relieved from the 12th Observation Group on 3 October 1940 and assigned to the Fourth Army. Further assigned on 9 November 1940 to the IX Corps. Relieved from the IX Corps 1 September 1941 and assigned to the 73rd Observation Group. Transferred on 26 September 1941 to Wheeler-Sack Field, NY. Location 7 December 1941—Wheeler-Sack Field, NY.

Status: Active in the U. S. Air Force as the 91st Network Warfare Squadron at Lackland A.F.B., TX.

Events: 34, 57, 84, 104, 108, 111, 112, 113, 116, 134, 135, 144, 238, 273, 289, 304, 309, 314, 326

Commanders, 91st Observation Squadron

Capt. Lowell H. Smith	ao Dec 20-23 Nov 22	Lt. Col. Gerald C. Brant	15 Aug 29-28 Sep 29
Capt. John W. Signer	23 Nov 22-6 Mar 24	Capt. Walter F. Kraus	28 Sep 29-13 Oct 30
Maj. Thomas J. Hanley, Jr.	6 Mar 24-16 Aug 24	Maj. Lawrence M. McIntosh	13 Oct 30-19 Nov 31
Capt. John W. Signer	16 Aug 24-17 Feb 25	Maj. Michael F. Davis	19 Nov 31-10 Mar 33
Maj. Delos C. Emmons	17 Feb 25-20 Jul 27	Maj. Donald P. Muse	10 Mar 33-5 Apr 33
Capt. William C. Ocker	20 Jul 27-10 Aug 27	Lt. Col. Floyd E. Galloway	5 Apr 33-10 Jul 37
Maj. Albert L. Sneed	10 Aug 27-10 Nov 27	Lt. Col. Charles B. Oldfield	10 Jul 37-27 Sep 38
Maj. Gerald C. Brant	10 Nov 27-29 Jul 29	Maj. Guy H. Gale	27 Sep 38-ao Jan 41
Maj. Maxwell Kirby	29 Jul 29-15 Aug 29	Unknown	ao Jan 41-ao Sep 41
	Maj. Frederick A. Bacher, Jr.		ao Sep 41-28 Feb 42

91st School Squadron

HQ-Maxwell Field, AL, 1936-41

Constituted in the Regular Army on 1 September 1936, assigned to the Air Corps Tactical School, and organized at Maxwell Field, AL. Location 7 December 1941—Maxwell Field, AL.

Status: Disbanded on 20 Apr 1944.

Commanders, 91st School Squadron

Capt. Sigmund F. Landers	1 Sep 36-7 Jun 37	Maj. Warren A. Maxwell	14 Apr 39-Apr 40
Capt. Charles D. McAllister	7 Jun 37-10 Sep 37	Maj. Norris B. Harbold	Apr 40-Oct 40
Maj. Bayard Johnson	10 Sep 37-14 Apr 39	Unknown	Oct 40-7 Dec 41

92nd Headquarters Squadron (G.H.Q.A.C.)

HQ-*Not organized* 1929-33

Constituted in the Regular Army on 8 May 1929, assigned to the General Headquarters, Air Corps, and allotted to the Eighth Corps Area. Designated mobilization training station was the Air Corps Training Center, Kelly Field, TX. Demobilized on 1 October 1933.

93rd Attack Squadron (1929-39) (33rd Attack Group)

93rd Bombardment Squadron (1939-41)

HQ-*Not organized* 1929-35; Fort Crockett, TX, 1935-36; *Inactive* 1936-39; March Field, CA, 1939-41; Clark Field, PI, 1941; Del Monte 1941

Constituted in the Regular Army on 8 May 1929 as the 93rd Attack Squadron, assigned to the 33rd Attack Group and allotted to the Eighth Corps Area. Reorganized and redesignated 93rd Bombardment Squadron on 1 March 1935, relieved from the 33rd Attack Group, and assigned to the 19th Bombardment Group. Organized on 23 August 1935 with Organized Reserve personnel as a RAI unit at Fort Crockett, TX. Withdrawn from the Eighth Corps Area on 5 June 1936 and allotted to the Sixth Corps Area. Inactivated on 31 October 1936 at Fort Crockett by relief of Reserve personnel. Chicago, IL, designated as headquarters location on reorganization, but the unit was never reorganized at that location. Consolidated in October 1936 with the 93rd Aero Squadron (a WWI unit organized on 21 August 1917 at Kelly Field, TX; demobilized on 31 March 1919 at Garden City, NY; reconstituted in October 1936). Redesignated as the 93rd Bombardment Squadron (Heavy) on 20 October 1939 and organized at March Field, CA. Transferred in June 1941 to Albuquerque, NM. Departed from the port of San Francisco on 4 October 1941 on the U.S.A.T. *Willard A. Holbrook* and arrived at Manila, PI, on 23 October 1941. Transferred to Clark Field, PI, the same day. Transferred on 6 December 1941 to Del Monte Field, PI. Location 7 December 1941—Del Monte, PI.

Status: Active in the U. S. Air Force as the 93rd Bomb Squadron at Barksdale A.F.B., LA.

Commanders, 93rd Bombardment Squadron

Unknown**	23 Aug 35-31 Oct 36	Maj. Hilbert M. Wittkop	11 Dec 39-Apr 41
<i>Inactive</i>	31 Oct 36-20 Oct 39	Capt. Jack W. Wood	Apr 41-Jun 41
Maj. Thomas W. Blackburn	20 Oct 39-11 Dec 39	Capt. William E. McDonald	Jun 41-Jul 41
	Maj. Cecil E. Combs	Jul 41-18 Mar 42	

** RAI Commanders: Organized Reserve officers.

94th Pursuit Squadron (1st Pursuit Group)

HQ-Mitchel Field, NY, 1919; Selfridge Field, MI, 1919; Kelly Field, TX, 1919-21; Ellington Field, TX, 1921-22; Selfridge Field, MI, 1922-41

Stationed at Mitchel Field, NY, as of 1 June 1919 as the 94th Aero Squadron. Transferred on 27 June 1919 to Selfridge Field, MI, 27 June 1919. Transferred on 31 August 1919 to Kelly Field, TX. Assigned on 22 August 1919 to the 1st Pursuit Group. Redesignated as the 94th Squadron (Pursuit) on 14 March 1921. Transferred on 1 July 1921 to Ellington Field, TX. Transferred on 1 July 1922 to Selfridge Field, MI. Redesignated as the 94th Pursuit Squadron on 25 January 1923. Consolidated on 8 April 1924 with the 103rd Aero Squadron (a WWI unit organized in August 1917 at Garden City, NY; demobilized on 18 August 1919 at Garden City, NY; reconstituted on 8 April 1924). Awarded the Frank Luke Trophy for 1939. Redesignated as the 94th Pursuit Squadron (Interceptor) on 6 December 1939. Redesignated as the 94th Pursuit Squadron (Fighter) on 12 March 1941. Location 7 December 1941—Selfridge Field, MI.

Organization Day: 20 August. Chosen to commemorate the date of the squadron's original date of organization 20 August 1917.

Status: Active in the U. S. Air Force as the 94th Fighter Squadron at Langley A.F.B., VA.

Events: 29, 39, 46, 55, 71, 85, 104, 107, 131, 164, 165, 197, 213, 214, 227, 249

Commanders, 94th Pursuit Squadron

1st Lt. Samuel G. Frierson	ao Dec 20-17 Mar 21	2nd Lt. Luther S. Smith	1 Oct 26-6 Nov 26
Capt. Byrne V. Baucom	17 Mar 21-16 May 21	Capt. Hugh M. Elmendorf	6 Nov 26-1 Jun 28
1st Lt. Willard S. Clark	16 May 21-19 Jul 21	1st Lt. John K. Cannon	13 Jun 28-12 Jan 29
Capt. Lawrence P. Hickey	19 Jul 21-15 Aug 21	Capt. Harry A. Johnson	12 Jan 29-14 Jul 32
1st Lt. Donald A. Hicks	15 Aug 21-30 Oct 21	Capt. Audrey B. Ballard	14 Jul 32-16 Nov 33
Capt. Byrne V. Baucom	30 Oct 21-21 Jun 22	1st Lt. Earle E. Partridge	16 Nov 33-12 Mar 34
1st Lt. Sam L. Ellis	21 Jun 22-3 Jul 22	Capt. Audrey B. Ballard	12 Mar 34-4 Jun 34
Capt. Frank O'D. Hunter	3 Jul 22-19 Oct 22	1st Lt. Earle E. Partridge	4 Jun 34-23 Oct 34
1st Lt. Sam L. Ellis	19 Oct 22-19 Jul 23	Maj. Edwin J. House	23 Oct 34-1 Sep 36
1st Lt. Frank O'D. Hunter	19 Jul 23-1 Apr 25	Capt. Leo H. Dawson	1 Sep 36-25 Jun 38
1st Lt. Sam L. Ellis	1 Apr 25-2 Sep 25	1st Lt. Edward W. Anderson	26 Jun 38-28 Jul 38
1st Lt. Stanton T. Smith	2 Sep 25-22 Aug 26	Maj. Harold H. George	28 Jul 38-1 Feb 40
1st Lt. St. Clair Streett	22 Aug 26-1 Oct 26	Maj. John R. Hawkins	1 Feb 40-1 Jul 41
	Unknown		
		1 Jul 41-7 Dec 41	

95th Pursuit Squadron (1919-35) (1st Pursuit Group)

95th Attack Squadron (1935-39)

95th Bombardment Squadron (1939-41)

HQ—Selfridge Field, MI, 1919; Kelly Field, TX, 1919-21; Ellington Field, TX, 1921-22; Selfridge Field, MI, 1922-27; March Field, CA, 1927; *Inactive* 1927-28; Rockwell Field, CA, 1928-31; March Field, CA, 1931-40; McChord Field, WA, 1940-41; Pendleton, OR, 1941

Reconstituted and organized on 12 August 1919 in the Regular Army as the 95th Aero Squadron at Selfridge Field, MI. Assigned on to the 1st Pursuit Group on 22 August 1919. Transferred on 31 August 1919 to Kelly Field, TX. Redesignated as the 95th Squadron (Pursuit) on 14 March 1921. Transferred on 1 July 1921 to Ellington Field, TX. Transferred on 1 July 1922 to Selfridge Field, MI. Redesignated as the 95th Pursuit Squadron on 25 January 1923. Conducted bombing missions of ice jams on the Clinton River in Michigan in order to prevent flooding in surrounding communities. Inactivated on 31 July 1927 at March Field, CA, and personnel transferred to the 53rd School Squadron. Activated on 1 June 1928 at Rockwell Field, CA. Relieved from assignment to the 1st Pursuit Group on 8 May 1929 and assigned to the 17th Pursuit Group. Transferred on 29 October 1931 to March Field, CA. Reorganized and redesignated 95th Attack Squadron on 1 March 1935 and assigned to the 17th Attack Group. Flew reconnaissance missions in support of flood relief operations in southern California 2-5 March 1938. Reorganized and redesignated 95th Bombardment Squadron (Medium) on 17 October 1939 and assigned to the 17th Bombardment Group. Transferred on 26 June 1940 to McChord Field, WA. Transferred on 29 June 1941 to Pendleton, OR. Location 7 December 1941—Pendleton, OR.

Status: Active in the U. S. Air Force as the 95th Reconnaissance Squadron at R.A.F. Mildenhall, UK.

Events: 29, 39, 46, 55, 71, 85, 104, 107, 116, 126, 131, 142, 164, 165, 195, 197, 201, 213, 214, 227, 231, 249, 252, 257, 289, 290

Commanders, 95th Pursuit Squadron

95th Attack Squadron

95th Bombardment Squadron

Capt. Arthur R. Brooks	ao Dec 20-12 Aug 21	1st Lt. Leo H. Dawson	29 Oct 31-4 Jan 33
1st Lt. Lloyd B. Blackburn	12 Aug 21-23 Nov 21	1st Lt. Towle H. Stewart	4 Jan 33-27 Jan 33
1st Lt. Samuel G. Frierson	23 Nov 21-28 Mar 22	Maj. Virgil Hine	27 Jan 33-18 Jan 36
1st Lt. Benjamin R. McBride	28 Mar 22-11 Nov 23	Capt. Kirtley J. Gregg	18 Jan 36-1 May 36
1st Lt. Thomas K. Matthews	11 Nov 23-17 Nov 25	Maj. John G. Golgen	5 May 36-1 Sep 36
1st Lt. Cyrus Bettis	17 Nov 25-25 Aug 26	Capt. Ernest H. Lawson	1 Sep 36-4 Jun 37
1st Lt. Victor H. Strahm	25 Aug 26-1 May 27	Maj. Samuel G. Frierson	4 Jun 37-20 Sep 37
2nd Lt. William G. Plummer**	1 May 27-1 Jun 28	Capt. Ernest H. Lawson	20 Sep 37-22 Aug 38
Capt. Hugh M. Elmendorf	1 Jun 28-17 Jul 30	Maj. Lotha A. Smith	22 Aug 38-12 Feb 40
2nd Lt. Irvin A. Woodring	17 Jul 30-1 Jan 31	Maj. Ernest H. Lawson	12 Feb 40-May 41
Capt. Frank O'D. Hunter	1 Jan 31-29 Oct 31	Maj. Charles G. Goodrich	May 41-Jul 41
	Capt Edward J. York	Jul 41-ao Apr 42	

** RAI commanders: Organized Reserve officers.

96th Bombardment Squadron (2nd Bombardment Group)

HQ-Ellington Field, TX, 1919; Camp Furlong, NM, 1919; Fort Bliss, TX, 1919-20; Kelly Field, TX, 1920-22; Langley Field, VA, 1922-41

Stationed at Ellington Field, TX, as of June 1919 as the 96th Aero Squadron. Transferred on 28 June 1919 to Camp Furlong, NM. Transferred on 3 July 1919 to Fort Bliss, TX. Assigned on 18 September 1919 to the 1st Day Bombardment Group (redesignated 2nd Bombardment Group on 14 March 1941). Transferred on 12 January 1920 to Kelly Field, TX. Participated in Mexican Border Patrols August 1919-10 January 1920. Redesignated as the 96th Squadron (Bombardment) on 14 March 1921. Attached to the 1st Provisional Air Brigade 20 May-26 October 1921 while supporting the battleship bombing tests off the Virginia coast. Transferred on 29 June 1922 to Langley Field, VA. Redesignated as the 96th Bombardment Squadron on 25 January 1923. Participated in air drop of food and supplies to stranded flood victims in the Chesapeake Bay area on 9 February 1936 and in Pennsylvania in March 1936. Location 7 December 1941—Langley Field, VA.

Status: Active in the U. S. Air Force as the 96th Bomb Squadron at Barksdale A.F.B., LA.

Events: 23, 39, 46, 55, 71, 85, 104, 107, 155, 164, 165, 178, 196, 197, 200, 213, 214, 227, 249

Commanders, 96th Bombardment Squadron

1st Lt. Devereaux M. Myers	ao Dec 20-20 May 21	Capt. John P. Richter	20 Jul 31-26 Dec 33
Capt. Henry Pascale	20 May 21-1 Sep 21	Capt. Milo McCune	26 Dec 33-23 Feb 34
Capt. Wolcott P. Hayes	1 Sep 21-1 Feb 22	2nd Lt. Dwight B. Schanep	23 Feb 34-13 May 34
Capt. Edward C. Black	1 Feb 22-1 Feb 26	2nd Lt. Maurice C. Bisson	13 May 34-31 May 34
Capt. Richard J. Kirkpatrick	1 Feb 26-1 May 26	1st Lt. Edward A. Hillery	31 May 34-1 Jun 34
Capt. Charles H. Rust	1 May 26-24 Jan 28	Capt. Edward C. Black	1 Jun 34-9 Mar 35
1st Lt. Lewis H. Webster	24 Jan 28-1 Mar 28	Maj. Jasper K. McDuffie	9 Mar 35-1 Jul 37
1st Lt. Harold W. Beaton	1 Mar 28-3 Sep 30	Maj. Harold L. George	1 Jul 37-1 Feb 40
Capt. James M. Gillespie	5 Sep 30-20 Jul 31	Capt. Darr H. Alkire	1 Feb 40-Nov 41
	Maj. Cecil F. Reynolds	Nov 41-ao Mar 42	

97th Attack Squadron (1929-33) (33rd Attack Group)

HQ-*Not organized* 1929-35; Fort Crockett, TX, 1935-36; *Inactive* 1936-38

Constituted in the Regular Army on 8 May 1929 as the 97th Attack Squadron, assigned to the 33rd Attack Group and allotted to the Eighth Corps Area. Organized on 23 August 1935 with Organized Reserve personnel as a RAI unit at Fort Crockett, TX. Withdrawn from the Eighth Corps Area on 5 June 1936 and allotted to the Sixth Corps Area. Inactivated on 31 October 1936 at Fort Crockett by relief of Reserve personnel. Chicago, IL, designated as headquarters location on organization, but the unit was never reorganized at that location. Demobilized on 1 January 1938.

Commanders, 97th Attack Squadron

Capt. Edward V. Pettis** 23 Aug 35-31 Oct 36

** RAI Commanders: Organized Reserve officers.

97th Observation Squadron (42nd Observation Group)

HQ-Mitchel Field, NY, 1935-40; Lawson Field, GA, 1940-41

Constituted in the Regular Army on 1 March 1935, assigned to the 42nd Observation Group (II Corps), and organized at Mitchel Field, NY. Consolidated on 5 June 1936 with the 97th Aero Squadron (a WWI unit organized in August 1917 at Garden City, NY; demobilized on 3 February 1919 at Garden City, NY; reconstituted on 5 June 1936). Relieved from the 42nd Observation Group (II Corps) on 17 July 1937 and assigned to the 43rd Observation Group (III Corps). Relieved from the 43rd Observation Group on 2 October 1940 and assigned to the IV Corps. Transferred on 20 November 1940 to Lawson Field, GA. Assigned on 1 September 1941 to the 66th Observation Group (IV Corps). Location 7 December 1941—Lawson Field, GA.

Status: Active in the U. S. Air Force as the 97th Intelligence Squadron at Offutt A.F.B., NE.

Events: 190, 219, 231, 266, 280, 293, 296, 301

Commanders, 97th Observation Squadron

Maj. George E. Rice	1 Mar 35-4 Dec 35	Maj. Charles A. Horn	4 Sep 37-3 Aug 38
Capt. Paul T. Cullen	4 Dec 35-9 Dec 35	1st Lt. Stuart P. Wright	3 Aug 38-2 Sep 38
Capt. Arthur J. Lehman	9 Dec 35-29 Feb 36	Maj. George C. Kenney	2 Sep 38-1 May 39
Capt. Paul T. Cullen	29 Feb 36-5 Mar 36	Capt. Donald W. Titus	1 May 39-1 Jul 39
Maj. George C. McDonald	5 Mar 36-4 Aug 37	Maj. Morton H. McKinnon	1 Jul 39-ao Apr 40
Capt. Arthur J. Lehman	4 Aug 37-4 Sep 37	Maj. Herbert B. Thatcher	ao Nov 40-ao Feb 41
	Unknown	ao Feb 41-7 Dec 41	

98th School Squadron (1933-35)

98th Service Squadron (1935-36)

HQ-Chanute Field, IL, 1933-36

Constituted in the Regular Army on 1 August 1933, assigned to the Air Corps Technical School, and concurrently organized at Chanute Field, IL, with personnel from the Air Corps Technical School Detachment. Consolidated in 1934 with the 98th Aero Squadron (a WWI unit organized on 20 August 1917 at Kelly Field, TX; demobilized on 15 May 1919 at Mitchel Field, NY; reconstituted in 1934). Reorganized and redesignated 98th Service Squadron on 1 March 1935. Reorganized and redesignated 10th Air Base Squadron on 1 July 1936.

Commanders, 98th School Squadron

98th Service Squadron

Capt. Edward H. Wood	1 Aug 33-10 Jul 34	Capt. William R. Turnbull	19 Jul 34-8 Dec 34
Capt. Malcolm N. Stewart	10 Jul 34-19 Jul 34	Maj. James B. Carroll	8 Dec 34-1 Sep 36

99th Observation Squadron (1919-35) (8th Division)

99th Bombardment Squadron (1935-41)

HQ-Hazelhurst Field, NY, 1919; Camp Alfred Vail, NJ 1919; Bolling Field, DC, 1919-27; *Inactive* 1927-28; Mitchel Field, NY, 1928-40; Rio Hato Airfield, Panama, 1940-41; Zandery Field, Surinam 1941

Stationed at Hazelhurst Field, NY, as of June 1919 as the 99th Aero Squadron and assigned to the Eastern Department. Transferred in August 1919 to Camp Alfred Vail, NJ. Transferred on 17 August 1919 to Bolling Field, DC. Assigned on 20 August 1920 to the Third Corps Area. Redesignated as the 99th Squadron (Observation) on 14 March 1921. Redesignated as the 99th Observation Squadron on 25 January 1923. Assigned on 24 March 1923 to the 8th Division. Transferred on 23 June 1927 to Kelly Field, TX. Inactivated on 31 July 1927 at Kelly Field. Relieved from the 8th Division 15 August 1927 and allotted to the Office of Chief of the Air Corps for mobilization purposes. Relieved from assignment to the OCAC on 1 September 1928 and allotted to the Eighth Corps Area. Withdrawn from the Eighth Corps Area on 27 October 1928 and allotted to the Second Corps Area. Activated on 9 November 1928 at Mitchel Field, NY, and attached to the 9th Observation Group. Assigned on 15 February 1929 to the 9th Observation Group. Reorganized and redesignated 99th Bombardment Squadron (Medium) on 1 March 1935 and assigned to the 9th Bombardment Group. Redesignated as the 99th Bombardment Squadron (Heavy) on 6 December 1939. Ground elements departed from the port of New York on 5 November 1940 on the U.S.A.T. *Chateau Thierry* and arrived on 13 November 1940 at Rio Hato Airfield in Panama. Aircraft and crews departed Mitchel Field on 17 November 1940 for Rio Hato and arrived several days later. Transferred on 3 December 1941 to Zandery Field, Surinam. Location 7 December 1941—Zandery Field, Surinam.

Status: Active in the U. S. Air Force as the 99th Reconnaissance Squadron at Beale A.F.B., CA.

Events: 85, 103, 107, 164, 249, 268, 283

Commanders, 99th Observation Squadron

99th Bombardment Squadron

2nd Lt. Paul C. Wilkins	ao Dec 20-1 Feb 21	<i>Inactive</i>	31 Jul 27-9 Nov 28
Capt. Ray A. Dunn	1 Feb 21-22 Aug 21	Capt. Francis M. Brady	9 Nov 28-11 Aug 29
1st Lt. Earle J. Carpenter	22 Aug 21-7 Nov 21	1st Lt. Paul H. Prentiss	11 Aug 29-5 Nov 29
1st Lt. Howard K. Ramey	7 Nov 21-12 Dec 21	Capt. Frederick W. Evans	5 Nov 29-28 Aug 33
1st Lt. Courtney Whitney	12 Dec 21-1 Aug 22	Capt. Charles A. Pursley	28 Aug 33-20 Oct 34
Maj. George E. Lovell, Jr.	1 Aug 22-16 Apr 23	Maj. Leo F. Post	20 Oct 34-12 Jul 36
Capt. Clearton H. Reynolds	16 Apr 23-28 May 26	Maj. Samuel M. Connell	12 Jul 36-25 Oct 39
Capt. William H. Crom	28 May 26-1 May 27	Capt. Fay R. Upthegrove	25 Oct 39-21 Oct 40
Capt. Byrnes V. Baucom	1 May 27-4 Jun 27	Unknown	21 Oct 40-ao Oct 41
1st Lt. James A. Healy	4 Jun 27-31 Jul 27	Maj. Gerald E. Williams	ao Oct 41-4 Jan 42

100th Service Squadron (G.H.Q.A.F.)

HQ-Bolling Field, DC, 1935-36

Constituted in the Regular Army on 1 March 1935, assigned to the General Headquarters Air Force, and organized at Bolling Field, DC. Consolidated in 1935 with the 100th Aero Squadron (a WWI unit organized on 22 August 1917 at Kelly Field, TX; demobilized on 13 June 1919 at Mitchel Field, NY; reconstituted in 1935). Consolidated with the Station Complement, Bolling Field and consolidated unit redesignated Base Headquarters and 14th Air Base Squadron on 1 September 1936.

Commanders, 100th Service Squadron

Maj. Jack C. Hodgson 1 Mar 35-1 Sep 36

101st Observation Squadron (26th Division)

Massachusetts National Guard

HQ-Boston Airport, Boston, MA, 1921-40; Otis Field, MA, 1940-41



Constituted in the National Guard in 1921 as the 101st Squadron (Observation), assigned to the 26th Division, and allotted to the state of Massachusetts. Organized from the 1st Aero Unit (organized about February 1921 at Boston, MA) and Federally recognized on 18 November 1921 at Boston. Stationed at Boston Airport. Redesignated as the 101st Observation Squadron on 25 January 1923. Relieved on 15 February 1929 from assignment to the 26th Division. Concurrently attached to the 26th Division for command and control purposes. Assigned on 1 October 1933 to the 41st Observation Group (I Corps). Consolidated on 20 October 1936 with the 101st Aero Squadron (a WWI unit organized in August 1917 at Kelly Field TX; demobilized on 14 April 1919 at Mitchel Field, NY; reconstituted on 20 October 1936). The squadron, or elements thereof, called up to perform

the following state duties: search for a lost yacht in 1933; search for a lost airliner in the Adirondack Mountains in 1934; air drop of food and supplies to stranded inhabitants of Isle au Haut in the winter storm of 1935; air support to flood relief efforts in March 1936; and air support to hurricane relief efforts in September 1938. Relieved in November 1940 from assignment to the 41st Observation Group. Conducted summer training at Marston's Mills, MA, and some years at Mitchel Field, NY, and Langley Field, VA. Inducted into active Federal service 25 November 1940 at Boston. Assigned on 30 December 1940 to the VI Corps. Transferred on 31 July 1941 to Otis Field, MA. Assigned on 1 September 1941 to the 26th Observation Group. Location 7 December 1941—Otis Field, MA.

Status: Active in the Massachusetts Air National Guard as the 101st Fighter Squadron at Otis Air National Guard Base, MA.

Events: 91, 126, 190, 280, 301

Commanders, 101st Observation Squadron

Maj. Charles H. Woolley
Maj. Louis E. Boutwell

4 Feb 22-ao Jun 25
3 May 29-16 Nov 31
Capt. Clyde C. Jackway

Maj. Clarence E. Hodge
Maj. Albert L. Edson
ao Sep 41-ao Jan 42

17 Nov 31-13 Nov 38
14 Nov 38-ao Jan 41

102nd Observation Squadron (27th Division)

New York National Guard

HQ-Hempstead, LI, NY, 1921-22; Miller Field, SI, NY, 1922-40; Fort McClellan, AL, 1940-41



Constituted in the National Guard on 30 December 1920 as the 102nd Squadron (Observation), assigned to the 27th Division, and allotted to the state of New York. Organized on 17 November 1921 from the Observation Squadron, New York National Guard (organized on 22 March 1921 at Hempstead, Long Island, NY, with personnel from K Company, 14th Infantry, New York National Guard). Concurrently Federally recognized at Hempstead. Inactivated on 3 September 1922 at Hempstead. Reorganized and Federally recognized on 4 November 1922 at Miller Field, Staten Island, NY. Redesignated as the 102nd Observation Squadron on 25 January 1923. The squadron, or elements thereof, was called up to perform the following state duties: to conduct reconnaissance for the Treasury Department of vessels conducting illegal-liquor trade off the New York-New Jersey coast in the 1920s; to support flood relief efforts in Vermont 6-16 November 1927; aid to civil

authorities during a prison break at Auburn, NY, 11-12 December 1930, and for flood relief efforts in upstate New York 11-13 July 1935. Relieved on 15 February 1929 from assignment to the 27th Division. Concurrently attached to the 27th Division for command and control purposes. Assigned on 1 October 1933 to the 42nd Observation Group (II Corps). Consolidated on 20 October 1936 with the 102nd Aero Squadron (a WWI unit organized in August 1917 at Kelly Field TX; demobilized on 1 May 1919 at Garden City, NY; reconstituted on 20 October 1936). Conducted summer training at Pine Camp, NY, 1921-40 where it generally supported the training of the 52nd Field Artillery Brigade. Conducted annual summer training most years at Miller Field and Mitchel Field. Inducted into active Federal service 15 October 1940 at Miller Field, relieved from assignment to the 42nd Observation Group, and assigned to the VII Corps. Transferred to Fort McClellan, AL, and arrived there on 26 October 1940. Further assigned 1 October 1941 to the 71st Observation Group (VII Corps). Location 7 December 1941—Fort McClellan, AL.

Status: Active in the New York Air National Guard as the 102nd Air Rescue Squadron at Gabreski Airport, NY.

Events: 91, 126, 173, 190, 280, 301, 324

Commanders, 102nd Observation Squadron

Maj. Kenneth P. Littauer
Maj. George A. Vaughn

17 Nov 21-20 Oct 23
29 Oct 23-10 Nov 30
Unknown

Maj. Lawrence G. Brower
Maj. Victor E. Nelson
ao Feb 41-7 Dec 41

12 Nov 30-2 Oct 40
15 Oct 40-ao Feb 41

103rd Observation Squadron (28th Division)

Pennsylvania National Guard

HQ-Not organized 1921-23; Philadelphia Airport, Philadelphia, PA, 1923-36; Pitcairn Field, Philadelphia, PA, 1936-41; Harrisburg Municipal Airport, PA, 1941



Constituted in the National Guard in 1921 as the 103rd Squadron (Observation), assigned to the 28th Division, and allotted to the state of Pennsylvania. Redesignated as the 103rd Observation Squadron on 25 January 1923. Organized and Federally recognized on 27 June 1924 at the Philadelphia Airport, Philadelphia, PA. Relieved on 15 February 1929 from assignment to the 28th Division. Concurrently assigned to the 315th Observation Group (III Corps) and further attached to the 28th Division for command and control purposes. Assigned on 1 October 1933 to the 43rd Observation Group (III Corps). Relocated in 1936 to Pitcairn Field near Philadelphia. The entire squadron called up to support flood relief efforts in central and eastern Pennsylvania in March-April 1936. Conducted summer training at Langley Field, VA, 1924-27 and Middletown Air Depot, PA, 1928-40. Also flew reconnaissance operations in support of the 28th Division and 52nd Cavalry Brigade during summer training; flew tracking missions for the 213th Coast Artillery Regiment (AA); and flew spotter missions for the 107th, 108th, 109th, and 176th Field Artillery Regiments at Tobyhanna Firing Range. Relieved from the 43rd Observation Group on 30 December 1940 and assigned to the II Corps. Inducted into active Federal service 17 February 1941 at Philadelphia, and transferred to the Harrisburg Municipal Airport, arriving there 27 February 1941. Further assigned on 1 September 1941 to the 59th Observation Group (II Corps). Location 7 December 1941—Harrisburg Municipal Airport, PA.

Status: Active in the Pennsylvania Air National Guard as the 103rd Fighter Squadron at NAS Willow Grove Joint Reserve Base, PA.

Events: 126, 203, 191, 281, 301, 330

Commanders, 103rd Observation Squadron

Maj. John S. Owens
Maj. John V. Dallin

27 Jun 24-1 Jul 32
2 Jul 32-7 Aug 38

Maj. Edgar M. Scattergood, Jr.
Unknown

8 Aug 38-1 Sep 41
1 Sep 41-7 Dec 41

104th Observation Squadron (29th Division)

Maryland National Guard

HQ-Logan Field, Baltimore, MD, 1921-41; Detrick Field, Frederick, MD, 1941

Constituted in the National Guard in 1921 as the 104th Squadron (Observation), assigned to the 29th Division, and allotted to the state of Maryland. Organized and Federally recognized on 29 June 1921 at Logan Field in Baltimore, MD. Redesignated as the 104th Observation Squadron on 25 January 1923. Relieved on 15 February 1929 from assignment to the 29th Division. Concurrently assigned to the 315th Observation Group (III Corps) and further attached to the 29th Division for command and control purposes. Assigned on 1 October 1933 to the 43rd Observation Group (III Corps). Relieved in November 1940 from assignment to the 43rd Observation Group. Conducted annual summer training at various locations to include Langley Field, VA; Shepard Field, Martinsburg, WV; Middletown Air Depot, PA; and at Detrick Field, Frederick, MD. Assigned on 30 December 1940 to the II Corps. Inducted into active Federal service 3 February 1941 at Logan Field. Assigned on 1 September 1941 to the 59th Observation Group (II Corps). Transferred on 29 September 1941 to Detrick Field, MD. Location 7 December 1941—Detrick Field, MD.

Status: Active in the Maryland Air National Guard as the 104th Fighter Squadron at Martin State Airport, MD.

Events: 126, 281, 330

Commanders, 104th Observation Squadron

Maj. George L. Jones
Maj. Paul V. Burwell

29 Jun 21-Feb 22
Feb 22-15 Sep 24

Maj. William D. Tipton
Maj. Charles A. Masson

15 Sep 24-10 Jun 30
10 Jun 30-1 Jun 42

105th Observation Squadron (30th Division)**Tennessee National Guard**

HQ-Blackwood Field, Nashville, TN, 1921-30; Woodstock Field, Memphis, TN, 1930-31; McConnell Field, Nashville, TN, 1931-32; Sky Harbor, Murfreesboro, TN, 1932-37; Nashville Municipal Airport, TN, 1937-40; Columbia, SC, 1940-41

Constituted in the National Guard in 1921 as the 136th Squadron (Observation), assigned to the 12th Observation Group (IV Corps), and allotted to the state of Tennessee. Originally organized in the fall of 1920, the squadron was Federally recognized on 4 December 1921 at Blackwood Field, Nashville, TN. Redesignated as the 136th Observation Squadron on 25 January 1923. Redesignated as the 105th Observation Squadron on 20 July 1923 and assigned to the 30th Division. Relieved on 15 February 1929 from assignment to the 30th Division. Concurrently attached to the 30th Division for command and control purposes. Relocated in November 1930 to Woodstock Field, Memphis, TN. Disbanded on 25 November 1930 at Woodstock Field. Though in a disbanded status, members continued to meet regularly without pay. Relocated to Nashville, TN, on 1 April 1931 and concurrently reconstituted and Federally recognized at McConnell Field. Relocated in November 1932 to Sky Harbor Airport, Murfreesboro, TN. Assigned on 1 October 1933 to the 44th Observation Group (IV Corps). Consolidated on 20 October 1936 with the 105th Aero Squadron (a WWI unit organized in August 1917 at Kelly Field, TX; demobilized on 8 May 1919 at Mitchel Field, NY; reconstituted on 20 October 1936). The entire squadron called up to support flood relief efforts along the Mississippi River in western Tennessee in January 1937. Relocated in March 1937 to Nashville Municipal Airport, TN. Conducted summer training at Maxwell Field, AL, or Camp Jackson, SC. Two-plane detachments were sent some years to fly spotter missions during the summer training of the 264th and 265th Coast Artillery Regiments at Fort Barrancas and Key West Barracks, FL. Inducted into active Federal service 16 September 1940 at Nashville Municipal Airport, and transferred to Columbia, SC, arriving there 24 September 1940. Relieved from assignment to the 44th Observation Group in October 1940 and assigned to the First Army. Relieved from the First Army 17 January 1941 and assigned to the IV Corps. Relieved from the IV Corps 1 September 1941 and assigned to the 65th Observation Group (I Corps). Location 7 December 1941—Columbia, SC.

Status: Active in the Tennessee Air National Guard as the 105th Airlift Squadron at Nashville International Airport, TN.

Events: 126, 255, 300, 330

Commanders, 105th Observation Squadron

Maj. John C. Bennett, Jr.	4 Dec 21-5 May 31	Maj. Walter M. Williams	19 Jan 34-ao Jan 41
Maj. Herbert F. Fox	6 May 31-18 Jan 34	Unknown	ao Jan 41-7 Dec 41

106th Observation Squadron (31st Division)**Alabama National Guard**

HQ-Roberts Field, Birmingham, AL, 1921-36; Birmingham Municipal Airport, Birmingham, AL, 1936-41



Constituted in the National Guard in 1921 as the 135th Squadron (Observation), assigned to the 12th Observation Group (IV Corps), and allotted to the state of Alabama. Organized as the 135th Squadron (Observation) on 21 January 1922 with personnel from the “Birmingham Escadrille” (a civilian flying club organized in 1919 by World War I ace Maj. James A. Meissner) and Federally recognized at Roberts Field, Birmingham, AL. Redesignated as the 135th Observation Squadron on 25 January 1923. Redesignated as the 114th Observation Squadron on 1 May 1923 and assigned to the 39th Division. Redesignated as the 106th Observation Squadron on 16 January 1924 and assigned to the 31st Division. Relieved on 15 February 1929 from assignment to the 31st Division. Concurrently attached to the 31st Division for command and control purposes. Assigned on 1 October 1933 to the 44th Observation Group (IV Corps). Consolidated on 20 October 1936 with the 106th Aero Squadron (a WWI unit organized on 27 August 1917 at Kelly Field TX; redesignated as the 800th Aero Squadron on 1 February 1918; demobilized 8 May-2 July 1919 at Mitchel Field, NY; reconstituted on 20 October 1936). Relocated in December 1936 to the Birmingham Municipal Airport. The squadron, or elements thereof, called up to perform the following state duties: transportation of men and equipment for mine rescue operations at Carbon Hill, AL, in November 1923; support for air mail test trials in 1924-29; flood relief efforts in southern Alabama 16-30 March 1929;

aerial surveys and hurricane relief efforts in south Alabama 21-24 March 1932. Conducted summer training at Maxwell Field, AL, and Camp McClellan, AL. Two-plane detachments were sent some years to fly spotter missions during the summer training of the 252nd and 263rd Coast Artillery Regiments at Fort Moultrie, SC, and with the 114th and 178th Field Artillery Regiments at Camp Knox, KY, in 1936. Inducted into active Federal service 25 November 1940 at Birmingham, relieved from assignment to the 44th Observation Group, and assigned to the Fourth Corps Area. Assigned in December 1940 to the IV Corps. Further assigned on 1 September 1941 to the 66th Observation Group (IV Corps). Location 7 December 1941—Birmingham, AL.

Status: Active in the Alabama Air National Guard as the 106th Air Refueling Squadron at Birmingham Airport, AL.

Events: 126, 255, 300

Commanders, 106th Observation Squadron

Maj. James A. Meissner	21 Jan 22-ao Feb 24	Maj. Sumpter Smith	15 May 25-1 Sep 31
Maj. W. V. M. Robertson	ao Apr 24-15 May 25	Maj. Henry L. Badham	1 Sep 31-ao Dec 41

107th Observation Squadron (32nd Division)

Michigan National Guard

HQ-*Not organized* 1921-26; Detroit, MI, 1926-29; Wayne County Airport, Romulus, MI, 1929-40; Camp Beauregard, LA, 1940-41



Constituted in the National Guard in 1921 as the 107th Squadron (Observation), assigned to the 32nd Division, and allotted to the state of Michigan. Redesignated as the 107th Observation Squadron on 25 January 1923. Organized and Federally recognized on 7 May 1926 at Detroit, MI. Relieved on 15 February 1929 from assignment to the 32nd Division. Concurrently attached to the 32nd Division for command and control purposes. Relocated in 1929 to the Wayne County Airport, Romulus, MI. Assigned on 1 October 1933 to the 46th Observation Group (VI Corps). Consolidated on 20 October 1936 with the 107th Aero Squadron (a WWI unit organized on 27 August 1917 at Kelly Field, TX; redesignated as the 801st Aero Squadron on 1 February 1918; demobilized on 18 March 1919 at Garden City, NY; reconstituted on 20 October 1936). Conducted summer training most years at Camp Grayling, MI. Inducted into active Federal service 15 October 1940

at Romulus, and transferred to Camp Beauregard, LA, arriving there 28 October 1940. Relieved from assignment to the 46th Observation Group in October 1940 and assigned to the Fourth Corps Area. Assigned in December 1940 to the V Corps. Further assigned 1 September 1941 to the 67th Observation Group (V Corps). Location 7 December 1941—Camp Beauregard, LA.

Status: Active in the Michigan Air National Guard as the 107th Fighter Squadron at Selfridge Air National Guard Base, MI.

Events: 126, 214, 302

Commanders, 107th Observation Squadron

Maj. Frederick R. Anderson	7 May 26-ao Nov 39	Unknown	ao Nov 39-7 Dec 41
----------------------------	--------------------	---------	--------------------

108th Observation Squadron (33rd Division)

Illinois National Guard

HQ-*Not organized* 1921-27; Municipal Airport, Chicago, IL, 1927-41



Constituted in the National Guard in 1921 as the 108th Squadron (Observation), assigned to the 33rd Division, and allotted to the state of Illinois. Redesignated as the 108th Observation Squadron on 25 January 1923. Organized and Federally recognized on 1 July 1927 at the Municipal Airport, Chicago, IL. Relieved on 15 February 1929 from assignment to the 33rd Division. Concurrently attached to the 33rd Division for command and control purposes. Assigned on 1 October 1933 to the 46th Observation Group (VI Corps). Consolidated on 20 October 1936 with the 108th Aero Squadron (a WWI unit organized on 27 August 1917 at Kelly Field, TX; redesignated as the 802nd Aero Squadron on 1 February 1918; demobilized on 11 June 1919 at Mitchel Field, NY; reconstituted on 20 October 1936). The entire squadron was called up to support flood relief efforts along the Ohio and Mississippi Rivers in southern Illinois 22 January-12

February 1937. Conducted summer training at Camp Grant, IL, and some years at Camp Logan, IL. Relieved in November 1940 from assignment to the 46th Observation Group. Attached on 30 December 1940 to the Second Army. Inducted into active Federal service 3 February 1941 at Chicago. Assigned on 1 September 1941 to the 72nd Observation Group (Second Army). Location 7 December 1941—Municipal Airport, Chicago, IL.

Status: Active in the Illinois Air National Guard as the 108th Air Refueling Squadron at Scott AFB, IL.

Events: 126, 214, 302, 324

Commanders, 108th Observation Squadron

Maj. Merrill D. Mann, Jr. (RA)

1 Jul 27-25 Jun 35

Maj. Clifford A. McElvain

25 Jun 35-Jan 42

109th Observation Squadron (34th Division)

Minnesota National Guard

HQ-Holman Municipal Airport, St. Paul, MN, 1921-41; Camp Beauregard, LA, 1941



Constituted in the National Guard in 1921 as the 109th Squadron (Observation), assigned to the 34th Division, and allotted to the state of Minnesota. Organized on 21 November 1921 by redesignation of the Observation Squadron, Minnesota National Guard (organized in July 1920 and Federally recognized on 17 January 1921 at Holman Municipal Airport in St. Paul, MN). Redesignated as the 109th Observation Squadron on 25 January 1923. Relieved on 15 February 1929 from assignment to the 34th Division. Concurrently attached to the 34th Division for command and control purposes. Assigned on 1 October 1933 to the 47th Observation Group (VII Corps). Consolidated on 20 October 1936 with the 109th Aero Squadron (a WWI unit organized on 27 August 1917 at Kelly Field TX; redesignated as the 803rd Aero Squadron on 1 February 1918; demobilized on 23 June

1919 at Mitchel Field, NY; reconstituted on 20 October 1936). The squadron, or elements thereof, called up to perform the following state duties: aerial support for fire fighting efforts in northern Minnesota during July-September 1922. Conducted summer training at Wold-Chamberlain Field, MN, or at Camp Ripley, MN, 1921-40. Relieved from assignment to the 47th Observation Group 30 December 1940 and assigned to the V Corps. Inducted into active Federal service 10 February 1941 at St. Paul, MN, and transferred to Camp Beauregard, LA, arriving there 27 February 1941. Assigned on 1 September 1941 to the 67th Observation Group (V Corps). Location 7 December 1941—Camp Beauregard, LA.

Status: Active in the Minnesota Air National Guard as the 109th Airlift Squadron at the Air National Guard Base, Minneapolis-St. Paul International Airport, MN.

Events: 126, 233, 303

Commanders, 109th Observation Squadron

Maj. Ray S. Miller

17 Jan 21-ao Aug 41

Unknown

ao Aug 41-7 Dec 41

110th Observation Squadron (35th Division)**Missouri National Guard**

HQ-*Not organized* 1921-23; Anglum Field, St. Louis, MO 1923-31; Lambert-St. Louis Municipal Airport, MO 1931-41; Little Rock, AR, 1941

Constituted in the National Guard in 1921 as the 110th Squadron (Observation), assigned to the 35th Division, and allotted to the state of Missouri. Redesignated as the 110th Observation Squadron on 25 January 1923. Organized and Federally recognized on 23 June 1923 at Anglum Field, St. Louis, MO. 1st Lt. Charles Lindburgh was a member of the squadron 1925-27. Relieved on 15 February 1929 from assignment to the 35th Division. Concurrently attached to the 35th Division for command and control purposes. Relocated in July 1931 to Lambert-St. Louis Municipal Airport, MO. Assigned on 1 October 1933 to the 47th Observation Group (VII Corps). Provided aerial surveillance of, and for, the 7th Cavalry Brigade (Mechanized) during its movement from Fort Knox, KY, to Fort Riley, KS, in April 1934. Consolidated on 20 October 1936 with the 110th Aero Squadron (a WWI unit organized on 27 August 1917 at Kelly Field, TX; redesignated as the 804th Aero Squadron on 1 February 1918; demobilized on 18 November 1918 at Kelly Field; reconstituted on 20 October 1936). The squadron, or elements thereof, called up to perform the following state duties: tornado relief duties in St. Louis, MO, 29 September-2 October 1927; flood relief efforts along the Mississippi River near Sikeston, MO, in January 1936; flood relief efforts along the Mississippi River in southeastern Missouri 23 January-2 February 1937. Conducted annual summer training at various locations to include: Camp Clark, MO; Lambert-St. Louis Municipal Airport; Marshall Field, Fort Riley, KS; and Anglum, MO. Detachments were also sent many years to support the summer training of the 203rd Coast Artillery at Fort Barrancas, FL, and the units of the 60th Field Artillery Brigade at Fort Riley and Fort Sill, OK. Relieved in November 1940 from assignment to the 47th Observation Group. Inducted into active Federal service 23 December 1940 at Lambert-St. Louis Municipal Airport, and transferred to Little Rock, AR, arriving there 3 January 1941. Assigned in January 1941 to the VII Corps. Assigned on 1 October 1941 to the 71st Observation Group (VII Corps). Location 7 December 1941—Little Rock, AR.

Status: Active in the Missouri Air National Guard as the 110th Fighter Squadron at Lambert-St. Louis International Airport, MO.

Events: 126, 236, 303, 324

Commanders, 110th Observation Squadron

Maj. William M. Robertson	23 Jun 23-16 Sep 24	Capt. John P. Sparks	8 Feb 30-23 Oct 30
Capt. Charles R. Wassell	16 Sep 24-21 May 25	Maj. Philip R. Love	23 Oct 30-Sep 36
Capt. William H. Leininger	21 May 25-14 Oct 25	Maj. Eben R. Alexander	Sep 36-2 Feb 39
Maj. Charles R. Wassell	14 Oct 25-16 Sep 29	Maj. Edwin H. Lauth	2 Feb 39-ao Feb 41
Capt. Russell A. Young	16 Sep 29-8 Feb 30	Unknown	ao Feb 41-7 Dec 41

111th Observation Squadron (36th Division)**Texas National Guard**

HQ-*Not organized* 1921-23; Ellington Field, Houston, TX, 1923-27; Houston Municipal Airport, Houston, TX, 1927-40; Stinson Field, Brownwood, TX, 1941

Constituted in the National Guard in 1921 as the 111th Squadron (Observation), assigned to the 36th Division, and allotted to the state of Texas. Redesignated as the 111th Observation Squadron on 25 January 1923. Organized in April 1923 and Federally recognized on 29 June 1923 at Ellington Field, Houston, TX. Relocated in December 1927 to the Houston Municipal Airport. Relieved on 15 February 1929 from assignment to the 36th Division. Concurrently attached to the 36th Division for command and control purposes. Assigned on 1 October 1933 to the 48th Observation Group (VIII Corps). Consolidated on 20 October 1936 with the 111th Aero Squadron (a WWI unit organized on 14 August 1917 at Kelly Field, TX; redesignated as the 632nd Aero Squadron on 1 February 1918; demobilized on 19 August 1919 at Kelly Field; reconstituted on 20 October 1936). The squadron, or elements thereof, called up to perform the following state duties: flights in support of experimental analysis of cosmic rays by scientists at Rice University 17-30 June 1932; numerous aerial photograph and mapping surveys of Texas in the 1930s to include reconnaissance photos of the Rio Grande River bridges with Mexico for border security operations; aerial support to martial law for operations to reduce the Borger, TX, criminal ring during September-October 1929; and aerial patrols of the oilfields in the East Texas martial law district during September 1931-December 1932. Conducted summer training at Ellington Field and Camp Hulen, TX. Also flew spotter missions at Camp Bullis, TX, for the training of the units of the 61st Field Artillery Brigade. Inducted into active Federal service 25 November 1940 at Ellington Field,

TX. Relieved from assignment to the 48th Observation Group on 30 December 1940 and assigned on to the Third Army. Transferred to Stinson Field, Brownwood, TX, arriving there 12 January 1941. Relieved from the Third Army in March 1941 and assigned to the VIII Corps. Relieved from the VIII Corps in June 1941 and assigned to the Third Army. Location 7 December 1941—Brownwood, TX.

Status: Active in the Texas Air National Guard as the 111th Fighter Squadron at Ellington Field, TX.

Events: 80, 126, 300

Commanders, 111th Observation Squadron

Maj. Bernard A. Law	29 Jun 23-1 Jan 26	Maj. Harry W. Weddington (RA)	Jun 35-24 Sep 39
Maj. Walter H. Reid (RA)	1 Jan 26-Jun 31	Maj. Christopher C. Scott	24 Sep 39-May 40
Maj. Thomas W. Blackburn (RA)	Jun 31-Jun 35	Maj. Aubrey W. Schofield	May 40-ao Dec 41

112th Observation Squadron (37th Division)

Ohio National Guard

HQ-*Not organized* 1921-27; Cleveland Airport, Cleveland, OH, 1927-40; Pope Field, NC, 1940-41



Constituted in the National Guard in 1921 as the 112th Squadron (Observation), assigned to the 37th Division, and allotted to the state of Ohio. Redesignated as the 112th Observation Squadron on 25 January 1923. Organized and Federally recognized on 20 June 1927 at Cleveland Airport, Cleveland, OH. Relieved on 15 February 1929 from assignment to the 37th Division. Concurrently attached to the 37th Division for command and control purposes. Assigned on 1 October 1933 to the 45th Observation Group (V Corps). Consolidated on 20 October 1936 with the 112th Aero Squadron (a WWI unit organized on 14 August 1917 at Kelly Field TX; redesignated as the 633rd Aero Squadron on 1 February 1918; demobilized on 19 August 1919 at Kelly Field, TX; reconstituted on 20

October 1936). The squadron, or elements thereof, called up to perform the following state duties: support to civil authorities during a mine worker's strike at Cadiz, OH, 16 April-17 August 1932; Electric Auto Lite strike at Toledo, OH, in 1934; flood relief efforts along the Ohio River in southern Ohio during January-February 1937; riot control during a labor strike at the Mahoning Valley steel plants 22 June-15 July 1937. Conducted summer training at Camp Perry, OH. Relieved in November 1940 from assignment to the 45th Observation Group. Inducted into active Federal service 25 November 1940 at Cleveland and transferred to Pope Field, NC, arriving there 2 December 1940. Assigned in December 1940 to the I Corps. Further assigned 1 September 1941 to the 65th Observation Group (I Corps). Location 7 December 1941—Pope Field, NC.

Status: Active in the Ohio Air National Guard as the 112th Fighter Squadron at Toledo, OH.

Events: 126, 213, 220, 302, 330

Commanders, 112th Observation Squadron

Maj. Thomas J. Herbert	20 Jun 27-10 Apr 31	Maj. Fred L. Smith	20 Sep 34-15 Nov 37
Maj. Errol H. Zistel	11 Apr 31-19 Sep 34	Maj. Clarence D. Barnhill	16 Nov 37-ao Mar 41
	Unknown	ao Mar 41-7 Dec 41	

113th Observation Squadron (38th Division)

Indiana National Guard

HQ-Kokomo, IN, 1921-26; Stout Field, Indianapolis, IN, 1926-41; Meridian, MS, 1941

Constituted in the National Guard 25 August 1921 as the 137th Squadron (Observation), assigned to the 333rd Observation Group (V Corps), and allotted to the state of Indiana. Organized in February 1921 and Federally recognized on 1 August 1921 at Kokomo, IN. Redesignated as the 113th Squadron (Observation) on 3 January 1923 and assigned to the 38th Division. Redesignated as the 113th Observation Squadron on 25 January 1923. Relocated on 10 June 1926 to Stout Field, Indianapolis, IN. Relieved on 15 February 1929 from assignment to the 38th Division. Concurrently attached to the 38th Division for command and control purposes. Assigned on 1 October 1933 to the 45th Observation Group (V Corps). Consolidated on 20 October 1936 with the 113th Aero Squadron (a WWI unit organized on 14 August 1917 at Kelly Field, TX; redesignated as the 634th Aero Squadron on 1 February 1918; demobilized on 31 March 1919 at Kelly Field; reconstituted on 20 October 1936). The squadron, or elements thereof, called up to perform

the following state duties: aerial surveillance of labor troubles in Vanderburg and Warwick Counties 22 February-23 March 1926; flood relief duties at Hazelton-Vincennes, IN, during the Wabash River flood 15-21 January 1930; aerial mapping survey of the state of Indiana in 1930; aerial surveillance of labor troubles during a coal miners' strike at the Dixie Bee Mine August-October 1932; flood relief efforts along the Ohio River in southern Indiana during January-February 1937. Supported the training of the 7th Cavalry Brigade at various times 1934-36. Conducted summer training at Wright Field, OH, or Godman Field, 1922-40. Relieved in November 1940 from assignment to the 45th Observation Group. Assigned on 30 December 1940 to the V Corps. Inducted into active Federal service 17 January 1941 at Stout Field and transferred to Meridian, MS, arriving there 27 January 1941. Assigned on 1 September 1941 to the 67th Observation Group. Location 7 December 1941—Meridian, MS.

Status: Active in the Indiana Air National Guard as the 113th Fighter Squadron at Hulman Field, Terre Haute, IN.

Events: 126, 213, 302

Commanders, 113th Observation Squadron

Maj. Wilbur Fagley	1 Aug 21-30 Jun 22	Maj. Oliver H. Stout	11 Sep 32-Aug 41
Maj. James C. Patten	1 Jul 22-9 Jun 26	Maj. Cecil F. Reynolds	Aug 41-Nov 41
Maj. Richard F. Taylor	10 Jun 26-10 Sep 32	Maj. Paul A. Eartman	Nov 41-ao Jan 42

114th Observation Squadron (39th Division)

Alabama National Guard

HQ-Not organized 1921-23; Roberts Field, Birmingham, AL, 1923-24

Constituted in the National Guard in 1921 as the 114th Squadron (Observation), assigned to the 39th Division, and allotted to the state of Alabama. Organized by the redesignation of the 135th Observation Squadron (organized and Federally recognized on 21 January 1922 at Roberts Field, Birmingham, AL, as the 135th Squadron (Observation); redesignated as the 135th Observation Squadron on 25 January 1923) as the 114th Observation Squadron on 1 May 1923 and assigned to the 39th Division. Conducted annual summer training at Maxwell Field, AL, in 1923. Redesignated as the 106th Observation Squadron on 16 January 1924 and assigned to the 31st Division.

Status: Active in the Alabama Air National Guard as the 106th Air Refueling Squadron at Birmingham Airport, AL.

Commanders, 114th Observation Squadron

Maj. James A. Meissner	1 May 23-15 Jan 24
------------------------	--------------------

115th Observation Squadron (40th Division)

California National Guard

HQ-Not organized 1921-24; Hollywood, CA, 1924; Clover Field, Santa Monica, CA, 1924-25; Griffith Park Field, Los Angeles, CA, 1925-41; Sherwood Field, Paso Robles, CA, 1941

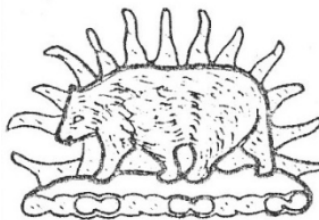

Constituted in the National Guard in 1921 as the 115th Squadron (Observation), assigned to the 40th Division, and allotted to the state of California. Redesignated as the 115th Observation Squadron on 25 January 1923. Organized in April 1924 at Hollywood, CA. Relocated on 16 June 1924 to Clover Field, Santa Monica, CA. Concurrently Federally recognized at Clover Field. Relocated in January 1925 to Griffith Field, Los Angeles, CA. One flight called up to support the 184th Infantry which performed riot control duty at the Folsom State Prison 24-29 November 1927. Relieved on 15 February 1929 from assignment to the 40th Division. Concurrently

attached to the 40th Division for command and control purposes. Assigned on 1 October 1933 to the 49th Observation Group (IX Corps). Consolidated on 20 October 1936 with the 115th Aero Squadron (a WWI unit organized on 28 August 1917 at Kelly Field, TX; redesignated as the 636th Aero Squadron on 1 February 1918; demobilized on 8 April 1919 at Garden City, NY; reconstituted on 20 October 1936). Conducted summer training at Clover Field, Griffith Field, or Camp San Luis Obispo, CA. Relieved in November 1940 from assignment to the 49th Observation Group. Assigned on 30 December 1940 to the III Corps. Inducted into active Federal service 3 March 1941 at Los Angeles and transferred to Paso Robles, CA, arriving there 13 March 1941. Further assigned on 3 September 1941 to the 69th Observation Group (III Corps). Location 7 December 1941—Paso Robles, CA.

Status: Active in the California Air National Guard as the 115th Airlift Squadron at Channel Islands Air National Guard Base, CA.

Events: 126, 231, 304, 331

Commanders, 115th Observation Squadron

Maj. Corliss C. Moseley (RA)	16 Jun 24-10 Aug 28	Maj. Eldo A. Peterson	7 May 31-ao Mar 41
Maj. John N. Jeffers	10 Aug 28-6 May 31	Capt. Charles Roberts	ao Nov 41-ao Jan 42

116th Observation Squadron (41st Division)

Washington National Guard

HQ-Not organized 1921-24; Felts Field, Parkwater, WA, 1924-40; Gray Field, WA, 1940-41

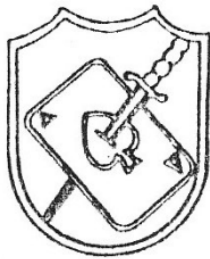

Constituted in the National Guard in 1921 as the 116th Squadron (Observation), assigned to the 41st Division, and allotted to the state of Washington. Redesignated as the 116th Observation Squadron on 25 January 1923. Organized on 24 July 1924 and Federally recognized on 6 August 1924 at Felts Field, Parkwater, WA. Relieved on 15 February 1929 from assignment to the 41st Division. Concurrently attached to the 41st Division for command and control purposes. Assigned on 1 October 1933 to the 49th Observation Group (IX Corps). Consolidated on 20 October 1936 with the 116th Aero Squadron (a WWI unit organized on 29 August 1917 at Kelly Field, TX; redesignated as the 637th Aero Squadron on 1 February 1918; demobilized on 20 May 1919 at Mitchel Field, NY; reconstituted on 20 October 1936).

Conducted summer training at Felts Field and Fort Lewis, WA. Inducted into active Federal service 16 September 1940 at Felts Field and transferred to Gray Field, WA, arriving there 24 September 1940. Relieved from assignment to the 49th Observation Group on 3 October 1940 and assigned to the Fourth Army. Further assigned in November 1940 to the IX Corps. Further assigned 1 September 1941 to the 70th Observation Group (IX Corps). Location 7 December 1941—Gray Field, WA.

Status: Active in the Washington Air National Guard as the 116th Air Refueling Squadron at Fairchild AFB, WA.

Events: 126, 238, 304, 309, 314

Commanders, 116th Observation Squadron

Maj. John T. Fancher	6 Aug 24-29 Apr 28	Maj. Robert G. Breene	17 Sep 31-3 Jul 34
Capt. Harold R. Neeley	29 Apr 28-18 May 28	Capt. Robert W. Owen	3 Jul 34-14 Nov 34
Maj. Caleb V. Haynes (R.A.)	18 May 28-17 Jul 31	Maj. Robin A. Day	14 Nov 34-1 Jun 38
Capt Warren W. Wadsworth	18 Jul 31-17 Sep 31	Maj. Hillford R. Wallace	2 Jun 38-16 Sep 41

118th Observation Squadron (43rd Division)

Connecticut National Guard

HQ-Not organized 1921-23; Brainard Field, Hartford, CT, 1923-41; Jacksonville, FL, 1941



Constituted in the National Guard in 1921 as the 118th Squadron (Observation), assigned to the 43rd Division, and allotted to the state of Connecticut. Redesignated as the 118th Observation Squadron on 25 January 1923. Organized on 27 July 1923 and Federally recognized on 1 November 1923 at Brainard Field, Hartford, CT. Relieved on 15 February 1929 from assignment to the 43rd Division. Concurrently attached to the 43rd Division for command and control purposes. Assigned on 1 October 1933 to the 41st Observation Group (I Corps). Consolidated on 20 October 1936 with the 118th Aero Squadron (a WWI unit organized on 31 August 1917 at Kelly Field, TX; redesignated as the 639th Aero Squadron on 1 February 1918; demobilized on 6 June 1919 at Kelly Field; reconstituted on 20 October 1936). The squadron, or elements thereof, called up to perform the following state duties:

riot control at the textile workers strike at Putnam, CT, in September 1934; and flood relief at Hartford, CT, 19 March-1 April 1936. Conducted summer training at Mitchell Field, NY, or Trumbull Field, CT. Detachments were sent some years to fly spotter missions during the summer training of the 192nd Field Artillery Regiment. Relieved from assignment to the 41st Observation Group on 30 December 1940 and assigned to the IV Corps. Inducted into active Federal service 24 February 1941 at Hartford and transferred to Jacksonville, FL, arriving there 16 March 1941.

Further assigned 1 September 1941 to the 66th Observation Group (IV Corps). Location 7 December 1941—Jacksonville, FL.

Status: Active in the Connecticut Air National Guard as the 118th Fighter Squadron at Bradley Air National Guard Base, CT.

Events: 126, 190, 280, 301

Commanders, 118th Observation Squadron

Maj. Talbot O. Freeman
Maj. William F. Ladd

1 Nov 23-31 Dec 25
31 Dec 25-31 Dec 29

Maj. Hubert E. Johnson
Maj. Harry W. Generous

1 Jan 30-May 41
May 41-4 Nov 41

119th Observation Squadron (44th Division)

New Jersey National Guard

HQ-Not organized 1921-30; Newark Airport, NJ 1930-41



Constituted in the National Guard in 1921 as the 119th Squadron (Observation), assigned to the 44th Division, and allotted to the state of New Jersey. Redesignated as the 119th Observation Squadron on 25 January 1923. Relieved on 15 February 1929 from assignment to the 44th Division. Organized and Federally recognized on 30 January 1930 at Newark Airport, Newark, NJ, and attached to the 44th Division for command and control purposes. Assigned on 1 October 1933 to the 42nd Observation Group (II Corps). Consolidated on 17 October 1936 with the 119th Aero Squadron (a WWI unit organized on 2 September 1917 at Langley Field, VA; redesignated as Detachment 11, Air Service Aircraft Production on 31 July 1918; demobilized on 29 May 1919 at Hampton, VA; reconstituted on 17 October 1936). The squadron was called up 7-8 September 1934 to support rescue efforts after the sinking of the S.S. *Morro Castle* off the coast of New Jersey. Conducted summer training at Newark Airport or Camp Dix, NJ, 1930-40. Inducted into active Federal service 16 September 1940 at Newark Airport. Relieved from assignment to the 42nd Observation Group on 3 October 1940 and assigned to the First Army. Relieved from the First Army in March 1941 and assigned to the II Corps. Relieved from the II Corps in June 1941 and assigned to the First Army. Attached on 1 September 1941 to the 59th Observation Group (II Corps). Location 7 December 1941—Newark Airport, NJ.

Status: Active in the New Jersey Air National Guard as the 119th Fighter Squadron at Atlantic City, NJ.

Events: 126, 190, 280, 301

Commanders, 119th Observation Squadron

Maj. Kellogg Sloan

30 Jan 30-26 Jan 31
Maj. Chester A. Charles

Maj. Robert L. Copsey
31 Jul 39-ao Dec 41

27 Jan 31-31 Jul 39

120th Observation Squadron (45th Division)

Colorado National Guard

HQ-Not organized 1921-23; Denver Municipal Airport, Denver, CO, 1923-38; Lowry Field, Denver, CO, 1938-41; Biggs Field, Fort Bliss, TX, 1941

Constituted in the National Guard in 1921 as the 120th Squadron (Observation), assigned to the 45th Division, and allotted to the state of Colorado. Organized and Federally recognized on 27 January 1923 at Denver Municipal Airport, Denver, CO, with Flight A located at Denver and Flight B at Pueblo. Redesignated as the 120th Observation Squadron on 25 January 1923. Flight B relocated to Denver on 30 June 1928. Relieved on 15 February 1929 from assignment to the 45th Division. Concurrently attached to the 45th Division for command and control purposes. Assigned on 1 October 1933 to the 48th Observation Group (VIII Corps). Consolidated on 20 October 1936 with the 120th Aero Squadron (a WWI unit organized in August 1917 at Kelly Field, TX, as the 136th Aero Squadron; redesignated September 1917 as the 120th Aero Squadron; demobilized on 17 May 1919 at Mitchel Field, NY; reconstituted on 20 October 1936). Relocated on 1 February 1938 to Lowry Field, CO. Relieved from assignment to the 48th Observation Group on 9 May 1939 and assigned to the 24th Cavalry Division. Relieved 15 September 1940 from the 24th Cavalry

Division. The squadron, or elements thereof, called up to perform the following state duties: aerial support to units engaged in strike duty at the Columbine Mine 21 November 1927-6 April 1928; aerial support to relief efforts in the grasshopper depredations in eastern Colorado 28 June-26 August 1937. Conducted summer training at various locations to include Post Field, Fort Sill, OK, and Lowry Field. The squadron also supported the training of the units of the 70th Field Artillery Brigade at Fort Sill and the 168th Field Artillery at Golden, CO. Attached to the Third Army 30 December 1940. Inducted into active Federal service 6 January 1941 at Denver, assigned to the Third Army, and transferred to Biggs Field, TX, arriving there 16 January 1941. Further assigned 1 September 1941 to the III Air Support Command. Location 7 December 1941—Biggs Field, Fort Bliss, TX.

Status: Active in the Colorado Air National Guard as the 120th Fighter Squadron at Buckley Air National Guard Base, CO.

Events: 80, 126, 300

Commanders, 120th Observation Squadron

Maj. William H. Dayton	6 Mar 24-16 May 27	Maj. Virgil D. Stone	2 Jan 34-13 Mar 38
Maj. Bruce Kistler	16 May 27-26 Aug 30	Maj. Frederick W. Bonfils	14 Mar 38-ao Jan 40
Maj. Carlos L. Reavis	26 Aug 30-1 Jan 34	Unknown	ao Jan 40-ao Oct 40
	Maj. Harrison W. Wellman, Jr.	ao Oct 40-2 Mar 42	

121st Observation Squadron

District of Columbia National Guard

HQ-*Not organized* 1940-41; Bolling Field, Washington, DC, 1941; Owens Field, SC, 1941

Constituted in the National Guard 30 July 1940 and allotted to the District of Columbia. Organized and Federally recognized on 10 April 1941 at 743 14th Street, NW, in Washington, DC. Inducted into active Federal service 1 September 1941 at Bolling Field in Washington and assigned to the 65th Observation Group. Transferred to Owens Field, SC, arriving there 23 September 1941. Location 7 December 1941—Owens Field, SC.

Status: Active in the District of Columbia Air National Guard as the 121st Fighter Squadron at Andrews A.F.B., MD.

Events: 330

Commanders, 121st Observation Squadron

Maj. James L. Higgs	10 Apr 41-ao May 41	Maj. Clifford C. Hutchison	ao Aug 41-ao Dec 41
---------------------	---------------------	----------------------------	---------------------

121st Service Squadron (I Corps)

Massachusetts National Guard

Air Park No. 101 (1921-23)

HQ-*Not organized* 1921-27

Constituted in the National Guard in 1921 as Air Park No. 101, assigned to the I Corps, and allotted to the state of Massachusetts. Redesignated as the 121st Service Squadron on 25 January 1923. Placed on the deferred list on 2 July 1923, transferred to the Organized Reserve as a Deferred National Guard unit, and redesignated as the 566th Service Squadron. Withdrawn from the state of Massachusetts 7 January 1927. Withdrawn from allotment to the National Guard and the First Corps Area on 17 September 1927 and demobilized.

122nd Observation Squadron

Louisiana National Guard

HQ-*Not organized* 1940; New Orleans Municipal Airport, LA, 1940-41; Esler Field, Alexandria, LA, 1941

Constituted in the National Guard 30 July 1940 and allotted to the state of Louisiana. Organized in December 1940 at New Orleans, LA. Federally recognized on 2 March 1941 at the New Orleans Municipal Airport, LA. Inducted into active Federal service 1 October 1941 at New Orleans and assigned to the 68th Observation Group. Transferred to Esler Field, Alexandria, LA, arriving there 6 October 1941. Location 7 December 1941—Eisler Field, LA.

Status: Active in the Louisiana Air National Guard as the 122nd Fighter Squadron at NAS New Orleans Joint Reserve Base, LA.

1450

Commanders, 122nd Observation Squadron

Maj. Glynn Jones 2 Mar 41-6 Jul 42

122nd Service Squadron (III Corps)

Pennsylvania National Guard

Air Park No. 102 (1921-23)

HQ-Not organized 1921-23

Constituted in the National Guard in 1921 as Air Park No. 102, assigned to the III Corps, and allotted to the state of Pennsylvania. Redesignated as the 122nd Service Squadron on 25 January 1923. Withdrawn from allotment to the Pennsylvania National Guard in April 1926 and demobilized.

123rd Observation Squadron

Oregon National Guard

HQ-Not organized 1940-41; Swan Island Airport, Portland, OR, 1941; Gray Field, WA, 1941

Constituted in the National Guard 30 July 1940 and allotted to the state of Oregon. Organized and Federally recognized on 18 April 1941 at Swan Island Airport, Portland, OR. Inducted into active Federal service 25 September 1941 at Portland and assigned to the 70th Observation Group. Transferred to Gray Field, WA. Location 7 December 1941—Gray Field, WA.

Status: Active in the Oregon Air National Guard as the 123rd Fighter Squadron at Portland Air National Guard Base, OR.

Commanders, 123rd Observation Squadron

Maj. G. Robert Dodson 18 Apr 41-30 Apr 42

123rd Service Squadron (V Corps)

Indiana National Guard

Air Park No. 103 (1921-23)

HQ-Not organized 1921-26

Constituted in the National Guard in 1921 as Air Park No. 103, assigned to the V Corps, and allotted to the state of Indiana. Redesignated as the 123rd Service Squadron on 25 January 1923. Withdrawn from allotment to the Indiana National Guard in April 1926 and demobilized.

124th Observation Squadron

Iowa National Guard

HQ-Not organized 1940-41; Des Moines Airport, Des Moines, IA, 1941; Sherman Field, KS, 1941

Constituted in the National Guard 30 July 1940 and allotted to the state of Iowa. Organized and Federally recognized on 25 February 1941 at the Des Moines Airport in Des Moines, IA. Inducted into active Federal service 15 September 1941 at Des Moines. Assigned on to the 72nd Observation Group (Second Army) on 26 September 1941 and transferred to Sherman Field, Fort Leavenworth, KS. Location 7 December 1941—Sherman Field, KS.

Status: Active in the Iowa Air National Guard as the 124th Fighter Squadron at Des Moines, IA.

Commanders, 124th Observation Squadron

Maj. Lester G. Orcutt 25 Feb 41-Apr 41 Maj. John O. Bradshaw Apr 41-Nov 42

124th Service Squadron (VI Corps)**Illinois National Guard****Air Park No. 104** (1921-23)**HQ-Not organized** 1921-27

Constituted in the National Guard in 1921 as Air Park No. 104, assigned to the VI Corps, and allotted to the state of Illinois. Redesignated as the 124th Service Squadron on 25 January 1923. Placed on the deferred list on 2 July 1923, transferred to the Organized Reserve as a Deferred National Guard unit, and redesignated as the 567th Service Squadron. Withdrawn from allotment to the National Guard and the Fourth Corps Area on 17 September 1927 and demobilized.

125th Observation Squadron**Oklahoma National Guard****HQ-Not organized** 1940-41; Tulsa Airport, Tulsa, OK, 1941; Post Field, OK, 1941

Constituted in the National Guard 30 July 1940 and allotted to the state of Oklahoma. Organized and Federally recognized on 10 February 1941 at the Tulsa Airport, Tulsa, OK. Inducted into active Federal service 15 September 1941 at Tulsa, assigned to the 68th Observation Group, and transferred to Post Field, OK, arriving there 20 September 1941. Location 7 December 1941—Post Field, OK.

Status: Active in the Oklahoma Air National Guard as the 125th Fighter Squadron at Tulsa International Airport, OK.**Commanders, 125th Observation Squadron**

Maj. Robert O. Lindsay

10 Feb 41-ao Aug 41

Unknown

ao Aug 41-7 Dec 41

125th Service Squadron (VII Corps)**Missouri National Guard****Air Park No. 105** (1921-23)**HQ-Not organized** 1921-27

Constituted in the National Guard in 1921 as Air Park No. 105, assigned to the VII Corps, and allotted to the state of Missouri. Redesignated as the 125th Service Squadron on 25 January 1923. Placed on the deferred list on 2 July 1923, transferred to the Organized Reserve as a Deferred National Guard unit, and redesignated as the 568th Service Squadron. Withdrawn from allotment to the National Guard and the Seventh Corps Area on 17 September 1927 and demobilized.

126th Observation Squadron**Wisconsin National Guard****HQ-Not organized** 1940-41; Milwaukee, WI, 1940-41; Fort Dix, NJ 1941; Hyannis, MA, 1941

Constituted in the National Guard 30 July 1940 and allotted to the state of Wisconsin. Organized and Federally recognized on 12 November 1940 at the Richards Street Armory in Milwaukee, WI. Inducted into active Federal service 2 June 1941 at the Milwaukee County Airport in Milwaukee. Transferred on 10 June 1941 to Fort Dix, NJ, and assigned to the II Corps. Transferred on 27 August 1941 to Hyannis, MA. Assigned on 1 September 1941 to the 59th Observation Group (II Corps). Location 7 December 1941—Hyannis, MA.

Status: Active in the Wisconsin Air National Guard as the 126th Air Refueling Squadron at General Mitchell International Airport, Milwaukee, WI.**Events:** 330**Commanders, 126th Observation Squadron**

Maj. Paul D. Meyers

12 Nov 40-1 Sep 41

Capt. Richard T. Crane

1 Seop 41-12 Aug 42

126th Service Squadron (VIII Corps)**Colorado National Guard****Air Park No. 106** (1921-23)**HQ-Not organized** 1921-26

Constituted in the National Guard in 1921 as Air Park No. 106, assigned to the VIII Corps, and allotted to the state of Colorado. Redesignated as the 126th Service Squadron on 25 January 1923. Placed on the deferred list on 2 July 1923, transferred to the Organized Reserve as a Deferred National Guard unit, and redesignated as the 569th Service Squadron. Withdrawn from allotment to the National Guard on 30 December 1926 and demobilized.

127th Observation Squadron**Kansas National Guard****HQ-Not organized** 1940-41; Wichita Municipal Airport, Wichita, KS, 1941; Sherman Field, KS, 1941

Constituted in the National Guard 30 July 1940 and allotted to the state of Kansas. Organized and Federally recognized on 4 August 1941 at the Wichita Municipal Airport at Wichita, KS. Inducted into active Federal service 6 October 1941 at Wichita and assigned to the 68th Observation Group Transferred to Sherman Field, Fort Leavenworth, KS, arriving there on 13 October 1941. Location 7 December 1941—Sherman Field, KS.

Status: Active in the Kansas Air National Guard as the 127th Bombardment Squadron at McConnell AFB, KS.**Commanders, 127th Observation Squadron**

Maj. Paul Flanary 24 May 41-29 Aug 43

127th Service Squadron (Third Army)**North Dakota National Guard****Air Park No. 112** (1921-23)**HQ-Not organized** 1921-27

Constituted in the National Guard in 1921 as Air Park No. 112, assigned to the Third Army, and allotted to the state of North Dakota. Redesignated as the 127th Service Squadron on 25 January 1923. Placed on the deferred list on 2 July 1923, transferred to the Organized Reserve as a Deferred National Guard unit, and redesignated as the 570th Service Squadron. Withdrawn from allotment to the National Guard and the Seventh Corps Area on 17 September 1927 and demobilized.

128th Observation Squadron**Georgia National Guard****HQ-Not organized** 1940-41; Atlanta Municipal Airport, GA, 1941; Lawson, GA, 1941

Constituted in the National Guard 30 July 1940 and allotted to the state of Georgia. Organized and Federally recognized on 1 May 1941 at the Atlanta Municipal Airport, GA. Inducted into active Federal service 15 September 1941 at Atlanta. Transferred to Lawson Field, GA, arriving there 23 September 1941. Assigned on 1 October 1941 to the 71st Observation Group (VII Corps). Location 7 December 1941—Lawson, GA.

Status: Active in the Georgia Air National Guard as the 128th Bombardment Squadron at Warner-Robins AFB, GA.**Commanders, 128th Observation Squadron**

Maj. George G. Finch 1 May 41-11 Aug 42

131st Observation Squadron (I Corps)**Massachusetts National Guard****HQ-Not organized 1921-27**

Constituted in the National Guard in 1921 as the 131st Squadron (Observation), assigned to the 323rd Observation Group (I Corps), and allotted to the state of Massachusetts. Placed on the deferred list on 2 July 1923 as the 550th Observation Squadron and transferred to the Organized Reserve as a Deferred National Guard unit. Withdrawn as a Deferred National Guard unit on 11 January 1927 and permanently allotted to the Organized Reserve as the 550th Observation Squadron.

132nd Observation Squadron (I Corps)**Rhode Island National Guard****HQ-Not organized 1921-27**

Constituted in the National Guard in 1921 as the 132nd Squadron (Observation), assigned to the 323rd Observation Group (I Corps), and allotted to the state of Rhode Island. Placed on the deferred list on 2 July 1923 as the 551st Observation Squadron and transferred to the Organized Reserve as a Deferred National Guard unit. Withdrawn as a Deferred National Guard unit 11 January 1927 and permanently allotted to the Organized Reserve as the 551st Observation Squadron.

133rd Observation Squadron (III Corps)**National Guard****HQ-Not organized 1921-27**

Constituted in the National Guard in 1921 as the 133rd Squadron (Observation) and assigned to the III Corps. Placed on the deferred list on 2 July 1923 and transferred to the Organized Reserve as a Deferred National Guard unit. Concurrently redesignated as the 552nd Observation Squadron and assigned to the 328th Observation Group (III Corps). Withdrawn from allotment to the National Guard and the Third Corps Area on 17 September 1927 and demobilized.

134th Observation Squadron (III Corps)**National Guard****HQ-Not organized 1921-27**

Constituted in the National Guard in 1921 as the 134th Squadron (Observation) and assigned to the III Corps. Placed on the deferred list on 2 July 1923 and transferred to the Organized Reserve as a Deferred National Guard unit. Concurrently redesignated as the 553rd Observation Squadron and assigned to the 328th Observation Group (III Corps). Withdrawn from allotment to the National Guard and the Third Corps Area on 17 September 1927 and demobilized.

135th Observation Squadron (I) (IV Corps)**Alabama National Guard****HQ-Not organized 1921-22; Birmingham, AL, 1922-23**

Constituted in the National Guard in 1921 as the 135th Squadron (Observation), assigned to the 12th Observation Group (IV Corps), and allotted to the state of Alabama. Organized and Federally recognized on 21 January 1922 at Birmingham, AL. Conducted annual summer training at Maxwell Field, AL, in 1922. Redesignated as the 135th Observation Squadron on 25 January 1923. Redesignated as the 114th Observation Squadron on 1 May 1923 and assigned to the 39th Division (see 114th Observation Squadron).

Commanders, 135th Observation Squadron

Maj. James A. Meissner

21 Jan 22-1 May 23

135th Observation Squadron (II) (IV Corps)**Louisiana National Guard****HQ-Not organized 1923-27**

Unit requirement for the 135th Observation Squadron allotted 1 May 1923 to the state of Louisiana. Placed on the deferred list on 2 July 1923, transferred to the Organized Reserve as a Deferred National Guard unit, and redesignated as the 554th Observation Squadron. Withdrawn from allotment to the National Guard and the Fourth Corps Area on 17 September 1927 and demobilized.

136th Observation Squadron (I) (IV Corps)**Tennessee National Guard****HQ-Blackwood Field, Nashville, TN, 1921-23**

Constituted in the National Guard in 1921 as the 136th Squadron (Observation), assigned to the 12th Observation Group (IV Corps), and allotted to the state of Tennessee. Originally organized in the fall of 1920, it was Federally recognized on 4 December 1921 at Blackwood Field, Nashville, TN. Redesignated as the 136th Observation Squadron on 25 January 1923. Redesignated as the 105th Observation Squadron on 20 July 1923 and assigned to the 30th Division. (Unit requirement for the 136th Observation Squadron placed on the deferred list on 2 July 1923-see 136th Observation Squadron [II] below and 105th Observation Squadron).

Commanders, 136th Observation Squadron

Maj. John C. Bennett, Jr.	4 Dec 21-20 Jul 23
---------------------------	--------------------

136th Observation Squadron (II) (IV Corps)**North Carolina National Guard****HQ-Not organized 1923-27**

Unit requirement for the 136th Observation Squadron allotted 1 May 1923 to the state of North Carolina. Placed on the deferred list on 2 July 1923, transferred to the Organized Reserve as a Deferred National Guard unit, and redesignated as the 554th Observation Squadron. Withdrawn from the state of North Carolina in March 1926. Withdrawn from the National Guard on 17 September 1927 and demobilized.

137th Observation Squadron (I) (V Corps)**Indiana National Guard****HQ-Not organized 1921-22; Kokomo, IN, 1922-23; Not organized 1923-27**

Constituted in the National Guard 25 August 1921 as the 137th Squadron (Observation), assigned to the 333rd Observation Group (V Corps), and allotted to the state of Indiana. Organized in February 1921 and Federally recognized on 1 August 1921 at Kokomo, IN. Conducted annual summer training at Wilbur Wright Field, OH, in 1922. Redesignated as the 113th Squadron (Observation) on 3 January 1923 (see 113th Observation Squadron).

Commanders, 137th Observation Squadron

Maj. Wilbur M. Fagley	1 Aug 21-29 Jul 22	Maj. James C. Patten	30 Jul 22-3 Jan 23
-----------------------	--------------------	----------------------	--------------------

137th Observation Squadron (II) (V Corps)**Indiana National Guard****HQ-Not organized 1923-27**

Unit requirement for the 137th Observation Squadron reallocated 2 January 1923 to the state of Indiana. Unit requirement placed on the deferred list on 2 July 1923 and transferred to the Organized Reserve as a Deferred National Guard unit. Withdrawn from allotment to the National Guard and the Fifth Corps Area on 17 September 1927 and demobilized.

138th Observation Squadron (V Corps)**Indiana National Guard**

HQ-Not organized 1921-27

Constituted in the National Guard in 1921 as the 138th Squadron (Observation), assigned to the 333rd Observation Group (V Corps), and allotted to the state of Indiana. Placed on the deferred list on 2 July 1923, transferred to the Organized Reserve as a Deferred National Guard unit, and redesignated as the 556th Observation Squadron. Withdrawn from allotment to the National Guard and the Fifth Corps Area on 17 September 1927 and demobilized.

139th Observation Squadron (VI Corps)**Michigan National Guard**

HQ-Not organized 1921-27

Constituted in the National Guard in 1921 as the 139th Squadron (Observation) and assigned to the 335th Observation Group (VI Corps). Allotted to the state of Michigan 20 April 1921. Placed on the deferred list on 2 July 1923 and transferred to the Organized Reserve as a Deferred National Guard unit. Concurrently redesignated as the 557th Observation Squadron and assigned to the 335th Observation Group (VI Corps). Withdrawn from allotment to the National Guard and the Sixth Corps Area on 14 November 1927 and demobilized.

140th Observation Squadron (VI Corps)**Illinois National Guard**

HQ-Not organized 1921-27

Constituted in the National Guard in 1921 as the 140th Squadron (Observation), assigned to the 335th Observation Group (VI Corps), and allotted to the state of Illinois. Placed on the deferred list on 2 July 1923, transferred to the Organized Reserve as a Deferred National Guard unit, and redesignated as the 558th Observation Squadron. Withdrawn from allotment to the National Guard and the Sixth Corps Area on 17 September 1927 and demobilized.

141st Observation Squadron (VII Corps)**Iowa National Guard**

HQ-Not organized 1921-27

Constituted in the National Guard in 1921 as the 141st Squadron (Observation), assigned to the 336th Observation Group (VII Corps), and allotted to the state of Iowa. Placed on the deferred list on 2 July 1923, transferred to the Organized Reserve as a Deferred National Guard unit, and redesignated as the 559th Observation Squadron. Withdrawn from allotment to the National Guard and the Seventh Corps Area on 17 September 1927 and demobilized.

142nd Observation Squadron (I) (VII Corps)**Nebraska National Guard**

HQ-Not organized 1921-27

Constituted in the National Guard in 1921 as the 142nd Squadron (Observation), assigned to the 336th Observation Group (VII Corps), and allotted to the state of Nebraska. Placed on the deferred list on 2 July 1923 and transferred to the Organized Reserve as a Deferred National Guard unit. Withdrawn from allotment to the National Guard and the Seventh Corps Area on 17 September 1927 and demobilized.

142nd Observation Squadron (II) (I Corps)

Connecticut National Guard

HQ-Not organized 1928-33

Constituted in the National Guard on 5 September 1928, assigned to the 323rd Observation Group (I Corps), and allotted to the state of Connecticut. Withdrawn from allotment to the National Guard and the First Corps Area on 1 October 1933 and demobilized.

143rd Observation Squadron (I) (VIII Corps)

Oklahoma National Guard

HQ-Not organized 1921-26

Constituted in the National Guard in 1921 as the 143rd Squadron (Observation) and assigned to the 339th Observation Group (VIII Corps). Allotted to the state of Oklahoma 29 August 1921. Placed on the deferred list on 2 July 1923 as the 561st Observation Squadron and transferred to the Organized Reserve as a Deferred National Guard unit. Withdrawn from allotment to the National Guard on 30 December 1926 and demobilized.

143rd Observation Squadron (II) (I Corps)

Connecticut National Guard

HQ-Not organized 1928-33

Constituted in the National Guard on 5 September 1928, assigned to the 323rd Observation Group (I Corps), and allotted to the state of Connecticut. Withdrawn from allotment to the National Guard and the First Corps Area on 1 October 1933 and demobilized.

144th Observation Squadron (I) (IX Corps)

Oregon/California National Guard

HQ-Not organized 1921-27

Constituted in the National Guard in 1921 as the 144th Squadron (Observation), assigned to the 341st Observation Group (IX Corps), and allotted to the state of Oregon. Placed on the deferred list on 2 July 1923, transferred to the Organized Reserve as a Deferred National Guard unit, redesignated as the 562nd Observation Squadron, and allotted to the state of California. Withdrawn from allotment to the National Guard and the Ninth Corps Area on 17 September 1927 and demobilized.

144th Observation Squadron (II) (II Corps)

National Guard

HQ-Not organized 1928-33

Constituted in the National Guard on 5 September 1928, assigned to the 325th Observation Group (II Corps), and allotted to the Second Corps Area. Withdrawn from allotment to the National Guard and the Second Corps Area on 1 October 1933 and demobilized.

145th Observation Squadron (II Corps)

National Guard

HQ-Not organized 1928-33

Constituted in the National Guard on 5 September 1928, assigned to the 325th Observation Group (II Corps), and allotted to the Second Corps Area. Withdrawn from allotment to the National Guard and the Second Corps Area on 1 October 1933 and demobilized.

146th Observation Squadron (III Corps)

National Guard

HQ-Not organized 1928-33

Constituted in the National Guard on 5 September 1928, assigned to the 328th Observation Group (III Corps), and allotted to the Third Corps Area. Withdrawn from allotment to the National Guard and the Third Corps Area on 1 October 1933 and demobilized.

147th Observation Squadron (III Corps)

National Guard

HQ-Not organized 1928-33

Constituted in the National Guard on 5 September 1928, assigned to the 328th Observation Group (III Corps), and allotted to the Third Corps Area. Withdrawn from allotment to the National Guard and the Third Corps Area on 1 October 1933 and demobilized.

148th Observation Squadron (IV Corps)

National Guard

HQ-Not organized 1928-33

Constituted in the National Guard on 5 September 1928, assigned to the IV Corps, and allotted to the Fourth Corps Area. Withdrawn from allotment to the National Guard and the Fourth Corps Area on 1 October 1933 and demobilized.

149th Observation Squadron (IV Corps)

National Guard

HQ-Not organized 1928-33

Constituted in the National Guard on 5 September 1928, assigned to the IV Corps, and allotted to the Fourth Corps Area. Withdrawn from allotment to the National Guard and the Fourth Corps Area on 1 October 1933 and demobilized.

150th Observation Squadron (V Corps)

National Guard

HQ-Not organized 1928-33

Constituted in the National Guard on 5 September 1928, assigned to the 333rd Observation Group (V Corps), and allotted to the Fifth Corps Area. Withdrawn from allotment to the National Guard and the Fifth Corps Area on 1 October 1933 and demobilized.

151st Observation Squadron (V Corps)

Michigan National Guard

HQ-Not organized 1928-33

Constituted in the National Guard on 5 September 1928, assigned to the 333rd Observation Group (V Corps), and allotted to the state of Michigan. Withdrawn from allotment to the National Guard and the Fifth Corps Area on 1 October 1933 and demobilized.

152nd Observation Squadron (I) (Corps)

North Dakota National Guard

HQ-Not organized 1921-23

Constituted in the National Guard in 1921 and allotted to the state of North Dakota. Withdrawn from allotment to the National Guard in 1923 and demobilized.

152nd Observation Squadron (II) (VI Corps)

National Guard

HQ-*Not organized 1928-33*

Constituted in the National Guard on 5 September 1928, assigned to the 335th Observation Group (VI Corps), and allotted to the Sixth Corps Area. Withdrawn from allotment to the National Guard and the Sixth Corps Area on 1 October 1933 and demobilized.

152nd Observation Squadron (III)

Rhode Island National Guard

HQ-Hillsgrove, RI, 1939-41; Fort Devens, MA, 1941



Constituted in the National Guard on 21 August 1939 and allotted to the state of Rhode Island. Organized and Federally recognized on 13 October 1939 at Hillsgrove, RI. Inducted into active Federal service on 25 November 1940 at Hillsgrove and assigned to the First Corps Area. Assigned on 30 December 1940 to the VI Corps. Transferred on 31 July 1941 to Fort Devens, MA. Further assigned on 1 September 1941 to the 26th Observation Group (VI Corps). Location 7 December 1941—Fort Devens, MA.

Status: Active in the Arizona Air National Guard as the 152nd Fighter Squadron at Tucson International Airport, Tucson, AZ.

Events: 301, 330

Commanders, 152nd Observation Squadron

Maj. Paul L. Smith 13 Oct 39-ao Dec 41

153rd Observation Squadron (I) (VI Corps)

National Guard

HQ-*Not organized 1928-33*

Constituted in the National Guard on 5 September 1928, assigned to the 335th Observation Group (VI Corps), and allotted to the Sixth Corps Area. Withdrawn from allotment to the National Guard and the Sixth Corps Area on 1 October 1933 and demobilized.

153rd Observation Squadron (II)

Mississippi National Guard

HQ-Key Field, Meridian, MS, 1939-41

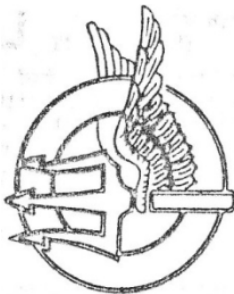

Constituted in the National Guard on 18 August 1939 and allotted to the state of Mississippi. Organized and Federally recognized on 27 September 1939 at Key Field, Meridian, MS. Inducted into active Federal service 15 October 1940 at Meridian and assigned to the Fourth Corps Area. Assigned in December 1940 to the V Corps. Further assigned on 1 September 1941 to the 67th Observation Group (V Corps). Location 7 December 1941—Key Field, Meridian, MS.

Status: Active in the Mississippi Air National Guard as the 153rd Air Refueling Squadron at Key Field, Meridian, MS.

Events: 300

Commanders, 153rd Observation Squadron

Maj. Allison J. Holifield 27 Sep 39-4 May 42

154th Observation Squadron (Third Army)

Arkansas National Guard

HQ-Not organized 1921-25; Little Rock, AR, 1925-40; Post Field, Fort Sill, OK, 1940-41

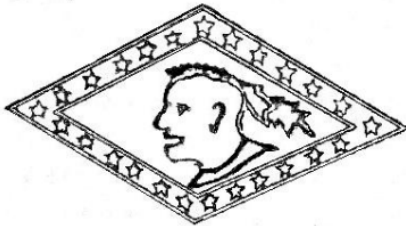

Constituted in the National Guard in 1921 as the 154th Squadron (Observation), assigned to the 320th Observation Group (Third Army), and allotted to the Seventh Corps Area. Placed on the deferred list on 2 July 1923, allotted to the Organized Reserve as a Deferred National Guard unit, and redesignated as the 564th Observation Squadron. Withdrawn from the Organized Reserve on 10 September 1925 and allotted to the Arkansas National Guard as the 154th Observation Squadron. Organized and Federally recognized on 24 October 1925 at Little Rock Airport, Little Rock, AR. Assigned 1 October 1933 to the 47th Observation Group (VII Corps). Consolidated on 20 October 1936 with

the 154th Aero Squadron (a WWI unit organized in December 1917 at Kelly Field, TX; demobilized on 1 February 1919 at Garden City, NY; reconstituted on 20 October 1936). The squadron, or elements thereof, called up to perform the following state duties: aerial support to flood relief efforts in eastern Arkansas during April-May 1927. Conducted summer training at various locations to include: Little Rock Air Intermediate Depot, Marshall Field, Fort Riley, KS; Post Field, Fort Sill, OK; Fort Barrancas, FL; and Camp Hulén, TX. Inducted into active Federal service 16 September 1940 at Little Rock and transferred to Post Field, Fort Sill, OK, arriving there 27 September 1940. Concurrently relieved from the 47th Observation Group (VII Corps) and assigned to the Eighth Corps Area. Relieved from the Eighth Corps Area on 3 October 1940 and assigned to the Third Army. Further assigned in November 1940 to the VIII Corps. Relieved from the VIII Corps on 1 September 1941 and assigned to the 68th Observation Group. Location 7 December 1941—Post Field, Fort Sill, OK.

Status: Active in the Arkansas Air National Guard as the 154th Training Squadron at Little Rock A.F.B., AR.

Events: 236, 303

Commanders, 154th Observation Squadron

Maj. Adrian Williamson 1 Jul 33-1 Sep 41 Unknown 1 Sep 41-7 Dec 41

155th Observation Squadron (VII Corps)

National Guard

HQ-Not organized 1928-33

Constituted in the National Guard on 5 September 1928, assigned to the 336th Observation Group (VII Corps), and allotted to the Seventh Corps Area. Withdrawn from allotment to the National Guard and the Seventh Corps Area on 1 October 1933 and demobilized.

156th Observation Squadron (VIII Corps)

National Guard

HQ-Not organized 1928-33

Constituted in the National Guard on 5 September 1928, assigned to the 338th Observation Group (VIII Corps), and allotted to the Eighth Corps Area. Withdrawn from allotment to the National Guard and the Eighth Corps Area on 1 October 1933 and demobilized.

157th Observation Squadron (VIII Corps)**National Guard****HQ-Not organized 1928-33**

Constituted in the National Guard on 5 September 1928, assigned to the 338th Observation Group (VIII Corps), and allotted to the Eighth Corps Area. Withdrawn from allotment to the National Guard and the Eighth Corps Area on 1 October 1933 and demobilized.

158th Observation Squadron (IX Corps)**National Guard****HQ-Not organized 1928-33**

Constituted in the National Guard on 5 September 1928, assigned to the 341st Observation Group (IX Corps), and allotted to the Ninth Corps Area. Withdrawn from allotment to the National Guard and the Ninth Corps Area on 1 October 1933 and demobilized.

159th Observation Squadron (IX Corps)**National Guard****HQ-Not organized 1928-33**

Constituted in the National Guard on 5 September 1928, assigned to the 341st Observation Group (IX Corps), and allotted to the Ninth Corps Area. Withdrawn from allotment to the National Guard and the Ninth Corps Area on 1 October 1933 and demobilized.

301st Observation Squadron (76th Division)**Organized Reserve Connecticut****HQ-Hartford, CT, 1921-41**

Constituted in the Organized Reserve on 24 June 1921 as the 301st Squadron (Observation), assigned to the 76th Division, and allotted to the First Corps Area. Initiated on 22 February 1922 at Hartford, CT. Redesignated as the 301st Observation Squadron on 25 January 1923. Relieved on 21 February 1929 from assignment to the 76th Division. Assigned on 1 October 1933 to the 41st Observation Group (I Corps). Conducted summer training at Mitchel Field, NY. Also attended summer training some years as individuals with National Guard observation squadrons at Trumbull Field, CT, and Boston Airport, MA. Location 7 December 1941—Hartford, CT.

Status: Disbanded on 31 May 1942.**Commanders, 301st Observation Squadron**

1st Lt. A. C. Bellinger	22 Feb 22-ao Mar 22	Maj. Charles R. Blake	Apr 27-ao Dec 32
Capt. Charles R. Blake	ao Dec 22-Feb 23	Unknown	ao Dec 32-24 Feb 36
Maj. Henry T. Morrison	Feb 23-Apr 27	Maj. Robert F. Raymond, Jr.	24 Feb 36-4 Jan 40
	Maj. Charles R. Blake	4 Jan 40-Jun 41	

302nd Observation Squadron (77th Division)**Organized Reserve New York****HQ-Garden City, L.I., NY, 1921-41**

Constituted in the Organized Reserve on 24 June 1921 as the 302nd Squadron (Observation), assigned to the 77th Division, and allotted to the Second Corps Area. Initiated on 1 October 1921 at Garden City, L.I., NY. Stationed at Mitchel Field. Redesignated as the 302nd Observation Squadron on 25 January 1923. Relieved on 21 February 1929 from assignment to the 77th Division. Assigned on 1 October 1933 to the 42nd Observation Group (II Corps). Consolidated on 24 November 1936 with the 302nd Aero Squadron (Service) (a WWI unit organized in June 1918; redesignated as Squadron F, Carlstrom Field in July 1918; demobilized in November 1918 at Carlstrom Field, FL; reconstituted on 24 November 1936). Relieved from assignment to the 42nd Observation Group (II Corps) on 7 May

1937 and assigned to the 307th Observation Group (XII Corps). Conducted summer training at Mitchel Field, NY. Designated mobilization station was Mitchel Field, NY. Location 7 December 1941—Garden City, L.I., NY.

Status: Disbanded on 31 May 1942.

Commanders, 302nd Observation Squadron

Maj. William G. Schaufler	1 Oct 21-12 Feb 23	Maj. Malcolm G. Spooner	27 Jan 30-22 Sep 33
Maj. George Peabody	12 Feb 23-9 Jan 24	Maj. Paul V. Burwell	22 Sep 33-30 Oct 34
Maj. Stedman S. Hanks	9 Jan 24-15 May 25	Maj. Malcolm G. Spooner	13 Nov 34-Aug 37
Capt. Paul C. Durbin	8 Mar 24-16 Dec 29	Maj. Gerald V. Kelley	Aug 37-13 Dec 40
Capt. George W. Ryan	2 Dec 29-27 Jan 30	Capt. Thomas R. Putnam	13 Dec 40-ao Dec 41

303rd Observation Squadron (78th Division)

Organized Reserve New Jersey

HQ—*Not initiated* 1921-22; Atlantic City, NJ 1922-37; *Inactive* 1937-41

Constituted in the Organized Reserve on 24 June 1921 as the 303rd Squadron (Observation), assigned to the 78th Division, and allotted to the Second Corps Area. Initiated on 20 January 1922 at Atlantic City, NJ. Redesignated as the 303rd Observation Squadron on 25 January 1923. Relieved on 21 February 1929 from assignment to the 78th Division. Col. Charles A. Lindbergh, Air Corps Reserve, was attached to the squadron in June 1932 for summer training at Mitchel Field, NY. Assigned on 1 October 1933 to the 307th Observation Group (XII Corps). Consolidated on 24 November 1936 with the 303rd Aero Squadron (Service) (a WWI unit organized in May 1918 at Kelly Field, TX; redesignated as Squadron K, Ellington Field in July 1918; demobilized in December 1918 at Ellington Field, TX; reconstituted on 24 November 1936). Conducted summer training at Mitchel Field. Inactivated in August 1937 at Atlantic City by relief of personnel. Designated mobilization station was Mitchel Field. Location 7 December 1941—*Inactive*.

Status: Disbanded on 31 May 1942.

Commanders, 303rd Observation Squadron

1st Lt. John W. Maxey	10 Jan 22-20 Jan 22	Maj. Glenn M. Pike	8 Mar 32-22 Sep 33
Maj. Rutherford S. Pierrepoint	20 Jan 22-11 Nov 24	Maj. Roy W. Ammel	18 Dec 33-5 Apr 35
Maj. Charles S. Lyons	11 Nov 24-24 Jun 28	Lt. Col. Thomas G. Lanphier	16 Jan 35-5 Apr 35
Maj. Edward M. Urband	24 Jun 28-29 Mar 30	Maj. Charles W. Richards	5 Apr 35-6 Aug 35
Maj. Donald Hudson	8 Apr 30-8 Mar 32	Maj. Gerald V. Kelley	3 Jul 36-Aug 37
	<i>Inactive</i>	Aug 37-7 Dec 41	

304th Observation Squadron (79th Division)

Organized Reserve Pennsylvania

HQ—Philadelphia, PA, 1921-39; *Inactive* 1939-41

Constituted in the Organized Reserve on 24 June 1921 as the 304th Squadron (Observation), assigned to the 79th Division, and allotted to the Third Corps Area. Initiated on 4 November 1921 at Philadelphia, PA. Redesignated as the 304th Observation Squadron on 25 January 1923. Relieved on 21 February 1929 from assignment to the 79th Division. Assigned on 1 October 1933 to the 315th Observation Group (XIII Corps). Inactivated on 23 October 1939 at Philadelphia by relief of personnel. Conducted summer training at Langley Field, VA. Location 7 December 1941—*Inactive*.

Status: Disbanded on 31 May 1942.

Commanders, 304th Observation Squadron

1st Lt. William S. Blakeley	4 Nov 21-15 Nov 21	Maj. William A. Reading	ao Feb 28-ao Sep 30
Capt. Guy W. Rogers	15 Nov 21-28 Aug 23	Unknown	ao Sep 30-ao Jun 32
Maj. William D. Grant	28 Aug 23-ao Sep 25	Maj. Ewing A. Day, Jr.	ao Jun 32-8 Apr 33
Unknown	ao Sep 25-ao Feb 28	Maj. Robert A. Culbertson	8 Apr 33-23 Oct 39
	<i>Inactive</i>	23 Oct 39-7 Dec 41	

305th Observation Squadron (80th Division)**Organized Reserve Virginia****HQ**-Richmond, VA, 1921-39; *Inactive* 1939-41

Constituted in the Organized Reserve on 24 June 1921 as the 305th Squadron (Observation), assigned to the 80th Division, and allotted to the Third Corps Area. Initiated on 5 December 1921 at Richmond, VA. Redesignated as the 305th Observation Squadron on 25 January 1923. Relieved on 21 February 1929 from assignment to the 80th Division. Assigned on 1 October 1933 to the 315th Observation Group (XIII Corps). Inactivated on 23 October 1939 at Richmond by relief of personnel. Conducted summer training at Langley Field, VA. Location 7 December 1941—*Inactive*.

Status: Disbanded on 31 May 1942.**Commanders, 305th Observation Squadron**

Capt. Eugene T. Dennis	5 Dec 21-9 Dec 21	Unknown	ao Sep 30-ao Dec 32
Capt. George W. May	9 Dec 21-ao Sep 22	Capt. Arthur A. Amick, Jr.	ao Dec 32-14 Feb 33
Capt. F. E. Galloway	ao Dec 22-30 Apr 23	Unknown	14 Feb 33-17 Jan 35
Maj. William A. Coleman	30 Apr 23-ao Jan 29	Maj. Edward M. Haight	17 Jan 35-22 Sep 35
Maj. Eugene T. Dennis	ao Apr 29-ao Sep 30	Maj. Chester A. Snow	22 Sep 35-23 Oct 39
	<i>Inactive</i>	23 Oct 39-7 Dec 41	

306th Observation Squadron (81st Division)**Organized Reserve Tennessee****HQ**-*Not initiated* 1921-22; Chattanooga, TN, 1922-39; *Inactive* 1939-41

Constituted in the Organized Reserve on 24 June 1921 as the 306th Squadron (Observation), assigned to the 81st Division, and allotted to the Fourth Corps Area. Initiated in February 1922 at Chattanooga, TN. Redesignated as the 306th Observation Squadron on 25 January 1923. Relieved on 21 February 1929 from assignment to the 81st Division. Assigned on 1 October 1933 to the 331st Observation Group (XIV Corps). Consolidated on 24 November 1936 with the 306th Aero Squadron (Service) (a WWI unit organized in July 1918 at Camp Greene, NC; demobilized in December 1918 at Camp Devens, MA; reconstituted on 24 November 1936). Inactivated on 23 July 1939 at Chattanooga by relief of personnel. Conducted summer training at Maxwell Field, AL. Location 7 December 1941—*Inactive*.

Status: Disbanded on 31 May 1942.**Events:** 126**Commanders, 306th Observation Squadron**

Unknown	Feb 22-ao Dec 23	Unknown	ao Jun 32-ao Dec 34
Capt. John A. Steward	ao Dec 23-ao Sep 25	Maj. Elbert E. Wilson	ao Dec 34-23 Apr 35
Unknown	ao Sep 25-ao Feb 28	Maj. George A. Wiggs	23 Apr 35-25 Mar 38
Maj. George A. Wiggs	ao Feb 28-25 Mar 28	Capt. Russell A. Young	22 Jun 38-ao Oct 38
Unknown	25 Mar 28-ao Jun 31	Capt. Bayard B. Borden	ao Jan 38-23 Jul 39
Maj. George C. Furrow	ao Jun 31-ao Jun 32	<i>Inactive</i>	23 Jul 39-7 Dec 41

307th Observation Squadron (82nd Division)**Organized Reserve Georgia/Florida****HQ**-*Not initiated* 1921-22; Macon, GA, 1922-34; Tampa, FL, 1934-37; Chapman Field, Miami, FL, 1937-39; *Inactive* 1939-41

Constituted in the Organized Reserve on 24 June 1921 as the 307th Squadron (Observation), assigned to the 82nd Division, and allotted to the Fourth Corps Area. Initiated on 14 January 1922 at Macon, GA. Redesignated as the 307th Observation Squadron on 25 January 1923. Relieved on 21 February 1929 from assignment to the 82nd Division. Assigned on 1 October 1933 to the 331st Observation Group (XIV Corps). Relocated on 19 June 1934 to Tampa, FL. Consolidated on 24 November 1936 with the 307th Aero Squadron (Service) (a WWI unit organized in July 1918 at Camp Greene, NC; demobilized in December 1918 at Garden City, NY; reconstituted on 24 November 1936). Relocated on 1 March 1937 to Chapman Field, Miami, FL. Inactivated on 27 August 1939 at Chapman Field by relief of personnel. Conducted summer training at Maxwell Field, AL, and some years at Candler Field, Atlanta, GA. Location 7 December 1941—*Inactive*.

Status: Disbanded on 31 May 1942.

Commanders, 307th Observation Squadron

Capt. Albert M. Willcox	14 Jan 22-ao Sep 25	Capt. Charles F. Carter	5 Mar 35-24 Sep 36
Unknown	ao Sep 25-12 Mar 29	Maj. Alexis B. McMullen	ao Nov 36-7 Mar 37
Capt. Samuel H. Mapes	12 Mar 29-9 Dec 29	Maj. George W. Snow	7 Mar 37-ao Apr 38
Maj. Robert H. McDonald	9 Dec 29-ao Jun 31	Capt. Addison G. Perso	ao Dec 38-27 Aug 39
Unknown	ao Jun 31-5 Mar 35	<i>Inactive</i>	27 Aug 39-7 Dec 41

308th Observation Squadron (83rd Division)

Organized Reserve Ohio

HQ-*Not initiated* 1921-22; Norton Field, Columbus, OH, 1922-41

Constituted in the Organized Reserve on 24 June 1921 as the 308th Squadron (Observation), assigned to the 83rd Division, and allotted to the Fifth Corps Area. Initiated about June 1922 at Norton Field, Columbus, OH. Redesignated as the 308th Observation Squadron on 25 January 1923. The squadron was one of a few in the Organized Reserve that possessed facilities, equipment, and aircraft. Relieved on 21 February 1929 from assignment to the 83rd Division. Assigned on 1 October 1933 to the 317th Observation Group (XV Corps). Consolidated on 24 November 1936 with the 308th Aero Squadron (Service) (a WWI unit organized in July 1918 at Camp Greene, NC; demobilized in December 1918 at Garden City, NY; reconstituted on 24 November 1936). Conducted summer training at Wright Field, OH, or Selfridge Field, MI. Location 7 December 1941—Columbus, OH.

Status: Disbanded on 31 May 1942.

Commanders, 308th Observation Squadron

Capt. Charles J. Cleary	Jun 22-29 Sep 23	Unknown	ao Sep 30-ao Dec 31
1st Lt. William F. Centner	29 Sep 23-1 Jul 24	Maj. William F. Centner	ao Dec 31-ao Jul 36
Maj. T. P. Walker	1 Jul 24-ao Sep 24	Unknown	ao Jul 36-ao Aug 37
Unknown	ao Sep 24-ao Jun 30	Maj. William A. Cahill	ao Aug 37-Nov 37
Maj. Charles J. Cleary	ao Jun 30-ao Sep 30	Maj. James L. Zimmerman	Nov 37-ao Feb 38
	Unknown	ao Feb 38-7 Dec 41	

309th Observation Squadron (84th Division)

Organized Reserve Ohio/Indiana

HQ-*Not initiated* 1921-22; Schoen Field, Fort Benjamin Harrison, IN, 1922-41

Constituted in the Organized Reserve on 24 June 1921 as the 309th Squadron (Observation), assigned to the 84th Division, and allotted to the Fifth Corps Area. Cleveland, OH, designated as headquarters on organization, but the unit was never organized at that location. Organized on 13 November 1922 at Schoen Field, Fort Benjamin Harrison, IN. Redesignated as the 309th Observation Squadron on 25 January 1923. The squadron was one of a few in the Organized Reserve that possessed facilities, equipment, and aircraft. Squadron commander in the late 1920s was World War I ace Major H. Weir Cook. Relieved on 21 February 1929 from assignment to the 84th Division. Assigned on 1 October 1933 to the 317th Observation Group (XV Corps). Consolidated on 24 November 1936 with the 309th Aero Squadron (Service) (a WWI unit organized in July 1918 at Camp Greene, NC; demobilized in December 1918 at Garden City, NY; reconstituted on 24 November 1936). Conducted summer training at Wright Field, OH, or Selfridge Field, MI, and one year at Schoen Field, IN. Location 7 December 1941—Indianapolis, IN.

Status: Disbanded on 31 May 1942.

Commanders, 309th Observation Squadron

Maj. Harry E. Cross	13 Nov 22-ao Sep 24	Capt. George W. Vawter	ao Aug 33-ao Dec 34
Unknown	ao Sep 24-ao May 29	Unknown	ao Dec 34-ao Jul 35
Maj. H. Weir Cook	ao May 29-ao Feb 31	Maj. Charles E. Cox, Jr.	ao Jul 35-ao Jul 38
Unknown	ao Feb 31-ao Aug 33	Unknown	ao Jul 38-7 Dec 41

310th Observation Squadron (85th Division)

Organized Reserve Michigan/Illinois

HQ-Detroit, MI, 1921-32; East St. Louis, IL, 1932-36; Belleville, IL, 1936-41

Constituted in the Organized Reserve on 24 June 1921 as the 310th Squadron (Observation), assigned to the 85th Division, and allotted to the Sixth Corps Area. Initiated on 8 November 1921 at Detroit, MI. Redesignated as the 310th Observation Squadron on 25 January 1923. Relieved on 21 February 1929 from assignment to the 85th Division. Relocated on 15 January 1932 to East St. Louis, IL. Assigned on 1 October 1933 to the 332nd Observation Group (XVI Corps). Relocated by 1936 to Belleville, IL. Consolidated on 24 November 1936 with the 310th Aero Squadron (Service) (a WWI unit organized in July 1918 at Camp Greene, NC; demobilized in December 1918 at Garden City, NY; reconstituted on 24 November 1936). Conducted summer training at Wright Field, OH, or Selfridge Field, MI, and one year at Schoen Field, IN. Location 7 December 1941—Belleville, IL.

Status: Disbanded on 31 May 1942.

Commanders, 310th Observation Squadron

Capt. William A. Coleman	8 Nov 21-14 Jun 22	Maj. Myron A. Sine	30 Jun 26-9 Oct 32
1st Lt. Cabell Carrington	15 Jun 22-23 Feb 23	Maj. Michael G. Harbula	9 Oct 32-27 Feb 36
Maj. John G. Rankin	23 Feb 23-2 Jul 25	Maj. Hugh Lowery	27 Feb 36-ao Jun 39
Maj. Floyd E. Evans	2 Jul 25-30 Jun 26	Unknown	ao Jun 39-7 Dec 41

311th Observation Squadron (86th Division)

Organized Reserve Illinois

HQ-Not initiated 1921-22; Municipal Airport, Chicago, IL, 1922-41

Constituted in the Organized Reserve on 24 June 1921 as the 311th Squadron (Observation), assigned to the 86th Division, and allotted to the Sixth Corps Area. Initiated on 21 January 1922 at the Municipal Airport, Chicago, IL. Redesignated as the 311th Observation Squadron on 25 January 1923. Relieved on 21 February 1929 from assignment to the 86th Division. Assigned on 1 October 1933 to the 332nd Observation Group (XVI Corps). Consolidated on 24 November 1936 with the 311th Aero Squadron (a WWI unit organized in June 1918 at March Field, CA; redesignated as Squadron E, March Field in July 1918; demobilized in November 1918 at March Field, CA; reconstituted on 24 November 1936). Typically conducted Inactive Training Period meetings at the Municipal Airport in Chicago. Conducted summer training at Chanute Field, IL, or Selfridge Field, MI, and for year at Scott Field, IL. Location 7 December 1941—Chicago, IL.

Status: Disbanded on 31 May 1942.

Commanders, 311th Observation Squadron

Maj. George F. Lee	21 Jan 22-10 Mar 22	Unknown	ao Jun 29-ao Jun 31
Maj. Frank A. Stockdale	22 Jun 22-ao Sep 25	Capt. Nelson B. Barrett	ao Jun 31-ao Aug 31
Unknown	ao Sep 25-ao Dec 26	Unknown	ao Aug 31-ao Jun 33
Capt. George J. Brew	ao Dec 26-ao Jun 29	Maj. Carl N. Goss	ao Jun 33-ao Mar 39
	Unknown	ao Mar 39-7 Dec 41	

312th Observation Squadron (87th Division)

Organized Reserve Alabama

HQ-Not initiated 1921-22; Montgomery, AL, 1922-41

Constituted in the Organized Reserve on 24 June 1921 as the 312th Squadron (Observation), assigned to the 87th Division, and allotted to the Fourth Corps Area. Initiated in July 1922 at Montgomery, AL. Redesignated as the 312th Observation Squadron on 25 January 1923. Relieved on 21 February 1929 from assignment to the 87th Division. Assigned on 1 October 1933 to the 331st Observation Group (XIV Corps). Consolidated on 24 November 1936 with the 312th Aero Squadron (Service) (a WWI unit organized in July 1918 at Bolling Field, DC; demobilized in September 1919 at Bolling Field, DC; reconstituted on 24 November 1936). Withdrawn from allotment to the Organized Reserve on 1 January 1938 and allotted to the Regular Army as a RAI unit. Withdrawn from allotment to the Regular Army on 27 May 1938 and allotted to the Organized Reserve. Conducted summer training at Maxwell Field, AL. Also attended summer training some years as individuals at Atlanta Municipal Airport. Location 7 December 1941—Montgomery, AL.

Status: Disbanded on 31 May 1942.

Commanders, 312th Observation Squadron

Unknown	Jul 22-Apr 24	Unknown	ao Nov 28-16 Aug 36
Maj. James A. Meissner	Apr 24-22 Feb 26	Maj. William H. Beatty	16 Aug 36-Oct 36
Unknown	22 Feb 26-11 Oct 28	Maj. Eugene C. Fleming	Oct 36-23 Nov 36
Capt. Harry W. Thompson	11 Oct 28-ao Nov 28	Maj. Lloyd A. Masterson	20 Dec 36-ao Mar 38
	Unknown	ao Mar 38-7 Dec 41	

313th Observation Squadron (88th Division)

Organized Reserve Iowa/Minnesota

HQ-*Not initiated* 1921-22; Des Moines, IA, 1922-26; Sioux City, IA, 1926-31; Wold-Chamberlain Field, Minneapolis, MN, 1931-39; *Inactive* 1939-41

Constituted in the Organized Reserve on 24 June 1921 as the 313th Squadron (Observation), assigned to the 88th Division, and allotted to the Seventh Corps Area. Initiated in January 1922 at Des Moines, IA. Redesignated as the 313th Observation Squadron on 25 January 1923. Relocated on 26 May 1926 to Sioux City, IA. 1st Lt. Charles Lindburgh was a member of the squadron from June to November 1925. Relieved on 21 February 1929 from assignment to the 88th Division. Relocated on 12 October 1931 to Wold-Chamberlain Field, Minneapolis, MN. Assigned on 1 October 1933 to the 320th Observation Group (XVII Corps). Consolidated on 24 November 1936 with the 313th Aero Squadron (a WWI unit organized in July 1918 at Kelly Field, TX; demobilized in August 1919 at Kelly Field, TX; reconstituted on 24 November 1936). Conducted summer training at Marshall Field, KS, or Richards Field, MO. Inactivated on 2 October 1939 at Minneapolis by relief of personnel. Location 7 December 1941—*Inactive*.

Status: Disbanded on 31 May 1942.

Commanders, 313th Observation Squadron

1st Lt. Charles W. Baker	Jan 22-13 Sep 22	Maj. Clarence M. Young	ao May 25-ao Jun 29
Capt. Herbert O. Koehler	13 Sep 22-ao Oct 22	Capt. James O. Lewis	ao Apr 30-ao Jun 30
Unknown	ao Oct 22-ao May 25	Unknown	ao Jun 30-2 Oct 39
	<i>Inactive</i>	2 Oct 39-7 Dec 41	

314th Observation Squadron (89th Division)

Organized Reserve Nebraska

HQ-Omaha, NE, 1921-39; *Inactive* 1939-41

Constituted in the Organized Reserve on 24 June 1921 as the 314th Squadron (Observation), assigned to the 89th Division, and allotted to the Seventh Corps Area. Initiated on 19 December 1921 at Omaha, NE. The squadron was one of a few in the Organized Reserve that possessed facilities, equipment, and aircraft. The squadron's equipment was stationed at Offut Field, NE. Redesignated as the 314th Observation Squadron on 25 January 1923. Relieved on 21 February 1929 from assignment to the 89th Division. Assigned on 1 October 1933 to the 320th Observation Group (XVII Corps). Consolidated on 24 November 1936 with the 314th Aero Squadron (Service) (a WWI unit organized in July 1918 at Garden City, NY; demobilized in December 1918 at Garden City, NY; reconstituted on 24 November 1936). Attached to the provisional 7th Division (RAI) for the 1937 Fourth Army maneuver at Camp Ripley, MN. Conducted summer training at Marshall Field, KS, or Richards Field, MO. Also attended summer training some years at Camp Dodge, IA, Fort Des Moines, IA, or Camp Ripley, MN. Inactivated on 2 October 1939 at Omaha by relief of personnel. Location 7 December 1941—*Inactive*.

Status: Disbanded on 31 May 1942.

Events: 233

Commanders, 314th Observation Squadron

Capt. A. V. Wortman	19 Dec 21-ao Jan 22	Maj. Rueben L. Wagner	ao Dec 35-1 Mar 36
Maj. Charles H. Anderson	ao Sep 22-ao Sep 27	Unknown	1 Mar 36-2 Oct 39
Unknown	ao Sep 27-ao Dec 35	<i>Inactive</i>	2 Oct 39-7 Dec 41

315th Observation Squadron (90th Division)**Organized Reserve Texas****HQ**-*Not initiated* 1921-22; El Paso, TX, 1922-25; Hensley Field, Dallas, TX, 1925-41

Constituted in the Organized Reserve on 24 June 1921 as the 315th Squadron (Observation), assigned to the 90th Division, and allotted to the Eighth Corps Area. Initiated on 9 January 1922 at El Paso, TX. Redesignated as the 315th Observation Squadron on 25 January 1923. Relocated on 15 April 1925 to Hensley Field, Dallas, TX. The squadron was one of a few in the Organized Reserve that possessed facilities, equipment, and aircraft. Relieved on 21 February 1929 from assignment to the 90th Division. Assigned on 1 October 1933 to the 339th Observation Group (XVIII Corps). Consolidated on 24 November 1936 with the 315th Aero Squadron (Service) (a WWI unit organized in July 1918 at Garden City, NY; demobilized in December 1918 at Garden City, NY; reconstituted on 24 November 1936). Typically conducted Inactive Training Period meetings on Sundays at Biggs Field, Fort Bliss, TX, 1922-25, using the aircraft of the 12th Observation Squadron. Typically conducted Inactive Training Period meetings at Hensley Field 1925-41. Conducted summer training at various locations to include Brooks Field, TX, Dodd Field, TX, Love Field, TX, and Hensley Field. Supported the summer training in July-August 1940 of the 56th Cavalry Brigade at Camp Wolters, TX, and of the 36th Division at Camp Hulen, TX. Location 7 December 1941—Hensley Field, Dallas, TX.

Status: Disbanded on 31 May 1942.**Events:** 258**Commanders, 315th Observation Squadron**

Capt. Maurice U. Blumenthal	9 Jan 22-23 Feb 23	Maj. Sylvanus C. Coon	12 May 28-Jan 29
Maj. Bernard A. Law	23 Feb 23-28 Jun 23	Maj. Edgar G. Tobin	Jan 29-9 Oct 32
Capt. Maurice U. Blumenthal	29 Jun 23-ao Jun 25	Maj. Frank W. Cawthon	9 Oct 32-15 Jan 37
Maj. Alva W. Snyder	ao Dec 25-12 May 28	Maj. Leland D. Crawford	15 Jan 37-ao Aug 37
	Unknown	ao Aug 37-7 Dec 41	

316th Observation Squadron (91st Division)**Organized Reserve California****HQ**-Crissy Field, San Francisco, CA, 1921-40; *Inactive* 1940-41

Constituted in the Organized Reserve on 24 June 1921 as the 316th Squadron (Observation), assigned to the 91st Division, and allotted to the Ninth Corps Area. Initiated on 23 November 1921 at Crissy Field, San Francisco, CA. Redesignated as the 316th Observation Squadron on 25 January 1923. The squadron was one of a few in the Organized Reserve that possessed facilities, equipment, and aircraft. In January 1922 the squadron received the use of a hanger at Crissy Field and was issued five aircraft for training purposes making it the first aircraft equipped reserve squadron in the United States. Relieved on 21 February 1929 from assignment to the 91st Division. Assigned on 1 October 1933 to the 312th Observation Group (XIX Corps). Consolidated on 24 November 1936 with the 316th Aero Squadron (Service) (a WWI unit organized in July 1918 at Garden City, NY; demobilized in December 1918 at Garden City, NY; reconstituted on 24 November 1936). Conducted summer training at Del Monte, CA, Crissy Field, CA, Moffett Field, CA, or Hamilton Field, CA. Inactivated on 1 September 1940 by relief of personnel. Location 7 December 1941—*Inactive*.

Status: Disbanded on 31 May 1942.**Commanders, 316th Observation Squadron**

1st Lt. August G. Rehlmeier	23 Nov 21-Apr 22	Unknown	ao Mar 28-ao Jul 30
1st Lt. Raymond Kearney	Apr 22-Jul 22	Capt. Charles H. Kruse	ao Jul 30-18 Sep 34
Maj. Edward P. Howard	Jul 22-ao Jan 24	Maj. Frank A. Flynn	18 Sep 34-18 Jan 37
Capt. William H. Royle	ao Sep 25-Sep 27	Maj. Charles H. Kruse	18 Jan 37-ao Jul 39
Maj. Livingston G. Irving	Sep 27-1 Feb 28	Unknown	ao Jul 39-ao Jun 40
Capt. William H. Royle	1 Feb 28-ao Mar 28	Maj. Frederick E. Edwards	ao Jun 40-1 Sep 40
	<i>Inactive</i>	1 Sep 40-7 Dec 41	

319th Observation Squadron (94th Division)**Organized Reserve Massachusetts****HQ**-Framingham Airdrome, MA, 1921-23; Boston Airport, Boston, MA, 1923-41

Constituted in the Organized Reserve on 24 June 1921 as the 319th Squadron (Observation), assigned to the 94th Division, and allotted to the First Corps Area. Initiated on 4 November 1921 at Boston, MA. The squadron was one of a few in the Organized Reserve that possessed facilities, equipment, and aircraft. Stationed initially at the Framingham Airdrome. The squadron's aircraft were transferred to the Boston Airport after its opening in 1923. Redesignated as the 319th Observation Squadron on 25 January 1923. Relieved on 21 February 1929 from assignment to the 94th Division. Assigned on 1 October 1933 to the 301st Observation Group (XI Corps). Consolidated on 18 November 1936 with the 319th Aero Squadron (Service) (a WWI unit organized in July 1918 at Camp Morrison, VA; demobilized in December 1918 at Garden City, NY; reconstituted on 18 November 1936). Typically conducted Inactive Training Period meetings at the Framingham Airdrome 1922-23, then at the Boston Airport thereafter. Conducted summer training at Mitchel Field, NY. Also attended summer training some years as individuals with National Guard observation squadrons at Trumbull Field, CT, and Boston Airport. Location 7 December 1941—Boston, MA.

Status: Disbanded on 31 May 1942.

Commanders, 319th Observation Squadron

Capt. Morris E. Knight	23 Dec 21-ao Mar 22	Unknown	ao Oct 30-ao Jul 32
Maj. Arthur L. Richmond	ao Jun 22-30 Aug 26	Maj. Howard W. Nestor	ao Jul 32-ao Jun 37
Unknown	30 Aug 26-ao Jun 28	Unknown	ao Jun 37-ao Mar 39
Capt. Peter C. Boree	ao Jun 28-ao Oct 30	Capt. William R. Taplin	ao Mar 39-ao Jul 39
	Unknown	ao Jul 39-7 Dec 41	

320th Observation Squadron (95th Division)

Organized Reserve Oklahoma

HQ-Not initiated 1921-22; Hatbox Field, Muskogee, OK, 1922-25; Tulsa, OK, 1925-41

Constituted in the Organized Reserve on 24 June 1921 as the 320th Squadron (Observation), assigned to the 95th Division, and allotted to the Eighth Corps Area. Initiated on 9 December 1921 at Hatbox Field, Muskogee, OK. Redesignated as the 320th Observation Squadron on 25 January 1923. Relocated on 10 July 1925 to Tulsa, OK. Relieved on 21 February 1929 from assignment to the 95th Division. Assigned on 1 October 1933 to the 339th Observation Group (XVIII Corps). Consolidated on 24 November 1936 with the 320th Aero Squadron (Service) (a WWI unit organized in July 1918 at Camp Morrison, VA; demobilized in December 1918 at Garden City, NY; reconstituted on 24 November 1936). Conducted summer training at various locations to include Brooks Field, TX, Dodd Field, TX, Love Field, TX, and Hensley Field, TX. Location 7 December 1941—Tulsa, OK.

Status: Disbanded on 31 May 1942.

Commanders, 320th Observation Squadron

Capt. Louis D. Abney	10 Dec 21-2 Sep 22	Maj. Jackson L. Freeze	ao Jul 32-9 Oct 32
Capt. Meinard H. Kotzebue	2 Sep 22-10 Jul 25	Maj. Burdette S. Graham	9 Oct 32-9 Dec 36
Capt. Frank D. McSherry	10 Jul 25-12 May 28	Maj. William C. Lewis	9 Dec 36-ao Sep 37
Unknown	12 May 28-ao Jul 32	Unknown	ao Sep 37-7 Dec 41

321st Observation Squadron (96th Division)

Organized Reserve Oregon/California

HQ-Not initiated 1921-22; Portland, OR, 1922-41

Constituted in the Organized Reserve on 24 June 1921 as the 321st Squadron (Observation), assigned to the 96th Division, and allotted to the Ninth Corps Area. Initiated on 13 February 1922 at Portland, OR. The squadron was one of a few in the Organized Reserve that possessed facilities, equipment, and aircraft. The squadron's equipment was stationed just across the Columbia River at Pearson Field, Vancouver Barracks, WA. 1st Lt. Oakley Kelly, Air Service Reserve, a pilot who made the first non-stop transcontinental flight in 1923, was the unit instructor 1924-28. Redesignated as the 321st Observation Squadron on 25 January 1923. Relieved on 21 February 1929 from assignment to the 96th Division. Consolidated on 12 August 1933 with the 321st Aero Squadron (Service) (a WWI unit organized on 8 July 1918 at Camp Morrison, VA; demobilized on 20 December 1918 at Garden City, NY; reconstituted on 12 August 1933). Assigned on 1 October 1933 to the 312th Observation Group (XIX Corps). Typically conducted

Inactive Training Period meetings at the Chamber of Commerce Building in Portland and at Pearson Field. Conducted summer training at Pearson Field or Gray Field, WA. Location 7 December 1941—Portland, OR. (Inactivated on 30 January 1942 by relief of personnel).

Status: Disbanded on 31 May 1942.

Commanders, 321st Observation Squadron

Unknown	13 Feb 22-5 May 22	Capt. Willard J. Chamberlain	ao Jan 23-ao Aug 24
1st Lt. George Mitchell	5 May 22-ao Jun 22	Maj. Howard C. French	ao Nov 24-30 Jul 38
Unknown	ao Jun 22-ao Jan 23	Maj. G. Robert Dodson	1 Aug 38-1 Apr 41

322nd Observation Squadron (97th Division)

Organized Reserve New Hampshire and Maine

HQ-*Not initiated* 1921-22; Concord, NH, 1922-41

Constituted in the Organized Reserve on 24 June 1921 as the 322nd Squadron (Observation), assigned to the 97th Division, and allotted to the First Corps Area. Initiated, less 1st Flight, in November 1922 at Concord, NH. The 1st Flight organized at Bangor, ME. Redesignated as the 322nd Observation Squadron on 25 January 1923. Squadron conducted a fly over at Boston, MA, 27 July 1927 for Charles A. Lindbergh's homecoming parade. Relieved on 21 February 1929 from assignment to the 97th Division. Assigned on 1 October 1933 to the 301st Observation Group (XI Corps). Consolidated on 23 November 1936 with the 322nd Aero Squadron (a WWI unit organized in February 1918 at Kelly Field, TX; demobilized in February 1919 at Kelly Field, TX; reconstituted on 23 November 1936). Conducted summer training at Mitchel Field, NY. Also attended summer training some years as individuals with National Guard observation squadrons at Trumbull Field, CT, and Boston Airport. Location 7 December 1941—Concord, NH.

Status: Disbanded on 31 May 1942.

Commanders, 322nd Observation Squadron

Unknown	Nov 22-ao Jun 23	Capt. Philip W. Watson	ao Jul 27-ao Jun 31
Capt. Herman G. Partridge	ao Jun 23-ao Jun 25	Unknown	ao Jun 31-ao Jul 32
Unknown	ao Jun 25-ao Jul 27	Capt. Edward H. Holterman	Jul 32-ao Jun 39
	Unknown	ao Jun 39-7 Dec 41	

323rd Observation Squadron (98th Division)

Organized Reserve New York

HQ-Syracuse, NY, 1921-41

Constituted in the Organized Reserve on 24 June 1921 as the 323rd Squadron (Observation), assigned to the 98th Division, and allotted to the Second Corps Area. Initiated on 15 December 1921 at Syracuse, NY. Redesignated as the 323rd Observation Squadron on 25 January 1923. Conducted summer training at Mitchel Field, NY. Relieved on 21 February 1929 from assignment to the 98th Division. Assigned on 1 October 1933 to the 324th Observation Group (XII Corps). Consolidated on 24 November 1936 with the 323rd Aero Squadron (a WWI unit organized in December 1917 at Kelly Field, TX; demobilized in August 1919 at Kelly Field, TX; reconstituted on 24 November 1936). Designated mobilization station was Mitchel Field, NY. Location 7 December 1941—Syracuse, NY.

Status: Disbanded on 31 May 1942.

Commanders, 323rd Observation Squadron

2nd Lt. Morell K. Brewster	17 Dec 21-29 Dec 21	Maj. Harold A. Gallop	2 Dec 29-24 Jan 30
Maj. Allen G. Waite	29 Dec 21-14 Mar 24	Maj. Kenneth P. Littauer	24 Jan 30-2 Dec 33
Capt. Robert F. Purcell	25 Mar 24-ao Apr 26	Maj. Burdette S. Wright	18 Dec 33-19 Jun 37
Unknown	ao Apr 26-8 May 29	Maj. Milton A. Stone	19 Jun 37-6 Apr 39
Capt. Charles S. Duddleston	8 May 29-2 Dec 29	Unknown	6 Apr 39-7 Dec 41

324th Observation Squadron (99th Division)

Organized Reserve Pennsylvania

HQ-*Not initiated* 1921-22; Rogers Field, Pittsburgh, PA, 1922-39; *Inactive* 1939-41

Constituted in the Organized Reserve on 24 June 1921 as the 324th Squadron (Observation), assigned to the 99th Division, and allotted to the Third Corps Area. Initiated in January 1922 at Pittsburgh, PA. The squadron was one of a few in the Organized Reserve that possessed facilities, equipment, and aircraft. The squadron's equipment was stationed at Rogers Field in Aspinwall, PA. Redesignated as the 324th Observation Squadron on 25 January 1923. Relieved on 21 February 1929 from assignment to the 99th Division. Assigned on 1 October 1933 to the 315th Observation Group (XIII Corps). Consolidated on 23 November 1936 with the 324th Aero Squadron (a WWI unit organized in February 1918 at Kelly Field, TX; demobilized in August 1919 at Kelly Field; reconstituted on 23 November 1936). Typically conducted Inactive Training Period meetings at the William Penn Hotel in Sharpsburg, PA, and Rogers Field in Aspinwall. Conducted summer training at Langley Field, VA. Inactivated on 23 October 1939 at Pittsburgh by relief of personnel. Location 7 December 1941—*Inactive*.

Status: Disbanded on 31 May 1942.

Commanders, 324th Observation Squadron

1st Lt. Edward M. Kelley	Jan 22-ao Oct 22	Maj. Harry F. McCaffrey	22 Jul 31-Jun 32
1st Lt. Howard B. Price	ao Jul 23-ao Aug 23	Maj. Halsey R. Bazley	Jul 32-ao Sep 32
Unknown	ao Aug 23-ao May 26	Maj. John P. Morris	ao Jun 33-Apr 34
Capt. Hadley Harvey	ao May 26-27 Feb 27	Maj. Christopher J. Evans, Jr.	Apr 34-ao Jan 39
Capt. Halsey R. Bazley	27 Feb 27-29 Apr 29	1st Lt. Lester A. Carlson	ao Sep 39-23 Oct 39
Maj. Herbert Von Thaden	29 Apr 29-22 Jul 31	<i>Inactive</i>	23 Oct 39-7 Dec 41

325th Observation Squadron (100th Division)

Organized Reserve Ohio/Kentucky

HQ-Cincinnati, OH, 1921-23; Lunken Airport, Cincinnati, OH, 1923-31; Bowman Field, Louisville, KY, 1931-41

Constituted in the Organized Reserve on 24 June 1921 as the 325th Squadron (Observation), assigned to the 100th Division, and allotted to the Fifth Corps Area. Initiated on 14 December 1921 at Cincinnati, OH. Relocated in 1923 to Lunken Airport in Cincinnati. Redesignated as the 325th Observation Squadron on 25 January 1923. Relieved on 21 February 1929 from assignment to the 100th Division. Relocated in July 1931 to Bowman Field, Louisville, KY. Consolidated on 19 November 1931 with the 325th Aero Squadron (Service) (a WWI unit organized on 10 December 1917 at Kelly Field, TX.; demobilized on 19 December 1918 at Garden City, NY; reconstituted on 19 November 1931). Assigned on 1 October 1933 to the 45th Observation Group (V Corps). On 21 December 1933 the squadron assumed control of the Reserve facilities and equipment at Bowman Field previously assigned to the demobilized 465th Pursuit Squadron. As such, it was one of a few squadrons in the Organized Reserve that possessed facilities, equipment, and aircraft. Thirty-four officers and forty-three enlisted men participated as a unit in the 1936 Second Army Maneuver at Fort Knox. Conducted summer training at Godman Field, KY, Wright Field, OH, Selfridge Field, MI. Location 7 December 1941—Louisville, KY.

Status: Disbanded on 31 May 1942.

Events: 165, 213

Commanders, 325th Observation Squadron

Capt. Karl F. Burkhardt	14 Dec 21-ao Feb 24	Unknown	ao Jun 31-ao Jul 32
Unknown	ao Feb 24-ao Jun 30	Maj. Albert W. Woody	ao Jul 32-ao Oct 36
Maj. Albert A. Price	ao Jun 30-ao Jun 31	Unknown	ao Oct 36-7 Dec 41

326th Observation Squadron (101st Division)

Organized Reserve Wisconsin

HQ-*Not initiated* 1921-22; Durand, WI, 1922-27; Sheboygan, WI, 1927-33

Constituted in the Organized Reserve on 24 June 1921 as the 326th Squadron (Observation), assigned to the 101st Division, and allotted to the Sixth Corps Area. Initiated on 20 January 1922 with squadron headquarters at Durand, WI. The 1st Flight was organized at Madison, WI, and the 2nd Flight organized at Milwaukee, WI. Redesignated as the 326th Observation Squadron on 25 January 1923. Entire squadron relocated on 2 June 1925 to Sheboygan, WI. Relieved on 21 February 1929 from assignment to the 101st Division. Conducted summer training at Chanute Field, IL, and Selfridge Field, MI. Demobilized on 1 October 1933.

Commanders, 326th Observation Squadron

Lt. Col. Horace P. Orlady

20 Jan 22-ao Aug 31

Unknown

ao Aug 31-1 Oct 33

327th Observation Squadron (102nd Division)

Organized Reserve Arkansas/Missouri

HQ-Little Rock, AR, 1921-26; Pine Bluff, AR, 1926-31; St. Louis, MO 1931-39; *Inactive* 1939-41

Constituted in the Organized Reserve on 24 June 1921 as the 327th Squadron (Observation), assigned to the 102nd Division, and allotted to the Seventh Corps Area. Initiated on 17 November 1921 at Little Rock. The squadron was one of a few in the Organized Reserve that possessed facilities, equipment, and aircraft. The squadron's equipment was stationed at the Little Rock Air Intermediate Depot. Redesignated as the 327th Observation Squadron on 25 January 1923. Relocated on 11 February 1926 to Pine Bluff, AR. Conducted summer training at Marshall Field, KS, or Richards Field, MO. Relieved on 21 February 1929 from assignment to the 102nd Division. Relocated on 12 October 1931 to St. Louis, MO. Consolidated on 23 November 1936 with the 327th Aero Squadron (a WWI unit organized on 10 December 1917 at Kelly Field, TX; demobilized in August 1919 at Kelly Field, TX; reconstituted on 23 November 1936). Inactivated on 2 October 1939 at St. Louis by relief of personnel. Location 7 December 1941—*Inactive*.

Status: Disbanded on 31 May 1942.

Commanders, 327th Observation Squadron

Unknown

17 Nov 21-9 Dec 21

Unknown

ao Jan 22-2 Oct 39

Capt. F. Van P. Ellsworth

9 Dec 21-ao Jan 22

Inactive

2 Oct 39-7 Dec 41

328th Observation Squadron (103rd Division)

Organized Reserve Colorado/Texas

HQ-Denver, CO, 1921-36; Brooks Field, TX, 1936-41

Constituted in the Organized Reserve on 24 June 1921 as the 328th Squadron (Observation), assigned to the 103rd Division, and allotted to the Eighth Corps Area. Initiated on 29 November 1921 at Denver, CO. Redesignated as the 328th Observation Squadron on 25 January 1923. Relieved on 21 February 1929 from assignment to the 103rd Division. Assigned on 1 October 1933 to the 338th Observation Group (XVIII Corps). Relocated on 18 November 1936 to Brooks Field, TX. Consolidated on 21 November 1936 with the 328th Aero Squadron (a WWI unit organized on 10 December 1917 at Kelly Field, TX; demobilized in August 1919 at Kelly Field, TX; reconstituted on 21 November 1936). Withdrawn from allotment to the Organized Reserve on 1 January 1938 and allotted to the Regular Army as a RAI unit. Typically conducted Inactive Training Period meetings at the Kitteridge Building in Denver. Conducted summer training at various locations to include Biggs Field, TX, Brooks Field, TX, Dodd Field, TX, Love Field, TX, and Hensley Field, TX. Location 7 December 1941—Denver, CO.

Status: Disbanded on 31 May 1942.

Commanders, 328th Observation Squadron

Capt. C. G. Mitchell

29 Nov 21-9 Jan 22

Unknown

ao Jun 28-28 Jan 30

Maj. Richard D. Gile

9 Jan 22-Dec 24

Capt. Fred E. D'Amour

28 Jan 30-7 Jul 31

Maj. Charles W. Keene

Dec 24-ao Jun 25

Maj. Cecil G. Sellers

7 Jul 31-9 Oct 32

Capt. Rex P. Arthur

ao Jan 26-ao Mar 26

Maj. Louis G. Geisendorf

9 Oct 32-18 Nov 36

Maj. Lilburn V. Chambers

ao Nov 26-12 May 28

Lt. Col. Jack H. Lapham

18 Nov 36-10 Dec 36

Maj. Charles W. Keene

12 May 28-ao Jun 28

Maj. William C. Lewis

10 Dec 36-ao Jan 37

Unknown

ao Jan 37-7 Dec 41

329th Observation Squadron (104th Division)

Organized Reserve Utah/California

HQ-*Not initiated* 1921-22; Woodward Field, Salt Lake City, UT, 1922-37; Municipal Airport, Los Angeles, CA, 1937-41

Constituted in the Organized Reserve on 24 June 1921 as the 329th Squadron (Observation), assigned to the 104th Division, and allotted to the Ninth Corps Area. Initiated in June 1922 at Woodward Field, Salt Lake City, UT. Redesignated as the 329th Observation Squadron on 25 January 1923. Relieved on 21 February 1929 from assignment to the 104th Division. Assigned on 1 October 1933 to the 329th Observation Group (XIX Corps). Consolidated on 24 November 1936 with the 329th Aero Squadron (Service) (a WWI unit organized in July 1918 at Camp Morrison, VA; demobilized in December 1918 at Garden City, NY; reconstituted on 24 November 1936). Relocated on 14 May 1937 to the Municipal Airport, Los Angeles, CA. Withdrawn from allotment to the Organized Reserve on 1 January 1938 and allotted to the Regular Army as a RAI unit. Conducted summer training at Woodward Field. Location 7 December 1941—Municipal Airport, Los Angeles, CA.

Status: Disbanded on 31 May 1942.

Commanders, 329th Observation Squadron

Capt. La Mar Nelson	Jun 22-ao Oct 22	Maj. Doyen P. Wardwell	ao Dec 28-Jun 29
Unknown	ao Oct 22-ao Aug 25	Maj. Raymond T. Elsmore	Jun 29-1 Oct 40
Capt. Kenneth Decker	ao Aug 25-Sep 25	Maj. Frank D. McSherry	1 Oct 40-ao Feb 41
Capt. Chauncey B. Whitney	Sep 25-ao Sep 28	Unknown	ao Feb 41-7 Dec 41

330th Service Squadron (XI Corps)

Organized Reserve Massachusetts

HQ-Not initiated 1921-22; Boston Airport, Boston, MA, 1922-33

Constituted in the Organized Reserve on 15 October 1921 as Air Park No. 301, assigned to the XI Corps Air Service and allotted to the First Corps Area. Initiated on 16 December 1922 at Boston, MA. The squadron's equipment was stationed at Boston Airport. Redesignated as the 330th Service Squadron 2 July 1923. Assigned on 31 March 1924 to the 301st Observation Group (XI Corps). Demobilized on 1 October 1933.

Commanders, 330th Service Squadron

Capt. Fenk C. Smith	16 Dec 22-1 Oct 33
---------------------	--------------------

331st Service Squadron (Fourth Army)

Organized Reserve Massachusetts

HQ-Not initiated 1921-23; Holyoke, MA, 1923-33

Constituted in the Organized Reserve on 15 October 1921 as Air Park No. 331, assigned to the 301st Observation Group (Fourth Army), and allotted to the First Corps Area. Initiated 28 February 1923 at Holyoke, MA. Redesignated as the 331st Service Squadron 2 July 1923. Relieved from assignment to the 301st Observation Group (Fourth Army) on 31 March 1924 and assigned to the 307th Observation Group (Fourth Army). Demobilized on 1 October 1933.

Commanders, 331st Service Squadron

1st Lt. Burton A. Gallup	28 Feb 23-ao May 26	Unknown	ao May 26-1 Oct 33
--------------------------	---------------------	---------	--------------------

332nd Service Squadron (Second Army)

Organized Reserve New York

HQ-Not initiated 1921-22; Buffalo, NY, 1922-41

Constituted in the Organized Reserve on 15 October 1921 as Air Park No. 332, assigned to the 302nd Pursuit Group (Second Army), and allotted to the Second Corps Area. Initiated on 10 January 1922 at Buffalo, NY. Redesignated as the 332nd Service Squadron 2 July 1923. Relieved 1 October 1933 from assignment to the 302nd Pursuit Group. Consolidated on 21 November 1936 with the 332nd Aero Squadron (Supply) (a WWI unit organized in December 1917 at Kelly Field, TX; redesignated as the 670th Aero Squadron (Supply) in February 1918; demobilized in December 1918 at Camp Morrison, VA; reconstituted on 21 November 1936). Location 7 December 1941—Buffalo, NY.

Status: Disbanded on 31 May 1942.

Commanders, 332nd Service Squadron

2nd Lt. Alfred H. Bingham	10 Jan 22-6 Mar 22	Unknown	22 Sep 23-22 Sep 26
Capt. Winfield G. Crandall	6 Mar 22-17 Feb 23	Capt. Christopher O. Anderson	22 Sep 26-ao Jan 27
Maj. Joseph F. Bell	17 Feb 23-22 Sep 23	Unknown	ao Jan 27-7 Dec 41

333rd Service Squadron (Fourth Army)

Organized Reserve New York

HQ-Syracuse, NY, 1921-41

Constituted in the Organized Reserve on 15 October 1921 as Air Park No. 333, assigned to the 303rd Attack Group (Fourth Army), and allotted to the Second Corps Area. Initiated on 23 November 1921 at Syracuse, NY. Redesignated as the 333rd Service Squadron 2 July 1923. Designated mobilization station was Mitchel Field, NY. Relieved 1 October 1933 from assignment to the 303rd Attack Group. Consolidated on 21 November 1936 with the 333rd Aero Squadron (Supply) (a WWI unit organized in December 1917 at Kelly Field, TX; redesignated as the 671st Aero Squadron (Supply) in February 1918; demobilized in December 1918 at Camp Morrison, VA; reconstituted on 21 November 1936). Location 7 December 1941—Syracuse, NY.

Status: Disbanded on 31 May 1942.

Commanders, 333rd Service Squadron

1st Lt. Michael J. Casey	23 Nov 21-17 Feb 23	Unknown	ao Jun 23-28 Feb 28
Maj. Clarence G. Spencer	17 Feb 23-ao Jun 23	1st Lt. James H. Mohr	28 Feb 28-ao Mar 28
	Unknown	ao Mar 28-7 Dec 41	

334th Service Squadron (Third Army)

Organized Reserve Pennsylvania/Maryland

HQ-Franklin, PA, 1921-23; Baltimore, MD, 1923-29; *Inactive* 1929-33

Constituted in the Organized Reserve on 15 October 1921 as Air Park No. 334, assigned to the 304th Pursuit Group (Third Army), and allotted to the Third Corps Area. Initiated on 30 December 1921 at Franklin, PA. Relocated by April 1923 to Baltimore, MD. Redesignated as the 334th Service Squadron 2 July 1923. Inactivated on 23 July 1929 at Baltimore by relief of personnel. Relieved from assignment to the 304th Pursuit Group in December 1929 and assigned to the 315th Observation Group (III Corps). Demobilized on 1 October 1933.

Commanders, 334th Service Squadron

Unknown	30 Dec 21-ao Jan 24	Unknown	ao Feb 24-1 Oct 33
Capt. Robert A. Coxeter	ao Jan 24-ao Feb 24	Capt. Richard B. Clayton	ao Jun 29-23 Jul 29
	<i>Inactive</i>	23 Jul 29-1 Oct 33	

335th Service Squadron (Fifth Army)

Organized Reserve Pennsylvania/Virginia

HQ-Altoona, PA, 1921-23; Richmond, VA, 1923-39; *Inactive* 1939-41

Constituted in the Organized Reserve on 15 October 1921 as Air Park No. 335, assigned to the 305th Attack Group (Fifth Army), and allotted to the Third Corps Area. Initiated on 30 December 1921 at Altoona, PA. Relocated by April 1923 to Richmond, VA. Redesignated as the 335th Service Squadron 2 July 1923. Relieved from assignment to the 305th Attack Group (Fifth Army) and assigned to the 315th Observation Group (XIII Corps). Consolidated on 21 November 1936 with the 335th Aero Squadron (Supply) (a WWI unit organized in December 1917 at Kelly Field, TX; redesignated as the 673rd Aero Squadron (Supply) in February 1918; demobilized in December 1918 at Camp Morrison, VA; reconstituted on 21 November 1936). Inactivated about September 1939 at Richmond by relief of personnel.

Location 7 December 1941—*Inactive*.

Status: Disbanded on 31 May 1942.

Commanders, 335th Service Squadron

Unknown	30 Dec 21-ao Dec 28	Unknown	ao Feb 30-ao Jul 33
Capt. Walter J. Conaty	ao Dec 28-6 Apr 29	Maj. Lloyd O. Yost	ao Jul 33-ao Jul 34
Capt. Ivor Massey	23 Jul 29-6 Dec 30	Unknown	ao Jul 34-ao Feb 38
Maj. Smith J. DeFrance	6 Dec 30-ao Feb 30	Capt. Clifford P. Burton	ao Feb 38-Sep 39
	<i>Inactive</i>	Sep 39-7 Dec 41	

336th Service Squadron (Second Army)

Organized Reserve Ohio

HQ-*Not initiated* 1921-23; Cleveland, OH, 1923-30; *Inactive* 1930-41

Constituted in the Organized Reserve on 15 October 1921 as Air Park No. 336, assigned to the 306th Pursuit Group (Second Army), and allotted to the Fifth Corps Area. Initiated in March 1923 at Cleveland, OH. Redesignated as the 336th Service Squadron 2 July 1923. Inactivated by March 1930 at Cleveland by relief of personnel. Relieved from assignment to the 306th Pursuit Group (Second Army) on 1 October 1933 and assigned to the 317th Observation Group (XV Corps). Consolidated on 21 November 1936 with the 336th Aero Squadron (Supply) (a WWI unit organized in December 1917 at Kelly Field, TX; redesignated as the 674th Aero Squadron (Supply) in February 1918; demobilized in December 1918 at Camp Morrison, VA; reconstituted on 21 November 1936). Conducted summer training at Selfridge Field, MI. Location 7 December 1941—*Inactive*.

Status: Disbanded on 31 May 1942.

Commanders, 336th Service Squadron

Unknown	Mar 23-Mar 30	<i>Inactive</i>	Mar 30-7 Dec 41
---------	---------------	-----------------	-----------------

337th Service Squadron (Second Army)

Organized Reserve Illinois

HQ-*Not initiated* 1921-22; Chicago, IL, 1922-29; *Inactive* 1929-36; Chicago, IL, 1936-41

Constituted in the Organized Reserve on 15 October 1921 as Air Park No. 337, assigned to the 315th Observation Group (Second Army), and allotted to the Sixth Corps Area. Initiated on 21 January 1922 at Chicago, IL. Redesignated as the 337th Service Squadron 2 July 1923. Relieved from the 315th Observation Group (Second Army) on 13 June 1924 and assigned to the 317th Observation Group (Second Army). Inactivated on 1 December 1929 at Chicago by relief of personnel. Relieved from assignment to the Second Army 1 October 1933 and assigned to the 332nd Observation Group (XVI Corps). Reorganized on 15 January 1936 at Chicago. Consolidated on 21 November 1936 with the 337th Aero Squadron (Supply) (a WWI unit organized in December 1917 at Kelly Field, TX; redesignated as the 675th Aero Squadron (Supply) in February 1918; demobilized in April 1919 at San Antonio, TX; reconstituted on 21 November 1936). Typically conducted Inactive Training Period meetings at the Municipal Airport in Chicago. Designated mobilization station was Selfridge Field, MI. Location 7 December 1941—Chicago, IL.

Status: Disbanded on 31 May 1942.

Commanders, 337th Service Squadron

1st Lt. Paul C. Hessler	21 Jan 22-ao Oct 22	<i>Inactive</i>	1 Dec 29-15 Jan 36
Unknown	ao Oct 22-1 Dec 29	Maj. Louis M. Young	15 Jan 36-ao Feb 37
	Unknown	ao Feb 37-7 Dec 41	

338th Service Squadron (Fifth Army)

Organized Reserve Illinois

HQ-*Not initiated* 1921-22; Chicago, IL, 1922-41

Constituted in the Organized Reserve on 15 October 1921 as Air Park No. 338, assigned to the 308th Pursuit Group (Fifth Army), and allotted to the Sixth Corps Area. Initiated on 21 January 1922 at Chicago, IL. Redesignated as the 338th Service Squadron 2 July 1923. Designated mobilization station was Chanute Field, IL. Relieved 1 October 1933 from assignment to the 308th Pursuit Group. Consolidated on 24 November 1936 with the 338th Aero Squadron (Supply) (a WWI unit organized in July 1918 at Camp Morrison, VA; demobilized in December 1918 at Garden City, NY; reconstituted on 24 November 1936). Typically conducted Inactive Training Period meetings at the Municipal Airport in Chicago. Location 7 December 1941—Chicago, IL.

Status: Disbanded on 31 May 1942.

Commanders, 338th Service Squadron

Capt. Frederick M. Byerly	21 Jan 22-ao Jul 22	Unknown	ao Oct 22-7 Dec 41
---------------------------	---------------------	---------	--------------------

339th Service Squadron (Sixth Army)

Organized Reserve Illinois

HQ-Not initiated 1921-22; Chicago, IL, 1922-25; Peoria, IL, 1925-29; *Inactive* 1929-33

Constituted in the Organized Reserve on 15 October 1921 as Air Park No. 339, assigned to the 309th Attack Group (Sixth Army), and allotted to the Sixth Corps Area. Initiated on 21 January 1922 at Chicago, IL. Redesignated as the 339th Service Squadron 2 July 1923. Relocated on 28 July 1925 to Peoria, IL. Inactivated on 1 December 1929 at Peoria by relief of personnel. Designated mobilization station was Chanute Field, IL. Conducted summer training at Selfridge Field, MI. Demobilized on 1 October 1933.

Commanders, 339th Service Squadron

Maj. George F. Lyon	10 Mar 22-ao Jul 22	Maj. Harley W. Lake	ao Nov 29-1 Dec 29
Unknown	ao Jul 22-ao Nov 29	<i>Inactive</i>	1 Dec 29-1 Oct 33

340th Service Squadron (Sixth Army)

Organized Reserve Kansas

HQ-Not initiated 1921-23; Kansas City, KS, 1923-31; Wichita, KS, 1931-41

Constituted in the Organized Reserve on 15 October 1921 as Air Park No. 340, assigned to the 310th Pursuit Group (Sixth Army), and allotted to the Seventh Corps Area. Redesignated as the 340th Service Squadron 2 July 1923. Initiated by December 1923 at Kansas City, KS. Relocated on 21 October 1931 to Wichita, KS. Location 7 December 1941—Wichita, KS.

Status: Disbanded on 31 May 1942.

Commanders, 340th Service Squadron

Unknown	ao Dec 23-7 Dec 41
---------	--------------------

341st Service Squadron (Sixth Army)

Organized Reserve Texas/New York

HQ-Not initiated 1921-23; Galveston, TX, 1923-36; Rochester, NY, 1937-41

Constituted in the Organized Reserve on 15 October 1921 as Air Park No. 341, assigned to the 311th Pursuit Group (Sixth Army), and allotted to the Eighth Corps Area. Initiated on 12 March 1923 at Galveston, TX. The squadron was one of a few in the Organized Reserve that possessed facilities, equipment, and aircraft. The squadron's equipment was stationed at Fort Crockett U.S. Army Airdrome. Redesignated as the 341st Service Squadron 2 July 1923. Relieved from Sixth Army 13 June 1924 and assigned to the General Headquarters Reserve. Conducted summer training at Kelly Field, TX. Withdrawn from the Eighth Corps Area on 5 June 1936 and allotted to the Second Corps Area. Inactivated on 31 October 1936 at Galveston by relief of personnel. Consolidated on 24 November 1936 with the 341st Aero Squadron (Service) (a WWI unit organized in July 1918 at Camp Greene, NC; demobilized in April 1919 at Garden City, NY; reconstituted on 24 November 1936). Reorganized by April 1937 at Rochester, NY. Inactivated on 16 January 1941 at Rochester by relief of personnel. Location 7 December 1941—*Inactive*.

Status: Disbanded on 31 May 1942.

Commanders, 341st Service Squadron

1st Lt. R. E. Blankenship	12 Mar 23-ao Jan 24	Capt. William Huddleston	ao Jun 25-ao Sep 25
Unknown	ao Jan 24-ao Jun 25	Unknown	ao Sep 25-16 Jan 41
	<i>Inactive</i>	16 Jan 41-7 Dec 41	

342nd Service Squadron (Sixth Army)

Organized Reserve California

HQ-Not initiated 1921-22; Crissy Field, Presidio of San Francisco, CA, 1922-28; *Inactive* 1928-33

Constituted in the Organized Reserve on 15 October 1921 as Air Park No. 342, assigned to the 312th Observation Group (Sixth Army), and allotted to the Ninth Corps Area. Initiated on 14 February 1922 at Crissy Field, Presidio of San Francisco, CA. Redesignated as the 342nd Service Squadron 2 July 1923. Inactivated on 1 September 1928 at Crissy Field by relief of personnel. Demobilized on 1 October 1933.

Commanders, 342nd Service Squadron

2nd Lt. Lloyd M. Dudley	10 Feb 22-ao Mar 22	Unknown	ao Jan 23-1 Sep 28
1st Lt. James A. Johnston	ao Oct 22-ao Jan 23	<i>Inactive</i>	1 Sep 28-1 Oct 33

343rd Service Squadron (First Army)

Organized Reserve Massachusetts

HQ-Not initiated 1921-22; Boston, MA, 1922-29; *Inactive* 1929-41

Constituted in the Organized Reserve on 15 October 1921 as Air Park No. 343, assigned to the 315th Group (First Army), and allotted to the First Corps Area. Initiated on 10 January 1922 at Boston, MA. Stationed at Boston Airport. Redesignated as the 343rd Service Squadron 2 July 1923. Inactivated by June 1929 at Boston by relief of personnel. Location 7 December 1941—*Inactive*.

Status: Disbanded on 31 May 1942.

Commanders, 343rd Service Squadron

2nd Lt. Melvin W. Hodgden	10 Jan 22-ao Dec 22	Capt. Neil J. Cronin	ao Jul 26-ao Jul 28
Unknown	ao Dec 22-ao Jul 26	Unknown	ao Jul 28-ao Jun 29
	<i>Inactive</i>	ao Jun 29-7 Dec 41	

344th Service Squadron (First Army)

Organized Reserve New York

HQ-Not initiated 1921-22; Mineola, L.I., NY, 1922-41

Constituted in the Organized Reserve on 15 October 1921 as Air Park No. 344, assigned to the 314th Pursuit Group (First Army), and allotted to the Second Corps Area. Initiated on 10 January 1922 at Mineola, L.I., NY. Stationed at Mitchel Field. Redesignated as the 344th Service Squadron 2 July 1923. Conducted summer training at Mitchel Field, NY. Designated mobilization station was Mitchel Field, NY. Relieved from assignment to the 314th Pursuit Group (First Army) on 1 October 1933 and assigned to the 307th Observation Group (XII Corps). Consolidated on 23 November 1936 with the 344th Aero Squadron (Service) (a WWI unit organized in September 1918 at Garden City, NY; demobilized in December 1918 at Garden City, NY; reconstituted on 23 November 1936). Location 7 December 1941—Mineola, L.I., NY.

Status: Disbanded on 31 May 1942.

Commanders, 344th Service Squadron

1st Lt. Russell P. Hoyt	10 Jan 22-17 Feb 23	1st Lt. Frederick R. Bay	17 Feb 23-ao May 23
	Unknown	ao May 23-7 Dec 41	

345th Service Squadron (First Army)**Organized Reserve Pennsylvania****HQ-Not initiated** 1921-22; Harrisburg, PA, 1922-41

Constituted in the Organized Reserve on 15 October 1921 as Air Park No. 345, assigned to the 315th Observation Group (First Army), and allotted to the Third Corps Area. Initiated on 17 February 1922 at Harrisburg, PA. Redesignated as the 345th Service Squadron 2 July 1923. Consolidated on 24 November 1936 with the 345th Aero (Service) (a WWI unit organized in September 1918 at Garden City, NY; demobilized in January 1919 at Garden City, NY; reconstituted on 24 November 1936). Location 7 December 1941—Harrisburg, PA.

Status: Disbanded on 31 May 1942.**Commanders, 345th Service Squadron**

2nd Lt. Morales C. Vendig Unknown	17 Feb 22-ao Sep 22 ao Sep 22-ao Jan 24	Maj. Robert C. Disque Unknown	ao Jan 24-ao Feb 24 ao Feb 24-7 Dec 41
--------------------------------------	--	----------------------------------	---

346th Service Squadron (Second Army)**Organized Reserve Alabama****HQ-Not initiated** 1921-22; Montgomery, AL, 1922-41

Constituted in the Organized Reserve on 15 October 1921 as Air Park No. 346, assigned to the 316th Pursuit Group (Second Army), and allotted to the Fourth Corps Area. Initiated on 18 April 1922 at Montgomery, AL. Redesignated as the 346th Service Squadron 2 July 1923. Consolidated on 24 November 1936 with the 346th Aero Squadron (Service) (a WWI unit organized in September 1918 at Garden City, NY; demobilized in January 1919 at Garden City, NY; reconstituted on 24 November 1936). Withdrawn from the Organized Reserve on 1 January 1938 and allotted to the Regular Army. Designated mobilization training station was Camp Joseph E. Johnston, FL, (later redesignated Camp J. Clifford R. Foster) 1922-30 and Maxwell Field, AL, 1930-41. Location 7 December 1941—Montgomery, AL.

Status: Disbanded on 31 May 1942.**Commanders, 346th Service Squadron**

Unknown	Apr 22-7 Dec 41
---------	-----------------

347th Service Squadron (Second Army)**Organized Reserve Ohio****HQ-Not initiated** 1921-22; Dayton, OH, 1922-30; *Inactive* 1930-41

Constituted in the Organized Reserve on 15 October 1921 as Air Park No. 347, assigned to the Second Army Air Service and allotted to the Fifth Corps Area. Initiated in June 1922 at Dayton, OH. The enlisted personnel of this squadron were almost all civilian aviation mechanics employed by the Fairfield Air Intermediate Depot. Redesignated as the 347th Service Squadron 2 July 1923. Relieved from assignment to the Second Army 31 March 1924 and assigned to the 348th Bombardment Group (GHQR). Inactivated by March 1930 at Dayton by relief of personnel. Toledo, OH, designated on 21 December 1933 as headquarters on reorganization, but the unit was never reorganized at that location. Conducted summer training at Selfridge Field, MI. Location 7 December 1941—*Inactive*.

Status: Disbanded on 31 May 1942.**Commanders, 347th Service Squadron**

Unknown	Jun 22-Mar 30	<i>Inactive</i>	Mar 30-7 Dec 41
---------	---------------	-----------------	-----------------

348th Service Squadron (GHQR)**Organized Reserve Indiana****HQ-Not initiated** 1921-22; Schoen Field, Indianapolis, IN, 1922-30; *Inactive* 1930-41

Constituted in the Organized Reserve on 15 October 1921 as Air Park No. 348, assigned to the 318th Pursuit Group (GHQR), and allotted to the Fifth Corps Area. Initiated in January 1922 at Schoen Field, Indianapolis, IN. Redesignated as the 348th Service Squadron 2 July 1923. Inactivated by March 1930 at Schoen Field by relief of personnel. Location 7 December 1941—*Inactive*.

Status: Disbanded on 31 May 1942.

Commanders, 348th Service Squadron

Unknown	Jun 22-Mar 30	<i>Inactive</i>	Mar 30-7 Dec 41
---------	---------------	-----------------	-----------------

349th Service Squadron (Second Army)

Organized Reserve Illinois

HQ-*Not initiated* 1921-22; Chicago, IL, 1922-41

Constituted in the Organized Reserve on 15 October 1921 as Air Park No. 349, assigned to the 319th Attack Group (Second Army), and allotted to the Sixth Corps Area. Initiated on 21 January 1922 at Chicago, IL. Redesignated as the 349th Service Squadron 2 July 1923. Designated mobilization station was Chanute Field, IL. Relieved from assignment to the 319th Attack Group on 1 October 1933 and redesignated 349th Service Squadron, Transport Group. Consolidated on 24 November 1936 with the 349th Aero Squadron (Service) (a WWI unit organized in January 1918 at Kelly Field, TX; demobilized in January 1919 at Garden City, NY; reconstituted on 24 November 1936). Typically conducted Inactive Training Period meetings at the Municipal Airport in Chicago. Conducted summer training at Selfridge Field, MI, 1922-40. Location 7 December 1941—Chicago, IL.

Status: Disbanded on 31 May 1942.

Commanders, 349th Service Squadron

1st Lt. Leslie M. Parker	21 Jan 22-ao Jul 22	Unknown	ao Jul 22-7 Dec 41
--------------------------	---------------------	---------	--------------------

350th Service Squadron (Third Army)

Organized Reserve Oklahoma/Texas

HQ-*Not initiated* 1921-23; Tulsa, OK, 1923-25; Houston, TX, 1925-41

Constituted in the Organized Reserve on 15 October 1921 as Air Park No. 350, assigned to the 321st Attack Group (Third Army), and allotted to the Eighth Corps Area. Enid, OK, designated as headquarters on organization, but the unit was never organized at that location. Initiated on 12 May 1923 at Tulsa, OK. Redesignated as the 350th Service Squadron 2 July 1923. Relocated in 1925 to Houston, TX. Relieved from assignment to the 321st Attack Group (Third Army) on 1 October 1933 and assigned to the 339th Observation Group (XVIII Corps). Consolidated on 24 November 1936 with the 350th Aero Squadron (Service) (a WWI unit organized in January 1918 at Kelly Field, TX; demobilized in December 1918 at Garden City, NY; reconstituted on 24 November 1936). Withdrawn from the Organized Reserve on 1 January 1938 and allotted to the Regular Army. Conducted summer training at Kelly Field and Fort Crockett U.S. Army Airdrome, TX. Location 7 December 1941—Houston, TX.

Status: Disbanded on 31 May 1942.

Commanders, 350th Service Squadron

Unknown	12 May 23-7 Dec 41
---------	--------------------

351st Observation Squadron (XI Corps)

Organized Reserve Massachusetts/New York

HQ-Springfield, MA, 1921-36; *Inactive* 1936-37; Buffalo, NY, 1937-38; *Inactive* 1938-41

Constituted in the Organized Reserve on 29 July 1921 as the 351st Squadron (Observation), assigned to the XI Corps and allotted to the First Corps Area. Initiated on 16 November 1921, less 2nd Flight, at Springfield, MA. The 2nd Flight organized at Greenfield, MA. Redesignated as the 351st Observation Squadron on 25 January 1923. The 2nd Flight relocated on 28 March 1923 to Pittsfield, MA. Assigned on 31 March 1924 to the 301st Observation Group

(XI Corps). Consolidated on 24 November 1936 with the 351st Aero Squadron (Service) (a WWI unit organized in March 1918 at Waco Field, TX; demobilized in April 1919 at Mitchel Field, NY; reconstituted on 24 November 1936). Conducted summer training at Mitchel Field, NY. Withdrawn from the First Corps Area on 5 June 1936 and allotted to the Second Corps Area. Reorganized on 19 June 1937 with squadron headquarters at Buffalo, NY; Flight A at Albany, NY, and Flights B and C at Syracuse, NY. Withdrawn from the Organized Reserve on 1 January 1938 and allotted to the Regular Army. Inactivated on 3 February 1938 at Buffalo by relief of personnel. Location 7 December 1941—*Inactive*.

Commanders, 351st Observation Squadron

2nd Lt. C. L. Bond	16 Nov 21-28 Nov 21	Unknown	ao Jan 34-ao Jul 35
1st Lt. Leonard L. Stanley	28 Nov 21-ao Jan 23	Capt. Milton A. Stone	ao Jul 35-ao Oct 35
Unknown	ao Jan 23-Jan 25	Capt. William W. Batchelder	ao Feb 36-5 Jun 36
Capt. George K. Pond	Jan 25-ao Dec 28	<i>Inactive</i>	5 Jun 36-18 Jun 37
Unknown	ao Dec 28-ao Sep 33	Maj. Burdette S. Wright	18 Jun 37-3 Feb 38
Capt. Byron R. Switzer	ao Sep 33-ao Jan 34	<i>Inactive</i>	3 Feb 38-7 Dec 41

352nd Observation Squadron (XI Corps)

Organized Reserve Connecticut

HQ—*Not initiated* 1921-22; New Haven, CT, 1922-36; *Inactive* 1936-41

Constituted in the Organized Reserve on 29 July 1921 as the 352nd Squadron (Observation), assigned to the XI Corps, and allotted to the First Corps Area. Initiated in April 1922 at New Haven, CT. Redesignated as the 352nd Observation Squadron on 25 January 1923. The 1st Flight relocated on 28 March 1923 to Hartford, CT. Assigned on 31 March 1924 to the 301st Observation Group (XI Corps). Consolidated on 24 November 1936 with the 352nd Aero Squadron (a WWI unit organized in March 1918 at Waco Field, TX; demobilized in January 1919 at Garden City, NY; reconstituted on 24 November 1936). Conducted summer training at Mitchel Field, NY. Withdrawn from the First Corps Area on 5 June 1936 and allotted to the Second Corps Area. Mitchel Field, NY, designated as headquarters on reorganization, but the unit was never organized at that location. Withdrawn from the Organized Reserve on 1 January 1938 and allotted to the Regular Army. Location 7 December 1941—*Inactive*.

Commanders, 352nd Observation Squadron

1st Lt. Arthur J. Petrie	Apr 22-Aug 22	Unknown	ao Apr 25-5 Jun 36
Capt. Benjamin H. Adams	Aug 22-ao Apr 25	<i>Inactive</i>	5 Jun 36-7 Dec 41

353rd Observation Squadron (XII Corps)

Organized Reserve New York

HQ—Poughkeepsie, NY, 1921-30; *Inactive* 1930-41

Constituted in the Organized Reserve on 29 July 1921 as the 353rd Squadron (Observation), assigned to the XII Corps and allotted to the Second Corps Area. Initiated on 23 November 1921 at Poughkeepsie, NY. Redesignated as the 353rd Observation Squadron on 25 January 1923. Assigned on 31 March 1924 to the 324th Observation Group (XII Corps). Inactivated on 10 February 1930 at Poughkeepsie by relief of personnel. Relieved from assignment to the 325th Observation Group (II Corps) on 1 October 1933 and assigned to the 307th Observation Group (XII Corps). Consolidated on 24 November 1936 with the 353rd Aero Squadron (Service) (a WWI unit organized in March 1918 at Waco Field, TX; demobilized in May 1919 at Mitchel Field, NY; reconstituted on 24 November 1936). Conducted summer training at Mitchel Field, NY. Designated mobilization station was Mitchel Field, NY. Location 7 December 1941—Poughkeepsie, NY.

Commanders, 353rd Observation Squadron

2nd Lt. Leonard V. Spangberg	23 Nov 21-20 Mar 22	Capt. John M. Hayward	22 Jul 25-10 Feb 30
Maj. Gordon Reel	20 Mar 22-14 Jul 25	<i>Inactive</i>	10 Feb 30-7 Dec 41

354th Observation Squadron (XII Corps)**Organized Reserve New York****HQ**-Ithaca, NY, 1921-33; *Inactive* 1930-33

Constituted in the Organized Reserve on 29 July 1921 as the 354th Squadron (Observation), assigned to the 325th Observation Group (XII Corps), and allotted to the Second Corps Area. Initiated on 23 November 1921 at Ithaca, NY. Redesignated as the 354th Observation Squadron on 25 January 1923. Assigned on 31 March 1924 to the 324th Observation Group (XII Corps). Inactivated on 24 January 1930 at Ithaca by relief of personnel. Conducted summer training at Mitchel Field, NY. Demobilized on 1 October 1933.

Commanders, 354th Observation Squadron

Capt. Edward M. Urband	23 Nov 21-4 May 23	Unknown	ao Jun 24-15 Mar 28
Maj. John H. Kelly	4 May 23-ao Jun 23	Maj. Kenneth P. Littauer	15 Mar 28-24 Jan 30
Capt. John C. Handy	16 May 24-ao Jun 24	<i>Inactive</i>	24 Jan 30-1 Oct 33

355th Observation Squadron (XIII Corps)**Organized Reserve Pennsylvania****HQ**-Rogers Field, Pittsburgh, PA, 1921-33

Constituted in the Organized Reserve on 29 July 1921 as the 355th Squadron (Observation), assigned to the XIII Corps and allotted to the Third Corps Area. Initiated on 30 December 1921 at Pittsburgh, PA. Stationed at Rogers Field in Aspinwall, PA. Redesignated as the 355th Observation Squadron on 25 January 1923. Assigned on 31 March 1924 to the 330th Observation Group (XIII Corps). Typically conducted Inactive Training Period meetings at the William Penn Hotel in Sharpsburg, PA, and Rogers Field in Aspinwall. Conducted summer training at Langley Field, VA, 1922-33. Demobilized on 1 October 1933.

Commanders, 355th Observation Squadron

1st Lt. Howard E. Gahagan	30 Dec 21-ao Sep 22	Capt. John J. Feery	ao Jun 28-21 Jul 28
1st Lt. John E. Albert	ao Aug 23-ao Sep 23	Capt. Albert S. Barnhart	21 Jul 28-22 Apr 30
Capt. Harmar D. Denny, Jr.	ao Jan 24-ao Feb 24	Maj. Cecil G. Sellers	22 Apr 30-14 Feb 31
Unknown	ao Feb 24-ao Jun 28	Capt. Albert S. Barnhart	14 Feb 31-7 Jul 31
	Maj. Halsey R. Bazley	7 Jul 31-1 Oct 33	

356th Observation Squadron (XIII Corps)**Organized Reserve Pennsylvania****HQ**-Harrisburg, PA, 1921-29; *Inactive* 1929-33

Constituted in the Organized Reserve on 29 July 1921 as the 356th Squadron (Observation), assigned to the XIII Corps and allotted to the Third Corps Area. Initiated on 30 December 1921 at Harrisburg, PA. Redesignated as the 356th Observation Squadron on 25 January 1923. Assigned on 31 March 1924 to the 330th Observation Group (XIII Corps). Inactivated on 25 July 1929 at Harrisburg by relief of personnel. Conducted summer training at Langley Field, VA, 1922-33. Demobilized on 1 October 1933.

Commanders, 356th Observation Squadron

Capt. Fred G. Dorwart	30 Dec 21-3 Aug 27	Capt. Herbert W. Crede	23 Jul 29-25 Jul 29
Capt. Edward M. Haight	3 Aug 27-23 Jul 29	<i>Inactive</i>	25 Jul 29-1 Oct 33

357th Observation Squadron (XIV Corps)**Organized Reserve Alabama/New York****HQ**-*Not initiated* 1921-22; Birmingham, AL, 1922-36; *Inactive* 1936-41

Constituted in the Organized Reserve on 29 July 1921 as the 357th Squadron (Observation), assigned to the XIV Corps, and allotted to the Fourth Corps Area. Initiated on 18 April 1922 at Birmingham, AL. Redesignated as the 357th Observation Squadron on 25 January 1923. Assigned on 31 March 1924 to the 331st Observation Group (XIV Corps). Withdrawn from the Fourth Corps Area on 5 June 1936 and allotted to the Second Corps Area. Inactivated on 11 October 1936 at Birmingham by relief of personnel. Mitchel Field, NY, designated as headquarters on reorganization, but the unit was never organized at that location. Consolidated on 24 November 1936 with the 357th Aero Squadron

(a WWI unit organized in March 1918 at Hazelhurst Field, NY; demobilized in September 1919 at Hazelhurst Field, NY; reconstituted on 24 November 1936). Withdrawn from the Organized Reserve on 1 January 1938 and allotted to the Regular Army. Conducted summer training at Maxwell Field, AL. Also attended summer training some years as individuals at Candler Field, GA. Designated mobilization station was Camp Joseph E. Johnston, FL, (later redesignated Camp J. Clifford R. Foster) 1922-36 and Mitchel Field, NY, 1936-41. Location 7 December 1941—*Inactive*.

Commanders, 357th Observation Squadron

1st Lt. William V. Chapman	18 Apr 22-27 Jan 25	Unknown	ao Feb 25-11 Oct 36
1st Lt. James R. Bailey	27 Jan 25-ao Feb 25	<i>Inactive</i>	11 Oct 36-7 Dec 41

358th Observation Squadron (XIV Corps)

Organized Reserve South Carolina/New York

HQ—*Not initiated* 1921-22; Columbia, SC, 1922-36; *Inactive* 1936-41

Constituted in the Organized Reserve on 29 July 1921 as the 358th Squadron (Observation), assigned to the XIV Corps, and allotted to the Fourth Corps Area. Initiated on 18 April 1922 at Columbia, SC. Redesignated as the 358th Observation Squadron on 25 January 1923. Assigned on 31 March 1924 to the 331st Observation Group (XIV Corps). Withdrawn from the Fourth Corps Area on 5 June 1936 and allotted to the Second Corps Area. Inactivated on 11 October 1936 at Columbia by relief of personnel. Consolidated on 24 November 1936 with the 358th Aero Squadron (a WWI unit organized in March 1918 at Hazelhurst Field, NY; demobilized in September 1919 at Roosevelt Field, NY; reconstituted on 24 November 1936). Withdrawn from the Organized Reserve on 1 January 1938 and allotted to the Regular Army. Conducted summer training at Maxwell Field, AL. Also attended summer training some years as individuals at Candler Field, GA. Designated mobilization station was Camp Joseph E. Johnston, FL, (later redesignated Camp J. Clifford R. Foster) 1922-36 and Mitchel Field, NY, 1936-41. Location 7 December 1941—*Inactive*.

Commanders, 358th Observation Squadron

Unknown	18 Apr 22-25 Sep 22	Maj. Elbert Wilson	ao May 30-ao Sep 30
Maj. James E. Dunlap	25 Sep 22-8 May 23	Unknown	ao Sep 30-11 Oct 36
Unknown	8 May 23-ao May 30	<i>Inactive</i>	11 Oct 36-7 Dec 41

359th Observation Squadron (XV Corps)

Organized Reserve Ohio

HQ—*Not initiated* 1921-22; Akron, OH, 1922-31; Lunken Airport, Cincinnati, OH, 1931-41



Constituted in the Organized Reserve on 29 July 1921 as the 359th Squadron (Observation), assigned to the XV Corps, and allotted to the Fifth Corps Area. Initiated in April 1922 at Akron, OH. The squadron was one of a few in the Organized Reserve that possessed facilities, equipment, and aircraft. Redesignated as the 359th Observation Squadron on 25 January 1923. Assigned on 31 March 1924 to the 332nd Observation Group (XV Corps). Relocated on 9 July 1931 to Lunken Airport, Cincinnati, OH. Consolidated on 24 November 1936 with the 359th Aero Squadron (a WWI unit organized in February 1918 at Waco Field, TX; demobilized in January 1919 at Garden City, NY; reconstituted on 24 November 1936). Withdrawn from the Organized Reserve on 1 January 1938 and allotted to the Regular Army. Conducted summer training at Wright Field, OH, Schoen Field, IN, and Selfridge Field, MI. Location 7 December 1941—Cincinnati, OH.

Events: 278

Commanders, 359th Observation Squadron

2nd Lt. Leslie O. Williams	Apr 22-ao Jan 23	Maj. Dudley Outcalt	ao Sep 36-Jan 37
Unknown	ao Jan 23-ao Sep 36	Capt. John Gulledege	Jan 37-7 Dec 41

360th Observation Squadron (XV Corps)**Organized Reserve Ohio/Kentucky****HQ**-*Not initiated* 1921-22; Cincinnati, OH, 1922-30; *Inactive* 1930-41

Constituted in the Organized Reserve on 29 July 1921 as the 360th Squadron (Observation), assigned to the XV Corps and allotted to the Fifth Corps Area. Initiated in April 1922 at Cincinnati, OH. Redesignated as the 360th Observation Squadron on 25 January 1923. Assigned on 31 March 1924 to the 332nd Observation Group (XV Corps). Inactivated by March 1930 at Cincinnati by relief of personnel. Bowman Field, KY, designated on 21 December 1933 as headquarters on reorganization, but the unit was never organized at that location. Withdrawn from the Organized Reserve on 1 January 1938 and allotted to the Regular Army. Conducted summer training at Bowman Field, KY, and Selfridge Field, MI. Location 7 December 1941—*Inactive*.

Commanders, 360th Observation Squadron

1st Lt. Albert A. Price	Apr 22-ao Dec 22 <i>Inactive</i>	Unknown Mar 30-7 Dec 41	ao Dec 23-Mar 30
-------------------------	-------------------------------------	----------------------------	------------------

361st Observation Squadron (XVI Corps)**Organized Reserve Wisconsin****HQ**-*Not initiated* 1921-22; Madison, WI, 1922-29; *Inactive* 1929-33

Constituted in the Organized Reserve on 29 July 1921 as the 361st Squadron (Observation), assigned to the XVI Corps and allotted to the Sixth Corps Area. Redesignated as the 361st Observation Squadron on 25 January 1923. Assigned on 31 March 1924 to the 334th Observation Group (XVI Corps). Initiated on 22 September 1922 at Madison, WI. Inactivated on 1 December 1929 at Madison by relief of personnel. Conducted summer training at Selfridge Field, MI, and Chanute Field, IL. Designated mobilization station was Selfridge Field, MI. Demobilized on 1 October 1933.

Commanders, 361st Observation Squadron

Unknown	22 Sep 22-ao Nov 29 <i>Inactive</i>	Maj. Leslie H. Ross 1 Dec 29-1 Oct 33	ao Nov 29-1 Dec 29
---------	--	--	--------------------

362nd Observation Squadron (XVI Corps)**Organized Reserve Wisconsin****HQ**-*Not initiated* 1921-22; Racine, WI, 1922-29; *Inactive* 1929-33

Constituted in the Organized Reserve on 29 July 1921 as the 362nd Squadron (Observation), assigned to the XVI Corps and allotted to the Sixth Corps Area. Initiated on 22 September 1922 at Racine, WI. Redesignated as the 362nd Observation Squadron on 25 January 1923. Assigned on 31 March 1924 to the 334th Observation Group (XVI Corps). Inactivated on 1 December 1929 at Racine by relief of personnel. Conducted summer training at Selfridge Field, MI, and Chanute Field, IL. Designated mobilization station was Selfridge Field, MI. Demobilized on 1 October 1933.

Commanders, 362nd Observation Squadron

Unknown	22 Sep 22-ao Nov 29 <i>Inactive</i>	Capt. Clarence C. Lange 1 Dec 29-1 Oct 33	ao Nov 29-1 Dec 29
---------	--	--	--------------------

363rd Observation Squadron (XVII Corps)**Organized Reserve Nebraska/Missouri****HQ**-*Not initiated* 1921-22; Lincoln, NE, 1922-26; Hastings, NE, 1926-31; St. Joseph, MO 1931-33

Constituted in the Organized Reserve on 29 July 1921 as the 363rd Squadron (Observation), assigned to the XVII Corps and allotted to the Seventh Corps Area. Initiated in March 1922 at Lincoln, NE. Redesignated as the 363rd Observation Squadron on 25 January 1923. Assigned on 31 March 1924 to the 337th Observation Group (XVII Corps). Relocated on 26 May 1926 to Hastings, NE. Relocated on 12 October 1931 to St. Joseph, MO. Conducted summer training at Richards Field, MO. Demobilized on 1 October 1933.

Commanders, 363rd Observation Squadron

Unknown	Mar 22-ao Jul 25 Unknown	Capt. R. C. Tooke ao Sep 25-1 Oct 33	ao Jul 25-ao Sep 25
---------	-----------------------------	---	---------------------

364th Observation Squadron (XVII Corps)**Organized Reserve North Dakota/Nebraska****HQ-Not initiated** 1921-22; Fargo, ND, 1922-26; Beatrice, NE, 1926-33

Constituted in the Organized Reserve on 29 July 1921 as the 364th Squadron (Observation), assigned to the XVII Corps and allotted to the Seventh Corps Area. Initiated in April 1922 at Fargo, ND. Redesignated as the 364th Observation Squadron on 25 January 1923. Assigned on 31 March 1924 to the 337th Observation Group (XVII Corps). Relocated on 26 May 1926 to Beatrice, NE. Conducted summer training at Marshall Field, KS. Demobilized on 1 October 1933.

Commanders, 364th Observation Squadron

Unknown	Apr 22-ao Apr 26 Unknown	Capt. Homer I. Sands 26 Mar 26-1 Oct 33	ao Apr 26-26 May 26
---------	-----------------------------	--	---------------------

365th Observation Squadron (XVIII Corps)**Organized Reserve Oklahoma/Texas/New York****HQ-Not initiated** 1921-22; Oklahoma City, OK, 1922-25; Belton, TX, 1925-36; *Inactive* 1936-37; Rochester, NY, 1937-38; *Inactive* 1938-41

Constituted in the Organized Reserve on 29 July 1921 as the 365th Squadron (Observation), assigned to the XVIII Corps, and allotted to the Eighth Corps Area. Tulsa, OK, designated as headquarters on organization, but the unit was never organized at that location. Initiated in October 1922 at Oklahoma City, OK. Redesignated as the 365th Observation Squadron on 25 January 1923. Relieved from assignment to the XVIII Corps 2 July 1923 and assigned to the 338th Observation Group (VIII Corps). Relocated on 15 April 1925 to Belton, TX. Consolidated on 24 November 1936 with the 365th Aero Squadron (Depot) (a WWI unit organized in January 1918 at Chicago, IL; redesignated as the 816th Aero Squadron (Depot) in February 1918; demobilized in August 1919 at Chicago, IL; reconstituted on 24 November 1936). Withdrawn from the Eighth Corps Area on 5 June 1936 and allotted to the Second Corps Area. Concurrently relieved from the 338th Observation Group (VIII Corps) and assigned to the 339th Observation Group (XVIII Corps). Inactivated on 31 October 1936 at Belton by relief of personnel. Reorganized on 19 June 1937 at Rochester, NY. Withdrawn from allotment to the Organized Reserve on 1 January 1938 and allotted to the Regular Army as a RAI unit. Inactivated on 3 February 1938 at Rochester by relief of personnel. Conducted summer training at various locations to include Post Field, OK, Biggs Field, TX, Dodd Field, TX, Love Field, TX, and Hensley Field, TX. Supported the summer training of the 56th Cavalry Brigade in July 1936 at Camp Wolters, TX. Location 7 December 1941—*Inactive*.

Commanders, 365th Observation Squadron

Capt. Louis D. Abney	Oct 22-ao Jun 25	Maj. Claude F. Gilchrist	9 Oct 32-31 Oct 36
Unknown	ao Jun 25-ao Aug 29	<i>Inactive</i>	31 Oct 36-18 Jun 37
Capt. J. L. Neyer	ao Aug 29-ao Sep 29	Capt. Leon S. Allen	18 Jun 37-3 Feb 38
Unknown	ao Sep 29-9 Oct 32	<i>Inactive</i>	3 Feb 38-7 Dec 41

366th Observation Squadron (XVIII Corps)**Organized Reserve Texas/New York****HQ-Not initiated** 1921-22; Sweetwater, TX, 1922-25; Lampasas, TX, 1925-36; *Inactive* 1936-41

Constituted in the Organized Reserve on 29 July 1921 as the 366th Squadron (Observation), assigned to the XVIII Corps, and allotted to the Eighth Corps Area. Initiated on 16 September 1922 at Sweetwater, TX. Redesignated as the 366th Observation Squadron on 25 January 1923. Relieved from assignment to the XVIII Corps 2 July 1923 and assigned to the 338th Observation Group (VIII Corps). Relocated on 15 April 1925 to Lampasas, TX. The squadron was one of a few in the Organized Reserve that possessed facilities, equipment, and aircraft. The squadron's equipment was stationed at Love Field 1925-29 and Hensley Field 1929-36 in Dallas, TX. In addition, most of its members were Dallas and Fort Worth residents as well. Consolidated on 28 November 1936 with the 366th Aero Squadron (Depot) (a WWI unit organized in March 1918 at Fort Sill, OK; demobilized in June 1918 at Fort Sill, OK; reconstituted on 28 November 1936). Withdrawn from the Eighth Corps Area on 5 June 1936 and allotted to the Second Corps Area. Concurrently relieved from the 338th Observation Group (VIII Corps) and assigned to the 339th Observation Group (XVIII Corps). Inactivated on 31 October 1936 at Lampasas by relief of personnel. Unit allotted to the Albany District, Northern New York Reserve Area 5 April 1937, but the unit was never organized at that location. Typically

conducted Inactive Training Period meetings at Love Field and later, Hensley Field. Conducted summer training at various locations to include Post Field, OK, Biggs Field, TX, Dodd Field, TX, Love Field and Hensley Field. Location 7 December 1941—*Inactive*.

Commanders, 366th Observation Squadron			
2nd Lt. Louis Van Abernathy	16 Sep 22-ao Oct 22	Maj. Josef H. Noyes	ao Jun 26-Sep 28
Unknown	ao Oct 22-ao Jan 25	Unknown	Sep 28-9 Oct 32
1st Lt. Louis C. Geisendorf	ao Jan 25-ao Feb 25	Maj. William F. Long	9 Oct 32-31 Oct 36
Unknown	ao Feb 25-ao Jun 26	<i>Inactive</i>	31 Oct 36-7 Dec 41

367th Observation Squadron (XIX Corps)

Organized Reserve California

HQ-*Not initiated* 1921-22; Municipal Airport, Los Angeles, CA, 1922-25; Municipal Airport, Oakland, CA, 1925-37; Los Angeles, CA, 1937; *Inactive* 1937-41

Constituted in the Organized Reserve on 29 July 1921 as the 367th Squadron (Observation), assigned to the XIX Corps, and allotted to the Ninth Corps Area. Initiated on 14 February 1922 at the Los Angeles Municipal Airport, Los Angeles, CA. Redesignated as the 367th Observation Squadron on 25 January 1923. Assigned on 31 March 1924 to the 340th Observation Group (XIX Corps). The squadron was one of a few in the Organized Reserve that possessed facilities, equipment, and aircraft. Relocated in 1925 to Hangar 1-B, Oakland Municipal Airport, CA. Relieved from assignment to the 340th Observation Group (XIX Corps) on 1 October 1933 and assigned to the 329th Observation Group (XIX Corps). Consolidated on 28 November 1936 with the 367th Aero Squadron (Depot) (a WWI unit organized in January 1918 at San Francisco, CA; redesignated as the 818th Aero Squadron (Depot) in February 1918; demobilized in August 1919 at San Francisco, CA; reconstituted on 28 November 1936). Relocated on 14 May 1937 to Los Angeles, CA. Inactivated on 2 September 1937 at Los Angeles by relief of assigned personnel. Withdrawn from allotment to the Organized Reserve on 1 January 1938 and allotted to the Regular Army as a RAI unit. Typically conducted Inactive Training Period meetings at the Hotel Oakland or the Municipal Airport in Oakland. Conducted summer training at various locations to include Camp San Luis Obispo, CA, Moffatt Field, CA, Rockwell Field, CA, Crissy Field, CA, and Hamilton Field, CA. Location 7 December 1941—*Inactive*.

Status: Disbanded on 31 May 1942.

Events: 231

Commanders, 367th Observation Squadron			
Capt. Alfred J. Ralph	14 Feb 22-ao Mar 22	Unknown	ao Sep 30-ao Jun 34
Unknown	ao Mar 22-ao Jul 30	Maj. Frederic F. T. Watson	ao Jun 34-5 Mar 36
Maj. R. H. McDonald	ao Jul 30-ao Sep 30	Maj. John C. Gray	5 Mar 36-ao Aug 39
	Unknown	ao Aug 39-7 Dec 41	

368th Observation Squadron (XIX Corps)

Organized Reserve Oregon/California

HQ-*Not initiated* 1921-22; Astoria, OR, 1922-25; Berkeley, CA, 1925-29; *Inactive* 1929-33

Constituted in the Organized Reserve on 29 July 1921 as the 368th Squadron (Observation), assigned to the XIX Corps, and allotted to the Ninth Corps Area. Initiated in October 1922 at Astoria, OR. Redesignated as the 368th Observation Squadron on 25 January 1923. Assigned on 31 March 1924 to the 340th Observation Group (XIX Corps). Relocated in 1925 to Berkeley, CA. Conducted summer training at various locations to include Camp San Luis Obispo, CA, Moffatt Field, CA, Rockwell Field, CA, Crissy Field, CA, and Hamilton Field, CA. Inactivated on 20 October 1929 at Berkeley by relief of personnel. Demobilized on 1 October 1933.

Commanders, 368th Observation Squadron			
2nd Lt. George A. Anderson	Oct 22-ao Jan 23	Unknown	ao Jan 23-20 Oct 29
	<i>Inactive</i>	20 Oct 29-1 Oct 33	

369th Observation Squadron (II Corps)**Organized Reserve New York****HQ**-New Dorp, S.I., NY, 1921-41

Constituted in the Organized Reserve on 29 July 1921 as the 369th Squadron (Observation), assigned to the II Corps and allotted to the Second Corps Area. Initiated on 2 November 1921 at New Dorp, NY. The squadron's equipment was stationed at Miller Field, NY. Redesignated as the 369th Observation Squadron on 25 January 1923. Assigned on 31 March 1924 to the 325th Observation Group (II Corps). Relieved from assignment to the 325th Observation Group on 1 October 1933 and assigned to the 307th Observation Group. Consolidated on 27 November 1936 with the 369th Aero Squadron (Service) (a WWI unit organized in January 1918 at Waco Field, TX; demobilized in June 1919 at Mitchel Field, NY; reconstituted on 27 November 1936). Conducted summer training at Mitchel Field, NY. Designated mobilization station was Mitchel Field, NY. Location 7 December 1941—New Dorp, NY.

Status: Disbanded on 31 May 1942.**Commanders, 369th Observation Squadron**

Maj. Edward C. J. McShane	2 Nov 21-ao May 23	Capt. Louis V. Heilbronn	24 Apr 29-9 Dec 29
Unknown	ao May 23-8 Aug 25	Maj. Giles W. Rich	9 Dec 29-10 Feb 30
Capt. William C. Hammond	8 Aug 25-2 Oct 25	Maj. John M. Hayward	10 Feb 30-ao Nov 39
Capt. Arthur T. Clark	2 Oct 25-24 Apr 29	Unknown	ao Nov 39-7 Dec 41

370th Observation Squadron (II Corps)**Organized Reserve New York****HQ**-Mitchel Field, NY, 1921-33

Constituted in the Organized Reserve on 15 October 1921 as the 370th Squadron (Observation), assigned to the II Corps, and allotted to the Second Corps Area. Initiated on 4 November 1921 at Mitchel Field, NY. Redesignated as the 370th Observation Squadron on 25 January 1923. Assigned on 31 March 1924 to the 325th Observation Group (II Corps). Conducted summer training at Mitchel Field. Demobilized on 1 October 1933.

Commanders, 370th Observation Squadron

Capt. David W. Lewis	4 Nov 21-Apr 22	Capt. Samuel H. Mapes	21 Apr 25-29 Oct 27
Maj. Carl A. Miller	Apr 22-16 Oct 23	Capt. Michael G. Harbula	29 Oct 27-15 Mar 28
Capt. Ogden D. Budd	16 Oct 23-15 Nov 24	Capt. Philip W. Stone	15 Mar 28-29 Apr 29
Capt. Philip W. Stone	15 Nov 24-21 Apr 25	Maj. Lilburn V. Chambers	29 Apr 29-ao May 29
	Unknown	ao May 29-1 Oct 33	

371st Observation Squadron (VIII Corps)**Organized Reserve Texas****HQ**-*Not initiated* 1921-22; Brownsville, TX, 1922-33

Constituted in the Organized Reserve on 15 October 1921 as the 371st Squadron (Observation), assigned to the 339th Observation Group (VIII Corps) and allotted to the Eighth Corps Area. Initiated on 23 September 1922 at Brownsville, TX. Redesignated as the 371st Observation Squadron on 25 January 1923. Conducted summer training at Brooks Field, TX, 1922-33. Relieved from assignment to the VIII Corps 2 July 1923 and assigned to the XVIII Corps. Demobilized on 1 October 1933.

Commanders, 371st Observation Squadron

1st Lt. Frank E. Hadden	23 Sep 22-ao Jan 23	Unknown	ao Jan 23-1 Oct 33
-------------------------	---------------------	---------	--------------------

372nd Observation Squadron (IX Corps)**Organized Reserve California/Oregon****HQ**-*Not initiated* 1921-22; Crissy Field, Presidio of San Francisco, CA, 1922-30; Portland, OR, 1930-33

Constituted in the Organized Reserve on 15 October 1921 as the 372nd Squadron (Observation), assigned to the 341st Observation Group (IX Corps), and allotted to the Ninth Corps Area. Initiated on 14 February 1922 at Crissy Field, Presidio of San Francisco, CA. Redesignated as the 372nd Observation Squadron on 25 January 1923. Conducted spotter missions for the 143rd Field Artillery 9-10 February 1924 during live practice fire at Leona Heights Reservation, CA. Relieved on 21 February 1929 from the IX Corps. Relocated on 28 January 1930 to Portland, OR. Conducted summer training at Crissy Field, CA, Pearson Field, WA, and Rockwell Field, CA. Demobilized on 1 October 1933.

Commanders, 372nd Observation Squadron

Capt. Joseph S. Marriott	14 Feb 22-ao Apr 22	Unknown	ao Mar 24-ao Sep 25
Unknown	ao Apr 22-ao Feb 24	Capt. James R. Cunningham	ao Sep 25-ao Oct 25
Maj. M. G. Randell	ao Feb 24-ao Mar 24	Unknown	ao Oct 25-1 Oct 33

373rd Service Squadron (GHQR)

Organized Reserve Washington

HQ-*Not initiated* 1921-23; Bellingham, WA, 1923; Sand Point Airdrome, Seattle, WA, 1923-37; *Inactive* 1937-41

Constituted in the Organized Reserve on 15 October 1921 as Air Park No. 373, assigned to the 328th Attack Group (GHQR), and allotted to the Ninth Corps Area. Initiated in September 1923 at Bellingham, WA. Relocated in late 1923 to Sand Point Airdrome, Seattle, WA. Redesignated as the 373rd Service Squadron on 25 January 1923. Relieved from assignment to the 328th Attack Group on 31 March 1924 and assigned to the 349th Bombardment Group (GHQR). Consolidated on 27 November 1936 with the 373rd Aero Squadron (a WWI unit organized in January 1918 at Waco Field, TX; demobilized in April 1919 at Garden City, NY; reconstituted on 27 November 1936). Inactivated on 2 March 1937 at Seattle by relief of personnel. Location 7 December 1941—*Inactive*.

Status: Disbanded on 31 May 1942.

Commanders, 373rd Observation Squadron

Unknown	Sep 23-2 Mar 37	<i>Inactive</i>	2 Mar 37-7 Dec 41
---------	-----------------	-----------------	-------------------

374th Service Squadron (GHQR)

Organized Reserve California

HQ-*Not initiated* 1921-22; Los Angeles, CA, 1922-28; *Inactive* 1928-41

Constituted in the Organized Reserve on 15 October 1921 as Air Park No. 374, assigned to the 329th Observation Group (GHQR), and allotted to the Ninth Corps Area. Initiated on 14 February 1922 at Los Angeles, CA. Redesignated as the 374th Service Squadron on 25 January 1923. Relieved from assignment to the 329th Observation Group on 31 March 1924 and assigned to the 349th Bombardment Group (GHQR). Inactivated on 1 September 1928 at Los Angeles by relief of personnel. Consolidated on 27 November 1936 with the 373rd Aero Squadron (a WWI unit organized in January 1918 at Waco Field, TX; demobilized in March 1919 at Garden City, NY; reconstituted on 27 November 1936). Location 7 December 1941—*Inactive*.

Status: Disbanded on 31 May 1942.

Commanders, 374th Service Squadron

1st Lt. Albert T. Dole	14 Feb 22-ao Mar 22	Unknown	ao Mar 22-1 Sep 28
	<i>Inactive</i>	1 Sep 28-7 Dec 41	

375th Service Squadron (XII Corps)

Organized Reserve New York

HQ-Albany, NY, 1921-29; *Inactive* 1929-41

Constituted in the Organized Reserve on 15 October 1921 as Air Park No. 302, assigned to the 324th Observation Group (XII Corps), and allotted to the Second Corps Area. Initiated on 4 November 1921 at Albany, NY. Redesignated as the 375th Service Squadron on 25 January 1923. Inactivated by June 1929 at Los Angeles by relief of personnel. Designated mobilization station was Mitchel Field, NY. Consolidated on 27 November 1936 with the 375th Aero

Squadron (a WWI unit organized in January 1918 at Waco Field, TX; demobilized in June 1919 at Mitchel Field, NY; reconstituted on 27 November 1936). Conducted summer training at Mitchel Field, NY. Location 7 December 1941—*Inactive*.

Status: Disbanded on 31 May 1942.

Commanders, 375th Service Squadron

Unknown	4 Nov 21-9 Mar 22	1st Lt. Fred B. Lathrop	15 Jun 27-ao Aug 27
1st Lt. Warren E. Diefendorf	9 Mar 22-17 Feb 23	Unknown	ao Aug 27-Jun 29
1st Lt. James M. Crummey	17 Feb 23-15 Jun 27	<i>Inactive</i>	Jun 29-7 Dec 41

376th Service Squadron (XIII Corps)

Organized Reserve Pennsylvania

HQ-Rogers Field, Aspinwall, PA, 1921-29; *Inactive* 1929-33

Constituted in the Organized Reserve on 15 October 1921 as Air Park No. 303 and allotted to the Third Corps Area. Initiated on 30 December 1921 at Pittsburgh, PA. The squadron's equipment was stationed at Rogers Field in Aspinwall, PA. Redesignated as the 376th Service Squadron on 25 January 1923. Assigned on 31 March 1924 to the 330th Observation Group (XIII Corps). Inactivated on 11 March 1929 at Pittsburgh by relief of personnel. Typically conducted Inactive Training Period meetings at the William Penn Hotel in Sharpsburg, PA, and Rogers Field in Aspinwall. Demobilized on 1 October 1933.

Commanders, 376th Service Squadron

Unknown	30 Dec 21-ao Jan 24	2nd Lt. Harry B. Bunting	22 Sep 26-18 Jan 27
Capt. Christopher O. Anderson	ao Jan 24-22 Sep 26	1st Lt. John F. Hardy	18 Jan 27-11 Mar 29
	<i>Inactive</i>	11 Mar 29-1 Oct 33	

377th Service Squadron (XV Corps)

Organized Reserve Indiana/Ohio

HQ-*Not initiated* 1921-22; Hamilton, OH, 1922-25; Indianapolis, IN, 1925-30; *Inactive* 1930-41

Constituted in the Organized Reserve on 15 October 1921 as Air Park No. 305, assigned to the 332nd Observation Group (XV Corps), and allotted to the Fifth Corps Area. Initiated in April 1922 at Hamilton, OH. Relocated on 15 April 1925 to Indianapolis, IN. Redesignated as the 377th Service Squadron on 25 January 1923. Relieved from assignment to the 332nd Observation Group on 31 March 1924 and assigned to the 352nd Bombardment Group (GQHR). Inactivated by March 1930 at Indianapolis by relief of personnel. Consolidated on 27 November 1936 with the 377th Aero Squadron (a WWI unit organized in January 1918 at Waco Field, TX; demobilized in December 1918 at Garden City, NY; reconstituted on 27 November 1936). Conducted summer training at Selfridge Field, MI. Location 7 December 1941—*Inactive*.

Status: Disbanded on 31 May 1942.

Commanders, 377th Service Squadron

Unknown	Apr 22-Mar 30	<i>Inactive</i>	Mar 30-7 Dec 41
---------	---------------	-----------------	-----------------

378th Service Squadron (XVI Corps)

Organized Reserve Illinois

HQ-*Not initiated* 1921-22; Downer's Grove, IL, 1922-25; Chicago, IL, 1925-29; *Inactive* 1929-41

Constituted in the Organized Reserve on 15 October 1921 as Air Park No. 306, assigned to the 334th Observation Group (XVI Corps), and allotted to the Sixth Corps Area. Initiated on 4 May 1922 at Downer's Grove, IL. Redesignated as the 378th Service Squadron on 25 January 1923. Relocated on 28 July 1925 to Chicago, IL. Inactivated on 1 December 1929 at Chicago by relief of personnel. Consolidated on 27 November 1936 with the 378th Aero Squadron (a WWI unit organized in January 1918 at Waco Field, TX; demobilized in December 1918 at Garden City, NY; reconstituted on 27 November 1936). Location 7 December 1941—*Inactive*.

Status: Disbanded on 31 May 1942.

Commanders, 378th Service Squadron

1st Lt. Arthur L Johnson

4 May 22-ao Dec 22
Inactive

Unknown
1 Dec 29-7 Dec 41

4 May 22-1 Dec 29

379th Service Squadron (XVII Corps)

Organized Reserve Nebraska

HQ-*Not initiated* 1921-22; St. Louis, MO 1922-26; Beatrice, NE, 1926-41

Constituted in the Organized Reserve on 15 October 1921 as Air Park No. 307, assigned to the 337th Observation Group (XVI Corps), and allotted to the Seventh Corps Area. Initiated in April 1922 at St. Louis, MO. Redesignated as the 379th Service Squadron on 25 January 1923. Relocated on 26 May 1926 to Beatrice, NE. Relieved from assignment to the 337th Observation Group on 1 October 1933 and redesignated 379th Service Squadron, Attack Group. Consolidated on 28 November 1936 with the 379th Aero Squadron (a WWI unit organized in January 1918 at Taliaferro Field #3, TX; redesignated as Squadron E, Taliaferro Field in July 1918; demobilized in November 1918 at Carruthers Field, TX; reconstituted on 28 November 1936). Location 7 December 1941—Beatrice, NE.

Status: Disbanded on 31 May 1942.

Commanders, 379th Service Squadron

Unknown Apr 22-7 Dec 41

380th Service Squadron (VIII Corps)

Organized Reserve Texas/New York

HQ-*Not initiated* 1921-22; Cameron, TX, 1922-25; Waco, TX, 1925-36; *Inactive* 1936-41

Constituted in the Organized Reserve on 15 October 1921 as Air Park No. 308, assigned to the 338th Observation Group (VIII Corps), and allotted to the Eighth Corps Area. Initiated in September 1922 at Cameron, TX. Redesignated as the 380th Service Squadron on 25 January 1923. Relieved from assignment to the 338th Observation Group on 1 October 1933 and redesignated 380th Service Squadron, Observation Group. Conducted summer training at Kelly Field, TX, and Love Field, TX. Withdrawn from the Eighth Corps Area on 5 June 1936 and allotted to the Second Corps Area. Inactivated on 31 October 1936 at Waco by relief of personnel. Consolidated on 28 November 1936 with the 380th Aero Squadron (a WWI unit organized in January 1918 at Selfridge Field, MI; redesignated as Squadron B, Selfridge Field in July 1918; demobilized in November 1918 at Selfridge Field, MI; reconstituted on 31 October 1936). Allotted to the Rochester District, Northern New York Reserve Area 5 April 1937. Location 7 December 1941—*Inactive*.

Status: Disbanded on 31 May 1942.

Commanders, 380th Service Squadron

Unknown
1st Lt. Frederick Pfaff

ao Sep 22-5 Feb 23
5 Feb 23-ao Mar 23

Unknown
Inactive

ao Mar 23-31 Oct 36
31 Oct 36-7 Dec 41

381st Service Squadron (XIX Corps)

Organized Reserve Washington/California

HQ-*Not initiated* 1921-22; Bremerton, WA, 1922-25; San Francisco, CA, 1925-37; *Inactive* 1939-41

Constituted in the Organized Reserve on 15 October 1921 as Air Park No. 309 and allotted to the Ninth Corps Area. Initiated on 26 May 1922 at Bremerton, WA. Redesignated as the 381st Service Squadron on 25 January 1923. Assigned on 31 March 1924 to the 340th Observation Group (XIX Corps). Relocated by 1925 to San Francisco, CA. Squadron commander, Capt. Burdette Palmer appointed Emelia Earhart as the honorary major of the squadron on 1 July 1929. Relieved from assignment to the General Headquarters Reserve on 1 October 1933 and assigned to the 312th Observation Group (XIX Corps). Conducted summer training at Crissy Field, CA, and Rockwell Field, CA. Inactivated in June 1939 at San Francisco by relief of assigned personnel. Location 7 December 1941—*Inactive*.

Status: Disbanded on 31 May 1942.

Commanders, 381st Service Squadron

Unknown	26 May 22-ao Aug 27	Maj. George A. Smith	ao Mar 35-9 Apr 35
Maj. Burdette A. Palmer	ao Aug 27-ao May 32	Maj. Charles H. Kruse	13 Apr 35-18 Jan 37
Unknown	ao May 32-25 Feb 35	Maj. Frank A. Flynn	18 Jan 37-Jun 39
Capt. Thomas E. Atchison	25 Feb 35-ao Mar 35	<i>Inactive</i>	Jun 39-7 Dec 41

382nd Service Squadron (II Corps)

Organized Reserve New York

HQ-Mineola, L.I., NY, 1921-41

Constituted in the Organized Reserve on 15 October 1921 as Air Park No. 310, assigned to the 325th Observation Group (II Corps), and allotted to the Second Corps Area. Initiated on 4 November 1921 at Mineola, L.I., NY. Stationed at Mitchel Field. Redesignated as the 382nd Service Squadron on 25 January 1923. Relieved 1 October 1933 from assignment to the 325th Observation Group. Conducted summer training at Mitchel Field, NY. Designated mobilization station was Mitchel Field, NY. Location 7 December 1941—Mineola, L.I., NY.

Status: Disbanded on 31 May 1942.

Commanders, 382nd Service Squadron

Unknown	4 Nov 21-17 Feb 23	Maj. Leon B. Lent	17 Feb 23-ao Jun 23
	Unknown	ao Jun 23-7 Dec 41	

383rd Service Squadron (IV Corps)

Organized Reserve Tennessee

HQ-*Not initiated* 1921-22; Chattanooga, TN, 1922-29; *Inactive* 1929-41

Constituted in the Organized Reserve on 15 October 1921 as Air Park No. 311, assigned to the IV Corps and allotted to the Fourth Corps Area. Initiated on 25 April 1922 at Chattanooga, TN. Redesignated as the 383rd Service Squadron on 25 January 1923. Further assigned to the 12th Observation Group (IV Corps) on 6 February 1923. Relieved from assignment to the 12th Observation Group on 8 May 1929 and assigned to the General Headquarters Reserve. Conducted summer training at Maxwell Field, AL. Designated mobilization training station was Maxwell Field, AL. Inactivated on 23 September 1929 at Chattanooga by relief of personnel. Location 7 December 1941—*Inactive*.

Status: Disbanded on 31 May 1942.

Commanders, 383rd Service Squadron

Unknown	Apr 22-23 Sep 29	<i>Inactive</i>	23 Sep 29-7 Dec 41
---------	------------------	-----------------	--------------------

384th Service Squadron (IX Corps)

Organized Reserve California/Oregon

HQ-*Not initiated* 1921-22; Los Angeles, CA, 1922-30; Portland, OR, 1930-37; *Inactive* 1937-41

Constituted in the Organized Reserve on 15 October 1921 as Air Park No. 312, assigned to the 341st Observation Group (IX Corps), and allotted to the Ninth Corps Area. Initiated on 24 July 1922 at Los Angeles, CA. Redesignated as the 384th Service Squadron on 25 January 1923. Relieved on 1 October 1933 from assignment to the the 341st Observation Group. Inactivated by December 1937 at Portland by relief of personnel. Location 7 December 1941—*Inactive*.

Status: Disbanded on 31 May 1942.

Commanders, 384th Service Squadron

Unknown	24 Jul 22-Dec 37	<i>Inactive</i>	Dec 37-7 Dec 41
---------	------------------	-----------------	-----------------

385th Service Squadron (Third Army)**Organized Reserve California****HQ-Not initiated** 1921-22; San Diego, CA, 1922-28; *Inactive* 1928-33

Constituted in the Organized Reserve on 15 October 1921 as Air Park No. 351, assigned to the 322nd Pursuit Group (Third Army), and allotted to the Ninth Corps Area. Initiated on 21 October 1922 at San Diego, CA. Redesignated as the 385th Service Squadron on 25 January 1923. Relieved from assignment to the Third Army 31 March 1924 and assigned to the General Headquarters Reserve. Conducted summer training at Clover Field, CA. Inactivated on 1 September 1928 at San Diego by relief of personnel. Los Angeles, CA, designated on 28 January 1930 as headquarters on reorganization, but the unit was never organized at that location. Demobilized on 1 October 1933.

Commanders, 385th Service Squadron

1st Lt. Jerry Sullivan, Jr.	21 Oct 22-ao Jan 23 <i>Inactive</i>	Unknown 1 Sep 28-7 Dec 41	ao Jan 23-1 Sep 28
-----------------------------	--	------------------------------	--------------------

386th Service Squadron (GHQR)**Organized Reserve Pennsylvania****HQ-Harrisburg, PA, 1921-29; Inactive** 1929-33

Constituted in the Organized Reserve on 15 October 1921 as Air Park No. 371, assigned to the 326th Pursuit Group (GHQR), and allotted to the Third Corps Area. Initiated on 8 November 1921 at Harrisburg, PA. Redesignated as the 386th Service Squadron on 25 January 1923. Inactivated on 23 July 1929 at Harrisburg by relief of personnel. Demobilized on 1 October 1933.

Commanders, 386th Service Squadron

2nd Lt. Arthur B. Gandy	8 Nov 21-ao Oct 22	Unknown	ao Jun 26-ao Jun 29
Unknown	ao Oct 22-ao Jan 24	1st Lt. Heath A. Melton	ao Jun 29-23 Jul 29
1st Lt. George D. Shaver	ao Jan 24-ao Jun 26	<i>Inactive</i>	23 Jul 29-1 Oct 33

387th Service Squadron (GHQR)**Organized Reserve Texas****HQ-Not initiated** 1921-23; San Antonio, TX, 1923-25; Beaumont 1925-33

Constituted in the Organized Reserve on 15 October 1921 as Air Park No. 372, assigned to the 327th Pursuit Group (GHQR), and allotted to the Eighth Corps Area. Initiated on 12 March 1923 at San Antonio. Redesignated as the 387th Service Squadron on 25 January 1923. Relocated on 15 April 1925 to Beaumont, TX. Conducted summer training at Kelly Field, TX. Demobilized on 1 October 1933.

Commanders, 387th Service Squadron

Capt. Joe L. Nix	12 Mar 23-12 Apr 25	Unknown	15 Apr 25-1 Oct 33
------------------	---------------------	---------	--------------------

388th Service Squadron (XIV Corps)**Organized Reserve Georgia****HQ-Not initiated** 1921-22; Atlanta, GA, 1922-29; *Inactive* 1929-33

Constituted in the Organized Reserve on 15 October 1921 as Air Park No. 304, assigned to the 331st Observation Group and allotted to the Fourth Corps Area. Initiated on 17 April 1922 at Atlanta, GA. Stationed at Candler Field in Atlanta. Redesignated as the 388th Service Squadron on 25 January 1923. Inactivated on 23 September 1929 at Atlanta by relief of personnel. Conducted summer training at Maxwell Field, AL, 1922-29. Designated mobilization station was Camp Joseph E. Johnston, FL, (later redesignated Camp J. Clifford R. Foster). Demobilized on 1 October 1933.

Commanders, 388th Service Squadron

2nd Lt. William W. Candler	17 Apr 22-ao May 22 <i>Inactive</i>	Unknown 23 Sep 29-1 Oct 33	ao May 22-23 Sep 29
----------------------------	--	-------------------------------	---------------------

389th Service Squadron (GHQR)**Organized Reserve Maryland****HQ-Not initiated** 1924-33

Constituted in the Organized Reserve on 31 March 1924 as the 389th Service Squadron, assigned to the 347th Bombardment Group (GHQR), and allotted to the Third Corps Area. Baltimore, MD, designated as headquarters on organization, but the unit was never organized at that location. Demobilized on 1 October 1933.

390th Service Squadron (GHQR)**Organized Reserve Wisconsin****HQ-Not initiated** 1924-33

Constituted in the Organized Reserve on 31 March 1924 as the 390th Service Squadron, assigned to the 350th Bombardment Group (GHQR), and allotted to the Sixth Corps Area. Milwaukee, WI, designated as headquarters on organization, but the unit was never organized at that location. Demobilized on 1 October 1933.

391st Observation Squadron (Fourth Army)**Organized Reserve Massachusetts/New Jersey****HQ-Pittsfield, MA, 1921-36; Inactive** 1936-41

Constituted in the Organized Reserve on 15 October 1921 as the 391st Squadron (Observation), assigned to the 301st Observation Group (Fourth Army), and allotted to the First Corps Area. Initiated in November 1921 at Pittsfield, MA. Redesignated as the 391st Observation Squadron on 25 January 1923. Relieved from assignment to the 301st Observation Group (Fourth Army) on 31 March 1924 and assigned to the 307th Observation Group (Fourth Army). Withdrawn from the First Corps Area on 5 June 1936 and allotted to the Second Corps Area. Elizabeth, NJ, designated as headquarters on organization, but the unit was never organized at that location. Location 7 December 1941—*Inactive*.

Status: Disbanded on 31 May 1942.**Commanders, 391st Observation Squadron**

Capt. Ralph E. Little	Nov 21-23 Feb 23	Unknown	ao Apr 25-ao May 26
Capt. Frederick H. Andres	23 Feb 23-11 Jun 23	1st Lt. Morton H. Cassidy	ao May 26-ao Jun 26
Capt. Ralph H. Cram	11 Jun 23-ao Apr 25	Unknown	ao Jun 26-5 Jun 36
	<i>Inactive</i>	5 Jun 36-7 Dec 41	

392nd Observation Squadron (1921-23) (Fourth Army)**Organized Reserve Massachusetts/****392nd Attack Squadron (1927-41) Pennsylvania****HQ-Not initiated** 1921-22; Worcester, MA, 1922-23; *Demobilized* 1923-27; *Inactive* 1927-41

Constituted in the Organized Reserve on 15 October 1921 as the 392nd Squadron (Observation), assigned to the 301st Observation Group (Fourth Army), and allotted to the First Corps Area. Initiated, less 2nd Flight, 11 December 1922 at Worcester, MA. The 2nd Flight was organized at Fitchburg, MA. Redesignated as the 392nd Observation Squadron on 25 January 1923. Demobilized on 2 July 1923 by omission of listing in the 1923 War Department General Mobilization Plan. Reconstituted as 392nd Attack Squadron 22 June 1927 and allotted to the Third Corps Area. Withdrawn from the Third Corps Area on 28 November 1928. Location 7 December 1941—*Inactive*.

Status: Disbanded on 31 May 1942.**Commanders, 392nd Observation Squadron**

1st Lt. Frederick T. Hunt	11 Dec 22-2 Jul 23	<i>Demobilized/Inactive</i>	2 Jul 23-7 Dec 41
---------------------------	--------------------	-----------------------------	-------------------

393rd Headquarters Squadron (Fourth Army)**Organized Reserve New York****393rd Observation Squadron****HQ-Not initiated** 1921-22; Binghamton, NY, 1922-28; *Inactive* 1928-33

Constituted in the Organized Reserve on 15 October 1921 as the 393rd Squadron (Headquarters), assigned to the Fourth Army and allotted to the First Corps Area. Initiated on 23 March 1922 at Binghamton, NY. Redesignated as the 393rd Observation Squadron on 25 January 1923 and assigned to the 301st Observation Group (Fourth Army). Relieved from assignment to the 301st Observation Group (Fourth Army) on 31 March 1924 and assigned to the 307th Observation Group (Fourth Army). Inactivated on 28 July 1928 at Binghamton by relief of personnel. Demobilized on 1 October 1933.

Commanders, 393rd Observation Squadron

2nd Lt. Alfred Paganini	23 Mar 22-23 Aug 22 <i>Inactive</i>	Maj. David W. Lewis 28 Jul 28-1 Oct 33	23 Aug 22-28 Jul 28
-------------------------	--	---	---------------------

394th Pursuit Squadron (1921-23) (Fourth Army)**Organized Reserve New York****394th Headquarters Squadron (1923-33) (Fourth Army)****HHS, 394th Air Depot (1933-41)****HQ-New Dorp, S.I., NY, 1921-27; Inactive** 1921-41

Constituted in the Organized Reserve on 15 October 1921 as the 394th Squadron (Pursuit), assigned to the 302nd Pursuit Group (Fourth Army), and allotted to the Second Corps Area. Initiated on 6 December 1921 at New Dorp, S.I., NY. Redesignated as the 394th Headquarters Squadron on 25 January 1923 and relieved from the 302nd Pursuit Group. Inactivated on 11 September 1927 at New Dorp by relief of personnel. Relieved from assignment to the Fourth Army 1 October 1933 and assigned to the General Headquarters Reserve. Concurrently, reorganized and redesignated Headquarters and Headquarters Squadron, 394th Air Depot. Location 7 December 1941—*Inactive*.

Status: Disbanded on 31 May 1942.**Commanders, 394th Headquarters Squadron**

1st Lt. Miner C. Markham	6 Dec 21-23 Aug 22	Capt. Alexander M. Roberts	4 May 23-15 Jan 26
2nd Lt. Van Slyck C. Williams	23 Aug 22-4 May 23 <i>Inactive</i>	1st Lt. Robert T. Palmer 11 Sep 27-7 Dec 41	15 Jan 26-11 Sep 27

395th Pursuit Squadron (Fourth Army)**Organized Reserve New York****HQ-Syracuse, NY, 1921-33**

Constituted in the Organized Reserve on 15 October 1921 as the 395th Squadron (Pursuit), assigned to the 302nd Pursuit Group (Fourth Army), and allotted to the Second Corps Area. Initiated on 23 November 1921 at Syracuse, NY. Redesignated as the 395th Pursuit Squadron on 25 January 1923. Demobilized on 1 October 1933.

Commanders, 395th Pursuit Squadron

1st Lt. Harold O. Nevin	23 Nov 21-ao Jan 22	Unknown	ao Feb 26-27 May 29
1st Lt. Floyd J. Buffington	ao Apr 22-14 Nov 23	Maj. Liam A. Tils	27 May 29-10 Feb 30
Capt. Donald S. Poley	14 Nov 23-15 Jul 25	Maj. Giles W. Rich	10 Feb 30-2 Oct 30
Capt. Alexander M. Roberts	16 Jan 26-ao Feb 26	Maj. Robert E. Ellis	8 Oct 30-22 Sep 33

396th Pursuit Squadron (Fourth Army)**Organized Reserve New Jersey****HQ-Not initiated** 1921-22; Newark, NJ 1922-30; *Inactive* 1930-33

Constituted in the Organized Reserve on 15 October 1921 as the 396th Squadron (Pursuit), assigned to the 302nd Pursuit Group (Fourth Army), and allotted to the Second Corps Area. Initiated on 7 March 1922 at Newark, NJ. Redesignated as the 396th Pursuit Squadron on 25 January 1923. Inactivated on 8 April 1930 at Newark by relief of personnel. Conducted summer training at Mitchel Field, NY. Demobilized on 1 October 1933.

Commanders, 396th Pursuit Squadron

1st Lt. J. F. Mullen	7 Mar 22-10 Jun 22	Capt. Douglas T. Goodale	ao Aug 26-2 Dec 26
Capt. John C. Rorison	10 Jun 22-18 Aug 23	Capt. Donald Hudson	2 Dec 26-6 Apr 29
Capt. Cyrus F. Smythe	18 Aug 23-16 Jul 24	Maj. Eric T. Bradley	6 Apr 29-9 Dec 29
Capt. Rutledge B. Barry	16 Jul 24-15 May 25	Maj. Donald Hudson	9 Dec 29-8 Apr 30
Unknown	15 May 25-ao Aug 26	<i>Inactive</i>	8 Apr 30-1 Oct 33

397th Pursuit Squadron (Fourth Army)

Organized Reserve New Jersey

HQ-*Not initiated* 1921-22; Newark, NJ 1922-29; *Inactive* 1929-33

Constituted in the Organized Reserve on 15 October 1921 as the 397th Squadron (Pursuit), assigned to the 302nd Pursuit Group (Fourth Army), and allotted to the Second Corps Area. Initiated in March 1922 at Newark, NJ. Redesignated as the 397th Pursuit Squadron on 25 January 1923. Inactivated on 9 December 1929 at Newark by relief of personnel. Conducted summer training at Mitchel Field, NY. Demobilized on 1 October 1933.

Commanders, 397th Pursuit Squadron

1st Lt. T. H. Hubbard	Mar 22-ao Apr 22	Maj. Eugene F. Gillespie	26 Oct 27-20 Apr 28
Unknown	ao Apr 22-ao May 23	Capt. Leroy A. Mullen	20 Apr 28-12 Oct 28
1st Lt. Charles T. Davis	ao May 23-ao Jun 23	Maj. Cyrus F. Smythe	12 Oct 28-9 Dec 29
Unknown	ao Jun 23-26 Oct 27	<i>Inactive</i>	9 Dec 29-1 Oct 33

398th Pursuit Squadron (Fourth Army)

Organized Reserve New York

HQ-Schenectady, NY, 1921-33

Constituted in the Organized Reserve on 15 October 1921 as the 398th Squadron (Pursuit), assigned to the 302nd Pursuit Group (Fourth Army), and allotted to the Second Corps Area. Initiated on 23 November 1921 Schenectady, NY. Redesignated as the 398th Attack Squadron on 25 January 1923. Redesignated as the 398th Pursuit Squadron on 31 March 1924. Relieved from assignment to the 303rd Attack Group (Fourth Army) and assigned to the 302nd Pursuit Group (Fourth Army). Demobilized on 1 October 1933.

Commanders, 398th Attack Squadron

Capt. Linford B. Hazzard	23 Nov 21-23 Aug 22	Unknown	11 Dec 24-16 Nov 26
Capt. Hugh C. Campfield	23 Aug 22-11 Dec 24	Capt. Leroy A. Mullen	16 Nov 26-26 Oct 27
	Unknown	26 Oct 27-1 Oct 33	

399th Attack Squadron (Fourth Army)

Organized Reserve New York

HQ-New Dorp, S.I., NY, 1921-41

Constituted in the Organized Reserve on 15 October 1921 as the 399th Squadron (Attack), assigned to the 303rd Attack Group (Fourth Army), and allotted to the Second Corps Area. Initiated on 23 November 1921 at New Dorp, S.I., NY. The squadron's aircraft and equipment was stationed at Miller Field, NY. Redesignated as the 399th Attack Squadron on 25 January 1923. Conducted summer training at Mitchel Field, NY. Designated mobilization station was Mitchel Field, NY. Assigned on 1 October 1933 to the 303rd Attack Group (GHQR). Location 7 December 1941—New Dorp, S.I., NY.

Status: Disbanded on 31 May 1942.

Commanders, 399th Attack Squadron

2nd Lt. William E. Abel	23 Nov 21-17 Jan 22	Capt. Ralph L. Hartman	23 Jan 28-2 Oct 28
1st Lt. Paul C. Durbin	17 Jan 22-ao May 22	Unknown	2 Oct 28-11 Feb 29
Unknown	ao May 22-ao May 23	Capt. Rex F. Gilmartin	11 Feb 29-5 Dec 29
Capt. Horace W. Mitchell	ao May 23-ao Jun 23	Capt. William E. Du Pree	5 Dec 29-29 Mar 30
Unknown	ao Jun 23-15 Jun 25	Maj. Edward M. Urband	29 Mar 30-17 Oct 35
Maj. Gordon Reel	15 Jul 25-ao Nov 26	Capt. Vincent B. Moore	17 Oct 35-3 Feb 36
Unknown	ao Nov 26-ao Dec 27	Maj. Herbert von Thaden	3 Feb 36-7 Jul 36
Capt. Malcolm G. Spooner	ao Dec 27-23 Jan 28	Unknown	7 Jul 36-7 Dec 41

400th Attack Squadron (Fourth Army)

Organized Reserve New York

HQ-*Not initiated* 1921-22; Buffalo, NY, 1922-41

Constituted in the Organized Reserve on 15 October 1921 as the 400th Squadron (Attack), assigned to the 303rd Attack Group (Fourth Army), and allotted to the Second Corps Area. Initiated on 7 March 1922 at Buffalo, NY. Redesignated as the 400th Attack Squadron on 25 January 1923. Assigned on 1 October 1933 to the 303rd Attack Group (GHQR). Consolidated on 27 November 1936 with the 400th Aero Squadron (Construction) (a WWI unit organized in July 1917 as the 29th Provisional Aero Squadron at Fort Wood, NY; redesignated as the 400th Aero Squadron [Construction] in February 1918; demobilized in July 1919 at Camp Devens, MA; reconstituted on 27 November 1936). Conducted summer training at Mitchel Field, NY. Designated mobilization station was Mitchel Field, NY. Location 7 December 1941—Buffalo, NY.

Status: Disbanded on 31 May 1942.

Commanders, 400th Attack Squadron

2nd Lt. Lyle C. Ray	7 Mar 22-12 Jun 22	Unknown	ao May 23-17 Dec 24
1st Lt. Herbert L. Evans	12 Jun 22-ao May 23	Capt. Howard D. Norris	17 Dec 24-26 Aug 31
	Unknown	26 Aug 31-7 Dec 41	

401st Attack Squadron (Fourth Army)

Organized Reserve New York

HQ-Buffalo, NY, 1921-30; *Inactive* 1930-41

Constituted in the Organized Reserve on 15 October 1921 as the 401st Squadron (Attack), assigned to the 303rd Attack Group (Fourth Army), and allotted to the Second Corps Area. Initiated on 7 March 1922 at Buffalo, NY. Redesignated as the 401st Attack Squadron on 25 January 1923. Inactivated on 18 September 1930 at Binghamton by relief of personnel. Assigned on 1 October 1933 to the 303rd Attack Group (GHQR). Consolidated on 27 November 1936 with the 401st Aero Squadron (Construction) (a WWI unit organized in November 1917 at Vancouver Barracks, WA; redesignated as the 15th Spruce Squadron [Construction] in July 1918; demobilized in February 1919 at Vancouver Barracks; reconstituted on 27 November 1936). Conducted summer training at Mitchel Field, NY. Designated mobilization station was Mitchel Field, NY. Location 7 December 1941—*Inactive*.

Status: Disbanded on 31 May 1942.

Commanders, 401st Attack Squadron

1st Lt. Walter Geldard	7 Mar 22-2 Nov 23	Capt. George H. Durar	22 Jul 25-Aug 28
1st Durston G. Richardson	2 Nov 23-ao Jun 24	Capt. Glenn M. Pike	Aug 28-18 Sep 30
Unknown	ao Jun 24-22 Jul 25	<i>Inactive</i>	18 Sep 30-7 Dec 41

402nd Attack Squadron (Fourth Army)

Organized Reserve New York

HQ-*Not initiated* 1921-22; New Dorp, S.I., NY, 1922-27; Binghamton, NY, 1927-29; *Inactive* 1929-41

Constituted in the Organized Reserve on 15 October 1921 as the 402nd Squadron (Attack), assigned to the 303rd Attack Group (Fourth Army), and allotted to the Second Corps Area. Initiated on 7 March 1922 at New Dorp, S.I., NY. The squadron's equipment was stationed at Miller Field, NY. Relocated about 1927 to Binghamton, NY. Redesignated as the 402nd Attack Squadron on 25 January 1923. Inactivated on 5 December 1929 at Binghamton by relief of personnel. Redesignated as the 402nd Attack Squadron on 1 October 1933. Consolidated on 27 November 1936 with the 402nd Aero Squadron (Construction) (a WWI unit organized in November 1917 at Vancouver Barracks, WA; redesignated as the 16th Spruce Squadron [Construction] in July 1918; demobilized in February 1919 at Vancouver Barracks; reconstituted on 27 November 1936). Conducted summer training at Mitchel Field, NY. Designated mobilization station was Mitchel Field, NY. Location 7 December 1941—*Inactive*.

Status: Disbanded on 31 May 1942.

Commanders, 402nd Observation Squadron

Capt. David W. Lewis	7 Mar 22-23 Aug 22	Capt. Horace W. Mitchel	25 Aug 25-24 Feb 26
Capt. Linford B. Hazzard	23 Aug 22-28 Jul 23	Capt. Douglas T. Goodale	24 Feb 26-23 Jan 28
Capt. George H. Durar	28 Jul 23-22 Jul 25	Capt. Thomas F. Ward	5 Jun 28-22 Nov 28
1st Lt. Hugh Sears	15 Jul 25-25 Aug 25	Maj. Robert L. Copsy	22 Nov 28-5 Dec 29
	<i>Inactive</i>	5 Dec 29-7 Dec 41	

403rd Pursuit Squadron (Third Army)

Organized Reserve Pennsylvania/Maryland

HQ-Mercer, PA, 1921-23; Baltimore, MD, 1923-29; *Inactive* 1929-33

Constituted in the Organized Reserve on 15 October 1921 as the 403rd Squadron (Pursuit), assigned to the 304th Pursuit Group (Third Army), and allotted to the Third Corps Area. Initiated on 15 December 1921 at Mercer, PA. Relocated by April 1923 to Baltimore, MD. Inactivated on 23 July 1929 at Baltimore by relief of personnel. Redesignated as the 403rd Pursuit Squadron on 25 January 1923. Conducted summer training at Langley Field, VA, 1922-28. Demobilized on 1 October 1933.

Commanders, 403rd Pursuit Squadron

Capt. Thomas Munroe	15 Dec 21-26 Jan 22	Capt. Chester A. Snow	ao Jun 26-ao Jul 27
2nd Lt. John B. McCormick	26 Jan 22-ao Oct 22	Unknown	ao Jul 27-ao Dec 28
Unknown	ao Oct 22-ao Jan 24	Capt. Charles C. Wood	ao Dec 28-14 Jan 29
1st Lt. Walter F. Moore	ao Jan 24-ao Feb 24	Capt. John P. Morris	14 Jan 29-23 Jul 29
Unknown	ao Feb 24-ao Jun 26	<i>Inactive</i>	23 Jul 29-1 Oct 33

404th Pursuit Squadron (Third Army)

Organized Reserve Pennsylvania/Maryland

HQ-Franklin, PA, 1921-23; Baltimore, MD, 1923-40; *Inactive* 1940-41

Constituted in the Organized Reserve on 15 October 1921 as the 404th Squadron (Pursuit), assigned to the 304th Pursuit Group (Third Army), and allotted to the Third Corps Area. Initiated on 15 December 1921 at Franklin, PA. Relocated by April 1923 to Baltimore, MD. Redesignated as the 404th Pursuit Squadron on 25 January 1923. Relieved 1 October 1933 from assignment to the 304th Pursuit Group. Consolidated on 30 November 1936 with the 404th Aero Squadron (Construction) (a WWI unit organized in November 1917 at Vancouver Barracks, WA; redesignated as the 18th Spruce Squadron in July 1918; demobilized in January 1919 at Vancouver Barracks; reconstituted on 30 November 1936). Inactivated by June 1940 at Baltimore by relief of personnel. Conducted summer training at Langley Field, VA. Location 7 December 1941—*Inactive*.

Status: Disbanded on 31 May 1942.

Commanders, 404th Pursuit Squadron

2nd Lt. Clair S. Black	15 Dec 21-26 Jan 22	Unknown	ao Jul 32-ao Jul 33
Capt. Thomas Munroe	26 Jan 22-ao Oct 22	Maj. Albert S. Barnhardt	ao Jul 33-25 Jan 34
Unknown	ao Oct 22-ao Jan 24	Maj. Earl W. Hutchison	25 Jan 34-22 Sep 35
1st Lt. Otis H. Williamson	ao Jan 24-ao Feb 24	Maj. Edward M. Haight	22 Sep 35-11 Jan 36
Unknown	ao Feb 24-23 Jul 29	Unknown	11 Jan 36-ao Jun 40
Maj. Lloyd O. Yost	23 Jul 29-ao Jul 32	<i>Inactive</i>	ao Jun 40-7 Dec 41

405th Pursuit Squadron (Third Army)**Organized Reserve Pennsylvania/Maryland****HQ**-Erie, PA, 1921-23; Baltimore, MD, 1923-41

Constituted in the Organized Reserve on 15 October 1921 as the 405th Squadron (Pursuit), assigned to the 304th Pursuit Group (Third Army), and allotted to the Third Corps Area. Initiated on 15 December 1921 at Erie, PA. Redesignated as the 405th Pursuit Squadron on 25 January 1923. Relocated by April 1923 to Baltimore, MD. Relieved 1 October 1933 from assignment to the 304th Pursuit Group. Consolidated on 30 November 1936 with the 405th Aero Squadron (Construction) (a WWI unit organized in November 1917 at Vancouver Barracks, WA; redesignated as the 19th Spruce Squadron in July 1918; demobilized in February 1919 at Vancouver Barracks; reconstituted on 30 November 1936). Conducted summer training at Langley Field, VA. Location 7 December 1941—Baltimore, MD.

Status: Disbanded on 31 May 1942.**Commanders, 405th Pursuit Squadron**

2nd Lt. G. R. Oberrender	21 Dec 21-21 Apr 22	Maj. William A. Robertson	23 Jul 29-30 Jan 30
Capt. Earl E. Neubig	21 Apr 22-22 May 23	Unknown	30 Jan 30-15 Jan 31
Maj. William G. Schauffler	22 May 23-30 Oct 23	Maj. Burdette S. Wright	15 Jan 31-18 Oct 32
Capt. James A. Langston	30 Oct 23-ao Jan 24	Maj. Bernard M. Cane	18 Oct 32-3 Nov 32
Unknown	ao Jan 24-ao May 28	Unknown	3 Nov 32-25 Jan 34
Capt. Joseph E. Boudwin, Jr.	ao May 28-21 Jul 28	Maj. Edward M. Haight	25 Jan 34-17 Jan 35
Unknown	21 Jul 28-23 Jul 29	Unknown	17 Jan 35-7 Dec 41

406th Pursuit Squadron (1921-33) (Third Army)**Organized Reserve Pennsylvania/Maryland****406th Attack Squadron (1933-41)****HQ**-Altoona, PA, 1921-23; Cumberland, MD, 1923-34; Rogers Field, Pittsburgh, PA, 1934-40; *Inactive* 1940-41

Constituted in the Organized Reserve on 15 October 1921 as the 406th Squadron (Pursuit), assigned to the 304th Pursuit Group (Third Army), and allotted to the Third Corps Area. Initiated on 15 December 1921 at Altoona, PA. Relocated by April 1923 to Cumberland, MD. Redesignated as the 406th Pursuit Squadron on 25 January 1923. Reorganized and redesignated 406th Attack Squadron on 1 October 1933 and relieved from assignment to the 304th Pursuit Group. Relocated in January 1934 to Rogers Field, Pittsburgh, PA. Consolidated on 30 November 1936 with the 406th Aero Squadron (Construction) (a WWI unit organized in November 1917 at Vancouver Barracks, WA; redesignated as the 20th Spruce Squadron [Construction] in July 1918; demobilized in January 1919 at Vancouver Barracks; reconstituted on 30 November 1936). Inactivated by June 1940 at Rogers Field by relief of personnel. Typically conducted Inactive Training Period meetings at the William Penn Hotel in Sharpsburg, PA, and Rogers Field in Aspinwall. Conducted summer training at Langley Field, VA. Location 7 December 1941—*Inactive*.

Status: Disbanded on 31 May 1942.**Commanders, 406th Pursuit Squadron**

2nd Lt. Raymond E. Noble	15 Dec 21-ao Jan 22	1st Lt. Arthur C. Jones	ao Feb 25-10 Jan 29
Capt. Eugene F. Gillespie	ao Oct 22-ao Jan 23	Capt. Wayne S. Greene	23 Jul 29-19 Aug 29
Unknown	ao Jan 23-ao Jan 24	Maj. Elihu H. Kelton	19 Aug 29-25 Jan 34
1st Lt. Lee Ross	ao Jan 24-ao Feb 24	Maj. Harry R. Bazley	25 Jan 34-Jun 40
	<i>Inactive</i>	Jun 40-7 Dec 41	

407th Attack Squadron (Fifth Army)**Organized Reserve Pennsylvania/Maryland****HQ**-Ridgway, PA, 1921-23; Hagerstown, MD, 1923-29; *Inactive* 1929-41

Constituted in the Organized Reserve on 15 October 1921 as the 407th Squadron (Attack), assigned to the 305th Attack Group (Fifth Army), and allotted to the Third Corps Area. Initiated in August 1922 at Ridgway, PA. Relocated by April 1923 to Hagerstown, MD. Redesignated as the 407th Attack Squadron on 25 January 1923. Inactivated on 25 July 1929 at Hagerstown by relief of personnel. Consolidated on 5 December 1936 with the 407th Aero Squadron

(Construction) (a WWI unit organized in November 1917 at Vancouver Barracks, WA; redesignated as the 1st Spruce Squadron [Construction] in July 1918; demobilized in January 1919 at Vancouver Barracks; reconstituted on 5 December 1936). Location 7 December 1941— *Inactive*.

Status: Disbanded on 31 May 1942.

Commanders, 407th Attack Squadron

2nd Lt. George M. Wirth	Aug 22-ao Oct 22	Capt. Roy M. Walker	ao May 28-21 Jul 28
Unknown	ao Oct 22-ao Apr 23	Capt. John J. Feery	21 Jul 28-ao Aug 28
1st Lt. Otto Malomet	ao Apr 23-22 May 23	Capt. Charles C. Wood	14 Jan 29-23 Jul 29
Maj. Louis A. McAbee	22 May 23-ao Jan 24	Capt. Jesse W. Langford	23 Jul 29-25 Jul 29
Unknown	ao Jan 24-ao May 28	<i>Inactive</i>	23 Jul 29-7 Dec 41

408th Attack Squadron (Fifth Army)

Organized Reserve Pennsylvania/Maryland

HQ-Franklin, PA, 1921-23; Baltimore, MD, 1923-41

Constituted in the Organized Reserve on 15 October 1921 as the 408th Squadron (Attack), assigned to the 305th Attack Group (Fifth Army), and allotted to the Third Corps Area. Initiated on 15 December 1921 at Franklin, PA. Relocated by April 1923 to Baltimore, MD. Redesignated as the 408th Attack Squadron on 25 January 1923. Consolidated on 5 December 1936 with the 408th Aero Squadron (Construction) (a WWI unit organized in November 1917 at Vancouver Barracks, WA; redesignated as the 2nd Spruce Squadron [Construction] in July 1918; demobilized in January 1919 at Vancouver Barracks; reconstituted on 5 December 1936). Location 7 December 1941—Baltimore, MD.

Status: Disbanded on 31 May 1942.

Commanders, 408th Attack Squadron

2nd Lt. Irvin L. Clark	15 Dec 21-30 Dec 21	Maj. Eric T. Bradley	ao May 26-11 Jun 26
Capt. Harmar D. Denny, Jr.	30 Dec 21-ao Oct 22	Unknown	11 Jun 26-21 Jul 28
Unknown	ao Oct 22-ao Jan 24	Maj. Lloyd O. Yost	21 Jul 28-23 Jul 29
1st Lt. John M. Barrett	ao Jan 24-ao Feb 24	Unknown	23 Jul 29-9 May 32
Unknown	ao Feb 24-ao May 26	Maj. Herbert Von Thaden	9 May 32-3 Feb 36
	Unknown	3 Feb 36-7 Dec 41	

409th Attack Squadron (Fifth Army)

Organized Reserve Pennsylvania/District of Columbia

HQ-Erie, PA, 1921-23; Washington, DC, 1923-41

Constituted in the Organized Reserve on 15 October 1921 as the 409th Squadron (Attack), assigned to the 305th Attack Group (Fifth Army), and allotted to the Third Corps Area. Initiated on 15 December 1921 at Erie, PA. Relocated by April 1923 to Washington, DC. The squadron's equipment was stationed at Bolling Field, DC. Redesignated as the 409th Attack Squadron on 25 January 1923. Consolidated on 30 November 1936 with the 409th Aero Squadron (Construction) (a WWI unit organized in November 1917 at Vancouver Barracks, WA; redesignated as the 3rd Spruce Squadron [Construction] in July 1918; demobilized in February 1919 at Vancouver Barracks; reconstituted on 30 November 1936). Conducted summer training at Langley Field, VA. Location 7 December 1941—Washington, DC.

Status: Disbanded on 31 May 1942.

Commanders, 409th Attack Squadron

Unknown	15 Dec 21-21 Apr 22	Capt. Lawrence H. Richards	ao Jun 30-30 Dec 30
2nd Lt. Ralph W. Barnes	21 Apr 22-ao Feb 22	Capt. Eugene L. Vidal	30 Dec 30-1 Dec 31
1st Lt. William O. Jacob	ao Oct 22-ao Jan 23	Maj. Bennett A. Molter	1 Dec 31-27 Dec 32
Unknown	ao Jan 23-22 Sep 25	Maj. Chester A. Snow, Jr.	27 Dec 32-ao Jan 34
Capt. Dennis Mulligan	22 Sep 25-11 Feb 26	Maj. Roy E. Whitehead	ao Jul 34-ao Aug 36
Capt. Merrill K. Riddick	11 Feb 26-9 Jul 26	Unknown	ao Aug 36-ao Nov 37
Capt. Luke Christopher	9 Jul 26-ao Jul 28	Capt. Joseph T. Shumate	ao Nov 37-13 Dec 37
Unknown	ao Jul 28-ao Jan 30	Unknown	13 Dec 37-7 Dec 41

410th Attack Squadron (Fifth Army)**Organized Reserve Pennsylvania/Virginia****HQ**-Altoona, PA, 1921-23; Richmond, VA, 1921-29; *Inactive* 1929-41

Constituted in the Organized Reserve on 15 October 1921 as the 410th Squadron (Attack), assigned to the 305th Attack Group (Fifth Army), and allotted to the Third Corps Area. Initiated on 30 December 1921 at Altoona, PA. Relocated by April 1923 to Richmond, VA. Redesignated as the 410th Attack Squadron on 25 January 1923. Inactivated on 23 July 1929 at Richmond by relief of personnel. Consolidated on 30 November 1936 with the 410th Aero Squadron (Construction) (a WWI unit organized in November 1917 at Vancouver Barracks, WA; redesignated as the 4th Spruce Squadron [Construction] in July 1918; demobilized in January 1919 at Vancouver Barracks; reconstituted on 30 November 1936). Location 7 December 1941—*Inactive*.

Status: Disbanded on 31 May 1942.**Commanders, 410th Attack Squadron**

2nd Lt. Earl R. Snavelly	30 Dec 21-ao Jan 22	Capt. Paul R. King	ao Dec 28-2 Apr 29
2nd Lt. George C. Kelso	ao Oct 22-ao Jan 23	Capt. Chester A. Charles	2 Apr 29-10 May 29
Capt. Charles L. Clark	ao Dec 23-21 Jul 28	Capt. Earl V. Compton	10 May 29-23 Jul 29
Capt. Harold F. Mook	21 Jul 28-ao Dec 28	<i>Inactive</i>	23 Jul 29-7 Dec 41

411th Observation Squadron (Fourth Army)**Organized Reserve Pennsylvania/Virginia****HQ**-*Not initiated* 1921-22; Ridgway, PA, 1922-23; Norfolk, VA, 1923-29; *Inactive* 1929-33

Constituted in the Organized Reserve on 15 October 1921 as the 411th Squadron (Observation), assigned to the 315th Observation Group (Fifth Army), and allotted to the Third Corps Area. Initiated in June 1922 at Ridgway, PA. Relocated by April 1923 to Norfolk, VA. Redesignated as the 411th Observation Squadron on 25 January 1923. Inactivated on 25 July 1929 at Norfolk by relief of personnel. Conducted summer training at Langley Field, VA. Demobilized on 1 October 1933.

Commanders, 411th Observation Squadron

1st Lt. Albert S. Barnhart	Jun 22-ao Oct 22	Unknown	ao Jan 26-ao Jun 29
Unknown	ao Oct 22-ao Dec 23	Capt. Ivor Massey	ao Jun 29-23 Jul 29
1st Lt. William D. Brown	ao Dec 23-ao Jun 26	Capt. Franklin P. Whitehurst	23 Jul 29-25 Jul 29
	<i>Inactive</i>	23 Jul 29-1 Oct 33	

412th Observation Squadron (Fourth Army)**Organized Reserve Mississippi****HQ**-*Not initiated* 1921-22; High Point, MS, 1922-29; *Inactive* 1929-41

Constituted in the Organized Reserve on 15 October 1921 as the 412th Squadron (Observation), assigned to the 307th Observation Group (Fifth Army), and allotted to the Fourth Corps Area. Initiated on 17 April 1922 at High Point, MS. Redesignated as the 412th Observation Squadron on 25 January 1923. Relieved from the 307th Observation Group (Fifth Army) on 31 March 1924 and assigned to the 315th Observation Group (Fifth Army). Inactivated on 19 September 1929 at High Point by relief of personnel. Consolidated on 28 November 1936 with the 412th Aero Squadron (Construction) (a WWI unit organized in November 1917 at Vancouver Barracks, WA; redesignated as the 6th Spruce Squadron in July 1918; demobilized in February 1919 at Vancouver Barracks; reconstituted on 28 November 1936). Withdrawn from the Organized Reserve on 1 January 1938 and allotted to the Regular Army as a RAI unit. Conducted summer training at Maxwell Field, AL. Designated mobilization training station was Camp Joseph E. Johnston, FL, (later redesignated Camp J. Clifford R. Foster) 1922-30 and Maxwell Field, AL, 1930-41. Location 7 December 1941—*Inactive*.

Status: Disbanded on 31 May 1942.**Commanders, 412th Observation Squadron**

Capt. Edwin Burge	17 Apr 22-ao May 22	Unknown	ao May 22-12 Sep 29
	<i>Inactive</i>	12 Sep 29-7 Dec 41	

413th Headquarters Squadron (Second Army)**Organized Reserve West Virginia****HQ-***Not initiated* 1921-22; Boone, WV 1922-28; *Inactive* 1928-41

Constituted in the Organized Reserve on 15 October 1921 as the 413th Squadron (Headquarters), assigned to the Second Army and allotted to the Fifth Corps Area. Initiated in April 1922 at Boone, WV. Redesignated as the 413th Headquarters Squadron on 25 January 1923. Inactivated on 6 October 1928 at Boone by relief of personnel. Concurrently withdrawn from the Fifth Corps Area. Location 7 December 1941—*Inactive*.

Status: Disbanded on 31 May 1942.**Commanders, 413th Headquarters Squadron**

1st Lt. John W. Cummins	Apr 22-Sep 22	Unknown	ao Jan 23-6 Oct 28
Capt. Thomas B. Lyons	Sep 22-ao Jan 23	<i>Inactive</i>	6 Oct 28-7 Dec 41

414th Pursuit Squadron (Second Army)**Organized Reserve Ohio****HQ-***Not initiated* 1921-22; Cleveland Airport, OH, 1922-37; *Inactive* 1937-41

Constituted in the Organized Reserve on 15 October 1921 as the 414th Squadron (Pursuit), assigned to the 306th Pursuit Group (Second Army), and allotted to the Fifth Corps Area. Initiated in March 1922 at Cleveland, OH. Redesignated as the 414th Pursuit Squadron on 25 January 1923. Consolidated on 28 November 1936 with the 414th Aero Squadron (Construction) (a WWI unit organized in November 1917 at Vancouver Barracks, WA; redesignated as the 102nd Spruce Squadron in July 1918; demobilized in January 1919 at Vancouver Barracks; reconstituted on 28 November 1936). Inactivated about June 1937 at Cleveland by relief of personnel. Typically conducted Inactive Training Period meetings at the Cleveland Grays Armory or at the Dungan Airways hanger at the Cleveland Airport. Conducted summer training at Wright Field, OH, or Selfridge Field, MI, and some years at Schoen Field, IN. Location 7 December 1941—*Inactive*.

Status: Disbanded on 31 May 1942.**Commanders, 414th Pursuit Squadron**

Unknown	Mar 22-11 Aug 22	Unknown	ao Jan 25-25 Apr 30
Maj. William F. Long	11 Aug 22-12 Sep 24	Maj. James B. McCalley	25 Apr 30-Jun 37
Capt. John M. Joyce	12 Sep 24- ao Jan 25	<i>Inactive</i>	Jun 37-7 Dec 41

415th Observation Squadron (Fourth Army)**Organized Reserve Ohio****HQ-***Not initiated* 1921-22; Toledo, OH, 1922-33

Constituted in the Organized Reserve on 15 October 1921 as the 415th Squadron (Pursuit), assigned to the 306th Pursuit Group (Second Army), and allotted to the Fifth Corps Area. Initiated in March 1922 at Toledo, OH. Redesignated as the 415th Pursuit Squadron on 25 January 1923. Conducted summer training at Selfridge Field, MI, and some years at Schoen Field, IN. Demobilized on 1 October 1933.

Commanders, 415th Pursuit Squadron

Unknown	Mar 22-1 Oct 33
---------	-----------------

416th Pursuit Squadron (Fourth Army)**Organized Reserve Ohio****HQ-***Not initiated* 1921-22; Norton Field, Columbus, OH, 1922-33

Constituted in the Organized Reserve on 15 October 1921 as the 416th Squadron (Pursuit), assigned to the 306th Pursuit Group (Second Army), and allotted to the Fifth Corps Area. Initiated in March 1922 at Columbus, OH. Redesignated as the 416th Pursuit Squadron on 25 January 1923. Stationed at Norton Field by 1923. Conducted summer training at Selfridge Field, MI, and some years at Schoen Field, IN. Demobilized on 1 October 1933.

Commanders, 416th Pursuit Squadron

Unknown	Mar 22-27 Apr 23 Unknown	Capt. John E. Davis ao May 23-1 Oct 33	27 Apr 23-ao May 23
---------	-----------------------------	---	---------------------

417th Pursuit Squadron (Fourth Army)

Organized Reserve Ohio

HQ-Not initiated 1921-22; Lunken Field, Cincinnati, OH, 1922-33

Constituted in the Organized Reserve on 15 October 1921 as the 416th Squadron (Pursuit), assigned to the 306th Pursuit Group (Second Army), and allotted to the Fifth Corps Area. Initiated in January 1922 at Cincinnati, OH. Redesignated as the 416th Pursuit Squadron on 25 January 1923. Stationed at Lunken Field by 1925. Conducted summer training at Selfridge Field, MI, and some years at Schoen Field, IN. Demobilized on 1 October 1933.

Commanders, 417th Pursuit Squadron

Unknown	Jan 22-1 Oct 33
---------	-----------------

418th Observation Squadron (Fourth Army)

Organized Reserve Ohio

HQ-Not initiated 1921-22; Bowling Green, OH, 1922-33

Constituted in the Organized Reserve on 15 October 1921 as the 418th Squadron (Observation), assigned to the 317th Observation Group (Second Army), and allotted to the Fifth Corps Area. Initiated in April 1922 at Bowling Green, OH. Redesignated as the 418th Observation Squadron on 25 January 1923. Conducted summer training at Selfridge Field, MI, and some years at Schoen Field, IN. Demobilized on 1 October 1933.

Commanders, 418th Pursuit Squadron

Unknown	Apr 22-1 Oct 33
---------	-----------------

419th Observation Squadron (Fourth Army)

Organized Reserve Michigan

HQ-Not initiated 1921-22; Detroit, MI, 1922-29; *Inactive* 1929-33

Constituted in the Organized Reserve on 15 October 1921 as the 419th Squadron (Observation), assigned to the 320th Observation Group (Third Army), and allotted to the Sixth Corps Area. Initiated on 21 March 1922 at Detroit, MI. Redesignated as the 419th Observation Squadron on 25 January 1923. Conducted summer training at Selfridge Field, MI, or Chanute Field, IL. Demobilized on 1 October 1933.

Commanders, 419th Observation Squadron

1st Lt. Charles P. McCormick Unknown	21 Mar 22-ao Apr 22 ao Apr 22-16 Dec 24	Maj. Campbell Wood Unknown	16 Dec 24-ao Jun 25 ao Jun 25-1 Oct 33
---	--	-------------------------------	---

420th Observation Squadron (Fourth Army)

Organized Reserve Michigan

HQ-Not initiated 1921-22; Detroit, MI, 1922-29; *Inactive* 1929-33

Constituted in the Organized Reserve on 15 October 1921 as the 420th Squadron (Observation), assigned to the 312th Observation Group (Sixth Army), and allotted to the Sixth Corps Area. Initiated on 7 November 1921 at Detroit, MI. Redesignated as the 420th Observation Squadron on 25 January 1923. Inactivated on 1 December 1929 at Detroit by relief of personnel. Conducted summer training at Selfridge Field, MI, or Chanute Field, IL. Demobilized on 1 October 1933.

Commanders, 420th Observation Squadron

2nd Lt. R. L. Wherritt Capt. Lionel W. Woolsen	7 Nov 21-ao Jan 22 ao Jul 22-ao Aug 22	Unknown <i>Inactive</i>	ao Aug 22-1 Dec 29 1 Dec 29-1 Oct 33
---	---	----------------------------	---

421st Pursuit Squadron (Fifth Army)**Organized Reserve Illinois/Michigan****HQ-***Not initiated* 1921-22; Belleville, IL, 1922-25; East St. Louis, IL, 1925-32; Detroit, MI, 1932-41

Constituted in the Organized Reserve on 15 October 1921 as the 421st Squadron (Pursuit), assigned to the 308th Pursuit Group (Fifth Army), and allotted to the Sixth Corps Area. Initiated in April 1922 at Belleville, IL. Redesignated as the 421st Pursuit Squadron on 25 January 1923. Relocated on 2 June 1925 to East St. Louis, IL. Relocated on 15 January 1932 to Detroit, MI. Consolidated on 2 December 1936 with the 421st Aero Squadron (Construction) (a WWI unit organized in January 1918 at Vancouver Barracks, WA; redesignated as the 45th Spruce Squadron in July 1918; demobilized in January 1919 at Vancouver Barracks; reconstituted on 2 December 1936). Conducted summer training at Selfridge Field, MI, or Chanute Field, IL. Location 7 December 1941—Detroit, MI.

Status: Disbanded on 31 May 1942.**Commanders, 421st Pursuit Squadron**

1st Lt. Guy L. Farquhar

Apr 22-ao Jan 23

Unknown

ao Jan 23-7 Dec 41

422nd Pursuit Squadron (Fifth Army)**Organized Reserve Wisconsin****HQ-***Not initiated* 1921-22; La Crosse, WI, 1922-37; Milwaukee, WI, 1937-41

Constituted in the Organized Reserve on 15 October 1921 as the 422nd Squadron (Pursuit), assigned to the 308th Pursuit Group (Fifth Army), and allotted to the Sixth Corps Area. Initiated in September 1922 at La Crosse, WI. Redesignated as the 421st Pursuit Squadron on 25 January 1923. Consolidated on 2 December 1936 with the 422nd Aero Squadron (Construction) (a WWI unit organized in January 1918 at Vancouver Barracks, WA; redesignated as the 36th Spruce Squadron in July 1918; demobilized in January 1919 at Vancouver Barracks; reconstituted on 2 December 1936). Relocated on 28 July 1937 to Milwaukee, WI. Conducted summer training at Selfridge Field, MI, or Chanute Field, IL. Location 7 December 1941—Milwaukee, WI.

Status: Disbanded on 31 May 1942.**Commanders, 422nd Pursuit Squadron**

Unknown

Sep 22-7 Dec 41

423rd Pursuit Squadron (1921-33) (Fifth Army)**Organized Reserve Illinois****423rd Attack Squadron (1933-41)****HQ-***Not initiated* 1921-22; Municipal Airport, Chicago, IL, 1922-41

Constituted in the Organized Reserve on 15 October 1921 as the 423rd Squadron (Pursuit), assigned to the 308th Pursuit Group (Fifth Army), and allotted to the Fifth Corps Area. Initiated on 21 January 1922 at the Municipal Airport, Chicago, IL. Redesignated as the 423rd Pursuit Squadron on 25 January 1923. Reorganized and redesignated 423rd Attack Squadron on 1 October 1933, but remained assigned to the 308th Pursuit Group. Consolidated on 2 December 1936 with the 423rd Aero Squadron (Construction) (a WWI unit organized in January 1918 at Vancouver Barracks, WA; redesignated as the 46th Spruce Squadron in July 1918; demobilized in January 1919 at Vancouver Barracks; reconstituted on 2 December 1936). Typically conducted Inactive Training Period meetings at the Municipal Airport in Chicago. Conducted summer training at Selfridge Field, MI, or Chanute Field, IL, and some years at Scott Field, IL. Location 7 December 1941—Chicago, IL.

Status: Disbanded on 31 May 1942.**Commanders, 423rd Pursuit Squadron**

Unknown

21 Jan 22-ao Jun 24

Capt. Samuel L. Mathews

17 Jun 36-ao Sep 36

Capt. John W. Schroeder

ao Jun 24-ao Jul 24

Maj. William C. Bausch

ao Nov 36-ao Aug 39

Unknown

ao Jul 24-17 Jun 36

Unknown

ao Aug 39-7 Dec 41

424th Pursuit Squadron (Fourth Army)**Organized Reserve Illinois****HQ**—*Not initiated* 1921-22; Bloomington, IL, 1922-29; *Inactive* 1929-33

Constituted in the Organized Reserve on 15 October 1921 as the 424th Squadron (Pursuit), assigned to the 308th Pursuit Group (Fifth Army), and allotted to the Sixth Corps Area. Initiated on 8 February 1922 at Bloomington, IL. Redesignated as the 424th Pursuit Squadron on 25 January 1923. Inactivated on 1 December 1929 at Bloomington by relief of personnel. Conducted summer training at Selfridge Field, MI, or Chanute Field, IL, and some years at Scott Field, IL. Demobilized on 1 October 1933.

Commanders, 424th Pursuit Squadron

Maj. Joseph B. Jiskra	1 Nov 23-ao Jun 24 <i>Inactive</i>	Unknown 1 Dec 29-7 Dec 41	ao Jun 24-1 Dec 29
-----------------------	---------------------------------------	------------------------------	--------------------

425th Attack Squadron (Fifth Army)**Organized Reserve Illinois****HQ**—Champaign, IL, 1921-25; Decatur, IL, 1925-41

Constituted in the Organized Reserve on 15 October 1921 as the 425th Squadron (Attack), assigned to the 309th Attack Group (Fifth Army), and allotted to the Sixth Corps Area. Initiated on 16 December 1921 at Champaign, IL. Relocated on 2 June 1925 to Decatur, IL. Redesignated as the 425th Attack Squadron on 25 January 1923. Consolidated on 3 December 1936 with the 425th Aero Squadron (Construction) (a WWI unit organized in December 1917 at Vancouver Barracks, WA; redesignated as the 29th Spruce Squadron in July 1918; demobilized in March 1919 at Vancouver Barracks; reconstituted on 3 December 1936). Typically conducted Inactive Training Period meetings at the Hotel Orlando in Decatur. Conducted summer training at Selfridge Field, MI, or Chanute Field, IL, and some years at Scott Field, IL. Location 7 December 1941—Decatur, IL.

Status: Disbanded on 31 May 1942.**Commanders, 425th Attack Squadron**

Capt. K. L. Moore	16 Dec 21-6 Mar 22	Capt. Charles P. McCormick	ao Jun 24-ao Jun 28
Capt. W. O. Benjamin	6 Mar 22-ao Apr 22	Unknown	ao Jun 28-ao Mar 30
Unknown	ao Apr 22-ao Jun 24	Maj. Charles W. Richard	ao Mar 30-ao Nov 39
	Unknown	ao Nov 39-7 Dec 41	

426th Attack Squadron (Fifth Army)**Organized Reserve Illinois****HQ**—Belleville, IL, 1921-25; Urbana, IL, 1925-29; *Inactive* 1929-38; Urbana, IL, 1938-41

Constituted in the Organized Reserve on 15 October 1921 as the 426th Squadron (Attack), assigned to the 309th Attack Group (Fifth Army), and allotted to the Sixth Corps Area. Initiated on 12 December 1921 at Belleville, IL. Redesignated as the 426th Attack Squadron on 25 January 1923. Relocated on 2 June 1925 to Urbana, IL. Inactivated on 1 December 1929 at Urbana by relief of personnel. Consolidated on 27 November 1936 with the 426th Aero Squadron (Construction) (a WWI unit organized in December 1917 at Vancouver Barracks, WA; redesignated as the 30th Spruce Squadron in July 1918; demobilized in January 1919 at Vancouver Barracks; reconstituted on 27 November 1936). Reorganized on 6 May 1938 at Urbana. Conducted summer training at Selfridge Field, MI, or Chanute Field, IL. Location 7 December 1941—Urbana, IL.

Status: Disbanded on 31 May 1942.**Commanders, 426th Attack Squadron**

Unknown	12 Dec 21-1 Dec 29	Capt. Carl M. Olson	6 May 38-ao Aug 39
<i>Inactive</i>	1 Dec 29-6 May 38	Unknown	ao Aug 39-7 Dec 41

427th Attack Squadron (Fifth Army)**Organized Reserve Illinois****HQ-Not initiated** 1921-22; Belleville, IL, 1922-25; Danville, IL, 1925-36; *Inactive* 1936-41

Constituted in the Organized Reserve on 15 October 1921 as the 427th Squadron (Attack), assigned to the 309th Attack Group (Fifth Army), and allotted to the Sixth Corps Area. Initiated on 1 April 1922 at Belleville, IL. Redesignated as the 427th Attack Squadron on 25 January 1923. Relocated on 2 June 1925 to Danville, IL. Inactivated on 28 July 1936 at Danville by relief of personnel. Consolidated on 25 November 1936 with the 427th Aero Squadron (Construction) (a WWI unit organized in December 1917 at Vancouver Barracks, WA; redesignated as the 47th Spruce Squadron in July 1918; demobilized in January 1919 at Vancouver Barracks; reconstituted on 25 November 1936). Conducted summer training at Selfridge Field, MI, or Chanute Field, IL. Location 7 December 1941—*Inactive*.

Status: Disbanded on 31 May 1942.**Commanders, 427th Attack Squadron**

1st Lt. Guy L. Farquhar	1 Apr 22-27 Apr 22	Unknown	1 Dec 29-ao Mar 36
Unknown	27 Apr 22-ao Jun 29	Capt. Cecil F. Delaseaux	ao Mar 36-28 Jul 36
Capt. Samuel H. Young	ao Jun 29-1 Dec 29	<i>Inactive</i>	28 Jul 36-7 Dec 41

428th Attack Squadron (Fifth Army)**Organized Reserve Michigan****HQ-Not initiated** 1921-22; Flint, MI, 1922-25; Bay City, MI, 1925-32; Detroit, MI, 1932-41

Constituted in the Organized Reserve on 15 October 1921 as the 428th Squadron (Attack), assigned to the 309th Attack Group (Fifth Army), and allotted to the Sixth Corps Area. Initiated on 25 January 1922 with squadron headquarters at Flint, MI. Remainder of squadron distributed as follows: Supply, Transportation, Engineering, and Communications sections located at Flint, MI; 1st Flight located at Owasso, MI; 2nd Flight located at Saginaw, MI; 3rd Flight and Armament Section located at Bay City, MI. Redesignated as the 428th Attack Squadron 24 May 1922. Entire squadron relocated on 2 June 1925 to Bay City. Inactivated on 1 December 1929 at Bay City by relief of personnel. Relocated on 27 September 1932 to Detroit. Consolidated on 16 November 1936 with the 428th Aero Squadron (Construction) (a WWI unit organized in January 1918 at Vancouver Barracks, WA; redesignated as the 67th Spruce Squadron in July 1918; demobilized in January 1919 at Vancouver Barracks; reconstituted on 16 November 1936). Conducted summer training at Selfridge Field, MI, or Chanute Field, IL. Location 7 December 1941—Danville, IL.

Status: Disbanded on 31 May 1942.**Commanders, 428th Pursuit Squadron**

Capt. Leslie P. Koepfgen	25 Jan 22-5 Jun 22	Capt. Burt A. Skellan	6 Jun 22-ao Jan 23
	Unknown	ao Jan 23-7 Dec 41	

429th Pursuit Squadron (Sixth Army)**Organized Reserve Kansas/North Dakota****HQ-Not initiated** 1921-22; Lincoln, KS, 1922-31; Bismarck, ND, 1931-33

Constituted in the Organized Reserve on 15 October 1921 as the 429th Squadron (Pursuit), assigned to the 310th Pursuit Group (Sixth Army), and allotted to the Seventh Corps Area. Initiated in March 1922 at Lincoln, KS. Redesignated as the 429th Pursuit Squadron on 25 January 1923. Relocated on 12 October 1931 to Bismarck, ND. Conducted summer training at Marshall Field, KS, or Camp Ripley, MN. Demobilized on 1 October 1933.

Commanders, 429th Pursuit Squadron

Unknown	Mar 22-1 Oct 33
---------	-----------------

430th Pursuit Squadron (Sixth Army)**Organized Reserve Missouri****HQ-Not initiated** 1921-22; St. Joseph, MO 1922-26; Richards Field, Kansas City, MO 1926-39; *Inactive* 1939-41

Constituted in the Organized Reserve on 15 October 1921 as the 430th Squadron (Pursuit), assigned to the 310th Pursuit Group (Sixth Army), and allotted to the Seventh Corps Area. Initiated in March 1922 at St. Joseph, MO. Redesignated as the 430th Pursuit Squadron on 25 January 1923. Relocated on 26 May 1926 to Richards Field, Kansas City, MO. This squadron was one of the few in the Organized Reserve that possessed facilities, equipment, and aircraft. Squadron personnel were largely pilots and ground support personnel employed by Trans-World Airways (TWA) at the Kansas City Municipal Airport. Participated in a "Fly By" in June 1932 for the Honorable Patrick J. Hurley, Secretary of War, at the grand opening of the Kansas City-St. Louis Waterway. Consolidated on 25 November 1936 with the 430th Aero Squadron (Construction) (a WWI unit organized in January 1918 at Vancouver Barracks, WA; redesignated as the 37th Spruce Squadron in July 1918; demobilized in January 1919 at Vancouver Barracks; reconstituted on 25 November 1936). Operated from Paso Robles Airfield, CA, in support of the 40th Division during the 1937 Fourth Army Maneuver. Conducted summer training at Marshall Field, KS; Richards Field, MO; Camp Dodge, IA; or Camp Ripley, MN, 1922-40. Inactivated on 2 October 1939 at Richards Field by relief of personnel. Location 7 December 1941—*Inactive*.

Status: Disbanded on 31 May 1942.**Events:** 231**Commanders, 430th Pursuit Squadron**

Unknown	Mar 22-ao May 30	Unknown	ao Jan 36-ao Jul 38
Capt. John W. Ranson	ao May 30-ao Jan 36	Maj. Thomas L. Dawson	ao Jul 38-2 Oct 39
	<i>Inactive</i>	2 Oct 39-7 Dec 41	

431st Observation Squadron (Sixth Army)**Organized Reserve Minnesota/Iowa****HQ-Not initiated** 1921-22; Wold-Chamberlain Field, Minneapolis, MN, 1922-31; Des Moines, IA, 1931-33

Constituted in the Organized Reserve on 15 October 1921 as the 431st Squadron (Pursuit), assigned to the 310th Pursuit Group (Sixth Army), and allotted to the Seventh Corps Area. Initiated in February 1922 at Wold-Chamberlain Field, Minneapolis, MN. Redesignated as the 431st Pursuit Squadron on 25 January 1923. Relocated on 12 October 1931 to Des Moines, IA. Conducted summer training at Marshall Field, KS; Richards Field, MO; or Camp Ripley, MN, 1922-33. Demobilized on 1 October 1933.

Commanders, 431st Pursuit Squadron

2nd Lt. Maurice J. Stack	Feb 22-11 Mar 22	Capt. William R. Ferris	11 Mar 22-ao Jan 23
	Unknown	ao Jan 23-1 Oct 33	

432nd Pursuit Squadron (Sixth Army)**Organized Reserve Missouri****HQ-Not initiated** 1921-22; St. Louis, MO 1922-33

Constituted in the Organized Reserve on 15 October 1921 as the 432nd Squadron (Pursuit), assigned to the 310th Pursuit Group (Sixth Army), and allotted to the Seventh Corps Area. Initiated on 21 January 1922 at St. Louis, MO. Redesignated as the 432nd Pursuit Squadron on 25 January 1923. Conducted summer training at Marshall Field, KS, or Camp Ripley, MN, 1922-33. Demobilized on 1 October 1933.

Commanders, 432nd Pursuit Squadron

Unknown	21 Jan 22-1 Oct 33
---------	--------------------

433rd Observation Squadron (Sixth Army)**Organized Reserve Missouri/Iowa****HQ-Not initiated** 1921-22; St. Charles, MO 1922-26; Burlington, IA, 1926-33

Constituted in the Organized Reserve on 15 October 1921 as the 433rd Squadron (Observation), assigned to the Sixth Army and allotted to the Seventh Corps Area. Initiated in February 1922 at St. Charles, MO. Relocated on 26 May 1926 to Burlington, IA. Redesignated as the 433rd Observation Squadron on 25 January 1923. Conducted summer training at Marshall Field, KS. Demobilized on 1 October 1933.

Commanders, 433rd Pursuit Squadron

Unknown	Feb 22-1 Oct 33
---------	-----------------

434th Observation Squadron (Sixth Army)**Organized Reserve Arizona/California****HQ-Not initiated** 1921-23; Phoenix, AZ, 1923-24; Bakersfield, CA, 1924-28; *Inactive* 1928-33

Constituted in the Organized Reserve on 15 October 1921 as the 434th Squadron (Observation), assigned to the 312th Observation Group (Sixth Army), and allotted to the Eighth Corps Area. Redesignated as the 434th Observation Squadron on 25 January 1923. Initiated on 26 February 1923 at Phoenix, AZ. Withdrawn from the Eighth Corps Area on 31 March 1924 and allotted to the Ninth Corps Area. Reorganized in November 1924 at Bakersfield, CA. Inactivated on 1 September 1928 at Bakersfield by relief of personnel. Demobilized on 1 October 1933.

Commanders, 434th Pursuit Squadron

Unknown	26 Feb 23-1 Sep 28	<i>Inactive</i>	1 Sep 28-1 Oct 33
---------	--------------------	-----------------	-------------------

435th Pursuit Squadron (Sixth Army)**Organized Reserve Texas/New York****HQ-Not initiated** 1921-23; Houston, TX, 1923-25; Galveston, TX, 1925-36; *Inactive* 1936-41

Constituted in the Organized Reserve on 15 October 1921 as the 435th Squadron (Pursuit), assigned to the 311th Pursuit Group (Sixth Army), and allotted to the Eighth Corps Area. Redesignated as the 435th Pursuit Squadron on 25 January 1923. Initiated on 26 February 1923 at Houston, TX. Relieved from the Sixth Army 13 June 1924 and assigned to the General Headquarters Reserve. Relocated to Galveston, TX, on 15 April 1925 and stationed at the Fort Crockett U.S. Army Airdrome. Withdrawn from the Eighth Corps Area on 5 June 1936 and allotted to the Second Corps Area. Inactivated on 31 October 1936 at Galveston by relief of personnel. Consolidated on 25 November 1936 with the 435th Aero Squadron (Construction) (a WWI unit organized in January 1918 at Vancouver Barracks, WA; redesignated as the 50th Spruce Squadron in July 1918; demobilized in January 1919 at Vancouver Barracks; reconstituted on 25 November 1936). Allotted to the Syracuse District, Northern New York Reserve Area 5 April 1937. Conducted summer training at various locations to include Biggs Field, TX; Kelly Field, TX; Fort Crockett, TX; or Hensley Field, TX, 1923-35. Location 7 December 1941—*Inactive*.

Status: Disbanded on 31 May 1942.**Commanders, 435th Pursuit Squadron**

Unknown	23 Feb 23-ao Jan 25	Maj. Alva W. Snyder	15 May 28-9 Oct 32
1st Lt. Jacob C. Stedman	ao Jan 25-ao Feb 25	Maj. John Van O. Weaver	9 Oct 32-31 Oct 36
Capt. Wade L. Hoecker	ao Jun 25-15 May 28	<i>Inactive</i>	31 Oct 36-7 Dec 41

436th Pursuit Squadron (Sixth Army)**Organized Reserve Colorado/Texas/New York****HQ-Not initiated** 1921-23; Denver, CO, 1923-25; Galveston, TX, 1925-36; *Inactive* 1936-41

Constituted in the Organized Reserve on 15 October 1921 as the 436th Squadron (Pursuit), assigned to the 311th Pursuit Group (Sixth Army), and allotted to the Eighth Corps Area. Pueblo, CO, initially designated as headquarters on organization, but the unit was never organized at that location. Redesignated as the 436th Pursuit Squadron on 25 January 1923. Initiated on 26 February 1923 at Denver, CO. Relieved from the Sixth Army 13 June 1924 and assigned

to the General Headquarters Reserve. Relocated to Galveston, TX, on 15 April 1925 and stationed at the Fort Crockett U.S. Army Airdrome. Withdrawn from the Eighth Corps Area on 5 June 1936 and allotted to the Second Corps Area. Inactivated on 31 October 1936 at Galveston by relief of personnel. Consolidated on 25 November 1936 with the 436th Aero Squadron (Construction) (a WWI unit organized in January 1918 at Vancouver Barracks, WA; redesignated as the 51st Spruce Squadron in July 1918; demobilized in January 1919 at Vancouver Barracks; reconstituted on 25 November 1936). Allotted to the Syracuse District, Northern New York Reserve Area 5 April 1937. Conducted summer training at Fort Crockett, TX, or Hensley Field, TX, 1923-35. Location 7 December 1941—*Inactive*.

Status: Disbanded on 31 May 1942.

Commanders, 436th Pursuit Squadron

Unknown	26 Feb 23-9 Oct 32 <i>Inactive</i>	Maj. Walter F. Parkin 31 Oct 36-7 Dec 41	9 Oct 32-31 Oct 36
---------	---------------------------------------	---	--------------------

437th Observation Squadron (Sixth Army)

Organized Reserve New Mexico/Texas

437th Pursuit Squadron

HQ-Not initiated 1921-23; Dallas, TX, 1923-25; Galveston, TX, 1925-33

Constituted in the Organized Reserve on 15 October 1921 as the 437th Squadron (Pursuit), assigned to the 311th Pursuit Group (Sixth Army), and allotted to the Eighth Corps Area. Deming, NM, initially designated as headquarters on organization, but the unit was never organized at that location. Redesignated as the 437th Pursuit Squadron on 25 January 1923. Initiated on 26 February 1923 at Dallas, TX. Relieved from the Sixth Army 13 June 1924 and assigned to the General Headquarters Reserve. Relocated 15 April 1925 to Galveston, TX, and stationed at the Fort Crockett U.S. Army Airdrome. Conducted summer training at Kelly Field, TX. Demobilized on 1 October 1933.

Commanders, 437th Observation Squadron

Unknown	26 Feb 23-1 Oct 33
---------	--------------------

438th Pursuit Squadron (Sixth Army)

Organized Reserve New Mexico/Texas

HQ-Not initiated 1921-23; Santa Fe, NM, 1923-25; Galveston, TX, 1925-33

Constituted in the Organized Reserve on 15 October 1921 as the 438th Squadron (Pursuit), assigned to the 311th Pursuit Group (Sixth Army), and allotted to the Eighth Corps Area. Redesignated as the 438th Pursuit Squadron on 25 January 1923. Initiated on 26 February 1923 at Santa Fe, NM. Relieved from the Sixth Army 13 June 1924 and assigned to the General Headquarters Reserve. Relocated to Galveston, TX, on 15 April 1925 and stationed at the Fort Crockett U.S. Army Airdrome. Conducted summer training at Kelly Field, TX, or Biggs Field, TX. Demobilized on 1 October 1933.

Commanders, 438th Pursuit Squadron

1st Lt. Frank M. Tierney	ao Mar 22-ao Oct 22	Capt. Fred Reasel	ao Dec 24-ao Jan 25
Unknown	ao Oct 22-ao Dec 24	Unknown	ao Jan 25-1 Oct 33

439th Headquarters Squadron (Sixth Army)

Organized Reserve Arizona/Texas/California

HQ-Not initiated 1921-23; Waco, TX, 1923-24; San Jose, CA, 1924-28; *Inactive* 1928-33

Constituted in the Organized Reserve on 15 October 1921 as the 439th Squadron (Headquarters), assigned to the Sixth Army and allotted to the Eighth Corps Area. Phoenix, AZ, designated as headquarters on organization, but the unit was never organized at that location. Redesignated as the 439th Headquarters Squadron on 25 January 1923. Initiated on 26 February 1923 in Waco, TX. Withdrawn from the Eighth Corps Area on 31 March 1924 and allotted to the Ninth Corps Area. Reorganized in 1924 at San Jose, CA. Inactivated on 1 September 1928 at San Jose by relief of personnel. Demobilized on 1 October 1933.

Commanders, 439th Headquarters Squadron

2nd Lt. A. L. Middleton	26 Feb 23-31 Mar 24 <i>Inactive</i>	Unknown 1 Sep 28-1 Oct 33	1 Apr 24-1 Sep 28
-------------------------	--	------------------------------	-------------------

440th Observation Squadron (Sixth Army)

Organized Reserve California

HQ-*Not initiated* 1921-22; San Jose, CA, 1922-28; *Inactive* 1928-30; Fresno, CA, 1930-33

Constituted in the Organized Reserve on 15 October 1921 as the 440th Squadron (Observation), assigned to the 312th Observation Group (Sixth Army), and allotted to the Ninth Corps Area. Initiated on 7 February 1922 at San Jose, CA. Redesignated as the 440th Observation Squadron on 25 January 1923. Typically conducted Inactive Training Period meetings at Crissy Field at the Presidio of San Francisco and occasionally at the Technical High School, San Jose, CA. Conducted summer training at Rockwell Field, CA. Inactivated on 1 September 1928 at San Jose by relief of personnel. Reorganized on 28 January 1930 at Fresno, CA. Demobilized on 1 October 1933.

Commanders, 440th Observation Squadron

Maj. William Cross	7 Feb 22-ao Mar 22	Capt. Charles Butner	ao Jun 25-ao Jul 25
Maj. George E. Sykes	ao Oct 22-ao Jan 23	Unknown	ao Jul 25-1 Sep 28
Unknown	ao Jan 23-ao Jun 25	<i>Inactive</i>	1 Sep 28-28 Jan 30
	Unknown	28 Jan 30-1 Oct 33	

441st Observation Squadron (Sixth Army)

Organized Reserve California

HQ-*Not initiated* 1921-22; Sacramento, CA, 1922-28; *Inactive* 1928-33

Constituted in the Organized Reserve on 15 October 1921 as the 441st Squadron (Observation), assigned to the 312th Observation Group (Sixth Army), and allotted to the Ninth Corps Area. Initiated on 14 February 1922 at Sacramento, CA. Redesignated as the 441st Observation Squadron on 25 January 1923. Conducted summer training at Rockwell Field, CA. Inactivated on 1 September 1928 at Sacramento by relief of personnel. Demobilized on 1 October 1933.

Commanders, 441st Observation Squadron

2nd Lt. Charles R. Mainwaring	14 Feb 22-ao Mar 22	Unknown	ao Jan 23-1 Sep 28
1st Lt. Charles W. Richard	ao Oct 22-ao Jan 23	<i>Inactive</i>	1 Sep 28-1 Oct 33

442nd Pursuit Squadron (First Army)

Organized Reserve Massachusetts

HQ-West Roxbury, MA, 1921-33

Constituted in the Organized Reserve on 15 October 1921 as the 442nd Squadron (Pursuit), assigned to the 313th Pursuit Group (First Army), and allotted to the First Corps Area. Initiated on 17 December 1921 at West Roxbury, MA. Redesignated as the 442nd Pursuit Squadron on 25 January 1923. Relieved from assignment to the First Army 31 March 1924 and assigned to the General Headquarters Reserve. Demobilized on 1 October 1933.

Events: 126

Commanders, 442nd Pursuit Squadron

Unknown	17 Dec 21-20 Jan 22	Capt. Peter C. Borree	ao Jul 24- ao Aug 26
1st Lt. James J. O'Neil	20 Jan 22-ao Dec 22	Unknown	ao Aug 26-ao Mar 31
Unknown	ao Dec 22-ao Jul 24	Maj. Bartlett Beaman	ao Mar 31-1 Oct 33

443rd Pursuit Squadron (First Army)**Organized Reserve Massachusetts/New York****HQ**-Roxbury, MA, 1921-36; *Inactive* 1936-41

Constituted in the Organized Reserve on 15 October 1921 as the 443rd Squadron (Pursuit), assigned to the 313th Pursuit Group (First Army), and allotted to the First Corps Area. Initiated on 3 January 1922 at Roxbury, MA. Redesignated as the 443rd Pursuit Squadron on 25 January 1923. Relieved from assignment to the First Army 31 March 1924 and assigned to the General Headquarters Reserve. Withdrawn from the First Corps Area on 5 June 1936 and allotted to the Second Corps Area. Consolidated on 25 November 1936 with the 443rd Aero Squadron (Construction) (a WWI unit organized in January 1918 at Vancouver Barracks, WA; redesignated as the 11th Spruce Squadron in July 1918; demobilized in February 1919 at Vancouver Barracks; reconstituted on 25 November 1936). Allotted to the Syracuse District, Northern New York Reserve Area 5 April 1937. Location 7 December 1941—*Inactive*.

Status: Disbanded on 31 May 1942.**Events:** 126**Commanders, 443rd Pursuit Squadron**

2nd Lt. R. C. Van Arsdale	3 Jan 22-9 Mar 22	Unknown	ao Apr 25-ao Dec 26
1st Lt. Edward S. Clark	9 Mar 22-ao Dec 22	Capt. Chester E. Wright	ao Dec 26-27 Feb 27
Unknown	ao Dec 22-ao Jul 24	Unknown	27 Feb 27-ao Sep 35
1st Lt. George H. Lusk	ao Jul 24-ao Apr 25	Capt. Clarence J. A' Hearn	ao Sep 35-5 Jun 36
	<i>Inactive</i>	5 Jun 36-7 Dec 41	

444th Pursuit Squadron (First Army)**Organized Reserve Massachusetts****HQ**-*Not initiated* 1921-22; Cambridge, MA, 1922-33

Constituted in the Organized Reserve on 15 October 1921 as the 444th Squadron (Pursuit), assigned to the 313th Pursuit Group (First Army), and allotted to the First Corps Area. Initiated on 10 January 1922 at Cambridge, MA. Redesignated as the 444th Pursuit Squadron on 25 January 1923. Relieved from assignment to the First Army 31 March 1924 and assigned to the General Headquarters Reserve. Demobilized on 1 October 1933.

Commanders, 444th Pursuit Squadron

2nd Lt. C. M. Cummings	10 Jan 22-12 Jan 22	1st Lt. John Van J. Weaver	ao Jan 23-ao Jun 23
1st Lt. J. Invalle, Jr.	12 Jan 22-9 Mar 22	Unknown	ao Jun 23-ao Jul 24
1st Lt. Mathew M. Leary	9 Mar 22-ao Jun 22	1st Lt. Otis C. Hale	ao Jul 24-ao Aug 24
	Unknown	ao Aug 24-1 Oct 33	

445th Pursuit Squadron (First Army)**Organized Reserve Massachusetts****HQ**-*Not initiated* 1921-22; Boston, MA, 1922-33

Constituted in the Organized Reserve on 15 October 1921 as the 445th Squadron (Pursuit), assigned to the 313th Pursuit Group (First Army), and allotted to the First Corps Area. Initiated on 12 January 1922 at Boston, MA. Stationed at Boston Airport. Redesignated as the 445th Pursuit Squadron on 25 January 1923. Relieved from assignment to the First Army 31 March 1924 and assigned to the General Headquarters Reserve. Conducted summer training at Mitchel Field, NY. Demobilized on 1 October 1933.

Commanders, 445th Pursuit Squadron

1st Lt. Tristan J. Campbell	12 Jan 22-ao Jan 25	Unknown	ao Jul 25-ao May 26
Unknown	ao Jan 25-ao Jun 25	Capt. Halsey R. Bazley	ao May 26-27 Feb 27
Capt. Neil J. Cronin	ao Jun 25-ao Jul 25	Unknown	27 Feb 27-ao Aug 29
	Maj. Robert F. Raymond, Jr.	ao Aug 29-1 Oct 33	

446th Headquarters Squadron (First Army)**Organized Reserve New Hampshire****HQ**-Not initiated 1921-22; Dover, NH, 1922-33

Constituted in the Organized Reserve on 15 October 1921 as the 446th Squadron (Headquarters), assigned to the First Army and allotted to the First Corps Area. Initiated on 2 January 1923 at Dover, NH. Redesignated as the 446th Headquarters Squadron on 25 January 1923. Demobilized on 1 October 1933.

Commanders, 446th Headquarters Squadron

1st Lt. Harold W. Schell	2 Jan 23-ao Jun 23	1st Lt. John W. Penick	ao Jan 25-ao Jul 26
Unknown	ao Jun 23-ao Jan 25	Unknown	ao Jul 26-1 Oct 33

447th Pursuit Squadron (First Army)**Organized Reserve New York****HQ**-Mineola, L.I., NY, 1921-29; *Inactive* 1929-41

Constituted in the Organized Reserve on 15 October 1921 as the 447th Squadron (Pursuit), assigned to the 314th Pursuit Group (First Army), and allotted to the Second Corps Area. Initiated on 2 November 1921 at Mineola, L.I., NY. Stationed at Mitchel Field, NY. Redesignated as the 447th Pursuit Squadron on 25 January 1923. Relieved from assignment to the First Army 31 March 1924 and assigned to the General Headquarters Reserve. Designated mobilization station was Mitchel Field, NY. Inactivated in June 1929 at Mineola by relief of personnel. Relieved from assignment to the 314th Pursuit Group on 1 October 1933 and assigned to the 302nd Pursuit Group. Consolidated on 25 November 1936 with the 447th Aero Squadron (Construction) (a WWI unit organized in February 1918 at Vancouver Barracks, WA; redesignated as the 70th Spruce Squadron in July 1918; demobilized in January 1919 at Vancouver Barracks; reconstituted on 25 November 1936). Conducted summer training at Mitchel Field, NY. Location 7 December 1941—*Inactive*.

Status: Disbanded on 31 May 1942.**Commanders, 447th Pursuit Squadron**

Maj. Peter H. McNulty	2 Nov 21-6 Jul 28	Capt. Ogden D. Budd	6 Jul 28-Jun 29
	<i>Inactive</i>	Jun 29-7 Dec 41	

448th Pursuit Squadron (First Army)**Organized Reserve New York****HQ**-Mineola, L.I., NY, 1921-41

Constituted in the Organized Reserve on 15 October 1921 as the 448th Squadron (Pursuit), assigned to the 314th Pursuit Group (First Army), and allotted to the Second Corps Area. Initiated on 2 November 1921 at Mineola, L.I., NY. Stationed at Mitchel Field, NY. Redesignated as the 448th Pursuit Squadron on 25 January 1923. Relieved from assignment to the First Army 31 March 1924 and assigned to the General Headquarters Reserve. Relieved from assignment to the 314th Pursuit Group on 1 October 1933 and assigned to the 302nd Pursuit Group. Consolidated on 25 November 1936 with the 448th Aero Squadron (Construction) (a WWI unit organized in February 1918 at Vancouver Barracks, WA; redesignated as the 54th Spruce Squadron in July 1918; demobilized in January 1919 at Vancouver Barracks; reconstituted on 25 November 1936). Conducted summer training at Mitchel Field, NY. Designated mobilization station was Mitchel Field, NY. Location 7 December 1941—Mineola, L.I., NY.

Status: Disbanded on 31 May 1942.**Commanders, 448th Pursuit Squadron**

Maj. Edwin B. Haggerty	2 Nov 21-ao May 23	Maj. Paul C. Durbin	14 Feb 30-19 Mar 32
Capt. Glenn M. Pike	15 Jul 24-15 May 25	Maj. Clayton C. Shangraw	19 Mar 32-16 Dec 32
Capt. Rutledge B. Barry	15 May 25-26 Oct 27	Maj. James N. Kelly	16 Dec 32-19 Nov 34
Capt. Hilbert L. Blair	26 Oct 27-26 Jan 28	Unknown	19 Nov 34-6 Apr 35
Unknown	26 Jan 28-9 Dec 29	Maj. Glenn M. Pike	6 Apr 35-ao May 35
Maj. Lorenzo T. Getty	9 Dec 29-14 Feb 30	Unknown	ao May 35-7 Dec 41

449th Pursuit Squadron (First Army)**Organized Reserve New York****HQ**-Albany, NY, 1921-41

Constituted in the Organized Reserve on 15 October 1921 as the 449th Squadron (Pursuit), assigned to the 314th Pursuit Group (First Army), and allotted to the Second Corps Area. Initiated on 23 November 1921 at Albany, NY. Redesignated as the 449th Pursuit Squadron on 25 January 1923. Relieved from assignment to the First Army 31 March 1924 and assigned to the General Headquarters Reserve. Relieved from assignment to the 314th Pursuit Group on 1 October 1933 and assigned to the 302nd Pursuit Group. Consolidated on 25 November 1936 with the 449th Aero Squadron (Construction) (a WWI unit organized in February 1918 at Vancouver Barracks, WA; redesignated as the 55th Spruce Squadron in July 1918; demobilized in January 1919 at Vancouver Barracks; reconstituted on 25 November 1936). Conducted summer training at Mitchel Field, NY. Location 7 December 1941—Albany, NY.

Status: Disbanded on 31 May 1942.**Commanders, 449th Pursuit Squadron**

1st Lt. Francis U. Wilcox	23 Nov 21-ao Jan 22	1st Lt. Victor P Pennington	ao Jul 27-Jun 28
1st Lt. Edward M. Ogden	ao Apr 22-21 Oct 22	Unknown	ao Jul 27-ao Aug 29
Capt. Miner C. Markham	21 Oct 22-ao Jul 23	Maj. Robert L. Copsey	ao Aug 29-1 Aug 30
Unknown	ao Jul 23-8 May 25	Maj. Glenn M. Pike	19 Sep 30-8 Mar 32
Capt. James D. Francis	8 May 25-ao Jun 25	Maj. Donald Hudson	8 Mar 32-5 Apr 35
Unknown	ao Jun 25-ao Jul 27	Maj. Roy W. Ammel	5 Apr 35-ao Jan 37
	Unknown	ao Jan 37-7 Dec 41	

450th Pursuit Squadron (First Army)**Organized Reserve New York****HQ**-*Not initiated* 1921-22; Rochester, NY, 1922-33

Constituted in the Organized Reserve on 15 October 1921 as the 450th Squadron (Pursuit), assigned to the 314th Pursuit Group (First Army), and allotted to the Second Corps Area. Initiated on 23 November 1921 at Rochester, NY. Redesignated as the 450th Pursuit Squadron on 25 January 1923. Relieved from assignment to the First Army 31 March 1924 and assigned to the General Headquarters Reserve. Conducted summer training at Mitchel Field, NY, 1922-33. Demobilized on 1 October 1933.

Commanders, 450th Pursuit Squadron

Capt. William S. Calkins	23 Nov 21-9 Feb 23	Maj. Robert R. Converse	9 Feb 23-23 May 28
	Unknown	23 May 28-1 Oct 33	

451st Observation Squadron (First Army)**Organized Reserve New York****HQ**-*Not initiated* 1921-22; Buffalo, NY, 1922-33

Constituted in the Organized Reserve on 15 October 1921 as the 451st Squadron (Observation), assigned to the 315th Observation Group (First Army), and allotted to the Second Corps Area. Initiated on 10 January 1922 at Buffalo, NY. Redesignated as the 451st Observation Squadron on 25 January 1923. Conducted summer training at Mitchel Field, NY, 1922-33. Demobilized on 1 October 1933.

Commanders, 451st Observation Squadron

2nd Lt. T. R. Hinckley	10 Jan 22-1 Feb 22	Capt. Sydney W. Caulfield	22 Sep 26-4 Oct 26
Capt. George W. Ryan	1 Feb 22-2 Dec 29	Maj. Clifford B. Harmon	4 Oct 26-30 Jul 29
	Capt. Sidney W. Caulfield	30 Jul 29-1 Oct 33	

452nd Observation Squadron (First Army)**Organized Reserve New York****HQ-Not initiated** 1921-22; Buffalo, NY, 1922-33

Constituted in the Organized Reserve on 15 October 1921 as the 451st Squadron (Observation), assigned to the 315th Observation Group (First Army), and allotted to the Second Corps Area. Initiated on 17 January 1922 at Buffalo, NY. Redesignated as the 452nd Observation Squadron on 25 January 1923. Conducted summer training at Mitchel Field, NY, 1922-33. Demobilized on 1 October 1933.

Commanders, 452nd Observation Squadron

1st Lt. Willis H. Proctor	17 Jan 22-11 May 24	Maj. Giles W. Rich	4 Oct 26-9 Dec 29
1st Lt. Leo F. Powers	11 May 24-4 Oct 26	Unknown	9 Dec 29-1 Oct 33

453rd Observation Squadron (First Army)**Organized Reserve Pennsylvania****HQ-Harrisburg, PA, 1921-29; Inactive** 1929-33

Constituted in the Organized Reserve on 15 October 1921 as the 453rd Squadron (Observation), assigned to the 315th Observation Group (First Army), and allotted to the Third Corps Area. Initiated on 2 November 1921 at Harrisburg, PA. Redesignated as the 453rd Observation Squadron on 25 January 1923. Inactivated on 23 July 1929 at Harrisburg by relief of personnel. Demobilized on 1 October 1933.

Commanders, 453rd Observation Squadron

2nd Lt. George H. Ervin	2 Nov 21-7 Nov 21	Capt. Walter E. Johnson	24 Aug 22-14 Jun 26
1st Lt. Francis B. Hitchcock	7 Nov 21-12 Nov 21	Capt. Lloyd O. Yost	14 Jun 26-21 Jul 28
Maj. Charles T. Waring	12 Nov 21-24 Aug 22	1st Lt. Sylvan Gusdorff	21 Jul 28-23 Jul 29
	<i>Inactive</i>	23 Jul 29-1 Oct 33	

454th Observation Squadron (First Army)**Organized Reserve Pennsylvania****HQ-Harrisburg, PA, 1921-33**

Constituted in the Organized Reserve on 15 October 1921 as the 454th Squadron (Observation), assigned to the 315th Observation Group (First Army), and allotted to the Third Corps Area. Initiated on 8 November 1921 at Harrisburg, PA. Redesignated as the 454th Observation Squadron on 25 January 1923. Inactivated in June 1929 at Harrisburg by relief of personnel. Demobilized on 1 October 1933.

Commanders, 454th Observation Squadron

2nd Lt. Howard L. Miller	7 Nov 21-ao Sep 22	Unknown	ao Jun 26-ao Jan 29
Unknown	ao Sep 22-ao Dec 23	Capt. Donald O. Woolf	ao Jan 29-Jun 29
1st Lt. Henry S. Greenwalt	ao Dec 23-ao Jun 26	<i>Inactive</i>	Jun 29-1 Oct 33

455th Pursuit Squadron (1921-33) (Second Army)**Organized Reserve North Carolina****455th Bombardment Squadron (1933-41)****HQ-Not initiated** 1921-22; Wilmington, NC, 1922-29; *Inactive* 1929-41

Constituted in the Organized Reserve on 15 October 1921 as the 455th Squadron (Pursuit), assigned to the 316th Pursuit Group (Second Army), and allotted to the Fourth Corps Area. Initiated on 17 April 1922 at Wilmington, NC. Redesignated as the 455th Pursuit Squadron on 25 January 1923. Relieved from the Second Army 31 March 1924 and assigned to the General Headquarters Reserve. Inactivated on 19 September 1929 at Wilmington by relief of personnel. Reorganized and redesignated as the 455th Bombardment Squadron on 18 August 1933, relieved from the 316th Pursuit Group, and assigned to the 316th Bombardment Group (GHQR). Consolidated on 25 November 1936 with the 455th Aero Squadron (Construction) (a WWI unit organized in February 1918 at Vancouver Barracks, WA; redesignated as the 81st Spruce Squadron in July 1918; demobilized in January 1919 at Vancouver Barracks; reconstituted on 25 November 1936). Conducted summer training at Maxwell Field, AL, 1922-29. Designated

mobilization training station was Camp Joseph E. Johnston, FL, (later redesignated Camp J. Clifford R. Foster) 1922-30 and Maxwell Field, AL, 1930-41. Location 7 December 1941—*Inactive*.

Status: Disbanded on 31 May 1942.

Commanders, 455th Pursuit Squadron

Capt. Nelson McRae	17 Apr 22-27 Apr 22	Unknown	20 Feb 25-19 Sep 28
Maj. Herman C. Rorison	27 Apr 22-20 Feb 25	<i>Inactive</i>	19 Sep 28-7 Dec 41

456th Pursuit Squadron (GHQR)

Organized Reserve Tennessee/Louisiana

HQ—*Not initiated* 1921-22; Woodstock Field, Memphis, TN, 1922-31; Shreveport, LA, 1931-41

Constituted in the Organized Reserve on 15 October 1921 as the 456th Squadron (Pursuit), assigned to the 316th Pursuit Group (GHQR), and allotted to the Fourth Corps Area. Initiated on 25 April 1922 at Woodstock Field, Memphis, TN. Redesignated as the 456th Pursuit Squadron on 25 January 1923. Relocated on 14 January 1931 to Shreveport, LA. Relieved 1 October 1933 from the 316th Pursuit Group. Consolidated on 25 November 1936 with the 456th Aero Squadron (Construction) (a WWI unit organized in February 1918 at Vancouver Barracks, WA; redesignated as the 72nd Spruce Squadron in July 1918; demobilized in January 1919 at Vancouver Barracks; reconstituted on 25 November 1936). Conducted summer training at Maxwell Field, AL, and Candler Field, GA. Designated mobilization training station was Camp Joseph E. Johnston, FL, (later redesignated Camp J. Clifford R. Foster) 1922-30 and Maxwell Field, AL, 1930-41. Location 7 December 1941—Shreveport, LA.

Status: Disbanded on 31 May 1942.

Commanders, 456th Pursuit Squadron

1st Lt. William C. Niell	25 Apr 22-ao May 22	Maj. Eugene Stevens	ao Jan 36-25 Nov 36
Unknown	ao May 22-ao Jan 36	Unknown	25 Nov 36-7 Dec 41

457th Pursuit Squadron (GHQR)

Organized Reserve Georgia

HQ—*Not initiated* 1921-22; Candler Field, Atlanta, GA, 1922-41

Constituted in the Organized Reserve on 15 October 1921 as the 457th Squadron (Pursuit), assigned to the 316th Pursuit Group (GHQR), and allotted to the Fourth Corps Area. Initiated on 25 April 1922 at Atlanta, GA. Redesignated as the 457th Pursuit Squadron on 25 January 1923. Relocated in February 1926 to Candler Field in Atlanta. Relieved 1 October 1933 from the 316th Pursuit Group. Consolidated on 25 November 1936 with the 457th Aero Squadron (Construction) (a WWI unit organized in February 1918 at Vancouver Barracks, WA; redesignated as the 73rd Spruce Squadron in July 1918; demobilized in January 1919 at Vancouver Barracks; reconstituted on 25 November 1936). Conducted summer training at Maxwell Field and Candler Field. Designated mobilization training station was Camp Joseph E. Johnston, FL, (later redesignated Camp J. Clifford R. Foster) 1922-30 and Maxwell Field, AL, 1930-41. Location 7 December 1941—Atlanta, GA.

Status: Disbanded on 31 May 1942.

Commanders, 457th Pursuit Squadron

1st Lt. Robert B. Snowden	25 Apr 22-ao May 22	Maj. Paul N. Montague	ao May 30-ao Sep 30
Unknown	ao May 22-ao Sep 24	Unknown	ao Sep 30-ao Sep 35
Capt. Harvey N. Pye	ao Sep 24-27 Jan 25	Maj. William L. Plummer	ao Sep 35-28 Mar 38
Capt. Henry U. Farnsworth	27 Jan 25-ao Feb 25	Maj. George Wiggs	28 Mar 38-ao Apr 38
Unknown	ao Feb 25-ao May 30	Unknown	ao Apr 38-7 Dec 41

458th Pursuit Squadron (1921-33) (Second Army)**Organized Reserve Georgia****458th Bombardment Squadron (1933-41)****HQ-Not initiated** 1921-22; Candler Field, Atlanta, GA, 1922-29; *Inactive* 1929-30; Candler Field, Atlanta, GA, 1930-41

Constituted in the Organized Reserve on 15 October 1921 as the 458th Squadron (Pursuit), assigned to the 316th Pursuit Group (Second Army), and allotted to the Fourth Corps Area. Initiated on 17 April 1922 at Atlanta, GA. Redesignated as the 458th Pursuit Squadron on 25 January 1923. Relocated in February 1926 to Candler Field in Atlanta. Conducted summer training at Maxwell Field, AL, 1922-29. Inactivated on 19 September 1929 at Candler Field by relief of personnel. Reorganized by June 1930 at Candler Field. Reorganized and redesignated as the 458th Bombardment Squadron on 18 August 1933, relieved from the 316th Pursuit Group, and assigned to the 316th Bombardment Group (GHQR). Consolidated on 3 December 1936 with the 458th Aero Squadron (Construction) (a WWI unit organized in February 1918 at Vancouver Barracks, WA; redesignated as the 74th Spruce Squadron in July 1918; demobilized in January 1919 at Vancouver Barracks; reconstituted on 3 December 1936). Conducted summer training at Maxwell Field and Candler Field. Designated mobilization training station was Camp Joseph E. Johnston, FL, (later redesignated Camp J. Clifford R. Foster) 1922-30 and Maxwell Field, AL, 1930-41. Location 7 December 1941—Candler Field, GA.

Status: Disbanded on 31 May 1942.**Commanders, 458th Pursuit Squadron**

Unknown	17 Apr 22-27 Sep 22	1st Lt. Robert E. L. Cone	20 Feb 25-ao Mar 25
1st Lt. Marven K. Curtis	27 Sep 22-10 Nov 22	Unknown	ao Mar 25-19 Sep 29
Capt. William R. Becker	10 Nov 22-20 Feb 25	<i>Inactive</i>	19 Sep 29-ao Jun 30
	Unknown	ao Jun 30-7 Dec 41	

459th Observation Squadron (Second Army)**Organized Reserve Tennessee****HQ-Not initiated** 1921-22; Woodstock Field, Memphis, TN, 1922-29; *Inactive* 1929-41

Constituted in the Organized Reserve on 15 October 1921 as the 459th Squadron (Observation), assigned to the 317th Observation Group (Second Army), and allotted to the Fourth Corps Area. Initiated on 17 April 1922 at Woodstock Field, Memphis, TN. Redesignated as the 459th Observation Squadron on 25 January 1923. Inactivated on 19 September 1929 at Woodstock Field by relief of personnel. Consolidated on 3 December 1936 with the 459th Aero Squadron (Construction) (a WWI unit organized in March 1919 at Vancouver Barracks, WA; redesignated as the 58th Spruce Squadron in July 1918; demobilized in January 1919 at Vancouver Barracks; reconstituted on 3 December 1936). Withdrawn from allotment to the Organized Reserve on 1 January 1938 and allotted to the Regular Army as a RAI unit. Conducted summer training at Maxwell Field, AL. Designated mobilization training station was Camp Joseph E. Johnston, FL, (later redesignated Camp J. Clifford R. Foster) 1922-30 and Maxwell Field, AL, 1930-41. Location 7 December 1941—*Inactive*.

Status: Disbanded on 31 May 1942.**Commanders, 459th Observation Squadron**

Unknown	17 Apr 22-27 Jan 25	Unknown	ao Feb 25-19 Sep 29
1st Lt. Duncan McK. Potter	27 Jan 25-ao Feb 25	<i>Inactive</i>	19 Sep 29-7 Dec 41

460th Observation Squadron (Second Army)**Organized Reserve Ohio****HQ-Not initiated** 1921-22; Marion, OH, 1922-30; *Inactive* 1930-33

Constituted in the Organized Reserve on 15 October 1921 as the 460th Squadron (Observation) assigned to the 317th Observation Group (Second Army), and allotted to the Fifth Corps Area. Initiated in April 1922 at Marion, OH. Redesignated as the 460th Attack Squadron on 25 January 1923. Inactivated by March 1930 at Marion by relief of personnel. Conducted summer training at Wright Field, OH, or Selfridge Field, MI. Demobilized on 1 October 1933.

Commanders, 460th Observation Squadron

Unknown	Apr 22-Mar 30	<i>Inactive</i>	Mar 30-1 Oct 33
---------	---------------	-----------------	-----------------

461st Observation Squadron (1921-23) (Second Army)**Organized Reserve Ohio****461st Attack Squadron (1923-33)****HQ**-Toledo, OH, 1921-30; *Inactive* 1930-33

Constituted in the Organized Reserve on 15 October 1921 as the 461st Squadron (Observation), assigned to the 317th Observation Group (Second Army), and allotted to the Fifth Corps Area. Initiated on 22 January 1923 at Toledo, OH. Redesignated as the 461st Attack Squadron on 25 January 1923. Inactivated by March 1930 at Toledo by relief of personnel. Conducted summer training at Selfridge Field, MI, and some years at Schoen Field, IN. Demobilized on 1 October 1933.

Commanders, 461st Observation Squadron

Unknown	22 Jan 23-Mar 30	<i>Inactive</i>	Mar 30-1 Oct 33
---------	------------------	-----------------	-----------------

462nd Pursuit Squadron (GHQR)**Organized Reserve Indiana/Kentucky****HQ**-*Not initiated* 1921-22; Kokomo, IN, 1922-25; Greenville, KY, 1925-30; *Inactive* 1930-33

Constituted in the Organized Reserve on 15 October 1921 as the 462nd Squadron (Pursuit), assigned to the 318th Pursuit Group (GHQR), and allotted to the Fifth Corps Area. Initiated in March 1922 at Kokomo, IN. Redesignated as the 462nd Pursuit Squadron on 25 January 1923. Relocated on 15 April 1925 to Greenville, KY. Inactivated by March 1930 at Greenville by relief of personnel. Conducted summer training at Selfridge Field, MI, and some years at Schoen Field, IN. Demobilized on 1 October 1933.

Commanders, 462nd Pursuit Squadron

Unknown	Mar 22-23-Mar 30	<i>Inactive</i>	Mar 30-1 Oct 33
---------	------------------	-----------------	-----------------

463rd Pursuit Squadron (GHQR)**Organized Reserve Indiana/Kentucky****HQ**-*Not initiated* 1921-22; Wabash, IN, 1922-25; Somerset, KY, 1925-33

Constituted in the Organized Reserve on 15 October 1921 as the 463rd Squadron (Pursuit), assigned to the 318th Pursuit Group (GHQR), and allotted to the Fifth Corps Area. Initiated in March 1922 at Wabash, IN. Redesignated as the 463rd Pursuit Squadron on 25 January 1923. Relocated on 15 April 1925 to Somerset, KY. Conducted summer training at Selfridge Field, MI, and some years at Schoen Field, IN. Demobilized on 1 October 1933.

Commanders, 463rd Pursuit Squadron

Unknown	Mar 22-1 Oct 33
---------	-----------------

464th Pursuit Squadron (GHQR)**Organized Reserve Indiana/Kentucky****HQ**-Schoen Field, Indianapolis, IN, 1921-33; Warsaw, KY, 1933-30; *Inactive* 1930-41

Constituted in the Organized Reserve on 15 October 1921 as the 464th Squadron (Pursuit), assigned to the 318th Pursuit Group (GHQR), and allotted to the Fifth Corps Area. Initiated on 1 December 1921 at Schoen Field, Indianapolis, IN. The squadron was one of a few in the Organized Reserve that possessed facilities, equipment, and aircraft. Redesignated as the 464th Pursuit Squadron on 25 January 1923. Inactivated by March 1930 at Schoen Field by relief of personnel. Relocated to Warsaw, KY, designated on 21 December 1933 as headquarters on reorganization, but the unit was never organized at that location. Relieved from assignment to the 318th Pursuit Group on 1 October 1933 and assigned to the 306th Pursuit Group. Conducted summer training at Selfridge Field, MI, and some years at Schoen Field, IN, or Camp Perry, OH. Location 7 December 1941—*Inactive*.

Status: Disbanded on 31 May 1942.**Commanders, 464th Pursuit Squadron**

1st Lt. Charles E. Cox	1 Dec 21-ao Jun 22	Unknown	ao Jun 22-Mar 30
	<i>Inactive</i>	Mar 30-7 Dec 41	

465th Pursuit Squadron (GHQR)**Organized Reserve Kentucky****HQ-Not initiated** 1921-22; Bowman Field, Louisville, KY, 1922-30; *Inactive* 1930-33

Constituted in the Organized Reserve on 15 October 1921 as the 465th Squadron (Attack), assigned to the 318th Pursuit Group (GHQR), and allotted to the Fifth Corps Area. Initiated in January 1922 at Louisville, KY. The squadron was one of a few in the Organized Reserve that possessed facilities, equipment, and aircraft. The squadron's equipment was stationed at Bowman Field in Louisville. Redesignated as the 465th Pursuit Squadron on 25 January 1923. Conducted summer training at Selfridge Field, MI, and some years at Schoen Field, IN, or Camp Perry, OH. Demobilized on 1 October 1933. Personnel and equipment transferred to the 325th Observation Squadron.

Commanders, 465th Pursuit Squadron

Capt. L. Stuart Vance	Jan 22-ao Sep 23	Unknown	ao Sep 23-1 Oct 33
-----------------------	------------------	---------	--------------------

466th Headquarters Squadron (Fifth Army)**Organized Reserve Ohio****HQ-Not initiated** 1921-22; Dayton, OH, 1922-28; *Inactive* 1928-41

Constituted in the Organized Reserve on 15 October 1921 as the 466th Squadron (Headquarters), assigned to the Fifth Army and allotted to the Fifth Corps Area. Initiated in April 1922 at Dayton, OH. Redesignated as the 466th Headquarters Squadron on 25 January 1923. Conducted summer training at Wright Field, OH, Camp Dodge, IA, or Camp Perry, OH. Withdrawn from the Fifth Corps Area on 28 November 1928. Location 7 December 1941—*Inactive*.

Status: Disbanded on 31 May 1942.**Commanders, 466th Headquarters Squadron**

1st Lt. John B. Garver	Apr 22-ao Dec 22	Unknown	ao Dec 22-28 Nov 28
	<i>Inactive</i>	28 Nov 28-7 Dec 41	

467th Attack Squadron (GHQR)**Organized Reserve Illinois****HQ-Not initiated** 1921-22; Chicago, IL, 1922-39; *Inactive* 1939-41

Constituted in the Organized Reserve on 15 October 1921 as the 467th Squadron (Attack), assigned to the 319th Attack Group (GHQR), and allotted to the Sixth Corps Area. Initiated on 21 January 1922 at Chicago, IL. Redesignated as the 467th Attack Squadron on 25 January 1923. Relieved from assignment to the 319th Attack Group (GHQR) on 1 October 1933 and assigned to the 309th Attack Group (GHQR). Inactivated in October 1939 at Peoria by relief of personnel. Typically conducted Inactive Training Period meetings at the Municipal Airport in Chicago. Conducted summer training at Chanute Field, IL. Designated mobilization station was Chanute Field, IL. Location 7 December 1941—*Inactive*.

Status: Disbanded on 31 May 1942.**Commanders, 467th Attack Squadron**

Unknown	21 Jan 22-ao Jun 24	Maj. Herbert L. Kumpfer	ao Jul 36-12 Jan 38
Capt. Walter A. Stahl	ao Jun 24-ao Jul 24	Maj. John K. S. Mitchell	12 Jan 38-Oct 39
Unknown	ao Jul 24-ao Jul 36	<i>Inactive</i>	Oct 39-7 Dec 41

468th Attack Squadron (GHQR)**Organized Reserve Illinois****HQ-Not initiated** 1921-22; Municipal Airport, Chicago, IL, 1922-41

Constituted in the Organized Reserve on 15 October 1921 as the 468th Squadron (Attack), assigned to the 319th Attack Group (GHQR), and allotted to the Sixth Corps Area. Initiated on 4 May 1922 at the Municipal Airport, Chicago, IL. Redesignated as the 468th Attack Squadron on 25 January 1923. Relieved from assignment to the 319th Attack Group (GHQR) on 1 October 1933 and assigned to the 309th Attack Group (GHQR). Consolidated on 3 December 1936 with the 468th Aero Squadron (Construction) (a WWI unit organized in August 1917 as the 56th Aero

Squadron [Construction] at Kelly Field, TX; redesignated as the 468th Aero Squadron [Construction] in February 1918; demobilized in July 1919 at Mitchel Field, NY; reconstituted on 3 December 1936). Typically conducted Inactive Training Period meetings at the Municipal Airport in Chicago. Conducted summer training at Selfridge Field, MI, and some years at Scott Field, IL. Designated mobilization station was Chanute Field, IL. Location 7 December 1941—Chicago, IL.

Status: Disbanded on 31 May 1942.

Commanders, 468th Attack Squadron

Capt. Benjamin F. McAuley	4 May 22-ao Jul 22	Unknown	ao Jul 24-27 Feb 26
Unknown	ao Jul 22-ao Jun 24	Maj. Michael G. Harbula	27 Feb 36-ao Sep 39
1st Lt. Owen S. Birdsall	ao Jun 24-ao Jul 24	Unknown	ao Sep 39-7 Dec 41

469th Attack Squadron (GHQR)

Organized Reserve Illinois

HQ-*Not initiated* 1921-22; Rock Island, IL, 1922-23; Moline, IL, 1923-29; *Inactive* 1929-41

Constituted in the Organized Reserve on 15 October 1921 as the 469th Squadron (Attack), assigned to the 319th Attack Group (GHQR), and allotted to the Sixth Corps Area. Initiated on 6 March 1922 at Rock Island, IL. Redesignated as the 469th Attack Squadron on 25 January 1923. Relocated in 1923 to Moline, IL. Inactivated on 10 May 1929 at Moline by relief of personnel. Relieved from assignment to the 319th Attack Group (GHQR) on 1 October 1933 and assigned to the 309th Attack Group (GHQR). Consolidated on 3 December 1936 with the 469th Aero Squadron (Construction) (a WWI unit organized in August 1917 as the 57th Aero Squadron [Construction] at Kelly Field, TX; redesignated as the 469th Aero Squadron [Construction] in February 1918; demobilized in March 1919 at Garden City, NY; reconstituted on 3 December 1936). Conducted summer training at Selfridge Field, MI, and some years at Chanute Field, IL. Designated mobilization station was Chanute Field, IL. Location 7 December 1941—Moline, IL.

Status: Disbanded on 31 May 1942.

Commanders, 469th Attack Squadron

1st Lt. John W. Smith	6 Mar 22-ao Apr 22	Unknown	ao Apr 22-10 May 29
	<i>Inactive</i>	10 May 29-7 Dec 41	

470th Attack Squadron (GHQR)

Organized Reserve Illinois

HQ-*Not initiated* 1921-22; Chicago, IL, 1922-41

Constituted in the Organized Reserve on 15 October 1921 as the 470th Squadron (Attack), assigned to the 319th Attack Group (GHQR), and allotted to the Sixth Corps Area. Initiated on 4 May 1922 at Chicago, IL. Redesignated as the 470th Attack Squadron on 25 January 1923. Relieved from assignment to the 319th Attack Group (GHQR) on 1 October 1933 and assigned to the 309th Attack Group (GHQR). Consolidated on 3 December 1936 with the 470th Aero Squadron (Construction) (a WWI unit organized in August 1917 as the 56th Aero Squadron [Construction] at Kelly Field, TX; redesignated as the 470th Aero Squadron [Construction] in February 1918; demobilized in December 1918 at Garden City, NY; reconstituted on 3 December 1936). Typically conducted Inactive Training Period meetings at the Municipal Airport in Chicago. Conducted summer training at Selfridge Field, MI, and some years at Chanute Field, IL. Designated mobilization station was Chanute Field, IL. Location 7 December 1941—Chicago, IL.

Status: Disbanded on 31 May 1942.

Commanders, 470th Attack Squadron

1st Lt. Ernest L. Byfield	22 Jun 22-1 Jul 22	Unknown	ao Sep 22-ao Jun 24
Capt. James J. Knowles	1 Jul 22-ao Sep 22	Capt. Kenneth T. Price	ao May 24-ao Jun 24
	Unknown	ao Jun 24-7 Dec 41	

471st Observation Squadron (Third Army)**Organized Reserve Minnesota****HQ-**Wold-Chamberlain Field, Minneapolis, MN, 1921-29; *Inactive* 1929-33

Constituted in the Organized Reserve on 15 October 1921 as the 471st Squadron (Observation), assigned to the 320th Observation Group (Third Army), and allotted to the Seventh Corps Area. Initiated on 2 December 1921 at Wold-Chamberlain Field, Minneapolis, MN. Redesignated as the 471st Observation Squadron on 25 January 1923. Inactivated on 30 July 1929 at Minneapolis by relief of personnel. Conducted summer training at Marshall Field, KS. Designated mobilization station was Camp Dodge, IA. Demobilized on 1 October 1933.

Commanders, 471st Observation Squadron

Unknown	2 Dec 21-14 Dec 21	Unknown	ao Mar 22-ao Jun 29
Capt. P. Goldsborough	14 Dec 21-29 Dec 21	Capt. Preston L. Crichton	ao Jun 29-30 Jul 29
Maj. H. H. Sellers	29 Dec 21-ao Mar 22	<i>Inactive</i>	30 Jul 29-1 Oct 33

472nd Attack Squadron (Third Army)**Organized Reserve Oklahoma/Texas/ New York****HQ-***Not initiated* 1921-23; Tulsa, OK, 1923-25; Houston, TX, 1925-36; *Inactive* 1936-41

Constituted in the Organized Reserve on 15 October 1921 as the 472nd Squadron (Attack), assigned to the 321st Attack Group (Third Army), and allotted to the Eighth Corps Area. Redesignated as the 472nd Attack Squadron on 25 January 1923. Enid, OK, initially designated as headquarters on organization, but the unit was never organized at that location. Initiated on 12 May 1923 at Tulsa, OK. Designated mobilization station was Ellington Field, TX. Relocated on 15 April 1925 to Houston, TX. Withdrawn from the Eighth Corps Area on 5 June 1936 and allotted to the Second Corps Area. Inactivated on 31 October 1936 at Houston by relief of personnel. Mitchel Field, NY, designated as headquarters on reorganization, but the unit was never organized at that location. Conducted summer training at various locations to include Post Field, OK; Kelly Field, TX; Fort Crockett U.S. Army Airdrome, TX; and Hensley Field, TX. Location 7 December 1941—*Inactive*.

Status: Disbanded on 31 May 1942.**Commanders, 472nd Attack Squadron**

Unknown	12 May 23-ao Sep 32	Maj. Alva W. Snyder	9 Oct 32-5 Jun 36
Maj. Nicholas Berglund	ao Sep 32-9 Oct 32	<i>Inactive</i>	5 Jun 36-7 Dec 41

473rd Attack Squadron (Third Army)**Organized Reserve Oklahoma/Texas/ New York****HQ-***Not initiated* 1921-23; Tulsa, OK, 1923-25; Houston, TX, 1925-36; *Inactive* 1936-41

Constituted in the Organized Reserve on 15 October 1921 as the 473rd Squadron (Attack), assigned to the 321st Attack Group (Third Army), and allotted to the Eighth Corps Area. Enid, OK, initially designated as headquarters on organization, but the unit was never organized at that location. Redesignated as the 473rd Attack Squadron on 25 January 1923. Initiated on 12 May 1923 at Tulsa, OK. Relocated on 15 April 1925 to Houston, TX. Withdrawn from the Eighth Corps Area on 5 June 1936 and allotted to the Second Corps Area. Inactivated on 31 October 1936 at Houston by relief of personnel. Mitchel Field, NY, designated as headquarters on reorganization, but the unit was never organized at that location. Conducted summer training at various locations to include Post Field, OK; Kelly Field, TX; Fort Crockett U.S. Army Airdrome, TX; and Hensley Field, TX. Designated mobilization station was Ellington Field, TX, 1923-36. Location 7 December 1941—*Inactive*.

Status: Disbanded on 31 May 1942.**Commanders, 473rd Attack Squadron**

Unknown	12 May 23-ao Dec 24	Maj. Charles W. Childress	9 Oct 32-5 Jun 36
1st Lt. James L. Gartner	ao Dec 24-ao Jan 25	<i>Inactive</i>	5 Jun 36-7 Dec 41

474th Attack Squadron (Third Army)**Organized Reserve Oklahoma/Texas/ New York****HQ**-*Not initiated* 1921-23; Okmulgee, OK, 1923-25; Houston, TX, 1925-36; *Inactive* 1936-41

Constituted in the Organized Reserve on 15 October 1921 as the 474th Squadron (Attack), assigned to the 321st Attack Group (Third Army), and allotted to the Eighth Corps Area. Enid, OK, initially designated as headquarters on organization, but the unit was never organized at that location. Redesignated as the 474th Attack Squadron on 25 January 1923. Initiated on 12 May 1923 at Okmulgee, OK. Relocated on 15 April 1925 to Houston, TX. Withdrawn from the Eighth Corps Area on 5 June 1936 and allotted to the Second Corps Area. Inactivated on 31 October 1936 at Houston by relief of personnel. Mitchel Field, NY, designated as headquarters on reorganization, but the unit was never organized at that location. Conducted summer training at various locations to include Post Field, OK; Kelly Field, TX; and Fort Crockett U.S. Army Airdrome, TX. Designated mobilization station was Ellington Field, TX, 1923-36. Location 7 December 1941—*Inactive*.

Status: Disbanded on 31 May 1942.**Commanders, 474th Attack Squadron**

Unknown	12 May 23-ao Dec 24	Unknown	ao Jan 25-31 Oct 36
1st Lt. William A. Burke	ao Dec 24-ao Jan 25	<i>Inactive</i>	31 Oct 36-7 Dec 41

475th Attack Squadron (Third Army)**Organized Reserve Texas/ New York****HQ**-*Not initiated* 1921-22; San Antonio, TX, 1922-25; Houston, TX, 1925-36; *Inactive* 1936-41

Constituted in the Organized Reserve on 15 October 1921 as the 475th Squadron (Attack), assigned to the 321st Attack Group (Third Army), and allotted to the Eighth Corps Area. Redesignated as the 475th Attack Squadron on 25 January 1923. Initiated on 12 March 1923 at San Antonio, TX. Relocated on 15 April 1925 to Houston, TX. Withdrawn from the Eighth Corps Area on 5 June 1936 and allotted to the Second Corps Area. Inactivated on 31 October 1936 at Houston by relief of personnel. Consolidated on 16 November 1936 with the 475th Aero Squadron (a WWI unit organized in September 1917 at Kelly Field, TX, as the 63rd Aero Squadron; redesignated as the 475th Aero Squadron [Construction] in February 1918; demobilized in December 1918 at Garden City, NY; reconstituted on 16 November 1936). Mitchel Field, NY, designated as headquarters on reorganization, but the unit was never organized at that location. Conducted summer training at various locations to include Post Field, OK; Kelly Field, TX; and Fort Crockett U.S. Army Airdrome, TX. Designated mobilization station was Ellington Field, TX, 1923-36. Location 7 December 1941—*Inactive*.

Status: Disbanded on 31 May 1942.**Commanders, 475th Attack Squadron**

Capt. Earl David	12 Mar 23-ao Dec 23	Unknown	ao Jan 25-ao Aug 26
Unknown	ao Dec 23-ao Dec 24	Capt. Ralph W. Stone	ao Aug 26-ao Sep 27
1st Lt. Ernest A. E. Pratt	ao Dec 24-ao Jan 25	Unknown	ao Sep 27-31 Oct 36
	<i>Inactive</i>	31 Oct 36-7 Dec 41	

476th Pursuit Squadron (Third Army)**Organized Reserve Oregon/California****HQ**-*Not initiated* 1921-22; Eugene, OR, 1922-30; *Inactive* 1930-33

Constituted in the Organized Reserve on 15 October 1921 as the 476th Squadron (Pursuit), assigned to the 322nd Pursuit Group (Third Army), and allotted to the Ninth Corps Area. Initiated on 14 February 1922 at Eugene, OR. Redesignated as the 476th Pursuit Squadron on 25 January 1923. Relieved from assignment to the Third Army on 31 March 1924 and assigned to the General Headquarters Reserve. The squadron adopted the nickname "Black Falcons" in 1925. Sid Grauman, of Grauman's Chinese Theater, was a unit sponsor in the 1920s. Inactivated on 19 March 1930 at Eugene by relief of personnel. Los Angeles, CA, designated as headquarters on reorganization, but the unit was never organized at that location. Consolidated on 24 January 1931 with the 476th Aero Squadron (a WWI unit organized 11 August 1917 at Kelly Field, TX, as the 64th Aero Squadron; redesignated as the 476th Aero Squadron [Construction] in February 1918; demobilized on 23 December 1918 at Garden City, NY; reconstituted on 24 January 1931). Conducted summer training at Clover Field, CA, and Rockwell Field, CA. Demobilized on 1 October 1933.

Commanders, 476th Pursuit Squadron

2nd Lt. Frederic F. T. Watson	14 Feb 22-ao Mar 22	1st Lt. H. B. Pentland	Mar 25-ao Aug 25
Unknown	ao Mar 22-Jan 25	Unknown	ao Aug 25-ao Nov 29
Capt. Peyton Gibson	Jan 25-Mar 25	1st Lt. Rufus J. Pilcher	ao Nov 29-19 Mar 30
	<i>Inactive</i>	19 Mar 30-7 Dec 41	

477th Pursuit Squadron (Third Army)

Organized Reserve California

HQ-*Not initiated* 1921-22; Crissy Field, San Francisco, CA, 1922-29; *Inactive* 1929-33

Constituted in the Organized Reserve on 15 October 1921 as the 477th Squadron (Pursuit), assigned to the 322nd Pursuit Group (Third Army), and allotted to the Ninth Corps Area. Initiated on 14 February 1922 at Crissy Field, San Francisco, CA. Redesignated as the 477th Pursuit Squadron on 25 January 1923. Relieved from assignment to the Third Army 31 March 1924 and assigned to the General Headquarters Reserve. Inactivated on 20 October 1929 at Crissy Field by relief of personnel. Los Angeles, CA, designated as headquarters on reorganization, but the unit was never organized at that location. Consolidated on 24 January 1931 with the 477th Aero Squadron (a WWI unit organized 11 August 1917 at Kelly Field, TX, as the 65th Aero Squadron; redesignated as the 477th Aero Squadron [Construction] in February 1918; demobilized on 29 January 1919 at Garden City, NY; reconstituted on 24 January 1931). Conducted summer training at Crissy Field, CA, Clover Field, CA, and Rockwell Field, CA. Demobilized on 1 October 1933.

Commanders, 477th Pursuit Squadron

Capt. Livingston G. Irving	14 Feb 22-ao Mar 22	Unknown	ao Apr 25-ao Jul 27
Unknown	ao Mar 22-Mar 25	Capt. James L. Giffin	ao Jul 27-30 Oct 29
Capt. Peyton Gibson	Mar 25-ao Apr 25	<i>Inactive</i>	20 Oct 29-1 Oct 33

478th Pursuit Squadron (Third Army)

Organized Reserve California

HQ-*Not initiated* 1921-22; Municipal Airport, Long Beach, CA, 1922-33

Constituted in the Organized Reserve on 15 October 1921 as the 478th Squadron (Pursuit), assigned to the 322nd Pursuit Group (Third Army), and allotted to the Ninth Corps Area. Initiated on 14 February 1922 at the Los Angeles Municipal Airport, Long Beach, CA. Redesignated as the 478th Pursuit Squadron on 25 January 1923. Relieved from assignment to the Third Army 31 March 1924 and assigned to the General Headquarters Reserve. Squadron members designated Hollywood actress Bebe Daniels as the honorary major of the squadron in 1931. Miss Daniels returned the honor by personally outfitting the squadron's meeting rooms at the Long Beach Municipal Airport at her own expense. Conducted summer training at Clover Field, CA, and Rockwell Field, CA. Demobilized on 1 October 1933. Personnel concurrently transferred to the 479th Pursuit Squadron.

Commanders, 478th Pursuit Squadron

Capt. William A. Frye	14 Feb 22-ao Feb 28	Capt. Lysle R. Bass	ao Jan 29-1 Oct 33
-----------------------	---------------------	---------------------	--------------------

479th Pursuit Squadron (Third Army)

Organized Reserve California

HQ-*Not initiated* 1921-22; San Diego, CA, 1922-30; Municipal Airport, Los Angeles, CA, 1930-37; *Inactive* 1937-41

Constituted in the Organized Reserve on 15 October 1921 as the 479th Squadron (Pursuit), assigned to the 322nd Pursuit Group (Third Army), and allotted to the Ninth Corps Area. Initiated on 7 February 1922 at San Diego, CA. Redesignated as the 479th Pursuit Squadron on 25 January 1923. Relieved from assignment to the Third Army 31 March 1924 and assigned to the General Headquarters Reserve. Relocated on 28 January 1930 to the Los Angeles Municipal Airport, Los Angeles, CA. There the squadron became one of a few in the Organized Reserve that possessed facilities, equipment, and aircraft. Consolidated on 24 January 1931 with the 479th Aero Squadron (a WWI unit organized 12 August 1917 at Kelly Field, TX, as the 67th Aero Squadron; redesignated as the 479th Aero Squadron [Construction] in February 1918; demobilized on 31 December 1918 at Garden City, NY; reconstituted on 24 January

1931). Supported a public demonstration of antiaircraft capabilities by the 63rd Coast Artillery at Fort MacArthur, CA, in June 1933. Conducted summer training at Clover Field, CA; Rockwell Field, CA; and Long Beach Municipal Airport. Inactivated on 2 September 1937 at Los Angeles by relief of personnel. Location 7 December 1941—Los Angeles, CA.

Status: Disbanded on 31 May 1942.

Commanders, 479th Pursuit Squadron

Maj. Arthur J. Davis	7 Feb 22-ao Oct 22	Capt. Frank B. Dudley	10 Jun 24-ao Jul 24
Unknown	ao Oct 23-ao Nov 23	Unknown	ao Jul 24-ao Nov 31
Maj. Theodore C. McCauley	ao Nov 23-ao Jan 24	Capt. Ed Deeds	ao Nov 31-9 Feb 33
Unknown	ao Jan 24-10 Jun 24	Maj. William A. Frye	9 Feb 33-2 Sep 37
	<i>Inactive</i>	2 Sep 37-7 Dec 41	

480th Headquarters Squadron (Third Army)

Organized Reserve California

HQ-*Not initiated* 1921-22; Municipal Airport, Oakland, CA, 1922-28; *Inactive* 1928-41

Constituted in the Organized Reserve on 15 October 1921 as the 480th Squadron (Headquarters), assigned to the Third Army and allotted to the Ninth Corps Area. Initiated on 31 March 1922 at Oakland, CA. Redesignated as the 480th Headquarters Squadron on 25 January 1923. Withdrawn from the Ninth Corps Area on 28 November 1928. Location 7 December 1941—*Inactive*.

Status: Disbanded on 31 May 1942.

Commanders, 480th Headquarters Squadron

Unknown	31 Mar 22-28 Nov 28	<i>Inactive</i>	29 Nov 28-7 Dec 41
---------	---------------------	-----------------	--------------------

481st Bombardment Squadron (GHQR)

Organized Reserve Maryland

HQ-*Not initiated* 1924-25; Baltimore, MD, 1925-40; *Inactive* 1940-41

Constituted in the Organized Reserve on 31 March 1924, assigned to the 347th Bombardment Group (GHQR), and allotted to the Third Corps Area. Initiated in March 1925 at Baltimore, MD. Consolidated on 3 December 1936 with the 481st Aero Squadron (a WWI unit organized in August 1917 at Kelly Field, TX, as the 69th Aero Squadron; redesignated as the 481st Aero Squadron [Construction] in February 1918; demobilized in February 1919 at Garden City, NY; reconstituted on 3 December 1936). Conducted summer training at Langley Field, VA. Inactivated by June 1940 at Baltimore by relief of personnel. Location 7 December 1941—*Inactive*.

Status: Disbanded on 31 May 1942.

Commanders, 481st Bombardment Squadron

Unknown	Mar 25-8 Oct 29	Capt. Harold F. Mook	6 Aug 31-27 Feb 32
Capt. Christopher J. Evans	23 Jul 29-8 Oct 29	Maj. Merrill K. Riddick	27 Feb 32-11 Apr 37
Maj. Joseph S. Marriott	8 Oct 29-Dec 29	Maj. Alexis B. McMullen	11 Apr 37-ao Sep 37
Maj. Cecil G. Sellers	Dec 29-22 Apr 30	Unknown	ao Sep 37-ao Jun 40
Maj. Joseph S. Marriott	22 Apr 30-6 Aug 31	<i>Inactive</i>	ao Jun 40-7 Dec 41

482nd Bombardment Squadron (GHQR)

Organized Reserve Maryland

HQ-*Not initiated* 1924-25; Baltimore, MD, 1925-29; *Inactive* 1929-41

Constituted in the Organized Reserve on 31 March 1924, assigned to the 347th Bombardment Group (GHQR), and allotted to the Third Corps Area. Initiated in March 1925 at Baltimore, MD. Inactivated on 23 July 1929 at Baltimore by relief of personnel. Consolidated on 2 December 1936 with the 482nd Aero Squadron (a WWI unit organized in August 1917 at Kelly Field, TX, as the 70th Aero Squadron; redesignated as the 482nd Aero Squadron [Construction] in February 1918; demobilized in March 1919 at Garden City, NY; reconstituted on 2 December 1936). Conducted summer training at Langley Field, VA. Location 7 December 1941—*Inactive*.

Status: Disbanded on 31 May 1942. Reconstituted and consolidated 28 February 1944 with the 482nd Bombardment Squadron (Very Heavy); inactivated on 30 June 1946 at Clark Field, PI.

Commanders, 482nd Bombardment Squadron

1st Lt. Richard W. Phillips

Mar 25-23 Jul 29

Inactive

23 Jul 29-7 Dec 41

483rd Bombardment Squadron (GHQR)

Organized Reserve Pennsylvania

HQ-*Not initiated* 1924-25; Coplay, PA, 1925-29; *Inactive* 1929-41

Constituted in the Organized Reserve on 31 March 1924, assigned to the 347th Bombardment Group (GHQR), and allotted to the Third Corps Area. Initiated in March 1925 at Coplay, PA. Inactivated on 23 July 1929 at Coplay by relief of personnel. Consolidated on 2 December 1936 with the 483rd Aero Squadron (a WWI unit organized in August 1917 at Kelly Field, TX, as the 71st Aero Squadron; redesignated as the 483rd Aero Squadron [Construction] in February 1918; demobilized in February 1919 at Camp Lee, VA; reconstituted on 2 December 1936). Conducted summer training at Phillips Field, MD, with the 49th Bombardment Squadron. Location 7 December 1941—*Inactive*.

Status: Disbanded on 31 May 1942.

Commanders, 483rd Bombardment Squadron

Capt. John R. Wright

Mar 25-23 Jul 29

Inactive

23 Jul 29-7 Dec 41

484th Bombardment Squadron (GHQR)

Organized Reserve Pennsylvania/Oklahoma/New Jersey

HQ-*Not initiated* 1924-29; Oklahoma City, OK, 1929-36; Camden, NJ 1936-37; *Inactive* 1937-41

Constituted in the Organized Reserve on 31 March 1924, assigned to the 347th Bombardment Group (GHQR), and allotted to the Third Corps Area. Withdrawn from the Third Corps Area on 21 May 1929 and allotted to the Eighth Corps Area. Initiated by December 1929 at Oklahoma City, OK. Conducted summer training at Hensley Field, TX. Withdrawn from the Eighth Corps Area on 5 June 1936 and allotted to the Second Corps Area. Reorganized by December 1936 at Camden, NJ. Consolidated on 2 December 1936 with the 484th Aero Squadron (a WWI unit organized in August 1917 at Kelly Field, TX, as the 72nd Aero Squadron; redesignated as the 484th Aero Squadron [Construction] in February 1918; demobilized in February 1919 at East Potomac Park, Washington, DC; reconstituted on 2 December 1936). Inactivated on 12 May 1937 at Camden by relief of personnel. Location 7 December 1941—*Inactive*.

Status: Disbanded on 31 May 1942. Reconstituted and consolidated 28 February 1944 with the 484th Bombardment Squadron (Very Heavy); inactivated on 30 June 1946 at Clark Field, PI.

Commanders, 484th Bombardment Squadron

Unknown

ao Dec 29-9 Oct 32

Unknown

5 Jun 36-12 May 37

Maj. Cecil G. Sellers

9 Oct 32-5 Jun 36

Inactive

12 May 37-7 Dec 41

485th Bombardment Squadron (GHQR)

Organized Reserve Ohio

HQ-*Not initiated* 1924-25; Dayton, OH, 1925-37; *Inactive* 1937-41

Constituted in the Organized Reserve on 31 March 1924, assigned to the 348th Bombardment Group (GHQR), and allotted to the Fifth Corps Area. Initiated in September 1925 at Dayton, OH. Consolidated on 5 December 1936 with the 485th Aero Squadron (a WWI unit organized in August 1917 at Kelly Field, TX, as the 73rd Aero Squadron; redesignated as the 485th Aero Squadron [Construction] in February 1918; demobilized in May 1919 at Mitchel Field, NY; reconstituted on 5 December 1936). Inactivated by June 1937 at Dayton by relief of personnel. Location 7 December 1941—*Inactive*.

Status: Disbanded on 31 May 1942. Reconstituted and consolidated 28 February 1944 with the 485th Bombardment Squadron (Very Heavy); inactivated on 10 June 1946 at Northwest Field, Guam.

Commanders, 485th Bombardment Squadron

Unknown Sep 25-ao Jun 37 *Inactive* ao Jun 37-7 Dec 41

486th Bombardment Squadron (GHQR)

Organized Reserve Indiana

HQ-*Not initiated* 1924-25; Schoen Field, Indianapolis, IN, 1925-30; *Inactive* 1930-41

Constituted in the Organized Reserve on 31 March 1924, assigned to the 348th Bombardment Group (GHQR), and allotted to the Fifth Corps Area. Initiated in September 1925 at Schoen Field, Indianapolis, IN. Inactivated by March 1930 at Schoen Field by relief of personnel. Consolidated on 5 December 1936 with the 486th Aero Squadron (a WWI unit organized in August 1917 at Kelly Field, TX, as the 74th Aero Squadron; redesignated as the 486th Aero Squadron [Construction] in February 1918; demobilized in June 1919 at Mitchel Field, NY; reconstituted on 5 December 1936). Conducted summer training at Schoen Field, IN. Location 7 December 1941—*Inactive*.

Status: Disbanded on 31 May 1942.

Commanders, 486th Bombardment Squadron

Unknown Sep 25-Mar 30 *Inactive* Mar 30-7 Dec 41

487th Bombardment Squadron (GHQR)

Organized Reserve Kentucky

HQ-*Not initiated* 1924-25; Bowman Field, Louisville, KY, 1925-30; *Inactive* 1930-41

Constituted in the Organized Reserve on 31 March 1924, assigned to the 348th Bombardment Group (GHQR), and allotted to the Fifth Corps Area. Initiated in September 1925 at Bowman Field, KY. Inactivated by March 1930 at Bowman Field by relief of personnel. Consolidated on 5 December 1936 with the 487th Aero Squadron (a WWI unit organized in August 1917 at Kelly Field, TX, as the 75th Aero Squadron; redesignated as the 487th Aero Squadron [Construction] in February 1918; demobilized on 17 May 1919 at Mitchel Field, NY; reconstituted on 5 December 1936). Location 7 December 1941—*Inactive*.

Status: Disbanded on 31 May 1942.

Commanders, 487th Bombardment Squadron

Unknown Sep 25-Mar 30 *Inactive* Mar 30-7 Dec 41

488th Bombardment Squadron (GHQR)

Organized Reserve West Virginia

HQ-*Not initiated* 1924-25; Williamson, WV 1925-36; *Inactive* 1936-41

Constituted in the Organized Reserve on 31 March 1924, assigned to the 348th Bombardment Group (GHQR), and allotted to the Fifth Corps Area. Initiated in September 1925 at Williamson, WV. Inactivated on 3 November 1936 at Williamson by relief of personnel. Consolidated on 5 December 1936 with the 488th Aero Squadron (a WWI unit organized in August 1917 at Kelly Field, TX, as the 76th Aero Squadron; redesignated as the 488th Aero Squadron [Construction] in February 1918; demobilized in March 1919 at Langley Field, VA; reconstituted on 5 December 1936). Huntington, WV, designated as headquarters on reorganization, but the unit was never organized at that location. Location 7 December 1941—*Inactive*.

Status: Disbanded on 31 May 1942.

Commanders, 488th Bombardment Squadron

Unknown Sep 25-3 Nov 36 *Inactive* 3 Nov 36-7 Dec 41

489th Bombardment Squadron (GHQR)**Organized Reserve Washington****HQ-Not initiated** 1924-25; Boeing Field, Seattle, WA, 1925-41

Constituted in the Organized Reserve on 31 March 1924, assigned to the 349th Bombardment Group (GHQR), and allotted to the Ninth Corps Area. Initiated in January 1925 at Boeing Field, Seattle, WA. The squadron was one of a few in the Organized Reserve that possessed facilities, equipment, and aircraft. Consolidated in June 1932 with the 489th Aero Squadron (a WWI unit organized 13 August 1917 at Kelly Field, TX, as the 77th Aero Squadron; redesignated as the 489th Aero Squadron [Construction] in February 1918; demobilized on 6 March 1919 at Camp Lee, VA; reconstituted in June 1932). Typically conducted Inactive Training Period meetings at the Butler Hotel and Boeing Field in Seattle. Conducted summer training at various locations to include Rockwell Field, CA, Pearson Field, WA, and Gray Field, WA. Location 7 December 1941—Seattle, WA, (Inactivated on 30 January 1942 by relief of personnel).

Status: Disbanded on 31 May 1942. Reconstituted and consolidated in 1958 with the 489th Bombardment Squadron (Medium). Inactivated on 1 January 1962 at Whitman A.F.B., MO.

Commanders, 489th Bombardment Squadron

Maj. Donald G. Graham	Jan 25-12 Feb 30	Maj. Robert D. Bedinger	2 Mar 39-ao Jun 39
Maj. David G. Logg	12 Feb 30-20 Feb 39	Unknown	ao Jun 39-7 Dec 41

490th Bombardment Squadron (GHQR)**Organized Reserve Washington****HQ-Not initiated** 1924-25; Sand Point Airport, Seattle, WA, 1925-37; *Inactive* 1937-41

Constituted in the Organized Reserve on 31 March 1924, assigned to the 349th Bombardment Group (GHQR), and allotted to the Ninth Corps Area. Initiated in January 1925 at Seattle, WA. Consolidated on 5 December 1936 with the 490th Aero Squadron (a WWI unit organized in August 1917 at Kelly Field, TX, as the 78th Aero Squadron; redesignated as the 490th Aero Squadron [Construction] in February 1918; demobilized in February 1919 at Garden City, NY; reconstituted on 5 December 1936). Conducted summer training at various locations to include Rockwell Field, CA, Pearson Field, WA, Boeing Field, WA, and Gray Field, WA. Inactivated on 2 March 1937 at Seattle by relief of personnel. Location 7 December 1941—*Inactive*.

Status: Disbanded on 31 May 1942.

Commanders, 490th Bombardment Squadron

Unknown	Jan 25-2 Mar 37	<i>Inactive</i>	2 Mar 37-7 Dec 41
---------	-----------------	-----------------	-------------------

491st Bombardment Squadron (GHQR)**Organized Reserve Washington****HQ-Not initiated** 1924-25; Sand Point Airport, Seattle, WA, 1925-37; *Inactive* 1937-41

Constituted in the Organized Reserve on 31 March 1924, assigned to the 349th Bombardment Group (GHQR), and allotted to the Ninth Corps Area. Initiated in January 1925 at Sand Point Airport, Seattle, WA. Consolidated on 5 December 1936 with the 491st Aero Squadron (a WWI unit organized in August 1917 at Kelly Field, TX, as the 79th Aero Squadron; redesignated as the 491st Aero Squadron [Construction] in February 1918; demobilized in January 1919 at Garden City, NY; reconstituted on 5 December 1936). Conducted summer training at various locations to include Rockwell Field, CA, and Pearson Field, WA. Inactivated on 2 March 1937 at Seattle by relief of personnel. Location 7 December 1941—*Inactive*.

Status: Disbanded on 31 May 1942. Reconstituted and consolidated in 1958 with the 491st Bombardment Squadron (Medium). Inactivated on 25 June 1961 at Dyess A.F.B., TX.

Commanders, 491st Bombardment Squadron

Unknown	Jan 25-2 Mar 37	<i>Inactive</i>	2 Mar 37-7 Dec 41
---------	-----------------	-----------------	-------------------

492nd Bombardment Squadron (GHQR)**Organized Reserve Washington****HQ**-*Not initiated* 1924-25; Sand Point Airport, Seattle, WA, 1925-37; *Inactive* 1937-41

Constituted in the Organized Reserve on 31 March 1924, assigned to the 349th Bombardment Group (GHQR), and allotted to the Ninth Corps Area. Initiated in January 1925 at Sand Point Airport, Seattle, WA. Consolidated on 5 December 1936 with the 492nd Aero Squadron (a WWI unit organized 11 August 1917 at Kelly Field, TX, as the 80th Aero Squadron; redesignated as the 492nd Aero Squadron [Construction] on 1 February 1918; demobilized in February 1919 at Garden City, NY; reconstituted on 5 December 1936). Conducted summer training at various locations to include Rockwell Field, CA, and Pearson Field, WA. Inactivated on 2 March 1937 at Seattle by relief of personnel. Location 7 December 1941—*Inactive*.

Status: Disbanded on 31 May 1942. Reconstituted and consolidated 31 March 1960 with the 492nd Bombardment Squadron (Very Heavy). Inactivated on 3 February 1963 at Columbus A.F.B., MS.

Commanders, 492nd Bombardment Squadron

Unknown	Jan 25-2 Mar 37	<i>Inactive</i>	2 Mar 37-7 Dec 41
---------	-----------------	-----------------	-------------------

493rd Bombardment Squadron (GHQR)**Organized Reserve Wisconsin****HQ**-*Not initiated* 1924-26; Racine, WI, 1926-29; *Inactive* 1929-37; Milwaukee, WI, 1937-41

Constituted in the Organized Reserve on 31 March 1924, assigned to the 350th Bombardment Group (GHQR), and allotted to the Sixth Corps Area. Initiated on 8 September 1926 at Racine, WI. Inactivated on 1 December 1929 at Racine by relief of personnel. Consolidated on 5 December 1936 with the 493rd Aero Squadron (a WWI unit organized in July 1917 at Kelly Field, TX, as the 45th Aero Squadron; redesignated as the 81st Aero Squadron August 1917; redesignated as the 493rd Aero Squadron [Construction] in February 1918; demobilized in January 1919 at Camp Devens, MA; reconstituted on 5 December 1936). Reorganized on 28 July 1937 at Milwaukee, WI. Conducted summer training at various locations to include Selfridge Field, MI, Chanute Field, IL, and Scott Field, IL. Location 7 December 1941—Milwaukee, WI.

Status: Disbanded on 31 May 1942.

Commanders, 493rd Bombardment Squadron

Maj. Fred W. Sizer	8 Sep 26-1 Dec 29	<i>Inactive</i>	1 Dec 29-28 Jul 37
	Unknown	28 Jul 37-7 Dec 41	

494th Bombardment Squadron (GHQR)**Organized Reserve Wisconsin/Illinois****HQ**-*Not initiated* 1924-26; Peoria, IL, 1926-41

Constituted in the Organized Reserve on 31 March 1924, assigned to the 350th Bombardment Group (GHQR), and allotted to the Sixth Corps Area. Kenosha, WI, initially designated as headquarters on organization, but the unit was never organized at that location. Designated headquarters location changed 28 July 1925 to Peoria, IL. Initiated on 8 September 1926 at Peoria. Consolidated on 7 December 1936 with the 494th Aero Squadron (a WWI unit organized in August 1917 at Kelly Field, TX, as the 82nd Aero Squadron; redesignated as the 494th Aero Squadron [Construction] in February 1918; demobilized in May 1919 at Mitchel Field, NY; reconstituted on 7 December 1936). Conducted summer training at various locations to include Selfridge Field, MI, Chanute Field, IL, and Scott Field, IL. Location 7 December 1941—Peoria, IL.

Status: Disbanded on 31 May 1942.

Commanders, 494th Bombardment Squadron

Unknown	8 Sep 26-ao Jul 36	Capt. W. L. Snowden	ao Jul 36-ao Dec 39
	Unknown	ao Dec 39-7 Dec 41	

495th Bombardment Squadron (GHQR)**Organized Reserve Wisconsin/Illinois****HQ**-*Not initiated* 1924-26; Alton, IL, 1926-29; *Inactive* 1929-41

Constituted in the Organized Reserve on 31 March 1924, assigned to the 350th Bombardment Group (GHQR), and allotted to the Sixth Corps Area. Janesville, WI, initially designated as headquarters on organization, but the unit was never organized at that location. Designated headquarters location changed 28 July 1925 to Alton, IL. Initiated on 8 September 1926 at Alton. Inactivated on 1 December 1929 at Alton by relief of personnel. Consolidated on 7 December 1936 with the 495th Aero Squadron (a WWI unit organized in August 1917 at Kelly Field, TX, as the 83rd Aero Squadron; redesignated as the 495th Aero Squadron [Construction] in February 1918; demobilized in January 1919 at Garden City, NY; reconstituted on 7 December 1936). Conducted summer training at Selfridge Field, MI, or Chanute Field, IL. Location 7 December 1941—*Inactive*.

Status: Disbanded on 31 May 1942.**Commanders, 495th Bombardment Squadron**

Unknown	8 Sep 26-1 Dec 29	<i>Inactive</i>	1 Dec 29-7 Dec 41
---------	-------------------	-----------------	-------------------

496th Bombardment Squadron (GHQR)**Organized Reserve Wisconsin****HQ**-*Not initiated* 1924-26; West Allis, WI, 1926-28; *Inactive* 1928-41

Constituted in the Organized Reserve on 31 March 1924, assigned to the 350th Bombardment Group (GHQR), and allotted to the Sixth Corps Area. Initiated on 8 September 1926 at West Allis, WI. Conducted summer training at Selfridge Field, MI. Withdrawn from the Sixth Corps Area on 30 November 1928. Location 7 December 1941—*Inactive*.

Status: Disbanded on 31 May 1942.**Commanders, 496th Bombardment Squadron**

Unknown	8 Sep 26-7 Dec 41
---------	-------------------

497th Pursuit Squadron (GHQR)**Organized Reserve Wisconsin****HQ**-Milwaukee, WI, 1924-33

Constituted in the Organized Reserve on 31 March 1924 as the 497th Squadron (Pursuit), assigned to the 351st Pursuit Group (GHQR), and allotted to the Sixth Corps Area. Redesignated as the 497th Pursuit Squadron on 25 January 1923. Initiated by December 1924 at Milwaukee, WI. Conducted summer training at Selfridge Field, MI. Demobilized on 1 October 1933.

Commanders, 497th Pursuit Squadron

Unknown	ao Dec 24-1 Oct 33
---------	--------------------

498th Pursuit Squadron (GHQR)**Organized Reserve Wisconsin****HQ**-Waukesha, WI, 1924-33

Constituted in the Organized Reserve on 31 March 1924 as the 498th Squadron (Pursuit), assigned to the 351st Pursuit Group (GHQR), and allotted to the Sixth Corps Area. Redesignated as the 498th Pursuit Squadron on 25 January 1923. Initiated by December 1924 at Waukesha, WI. Conducted summer training at Selfridge Field, MI. Demobilized on 1 October 1933.

Commanders, 498th Pursuit Squadron

Unknown	ao Dec 24-1 Oct 33
---------	--------------------

499th Pursuit Squadron (GHQR)**Organized Reserve Illinois/Wisconsin****HQ**-Chicago, IL, 1924-29; Madison, WI, 1929-33

Constituted in the Organized Reserve on 31 March 1924 as the 499th Squadron (Pursuit), assigned to the 351st Pursuit Group (GHQR), and allotted to the Sixth Corps Area. Redesignated as the 499th Pursuit Squadron on 25 January 1923. Initiated by December 1924 at Chicago, IL. Relocated on 29 March 1929 to Madison, WI. Conducted summer training at Selfridge Field, MI. Demobilized on 1 October 1933.

Commanders, 499th Pursuit Squadron

Unknown	ao Dec 24-1 Oct 33
---------	--------------------

500th Pursuit Squadron (GHQR)**Organized Reserve Illinois/Wisconsin****HQ**-Rockford, IL, 1924-27; Beaver Dam, WI, 1927-33

Constituted in the Organized Reserve on 31 March 1924, assigned to the 351st Pursuit Group (GHQR), and allotted to the Sixth Corps Area. Initiated by December 1924 at Rockford, IL. Relocated in 1927 to Beaver Dam, WI. Conducted summer training at Selfridge Field, MI, 1922-33. Designated mobilization station was Selfridge Field, MI. Demobilized on 1 October 1933.

Commanders, 500th Pursuit Squadron

Unknown	ao Dec 24-1 Oct 33
---------	--------------------

501st Pursuit Squadron (1921-33) (GHQR)**Organized Reserve Pennsylvania****501st Transport Squadron (1933-41)****HQ**-Philadelphia, PA, 1921-29; *Inactive* 1929-41

Constituted in the Organized Reserve on 15 October 1921, assigned to the 326th Pursuit Group (GHQR), and allotted to the Third Corps Area. Initiated on 7 November 1921 at Philadelphia, PA. Inactivated on 23 July 1929 at Philadelphia by relief of personnel. Reorganized and redesignated as the 501st Transport Squadron on 1 October 1933 and relieved from assignment to the 326th Pursuit Group. Consolidated on 7 December 1936 with the 501st Aero Squadron (Construction) (a WWI unit organized in December 1917 as the 205th Aero Squadron at Camp Morrison, VA; redesignated as the 501st Aero Squadron [Construction] in February 1918; demobilized in January 1919 at Langley Field, VA; reconstituted on 7 December 1936). Location 7 December 1941—*Inactive*.

Status: Disbanded on 31 May 1942.**Commanders, 501st Pursuit Squadron**

Capt. Harry Weber	7 Nov 21-ao Oct 22	Capt. Lloyd O. Yost	ao Jul 23-14 Jun 26
Unknown	ao Oct 22-ao Jul 23	Capt. Lawrence H. Richards	14 Jun 26-23 Jul 29
	<i>Inactive</i>	23 Jul 29-7 Dec 41	

502nd Pursuit Squadron (1921-33) (GHQR)**Organized Reserve Pennsylvania****502nd Transport Squadron (1933-41)****HQ**-Philadelphia, PA, 1921-29; *Inactive* 1929-41

Constituted in the Organized Reserve on 15 October 1921, assigned to the 326th Pursuit Group (GHQR), and allotted to the Third Corps Area. Initiated on 8 November 1921 at Philadelphia, PA. Inactivated on 23 July 1929 at Philadelphia by relief of personnel. Reorganized and redesignated as the 502nd Transport Squadron on 1 October 1933 and relieved from assignment to the 326th Pursuit Group. Consolidated on 7 December 1936 with the 502nd Aero Squadron (Construction) (a WWI unit organized in December 1917 as the 206th Aero Squadron at Camp Morrison, VA; redesignated as the 502nd Aero Squadron [Construction] in February 1918; demobilized in January 1919 at Garden City, NY; reconstituted on 7 December 1936). Conducted summer training at Selfridge Field, MI. Location 7 December 1941—*Inactive*.

Status: Disbanded on 31 May 1942.

Commanders, 502nd Pursuit Squadron

2nd Lt. Lawrence G. Coveney	7 Nov 21-ao Jan 22	1st Lt. John S. Owens	ao Jul 23-Aug 23
1st Lt. Ejner C. Myland	ao Sep 22-ao Oct 22	Capt. Elihu H. Kelton	Aug 23-21 Oct 26
Unknown	ao Oct 22-ao Jul 23	Maj. William A. Robertson	21 Oct 26-23 Jul 29
	<i>Inactive</i>	23 Jul 29-7 Dec 41	

503rd Pursuit Squadron (1921-33) (GHQR)

Organized Reserve Pennsylvania

503rd Transport Squadron (1933-41)

HQ-*Not initiated* 1921-22; Harrisburg, PA, 1922-29; *Inactive* 1929-41

Constituted in the Organized Reserve on 15 October 1921, assigned to the 326th Pursuit Group (GHQR), and allotted to the Third Corps Area. Initiated on 21 March 1922 at Harrisburg, PA. Inactivated on 23 July 1929 at Harrisburg by relief of personnel. Philadelphia, PA, designated on 11 December 1929 as headquarters on reorganization, but the unit was never organized at that location. Reorganized and redesignated as the 503rd Transport Squadron on 1 October 1933 and relieved from assignment to the 326th Pursuit Group. Consolidated on 7 December 1936 with the 503rd Aero Squadron (Construction) (a WWI unit organized in December 1917 as the 207th Aero Squadron at Camp Morrison, VA; redesignated as the 501st Aero Squadron [Construction] in February 1918; demobilized in March 1919 at Middletown, PA; reconstituted on 7 December 1936). Conducted summer training at Selfridge Field, MI. Location 7 December 1941—Philadelphia, PA.

Status: Disbanded on 31 May 1942.

Commanders, 503rd Pursuit Squadron

2nd Lt. French E. Wilson	21 Mar 22-18 Apr 22	1st Lt. Earl V. Compton	ao Jul 23-ao Sep 23
1st Lt. William C. Grieb	18 Apr 22-ao Oct 22	Capt. Earl E. Neubig	ao Dec 23-23 Jul 29
	<i>Inactive</i>	23 Jul 29-7 Dec 41	

504th Pursuit Squadron (GHQR)

Organized Reserve Pennsylvania

HQ-*Not initiated* 1921-22; Harrisburg, PA, 1922-29; *Inactive* 1929-33

Constituted in the Organized Reserve on 15 October 1921, assigned to the 326th Pursuit Group (GHQR), and allotted to the Third Corps Area. Initiated in August 1922 at Harrisburg, PA. Inactivated on 23 July 1929 at Harrisburg by relief of personnel. Philadelphia, PA, designated on 11 December 1929 as headquarters on reorganization, but the unit was never organized at that location. Conducted summer training at Langley Field, VA. Demobilized on 1 October 1933.

Commanders, 504th Pursuit Squadron

2nd Lt. A. B. McCarty	Aug 22-ao Oct 22	Capt. Jacob S. Sides	26 Oct 27-23 Apr 29
Unknown	ao Oct 22-ao Dec 23	1st Lt. William Curry	23 Apr 29-23 Jul 29
Maj. Eugene F. Gillespie	ao Dec 23-26 Oct 27	<i>Inactive</i>	23 Apr 29-1 Oct 33

505th Pursuit Squadron (1921-33) (GHQR)

Organized Reserve Texas/New York

505th Transport Squadron (1933-41)

HQ-*Not initiated* 1921-23; San Antonio, TX, 1923-25; Beaumont, TX, 1925-36; *Inactive* 1936-41

Constituted in the Organized Reserve on 15 October 1921, assigned to the 327th Pursuit Group (GHQR), and allotted to the Eighth Corps Area. Initiated on 26 February 1923 at San Antonio, TX. Relocated on 15 April 1925 to Beaumont, TX. Reorganized and redesignated as the 505th Transport Squadron on 1 October 1933 and relieved from assignment to the 327th Pursuit Group. Conducted summer training at Biggs Field, TX, and Kelly Field, TX. Withdrawn from the Eighth Corps Area on 5 June 1936 and allotted to the Second Corps Area. Inactivated on 31 October 1936 at Beaumont by relief of personnel. Consolidated on 7 December 1936 with the 505th Aero Squadron (Construction) (a WWI unit organized in December 1917 as the 209th Aero Squadron at Kelly Field; redesignated as the 505th Aero Squadron

[Construction] in February 1918; demobilized in January 1919 at Garden City, NY; reconstituted on 7 December 1936). Location 7 December 1941—*Inactive*.

Status: Disbanded on 31 May 1942.

Commanders, 505th Pursuit Squadron

Maj. Edgar G. Tobin	23 Feb 23-ao Jan 25	Unknown	ao Jan 25-31 Oct 36
	<i>Inactive</i>	31 Oct 36-7 Dec 41	

506th Pursuit Squadron (1921-33) (GHQR)

Organized Reserve Texas

506th Transport Squadron (1933-41)

HQ-*Not initiated* 1921-23; El Paso, TX, 1923-25; Beaumont, TX, 1925-36; *Inactive* 1936-41

Constituted in the Organized Reserve on 15 October 1921, assigned to the 327th Pursuit Group (GHQR), and allotted to the Eighth Corps Area. Initiated on 12 March 1923 at El Paso, TX. Relocated on 15 April 1925 to Beaumont, TX. Reorganized and redesignated as the 506th Transport Squadron on 1 October 1933 and relieved from assignment to the 327th Pursuit Group. Conducted summer training at Kelly Field, TX. Withdrawn from the Eighth Corps Area on 5 June 1936 and allotted to the Second Corps Area. Inactivated on 31 October 1936 at Beaumont by relief of personnel. Location 7 December 1941—*Inactive*.

Status: Disbanded on 31 May 1942.

Commanders, 506th Pursuit Squadron

Unknown	12 Mar 23-ao Dec 24	Unknown	ao Jan 25-31 Oct 36
Capt. Obed J. Stallings	ao Dec 24-ao Jan 25	<i>Inactive</i>	31 Oct 36-7 Dec 41

507th Pursuit Squadron (GHQR)

Organized Reserve Texas

HQ-*Not initiated* 1921-23; Austin, TX, 1923-25; Beaumont, TX, 1925-33

Constituted in the Organized Reserve on 15 October 1921, assigned to the 327th Pursuit Group (GHQR), and allotted to the Eighth Corps Area. Initiated on 12 March 1923 at Austin, TX. Relocated on 15 April 1925 to Beaumont, TX. Demobilized on 1 October 1933.

Commanders, 507th Pursuit Squadron

Capt. Obed J. Stallings	12 Mar 23-ao Apr 23	Capt. Sam V. Stone	ao Dec 24-13 Jan 28
Unknown	ao Apr 23-ao Dec 24	Unknown	13 Jan 28-1 Oct 33

508th Pursuit Squadron (1921-33) (GHQR)

Organized Reserve Texas

HQ-*Not initiated* 1921-23; Fort Worth, TX, 1923-25; Beaumont, TX, 1925-33

Constituted in the Organized Reserve on 15 October 1921, assigned to the 327th Pursuit Group (GHQR), and allotted to the Eighth Corps Area. Initiated on 26 February 1923 at Fort Worth, TX. Relocated on 15 April 1925 to Beaumont, TX. Conducted summer training at Kelly Field, TX. Demobilized on 1 October 1933.

Commanders, 508th Pursuit Squadron

1st Lt. Allen Clark	26 Feb 23-ao Apr 23	Capt. Frank W. Cawthon	ao Jan 25-ao Mar 25
Unknown	ao Apr 23-ao Jan 25	Unknown	ao Mar 25-1 Oct 33

509th Attack Squadron (1921-24) (GHQR)**Organized Reserve Washington/Ohio****509th Pursuit Squadron (1924-33)****509th Transport Squadron (1933-41)****HQ**—*Not initiated* 1921-22; Seattle, WA, 1922-24; *Inactive* 1924-41

Constituted in the Organized Reserve on 15 October 1921 as the 509th Attack Squadron, assigned to the 328th Attack Group (GHQR), and allotted to the Ninth Corps Area. Initiated on 26 May 1922 at Seattle, WA. Withdrawn from the Ninth Corps Area on 31 March 1924 and allotted to the Fifth Corps Area. Concurrently, reorganized and redesignated as the 509th Pursuit Squadron and assigned to the 352nd Pursuit Group (GHQR). Cincinnati, OH, designated as headquarters on reorganization, but the unit was never organized at that location. Reorganized and redesignated as the 509th Transport Squadron on 1 October 1933, but remained assigned to the 352nd Pursuit Group. Location 7 December 1941—*Inactive*.

Status: Disbanded on 31 May 1942.**Commanders, 509th Attack Squadron**

Unknown	26 May 22-31 Mar 24	<i>Inactive</i>	31 Mar 24-7 Dec 41
---------	---------------------	-----------------	--------------------

510th Attack Squadron (1921-24) (GHQR)**Organized Reserve Washington/Indiana****510th Pursuit Squadron (1924-33)****510th Transport Squadron (1933-41)****HQ**—*Not initiated* 1921-22; Everett, WA, 1922-24; Indianapolis, IN, 1924-30; *Inactive* 1930-41

Constituted in the Organized Reserve on 15 October 1921 as the 510th Attack Squadron, assigned to the 328th Attack Group (GHQR), and allotted to the Ninth Corps Area. Initiated on 21 October 1922 at Everett, WA. Withdrawn from the Ninth Corps Area on 31 March 1924 and allotted to the Fifth Corps Area. Concurrently, reorganized and redesignated as the 510th Pursuit Squadron and assigned to the 352nd Pursuit Group (GHQR). Reorganized by December 1924 at Indianapolis, IN. Inactivated by March 1930 at Indianapolis by relief of personnel. Reorganized and redesignated as the 510th Transport Squadron on 1 October 1933, but remained assigned to the 352nd Pursuit Group. Location 7 December 1941—*Inactive*.

Status: Disbanded on 31 May 1942.**Commanders, 510th Attack Squadron**

2nd Lt. Charles W. English	21 Oct 22-ao Jan 23	Capt. Peyton Gibson	ao Dec 24-Jan 25
Unknown	ao Jan 23-ao Dec 24	Unknown	Jan 25-Mar 30
	<i>Inactive</i>	Mar 30-7 Dec 41	

511th Attack Squadron (1921-24) (GHQR)**Organized Reserve Washington/Kentucky****511th Pursuit Squadron (1924-33)****511th Transport Squadron (1933-41)****HQ**—*Not initiated* 1921-22; Spokane, WA, 1922-24; Warsaw, KY, 1924-30; *Inactive* 1930-41

Constituted in the Organized Reserve on 15 October 1921 as the 511th Attack Squadron, assigned to the 328th Attack Group (GHQR), and allotted to the Ninth Corps Area. Initiated on 26 May 1922 at Spokane, WA. Withdrawn from the Ninth Corps Area on 31 March 1924 and allotted to the Fifth Corps Area. Concurrently, reorganized and redesignated as the 511th Pursuit Squadron, and assigned to the 352nd Pursuit Group (GHQR). Reorganized in December 1924 at Warsaw, KY. Inactivated by March 1930 at Warsaw by relief of personnel. Reorganized and redesignated as the 510th Transport Squadron on 1 October 1933, but remained assigned to the 352nd Pursuit Group. Location 7 December 1941—*Inactive*.

Status: Disbanded on 31 May 1942.

Commanders, 511th Attack Squadron

Unknown 26 May 22-Mar 30 *Inactive* Mar 30-7 Dec 41

512th Attack Squadron (1921-24)

Organized Reserve Washington/Ohio

512th Pursuit Squadron (1924-33)

HQ-Not initiated 1921-22; Spokane, WA, 1922-24; Cincinnati, OH, 1924-30; *Inactive* 1930-33

Constituted in the Organized Reserve on 15 October 1921 as the 512th Attack Squadron, assigned to the 328th Attack Group (GHQR), and allotted to the Ninth Corps Area. Initiated in November 1922 at Seattle, WA. Withdrawn from the Ninth Corps Area on 31 March 1924 and allotted to the Fifth Corps Area. Concurrently, reorganized and redesignated as the 512th Pursuit Squadron and assigned to the 352nd Pursuit Group (GHQR). Reorganized by December 1924 at Cincinnati, OH. Inactivated by March 1930 at Cincinnati by relief of personnel. Demobilized on 1 October 1933.

Commanders, 512th Attack Squadron

Unknown Nov 22-Mar 30 *Inactive* Mar 30-1 Oct 33

513th Observation Squadron (GHQR)

Organized Reserve California

HQ-Not initiated 1921-22; Los Angeles, CA, 1922-23; Stockton, CA, 1923-28; *Inactive* 1928-33

Constituted in the Organized Reserve on 15 October 1921, assigned to the 329th Observation Group (GHQR), and allotted to the Ninth Corps Area. Initiated on 14 February 1922 at Los Angeles, CA. Relocated on 30 January 1923 to Stockton, CA. Inactivated on 1 December 1928 at Stockton by relief of personnel. Demobilized on 1 October 1933.

Commanders, 513th Observation Squadron

1st Lt. Arthur H. Savage 14 Feb 22-ao Mar 22 Unknown ao Feb 23-1 Dec 28
Capt. John K. Nissley ao Oct 22-ao Feb 23 *Inactive* 1 Dec 28-7 Dec 41

514th Observation Squadron (GHQR)

Organized Reserve Oregon/California

HQ-Not initiated 1921-22; Portland, OR, 1922-25; San Diego, CA, 1925-29; *Inactive* 1929-32; San Diego, CA, 1932-37; *Inactive* 1937

Constituted in the Organized Reserve on 15 October 1921, assigned to the 329th Observation Group (GHQR), and allotted to the Ninth Corps Area. Initiated on 14 February 1922 at Portland, OR. Relocated by 1925 to San Diego, CA. Inactivated on 20 October 1929 at San Diego by relief of personnel. Reorganized by June 1932 at San Diego. Inactivated on 2 March 1937 at San Diego by relief of personnel. Conducted summer training at Rockwell Field, CA, and Long Beach Municipal Airport, CA. Demobilized on 11 June 1937.

Commanders, 514th Observation Squadron

2nd Lt. Louis D. Lighton 14 Feb 22-ao Oct 22 Capt. James A. Moore ao Jun 32-ao Aug 34
Unknown ao Oct 22-20 Oct 29 Unknown ao Aug 34-ao Dec 36
Inactive 20 Oct 29-ao Jun 32 Maj. Wayne Van Stewart ao Dec 36-2 Mar 37
Inactive 2 Mar 37-11 Jun 37

515th Observation Squadron (GHQR)

Organized Reserve Oregon/California

HQ-Not initiated 1921-22; Medford, OR, 1922-25; Eugene, OR, 1925-28; *Inactive* 1928-30; San Diego, CA, 1930-33

Constituted in the Organized Reserve on 15 October 1921, assigned to the 329th Observation Group (GHQR), and allotted to the Ninth Corps Area. Initiated in April 1923 at Medford, OR. Relocated by 1925 to Eugene, OR. Inactivated on 1 September 1928 at Eugene by relief of personnel. Reorganized on 28 January 1930 at San Diego, CA. Demobilized on 1 October 1933.

Commanders, 515th Observation Squadron

Unknown	Apr 23-1 Sep 28	<i>Inactive</i>	1 Sep 28-28 Jan 30
	Unknown	28 Jan 30-1 Oct 33	

516th Observation Squadron (GHQR)

Organized Reserve California

HQ-Not initiated 1921-22; Berkeley, CA, 1922-28; *Inactive* 1928-30; San Diego, CA, 1930-33

Constituted in the Organized Reserve on 15 October 1921, assigned to the 329th Observation Group (GHQR), and allotted to the Ninth Corps Area. Initiated on 14 February 1922 at Berkeley, CA. Inactivated on 1 September 1928 at Berkeley by relief of personnel. Reorganized on 28 January 1930 at San Diego, CA. Demobilized on 1 October 1933.

Commanders, 516th Observation Squadron

2nd Lt. Earle H. Davis	14 Feb 22-ao Mar 22	Unknown	ao Oct 22-1 Sep 28
1st Lt. Harry H. Lynch	ao Sep 22-ao Oct 22	<i>Inactive</i>	1 Sep 28-28 Jan 30
	Unknown	28 Jan 30-1 Oct 33	

517th Headquarters Squadron (1921-33) (GHQR)

Organized Reserve New York

HHS, 517th Air Depot (1933-41)

HQ-Not initiated 1921-22; Mineola, L.I., NY, 1922-28; *Inactive* 1928-41

Constituted in the Organized Reserve on 15 October 1921, assigned to the General Headquarters Reserve, and allotted to the Second Corps Area. Initiated in May 1922 at Mineola, NY. Stationed at Mitchel Field, NY. Withdrawn from the Second Corps Area on 1 October 1933 and allotted to the Third Corps Area. Reorganized and redesignated 1 October 1933 as Headquarters and Headquarters Squadron, 517th Air Depot. Location 7 December 1941—*Inactive*.

Status: Disbanded on 31 May 1942.

Commanders, 517th Headquarters Squadron

1st Lt. Paul G. Wehle	May 22-13 Jun 23	Capt. Thomas F. Ward	13 Jun 23-6 Jun 28
	<i>Inactive</i>	6 Jun 28-7 Dec 41	

518th Headquarters Squadron (1924-33) (GHQR)

Organized Reserve Alabama/New York

HHS, 518th Air Depot (1933-41)

HQ-Not initiated 1921-41

Constituted in the Organized Reserve on 31 March 1924, assigned to the General Headquarters Reserve, and allotted to the Fourth Corps Area. Mobile, AL, initially designated as headquarters on organization, but the unit was never organized at that location. Reorganized and redesignated 1 October 1933 as Headquarters and Headquarters Squadron, 518th Air Depot. Withdrawn from the Fourth Corps Area on 5 June 1936 and allotted to the Second Corps Area. Location 7 December 1941—*Not initiated*.

Status: Disbanded on 31 May 1942.

519th Headquarters Squadron (1924-33) (GHQR)

Organized Reserve Ohio

HHS, 519th Air Depot (1933-41)

HQ-Not initiated 1921-33; Dayton, OH, 1933-37; *Inactive* 1937-41

Constituted in the Organized Reserve on 31 March 1924, assigned to the General Headquarters Reserve, and allotted to the Fifth Corps Area. Reorganized and redesignated 1 October 1933 as Headquarters and Headquarters Squadron, 519th Air Depot. Initiated by December 1933 at Dayton, OH. Inactivated by June 1937 at Dayton by relief of personnel. Location 7 December 1941—*Inactive*.

Status: Disbanded on 31 May 1942.

520th Headquarters Squadron (1924-33) (GHQR)

Organized Reserve Illinois

HHS, 520th Air Depot (1933-41)

HQ-Not initiated 1924-25; Chicago, IL, 1925-29; *Inactive* 1929-37; Chicago, IL, 1937-41

Constituted in the Organized Reserve on 31 March 1924, assigned to the General Headquarters Reserve, and allotted to the Sixth Corps Area. Initiated by December 1925 at Chicago, IL. Inactivated on 1 December 1929 at Chicago by relief of personnel. Designated mobilization station was Chanute Field, IL. Reorganized and redesignated 1 October 1933 as Headquarters and Headquarters Squadron, 520th Air Depot. Reorganized on 1 September 1936 at Chicago, IL. Location 7 December 1941—Chicago, IL.

Status: Disbanded on 31 May 1942.

Commanders, 520th Headquarters Squadron

Unknown

ao Dec 25-1 Dec 29
Unknown

Inactive
1 Sep 36-7 Dec 41

1 Dec 29-1 Sep 36

521st Headquarters Squadron (1924-33) (GHQR)

Organized Reserve Nebraska

HHS, 521st Air Depot (1933-41)

HQ-Omaha, NE, 1924-41

Constituted in the Organized Reserve on 31 March 1924, assigned to the General Headquarters Reserve, and allotted to the Seventh Corps Area. Initiated by December 1924 at Omaha, NE. Reorganized and redesignated 1 October 1933 as Headquarters and Headquarters Squadron, 521st Air Depot. Location 7 December 1941—Omaha, NE.

Status: Disbanded on 31 May 1942.

Commanders, 520th Headquarters Squadron

Unknown

ao Dec 24-7 Dec 41

522nd Pursuit Squadron (GHQR)

Organized Reserve New York

HQ-Not initiated 1924-33

Constituted in the Organized Reserve on 31 March 1924, assigned to the 353rd Pursuit Group (GHQR), and allotted to the Second Corps Area. Brooklyn, NY, designated as headquarters on organization, but the unit was never organized at that location. Demobilized on 1 October 1933.

523rd Pursuit Squadron (1924-33) (GHQR)

Organized Reserve New York

523rd Bombardment Squadron (1933-41)

HQ-Not initiated 1924-41

Constituted in the Organized Reserve on 31 March 1924 as the 523rd Pursuit Squadron, assigned to the 353rd Pursuit Group (GHQR), and allotted to the Second Corps Area. Bronx, NY, designated as headquarters on organization, but the unit was never organized at that location. Redesignated as the 523rd Bombardment Squadron on 1 October 1933. Location 7 December 1941—*Not initiated*.

Status: Disbanded on 31 May 1942.

524th Pursuit Squadron (GHQR)

Organized Reserve New York

HQ-*Not initiated* 1924-33

Constituted in the Organized Reserve on 31 March 1924, assigned to the 353rd Pursuit Group (GHQR), and allotted to the Second Corps Area. Manhattan, NY, designated as headquarters on organization, but the unit was never organized at that location. Demobilized on 1 October 1933.

525th Pursuit Squadron (GHQR)

Organized Reserve New York

HQ-*Not initiated* 1924-33

Constituted in the Organized Reserve on 31 March 1924, assigned to the 353rd Pursuit Group (GHQR), and allotted to the Second Corps Area. Flushing, NY, designated as headquarters on organization, but the unit was never organized at that location. Demobilized on 1 October 1933.

526th Pursuit Squadron (GHQR)

Organized Reserve Minnesota

HQ-St. Paul, MN, 1924-26; Minneapolis, MN, 1926-39; *Inactive* 1939-41

Constituted in the Organized Reserve on 31 March 1924, assigned to the 354th Pursuit Group (GHQR), and allotted to the Seventh Corps Area. Initiated in November 1924 at St. Paul, MN. Relocated on 26 May 1926 to Minneapolis, MN. Conducted summer training at Marshall Field, KS. Conducted summer training in 1930 with the 34th Division at Camp Dodge, IA. Inactivated on 2 October 1939 at Minneapolis by relief of personnel. Location 7 December 1941—*Inactive*.

Status: Disbanded on 31 May 1942.

Commanders, 526th Pursuit Squadron

Unknown	Nov 24-ao Apr 30	Unknown	ao May 30-2 Oct 39
Capt. Roy B. Mosher	ao Apr 30-ao May 30	<i>Inactive</i>	2 Oct 39-7 Dec 41

527th Pursuit Squadron (1924-33) (GHQR)

Organized Reserve Minnesota

527th Transport Squadron (1933-41) (GHQR)

HQ-St. Paul, MN, 1924-41

Constituted in the Organized Reserve on 31 March 1924 as the 527th Pursuit Squadron, assigned to the 354th Pursuit Group (GHQR), and allotted to the Ninth Corps Area. Initiated in November 1924 at St. Paul, MN. Reorganized and redesignated as the 527th Transport Squadron on 1 October 1933, and relieved from assignment to the 354th Pursuit Group. Conducted summer training at Marshall Field, KS. Location 7 December 1941—St. Paul, MN.

Status: Disbanded on 31 May 1942.

Commanders, 527th Pursuit Squadron

527th Transport Squadron

Unknown	Nov 24-7 Dec 41
---------	-----------------

528th Pursuit Squadron (1924-33) (GHQR)

Organized Reserve Minnesota

528th Transport Squadron (1933-41) (GHQR)

HQ-Pine City, MN, 1924-41

Constituted in the Organized Reserve on 31 March 1924 as the 528th Pursuit Squadron, assigned to the 354th Pursuit Group (GHQR), and allotted to the Ninth Corps Area. Initiated in November 1924 at Pine City, MN. Reorganized and redesignated as the 528th Transport Squadron on 1 October 1933, and relieved from assignment to the 354th Pursuit Group. Location 7 December 1941—Pine City, MN.

Status: Disbanded on 31 May 1942.

Commanders, 528th Pursuit Squadron

528th Transport Squadron

Unknown Nov 24-7 Dec 41

529th Pursuit Squadron (1924-33) (GHQR)

Organized Reserve Minnesota

529th Transport Squadron (1933-41) (GHQR)

HQ-Brainerd, MN, 1924-41

Constituted in the Organized Reserve on 31 March 1924 as the 529th Pursuit Squadron, assigned to the 354th Pursuit Group (GHQR), and allotted to the Ninth Corps Area. Initiated in December 1924 at Brainerd, MN. Reorganized and redesignated as the 529th Transport Squadron on 1 October 1933, and relieved from assignment to the 354th Pursuit Group. Location 7 December 1941—Brainerd, MN.

Status: Disbanded on 31 May 1942.

Commanders, 529th Pursuit Squadron

529th Transport Squadron

Unknown Dec 24-7 Dec 41

530th Pursuit Squadron (GHQR)

Organized Reserve Missouri/Arkansas

HQ-St. Louis, MO 1924-26; Fayetteville, AR, 1926-31; Pine Bluff, AR, 1931-33

Constituted 31 March 1924 in the Organized Reserve, assigned to the 355th Pursuit Group (GHQR), and allotted to the Seventh Corps Area. Initiated in November 1924 at St. Louis, MO. Relocated on 26 May 1926 to Fayetteville, AR. Relocated on 12 October 1931 to Pine Bluff, AR. Conducted summer training at Marshall Field, KS. Demobilized on 1 October 1933.

Commanders, 530th Pursuit Squadron

Unknown Nov 24-1 Oct 33

531st Pursuit Squadron (1924-33) (GHQR)

Organized Reserve Missouri/Arkansas

531st Transport Squadron (1933-41) (GHQR)

HQ-St. Louis, MO 1924-26; Russellville, AR, 1926-41

Constituted in the Organized Reserve on 31 March 1924 as the 531st Pursuit Squadron, assigned to the 355th Pursuit Group (GHQR), and allotted to the Seventh Corps Area. Initiated in November 1924 at St. Louis, MO. Relocated on 26 May 1926 to Russellville, AR. Reorganized and redesignated as the 529th Transport Squadron on 1 October 1933, and relieved from assignment to the 355th Pursuit Group. Location 7 December 1941—Russellville, AR.

Commanders, 531st Pursuit Squadron

Unknown Nov 24-7 Dec 41

532nd Pursuit Squadron (GHQR)**Organized Reserve Missouri/Arkansas****HQ**-St. Louis, MO 1924-26; Texarkana, AR, 1926-33

Constituted in the Organized Reserve on 31 March 1924, assigned to the 355th Pursuit Group (GHQR), and allotted to the Seventh Corps Area. Initiated by December 1924 at St. Louis, MO. Relocated on 26 May 1926 to Texarkana, AR. Conducted summer training at Marshall Field, KS. Demobilized on 1 October 1933.

Commanders, 532nd Pursuit Squadron

Unknown ao Dec 24-1 Oct 33

533rd Pursuit Squadron (GHQR)**Organized Reserve Missouri****HQ**-St. Louis, MO 1924-26; Paragould, AR, 1926-33

Constituted in the Organized Reserve on 31 March 1924, assigned to the 355th Pursuit Group (GHQR), and allotted to the Seventh Corps Area. Initiated by December 1924 at St. Louis, MO. Relocated on 26 May 1926 to Paragould, AR. Demobilized on 1 October 1933.

Commanders, 533rd Pursuit Squadron

Unknown ao Dec 24-1 Oct 33

534th Pursuit Squadron (GHQR)**Organized Reserve Minnesota****HQ**-Minneapolis, MN, 1924-33

Constituted in the Organized Reserve on 31 March 1924, assigned to the 356th Pursuit Group (GHQR), and allotted to the Seventh Corps Area. Initiated in November 1924 at Minneapolis, MN. Conducted summer training at Marshall Field, KS. Demobilized on 1 October 1933.

Commanders, 534th Pursuit Squadron

Unknown Nov 24-1 Oct 33

535th Pursuit Squadron (GHQR)**Organized Reserve Minnesota/North Dakota****HQ**-Minneapolis, MN, 1924-31; Mandan, ND, 1931-33

Constituted in the Organized Reserve on 31 March 1924, assigned to the 356th Pursuit Group (GHQR), and allotted to the Seventh Corps Area. Initiated in December 1924 at Minneapolis, MN. Relocated on 12 October 1931 to Mandan, ND. Demobilized on 1 October 1933.

Commanders, 535th Pursuit Squadron

Unknown Dec 24-1 Oct 33

536th Pursuit Squadron (GHQR)**Organized Reserve Minnesota/North Dakota****HQ**-St. Paul, MN, 1924-31; Jamestown, ND, 1931-33

Constituted in the Organized Reserve on 31 March 1924, assigned to the 356th Pursuit Group (GHQR), and allotted to the Seventh Corps Area. Initiated in December 1924 at St. Paul, MN. Relocated on 12 October 1931 to Jamestown, ND. Demobilized on 1 October 1933.

Commanders, 536th Pursuit Squadron

Unknown Dec 24-1 Oct 33

537th Pursuit Squadron (GHQR)**Organized Reserve Minnesota/South Dakota****HQ**-St. Paul, MN, 1924-31; Rapid City, SD, 1931-33

Constituted in the Organized Reserve on 31 March 1924, assigned to the 356th Pursuit Group (GHQR), and allotted to the Seventh Corps Area. Initiated in December 1924 at St. Paul, MN. Relocated on 12 October 1931 to Rapid City, SD. Demobilized on 1 October 1933.

Commanders, 537th Pursuit Squadron

Unknown	Dec 24-1 Oct 33
---------	-----------------

538th Service Squadron (GHQR)**Organized Reserve Illinois****HQ**-*Not initiated* 1924-28

Constituted in the Organized Reserve on 31 March 1924, assigned to the 351st Pursuit Group (GHQR), and allotted to the Sixth Corps Area. Rock Island, IL, designated as headquarters on organization, but the unit was never organized at that location. Withdrawn from the Sixth Corps Area 5 September 1928. Location 7 December 1941—*Not initiated*.

Status: Disbanded on 31 May 1942.**539th Service Squadron (GHQR)****Organized Reserve Indiana****HQ**-*Not initiated* 1924-41

Constituted in the Organized Reserve on 31 March 1924, assigned to the 352nd Pursuit Group (GHQR), and allotted to the Fifth Corps Area. Indianapolis, IN, designated as headquarters on organization, but the unit was never organized at that location. Relieved from assignment to the 352nd Pursuit Group on 1 October 1933 and redesignated 539th Service Squadron, Observation Group. Location 7 December 1941—*Inactive*.

Status: Disbanded on 31 May 1942.**540th Service Squadron (GHQR)****Organized Reserve New Jersey****HQ**-*Not initiated* 1924-25; Englewood, NJ 1925-39; *Inactive* 1939-41

Constituted in the Organized Reserve on 31 March 1924, assigned to the 353rd Pursuit Group (GHQR), and allotted to the Second Corps Area. Initiated in November 1925 at Englewood, NJ. Conducted summer training at Mitchel Field, NY, 1926-40. Designated mobilization station was Mitchel Field, NY. Inactivated by September 1939 at Englewood by relief of personnel. Location 7 December 1941—*Inactive*.

Status: Disbanded on 31 May 1942.**Commanders, 540th Service Squadron**

Unknown	Nov 25-Sep 39	<i>Inactive</i>	Sep 39-7 Dec 41
---------	---------------	-----------------	-----------------

541st Service Squadron (GHQR)**Organized Reserve Minnesota****HQ**-Buffalo, MN, 1924-31; Rapid City, SD, 1931-33

Constituted in the Organized Reserve on 31 March 1924, assigned to the 354th Pursuit Group (GHQR), and allotted to the Seventh Corps Area. Initiated in November 1924 at Buffalo, MN. Relocated on 12 October 1931 to Rapid City, SD. Demobilized on 1 October 1933.

Commanders, 541st Service Squadron

Unknown	Nov 24-1 Oct 33
---------	-----------------

542nd Service Squadron (GHQR)**Organized Reserve Missouri/
Arkansas/South Dakota****HQ-Not initiated** 1924-25; St. Louis, MO 1925-26; Batesville, AR, 1926-31; Mitchell, SD, 1931-41

Constituted in the Organized Reserve on 31 March 1924, assigned to the 355th Pursuit Group (GHQR), and allotted to the Seventh Corps Area. Initiated in March 1925 at St. Louis, MO. Relocated on 26 May 1926 to Batesville, AR. Relocated on 12 October 1931 to Mitchell, SD. Relieved from assignment to the 355th Pursuit Group on 1 October 1933 and assigned to the 310th Pursuit Group (GHQR). Location 7 December 1941—Mitchell, SD.

Status: Disbanded on 31 May 1942.**Commanders, 542nd Service Squadron**

Unknown

Mar 25-22 Jul 25
UnknownCapt. Harry Secord
ao Sep 25-7 Dec 41

22 Jul 25-ao Sep 25

543rd Service Squadron (GHQR)**Organized Reserve Minnesota/North Dakota****HQ-Minneapolis, MN, 1924-31; Minot, ND, 1931-41**

Constituted in the Organized Reserve on 31 March 1924, assigned to the 356th Pursuit Group (GHQR), and allotted to the Seventh Corps Area. Initiated in November 1924 at Minneapolis, MN. Relocated on 12 October 1931 to Minot, ND. Relieved 1 October 1933 from assignment to the 356th Pursuit Group. Location 7 December 1941—Minot, ND.

Status: Disbanded on 31 May 1942.**Commanders, 543rd Service Squadron**

Unknown

Nov 24-7 Dec 41

549th Bombardment Squadron**Organized Reserve****HQ-Not initiated** 1924-41

Constituted in the Organized Reserve 22 June 1927 and allotted to the Third Corps Area. Withdrawn from the Third Corps Area on 28 November 1928. Location 7 December 1941—*Not initiated*.

Status: Disbanded on 31 May 1942.**550th Observation Squadron (I Corps)****Organized Reserve****HQ-Not initiated** 1923-27

Constituted in the Organized Reserve on 2 July 1923 as a Deferred National Guard unit, assigned to the 323rd Observation Group (I Corps), and allotted to the Third Corps Area. Withdrawn from the Third Corps Area on 11 January 1927 and allotted to the Fifth Corps Area as an Organized Reserve unit. Demobilized on 1 October 1933.

551st Observation Squadron (I Corps)**Organized Reserve****HQ-Not initiated** 1923-27

Constituted in the Organized Reserve on 2 July 1923 as a Deferred National Guard unit, assigned to the 323rd Observation Group (I Corps), and allotted to the Third Corps Area. Withdrawn from the Third Corps Area on 11 January 1927 and allotted to the Fifth Corps Area as an Organized Reserve unit. Demobilized on 1 October 1933.

552nd Observation Squadron (III Corps)

Organized Reserve

HQ-Not initiated 1923-27

Constituted in the Organized Reserve on 2 July 1923 as a Deferred National Guard unit, assigned to the 328th Observation Group (III Corps), and allotted to the Third Corps Area. Withdrawn from the National Guard 17 September 1927.

553rd Observation Squadron (III Corps)

Organized Reserve

HQ-Not initiated 1923-27

Constituted in the Organized Reserve on 2 July 1923 as a Deferred National Guard unit, assigned to the 328th Observation Group (III Corps), and allotted to the Third Corps Area. Withdrawn from the National Guard 17 September 1927.

554th Observation Squadron (IV Corps)

Organized Reserve Florida

HQ-Not initiated 1923-27

Constituted in the Organized Reserve on 2 July 1923 as a Deferred National Guard unit, assigned to the 12th Observation Group (IV Corps), and allotted to the Fourth Corps Area. Jacksonville, FL, designated as headquarters on organization, but the unit was never organized at that location. Designated mobilization station was Pope Field, NC. Withdrawn from the National Guard 17 September 1927.

555th Observation Squadron (V Corps)

Organized Reserve

HQ-Not initiated 1923-28; Fifth Corps Area 1928-33

Constituted in the Organized Reserve on 2 July 1923 as a Deferred National Guard unit, assigned to the 333rd Observation Group (V Corps), and allotted to the Fifth Corps Area. Withdrawn from the National Guard 17 September 1927 and permanently allotted to the Organized Reserve. Initiated by May 1928 in the Fifth Corps Area. Conducted summer training at Wright Field, OH. Demobilized on 1 October 1933.

556th Observation Squadron (V Corps)

Organized Reserve

HQ-Not initiated 1923-28; Fifth Corps Area 1928-33

Constituted in the Organized Reserve on 2 July 1923 as a Deferred National Guard unit, assigned to the 333rd Observation Group (V Corps), and allotted to the Fifth Corps Area. Withdrawn from the National Guard 17 September 1927 and permanently allotted to the Organized Reserve. Initiated by May 1928 in the Fifth Corps Area. Conducted summer training at Wright Field, OH. Demobilized on 1 October 1933.

Commanders, 556th Service Squadron

Unknown May 28-1 Oct 33

557th Observation Squadron (VI Corps)

Organized Reserve

HQ-Not initiated 1923-27

Constituted in the Organized Reserve on 2 July 1923 as a Deferred National Guard unit, assigned to the 335th Observation Group (VI Corps), and allotted to the Sixth Corps Area. Withdrawn from the National Guard 17 September 1927.

558th Observation Squadron (VI Corps)**Organized Reserve****HQ-***Not initiated 1923-27*

Constituted in the Organized Reserve on 2 July 1923 as a Deferred National Guard unit, assigned to the 335th Observation Group (VI Corps), and allotted to the Sixth Corps Area. Withdrawn from the National Guard 17 September 1927.

559th Observation Squadron (VII Corps)**Organized Reserve Missouri****HQ-***Not initiated 1923-27*

Constituted in the Organized Reserve on 2 July 1923 as a Deferred National Guard unit, assigned to the 336th Observation Group (VII Corps), and allotted to the Seventh Corps Area. St. Louis, MO, designated as headquarters on organization, but the unit was never organized at that location. Withdrawn from the National Guard 17 September 1927.

560th Observation Squadron (VII Corps)**Organized Reserve Missouri****HQ-***Not initiated 1923-27*

Constituted in the Organized Reserve on 2 July 1923 as a Deferred National Guard unit, assigned to the 336th Observation Group (VII Corps), and allotted to the Seventh Corps Area. St. Louis, MO, designated as headquarters on organization, but the unit was never organized at that location. Withdrawn from the National Guard 17 September 1927.

561st Observation Squadron (XVIII Corps)**Organized Reserve Kansas****HQ-***Not initiated 1921-27; Wichita, KS, 1927-39; Inactive 1939-41*

Constituted in the National Guard 1 June 1921 as the 143rd Observation Squadron, assigned to the 339th Observation Group (VIII Corps), and allotted to the Eighth Corps Area. Placed on the deferred list on 2 July 1923, transferred to the Organized Reserve as a Deferred National Guard unit, and redesignated as the 561st Observation Squadron. Withdrawn from the Eighth Corps Area on 11 January 1927 and allotted to the Seventh Corps Area. Initiated in August 1927 at Wichita, KS. Relieved from assignment to the 339th Observation Group (VIII Corps) on 1 October 1933 and assigned to the 15th Observation Group (Fourth Army). Conducted summer training at Marshall Field, KS. Withdrawn from allotment to the Organized Reserve on 1 January 1938 and allotted to the Regular Army as a RAI unit. Inactivated on 2 October 1939 at Wichita by relief of personnel. Location 7 December 1941—*Inactive*.

Status: Disbanded on 31 May 1942.**Commanders, 561st Observation Squadron**

Unknown	Aug 27-2 Oct 39	<i>Inactive</i>	2 Oct 39-7 Dec 41
---------	-----------------	-----------------	-------------------

562nd Observation Squadron (IX Corps)**Organized Reserve California****HQ-***Not initiated 1924-25; Los Angeles, CA, 1925-39; Inactive 1939-41*

Constituted in the National Guard 1 June 1921 as the 144th Observation Squadron, assigned to the 341st Observation Group (IX Corps), and allotted to the Ninth Corps Area. Placed on the deferred list on 2 July 1923, transferred to the Organized Reserve as a Deferred National Guard unit, and redesignated as the 562nd Observation Squadron. Initiated by December 1925 at Los Angeles, CA. Inactivated about October 1939 at Los Angeles by relief of personnel. Location 7 December 1941—*Inactive*.

Status: Disbanded on 31 May 1942.

Commanders, 562nd Observation Squadron

Unknown

ao Dec 25-ao Oct 39

Inactive

Oct 39-7 Dec 41

564th Observation Squadron (Third Army)

Organized Reserve Arkansas

HQ-Not initiated 1921-25

Constituted in the National Guard 1 June 1921 as the 154th Observation Squadron, assigned to the 320th Observation Group (Third Army), and allotted to the Seventh Corps Area. Placed on the deferred list on 2 July 1923, transferred to the Organized Reserve as a Deferred National Guard unit, and redesignated as the 564th Observation Squadron. Transferred back to the Arkansas National Guard in October 1925 as the 154th Observation Squadron.

566th Service Squadron (I Corps)

Organized Reserve

HQ-Not initiated 1923-33

Constituted in the Organized Reserve on 2 July 1923, assigned to the 323rd Observation Group (I Corps), and allotted to the First Corps Area. Withdrawn from the First Corps Area on 11 January 1927 and allotted to the Fifth Corps Area. Withdrawn from the National Guard 17 September 1927 and allotted to the Organized Reserve. Demobilized on 1 October 1933.

567th Service Squadron (VI Corps)

Organized Reserve

HQ-Not initiated 1923-41

Constituted in the Organized Reserve on 2 July 1923, assigned to the 335th Observation Group (VI Corps), and allotted to the Sixth Corps Area. Designated mobilization station was Selfridge Field, MI. Location 7 December 1941—*Not initiated*.

Status: Disbanded on 31 May 1942.

568th Service Squadron (VII Corps)

Organized Reserve Missouri

HQ-Not initiated 1923-41

Constituted in the Organized Reserve on 2 July 1923, assigned to the 336th Observation Group (VII Corps), and allotted to the Seventh Corps Area. St. Louis, MO, designated as headquarters on organization, but the unit was never organized at that location. Location 7 December 1941—*Not initiated*.

Status: Disbanded on 31 May 1942.

569th Service Squadron (XVIII)

Organized Reserve Kansas

HQ-Not initiated 1923-27; Wichita, KS, 1927-31; Winfield, KS, 1931-41

Constituted in the Organized Reserve on 2 July 1923, assigned to the 339th Observation Group (XVIII), and allotted to the Eighth Corps Area. Withdrawn from the Eighth Corps Area on 11 January 1927 and allotted to the Seventh Corps Area. Initiated in August 1927 at Wichita, KS. Relocated on 12 October 1931 to Winfield, KS. Location 7 December 1941—Winfield, KS.

Status: Disbanded on 31 May 1942.

Commanders, 569th Service Squadron

Unknown Aug 27-7 Dec 41

570th Service Squadron (Third Army)

Organized Reserve Missouri/Iowa

HQ-Not initiated 1923-27

Constituted in the Organized Reserve on 2 July 1923 as a Deferred National Guard unit, assigned to the 320th Observation Group (Third Army), and allotted to the Seventh Corps Area. St. Louis, MO, designated as headquarters on organization, but the unit was never organized at that location. Designated headquarters location changed 26 May 1926 to Dubuque, IA. Withdrawn from the National Guard 17 September 1927 and demobilized.

677th Service Squadron (ZI)

Organized Reserve

HQ-Not initiated 1923-28

Constituted in the Organized Reserve on 2 July 1923, assigned to the Zone of the Interior, but not allotted to a Corps Area. Withdrawn from the Organized Reserve 30 November 1928 and demobilized.

678th Service Squadron (ZI)

Organized Reserve

HQ-Not initiated 1923-28

Constituted in the Organized Reserve on 2 July 1923, assigned to the Zone of the Interior, but not allotted to a Corps Area. Withdrawn from the Organized Reserve 30 November 1928 and demobilized.

679th Service Squadron (ZI)

Organized Reserve

HQ-Not initiated 1923-28

Constituted in the Organized Reserve on 2 July 1923, assigned to the Zone of the Interior, but not allotted to a Corps Area. Withdrawn from the Organized Reserve 30 November 1928 and demobilized.

680th Service Squadron (ZI)

Organized Reserve

HQ-Not initiated 1923-28

Constituted in the Organized Reserve on 2 July 1923, assigned to the Zone of the Interior, but not allotted to a Corps Area. Withdrawn from the Organized Reserve 30 November 1928 and demobilized.

681st Service Squadron (ZI)

Organized Reserve

HQ-Not initiated 1923-28

Constituted in the Organized Reserve on 2 July 1923, assigned to the Zone of the Interior, but not allotted to a Corps Area. Withdrawn from the Organized Reserve 30 November 1928 and demobilized.

682nd Service Squadron (ZI)

Organized Reserve

HQ-Not initiated 1923-28

Constituted in the Organized Reserve on 2 July 1923, assigned to the Zone of the Interior, but not allotted to a Corps Area. Withdrawn from the Organized Reserve 30 November 1928 and demobilized.

683rd Service Squadron (ZI)

Organized Reserve

HQ-Not initiated 1923-28

Constituted in the Organized Reserve on 2 July 1923, assigned to the Zone of the Interior, but not allotted to a Corps Area. Withdrawn from the Organized Reserve 30 November 1928 and demobilized.

684th Service Squadron (ZI)

Organized Reserve

HQ-Not initiated 1923-28

Constituted in the Organized Reserve on 2 July 1923, assigned to the Zone of the Interior, but not allotted to a Corps Area. Withdrawn from the Organized Reserve 30 November 1928 and demobilized.

685th Service Squadron (ZI)

Organized Reserve

HQ-Not initiated 1923-28

Constituted in the Organized Reserve on 2 July 1923, assigned to the Zone of the Interior, and allotted to the Fourth Corps Area. Withdrawn from the Fourth Corps Area on 19 March 1926 and allotted to the Sixth Corps Area. Withdrawn from the Sixth Corps Area on 30 November 1928 and demobilized.

686th Service Squadron (ZI)

Organized Reserve Missouri

HQ-Not initiated 1923-28

Constituted in the Organized Reserve on 2 July 1923, assigned to the Zone of the Interior, and allotted to the Fourth Corps Area. Withdrawn from the Fourth Corps Area on 19 March 1926 and allotted to the Seventh Corps Area. Kansas City, MO, designated as headquarters on organization, but the Withdrawn from the Seventh Corps Area on 30 November 1928 and demobilized.

687th Service Squadron (ZI)

Organized Reserve Minnesota/North Dakota

HQ-Not initiated 1923-26; Minneapolis, MN, 1926-31; Fargo, ND, 1931-41

Constituted in the Organized Reserve on 2 July 1923, assigned to the Zone of the Interior, and allotted to the Sixth Corps Area. Withdrawn from the Sixth Corps Area in 1926 and allotted to the Seventh Corps Area. Organized by December 1926 at Minneapolis, MN. Relocated on 12 October 1931 to Fargo, ND. Location 7 December 1941—Fargo, ND.

Status: Disbanded on 31 May 1942.

Commanders, 687th Service Squadron

Unknown ao Dec 26-7 Oct 33

688th Service Squadron (ZI)**Organized Reserve Nebraska****HQ-Not initiated** 1923-28

Constituted in the Organized Reserve on 2 July 1923, assigned to the Zone of the Interior, and allotted to the Sixth Corps Area. Withdrawn from the Sixth Corps Area on 19 March 1926 and allotted to the Seventh Corps Area. Lincoln, NE, designated as headquarters on organization, but the unit was never organized at that location. Withdrawn from the Seventh Corps Area on 30 November 1928 and demobilized.

689th Service Squadron (ZI)**Organized Reserve Iowa****HQ-Not initiated** 1923-28

Constituted in the Organized Reserve on 2 July 1923, assigned to the Zone of the Interior, and allotted to the Eighth Corps Area. Withdrawn from the Eighth Corps Area on 19 March 1926 and allotted to the Seventh Corps Area. Clinton, IA, designated as headquarters on organization, but the unit was never organized at that location. Withdrawn from the Seventh Corps Area on 30 November 1928 and demobilized.

690th Service Squadron (ZI)**Organized Reserve Minnesota****HQ-Not initiated** 1923-28

Constituted in the Organized Reserve on 2 July 1923, assigned to the Zone of the Interior, and allotted to the Eighth Corps Area. Withdrawn from the Eighth Corps Area on 19 March 1926 and allotted to the Seventh Corps Area. Mankato, MN, designated as headquarters on organization, but the unit was never organized at that location. Withdrawn from the Seventh Corps Area on 30 November 1928 and demobilized.

697th Service Squadron (ZI)**Organized Reserve****HQ-Not initiated** 1924-41

Constituted in the Organized Reserve on 31 March 1924, assigned to the Zone of the Interior, but not allotted to a Corps Area. Withdrawn from the Organized Reserve 5 September 1928.

Status: Disbanded on 31 May 1942.**698th Service Squadron (ZI)****Organized Reserve****HQ-Not initiated** 1924-41

Constituted in the Organized Reserve on 31 March 1924, assigned to the Zone of the Interior, but not allotted to a Corps Area. Withdrawn from the Organized Reserve 5 September 1928.

Status: Disbanded on 31 May 1942.**699th Service Squadron (ZI)****Organized Reserve****HQ-Not initiated** 1924-41

Constituted in the Organized Reserve on 31 March 1924, assigned to the Zone of the Interior, and allotted to the Sixth Corps Area. Withdrawn from the Sixth Corps Area on 19 March 1926 and allotted to the Ninth Corps Area. Withdrawn from the Ninth Corps Area 5 September 1928.

Status: Disbanded on 31 May 1942.

775th Service Squadron (ZI)

Organized Reserve

HQ-*Not initiated* 1924-41

Constituted in the Organized Reserve on 2 July 1923, assigned to the Zone of the Interior, and allotted to the Seventh Corps Area. Withdrawn from the Seventh th Corps Area on 19 March 1926 and allotted to the Second Corps Area. Withdrawn from the Second Corps Area on 28 November 1928.

Status: Disbanded on 31 May 1942.

776th Service Squadron (ZI)

Organized Reserve

HQ-*Not initiated* 1924-41

Constituted in the Organized Reserve on 31 March 1924 and assigned to the Zone of the Interior, but initially allotted to a Corps Area. Allotted to the Second Corps Area on 19 March 1926. Withdrawn from the Second Corps Area on 28 November 1928. Location 7 December 1941—*Not initiated*.

Status: Disbanded on 31 May 1942.

777th Service Squadron (ZI)

Organized Reserve

HQ-*Not initiated* 1924-41

Constituted in the Organized Reserve on 31 March 1924 and assigned to the Zone of the Interior, but initially allotted to a Corps Area. Allotted to the Second Corps Area on 19 March 1926. Withdrawn from the Second Corps Area on 28 November 1928. Location 7 December 1941—*Not initiated*.

Status: Disbanded on 31 May 1942.

778th Service Squadron (ZI)

Organized Reserve

HQ-*Not initiated* 1924-41

Constituted in the Organized Reserve on 31 March 1924 and assigned to the Zone of the Interior, but initially allotted to a Corps Area. Allotted to the Second Corps Area on 19 March 1926. Withdrawn from the Second Corps Area on 28 November 1928. Location 7 December 1941—*Not initiated*.

Status: Disbanded on 31 May 1942.

779th Service Squadron (ZI)

Organized Reserve

HQ-*Not initiated* 1924-41

Constituted in the Organized Reserve on 31 March 1924 and assigned to the Zone of the Interior, but initially allotted to a Corps Area. Allotted to the Second Corps Area on 19 March 1926. Withdrawn from the Second Corps Area on 28 November 1928. Location 7 December 1941—*Not initiated*.

Status: Disbanded on 31 May 1942.

780th Service Squadron (ZI)

Organized Reserve

HQ-*Not initiated* 1924-41

Constituted in the Organized Reserve on 31 March 1924 and assigned to the Zone of the Interior, but not initially allotted to a Corps Area. Allotted to the Second Corps Area on 19 March 1926. Withdrawn from the Second Corps Area on 28 November 1928. Location 7 December 1941—*Not initiated*.

Status: Disbanded on 31 May 1942.

781st Service Squadron (ZI)

Organized Reserve

HQ-*Not initiated* 1924-41

Constituted in the Organized Reserve on 31 March 1924 and assigned to the Zone of the Interior, but not initially allotted to a Corps Area. Allotted to the Second Corps Area on 19 March 1926. Withdrawn from the Second Corps Area on 28 November 1928. Location 7 December 1941—*Not initiated*.

Status: Disbanded on 31 May 1942.

782nd Service Squadron (ZI)

Organized Reserve

HQ-*Not initiated* 1924-41

Constituted in the Organized Reserve on 31 March 1924 and assigned to the Zone of the Interior, but not initially allotted to a Corps Area. Allotted to the Second Corps Area on 19 March 1926. Withdrawn from the Second Corps Area on 28 November 1928. Location 7 December 1941—*Not initiated*.

Status: Disbanded on 31 May 1942.

783rd Service Squadron (ZI)

Organized Reserve

HQ-*Not initiated* 1924-41

Constituted in the Organized Reserve on 31 March 1924 and assigned to the Zone of the Interior, but not initially allotted to a Corps Area. Allotted to the Second Corps Area on 19 March 1926. Withdrawn from the Second Corps Area on 28 November 1928. Location 7 December 1941—*Not initiated*.

Status: Disbanded on 31 May 1942.

784th Service Squadron (ZI)

Organized Reserve

HQ-*Not initiated* 1924-41

Constituted in the Organized Reserve on 31 March 1924 and assigned to the Zone of the Interior, but not allotted to a Corps Area. Demobilized on 19 March 1926.

785th Service Squadron (ZI)

Organized Reserve

HQ-*Not initiated* 1924-41

Constituted in the Organized Reserve on 31 March 1924 and assigned to the Zone of the Interior, but not allotted to a Corps Area. Demobilized on 19 March 1926.

786th Service Squadron (ZI)

Organized Reserve

HQ-Not initiated 1924-41

Constituted in the Organized Reserve on 31 March 1924 and assigned to the Zone of the Interior, but not allotted to a Corps Area. Demobilized on 19 March 1926.

787th Service Squadron (ZI)

Organized Reserve

HQ-Not initiated 1924-41

Constituted in the Organized Reserve on 31 March 1924 and assigned to the Zone of the Interior, but not allotted to a Corps Area. Demobilized on 19 March 1926.

788th Service Squadron (ZI)

Organized Reserve

HQ-Not initiated 1924-41

Constituted in the Organized Reserve on 31 March 1924 and assigned to the Zone of the Interior, but not allotted to a Corps Area. Demobilized on 19 March 1926.

789th Service Squadron (ZI)

Organized Reserve

HQ-Not initiated 1924-41

Constituted in the Organized Reserve on 31 March 1924 and assigned to the Zone of the Interior, but not allotted to a Corps Area. Demobilized on 19 March 1926.

790th Service Squadron (ZI)

Organized Reserve

HQ-Not initiated 1924-41

Constituted in the Organized Reserve on 31 March 1924 and assigned to the Zone of the Interior, but not allotted to a Corps Area. Demobilized on 19 March 1926.

791st Service Squadron (ZI)

Organized Reserve

HQ-Not initiated 1924-41

Constituted in the Organized Reserve on 31 March 1924 and assigned to the Zone of the Interior, but not allotted to a Corps Area. Demobilized on 19 March 1926.

792nd Service Squadron (ZI)

Organized Reserve

HQ-Not initiated 1924-41

Constituted in the Organized Reserve on 31 March 1924 and assigned to the Zone of the Interior, but not allotted to a Corps Area. Demobilized on 19 March 1926.

793rd Service Squadron (ZI)

Organized Reserve

HQ-Not initiated 1924-41

Constituted in the Organized Reserve on 31 March 1924 and assigned to the Zone of the Interior, but not allotted to a Corps Area. Demobilized on 19 March 1926.

794th Service Squadron (ZI)

Organized Reserve

HQ-Not initiated 1924-41

Constituted in the Organized Reserve on 31 March 1924 and assigned to the Zone of the Interior, but not allotted to a Corps Area. Demobilized on 19 March 1926.

795th Service Squadron (ZI)

Organized Reserve

HQ-Not initiated 1924-41

Constituted in the Organized Reserve on 31 March 1924 and assigned to the Zone of the Interior, but not allotted to a Corps Area. Demobilized on 19 March 1926.

796th Service Squadron (ZI)

Organized Reserve

HQ-Not initiated 1924-41

Constituted in the Organized Reserve on 31 March 1924 and assigned to the Zone of the Interior, but not allotted to a Corps Area. Demobilized on 19 March 1926.

797th Service Squadron (ZI)

Organized Reserve

HQ-Not initiated 1924-41

Constituted in the Organized Reserve on 31 March 1924 and assigned to the Zone of the Interior, but not allotted to a Corps Area. Demobilized on 19 March 1926.

798th Service Squadron (ZI)

Organized Reserve

HQ-Not initiated 1924-41

Constituted in the Organized Reserve on 31 March 1924 and assigned to the Zone of the Interior, but not allotted to a Corps Area. Demobilized on 19 March 1926.

799th Observation Squadron (ZI)

Organized Reserve Maryland

HQ-Not initiated 1924-33

Constituted in the Organized Reserve on 31 March 1924, assigned to the Coast Artillery School, and allotted to the Third Corps Area. Hagerstown, MD, designated as headquarters on organization, but the unit was never organized at that location. Mobilization mission was to provide aerial observation support to the Coast Artillery School. Demobilized on 1 October 1933.

800th Observation Squadron (ZI)**Organized Reserve Louisiana****HQ-***Not initiated* 1924-25; Shreveport, LA, 1925-33

Constituted in the Organized Reserve on 31 March 1924, assigned to the Infantry School, and allotted to the Fourth Corps Area. Initiated by December 1925 at Shreveport, LA. Conducted summer training at Lawson Field, GA, 1922-33. Mobilization mission was to provide aerial observation support to the Infantry School. Demobilized on 1 October 1933.

Commanders, 800th Observation Squadron

Unknown	Dec 25-1 Oct 33
---------	-----------------

801st Observation Squadron (ZI)**Organized Reserve Florida****HQ-***Not initiated* 1924-33

Constituted in the Organized Reserve on 31 March 1924, assigned to the Zone of the Interior, and allotted to the Fourth Corps Area. Miami, FL, designated as headquarters on organization, but the unit was never organized at that location. Mobilization mission was to provide aerial observation support to the Commanding General, Fourth Corps Area. Demobilized on 1 October 1933.

802nd Observation Squadron (ZI)**Organized Reserve Indiana****HQ-***Not initiated* 1924-25; Indianapolis, IN, 1925-30; *Inactive* 1930-3

Constituted in the Organized Reserve on 31 March 1924, assigned to the Zone of the Interior, and allotted to the Fifth Corps Area. Initiated in September 1925 at Indianapolis, IN. Inactivated by March 1930 at Indianapolis by relief of personnel. Conducted summer training at Schoen Field, IN. Mobilization mission was to provide aerial observation support to the Commanding General, Fifth Corps Area. Demobilized on 1 October 1933.

803rd Observation Squadron (ZI)**Organized Reserve Iowa/South Dakota****HQ-**Davenport, IA, 1924-26; Sheldon, IA, 1926-31; Aberdeen, SD, 1931-33

Constituted in the Organized Reserve on 31 March 1924, assigned to the Zone of the Interior, and allotted to the Seventh Corps Area. Initiated in November 1924 at Davenport, IA. Relocated on 26 May 1926 to Sheldon, IA. Relocated on 12 October 1931 to Aberdeen, SD. Mobilization mission was to provide aerial observation support to the Cavalry School. Conducted summer training at Marshall Field, KS. Demobilized on 1 October 1933.

Commanders, 803rd Observation Squadron

Unknown	Nov 24-1 Oct 33
---------	-----------------

804th Observation Squadron (ZI)**Organized Reserve Texas****HQ-**Kelly Field, TX, 1924-33

Constituted in the Organized Reserve on 31 March 1924, assigned to the Zone of the Interior, and allotted to the Eighth Corps Area. Initiated by August 1924 at Kelly Field, TX. Conducted summer training at Kelly Field, TX. Mobilization mission was to provide aerial observation support to the Field Artillery School. Demobilized on 1 October 1933.

Commanders, 804th Observation Squadron

Unknown	Aug 25-1 Oct 33
---------	-----------------

805th Observation Squadron (ZI)**Organized Reserve Oregon/Washington****HQ-Not initiated** 1924-25; Portland, OR, 1925-37; *Inactive* 1937-41

Constituted in the Organized Reserve on 31 March 1924, assigned to the Ninth Corps Area Air Service, and allotted to the Ninth Corps Area. Initiated by December 1925 at Portland, OR. Assigned on 28 January 1930 to the 341st Observation Group. Consolidated on 8 December 1936 with the 805th Aero Squadron (Repair) (a WWI unit organized in November 1917 as the 244th Aero Squadron; redesignated as the 805th Aero Squadron (Repair) in February 1918; demobilized in June 1919 at Mitchel Field, NY; reconstituted on 8 December 1936). Inactivated on 11 June 1937. Mobilization mission was to provide aerial observation support to the Commanding General, Ninth Corps Area. Location 7 December 1941—*Inactive*.

Status: Disbanded on 31 May 1942.**Commanders, 805th Observation Squadron**

Unknown

Dec 25-11 Jun 37

Inactive

11 Jun 37-7 Dec 41

806th Headquarters Squadron (1924-33) (ZI)**Organized Reserve New Jersey****HHS, 806th Air Depot (1933-41)****HQ-Not initiated** 1924-33; Eighth Corps Area on 1933-36; *Inactive* 1936-41

Constituted in the Organized Reserve on 31 March 1924 as the 806th Headquarters Squadron, assigned to the Zone of the Interior, and allotted to the Third Corps Area. Withdrawn from the Third Corps Area on 19 March 1926 and allotted to the Fifth Corps Area. Redesignated as the 16 August 1933 as Headquarters and Headquarters Squadron, 806th Air Depot. Concurrently withdrawn from the Fifth Corps Area and allotted to the Eighth Corps Area. Initiated by December 1933 in the Eighth Corps Area. Withdrawn from the Eighth Corps Area on 5 June 1936 and allotted to the Second Corps Area. Inactivated on 3 November 1936 in the Eighth Corps Area by relief of personnel. Consolidated on 8 December 1936 with the 806th Aero Squadron (Repair) (a WWI unit organized in November 1917 at Kelly Field, TX, as the 245th Aero Squadron (Repair); redesignated as the 806th Aero Squadron (Repair) in February 1918; demobilized in December 1918 at Garden City, NY; reconstituted on 8 December 1936). Location 7 December 1941—*Inactive*.

Commanders, 806th Air Depot

Unknown

Dec 33-3 Nov 36

Inactive

3 Nov 36-7 Dec 41

807th Headquarters Squadron (ZI)**Organized Reserve Missouri****HQ-Not initiated** 1924-41

Constituted in the Organized Reserve on 13 June 1924, assigned to the Zone of the Interior, and allotted to the Seventh Corps Area. St. Louis, MO, designated as headquarters on organization, but the unit was never organized at that location. Withdrawn from the Organized Reserve on 6 October 1928. Location 7 December 1941—*Not initiated*.

Status: Disbanded on 31 May 1942.**808th Headquarters Squadron (ZI)****Organized Reserve****HQ-Not initiated** 1924-41

Constituted in the Organized Reserve on 13 June 1924, assigned to the Zone of the Interior, and allotted to the Ninth Corps Area. Withdrawn from the Organized Reserve on 6 October 1928. Location 7 December 1941—*Not initiated*.

Status: Disbanded on 31 May 1942.

809th Observation Squadron (ZI)**Organized Reserve Oklahoma****HQ-Not initiated** 1924-41

Constituted in the Organized Reserve on 13 June 1924, assigned to the Zone of the Interior, and allotted to the Second Corps Area. Oklahoma City, OK, designated as headquarters on organization, but the unit was never organized at that location. Withdrawn from the Organized Reserve on 6 October 1928. Location 7 December 1941—*Not initiated*.

Status: Disbanded on 31 May 1942.**810th Observation Squadron (ZI)****Organized Reserve New Mexico****HQ-Not initiated** 1924-41

Constituted in the Organized Reserve on 13 June 1924, assigned to the Zone of the Interior, and allotted to the Eighth Corps Area. Withdrawn from the Organized Reserve on 6 October 1928. Location 7 December 1941—*Not initiated*.

Status: Disbanded on 31 May 1942.**811th Observation Squadron (ZI)****Organized Reserve Colorado****HQ-Not initiated** 1924-41

Constituted in the Organized Reserve on 13 June 1924, assigned to the Zone of the Interior, and allotted to the Eighth Corps Area. Withdrawn from the Organized Reserve on 6 October 1928. Location 7 December 1941—*Not initiated*.

Status: Disbanded on 31 May 1942.**861st Observation Squadron (61st Cavalry Division)****Organized Reserve New York****HQ-Not initiated** 1928-29; New York City, NY, 1929-41

Constituted in the Organized Reserve on 20 December 1928, assigned to the 61st Cavalry Division, and allotted to the Second Corps Area. Relieved from assignment to the 61st Cavalry Division. Initiated on 1 July 1929 at New York City, NY. Conducted summer training at Mitchel Field, NY. Designated mobilization station was Mitchel Field, NY. Assigned on 7 May 1937 to the 307th Observation Group. Location 7 December 1941—New York City, NY.

Status: Disbanded on 31 May 1942.**Commanders, 861st Observation Squadron**

1st Lt. Paul A. Sandberg	4 Nov 29-2 Dec 29	Maj. Clayton C. Shangraw	25 Jun 31-19 Mar 32
Maj. Floyd N. Shumaker	2 Dec 29-3 Jun 30	Maj. Paul C. Durbin	19 Mar 32-15 Jul 39
Maj. John F. O'Laughlin	3 Jun 30-25 Jun 31	Unknown	15 Jul 39-7 Dec 41

862nd Observation Squadron (62nd Cavalry Division)**Organized Reserve District of Columbia****HQ-Not initiated** 1928-29; Washington, DC, 1929-33

Constituted in the Organized Reserve on 20 December 1928, assigned to the 62nd Cavalry Division, and allotted to the Third Corps Area. Initiated in December 1929 at Washington, DC. Relieved on 21 February 1929 from assignment to the 62nd Cavalry Division. Conducted summer training at Langley Field, VA. Demobilized on 1 October 1933.

Commanders, 862nd Observation Squadron

Unknown	Dec 29-6 Aug 31	Maj. Earl W. Hutchison	6 Aug 31-1 Oct 33
---------	-----------------	------------------------	-------------------

863rd Observation Squadron (63rd Cavalry Division)**Organized Reserve North Carolina****HQ-Not initiated** 1928-29; Goldsboro, NC, 1929-33

Constituted in the Organized Reserve on 20 December 1928, assigned to the 63rd Cavalry Division, and allotted to the Fourth Corps Area. Relieved on 21 February 1929 from assignment to the 63rd Cavalry Division. Initiated in October 1929 at Goldsboro, NC. Conducted summer training at Maxwell Field, AL, or Candler Field, GA. Demobilized on 1 October 1933.

Commanders, 863rd Observation Squadron

Unknown	Oct 29-1 Oct 33
---------	-----------------

864th Observation Squadron (64th Cavalry Division)**Organized Reserve Ohio****HQ-Not initiated** 1928-31; Akron, OH, 1931-37; *Inactive* 1937-41

Constituted in the Organized Reserve on 20 December 1928, assigned to the 64th Cavalry Division, and allotted to the Fifth Corps Area. Relieved on 21 February 1929 from assignment to the 64th Cavalry Division. Initiated by October 1931 at Akron, OH. Consolidated on 8 December 1936 with the 864th Aero Squadron (Depot) (a WWI unit organized in March 1918 at St. Paul, MN; demobilized in November 1919 at St. Paul; reconstituted on 8 December 1936). Inactivated by June 1937 at Akron by relief of personnel. Location 7 December 1941—*Inactive*.

Status: Disbanded on 31 May 1942.**Commanders, 864th Observation Squadron**

Unknown	ao Oct 31- Jun 37	<i>Inactive</i>	Jun 37-7 Dec 41
---------	-------------------	-----------------	-----------------

865th Observation Squadron (65th Cavalry Division)**Organized Reserve Illinois****HQ-Not initiated** 1928-29; Chicago, IL, 1929-41

Constituted in the Organized Reserve on 20 December 1928, assigned to the 65th Cavalry Division, and allotted to the Sixth Corps Area. Relieved on 21 February 1929 from assignment to the 65th Cavalry Division. Initiated by December 1929 at Chicago, IL. Assigned on 1 October 1933 to the 11th Observation Group (Second Army). Consolidated on 30 November 1936 with the 865th Aero Squadron (Repair) (a WWI unit organized in March 1918 at Love Field, TX; demobilized in March 1919 at Dallas, TX; reconstituted on 30 November 1936). Typically conducted Inactive Training Period meetings at the Municipal Airport in Chicago. Location 7 December 1941—Chicago, IL.

Status: Disbanded on 31 May 1942.**Commanders, 865th Observation Squadron**

Unknown	ao Dec 29-17 Jan 36	Lt. Col. Willis H. Proctor	17 Jan 36-ao Jan 40
	Unknown	ao Jan 40-7 Dec 41	

866th Observation Squadron (66th Cavalry Division)**Organized Reserve Kansas****HQ-Not initiated** 1928-31; Wichita, KS, 1931-33

Constituted in the Organized Reserve on 20 December 1928, assigned to the 66th Cavalry Division, and allotted to the Seventh Corps Area. Relieved on 21 February 1929 from assignment to the 66th Cavalry Division. Initiated by December 1931 at Wichita, KS. Demobilized on 1 October 1933.

Commanders, 866th Observation Squadron

Unknown	ao Dec 31-1 Oct 33
---------	--------------------

Chapter 32

Companies and Squadrons, Lighter Than Air



Airship C-41 from the 19th Airship Squadron at Virginia Beach, VA in 1930.

Lighter Than Air (LTA) squadrons provided aerial reconnaissance and observation support to the arms.

Organization

There were four types of LTA companies in the interwar US Army force structure. These included airship companies, balloon companies, airship service companies, and balloon service companies. There were a number of these companies that were designated as school and air depot units, but those designations appear to have referred to mobilization assignments and did not indicate a material difference in their T/O from any companies of their type. The following table shows the allotment of companies and squadrons by type as they were originally organized as of 1921 (in the case of Regular Army units) or as originally constituted and in the component to which they were originally allotted in the interwar period.

Allotment of companies and squadrons by type organized as of 1921.

	Ash	Ash Sv	Bln	Bln Sv
RA	5	1	27	0
RAI	1	2	12	4
NG	0	0	36	9
OR	24	1	125	34
Totals	30	4	200	47

Airship Company, 1921

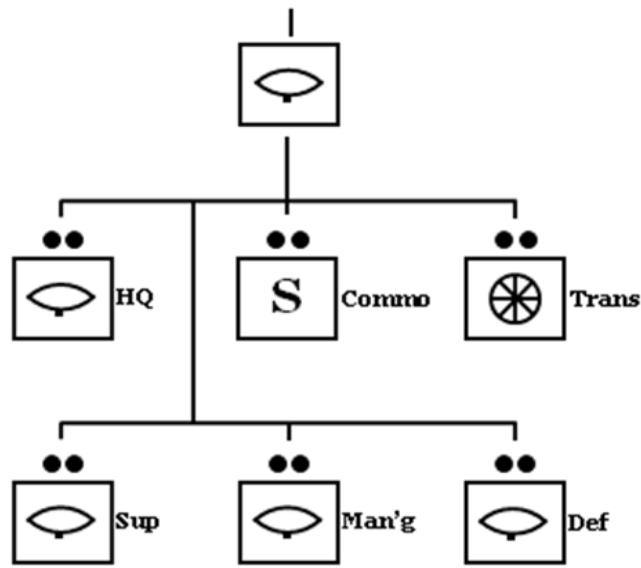

T/O: 580W
 Effective: 31 August 1921
 Commander: Maj.
 Officers: 9
 W. O.: -
 Enlisted: 175
 Total: 184

Key Equipment:
 Airship 1
 Trucks, various 12
 Guns, 37 mm 2
 Machine guns, AA 12

Airship Service Company, 1926

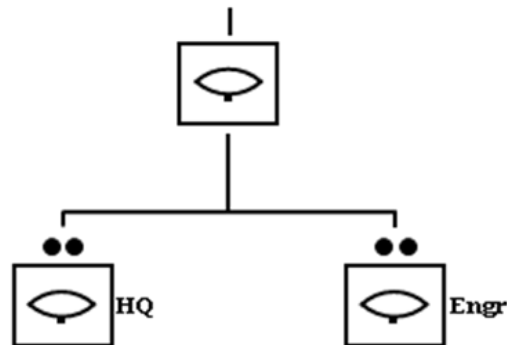

T/O: 579W
 Effective: 29 June 1926
 Commander: Maj.
 Officers: 6
 W. O.: -
 Enlisted: 170
 Total: 176

Key Equipment:
 Trucks, various 13
 Machine guns, AA 3

TOEs for the airship and airship service companies.

Balloon Company, 1921

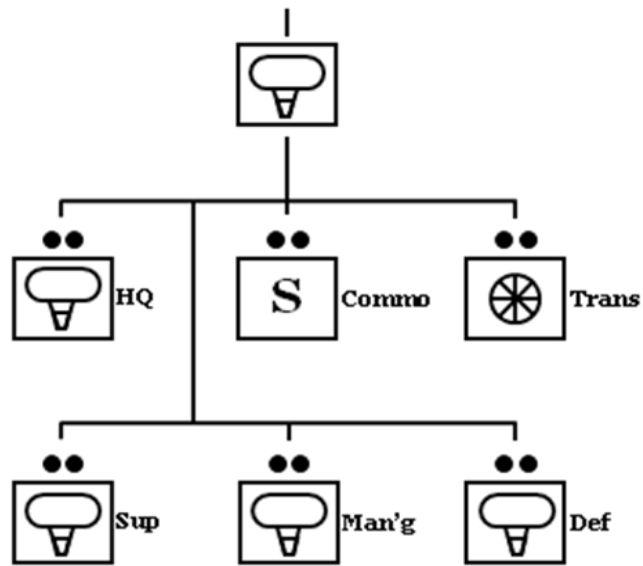

T/O: 178W
 Effective: 5 July 1921
 Commander: Capt.
 Officers: 9
 W. O.: --
 Enlisted: 175
 Total: 184

Key Equipment:
 Balloon: 1
 Trucks, various: 12
 Guns, 37 mm: 2
 Machine guns, AA: 12

Balloon Squadron, 1930

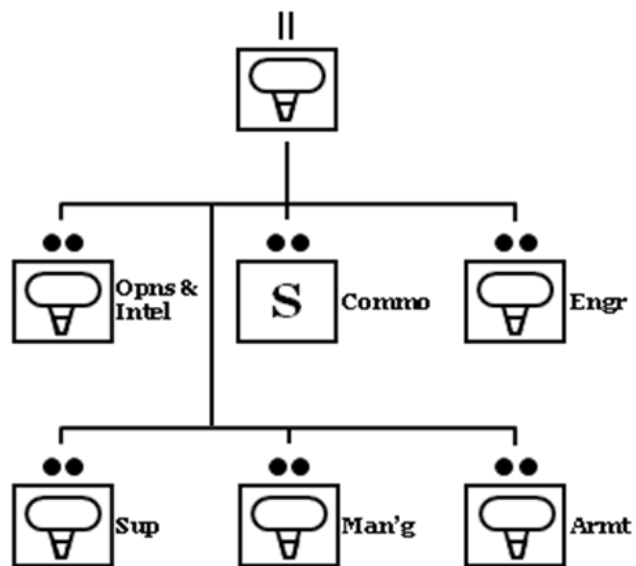

T/O: 178
 Effective: 10 June 1930
 Commander: Maj.
 Officers: 8
 W. O.: --
 Enlisted: 130
 Total: 138

Key Equipment:
 Balloons, various: 2
 Trucks, various: 10
 Machine guns, AA: 2

TOEs for the balloon companies and balloon squadrons.

The story of the US Army's experience with LTA operations is one of a technology that seemed to have great potential coming out of the Great War, but could not realize that potential when competing against the reality of peacetime military budgets and the onward march of its heavier than air competition. Proponents in the air service envisioned many ways that LTA organizations could contribute to the Army's wartime missions. From coast defense operations to what amounted to the strategic mission of terror bombing civilian populations deep in the enemy's interior, a la Giulio Douhet, LTA enthusiasts had great plans for the airship and balloon in warfare. The plans of these proponents soon ran up against battles in the Army budgeting process as the Congress slashed funding to the Army. Army planners and leaders, while agreeing that LTA organizations and capabilities were needed in the force structure, believed that HTA technologies and organizations held much greater potential for future warfare. Thus, the lion's share of money went to funding the air service's HTA arm.

Still, planning for LTA capabilities went forward. In 1920 there were thirty-two World War I-era balloon companies still on active duty. That year, the air service estimated that it would only need ten active balloon companies for the purposes of coast defense and patrolling duties on the Mexican border. To support these plans, the air service began construction of balloon sheds near various harbor defense locations on the east and west coasts, as well as several along the Mexican border. Additionally, several balloon companies began a series of tests and experiments working with coast artillery batteries in California, Washington, and Hawaii. Within two years, however, twenty-two of these companies were demobilized or inactivated, another eight reorganized as airship companies, and the remaining two were reorganized as LTA school units, one of which was also demobilized a short time later. By 1922 no balloon companies were on active duty. By then the Army's active LTA force consisted only of one airship group headquarters, four airship companies, and one airship service squadron.

Over the next nineteen years, the active LTA force would undergo a number of activations, inactivations, and demobilizations. In 1927 several new balloon companies were constituted in the Regular Army to replace some of those companies that were demobilized in 1922. Several of those companies were then demobilized several years later in 1933 as the Army continued to struggle with mobilization plans and force structure. By 1933, there were only two balloon squadrons, two airship squadrons, and one airship service squadron on active duty, though there were several others that were active as RAI units. In 1935, the one remaining service squadron was inactivated and two years later, the Army agreed to transfer the airship mission to the Navy. At that time, the two remaining airship squadrons were consolidated with other air corps units and all airships and related equipment was handed over to the Navy. Concurrently, the Army organized a third balloon squadron from one of the former airship organizations. For the next several years these three squadrons supported the training of the field artillery and coast artillery schools as well as several harbor defense commands.

In 1940, the 3rd Balloon Squadron at Camp Davis, North Carolina, was reorganized as a barrage balloon organization for testing with coast artillery anti-aircraft units. A dozen or so barrage balloon squadrons were contemplated for mobilization but at the time it was not clear whether the units would come under air corps or coast artillery control. Nevertheless, the 3rd Squadron set about helping to validate the concept and, once the decision was made to put the units under the coast artillery, it formed the basis of the training center for the new barrage balloon units.

During the Louisiana maneuvers in 1941, the 1st Balloon Squadron encountered a new competitor. Several Piper Cub aircraft were used for spotting artillery fire and they proved to be very successful. The writing was now on the wall for the army's LTA air arm. Though the three remaining squadrons were still on active duty at the time of Pearl Harbor, all soon went the way of the horse cavalry. With the inactivation of all three squadrons in February 1942, the air corps' experiments with lighter than air platforms passed into history.

The structure for balloon and airship companies were almost identical. Both consisted of six sections: headquarters, communications, transportation, supply, maneuvering, and armament. Both also possessed 184 officers and men to support, maintain, and operate one balloon or airship. The fact that there was only one craft per company indicates the complexity associated with LTA aircraft. The service company was a simpler organization, but as large. It consisted of a headquarters and an engineering section. The organization of the LTA companies underwent a T/O reorganization in 1930 that authorized two aircraft to each type of organization. Though the T/Os for LTA squadrons were adopted in 1930, the change in designation did not take place until over three years later.

Balloon companies and groups, were typically assigned to army corps to support artillery operations and provide battlefield observation. Companies were assigned four to a group along with one service company. Though a large number of balloon companies and groups in the mobilization plans were slated for assignment to army corps, there were also a number allotted to the General Headquarters Reserve and the Zone of the Interior, with the latter being mostly school troops. Airship companies along with one service company were also assigned four to each airship group. Most of the airship companies and service companies were assigned to the General Headquarters Reserve. Three airship groups, however, were assigned to the overseas departments. Like the balloon companies, there were a number of companies assigned to the Zone of the Interior as school troops.

There were a sizable number of balloon and balloon service companies assigned to the National Guard. These units were mostly corps troops although one Guard balloon group was assigned to the General Headquarters Reserve. None of the NG units, however, were ever organized and all were demobilized in 1927.

By far, the majority of LTA companies were OR organizations. Many of those units were initiated at some point in the interwar period, but substantial numbers were never assigned any personnel. Many others were demobilized in 1927 and 1928, and by the following year, many of those that had been initiated had now been inactivated. Most of those personnel appear to have been transferred to other Reserve organizations, but not necessarily air corps units. In 1933, a large number of additional Reserve LTA units were demobilized as the Army struggled to find the right mix of units. By the late 1930s, relatively few of the OR balloon and airship squadrons originally initiated in the early 1920s remained active. By the time of Pearl Harbor even fewer were functional units and none were ordered to active duty.

Training

The Regular Army's LTA companies and squadrons were fairly active organizations between the wars mainly because there were so few of them. In addition to their own training exercises to maintain proficiency in their primary missions, these units supported a variety of other training events to include maneuver training with coast and field artillery units, Billy Mitchell's aerial bombing tests of obsolete battleships off the Virginia coast, and exercises with naval sea and air units. These units also frequently entered their balloons and airships in the annual National Balloon Race, the International Balloon Race, and other prestigious LTA races. In fact, a US Army balloon crew won the former race three years running from 1926 to 1928. In addition to activities, balloon and airship companies often supported the summer training of Organized Reserve LTA units as well.

All of the RAI LTA units that were organized with Reserve personnel were concentrated in the area of Chicago, Illinois. Given that fact the largest concentration of LTA units and the airship school was located only a four-hour drive away at Scott Field, that concentration seemed to make sense. For the relatively short period the RAI units in Chicago were functional units, those units' personnel were largely concentrated in and around the city and were thus easily assembled for training. For unknown reasons, most of the units in Chicago were inactivated in 1932 and apparently none were ever ordered to camp as a unit.

It is unlikely that very many of the Organized Reserve LTA units were functional organizations. The most active were those units located at or near installations where Regular Army LTA units were based.

In those instances Regular units could make their equipment and facilities available to the Reservists to support their training. These examples are few, however. Most of the Reserve LTA units were typically located in small communities and cities too far away from active units to enjoy such benefits. Additionally, the Reserve companies typically consisted of only four to eight officers whose residences were often geographically dispersed making it difficult to frequently assemble the unit during the Inactive Training Period. Thus, the large majority of the Reserve organizations were most probably pool units. Moreover, less than thirty of these units were ever ordered to summer training as units. Generally speaking, functional organizations were ordered to camp as units; the personnel of pool units were usually ordered to camp as individuals and were attached for training to the functional units.

1st Balloon Company (I) (1919-23)

1st Airship Company (1923-29) (23rd Airship Group)

1st Balloon Company (1929-37) (26th Balloon Group)

1st Balloon Squadron (1937-39) (21st Balloon Group)

HQ-Camp Lee, VA, 1919; Ross Field, CA, 1919-22; *Inactive* 1922-29; Post Field, OK, 1929-41

Arrived at the port of Newport News, VA, on 5 June 1919 on the U.S.S. *Ancon* as Balloon Company No. 1. Transferred to Camp Lee, VA, and arrived there on 9 June 1919. Transferred on 3 July 1919 to Ross Field, Arcadia, CA, and assigned to the Army Balloon School. Inactivated on 25 July 1922 at Ross Field. Assigned to the 23rd Airship Group on 6 February 1923. Redesignated as the 1st Balloon Company on 12 February 1923. Redesignated as the 1st Airship Company on 24 March 1923. Concurrently the 18th Airship Company was designated Active Associate. Allotted to the Eighth Corps Area on 28 February 1927. Fort Sam Houston, TX, designated as headquarters on reorganization, but the unit was never organized at that location. Withdrawn from the Eighth Corps Area on 1 September 1928 and allotted to the Sixth Corps Area. Relieved from the 23rd Airship Group on 8 May 1929 and assigned to the 26th Balloon Group. Chicago, IL, designated on 10 June 1929 as headquarters on reorganization, but the unit was never organized at that location. Redesignated as the 1st Balloon Company on 31 July 1929 and activated at Post Field, Fort Sill, OK, by consolidation with the 1st Balloon Company, then active at Fort Sill. Concurrently attached to the Field Artillery School as school support troops. Redesignated as the 1st Balloon Squadron on 1 October 1933. Relieved from the 26th Balloon Group on 1 June 1937 and assigned to the 21st Balloon Group. Relieved on 1 June 1939 from the 21st Balloon Group. Assigned to the III Air Support Command 1 September 1941. Location 7 December 1941—Post Field, OK.

Status: Disbanded 6 February 1942. With the 1st Ferrying Squadron, reconstituted 19 September 1985 and consolidated with the 1st Airborne Command Control Squadron. Active in the U. S. Air Force as the 1st Airborne Command Control Squadron at Offutt A.F.B., NE.

Events: 214, 295, 300, 328

Commanders, 1st Balloon Company

1st Airship Company

1st Balloon Company

1st Balloon Squadron

1st Lt. Dache M. Reeves	ao Jan 20-28 Mar 21	Capt. Henry C. White	12 Dec 21-25 Jul 22
Capt. Joseph W. Benson	28 Mar 21-25 Apr 21	<i>Inactive</i>	25 Jul 22-17 May 29
Capt. William E. Kepner	25 Apr 21-4 May 21	Capt. Neal Creighton	17 May 29-31 May 34
Capt. Warner B. Gates	4 May 21-25 Jul 21	Capt. Raymond E. O'Neill	31 May 34-9 Jun 34
Capt. Roland W. Wittman	25 Jul 21-12 Dec 21	Maj. Ira R. Koenig	9 Jun 34-6 Feb 42

1st Balloon Company (II) (26th Balloon Group)

HQ-*Not organized* 1927-29; Scott Field, IL, 1929; Post Field, OK, 1929

Constituted in the Regular Army on 18 October 1927, assigned to the 26th Balloon Group, and allotted to the Sixth Corps Area. Organized on 17 May 1929 at Scott Field, IL. Transferred by July 1929 to Post Field, Fort Sill, OK. Consolidated with the 1st Airship Company on 31 July 1929 and consolidated unit designated as the 1st Balloon Company (see unit above for lineage hereafter).

Commanders, 1st Balloon Company

Capt. Neal Creighton 17 May 29-31 Jul 29

1st Airship Company (II) (23rd Airship Group)

Regular Army Inactive

HQ-*Not organized* 1929-30; Chicago, IL, 1930-32; *Inactive* 1932-33

Constituted in the Regular Army on 31 July 1929, assigned to the 23rd Airship Group, and allotted to the Sixth Corps Area. Organized by June 1930 with Organized Reserve personnel as a RAI unit at Chicago, IL. Inactivated by June 1932 at Chicago by relief of personnel. Demobilized on 1 October 1933.

Commanders, 1st Airship Company

1st Lt. William J. Flood*	3 Mar 26-7 Jun 26	Capt. William O. Butler*	7 Jun 26-9 Apr 29
---------------------------	-------------------	--------------------------	-------------------

* Regular Army officers who were designated as commander for mobilization purposes only.

2nd Balloon Company (I) (1919-21)

Air Service Balloon School (1921)

Air Service Balloon School Detachment (1921-22)

HQ-Garden City, NY, 1919; Ross Field, CA, 1919-22

Arrived at the port of New York, NY, on 22 June 1919 on the U.S.S. *Patria* as Balloon Company No. 2. Transferred to Garden City, NY, and arrived there on the same day. Transferred on 11 August 1919 to Ross Field, Arcadia, CA, and assigned to the Army Balloon School. Reorganized on 1 October 1921 and redesignated as the Air Service Balloon School. Further redesignated as the Air Service Balloon School Detachment 19 December 1921. Demobilized on 31 May 1922 at Ross Field.

Status: Reconstituted and consolidated on 6 August 1930 with the 2nd Balloon Company at Pope Field, Fort Bragg, NC.

Commanders, Balloon Company No. 2

Air Service Balloon School

Air Service Balloon School Detachment

Capt. George F. Parris	ao Dec 19-15 Jan 21	1st Lt. Bruce N. Martin	24 Jan 21-25 Jul 21
	Capt. Warner B. Gates	25 Jul 21-31 May 22	

2nd Balloon Company (II) (1927-33) (26th Balloon Group)

2nd Balloon Squadron (1933-41) (24th Balloon Group)

HQ-*Not organized* 1927-30; Pope Field, NC, 1930-41

Constituted in the Regular Army on 18 October 1927 as the 2nd Balloon Company, allotted to the Eighth Corps Area, and assigned to the 26th Balloon Group. Fort Sam Houston, TX, designated as headquarters on organization, but the unit was never organized at that location. Withdrawn from the Eighth Corps Area on 1 September 1928 and allotted to the Sixth Corps Area. Organized on 20 May 1930 at Pope Field, Fort Bragg, NC, and attached to Headquarters, Fourth Corps Area. Consolidated on 6 August 1930 with the Air Service Balloon School Detachment (organized on 13 September 1917 in the Regular Army as B Company, 2nd Balloon Squadron; redesignated as Balloon Company No. 2 in France on 19 June 1918; redesignated as the Air Service Balloon School Detachment on 19 December 1921; demobilized on 31 May 1922 at Ross Field, Arcadia, CA; reconstituted on 6 August 1930). Redesignated as the 2nd Balloon Squadron on 1 October 1933, relieved from the 26th Balloon Group, and assigned to the 24th Balloon Group. Relieved from the 24th Balloon Group on 1 June 1937 and assigned to the 21st Balloon Group. Relieved on 1 June 1939 from the 21st Balloon Group. Supported activities of the Coast Artillery Barrage Balloon Training Center at Camp Davis, NC, 1940-41. Assigned on 1 September 1941 to the I Air Support Command. Location 7 December 1941—Pope Field, NC.

Status: Disbanded 14 May 1943.

Events: 121, 213, 214, 293, 296, 300, 330

Commanders, 2nd Balloon Company

2nd Balloon Squadron

1st Lt. William R. Turnbull	20 May 30-26 Jun 30	Maj. Joseph W. Benson	1 Oct 33-21 Dec 37
Capt. Alfred I. Puryear	26 Jun 30-2 Aug 30	Capt. Robert R. Selway	21 Dec 37-1 Jul 38

1st Lt. William R. Turnbull	2 Aug 30-16 Sep 30	Capt. Sheldon B. Edwards	1 Jul 38-25 Sep 38
Capt. Alfred I. Puryear	16 Sep 30-12 Aug 33	Maj. Neal Creighton	25 Sep 38-15 Dec 39
1st Lt. Joseph W. Benson	12 Aug 33-30 Sep 33	Maj. Joseph W. Benson	15 Dec 39-ao Apr 41

3rd Balloon Company (I)

HQ-Camp Lee, VA, 1919; Ross Field, CA, 1919-20; Fort Ruger, TH, 1920-22; *Inactive* 1922-27

Arrived at the port of Newport News, VA, 25 June 1919 on the S.S. *Virginian* as Balloon Company No. 3. Transferred to Camp Lee, VA, and arrived there on 30 June 1919. Transferred on 14 July 1919 to Ross Field, Arcadia, CA, and assigned to the Army Balloon School. Departed the port of San Francisco on 27 April 1920 on the U.S.A.T. *Logan* en route to Hawaii. Arrived 6 May 1920 at Honolulu and transferred to Fort Ruger, TH, on the same day. Assigned to the Coast Defenses of Honolulu as a coast defense balloon company. Redesignated as Balloon Company No. 3 (Coast Defense) on 13 September 1921. Inactivated on 1 August 1922 at Fort Ruger and personnel transferred to the 4th Squadron (Observation). Concurrently, the 9th Airship Company made Active Associate. The 4th Squadron (Observation) made Active Associate 20 September 1922 in lieu of 9th Airship Company. Assigned on 6 February 1923 to the 26th Balloon Group. Redesignated as the 3rd Balloon Company on 12 February 1923. Designated mobilization training station was Schofield Barracks, TH, 1922-27. Demobilized on 28 February 1927.

Commanders, 3rd Balloon Company

Capt. Lee W. Felt	ao Jan 20-ao Apr 20	1st Lt. Robert Oldys	ao Dec 20-1 Feb 21
	1st Lt. Ross G. Hoyt	1 Feb 21-1 Aug 22	

3rd Balloon Company (II) (1927-33) (26th Balloon Group) Group)

3rd Balloon Squadron (1933-40) (21st Balloon Group)

3rd Barrage Balloon Squadron (1940-41)

HQ-*Not organized* 1927-30; Chicago, IL, 1930-32; *Inactive* 1932-37; Gray Field, WA, 1937-41; Camp Davis, NC, 1941

Constituted in the Regular Army on 18 October 1927 as the 3rd Balloon Company, allotted to the Eighth Corps Area, and assigned to the 26th Balloon Group. Fort Sam Houston, TX, designated as headquarters on organization, but the unit was never organized at that location. Withdrawn from the Eighth Corps Area on 1 September 1928 and allotted to the Sixth Corps Area. Organized by June 1930 with Organized Reserve personnel as a RAI unit at Chicago, IL. Inactivated by June 1932 at Chicago by relief of personnel. Withdrawn from the Sixth Corps Area on 1 October 1933 and allotted to the Eighth Corps Area. Consolidated with the 19th Airship Company on 1 June 1937 and consolidated unit designated the 3rd Balloon Company. Concurrently organized at Moffett Field, CA, and assigned to the 21st Balloon Group. Transferred on 15 June 1937 to Gray Field, WA, and assigned to Headquarters, Ninth Corps Area. Redesignated as the 3rd Barrage Balloon Squadron 4 December 1940. Relieved from the Ninth Corps Area in 1941 and assigned to the Chief of the Coast Artillery Corps to support anti-aircraft artillery training. Concurrently transferred to Camp Davis, NC. Location 7 December 1941—Camp Davis, NC.

Status: Disbanded in February 1942.

Events: 304, 309, 314

Commanders, 3rd Balloon Squadron

3rd Balloon Squadron

3rd Barrage Balloon Squadron

Unknown**	ao Jun 30-Jun 32	Maj. Michael E. McHugo	5 Jun 37-1 Jul 38
<i>Inactive</i>	Jun 32-1 Jun 37	Maj. Clarence B. Lober	1 Jul 38-2 Aug 38
Maj. Lawrence A. Lawson	1 Jun 37-5 Jun 37	Maj. Michael E. McHugo	2 Aug 38-ao Apr 41

** RAI commanders: Organized Reserve officers.

4th Balloon Company (I)

HQ-Camp Lee, VA, 1919; Brooks Field, TX, 1919-20; Fort Leavenworth, KS, 1920; Brooks Field, TX, 1920-22

Arrived at the port of Newport News, VA, on 4 May 1919 on the U.S.S. *Susquehanna* as Balloon Company No. 4. Transferred to Camp Lee, VA, and arrived there on 8 May 1919. Transferred on 19 May 1919 to Brooks Field, TX, where the company arrived 28 May. Transferred to Fort Leavenworth, KS, for temporary duty 22 April 1920-12 October 1920. The company supported training of the 17th Infantry at Fort Leavenworth and of the General Service School and other units at Fort Riley, KS. Transferred on 15 October 1920 to Brooks Field. Redesignated as Balloon Company No. 4 (Coast Defense) on 13 September 1921. Demobilized on 30 June 1922 at Brooks Field and personnel transferred to the 16th Airship Company.

Commanders, 4th Balloon Company

1st Lt. Harry C. Oatman	ao Jan 20-30 Nov 20	1st Lt. Harold K. Hine	25 Sep 21-16 Jan 22
1st Lt. William C. Farum	30 Nov 20-14 May 21	1st Lt. William R. Turnbull	16 Jan 22-1 May 22
1st Lt. John S. Crawford	14 May 21-25 Sep 21	1st Lt. Don L. Hutchins	1 May 22-14 Jun 22
	1st Lt. Orin J. Bushey	14 Jun 22-30 Jun 22	

4th Balloon Company (II) (25th Balloon Group)

HQ-Not organized 1923-27

Authorized in the Regular Army 6 February 1923 as the 4th Balloon Company (Coast Defense), assigned to the 25th Balloon Group, and allotted to the Panama Canal Department. The 7th Observation Squadron made Active Associate on 14 March 1923. Designated mobilization training station was France Field, CZ. Demobilized on 28 February 1927.

4th Balloon Company (III) (1927-33) (26th Balloon Group)

Regular Army Inactive

4th Balloon Squadron (1933-41)

HQ-Not organized 1927-30; Chicago, IL, 1930-32; Inactive 1932-41

Constituted in the Regular Army on 18 October 1927 as the 4th Balloon Company, assigned to the 25th Balloon Group, and allotted to the Eighth Corps Area. Fort Sam Houston, TX, designated as headquarters on organization, but the unit was never organized at that location. Withdrawn from the Eighth Corps Area on 1 September 1928 and allotted to the Sixth Corps Area. Relieved from the 25th Balloon Group on 8 May 1929 and assigned to the 26th Balloon Group. Organized by June 1930 with Organized Reserve personnel as a RAI unit at Chicago, IL. Inactivated by June 1932 at Chicago by relief of personnel. Withdrawn from the Sixth Corps Area on 1 October 1933 and allotted to the Eighth Corps Area. Concurrently redesignated as the 4th Balloon Squadron. Designated mobilization training station was Post Field, OK. Mobilization assignment was to support the training of the Field Artillery School. Location 7 December 1941—*Inactive*.

Status: Disbanded 14 May 1943.

Commanders, 4th Balloon Company

4th Balloon Squadron

Unknown	ao Jun 30-Jun 32	<i>Inactive</i>	Jun 32-7 Dec 41
---------	------------------	-----------------	-----------------

5th Balloon Company (I)

HQ-Camp Lee, VA, 1919; Brooks Field, TX, 1919-22

Arrived at the port of Newport News, VA, on 4 May 1919 on the U.S.S. *Susquehanna* as Balloon Company No. 5. Transferred to Camp Lee, VA, and arrived there on 8 May 1919. Transferred to Brooks Field, TX, and arrived there on 23 May 1919. Conducted observation and spotter tests 25 August-1 September 1920 with field artillery units of the 2nd Division at Camp Stanley, TX. Redesignated as Balloon Company No. 5 (Coast Defense) on 13 September 1921. Demobilized on 30 June 1922 at Brooks Field and personnel transferred to 8th and 16th Airship Companies and other units at Kelly Field, TX.

Events: 5

Commanders, 5th Balloon Company

Capt. John D. Jones	ao Jan 20-30 Nov 20	1st Lt. Joseph W. Benson	7 Feb 22-20 May 22
Capt. Roland L. Davis	30 Nov 20-7 Feb 22	1st Lt. Edward L. Fernsten	20 May 21-16 Jun 22
	1st Lt. Joseph W. Benson	16 Jun 22-30 Jun 22	

5th Balloon Company (II) (25th Balloon Group)

HQ-Not organized 1923-27

Authorized in the Regular Army 6 February 1923, assigned to the 25th Balloon Group, and allotted to the Panama Canal Department. The 25th Bombardment Squadron made Active Associate on 14 March 1923. Designated mobilization training station was France Field, CZ. Demobilized on 28 February 1927.

5th Balloon Company (III) (1927-33) (24th Balloon Group)

Regular Army Inactive

5th Balloon Squadron (1933-41)

HQ-Not organized 1927-30; Chicago, IL, 1930-32; Inactive 1932-41

Constituted in the Regular Army on 18 October 1927 as the 5th Balloon Company, assigned to the 25th Balloon Group, and allotted to the Eighth Corps Area. Fort Sam Houston, TX, designated as headquarters on organization, but the unit was never organized at that location. Withdrawn from the Eighth Corps Area on 1 September 1928 and allotted to the Sixth Corps Area. Relieved the 25th Balloon Group on 8 May 1929 and assigned to the 24th Balloon Group. Organized by June 1930 with Organized Reserve personnel as a RAI unit at Chicago, IL. Inactivated by June 1932 at Chicago by relief of personnel. Redesignated as the 5th Balloon Squadron on 1 October 1933. Concurrently withdrawn from the Sixth Corps Area and allotted to the Fourth Corps Area. Designated mobilization training station was Pope Field, NC. Location 7 December 1941— *Inactive*.

Status: Disbanded 14 May 1943.

Commanders, 5th Balloon Company

Unknown	ao Jun 30-Jun 32	<i>Inactive</i>	Jun 32-7 Dec 41
---------	------------------	-----------------	-----------------

6th Balloon Company (1919-33) (24th Balloon Group)

Regular Army Inactive

6th Balloon Squadron (1933-41)

HQ-Camp Lee, VA, 1919; Brooks Field, TX, 1919-22; Inactive 1922-30; Chicago, IL, 1930-32; Inactive 1932-41

Arrived at the port of Newport News, VA, on 4 May 1919 on the U.S.S. *Susquehanna* as Balloon Company No. 6. Transferred to Camp Lee, VA, and arrived there on 8 May 1919. Transferred on 23 May 1919 to Brooks Field, TX. Redesignated as Balloon Company No. 6 (Coast Defense) on 13 September 1921, inactivated at Brooks Field, and 23rd Balloon Company made Active Associate. Assigned to the 24th Balloon Group on 6 February 1923. Redesignated as the 6th Balloon Company on 12 February 1923. The 9th Airship Company made Active Associate on 14 March 1923 in lieu of the 23rd Balloon Company. The 24th Balloon Group assigned to the Zone of the Interior on 13 June 1924. Allotted to the Sixth Corps Area on 28 February 1927. Organized by June 1930 with Organized Reserve personnel as a RAI unit at Chicago, IL. Inactivated by June 1932 at Chicago by relief of personnel. Redesignated as the 6th Balloon

Squadron on 1 October 1933. Concurrently withdrawn from the Sixth Corps Area and allotted to the Fourth Corps Area. Designated mobilization training station was Scott Field, IL, 1923-33 and Pope Field, NC, 1933-41. Location 7 December 1941—*Inactive*.

Status: Disbanded 14 May 1943.

Commanders, 6th Balloon Company

1st Lt. Roscoe S. O'Hara	ao Jan 20-30 Sep 20	<i>Inactive</i>	13 Oct 21-ao Jun 30
1st Lt. Harold K. Hine	30 Sep 20-13 Sep 21	Unknown	ao Jun 30-Jun 32
	<i>Inactive</i>	Jun 32-7 Dec 41	

7th Balloon Company (24th Balloon Group)

HQ-Camp Lee, VA, 1919; Brooks Field, TX, 1919-22; *Inactive* 1922-30; Chicago, IL, 1930-32; *Inactive* 1932-33

Arrived at the port of Newport News, VA, 4 May 1919 on the U.S.S. *Susquehanna* as Balloon Company No. 7. Transferred to Camp Lee, VA, and arrived there on 8 May 1919. Transferred on 23 May 1919 to Brooks Field, TX. Redesignated as Balloon Company No. 7 (Coast Defense) on 13 September 1921, inactivated at Brooks Field, and 23rd Balloon Company made Active Associate. Assigned to the 24th Balloon Group on 6 February 1923. Redesignated as the 7th Balloon Company on 12 February 1923. The 9th Airship Company made Active Associate on 14 March 1923 in lieu of the 23rd Balloon Company. The 24th Balloon Group assigned to the Zone of the Interior on 13 June 1924. Allotted to the Sixth Corps Area on 28 February 1927. Organized by June 1930 with Organized Reserve personnel as a RAI unit at Chicago, IL. Inactivated by June 1932 at Chicago by relief of personnel. Designated mobilization training station was Scott Field, IL, 1923-33. Demobilized on 1 October 1933.

Commanders, 7th Balloon Company

Capt. Asa J. Etheridge	ao Jan 20-5 Jun 20	1st Lt. John S. Crawford	7 Jan 21-6 May 21
1st Lt. Harold K. Hine	5 Jun 20-1 Jul 20	1st Lt. Orin J. Bushey	6 May 21-13 Sep 21
2nd Lt. Frank Krick	1 Jul 20-ao Aug 20	<i>Inactive</i>	13 Sep 21-ao Jun 30
2nd Lt. Ernest L. Hurst	ao Dec 20-7 Jan 21	Unknown	ao Jun 30-Jun 32
	<i>Inactive</i>	Jun 32-1 Oct 33	

8th Balloon Company (1919-20)

8th Airship Company (1920-33) (21st Airship Group)

8th Airship Squadron (1933-37)

8th Balloon Squadron (1937-41) (21st Balloon Group)

HQ-Camp Lee, VA, 1919; Brooks Field, TX, 1919; Camp Owen Bierne, TX, 1919-20; Biggs Field, TX, 1920-21; Brooks Field, TX, 1921-22; Scott Field, IL, 1922-30; Chicago, IL, 1930-32; *Inactive* 1932-34; Chicago, IL, 1934-41

Assigned Airships: TC-6-241; TC-10-242; TC-10-253; TC-11-271

Arrived at the port of Newport News, VA, on 4 May 1919 on the U.S.S. *Susquehanna* as Balloon Company No. 8. Transferred to Camp Lee, VA, and arrived there on 8 May 1919. Transferred on 23 May 1919 to Brooks Field, TX. Transferred on 15 November 1919 to Camp Owen Bierne, TX, (redesignated Biggs Field in 1920). Redesignated as the Airship Company No. 8 on 30 April 1920. Transferred on 26 September 1921 to Brooks Field, TX. Transferred on 1 July 1922 to Scott Field, IL. Assigned on 19 July 1922 to the 1st (later redesignated 21st) Airship Group. Redesignated as the 8th Airship Company on 25 January 1923. Inactivated on 19 May 1930 at Scott Field, IL, and allotted to the Sixth Corps Area. Organized by June 1930 with Organized Reserve personnel as a RAI unit at Chicago, IL. Inactivated by June 1932 at Chicago by relief of personnel. Redesignated as the 8th Airship Squadron on 1 October 1933. Reorganized by April 1934 with Organized Reserve personnel as a RAI unit with headquarters at Chicago, IL. Redesignated as the 8th Balloon Squadron on 17 July 1937 and assigned to the 21st Balloon Group. Designated mobilization training station was Scott Field, IL, 1930-37 and Pope Field, NC, 1937-41. Location 7 December 1941—Chicago, IL.

Status: Disbanded 14 May 1943.

Commanders, 8th Airship Company/Squadron

8th Airship Company

8th Airship Squadron

8th Balloon Squadron

1st Lt. Byron T. Burt	ao Nov 19-14 Jun 22	1st Lt. George A. Lundberg	1 Jan 28-18 Jun 28
1st Lt. Don L. Hutchins	14 Jun 22-26 Jun 22	Capt. Lester T. Miller	18 Jun 28-13 Mar 29
1st Lt. William J. Flood	26 Jun 22-6 Oct 22	1st Lt. William R. Turnbull	13 Mar 29-20 May 30
Capt. Lester T. Miller	6 Oct 22-1 Mar 24	Unknown	19 May 30-Jun 32
Capt. Charles M. Savage	1 Mar 24-11 Feb 26	<i>Inactive</i>	Jun 32-ao Jun 34
1st Lt. Orvil A. Anderson	11 Feb 26-1 Jan 28	Unknown	ao Jun 34-7 Dec 41

8th Balloon Company (24th Balloon Group)

HQ-Not organized 1927-33

Constituted in the Regular Army on 18 October 1927 and allotted to the Eighth Corps Area. Fort Sam Houston, TX, designated as headquarters on organization, but the unit was never organized at that location. Withdrawn from the Eighth Corps Area on 1 September 1928 and allotted to the Sixth Corps Area. Assigned to the 24th Balloon Group on 8 May 1929. Chicago, IL, designated as headquarters on organization, but unit never organized at that location. Demobilized on 1 October 1933.

9th Balloon Company (I) (1919-21)

9th Airship Company (1921-33) (21st Airship Group)

9th Airship Squadron (1933-37)

HQ-Fort Omaha, NE, 1919-21; Scott Field, IL, 1921-37; Marshall Field, KS, 1937

Arrived at the port of Newport News, VA, 4 May 1919 on the U.S.S. *Susquehanna* as Balloon Company No. 9. Transferred to Fort Omaha, NE, and stationed there as of June 1919. Assigned to the U. S. Army Balloon School. Redesignated as the Airship Company No. 9 on 30 August 1921. Transferred on 28 October 1921 to Scott Field, IL, and assigned to the Sixth Corps Area. Assigned to the 21st Airship Group on 19 July 1922. Redesignated as the 9th Airship Company on 25 January 1923. Redesignated as the 9th Airship Squadron on 1 October 1933. Functioned as the school and demonstration unit for the U. S. Army Balloon and Airship School. As such, the unit was responsible for training Organized Reserve and RAI balloon and airship units from across the United States. Frequently entered ships to compete in the annual National Airship Races in the 1920s. Participated in airship research and development projects and experiments with the U.S. Weather Bureau and the U. S. Bureau of Mines in the 1920s and 30s. Supported the National Geographic Society's stratospheric balloon flights in 1934 and 1935. Participated in flood relief operations in southern Illinois during January-February 1937. Transferred on 15 June 1937 to Marshall Field, KS. Reorganized and redesignated as the 1st Observation Squadron on 1 July 1937.

Status: Active in the U. S. Air Force as the 41st Electronic Combat Squadron at Davis-Monthan A.F.B., AZ.

Events: 214

Commanders, 9th Balloon Company

9th Airship Company

9th Airship Squadron

1st Lt. George A. Lundberg	May 19-11 Sep 20	Capt. Allan P. McFarland	11 Sep 20-16 Apr 21
1st Lt. James B. Jordan	16 Apr 21-30 Aug 21	Capt. William E. Kepner	10 Aug 26-18 Jul 27
Capt. Ralph A. Gibson	1 Sep 21-1 Jul 22	1st Lt. Elmer J. Bowling	18 Jul 27-3 Jul 28
Capt. William B. Mayer	1 Jul 22-25 Jan 23	Capt. Edmund W. Hill	3 Jul 28-2 Oct 28
Capt. Henry C. White	25 Jan 23-14 Apr 24	1st Lt. George A. Lundberg	2 Oct 28-22 Jun 29
1st Lt. William A. Gray	14 Apr 24-12 Sep 24	1st Lt. Fred A. Ingalls	22 Jun 29-17 Jul 29
Capt. Edmund W. Hill	12 Sep 24-9 Dec 24	1st Lt. Orin J. Bushey	17 Jul 29-1 Dec 29
1st Lt. William A. Gray	9 Dec 24-13 Mar 25	Capt. Karl S. Axtater	11 Dec 29-12 May 30
1st Lt. Benjamin B. Cassiday	13 Mar 25-4 Jul 25	1st Lt. William O. Eareckson	12 May 30-10 Oct 30
Capt. Edmund W. Hill	4 Jul 24-10 Aug 26	1st Lt. Elmer J. Bowling	10 Oct 30-1 Jun 34
	Maj. Neal Creighton	1 Jun 34-1 Jun 37	

9th Balloon Company (II) (25th Balloon Group)**Regular Army Inactive****HQ-Not organized** 1927-30; Chicago, IL, 1930-32; *Inactive* 1932-33

Constituted in the Regular Army on 18 October 1927 and allotted to the Eighth Corps Area. Fort Sam Houston, TX, designated as headquarters on organization, but the unit was never organized at that location. Withdrawn from the Eighth Corps Area on 1 September 1928 and allotted to the Sixth Corps Area. Assigned to the 25th Balloon Group on 8 May 1929. Organized by June 1930 with Organized Reserve personnel as a RAI unit at Chicago, IL. Inactivated by June 1932 at Chicago by relief of personnel. Demobilized on 1 October 1933.

Commanders, 9th Balloon Company

Unknown **	ao Jun 30-Jun 32	<i>Inactive</i>	Jun 32-1 Oct 33
------------	------------------	-----------------	-----------------

** RAI commanders: Organized Reserve officers.

10th Balloon Company (I) (1919-20)**10th Airship Company (1920-21)****Airship School Detachment (1921-28)****HQ-Camp Lee, VA, 1919; Langley Field, VA, 1919-22; Scott Field, IL, 1922-28**

Arrived at the port of Newport News, VA, 25 May 1919 on the S.S. *Virginian* as Balloon Company No. 10. Transferred to Camp Lee, VA, and arrived there on 28 May 1919. Transferred on 22 September 1919 to Langley Field, VA. Redesignated as the 10th Airship Company on 5 April 1920. Redesignated as the Airship School Detachment, Langley Field 1 October 1921. Transferred on 30 June 1922 to Scott Field. Demobilized on 1 July 1928 as the Airship School Detachment, U. S. Army Balloon and Airship School.

Commanders, 10th Balloon Company**10th Airship Company****Airship School Detachment**

1st Lt. Bruce N. Martin	ao Jan 20-ao Apr 20 Unknown	Capt. Walter J. Reed ao Jan 21-1 Jul 28	ao Oct 20-ao Jan 21
-------------------------	--------------------------------	--	---------------------

10th Balloon Company (II) (25th Balloon Group)**Regular Army Inactive****HQ-Not organized** 1927-30; Chicago, IL, 1930-32; *Inactive* 1932-33

Constituted in the Regular Army on 18 October 1927 and allotted to the Eighth Corps Area. Fort Sam Houston, TX, designated as headquarters on organization, but the unit was never organized at that location. Withdrawn from the Eighth Corps Area on 1 September 1928 and allotted to the Sixth Corps Area. Assigned to the 25th Balloon Group on 8 May 1929. Organized by June 1930 with Organized Reserve personnel as a RAI unit at Chicago, IL. Inactivated by June 1932 at Chicago by relief of personnel. Demobilized on 1 October 1933.

Commanders, 10th Balloon Company

Unknown **	ao Jun 30-Jun 32	<i>Inactive</i>	Jun 32-1 Oct 33
------------	------------------	-----------------	-----------------

** RAI commanders: Organized Reserve officers.

11th Balloon Company (I)**HQ-Camp Lee, VA, 1919; Brooks Field, TX, 1919-22**

Stationed at Camp Lee, VA, as of May 1919 as Balloon Company No. 11. Transferred on 22 May 1919 to Brooks Field, TX. Inactivated about August 1921 at Brooks Field and 23rd Balloon Company made Active Associate. Personnel concurrently transferred to 8th and 16th Airship Companies and other units at Kelly Field, TX.

Commanders, 11th Balloon Company

1st Lt. William Turnbull	ao Jan 20-ao Jun 20	1st Lt. Orin J. Bushey	ao Jun 21-Aug 21
--------------------------	---------------------	------------------------	------------------

11th Balloon Company (II) (25th Balloon Group)

Regular Army Inactive

HQ-*Not organized* 1927-30; Chicago, IL, 1930-32; *Inactive* 1932-33

Constituted in the Regular Army on 18 October 1927 and allotted to the Eighth Corps Area. Fort Sam Houston, TX, designated as headquarters on organization, but the unit was never organized at that location. Withdrawn from the Eighth Corps Area on 1 September 1928 and allotted to the Sixth Corps Area. Assigned to the 25th Balloon Group on 8 May 1929. Organized by June 1930 with Organized Reserve personnel as a RAI unit at Chicago, IL. Inactivated by June 1932 at Chicago by relief of personnel. Demobilized on 1 October 1933.

Commanders, 11th Balloon Company

Unknown **	ao Jun 30-Jun 32	<i>Inactive</i>	Jun 32-1 Oct 33
------------	------------------	-----------------	-----------------

** RAI commanders: Organized Reserve officers.

12th Balloon Company (1919-21)

12th Airship Company (1921-33) (21st Airship Group)

12th Airship Squadron (1933-37)

12th Balloon Squadron (1937-41) (21st Balloon Group)

HQ- Langley Field, VA, 1919; Fort Omaha, NE, 1919-21; Scott Field, IL, 1921-29; *Inactive* 1929-34; Chicago, IL, 1934-41

Arrived at the port of Newport News, VA, 20 March 1919 on the U.S.S. *Princess Matoika* as the 12th Balloon Company. Transferred to Langley Field, VA, and arrived there on 20 March 1919. Transferred by June 1919 to Fort Omaha, NE. Redesignated as the Airship Company No. 12 on 13 September 1921. Participated in a parade for President Woodrow Wilson on 1 October 1919 in St. Louis, MO. Transferred on 28 October 1921 to Scott Field, IL. Assigned to the 1st (later redesignated 21st) Airship Group on 19 July 1922. Redesignated as the 12th Airship Company on 25 January 1923. Functioned as a school and demonstration unit for the U.S. Army Balloon and Airship School. As such, the unit was responsible for training Organized Reserve and RAI balloon and airship units from across the United States. Frequently participated in the annual National Balloon Races in the 1920s. Inactivated on 16 May 1929 at Scott Field, IL, and allotted to the Sixth Corps Area. Redesignated as the 12th Airship Squadron on 1 October 1933. Organized by April 1934 with Organized Reserve personnel as a RAI unit at Chicago, IL. Redesignated as the 12th Balloon Squadron on 17 July 1937 and assigned to the 21st Balloon Group. Designated mobilization training station was Scott Field, IL, 1933-39 and Pope Field, NC, 1939-41. Location 7 December 1941—Chicago, IL.

Status: Disbanded 14 May 1943.

Commanders, 12th Balloon Company

12th Airship Company

12th Airship Squadron

12th Balloon Squadron

Capt. Ashley C. McKinley	ao Sep 18-7 Jun 21	1st Lt. Douglas Johnston	11 Jun 23-12 Sep 23
1st Lt. Angier H. Forest	17 Aug 21-30 Sep 21	Capt. Warren B. Gates	12 Sep 23-1 Jul 25
1st Lt. James H. C. Hill	1 Oct 21-Dec 21	Capt. Ronald W. Wittman	1 Jul 25-3 Mar 26
1st Lt. Ashley C. McKinley	Dec 21-14 Apr 22	1st Lt. William J. Flood	3 Mar 26-7 Jun 26
1st Lt. James H. C. Hill	14 Apr 22-1 Jul 22	Capt. William O. Butler	7 Jun 26-9 Apr 29
Capt. John P. Temple	1 Jul 22-15 Jan 23	Capt. Karl S. Axtater	9 Apr 29-16 May 29
1st Lt. Ira R. Koenig	15 Jan 23-11 Jun 23	<i>Inactive</i>	16 May 29-ao Apr 34
1st Lt. George C. Lundberg	16 Jun 21-17 Aug 21	Unknown**	ao Apr 34-7 Dec 41

** RAI commanders: Organized Reserve officers.

13th Balloon Company (1919-23)

13th Airship Company (1923-33) (23rd Airship Group)

HQ-Camp Mills, NY, 1919, Garden City, NY, 1919; Ross Field, CA, 1919-22; *Inactive* 1922-30; Chicago, IL, 1930-32; *Inactive* 1932-30

Arrived at the port of New York, NY, on 18 June 1919 on the S.S. *Duca Degli Abruzz* as Balloon Company No. 13. Transferred on 24 June 1919 to Garden City, NY. Transferred on 24 July 1919 to Ross Field, Arcadia, CA, and assigned to the Army Balloon School. Inactivated on 26 July 1922 at Ross Field and 18th Airship Company designated Active Associate. Redesignated as the 13th Balloon Company on 12 February 1923. Redesignated as the 13th Airship Company on 24 March 1923 and assigned to the 23rd Airship Group. Withdrawn from the Ninth Corps Area on 1 September 1928 and allotted to the Sixth Corps Area. Organized by June 1930 with Organized Reserve personnel as a RAI unit at Chicago, IL. Inactivated by June 1932 at Chicago by relief of personnel. Demobilized on 1 October 1933.

Commanders, 13th Balloon Company

13th Airship Company

Capt. Charles P. Clark	ao Jan 20-14 Dec 20	Capt. Lester T. Miller	25 Apr 21-21 Jun 22
1st Lt. Karl S. Axtater	14 Dec 20-3 Jan 21	Capt. Garth B. Haddock	21 Jun 22-25 Jul 22
Capt. Harold E. Weeks	3 Jan 21-17 Feb 21	<i>Inactive</i>	13 Oct 21-ao Jun 30
1st Lt. Karl S. Axtater	17 Feb 21-25 Apr 21	Unknown**	ao Jun 30-Jun 32
	<i>Inactive</i>	Jun 32-1 Oct 33	

** RAI commanders: Organized Reserve officers.

14th Balloon Company (25th Balloon Group)

HQ-Garden City, NY, 1919; Fort Omaha, NE, 1919-20, Crissey Field, CA, 1920-21; Camp Lewis, WA, 1921; *Inactive* 1921-30; Chicago, IL, 1930-32; *Inactive* 1932-33

Arrived at the port of New York, NY, on 8 May 1919 on the S.S. *Julia Luckenbach* as Balloon Company No. 14. Transferred to Garden City, NY, on the same day. Transferred on 8 September 1919 to Fort Omaha, NE. Transferred on 14 April 1920 to Crissey Field, CA. Served at numerous locations for short periods over the next twelve months to include Fort Funston, CA, Fort Casey, WA, Camp Lewis, WA, Fort Winfield Scott, CA, and Fort Miley, CA, for the purposes of conducting aerial spotter tests with various coast defense commands. Transferred on 6 May 1921 to Camp Lewis, WA. Redesignated as Balloon Company No. 14 (Coast Defense) on 13 September 1921. Inactivated on 13 October 1921 at Camp Lewis and the 1st Balloon Company designated Active Associate. The 9th Airship Company made Active Associate 6 September 1922 in lieu of 1st Balloon Company. Redesignated as the 14th Balloon Company on 12 February 1923. Allotted to the Sixth Corps Area on 5 September 1928. Assigned to the 25th Balloon Group on 8 May 1929. Organized by June 1930 with Organized Reserve personnel as a RAI unit at Chicago, IL. Inactivated by June 1932 at Chicago by relief of personnel. Demobilized on 1 October 1933.

Commanders, 14th Balloon Company

2nd Lt. Joseph A. Physioc	ao Jan 20-10 Apr 20	<i>Inactive</i>	13 Oct 21-ao Jun 30
1st Lt. Wallace C. Burns	10 Apr 20-7 May 21	Unknown**	ao Jun 30-Jun 32
Capt. George S. Warren	7 May 21-13 Oct 21	<i>Inactive</i>	Jun 32-1 Oct 33

** RAI commanders: Organized Reserve officers.

15th Balloon Company (22nd Balloon Group)

HQ-Camp Lee, VA, 1919; Ross Field, CA, 1919-21; *Inactive* 1921-33

Arrived at the port of Newport News, VA, on 25 June 1919 on the S.S. *Virginian* as Balloon Company No. 15. Transferred to Camp Lee, VA, and arrived there on 29 June 1919. Transferred on 15 July 1919 to Ross Field, Arcadia, CA, and assigned to the Army Balloon School. Redesignated as Balloon Company No. 15 (Coast Defense) on 13 September 1921. Inactivated on 1 October 1921 at Ross Field and 13th Balloon Company designated Active Associate. The 12th Airship Company made Active Associate 6 September 1922 in lieu of the 13th Balloon Company. Redesignated as the 15th Balloon Company on 12 February 1923. Allotted to the Sixth Corps Area on 5 September 1928. Chicago, IL, designated as headquarters on reorganization, but unit never organized at that location. Designated mobilization training station was Scott Field, IL, 1923-33. Assigned to the 22nd Balloon Group on 8 May 1929. Demobilized on 1 October 1933.

Commanders, 15th Balloon Company

2nd Lt. Joseph I. Sullivan	ao Jan 20-25 Apr 21 <i>Inactive</i>	Capt. Roland W. Wittman 1 Oct 21-1 Oct 33	25 Apr 21-1 Oct 21
----------------------------	--	--	--------------------

16th Balloon Company (1919-20)

16th Airship Company (1920-33) (21st Airship Group)

HQ-Camp Lee, VA, 1919; Fort Omaha, NE, 1919; Brooks Field, TX, 1919-22; Scott Field, IL, 1922; *Inactive* 1922-30; Chicago, IL, 1930-32; *Inactive* 1932-33

Arrived at the port of Newport News, VA, on 25 June 1919 on the S.S. *Virginian* as Balloon Company No. 16. Transferred to Camp Lee, VA, and arrived there on 25 June 1919. Transferred on 8 July 1919 to Fort Omaha, NE. Transferred on 21 August 1919 to Brooks Field, TX. Redesignated as the 16th Airship Company on 5 April 1920. Transferred on 1 July 1922 to Scott Field, IL. Inactivated on 15 August 1922 at Scott Field and 12th Airship Company designated Active Associate. Assigned to the 21st Airship Group on 6 February 1923 and designated as Special Service School Troops. Redesignated as the 16th Balloon Company on 12 February 1923. Designated Zone of the Interior Troops 13 June 1924. Allotted to the Sixth Corps Area on 28 February 1927. The 21st Airship Group assigned to the General Headquarters Reserve on 8 May 1929. Organized by June 1930 with Organized Reserve personnel as a RAI unit at Chicago, IL. Inactivated by June 1932 at Chicago by relief of personnel. Demobilized on 1 October 1933.

Commanders, 16th Airship Company

2nd Lt. Stuart N. Svedeman	ao Jan 20-18 May 20	1st Lt. Edward L. Fernsten	Apr 21-15 Aug 22
1st Lt. Glenn Phelps	18 May 20-5 Jun 20	<i>Inactive</i>	13 Oct 21-ao Jun 30
Capt. Asa J. Etheridge	5 Jun 20-Apr 21 <i>Inactive</i>	Unknown** Jun 32-1 Oct 33	ao Jun 30-Jun 32

** RAI commanders: Organized Reserve officers.

17th Balloon Company (27th Balloon Group)

HQ-Camp Lee, VA, 1919; Fort Omaha, NE, 1919-20; Kindley Field, PI, 1920-22; *Inactive* 1922-27

Arrived at the port of Newport News, VA, on 4 May 1919 on the U.S.S. *Susquehanna* as Balloon Company No. 17. Transferred to Camp Lee, VA, and arrived there on 8 May 1919. Transferred on 17 May 1919 to Fort Omaha, NE. Departed the port of San Francisco on 5 April 1920 on the U.S.A.T. *Sherman* en route to the Philippines. Arrived 4 May 1920 at Manila, PI, and transferred to Kindley Field, PI, on the same day. Redesignated as Balloon Company No. 17 (Coast Defense) on 17 October 1921. The company's mission in the Philippines was to provide aerial observation and fire adjustment service for the Coast Defenses of Manila and Subic Bays. Inactivated on 1 September 1922 at Kindley Field and 8th Airship Company made Active Associate. Assigned to the 27th Balloon Group on 6 February 1923. Redesignated as the 17th Balloon Company on 12 February 1923. The 2nd Observation Squadron made Active Associate on 14 March 1923 in lieu of the 8th Airship Company. Designated mobilization training station was Kindley Field 1923-27. Demobilized on 28 February 1927.

Events: 5

Commanders, 17th Balloon Company

Capt. Harry T. Lewis	ao Jan 20-18 Nov 20	1st Lt. Neal Creighton	7 Jun 21-2 Feb 22
Capt. William B. Mayer	18 Nov 20-11 May 21	Capt. Ivan B. Snell	2 Feb 22-25 Aug 22
1st Lt. Elmer J. Bolling	11 May 21-7 Jun 21 <i>Inactive</i>	1st Lt. Neal Creighton 1 Sep 22-28 Feb 27	25 Aug 22-1 Sep 22

18th Balloon Company (1919-21)

18th Airship Company (1921-33) (23rd Airship Group)

HQ-Camp Lee, VA, 1919; Lee Hall, VA, 1919; Phillips Field, MD 1919-26; Scott Field, IL, 1926; *Inactive* 1926-28; Chicago, IL, 1928-32; *Inactive* 1932-33

Assigned Airships: TC-5, 1919-26

Arrived at the port of Newport News, VA, 4 May 1919 on the U.S.S. *Susquehanna* as Balloon Company No. 18. Transferred on 9 May 1919 to Camp Lee, VA. Transferred on 16 May 1919 to Lee Hall, VA, and assigned to the Army Balloon School. Transferred on 10 August 1919 to Phillips Field, Aberdeen Proving Ground, MD. Redesignated as the Airship Company No. 18 on 28 September 1921. Redesignated as the 18th Airship Company on 25 January 1923. Assigned on 24 March 1923 to the General Headquarters Reserve. Participated in numerous tests of aerial bombardment weapons with the ordnance center at Aberdeen Proving Ground. Annually entered ships to compete in the National Airship Races in the 1920s. Transferred on 12 May 1926 to Scott Field, IL. Inactivated on 15 June 1926 at Scott Field. Concurrently the 24th Airship Service Company designated as Active Associate. Allotted to the Third Corps Area on 28 February 1927. Withdrawn from the Third Corps Area on 14 January 1929 and allotted to the Sixth Corps Area. Assigned on 8 May 1929 to the 23rd Airship Group. Organized by June 1928 with Organized Reserve personnel as a RAI unit at Chicago, IL. Inactivated by June 1932 at Chicago by relief of personnel. Demobilized on 1 October 1933.

Commanders, 18th Balloon Company

18th Airship Company

1st Lt. Harvey H. Holland	ao Dec 20-1 May 21	1st Lt. James F. Powell	17 Sep 24-8 Jun 26
1st Lt. Max F. Moyer	1 May 21-18 Apr 22	<i>Inactive</i>	8 Jun 26-ao Jun 30
1st Lt. Michael M. McHugo	18 Apr 22-ao May 22	Unknown**	ao Jun 30-Jun 32
Capt. William E. Kepner	ao Aug 22-17 Sep 24	<i>Inactive</i>	Jun 32-1 Oct 33

** RAI commanders: Organized Reserve officers.

19th Balloon Company (1919)

19th Dirigible Company (1919-23)

19th Airship Company (1923-33) (23rd Airship Group)

19th Airship Squadron (1933-37) (21st Airship Group)

HQ- Mitchel Field, NY, 1919; Lee Hall, VA, 1919; Langley Field, VA, 1919-35; Moffett Field, CA, 1935-37

Assigned Airships: TA-5; TC-4; TC-5; TC-9; TC-11; TC-11-271; TC-13; TC 14; TC-18; TE-2



Arrived at the port of New York 17 April 1919 on the U.S.S. *Sierra* as Balloon Company No. 19 and transferred to Mitchel Field, NY. Inactivated on 29 April 1919 at Mitchel Field. Reactivated 23 July 1919 at Lee Hall, VA, and assigned to the Army Balloon School. Transferred in late July 1919 to Langley Field, VA. Redesignated as Dirigible Company No. 19 on 5 April 1920. Redesignated as the 19th Airship Company on 25 January 1923 and assigned to the 15th School Group. Relieved on 13 June 1924 from the 15th School Group. Assigned to the 23rd Airship Group on 28 February 1927. A crew from the unit landed the TC-5 on the S.S. *American Trader* on 11 May 1928 off Ambrose Light, NY. This was the first ever landing of an airship on a moving vessel at sea. Relieved from the 23rd Airship Group on 16 August 1933 and assigned to the 21st Airship Group. Attached to the 2nd Wing 1 March 1935. Supported the training of the

Coast Artillery School at Fort Monroe 1919-35. Transferred to Moffett Field and arrived there on 19 November 1935. Consolidated with the 3rd Balloon Company on 1 June 1937 and consolidated unit designated the 3rd Balloon Company (see 3rd Balloon Company above for lineage hereafter).

Events: 23, 128, 178, 201

Commanders, 19th Airship Company

19th Dirigible Company

19th Airship Company

19th Airship Squadron

1st Lt. Don L. Hutchins	ao Jan 20-Mar 20	Capt. Charles P. Clark	ao May 26-ao Jun 26
2nd Lt. Orville A. Anderson	Mar 20-5 Jun 20	Capt. James F. Doherty	ao Dec 26-ao Jan 27
Capt. Dale Mabry	5 Jun 20-1 Feb 21	2nd Lt. Leslie A. Skinner	ao Aug 27-19 Sep 27
Maj. Arthur G. Fisher	1 Feb 21-1 Oct 21	1st Lt. Uzal G. Ent	19 Sep 27-ao Jun 29
Maj. John G. Thornell	1 Oct 21-ao Jan 22	Unknown	ao Jun 29-15 Jul 33
Capt. William O. Butler	1 Jul 22-31 Aug 25	1st Lt. James C. Shively	16 Jul 33-19 Dec 33
Unknown	1 Sep 25-17 Nov 25	Maj. Clarence B. Lober	19 Dec 33-1 Sep 36
1st Lt. Walter J. Reed	18 Nov 25-ao Dec 25	Maj. Lawrence A. Lawson	1 Sep 36-1 Jun 37

20th Balloon Company (22nd Balloon Group)

HQ-Mitchel Field, NY, 1919; Lee Hall, VA, 1919-22; *Inactive* 1922-33

Arrived at the port of Hoboken, NJ, on 18 April 1919 on the S.S. *Ostego* as Balloon Company No. 20. Transferred to Camp Mills, NY, on the same day. Transferred on 19 April 1919 to Mitchel Field, NY. Transferred on 16 May 1919 to Lee Hall, VA, and assigned to the Army Balloon School. Redesignated as Balloon Company No. 20 (Coast Defense) on 30 September 1921. Inactivated on 11 September 1922 at Lee Hall, VA, and 19th Airship Company made Active Associate. Assigned to the 22nd Balloon Group on 6 February 1923. Redesignated as the 20th Balloon Company on 12 February 1923. The 22nd Balloon Group assigned to the Zone of the Interior on 13 June 1924. Allotted to the Sixth Corps Area on 28 February 1927. Chicago, IL, designated as headquarters on reorganization, but unit never organized at that location. Designated mobilization training station was Langley Field 1923-27 and Scott Field 1927-33. Demobilized on 1 October 1933.

Commanders, 20th Balloon Company

1st Lt. Junius A. Smith	ao Jan 20-9 May 21	1st Lt. Robert S. Heald	17 Jan 22-28 Mar 22
1st Lt. Frederick W. Evans	9 May 21-30 Sep 21	1st Lt. Ira R. Koenig	28 Mar 22-18 Apr 22
1st Lt. Dache M. Reeves	30 Sep 21-17 Jan 22	1st Lt. George G. Gressey	18 Apr 22-11 Sep 22
	<i>Inactive</i>	11 Sep 22-1 Oct 33	

21st Balloon Company (26th Balloon Group)

HQ-Camp Morrison, VA, 1919; Ross Field, CA, 1919-20; Fort Shafter, TH, 1920; Fort Kamehameha, TH, 1920-22; *Inactive* 1922-27

Demobilized at Camp Morrison, VA, in December 1918 as the 21st Balloon Company. Reconstituted and organized in June 1919 at Ross Field, Arcadia, CA. Transferred in April 1920 to Fort Shafter, TH. Departed the port of San Francisco on 27 April 1920 on the U.S.A.T. *Logan* en route to Hawaii. Arrived 6 May 1920 at Honolulu and transferred to Fort Shafter, TH, on the same day. Transferred on 18 September 1920 to Fort Kamehameha, TH, and assigned to the Coast Defenses of Honolulu. Redesignated as Balloon Company No. 21 (Coast Defense) on 30 September 1921. Inactivated on 31 July 1922 at Fort Kamehameha. Concurrently, personnel transferred to the 6th Aero Squadron and the 16th Airship Company made Active Associate. The 23rd Bombardment Squadron made Active Associate 20 September 1922 in lieu of 9th Airship Company. Redesignated as the 21st Balloon Company on 12 February 1923. Assigned to the 26th Balloon Group on 6 February 1923. Demobilized on 28 February 1927.

Commanders, 21st Balloon Company

Capt. Ira R. Koenig	ao Jan 20-ao Jun 20	1st Lt. Lawrence A. Lawson	12 Jan 21-1 Feb 22
1st Lt. Harry H. Young	ao Oct 20-2 Jan 21	1st Lt. Walter D. Williams	1 Feb 22-1 Mar 22
1st Lt. Hoyt G. Ross	2 Jan 21-12 Jan 21	Capt. Horace W. Mooney	1 Mar 22-31 Jul 22
	<i>Inactive</i>	31 Jul 22-28 Feb 27	

22nd Balloon Company (22nd Balloon Group)

HQ-Lee Hall, VA, 1919-22; *Inactive* 1922-30; Chicago, IL, 1930-32; *Inactive* 1932-33

Stationed at Lee Hall, VA, as of January 1919 as the 22nd Balloon Company and assigned to the Army Balloon School. Redesignated as Balloon Company No. 22 (Coast Defense) on 30 September 1921. Inactivated on 11 September 1922 at Lee Hall, VA, and 19th Airship Company made Active Associate. Assigned to the 22nd Balloon Group on 6 February 1923. Redesignated as the 22nd Balloon Company on 12 February 1923. The 22nd Balloon Group assigned to the Zone of the Interior on 13 June 1924. Allotted to the Sixth Corps Area on 28 February 1927. Organized by June 1930 with Organized Reserve personnel as a RAI unit at Chicago, IL. Inactivated by June 1932 at Chicago by relief of personnel. Designated mobilization training station was Langley Field 1923-27 and Scott Field 1927-33. Demobilized on 1 October 1933.

Commanders, 22nd Balloon Company

1st Lt. Clarence B. Lober	ao Jan 20-17 Jan 22	<i>Inactive</i>	1 Sep 22-ao Jun 30
1st Lt. Dache M. Reeves	17 Jan 22-18 Apr 22	Unknown**	ao Jun 30-Jun 32
Capt. Asa J. Etheridge	18 Apr 22-1 Sep 22	<i>Inactive</i>	Jun 32-1 Oct 33

** RAI commanders: Organized Reserve officers.

23rd Balloon Company (22nd Balloon Group)

HQ-Post Field, OK, 1919-22; *Inactive* 1923-30; Chicago, IL, 1930-32; *Inactive* 1932-33

Arrived at the port of Boston, MA, on 21 January 1919 on the S.S. *Canada* as Balloon Company No. 23. Transferred to Camp Devens, MA, and arrived there the same day. Demobilized on 29 January 1919 at Camp Devens. Reconstituted and organized 16 June 1919 at Ross Field, Arcadia, CA. Demobilized on 31 August 1919 at Ross Field. Reconstituted and organized 25 September 1919 at Post Field, OK, as the 23rd Balloon Company. Reactivated with personnel from the inactivated 39th Balloon Company. Redesignated as Balloon Company No. 23 on 13 September 1921. Demobilized on 26 June 1922 at Post Field. Reconstituted in the Regular Army as the 23rd Balloon Company on 24 March 1923 and 19th Airship Company made Active Associate. Allotted to the Sixth Corps Area on 5 September 1928. Assigned to the 22nd Balloon Group on 8 May 1929. Organized by June 1930 with Organized Reserve personnel as a RAI unit at Chicago, IL. Inactivated by June 1932 at Chicago by relief of personnel. Designated mobilization training station was Scott Field 1923-33. Demobilized on 1 October 1933.

Organization Day: 25 September. Chosen to commemorate the company's reorganization at Fort Sill, OK, on 25 September 1919.

Commanders, 23rd Balloon Company

1st Lt. Carlton F. Bond	25 Sep 19-Oct 20	<i>Inactive</i>	26 Jun 22-ao Jun 30
Capt. Roger S. McCullough	Oct 20-27 Jan 22	Unknown**	ao Jun 30-Jun 32
Capt. William B. Mayer	27 Jan 22-26 Jun 22	<i>Inactive</i>	Jun 32-1 Oct 33

** RAI commanders: Organized Reserve officers.

24th Balloon Company (1919-22)

24th Airship Service Company (1922-33) (21st Airship Group)

24th Airship Service Squadron (1933-37) (21st Airship Group)

24th Service Squadron (1937-41) (21st Balloon Group)

HQ-Mitchel Field, LI, NY, 1919; Fort Omaha, NE, 1919-20, Crissey Field, CA, 1920; Fort Baker, CA, 1920-21; Fort Miley, CA, 1921; *Inactive* 1921-22; Scott Field, IL, 1922-35; *Inactive* 1935-41

Arrived at the port of New York, NY, on 1 August 1919 on the S.S. *Pocahontas* as Balloon Company No. 24. Transferred to Mitchel Field, LI, NY, and arrived there on the same day. Transferred on 12 August 1919 to Fort Omaha, NE. Transferred on 10 April 1920 to Crissey Field at the Presidio of San Francisco, CA. The company temporarily served at numerous locations to include Fort Barry, CA, Fort Worden, WA, Camp Lewis, WA, Fort Winfield Scott, CA, and Fort Miley, CA, for short periods over the next five months for the purposes of conducting aerial spotter tests with various coast defense commands. Transferred on 30 September 1920 to Fort Baker, CA. Assigned to the Coast Defenses of San Francisco on 20 December 1920. Transferred on 1 August 1921 to Fort Miley. Inactivated on 30 September 1921 at Fort Miley and the 1st Balloon Company designated Active Associate. Assigned on 19 July 1922 to the 1st Airship Group (subsequently redesignated on 1 January 1923 as the 21st Airship Group). Reorganized on 15 August 1922 at Scott Field, IL. Redesignated as Service Company No. 24 (Airship) on 6 September 1922. Redesignated as the 24th Airship Service Company on 12 February 1923. Reorganized and redesignated as the 24th Airship Service Squadron on 4 November 1933. Inactivated on 27 February 1935 at Scott Field, IL. Redesignated as the 24th Service Squadron on 17 July 1937 and assigned to the 21st Balloon Group. Designated mobilization training station was Scott Field, IL, 1935-37 and Pope Field, NC, 1937-41. Location 7 December 1941—*Inactive*.

Status: Disbanded 14 May 1943.

Commanders, 24th Airship Service Company

24th Airship Service Company

24th Airship Service Squadron

24th Service Squadron

Capt. Frederick J. Durrschmidt	20 May 19-1 Jul 21	Capt. George S. Warren	6 Sep 23-20 May 26
Capt. Ivan B. Snell	1 Jul 21-28 Sep 21	Capt. Douglas Johnston	20 May 26-11 Sep 27
<i>Inactive</i>	29 Sep 21-5 Sep 22	Capt. James F. Powell	11 Sep 27-1 Dec 31
1st Lt. Clyde A. Kuntz	6 Sep 22-6 Sep 23	Capt. Michael E. McHugo	1 Dec 31-1 Mar 35

Inactive 1 Mar 35-7 Dec 41

25th Balloon Company

HQ-Ross Field, CA, 1919-20; Post Field, OK, 1920-21; *Inactive* 1921-22

Active at Ross Field, Arcadia, CA, as of June 1919 as Balloon Company No. 25. Transferred about December 1920 to Post Field, OK. Inactivated in 1 October 1921 at Post Field and 13th Balloon Company made Active Associate. Demobilized on 6 September 1922.

Commanders, 25th Balloon Company

1st Lt. Loren D. Schiff	ao Jun 20-Jul 20	Capt. Charles P. Clark	3 Jan 21-25 Apr 21
Capt. Charles P. Clark	Jul 20-18 Dec 20	Capt. George D. Watts	25 Apr 21-25 Jul 21
1st Lt. Harry G. Montgomery	18 Dec 20-3 Jan 21	Capt. Lester T. Miller	25 Jul 21-1 Oct 21
	<i>Inactive</i>	1 Oct 21-6 Sep 22	

25th Airship Service Company (23rd Airship Group)

HQ-*Not organized* 1927-33

Constituted in the Regular Army on 18 October 1927 as the 25th Airship Service Company, assigned to the 23rd Airship Group, and allotted to the Sixth Corps Area. Demobilized on 1 October 1933.

26th Balloon Company

HQ-Lee Hall, VA, 1919-22; *Inactive* 1922-24

Arrived at the port of Newport News, VA, on 28 June 1919 on the S.S. *Virginian* as Balloon Company No. 26. Transferred to Camp Lee, VA, and arrived there on 29 June 1919. Assigned to the U.S. Army Balloon School. Redesignated as Balloon Company No. 26 on 13 September 1921. Inactivated in January 1922 at Lee Hall and 20th Balloon Company made Active Associate. Demobilized on 6 September 1922. Reconstituted in the Regular Army as the 26th Balloon Company on 24 March 1923 and 19th Airship Company made Active Associate. Designated mobilization training station was Fort Eustis, VA, 1923-24. Demobilized in 1924.

Commanders, 26th Balloon Company

2nd Lt. Robert V. Ignico	ao Jan 20-8 Feb 21	1st Lt. Ira B. Koenig	18 Feb 21-30 Sep 21
1st Lt. William J. Flood	8 Feb 21-18 Feb 21	1st Lt. Dache M. Reeves	30 Sep 21-Jan 22

26th Airship Service Company (1927-33) (23rd Airship Group)

26th Service Squadron, Balloon Group (1933-37) (26th Balloon Group)

HQ-*Not organized* 1927-37

Constituted in the Regular Army on 18 October 1927 as the 26th Airship Service Company, assigned to the 23rd Airship Group, and allotted to the Sixth Corps Area. Redesignated as the 26th Service Squadron, Balloon Group on 1 October 1933, relieved from the 23rd Airship Group, and assigned to the 26th Balloon Group.

27th Balloon Company (27th Balloon Group)

HQ-Fort Omaha, NE, 1919-20; Kindley Field, PI, 1919-22; *Inactive* 1922-27

Demobilized at Camp Morrison, VA, in December 1918 as Balloon Company No. 27. Reconstituted and organized in June 1919 at Fort Omaha, NE. Transferred about May 1920 to Kindley Field, PI, and assigned to the Philippine Department. The company's mission in the Philippines was to provide aerial observation and fire adjustment service for the Coast Defenses of Manila and Subic Bays. Redesignated as Balloon Company No. 27 (Coast Defense) on 13 September 1921. Inactivated on 1 September 1922 at Kindley Field. Demobilized on 6 September 1922. Reconstituted in the Regular Army as the 27th Balloon Company on 24 March 1923 and 8th Airship Company made Active Associate. Concurrently assigned to the 27th Balloon Group. Demobilized on 28 February 1927.

Events: 5

Commanders, 27th Balloon Company

Capt. William A. Gray	ao Jan 20-1 Feb 22 <i>Inactive</i>	Capt. Roland W. Wittman 1 Sep 22-28 Feb 27	1 Feb 22-1 Sep 22
-----------------------	---------------------------------------	---	-------------------

28th Balloon Company

HQ-Lee Hall, VA, 1919-22; *Inactive* 1922-24

Active at Lee Hall, VA, as of June 1919 as Balloon Company No. 28 and assigned to the Army Balloon School. Redesignated as Balloon Company No. 28 on 13 September 1921. Inactivated about January 1922 at Lee Hall and 22nd Balloon Company made Active Associate. Demobilized on 6 September 1922. Reconstituted in the Regular Army as the 28th Balloon Company on 24 March 1923 and 19th Airship Company made Active Associate. Demobilized in 1924.

Commanders, 28th Balloon Company

Capt. William H. Carthy	ao Jan 20-28 Jul 20	1st Lt. Clarence B. Lober	30 Sep 21-20 Dec 21
1st Lt. Neal Creighton	28 Jul 20-10 Oct 20	1st Lt. Dache M. Reeves	20 Dec 21-Jan 22
1st Lt. William H. Carthy	10 Oct 20-30 Sep 21	<i>Inactive</i>	Jan 22-6 Sep 22

29th Balloon Company

HQ-Lee Hall, VA, 1919-21; *Inactive* 1922-24

Active at Lee Hall, VA, as of June 1919 as the 29th Balloon Company and assigned to the Army Balloon School. Redesignated as Balloon Company No. 29 on 13 September 1921. Inactivated on 30 September 1921 at Lee Hall and 20th Balloon Company made Active Associate. Demobilized on 6 September 1922. Reconstituted in the Regular Army as the 29th Balloon Company on 24 March 1923 and 19th Airship Company made Active Associate. Designated mobilization training station was Fort Eustis, VA, 1923-24. Demobilized in 1924.

Commanders, 29th Balloon Company

Capt. Hoyt G. Ross	ao Feb 19-1 Jun 20 <i>Demobilized/Inactive</i>	1st Lt. Clarence B. Lober 30 Sep 21-1924	1 Jun 20-30 Sep 21
--------------------	---	---	--------------------

30th Balloon Company

HQ-Lee Hall, VA, 1919-22; *Inactive* 1922-24

Active at Lee Hall, VA, as of June 1919 as the 30th Balloon Company and assigned to the Army Balloon School. Redesignated as Balloon Company No. 30 on 13 September 1921. Inactivated on 20 September 1921 at Lee Hall and 22nd Balloon Company made Active Associate. Demobilized on 6 September 1922. Reconstituted in the Regular Army as the 30th Balloon Company on 24 March 1923 and 19th Airship Company made Active Associate. Designated mobilization training station was Fort Eustis, VA, 1923-24. Demobilized in 1924.

Commanders, 30th Balloon Company

2nd Lt. Elmer J. Bowling	ao Jan 20-9 Mar 20	2nd Lt. Robert V. Ignico	16 Dec 20-8 Feb 21
1st Lt. James B. Wallace	9 Mar 20-10 Sep 20	1st Lt. William J. Flood	8 Feb 21-18 Feb 21
Capt. Hoyt G. Ross	10 Sep 20-27 Nov 20	1st Lt. Ira B. Koenig	18 Feb 21-30 Sep 21
2nd Lt. Ambrose V. Clinton	27 Nov 20-16 Dec 20	<i>Demobilized/Inactive</i>	30 Sep 21-1924

31st Balloon Company

HQ-Godman Field, KY, 1919-21; *Inactive* 1922-24

Active at Godman Field, Fort Knox, KY, as of June 1919 as the 31st Balloon Company. Redesignated as Balloon Company No. 31 on 13 September 1921. The company's mission at Godman Field was to provide aerial observation and fire adjustment service for the field artillery training center at Fort Knox. Inactivated on 25 October 1921 at Godman Field and 20th Balloon Company made Active Associate. Demobilized on 6 September 1922. Reconstituted in the Regular Army as the 31st Balloon Company on 24 March 1923 and 19th Airship Company made Active Associate. Designated mobilization training station was Fort Eustis, VA, 1923-24. Demobilized in 1924.

Commanders, 31st Balloon Company

Capt. Arthur Thomas	ao Feb 19-23 Apr 21	1st Lt. W. C. Farnum	28 Apr 21-25 Oct 21
1st Lt. John P. Temple	23 Apr 21-28 Apr 21	<i>Demobilized/Inactive</i>	25 Oct 21-1924

31st Balloon Service Squadron (1929-33) (26th Balloon Group)

1st Balloon Service Company (1927-29) (26th Balloon Group)

31st Service Squadron (Balloon Group) (1933-36)

HQ-Not organized 1927-36

Constituted in the Regular Army on 18 October 1927 as the 1st Balloon Service Company, assigned to the 26th Balloon Group, and allotted to the Sixth Corps Area. Redesignated as the 31st Balloon Service Company on 8 May 1929. Relieved on 1 October 1933 from the 26th Balloon Group. Redesignated as the 31st Service Squadron (Balloon Group) on 1 October 1933. Concurrently withdrawn from the Sixth Corps Area and allotted to the Eighth Corps Area. Demobilized in 1936.

32nd Balloon Company

HQ-Lee Hall, VA, 1919-20; Camp Benning, GA, 1920-21; *Inactive* 1921-24

Active at Lee Hall, VA, as of June 1919 as the 32nd Balloon Company and assigned to the Army Balloon School. Transferred on 22 March 1920 to Camp Benning, GA. The company's mission at Camp Benning was to provide aerial observation and fire adjustment service for the field artillery units at the Infantry School. Redesignated as Balloon Company No. 32 on 13 September 1921. Transferred to Lee Hall, VA, and arrived there on 5 November 1921. Inactivated in November 1921 at Lee Hall and 20th Balloon Company made Active Associate. Demobilized on 6 September 1922. Reconstituted in the Regular Army as the 32nd Balloon Company on 24 March 1923 and 19th Airship Company made Active Associate. Designated mobilization training station was Fort Eustis, VA, 1923-24. Demobilized in 1924.

Commanders, 32nd Balloon Company

1st Lt. Charles E. Barber	ao Jan 20-ao Mar 20	1st Lt. Ambrose V. Clinton	1 Apr 21-7 Jun 21
1st Lt. Neal Creighton	ao Dec 20-1 Apr 21	Capt. William E. Kepner	7 Jun 21-Nov 21
	<i>Demobilized/Inactive</i>	Nov 21-1924	

32nd Balloon Service Company (1929-33) (24th Balloon Group)

Regular Army Inactive

2nd Balloon Service Company (1927-29) (24th Balloon Group)

32nd Service Squadron (Balloon Group) (1933-38)

HQ-Not organized 1927-31; Chicago, IL, 1931-33; *Inactive* 1933-38

Constituted in the Regular Army on 18 October 1927 as the 2nd Balloon Service Company, assigned to the 24th Balloon Group, and allotted to the Sixth Corps Area. Redesignated as the 32nd Balloon Service Company on 8 May 1929. Organized by June 1931 with Organized Reserve personnel as a RAI unit at Chicago, IL. Inactivated by June 1933 at Chicago by relief of personnel. Designated mobilization training station was Scott Field 1923-33. Redesignated as the 32nd Service Squadron (Balloon Group) on 1 October 1933. Concurrently withdrawn from the Sixth Corps Area and allotted to the Fourth Corps Area. Redesignated as the 32nd Air Base Squadron on 1 January 1938.

Commanders, 32nd Balloon Service Company

Unknown**

ao Jun 31-Jun 33

Inactive

Jun 33-1 Jan 38

** RAI commanders: Organized Reserve officers.

33rd Balloon Service Company (1929-33) (25th Balloon Group)

Regular Army Inactive

3rd Balloon Service Company (1927-29) (25th Balloon Group)

HQ-Not organized 1927-31; Chicago, IL, 1931-33; *Inactive* 1933-38

Constituted in the Regular Army on 18 October 1927 as the 3rd Balloon Service Company, assigned to the 25th Balloon Group, and allotted to the Sixth Corps Area. Redesignated as the 33rd Balloon Service Company on 8 May 1929. Organized by June 1931 with Organized Reserve personnel as a RAI unit at Chicago, IL. Inactivated by June 1933 at Chicago by relief of personnel. Designated mobilization training station was Scott Field 1923-33. Demobilized on 1 October 1933.

Commanders, 33rd Balloon Service Company

Unknown**

ao Jun 31-Jun 33

Inactive

Jun 33-1 Oct 33

** RAI commanders: Organized Reserve officers.

34th Balloon Service Company (1927-33) (22nd Balloon Group)

HQ-Not organized 1929-33

Constituted in the Regular Army 8 May 1929 as the 34th Balloon Service Company, assigned to the 22nd Balloon Group, and allotted to the Sixth Corps Area. Redesignated as the 34th Service Squadron (Balloon Group) on 1 October 1933.

101st Balloon Company (32nd Balloon Group)

New Hampshire National Guard

HQ-Not organized 1921-27

Constituted in the National Guard in 1921 as Balloon Company No. 101, assigned to the 11th Balloon Group (I Corps), and allotted to the state of New Hampshire. Redesignated as the 101st Balloon Company on 25 January 1923 and assigned to the 32nd Balloon Group (I Corps). Placed on the deferred list on 2 July 1923, unit requirement transferred to the Organized Reserve as a Deferred National Guard unit, and replaced by the 451st Balloon Company. Withdrawn as a Deferred National Guard unit on 11 January 1927 and allotted permanently to the Organized Reserve as the 451st Balloon Company.

102nd Balloon Company (32nd Balloon Group)

Rhode Island National Guard

HQ-Not organized 1921-27

Constituted in the National Guard in 1921 as Balloon Company No. 102, assigned to the 11th Balloon Group (I Corps), and allotted to the state of Rhode Island. Redesignated as the 102nd Balloon Company on 25 January 1923 and assigned to the 32nd Balloon Group (I Corps). Placed on the deferred list on 2 July 1923, unit requirement transferred to the Organized Reserve as a Deferred National Guard unit, and replaced by the 452nd Balloon Company. Withdrawn as a Deferred National Guard unit on 11 January 1927 and allotted permanently to the Organized Reserve as the 452nd Balloon Company.

103rd Balloon Company (32nd Balloon Group)**Maine National Guard****HQ-Not organized 1921-27**

Constituted in the National Guard in 1921 as Balloon Company No. 103, assigned to the 11th Balloon Group (I Corps), and allotted to the state of Maine. Redesignated as the 103rd Balloon Company on 25 January 1923 and assigned to the 32nd Balloon Group (I Corps). Placed on the deferred list on 2 July 1923, unit requirement transferred to the Organized Reserve as a Deferred National Guard unit, and replaced by the 453rd Balloon Company. Withdrawn from the state of Maine 7 January 1927. Withdrawn as a Deferred National Guard unit on 11 January 1927 and allotted permanently to the Organized Reserve as the 453rd Balloon Company.

104th Balloon Company (32nd Balloon Group)**Vermont National Guard****HQ-Not organized 1921-27**

Constituted in the National Guard in 1921 as Balloon Company No. 104, assigned to the 11th Balloon Group (I Corps), and allotted to the state of Vermont. Redesignated as the 104th Balloon Company on 25 January 1923 and assigned to the 32nd Balloon Group (I Corps). Placed on the deferred list on 2 July 1923, unit requirement transferred to the Organized Reserve as a Deferred National Guard unit, and replaced by the 454th Balloon Company. Withdrawn as a Deferred National Guard unit on 11 January 1927 and allotted permanently to the Organized Reserve as the 454th Balloon Company.

105th Balloon Company (33rd Balloon Group)**Pennsylvania National Guard****HQ-Not organized 1921-27**

Constituted in the National Guard in 1921 as Balloon Company No. 105, assigned to the 12th Balloon Group (III Corps), and allotted to the state of Pennsylvania. Redesignated as the 105th Balloon Company on 25 January 1923 and assigned to the 33rd Balloon Group (III Corps). Placed on the deferred list on 2 July 1923, unit requirement transferred to the Organized Reserve as a Deferred National Guard unit, and replaced by the 455th Balloon Company. Withdrawn from allotment to the National Guard on 17 September 1927 and demobilized.

106th Balloon Company (33rd Balloon Group)**Pennsylvania National Guard****HQ-Not organized 1921-27**

Constituted in the National Guard in 1921 as Balloon Company No. 106, assigned to the 12th Balloon Group (III Corps), and allotted to the state of Pennsylvania. Redesignated as the 106th Balloon Company on 25 January 1923 and assigned to the 33rd Balloon Group (III Corps). Placed on the deferred list on 2 July 1923, unit requirement transferred to the Organized Reserve as a Deferred National Guard unit, and replaced by the 456th Balloon Company. Withdrawn from allotment to the National Guard on 17 September 1927 and demobilized.

107th Balloon Company (33rd Balloon Group)**Pennsylvania National Guard****HQ-Not organized 1921-27**

Constituted in the National Guard in 1921 as Balloon Company No. 107, assigned to the 12th Balloon Group (III Corps), and allotted to the state of Pennsylvania. Redesignated as the 107th Balloon Company on 25 January 1923 and assigned to the 33rd Balloon Group (III Corps). Placed on the deferred list on 2 July 1923, unit requirement transferred to the Organized Reserve as a Deferred National Guard unit, and replaced by the 457th Balloon Company. Withdrawn from allotment to the National Guard on 17 September 1927 and demobilized.

108th Balloon Company (33rd Balloon Group)**Pennsylvania National Guard****HQ-Not organized 1921-27**

Constituted in the National Guard in 1921 as Balloon Company No. 108, assigned to the 12th Balloon Group (III Corps), and allotted to the state of Pennsylvania. Redesignated as the 108th Balloon Company on 25 January 1923 and assigned to the 33rd Balloon Group (III Corps). Placed on the deferred list on 2 July 1923, unit requirement transferred to the Organized Reserve as a Deferred National Guard unit, and replaced by the 458th Balloon Company. Withdrawn from allotment to the National Guard on 17 September 1927 and demobilized.

109th Balloon Company (34th Balloon Group)**North Carolina National Guard****HQ-Not organized 1921-27**

Constituted in the National Guard in 1921 as Balloon Company No. 109, assigned to the 13th Balloon Group (IV Corps), and allotted to the state of North Carolina. Wilmington, NC, designated as headquarters on organization, but the unit was never organized at that location. Redesignated as the 109th Balloon Company on 25 January 1923 and assigned to the 34th Balloon Group (IV Corps). Placed on the deferred list on 2 July 1923, unit requirement transferred to the Organized Reserve as a Deferred National Guard unit, and replaced by the 459th Balloon Company. Withdrawn from allotment to the National Guard on 17 September 1927 and demobilized.

110th Balloon Company (34th Balloon Group)**Alabama/Louisiana National Guard****HQ-Not organized 1921-27**

Constituted in the National Guard in 1921 as Balloon Company No. 110, assigned to the 13th Balloon Group (IV Corps), and allotted to the state of Alabama. Birmingham, AL, designated as headquarters on organization, but the unit was never organized at that location.. Redesignated as the 110th Balloon Company on 25 January 1923 and assigned to the 34th Balloon Group (IV Corps). Placed on the deferred list on 2 July 1923, unit requirement transferred to the Organized Reserve as a Deferred National Guard unit, and replaced by the 460th Balloon Company. Withdrawn from the Alabama National Guard 2 September 1925 and allotted to the Louisiana National Guard. Withdrawn from allotment to the National Guard on 17 September 1927 and demobilized.

111th Balloon Company (34th Balloon Group)**Mississippi National Guard****HQ-Not organized 1921-27**

Constituted in the National Guard in 1921 as Balloon Company No. 111, assigned to the 13th Balloon Group (IV Corps), and allotted to the state of Mississippi. Jackson, MS, designated as headquarters on organization, but the unit was never organized at that location. Redesignated as the 111th Balloon Company on 25 January 1923 and assigned to the 34th Balloon Group (IV Corps). Placed on the deferred list on 2 July 1923, unit requirement transferred to the Organized Reserve as a Deferred National Guard unit, and replaced by the 461st Balloon Company. Withdrawn from allotment to the National Guard on 17 September 1927 and demobilized.

112th Balloon Company (34th Balloon Group)**Georgia National Guard****HQ-Not organized 1921-27**

Constituted in the National Guard in 1921 as Balloon Company No. 112, assigned to the 13th Balloon Group (IV Corps), and allotted to the state of Georgia. Augusta, GA, designated as headquarters on organization, but the unit was never organized at that location. Redesignated as the 112th Balloon Company on 25 January 1923 and assigned to the 34th Balloon Group (IV Corps). Placed on the deferred list on 2 July 1923, unit requirement transferred to the Organized Reserve as a Deferred National Guard unit, and replaced by the 462nd Balloon Company. Withdrawn from allotment to the National Guard on 17 September 1927 and demobilized.

113th Balloon Company (35th Balloon Group)

Indiana National Guard

HQ-Not organized 1921-27

Constituted in the National Guard in 1921 as Balloon Company No. 113, assigned to the 14th Balloon Group (V Corps), and allotted to the state of Indiana. Redesignated as the 113th Balloon Company on 25 January 1923 and assigned to the 35th Balloon Group (V Corps). Placed on the deferred list on 2 July 1923, unit requirement transferred to the Organized Reserve as a Deferred National Guard unit, and replaced by the 463rd Balloon Company. Withdrawn from allotment to the National Guard on 17 September 1927 and demobilized.

114th Balloon Company (35th Balloon Group)

Indiana National Guard

HQ-Not organized 1921-27

Constituted in the National Guard in 1921 as Balloon Company No. 114, assigned to the 14th Balloon Group (V Corps), and allotted to the state of Indiana. Redesignated as the 114th Balloon Company on 25 January 1923 and assigned to the 35th Balloon Group (V Corps). Placed on the deferred list on 2 July 1923, unit requirement transferred to the Organized Reserve as a Deferred National Guard unit, and replaced by the 464th Balloon Company. Withdrawn from allotment to the National Guard on 17 September 1927 and demobilized.

115th Balloon Company (35th Balloon Group)

Indiana National Guard

HQ-Not organized 1921-27

Constituted in the National Guard in 1921 as Balloon Company No. 115, assigned to the 14th Balloon Group (V Corps), and allotted to the state of Indiana. Redesignated as the 115th Balloon Company on 25 January 1923 and assigned to the 35th Balloon Group (V Corps). Placed on the deferred list on 2 July 1923, unit requirement transferred to the Organized Reserve as a Deferred National Guard unit, and replaced by the 465th Balloon Company. Withdrawn from allotment to the National Guard on 17 September 1927 and demobilized.

116th Balloon Company (35th Balloon Group)

Indiana National Guard

HQ-Not organized 1921-27

Constituted in the National Guard in 1921 as Balloon Company No. 116, assigned to the 14th Balloon Group (V Corps), and allotted to the state of Indiana. Redesignated as the 116th Balloon Company on 25 January 1923 and assigned to the 35th Balloon Group (V Corps). Placed on the deferred list on 2 July 1923, unit requirement transferred to the Organized Reserve as a Deferred National Guard unit, and replaced by the 466th Balloon Company. Withdrawn from allotment to the National Guard on 17 September 1927 and demobilized.

117th Balloon Company (36th Balloon Group)

Illinois National Guard

HQ-Not organized 1921-27

Constituted in the National Guard in 1921 as Balloon Company No. 117, assigned to the 15th Balloon Group (VI Corps), and allotted to the state of Illinois. Chicago, IL, designated as headquarters on organization, but the unit was never organized at that location. Redesignated as the 117th Balloon Company on 25 January 1923 and assigned to the 36th Balloon Group (VI Corps). Placed on the deferred list on 2 July 1923, unit requirement transferred to the Organized Reserve as a Deferred National Guard unit, and replaced by the 467th Balloon Company. Withdrawn from allotment to the National Guard on 17 September 1927 and demobilized.

118th Balloon Company (36th Balloon Group)

Illinois National Guard

HQ-Not organized 1921-27

Constituted in the National Guard in 1921 as Balloon Company No. 118, assigned to the 15th Balloon Group (VI Corps), and allotted to the state of Illinois. East St. Louis, IL, designated as headquarters on organization, but the unit was never organized at that location. Redesignated as the 118th Balloon Company on 25 January 1923 and assigned to the 36th Balloon Group (VI Corps). Placed on the deferred list on 2 July 1923, unit requirement transferred to the Organized Reserve as a Deferred National Guard unit, and replaced by the 468th Balloon Company. Withdrawn from allotment to the National Guard on 17 September 1927 and demobilized.

119th Balloon Company (36th Balloon Group)

Illinois National Guard

HQ-Not organized 1921-27

Constituted in the National Guard in 1921 as Balloon Company No. 119, assigned to the 15th Balloon Group (VI Corps), and allotted to the state of Illinois. Peoria, IL, designated as headquarters on organization, but the unit was never organized at that location. Redesignated as the 119th Balloon Company on 25 January 1923 and assigned to the 36th Balloon Group (VI Corps). Placed on the deferred list on 2 July 1923, unit requirement transferred to the Organized Reserve as a Deferred National Guard unit, and replaced by the 469th Balloon Company. Withdrawn from allotment to the National Guard on 17 September 1927 and demobilized.

120th Balloon Company (36th Balloon Group)

Illinois National Guard

HQ-Not organized 1921-27

Constituted in the National Guard in 1921 as Balloon Company No. 120, assigned to the 15th Balloon Group (VI Corps), and allotted to the state of Illinois. Rockford, IL, designated as headquarters on organization, but the unit was never organized at that location. Redesignated as the 120th Balloon Company on 25 January 1923 and assigned to the 36th Balloon Group (VI Corps). Placed on the deferred list on 2 July 1923, unit requirement transferred to the Organized Reserve as a Deferred National Guard unit, and replaced by the 470th Balloon Company. Withdrawn from allotment to the National Guard on 17 September 1927 and demobilized.

121st Balloon Company (37th Balloon Group)

Minnesota National Guard

HQ-Not organized 1921-27

Constituted in the National Guard in 1921 as Balloon Company No. 121, assigned to the 16th Balloon Group (VII Corps), and allotted to the state of Minnesota. Redesignated as the 121st Balloon Company on 25 January 1923 and assigned to the 37th Balloon Group (VII Corps). Placed on the deferred list on 2 July 1923, unit requirement transferred to the Organized Reserve as a Deferred National Guard unit, and replaced by the 471st Balloon Company. Withdrawn from allotment to the National Guard on 17 September 1927 and demobilized.

122nd Balloon Company (37th Balloon Group)

Minnesota National Guard

HQ-Not organized 1921-27

Constituted in the National Guard in 1921 as Balloon Company No. 122, assigned to the 16th Balloon Group (VII Corps), and allotted to the state of Minnesota. Redesignated as the 122nd Balloon Company on 25 January 1923 and assigned to the 37th Balloon Group (VII Corps). Placed on the deferred list on 2 July 1923, unit requirement transferred to the Organized Reserve as a Deferred National Guard unit, and replaced by the 472nd Balloon Company. Withdrawn from allotment to the National Guard on 17 September 1927 and demobilized.

123rd Balloon Company (37th Balloon Group)

Minnesota National Guard

HQ-Not organized 1921-27

Constituted in the National Guard in 1921 as Balloon Company No. 123, assigned to the 16th Balloon Group (VII Corps), and allotted to the state of Minnesota. Redesignated as the 123rd Balloon Company on 25 January 1923 and assigned to the 37th Balloon Group (VII Corps). Placed on the deferred list on 2 July 1923, unit requirement transferred to the Organized Reserve as a Deferred National Guard unit, and replaced by the 473rd Balloon Company. Withdrawn from allotment to the National Guard on 17 September 1927 and demobilized.

124th Balloon Company (37th Balloon Group)

Minnesota National Guard

HQ-Not organized 1921-27

Constituted in the National Guard in 1921 as Balloon Company No. 124, assigned to the 16th Balloon Group (VII Corps), and allotted to the state of Minnesota. Redesignated as the 124th Balloon Company on 25 January 1923 and assigned to the 37th Balloon Group (VII Corps). Placed on the deferred list on 2 July 1923, unit requirement transferred to the Organized Reserve as a Deferred National Guard unit, and replaced by the 474th Balloon Company. Withdrawn from allotment to the National Guard on 17 September 1927 and demobilized.

125th Balloon Company (551st Balloon Group)

Texas National Guard

HQ-Not organized 1921-26

Constituted in the National Guard in 1921 as Balloon Company No. 125, assigned to the 551st Balloon Group (VIII Corps), and allotted to the state of Texas. Redesignated as the 125th Balloon Company on 25 January 1923. Placed on the deferred list on 2 July 1923, unit requirement transferred to the Organized Reserve as a Deferred National Guard unit, and replaced by the 475th Balloon Company. Withdrawn as a Deferred National Guard unit on 11 January 1927 and allotted permanently to the Organized Reserve as the 475th Balloon Company.

126th Balloon Company (551st Balloon Group)

Texas National Guard

HQ-Not organized 1921-26

Constituted in the National Guard in 1921 as Balloon Company No. 126, assigned to the 551st Balloon Group (VIII Corps), and allotted to the state of Texas. Redesignated as the 126th Balloon Company on 25 January 1923. Placed on the deferred list on 2 July 1923, unit requirement transferred to the Organized Reserve as a Deferred National Guard unit, and replaced by the 476th Balloon Company. Withdrawn as a Deferred National Guard unit on 11 January 1927 and allotted permanently to the Organized Reserve as the 476th Balloon Company.

127th Balloon Company (38th Balloon Group)

California National Guard

HQ-Not organized 1921-27

Constituted in the National Guard in 1921 as Balloon Company No. 127, assigned to the 17th Balloon Group (IX Corps), and allotted to the state of California. Redesignated as the 127th Balloon Company on 25 January 1923 and assigned to the 38th Balloon Group (IX Corps). Placed on the deferred list on 2 July 1923, unit requirement transferred to the Organized Reserve as a Deferred National Guard unit, and replaced by the 477th Balloon Company. Withdrawn from allotment to the National Guard on 17 September 1927 and demobilized.

128th Balloon Company (38th Balloon Group)

Idaho National Guard

HQ-Not organized 1921-27

Constituted in the National Guard in 1921 as Balloon Company No. 128, assigned to the 17th Balloon Group (IX Corps), and allotted to the state of Idaho. Redesignated as the 128th Balloon Company on 25 January 1923 and assigned to the 38th Balloon Group (IX Corps). Placed on the deferred list on 2 July 1923, unit requirement transferred to the Organized Reserve as a Deferred National Guard unit, and replaced by the 478th Balloon Company. Withdrawn from allotment to the National Guard on 17 September 1927 and demobilized.

129th Balloon Company (38th Balloon Group)

Utah National Guard

HQ-Not organized 1921-27

Constituted in the National Guard in 1921 as Balloon Company No. 129, assigned to the 17th Balloon Group (IX Corps), and allotted to the state of Utah. Redesignated as the 129th Balloon Company on 25 January 1923 and assigned to the 38th Balloon Group (IX Corps). Placed on the deferred list on 2 July 1923, unit requirement transferred to the Organized Reserve as a Deferred National Guard unit, and replaced by the 479th Balloon Company. Withdrawn from allotment to the National Guard on 17 September 1927 and demobilized.

130th Balloon Company (38th Balloon Group)

Oregon National Guard

HQ-Not organized 1921-27

Constituted in the National Guard in 1921 as Balloon Company No. 130, assigned to the 17th Balloon Group (IX Corps), and allotted to the state of Oregon. Redesignated as the 130th Balloon Company on 25 January 1923 and assigned to the 38th Balloon Group (IX Corps). Placed on the deferred list on 2 July 1923, unit requirement transferred to the Organized Reserve as a Deferred National Guard unit, and replaced by the 480th Balloon Company. Withdrawn from allotment to the National Guard on 17 September 1927 and demobilized.

131st Balloon Service Company (1923-26) (32nd Balloon Group)

New Hampshire National Guard

Balloon Park No. 11 (1921-23)

HQ-Not organized 1921-26

Constituted in the National Guard in 1921 as Balloon Park No. 11, assigned to the 11th Balloon Group (I Corps), and allotted to the state of New Hampshire. Redesignated as the 131st Balloon Service Company on 25 January 1923 and assigned to the 32nd Balloon Group (I Corps). Placed on the deferred list on 2 July 1923, unit requirement transferred to the Organized Reserve as a Deferred National Guard unit. Withdrawn from allotment to the National Guard 30 December 1926 and demobilized.

132nd Balloon Service Company (1923-27) (33rd Balloon Group)

Pennsylvania National Guard

Balloon Park No. 12 (1921-23)

HQ-Not organized 1921-27

Constituted in the National Guard in 1921 as Balloon Park No. 12, assigned to the 12th Balloon Group (III Corps), and allotted to the state of Pennsylvania. Redesignated as the 132nd Balloon Service Company on 25 January 1923 and assigned to the 33rd Balloon Group (III Corps). Placed on the deferred list on 2 July 1923, unit requirement transferred to the Organized Reserve as a Deferred National Guard unit, and replaced by the 482nd Balloon Service Company. Withdrawn from allotment to the National Guard on 17 September 1927 and demobilized.

133rd Balloon Service Company (1923-27) (34th Balloon Group)

Georgia National Guard

Balloon Park No. 13 (1921-23)

HQ-Not organized 1921-27

Constituted in the National Guard in 1921 as Balloon Park No. 13, assigned to the 13th Balloon Group (IV Corps), and allotted to the state of Georgia. Redesignated as the 133rd Balloon Service Company on 25 January 1923 and assigned to the 34th Balloon Group (IV Corps). Placed on the deferred list on 2 July 1923, unit requirement transferred to the Organized Reserve as a Deferred National Guard unit, and replaced by the 483rd Balloon Service Company. Withdrawn from allotment to the National Guard on 17 September 1927 and demobilized.

134th Balloon Service Company (1923-27) (35th Balloon Group)

Indiana National Guard

Balloon Park No. 14 (1921-23)

HQ-Not organized 1921-27

Constituted in the National Guard in 1921 as Balloon Park No. 14, assigned to the 14th Balloon Group (V Corps), and allotted to the state of Indiana. Redesignated as the 134th Balloon Service Company on 25 January 1923 and assigned to the 35th Balloon Group (V Corps). Placed on the deferred list on 2 July 1923, unit requirement transferred to the Organized Reserve as a Deferred National Guard unit, and replaced by the 484th Balloon Service Company. Withdrawn from allotment to the National Guard on 17 September 1927 and demobilized.

135th Balloon Service Company (1923-27) (36th Balloon Group)

Illinois National Guard

Balloon Park No. 15 (1921-23)

HQ-Not organized 1921-27

Constituted in the National Guard in 1921 as Balloon Park No. 15, assigned to the 15th Balloon Group (VI Corps), and allotted to the state of Illinois. Chicago, IL, designated as headquarters on organization, but the unit was never organized at that location. Redesignated as the 135th Balloon Service Company on 25 January 1923 and assigned to the 36th Balloon Group (VI Corps). Placed on the deferred list on 2 July 1923, unit requirement transferred to the Organized Reserve as a Deferred National Guard unit, and replaced by the 485th Balloon Service Company. Withdrawn from allotment to the National Guard on 17 September 1927 and demobilized.

136th Balloon Service Company (1923-27) (37th Balloon Group)

Minnesota National Guard

Balloon Park No. 16 (1921-23)

HQ-Not organized 1921-27

Constituted in the National Guard in 1921 as Balloon Park No. 16, assigned to the 16th Balloon Group (VII Corps), and allotted to the state of Minnesota. Redesignated as the 136th Balloon Service Company on 25 January 1923 and assigned to the 37th Balloon Group (VII Corps). Placed on the deferred list on 2 July 1923, unit requirement transferred to the Organized Reserve as a Deferred National Guard unit, and replaced by the 486th Balloon Service Company. Withdrawn from allotment to the National Guard on 17 September 1927 and demobilized.

137th Balloon Service Company (1923-27) (551st Balloon Group)

Colorado National Guard

Balloon Park No. 17 (1921-23)

HQ-Not organized 1921-26

Constituted in the National Guard in 1921 as Balloon Park No. 17, assigned to the 51st Balloon Group (VIII Corps), and allotted to the state of Colorado. Redesignated as the 137th Balloon Service Company on 25 January 1923 and assigned to the 551st Balloon Group (VIII Corps). Placed on the deferred list on 2 July 1923, unit requirement transferred to the Organized Reserve as a Deferred National Guard unit, and replaced by the 487th Balloon Service Company. Withdrawn as a Deferred National Guard unit on 11 January 1927 and allotted permanently to the Organized Reserve as the 487th Balloon Service Company. Concurrently withdrawn from the Eighth Corps Area and allotted to the Seventh Corps Area.

138th Balloon Service Company (1923-27) (38th Balloon Group)

California National Guard

Balloon Park No. 18 (1921-23)

HQ-Not organized 1921-27

Constituted in the National Guard in 1921 as Balloon Park No. 18, assigned to the 17th Balloon Group (IX Corps), and allotted to the state of California. Redesignated as the 138th Balloon Service Company on 25 January 1923 and assigned to the 38th Balloon Group (IX Corps). Placed on the deferred list on 2 July 1923, unit requirement transferred to the Organized Reserve as a Deferred National Guard unit, and replaced by the 488th Balloon Service Company. Withdrawn from allotment to the National Guard on 17 September 1927 and demobilized.

139th Balloon Service Company (1923-27) (151st Balloon Group)

Nebraska National Guard

Balloon Park No. 21 (1921-23)

HQ-Not organized 1921-27

Constituted in the National Guard in 1921 as Balloon Park No. 21, assigned to the 151st Balloon Group (GHQR), and allotted to the state of Nebraska. Redesignated as the 139th Balloon Service Company on 25 January 1923 and assigned to the 151st Balloon Group (GHQR). Placed on the deferred list on 2 July 1923, unit requirement transferred to the Organized Reserve as a Deferred National Guard unit, and replaced by the 495th Balloon Service Company. Withdrawn from allotment to the National Guard on 17 September 1927 and demobilized.

141st Balloon Company (151st Balloon Group)

Nebraska National Guard

HQ-Not organized 1921-27

Constituted in the National Guard in 1921 as Balloon Company No. 141, assigned to the 151st Balloon Group (GHQR), and allotted to the state of Nebraska. Redesignated as the 141st Balloon Company on 25 January 1923. Placed on the deferred list on 2 July 1923, unit requirement transferred to the Organized Reserve as a Deferred National Guard unit, and replaced by the 489th Balloon Company. Withdrawn from allotment to the National Guard on 17 September 1927 and demobilized.

142nd Balloon Company (151st Balloon Group)

Nebraska National Guard

HQ-Not organized 1921-27

Constituted in the National Guard in 1921 as Balloon Company No. 142, assigned to the 151st Balloon Group (GHQR), and allotted to the state of Nebraska. Redesignated as the 142nd Balloon Company on 25 January 1923. Placed on the deferred list on 2 July 1923, unit requirement transferred to the Organized Reserve as a Deferred National Guard unit, and replaced by the 490th Balloon Company. Withdrawn from allotment to the National Guard on 17 September 1927 and demobilized.

143rd Balloon Company (151st Balloon Group)

Nebraska National Guard

HQ-*Not organized* 1921-27

Constituted in the National Guard in 1921 as Balloon Company No. 143, assigned to the 151st Balloon Group (GHQR), and allotted to the state of Nebraska. Redesignated as the 143rd Balloon Company on 25 January 1923. Placed on the deferred list on 2 July 1923, unit requirement transferred to the Organized Reserve as a Deferred National Guard unit, and replaced by the 491st Balloon Company. Withdrawn from allotment to the National Guard on 17 September 1927 and demobilized.

144th Balloon Company (151st Balloon Group)

Nebraska National Guard

HQ-*Not organized* 1921-27

Constituted in the National Guard in 1921 as Balloon Company No. 144, assigned to the 151st Balloon Group (GHQR), and allotted to the state of Nebraska. Redesignated as the 144th Balloon Company on 25 January 1923. Placed on the deferred list on 2 July 1923, unit requirement transferred to the Organized Reserve as a Deferred National Guard unit, and replaced by the 492nd Balloon Company. Withdrawn from allotment to the National Guard on 17 September 1927 and demobilized.

145th Balloon Company (63rd Balloon Group)

Arkansas National Guard

HQ-*Not organized* 1921-27

Constituted in the National Guard in 1921 as Balloon Company No. 145, assigned to the 63rd Balloon Group (GHQR), and allotted to the state of Arkansas. Redesignated as the 145th Balloon Company on 25 January 1923. Placed on the deferred list on 2 July 1923, unit requirement transferred to the Organized Reserve as a Deferred National Guard unit, and replaced by the 493rd Balloon Company. Withdrawn from allotment to the National Guard on 17 September 1927 and demobilized.

146th Balloon Company (63rd Balloon Group)

Nebraska National Guard

HQ-*Not organized* 1921-27

Constituted in the National Guard in 1921 as Balloon Company No. 146, assigned to the 63rd Balloon Group (GHQR), and allotted to the state of Nebraska. Redesignated as the 146th Balloon Company on 25 January 1923. Placed on the deferred list on 2 July 1923, unit requirement transferred to the Organized Reserve as a Deferred National Guard unit, and replaced by the 494th Balloon Company. Withdrawn from allotment to the National Guard on 17 September 1927 and demobilized.

301st Balloon Company (541st Balloon Group)

Organized Reserve Maine

HQ-Bangor, ME, 1921-34; *Inactive* 1934-41

Constituted in the Organized Reserve on 29 July 1921 as the 301st Balloon Company, assigned to 41st Balloon Group (redesignated as the 541st Balloon Group on 20 February 1924), and allotted to the First Corps Area. Initiated on 10 November 1921 at Bangor, ME. Redesignated as the 301st Balloon Squadron on 1 October 1933. Inactivated by June 1934 at Bangor by relief of personnel. Location 7 December 1941—*Inactive*.

Status: Disbanded on 31 May 1942.

302nd Balloon Company (541st Balloon Group)**Organized Reserve Maine/Massachusetts**

HQ—*Not initiated* 1921-23; Aurora, ME, 1923-27; *Inactive* 1927-28; Boston, MA, 1928-41

Constituted in the Organized Reserve on 29 July 1921 as the 302nd Balloon Company, assigned to 41st Balloon Group (redesignated as the 541st Balloon Group on 20 February 1924), and allotted to the First Corps Area. Initiated in February 1923 at Aurora, ME. Inactivated on 29 January 1927 at Aurora by relief of personnel. Reorganized by July 1928 at Boston, MA. Redesignated as the 302nd Balloon Squadron on 1 October 1933. Location 7 December 1941—Boston, MA.

Status: Disbanded on 31 May 1942.

303rd Balloon Company (541st Balloon Group)**Organized Reserve Maine/Massachusetts**

HQ—*Not initiated* 1921-23; Bath, ME, 1923-27; *Inactive* 1927-31; Boston, MA, 1931-41

Constituted in the Organized Reserve on 29 July 1921 as the 303rd Balloon Company, assigned to 41st Balloon Group (redesignated as the 541st Balloon Group on 20 February 1924), and allotted to the First Corps Area. Initiated in May 1923 at Bath, ME. Inactivated on 29 January 1927 at Bath by relief of personnel. Reorganized by June 1931 in Massachusetts. Redesignated as the 303rd Balloon Squadron on 1 October 1933. Location 7 December 1941—Boston, MA.

Status: Disbanded on 31 May 1942.

304th Balloon Company (541st Balloon Group)**Organized Reserve New Hampshire**

HQ—Concord, NH, 1921-27; New Haven, CT, 1927-33

Constituted in the Organized Reserve on 29 July 1921 as the 304th Balloon Company, assigned to the 541st Balloon Group (redesignated as the 541st Balloon Group on 20 February 1924), and allotted to the First Corps Area. Initiated in May 1923 at Concord, NH. Relocated on 29 January 1927 to New Haven, CT. Demobilized on 1 October 1933.

305th Balloon Company (542nd Balloon Group)**Organized Reserve New Jersey**

HQ—Trenton, NJ, 1921-37; *Inactive* 1937-41.

Constituted in the Organized Reserve on 29 July 1921 as the 305th Balloon Company, assigned to the 42nd Balloon Group (redesignated as the 542nd Balloon Group on 20 February 1924), and allotted to the Second Corps Area. Initiated on 4 November 1921 at Trenton, NJ. Redesignated as the 305th Balloon Squadron on 1 October 1933. Inactivated about September 1937 at Trenton by relief of personnel. Location 7 December 1941—*Inactive*.

Status: Disbanded on 31 May 1942.

306th Balloon Company (542nd Balloon Group)**Organized Reserve New Jersey**

HQ—*Not initiated* 1921-22; Atlantic City, NJ, 1922-34; *Inactive* 1934-41

Constituted in the Organized Reserve on 29 July 1921 as the 306th Balloon Company, assigned to the 42nd Balloon Group (redesignated as the 542nd Balloon Group on 20 February 1924), and allotted to the Second Corps Area. Initiated in November 1921 at Atlantic City, NJ. Inactivated about September 1934 at Atlantic City by relief of personnel. Trenton, NJ, designated as headquarters on organization, but the unit was never organized at that location. Redesignated as the 306th Balloon Squadron on 1 October 1933. Inactivated about September 1937 at Trenton by relief of personnel. Location 7 December 1941—*Inactive*.

Status: Disbanded on 31 May 1942.

307th Balloon Company (542nd Balloon Group)**Organized Reserve Delaware****HQ**-Wilmington, DE, 1921-37; *Inactive* 1937-41

Constituted in the Organized Reserve on 29 July 1921 as the 307th Balloon Company, assigned to the 42nd Balloon Group (redesignated as the 542nd Balloon Group on 20 February 1924), and allotted to the Second Corps Area. Initiated on 4 November 1921 at Wilmington, DE. Redesignated as the 307th Balloon Squadron on 1 October 1933. Inactivated about September 1937 at Wilmington by relief of personnel. Location 7 December 1941—*Inactive*.

Status: Disbanded on 31 May 1942.**308th Balloon Company** (542nd Balloon Group)**Organized Reserve New York****HQ**-*Not initiated* 1921-22; Buffalo, NY, 1922-32; *Inactive* 1932-41

Constituted in the Organized Reserve on 29 July 1921 as the 308th Balloon Company, assigned to the 42nd Balloon Group (redesignated as the 542nd Balloon Group on 20 February 1924), and allotted to the Second Corps Area. Initiated on 27 March 1922 at Buffalo, NY. Redesignated as the 308th Balloon Squadron on 1 October 1933. Inactivated by January 1932 at Buffalo by relief of personnel. Location 7 December 1941—Buffalo, NY.

Status: Disbanded on 31 May 1942.**309th Balloon Company** (543rd Balloon Group)**Organized Reserve Pennsylvania****HQ**-*Not initiated* 1921-22; Pittsburgh Airport, Pittsburgh, PA, 1922-26; *Inactive* 1926-41

Constituted in the Organized Reserve on 29 July 1921 as the 309th Balloon Company, assigned to the 43rd Balloon Group (redesignated as the 543rd Balloon Group on 20 February 1924), and allotted to the Third Corps Area. Initiated in September 1922 at Pittsburgh Airport, Pittsburgh, PA. Inactivated on 3 December 1926 at Pittsburgh by relief of personnel. Redesignated as the 309th Balloon Squadron on 1 October 1933. Location 7 December 1941—*Inactive*.

Status: Disbanded on 31 May 1942.**310th Balloon Company** (543rd Balloon Group)**Organized Reserve Pennsylvania****HQ**-*Not initiated* 1921-22; Greensburg, PA, 1922-28; *Inactive* 1928-41

Constituted in the Organized Reserve on 29 July 1921 as the 310th Balloon Company, assigned to the 43rd Balloon Group (redesignated as the 543rd Balloon Group on 20 February 1924), and allotted to the Third Corps Area. Initiated in September 1922 at Greensburg, PA. Inactivated about May 1928 at Greensburg by relief of personnel. Redesignated as the 310th Balloon Squadron on 1 October 1933. Pittsburgh Airport at Pittsburgh, PA, designated as headquarters on reorganization, but the unit was never organized at that location. Location 7 December 1941—*Inactive*.

Status: Disbanded on 31 May 1942.**311th Balloon Company** (543rd Balloon Group)**Organized Reserve Pennsylvania****HQ**-*Not initiated* 1921-22; Washington, PA, 1922-28; *Inactive* 1928-32; Pittsburgh, PA, 1932-35; *Inactive* 1935-41

Constituted in the Organized Reserve on 29 July 1921 as the 311th Balloon Company, assigned to the 43rd Balloon Group (redesignated as the 543rd Balloon Group on 20 February 1924), and allotted to the Third Corps Area. Initiated in September 1922 at Washington, PA. Inactivated about May 1928 at Washington by relief of personnel. Redesignated as the 311th Balloon Squadron on 1 October 1933. Reorganized by June 1932 at the Pittsburgh Airport, Pittsburgh, PA. Inactivated by June 1935 at Pittsburgh by relief of personnel. Location 7 December 1941—*Inactive*.

Status: Disbanded on 31 May 1942.

312th Balloon Company (543rd Balloon Group)**Organized Reserve Pennsylvania**

HQ-*Not initiated* 1921-22; Uniontown, PA, 1922-26; *Inactive* 1926-32; Pittsburgh, PA, 1932-35; *Inactive* 1935-41

Constituted in the Organized Reserve on 29 July 1921 as the 312th Balloon Company, assigned to the 43rd Balloon Group (redesignated as the 543rd Balloon Group on 20 February 1924), and allotted to the Third Corps Area. Initiated in September 1922 at Uniontown, PA. Inactivated on 3 December 1926 at Uniontown by relief of personnel. Reorganized by June 1932 at the Pittsburgh Airport, Pittsburgh, PA. Redesignated as the 312th Balloon Squadron on 1 October 1933. Inactivated by June 1935 at Pittsburgh by relief of personnel. Location 7 December 1941—*Inactive*.

Status: Disbanded on 31 May 1942.

313th Balloon Company (544th Balloon Group)**Organized Reserve Florida/South Carolina**

HQ-Jacksonville, FL, 1921-32; *Inactive* 1932-41

Constituted in the Organized Reserve on 29 July 1921 as the 313th Balloon Company, assigned to the 44th Balloon Group (redesignated as the 544th Balloon Group on 20 February 1924), and allotted to the Fourth Corps Area. Initiated on 14 December 1921 at Jacksonville, FL. Inactivated by June 1932 at Jacksonville by relief of personnel. Redesignated as the 313th Balloon Squadron on 1 October 1933. Charleston, SC, designated on 4 April 1934 as headquarters on reorganization, but the unit was never organized at that location. Withdrawn from the Organized Reserve 1 January 1938 and allotted to the Regular Army. Conducted annual summer training at Scott Field, IL. Designated mobilization station was Camp Joseph E. Johnston, FL, (later redesignated Camp J. Clifford R. Foster). Location 7 December 1941—*Inactive*.

Status: Disbanded on 31 May 1942.

314th Balloon Company (544th Balloon Group)**Organized Reserve Florida/South Carolina**

HQ-*Not initiated* 1921-22; Tampa, FL, 1922-32; *Inactive* 1932-41

Constituted in the Organized Reserve on 29 July 1921 as the 314th Balloon Company, assigned to the 44th Balloon Group (redesignated as the 544th Balloon Group on 20 February 1924), and allotted to the Fourth Corps Area. Initiated on 17 April 1922 at Tampa, FL. Inactivated by June 1932 at Tampa by relief of personnel. Redesignated as the 314th Balloon Squadron on 1 October 1933. Charleston, SC, designated on 4 April 1934 as headquarters on reorganization, but the unit was never organized at that location. Withdrawn from the Organized Reserve 1 January 1938 and allotted to the Regular Army. Conducted annual summer training at Scott Field, IL. Designated mobilization station was Camp Joseph E. Johnston, FL, (later redesignated Camp J. Clifford R. Foster). Location 7 December 1941—*Inactive*.

Status: Disbanded on 31 May 1942.

315th Balloon Company (544th Balloon Group)**Organized Reserve Georgia/North Carolina**

HQ-*Not initiated* 1921-22; Augusta, GA, 1922-35; Henderson, NC, 1935-39; *Inactive* 1939-41

Constituted in the Organized Reserve on 29 July 1921 as the 315th Balloon Company, assigned to the 44th Balloon Group (redesignated as the 544th Balloon Group on 20 February 1924), and allotted to the Fourth Corps Area. Initiated on 17 April 1922 at Augusta, GA. Redesignated as the 313th Balloon Squadron on 1 October 1933. Relocated on 29 January 1935 to Henderson, NC. Inactivated by June 1939 at Henderson by relief of personnel. Designated mobilization station was Camp Joseph E. Johnston, FL, (later redesignated Camp J. Clifford R. Foster). Location 7 December 1941—*Inactive*.

Status: Disbanded on 31 May 1942.

316th Balloon Company (544th Balloon Group)**Organized Reserve South Carolina/Florida**

HQ-*Not initiated* 1921-22; Charleston, SC, 1922-32; *Inactive* 1932-41

Constituted in the Organized Reserve on 29 July 1921 as the 316th Balloon Company, assigned to the 44th Balloon Group (redesignated as the 544th Balloon Group on 20 February 1924), and allotted to the Fourth Corps Area. Initiated on 25 April 1922 at Charleston, SC. Inactivated by June 1932 at Charleston by relief of personnel. Redesignated as the 316th Balloon Squadron on 1 October 1933. Jacksonville, FL, designated on 29 January 1935 as headquarters on reorganization, but the unit was never organized at that location. Designated mobilization station was Camp Joseph E. Johnston, FL, (later redesignated Camp J. Clifford R. Foster). Location 7 December 1941—*Inactive*.

Status: Disbanded on 31 May 1942.

317th Balloon Company (545th Balloon Group)**Organized Reserve Indiana**

HQ-*Not initiated* 1921-22; Indianapolis, IN, 1924-34; *Inactive* 1934-41

Constituted in the Organized Reserve on 29 July 1921 as the 317th Balloon Company, assigned to the 45th Balloon Group (redesignated as the 545th Balloon Group on 20 February 1924), and allotted to the Fifth Corps Area. Initiated in September 1924 at Indianapolis, IN. Redesignated as the 317th Balloon Squadron on 1 October 1933. Inactivated by June 1934 at Indianapolis by relief of personnel. Location 7 December 1941—*Inactive*.

Status: Disbanded on 31 May 1942.

318th Balloon Company (545th Balloon Group)**Organized Reserve Ohio**

HQ-*Not initiated* 1921-22; Columbus, OH, 1922-30; Akron, OH, 1930-34; *Inactive* 1934-41

Constituted in the Organized Reserve on 29 July 1921 as the 318th Balloon Company, assigned to the 45th Balloon Group (redesignated as the 545th Balloon Group on 20 February 1924), and allotted to the Fifth Corps Area. Initiated in January 1922 at Columbus, OH. Relocated by 1930 to Akron, OH. Redesignated as the 318th Balloon Squadron on 1 October 1933. Inactivated by June 1934 at Akron by relief of personnel. Location 7 December 1941—*Inactive*.

Status: Disbanded on 31 May 1942.

319th Balloon Company (545th Balloon Group)**Organized Reserve Ohio**

HQ-*Not initiated* 1921-24; Cleveland, OH, 1924-37; *Inactive* 1937-41

Constituted in the Organized Reserve on 29 July 1921 as the 319th Balloon Company, assigned to the 45th Balloon Group (redesignated as the 545th Balloon Group on 20 February 1924), and allotted to the Fifth Corps Area. Initiated in September 1924 at Cleveland, OH. Redesignated as the 319th Balloon Squadron on 1 October 1933. Inactivated by June 1937 at Dayton by relief of personnel. Location 7 December 1941—*Inactive*.

Status: Disbanded on 31 May 1942.

320th Balloon Company (545th Balloon Group)**Organized Reserve Kentucky/West Virginia**

HQ-*Not initiated* 1921-22; Scottsville, KY, 1922-30; Huntington, WV 1930-34; *Inactive* 1934-41

Constituted in the Organized Reserve on 29 July 1921 as the 320th Balloon Company, assigned to the 45th Balloon Group (redesignated as the 545th Balloon Group on 20 February 1924), and allotted to the Fifth Corps Area. Initiated in January 1922 at Scottsville, KY. Relocated by 1930 to Huntington, WV. Redesignated as the 320th Balloon Squadron on 1 October 1933. Inactivated by June 1934 at Huntington by relief of personnel. Location 7 December 1941—*Inactive*.

Status: Disbanded on 31 May 1942.

321st Balloon Company (546th Balloon Group)**Organized Reserve Illinois**

HQ-*Not initiated* 1921-22; Chicago, IL, 1922-29; *Inactive* 1929-30; Chicago, IL, 1930-41

Constituted in the Organized Reserve on 29 July 1921 as the 321st Balloon Company, assigned to the 46th Balloon Group (redesignated as the 546th Balloon Group on 20 February 1924), and allotted to the Sixth Corps Area. Initiated on 21 January 1922 at Chicago, IL. Inactivated on 1 December 1929 at Chicago by relief of personnel. Reorganized by June 1930 at Chicago. Redesignated as the 321st Balloon Squadron on 1 October 1933. Conducted annual summer training at Scott Field, IL. Location 7 December 1941—Chicago, IL.

Status: Disbanded on 31 May 1942.

322nd Balloon Company (546th Balloon Group)**Organized Reserve Michigan**

HQ-Jackson, MI, 1921-25; Flint, MI, 1925-32; Detroit, MI, 1932-41

Constituted in the Organized Reserve on 29 July 1921 as the 322nd Balloon Company, assigned to the 46th Balloon Group (redesignated as the 546th Balloon Group on 20 February 1924), and allotted to the Sixth Corps Area. Initiated on 16 November 1921 at Jackson, MI. Relocated on 2 June 1925 to Flint, MI. Relocated on 26 September 1932 to Detroit, MI. Redesignated as the 322nd Balloon Squadron on 1 October 1933. Location 7 December 1941—Flint, MI.

Status: Disbanded on 31 May 1942.

323rd Balloon Company (546th Balloon Group)**Organized Reserve Wisconsin/California**

HQ-*Not initiated* 1921-22; Green Bay, WI, 1922-29; *Inactive* 1929-41

Constituted in the Organized Reserve on 29 July 1921 as the 323rd Balloon Company, assigned to the 46th Balloon Group (redesignated as the 546th Balloon Group on 20 February 1924), and allotted to the Sixth Corps Area. Initiated in August 1922 at Green Bay, WI. Inactivated by June 1929 at Green Bay by relief of personnel. Redesignated as the 323rd Balloon Squadron on 1 October 1933. Withdrawn from the Sixth Corps Area on 1 January 1938 and allotted to the Ninth Corps Area. Concurrently relieved from the 546th Balloon Group and assigned to the 66th Balloon Group. Los Angeles, CA, designated as headquarters on reorganization, but the unit was never organized at that location. Location 7 December 1941—*Inactive*.

Status: Disbanded on 31 May 1942.

324th Balloon Company (546th Balloon Group)**Organized Reserve Wisconsin/Illinois**

HQ-*Not initiated* 1921-22; Appleton, WI, 1922-25; Belleville, IL, 1925-29; *Inactive* 1929-30; Belleville, IL, 1930-39; *Inactive* 1939-41

Constituted in the Organized Reserve on 29 July 1921 as the 324th Balloon Company, assigned to the 46th Balloon Group (redesignated as the 546th Balloon Group on 20 February 1924), and allotted to the Sixth Corps Area. Initiated on 24 November 1922 at Appleton, WI. Relocated on 28 July 1925 to Belleville, IL. Inactivated on 1 December 1929 at Belleville by relief of personnel. Reorganized by June 1930 at Belleville. Redesignated as the 324th Balloon Squadron on 1 October 1933. Inactivated about March 1939 at Belleville by relief of personnel. Location 7 December 1941—*Inactive*.

Status: Disbanded on 31 May 1942.

325th Balloon Company (547th Balloon Group)**Organized Reserve Nebraska/Missouri**

HQ-*Not initiated* 1921-22; Omaha, NE, 1922-26; Kansas City, MO, 1926-31; Omaha, NE, 1931-41

Constituted in the Organized Reserve on 29 July 1921 as the 325th Balloon Company, assigned to the 47th Balloon Group (redesignated as the 547th Balloon Group on 20 February 1924), and allotted to the Seventh Corps Area. Initiated in February 1922 at Omaha, NE. Relocated on 26 May 1926 to Kansas City, MO. Relocated on 12 October 1931 to Omaha, NE. Redesignated as the 325th Balloon Squadron on 1 October 1933. Conducted annual summer training at Scott Field, IL, 1922-40. Location 7 December 1941—Omaha, NE.

Status: Disbanded on 31 May 1942.

326th Balloon Company (547th Balloon Group)

Organized Reserve Nebraska/Missouri

HQ-Not initiated 1921-22; Lincoln, NE, 1922-26; St. Joseph, MO, 1926-31; Omaha, NE, 1931-41

Constituted in the Organized Reserve on 29 July 1921 as the 325th Balloon Company, assigned to the 47th Balloon Group (redesignated as the 547th Balloon Group on 20 February 1924), and allotted to the Seventh Corps Area. Initiated in February 1922 at Lincoln, NE. Relocated on 26 May 1926 to St. Joseph, MO. Relocated on 12 October 1931 to Omaha, NE. Redesignated as the 326th Balloon Squadron on 1 October 1933. Conducted annual summer training at Scott Field, IL, 1922-40. Location 7 December 1941—Omaha, NE.

Status: Disbanded on 31 May 1942.

327th Balloon Company (547th Balloon Group)

Organized Reserve Missouri

HQ-Not initiated 1921-22; St. Louis, MO, 1922-41

Constituted in the Organized Reserve on 29 July 1921 as the 327th Balloon Company, assigned to the 47th Balloon Group (redesignated as the 547th Balloon Group on 20 February 1924), and allotted to the Seventh Corps Area. Initiated in March 1922 at St. Louis, MO. Redesignated as the 327th Balloon Squadron on 1 October 1933. Conducted annual summer training at Scott Field, IL, 1922-40. Location 7 December 1941—St. Louis, MO.

Status: Disbanded on 31 May 1942.

328th Balloon Company (547th Balloon Group)

Organized Reserve Kansas/Missouri/Iowa

HQ-Not initiated 1921-22; Leavenworth, KS, 1922-26; Kansas City, MO, 1926-31; Des Moines, IA, 1931-41

Constituted in the Organized Reserve on 29 July 1921 as the 328th Balloon Company, assigned to the 47th Balloon Group (redesignated as the 547th Balloon Group on 20 February 1924), and allotted to the Seventh Corps Area. Initiated in April 1922 at Leavenworth, KS. Relocated on 26 May 1926 to Kansas City, MO. Relocated on 12 October 1931 to Des Moines, IA. Redesignated as the 328th Balloon Squadron on 1 October 1933. Conducted annual summer training at Scott Field, IL, 1922-40. Location 7 December 1941—Des Moines, IA.

Status: Disbanded on 31 May 1942.

329th Balloon Company (548th Balloon Group)

Organized Reserve Oklahoma/Texas

HQ-Not initiated 1921-22; Hamilton, TX, 1922-41

Constituted in the Organized Reserve on 29 July 1921 as the 329th Balloon Company, assigned to the 48th Balloon Group (redesignated as the 548th Balloon Group on 20 February 1924), and allotted to the Eighth Corps Area. Oklahoma City, OK, designated as headquarters on organization, but the unit was never organized at that location. Initiated in October 1922 at Hamilton, TX. Redesignated as the 329th Balloon Squadron on 1 October 1933. Location 7 December 1941—Hamilton, TX.

Status: Disbanded on 31 May 1942.

330th Balloon Company (548th Balloon Group)

Organized Reserve Texas

HQ-Not initiated 1921-22; Gatesville, TX, 1922-41

Constituted in the Organized Reserve on 29 July 1921 as the 330th Balloon Company, assigned to the 48th Balloon Group (redesignated as the 548th Balloon Group on 20 February 1924), and allotted to the Eighth Corps Area. Initiated on 5 September 1922 at Gatesville, TX. Redesignated as the 330th Balloon Squadron on 1 October 1933. Location 7 December 1941—Gatesville, TX.

Status: Disbanded on 31 May 1942.

331st Balloon Company (548th Balloon Group)

Organized Reserve Texas

HQ-Not initiated 1921-22; McGregor, TX, 1922-41

Constituted in the Organized Reserve on 29 July 1921 as the 331st Balloon Company, assigned to the 48th Balloon Group (redesignated as the 548th Balloon Group on 20 February 1924), and allotted to the Eighth Corps Area. Initiated in November 1922 at McGregor, TX. Redesignated as the 331st Balloon Squadron on 1 October 1933. Location 7 December 1941—McGregor, TX.

Status: Disbanded on 31 May 1942.

332nd Balloon Company (548th Balloon Group)

Organized Reserve Texas

HQ-Not initiated 1921-23; Taylor, TX, 1923-33

Constituted in the Organized Reserve on 29 July 1921 as the 332nd Balloon Company, assigned to the 48th Balloon Group (redesignated as the 548th Balloon Group on 20 February 1924), and allotted to the Eighth Corps Area. Initiated on 6 January 1923 at Taylor, TX. Demobilized on 1 October 1933.

333rd Balloon Company (549th Balloon Group)

Organized Reserve California

HQ-Not initiated 1921-22; San Francisco, CA, 1922-30; Los Angeles, CA, 1930-37; *Inactive* 1937-39; Los Angeles, CA, 1939-41

Constituted in the Organized Reserve on 29 July 1921 as the 333rd Balloon Company, assigned to the 49th Balloon Group (redesignated as the 549th Balloon Group on 20 February 1924), and allotted to the Ninth Corps Area. Initiated in February 1922 at San Francisco, CA. Relocated on 28 January 1930 to Los Angeles, CA. Redesignated as the 333rd Balloon Squadron on 1 October 1933. Inactivated on 2 September 1937 by relief of assigned personnel. Reorganized by August 1939 at Los Angeles. Conducted annual summer training at Ross Field, CA. Location 7 December 1941—Los Angeles, CA.

Status: Disbanded on 31 May 1942.

334th Balloon Company (549th Balloon Group)

Organized Reserve California

HQ-Not initiated 1921-22; San Francisco, CA, 1922-30; Los Angeles, CA, 1930-40; *Inactive* 1940-41

Constituted in the Organized Reserve on 29 July 1921 as the 334th Balloon Company, assigned to the 49th Balloon Group (redesignated as the 549th Balloon Group on 20 February 1924), and allotted to the Ninth Corps Area. Initiated in February 1922 at San Francisco, CA. Relocated on 28 January 1930 to Los Angeles, CA. Redesignated as the 334th Balloon Squadron on 1 October 1933. Inactivated on 30 July 1940 at Los Angeles by relief of personnel. Conducted annual summer training at Ross Field, CA. Location 7 December 1941—*Inactive*.

Status: Disbanded on 31 May 1942.

335th Balloon Company (549th Balloon Group)**Organized Reserve California**

HQ-*Not initiated* 1921-22; Los Angeles, CA, 1922-28; *Inactive* 1928-39; Los Angeles, CA, 1939-41

Constituted in the Organized Reserve on 29 July 1921 as the 335th Balloon Company, assigned to the 49th Balloon Group (redesignated as the 549th Balloon Group on 20 February 1924), and allotted to the Ninth Corps Area. Initiated in February 1922 at Los Angeles, CA. Inactivated on 1 September 1928 at Los Angeles by relief of personnel. Redesignated as the 335th Balloon Squadron on 1 October 1933. Reorganized by August 1939 at Los Angeles. Conducted annual summer training at Ross Field, CA. Location 7 December 1941—Los Angeles, CA.

Status: Disbanded on 31 May 1942.

336th Balloon Company (549th Balloon Group)**Organized Reserve California**

HQ-Los Angeles, CA, 1921-28; *Inactive* 1928-33

Constituted in the Organized Reserve on 29 July 1921 as the 336th Balloon Company, assigned to the 49th Balloon Group (redesignated as the 549th Balloon Group on 20 February 1924), and allotted to the Ninth Corps Area. Initiated in April 1922 at Los Angeles, CA. Inactivated on 1 September 1928 at Los Angeles by relief of personnel. Conducted annual summer training at Ross Field, CA. Demobilized on 1 October 1933.

337th Balloon Company (550th Balloon Group)**Organized Reserve New York**

HQ-*Not initiated* 1921-22; Plattsburg, NY, 1922-29; *Inactive* 1929-41

Constituted in the Organized Reserve on 29 July 1921 as the 337th Balloon Company, assigned to the 50th Balloon Group (redesignated as the 550th Balloon Group on 20 February 1924), and allotted to the Second Corps Area. Initiated in November 1922 at Plattsburg, NY. Inactivated in June 1929 at Plattsburg by relief of personnel. Redesignated as the 337th Balloon Squadron on 1 October 1933. Location 7 December 1941—*Inactive*.

Status: Disbanded on 31 May 1942.

338th Balloon Service Company (541st Balloon Group)**Organized Reserve Maine**

HQ-Auburn, ME, 1921-27; New Haven, CT, 1927-34; *Inactive* 1934-41

Constituted in the Organized Reserve on 29 July 1921 as Balloon Park No. 31, assigned to the 41st Balloon Group (redesignated as the 541st Balloon Group on 20 February 1924), and allotted to the First Corps Area. Initiated in November 1921 at Auburn, ME. Redesignated as the 338th Balloon Service Company on 25 January 1923. Relocated on 29 January 1927 to New Haven, CT. Redesignated as the 338th Service Squadron, Balloon Group on 1 October 1933. Inactivated by June 1934 at New Haven by relief of personnel. Location 7 December 1941—*Inactive*.

Status: Disbanded on 31 May 1942.

339th Balloon Service Company (542nd Balloon Group)**Organized Reserve New York**

HQ-Buffalo, NY, 1921-41

Constituted in the Organized Reserve on 29 July 1921 as Balloon Park No. 32, assigned to the 42nd Balloon Group (redesignated as the 542nd Balloon Group on 20 February 1924), and allotted to the Second Corps Area. Initiated on 4 November 1921 at Buffalo, NY. Redesignated as the 339th Balloon Service Company on 25 January 1923. Redesignated as the 339th Service Squadron, Balloon Group on 1 October 1933. Location 7 December 1941—Buffalo, NY.

Status: Disbanded on 31 May 1942.

340th Balloon Service Company (543rd Balloon Group)**Organized Reserve Pennsylvania**

HQ—*Not initiated* 1921-22; Pittsburgh, PA, 1922-32; *Inactive* 1932-41

Constituted in the Organized Reserve on 29 July 1921 as Balloon Park No. 33, assigned to the 43rd Balloon Group (redesignated as the 543rd Balloon Group on 20 February 1924), and allotted to the Third Corps Area. Initiated in September 1922 at Pittsburgh, PA. Redesignated as the 340th Balloon Service Company on 25 January 1923. Inactivated about by June 1932 at Pittsburgh by relief of personnel. Redesignated as the 340th Service Squadron, Balloon Group on 1 October 1933. Location 7 December 1941—*Inactive*.

Status: Disbanded on 31 May 1942.

341st Balloon Service Company (544th Balloon Group)**Organized Reserve South Carolina**

HQ—*Not initiated* 1921-22; Charleston, SC, 1922-29; Spartanburg, SC, 1929-32; *Inactive* 1932-41

Constituted in the Organized Reserve on 29 July 1921 as Balloon Park No. 34, assigned to the 44th Balloon Group (redesignated as the 544th Balloon Group on 20 February 1924), and allotted to the Fourth Corps Area. Initiated on 25 April 1922 at Charleston, SC. Redesignated as the 341st Balloon Service Company on 25 January 1923. Relocated on 22 October 1929 to Spartanburg, SC. Inactivated about by June 1932 at Spartanburg by relief of personnel. Redesignated as the 341st Service Squadron, Balloon Group on 1 October 1933. Designated mobilization station was Camp Joseph E. Johnston, FL, (later redesignated Camp J. Clifford R. Foster). Location 7 December 1941—*Inactive*.

Status: Disbanded on 31 May 1942.

342nd Balloon Service Company (545th Balloon Group)**Organized Reserve Kentucky**

HQ—*Not initiated* 1921-22; Louisville, KY, 1922-34; *Inactive* 1934-41

Constituted in the Organized Reserve on 29 July 1921 as Balloon Park No. 35, assigned to the 45th Balloon Group (redesignated as the 545th Balloon Group on 20 February 1924), and allotted to the Fifth Corps Area. Initiated in January 1922 at Louisville, KY. Redesignated as the 342nd Balloon Service Company on 25 January 1923. Redesignated as the 342nd Service Squadron, Balloon Group on 1 October 1933. Inactivated by June 1934 at Louisville by relief of personnel. Location 7 December 1941—*Inactive*.

Status: Disbanded on 31 May 1942.

343rd Balloon Service Company (546th Balloon Group)**Organized Reserve Wisconsin**

HQ—*Not initiated* 1921-22; Oshkosh, WI, 1922-25; Appleton, WI, 1925-32; *Inactive* 1932-41

Constituted in the Organized Reserve on 29 July 1921 as Balloon Park No. 36, assigned to the 46th Balloon Group (redesignated as the 546th Balloon Group on 20 February 1924), and allotted to the Sixth Corps Area. Initiated in November 1922 at Oshkosh, WI. Relocated on 2 June 1925 to Appleton, WI. Redesignated as the 343rd Balloon Service Company on 25 January 1923. Inactivated by June 1932 at Appleton by relief of personnel. Redesignated as the 343rd Service Squadron, Balloon Group on 1 October 1933. Location 7 December 1941—*Inactive*.

Status: Disbanded on 31 May 1942.

344th Balloon Service Company (547th Balloon Group)**Organized Reserve Missouri**

HQ—*Not initiated* 1921-22; St. Louis, MO, 1922-41

Constituted in the Organized Reserve on 29 July 1921 as Balloon Park No. 37, assigned to the 47th Balloon Group (redesignated as the 547th Balloon Group on 20 February 1924), and allotted to the Seventh Corps Area. Initiated in March 1922 at St. Louis, MO. Redesignated as the 344th Balloon Service Company on 25 January 1923. Redesignated as the 344th Service Squadron, Balloon Group on 1 October 1933. Location 7 December 1941—St. Louis, MO.

Status: Disbanded on 31 May 1942.

345th Balloon Service Company (548th Balloon Group)

Organized Reserve Texas

HQ-*Not initiated* 1921-22; Austin, TX, 1922-25; Bartlett, TX, 1925-41

Constituted in the Organized Reserve on 29 July 1921 as Balloon Park No. 38, assigned to the 48th Balloon Group (redesignated as the 548th Balloon Group on 20 February 1924), and allotted to the Eighth Corps Area. Initiated in October 1922 at Austin, TX. Redesignated as the 345th Balloon Service Company on 25 January 1923. Relocated on 15 April 1925 to Bartlett, TX. Redesignated as the 345th Service Squadron, Balloon Group on 1 October 1933. Location 7 December 1941—Bartlett, TX.

Status: Disbanded on 31 May 1942.

346th Balloon Service Company (549th Balloon Group)

Organized Reserve California

HQ-*Not initiated* 1921-22; Los Angeles, CA, 1922-37; *Inactive* 1937-41

Constituted in the Organized Reserve on 29 July 1921 as Balloon Park No. 39, assigned to the 49th Balloon Group (redesignated as the 549th Balloon Group on 20 February 1924), and allotted to the Ninth Corps Area. Initiated on 26 August 1922 at Los Angeles, CA. Redesignated as the 346th Balloon Service Company on 25 January 1923. Redesignated as the 346th Service Squadron, Balloon Group on 1 October 1933. Inactivated on 16 February 1937 at Los Angeles by relief of personnel. Conducted annual summer training at Ross Field, CA. Designated mobilization training station was Pope Field, NC. Location 7 December 1941—*Inactive*.

Status: Disbanded on 31 May 1942.

347th Balloon Service Company (550th Balloon Group)

Organized Reserve New York

HQ-*Not initiated* 1921-22; Rochester, NY, 1922-41

Constituted in the Organized Reserve on 29 July 1921 as Balloon Park No. 40, assigned to the 50th Balloon Group (redesignated as the 550th Balloon Group on 20 February 1924), and allotted to the Second Corps Area. Initiated in 1922 at Rochester, NY. Redesignated as the 347th Balloon Service Company on 25 January 1923. Redesignated as the 347th Service Squadron, Balloon Group on 1 October 1933. Location 7 December 1941—Rochester, NY.

Status: Disbanded on 31 May 1942.

348th Balloon Service Company (561st Balloon Group)

Organized Reserve Connecticut

HQ-New Haven, CT, 1921-27; *Inactive* 1927-33

Constituted in the Organized Reserve on 29 July 1921 as Balloon Park No. 51, assigned to the 61st Balloon Group (redesignated as the 561st Balloon Group on 20 February 1924), and allotted to the First Corps Area. Redesignated as the 348th Balloon Service Company on 25 January 1923. Initiated in April 1923 at New Haven, CT. Withdrawn from the First Corps Area on 11 January 1927 and allotted to the Fifth Corps Area. Inactivated on 1 February 1927 at New Haven by relief of personnel. Demobilized on 1 October 1933.

349th Balloon Service Company (562nd Balloon Group)

Organized Reserve New York

HQ-*Not initiated* 1921-22; Rochester, NY, 1922-41

Constituted in the Organized Reserve on 29 July 1921 as Balloon Park No. 52, assigned to the 62nd Balloon Group (redesignated as the 562nd Balloon Group on 20 February 1924), and allotted to the Second Corps Area. Initiated on 2 June 1922 at Rochester, NY. Redesignated as the 349th Balloon Service Company on 25 January 1923. Redesignated as the 349th Service Squadron, Balloon Group on 1 October 1933. Location 7 December 1941—Rochester, NY.

Status: Disbanded on 31 May 1942.

350th Balloon Service Company (563rd Balloon Group)

Organized Reserve Pennsylvania

HQ-*Not initiated* 1921-22; Philadelphia, PA, 1922-41

Constituted in the Organized Reserve on 29 July 1921 as Balloon Park No. 53, assigned to the 63rd Balloon Group (redesignated as the 563rd Balloon Group on 20 February 1924), and allotted to the Third Corps Area. Initiated in September 1922 at Philadelphia, PA. Redesignated as the 350th Balloon Service Company on 25 January 1923. Redesignated as the 350th Service Squadron, Balloon Group on 1 October 1933. Location 7 December 1941—Philadelphia, PA.

Status: Disbanded on 31 May 1942.

351st Balloon Company (561st Balloon Group)

Organized Reserve Massachusetts/Indiana

HQ-*Not initiated* 1921-23; Boston, MA, 1923-27; Lafayette, IN, 1927-30; *Inactive* 1930-41

Constituted in the Organized Reserve on 29 July 1921 as the 351st Balloon Company, assigned to the 61st Balloon Group (redesignated as the 561st Balloon Group on 20 February 1924), and allotted to the First Corps Area. Initiated in January 1923 at Boston, MA. Withdrawn from the First Corps Area on 11 January 1927 and allotted to the Fifth Corps Area. Inactivated on 1 February 1927 at Boston by relief of personnel. Reorganized by December 1927 at Lafayette, IN. Redesignated as the 351st Balloon Squadron on 1 October 1933. Inactivated by March 1930 at Lafayette by relief of personnel. Location 7 December 1941—*Inactive*.

Status: Disbanded on 31 May 1942.

352nd Balloon Company (561st Balloon Group)

Organized Reserve Massachusetts/Ohio

HQ-Boston, MA, 1921-27; Dayton, OH, 1927-30; *Inactive* 1930-41

Constituted in the Organized Reserve on 29 July 1921 as the 352nd Balloon Company, assigned to the 61st Balloon Group (redesignated as the 561st Balloon Group on 20 February 1924), and allotted to the First Corps Area. Initiated on 2 November 1921 at Boston, MA. Withdrawn from the First Corps Area on 11 January 1927 and allotted to the Fifth Corps Area. Inactivated on 1 February 1927 at Boston by relief of personnel. Reorganized by December 1927 at Dayton, OH. Inactivated by March 1930 at Dayton by relief of personnel. Redesignated as the 352nd Balloon Squadron on 1 October 1933. Location 7 December 1941—*Inactive*.

Status: Disbanded on 31 May 1942.

353rd Balloon Company (561st Balloon Group)

Organized Reserve Connecticut/Kentucky

HQ-*Not initiated* 1921-22; New Haven, CT, 1922-27; Bowling Green, KY, 1927-30; *Inactive* 1930-41

Constituted in the Organized Reserve on 29 July 1921 as the 353rd Balloon Company, assigned to the 61st Balloon Group (redesignated as the 561st Balloon Group on 20 February 1924), and allotted to the First Corps Area. Initiated on 5 May 1922 at New Haven, CT. Withdrawn from the First Corps Area on 11 January 1927 and allotted to the Fifth Corps Area. Inactivated on 1 February 1927 at New Haven by relief of personnel. Reorganized by December 1927 at Bowling Green, KY. Inactivated by March 1930 at Bowling Green by relief of personnel. Location 7 December 1941—*Inactive*.

Status: Disbanded on 31 May 1942.

354th Balloon Company (561st Balloon Group)

Organized Reserve Connecticut

HQ-*Not initiated* 1921-22; New London, CT, 1922-27; *Inactive* 1927-33

Constituted in the Organized Reserve on 29 July 1921 as the 354th Balloon Company, assigned to the 61st Balloon Group (redesignated as the 561st Balloon Group on 20 February 1924) allotted to the First Corps Area. Initiated on 5 May 1922 at New London, CT. Withdrawn from the First Corps Area on 11 January 1927 and allotted to the Fifth Corps Area. Inactivated on 1 February 1927 at New London by relief of personnel. Demobilized on 1 October 1933.

355th Balloon Company (562nd Balloon Group)

Organized Reserve New Jersey

HQ-Trenton, NJ, 1921-28; *Inactive* 1928-41

Constituted in the Organized Reserve on 29 July 1921 as the 355th Balloon Company, assigned to the 62nd Balloon Group (redesignated as the 562nd Balloon Group on 20 February 1924), and allotted to the Second Corps Area. Initiated on 3 March 1922 at Trenton, NJ. Redesignated as the 355th Balloon Squadron on 1 October 1933. Inactivated about June 1928 at Trenton by relief of personnel. Location 7 December 1941—*Inactive*.

Status: Disbanded on 31 May 1942.

356th Balloon Company (562nd Balloon Group)

Organized Reserve New York

HQ-Rochester, NY, 1921-28; *Inactive* 1928-41

Constituted in the Organized Reserve on 29 July 1921 as the 356th Balloon Company, assigned to 62nd Balloon Group (redesignated as the 562nd Balloon Group on 20 February 1924) allotted to the Second Corps Area. Initiated on 2 June 1922 at Rochester, NY. Inactivated about June 1928 at Rochester by relief of personnel. Redesignated as the 356th Balloon Squadron on 1 October 1933. Location 7 December 1941—*Inactive*.

Status: Disbanded on 31 May 1942.

357th Balloon Company (562nd Balloon Group)

Organized Reserve Pennsylvania

HQ-*Not initiated* 1921-22; Philadelphia, PA, 1922-26; *Inactive* 1926-41

Constituted in the Organized Reserve on 29 July 1921 as the 357th Balloon Company, assigned to the 62nd Balloon Group (redesignated as the 562nd Balloon Group on 20 February 1924), and allotted to the Third Corps Area. Initiated on 8 November 1921 at Philadelphia, PA. Inactivated on 3 December 1926 at Philadelphia by relief of personnel. Redesignated as the 357th Balloon Squadron on 1 October 1933. Location 7 December 1941—*Inactive*.

Status: Disbanded on 31 May 1942.

358th Balloon Company (562nd Balloon Group)

Organized Reserve Pennsylvania

HQ-*Not initiated* 1921-22; Philadelphia, PA, 1922-28; *Inactive* 1928-33

Constituted in the Organized Reserve on 29 July 1921 as the 358th Balloon Company, assigned to the 62nd Balloon Group (redesignated as the 562nd Balloon Group on 20 February 1924), and allotted to the Third Corps Area. Initiated on 2 March 1922 at Philadelphia, PA. Inactivated about May 1928 at Philadelphia by relief of personnel. Demobilized on 1 October 1933.

359th Balloon Company (563rd Balloon Group)

Organized Reserve South Carolina

HQ-*Not initiated* 1921-22; Charleston, SC, 1922-29; *Inactive* 1929-41

Constituted in the Organized Reserve on 29 July 1921 as the 359th Balloon Company, assigned to the 63rd Balloon Group (redesignated as the 563rd Balloon Group on 20 February 1924), and allotted to the Fourth Corps Area. Initiated on 25 April 1922 at Charleston, SC. Inactivated on 19 September 1929 by relief of assigned personnel. Redesignated as the 359th Balloon Squadron on 1 October 1933. Tampa, FL, designated on 29 January 1935 as headquarters on reorganization, but the unit was never organized at that location. Designated mobilization training station was Camp Joseph E. Johnston, FL, (later redesignated Camp J. Clifford R. Foster). Location 7 December 1941—*Inactive*.

Status: Disbanded on 31 May 1942.

360th Balloon Company (563rd Balloon Group)

Organized Reserve Florida

HQ-*Not initiated* 1921-22; Pensacola, FL, 1922-29; *Inactive* 1929-33

Constituted in the Organized Reserve on 29 July 1921 as the 360th Balloon Company, assigned to the 63rd Balloon Group (redesignated as the 563rd Balloon Group on 20 February 1924), and allotted to the Fourth Corps Area. Initiated on 18 April 1922 at Pensacola, FL. Inactivated on 19 September 1929 by relief of assigned personnel. Designated mobilization training station was Camp Joseph E. Johnston, FL, (later redesignated Camp J. Clifford R. Foster). Demobilized on 1 October 1933.

361st Balloon Company (564th Balloon Group)

Organized Reserve Ohio

HQ-*Not initiated* 1921-22; Akron, OH, 1922-30; *Inactive* 1930-33

Constituted in the Organized Reserve on 29 July 1921 as the 361st Balloon Company, assigned to the 64th Balloon Group (redesignated as the 564th Balloon Group on 20 February 1924), and allotted to the Fifth Corps Area. Initiated in April 1922 at Akron, OH. Inactivated by March 1930 at Akron by relief of personnel. Demobilized on 1 October 1933.

362nd Balloon Company (564th Balloon Group)

Organized Reserve Ohio

HQ-*Not initiated* 1921-22; Akron, OH, 1922-30; *Inactive* 1930-33

Constituted in the Organized Reserve on 29 July 1921 as the 362nd Balloon Company, assigned to the 64th Balloon Group (redesignated as the 564th Balloon Group on 20 February 1924), and allotted to the Fifth Corps Area. Initiated in May 1924 at Akron, OH. Inactivated by March 1930 at Akron by relief of personnel. Conducted annual summer training at Scott Field, IL. Demobilized on 1 October 1933.

363rd Balloon Company (564th Balloon Group)

Organized Reserve West Virginia

HQ-*Not initiated* 1921-22; Wheeling, WV 1922-30; *Inactive* 1930-33

Constituted in the Organized Reserve on 29 July 1921 as the 363rd Balloon Company, assigned to the 64th Balloon Group (redesignated as the 564th Balloon Group on 20 February 1924), and allotted to the Fifth Corps Area. Initiated in 1922 at Wheeling, WV. Inactivated by March 1930 at Wheeling by relief of personnel. Conducted annual summer training at Langley Field, VA. Demobilized on 1 October 1933.

364th Balloon Company (564th Balloon Group)

Organized Reserve West Virginia

HQ-*Not initiated* 1921-22; Charleston, WV 1922-30; *Inactive* 1930-33

Constituted in the Organized Reserve on 29 July 1921 as the 364th Balloon Company, assigned to the 64th Balloon Group (redesignated as the 564th Balloon Group on 20 February 1924), and allotted to the Fifth Corps Area. Initiated in April 1922 at Charleston, WV. Inactivated by March 1930 at Charleston by relief of personnel. Demobilized on 1 October 1933.

365th Balloon Company (565th Balloon Group)

Organized Reserve Michigan

HQ—*Not initiated* 1921-22; Grand Rapids, MI, 1922-29; *Inactive* 1929-38; Detroit, MI, 1938-41

Constituted in the Organized Reserve on 29 July 1921 as the 365th Balloon Company, assigned to the 65th Balloon Group (redesignated as the 565th Balloon Group on 20 February 1924), and allotted to the Sixth Corps Area. Initiated on 6 June 1922 at Grand Rapids, MI. Inactivated on 1 December 1929 at Grand Rapids by relief of personnel. Redesignated as the 365th Balloon Squadron on 1 October 1933. Reorganized about January 1938 at Detroit, MI. Conducted annual summer training at Scott Field, IL, 1922-29. Location 7 December 1941—Detroit, MI.

Status: Disbanded on 31 May 1942.

366th Balloon Company (565th Balloon Group)

Organized Reserve Illinois

HQ—*Not initiated* 1921-22; Belleville, IL, 1922-29; *Inactive* 1929-38; Detroit, MI, 1938-41

Constituted in the Organized Reserve on 29 July 1921 as the 366th Balloon Company, assigned to the 65th Balloon Group (redesignated as the 565th Balloon Group on 20 February 1924), and allotted to the Sixth Corps Area. Initiated in 1922 at Belleville, IL. Inactivated by June 1929 at Belleville by relief of personnel. Redesignated as the 366th Balloon Squadron on 1 October 1933. Reorganized about January 1938 at Detroit, MI. Conducted annual summer training at Scott Field, IL, 1922-40. Location 7 December 1941—Detroit, MI.

Status: Disbanded on 31 May 1942.

367th Balloon Company (565th Balloon Group)

Organized Reserve Michigan

HQ—*Not initiated* 1921-22; Bay City, MI, 1922-25; Saginaw, MI, 1925-29; *Inactive* 1929-41

Constituted in the Organized Reserve on 29 July 1921 as the 367th Balloon Company, assigned to the 65th Balloon Group (redesignated as the 565th Balloon Group on 20 February 1924), and allotted to the Sixth Corps Area. Initiated in September 1922 at Bay City, MI. Relocated on 2 June 1925 to Saginaw, MI. Inactivated by June 1929 at Saginaw by relief of personnel. Redesignated as the 367th Balloon Squadron on 1 October 1933. Withdrawn from the Sixth Corps Area on 1 January 1938 and allotted to the First Corps Area. Conducted annual summer training at Scott Field, IL, 1922-29. Location 7 December 1941—*Inactive*.

Status: Disbanded on 31 May 1942.

368th Balloon Company (565th Balloon Group)

Organized Reserve Illinois

HQ—*Not initiated* 1921-22; Chicago, IL, 1922-35; *Inactive* 1935-41

Constituted in the Organized Reserve on 29 July 1921 as the 368th Balloon Company, assigned to 65th Balloon Group (redesignated as the 565th Balloon Group on 20 February 1924), and allotted to the Sixth Corps Area. Initiated on 21 January 1922 at Chicago, IL. Redesignated as the 368th Balloon Squadron on 1 October 1933. Conducted annual summer training at Scott Field, IL. Inactivated by June 1935 at Chicago by relief of personnel. Location 7 December 1941—*Inactive*.

Status: Disbanded on 31 May 1942.

369th Balloon Company (566th Balloon Group)

Organized Reserve Missouri

HQ-Not initiated 1921-22; St. Joseph, MO, 1922-41

Constituted in the Organized Reserve on 29 July 1921 as the 369th Balloon Company, assigned to the 66th Balloon Group (redesignated as the 566th Balloon Group on 20 February 1924), and allotted to the Seventh Corps Area. Initiated in February 1922 at St. Joseph, MO. Redesignated as the 369th Balloon Squadron on 1 October 1933. Conducted annual summer training at Scott Field, IL. Location 7 December 1941—St. Joseph, MO.

Status: Disbanded on 31 May 1942.

370th Balloon Company (566th Balloon Group)

Organized Reserve Missouri

HQ-Not initiated 1921-22; St. Joseph, MO, 1922-26; Kansas City, MO, 1926-41

Constituted in the Organized Reserve on 29 July 1921 as the 370th Balloon Company, assigned to the 66th Balloon Group (redesignated as the 566th Balloon Group on 20 February 1924), and allotted to the Seventh Corps Area. Initiated in February 1922 at St. Joseph, MO. Relocated on 26 May 1926 to Kansas City, MO. Redesignated as the 370th Balloon Squadron on 1 October 1933. Conducted annual summer training at Scott Field, IL. Location 7 December 1941—Kansas City, MO.

Status: Disbanded on 31 May 1942.

371st Balloon Company (566th Balloon Group)

Organized Reserve Iowa

HQ-Not initiated 1921-22; Council Bluffs, IA, 1922-33

Constituted in the Organized Reserve on 29 July 1921 as the 371st Balloon Company, assigned to the 66th Balloon Group (redesignated as the 566th Balloon Group on 20 February 1924), and allotted to the Seventh Corps Area. Initiated in August 1922 at Council Bluffs, IA. Conducted annual summer training at Scott Field, IL. Demobilized on 1 October 1933.

372nd Balloon Company (566th Balloon Group)

Organized Reserve Iowa

HQ-Not initiated 1921-22; Cedar Rapids, IA, 1922-33

Constituted in the Organized Reserve on 29 July 1921 as the 372nd Balloon Company, assigned to the 66th Balloon Group (redesignated as the 566th Balloon Group on 20 February 1924), and allotted to the Seventh Corps Area. Initiated in July 1922 at Cedar Rapids, IA. Conducted annual summer training at Scott Field, IL. Demobilized on 1 October 1933.

373rd Balloon Company (567th Balloon Group)

Organized Reserve Texas/Oregon

HQ-Not initiated 1921-25; Portland, OR, 1925-33

Constituted in the Organized Reserve on 29 July 1921 as the 373rd Balloon Company, assigned to the 67th Balloon Group (redesignated as the 567th Balloon Group on 20 February 1924), and allotted to the Eighth Corps Area. Galveston, TX, designated as headquarters on organization, but the unit was never organized at that location. Withdrawn from the Eighth Corps Area on 31 March 1924 and allotted to the Ninth Corps Area. Initiated in November 1925 at Portland, OR. Conducted annual summer training at Ross Field, CA. Demobilized on 1 October 1933.

374th Balloon Company (567th Balloon Group)

Organized Reserve Texas/Oregon

HQ-*Not initiated* 1921-23; Beaumont, TX, 1923-24; *Inactive* 1924-25; Portland, OR, 1925-28; *Inactive* 1928-33

Constituted in the Organized Reserve on 29 July 1921 as the 374th Balloon Company, assigned to the 67th Balloon Group (redesignated as the 567th Balloon Group on 20 February 1924), and allotted to the Eighth Corps Area. Initiated on 12 March 1923 at Beaumont, TX. Withdrawn from the Eighth Corps Area on 31 March 1924 and allotted to the Ninth Corps Area. Reorganized in November 1925 at Portland, OR. Inactivated on 1 September 1928 at Portland by relief of personnel. Conducted annual summer training at Ross Field, CA. Demobilized on 1 October 1933.

375th Balloon Company (567th Balloon Group)

Organized Reserve Oregon

HQ-*Not initiated* 1921-22; Portland, OR, 1922-28; *Inactive* 1928-33

Constituted in the Organized Reserve on 29 July 1921 as the 375th Balloon Company, assigned to 67th Balloon Group (redesignated as the 567th Balloon Group on 20 February 1924), and allotted to the Ninth Corps Area. Initiated in May 1922 at Portland, OR. Inactivated on 1 September 1928 at Portland by relief of personnel. Conducted annual summer training at Ross Field, CA. Demobilized on 1 October 1933.

376th Balloon Company (567th Balloon Group)

Organized Reserve Oregon/Washington

HQ-*Not initiated* 1921-22; Portland, OR, 1922-28; *Inactive* 1928-33

Constituted in the Organized Reserve on 29 July 1921 as the 375th Balloon Company, assigned to the 67th Balloon Group (redesignated as the 567th Balloon Group on 20 February 1924), and allotted to the Ninth Corps Area. Initiated in May 1922 at Portland, OR. Inactivated on 1 September 1928 at Portland by relief of personnel. Seattle WA, designated in April 1930 as headquarters on reorganization, but the unit was never organized at that location. Conducted annual summer training at Ross Field, CA. Demobilized on 1 October 1933.

377th Airship Company (344th Airship Group)

Organized Reserve Massachusetts

HQ-*Not initiated* 1921-22; Boston, MA, 1922-27; *Inactive* 1927-33

Constituted in the Organized Reserve on 29 July 1921 as the 377th Airship Company, assigned to the General Headquarters Reserve and allotted to the First Corps Area. Initiated in 1922 at Boston, MA. Assigned on 31 March 1924 to the 344th Airship Group. Withdrawn from the First Corps Area on 11 January 1927 and allotted to the Fifth Corps Area. Demobilized on 1 October 1933.

378th Airship Company (344th Airship Group)

Organized Reserve New York

HQ-*Not initiated* 1921-22; Mineola, L.I., NY, 1922-33

Constituted in the Organized Reserve on 29 July 1921 as the 378th Airship Company, assigned to the General Headquarters Reserve and allotted to the Second Corps Area. Initiated on 2 June 1922 at Mineola, L.I., NY.

Assigned 31 March 1924 to the 344th Airship Group. Demobilized on 1 October 1933.

379th Airship Company (342nd Airship Group)

Organized Reserve Pennsylvania

HQ-Philadelphia, PA, 1921-33

Constituted in the Organized Reserve on 29 July 1921 as the 379th Airship Company, assigned to the General Headquarters Reserve and allotted to the Third Corps Area. Initiated on 8 November 1921 at Philadelphia, PA. Assigned on 31 March 1924 to the 342nd Airship Group. Demobilized on 1 October 1933.

380th Airship Company (342nd Airship Group)

Organized Reserve Pennsylvania

HQ-Philadelphia, PA, 1921-33

Constituted in the Organized Reserve on 29 July 1921 as the 380th Airship Company, assigned to the General Headquarters Reserve and allotted to the Third Corps Area. Initiated on 8 November 1921 at Philadelphia, PA. Assigned on 31 March 1924 to the 342nd Airship Group. Demobilized on 1 October 1933.

381st Airship Company (342nd Airship Group)

Organized Reserve Pennsylvania

HQ-Philadelphia, PA, 1921-28; *Inactive* 1928-33

Constituted in the Organized Reserve on 29 July 1921 as the 381st Airship Company, assigned to the General Headquarters Reserve and allotted to the Third Corps Area. Initiated on 12 November 1921 at Philadelphia, PA. Assigned on 31 March 1924 to the 342nd Airship . Inactivated about May 1928 at Philadelphia by relief of personnel. Demobilized on 1 October 1933.

382nd Airship Company (342nd Airship Group)

Organized Reserve Pennsylvania

HQ-*Not initiated* 1921-22; Philadelphia, PA, 1922-29; *Inactive* 1929-33

Constituted in the Organized Reserve on 29 July 1921 as the 382nd Airship Company, assigned to the General Headquarters Reserve and allotted to the Third Corps Area. Initiated in September 1922 at Philadelphia, PA. Assigned on 31 March 1924 to the 342nd Airship Group. Inactivated by July 1929 at Philadelphia by relief of personnel. Demobilized on 1 October 1933.

383rd Airship Company (344th Airship Group)

Organized Reserve Georgia

HQ-*Not initiated* 1921-22; Atlanta, GA, 1922-33

Constituted in the Organized Reserve on 29 July 1921 as the 383rd Airship Company, assigned to the General Headquarters Reserve and allotted to the Fourth Corps Area. Initiated on 18 April 1922 at Atlanta, GA. Assigned on 31 March 1924 to the 344th Airship Group. Designated mobilization training station was Camp Joseph E. Johnston, FL, (later redesignated Camp J. Clifford R. Foster). Demobilized on 1 October 1933.

384th Airship Company (344th Airship Group)

Organized Reserve Florida

HQ-*Not initiated* 1921-22; Pensacola, FL, 1922-33

Constituted in the Organized Reserve on 29 July 1921 as the 384th Airship Company, assigned to the General Headquarters Reserve and allotted to the Fourth Corps Area. Initiated on 10 November 1922 at Pensacola, FL. Assigned on 31 March 1924 to the 344th Airship Group. Designated mobilization training station was Camp Joseph E. Johnston, FL, (later redesignated Camp J. Clifford R. Foster). Demobilized on 1 October 1933.

385th Airship Company (343rd Airship Group)

Organized Reserve Ohio

HQ-*Not initiated* 1921-22; Monroesville, OH, 1922-30; *Inactive* 1930-33

Constituted in the Organized Reserve on 29 July 1921 as the 385th Airship Company, assigned to the General Headquarters Reserve and allotted to the Fifth Corps Area. Initiated in April 1922 at Monroesville, OH. Assigned on 31 March 1924 to the 343rd Airship Group. Inactivated about March 1930 at Monroesville by relief of personnel. Demobilized on 1 October 1933.

386th Airship Company (343rd Airship Group)

Organized Reserve Ohio

HQ-Cincinnati, OH, 1921-30; *Inactive* 1930-33

Constituted in the Organized Reserve on 29 July 1921 as the 386th Airship Company, assigned to the General Headquarters Reserve and allotted to the Fifth Corps Area. Initiated in September 1924 at Cincinnati, OH. Assigned on 31 March 1924 to the 343rd Airship Group. Inactivated about March 1930 at Cincinnati by relief of personnel. Demobilized on 1 October 1933.

387th Airship Company (343rd Airship Group)

Organized Reserve Indiana

HQ-*Not initiated* 1921-22; Indianapolis, IN, 1922-30; *Inactive* 1930-33

Constituted in the Organized Reserve on 29 July 1921 as the 387th Airship Company, assigned to the General Headquarters Reserve and allotted to the Fifth Corps Area. Initiated in May 1922 at Indianapolis, IN. Assigned on 31 March 1924 to the 343rd Airship Group. Inactivated about March 1930 at Indianapolis by relief of personnel. Demobilized on 1 October 1933.

388th Airship Company (343rd Airship Group)

Organized Reserve Kentucky

HQ-*Not initiated* 1921-22; Richmond, KY, 1922-30; *Inactive* 1930-33

Constituted in the Organized Reserve on 29 July 1921 as the 388th Airship Company, assigned to the General Headquarters Reserve and allotted to the Fifth Corps Area. Initiated in January 19 22 at Richmond, KY. Assigned on 31 March 1924 to the 343rd Airship Group. Inactivated about March 1930 at Richmond by relief of personnel. Demobilized on 1 October 1933.

389th Airship Company (345th Airship Group)

Organized Reserve Illinois

HQ-*Not initiated* 1921-22; Belleville, IL, 1922-29; *Inactive* 1929-30; Belleville, IL, 1930-36; *Inactive* 1936-41

Constituted in the Organized Reserve on 29 July 1921 as the 389th Airship Company, assigned to the General Headquarters Reserve and allotted to the Sixth Corps Area. Initiated in 1922 at Belleville, IL. Assigned on 31 March 1924 to the 345th Airship Group. Inactivated by June 1929 at Belleville by relief of personnel. Reorganized by June 1930 at Belleville. Redesignated as the 389th Airship Squadron on 1 October 1933. Relieved from the 345th Airship Group on 7 October 1933 and assigned to the 344th Airship Group. Inactivated September 1936 at Belleville by relief of personnel. Conducted annual summer training at Scott Field, IL, 1922-40. Location 7 December 1941—*Inactive*.

Status: Disbanded on 31 May 1942.

390th Airship Company (345th Airship Group)

Organized Reserve Wisconsin

HQ-Not initiated 1921-22; Madison, WI, 1922-41

Constituted in the Organized Reserve on 29 July 1921 as the 390th Airship Company, assigned to the General Headquarters Reserve and allotted to the Sixth Corps Area. Initiated on 24 November 1922 at Madison, WI. Assigned on 31 March 1924 to the 345th Airship Group. Redesignated as the 390th Airship Squadron on 1 October 1933. Relieved from the 345th Airship Group on 7 October 1933 and assigned to the 344th Airship Group. Conducted annual summer training at Scott Field, IL. Location 7 December 1941—Madison, WI.

Status: Disbanded on 31 May 1942.

391st Airship Company (345th Airship Group)

Organized Reserve Minnesota/Kansas

HQ-Not initiated 1921-22; Minneapolis, MN 1922-26; Winfield, KS, 1926-41

Constituted in the Organized Reserve on 29 July 1921 as the 391st Airship Company, assigned to the General Headquarters Reserve and allotted to the Seventh Corps Area. Initiated in 1922 at Minneapolis, MN. Assigned on 31 March 1924 to the 345th Airship Group. Relocated on 26 May 1926 to Winfield, KS. Redesignated as the 391st Airship Squadron on 1 October 1933. Location 7 December 1941—Winfield, KS.

Status: Disbanded on 31 May 1942.

392nd Airship Company (345th Airship Group)

Organized Reserve Minnesota/Kansas

HQ-Not initiated 1921-22; St. Paul, MN 1922-26; El Dorado, KS, 1926-41

Constituted in the Organized Reserve on 29 July 1921 as the 392nd Airship Company, assigned to the General Headquarters Reserve and allotted to the Seventh Corps Area. Initiated in August 1922 at St. Paul, MN. Assigned on 31 March 1924 to the 345th Airship Group. Relocated on 26 May 1926 to El Dorado, KS. Redesignated as the 392nd Airship Squadron on 1 October 1933. Location 7 December 1941—El Dorado, KS.

Status: Disbanded on 31 May 1942.

393rd Airship Company (346th Airship Group)

Organized Reserve Texas/Washington

HQ-Not initiated 1921-33

Constituted in the Organized Reserve on 29 July 1921 as the 393rd Airship Company, assigned to the General Headquarters Reserve and allotted to the Eighth Corps Area. San Antonio, TX, designated as headquarters on organization, but the unit was never organized at that location. Withdrawn from the Eighth Corps Area on 31 March 1924 and allotted to the Ninth Corps Area. Concurrently assigned to the 346th Airship Group. Tacoma, WA, designated as headquarters on organization, but the unit was never organized at that location. Demobilized on 1 October 1933.

394th Airship Company (346th Airship Group)

Organized Reserve Texas/Washington

HQ-Not initiated 1921-33

Constituted in the Organized Reserve on 29 July 1921 as the 394th Airship Company, assigned to the General Headquarters Reserve and allotted to the Eighth Corps Area. El Paso, TX, designated as headquarters on organization, but the unit was never organized at that location. Withdrawn from the Eighth Corps Area on 31 March 1924 and allotted to the Ninth Corps Area. Concurrently assigned to the 346th Airship Group. Seattle, WA, designated as headquarters on organization, but the unit was never organized at that location. Demobilized on 1 October 1933.

395th Airship Company (346th Airship Group)

Organized Reserve Washington

HQ-Not initiated 1921-33

Constituted in the Organized Reserve on 29 July 1921 as the 395th Airship Company, assigned to the General Headquarters Reserve and allotted to the Ninth Corps Area. Assigned on 31 March 1924 to the 346th Airship Group. Bellingham, WA, designated as headquarters on organization, but the unit was never organized at that location. Demobilized on 1 October 1933.

396th Airship Company (346th Airship Group)

Organized Reserve Washington

HQ-Not initiated 1921-33

Constituted in the Organized Reserve on 29 July 1921 as the 396th Airship Company, assigned to the General Headquarters Reserve and allotted to the Ninth Corps Area. Assigned on 31 March 1924 to the 346th Airship Group. Walla Walla, WA, designated as headquarters on organization, but the unit was never organized at that location. Demobilized on 1 October 1933.

397th Balloon Service Company (564th Balloon Group)

Organized Reserve Ohio

HQ-Not initiated 1921-24; Norton Field, Cincinnati, OH, 1924-30; *Inactive* 1930-33

Constituted in the Organized Reserve on 29 July 1921 as Balloon Park No. 54, assigned to 64th Balloon Group (redesignated as the 564th Balloon Group on 20 February 1924), and allotted to the Fifth Corps Area. Redesignated as the 397th Balloon Service Company on 25 January 1923. Initiated in September 1924 at Norton Field, Cincinnati, OH. Inactivated by March 1930 at Cincinnati by relief of personnel. Demobilized on 1 October 1933.

398th Balloon Service Company (565th Balloon Group)

Organized Reserve Michigan

HQ-Not initiated 1921-22; Flint, MI, 1922-25; Kalamazoo, MI, 1925-29; *Inactive* 1929-32; Kalamazoo, MI, 1932-41

Constituted in the Organized Reserve on 29 July 1921 as Balloon Park No. 55, assigned to 65th Balloon Group (redesignated as the 565th Balloon Group on 20 February 1924), and allotted to the Sixth Corps Area. Initiated in 1922 at Flint, MI. Redesignated as the 398th Balloon Service Company on 25 January 1923. Relocated on 2 June 1925 to Kalamazoo, MI. Inactivated by June 1929 at Kalamazoo by relief of personnel. Reorganized by June 1932 at Kalamazoo. Redesignated as the 398th Service Squadron, Balloon Group on 1 October 1933. Conducted annual summer training at Scott Field, IL, 1922-40. Location 7 December 1941—*Inactive*.

Status: Disbanded on 31 May 1942.

399th Balloon Service Company (566th Balloon Group)

Organized Reserve Missouri

HQ-Not initiated 1921-22; St. Joseph, MO, 1922-26; Kansas City, MO, 1926-41

Constituted in the Organized Reserve on 29 July 1921 as Balloon Park No. 56, assigned to 66th Balloon Group (redesignated as the 566th Balloon Group on 20 February 1924), and allotted to the Sixth Corps Area. Initiated on 11 March 1922 at St. Joseph, MO. Redesignated as the 399th Balloon Service Company on 25 January 1923. Relocated on 26 May 1926 to Kansas City, MO. Redesignated as the 399th Service Squadron, Balloon Group on 1 October 1933. Location 7 December 1941—Kansas City, MO.

Status: Disbanded on 31 May 1942.

400th Balloon Service Company (567th Balloon Group)

Organized Reserve Oregon

HQ-Not initiated 1921-22; Portland, OR, 1922-28; *Inactive* 1928-41

Constituted in the Organized Reserve on 29 June 1921 as Balloon Park No. 57, assigned to 67th Balloon Group (redesignated as the 567th Balloon Group on 20 February 1924) allotted to the Ninth Corps Area. Initiated in June 1922 at Portland, OR. Redesignated as the 400th Balloon Service Company on 25 January 1923. Inactivated on 1 September 1928 at Portland by relief of personnel. Redesignated as the 400th Service Squadron, Balloon Group on 1 October 1933. Location 7 December 1941—Portland, OR.

Status: Disbanded on 31 May 1942.

424th Balloon Company (551st Balloon Group)

Organized Reserve Texas

HQ-Not initiated 1921-26; McGregor, TX, 1926-33

Constituted in the Organized Reserve on 29 June 1921 as the 424th Balloon Company and assigned to 51st Balloon Group (redesignated as the 551st Balloon Group on 20 February 1924), and allotted to the Eighth Corps Area. Initiated in May 1926 at McGregor, TX. Demobilized on 1 October 1933.

425th Balloon Company (551st Balloon Group)

Organized Reserve Texas

HQ-Not initiated 1921-23; Bartlett, TX, 1923-33

Constituted in the Organized Reserve on 29 June 1921 as the 425th Balloon Company and assigned to 51st Balloon Group (redesignated as the 551st Balloon Group on 20 February 1924), and allotted to the Eighth Corps Area. Initiated in July 1923 at Bartlett, TX. Demobilized on 1 October 1933.

451st Balloon Company (552nd Balloon Group)

Organized Reserve

HQ-Not initiated 1923-27

Constituted in the Organized Reserve on 2 July 1923 as the 451st Balloon Company (DNG), and replaced the 101st Balloon Company (Deferred National Guard list) in the mobilization plans. Assigned to the 52nd Balloon Group (redesignated as the 552nd Balloon Group on 20 February 1924), and allotted to the First Corps Area. Withdrawn as a Deferred National Guard unit on 11 January 1927 and allotted permanently to the Organized Reserve as the 451st Balloon Company. Concurrently withdrawn from the First Corps Area and allotted to the Fifth Corps Area. Withdrawn from the Fifth Corps Area on 22 June 1927. Demobilized on 1 October 1933.

452nd Balloon Company (552nd Balloon Group)

Organized Reserve

HQ-Not initiated 1923-27

Constituted in the Organized Reserve on 2 July 1923 as the 452nd Balloon Company (DNG), and replaced the 102nd Balloon Company (Deferred National Guard list) in the mobilization plans. Assigned to the 52nd Balloon Group (redesignated as the 552nd Balloon Group on 20 February 1924), and allotted to the First Corps Area. Withdrawn as a Deferred National Guard unit on 11 January 1927 and allotted permanently to the Organized Reserve as the 451st Balloon Company. Concurrently withdrawn from the First Corps Area and allotted to the Fifth Corps Area. Withdrawn from the Fifth Corps Area on 22 June 1927. Demobilized on 1 October 1933.

453rd Balloon Company (552nd Balloon Group)

Organized Reserve

HQ-Not initiated 1923-27

Constituted in the Organized Reserve on 2 July 1923 as the 453rd Balloon Company (DNG), and replaced the 103rd Balloon Company (Deferred National Guard list) in the mobilization plans. Assigned to the 52nd Balloon Group (redesignated as the 552nd Balloon Group on 20 February 1924), and allotted to the First Corps Area. Withdrawn as a Deferred National Guard unit on 11 January 1927 and allotted permanently to the Organized Reserve as the 451st Balloon Company. Concurrently withdrawn from the First Corps Area and allotted to the Fifth Corps Area. Withdrawn from the Fifth Corps Area on 22 June 1927. Demobilized on 1 October 1933.

454th Balloon Company (552nd Balloon Group)

Organized Reserve

HQ-Not initiated 1923-27

Constituted in the Organized Reserve on 2 July 1923 as the 454th Balloon Company (DNG), and replaced the 104th Balloon Company (Deferred National Guard list) in the mobilization plans. Assigned to the 52nd Balloon Group (redesignated as the 552nd Balloon Group on 20 February 1924), and allotted to the First Corps Area. Withdrawn as a Deferred National Guard unit on 11 January 1927 and allotted permanently to the Organized Reserve as the 451st Balloon Company. Concurrently withdrawn from the First Corps Area and allotted to the Fifth Corps Area. Withdrawn from the Fifth Corps Area on 22 June 1927. Demobilized on 1 October 1933.

455th Balloon Company (I) (553rd Balloon Group)

Organized Reserve

HQ-Not initiated 1923-27

Constituted in the Organized Reserve on 2 July 1923 as the 455th Balloon Company (DNG), and replaced the 105th Balloon Company (Deferred National Guard list) in the mobilization plans. Assigned to the 53rd Balloon Group (redesignated as the 553rd Balloon Group on 20 February 1924), and allotted to the Third Corps Area. Withdrawn from the Third Corps Area on 22 June 1927 and demobilized.

455th Balloon Company (II) (553rd Balloon Group)

Organized Reserve Illinois

HQ-Not initiated 1928-33

Constituted in the Organized Reserve on 5 September 1928 as the 455th Balloon Company, assigned to the 553rd Balloon Group and allotted to the Sixth Corps Area. Waukegan, IL, designated as headquarters on organization, but the unit was never organized at that location. Withdrawn from the Sixth Corps Area on 1 October 1933 and demobilized.

456th Balloon Company (I) (553rd Balloon Group)

Organized Reserve

HQ-Not initiated 1923-27

Constituted in the Organized Reserve on 2 July 1923 as the 456th Balloon Company (DNG), and replaced the 106th Balloon Company (Deferred National Guard list) in the mobilization plans. Assigned to the 53rd Balloon Group (redesignated as the 553rd Balloon Group on 20 February 1924), and allotted to the Third Corps Area. Withdrawn from the Third Corps Area on 22 June 1927 and demobilized.

456th Balloon Company (II) (553rd Balloon Group)

Organized Reserve Illinois

HQ-Not initiated 1928-33

Constituted in the Organized Reserve on 5 September 1928 as the 456th Balloon Company, assigned to the 553rd Balloon Group and allotted to the Sixth Corps Area. Waukegan, IL, designated as headquarters on organization, but the unit was never organized at that location. Withdrawn from the Sixth Corps Area on 1 October 1933 and demobilized.

457th Balloon Company (I) (553rd Balloon Group)

Organized Reserve

HQ-Not initiated 1923-27

Constituted in the Organized Reserve on 2 July 1923 as the 457th Balloon Company (DNG), and replaced the 107th Balloon Company (Deferred National Guard list) in the mobilization plans. Assigned to the 53rd Balloon Group (redesignated as the 553rd Balloon Group on 20 February 1924), and allotted to the Third Corps Area. Withdrawn from the Third Corps Area on 22 June 1927 and demobilized.

457th Balloon Company (II) (553rd Balloon Group)

Organized Reserve Illinois

HQ-Not initiated 1928-33

Constituted in the Organized Reserve on 5 September 1928 as the 457th Balloon Company, assigned to the 553rd Balloon Group and allotted to the Sixth Corps Area. Evanston, IL, designated as headquarters on organization, but the unit was never organized at that location. Withdrawn from the Sixth Corps Area on 1 October 1933 and demobilized.

458th Balloon Company (I) (553rd Balloon Group)

Organized Reserve

HQ-Not initiated 1923-27

Constituted in the Organized Reserve on 2 July 1923 as the 458th Balloon Company (DNG), and replaced the 108th Balloon Company (Deferred National Guard list) in the mobilization plans. Assigned to the 53rd Balloon Group (redesignated as the 553rd Balloon Group on 20 February 1924), and allotted to the Third Corps Area. Withdrawn from the Third Corps Area on 22 June 1927 and demobilized.

458th Balloon Company (II) (553rd Balloon Group)

Organized Reserve Michigan

HQ-Not initiated 1928-33

Constituted in the Organized Reserve on 5 September 1928 as the 458th Balloon Company, assigned to the 553rd Balloon Group and allotted to the Sixth Corps Area. Vassar, MI, designated as headquarters on organization, but the unit was never organized at that location. Withdrawn from the Sixth Corps Area on 1 October 1933 and demobilized.

459th Balloon Company (I) (554th Balloon Group)

Organized Reserve Georgia

HQ-Not initiated 1923-27

Constituted in the Organized Reserve on 2 July 1923 as the 459th Balloon Company (DNG), and replaced the 109th Balloon Company (Deferred National Guard list) in the mobilization plans. Assigned to the 54th Balloon Group (redesignated as the 554th Balloon Group on 20 February 1924), and allotted to the Fourth Corps Area. Brunswick, GA, designated as headquarters on organization, but the unit was never organized at that location. Withdrawn from the Fourth Corps Area on 22 June 1927 and demobilized.

459th Balloon Company (II) (554th Balloon Group)

Organized Reserve Michigan

HQ-Not initiated 1928-33

Constituted in the Organized Reserve on 5 September 1928 as the 459th Balloon Company, assigned to the 554th Balloon Group and allotted to the Sixth Corps Area. Owosso, MI, designated as headquarters on organization, but the unit was never organized at that location. Withdrawn from the Sixth Corps Area on 1 October 1933 and demobilized.

460th Balloon Company (I) (554th Balloon Group)

Organized Reserve Alabama

HQ-Not initiated 1923-27

Constituted in the Organized Reserve on 2 July 1923 as the 460th Balloon Company (DNG), and replaced the 110th Balloon Company (Deferred National Guard list) in the mobilization plans. Dothan, AL, designated as headquarters on organization, but the unit was never organized at that location. Assigned to the 54th Balloon Group (redesignated as the 554th Balloon Group on 20 February 1924), and allotted to the Fourth Corps Area. Designated mobilization station was Fort Bragg, NC. Withdrawn from the Fourth Corps Area on 22 June 1927 and demobilized.

460th Balloon Company (II) (554th Balloon Group)

Organized Reserve Michigan

HQ-Not initiated 1928-33

Constituted in the Organized Reserve on 5 September 1928 as the 460th Balloon Company, assigned to the 554th Balloon Group and allotted to the Sixth Corps Area. Chesanning, MI, designated as headquarters on organization, but the unit was never organized at that location. Withdrawn from the Sixth Corps Area on 1 October 1933 and demobilized.

461st Balloon Company (I) (554th Balloon Group)

Organized Reserve Florida

HQ-Not initiated 1923-27

Constituted in the Organized Reserve on 2 July 1923 as the 461st Balloon Company (DNG), and replaced the 111th Balloon Company (Deferred National Guard list) in the mobilization plans. Assigned to the 54th Balloon Group (redesignated as the 554th Balloon Group on 20 February 1924), and allotted to the Fourth Corps Area. Daytona, FL, designated as headquarters on organization, but the unit was never organized at that location. Designated mobilization station was Fort Bragg, NC. Withdrawn from the Fourth Corps Area on 22 June 1927 and demobilized.

461st Balloon Company (II) (554th Balloon Group)

Organized Reserve

HQ-Not initiated 1928

Constituted in the Organized Reserve on 5 September 1928 as the 461st Balloon Company, assigned to the 554th Balloon Group and allotted to the Sixth Corps Area. Withdrawn from the Sixth Corps Area on 28 November 1928 and demobilized.

462nd Balloon Company (I) (554th Balloon Group)

Organized Reserve Mississippi

HQ-Not initiated 1923-27

Constituted in the Organized Reserve on 2 July 1923 as the 462nd Balloon Company (DNG), and replaced the 112th Balloon Company (Deferred National Guard list) in the mobilization plans. Assigned to the 54th Balloon Group (redesignated as the 554th Balloon Group on 20 February 1924), and allotted to the Fourth Corps Area. Biloxi, MS, designated as headquarters on organization, but the unit was never organized at that location. Withdrawn from the Fourth Corps Area on 22 June 1927 and demobilized.

462nd Balloon Company (II) (554th Balloon Group)

Organized Reserve

HQ-Not initiated 1928

Constituted in the Organized Reserve on 5 September 1928 as the 462nd Balloon Company, assigned to the 554th Balloon Group and allotted to the Sixth Corps Area. Withdrawn from the Sixth Corps Area on 28 November 1928 and demobilized.

463rd Balloon Company (I) (555th Balloon Group)

Organized Reserve

HQ-Not initiated 1923-27

Constituted in the Organized Reserve on 2 July 1923 as the 463rd Balloon Company (DNG), and replaced the 113th Balloon Company (Deferred National Guard list) in the mobilization plans. Assigned to the 55th Balloon Group (redesignated as the 555th Balloon Group on 20 February 1924), and allotted to the Fifth Corps Area. Withdrawn from the Fifth Corps Area on 22 June 1927 and demobilized.

463rd Balloon Company (II) (555th Balloon Group)

Organized Reserve

HQ-Not initiated 1928

Constituted in the Organized Reserve on 5 September 1928 as the 463rd Balloon Company, assigned to the 555th Balloon Group and allotted to the Sixth Corps Area. Withdrawn from the Sixth Corps Area on 28 November 1928 and demobilized.

464th Balloon Company (I) (555th Balloon Group)

Organized Reserve

HQ-Not initiated 1923-27

Constituted in the Organized Reserve on 2 July 1923 as the 464th Balloon Company (DNG), and replaced the 114th Balloon Company (Deferred National Guard list) in the mobilization plans. Assigned to the 55th Balloon Group (redesignated as the 555th Balloon Group on 20 February 1924), and allotted to the Fifth Corps Area. Withdrawn from the Fifth Corps Area on 22 June 1927 and demobilized.

464th Balloon Company (II) (555th Balloon Group)

Organized Reserve

HQ-Not initiated 1928

Constituted in the Organized Reserve on 5 September 1928 as the 464th Balloon Company, assigned to the 555th Balloon Group and allotted to the Sixth Corps Area. Withdrawn from the Sixth Corps Area on 28 November 1928 and demobilized.

465th Balloon Company (I) (555th Balloon Group)

Organized Reserve

HQ-Not initiated 1923-27

Constituted in the Organized Reserve on 2 July 1923 as the 465th Balloon Company (DNG), and replaced the 115th Balloon Company (Deferred National Guard list) in the mobilization plans. Assigned to the 55th Balloon Group (redesignated as the 555th Balloon Group on 20 February 1924), and allotted to the Fifth Corps Area. Withdrawn from the Fifth Corps Area on 22 June 1927 and demobilized.

465th Balloon Company (II) (555th Balloon Group)

Organized Reserve

HQ-Not initiated 1928

Constituted in the Organized Reserve on 5 September 1928 as the 465th Balloon Company, assigned to the 555th Balloon Group and allotted to the Sixth Corps Area. Withdrawn from the Sixth Corps Area on 28 November 1928 and demobilized.

466th Balloon Company (I) (555th Balloon Group)

Organized Reserve

HQ-Not initiated 1923-27

Constituted in the Organized Reserve on 2 July 1923 as the 466th Balloon Company (DNG), and replaced the 116th Balloon Company (Deferred National Guard list) in the mobilization plans. Assigned to the 55th Balloon Group (redesignated as the 555th Balloon Group on 20 February 1924), and allotted to the Fifth Corps Area. Withdrawn from the Fifth Corps Area on 22 June 1927 and demobilized.

466th Balloon Company (II) (555th Balloon Group)

Organized Reserve

HQ-Not initiated 1928

Constituted in the Organized Reserve on 5 September 1928 as the 466th Balloon Company, assigned to the 555th Balloon Group and allotted to the Sixth Corps Area. Withdrawn from the Sixth Corps Area on 28 November 1928 and demobilized.

467th Balloon Company (I) (556th Balloon Group)

Organized Reserve

HQ-Not initiated 1923-27

Constituted in the Organized Reserve on 2 July 1923 as the 467th Balloon Company (DNG), and replaced the 117th Balloon Company (Deferred National Guard list) in the mobilization plans. Assigned to the 56th Balloon Group (redesignated as the 556th Balloon Group on 20 February 1924), and allotted to the Sixth Corps Area. Withdrawn from the Sixth Corps Area on 22 June 1927 and demobilized.

467th Balloon Company (II) (556th Balloon Group)

Organized Reserve

HQ-Not initiated 1928

Constituted in the Organized Reserve on 5 September 1928 as the 467th Balloon Company, assigned to the 556th Balloon Group and allotted to the Sixth Corps Area. Withdrawn from the Sixth Corps Area on 28 November 1928 and demobilized.

468th Balloon Company (556th Balloon Group)

Organized Reserve

HQ-Not initiated 1923-27

Constituted in the Organized Reserve on 2 July 1923 as the 468th Balloon Company (DNG), and replaced the 118th Balloon Company (Deferred National Guard list) in the mobilization plans. Assigned to the 56th Balloon Group (redesignated as the 556th Balloon Group on 20 February 1924), and allotted to the Sixth Corps Area. Withdrawn from the Sixth Corps Area on 22 June 1927 and demobilized.

469th Balloon Company (556th Balloon Group)

Organized Reserve

HQ-Not initiated 1923-27

Constituted in the Organized Reserve on 2 July 1923 as the 469th Balloon Company (DNG), and replaced the 119th Balloon Company (Deferred National Guard list) in the mobilization plans. Assigned to the 56th Balloon Group (redesignated as the 556th Balloon Group on 20 February 1924), and allotted to the Sixth Corps Area. Withdrawn from the Sixth Corps Area on 22 June 1927 and demobilized.

470th Balloon Company (556th Balloon Group)

Organized Reserve

HQ-Not initiated 1923-27

Constituted in the Organized Reserve on 2 July 1923 as the 470th Balloon Company (DNG), and replaced the 120th Balloon Company (Deferred National Guard list) in the mobilization plans. Assigned to the 56th Balloon Group (redesignated as the 556th Balloon Group on 20 February 1924), and allotted to the Sixth Corps Area. Withdrawn from the Sixth Corps Area on 22 June 1927 and demobilized.

471st Balloon Company (557th Balloon Group)

Organized Reserve South Dakota

HQ-Not initiated 1923-27

Constituted in the Organized Reserve on 2 July 1923 as the 471st Balloon Company (DNG), and replaced the 121st Balloon Company (Deferred National Guard list) in the mobilization plans. Assigned to the 57th Balloon Group (redesignated as the 557th Balloon Group on 20 February 1924), and allotted to the Seventh Corps Area. Redfield, SD, designated as headquarters on organization, but the unit was never organized at that location. Withdrawn from the Seventh Corps Area on 22 June 1927 and demobilized.

472nd Balloon Company (557th Balloon Group)

Organized Reserve South Dakota

HQ-Not initiated 1923-27

Constituted in the Organized Reserve on 2 July 1923 as the 472nd Balloon Company (DNG), and replaced the 122nd Balloon Company (Deferred National Guard list) in the mobilization plans. Assigned to the 57th Balloon Group (redesignated as the 557th Balloon Group on 20 February 1924), and allotted to the Seventh Corps Area. Watertown, SD, designated as headquarters on organization, but the unit was never organized at that location. Withdrawn from the Seventh Corps Area on 22 June 1927 and demobilized.

473rd Balloon Company (557th Balloon Group)

Organized Reserve South Dakota

HQ-Not initiated 1923-27

Constituted in the Organized Reserve on 2 July 1923 as the 473rd Balloon Company (DNG), and replaced the 123rd Balloon Company (Deferred National Guard list) in the mobilization plans. Assigned to the 57th Balloon Group (redesignated as the 557th Balloon Group on 20 February 1924), and allotted to the Seventh Corps Area. Mitchell, SD, designated as headquarters on organization, but the unit was never organized at that location. Withdrawn from the Seventh Corps Area on 22 June 1927 and demobilized.

474th Balloon Company (557th Balloon Group)

Organized Reserve South Dakota

HQ-Not initiated 1923-27

Constituted in the Organized Reserve on 2 July 1923 as the 474th Balloon Company (DNG), and replaced the 124th Balloon Company (Deferred National Guard list) in the mobilization plans. Assigned to the 57th Balloon Group (redesignated as the 557th Balloon Group on 20 February 1924), and allotted to the Seventh Corps Area. Brookings, SD, designated as headquarters on organization, but the unit was never organized at that location. Withdrawn from the Seventh Corps Area on 22 June 1927 and demobilized.

475th Balloon Company (551st Balloon Group)

Organized Reserve Texas/Nebraska

HQ-Not initiated 1923-33

Constituted in the Organized Reserve on 2 July 1923 as the 475th Balloon Company (DNG), and replaced the 125th Balloon Company (Deferred National Guard list) in the mobilization plans. Assigned to the 51st Balloon Group (redesignated as the 551st Balloon Group on 20 February 1924), and allotted to the Eighth Corps Area. Kelly Field, TX, designated as headquarters on organization, but the unit was never organized at that location. Withdrawn as a Deferred National Guard unit on 11 January 1927 and allotted permanently to the Organized Reserve as the 475th Balloon Company. Concurrently withdrawn from the Eighth Corps Area and allotted to the Seventh Corps Area. North Platte, NE, designated as headquarters on organization, but the unit was never organized at that location. Demobilized on 1 October 1933.

476th Balloon Company (551st Balloon Group)

Organized Reserve Texas/Nebraska

HQ-Not initiated 1923-33

Constituted in the Organized Reserve on 2 July 1923 as the 476th Balloon Company (DNG), and replaced the 126th Balloon Company (Deferred National Guard list) in the mobilization plans. Assigned to the 51st Balloon Group (redesignated as the 551st Balloon Group on 20 February 1924), and allotted to the Eighth Corps Area. Kelly Field, TX, designated as headquarters on organization, but the unit was never organized at that location. Withdrawn as a Deferred National Guard unit on 11 January 1927 and allotted permanently to the Organized Reserve as the 475th Balloon Company. Concurrently withdrawn from the Eighth Corps Area and allotted to the Seventh Corps Area. Norfolk, NE, designated as headquarters on organization, but the unit was never organized at that location. Demobilized on 1 October 1933.

477th Balloon Company (558th Balloon Group)

Organized Reserve

HQ-Not initiated 1923-27

Constituted in the Organized Reserve on 2 July 1923 as the 477th Balloon Company (DNG), and replaced the 127th Balloon Company (Deferred National Guard list) in the mobilization plans. Assigned to the 58th Balloon Group (redesignated as the 558th Balloon Group on 20 February 1924), and allotted to the Ninth Corps Area. Withdrawn from the Ninth Corps Area on 22 June 1927 and demobilized.

478th Balloon Company (558th Balloon Group)

Organized Reserve

HQ-Not initiated 1923-27

Constituted in the Organized Reserve on 2 July 1923 as the 478th Balloon Company (DNG), and replaced the 128th Balloon Company (Deferred National Guard list) in the mobilization plans. Assigned to the 58th Balloon Group (redesignated as the 558th Balloon Group on 20 February 1924), and allotted to the Ninth Corps Area. Withdrawn from the Ninth Corps Area on 22 June 1927 and demobilized.

479th Balloon Company (558th Balloon Group)

Organized Reserve

HQ-Not initiated 1923-27

Constituted in the Organized Reserve on 2 July 1923 as the 479th Balloon Company (DNG), and replaced the 129th Balloon Company (Deferred National Guard list) in the mobilization plans. Assigned to the 58th Balloon Group (redesignated as the 558th Balloon Group on 20 February 1924), and allotted to the Ninth Corps Area. Withdrawn from the Ninth Corps Area on 22 June 1927 and demobilized.

480th Balloon Company (558th Balloon Group)

Organized Reserve

HQ-Not initiated 1923-27

Constituted in the Organized Reserve on 2 July 1923 as the 480th Balloon Company (DNG), and replaced the 130th Balloon Company (Deferred National Guard list) in the mobilization plans. Assigned to the 58th Balloon Group (redesignated as the 558th Balloon Group on 20 February 1924), and allotted to the Ninth Corps Area. Withdrawn from the Ninth Corps Area on 22 June 1927 and demobilized.

481st Balloon Service Company (552nd Balloon Group)

Organized Reserve Maine

HQ-Not initiated 1923-33

Constituted in the Organized Reserve on 2 July 1923 as the 481st Balloon Service Company (DNG), and replaced the 131st Balloon Service Company (Deferred National Guard list) in the mobilization plans. Assigned to the 52nd Balloon Group (redesignated as the 552nd Balloon Group on 20 February 1924), and allotted to the First Corps Area. Bangor, ME, designated as headquarters on organization, but the unit was never organized at that location. "Deferred National Guard" designation withdrawn 1927. Withdrawn from the First Corps Area on 1 October 1933 and demobilized.

482nd Balloon Service Company (553rd Balloon Group)

Organized Reserve Michigan

HQ-Not initiated 1923-32; Richmond, MI, 1932-37; Inactive 1937-38; Detroit, MI, 1938-41

Constituted in the Organized Reserve on 2 July 1923 as the 482nd Balloon Service Company (DNG), and replaced the 132nd Balloon Service Company (Deferred National Guard list) in the mobilization plans. Assigned to the 53rd Balloon Group (redesignated as the 553rd Balloon Group on 20 February 1924), and allotted to the Sixth Corps Area. Initiated by June 1932 at Richmond, MI. Inactivated by July 1937 at Richmond by relief of personnel. Reorganized about January 1938 at Detroit, MI. Location 7 December 1941—Detroit, MI.

483rd Balloon Service Company (554th Balloon Group)

Organized Reserve Georgia

HQ-Not initiated 1923-28

Constituted in the Organized Reserve on 2 July 1923 as the 483rd Balloon Service Company (DNG), and replaced the 133rd Balloon Service Company (Deferred National Guard list) in the mobilization plans. Assigned to the 54th Balloon Group (redesignated as the 554th Balloon Group on 20 February 1924), and allotted to the Fourth Corps Area. Savannah, GA, designated as headquarters on organization, but the unit was never organized at that location. Designated mobilization station was Fort Bragg, NC. Withdrawn from the Fourth Corps Area on 28 November 1928 and demobilized.

484th Balloon Service Company (555th Balloon Group)

Organized Reserve

HQ-Not initiated 1923-28

Constituted in the Organized Reserve on 2 July 1923 as the 484th Balloon Service Company (DNG), and replaced the 134th Balloon Service Company (Deferred National Guard list) in the mobilization plans. Assigned to the 55th Balloon Group (redesignated as the 555th Balloon Group on 20 February 1924), and allotted to the Fifth Corps Area. Withdrawn from the Fifth Corps Area on 28 November 1928 and demobilized.

485th Balloon Service Company (556th Balloon Group)

Organized Reserve

HQ-Not initiated 1923-28

Constituted in the Organized Reserve on 2 July 1923 as the 485th Balloon Service Company (DNG), and replaced the 135th Balloon Service Company (Deferred National Guard list) in the mobilization plans. Assigned to the 56th Balloon Group (redesignated as the 556th Balloon Group on 20 February 1924), and allotted to the Sixth Corps Area. Withdrawn from the Sixth Corps Area on 28 November 1928 and demobilized.

486th Balloon Service Company (557th Balloon Group)

Organized Reserve South Dakota

HQ-Not initiated 1923-28

Constituted in the Organized Reserve on 2 July 1923 as the 486th Balloon Service Company (DNG), and replaced the 136th Balloon Service Company (Deferred National Guard list) in the mobilization plans. Assigned to the 57th Balloon Group (redesignated as the 557th Balloon Group on 20 February 1924), and allotted to the Seventh Corps Area. Parker, SD, designated as headquarters on organization, but the unit was never organized at that location. Withdrawn from the Seventh Corps Area on 28 November 1928 and demobilized.

487th Balloon Service Company (551st Balloon Group)

Organized Reserve Texas/Nebraska

HQ-Not initiated 1923-24; Cameron, TX, 1924-28; *Inactive* 1928-33

Constituted in the Organized Reserve on 2 July 1923 as the 487th Balloon Service Company (DNG), and replaced the 137th Balloon Service Company (Deferred National Guard list) in the mobilization plans. Assigned to the 51st Balloon Group (redesignated as the 551st Balloon Group on 20 February 1924), and allotted to the Eighth Corps Area. Initiated in 1924 at Cameron, TX. Withdrawn as a Deferred National Guard unit on 11 January 1927 and allotted permanently to the Organized Reserve as the 487th Balloon Service Company. Concurrently withdrawn from the Eighth Corps Area and allotted to the Seventh Corps Area. Inactivated on 5 January 1928 at Cameron by relief of personnel. Blair, NE, designated as headquarters on organization, but the unit was never organized at that location. Demobilized on 1 October 1933.

488th Balloon Service Company (558th Balloon Group)

Organized Reserve

HQ-Not initiated 1923-28

Constituted in the Organized Reserve on 2 July 1923 as the 488th Balloon Service Company (DNG), and replaced the 138th Balloon Service Company (Deferred National Guard list) in the mobilization plans. Assigned to the 58th Balloon Group (redesignated as the 558th Balloon Group on 20 February 1924), and allotted to the Ninth Corps Area. Withdrawn from the Ninth Corps Area on 28 November 1928 and demobilized.

489th Balloon Company (559th Balloon Group)

Organized Reserve Minnesota/Arkansas

HQ-Not initiated 1923-27

Constituted in the Organized Reserve on 2 July 1923 as the 489th Balloon Company (DNG), and replaced the 141st Balloon Company (Deferred National Guard list) in the mobilization plans. Assigned to the 59th Balloon Group (redesignated as the 559th Balloon Group on 20 February 1924), and allotted to the Seventh Corps Area. Glenwood, MN, designated as headquarters on organization, but the unit was never organized at that location. Designated headquarters location changed 26 May 1926 to Marianna, AR. Withdrawn from the Seventh Corps Area on 22 June 1927 and demobilized.

490th Balloon Company (559th Balloon Group)

Organized Reserve Minnesota/Arkansas

HQ-Not initiated 1923-27

Constituted in the Organized Reserve on 2 July 1923 as the 490th Balloon Company (DNG), and replaced the 142nd Balloon Company (Deferred National Guard list) in the mobilization plans. Assigned to the 59th Balloon Group (redesignated as the 559th Balloon Group on 20 February 1924), and allotted to the Seventh Corps Area. Benson, MN, designated as headquarters on organization, but the unit was never organized at that location. Designated headquarters location changed 26 May 1926 to Osceola, AR. Withdrawn from the Seventh Corps Area on 22 June 1927 and demobilized.

491st Balloon Company (559th Balloon Group)

Organized Reserve Minnesota/Arkansas

HQ-Not initiated 1923-27

Constituted in the Organized Reserve on 2 July 1923 as the 491st Balloon Company (DNG), and replaced the 143rd Balloon Company (Deferred National Guard list) in the mobilization plans. Assigned to the 59th Balloon Group (redesignated as the 559th Balloon Group on 20 February 1924), and allotted to the Seventh Corps Area. Sauk Center, MN, designated as headquarters on organization, but the unit was never organized at that location. Designated headquarters location changed 26 May 1926 to Pocahontas, AR. Withdrawn from the Seventh Corps Area on 22 June 1927 and demobilized.

492nd Balloon Company (559th Balloon Group)

Organized Reserve Minnesota/Arkansas

HQ-Not initiated 1923-27

Constituted in the Organized Reserve on 2 July 1923 as the 492nd Balloon Company (DNG), and replaced the 144th Balloon Company (Deferred National Guard list) in the mobilization plans. Assigned to the 59th Balloon Group (redesignated as the 559th Balloon Group on 20 February 1924), and allotted to the Seventh Corps Area.

Alexandria, MN, designated as headquarters on organization, but the unit was never organized at that location. Designated headquarters location changed 26 May 1926 to Jonesboro, AR. Withdrawn from the Seventh Corps Area on 22 June 1927 and demobilized.

493rd Balloon Company (563rd Balloon Group)

Organized Reserve Kansas

HQ-Not initiated 1923-27

Constituted in the Organized Reserve on 2 July 1923 as the 493rd Balloon Company (DNG), and replaced the 145th Balloon Company (Deferred National Guard list) in the mobilization plans. Assigned to the 63rd Balloon Group (redesignated as the 563rd Balloon Group on 20 February 1924), and allotted to the Seventh Corps Area. Kansas City, KS, designated as headquarters on organization, but the unit was never organized at that location. Withdrawn from the Seventh Corps Area on 22 June 1927 and demobilized.

494th Balloon Company (563rd Balloon Group)

Organized Reserve Kansas

HQ-Not initiated 1923-27

Constituted in the Organized Reserve on 2 July 1923 as the 494th Balloon Company (DNG), and replaced the 146th Balloon Company (Deferred National Guard list) in the mobilization plans. Assigned to the 63rd Balloon Group (redesignated as the 563rd Balloon Group on 20 February 1924), and allotted to the Seventh Corps Area. Ottawa, KS, designated as headquarters on organization, but the unit was never organized at that location. Withdrawn from the Seventh Corps Area on 22 June 1927 and demobilized.

495th Balloon Service Company (559th Balloon Group)

Organized Reserve Minnesota/Arkansas

HQ-Not initiated 1923-27

Constituted in the Organized Reserve on 2 July 1923 as the 495th Balloon Service Company (DNG), and replaced the 139th Balloon Service Company (Deferred National Guard list) in the mobilization plans. Assigned to the 59th Balloon Group (redesignated as the 559th Balloon Group on 20 February 1924), and allotted to the Seventh Corps Area. Park Rapids, MN, designated as headquarters on organization, but the unit was never organized at that location. Designated headquarters location changed 26 May 1926 to Newport, AR. Withdrawn from the Seventh Corps Area on 22 June 1927 and demobilized.

501st Airship Company (School) (ZI)

Organized Reserve

HQ-Not initiated 1923-26

Constituted in the Organized Reserve on 2 July 1923 and assigned to Zone of the Interior as school troops. Demobilized in 1926.

502nd Airship Company (School) (ZI)

Organized Reserve

HQ-Not initiated 1923-26

Constituted in the Organized Reserve on 2 July 1923 and assigned to Zone of the Interior as school troops. Demobilized in 1926.

503rd Airship Company (School) (ZI)

Organized Reserve

HQ-Not initiated 1923-28

Constituted in the Organized Reserve on 2 July 1923, assigned to Zone of the Interior as school troops, and allotted to the Sixth Corps Area. Withdrawn from the Sixth Corps Area on 30 November 1928 and demobilized.

504th Balloon Company (School) (ZI)

Organized Reserve Michigan

HQ-Not initiated 1923-33

Constituted in the Organized Reserve on 2 July 1923, assigned to Zone of the Interior as school troops, and allotted to the Sixth Corps Area. Battle Creek, MI, designated as headquarters on organization, but the unit was never organized at that location. Demobilized on 1 October 1933.

505th Balloon Company (School) (ZI)

Organized Reserve Michigan

HQ-Not initiated 1923-33

Constituted in the Organized Reserve on 2 July 1923, assigned to Zone of the Interior as school troops, and allotted to the Sixth Corps Area. Grand Rapids, MI, designated as headquarters on organization, but the unit was never organized at that location. Demobilized on 1 October 1933.

506th Balloon Company (School) (ZI)

Organized Reserve Wisconsin

HQ-Not initiated 1923-33

Constituted in the Organized Reserve on 2 July 1923, assigned to Zone of the Interior as school troops, and allotted to the Sixth Corps Area. Watertown, WI, designated as headquarters on organization, but the unit was never organized at that location. Demobilized on 1 October 1933.

507th Balloon Company (School) (ZI)

Organized Reserve Wisconsin

HQ-Not initiated 1923-33

Constituted in the Organized Reserve on 2 July 1923, assigned to Zone of the Interior as school troops, and allotted to the Sixth Corps Area. Janesville, WI, designated as headquarters on organization, but the unit was never organized at that location. Demobilized on 1 October 1933.

508th Balloon Service Company (School) (ZI)

Organized Reserve Illinois

HQ-Not initiated 1923-32; Danville, IL, 1932-36; *Inactive* 1936-41

Constituted in the Organized Reserve on 2 July 1923, assigned to Zone of the Interior as school troops, and allotted to the Sixth Corps Area. Initiated by June 1932 at Danville, IL, designated as headquarters on organization, but the unit was never organized at that location. Assigned 1 October 1933 to the 555th Balloon Group. Inactivated September 1936 at Danville by relief of personnel. Location 7 December 1941—*Inactive*.

509th Airship Service Company (ZI)

Organized Reserve Pennsylvania

HQ-Not initiated 1923-32; Birdsboro, PA, 1932-33

Constituted in the Organized Reserve on 2 July 1923, assigned to Zone of the Interior as school troops, and allotted to the Third Corps Area. Initiated by June 1932 at Birdsboro, PA. Demobilized on 1 October 1933.

510th Airship Company (School) (ZI)

Organized Reserve

HQ-Not initiated 1923-28

Constituted in the Organized Reserve 31 March 1924 and assigned to Zone of the Interior as school troops. Withdrawn from the Sixth Corps Area on 30 November 1928 and demobilized.

511th Airship Company (School) (ZI)

Organized Reserve Illinois

HQ-Not initiated 1923-30; Belleville, IL, 1930-33

Constituted in the Organized Reserve on 2 July 1923, assigned to Zone of the Interior as school troops, and allotted to the Sixth Corps Area. Initiated by June 1930 at Belleville, IL. Unit mobilization mission was to support operations of the U.S. Army Balloon and Airship School at Scott Field, IL. Withdrawn from the Sixth Corps Area on 1 October 1933 and demobilized.

512th Airship Company (School) (ZI)

Organized Reserve Minnesota

HQ-Not initiated 1923-33

Constituted in the Organized Reserve on 2 July 1923, assigned to Zone of the Interior as school troops, and allotted to the Seventh Corps Area. St. Paul, MN, designated as headquarters on organization, but the unit was never organized at that location. Withdrawn from the Sixth Corps Area on 1 October 1933 and demobilized.

513th Airship Company (School) (ZI)

Organized Reserve Minnesota

HQ-Not initiated 1923-33

Constituted in the Organized Reserve on 2 July 1923, assigned to Zone of the Interior as school troops, and allotted to the Seventh Corps Area. St. Paul, MN, designated as headquarters on organization, but the unit was never organized at that location. Withdrawn from the Sixth Corps Area on 1 October 1933 and demobilized.

514th Airship Company (School) (ZI)

Organized Reserve

HQ-Not initiated 1923-28

Constituted in the Organized Reserve on 2 July 1923, assigned to Zone of the Interior as school troops, and allotted to the Sixth Corps Area. Withdrawn from the Sixth Corps Area on 1 October 1933 and demobilized.

515th Airship Company (School) (ZI)

Organized Reserve

HQ-Not initiated 1923-33

Constituted in the Organized Reserve on 2 July 1923, assigned to Zone of the Interior as school troops, and allotted to the Sixth Corps Area. Withdrawn from the Sixth Corps Area on 1 October 1933 and demobilized.

521st Airship Company (School) (ZI)

Organized Reserve

HQ-Not initiated 1923-28

Constituted in the Organized Reserve on 2 July 1923, assigned to Zone of the Interior as school troops, and allotted to the Sixth Corps Area. Withdrawn from the Sixth Corps Area on 30 November 1928 and demobilized.

522nd Airship Company (School) (ZI)

Organized Reserve

HQ-Not initiated 1923-28

Constituted in the Organized Reserve on 2 July 1923, assigned to Zone of the Interior as school troops, and allotted to the Sixth Corps Area. Withdrawn from the Sixth Corps Area on 30 November 1928 and demobilized.

523rd Airship Company (School) (ZI)

Organized Reserve

HQ-Not initiated 1923-28

Constituted in the Organized Reserve on 2 July 1923, assigned to Zone of the Interior as school troops, and allotted to the Sixth Corps Area. Withdrawn from the Sixth Corps Area on 30 November 1928 and demobilized.

524th Airship Company (School) (ZI)

Organized Reserve

HQ-Not initiated 1923-28

Constituted in the Organized Reserve on 2 July 1923, assigned to Zone of the Interior as school troops, and allotted to the Sixth Corps Area. Upon mobilization, assigned to the Chief of Ordnance to support the development of aerial bombardment munitions. Withdrawn from the Sixth Corps Area on 30 November 1928 and demobilized.

526th Balloon Service Company (School) (ZI)

Organized Reserve Illinois

HQ-Not initiated 1924-33

Constituted in the Organized Reserve on 2 July 1923, assigned to Zone of the Interior as school troops, and allotted to the Sixth Corps Area. Edwardsville, IL, designated as headquarters on organization, but the unit was never organized at that location. Demobilized on 1 October 1933.

527th Balloon Service Company (Air Depot) (ZI)

Organized Reserve

HQ-Not initiated 1924-26

Constituted in the Organized Reserve 31 March 1924 and assigned to Zone of the Interior. Demobilized in 1926.

528th Balloon Service Company (Air Depot) (ZI)

Organized Reserve

HQ-Not initiated 1923-26

Constituted in the Organized Reserve 31 March 1924 and assigned to Zone of the Interior. Designated mobilization station was Maxwell Field, AL. Demobilized in 1926.

529th Balloon Service Company (Air Depot) (ZI)

Organized Reserve

HQ-Not initiated 1924-26

Constituted in the Organized Reserve 31 March 1924 and assigned to Zone of the Interior. Designated mobilization assignment and station was the Field Artillery Center, Camp Knox, KY. Demobilized in 1926.

530th Balloon Service Company (Air Depot) (ZI)

Organized Reserve

HQ-Not initiated 1924-26

Constituted in the Organized Reserve 31 March 1924 and assigned to Zone of the Interior. Demobilized in 1926.

531st Balloon Service Company (Air Depot) (ZI)

Organized Reserve Texas

HQ-Not initiated 1924-26

Constituted in the Organized Reserve 31 March 1924 and assigned to Zone of the Interior. San Antonio, TX, designated as headquarters on organization, but the unit was never organized at that location. Designated mobilization station was Kelly Field, TX. Demobilized in 1926.

532nd Balloon Service Company (Air Depot) (ZI)

Organized Reserve

HQ-Not initiated 1924-26

Constituted in the Organized Reserve 31 March 1924 and assigned to Zone of the Interior. Demobilized in 1926.

533rd Balloon Company (School) (ZI)

Organized Reserve Maryland

HQ-Not initiated 1923-33

Constituted in the Organized Reserve on 2 July 1923, assigned to Zone of the Interior as school troops, and allotted to the Third Corps Area. Baltimore, MD, designated as headquarters on organization, but the unit was never organized at that location. Demobilized on 1 October 1933.

534th Balloon Company (School) (ZI)

Organized Reserve Georgia

HQ-Not initiated 1924-30; Augusta, GA, 1930-41

Constituted in the Organized Reserve 31 March 1924, assigned to Zone of the Interior as school troops, and allotted to the Fourth Corps Area. Demobilized in 1926. Reconstituted and allotted to the Fourth Corps Area by 1930 and organized at Augusta, GA. Redesignated as the 534th Balloon Squadron on 1 October 1933. Designated mobilization training station was Maxwell Field, AL. Location 7 December 1941—Augusta, GA.

Status: Disbanded on 31 May 1942.

535th Balloon Company (School) (ZI)

Organized Reserve Tennessee

HQ-Not initiated 1924-25; Nashville, TN, 1925-29; *Inactive* 1929-33

Constituted in the Organized Reserve 31 March 1924, assigned to Zone of the Interior as school troops, and allotted to the Fourth Corps Area. Initiated about 1925 at Nashville, TN. Designated mobilization station was Maxwell Field, AL. Inactivated on 19 September 1929 at Nashville by relief of personnel. Demobilized on 1 October 1933.

536th Balloon Company (School) (ZI)

Organized Reserve

HQ-Not initiated 1924-33

Constituted in the Organized Reserve 31 March 1924 and assigned to Zone of the Interior as school troops, and allotted to the Fifth Corps Area. Designated mobilization assignment and station was the Coast Artillery School, Fort Monroe, VA. Demobilized on 1 October 1933.

537th Balloon Company (School) (ZI)

Organized Reserve Iowa

HQ-Davenport, IA, 1924-26; Fort Dodge, IA, 1926-33

Constituted in the Organized Reserve 31 March 1924, assigned to Zone of the Interior as school troops, and allotted to the Seventh Corps Area. Initiated in December 1924 at Davenport, IA. Relocated on 26 May 1926 to Fort Dodge, IA. Demobilized on 1 October 1933.

538th Balloon Company (School) (ZI)

Organized Reserve Texas

HQ-*Not initiated* 1923-33

Constituted in the Organized Reserve on 2 July 1923, assigned to Zone of the Interior as school troops, and allotted to the Eighth Corps Area. Kelly Field, TX, designated as headquarters on organization, but the unit was never organized at that location. Demobilized on 1 October 1933.

539th Balloon Company (School) (ZI)

Organized Reserve California

HQ-*Not initiated* 1923-33

Constituted in the Organized Reserve on 2 July 1923, assigned to Zone of the Interior as school troops, and allotted to the Ninth Corps Area. Los Angeles, CA, designated as headquarters on organization, but the unit was never organized at that location. Demobilized on 1 October 1933.

Chapter 33

Squadrons, Non-Flying



Formation flying over the "Taj Mahal" at Randolph Field, TX. Randolph became known as the "West Point of the Air" in the 1930s.

These squadrons had a variety of missions which they performed to support the operations of other organizations or the operation of the air corps' training base.

Organization

When organized in 1936, base headquarters and air base squadrons were created largely by subsuming existing airfield station complements (i.e., support detachments) and the service squadrons assigned to flying groups. The intent in creating these units was to eliminate the need for air corps groups to have an assigned service squadron. To whatever airfield the group traveled for training and exercises, it could now rely on the field's air base squadron for the required support for its personnel and equipment. These units provided a wide variety of base support functions for Army airfields. Their focus was on broad generic support for the entire air base including non-flying activities. These base support functions included personnel administration, transportation, maintenance, medical, and logistics operations. The latter function included all classes of supply to include fuel, food services, ammunition storage and issue, and repair parts. The base headquarters commander was the airfield commander. His staff provided the overall supervision of air base support operations. The air base squadron provided the support functions as outlined above. These

units were reorganized in 1940 into headquarters and headquarters squadrons and redesignated as air base groups.

Airdrome companies, and later as airdrome squadrons, focused their support on airfield and flight-line support operations, i.e., support of flying activities. The airdrome units provided service station-type support to the field. This included aircraft refueling, routine maintenance and repair, calibration and adjustment of aircraft components, taxi control and parking of aircraft on the apron, etc. These units were usually assigned or attached to air depots and later to the base headquarters at the airfield where they were operating.

Repair squadrons provided higher echelons of maintenance and repair for supported groups and squadrons. These squadrons were typically assigned two to each air depot.

Supply squadrons provided higher echelons of logistics support for supported groups and squadrons. These squadrons were also usually assigned two to each air depot.

Weather squadrons provided weather data to airfield operations centers for the purposes of mission planning and execution. The squadrons were organized into small detachments that were deployed to a number of airfields within a geographical region.

Training

The only squadrons listed in this chapter that were in active service prior to Pearl Harbor were the base headquarters and air base squadrons and weather squadrons, all of which were Regular Army organizations. Since these units performed their real-world support missions on a daily basis, one could say they were in training all the time.

The remaining squadrons were Regular Army Inactive or Organized Reserve units. None were in the National Guard. A number of the RAI units were organized with Reserve personnel, as were many of the OR units. None appear to have been functional units in the Inactive Training Period and only ten were known to have attended a summer camp as a unit. Most likely, the personnel assigned to the initiated RAI and OR organizations trained as individuals with other units both at camp and during the Inactive Training Period.

Base Headquarters and 1st Air Base Squadron

HQ-Langley Field, VA, 1935-40



Constituted and organized 1 March 1935 as the Station Complement, Langley Field. Reorganized and redesignated on 1 September 1936 as Base Headquarters and 1st Air Base Squadron and assigned the General Headquarters Air Force. Reorganization effected by transfer of personnel and equipment from the 58th Service Squadron. Redesignated on 6 December 1939 as Base Headquarters and 1st Air Base Squadron (2 Group). Redesignated on 1 February 1940 as Base Headquarters and 1st Air Base Squadron (Double). Reorganized and redesignated 1 September 1940 as HHS, 1st Air Base Group (Reinforced).

Status: Active in the U.S. Air Force as the 1st Special Operations Maintenance Group at Hurlburt A.F.B., FL.

Commanders, BHQ & 1st Air Base Squadron

Col. Walter R. Weaver

1 Sep 36-8 Feb 39

Col. Jacob W. S. Wuest

Col. Lawrence S. Churchill

6 Sep 39-1 Sep 40

8 Feb 39-1 Sep 39

1st Airdrome Squadron (GHQR)

Regular Army Inactive

HQ-Waco, TX, 1928-36; *Inactive* 1936-41

Constituted in the Regular Army on 18 October 1927 as the 1st Airdrome Company, assigned to the General Headquarters Reserve, and allotted to the Eighth Corps Area. Organized on 16 May 28 with Organized Reserve personnel as a RAI unit at Waco, TX. Designated mobilization training station was Dodd Field, Fort Sam Houston, TX, 1927-33 and Waco Field, TX 1933-41. Conducted annual summer training at Kelly Field, TX. Redesignated on 1 October 1933 as the 1st Airdrome Squadron. Withdrawn from the Eighth Corps Area 5 June 1936 and allotted to the Sixth Corps Area. Chicago, IL, designated as headquarters on reorganization, but the unit was never organized at that location. Location 7 December 1941—*Inactive*.

1st Repair Squadron (1st Air Depot)

Regular Army Inactive

HQ—*Not organized* 1936-38; Rochester, NY, 1938-41

Constituted in the Regular Army on 1 October 1933, assigned to the 1st Air Depot, and allotted to the Second Corps Area. Organized by April 1938 with Organized Reserve personnel as a RAI unit at Rochester, NY. Location 7 December 1941—Rochester, NY.

1st School Squadron

HQ-Chanute Field, IL, 1936-41

Constituted in the Regular Army on 1 September 1936, assigned to General Headquarters Air Force, and allotted to the Sixth Corps Area. Concurrently organized at Chanute Field, IL. Location 7 December 1941—Chanute Field, IL.

Commanders, 1st School Squadron

Capt. Oscar L. Rogers

1 Sep 36-21 Sep 36

Maj. Orlo H. Quinn

21 Sep 36-19 Jul 37

Maj. Clarence C. Wilson

19 Jul 37-2 Aug 37

Maj. James N. Duke, jr.

Capt. Ray H. Clark

Unknown

2 Aug 37-23 Aug 38

23 Aug 38-Jun 40

Jun 40-7 Dec 41

1st Supply Squadron (1st Air Depot)

Regular Army Inactive

HQ-Not organized 1936-38; Brooklyn, NY, 1938-41

Constituted in the Regular Army on 1 September 1936, assigned to the 1st Air Depot, and allotted to the Second Corps Area. Organized on 15 April 1938 with Organized Reserve personnel as a RAI unit with headquarters at Brooklyn, NY. Location 7 December 1941—Brooklyn, NY.

1st Weather Squadron

HQ-March Field, CA, 1936-41; McClellan Field, CA, 1941

Constituted 1 July 1937 in the Regular Army, assigned to the General Headquarters Air Force, and allotted to the Ninth Corps Area. Concurrently organized at March Field, CA, with personnel from the 8th Signal Service Company. The squadron provided weather information service to the 1st Weather Region (which embraced the Ninth Corps Area). Transferred 4 February 1941 to McClellan Field, CA. Location 7 December 1941—McClellan Field, CA.

Commanders, 1st Weather Squadron

1st Lt. Harold H. Bassett	1 Jul 37-ao Apr 40	Capt. Ivan L. Farman	ao Dec 40-Feb 41
---------------------------	--------------------	----------------------	------------------

Base Headquarters and 2nd Air Base Squadron

HQ-Mitchel Field, NY, 1935-40



Constituted and organized 1 March 1935 as the Station Complement, Mitchel Field. Reorganized and redesignated 1 September 1936 as Base Headquarters and 2nd Air Base Squadron and assigned the General Headquarters Air Force. Reorganization effected by transfer of personnel and equipment from the 61st Service Squadron. Redesignated on 6 December 1939 as Base Headquarters and 2nd Air Base Squadron (1 Group). Redesignated on 1 February 1940 as Base Headquarters and 2nd Air Base Squadron (Single). Reorganized and redesignated 1 September 1940 as HHS, 2nd Air Base Group (Reinforced).

Commanders, BHQ & 2nd Air Base Squadron

Col. Walter H. Frank	1 Sep 36-6 Feb 38	Lt. Col. Thomas J. Hanley, Jr.	6 Feb 38-17 Jul 38
	Col. James E. Chaney	17 Jul 38-14 Mar 40	

2nd Airdrome Squadron (GHQR)

Regular Army Inactive

HQ-Waco, TX, 1928-36; *Inactive* 1936-41

Constituted in the Regular Army on 18 October 1927 as the 2nd Airdrome Company, assigned to the General Headquarters Reserve, and allotted to the Eighth Corps Area. Organized on 16 May 28 with Organized Reserve personnel as a RAI unit at Waco, TX. Designated mobilization training station was Dodd Field, Fort Sam Houston, TX, 1927-33 and Waco Field, TX, 1933-41. Conducted annual summer training at Kelly Field, TX. Redesignated on 1 October 1933 as the 2nd Airdrome Squadron. Withdrawn from the Eighth Corps Area 5 June 1936 and allotted to the Sixth Corps Area. Chicago, IL, designated as headquarters on reorganization, but the unit was never organized at that location. Location 7 December 1941—*Inactive*.

Commanders, 2nd Airdrome Squadron

Capt. Thomas L. Weatherford** 16 May 28-5 Jun 36

** RAI Commanders: Organized Reserve officers.

2nd Repair Squadron (1st Air Depot)

Regular Army Inactive

HQ-Not organized 1936-38; Rochester, NY, 1938-41

Constituted in the Regular Army on 1 October 1933, assigned to the 1st Air Depot, and allotted to the Second Corps Area. Organized by April 1938 with Organized Reserve personnel as a RAI unit at Rochester, NY. Location 7 December 1941—Rochester, NY.

2nd School Squadron

HQ-Chanute Field, IL, 1936-38; Lowry Field, CO, 1938-41

Constituted in the Regular Army on 1 September 1936, assigned to the General Headquarters Air Force, and allotted to the Sixth Corps Area. Concurrently organized at Chanute Field, IL. Transferred 15 October 1938 to Lowry Field, CO. Location 7 December 1941—Lowry Field, CO.

Commanders, 2nd School Squadron

Capt. Oscar F. Carlson	1 Sep 36-5 Oct 36	1st Lt. James McK. Thompson	11 Aug 38-14 Oct 38
Capt. Oscar L. Rogers	5 Oct 36-26 May 38	Capt. Arnold H. Rich	14 Oct 38-8 Jun 39
1st Lt. Samuel V. Stephenson	26 May 38-19 Jun 38	Maj. Clarence C. Wilson	9 Jun 38-ao Sep 39
1st Lt. Richard A. Legg	22 Jun 38-11 Aug 38	Unknown	ao Sep 39-7 Dec 41

2nd Supply Squadron (1st Air Depot)

Regular Army Inactive

HQ-Not organized 1936-38; Brooklyn, NY, 1938-41

Constituted in the Regular Army on 1 September 1936, assigned to the 1st Air Depot, and allotted to the Second Corps Area. Organized on 15 April 1938 with Organized Reserve personnel as a RAI unit with headquarters at Brooklyn, NY. Location 7 December 1941—Brooklyn, NY.

2nd Weather Squadron

HQ-Langley Field, VA, 1937-41; Patterson Field, OH, 1941

Constituted in the Regular Army on 1 July 1937 and assigned to the General Headquarters Air Force, and allotted to the Third Corps Area. Concurrently organized at Langley Field, VA, with personnel from the Army Signal Corps. The squadron provided weather information service to the 2nd Weather Region (which embraced the First, Second, Third, Fifth and Sixth Corps Areas). Transferred 4 April 1941 to Patterson Field, OH. Location 7 December 1941—Patterson Field, OH.

Commanders, 2nd Weather Squadron

1st Lt. Julius K. Lacey	1 Jul 37-ao Jan 39	Unknown	ao Jan 39-7 Dec 41
-------------------------	--------------------	---------	--------------------

Base Headquarters and 3rd Air Base Squadron

HQ-Selfridge Field, MI, 1935-40



Constituted and organized on 1 March 1935 as the Station Complement, Selfridge Field. Reorganized and redesignated 1 September 1936 as Base Headquarters and 3rd Air Base Squadron and assigned the General Headquarters Air Force. Reorganization effected by transfer of personnel and equipment from the 56th Service Squadron. Redesignated on 6 December 1939 as Base Headquarters and 3rd Air Base Squadron (1 Group). Redesignated on 1 February 1940 as Base Headquarters and 3rd Air Base Squadron (Single). Reorganized and redesignated 1 September 1940 as HHS, 3rd Air Base Group (Reinforced).

Commanders, BHQ & 3rd Air Base Squadron

Lt. Col. Ralph Royce

1 Sep 36-8 Sep 36

Col. Henry B. Clagett

8 Sep 36-1 Sep 40

3rd Airdrome Squadron (Fourth Army)

Regular Army Inactive

HQ-Not organized 1933-35; Kansas City, MO, 1935-39; Inactive 1939-41

Constituted in the Regular Army on 1 October 1933, assigned to the Fourth Army, and allotted to the Seventh Corps Area. Organized by June 1935 Organized Reserve personnel as a RAI unit at Kansas City, MO. Inactivated in 1939 at Kansas City by relief of reserve personnel. Location 7 December 1941—*Inactive*.

3rd Repair Squadron (2nd Air Depot)

Regular Army Inactive

HQ-Not organized 1933-35; Detroit, MI, 1935-41

Constituted in the Regular Army on 1 October 1933, assigned to the 2nd Air Depot, and allotted to the Sixth Corps Area. Organized by June 1935 with Organized Reserve personnel as a RAI unit at Detroit, MI. Location 7 December 1941—Detroit, MI.

3rd Supply Squadron (2nd Air Depot)

Regular Army Inactive

HQ-Not organized 1933-35; Detroit, MI, 1935-41

Constituted in the Regular Army on 1 October 1933, assigned to the 2nd Air Depot, and allotted to the Sixth Corps Area. Organized by June 1935 with Organized Reserve personnel as a RAI unit at Detroit, MI. Location 7 December 1941—Detroit, MI.

3rd Weather Squadron

HQ-Barksdale Field, LA, 1937-41; Kelly Field, TX, 1941

Constituted 1 July 1937 in the Regular Army, assigned to the General Headquarters Air Force, and allotted to the Fourth Corps Area. Concurrently organized at Barksdale Field, LA, with Army Signal Corps personnel. The squadron provided weather information service to the 3rd Weather Region (which embraced the Fourth, Seventh and Eighth Corps Areas). Transferred 1 March 1941 to Kelly Field, TX. Location 7 December 1941—Kelly Field, TX.

Commanders, 3rd Weather Squadron

Capt. Leon W. Johnson

1 Jul 37-ao Apr 41

Unknown

ao Apr 41-7 Dec 41

Base Headquarters and 4th Air Base Squadron

HQ-March Field, CA, 1935-40



Constituted and organized 1 March 1935 as the Station Complement, March Field. Reorganized and redesignated 1 September 1936 as Base Headquarters and 4th Air Base Squadron and assigned the General Headquarters Air Force. Reorganization effected by transfer of personnel and equipment from the 64th Service Squadron. Redesignated on 6 December 1939 as Base Headquarters and 4th Air Base Squadron (2 Group). Redesignated on 1 February 1940 as Base Headquarters and 4th Air Base Squadron (Double). Reorganized and redesignated 1 September 1940 as HHS, 4th Air Base Group (Reinforced).

Commanders, BHQ & 4th Air Base Squadron

Col. John H. Pirie
Lt. Col. Carlyle H. Walsh
Col. Percy E. Van Nostrand

1 Sep 36-15 Jun 38
15 Jun 38-30 Sep 38
30 Sep 38-10 Oct 38

Lt. Col. Carlyle H. Walsh
Col. Rush B. Lincoln
Col. Benjamin G. Weir

10 Oct 38-1 Mar 39
1 Mar 39-31 Dec 39
1 Jan 40-1 Sep 40

4th Airdrome Squadron (Fourth Army)

Regular Army Inactive

HQ-*Not organized* 1933-35; Kansas City, MO, 1935-39; *Inactive* 1939-41

Constituted in the Regular Army on 1 October 1933, assigned to the Fourth Army, and allotted to the Seventh Corps Area. Organized by June 1935 with Organized Reserve personnel as a RAI unit at Kansas City, MO. Inactivated in 1939 at Kansas City by relief of reserve personnel. Location 7 December 1941—*Inactive*.

4th Repair Squadron (2nd Air Depot)

Regular Army Inactive

HQ-*Not organized* 1933-35; Detroit, MI, 1933-41

Constituted in the Regular Army on 1 October 1933, assigned to the 2nd Air Depot, and allotted to the Sixth Corps Area. Organized by June 1935 with Organized Reserve personnel as a RAI unit at Detroit, MI. Location 7 December 1941—Detroit, MI.

4th Supply Squadron (2nd Air Depot)

Regular Army Inactive

HQ-*Not organized* 1933-35; Detroit, MI, 1933-41

Constituted in the Regular Army on 1 October 1933, assigned to the 2nd Air Depot, and allotted to the Sixth Corps Area. Organized by June 1935 with Organized Reserve personnel as a RAI unit at Detroit, MI. Location 7 December 1941—Detroit, MI.

Base Headquarters and 5th Air Base Squadron

HQ-Hamilton Field, CA, 1935-40

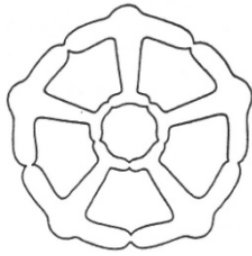

Constituted and organized 1 March 1935 as the Station Complement, Hamilton Field. Reorganized and redesignated 1 September 1936 as Base Headquarters and 5th Air Base Squadron and assigned the General Headquarters Air Force. Reorganization effected by transfer of personnel and equipment from the 69th and 70th Service Squadrons. Redesignated on 6 December 1939 as Base Headquarters and 5th Air Base Squadron (2 Group). Redesignated on 1 February 1940 as Base Headquarters and 5th Air Base Squadron (Double). Reorganized and redesignated 1 September 1940 as HHS, 5th Air Base Group.

Commanders, BHQ & 5th Air Base Squadron

Col. Clarence L. Tinker	1 Sep 36-7 Nov 36	Col. John F. Curry	12 Apr 39-1 Sep 40
Col. Davenport Johnson	7 Nov 36-26 Feb 38	Col. Shepler W. FitzGerald	1 Sep 40-Feb 41
Lt. Col. Clinton W. Russell	26 Feb 38-12 Apr 38	Col. Lowell H. Smith	Feb 41-1 Sep 40

5th Airdrome Squadron (Fourth Army)

Regular Army Inactive

HQ-Not organized 1933-35; Oakland, CA, 1935-39; *Inactive* 1939-41

Constituted in the Regular Army on 1 October 1933, assigned to the Fourth Army, and allotted to the Seventh Corps Area. Organized by June 1935 with Organized Reserve personnel as a RAI unit at Oakland, CA. Inactivated in 1939 at Oakland by relief of reserve personnel. Location 7 December 1941—*Inactive*.

5th Repair Squadron (3rd Air Depot)

Regular Army Inactive

HQ-Not organized 1933-35; Texas 1935-39; *Inactive* 1939-41

Constituted in the Regular Army on 1 October 1933, assigned to the 3rd Air Depot, and allotted to the Eighth Corps Area. Organized on 20 June 1935 with Organized Reserve personnel as a RAI unit in Texas. Inactivated in 1939 in Texas by relief of reserve personnel. Location 7 December 1941—*Inactive*.

5th Supply Squadron (3rd Air Depot)

Regular Army Inactive

HQ-Not organized 1933-35; Texas 1935-39; *Inactive* 1939-41

Constituted in the Regular Army on 1 October 1933, assigned to the 3rd Air Depot, and allotted to the Eighth Corps Area. Organized on 20 June 1935 with Organized Reserve personnel as a RAI unit in Texas. Inactivated in 1939 in Texas by relief of reserve personnel. Location 7 December 1941—*Inactive*.

Base Headquarters and 6th Air Base Squadron

HQ-Barksdale Field, LA, 1935-40



Constituted and organized 1 March 1935 as the Station Complement, Barksdale Field. Reorganized and redesignated 1 September 1936 as Base Headquarters and 6th Air Base Squadron and assigned the General Headquarters Air Force. Reorganization effected by transfer of personnel and equipment from the 60th Service Squadron. Redesignated on 6 December 1939 as Base Headquarters and 6th Air Base Squadron (2 Group). Redesignated on 1 February 1940 as Base Headquarters and 6th Air Base Squadron (Double). Reorganized and redesignated 1 September 1940 as HHS, 6th Air Base Group (Special).

Commanders, BHQ & 6th Air Base Squadron

Col. Robert E. M. Goolrick	1 Sep 36-7 Jul 38	Col. Ira A. Rader	15 Aug 38-31 Aug 39
Col. John C. McDonell	7 Jul 38-15 Aug 38	Lt. Col. Louis H. Brereton	31 Aug 39-1 Sep 40

6th Airdrome Squadron (Fourth Army)

Regular Army Inactive

HQ-*Not organized* 1933-35; Oakland, CA, 1935-39; *Inactive* 1939-41

Constituted in the Regular Army on 1 October 1933, assigned to the Fourth Army, and allotted to the Ninth Corps Area. Organized by June 1935 with Organized Reserve personnel as a RAI unit at Oakland, CA. Inactivated in 1939 at Oakland by relief of reserve personnel. Location 7 December 1941—*Inactive*.

6th Repair Squadron (3rd Air Depot)

Regular Army Inactive

HQ-*Not organized* 1933-35; Texas 1935-39; *Inactive* 1939-41

Constituted in the Regular Army on 1 October 1933, assigned to the 3rd Air Depot, and allotted to the Eighth Corps Area. Organized on 20 June 1935 with Organized Reserve personnel as a RAI unit in Texas. Inactivated in 1939 in Texas by relief of reserve personnel. Location 7 December 1941—*Inactive*.

6th Supply Squadron (3rd Air Depot)

Regular Army Inactive

HQ-*Not organized* 1933-35; Texas 1935-39; *Inactive* 1939-41

Constituted in the Regular Army on 1 October 1933, assigned to the 3rd Air Depot, and allotted to the Eighth Corps Area. Organized on 20 June 1935 with Organized Reserve personnel as a RAI unit in Texas. Inactivated in 1939 in Texas by relief of reserve personnel. Location 7 December 1941—*Inactive*.

Base Headquarters and 7th Air Base Squadron

HQ-Scott Field, IL, 1935-40

Constituted and organized 1 March 1935 as the Station Complement, Scott Field. Reorganized and redesignated 1 September 1936 as Base Headquarters and 7th Air Base Squadron and assigned to the Seventh Corps Area. Reorganization effected by transfer of personnel and equipment from the Station Complement, Scott Field. Reorganized and redesignated 1 June 1939 as 7th Air Base Squadron and assigned to the Air Corps Technical School. Redesignated on 6 December 1939 as 7th Air Base Squadron (Special). Reorganized and redesignated 1 September 1940 as HHS, 7th Air Base Group (Special).

Commanders, BHQ & 7th Air Base Squadron

Col. Frank M. Kennedy	1 Sep 36-1 Mar 37	Maj. Earl S. Schofield	1 Oct 37-1 Jul 39
Lt. Col. William B. Mayer	1 Mar 37-1 Oct 37	Maj. Leo F. Post	1 Jul 39-1 Sep 40

7th Airdrome Squadron (Third Army)

Regular Army Inactive

HQ-*Not organized* 1933-35; Fourth Corps Area 1933-39; *Inactive* 1939-41

Constituted in the Regular Army on 1 October 1933, assigned to the Third Army, and allotted to the Fourth Corps Area. Organized by June 1935 with Organized Reserve personnel as a RAI unit in the Fourth Corps Area. Inactivated in 1939 in the Fourth Corps Area by relief of reserve personnel. Location 7 December 1941—*Inactive*.

7th Repair Squadron (4th Air Depot)**Regular Army Inactive****HQ-Not organized** 1933-35; Los Angeles, CA, 1935-41

Constituted in the Regular Army on 1 October 1933, assigned to the 4th Air Depot, and allotted to the Ninth Corps Area. Organized by June 1935 with Organized Reserve personnel as a RAI unit at Los Angeles, CA. Location 7 December 1941—Los Angeles, CA.

7th Supply Squadron (4th Air Depot)**Regular Army Inactive****HQ-Not organized** 1933-35; Los Angeles, CA, 1935-41

Constituted in the Regular Army on 1 October 1933, assigned to the 4th Air Depot, and allotted to the Ninth Corps Area. Organized by June 1935 with Organized Reserve personnel as a RAI unit at Los Angeles, CA. Location 7 December 1941—Los Angeles, CA.

Base Headquarters and 8th Air Base Squadron**HQ-Brooks Field, TX, 1935-40**

Constituted and organized 1 March 1935 as the Station Complement, Brooks Field. Reorganized and redesignated 1 September 1936 as Base Headquarters and 8th Air Base Squadron and assigned to the Eighth Corps Area. Reorganization effected by transfer of personnel and equipment from the 62nd Service Squadron. Inactivated 1 February 1940 at Brooks Field. Concurrently, personnel transferred to the newly activated 8th Transport Squadron.

Commanders, BHQ & 8th Air Base Squadron

Lt. Col. William C. Ocker
Lt. Col. Henry J. F. Miller

1 Sep 36-1 Jul 37
1 Jul 37-8 Jul 38

Maj. Douglas Johnston
Maj. Edwin Sullivan

8 Jul 38-31 Aug 39
31 Aug 39-1 Feb 40

8th Airdrome Squadron (Third Army)**Regular Army Inactive****HQ-Not organized** 1933-35; Fourth Corps Area 1935-39; *Inactive* 1939-41

Constituted in the Regular Army on 1 October 1933, assigned to the Third Army, and allotted to the Fourth Corps Area. Organized by June 1935 with Organized Reserve personnel as a RAI unit in the Fourth Corps Area. Inactivated in 1939 in the Fourth Corps Area by relief of reserve personnel. Location 7 December 1941—*Inactive*.

8th Repair Squadron (4th Air Depot)**Regular Army Inactive****HQ-Not organized** 1933-35; Los Angeles, CA, 1935-41

Constituted in the Regular Army on 1 October 1933, assigned to the 4th Air Depot, and allotted to the Ninth Corps Area. Organized by June 1935 with Organized Reserve personnel as a RAI unit at Los Angeles, CA. Location 7 December 1941—Los Angeles, CA.

8th Supply Squadron (4th Air Depot)**Regular Army Inactive****HQ-Not organized** 1933-35; Los Angeles, CA, 1935-41

Constituted in the Regular Army on 1 October 1933, assigned to the 4th Air Depot, and allotted to the Ninth Corps Area. Organized by June 1935 with Organized Reserve personnel as a RAI unit at Los Angeles, CA. Location 7 December 1941—Los Angeles, CA.

Base Headquarters and 9th Air Base Squadron

HQ-Moffett Field, CA, 1935-40

Constituted and organized 1 March 1935 as the Station Complement, Moffett Field. Reorganized and redesignated 1 September 1936 as Base Headquarters and 9th Air Base Squadron and assigned to the Ninth Corps Area. Relieved from the Ninth Corps Area 15 November 1939 and assigned to the General Headquarters Air Force. Redesignated on 6 December 1939 as Base Headquarters and 9th Air Base Squadron (1 Group). Redesignated on 1 February 1940 as Base Headquarters and 9th Air Base Squadron (Single). Reorganized and redesignated 1 September 1940 as HHS, 9th Air Base Group (Special).

Status: Disbanded 25 April 1944.

Commanders, BHQ & 9th Air Base Squadron

Maj. Clarence B. Lober	1 Sep 36-15 Jun 37	Maj. Earle G. Harper	1 Jun 39-30 Jun 39
Maj. Horace S. Kenyon	15 Jun 37-25 Feb 38	Lt. Col. George L. Usher	30 Jun 39-ao Sep 39
Col. Follett Bradley	25 Feb 38-1 Jun 39	Lt. Col. Earle G. Harper	ao Mar 40-1 Sep 40

9th Airdrome Squadron (Third Army)

Regular Army Inactive

HQ-*Not organized* 1933-35; Waco, TX, 1935-39; *Inactive* 1939-41

Constituted in the Regular Army on 1 October 1933, assigned to the Third Army, and allotted to the Eighth Corps Area. Organized on 1 April 1935 with Organized Reserve personnel as a RAI unit at Waco, TX. Inactivated in 1939 at Waco by relief of reserve personnel. Location 7 December 1941—*Inactive*.

9th Repair Squadron (5th Air Depot)

Regular Army Inactive

HQ-*Not organized* 1933-34; Toledo, OH, 1934-41

Constituted in the Regular Army on 1 October 1933, assigned to the 5th Air Depot, and allotted to the Fifth Corps Area. Organized by June 1934 with Organized Reserve personnel as a RAI unit at Toledo, OH. Location 7 December 1941—Toledo, OH.

9th Supply Squadron (5th Air Depot)

Regular Army Inactive

HQ-*Not organized* 1933-34; Canton, OH, 1934-41

Constituted in the Regular Army on 1 October 1933, assigned to the 5th Air Depot, and allotted to the Fifth Corps Area. Organized by June 1934 with Organized Reserve personnel as a RAI unit at Canton, OH. Location 7 December 1941—Canton, OH.

10th Air Base Squadron

HQ-Chanute Field, IL, 1935-40

Constituted and organized 1 March 1935 as the Station Complement, Chanute Field. Reorganized and redesignated 1 September 1936 as the 10th Air Base Squadron and assigned to the Air Corps Technical School. Reorganization effected by transfer of personnel and equipment from the 98th Service Squadron. Redesignated on 6 December 1939 as the 10th Air Base Squadron (Special). Reorganized and redesignated 1 September 1940 as HHS, 10th Air Base Group (Special).

Commanders, 10th Air Base Squadron

Maj. James B. Carroll
Maj. Alfred L. Jewett
Capt. Oscar F. Carlson

1 Sep 36-5 Oct 36
5 Oct 36-25 Mar 37
25 Mar 37-21 Jul 37
Maj. Lewis A. Dayton

Maj. James E. Duke
Maj. Roy W. Camblin
Capt. Joel G. O'Neal
14 Jun 39-1 Sep 40

21 Jul 37-9 Aug 37
9 Aug 37-16 May 39
16 May 39-14 Jun 39

10th Airdrome Squadron (Third Army)

Regular Army Inactive

HQ-*Not organized* 1933-35; Waco, TX, 1935-39; *Inactive* 1939-41

Constituted in the Regular Army on 1 October 1933, assigned to the Third Army, and allotted to the Eighth Corps Area. Organized on 1 April 1935 with Organized Reserve personnel as a RAI unit at Waco, TX. Inactivated in 1939 at Waco by relief of reserve personnel. Location 7 December 1941—*Inactive*.

10th Repair Squadron (5th Air Depot)

Regular Army Inactive

HQ-*Not organized* 1933-34; Cleveland, OH, 1934-41

Constituted in the Regular Army on 1 October 1933, assigned to the 5th Air Depot, and allotted to the Fifth Corps Area. Organized by June 1934 with Organized Reserve personnel as a RAI unit at Cleveland, OH. Location 7 December 1941—Cleveland, OH.

10th Supply Squadron (5th Air Depot)

Regular Army Inactive

HQ-*Not organized* 1933-34; Toledo, OH, 1934-41

Constituted in the Regular Army on 1 October 1933, assigned to the 5th Air Depot, and allotted to the Fifth Corps Area. Organized by June 1934 with Organized Reserve personnel as a RAI unit at Toledo, OH. Location 7 December 1941—Toledo, OH.

11th Air Base Squadron

HQ-Randolph Field, TX, 1935-40

Constituted and organized 1 March 1935 as the Station Complement, Randolph Field. Reorganized and redesignated 1 September 1936 as the 11th Air Base Squadron and assigned to the Air Corps Basic Flying School. Reorganization effected by transfer of personnel and equipment from the 67th Service Squadron. Redesignated on 6 December 1939 as the 11th Air Base Squadron (Special). Reorganized and redesignated 1 September 1940 as HHS, 11th Air Base Group (Special).

Commanders, 11th Air Base Squadron

Maj. Eugene B. Bayley 1 Sep 36-1 Sep 40

11th Airdrome Squadron (Second Army)

Regular Army Inactive

HQ-*Not organized* 1933-35; Youngstown, OH, 1935-39; *Inactive* 1939-41

Constituted in the Regular Army on 1 October 1933, assigned to the Second Army, and allotted to the Fifth Corps Area. Organized by June 1935 with Organized Reserve personnel as a RAI unit at Youngstown, OH. Inactivated in 1939 at Youngstown by relief of reserve personnel. Location 7 December 1941—*Inactive*.

11th Repair Squadron (6th Air Depot)**Regular Army Inactive****HQ**-*Not organized* 1933-35; Eighth Corps Area, 1935-36; *Inactive* 1936-41

Constituted in the Regular Army on 1 October 1933, assigned to the 6th Air Depot, and allotted to the Eighth Corps Area. Organized on 20 June 1935 with Organized Reserve personnel as a RAI unit in the Eighth Corps Area. Withdrawn from the Eighth Corps Area 5 June 1936 and allotted to the Sixth Corps Area. Inactivated 31 October 1936 in the Eighth Corps Area by relief of Reserve personnel. Designated mobilization training station was Duncan Field, TX. Location 7 December 1941—*Inactive*.

11th Supply Squadron (6th Air Depot)**Regular Army Inactive****HQ**-*Not organized* 1933-35; Eighth Corps Area, 1935-36; *Inactive* 1936-41

Constituted in the Regular Army on 1 October 1933, assigned to the 6th Air Depot, and allotted to the Eighth Corps Area. Organized on 20 June 1935 with Organized Reserve personnel as a RAI unit in the Eighth Corps Area. Withdrawn from the Eighth Corps Area 5 June 1936 and allotted to the Sixth Corps Area. Inactivated 31 October 1936 in the Eighth Corps Area by relief of Reserve personnel. Designated mobilization training station was Duncan Field, TX. Location 7 December 1941—*Inactive*.

12th Air Base Squadron**HQ**-Kelly Field, TX, 1935-40

Constituted in the Regular Army 1 March 1935 as the Station Complement, Kelly Field and concurrently activated at Kelly Field, TX. Reorganized and redesignated 1 September 1936 as the 12th Air Base Squadron and assigned to the Air Corps Advanced Flying School. Concurrently consolidated with the 81st Service Squadron. Consolidated on 1 December 1936 with the 81st Aero Squadron (a WWI unit organized in March 1918 at Waco, TX; demobilized in January 1919 at Post Field, OK; reconstituted on 1 December 1936). Redesignated on 12th Air Base Squadron (Special) 6 December 1939. Reorganized and redesignated 1 September 1940 as HHS, 12th Air Base Group (Special).

Commanders, 12th Air Base Squadron

Maj. George M. Palmer

1 Sep 36-1 Apr 38

Maj. Albert C. Foulk

1 Apr 38-1 Sep 40

12th Airdrome Squadron (Second Army)**Regular Army Inactive****HQ**-*Not organized* 1933-35; Indianapolis, IN, 1933-39; *Inactive* 1939-41

Constituted in the Regular Army on 1 October 1933, assigned to the Second Army, and allotted to the Fifth Corps Area. Organized by June 1935 with Organized Reserve personnel as a RAI unit at Indianapolis, IN. Inactivated in 1939 at Indianapolis by relief of reserve personnel. Location 7 December 1941—*Inactive*.

12th Repair Squadron (6th Air Depot)**Regular Army Inactive****HQ**-*Not organized* 1933-35; Eighth Corps Area, 1935-36; *Inactive* 1936-41

Constituted in the Regular Army on 1 October 1933, assigned to the 6th Air Depot, and allotted to the Eighth Corps Area. Organized on 20 June 1935 with Organized Reserve personnel as a RAI unit in the Eighth Corps Area. Withdrawn from the Eighth Corps Area 5 June 1936 and allotted to the Sixth Corps Area. Inactivated 31 October 1936 in the Eighth Corps Area by relief of Reserve personnel. Designated mobilization training station was Duncan Field, TX. Location 7 December 1941—*Inactive*.

12th Supply Squadron (6th Air Depot)**Regular Army Inactive****HQ**—*Not organized* 1933-35; Eighth Corps Area, 1935-36; *Inactive* 1936-41

Constituted in the Regular Army on 1 October 1933, assigned to the 6th Air Depot, and allotted to the Eighth Corps Area. Organized on 20 June 1935 with Organized Reserve personnel as a RAI unit in the Eighth Corps Area. Withdrawn from the Eighth Corps Area 5 June 1936 and allotted to the Sixth Corps Area. Inactivated 31 October 1936 in the Eighth Corps Area by relief of Reserve personnel. Designated mobilization training station was Duncan Field, TX. Location 7 December 1941—*Inactive*.

13th Airdrome Squadron**Regular Army Inactive****HQ**—*Not organized* 1933-34; Mt. Clemens, MI, 1933-39; *Inactive* 1939-41

Constituted in the Regular Army on 1 October 1933, assigned to the Second Army, and allotted to the Fifth Corps Area. Organized by June 1934 with Organized Reserve personnel as a RAI unit at Mt. Clemens, MI. Inactivated at Mt. Clemens in 1939 by relief of reserve personnel. Location 7 December 1941—*Inactive*.

13th Air Base Squadron**HQ**—Maxwell Field, AL, 1935-40

Constituted and organized 1 March 1935 as the Station Complement, Maxwell Field. Reorganized and redesignated 1 September 1936 as the 13th Air Base Squadron and assigned to the Air Corps Tactical School. Reorganization effected by transfer of personnel and equipment from the 84th Service Squadron. Redesignated on 6 December 1939 as the 13th Air Base Squadron (Special). Reorganized and redesignated 1 September 1940 as HHS, 13th Air Base Group (Special).

Commanders, 13th Air Base Squadron

Maj. Lewis A. Dayton

1 Sep 36-10 Apr 39

Maj. Aubrey Hornsby

10 Apr 39-1 Sep 40

14th Airdrome Squadron**Regular Army Inactive****HQ**—*Not organized* 1933-35; Rantoul, IL, 1933-41; *Inactive* 1939-41

Constituted in the Regular Army on 1 October 1933, assigned to the Second Army, and allotted to the Fifth Corps Area. Organized by June 1935 with Organized Reserve personnel as a RAI unit at Rantoul, IL. Inactivated in 1939 at Rantoul by relief of reserve personnel. Location 7 December 1941—*Inactive*.

Base Headquarters and 14th Air Base Squadron**HQ**—Bolling Field, DC, 1935-40

Constituted and organized 1 March 1935 as the Station Complement, Bolling Field. Reorganized and redesignated 1 September 1936 as Base Headquarters and 14th Air Base Squadron and assigned to the Office of the Chief of the Air Corps. Concurrently consolidated with the 100th Service Squadron. Redesignated on 6 December 1939 on the 14th Air Base Squadron (Special). Reorganized and redesignated 1 September 1940 as the HHS, 14th Air Base Group (Special).

Commanders, BHQ & 14th Air Base Squadron

Lt. Col. William O. Ryan	1 Sep 36-5 Jun 38	Lt. Col. Floyd E. Galloway	22 Jun 38-20 Aug 39
Maj. Samuel C. Eaton, jr.	5 Jun 38-22 Jun 38	Lt. Col. Edmund W. Hill	20 Aug 39-1 Sep 40

Base Headquarters and 15th Air Base Squadron

HQ-Albrook Field, CZ, 1937-40

Constituted in the Regular Army on 18 October 1927 as the 80th Observation Squadron and allotted to the Eighth Corps Area (see 80th Observation Squadron Chapter 31). Redesignated as the 80th Service Squadron on 8 May 1929 and assigned to the 20th Pursuit Group. Activated on 15 November 1930 at Mather Field, CA, with personnel from the Air Corps Detachment, Mather Field. Consolidated on 24 August 1932 with the 80th Aero Squadron (a WWI unit organized on 1 March 1918 at Waco Field, TX; demobilized on 22 September 1919 at Post Field, OK; reconstituted on 24 August 1932). Sailed from San Francisco for the Panama Canal on the U.S.A.T. *Gen. U.S. Grant* about 15 October 1932. Arrived at Balboa, CZ, on 24 October 1932 and transferred to Albrook Field, CZ, the same day. Reorganized and redesignated Base Headquarters and 15th Air Base Squadron on 1 September 1937. Redesignated on 6 December 1939 as Base Headquarters and 15th Air Base Squadron (2 Group). Redesignated on 1 February 1940 as Base Headquarters and 15th Air Base Squadron (Double). Reorganized and redesignated 1 September 1940 as HHS, 15th Air Base Group (Reinforced).

Status: Disbanded on 1 November 1943.

Commanders, BHQ & 15th Air Base Squadron

Lt. Col. Benjamin G. Weir	1 Sep 37-11 Jul 38	Lt. Col. Willis H. Hale	11 Jul 38-31 Aug 39
	Lt. Col. Adlai H. Gilkeson	31 Aug 39-1 Sep 40	

15th Airdrome Squadron (First Army)

HQ-*Not organized* 1933-41

Constituted in the Regular Army on 1 October 1933, assigned to the First Army, and allotted to the Second Corps Area. New York City, NY, designated as headquarters on organization, but the unit was never organized at that location. Location 7 December 1941—*Not organized*.

Base Headquarters and 16th Air Base Squadron

HQ-France Field, CZ, 1937-40

Constituted and organized 1 March 1935 as the Station Complement, France Field. Reorganized and redesignated 1 September 1937 as Base Headquarters and 16th Air Base Squadron. Redesignated on 6 December 1939 on Base Headquarters and 16th Air Base Squadron (2 Group). Redesignated on 1 February 1940 as Base Headquarters and 16th Air Base Squadron (Double). Reorganized and redesignated 1 September 1940 as HHS, 16th Air Base Group (Reinforced).

Status: Active in the U.S. Air Force as the 1st Special Operations Mission Support Group at Hurlburt A.F.B., FL.

Commanders, BHQ & 16th Air Base Squadron

Lt. Col. William O. Butler	1 Sep 37-7 Jun 39	Lt. Col. Vernon L. Burge	7 Jun 39-ao Sep 39
	Unknown	ao Sep 39-1 Sep 40	

16th Airdrome Squadron (First Army)

HQ-Not organized 1933-41

Constituted in the Regular Army on 1 October 1933, assigned to the First Army, and allotted to the Second Corps Area. New York City, NY, designated as headquarters on organization, but the unit was never organized at that location. Location 7 December 1941—*Not organized*.

Base Headquarters and 17th Air Base Squadron

HQ-Hickam Field, TH, 1938-40

Organized on 6 June 1921 in the Regular Army at Luke Field, TH, as Air Park No. 10, assigned to the 5th Composite Group, and allotted to the Hawaiian Department. Redesignated as the 65th Service Squadron on 22 December 1922. Consolidated on 16 October 1936 with the 65th Aero Squadron (a WWI unit organized on 8 April 1918 at Kelly Field, TX; demobilized on 19 July 1919 at Park Field, TN; reconstituted on 16 October 1936). Reorganized and redesignated 25 January 1938 as Base Headquarters and 17th Air Base Squadron. Redesignated on 6 December 1939 as Base Headquarters and 17th Air Base Squadron (2 Group). Redesignated on 1 February 1940 as Base Headquarters and 17th Air Base Squadron (Double). Reorganized and redesignated 1 September 1940 as HHS, 17th Air Base Group (Reinforced).

Status: Disbanded 1 April 1943 as HHS, 17th Service Group.

Commanders, BHQ & 17th Air Base Squadron

Col. H. C. Kress Muhlenberg	25 Jan 38-1 Jan 39	Col. Shepler W. Fitz Gerald	1 Jan 39-27 Jul 40
	Col. Howard C. Davidson	27 Jul 40-1 Sep 40	

17th Airdrome Squadron (First Army)

Regular Army Inactive

HQ-Not organized 1933-34; Third Corps Area, 1934-41

Constituted in the Regular Army on 1 October 1933, assigned to the First Army, and allotted to the Third Corps Area. Organized on 22 December 1934 with Organized Reserve personnel as a RAI unit in the Third Corps Area. Designated mobilization station was Langley Field, VA. Location 7 December 1941—Third Corps Area.

Base Headquarters and 18th Air Base Squadron

HQ-Wheeler Field, TH, 1937-40

Constituted in the Regular Army on 18 October 1927 as the 75th Attack Squadron, assigned to the 18th Pursuit Group, and allotted to the Eighth Corps Area (see 75th Attack Squadron, Chapter 31). Activated on 15 September 1930 at Wheeler Field, TH. Consolidated on 16 October 1936 with the 75th Aero Squadron (a WWI unit organized on 22 January 1918 at Waco Field, TX; demobilized on 17 November 1919 at Gerstner Field, LA; reconstituted on 16 October 1936). Reorganized and redesignated Base Headquarters and 18th Air Base Squadron (Single) on 1 March 1938. Redesignated on 6 December 1939 as Base Headquarters and 18th Air Base Squadron (1 Group). Redesignated on 1 February 1940 as Base Headquarters and 18th Air Base Squadron (Single). Reorganized and redesignated 1 September 1940 as HHS, 18th Air Base Group (Reinforced).

Status: Disbanded 1 April 1943.

Commanders, BHQ & 18th Air Base Squadron

Maj. Bernard J. Toohar	1 Mar 38-7 Feb 38	1st Archibald M. Kelley	7 Feb 38-ao Jun 38
	Unknown	ao Jun 38-1 Sep 40	

18th Airdrome Squadron (First Army)

Regular Army Inactive

HQ-Not organized 1933-34; Third Corps Area, 1934-41

Constituted in the Regular Army on 1 October 1933, assigned to the First Army, and allotted to the Third Corps Area. Organized on 22 December 1934 with Organized Reserve personnel as a RAI unit in the Third Corps Area. Designated mobilization station was Langley Field, VA. Location 7 December 1941—Third Corps Area.

Base Headquarters and 19th Air Base Squadron

HQ-Hamilton Field, CA 1940; McChord Field, WA, 1940

Constituted in the Regular Army 22 December 1939 as Base Headquarters and 19th Air Base Squadron (1 Group) and allotted to the Ninth Corps Area. Organized on 1 February 1940 at Hamilton Field, CA, as Base Headquarters and 19th Air Base Squadron (Single). Transferred on 1 June 1940 to McChord Field, WA. Reorganized and redesignated 1 September 1940 as HHS, 19th Air Base Group.

Status: Disbanded 1 April 1943.

Commanders, BHQ & 19th Air Base Squadron

Maj. Raymond Morrison

1 Feb 40-20 Mar 40

Col. Carlyle H. Walsh

20 Mar 40-1 Sep 40

19th Airdrome Squadron (GHQR)

Regular Army Inactive

HQ-Not organized 1933-35; Waco, TX, 1935-36; *Inactive* 1936-41

Constituted in the Regular Army on 1 October 1933, assigned to the General Headquarters Reserve and allotted to the Eighth Corps Area. Organized on 20 June 1935 with Organized Reserve personnel as a RAI unit at Waco, TX. Withdrawn from the Eighth Corps Area 5 June 1936 and allotted to the Sixth Corps Area. Chicago, IL, designated as headquarters on reorganization, but the unit was never organized at that location. Location 7 December 1941—*Not organized*.

Base Headquarters and 20th Air Base Squadron

HQ-Nichols Field, PI, 1938-40



Organized on 2 June 1921 in the Regular Army at Clark Field, PI, as Air Park No. 11, assigned to the 4th Composite Group, and allotted to the Philippine Department. Transferred on 14 December 1921 to Camp Nichols, PI, (later redesignated Nichols Field). Redesignated as the 66th Service Squadron on 25 January 1923. Consolidated in October 1936 with the 66th Aero Squadron (a WWI unit organized on 26 April 1918 at Kelly Field, TX; demobilized on 15 November 1918 at Eberts Field, AR; reconstituted in October 1936). Consolidated with Station Complement, Nichols Field on 25 March 1938 and consolidated unit reorganized and redesignated as Base Headquarters and 20th Air Base Squadron. Redesignated on 6 December 1939 as Base Headquarters and 20th Air Base Squadron (1 Group). Redesignated on 1 February 1940 as Base Headquarters and 20th Air Base Squadron (Single). Reorganized and redesignated 1 September 1940 as HHS, 20th Air Base Group (Reinforced).

Commanders, BHQ & 20th Air Base Squadron

Maj. Earle J. Carpenter
1st Lt. John P. Ryan

25 Mar 38-1 Nov 39
1 Nov 39-16 Jan 40

1st Lt. James R. Gunn
Capt. William K. Horrigan

16 Jan 40-31 May 40
1 Jun 40-1 Sep 40

20th Airdrome Squadron (GHQR)**Regular Army Inactive****HQ**—*Not organized* 1933-41

Constituted in the Regular Army on 1 October 1933, assigned to the General Headquarters Reserve and allotted to the Eighth Corps Area. Withdrawn from the Eighth Corps Area 5 June 1936 and allotted to the Sixth Corps Area. Chicago, IL, designated as headquarters on reorganization, but the unit was never organized at that location. Location 7 December 1941—*Not organized*.

21st Air Base Squadron**HQ**—Lowry Field, CO, 1935-40

Constituted in the Regular Army on 15 October 1938 as Base Headquarters and 21st Air Base Squadron and assigned to the Air Corps Technical School. Organized 15 October 1938 at Lowry Field, CO. Redesignated on 6 December 1939 as the 21st Air Base Squadron (Special). Reorganized and redesignated 1 September 1940 as HHS, 21st Air Base Group (Special). Location 7 December 1941—Lowry Field, CO.

Status: Disbanded on 8 Oct 1948.**Commanders, 21st Air Base Squadron**

Maj. Donald G. Stitt

1 Sep 36-14 Dec 38

Maj. Frederick L. Anderson

14 Dec 39-14 May 41

21st Airdrome Squadron (GHQAF)**Regular Army Inactive****HQ**—*Not organized* 1933-34; Third Corps Area, 1934-41

Constituted in the Regular Army on 1 October 1933, assigned to the General Headquarters Air Force, and allotted to the Third Corps Area. Organized on 22 December 1934 with Organized Reserve personnel as a RAI unit in the Third Corps Area. Designated mobilization station was Langley Field, VA. Location 7 December 1941—Third Corps Area.

22nd Airdrome Squadron (GHQAF)**Regular Army Inactive****HQ**—*Not organized* 1933-34; Third Corps Area, 1934-41

Constituted in the Regular Army on 1 October 1933, assigned to the General Headquarters Air Force, and allotted to the Third Corps Area. Organized on 22 December 1934 with Organized Reserve personnel as a RAI unit in the Third Corps Area. Designated mobilization station was Langley Field, VA. Location 7 December 1941—Third Corps Area.

23rd Airdrome Squadron (GHQAF)**Regular Army Inactive****HQ**—*Not organized* 1933-35; Toledo, OH, 1935-39; *Inactive* 1939-41

Constituted in the Regular Army on 1 October 1933, assigned to the General Headquarters Air Force, and allotted to the Fifth Corps Area. Organized by June 1935 with Organized Reserve personnel as a RAI unit at Toledo, OH. Inactivated in 1939 at Toledo by relief of reserve personnel. Location 7 December 1941—*Inactive*.

Base Headquarters and 23rd Air Base Squadron**HQ**—March Field, CA, 1940

Constituted in the Regular Army 22 December 1939 as Base Headquarters and 23rd Air Base Squadron (1 Group) and allotted to the Ninth Corps Area. Organized on 1 February 1940 at March Field, CA, as Base Headquarters and 23rd Air Base Squadron (Single). The unit was organized and trained at March Field for deployment to Elmendorf Field, TA (movement scheduled for 1941). Reorganized and redesignated 1 September 1940 as HHS, 23rd Air Base Group (Reinforced).

Commanders, BHQ & 23rd Air Base Squadron

Lt. Col. Robin A. Day 1 Feb 40-1 Sep 40

24th Airdrome Squadron (GHQAF)

Regular Army Inactive

HQ-*Not organized* 1933-35; Cincinnati, OH, 1935-39; *Inactive* 1939-41

Constituted in the Regular Army on 1 October 1933, assigned to the General Headquarters Air Force, and allotted to the Fifth Corps Area. Organized by June 1935 with Organized Reserve personnel as a RAI unit at Cincinnati, OH. Inactivated in 1939 at Cincinnati by relief of reserve personnel. Location 7 December 1941—*Inactive*.

Base Headquarters and 24th Air Base Squadron

HQ-Kelly Field, TX, 1940

Constituted in the Regular Army 22 December 1939 as Base Headquarters and 24th Air Base Squadron (21 Group) and allotted to the Eighth Corps Area. Organized on 1 February 1940 at Kelly Field, TX, as Base Headquarters and 24th Air Base Squadron (Double). The unit was organized and trained at Kelly Field for deployment to Borinquen Field, PR. The first contingent of about 100 men departed Kelly Field 23 February 1940 by train to sail for Puerto Rico via Charleston, SC. A second contingent departed 20 July 1940 using the same route. The headquarters and remaining elements of the unit were slated for movement to Borinquen Field in July 1941. Reorganized and redesignated 1 September 1940 as HHS, 24th Air Base Group (Reinforced).

Commanders, BHQ & 24th Air Base Squadron

Maj. Harvey W. Prosser 1 Feb 40-1 Sep 40

25th Airdrome Company (GHQR)

Organized Reserve Ohio

HQ-Cleveland, OH, 1922-36; *Inactive* 1936-41

Constituted in the Organized Reserve 15 October 1921, assigned to the General Headquarters Reserve, and allotted to the Fifth Corps Area. Initiated by August 1922 at Cleveland, OH. Withdrawn from the Organized Reserve 5 June 1936 and allotted to the Regular Army. Concurrently withdrawn from the Fifth Corps Area and allotted to the Sixth Corps Area. Chicago, IL, designated as headquarters on reorganization, but the unit was never organized at that location. Location 7 December 1941—*Inactive*.

26th Airdrome Company (GHQR)

Organized Reserve Ohio/Illinois

HQ-*Not organized* 1921-41

Constituted in the Organized Reserve 15 October 1921, assigned to the General Headquarters Reserve, and allotted to the Fifth Corps Area. Withdrawn from the Organized Reserve 5 June 1936 and allotted to the Regular Army. Concurrently withdrawn from the Fifth Corps Area and allotted to the Sixth Corps Area. Chicago, IL, designated as headquarters on organization, but the unit was never organized at that location. Location 7 December 1941—*Inactive*.

Base Headquarters and 26th Air Base Squadron

HQ-Maxwell Field, AL, 1940

Constituted in the Regular Army 22 December 1939 as Base Headquarters and 26th Air Base Squadron (1 Group) and allotted to the Fourth Corps Area. Organized on 1 February 1940 at Maxwell Field, AL, as Base Headquarters and 26th Air Base Squadron (Single). The unit was organized and trained at Kelly Field for deployment to Westover Field, MA. Reorganized and redesignated 1 September 1940 as HHS, 26th Air Base Group.

Commanders, BHQ & 26th Air Base Squadron

Lt. Col. Thomas S. Voss

1 Feb 40-1 May 40

Maj. John R. Drum

1 May 40-1 Sep 40

Base Headquarters and 27th Air Base Squadron

HQ-Barksdale Field, LA, 1940; MacDill Field, FL, 1940

Constituted in the Regular Army 22 December 1939 as Base Headquarters and 27th Air Base Squadron (1 Group) and allotted to the Fourth Corps Area. Organized on 1 February 1940 at Barksdale Field, LA, as Base Headquarters and 27th Air Base Squadron (Single). The unit was organized and trained at Kelly Field for deployment to MacDill Field, FL. The first contingent of about 50 men departed Barksdale Field 9 March 1940 by train for MacDill Field. The remaining contingents, including the headquarters, departed 21-22 April 1940 using the same route. Reorganized and redesignated 1 September 1940 as HHS, 27th Air Base Group.

Commanders, BHQ & 27th Air Base Squadron

Lt. Col. Harry H. Young

1 Feb 40-15 May 40

Col. Clarence H. Tinker

15 May 40-1 Sep 40

401st Airdrome Company (Fourth Army)

Organized Reserve Massachusetts/New York

HQ-Boston, MA, 1923-36; *Inactive* 1936-41

Constituted in the Organized Reserve 15 October 1921 as the 11th Airdrome Company, assigned to the Fourth Army, and allotted to the First Corps Area. Initiated in February 1923 at Boston, MA. Redesignated on the 401st Airdrome Company 25 January 1923. Relieved from the Fourth Army 31 March 1924 and assigned to the General Headquarters Reserve. Redesignated on 401st Airdrome Squadron 1 October 1933. Withdrawn from the First Corps Area 5 June 1936 and allotted to the Second Corps Area. Further allotted 5 April 1937 to the Syracuse District, Northern New York Reserve Area. Location 7 December 1941—*Inactive*.

Status: Disbanded 31 May 42.

402nd Airdrome Company (Fourth Army)

Organized Reserve New York

HQ-New Dorp, S.I., NY, 1921-35; *Inactive* 1935-41

Constituted in the Organized Reserve 15 October 1921 as the 12th Airdrome Company, assigned to the Fourth Army, and allotted to the Second Corps Area. Initiated 16 November 1921 at New Dorp, S.I., NY. Redesignated on the 402nd Airdrome Company 25 January 1923. Redesignated on 402nd Airdrome Squadron 1 October 1933. Inactivated about July 1935 at New Dorp by relief of personnel. Location 7 December 1941—*Inactive*.

Status: Disbanded 31 May 42.

403rd Airdrome Company (Fourth Army)**Organized Reserve Pennsylvania****HQ**-Franklin, PA, 1921-29; *Inactive* 1929-41

Constituted in the Organized Reserve 15 October 1921 as the 13th Airdrome Company, assigned to the Fourth Army, and allotted to the Third Corps Area. Initiated 30 December 1921 at Franklin, PA. Redesignated on the 403rd Airdrome Company 25 January 1923. Inactivated 23 July 1929 at Franklin by relief of personnel. Relocated to Beaver Falls, PA, designated 11 December 1929 as headquarters on reorganization, but the unit was never organized at that location. Redesignated on 403rd Airdrome Squadron 1 October 1933. Consolidated on 28 November 1936 with the 403rd Aero Squadron (Construction) (a WWI unit organized in November 1917 at Vancouver Barracks, WA; redesignated as the 17th Spruce Squadron July 1918; demobilized in January 1919 at Vancouver Barracks; reconstituted on 28 November 1936). Location 7 December 1941—*Inactive*.

Status: Disbanded 31 May 42.**404th Airdrome Company (Fifth Army)****Organized Reserve Tennessee/New York****HQ**-Memphis, TN, 1922-36; *Inactive* 1936-41

Constituted in the Organized Reserve 15 October 1921 as the 14th Airdrome Company, assigned to the Fifth Army, and allotted to the Fourth Corps Area. Initiated in January 1922 at Memphis, TN. Redesignated on the 404th Airdrome Company 25 January 1923. Relieved from the Fifth Army 31 March 1924 and assigned to the General Headquarters Reserve. Redesignated on 404th Airdrome Squadron 1 October 1933. Conducted summer training at Maxwell Field, AL 1922-33. Designated mobilization training station was Camp Joseph E. Johnston, FL (later redesignated Camp J. Clifford R. Foster) 1922-30 and Maxwell Field, AL 1930-36. Withdrawn from the Fourth Corps Area 5 June 1936 and allotted to the Second Corps Area. Further allotted 5 April 1937 to the Metropolitan District, Southern New York Reserve Area. Mitchel Field, NY, designated as headquarters on reorganization, but the unit was never organized at that location. Location 7 December 1941—*Inactive*.

Status: Disbanded 31 May 42.**405th Airdrome Company (Fifth Army)****Organized Reserve Indiana****HQ**-Indianapolis, IN, 1924-33; Evansville, IN, 1933-39; *Inactive* 1939-41

Constituted in the Organized Reserve 15 October 1921 as the 15th Airdrome Company, assigned to the Fifth Army, and allotted to the Fifth Corps Area. Initiated in September 1924 at Indianapolis, IN. Redesignated on the 405th Airdrome Company 25 January 1923. Redesignated on 405th Airdrome Squadron 1 October 1933. Relocated 21 December 1933 to Evansville, IN. Inactivated in 1939 at Indianapolis by relief of personnel. Location 7 December 1941—*Inactive*.

Status: Disbanded 31 May 42.**406th Airdrome Company (Fifth Army)****Organized Reserve Wisconsin****HQ**-Janesville, WI, 1922-37; Milwaukee, WI, 1937-41

Constituted in the Organized Reserve 15 October 1921 as the 16th Airdrome Company, assigned to the Fifth Army, and allotted to the Sixth Corps Area. Initiated 24 November 1922 at Janesville, WI. Redesignated on the 406th Airdrome Company 25 January 1923. Redesignated on 406th Airdrome Squadron 1 October 1933. Relocated in 1937 to Milwaukee, WI. Location 7 December 1941—Milwaukee, WI.

Status: Disbanded 31 May 42.

407th Airdrome Company (Sixth Army)

Organized Reserve Missouri

HQ-Kansas City, MO, 1922-39; *Inactive* 1939-41

Constituted in the Organized Reserve 15 October 1921 as the 17th Airdrome Company, assigned to the Sixth Army, and allotted to the Seventh Corps Area. Initiated in February 1922 at Kansas City, MO. Redesignated on the 407th Airdrome Company 25 January 1923. Redesignated on 407th Airdrome Squadron 1 October 1933. Conducted summer training at Marshal Field, KS. Inactivated 30 June 1939 at Kansas City by relief of personnel. Location 7 December 1941—*Inactive*.

Status: Disbanded 31 May 42.

408th Airdrome Company (Sixth Army)

Organized Reserve Texas

HQ-Galveston, TX, 1923-41

Constituted in the Organized Reserve 15 October 1921 as the 18th Airdrome Company, assigned to the Sixth Army, and allotted to the Eighth Corps Area. Initiated 26 February 1923 at Galveston, TX. Redesignated on the 408th Airdrome Company 25 January 1923. Redesignated on 408th Airdrome Squadron 1 October 1933. Location 7 December 1941—Galveston, TX.

Status: Disbanded 31 May 42.

409th Airdrome Company (Sixth Army)

Organized Reserve Washington/California

HQ-Aberdeen, WA, 1922-30; San Francisco, CA, 1930-39; *Inactive* 1939-41

Constituted in the Organized Reserve 15 October 1921 as the 19th Airdrome Company, assigned to the Sixth Army, and allotted to the Ninth Corps Area. Initiated in May 22 at Aberdeen, WA. Redesignated on the 409th Airdrome Company 25 January 1923. Relieved from the Sixth Army 31 March 1924 and assigned to the General Headquarters Reserve. Relocated 26 January 1930 to San Francisco, CA. Redesignated on 409th Airdrome Squadron 1 October 1933. Inactivated 30 June 1939 by relief of personnel. Location 7 December 1941—*Inactive*.

Status: Disbanded 31 May 42.

410th Airdrome Company (First Army)

Organized Reserve New York

HQ-Albany, NY, 1922-29; *Inactive* 1929-41

Constituted in the Organized Reserve 15 October 1921 as the 20th Airdrome Company, assigned to the First Army, and allotted to the Second Corps Area. Initiated 16 February 1922 at Albany, NY. Redesignated on the 410th Airdrome Company 25 January 1923. Inactivated about July 1929 at Albany by relief of personnel.

Redesignated 410th Airdrome Squadron 1 October 1933. Concurrently relieved from the First Army and assigned to the General Headquarters Reserve. Designated mobilization training station was Mitchel Field, NY. Location 7 December 1941—*Inactive*.

Status: Disbanded 31 May 42.

411th Airdrome Company (First Army)

Organized Reserve New York

HQ-Albany, NY, 1922-27; *Inactive* 1929-41

Constituted in the Organized Reserve 15 October 1921 as the 21st Airdrome Company, assigned to the Sixth Army, and allotted to the Second Corps Area. Initiated 7 March 1922 at Albany, NY. Redesignated on the 411th Airdrome Company 25 January 1923. Inactivated about July 1927 at Albany by relief of personnel. Redesignated 411th Airdrome Squadron 1 October 1933. Concurrently relieved from the First Army and assigned to the General Headquarters Reserve. Consolidated on 28 November 1936 with the 411th Aero Squadron (Construction) (a WWI unit organized in November 1917 at Vancouver Barracks, WA; redesignated as the 5th Spruce Squadron July 1918; demobilized in January 1919 at Vancouver Barracks, WA; reconstituted on 28 November 1936). Designated mobilization training station was Mitchel Field, NY. Location 7 December 1941—*Inactive*.

Status: Disbanded 31 May 42.

412th Airdrome Company (First Army)

Organized Reserve Pennsylvania

HQ-Harrisburg, PA, 1921-29; *Inactive* 1929-41

Constituted in the Organized Reserve 15 October 1921 as the 22nd Airdrome Company, assigned to the First Army, and allotted to the Third Corps Area. Initiated 2 November 1921 at Harrisburg, PA. Redesignated on the 412th Airdrome Company 25 January 1923. Inactivated 23 July 1929 at Harrisburg by relief of personnel. Redesignated on 412th Airdrome Squadron 1 October 1933. Location 7 December 1941—*Inactive*.

Status: Disbanded 31 May 42.

413th Airdrome Company (Second Army)

Organized Reserve Pennsylvania

HQ-Harrisburg, PA, 1922-39; *Inactive* 1939-41

Constituted in the Organized Reserve 15 October 1921 as the 23rd Airdrome Company, assigned to the Second Army, and allotted to the Third Corps Area. Initiated in September 1922 at Harrisburg, PA. Redesignated on the 413th Airdrome Company 25 January 1923. Redesignated on 413th Airdrome Squadron 1 October 1933. Consolidated on 28 November 1936 with the 413th Aero Squadron (Construction) (a WWI unit organized in December 1917 at Vancouver Barracks, WA; redesignated as the 42nd Spruce Squadron July 1918; demobilized in January 1919 at Vancouver Barracks, WA; reconstituted on 28 November 1936). Inactivated 30 June 1939 by relief of personnel. Location 7 December 1941—*Inactive*.

Status: Disbanded 31 May 42.

414th Airdrome Company (Second Army)

Organized Reserve Georgia

HQ-Atlanta, GA, 1922-29; *Inactive* 1929-41

Constituted in the Organized Reserve 15 October 1921 as the 24th Airdrome Company, assigned to the Second Army, and allotted to the Fourth Corps Area. Initiated 17 April 1922 at Atlanta, GA. Redesignated on the 414th Airdrome Company 25 January 1923. Relieved from the Second Army 31 March 1924 and assigned to the General Headquarters Reserve. Inactivated 19 January 1929 at Atlanta by relief of personnel. Redesignated on 414th Airdrome Squadron 1 October 1933. Conducted summer training at Maxwell Field, AL. Designated mobilization training station was Camp Joseph E. Johnston, FL (later redesignated Camp J. Clifford R. Foster) 1922-30 and Maxwell Field, AL 1930-41. Location 7 December 1941—*Inactive*.

Status: Disbanded 31 May 42.

415th Airdrome Company (Second Army)**Organized Reserve Ohio**

HQ-Cleveland, OH, 1922-31; Columbus, OH, 1931-33; Chillicothe, OH, 1933-37; *Inactive* 1937-41

Constituted in the Organized Reserve 15 October 1921 as the 25th Airdrome Company, assigned to the Second Army, and allotted to the Fifth Corps Area. Initiated in May 22 at Cleveland, OH. Redesignated on the 415th Airdrome Company 25 January 1923. Relocated 9 July 1931 to Columbus, OH. Redesignated on 415th Airdrome Squadron 1 October 1933. Relocated 21 December 1933 to Chillicothe, OH. Conducted annual summer training at Wright Field, OH. Consolidated on 28 November 1936 with the 415th Aero Squadron (Construction) (a WWI unit organized in December 1917 at Vancouver Barracks, WA; redesignated as the 32nd Spruce Squadron July 1918; demobilized in January 1919 at Vancouver Barracks, WA; reconstituted on 28 November 1936). Inactivated by June 1937 at Chillicothe by relief of personnel. Location 7 December 1941—*Inactive*.

Status: Disbanded 31 May 42.

416th Airdrome Company (Third Army)**Organized Reserve Ohio**

HQ-Cleveland, OH, 1923-31; Dayton, OH, 1931-33; Portsmouth, OH, 1933-37; *Inactive* 1937-41

Constituted in the Organized Reserve 15 October 1921 as the 26th Airdrome Company, assigned to the Third Army, and allotted to the Fifth Corps Area. Initiated 29 September 1923 at Cleveland, OH. Redesignated on the 416th Airdrome Company 25 January 1923. Relocated 9 July 1931 to Dayton, OH. Redesignated on 416th Airdrome Squadron 1 October 1933. Relocated 21 December 1933 to Portsmouth, OH. Conducted annual summer training at Wright Field, OH. Consolidated on 28 November 1936 with the 416th Aero Squadron (Construction) (a WWI unit organized in December 1917 at Vancouver Barracks, WA; redesignated as the 33rd Spruce Squadron July 1918; demobilized in January 1919 at Vancouver Barracks, WA; reconstituted on 28 November 1936). Inactivated by June 1937 at Portsmouth by relief of personnel. Location 7 December 1941—*Inactive*.

Status: Disbanded 31 May 42.

417th Airdrome Company (Third Army)**Organized Reserve Wisconsin**

HQ-Green Bay, WI, 1922-29; *Inactive* 1929-37; Milwaukee, WI, 1937-41

Constituted in the Organized Reserve 15 October 1921 as the 27th Airdrome Company, assigned to the Third Army, and allotted to the Sixth Corps Area. Initiated 24 November 1922 at Green Bay, WI. Redesignated on the 417th Airdrome Company 25 January 1923. Inactivated 1 December 1929 at Green Bay by relief of personnel. Redesignated on 417th Airdrome Squadron 1 October 1933. Consolidated on 25 November 1936 with the 417th Aero Squadron (Construction) (a WWI unit organized in December 1917 at Vancouver Barracks, WA; redesignated as the 34th Spruce Squadron July 1918; demobilized in January 1919 at Vancouver Barracks; reconstituted on 25 November 1936). Reorganized 28 July 1937 at Milwaukee, WI. Location 7 December 1941—Milwaukee, WI.

Status: Disbanded 31 May 42.

418th Airdrome Company (Third Army)**Organized Reserve Arkansas/Kansas**

HQ-Fort Smith, AR, 1921-31; Wichita, KS, 1931-39; *Inactive* 1939-41

Constituted in the Organized Reserve 15 October 1921 as the 28th Airdrome Company, assigned to the Third Army, and allotted to the Seventh Corps Area. Initiated 28 November 1921 at Fort Smith, AR. Redesignated on the 418th Airdrome Company 25 January 1923. Relocated 12 October 1931 to Wichita, KS. Redesignated on 418th Airdrome Squadron 1 October 1933. Consolidated on 25 November 1936 with the 418th Aero Squadron (Construction) (a

WWI unit organized in January 1918 at Vancouver Barracks, WA; redesignated as the 35th Spruce Squadron July 1918; demobilized in January 1919 at Vancouver Barracks; reconstituted on 25 November 1936). Conducted summer training at Marshal Field, KS. Inactivated 2 October 1939 at Wichita by relief of personnel. Location 7 December 1941—*Inactive*.

Status: Disbanded 31 May 42.

419th Airdrome Company (GHQR)

Organized Reserve New York

HQ-New Dorp, S.I., NY, 1921-35; *Inactive* 1935-41

Constituted in the Organized Reserve 15 October 1921 as the 31st Airdrome Company, assigned to the General Headquarters Reserve, and allotted to the Second Corps Area. Initiated 10 December 1921 at New Dorp, S.I., NY. Redesignated on the 419th Airdrome Company 25 January 1923. Redesignated on 419th Airdrome Squadron 1 October 1933. Inactivated about July 1935 at New Dorp by relief of personnel. Consolidated on 25 November 1936 with the 419th Aero Squadron (Construction) (a WWI unit organized in March 1918 at Vancouver Barracks, WA; redesignated as the 43rd Spruce Squadron July 1918; demobilized in January 1919 at Vancouver Barracks; reconstituted on 25 November 1936). Designated mobilization training station was Mitchel Field, NY. Location 7 December 1941—*Inactive*.

Status: Disbanded 31 May 42.

420th Airdrome Company (GHQR)

Organized Reserve Ohio/Kentucky

HQ-*Not initiated* 1921-24; Akron, OH, 1924-30; *Inactive* 1930-41

Constituted in the Organized Reserve 15 October 1921 as the 32nd Airdrome Company, assigned to the General Headquarters Reserve, and allotted to the Fifth Corps Area. Initiated in May 24 at Akron, OH. Redesignated on the 420th Airdrome Company 25 January 1923. Inactivated by March 1930 at Akrby relief of personnel. Redesignated on 420th Airdrome Squadron 1 October 1933. Bowman Field, KY, designated 21 December 1933 as headquarters on reorganization, but the unit was never organized at that location. Consolidated on 25 November 1936 with the 420th Aero Squadron (Construction) (a WWI unit organized in January 1918 at Vancouver Barracks, WA; redesignated as the 44th Spruce Squadron July 1918; demobilized in January 1919 at Vancouver Barracks; reconstituted on 25 November 1936). Location 7 December 1941—*Inactive*.

Status: Disbanded 31 May 42.

421st Airdrome Company (GHQR)

Organized Reserve Iowa/Minnesota

HQ-Des Moines, IA, 1922-31; Mankato, MN, 1931-41

Constituted in the Organized Reserve 15 October 1921 as the 33rd Airdrome Company, assigned to the General Headquarters Reserve, and allotted to the Seventh Corps Area. Initiated in August 1922 at Des Moines, IA. Redesignated on the 421st Airdrome Company 25 January 1923. Redesignated on 421st Airdrome Squadron 1 October 1933. Conducted summer training at Marshal Field, KS. Location 7 December 1941—Mankato, MN.

Status: Disbanded 31 May 42.

422nd Airdrome Company (GHQR)

Organized Reserve Nebraska

HQ-Omaha, NE, 1924-39; *Inactive* 1939-41

Constituted in the Organized Reserve 31 March 1924, assigned to the General Headquarters Reserve, and allotted to the Seventh Corps Area. Initiated in November 1924 at Omaha, NE. Redesignated on 422nd Airdrome Squadron 1 October 1933. Conducted summer training at Marshal Field, KS. Inactivated 30 June 1939 at Omaha by relief of personnel. Location 7 December 1941—*Inactive*.

Status: Disbanded 31 May 42.

423rd Airdrome Company (GHQR)

Organized Reserve Wisconsin

HQ-*Not initiated* 1924-41

Constituted in the Organized Reserve 31 March 1924, assigned to the General Headquarters Reserve, and allotted to the Sixth Corps Area. Janesville, WI, designated as headquarters on organization, but the unit was never organized at that location. Redesignated on the 423rd Airdrome Company 25 January 1923. Redesignated on 423rd Airdrome Squadron 1 October 1933. Location 7 December 1941—*Not initiated*.

Status: Disbanded 31 May 42.

426th Airdrome Company (GHQR)

Organized Reserve Illinois

HQ-*Not initiated* 1924-41

Constituted in the Organized Reserve 31 March 1924, assigned to the General Headquarters Reserve, and allotted to the Sixth Corps Area. Redesignated on 426th Airdrome Squadron 1 October 1933. Belleville, IL, designated as headquarters on organization, but the unit was never organized at that location. Location 7 December 1941—*Not initiated*.

Status: Disbanded 31 May 42.

435th Airdrome Company (ZI)

Organized Reserve

HQ-*Not initiated* 1924-26

Constituted in the Organized Reserve 31 March 1924, assigned to the Zone of the Interior, and allotted to the Third Corps Area. Demobilized in 1926.

436th Airdrome Company (ZI)

Organized Reserve

HQ-*Not initiated* 1924-26

Constituted in the Organized Reserve 31 March 1924, assigned to the Zone of the Interior, and allotted to the Third Corps Area. Demobilized in 1926.

437th Airdrome Company (ZI)

Organized Reserve

HQ-*Not initiated* 1924-26

Constituted in the Organized Reserve 31 March 1924, assigned to the Zone of the Interior, and allotted to the Fourth Corps Area. Demobilized in 1926.

438th Airdrome Company (ZI)

Organized Reserve

HQ-*Not initiated* 1924-26

Constituted in the Organized Reserve 31 March 1924, assigned to the Zone of the Interior, and allotted to the Fourth Corps Area. Demobilized in 1926.

439th Airdrome Company (ZI)

Organized Reserve Indiana

HQ-Indianapolis, IN, 1925-26

Constituted in the Organized Reserve 31 March 1924, assigned to the Zone of the Interior, and allotted to the Fifth Corps Area. Demobilized in 1926.

440th Airdrome Company (ZI)

Organized Reserve Indiana

HQ-Indianapolis, IN, 1925-26

Constituted in the Organized Reserve 31 March 1924, assigned to the Zone of the Interior, and allotted to the Fifth Corps Area. Demobilized in 1926.

441st Airdrome Company (ZI)

Organized Reserve

HQ-*Not initiated* 1924-26

Constituted in the Organized Reserve 31 March 1924, assigned to the Zone of the Interior, and allotted to the Sixth Corps Area. Demobilized in 1926.

442nd Airdrome Company (ZI)

Organized Reserve

HQ-*Not initiated* 1924-26

Constituted in the Organized Reserve 31 March 1924, assigned to the Zone of the Interior, and allotted to the Sixth Corps Area. Demobilized in 1926.

443rd Airdrome Company (ZI)

Organized Reserve Texas

HQ-San Antonio, TX, 1925-26

Constituted in the Organized Reserve 31 March 1924, assigned to the Zone of the Interior, and allotted to the Eighth Corps Area. Demobilized in 1926.

444th Airdrome Company (ZI)

Organized Reserve Texas

HQ-San Antonio, TX, 1925-26

Constituted in the Organized Reserve 31 March 1924, assigned to the Zone of the Interior, and allotted to the Eighth Corps Area. Demobilized in 1926.

445th Airdrome Company (ZI)

Organized Reserve

HQ-Not initiated 1924-26

Constituted in the Organized Reserve 31 March 1924, assigned to the Zone of the Interior, and allotted to the Ninth Corps Area. Demobilized in 1926.

446th Airdrome Company (ZI)

Organized Reserve

HQ-Not initiated 1924-26

Constituted in the Organized Reserve 31 March 1924, assigned to the Zone of the Interior, and allotted to the Ninth Corps Area. Demobilized in 1926.

601st School Squadron (ZI)

Organized Reserve New Jersey/South Dakota

HQ-Not initiated 1923-28

Constituted in the Organized Reserve 2 July 1923, assigned to the Zone of the Interior, and allotted to the Second Corps Area. Newark, NJ, designated as headquarters on organization, but the unit was never organized at that location. Withdrawn from the Second Corps Area in 1925 and allotted to the Seventh Corps Area. Tyndall, SD, designated as headquarters on organization, but the unit was never organized at that location. Withdrawn from the Seventh Corps Area 5 September 1928 and demobilized.

602nd School Squadron (ZI)

Organized Reserve New Jersey/South Dakota

HQ-Not initiated 1923-28

Constituted in the Organized Reserve 2 July 1923, assigned to the Zone of the Interior, and allotted to the Second Corps Area. Newark, NJ, designated as headquarters on organization, but the unit was never organized at that location. Withdrawn from the Second Corps Area in 1925 and allotted to the Seventh Corps Area. Mitchell, SD, designated as headquarters on organization, but the unit was never organized at that location. Withdrawn from the Seventh Corps Area 5 September 1928 and demobilized.

602nd Supply Squadron (394th Air Depot)

Organized Reserve New York

HQ-Not initiated 1933-41

Constituted in the Organized Reserve 1 October 1933, assigned to the 394th Air Depot, and allotted to the Second Corps Area. New York City, NY, designated as headquarters on organization, but the unit was never organized at that location. Location 7 December 1941—*Not initiated*.

Status: Disbanded 31 May 42.

603rd School Squadron (ZI)

Organized Reserve New Jersey/Iowa

HQ-Not initiated 1923-28

Constituted in the Organized Reserve 2 July 1923, assigned to the Zone of the Interior, and allotted to the Second

Corps Area. Jersey City, NJ, designated as headquarters on organization, but the unit was never organized at that location. Withdrawn from the Second Corps Area in 1925 and allotted to the Seventh Corps Area. Shenandoah, IA, designated as headquarters on organization, but the unit was never organized at that location. Withdrawn from the Seventh Corps Area 5 September 1928 and demobilized.

603rd Supply Squadron (394th Air Depot)

Organized Reserve New York

HQ-*Not initiated* 1933-41

Constituted in the Organized Reserve 1 October 1933, assigned to the 394th Air Depot, and allotted to the Second Corps Area. New York City, NY, designated as headquarters on organization, but the unit was never organized at that location. Location 7 December 1941—*Not initiated*.

Status: Disbanded 31 May 42.

604th School Squadron (ZI)

Organized Reserve New Jersey/Iowa

HQ-*Not initiated* 1923-28

Constituted in the Organized Reserve 2 July 1923, assigned to the Zone of the Interior, and allotted to the Second Corps Area. Jersey City, NJ, designated as headquarters on organization, but the unit was never organized at that location. Withdrawn from the Second Corps Area in 1925 and allotted to the Seventh Corps Area. Council Bluffs, IA, designated as headquarters on organization, but the unit was never organized at that location. Withdrawn from the Seventh Corps Area 5 September 1928 and demobilized.

604th Supply Squadron (517th Air Depot)

Organized Reserve

HQ-*Not initiated* 1933-41

Constituted in the Organized Reserve 1 October 1933, assigned to the 517th Air Depot, and allotted to the Third Corps Area. Location 7 December 1941—*Not initiated*.

Status: Disbanded 31 May 42.

605th School Squadron (ZI)

Organized Reserve New Jersey/Iowa

HQ-*Not initiated* 1923-28

Constituted in the Organized Reserve 2 July 1923, assigned to the Zone of the Interior, and allotted to the Second Corps Area. Paterson, NJ, designated as headquarters on organization, but the unit was never organized at that location. Withdrawn from the Second Corps Area in 1925 and allotted to the Seventh Corps Area. Des Moines, IA, designated as headquarters on organization, but the unit was never organized at that location. Withdrawn from the Seventh Corps Area 5 September 1928 and demobilized.

605th Supply Squadron (517th Air Depot)

Organized Reserve

HQ-*Not initiated* 1933-41

Constituted in the Organized Reserve 1 October 1933, assigned to the 517th Air Depot, and allotted to the Third Corps Area. Location 7 December 1941—*Not initiated*.

Status: Disbanded 31 May 42.

606th School Squadron ((ZI)**Organized Reserve New Jersey/Iowa****HQ-Not initiated** 1923-28

Constituted in the Organized Reserve 2 July 1923, assigned to the Zone of the Interior, and allotted to the Second Corps Area. Trenton, NJ, designated as headquarters on organization, but the unit was never organized at that location. Withdrawn from the Second Corps Area in 1925 and allotted to the Seventh Corps Area. Boone, IA, designated as headquarters on organization, but the unit was never organized at that location. Withdrawn from the Seventh Corps Area 5 September 1928 and demobilized.

606th Supply Squadron (519th Air Depot)**Organized Reserve Ohio****HQ-Not initiated** 1933-41

Constituted in the Organized Reserve 1 October 1933, assigned to the 519th Air Depot, and allotted to the Fifth Corps Area. Cincinnati, OH, designated as headquarters on organization, but the unit was never organized at that location. Location 7 December 1941—*Not initiated*.

Status: Disbanded 31 May 42.**607th School Squadron (ZI)****Organized Reserve New York/Iowa****HQ-Not initiated** 1923-28

Constituted in the Organized Reserve 2 July 1923, assigned to the Zone of the Interior, and allotted to the Second Corps Area. Buffalo, NY, designated as headquarters on organization, but the unit was never organized at that location. Withdrawn from the Second Corps Area in 1925 and allotted to the Seventh Corps Area. Sioux City, IA, designated as headquarters on organization, but the unit was never organized at that location. Withdrawn from the Seventh Corps Area 5 September 1928 and demobilized.

607th Supply Squadron (519th Air Depot)**Organized Reserve Indiana****HQ-Not initiated** 1933-41

Constituted in the Organized Reserve 1 October 1933, assigned to the 519th Air Depot, and allotted to the Fifth Corps Area. Indianapolis, IN, designated as headquarters on organization, but the unit was never organized at that location. Consolidated on 23 November 1936 with the 607th Aero Squadron (Supply) (a WWI unit organized in December 1917 at Kelly Field, TX; demobilized in February 1919 at Fort Wayne, MI; reconstituted on 23 November 1936). Location 7 December 1941—*Not initiated*.

Status: Disbanded 31 May 42.**608th School Squadron (ZI)****Organized Reserve New York/North Dakota****HQ-Not initiated** 1923-28

Constituted in the Organized Reserve 2 July 1923, assigned to the Zone of the Interior, and allotted to the Second Corps Area. Buffalo, NY, designated as headquarters on organization, but the unit was never organized at that location. Withdrawn from the Second Corps Area in 1925 and allotted to the Seventh Corps Area. Fargo, ND, designated as

headquarters on organization, but the unit was never organized at that location. Withdrawn from the Seventh Corps Area 5 September 1928 and demobilized.

608th Supply Squadron (520th Air Depot)

Organized Reserve Illinois

HQ-*Not initiated* 1933-41

Constituted in the Organized Reserve 1 October 1933, assigned to the 520th Air Depot, and allotted to the Sixth Corps Area. Chicago, IL, designated as headquarters on organization, but the unit was never organized at that location. Consolidated on 12 December 1936 with the 608th Aero Squadron (Supply) (a WWI unit organized in January 1918 at Kelly Field, TX; demobilized in September 1919 at Mitchel Field, NY; reconstituted on 12 December 1936). Location 7 December 1941—*Not initiated*.

Status: Disbanded 31 May 42.

609th School Squadron (ZI)

Organized Reserve New York/North Dakota

HQ-*Not initiated* 1923-28

Constituted in the Organized Reserve 2 July 1923, assigned to the Zone of the Interior, and allotted to the Second Corps Area. Buffalo, NY, designated as headquarters on organization, but the unit was never organized at that location. Withdrawn from the Second Corps Area in 1925 and allotted to the Seventh Corps Area. Bismarck, ND, designated as headquarters on organization, but the unit was never organized at that location. Withdrawn from the Seventh Corps Area 5 September 1928 and demobilized.

609th Supply Squadron (520th Air Depot)

Organized Reserve Illinois

HQ-*Not initiated* 1933-41

Constituted in the Organized Reserve 1 October 1933, assigned to the 520th Air Depot, and allotted to the Sixth Corps Area. Chicago, IL, designated as headquarters on organization, but the unit was never organized at that location. Consolidated on 12 December 1936 with the 609th Aero Squadron (Supply) (a WWI unit organized in January 1918 at Kelly Field, TX; demobilized in September 1919 at Mitchel Field, NY; reconstituted on 12 December 1936). Location 7 December 1941—*Not initiated*.

Status: Disbanded 31 May 42.

610th School Squadron (ZI)

Organized Reserve New York/South Dakota

HQ-*Not initiated* 1923-28

Constituted in the Organized Reserve 2 July 1923, assigned to the Zone of the Interior, and allotted to the Second Corps Area. Buffalo, NY, designated as headquarters on organization, but the unit was never organized at that location. Withdrawn from the Second Corps Area in 1925 and allotted to the Seventh Corps Area. Sioux Falls, SD, designated as headquarters on organization, but the unit was never organized at that location. Withdrawn from the Seventh Corps Area 5 September 1928 and demobilized.

610th Supply Squadron (518th Air Depot)**Organized Reserve Georgia/New York****HQ-Not initiated** 1933-41

Constituted in the Organized Reserve 1 October 1933, assigned to the 518th Air Depot, and allotted to the Fourth Corps Area. Atlanta, GA, designated as headquarters on organization, but the unit was never organized at that location. Withdrawn from the Fourth Corps Area 5 June 1936 and allotted to the Second Corps Area. Mitchel Field, NY, designated as headquarters on organization, but the unit was never organized at that location. Consolidated on 7 December 1936 with the 610th Aero Squadron (Supply) (a WWI unit organized in January 1918 at Kelly Field, TX; demobilized in March 1919 at Middletown, PA; reconstituted on 7 December 1936). Location 7 December 1941—*Not initiated*.

Status: Disbanded 31 May 42.**611th School Squadron (ZI)****Organized Reserve New York/Minnesota****HQ-Not initiated** 1923-28

Constituted in the Organized Reserve 2 July 1923, assigned to the Zone of the Interior, and allotted to the Second Corps Area. Rochester, NY, designated as headquarters on organization, but the unit was never organized at that location. Withdrawn from the Second Corps Area in 1925 and allotted to the Seventh Corps Area. Anoka, MN, designated as headquarters on organization, but the unit was never organized at that location. Withdrawn from the Seventh Corps Area 5 September 1928 and demobilized.

611th Supply Squadron (518th Air Depot)**Organized Reserve Alabama/New York****HQ-Not initiated** 1933-41

Constituted in the Organized Reserve 1 October 1933, assigned to the 518th Air Depot, and allotted to the Fourth Corps Area. Birmingham, AL, designated as headquarters on organization, but the unit was never organized at that location. Withdrawn from the Fourth Corps Area 5 June 1936 and allotted to the Second Corps Area. Mitchel Field, NY, designated as headquarters on organization, but the unit was never organized at that location. Consolidated on 8 December 1936 with the 611th Aero Squadron (Supply) (a WWI unit organized in January 1918 at Kelly Field, TX; demobilized in January 1919 at Langley Field, VA; reconstituted on 8 December 1936). Location 7 December 1941—*Not initiated*.

Status: Disbanded 31 May 42.**612th School Squadron (ZI)****Organized Reserve New York/Minnesota****HQ-Not initiated** 1923-28

Constituted in the Organized Reserve 2 July 1923, assigned to the Zone of the Interior, and allotted to the Second Corps Area. Syracuse, NY, designated as headquarters on organization, but the unit was never organized at that location. Withdrawn from the Second Corps Area in 1925 and allotted to the Seventh Corps Area. Brainerd, MN, designated as headquarters on organization, but the unit was never organized at that location. Withdrawn from the Seventh Corps Area 5 September 1928 and demobilized.

612th Supply Squadron (806th Air Depot)**Organized Reserve New York****HQ-Not initiated** 1933-35; Eighth Corps Area 1935-36; *Inactive* 1936-41

Constituted in the Organized Reserve 1 October 1933, assigned to the 806th Air Depot, and allotted to the Eighth Corps Area. Initiated 20 June 1935 in the Eighth Corps Area. Withdrawn from the Eighth Corps Area 5 June 1936

and allotted to the Second Corps Area. Mitchel Field, NY, designated as headquarters on organization, but the unit was never organized at that location. Consolidated on 30 November 1936 with the 612th Aero Squadron (Supply) (a WWI unit organized in January 1918 at Kelly Field, TX; demobilized in March 1919 at Wilbur Wright Field, OH; reconstituted on 30 November 1936). Location 7 December 1941—*Inactive*.

Status: Disbanded 31 May 42.

613th School Squadron (ZI)

Organized Reserve New York/Minnesota

HQ-*Not initiated* 1923-28

Constituted in the Organized Reserve 2 July 1923, assigned to the Zone of the Interior, and allotted to the Second Corps Area. Albany, NY, designated as headquarters on organization, but the unit was never organized at that location. Withdrawn from the Second Corps Area in 1925 and allotted to the Seventh Corps Area. Duluth, MN, designated as headquarters on organization, but the unit was never organized at that location. Withdrawn from the Seventh Corps Area 5 September 1928 and demobilized.

613th Supply Squadron (806th Air Depot)

Organized Reserve New York

HQ-*Not initiated* 1933-35; Eighth Corps Area 1935-36; *Inactive* 1936-41

Constituted in the Organized Reserve 1 October 1933, assigned to the 806th Air Depot, and allotted to the Eighth Corps Area. Initiated 20 June 1935 in the Eighth Corps Area. Withdrawn from the Eighth Corps Area 5 June 1936 and allotted to the Second Corps Area. Mitchel Field, NY, designated as headquarters on organization, but the unit was never organized at that location. Consolidated on 30 November 1936 with the 613th Aero Squadron (Supply) (a WWI unit organized in January 1918 at Kelly Field, TX; demobilized in January 1919 at Garden City, NY; reconstituted on 30 November 1936). Location 7 December 1941—*Inactive*.

Status: Disbanded 31 May 42.

614th School Squadron (ZI)

Organized Reserve New York/Minnesota

HQ-*Not initiated* 1923-28

Constituted in the Organized Reserve 2 July 1923, assigned to the Zone of the Interior, and allotted to the Second Corps Area. Schenectady, NY, designated as headquarters on organization, but the unit was never organized at that location. Withdrawn from the Second Corps Area in 1925 and allotted to the Seventh Corps Area. Wadena, MN, designated as headquarters on organization, but the unit was never organized at that location. Withdrawn from the Seventh Corps Area 5 September 1928 and demobilized.

614th Supply Squadron (521st Air Depot)

Organized Reserve

HQ-*Not initiated* 1936-41

Constituted in the Organized Reserve 1 October 1933, assigned to the 521st Air Depot, and allotted to the Seventh Corps Area. Consolidated on 3 December 1936 with the 614th Aero Squadron (Supply) (a WWI unit organized in January 1918 at Kelly Field, TX; demobilized in January 1919 at Garden City, NY; reconstituted on 3 December 1936). Location 7 December 1941—*Not initiated*.

Status: Disbanded 31 May 42.

615th School Squadron (ZI)**Organized Reserve New York/Minnesota****HQ-Not initiated** 1923-28

Constituted in the Organized Reserve 2 July 1923, assigned to the Zone of the Interior, and allotted to the Second Corps Area. Manhattan, NY, designated as headquarters on organization, but the unit was never organized at that location. Withdrawn from the Second Corps Area in 1925 and allotted to the Seventh Corps Area. Breckenridge, MN, designated as headquarters on organization, but the unit was never organized at that location. Withdrawn from the Seventh Corps Area 5 September 1928 and demobilized.

615th Supply Squadron (521st Air Depot)**Organized Reserve****HQ-Not initiated** 1936-41

Constituted in the Organized Reserve 1 October 1933, assigned to the 521st Air Depot, and allotted to the Seventh Corps Area. Consolidated on 3 December 1936 with the 615th Aero Squadron (Supply) (a WWI unit organized in January 1918 at Kelly Field, TX; demobilized in March 1919 at Souther Field, GA; reconstituted on 3 December 1936). Location 7 December 1941—*Not initiated*.

Status: Disbanded 31 May 42.**616th School Squadron (ZI)****Organized Reserve New York/Minnesota****HQ-Not initiated** 1923-28

Constituted in the Organized Reserve 2 July 1923, assigned to the Zone of the Interior, and allotted to the Second Corps Area. Manhattan, NY, designated as headquarters on organization, but the unit was never organized at that location. Withdrawn from the Second Corps Area in 1925 and allotted to the Seventh Corps Area. Moorhead, MN, designated as headquarters on organization, but the unit was never organized at that location. Withdrawn from the Seventh Corps Area 5 September 1928 and demobilized.

617th School Squadron (ZI)**Organized Reserve New York/Missouri****HQ-Not initiated** 1923-28

Constituted in the Organized Reserve 2 July 1923, assigned to the Zone of the Interior, and allotted to the Second Corps Area. Manhattan, NY, designated as headquarters on organization, but the unit was never organized at that location. Withdrawn from the Second Corps Area in 1925 and allotted to the Seventh Corps Area. Maryville, MO, designated as headquarters on organization, but the unit was never organized at that location. Withdrawn from the Seventh Corps Area 5 September 1928 and demobilized.

618th School Squadron (ZI)**Organized Reserve New York/Missouri****HQ-Not initiated** 1923-28

Constituted in the Organized Reserve 2 July 1923, assigned to the Zone of the Interior, and allotted to the Second Corps Area. Brooklyn, NY, designated as headquarters on organization, but the unit was never organized at that location. Withdrawn from the Second Corps Area in 1925 and allotted to the Seventh Corps Area. Maryville, MO, designated as headquarters on organization, but the unit was never organized at that location. Withdrawn from the Seventh Corps Area 5 September 1928 and demobilized.

619th School Squadron (ZI)**Organized Reserve New York/Missouri****HQ-Not initiated** 1923-28

Constituted in the Organized Reserve 2 July 1923, assigned to the Zone of the Interior, and allotted to the Second Corps Area. Brooklyn, NY, designated as headquarters on organization, but the unit was never organized at that location. Withdrawn from the Second Corps Area in 1925 and allotted to the Seventh Corps Area. St. Joseph, MO, designated as headquarters on organization, but the unit was never organized at that location. Withdrawn from the Seventh Corps Area 5 September 1928 and demobilized.

620th School Squadron (ZI)**Organized Reserve New York/Arkansas****HQ-Not initiated** 1923-28

Constituted in the Organized Reserve 2 July 1923, assigned to the Zone of the Interior, and allotted to the Second Corps Area. Bronx, NY, designated as headquarters on organization, but the unit was never organized at that location. Withdrawn from the Second Corps Area in 1925 and allotted to the Seventh Corps Area. Little Rock, AR, designated as headquarters on organization, but the unit was never organized at that location. Withdrawn from the Seventh Corps Area 5 September 1928 and demobilized.

621st School Squadron (ZI)**Organized Reserve South Dakota****HQ-Not initiated** 1923-28

Constituted in the Organized Reserve 2 July 1923, assigned to the Zone of the Interior, and allotted to the Second Corps Area. Withdrawn from the Second Corps Area in 1925 and allotted to the Seventh Corps Area. Withdrawn from the Seventh Corps Area 5 September 1928 and demobilized.

622nd School Squadron (ZI)**Organized Reserve****HQ-Not initiated** 1923-28

Constituted in the Organized Reserve 2 July 1923, assigned to the Zone of the Interior, and allotted to the Second Corps Area. Withdrawn from the Second Corps Area in 1925 and allotted to the Seventh Corps Area. Withdrawn from the Seventh Corps Area 5 September 1928 and demobilized.

623rd School Squadron (ZI)**Organized Reserve****HQ-Not initiated** 1923-28

Constituted in the Organized Reserve 2 July 1923, assigned to the Zone of the Interior, and allotted to the Second Corps Area. Withdrawn from the Second Corps Area in 1925 and allotted to the Seventh Corps Area. Withdrawn from the Seventh Corps Area 5 September 1928 and demobilized.

624th School Squadron (ZI)**Organized Reserve****HQ-Not initiated** 1923-28

Constituted in the Organized Reserve 2 July 1923, assigned to the Zone of the Interior, and allotted to the Second Corps Area. Withdrawn from the Second Corps Area in 1925 and allotted to the Seventh Corps Area. Withdrawn from the Seventh Corps Area 5 September 1928 and demobilized.

625th School Squadron (ZI)

Organized Reserve

HQ-Not initiated 1923-28

Constituted in the Organized Reserve 2 July 1923, assigned to the Zone of the Interior, and allotted to the Second Corps Area. Withdrawn from the Second Corps Area in 1925 and allotted to the Seventh Corps Area. Withdrawn from the Seventh Corps Area 5 September 1928 and demobilized.

626th School Squadron (ZI)

Organized Reserve

HQ-Not initiated 1923-28

Constituted in the Organized Reserve 2 July 1923, assigned to the Zone of the Interior, and allotted to the Second Corps Area. Withdrawn from the Second Corps Area in 1925 and allotted to the Seventh Corps Area. Withdrawn from the Seventh Corps Area 5 September 1928 and demobilized.

627th School Squadron (ZI)

Organized Reserve

HQ-Not initiated 1923-28

Constituted in the Organized Reserve 2 July 1923, assigned to the Zone of the Interior, and allotted to the Second Corps Area. Withdrawn from the Second Corps Area in 1925 and allotted to the Seventh Corps Area. Withdrawn from the Seventh Corps Area 5 September 1928 and demobilized.

628th School Squadron (ZI)

Organized Reserve

HQ-Not initiated 1923-28

Constituted in the Organized Reserve 2 July 1923, assigned to the Zone of the Interior, and allotted to the Second Corps Area. Withdrawn from the Second Corps Area in 1925 and allotted to the Seventh Corps Area. Withdrawn from the Seventh Corps Area 5 September 1928 and demobilized.

629th School Squadron (ZI)

Organized Reserve

HQ-Not initiated 1923-28

Constituted in the Organized Reserve 2 July 1923, assigned to the Zone of the Interior, and allotted to the Second Corps Area. Withdrawn from the Second Corps Area in 1925 and allotted to the Seventh Corps Area. Withdrawn from the Seventh Corps Area 5 September 1928 and demobilized.

630th School Squadron (ZI)

Organized Reserve

HQ-Not initiated 1923-28

Constituted in the Organized Reserve 2 July 1923, assigned to the Zone of the Interior, and allotted to the Second Corps Area. Withdrawn from the Second Corps Area in 1925 and allotted to the Seventh Corps Area. Withdrawn from the Seventh Corps Area 5 September 1928 and demobilized.

631st School Squadron (ZI)

Organized Reserve

HQ-Not initiated 1923-28

Constituted in the Organized Reserve 2 July 1923, assigned to the Zone of the Interior, and allotted to the Second Corps Area. Withdrawn from the Second Corps Area in 1925 and allotted to the Seventh Corps Area. Withdrawn from the Seventh Corps Area 5 September 1928 and demobilized.

632nd School Squadron (ZI)

Organized Reserve

HQ-Not initiated 1923-28

Constituted in the Organized Reserve 2 July 1923, assigned to the Zone of the Interior, and allotted to the Second Corps Area. Withdrawn from the Second Corps Area in 1925 and allotted to the Seventh Corps Area. Withdrawn from the Seventh Corps Area 5 September 1928 and demobilized.

633rd School Squadron (ZI)

Organized Reserve

HQ-Not initiated 1923-28

Constituted in the Organized Reserve 2 July 1923, assigned to the Zone of the Interior, and allotted to the Second Corps Area. Withdrawn from the Second Corps Area in 1925 and allotted to the Seventh Corps Area. Withdrawn from the Seventh Corps Area 5 September 1928 and demobilized.

634th School Squadron (ZI)

Organized Reserve

HQ-Not initiated 1923-28

Constituted in the Organized Reserve 2 July 1923, assigned to the Zone of the Interior, and allotted to the Second Corps Area. Withdrawn from the Second Corps Area in 1925 and allotted to the Seventh Corps Area. Withdrawn from the Seventh Corps Area 5 September 1928 and demobilized.

635th School Squadron (ZI)

Organized Reserve

HQ-Not initiated 1923-28

Constituted in the Organized Reserve 2 July 1923, assigned to the Zone of the Interior, and allotted to the Second Corps Area. Withdrawn from the Second Corps Area in 1925 and allotted to the Seventh Corps Area. Withdrawn from the Seventh Corps Area 5 September 1928 and demobilized.

636th School Squadron (ZI)

Organized Reserve

HQ-Not initiated 1923-28

Constituted in the Organized Reserve 2 July 1923, assigned to the Zone of the Interior, and allotted to the Second Corps Area. Withdrawn from the Second Corps Area in 1925 and allotted to the Seventh Corps Area. Withdrawn from the Seventh Corps Area 5 September 1928 and demobilized.

637th School Squadron (ZI)

Organized Reserve

HQ-Not initiated 1923-28

Constituted in the Organized Reserve 2 July 1923, assigned to the Zone of the Interior, and allotted to the Second Corps Area. Withdrawn from the Second Corps Area in 1925 and allotted to the Seventh Corps Area. Withdrawn from the Seventh Corps Area 5 September 1928 and demobilized.

638th School Squadron (ZI)

Organized Reserve

HQ-Not initiated 1923-28

Constituted in the Organized Reserve 2 July 1923, assigned to the Zone of the Interior, and allotted to the Second Corps Area. Withdrawn from the Second Corps Area in 1925 and allotted to the Seventh Corps Area. Withdrawn from the Seventh Corps Area 5 September 1928 and demobilized.

639th School Squadron (ZI)

Organized Reserve

HQ-Not initiated 1923-28

Constituted in the Organized Reserve 2 July 1923, assigned to the Zone of the Interior, and allotted to the Second Corps Area. Withdrawn from the Second Corps Area in 1925 and allotted to the Seventh Corps Area. Withdrawn from the Seventh Corps Area 5 September 1928 and demobilized.

640th School Squadron (ZI)

Organized Reserve

HQ-Not initiated 1923-28

Constituted in the Organized Reserve 2 July 1923, assigned to the Zone of the Interior, and allotted to the Second Corps Area. Withdrawn from the Second Corps Area in 1925 and allotted to the Seventh Corps Area. Withdrawn from the Seventh Corps Area 5 September 1928 and demobilized.

641st School Squadron (ZI)

Organized Reserve South Dakota

HQ-Not initiated 1923-28

Constituted in the Organized Reserve 2 July 1923, assigned to the Zone of the Interior, and allotted to the Second Corps Area. Withdrawn from the Second Corps Area in 1925 and allotted to the Seventh Corps Area. Withdrawn from the Seventh Corps Area 5 September 1928 and demobilized.

642nd School Squadron (ZI)

Organized Reserve

HQ-Not initiated 1923-28

Constituted in the Organized Reserve 2 July 1923, assigned to the Zone of the Interior, and allotted to the Second Corps Area. Withdrawn from the Second Corps Area in 1925 and allotted to the Seventh Corps Area. Withdrawn from the Seventh Corps Area 5 September 1928 and demobilized.

643rd School Squadron (ZI)

Organized Reserve

HQ-Not initiated 1923-28

Constituted in the Organized Reserve 2 July 1923, assigned to the Zone of the Interior, and allotted to the Second Corps Area. Withdrawn from the Second Corps Area in 1925 and allotted to the Seventh Corps Area. Withdrawn from the Seventh Corps Area 5 September 1928 and demobilized.

644th School Squadron (ZI)

Organized Reserve

HQ-Not initiated 1923-28

Constituted in the Organized Reserve 2 July 1923, assigned to the Zone of the Interior, and allotted to the Second Corps Area. Withdrawn from the Second Corps Area in 1925 and allotted to the Seventh Corps Area. Withdrawn from the Seventh Corps Area 5 September 1928 and demobilized.

645th School Squadron (ZI)

Organized Reserve

HQ-Not initiated 1923-28

Constituted in the Organized Reserve 2 July 1923, assigned to the Zone of the Interior, and allotted to the Second Corps Area. Withdrawn from the Second Corps Area in 1925 and allotted to the Seventh Corps Area. Withdrawn from the Seventh Corps Area 5 September 1928 and demobilized.

646th School Squadron (ZI)

Organized Reserve

HQ-Not initiated 1923-28

Constituted in the Organized Reserve 2 July 1923, assigned to the Zone of the Interior, and allotted to the Second Corps Area. Withdrawn from the Second Corps Area in 1925 and allotted to the Seventh Corps Area. Withdrawn from the Seventh Corps Area 5 September 1928 and demobilized.

647th School Squadron (ZI)

Organized Reserve

HQ-Not initiated 1923-28

Constituted in the Organized Reserve 2 July 1923, assigned to the Zone of the Interior, and allotted to the Second Corps Area. Withdrawn from the Second Corps Area in 1925 and allotted to the Seventh Corps Area. Withdrawn from the Seventh Corps Area 5 September 1928 and demobilized.

648th School Squadron (ZI)

Organized Reserve

HQ-Not initiated 1923-28

Constituted in the Organized Reserve 2 July 1923, assigned to the Zone of the Interior, and allotted to the Second Corps Area. Withdrawn from the Second Corps Area in 1925 and allotted to the Seventh Corps Area. Withdrawn from the Seventh Corps Area 5 September 1928 and demobilized.

649th School Squadron (ZI)**Organized Reserve****HQ-Not initiated** 1923-28

Constituted in the Organized Reserve 2 July 1923, assigned to the Zone of the Interior, and allotted to the Second Corps Area. Withdrawn from the Second Corps Area in 1925 and allotted to the Seventh Corps Area. Withdrawn from the Seventh Corps Area 5 September 1928 and demobilized.

650th School Squadron (ZI)**Organized Reserve****HQ-Not initiated** 1923-28

Constituted in the Organized Reserve 2 July 1923, assigned to the Zone of the Interior, and allotted to the Second Corps Area. Withdrawn from the Second Corps Area in 1925 and allotted to the Seventh Corps Area. Withdrawn from the Seventh Corps Area 5 September 1928 and demobilized.

651st School Squadron (ZI)**Organized Reserve South Dakota****HQ-Not initiated** 1923-28

Constituted in the Organized Reserve 2 July 1923, assigned to the Zone of the Interior, and allotted to the Second Corps Area. Withdrawn from the Second Corps Area in 1925 and allotted to the Seventh Corps Area. Madison, SD, designated as headquarters on organization, but the unit was never organized at that location. Withdrawn from the Seventh Corps Area 5 September 1928 and demobilized.

652nd School Squadron (ZI)**Organized Reserve South Dakota****HQ-Not initiated** 1923-28

Constituted in the Organized Reserve 2 July 1923, assigned to the Zone of the Interior, and allotted to the Second Corps Area. Withdrawn from the Second Corps Area in 1925 and allotted to the Seventh Corps Area. Aberdeen, SD, designated as headquarters on organization, but the unit was never organized at that location. Withdrawn from the Seventh Corps Area 5 September 1928 and demobilized.

652nd Repair Squadron (394th Air Depot)**Organized Reserve New York****HQ-Not initiated** 1933-41

Constituted in the Organized Reserve 1 October 1933, assigned to the 394th Air Depot, and allotted to the Second Corps Area. Buffalo, NY, designated as headquarters on organization, but the unit was never organized at that location. Consolidated on 3 December 1936 with the 652nd Aero Squadron (Supply) (a WWI unit organized in September 1917 as the 133rd Aero Squadron (Supply) at Kelly Field, TX; redesignated as the 652nd Aero Squadron (Supply) February 1918; demobilized in December 1918 at Garden City, NY; reconstituted on 3 December 1936). Location 7 December 1941—*Not initiated*.

Status: Disbanded 31 May 42.

653rd School Squadron (ZI)**Organized Reserve Kansas****HQ-Not initiated** 1923-28

Constituted in the Organized Reserve 2 July 1923, assigned to the Zone of the Interior, and allotted to the Second Corps Area. Withdrawn from the Second Corps Area in 1925 and allotted to the Seventh Corps Area. Hutchinson, KS designated as headquarters on organization, but the unit was never organized at that location. Withdrawn from the Seventh Corps Area 5 September 1928 and demobilized.

653rd Repair Squadron (394th Air Depot)**Organized Reserve New York****HQ-Not initiated** 1933-41

Constituted in the Organized Reserve 1 October 1933, assigned to the 394th Air Depot, and allotted to the Second Corps Area. Buffalo, NY, designated as headquarters on organization, but the unit was never organized at that location. Consolidated on 3 December 1936 with the 653rd Aero Squadron (Supply) (a WWI unit organized in September 1917 as the 134th Aero Squadron (Supply) September 1917 at Kelly Field, TX; redesignated as the 653rd Aero Squadron (Supply) February 1918; demobilized in December 1918 at Camp Morrison, VA; reconstituted on 3 December 1936). Location 7 December 1941—*Not initiated*.

Status: Disbanded 31 May 42.**654th School Squadron (ZI)****Organized Reserve Kansas****HQ-Not initiated** 1923-28

Constituted in the Organized Reserve 2 July 1923, assigned to the Zone of the Interior, and allotted to the Second Corps Area. Withdrawn from the Second Corps Area in 1925 and allotted to the Seventh Corps Area. Atchison, KS, designated as headquarters on organization, but the unit was never organized at that location. Withdrawn from the Seventh Corps Area 5 September 1928 and demobilized.

654th Repair Squadron (517th Air Depot)**Organized Reserve****HQ-Not initiated** 1933-41

Constituted in the Organized Reserve 1 October 1933, assigned to the 517th Air Depot, and allotted to the Third Corps Area. Consolidated on 4 December 1936 with the 654th Aero Squadron (Supply) (a WWI unit organized in October 1917 as the 146th Aero Squadron (Supply) at Garden City, NY; redesignated as the 654th Aero Squadron (Supply) January 1918; demobilized in January 1919 at Garden City, NY; reconstituted on 4 December 1936). Location 7 December 1941—*Not initiated*.

Status: Disbanded 31 May 42.**655th School Squadron (ZI)****Organized Reserve Kansas****HQ-Not initiated** 1923-28

Constituted in the Organized Reserve 2 July 1923, assigned to the Zone of the Interior, and allotted to the Second Corps Area. Withdrawn from the Second Corps Area in 1925 and allotted to the Seventh Corps Area. Emporia, KS, designated as headquarters on organization, but the unit was never organized at that location. Withdrawn from the Seventh Corps Area 5 September 1928 and demobilized.

655th Repair Squadron (517th Air Depot)**Organized Reserve****HQ**-*Not initiated* 1933-41

Constituted in the Organized Reserve 1 October 1933, assigned to the 517th Air Depot, and allotted to the Third Corps Area. Consolidated on 4 December 1936 with the 655th Aero Squadron (Supply) (a WWI unit organized in December 1917 as the 229th Aero Squadron (Supply) at Kelly Field, TX; redesignated as the 655th Aero Squadron (Supply) February 1918; demobilized in May 19 at Mitchel Field, NY; reconstituted on 4 December 1936). Location 7 December 1941—*Not initiated*.

Status: Disbanded 31 May 42.**656th School Squadron (ZI)****Organized Reserve Nebraska****HQ**-*Not initiated* 1923-28

Constituted in the Organized Reserve 2 July 1923, assigned to the Zone of the Interior, and allotted to the Second Corps Area. Withdrawn from the Second Corps Area in 1925 and allotted to the Seventh Corps Area. Lincoln, NE, designated as headquarters on organization, but the unit was never organized at that location. Withdrawn from the Seventh Corps Area 5 September 1928 and demobilized.

656th Repair Squadron (519th Air Depot)**Organized Reserve Ohio****HQ**-*Not initiated* 1933-41

Constituted in the Organized Reserve 1 October 1933, assigned to the 519th Air Depot, and allotted to the Fifth Corps Area. Columbus, OH, designated as headquarters on organization, but the unit was never organized at that location. Consolidated on 4 December 1936 with the 656th Aero Squadron (Supply) (a WWI unit organized in December 1917 as the 230th Aero Squadron (Supply) at Kelly Field, TX; redesignated as the 656th Aero Squadron (Supply) February 1918; demobilized in May 19 at Mitchel Field, NY; reconstituted on 4 December 1936). Location 7 December 1941—*Not initiated*.

Status: Disbanded 31 May 42.**657th School Squadron (ZI)****Organized Reserve Nebraska****HQ**-*Not initiated* 1923-28

Constituted in the Organized Reserve 2 July 1923, assigned to the Zone of the Interior, and allotted to the Second Corps Area. Withdrawn from the Second Corps Area in 1925 and allotted to the Seventh Corps Area. Lincoln, NE, designated as headquarters on organization, but the unit was never organized at that location. Withdrawn from the Seventh Corps Area 5 September 1928 and demobilized.

657th Repair Squadron (519th Air Depot)**Organized Reserve Indiana****HQ**-*Not initiated* 1933-41

Constituted in the Organized Reserve 1 October 1933, assigned to the 519th Air Depot, and allotted to the Fifth Corps Area. Indianapolis, IN, designated as headquarters on organization, but the unit was never organized at that location. Consolidated on 4 December 1936 with the 657th Aero Squadron (Supply) (a WWI unit organized in December 1917 as the 231st Aero Squadron (Supply) at Kelly Field, TX; redesignated as the 657th Aero Squadron (Supply) February 1918; demobilized in March 1919 at Garden City, NY; reconstituted on 4 December 1936). Location 7 December 1941—*Not initiated*.

Status: Disbanded 31 May 42.

658th School Squadron (ZI)**Organized Reserve Missouri****HQ-Not initiated** 1923-28

Constituted in the Organized Reserve 2 July 1923, assigned to the Zone of the Interior, and allotted to the Second Corps Area. Withdrawn from the Second Corps Area in 1925 and allotted to the Seventh Corps Area. Joplin, MO, designated as headquarters on organization, but the unit was never organized at that location. Withdrawn from the Seventh Corps Area 5 September 1928 and demobilized.

658th Repair Squadron (520th Air Depot)**Organized Reserve Illinois****HQ-Not initiated** 1933-41

Constituted in the Organized Reserve 1 October 1933, assigned to the 520th Air Depot, and allotted to the Sixth Corps Area. Chicago, IL, designated as headquarters on organization, but the unit was never organized at that location. Consolidated on 4 December 1936 with the 658th Aero Squadron (Supply) (a WWI unit organized in December 1917 as the 232nd Aero Squadron (Supply) at Kelly Field, TX; redesignated as the 658th Aero Squadron (Supply) February 1918; demobilized in May 19 at Mitchel Field, NY; reconstituted on 4 December 1936). Location 7 December 1941—*Not initiated*.

Status: Disbanded 31 May 42.**659th School Squadron (ZI)****Organized Reserve Missouri****HQ-Not initiated** 1923-28

Constituted in the Organized Reserve 2 July 1923, assigned to the Zone of the Interior, and allotted to the Second Corps Area. Withdrawn from the Second Corps Area in 1925 and allotted to the Seventh Corps Area. Sedalia, MO, designated as headquarters on organization, but the unit was never organized at that location. Withdrawn from the Seventh Corps Area 5 September 1928 and demobilized.

659th Repair Squadron (520th Air Depot)**Organized Reserve Illinois****HQ-Not initiated** 1933-41

Constituted in the Organized Reserve 1 October 1933, assigned to the 520th Air Depot, and allotted to the Sixth Corps Area. Chicago, IL, designated as headquarters on organization, but the unit was never organized at that location. Consolidated on 4 December 1936 with the 659th Aero Squadron (Supply) (a WWI unit organized in December 1917 as the 233rd Aero Squadron (Supply) at Kelly Field, TX; redesignated as the 659th Aero Squadron (Supply) February 1918; demobilized in July 1919 at Mitchel Field, NY; reconstituted on 4 December 1936). Location 7 December 1941—*Not initiated*.

Status: Disbanded 31 May 42.**660th School Squadron (ZI)****Organized Reserve Missouri****HQ-Not initiated** 1923-28

Constituted in the Organized Reserve 2 July 1923, assigned to the Zone of the Interior, and allotted to the Second Corps Area. Withdrawn from the Second Corps Area in 1925 and allotted to the Seventh Corps Area. St. Louis, MO, designated as headquarters on organization, but the unit was never organized at that location. Withdrawn from the Seventh Corps Area 5 September 1928 and demobilized.

660th Repair Squadron (518th Air Depot)**Organized Reserve Alabama/New York****HQ-Not initiated** 1933-41

Constituted in the Organized Reserve 1 October 1933, assigned to the 518th Air Depot, and allotted to the Fourth Corps Area. Montgomery, AL, designated as headquarters on organization, but the unit was never organized at that location. Withdrawn from the Fourth Corps Area 5 June 1936 and allotted to the Second Corps Area. Mitchel Field, NY, designated as headquarters on organization, but the unit was never organized at that location. Consolidated on 4 December 1936 with the 660th Aero Squadron (Supply) (a WWI unit organized in December 1917 as the 234th Aero Squadron (Supply) at Kelly Field, TX; redesignated as the 660th Aero Squadron (Supply) February 1918; demobilized in June 1919 at Mitchel Field, NY; reconstituted on 4 December 1936). Location 7 December 1941—*Not initiated*.

Status: Disbanded 31 May 42.**661st School Squadron (ZI)****Organized Reserve Iowa****HQ-Not initiated** 1923-28

Constituted in the Organized Reserve 2 July 1923, assigned to the Zone of the Interior, and allotted to the Seventh Corps Area. Oelwein, IA, designated as headquarters on organization, but the unit was never organized at that location. Withdrawn from the Seventh Corps Area 5 September 1928 and demobilized.

661st Repair Squadron (518th Air Depot)**Organized Reserve Louisiana/New York****HQ-Not initiated** 1933-41

Constituted in the Organized Reserve 1 October 1933, assigned to the 518th Air Depot, and allotted to the Fourth Corps Area. Shreveport, LA, designated as headquarters on organization, but the unit was never organized at that location. Withdrawn from the Fourth Corps Area 5 June 1936 and allotted to the Second Corps Area. Mitchel Field, NY, designated as headquarters on organization, but the unit was never organized at that location. Consolidated 4 December 1936 with the 661st Aero Squadron (Supply) (a WWI unit organized in December 1917 as the 235th Aero Squadron (Supply) at Kelly Field, TX; redesignated as the 661st Aero Squadron (Supply) February 1918; demobilized in December 1918 at Garden City, NY; reconstituted on 4 December 1936). Location 7 December 1941—*Not initiated*.

Status: Disbanded 31 May 42.**662nd Repair Squadron (806th Air Depot)****Organized Reserve New York****HQ-Not initiated** 1933-35; Eighth Corps Area 1935-36; *Inactive* 1936-41

Constituted in the Organized Reserve 1 October 1933, assigned to the 806th Air Depot, and allotted to the Eighth Corps Area. Initiated 20 June 1935 in the Eighth Corps Area. Withdrawn from the Eighth Corps Area 5 June 1936 and allotted to the Second Corps Area. Buffalo, NY, designated as headquarters on organization, but the unit was never organized at that location. Inactivated 31 October 1936 in the Eighth Corps Area by relief of personnel. Consolidated on 4 December 1936 with the 662nd Aero Squadron (Supply) (a WWI unit organized in December 1917 as the 236th Aero Squadron (Supply) at Kelly Field, TX; redesignated as the 662nd Aero Squadron (Supply) February 1918; demobilized in April 1919 at San Antonio, TX; reconstituted on 4 December 1936). Location 7 December 1941—*Inactive*.

Status: Disbanded 31 May 42.

662nd School Squadron (ZI)**Organized Reserve Iowa****HQ-Not initiated** 1923-28

Constituted in the Organized Reserve 2 July 1923, assigned to the Zone of the Interior, and allotted to the Seventh Corps Area. Mason City, IA, designated as headquarters on organization, but the unit was never organized at that location. Withdrawn from the Seventh Corps Area 5 September 1928 and demobilized.

663rd Repair Squadron (806th Air Depot)**Organized Reserve New Jersey****HQ-Not initiated** 1933-35; Eighth Corps Area 1935-36; Newark, NJ 1936-37; Not organized 1937-41

Constituted in the Organized Reserve 1 October 1933, assigned to the 806th Air Depot, and allotted to the Eighth Corps Area. Initiated 20 June 1935 in the Eighth Corps Area. Withdrawn from the Eighth Corps Area 5 June 1936 and allotted to the Second Corps Area. Inactivated 31 October 1936 in the Eighth Corps Area by relief of personnel. Reorganized in 1937 at Newark, NJ. Consolidated on 4 December 1936 with the 663rd Aero Squadron (Supply) (a WWI unit organized in December 1917 as the 237th Aero Squadron (Supply) at Kelly Field, TX; redesignated as the 662nd Aero Squadron (Supply) February 1918; demobilized in December 1918 at Garden City, NY; reconstituted on 4 December 1936). Inactivated by September 1937 at Newark by relief of personnel. Location 7 December 1941—*Inactive*.

Status: Disbanded 31 May 42.**664th Repair Squadron (521st Air Depot)****Organized Reserve****HQ-Not initiated** 1933-41

Constituted in the Organized Reserve 1 October 1933, assigned to the 521st Air Depot, and allotted to the Seventh Corps Area. Location 7 December 1941—*Not initiated*.

Status: Disbanded 31 May 42.**665th Repair Squadron (521st Air Depot)****Organized Reserve****HQ-Not initiated** 1933-41

Constituted in the Organized Reserve 1 October 1933, assigned to the 521st Air Depot, and allotted to the Seventh Corps Area. Consolidated on 4 December 1936 with the 665th Aero Squadron (Supply) (a WWI unit organized in December 1917 as the 239th Aero Squadron (Supply) at Kelly Field, TX; redesignated as the 665th Aero Squadron (Supply) February 1918; demobilized in December 1918 at Garden City, NY; reconstituted on 4 December 1936). Location 7 December 1941—*Not initiated*.

Status: Disbanded 31 May 42.**747th School Squadron (ZI)****Organized Reserve Minnesota****HQ-Not initiated** 1923-25; St. Paul, MN, 1925-28

Constituted in the Organized Reserve 2 July 1923, assigned to the Zone of the Interior, and allotted to the Seventh Corps Area. Initiated by June 1925 at St. Paul, MN. Withdrawn from the Seventh Corps Area 5 September 1928 and demobilized.

748th School Squadron (ZI)

Organized Reserve Minnesota

HQ-Not initiated 1923-25; St. Paul, MN, 1925-28

Constituted in the Organized Reserve 2 July 1923, assigned to the Zone of the Interior, and allotted to the Seventh Corps Area. Initiated by June 1925 at St. Paul, MN. Withdrawn from the Seventh Corps Area 5 September 1928 and demobilized.

749th School Squadron (ZI)

Organized Reserve Minnesota

HQ-Not initiated 1923-25; St. Paul, MN, 1925-28

Constituted in the Organized Reserve 2 July 1923, assigned to the Zone of the Interior, and allotted to the Seventh Corps Area. Initiated by June 1925 at St. Paul, MN. Withdrawn from the Seventh Corps Area 5 September 1928 and demobilized.

750th School Squadron (ZI)

Organized Reserve North Dakota

HQ-Not initiated 1923-25; Oaks, ND, 1925-28

Constituted in the Organized Reserve 2 July 1923, assigned to the Zone of the Interior, and allotted to the Seventh Corps Area. Initiated by June 1925 at Oaks, ND. Withdrawn from the Seventh Corps Area 5 September 1928 and demobilized.

751st School Squadron (ZI)

Organized Reserve Minnesota

HQ-Not initiated 1923-28

Constituted in the Organized Reserve 2 July 1923, assigned to the Zone of the Interior, and allotted to the Seventh Corps Area. St. Paul, MN, designated as headquarters on organization, but the unit was never organized at that location. Withdrawn from the Seventh Corps Area 5 September 1928 and demobilized.

752nd School Squadron (ZI)

Organized Reserve Minnesota

HQ-Not initiated 1923-25; St. Paul, MN, 1925-28

Constituted in the Organized Reserve 2 July 1923, assigned to the Zone of the Interior, and allotted to the Seventh Corps Area. Initiated by June 1925 at St. Paul, MN. Withdrawn from the Seventh Corps Area 5 September 1928 and demobilized.

753rd School Squadron (ZI)

Organized Reserve Missouri

HQ-Not initiated 1923-25; St. Louis, MO, 1925-28

Constituted in the Organized Reserve 2 July 1923, assigned to the Zone of the Interior, and allotted to the Seventh Corps Area. Initiated by June 1925 at St. Louis, MO. Withdrawn from the Seventh Corps Area 5 September 1928 and demobilized.

754th School Squadron (ZI)

Organized Reserve Missouri

HQ-Not initiated 1923-28

Constituted in the Organized Reserve 2 July 1923, assigned to the Zone of the Interior, and allotted to the Seventh Corps Area. St. Louis, MO, designated as headquarters on organization, but the unit was never organized at that location. Withdrawn from the Seventh Corps Area 5 September 1928 and demobilized.

755th School Squadron (ZI)

Organized Reserve Missouri

HQ-Not initiated 1923-28

Constituted in the Organized Reserve 2 July 1923, assigned to the Zone of the Interior, and allotted to the Seventh Corps Area. St. Louis, MO, designated as headquarters on organization, but the unit was never organized at that location. Withdrawn from the Seventh Corps Area 5 September 1928 and demobilized.

756th School Squadron (ZI)

Organized Reserve Missouri

HQ-Not initiated 1923-28

Constituted in the Organized Reserve 2 July 1923, assigned to the Zone of the Interior, and allotted to the Seventh Corps Area. St. Louis, MO, designated as headquarters on organization, but the unit was never organized at that location. Withdrawn from the Seventh Corps Area 5 September 1928 and demobilized.

757th School Squadron (ZI)

Organized Reserve Missouri

HQ-Not initiated 1923-28

Constituted in the Organized Reserve 2 July 1923, assigned to the Zone of the Interior, and allotted to the Seventh Corps Area. St. Louis, MO, designated as headquarters on organization, but the unit was never organized at that location. Withdrawn from the Seventh Corps Area 5 September 1928 and demobilized.

758th School Squadron (ZI)

Organized Reserve Missouri

HQ-Not initiated 1923-28

Constituted in the Organized Reserve 2 July 1923, assigned to the Zone of the Interior, and allotted to the Seventh Corps Area. St. Louis, MO, designated as headquarters on organization, but the unit was never organized at that location. Withdrawn from the Seventh Corps Area 5 September 1928 and demobilized.

759th School Squadron (ZI)

Organized Reserve Missouri

HQ-Not initiated 1923-25; Kansas City, MO, 1925-28

Constituted in the Organized Reserve 2 July 1923, assigned to the Zone of the Interior, and allotted to the Seventh Corps Area. Initiated by June 1925 at Kansas City, MO. Withdrawn from the Seventh Corps Area 5 September 1928 and demobilized.

760th School Squadron (ZI)

Organized Reserve Missouri

HQ-Not initiated 1923-25; Kansas City, MO, 1925-28

Constituted in the Organized Reserve 2 July 1923, assigned to the Zone of the Interior, and allotted to the Seventh Corps Area. Initiated by June 1925 at Kansas City, MO. Withdrawn from the Seventh Corps Area 5 September 1928 and demobilized.

761st School Squadron (ZI)

Organized Reserve Missouri

HQ-Not initiated 1923-25; Kansas City, MO, 1925-28

Constituted in the Organized Reserve 2 July 1923, assigned to the Zone of the Interior, and allotted to the Seventh Corps Area. Initiated by June 1925 at Kansas City, MO. Withdrawn from the Seventh Corps Area 5 September 1928 and demobilized.

762nd School Squadron (ZI)

Organized Reserve Missouri

HQ-Not initiated 1923-25; Kansas City, MO, 1925-28

Constituted in the Organized Reserve 2 July 1923, assigned to the Zone of the Interior, and allotted to the Seventh Corps Area. Initiated by June 1925 at Kansas City, MO. Withdrawn from the Seventh Corps Area 5 September 1928 and demobilized.

763rd School Squadron (ZI)

Organized Reserve Missouri

HQ-Not initiated 1923-25; Kansas City, MO, 1925-28

Constituted in the Organized Reserve 2 July 1923, assigned to the Zone of the Interior, and allotted to the Seventh Corps Area. Initiated by June 1925 at Kansas City, MO. Withdrawn from the Seventh Corps Area 5 September 1928 and demobilized.

764th School Squadron (ZI)

Organized Reserve Missouri

HQ-Not initiated 1923-25; Kansas City, MO, 1925-28

Constituted in the Organized Reserve 2 July 1923, assigned to the Zone of the Interior, and allotted to the Seventh Corps Area. Initiated by June 1925 at Kansas City, MO. Withdrawn from the Seventh Corps Area 5 September 1928 and demobilized.

765th School Squadron (ZI)

Organized Reserve Missouri

HQ-Not initiated 1923-25; St. Joseph, MO, 1925-28

Constituted in the Organized Reserve 2 July 1923, assigned to the Zone of the Interior, and allotted to the Seventh Corps Area. Initiated by June 1925 at St. Joseph, MO. Withdrawn from the Seventh Corps Area 5 September 1928 and demobilized.

766th School Squadron (ZI)

Organized Reserve Missouri

HQ-Not initiated 1923-25; St. Joseph, MO, 1925-28

Constituted in the Organized Reserve 2 July 1923, assigned to the Zone of the Interior, and allotted to the Seventh Corps Area. Initiated by June 1925 at St. Joseph, MO. Withdrawn from the Seventh Corps Area 5 September 1928 and demobilized.

767th School Squadron (ZI)

Organized Reserve Missouri

HQ-Not initiated 1923-25; St. Joseph, MO, 1925-28

Constituted in the Organized Reserve 2 July 1923, assigned to the Zone of the Interior, and allotted to the Seventh Corps Area. Initiated by June 1925 at St. Joseph, MO. Withdrawn from the Seventh Corps Area 5 September 1928 and demobilized.

768th School Squadron (ZI)

Organized Reserve Missouri

HQ-Not initiated 1923-25; St. Joseph, MO, 1925-28

Constituted in the Organized Reserve 2 July 1923, assigned to the Zone of the Interior, and allotted to the Seventh Corps Area. Initiated by June 1925 at St. Joseph, MO. Withdrawn from the Seventh Corps Area 5 September 1928 and demobilized.

769th School Squadron (ZI)

Organized Reserve Missouri

HQ-Not initiated 1923-25; St. Joseph, MO, 1925-28

Constituted in the Organized Reserve 2 July 1923, assigned to the Zone of the Interior, and allotted to the Seventh Corps Area. Initiated by June 1925 at St. Joseph, MO. Withdrawn from the Seventh Corps Area 5 September 1928 and demobilized.

770th School Squadron (ZI)

Organized Reserve Missouri

HQ-Not initiated 1923-25; St. Joseph, MO, 1925-28

Constituted in the Organized Reserve 2 July 1923, assigned to the Zone of the Interior, and allotted to the Seventh Corps Area. Initiated by June 1925 at St. Joseph, MO. Withdrawn from the Seventh Corps Area 5 September 1928 and demobilized.

Part VII

Engineer Organizations

1919-41

Chapter 34

Engineer Major Commands



The Military Engineer

Troops of the 4th Engineers construct a pontoon bridge across the Chattahoochee River at Fort Benning, GA.

There were a number of different types of major engineer commands in the interwar army, some with very specialized missions, others possessing a more general engineering function. All provided command and control for various types of engineer organizations and operations.

Organization

The largest engineer command was the Engineer Headquarters, General Headquarters constituted in 1921. This command was demobilized in 1928 and replaced in 1933 by the Headquarters Engineer Service, General Headquarters. Both commands provided the same function—providing command and control of General Headquarters Reserve engineer units. The former command was an Organized Reserve headquarters; the latter was constituted in the Regular Army.

Another major command was the Engineer Headquarters, Communications Zone constituted in the Regular Army in 1928. The mission of this headquarters was to command and control railroad operations in the communications zone of a major theater of war.

Six army engineer headquarters were constituted in the Organized Reserve in 1921. These commands were responsible for the improvement and construction of roads, railroads, and bridges in the army area of operations. Its units also provided camouflage, topographic, and water supply services to the field army. The army engineer service consisted of the following units:

- Headquarters, Army Engineer Service
- Three Engineer Regiments (General Service)
- Six Engineer Battalions (Auxiliary)

- One Engineer Battalion (Topographic)
- One Engineer Train (Water Tank)
- Five Engineer Trains (Heavy Bridge)
- Two Engineer Trains (Light Bridge)
- One Engineer Train (Dump Truck)
- One Engineer Company (Camouflage)

Of the eighteen corps engineer headquarters two were constituted in the National Guard, the remainder in the Organized Reserve. These commands did much of the same work for the corps as did the army engineers at that level, although their capabilities in most areas were far more limited. The corps engineer service consisted of one engineer regiment (general service) and three auxiliary engineer battalions.

Seventeen Engineer Headquarters (Railway Service) were constituted in the Army between 1921 and 1941. Four of these were in the Regular Army, the remainder in the Organized Reserve. These headquarters' mission was to provide command and control to two or more engineer railway operating battalions operating rail system sections within the advanced, intermediate, or base sections of the Communications Zone. These headquarters answered to the Engineer Headquarters, Communications Zone.

Six Engineer Headquarters (Communications Zone Section) were constituted in the Organized Reserve in 1923. These headquarters' mission was to provide command and control to engineer organizations operating within a designated geographical section of the advanced, intermediate, or base sections in the Communications Zone. These headquarters also answered to the Engineer Headquarters, Communications Zone.

Training

None of these headquarters served on active duty in the interwar period, though many were organized in the Reserves during that period. With the exception of several RAI railway service headquarters, all were inactivated by 1929. None functioned as actual headquarters. These units were primarily used for mobilization assignments (i.e. pool units) for Organized Reserve engineer officers with professional engineering skills gained from their civilian employment. There's no evidence any were functional units during the Inactive Training period or attended training camps, CPXs, or maneuvers as such.

ENGINEER HEADQUARTERS

Engineer Headquarters, General Headquarters

Organized Reserve New York

HQ-Manhattan, NY, 1921-28

Constituted in the Organized Reserve 15 October 1921 and allotted to the Second Corps Area. Headquarters initiated 15 October 1921 at 39 Whitehall Street, Manhattan, NY. This headquarters was constituted to provide command and control of mobilized engineer units assigned to the General Headquarters Reserve. Withdrawn from the Second Corps Area 5 September 1928 and demobilized.

Commanders, Engineer Headquarters, General Headquarters (Deputy Chief Engineer)

Col. Frederick Scheidenhelm	15 Sep 21-6 Mar 22	Col. Frederick Scheidenhelm	11 Mar 25-21 Aug 26
Brig. Gen. William B. Parsons	7 Mar 22-11 Mar 25	Col. William G. Atwood	21 Aug 26-23 Jan 28
	Brig. Gen. Jay J. Morrow	23 Jan 28-5 Sep 28	

Engineer Headquarters, Communications Zone

Regular Army Inactive

HQ-*Not organized* 1928-41

Constituted in the Regular Army 5 September 1928 and allotted to the Second Corps Area. This headquarters was constituted to provide military liaison personnel to command and control railroad operations in the communications zone of a major theater of war. Location 7 December 1941—*Not organized*.

Status: Disbanded 18 October 1943.

Headquarters Engineer Service, General Headquarters

Regular Army Inactive

HQ-*Not organized* 1933-41

Constituted in the Regular Army 1 October 1933 and allotted to the Second Corps Area. This headquarters was constituted to provide command and control of mobilized engineer units assigned to the General Headquarters Reserve. Location 7 December 1941—*Not organized*.

First Army Engineer Headquarters (First Army)

Organized Reserve New York

HQ-*Not initiated* 1921-22; Manhattan, NY, 1922-28

Subordinate elements-330th Engineer Regiment; 340th Engineer Regiment; 350th Engineer Regiment; 653rd Engineer Battalion (Topo); 524th Engineer Battalion; 525th Engineer Battalion; 526th Engineer Battalion; 527th Engineer Battalion; 590th Engineer Battalion; 644th Engineer Battalion; 534th Engineer Battalion (WS); 474th Engineer Company (HP); 475th Engineer Company (HP); 535th Engineer Company (HP); 536th Engineer Company (HP); 655th Engineer Company (HP); 537th Engineer Company (LP); 658th Engineer Company (LP); 578th Engineer Company (DT); D/40th Engineer Regiment (Camo)

Constituted in the Organized Reserve 15 October 1921, assigned to the First Army, and allotted to the Second Corps Area. Headquarters initiated 11 February 1922 at Manhattan, NY. Withdrawn from the Organized Reserve 18 October 1927 and allotted to the Regular Army. Withdrawn from the Second Corps Area 5 September 1928.

Commanders, First Army Engineer Headquarters

Col. Frederic A. Snyder	11 Feb 22-22 Mar 23	Col. Harrison D. Emerson	22 Mar 23-2 Aug 26
	Brig. Gen. Jay J. Morrow	2 Aug 26-23 Jan 28	

Second Army Engineer Headquarters (Second Army)**Organized Reserve Illinois****HQ-Not initiated** 1921-22; Chicago, IL, 1922-28

Subordinate elements-356th Engineer Regiment; 363rd Engineer Regiment; 364th Engineer Regiment; 29th Engineer Battalion (Topo); 528th Engineer Battalion; 645th Engineer Battalion; 646th Engineer Battalion; 647th Engineer Battalion; 648th Engineer Battalion; 649th Engineer Battalion; 486th Engineer Battalion (WS); 540th Engineer Company (HP); 542nd Engineer Company (HP); 543rd Engineer Company (HP); 545th Engineer Company (HP); 546th Engineer Company (HP); 481st Engineer Company (LP); 547th Engineer Company (LP); 576th Engineer Company (DT); E/40th Engineer Regiment (Camo)

Constituted in the Organized Reserve 15 October 1921, assigned to the Second Army, and allotted to the Sixth Corps Area. Headquarters initiated in December 1922 at Chicago, IL. Withdrawn from the Organized Reserve and Sixth Corps Area 5 September 1928.

Commanders, Second Army Engineer Headquarters

Unknown	Dec 22-6 Mar 24	Lt. Col. William H. Messenger	6 Mar 24-ao Apr 24
	Unknown	ao Apr 24-5 Sep 28	

Third Army Engineer Headquarters (Third Army)**Organized Reserve Arkansas****HQ-Not initiated** 1921-22; Hot Springs, AR, 1922-28

Subordinate elements-365th Engineer Regiment; 369th Engineer Regiment; 370th Engineer Regiment; 654th Engineer Battalion (Topo); 529th Engineer Battalion; 530th Engineer Battalion; 531st Engineer Battalion; 532nd Engineer Battalion; 533rd Engineer Battalion; 650th Engineer Battalion; 548th Engineer Battalion (WS); 479th Engineer Company (HP); 549th Engineer Company (HP); 550th Engineer Company (HP); 551st Engineer Company (HP); 623rd Engineer Company (HP); 541st Engineer Company (LP); 552nd Engineer Company (LP); 580th Engineer Company (DT); F/40th Engineer Regiment (Camo)

Constituted in the Organized Reserve 15 October 1921, assigned to the Third Army, and allotted to the Seventh Corps Area. Headquarters initiated 11 March 1922 at Hot Springs, AR. Withdrawn from the Organized Reserve and Seventh Corps Area 5 September 1928.

Commanders, Third Army Engineer Headquarters

Lt. Col. James F. Hickey	11 Mar 22-ao May 22	Unknown	ao May 22-5 Sep 28
--------------------------	---------------------	---------	--------------------

Fourth Army Engineer Headquarters (Fourth Army)**Organized Reserve Pennsylvania****HQ-Not initiated** 1921-22; Harrisburg, PA, 1922-28; *Inactive* 1928

Subordinate elements-351st Engineer Regiment; 352nd Engineer Regiment; 353rd Engineer Regiment; 447th Engineer Battalion (Topo); 448th Engineer Battalion; 449th Engineer Battalion; 450th Engineer Battalion; 451st Engineer Battalion; 452nd Engineer Battalion; 453rd Engineer Battalion; 473rd Engineer Battalion (WS); 468th Engineer Company (HP); 469th Engineer Company (HP); 470th Engineer Company (HP); 471st Engineer Company (HP); 575th Engineer Company (HP); 472nd Engineer Company (LP); 476th Engineer Company (LP); 587th Engineer Company (DT); G/40th Engineer Regiment (Camo)

Constituted in the Organized Reserve 15 October 1921, assigned to the Fourth Army, and allotted to the Third Corps Area. Headquarters initiated in June 1922 at Harrisburg, PA. Inactivated 8 March 1928 at Harrisburg by relief of personnel. Withdrawn from the Organized Reserve and Third Corps Area 5 September 1928.

Commanders, Fourth Army Engineer Headquarters

Lt. Col. George J. Richers	Jun 22-26 Sep 22	Unknown	ao Jun 24-ao Sep 25
Col. James Milliken	26 Sep 22-ao Jun 24	Col. George J. Richers	ao Sep 25-12 Apr 26
	Col. James Milliken	12 Apr 26-8 Mar 28	

Fifth Army Engineer Headquarters (Fifth Army)**Organized Reserve Indiana****HQ-***Not initiated* 1921-23; Indianapolis, IN, 1923-28**Subordinate elements-***164th Engineer Regiment; 354th Engineer Regiment; 355th Engineer Regiment; 458th Engineer Battalion (Topo); 454th Engineer Battalion; 455th Engineer Battalion; 456th Engineer Battalion; 457th Engineer Battalion; 460th Engineer Battalion; 461st Engineer Battalion; 544th Engineer Battalion (WS); 477th Engineer Company (HP); 478th Engineer Company (HP); 482nd Engineer Company (HP); 538th Engineer Company (HP); 539th Engineer Company (HP); 488th Engineer Company (LP); 588th Engineer Company (LP); 579th Engineer Company (DT); H/40th Engineer Regiment (Camo)*

Constituted in the Organized Reserve 15 October 1921, assigned to the Fifth Army, and allotted to the Fifth Corps Area. Headquarters initiated in October 1923 at Indianapolis, IN. Withdrawn from the Organized Reserve and Fifth Corps Area 5 September 1928.

Commanders, Fifth Army Engineer Headquarters

Maj. Francis H. Miller

14 Dec 23-ao Jun 24

Unknown

ao Jun 24-5 Sep 28

Sixth Army Engineer Headquarters (Sixth Army)**Organized Reserve Missouri****HQ-***Not initiated* 1921-22; Kansas City, MO, 1922-28**Subordinate elements-***357th Engineer Regiment; 358th Engineer Regiment; 359th Engineer Regiment; 459th Engineer Battalion (Topo); 462nd Engineer Battalion; 463rd Engineer Battalion; 464th Engineer Battalion; 465th Engineer Battalion; 466th Engineer Battalion; 467th Engineer Battalion; 487th Engineer Battalion (WS); 480th Engineer Company (HP); 483rd Engineer Company (HP); 484th Engineer Company (HP); 485th Engineer Company (HP); 622nd Engineer Company (HP); 589th Engineer Company (LP); 624th Engineer Company (LP); 577th Engineer Company (DT); I/40th Engineer Regiment (Camo)*

Constituted in the Organized Reserve 15 October 1921, assigned to the Six Army, and allotted to the Seventh Corps Area. Headquarters initiated in April 1922 at Kansas City, MO. Withdrawn from the Organized Reserve and Seventh Corps Area 5 September 1928.

Commanders, Sixth Army Engineer Headquarters

Unknown

Apr 22-ao Mar 25

Lt. Col. Edward E. McKeighan

ao Mar 25-5 Sep 28

I Corps Engineer Headquarters (I Corps)**Organized Reserve Massachusetts****HQ-**Boston, MA, 1921-28**Subordinate elements-***13th Engineer Regiment (GS); 438th Engineer Battalion (Aux); 439th Engineer Battalion (Aux); 440th Engineer Battalion (Aux)*

Constituted in the Organized Reserve 15 October 1921, assigned to the I Corps, and allotted to the First Corps Area. Headquarters initiated in December 1921 at Boston, MA. Withdrawn from the Organized Reserve and Seventh Corps Area 5 September 1928.

Commanders, I Corps Engineer Headquarters

Col. Dugald C. Jackson, Jr.

Dec 21-5 Sep 28

II Corps Engineer Headquarters (II Corps)**New York National Guard****HQ-***Not organized* 1920-28**Subordinate elements-***131st Engineer Regiment (GS); 139th Engineer Battalion (Aux); 441st Engineer Battalion (Aux); 442nd Engineer Battalion (Aux)*

Constituted in the National Guard 30 December 1920, assigned to the II Corps, and allotted to the state of New York. Manhattan, NY, designated as the unit's headquarters location upon organization, but the unit was never organized. Withdrawn from the state of New York 6 December 1921. Further withdrawn from the Second Corps Area 5 September 1928 and demobilized.

III Corps Engineer Headquarters (III Corps)

Organized Reserve Pennsylvania

HQ-*Not initiated* 1921-22; Philadelphia, PA, 1922-28; *Inactive* 1928

Subordinate elements-*132nd Engineer Regiment (GS); 140th Engineer Battalion (Aux); 141st Engineer Battalion (Aux); 142nd Engineer Battalion (Aux)*

Constituted in the Organized Reserve 15 October 1921, assigned to the III Corps, and allotted to the Third Corps Area. Headquarters initiated 25 January 1922 at Philadelphia, PA. Inactivated 8 March 1928 at Philadelphia by relief of personnel. Withdrawn from the Organized Reserve and Seventh Corps Area 5 September 1928.

Commanders, III Corps Engineer Headquarters

Maj. Otley E. Jackson	25 Jan 22-12 Oct 23	Col. Claude H. Birdseye	12 Oct 23-8 Mar 28
-----------------------	---------------------	-------------------------	--------------------

IV Corps Engineer Headquarters (IV Corps)

Organized Reserve Georgia

HQ-Atlanta, GA, 1921-28

Subordinate elements-*133rd Engineer Regiment (GS); 143rd Engineer Battalion (Aux); 144th Engineer Battalion (Aux); 443rd Engineer Battalion (Aux)*

Constituted in the Organized Reserve 15 October 1921, assigned to the IV Corps, and allotted to the Fourth Corps Area. Headquarters initiated 14 December 1921 at Atlanta, GA. Withdrawn from the Organized Reserve and Fourth Corps Area 5 September 1928.

Commanders, IV Corps Engineer Headquarters

Lt. Col. Harold U. Wallace	14 Dec 21-6 Mar 22	Lt. Col. Harold U. Wallace	3 Jan 23-21 Mar 23
Maj. John J. Grafflin	6 Mar 22-25 Mar 22	Lt. Col. Edward S. Bres	21 Mar 23-8 Jun 25
Lt. Col. Perrin C. Cothran	25 Mar 22-3 Jan 23	Maj. Theodore S. Dunn	8 Jun 25-ao May 27
	Unknown	ao May 27-5 Sep 28	

V Corps Engineer Headquarters (V Corps)

Ohio National Guard

HQ-*Not organized* 1921-27

Subordinate elements-*134th Engineer Regiment (GS); 145th Engineer Battalion (Aux); 146th Engineer Battalion (Aux); 147th Engineer Battalion (Aux)*

Constituted in the National Guard 15 October 1921, assigned to the V Corps, and allotted to the state of Ohio. Withdrawn from the Ohio National Guard 22 June 1927.

VI Corps Engineer Headquarters (VI Corps)

Organized Reserve Illinois

HQ-*Not initiated* 1921-23; Chicago, IL, 1923-27; *Inactive* 1927-28

Subordinate elements-*135th Engineer Regiment (GS); 148th Engineer Battalion (Aux); 148th Engineer Battalion (Aux); 150th Engineer Battalion (Aux)*

Constituted in the Organized Reserve 15 October 1921, assigned to the VI Corps, and allotted to the Sixth Corps Area. Headquarters initiated in November 1923 at Chicago, IL. Inactivated 13 June 1927 at Chicago by relief of personnel. Withdrawn from the Sixth Corps Area 5 September 1928.

Commanders, VI Corps Engineer Headquarters

Col. George W. Rathjens	Nov 23-21 Oct 24	Lt. Col. Mahlon O. Kasson	9 Feb 26-17 Feb 26
Col. Charles L. Whiting	21 Oct 24-9 Feb 26	Lt. Col. Byron K. Coughlin	17 Feb 26-13 Jun 27
	<i>Inactive</i>	13 Jun 27-5 Sep 28	

VII Corps Engineer Headquarters (VII Corps)

Organized Reserve Nebraska

HQ-*Not initiated* 1921-22; Omaha, NE, 1922-28

Subordinate elements-*136th Engineer Regiment (GS); 151st Engineer Battalion (Aux); 152nd Engineer Battalion (Aux); 153rd Engineer Battalion (Aux)*

Constituted in the Organized Reserve 15 October 1921, assigned to the VII Corps, and allotted to the Seventh Corps Area. Headquarters initiated in May 1922 at Omaha, NE. Withdrawn from the Seventh Corps Area 5 September 1928.

Commanders, VII Corps Engineer Headquarters

Unknown	May 22-ao Mar 23	Maj. A. G. Bradley	ao Mar 23-ao Jun 27
	Unknown	ao Jun 27-5 Sep 28	

VIII Corps Engineer Headquarters (VIII Corps)

Organized Reserve Texas

HQ-*Not initiated* 1921-22; San Antonio, TX, 1922-28

Subordinate elements-*137th Engineer Regiment (GS); 154th Engineer Battalion (Aux); 155th Engineer Battalion (Aux); 156th Engineer Battalion (Aux)*

Constituted in the Organized Reserve 15 October 1921, assigned to the VIII Corps, and allotted to the Eighth Corps Area. Headquarters initiated 26 July 1922 at San Antonio, TX. Withdrawn from the Eighth Corps Area 5 September 1928.

Commanders, VIII Corps Engineer Headquarters

Col. Sam A. Robertson	26 Jul 22-26 Feb 23	Col. James S. Burk	26 Feb 23-Jan 27
	Maj. Tucker S. Wyche	Jan 27-5 Sep 28	

IX Corps Engineer Headquarters (IX Corps)

Organized Reserve California

HQ-San Francisco, CA, 1921-28

Subordinate elements-*138th Engineer Regiment (GS); 444th Engineer Battalion (Aux); 445th Engineer Battalion (Aux); 446th Engineer Battalion (Aux)*

Constituted in the Organized Reserve 15 October 1921, assigned to the IX Corps, and allotted to the Ninth Corps Area. Headquarters initiated 22 December 1921 at San Francisco, CA. Withdrawn from the Ninth Corps Area 5 September 1928.

Commanders, IX Corps Engineer Headquarters

Lt. Col. Joseph S. Williams	22 Dec 21-29 Dec 21	Col. John H. Poole	29 Dec 21-ao Mar 23
	Unknown	ao Mar 23-5 Sep 28	

XI Corps Engineer Headquarters (XI Corps)

Organized Reserve Massachusetts

HQ-Boston, MA, 1921-28

Subordinate elements-*341st Engineer Regiment (GS); 411th Engineer Battalion (Aux); 412th Engineer Battalion (Aux); 413th Engineer Battalion (Aux)*

Constituted in the Organized Reserve 15 October 1921, assigned to the XI Corps, and allotted to the First Corps Area. Headquarters initiated 10 October 1921 at Boston, MA. Withdrawn from the First Corps Area 5 September 1928.

Commanders, XI Corps Engineer Headquarters

Col. Theodore H. Dillon 10 Oct 21-5 Sep 28

XII Corps Engineer Headquarters (XII Corps)

Organized Reserve New Jersey

HQ-Manhattan, NY, 1921-28

Subordinate elements-342nd Engineer Regiment (GS); 414th Engineer Battalion (Aux); 415th Engineer Battalion (Aux); 416th Engineer Battalion (Aux)

Constituted in the Organized Reserve 15 October 1921, assigned to the XII Corps, and allotted to the Second Corps Area. Headquarters initiated 23 December 1921 at Manhattan, NY. Withdrawn from the Second Corps Area 5 September 1928.

Commanders, XII Corps Engineer Headquarters

Col. Thacher T. P. Luquer
Brig. Gen. Jay J. Morrow

23 Dec 21-9 Feb 25
9 Feb 25-2 Aug 26

Col. Thacher T. P. Luquer
Unknown

2 Aug 26-3 Jan 28
3 Jun 28-5 Sep 28

XIII Corps Engineer Headquarters (XIII Corps)

Organized Reserve District of Columbia

HQ-*Not initiated* 1921-22; Washington, DC, 1922-28; *Inactive* 1928

Subordinate elements-343rd Engineer Regiment (GS); 417th Engineer Battalion (Aux); 418th Engineer Battalion (Aux); 419th Engineer Battalion (Aux)

Constituted in the Organized Reserve 15 October 1921, assigned to the XIII Corps, and allotted to the Third Corps Area. Headquarters initiated 4 February 1922 at Washington, DC. Inactivated 8 March 1928 at Washington, DC, by relief of personnel. Withdrawn from the Third Corps Area 5 September 1928.

Commanders, XIII Corps Engineer Headquarters

1st Lt. William J. Weber
Maj. Frazier C. Hilder

4 Feb 22-3 Apr 22
3 Apr 22-11 Mar 23

Col. Charles A. McKenney
Inactive

11 Mar 23-8 Mar 28
8 Mar 28-5 Sep 28

XIV Corps Engineer Headquarters (XIV Corps)

Organized Reserve Alabama

HQ-*Not initiated* 1921-22; Birmingham, AL, 1922-28

Subordinate elements-344th Engineer Regiment (GS); 420th Engineer Battalion (Aux); 421st Engineer Battalion (Aux); 422nd Engineer Battalion (Aux)

Constituted in the Organized Reserve 15 October 1921, assigned to the XIV Corps, and allotted to the Fourth Corps Area. Headquarters initiated 6 March 1922 at Birmingham, AL. Withdrawn from the Fourth Corps Area 5 September 1928.

Commanders, XIV Corps Engineer Headquarters

Maj. Robert T. Fraser, Jr.

6 Mar 22-12 Apr 22
Unknown

Lt. Col. Frank E. Estes
ao Mar 23-5 Sep 28

12 Apr 22-ao Mar 23

XV Corps Engineer Headquarters (XV Corps)**Organized Reserve Ohio/Indiana/Kentucky**

HQ-Not initiated 1921-22; Chillicothe, OH, 1922-23; Indianapolis, IN, 1923-25; Covington, KY, 1925-28

Subordinate elements-345th Engineer Regiment (GS); 423rd Engineer Battalion (Aux); 424th Engineer Battalion (Aux); 425th Engineer Battalion (Aux)

Constituted in the Organized Reserve 15 October 1921, assigned to the XV Corps, and allotted to the Fifth Corps Area. Headquarters initiated 4 March 1922 at Chillicothe, OH. Headquarters successively relocated in 1923 to Indianapolis, IN, and 15 April 1925 to Covington, KY. Withdrawn from the Fifth Corps Area 5 September 1928.

Commanders, XV Corps Engineer Headquarters

Lt. Col. Theodore S. Pattison

4 Mar 22-ao Sep 24

Unknown

ao Sep 24-5 Sep 28

XVI Corps Engineer Headquarters (XVI Corps)**Organized Reserve Wisconsin**

HQ-Not initiated 1921-23; Madison, WI, 1923-28

Subordinate elements-346th Engineer Regiment (GS); 426th Engineer Battalion (Aux); 427th Engineer Battalion (Aux); 428th Engineer Battalion (Aux)

Constituted in the Organized Reserve 15 October 1921, assigned to the XVI Corps, and allotted to the Sixth Corps Area. Headquarters initiated in October 1923 at Madison, WI. Withdrawn from the Sixth Corps Area 5 September 1928.

Commanders, XVI Corps Engineer Headquarters

Unknown

Oct 23-5 Sep 28

XVII Corps Engineer Headquarters (XVII Corps)**Organized Reserve Iowa**

HQ-Not initiated 1921-22; Des Moines, IA, 1922-28

Subordinate elements-347th Engineer Regiment (GS); 429th Engineer Battalion (Aux); 430th Engineer Battalion (Aux); 431st Engineer Battalion (Aux)

Constituted in the Organized Reserve 15 October 1921, assigned to the XVII Corps, and allotted to the Seventh Corps Area. Headquarters initiated in June 1922 at Des Moines, IA. Withdrawn from the Seventh Corps Area 5 September 1928.

Commanders, XVII Corps Engineer Headquarters

Maj. B. P. Fleming

ao Mar 23-4 Jun 23

Unknown

Maj. Harry P. Wood

2 Jun 27-5 Sep 28

4 Jun 23-2 Jun 27

XVIII Corps Engineer Headquarters (XVIII Corps)**Organized Reserve Texas**

HQ-Not initiated 1921-22; San Antonio, TX, 1922-28

Subordinate elements-348th Engineer Regiment (GS); 432nd Engineer Battalion (Aux); 433rd Engineer Battalion (Aux); 434th Engineer Battalion (Aux)

Constituted in the Organized Reserve 15 October 1921, assigned to the XVIII Corps, and allotted to the Eighth Corps Area. Headquarters initiated 12 September 1922 at San Antonio, TX. Withdrawn from the Eighth Corps Area 5 September 1928.

Commanders, XVIII Corps Engineer Headquarters

Lt. Col. Louis D. Blauvelt

12 Sep 22-1 Mar 23

Lt. Col. Charles C. Cragin

1 Mar 23-5 Sep 28

XIX Corps Engineer Headquarters (XIX Corps)**Organized Reserve California**

HQ-San Francisco, CA, 1921-28

Subordinate elements-349th Engineer Regiment (GS); 445th Engineer Battalion (Aux); 446th Engineer Battalion (Aux); 447th Engineer Battalion (Aux)

Constituted in the Organized Reserve 15 October 1921, assigned to the XIX Corps, and allotted to the Ninth Corps Area. Headquarters initiated 12 December 1921 at San Francisco, CA. Withdrawn from the Ninth Corps Area 5 September 1928.

Commanders, XIX Corps Engineer Headquarters

Lt. Col. Robert E. Child

22 Dec 21-ao Mar 23

Unknown

ao Mar 23-5 Sep 28

21st Engineer Headquarters (Railway Service)**Regular Army Inactive**

HQ-Chicago, IL, 1928-41

Constituted in the Regular Army 5 September 1928 as the 21st Engineer Headquarters (Railway Service) and allotted to the Sixth Corps Area. Headquarters organized 4 December 1928 with Organized Reserve personnel as a RAI unit at Chicago, IL. Redesignated as the 21st Engineer Headquarters (Railway Grand Division) 6 February 1939. Location 7 December 1941—Chicago, IL.

Commanders, 21st Engineer Headquarters (Railway Service)

Unknown

4 Dec 28-ao Feb 38
UnknownLt. Col. B. B. Browne
ao Jan 39-7 Dec 41

ao Feb 38-ao Jan 39

87th Engineer Headquarters (Railway Service) (GHQR)**Regular Army Inactive**HQ-*Not organized* 1927-30; New York City, NY, 1930-41

Constituted in the Regular Army 18 October 27 as 87th Engineer Railway Service Headquarters, assigned to the General Headquarters Reserve, and allotted to the Second Corps Area. Headquarters organized 6 August 1930 with Organized Reserve personnel as a RAI unit at New York City, NY. Redesignated as the 87th Engineer Headquarters (Railway Service) 30 August 1930. Location 7 December 1941—New York City, NY.

Commanders, 87th Engineer Headquarters (Railway Service)

Maj. Edward J. Langford

6 Aug 30-25 Jan 32

Unknown

25 Jan 32-7 Dec 41

88th Engineer Headquarters (Railway Service) (GHQR)**Regular Army Inactive**HQ-Chicago, IL, 1928-31; *Inactive* 1931-33

Constituted in the Regular Army 18 Oct 1927 as the 88th Engineer Railway Service Headquarters, assigned to the General Headquarters Reserve, and allotted to the Sixth Corps Area. Headquarters organized 4 December 1928 with Organized Reserve personnel as a RAI unit at Chicago, IL. Redesignated as the 88th Engineer Headquarters (Railway Service) 30 August 1930. Attached 3 November 1930 to the 86th Division for organization, administration, and training. Inactivated 21 April 1931 at Chicago by relief of personnel. Demobilized 1 October 1933.

Commanders, 88th Engineer Headquarters (Railway Service)

Lt. Col. William G. Arm

4 Dec 28-21 Apr 31

Inactive

21 Apr 31-1 Oct 33

89th Engineer Headquarters (Railway Service) (GHQR)**Regular Army Inactive**HQ-*Not organized* 1927-28; Fort Sam Houston, TX, 1928-31; *Inactive* 1931-33

Constituted in the Regular Army 18 October 1927, assigned to the General Headquarters Reserve, as 89th Engineer Railway Service Headquarters and allotted to the Eighth Corps Area. Headquarters organized 5 November 1928 with Organized Reserve personnel as a RAI unit at Fort Sam Houston, TX. Redesignated 89th Engineer Headquarters (Railway Service) 30 August 1930. Inactivated 29 May 1931 at Fort Sam Houston by relief of personnel. Conducted summer training at Fort Sam Houston and Fort McIntosh, TX. Designated mobilization training station was Fort Sam Houston. Demobilized 1 October 1933.

Commanders, 89th Engineer Headquarters (Railway Service)

Col. Sam A. Robertson

5 Nov 28-2 Dec 29
Inactive

Col. James S. Burk
29 May 31-1 Oct 33

2 Dec 29-29 May 31

673rd Engineer Headquarters (Railway Service) (CZ)

Organized Reserve Connecticut/Illinois

HQ-Not initiated 1927-41

Constituted in the Organized Reserve 1 April 1927, assigned to the Communication Zone, and allotted to the First Corps Area. New Haven, CT, designated 5 March 1929 as headquarters upon organization, but the unit was never organized at that location. Redesignated 673rd Engineer Headquarters (Railway Service) 20 August 1931. Withdrawn from the First Corps Area 5 June 1936, and allotted to the Sixth Corps Area. Chicago, IL, designated as headquarters location upon organization, but the unit was never organized at that location. Redesignated 673rd Engineer Headquarters (Railway Grand Division) 1 October 1938. Disbanded 21 February 1941.

674th Engineer Headquarters (Railway Service) (CZ)

Organized Reserve New Jersey

HQ-Not initiated 1927-41

Constituted in the Organized Reserve 1 April 1927, assigned to the Communication Zone, and allotted to the Second Corps Area. Jersey City, NJ, designated 2 July 1929 as headquarters location upon organization, but the unit was never organized at that location. Redesignated 674th Engineer Headquarters (Railway Service) 20 August 1931. Redesignated 674th Engineer Headquarters (Railway Grand Division) 1 October 1938. Disbanded 21 February 1941.

675th Engineer Headquarters (Railway Service) (CZ)

Organized Reserve Georgia

HQ-Not initiated 1933-37; Atlanta, GA, 1937-41

Constituted in the Organized Reserve 1 October 1933, assigned to the Communication Zone, and allotted to the Fourth Corps Area. Headquarters initiated 14 February 1937 at Atlanta, GA. Redesignated 675th Engineer Headquarters (Railway Grand Division) 1 October 1938. Conducted summer training with A Company, 4th Engineer Regiment at Fort Benning, GA. Disbanded 21 February 1941.

Commanders, 675th Engineer Headquarters

Lt. Col. Percival S. Moses

14 Feb 37-21 Feb 41

676th Engineer Headquarters (Railway Service) (I) (CZ)

Organized Reserve

HQ-Not initiated 1927-28

Constituted in the Organized Reserve 1 April 1927, assigned to the Communication Zone, and allotted to the Fourth Corps Area. Withdrawn from the Fourth Corps Area 6 October 1928 and demobilized.

676th Engineer Headquarters (Railway Service) (II) (CZ)

Organized Reserve California

HQ-Not initiated 1933-41

Constituted in the Organized Reserve 1 October 1933, assigned to the Communication Zone, and allotted to the Ninth Corps Area. Los Angeles, CA, designated 20 February 1934 as headquarters location upon organization, but the unit was never organized at that location. Redesignated 676th Engineer Headquarters (Railway Grand Division) 1 October 1938. Disbanded 21 Feb 1941.

677th Engineer Headquarters (Railway Service) (CZ)

Organized Reserve Indiana

HQ-Not initiated 1927-41

Constituted in the Organized Reserve 1 April 1927, assigned to the Communication Zone, and allotted to the Fifth Corps Area. Gary, IN, designated 9 July 1931 as headquarters location upon organization, but the unit was never organized at that location. Redesignated 677th Engineer Headquarters (Railway Service) 20 August 1931. Redesignated 677th Engineer Headquarters (Railway Grand Division) 1 October 1938. Disbanded 21 February 1941.

678th Engineer Headquarters (Railway Service) (CZ)

Organized Reserve Michigan

HQ-Not initiated 1927-39; Detroit, MI, 1939-41

Constituted in the Organized Reserve 1 April 1927, assigned to the Communication Zone, and allotted to the Sixth Corps Area. Redesignated 678th Engineer Headquarters (Railway Service) 20 August 1931. Redesignated 678th Engineer Headquarters (Railway Grand Division) 1 October 1938. Headquarters initiated by June 1939 at Detroit, MI. Disbanded 21 February 1941.

Commanders, 678th Engineer Headquarters

Unknown Jun 39-21 Feb 41

679th Engineer Headquarters (Railway Service) (CZ)

Organized Reserve Nebraska

HQ-Not initiated 1927-41

Constituted in the Organized Reserve 1 April 1927, assigned to the Communication Zone, and allotted to the Seventh Corps Area. Omaha, NE, designated 12 October 1931 as headquarters location upon organization, but the unit was never organized at that location. Redesignated 679th Engineer Headquarters (Railway Service) 20 August 1931. Redesignated 679th Engineer Headquarters (Railway Grand Division) 1 October 1938. Disbanded 21 February 1941.

680th Engineer Headquarters (Railway Service) (CZ)

Organized Reserve Texas

HQ-Houston, TX, 1927-29; Inactive 1929-41

Constituted in the Organized Reserve 1 April 1927, assigned to the Communication Zone, and allotted to the Eighth Corps Area. Headquarters initiated 22 August 1927 at Houston, TX. Inactivated 21 August 1929 at Houston by relief of personnel. Redesignated 680th Engineer Headquarters (Railway Service) 20 August 1931. Conducted summer training at Fort McIntosh, TX, or Fort Logan, CO. Designated mobilization training station was the Waco Concentration Camp, Waco, TX. Redesignated 680th Engineer Headquarters (Railway Grand Division) 1 October 1938.

Disbanded 21 February 1941.

Commanders, 680th Engineer Headquarters

Col. James S. Burk 22 Aug 27-21 Aug 29 *Inactive* 21 Aug 29-21 Feb 41

681st Engineer Headquarters (Railway Service) (CZ)**Organized Reserve****HQ-Not initiated** 1927-28

Constituted in the Organized Reserve 1 April 1927, assigned to the Communication Zone, and allotted to the Ninth Corps Area. Withdrawn from the Ninth Corps Area 6 October 1928 and demobilized.

682nd Engineer Headquarters (Railway Service) (CZ)**Organized Reserve New York****HQ-Not initiated** 1927-41

Constituted in the Organized Reserve 1 April 1927, assigned to the Communication Zone, and allotted to the Second Corps Area. Manhattan, NY, designated 2 July 1929 as headquarters location upon organization, but the unit was never organized at that location. Redesignated 682nd Engineer Headquarters (Railway Service) 20 August 1931. Redesignated 679th Engineer Headquarters (Railway Grand Division) 1 October 1938. Disbanded 21 February 1941.

683rd Engineer Headquarters (Railway Service) (CZ)**Organized Reserve Ohio****HQ-Not initiated** 1927-41

Constituted in the Organized Reserve 1 April 1927, assigned to the Communication Zone, and allotted to the Fifth Corps Area. Columbus, OH, designated 9 July 1931 as headquarters location upon organization, but the unit was never organized at that location. Redesignated 683rd Engineer Headquarters (Railway Service) 20 August 1931. Redesignated 683rd Engineer Headquarters (Railway Grand Division) 1 October 1938. Disbanded 21 February 1941.

684th Engineer Headquarters (Railway Service) (CZ)**Organized Reserve Minnesota****HQ-Not initiated** 1927-41

Constituted in the Organized Reserve 1 April 1927, assigned to the Communication Zone, and allotted to the Seventh Corps Area. Redesignated 684th Engineer Headquarters (Railway Service) 20 August 1931. Minneapolis, MN, designated 12 October 1931 as headquarters location upon organization, but the unit was never organized at that location. Redesignated 684th Engineer Headquarters (Railway Grand Division) 1 October 1938. Disbanded 21 February 1941.

685th Engineer Headquarters (Communications Zone Section)**Organized Reserve Massachusetts****HQ-Not initiated** 1923-25; Boston, MA, 1925-28; *Inactive* 1928-41

Constituted in the Organized Reserve 2 July 1923, assigned to the Communication Zone, and allotted to the First Corps Area. Headquarters initiated in January 1925 at Boston, MA. Inactivated by July 1928 at Boston by relief of personnel. Withdrawn from the First Corps Area 5 June 1936 and allotted to the Sixth Corps Area. Chicago, IL, designated as headquarters location upon organization, but the unit was never organized at that location. Location 7 December 1941—*Inactive*.

Status: Disbanded 22 December 1942.**Commanders, 685th Engineer Headquarters**

Brig Gen. Luke H. Callan

Jan 22-May 28

Inactive

Col. Lewis E. Moore

Jul 28-7 Dec 41

May 28-Jul 28

686th Engineer Headquarters (Communications Zone Section)**Organized Reserve West Virginia****HQ-Not initiated** 1923-27; Morgantown, WV, 1927-30; *Inactive* 1930-41

Constituted in the Organized Reserve 2 July 1923, assigned to the Communication Zone, and allotted to the Fifth Corps Area. Headquarters initiated by December 1927 at Morgantown, WV. Inactivated by March 1930 at Morgantown by relief of personnel. Location 7 December 1941—*Inactive*.

Status: Disbanded 22 December 1942.**Commanders, 686th Engineer Headquarters**

Maj. Thomas C. Gary

ao Dec 27-3 Mar 28
*Inactive*Unknown
Mar 30-7 Dec 41

3 Mar 28-Mar 30

687th Engineer Headquarters (Communications Zone Section)**Organized Reserve New Jersey/New York****HQ-Not initiated** 1923-41

Constituted in the Organized Reserve 2 July 1923, assigned to the Communication Zone, and allotted to the Second Corps Area. Jersey City, NJ, designated as headquarters location upon organization, but the unit was never organized at that location. Designated headquarters location changed 2 July 1929 to Manhattan, NY. Location 7 December 1941—*Not initiated*.

Status: Disbanded 22 December 1942.**688th Engineer Headquarters (Communications Zone Section)****Organized Reserve Virginia****HQ-Not initiated** 1923-41

Constituted in the Organized Reserve 2 July 1923, assigned to the Communication Zone, and allotted to the Third Corps Area. Richmond, VA, designated 11 December 1929 as headquarters location upon organization, but the unit was never organized at that location. Location 7 December 1941—*Not initiated*.

Status: Disbanded 22 December 1942.**689th Engineer Headquarters (Communications Zone Section)****Organized Reserve Illinois****HQ-Not initiated** 1923-26; Chicago, IL, 1926-28; *Inactive* 1928-41

Constituted in the Organized Reserve 2 July 1923, assigned to the Communication Zone, and allotted to the Sixth Corps Area. Headquarters initiated 26 January 1926 at Chicago, IL. Inactivated 20 November 1928 at Chicago by relief of personnel. Highland Park, IL, designated 29 March 1929 as headquarters location upon reorganization, but the unit was never organized at that location. Location 7 December 1941—*Inactive*.

Status: Disbanded 22 December 1942.**Commanders, 689th Engineer Headquarters**

Lt. Col. Mahlon O. Kasson

26 Jan 26-11 Mar 26

Lt. Col. Harris P. Ralston

12 Oct 27-6 Jun 28

Col. Christopher Van Deventer

11 Mar 26-12 Oct 27

Lt. Col. Oliver B. Zimmerman

6 Jun 28-20 Nov 28

Inactive

20 Nov 28-7 Dec 41

690th Engineer Headquarters (Communications Zone Section)**Organized Reserve California****HQ-Not initiated** 1923-28; San Francisco, CA, 1928; *Inactive* 1928-41

Constituted in the Organized Reserve 2 July 1923, assigned to the Communication Zone, and allotted to the Ninth Corps Area. Headquarters initiated by January 1928 at San Francisco, CA. Inactivated 20 October 1928 at San Francisco, CA by relief of personnel. Location 7 December 1941—*Inactive*.

Status: Disbanded 22 December 1942.

Commanders, 686th Engineer Headquarters

Unknown

Jan 28-20 Oct 28

Inactive

20 Oct 28-7 Dec 41

Chapter 35

Engineer Regiments

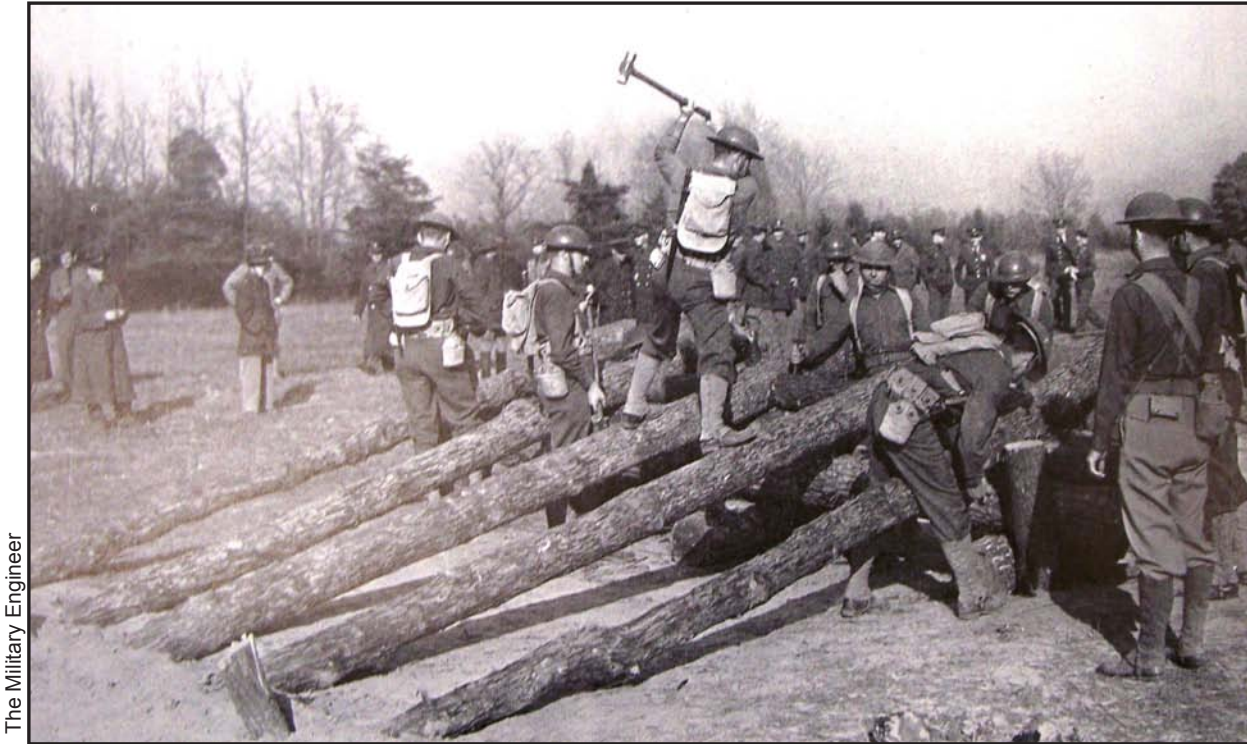

The Military Engineer

Men of the 5th Engineer Regiment build an antitank log crib at Fort Belvoir, VA.

Engineer regiments provided road and trail improvement and vertical structure, battle position, and obstacle construction support to mobile units of the field army, corps, and division. Under extreme circumstances, engineers could be used as infantry.

Organization

The organization and types of engineer regiments in the post-war Army were modified and reduced versions of the types of units that served in World War I. Rather than the approximately ten different types of engineer regiments that existed during the war, there now existed only three distinct organizations: the divisional combat regiment, the general service regiment, and one short-lived camouflage regiment. Many of the functions performed by the specialized wartime regiments were now either incorporated into one of the new post-war engineer battalion structures, or, in a few cases, were transferred to the Chemical Warfare Service, Coast Artillery, or Field Artillery. The following table illustrates the allotment of the types of units to the various components through 1940.

Allotment of the Types of Units to the Various Components through 1940.

Regiments	Combat	GS	Camo
RA	7	1	0
RAI	7	22	1
NG	20	15	0
OR	27	54	0
Totals	61	82	1

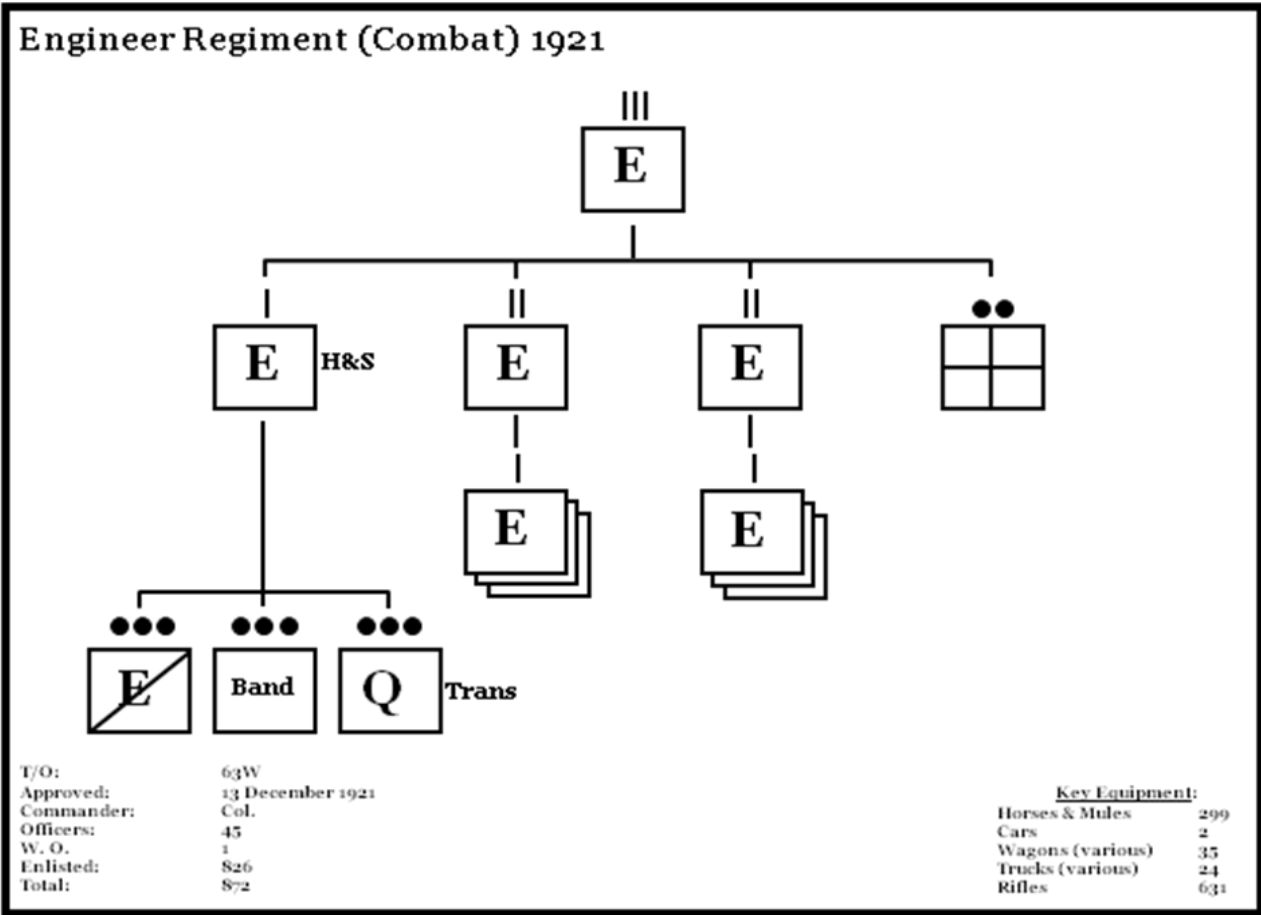

Engineer Regiment TOE.

The sapper regiment of the First World War evolved into the post-war divisional combat engineer regiment. Each division was assigned one of these regiments to provide the command with the ability to improve mobility corridors such as roads and trails, as well as avenues of approach toward enemy positions. The units provided obstacle breaching and construction services, as well as defense position improvement and reinforcement capabilities. Each regiment consisted of a headquarters, a headquarters and service company, and two sapper battalions of three companies each.

The general service regiment was organized similarly to the combat engineers. This regiment, however, was substantially larger (by approximately 25 percent) and provided greater road improvement and vertical construction capability than the combat engineers. It could also perform some specialized functions, such as forestry skills, not typically present in the divisional regiment. Three GS regiments were assigned to each field army and one to each corps. Additionally, a significant number were assigned to the GHQR and CZ for employment in the rear areas or for reinforcing army, corps, or division operations. One regiment was assigned duties as a training unit and was slated for mobilization at Fort Belvoir, Virginia.

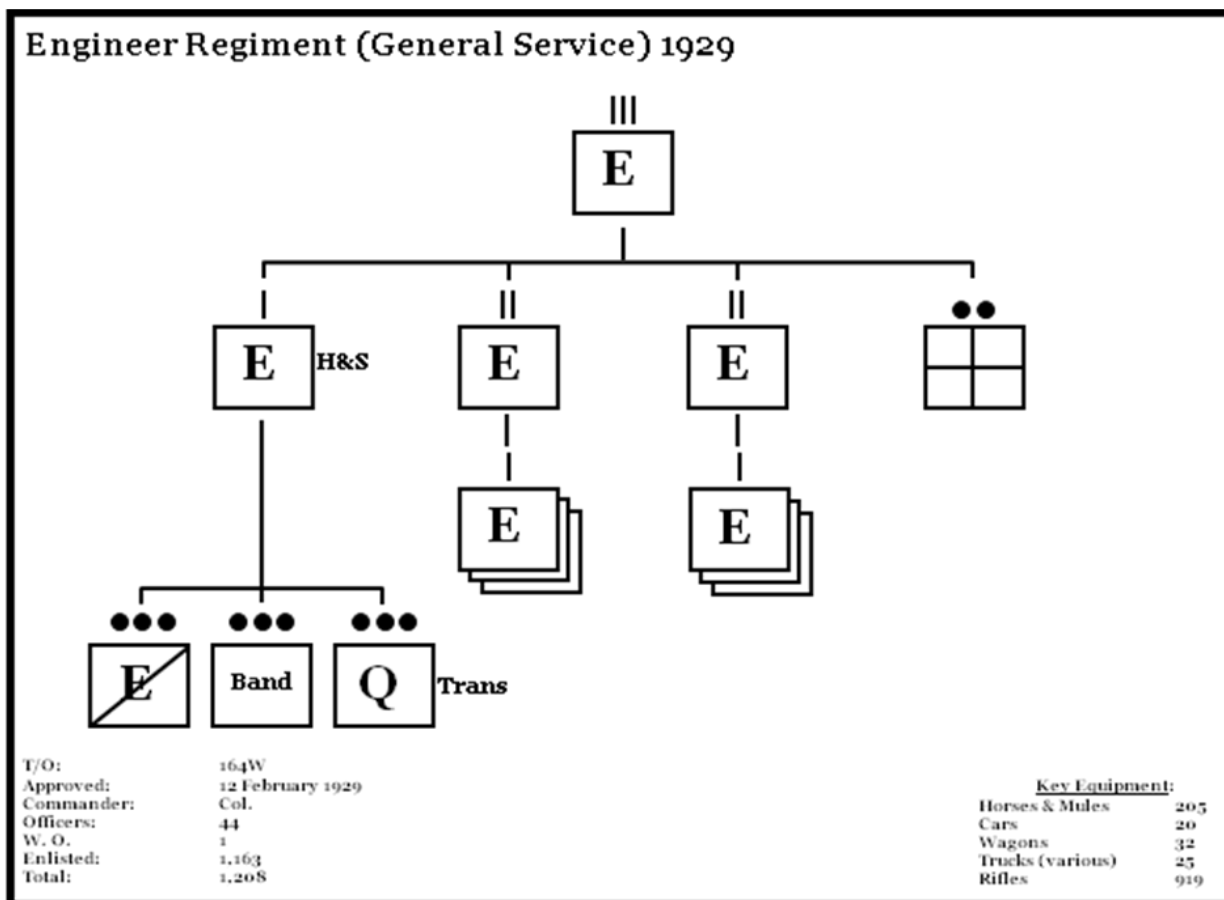

Engineer General Service Regiment TOE.

The single camouflage regiment, the 40th Engineers, possessed an odd table of organization. It consisted of one battalion of three companies (companies A–C) and six separate camouflage companies (companies D–H). There was no regimental headquarters. The single battalion was assigned to the GHQR and each of the separate companies was assigned to one of the six field armies. This regiment was broken up in 1930 when the companies were demobilized and the 1st Battalion was reorganized and redesignated as a separate camouflage battalion.

The organization of the engineer regiments remained relatively constant until 1939 when the combat regiments of the Regular Army divisions were reorganized into battalions as part of the triangular division concept. The combat regiments in the National Guard and Organized Reserve divisions would not follow suit until early 1942. The general service regiments remained relatively unchanged although one was converted to an airfield construction regiment in 1940. By the time of Pearl Harbor virtually all of the RAI and National Guard units had been activated for duty, but none of the Reserve regiments. A handful of the existing Reserve regiments would eventually be activated, however, later in 1942.

Training

The annual training cycle for Regular Army engineer regiments was similar to that for other combat arms units (see Chapter 9, Infantry Regiments, for a general description). Since all but one of the active engineer regiments in the interwar period were divisional units, training events for engineer regiments tended to be centered on providing support to other units of their assigned division. This was particularly true for the three overseas regiments—the 3rd, 11th, and 14th Engineers. All three not only participated in the annual division and department maneuvers, they also performed various construction projects, many related to improving roads, trails, and battle positions to support aspects of existing defense plans. The 11th

and 14th also mapped various areas of the Canal Zone and the Philippines that were that were important to war plans and were previously uncharted in any geographic detail.

The stateside regiments also participated in the exercises and maneuvers of their assigned divisions and reinforced brigades. These regiments, and there were only four relatively complete regiments—the 1st, 2nd, 6th, and 13th—were also heavily taxed to support the training of the Organized Reserve, Reserve Officer Training Corps, and Citizens Military Training Corps during the summer. In this regard, the 1st Engineers supported the civilian components of multiple corps areas as did the 13th Engineers as there were no active Army engineer units in the First and Sixth Corps Areas. Like their overseas counterparts, the stateside units also performed various construction and mapping projects as well.

Most RAI engineer regiments seem to have been functional units. These units usually conducted their Inactive Training Period assemblies similarly to other Reserve regiments. In several instances RAI regiments conducted their training meetings in conjunction with other local engineer reserve units. Additionally, when ordered to camp, the RAI commands performed summer training with similarly organized and equipped active Army units.

During the Inactive Training Period, National Guard regiments participated in the typical drill activities carried out by most Guard units. Like their active duty counterparts, these regiments often supported the training of their assigned divisions for some aspects of summer training. In other cases, elements were employed in improving the physical structures, roads, trails, and support facilities of their state's training camps. Given their special skills, the Guard engineers were also often called up for disaster relief duties.

As with the RAI organizations, most of the Organized Reserve engineer regiments were functional units and were some of the most active and well-trained Reserve organizations in the Army. Several of the regiments had numerous members who were engineers by profession and belonged to various engineer firms and professional societies. An usually high number of the post-war commanders of Reserve engineer regiments had also commanded engineer regiments during World War I. Many other post-war reserve regiments were commanded by men who had been at least regimental executive officers during the war as well. Additionally, many of the company and battalion officers had served in France with engineer units. Thus, the high level of professional and wartime experience of unit leaders in many engineer regiments gave those organizations a distinct advantage not available to many other Reserve organizations. This experience and training was no doubt imparted to the many new lieutenants who joined these reserve regiments over the interwar years.

1st Engineer Regiment (1st Division)

HQ-Camp Zachary Taylor, KY, 1919-20; Camp Dix, NJ, 1920-22; Fort DuPont, DE, 1922-39



Arrived at the port of New York 3 September 1919 on the U.S.S. *Orizaba* as an element of the 1st Division. Transferred 4 October 1919 to Camp Zachary Taylor, KY. Transferred 16 September 1920 to Camp Dix, NJ. Transferred in September 1922 to Fort DuPont, DE. Company D constructed a 368-foot pontoon bridge across the Winooski River at Burlington, VT, in November 1927 to replace a bridge washed out during the heavy floods that fall. The company remained on duty to maintain the bridge until October 1928. Company A (commanded by 1st Lt. Leslie R. Groves) was attached to the 29th Engineer Battalion (Topographic) 15 October 1929-25 July 1931 and conducted surveys in Nicaragua for possible canal routes across Central America. In April 1933, the regiment assumed command and control of the Delaware CCC District. The regiment undertook a construction and renovation project from February to November 1934 at Camp Dix, NJ, to improve roads, build artillery shelters, and

construct vehicle maintenance buildings. Assisted the summer training of Organized Reserve engineer units of the First, Second, and Third Corps Areas at Fort DuPont 1922-39. The 2nd Battalion was redesignated as the 27th Engineer Battalion (Combat) 9 October 1939 and relieved from the 1st Division. The 1st Battalion was redesignated 12 October 1939 as the 1st Engineer Battalion (Combat). Regiment, less 1st and 2nd Battalions, disbanded 16 October 1939.

Organization Day: 15 May. Chosen to commemorate the regiment's formation as the 1st Battalion of U.S. Engineers 15 May 1901.

Status: The 1st Engineer Battalion is active in the Regular Army at Fort Riley, KS, as a component of the 1st Infantry Division (Mechanized); the 27th Engineer Battalion was disbanded on 22 December 1942.

Events: 60, 63, 66, 72, 89, 99, 106, 153, 190, 241, 266, 280, 287, 293, 296, 298, 301, 307, 323, 330

Commanders, 1st Engineer Regiment

Col. Mason M. Patrick	24 Sep 16-20 Aug 17	Col. George M. Hoffman	5 Jul 26-24 Jul 28
Col. Gustave R. Lukesh	21 Aug 17-15 Oct 17	Maj. Clarence S. Ridley	24 Jul 28-9 Jan 29
Col. Lawrence V. Frazier	15 Oct 17-3 Sep 18	Maj. George Mayo	9 Jan 29-21 May 31
Col. W. Goff Caples	3 Sep 18-27 Sep 18	Capt. Robert D. Ingalls	21 May 31-3 Jun 31
Col. Francis B. Wiley	27 Sep 18-10 Mar 19	Lt. Col. Lewis H. Watkins	3 Jun 31-14 May 34
Col. Earl J. Atkisson	10 Mar 19-4 Sep 19	Maj. Tatnall D. Simkins	14 May 34-28 Jun 34
Col. Ernest F. Miller	4 Sep 19-16 Oct 19	Col. Ulysses S. Grant, III	28 Jun 34-26 Aug 36
Col. James J. Loving	16 Oct 19-12 Jan 21	Maj. Clinton W. Ball	26 Aug 36-11 Sep 36
Col. William B. Ladue	12 Jan 21-18 Jul 21	Col. Charles L. Hall	11 Sep 36-23 Sep 38
Maj. Roger G. Powell	18 Jul 21-16 Jun 24	Lt. Col. Milo P. Fox	23 Sep 38-1 Jul 39
Col. John J. Kingman	16 Jun 24-5 Jul 26	Lt. Col. Joseph C. Mohaffey	1 Jul 39-1 Oct 39

2nd Engineer Regiment (2nd Division)

HQ-Fort Sam Houston, TX, 1919-27; Fort Logan, CO, 1927-39



Arrived at the port of New York 8 August 1919 on the U.S.S. *Great Northern* as an element of the 2nd Division. Transferred to Camp Travis, TX, and arrived there 16 August 1919 (Camp Travis consolidated with Fort Sam Houston, TX, 12 December 1922). The regiment conducted topographical surveys of the Texas-Mexico border areas during the period November 1922 to July 1924. Transferred 14 June 1927 to Fort Logan, CO. Assisted the summer training of Organized Reserve engineer units of the Eighth Corps Area 1922-39. Reserve officers assigned to the regiment conducted summer training with the regiment at Fort Logan. Responsible for the supervision and administration of twenty-nine camps in the Colorado CCC District, 1933-34. The 2nd Battalion inactivated 1 August 1933 at Fort Logan. The 1st Battalion was redesignated 12 October 1939 as the 2nd Engineer Battalion (Combat). Regiment, less 1st Battalion, disbanded 16 October 1939.

Organization Day: 18 July. Chosen to commemorate the regiment's accomplishments in the Battle of Soissons, 18-22 July 1918.

Status: The 2nd Engineer Battalion is active in the Regular Army at Camp Castle, Korea, as a component of the 2nd Infantry Division.

Events: 45, 47, 55, 74, 130, 152, 166, 242, 260, 282, 288, 295, 296, 299, 300, 317, 328

Commanders, 2nd Engineer Regiment

Col. George A. Zinn	25 Sep 16-20 May 17	Maj. Earl E. Gesler	22 Jul 25-29 Sep 25
Lt. Col. Meriwether L. Walker	20 May 17-27 Aug 17	Col. Lytle Brown	29 Sep 25-1 Aug 26
Col. James F. McIndoe	27 Aug 17-3 Jul 18	Lt. Col. Warren T. Hannum	1 Aug 26-7 May 29
Col. William A. Mitchell	3 Jul 18-20 Nov 18	Lt. Col. Charles R. Pettis	7 May 29-29 May 32
Col. William E. R. Covell	20 Nov 18-18 Apr 19	Maj. Cleveland H. Bandholtz	29 May 32-29 Aug 32
Col. Stuart C. Godfrey	18 Apr 19-15 Aug 19	Col. Sherwood A. Cheney	29 Aug 32-25 May 33
Lt. Col. Lunsford E. Oliver	15 Aug 19-19 Oct 19	Maj. Charles R. Perry	25 May 33-1 Jul 33
Col. Glenn E. Edgerton	19 Oct 19-25 Mar 20	Col. Wildurr Willing	1 Jul 33-11 Jul 35
Col. Ernest Graves	25 Mar 20-20 Aug 20	Col. Jarvis J. Bain	11 Jul 35-23 Apr 37
Maj. Paul Reisinger	20 Aug 20-12 Oct 20	Lt. Col. Cleveland C. Gee	23 Apr 37-2 Jul 37
Col. Lytle Brown	12 Oct 20-25 Aug 21	Col. Richard C. Moore	2 Jul 37-2 Mar 38
Maj. Raymond F. Fowler	21 Sep 21-22 Sep 22	Col. Cleveland C. Gee	2 Mar 38-9 Sep 38
Maj. William D. A. Anderson	22 Sep 22-29 Jul 24	Maj. Horatio G. Fairbanks	9 Sep 38-26 Sep 38
Maj. James J. Loving	30 Jul 24-10 Feb 25	Col. Daniel I. Sultan	26 Sep 38-1 Dec 38
Maj. Richard V. Nicholas	10 Feb 25-22 Jul 25	Maj. Horatio G. Fairbanks	1 Dec 38-5 Apr 39
	Col. Donald H. Connelly	5 Apr 39-16 Oct 39	

3rd Engineer Regiment (Hawaiian Division)

HQ-Fort McKinley, PI 1919-21; Schofield Barracks, TH 1921-41



Regiment, less the 2nd and Provisional Battalions, was stationed at Fort McKinley, PI, as of June 1919. The 2nd Battalion was stationed at Corozal, CZ, and the Provisional Battalion at Fort Shafter, TH. The 2nd Battalion transferred to Schofield Barracks, TH, and arrived there 4 November 1920. The regiment was assigned to the Hawaiian Division 5 February 1921 and the remainder of the regiment ordered to transfer to the Territory of Hawaii. All elements arrived at Schofield Barracks by 12 April 1921; the provisional battalion concurrently integrated and discontinued. Built one and one-half miles of rail line in 1928 at Fort Kamehameha for use by the 52nd Coast Artillery. Built concrete roads in the vicinity of the new hospital area of Schofield Barracks in 1928 and Carter Gate Road in 1929. Conducted the following surveys in 1929: reservation monument survey; coast artillery triangularization of base lines and base end stations; and an airfield survey at Fort Kamehameha (Hickam Field). Constructed the Kolekole Pass road

November 1935-June 1937. During the same period the regiment constructed the Wahiawa-Pupukea Trail and the Barber's Point road net. Regiment reorganized and redesignated 3rd Engineer Battalion 26 September 1941 and assigned to the 24th Infantry Division.

Status: Inactive in the Regular Army as the 3rd Engineer Battalion, a component of the 24th Infantry Division (Mechanized).

Events: 33, 37, 75, 88, 120, 138, 141, 158, 189, 211, 225, 248, 276, 297, 312

Commanders, 3rd Engineer Regiment

Lt. Col. Robert R. Raymond	1 Jul 16-3 Sep 17	Col. Albert L. Waldron	24 Aug 27-10 Apr 28
Col. Thomas A. Rees	4 Sep 17-16 Dec 17	Maj. James A. Dorst	10 Apr 28-27 Jul 28
Col. Robert R. Raymond	Jan 18-24 Mar 19	Col. Charles W. Kutz	27 Jul 28-30 Jul 29
Col. Henry C. Newcomer	24 Mar 19-12 Aug 20	Maj. James A. Dorst	30 Jul 29-11 Jan 30
Col. Clement A. F. Flagler	12 Aug 20-8 May 21	Lt. Col. DeWitt C. Jones	11 Jan 30-21 Jan 32
Capt. Bennett H. Bowley, Jr.	8 May 21-25 Nov 21	Maj. Francis K. Newcomer	21 Jan 32-11 Feb 32
Col. Thomas A. Rees	25 Nov 21-10 Nov 22	Lt. Col. Robert R. Ralston	11 Feb 32-22 Feb 34
Maj. Harry F. Cameron	10 Nov 22-2 Jun 23	Lt. Col. James L. Patterson	22 Feb 34-28 Jan 36
Col. Edward H. Schulz	3 Jun 23-5 Feb 26	Col. Robert S. Thomas	28 Jan 36-13 Mar 38
Maj. John H. Carruth	6 Feb 26-29 Jul 26	Col. John N. Hodges	13 Mar 38-25 Mar 40
Col. Albert L. Waldron	29 Jul 26-12 Apr 27	Lt. Col. Robert C. Williams	25 Mar 40-9 Jul 40
Maj. John H. Carruth	12 Apr 27-23 Aug 27	Col. Albert K. B. Lyman	9 Jul 40-26 Sep 41

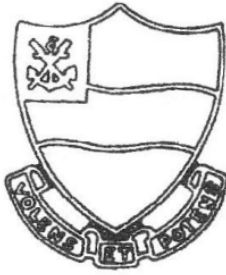
4th Engineer Regiment (4th Division)**Regular Army Inactive****HQ**-Camp Dodge, IA, 1919-21; Camp Lewis, WA, 1921; *Inactive* 1921-26; Auburn, AL, 1926-39

Arrived at the port of New York 29 July 1919 on the U.S.S. *Von Steuben* as an element of the 4th Division. Transferred to Camp Dodge, IA, and arrived there 8 August 1919. Transferred to Camp Lewis, WA, and arrived there 24 August 1920. Inactivated at Camp Lewis 21 September 1921 and personnel transferred to the 6th Engineer Regiment. Allotted to the Fourth Corps Area and the 6th Engineer Regiment made the Active Associate 1921-22. Company A activated at Fort Bragg, NC, 24 July 1922 and made the Active Associate for the 4th Engineers in lieu of the 6th Engineer Regiment. Regiment, less Company A, organized 19 July 1926 with Organized Reserve personnel as a RAI unit with headquarters at Auburn, AL. Regiment, less 2nd Battalion, affiliated with Alabama Polytechnic Institute R.O.T.C. 25 February 1927 and organized as a RAI unit with Regular Army personnel from the R.O.T.C. detachment and Reserve officers commissioned from the program. The 2nd Battalion concurrently affiliated with the University of Alabama and organized there. Regiment relieved from the 4th Division 15 August 1927 and assigned to the 6th Division. Company A inactivated 30 September 1929 at Fort Bragg. Regiment relieved from the 6th Division 1 October 1933 and assigned to the 4th Division. Company A concurrently reactivated at Fort Benning with personnel and equipment from Company A, 7th Engineers. For the period 1933-39, Company A performed the duties of engineer support and demonstration unit for the Infantry School. Company A also assisted the summer training of Organized Reserve engineer units of the Fourth Corps Area at Fort Bragg, NC, 1923-29, and at Fort Benning, GA, 1933-39. Reserve officers assigned to the regiment habitually performed summer training with Company A at Fort Benning. Designated mobilization training station was Fort Benning. Reorganized and redesignated 19 October 1939 as the 4th Engineer Battalion (Combat).

Organization Day: 6 June.**Current status** Active in the Regular Army at Fort Carson, CO, as the 4th Engineer Battalion, a component of the 4th Infantry Division (Mechanized).**Events:** 54, 94, 96, 121, 209, 293, 296, 300, 310, 330**Commanders, 4th Engineer Regiment**

Col. Edward Burr	4 Jun 17-21 Aug 17	Capt. Henry M. Kirkman**	ao Jan 27-25 Feb 27
Col. Jay J. Morrow	21 Aug 17-18 Jun 18	Unknown	25 Feb 27-17 Jun 27
Col. Albert H. Archer	18 Jun 18-9 Oct 18	Maj. Robert R. Neyland*	17 Jun 27-31 Dec 29
Col. Raymond A. Wheeler	10 Oct 18-14 Jan 19	Maj. Harry C. Diesem*	31 Dec 29-23 Jun 30
Col. Elliot J. Dent	14 Jan 19-5 Mar 19	Maj. Robert P. Neyland*	23 Jun 30-ao Jul 30
Col. Raymond A. Wheeler	5 Mar 19-Oct 19	Unknown	ao Jul 30-ao Jul 32
Col. William P. Wooten	Oct 19-Dec 19	Lt. Col. George H. Heakes*	ao Jul 32-1 Mar 33
Maj. Stanley L. Scott	Jan 20-11 Jun 20	Maj. Harry C. Diesem*	1 Mar 33-13 Jun 33
Lt. Col. Lewis H. Rand	11 Jun 20-7 Sep 21	Maj. Clarence S. Stroup**	25 Jul 33-6 Dec 34
<i>Inactive</i>	21 Sep 21-19 Jul 26	Capt. Robert W. Beall**	6 Dec 34-9 Nov 35
1st Lt. Vernon A. Vaughn**	19 Jul 26-ao Sep 26	Maj. Thomas H. Winchester**	9 Nov 35-18 Dec 38
	Maj. James A. Barksdale**	18 Dec 38-19 Oct 39	

* RAI Commanders: Regular Army officers who were concurrently PMS&T at Alabama Polytechnic Institute.

** RAI Commanders: Organized Reserve officers.

5th Engineer Regiment (7th Division)**Regular Army Inactive****HQ**-Camp A. A. Humphreys, VA, 1919-20; Camp Funston, KS, 1920; Camp George G. Meade, MD, 1920-21; *Inactive* 1921-26; Iowa City, IA, 1926-36; Fort Belvoir, VA, 1936-41; Reykjavik, Iceland 1941



Arrived at the port of New York 25 February 1919 on the U.S.S. *George Washington* as an element of the 7th Division. Transferred to Camp A. A. Humphreys, VA, and arrived there 5 March 1919. Transferred to Camp Funston, KS, and arrived there 11 July 1920. Transferred to Camp George G. Meade, MD, and arrived there 18 December 1920. Inactivated 27 September 1921 at Camp A. A. Humphreys and personnel transferred to the 13th Engineer Regiment. Allotted to the Seventh Corps Area, and the 13th Engineer Regiment made the Active Associate, 1921-27. Organized about April 1926 with Organized Reserve personnel as a RAI unit with headquarters at Iowa City, IA. Conducted summer training with Troop A, 9th Engineer Squadron at Fort Riley, KS. Relieved from the 7th Division 11 January 1936 and assigned to the 8th Division. Activated, less Reserve personnel, at Fort Belvoir, VA, 1 February 1936 with personnel and equipment from the inactivated 13th Engineer Regiment. Assisted the summer training of Organized Reserve engineer units of the

Third Corps Area at Fort Belvoir, VA, 1936-40. Reserve officers assigned to the regiment during 1936-41 habitually performed summer training with the regiment at Fort Belvoir. Relieved from the 8th Division 16 September 1939 and assigned to the II Corps. Departed the NYPOE 5 September 1941 and arrived in Iceland 16 September 1941. Location 7 December 1941—Reykjavik, Iceland.

Organization Day: 21 May. Chosen to commemorate the regiment's initial organization 21 May 1917.

Status: Regimental Headquarters, and Headquarters & Service Company, 5th Engineer Regiment are active in the Regular Army at Fort Bragg, NC, as HHC, 20th Engineer Brigade; the 1st Battalion is inactive in the Regular Army as the 21st Engineer Battalion; the 2nd Battalion is active in the Regular Army at Fort Leonard Wood, MO, as the 5th Engineer Battalion.

Events: 213, 214, 220, 240, 281, 295, 296, 301, 330

Commanders, 5th Engineer Regiment

Lt. Col. William J. Barden	21 May 17-21 Aug 17	Col. Albert E. Waldron	27 Dec 20-31 May 21
Maj. Glen E. Edgerton	21 Aug 17-9 Sep 17	Maj. Henry H. Stickney, Jr.	31 May 21-21 Sep 21
Col. Spencer Crosby	9 Sep 17-13 Jun 18	<i>Inactive</i>	21 Sep 21-Apr 26
Col. John C. Oakes	13 Jun 18-9 Dec 18	Unknown	Apr 26-ao Dec 35
Col. Frederick R. Downing	9 Dec 18-31 Jan 19	Maj. Andrew Holt**	ao Dec 35-1 Feb 36
Col. Albert E. Waldron	1 Feb 19-21 Apr 19	Col. William A. Johnson	1 Feb 36-4 Aug 37
Lt. Col. Lunsford E. Oliver	21 Apr 19-13 May 19	Maj. Heston R. Cole	4 Aug 37-16 Aug 37
Col. Richard Park	11 Dec 19-9 Jul 20	Col. James A. O'Connor	16 Aug 37-31 Aug 39
Maj. William H. Lanahan	9 Jul 20-6 Aug 20	Lt. Col. Roscoe C. Crawford	1 Sep 39-13 Jun 40
Maj. Charles L. Marsh	6 Aug 20-27 Dec 20	Col. Raymond G. Moses	13 Jul 40-May 41
	Unknown	May 41-7 Dec 41	

** RAI Commanders: Organized Reserve officers.

6th Engineer Regiment (3rd Division)

HQ-Camp Pike, AR, 1919-21; Camp Lewis, WA, 1921-27; Fort Lawton, WA, 1927-39



Arrived at the port of New York 25 August 1919 on the U.S.S. *Manchuria* as an element of the 3rd Division. Transferred to Camp Pike, AR, and arrived there 30 August 1919. Transferred to Camp Lewis, WA, and arrived there 21 September 1921. The 2nd Battalion was transferred in May 1922 to Fort Winfield Scott, CA. Regiment (less 2nd Battalion) transferred 8 October 1927 to Fort Lawton, WA. Regiment, less 2nd Battalion, assisted the summer training of Organized Reserve engineer units of the Ninth Corps Area at Fort Lewis. The 2nd Battalion assisted Organized Reserve summer training at Del Monte, CA, 1922-39. The 1st Battalion redesignated 12 October 1939 as the 6th Engineer Battalion (Combat), and remainder of the regiment, less 2nd Battalion, disbanded. The 2nd Battalion redesignated 13 October 1939 as the 10th Engineer Battalion (Combat) and relieved from the 3rd Division.

Organization Day: 27 May. Chosen to commemorate the regiment's initial combat action 27 May 1918.

Status: The 6th Engineer Battalion is inactive in the Regular Army, a component of the 6th Infantry Division (Light); the 10th Engineer Battalion is active in the Regular Army at Fort Stewart, GA, as a component of the 3rd Infantry Division (Mechanized).

Events: 57, 114, 135, 145, 161, 203, 208, 226, 238, 251, 273, 289, 293, 296, 303, 328

Commanders, 6th Engineer Regiment

Col. John Biddle	May 17-Jun 17	Maj. Herbert J. Wild	12 Nov 21-3 Jul 23
Col. John N. Hodges	22 Aug 17-21 Sep 17	Lt. Col. Edward N. Johnston	3 Jul 23-4 Oct 24
Col. William W. Harts	25 Sep 17-17 Dec 17	Maj. Edward D. Ardery	4 Oct 24-6 Dec 26
Col. John N. Hodges	12 Feb 18-14 Jul 18	Lt. Col. Harold C. Fiske	6 Dec 26-28 Feb 30
Col. Roger G. Powell	Feb 18-1 Apr 18	Maj. Paul A. Hodgson	28 Feb 30-12 Jun 30
Col. Harry A. Finch	16 Jun 18-1 Aug 18	Maj. Tatnall D. Simkins	12 Jun 30-5 Aug 30
Col. Edmund L. Daley	1 Aug 18-25 Feb 19	Maj. Lincoln B. Chambers	5 Aug 30-29 Nov 31
Col. Henry A. Finch	25 Feb 19-Aug 19	Lt. Col. Robert P. Howell, Jr.	29 Nov 31-3 Oct 35
Col. Eugene J. Spencer	Aug 19-20 Oct 19	Col. Henry A. Finch	3 Oct 35-1 Oct 38
Maj. Clarence L. Sturdevant	20 Oct 19-12 Nov 21	Lt. Col. Beverly C. Dunn	1 Oct 38-12 Oct 39

7th Engineer Regiment (5th Division)

Regular Army Inactive

HQ-Camp Gordon, GA, 1919-21; Camp Jackson, SC, 1921; *Inactive* 1921-26; Cincinnati, OH, 1926-34; Cleveland, OH, 1934-39



Arrived at the port of New York 28 July 1919 on the U.S.S. *Radnor* as an element of the 5th Division. Transferred to Camp Gordon, GA, and arrived there 2 August 1919. Transferred to Camp Jackson, SC, and arrived there 24 September 1920. Transferred to Camp Benning, GA, and arrived there 24 September 1921. Inactivated 10 October 1921, less Company A, at Camp Benning. Allotted to the Fifth Corps Area and Company A made the Active Associate, 1921-27. For the period 1921-33, Company A performed the duties as the engineer support and demonstration unit for the Infantry School. Company A also assisted the summer training of Organized Reserve engineer units of the Fourth Corps Area at Fort Benning 1922-33. Regiment, less Company A, organized 12 July 1926 with Organized Reserve personnel as a RAI unit with headquarters at Cincinnati, OH. Company A performed emergency construction work to save the Upatoi Creek bridge (at the entrance to Fort Benning) from flood destruction 5-6 March

1929. Company A inactivated at Fort Benning 1 October 1933 and personnel and equipment transferred to Company A, 4th Engineers. Regimental headquarters relocated in September 1934 to Cleveland, OH. The regimental colors were presented to the RAI regiment by Brig. Gen. Guy V. Henry in ceremonies at Fort Knox during summer training in August 1935. Typically conducted Inactive Training Period meetings at the armory of the Cleveland Grays in Cleveland. Conducted summer training at Fort Benjamin Harrison, IN, or Fort Knox, KY. Regiment reorganized and redesignated as the 7th Engineer Battalion (Combat) 16 October 1939 and concurrently activated, less Reserve personnel, at Fort Logan, CO.

Organization Day: 5 November. Chosen to commemorate the regiment's efforts to bridge the Meuse River at Brieculles, France, 5 November 1918. On activation as the 7th Engineer Battalion on 16 October 1939, that date became the new Organization Day.

Status: Inactive in the Regular Army as the 7th Engineer Battalion, a component of the 5th Infantry Division (Mechanized).

Events: 143, 293, 296, 302, 316, 328

Commanders, 7th Engineer Regiment

Lt. Col. Meriwether L. Walker	2 Jun 17-31 Aug 17	<i>Inactive</i>	25 Sep 21-11 Jul 26
Col. Clement C. Flagler	31 Aug 17-17 Dec 17	Maj. Wyman R. Swan**	12 Jul 26-20 Mar 28
Col. Lewis H. Adams	17 Dec 17-23 Sep 18	Maj. Willet E. Stark**	20 Mar 28-ao Jun 28
Col. Earl G. Paules	23 Sep 18-2 Aug 19	Unknown	ao Jun 28-ao Aug 35
Col. William D. A. Anderson	25 Oct 19-29 Jun 20	Capt. Thomas E. Ormiston**	ao Aug 35-ao Sep 35

Capt. John B. LaGuardia	29 Jun 20-8 Aug 20	Unknown	20 Mar 28-ao Aug 35
Col. Clarke S. Smith	8 Aug 20-16 Aug 21	Maj. Orville V. Derr**	ao May 37-ao Jun 38
Capt. John B. LaGuardia	16 Aug 21-24 Sep 21	Unknown	ao Jun 38-16 Oct 39

** RAI Commanders: Organized Reserve officers.

10th Engineer Regiment (8th Division)

Regular Army Inactive

HQ-Inactive 1921-26; Fort A. A. Humphreys, VA, 1926-27; Cincinnati, OH, 1927-30; Morgantown, WV 1930-33; **Inactive** 1933-34; Chicago, IL, 1933-39

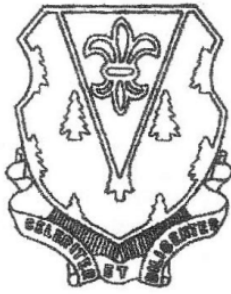

Reconstituted in the Regular Army 25 August 1921 as the 10th Engineer Regiment (a WWI unit constituted in the National Army as the 10th Engineers (Forestry); organized 22 August 1917 at American University, Washington, DC; demobilized as companies of the 20th Engineers (Forestry Regiment) during February 1919 at various locations throughout the United States). Active Associates were the 2nd Engineer Regiment, 1921-23, and the 13th Engineer Regiment 1923-27. Assigned 24 March 1923 to the 8th Division. Organized 22 April 1926 with Organized Reserve personnel as a RAI unit with headquarters at Fort A. A. Humphreys, VA. Withdrawn from the Third Corps Area 19 February 1927 and allotted to the Fifth Corps Area. Organized 15 August 1927 with Organized Reserve personnel as a RAI unit with headquarters at Cincinnati, OH. Regiment was inactivated 28 April 1930 at Cincinnati.

Concurrently affiliated with West Virginia University R.O.T.C. at Morgantown, WV, and immediately organized as a RAI unit with Regular Army personnel from the R.O.T.C. detachment and Reserve officers commissioned from the program. Withdrawn from the Fifth Corps Area 1 October 1933 and allotted to the Sixth Corps Area. Concurrently relieved from the 8th Division and assigned to the 6th Division. Organized 29 March 1934 with Organized Reserve personnel as a RAI unit with headquarters at Chicago, IL. Conducted summer training at Camp Knox, KY, or Fort Benjamin Harrison, IN, 1927-33 and at Camp Custer, MI, 1933-39. Conducted summer training in 1937 with the 108th Engineer Regiment at Camp Grant, IL. Also conducted C.M.T.C. at Camp Custer in 1939 as an alternate form of summer training. Primary R.O.T.C. feeder school was the University of Illinois. Disbanded 16 October 1939.

Events: 162

Commanders, 10th Engineer Regiment

Col. James A. Woodruff	9 Sep 17-11 Jul 19	Capt. Howard C. Molsberry**	May 28-19 Oct 28
<i>Inactive</i>	11 Jul 19-22 Apr 26	Capt. Alexander J. Ciani**	19 Oct 28-28 Apr 30
1st Lt. James B. Cullum, Jr.**	22 Apr 26-1 Dec 26	Capt. Charles S. Jones**	29 Apr 30-30 Sep 33
1st Lt. Merrill R. Thompson**	1 Dec 26-28 Feb 27	<i>Inactive</i>	1 Oct 33-29 Mar 34
<i>Inactive</i>	29 Feb 27-14 Aug 27	Maj. Ernest J. Teberg**	29 Mar 34-ao Jun 35
Maj. Harvey H. Fletcher**	15 Aug 27-11 Oct 27	Unknown	ao Jun 35-ao Nov 36
Unknown	11 Oct 27-May 28	Maj. Henslee D. Goza**	ao Nov 36-2 Dec 36
Col. Clarence O. Sherrill**	May 28-1 Mar 33	Maj. Ernest J. Teberg**	2 Dec 36-16 Oct 39

** RAI Commanders: Organized Reserve officers.

11th Engineer Regiment (Panama Canal Division)

HQ-Corozal, CZ 1920-40; Fort Clayton, CZ 1940-41



Organized in the Regular Army 20 November 1920 at Corozal, CZ, with personnel and equipment of the 2nd Battalion, 3rd Engineers. Assigned 3 July 1921 to the Panama Canal Division. Regiment conducted topographical surveys of Panama during the dry seasons of 1923-25. Engaged in a major topographic survey of the Canal Zone from April 1927 to April 1930. Company F attached to the 29th Engineer Battalion (Topographic) from August 1929 to April 1931 and conducted surveys in Nicaragua for possible canal routes across Central America. Consolidated 25 April 1932 with the 11th Engineer Regiment (Railway) (a WWI unit organized 2 May 1917 at Fort Totten, NY; arrived at the port of New York 27 April 1919 on the U.S.S. *Chicago*; demobilized 8 May

1919 at Camp Upton, NY; reconstituted 25 April 1932). Conducted a 1,500 square-mile map survey of Parita Bay, Panama, 4 April-30 June 1935. Provided the honor guard and security for President Roosevelt's brief visit to the Panama Canal Zone in October 1935. Assisted in the construction of the Quarry Heights command tunnel in the 1930s. Relieved from the Panama Canal Division 10 October 1938. Transferred 13 January 1940 to Fort Clayton, CZ. Assigned 1 February 1940 to the Panama Mobile Force. Location 7 December 1941—Fort Clayton, CZ.

Organization Day: 20 November. Chosen to commemorate the regiment's initial organization on 20 November 1920. On 9 November 1932, after consolidation with the 11th Engineer Regiment (Railway), 2 May became the new Organization Day to commemorate the consolidated regiment's initial organization on 2 May 1917.

Status: Active in the Regular Army at Fort Stewart, GA, as the 11th Engineer Battalion, a component of the 3rd Infantry Division.

Events: 26, 31, 36, 40, 43, 53, 58, 69, 81, 99, 101, 119, 140 167, 170, 181, 223, 271, 292

Commanders, 11th Engineer Regiment

Col. Charles H. McKinstry	May 17-5 Aug 17	Lt. Col. W. Goff Caples	22 Sep 28-13 Dec 30
Col. George M. Hoffman	5 Aug 17-24 Jan 18	Lt. Col. Edward D. Ardery	13 Dec 30-12 Dec 32
Col. Herbert Deakyne	24 Jan 18-17 May 18	Maj. Harry F. Cameron	12 Dec 32-23 Dec 32
Col. William B. Parsons	18 May 18-8 May 19	Lt. Col. Richard T. Coiner	23 Dec 32-30 Aug 33
Maj. Alfred L. Ganahl	20 Nov 20-23 May 21	Maj. Harry F. Cameron	30 Aug 33-25 Jan 34
Maj. Daniel D. Pullen	23 May 21-1 Aug 21	Lt. Col. Richard Park	25 Jan 34-27 Feb 36
Col. William B. Ladue	1 Aug 21-13 May 24	Lt. Col. Stuart C. Godfrey	28 Feb 36-7 Jun 37
Maj. Dabney O. Elliot	13 May 24-3 Feb 25	Lt. Col. Richard V. Nicholas	7 Jun 37-23 Sep 37
Lt. Col. Wildurr Willing	3 Feb 25-21 Sep 27	Lt. Col. John F. Conklin	23 Sep 37-14 Aug 39
Lt. Col. Harry M. Trippe	21 Sep 27-20 Jul 28	Lt. Col. Thomas B. Larkin	14 Aug 39-11 Sep 39
Lt. Col. Julian L. Schley	20 Jul 28-22 Sep 28	Lt. Col. Gordon R. Young	11 Sep 39-Sep 42

12th Engineer Regiment (Combat) (6th Division)

Regular Army Inactive

HQ-Camp Grant, IL, 1919-21; *Inactive* 1921-26; Chicago, IL, 1926-27

Arrived at Newport News 11 June 1919 on the U.S.S. *Orizaba* as the 318th Engineer Regiment, an element of the 6th Division. Transferred to Camp Grant, IL, and arrived there 17 June 1919. Redesignated 1 December 1920 as the 12th Engineer Regiment. Inactivated at Camp Grant 7 September 1921 and allotted to the Sixth Corps Area. Active Associate was the 1st Engineer Regiment, 1921-23. Assigned 24 August 1923 to the 6th Division. The 13th Engineer Regiment designated as the Active Associate 1923-27. Fort A. A. Humphreys, VA, designated as mobilization training station 1923-27. Organized 17 March 1926 with Organized Reserve personnel as a RAI unit with headquarters at Chicago, IL. Conducted summer training at Camp Custer, MI, 1926-27. Relieved from the 6th Division 15 August 1927, reorganized and redesignated as the 12th Engineer Battalion (Mounted), and assigned to the 3rd Cavalry Division.

Status: See 12th Engineer Battalion (Mounted).

Commanders, 12th Engineer Regiment

Col. Thomas H. Jackson	1 Dec 20-10 Aug 21	Maj. John B. Jackson**	17 Mar 26-17 Apr 26
Maj. Bowyer B. Brown	10 Aug 21-7 Sep 21	Lt. Col. Henry L. Kellogg**	17 Apr 26-9 Jun 26
<i>Inactive</i>	7 Sep 21-16 Mar 26	Lt. Col. Harris P. Ralston**	9 Jun 26-15 Aug 27

13th Engineer Regiment (General Service) (I Corps)

HQ-Fort A. A. Humphreys, VA, 1921-36; Iowa City, IA, 1936-39

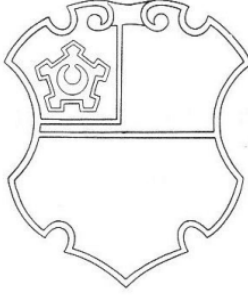

Constituted in the Regular Army 13 January 1921 and organized at Camp A. A. Humphreys, VA, with personnel and equipment from the 1st Battalion, 5th Engineers. Assigned in late 1921 to I Corps as a General Service regiment. The 2nd Battalion was inactivated 21 August 1922. Redesignated 18 May 1925 as 13th Engineer General Service Regiment. Relieved from the I Corps 15 August 1927 and assigned to the 4th Division. Reorganized and redesignated 31 August 1928 as the 13th Engineer Regiment (Combat). The regiment participated in the inaugural parade of President Herbert Hoover 4 March 1929. The 2nd Battalion was reactivated by companies 26 April-13 May 1930 at Fort A. A. Humphreys, VA. Company C built roads and paths throughout the Yorktown Battlefield Park for the sesquicentennial celebration in October 1931. Company C transferred 5 November 1931 to Fort Knox, KY, with remnants of the Experimental Mechanized Force. Consolidated 26 April 1932 with the

13th Engineer Regiment (Railway) (a WWI unit organized 3 May 1917 at Fort Sheridan, IL; demobilized 5 May 1919 at Camp Grant, IL; reconstituted 26 April 1932). Company C transferred 9 May 1933 to Fort Humphreys. Relieved from the 4th Division 1 October 1933 and assigned to 8th Division. Relieved from the 8th Division 10 January 1936 and assigned to the 7th Division. Assisted the summer training of Organized Reserve engineer units of the Third Corps Area at Fort A. A. Humphreys/Fort Belvoir, VA, 1921-35. Regiment also sent companies to Camp Custer, MI, to support the summer training there of Organized Reserve engineer units of the Sixth Corps Area in the 1920s. Regiment inactivated 1 February 1936 at Fort Belvoir, VA; personnel and equipment transferred to the 5th Engineer Regiment. Concurrently, 13th Engineers organized with Organized Reserve personnel as a RAI unit at the State University of Iowa at Iowa City, IA. Conducted summer training at Fort Riley, KS, 1936-39. Conducted C.M.T.C. at Fort Snelling, MN, as an alternate form of summer training. Regiment reorganized and redesignated 16 October 1939 as the 13th Engineer Battalion (Combat).

Organization Day: 13 January. Chosen to commemorate the regiment's initial organization 13 January 1921.

Status: Inactive in the Regular Army as the 13th Engineer Battalion, a component of the 7th Infantry Division.

Events: 137, 151, 176, 314, 326, 331

Commanders, 13th Engineer Regiment

Col. William C. Langfitt	23 Jun 17-24 Aug 17	Maj. Edwin H. Marks	20 Jul 26-6 Jul 28
Col. Charles W. Kutz	28 Aug 17-23 May 18	Maj. DeWitt C. Jones	6 Jul 28-20 Nov 29
Col. Nathaniel L. Howard	23 May 18-Nov 18	Col. Elliot J. Dent	20 Nov 29-1 Feb 32
Lt. Col. C. L. Whiting	Nov 18-5 May 19	Maj. John R. D. Matheson	1 Feb 32-30 Aug 33
<i>Demobilized</i>	5 May 19-12 Jan 21	Col. James A. Woodruff	30 Aug 33-1 Dec 33
Maj. Charles P. Gross	13 Jan 21-29 Jun 22	Lt. Col. William A. Johnson	5 Dec 33-1 Feb 36
Maj. James A. Dorst	29 Jun 22-4 Jul 22	Maj. Andrew Holt**	2 Feb 36-ao Mar 36
Col. James A. Woodruff	4 Jul 22-1 Sep 24	Unknown	ao Mar 36-ao Jul 38
Maj. John F. Conklin	1 Sep 24-20 Jul 26	Lt. Col. Frank R. Allen**	ao Jul 38-1 Oct 39

** RAI Commanders: Organized Reserve officers.

14th Engineer Regiment (PS) (Philippine Division)

HQ-Camp Eldridge, PI 1921; Fort McKinley, PI 1921-22; *Inactive* 1922-24; Fort McKinley, PI 1924-41



Constituted in the Regular Army 21 December 1920 and allotted to the Philippine Department. Regiment, less the 2nd Battalion, organized 3 May 1921 at Camp Eldridge, PI, with personnel and equipment of the disbanded 1st Philippine Engineers (organized 7 April 1918 at Camp Nichols, PI) and personnel from the 1st Battalion, 3rd Engineers. The 2nd Battalion organized 22 September 1921 at Fort Mills, PI, with personnel from the inactivated 62nd Infantry Regiment (PS). Regiment transferred to Fort McKinley, PI, and arrived there 23 September 1921. Assigned 10 April 1922 to the Philippine Division. Regiment, less 1st Battalion, inactivated 12 September 1922. Regimental Headquarters & Service Company reactivated 16 July 1924. Headquarters, 1st Battalion inactivated 25 March 1925; active elements at this time were the regimental headquarters, Headquarters & Service Company, and Companies A, B, and C. The regiment, or elements thereof, conducted the following engineering projects: 1st Battalion conducted topographical surveys of

the Bataan Peninsula during September 1921-June 1923 and portions of Luzon during December 1923-May 1924; portions of Luzon and the Bataan Peninsula during October 1924-May 25, and during the dry seasons of 1928-30; all

elements performed extensive road building and defense improvements on Luzon and Bataan 1922-41. Remainder of regiment reactivated 19 April 1941 at Fort McKinley. Location 7 December 1941—Fort McKinley, PI.

Regimental Day: 3 May. Chosen to commemorate the regiment's initial organization 3 May 1921.

Status: Disbanded 15 July 1953 as the 514th Engineer Construction Battalion (PS).

Events: 27, 35, 41, 52, 68, 82, 100, 118, 139, 157, 169, 179, 198, 223, 245, 270

Commanders, 14th Engineer Regiment (Philippine Scouts) Regiment

	Lt. Col. Francis A. Pope	3 May 21-2 Jul 23	
	1st Battalion		
Maj. Houston G. Parrott	23 May 21-31 Dec 22	Capt. Thomas F. Wirth	2 Jul 23-17 Sep 23
Capt. Frank Tillotson	31 Dec 22-2 Jul 23	Capt. Horatio G. Fairbanks	17 Sep 23-17 Oct 23
	Maj. Charles E. Perry	17 Oct 23-16 Jul 24	
	Regiment		
Maj. Charles E. Perry	16 Jul 24-11 Dec 25	Capt. Roy M. McCutcheon	16 Jan 32-27 Feb 32
Maj. Elihu H. Ropes	15 Dec 25-1 Dec 27	Maj. William H. Holcombe	27 Feb 32-28 Jun 35
Capt. Daniel L. Hooper	1 Dec 27-10 Feb 28	Lt. Col. William M. Hoge	28 Jun 35-29 Oct 37
Maj. Robert A. Sharrer	10 Feb 28-3 Mar 30	Lt. Col. Edwin C. Kelton	29 Oct 37-19 Jul 39
Maj. Albert K. B. Lyman	4 Mar 30-16 Jan 32	Lt. Col. Henry W. Stickney	19 Jul 39-20 Jul 40
	Lt. Col. Harry A. Skerry	20 Jul 40-Apr 42	

15th Engineer Regiment (9th Division)

Regular Army Inactive

HQ-*Not organized* 1921-26; Albany, NY, 1926-33; Fort Devens, MA, 1933-40

Constituted in the Regular Army 25 August 1921. Active Associate was the 13th Engineer Regiment 1921-27. Assigned to the 9th Division 24 March 1923 and allotted to the First Corps Area. Concurrently, consolidated with the 15th Engineer Regiment (Railway) (a WWI unit organized 21 May 1917 at Oakmont, PA, as the 5th Reserve Engineer Regiment; redesignated 8 August 1917 as the 15th Engineers Regiment (Railway); arrived at the port of New York 27 April 1919 on the U.S.S. *Santa Clara*; demobilized 15 June 1919 at Camp Devens, MA, and Camp Sherman, OH; reconstituted 24 March 1923). Organized 9 May 1926 with Organized Reserve personnel as a RAI unit with headquarters in the First Corps Area. Withdrawn from the First Corps Area 19 February 1927 and allotted to the Second Corps Area. Organized 9 May 1927 with Organized Reserve personnel as a RAI unit with headquarters at Albany, NY. Withdrawn from the Second Corps Area 1 October 1933 and allotted to the First Corps Area. Organized in October 1933 with Organized Reserve personnel as a RAI unit with headquarters at Fort Devens, MA. Reserve personnel from the Second Corps Area transferred 9 November 1933 to the 36th Engineer Regiment (RAI). Conducted summer training at Fort FuPont, DE, with the 1st Engineers and some years at Fort A. A. Humphreys, VA, with the 13th Engineers 1928-33. Conducted summer training at Fort Devens 1934-39. Designated mobilization training station was Fort A. A. Humphreys 1928-33 and Camp Dix, NJ, 1933-40. Regiment reorganized and redesignated 1 July 1940 as the 15th Engineer Battalion (Combat).

Status: Inactive in the Regular Army as the 15th Engineer Battalion, a component of the 9th Infantry Division.

Events: 330

Commanders, 15th Engineer Regiment

Col. Edgar Jadwin	May 17-17 Dec 17	Maj. Thomas F. Farrell**	9 May 27-1 Oct 33
Unknown	18 Dec 17-Mar 18	Capt. Werner C. Strecher**	ao Oct 33-ao Jan 34
Col. Ernest Graves	Mar 18-22 Sep 18	Unknown	ao Jan 34-ao Feb 37
Unknown	23 Sep 18-May 19	Capt. Webster L. Simons**	ao Feb 37-ao Mar 37
<i>Demobilized/Inactive</i>	May 19-8 May 26	Unknown	ao Mar 37-ao Jul 39
1st Lt. Thornton C. Fitzsimons**	9 May 26-19 Feb 27	Capt. George W. Gardez**	ao Jul 39-1 Jul 40

** RAI Commanders: Organized Reserve officers.

16th Engineer Regiment (General Service)

Regular Army Inactive

HQ-Not organized 1935-40

Constituted in the Regular Army 11 December 1935 and allotted to the Panama Canal Department. Withdrawn from the Panama Canal Department 15 July 1940. Concurrently, reorganized and redesignated as the 16th Engineer Battalion (Armored), assigned to the 1st Armored Division, and activated at Fort Knox, KY, from personnel and assets of the 47th Engineer Troop (Mecz).

Status: Active in the Regular Army at Friedburg, Germany, as the 16th Engineer Battalion, a component of the 1st Armored Division.

18th Engineer Regiment (Combat)

HQ-Fort Devens, MA, 1939-40; Fort Benning, GA, 1940; Fort Logan, CO, 1940-41; Vancouver Barracks, WA, 1941



Constituted in the Regular Army 16 October 1939 and allotted to the First Corps Area. Activated 21 October 1939 at Fort Devens, MA. Transferred to Fort Benning, GA, 30 March 1940 and assigned to the VIII Corps. Transferred to Fort Logan, CO, and arrived there 2 September 1940. Transferred to Vancouver Barracks, WA, and arrived there 14 February 1941. Concurrently, relieved from the VIII Corps assigned to the IX Corps. Location 7 December 1941—Vancouver Barracks, WA.

Status: Regimental Headquarters and Headquarters & Service Company, 18th Engineer Regiment are active in the Regular Army at Fort Lewis, WA, as the 18th Engineer Company; The 1st Battalion is inactive in the Regular Army as the 18th Engineer Battalion; the 2nd Battalion is inactive in the Regular Army as the 410th Engineer Battalion.

Events: 293, 296, 302, 314, 326

Commanders, 18th Engineer Regiment

Lt. Col. Dabney O. Elliot

25 Oct 39-1 Sep 41

Lt. Col. Walter D. Luplow

1 Sep 41-Feb 42

19th Engineer Regiment (Combat)

HQ-Not organized 1933-34; Chicago, IL, 1934-40, Camp Ord, CA, 1940-41



Demobilized 11-12 July 1919 at Camp Upton, NY, as the 39th Regiment (Transportation Corps). Reconstituted in the Regular Army 1 October 1933 as the 39th Engineer Regiment (General Service), assigned to the Second Army, and allotted to the Sixth Corps Area. Organized by June 1934 with Organized Reserve personnel as a RAI unit with headquarters at Chicago, IL. Designated mobilization training station was Fort McClellan, AL, 1933-38 and the Georgia National Guard Reservation at Toccoa, GA, 1939-40. Activated 1 June 1940, less Reserve personnel, at Camp Ord, CA. Redesignated as the 19th Engineer Regiment (Combat) 1 July 1940 and assigned to the III Corps. Location 7 December 1941—Fort Ord, CA.

Status: Regimental Headquarters, and Headquarters & Service Company, 19th Engineer Regiment (Combat) are inactive in the Regular Army as HHC, 19th Engineer Group; 1st Battalion is active in the Regular Army at Fort Carson, CO, as the 52nd Engineer Battalion; 2nd Battalion inactive in the Regular Army as the 61st Engineer Battalion.

Events: 304

Commanders, 19th Engineer Regiment

Col. Herbert Deakyne

9 May 17-21 Jan 18

Unknown

ao Jun 34-ao May 35

Col. H.H. Maxfield

21 Jan 18-12 Jul 19

Maj. Clarence A. DeCamp**

ao May 35-1 Jun 40

Demobilized/Inactive

12 Jul 19-ao Jun 34

Unknown

1 Jun 40-1 Jul 40

Col. George J. Richards

1 Jul 40-Jul 41

** RAI Commanders: Organized Reserve officers.

20th Engineer Regiment (General Service) (Third Army)

HQ-*Not organized* 1933-39; Birmingham, AL, 1939-40; Fort Benning, GA, 1940

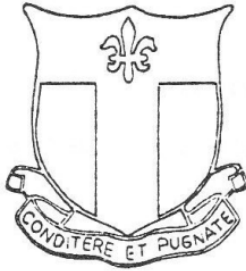

Demobilized June-July 1919 as four separate companies of the 20th Engineers (Forestry) at Camp Merritt, NJ, and Newport News, VA. Reconstituted in the Regular Army 1 October 1933 as the 42nd Engineer Regiment (General Service), assigned to the Third Army, and allotted to the Fourth Corps Area. Organized by December 1939 with Organized Reserve personnel as a RAI unit with headquarters at Birmingham, AL. Activated 1 June 1940, less Reserve personnel, at Fort Benning, GA. Redesignated 20th Engineer Regiment (Combat) 1 July 1940 and assigned to the IV Corps. Location 7 December 1941—Fort Benning, GA.

Status: Regimental Headquarters and Headquarters & Service Company, 20th Engineer Regiment were consolidated with the 1st Battalion and redesignated as the 20th Engineer Battalion which is active in the Regular Army at Fort Hood, TX, as a component of the 1st Cavalry Division; the 2nd Battalion is active in the Regular Army at Bamberg Germany, as the 54th Engineer Battalion (Corps, Mechanized).

Events: 300, 328

Commanders, 20th Engineer Regiment

Unknown	ao Dec 39-1 Jun 40	Col. William F. Heavey	1 Jun 40-Jul 41
---------	--------------------	------------------------	-----------------

21st Engineer Regiment (General Service) (II Corps)

Regular Army Inactive

HQ-*Not organized* 1927-28; Schenectady, NY, 1928-39; Fort Benning, GA, 1939-40; Langley Field, VA, 1940-41

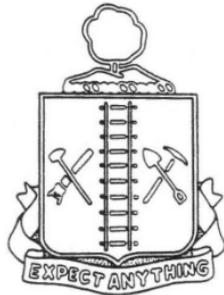

Constituted in the Regular Army 18 October 1927, assigned to the II Corps, and allotted to the Second Corps Area. Organized 18 April 1928 with Organized Reserve personnel as a RAI unit with headquarters at Schenectady, NY. Consolidated 25 April 1932 with the 21st Engineer Regiment (Light Railway) (a WWI unit organized in August 1917 at Camp Grant, IL; arrived at the port of New York 16 June 1919 on the U.S.S. *Plattsburg* and demobilized in late June 1919 at Camp Devens, MA; reconstituted 25 April 1932). Typically conducted Inactive Training Period meetings at 5 Stark Avenue, 243rd State Street, or the State Armory in Schenectady. Typically conducted summer training with the 1st Engineer Regiment at Fort DuPont, DE, and some years with the 13th Engineers at Fort A. A. Humphreys. Designated mobilization training station was Fort Belvoir, VA, 1927-33 and Camp Smith, NY, 1933-39. Withdrawn from the Second Corps Area 16 October 1939 and allotted to the Fourth Corps Area. Concurrently,

reserve personnel transferred to the 36th Engineer Regiment. Activated 20 October 1939 at Fort Benning, GA. Assigned 8 April 1940 to the IV Corps. Redesignated 4 June 1940 as the 21st Engineer Regiment (Aviation), relieved from the IV Corps, and assigned to the General Headquarters Air Force. Transferred to Langley Field, VA, and arrived there 17 June 1940. Location 7 December 1941—Langley Field, VA.

Organization Day: 20 October. Chosen to commemorate the regiment's initial activation 20 October 1939.

Status: Inactive in the Regular Army as the 921st Engineer Regiment (Aviation).

Events: 293, 296, 330

Commanders, 21st Engineer Regiment

Col. Ernest D. Peek	10 Sep 17-19 Nov 18	Col. Frederick S. Greene **	18 Apr 28-10 May 34
Unknown	19 Nov 18-Jun 19	Maj. Arthur W. Wheeler**	10 May 34-16 Oct 39
<i>Demobilized/Inactive</i>	Jun 19-18 Apr 28	Lt. Col. Donald A. Davidson	22 Oct 39-30 Jul 40
	Col. Dwight F. Johns	30 Jul 40-11 Jan 42	

** RAI Commanders: Organized Reserve officers.

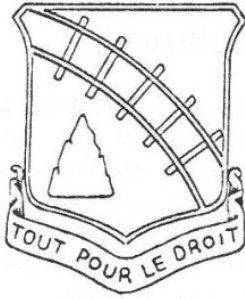
22nd Engineer Regiment (General Service) (III Corps)**Regular Army Inactive****HQ-Not organized** 1927-29; Pittsburgh, PA, 1929-41

Constituted in the Regular Army 18 October 1927, assigned to the III Corps, and allotted to the Third Corps Area. Organized 10 October 1929 with Organized Reserve personnel as a RAI unit with headquarters at Pittsburgh, PA. Consolidated 26 September 1930 with the 22nd Engineer Regiment (Light Railway Construction) (a WWI unit organized 20 March 1918 at Camp Sheridan, AL; demobilized 22 July 1919 at Camp Zachary Taylor, KY; reconstituted 26 September 1930). Typically conducted Inactive Training Period meetings at the New Federal Building in Pittsburgh or at the University Club in State College, PA. Conducted summer training with 13th Engineer Regiment at Fort A. A. Humphreys, VA. Designated mobilization training station was Fort Belvoir, VA. Primary R.O.T.C. feeder school was Pennsylvania State College. Redesignated 22nd Engineer Battalion (Armored) 28 August 1941 and assigned to the 5th Armored Division. Concurrently, Organized Reserve personnel relieved from assignment.

Status: Inactive in the Regular Army as the 22nd Engineer Battalion, a component of the 5th Armored Division.**Commanders, 22nd Engineer Regiment**

Col. Robert S. Thomas	4 Apr 18-26 Jun 18	Maj. Lewis E. Burnside**	10 Oct 29-20 Nov 29
Unknown	26 Jun 18-22 Jul 19	Lt. Col. Elton D. Walker**	20 Nov 29-9 Mar 33
<i>Demobilized/Inactive</i>	22 Jul 19-10 Oct 29	Lt. Col. Lewis E. Burnside**	9 Mar 33-28 Aug 41

** RAI Commanders: Organized Reserve officers.

23rd Engineer Regiment (General Service) (VIII Corps)**Regular Army Inactive****HQ-Not organized** 1927-29; Pittsburgh, PA, 1929-34; San Antonio, TX, 1934-40

Constituted in the Regular Army 18 October 1927 and allotted to the Third Corps Area. Organized 22 October 1929 with Organized Reserve personnel as a RAI unit with headquarters at Pittsburgh, PA. Consolidated 28 April 1932 with the 23rd Engineer Regiment (Highways) (a WWI unit organized in September 1917 at Camp George G. Meade, MD; demobilized 16 June 1919 at Camp Devens, MA; reconstituted 28 April 1932). Typically conducted Inactive Training Period meetings at the 176th Field Artillery armory in Pittsburgh. Conducted summer training with 13th Engineer Regiment at Fort A. A. Humphreys, VA, 1927-33. Withdrawn from the Third Corps Area 1 October 1933 and allotted to the Eighth Corps Area. Concurrently assigned to the VIII Corps. Inactivated 25 January 1934 at Pittsburgh by relief of personnel.

Organized 26 November 1934 with Organized Reserve personnel as a RAI unit with headquarters at San Antonio, TX. Conducted summer training in 1940 at Nacogdoches, TX. Designated mobilization training station was Fort McIntosh, TX, 1933-40. Redesignated 23rd Engineer Battalion (Armored) 16 December 1940 and assigned to the 3rd Armored Division.

Status: Inactive in the Regular Army as the 23rd Engineer Battalion, a component of the 3rd Armored Division.**Commanders, 23rd Engineer Regiment**

Col. Edward N. Johnston	Sep 17-May 18	Lt. Col. John T. Keenan**	20 Nov 29-25 Jan 34
Unknown	May 18-Jun 19	<i>Inactive</i>	26 Jan 34-25 Nov 34
<i>Demobilized/Inactive</i>	Jun 19-22 Oct 29	1st Lt. James E. Turner**	26 Nov 36-ao Jan 37
Lt. Col. Elton D. Walker**	22 Oct 29-20 Nov 29	Unknown	ao Jan 37-16 Dec 40

** RAI Commanders: Organized Reserve officers.

24th Engineer Regiment (General Service) (VI Corps)**Regular Army Inactive****HQ-Not organized** 1927-28; Chicago, IL, 1928-40

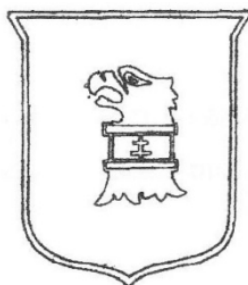

Constituted in the Regular Army 18 October 1927, assigned to the VI Corps, and allotted to the Sixth Corps Area. Organized 24 April 1928 with Organized Reserve personnel as a RAI unit with headquarters at Chicago, IL. Attached 3 November 1930 to the 86th Division for administrative control. Consolidated 3 April 1931 with the 24th Engineer Regiment (Supply and Shop) (a WWI unit organized in November 1917 at Camp Dix, NJ; demobilized 3 June 1919 at Camp Jackson, SC; reconstituted 3 April 1931). Typically conducted Inactive Training Period meetings at the 202nd Coast Artillery armory or the Post Office Building in Chicago. Conducted summer training at various locations to include Fort A. A. Humphreys, VA, Camp Custer, MI, and Fort Snelling, MN. Also conducted C.M.T.C. training some years at Camp Custer as an alternate form of annual training. Designated mobilization training station was Fort McClellan, AL, 1927-38, and the Georgia National Guard Reservation at

Toccoa, GA, 1938-41. Redesignated as the 24th Engineer Battalion (Armored) 16 December 1940 and assigned to the 4th Armored Division.

Status: Inactive in the Regular Army as the 24th Engineer Battalion, a component of the 4th Armored Division.

Commanders, 24th Engineer Regiment

Col. James F. Bell	27 Dec 17-15 Feb 19	Unknown	24 Apr 28-20 Nov 28
Unknown	15 Feb 19-3 Jun 19	Lt. Col. Harris P. Ralston**	20 Nov 28-13 Jan 30
<i>Demobilized/Inactive</i>	3 Jun 19-24 Apr 28	Lt. Col. John B. Jackson**	13 Jan 30-4 Jan 35
	Lt. Col. Jerome J. Cerny**	5 Jan 35-16 Dec 40	

** RAI Commanders: Organized Reserve officers.

25th Engineer Regiment (General Service) (VII Corps)

Regular Army Inactive

HQ-*Not organized* 1927-28; St. Paul, MN, 1928-41

Constituted in the Regular Army 18 October 1927, assigned to the VII Corps, and allotted to the Seventh Corps Area. Organized by December 1928 with Organized Reserve personnel as a RAI unit with headquarters at St. Paul, MN. Consolidated 26 April 1932 with the 25th Engineer Regiment (General Construction) (a WWI unit organized 13 September 1917 at Camp Devens, MA; demobilized 30 May 1919 at Camp Upton, NY; reconstituted 26 April 1932). Typically conducted Inactive Training Period meetings at the Union Building, University of Minnesota in Minneapolis. Conducted summer training at various locations to include Fort Riley, KS, Fort Logan, CO, Fort Snelling, MN, and Fort Des Moines, IA. Redesignated 28 August 1941 as the 25th Engineer Battalion (Armored) and assigned to the 6th Armored Division.

Status: Inactive in the Regular Army as the 25th Engineer Battalion, a component of the 6th Armored Division.

Commanders, 25th Engineer Regiment

Col. Wildurr Willing	4 Sep 17-23 Mar 18	Unknown	Dec 28-14 Jul 35
Lt. Col. E. V. R. Payne	28 Mar 18-30 May 19 1st.	Lt. Col. Francis J. Starr**	14 Jul 35-ao Aug 35
<i>Demobilized/Inactive</i>	30 May 19-Dec 28	Col. Alfred C. Whitney**	ao Dec 35-27 Aug 41

** RAI Commanders: Organized Reserve officers.

26th Engineer Regiment (General Service) (IX Corps)

Regular Army Inactive

HQ-*Not organized* 1927-28; Seattle, WA, 1928-36; San Francisco, CA, 1936-41

Constituted in the Regular Army 18 October 1927, assigned to the IX Corps, and allotted to the Ninth Corps Area. Organized by June 1928 with Organized Reserve personnel as a RAI unit with headquarters at Seattle, WA. Consolidated 25 April 1932 with the 26th Engineer Regiment (Water Supply) (a WWI unit organized 11 September 1917 at Camp Dix, NJ; demobilized 13 March 1919 at Camp Dix, NJ; reconstituted 25 April 1932). Entire regiment relocated in 1936 to San Francisco, CA. Conducted summer training at Fort Lewis, WA. Location 7 December 1941—San Francisco, CA.

Status: Disbanded 22 December 1942.

Commanders, 26th Engineer Regiment

Col. Elliot J. Dent	Sep 17-Aug 18	Maj. David D. Hall	ao May 36-25 Sep 36
Col. Francis F. Longley	1 Oct 18-Jan 19	Capt. Lionel H. Rosenthal	25 Sep 36-ao Jan 37
<i>Demobilized/Inactive</i>	Jan 19-Jun 28	Capt. Glenn E. Morehead	ao Jan 38-19 Mar 38
Unknown	Jun 28-ao Oct 30	Unknown	19 Mar 38-2 Aug 38
Capt. Benjamin B. Bessesen**	ao Oct 30-ao Jun 31	Capt. John S. Wilfong	2 Aug 38-8 Nov 38
Unknown	ao Jun 31-ao May 36	Lt. Col. Charles D. Jenkins	8 Nov 38-ao Jan 39
	Unknown	ao Jan 39-7 Dec 41	

** RAI Commanders: Organized Reserve officers.

34th Engineer Regiment (General Service) (GHQR)

Regular Army Inactive

HQ-*Not organized* 1933-34; Okmulgee, OK, 1934-36; *Inactive* 1936-41; Schofield Barracks, TH 1941

Constituted in the Regular Army 1 October 1933, assigned to the General Headquarters Reserve, and allotted to the Eighth Corps Area. Organized 28 November 1934 with Organized Reserve personnel as a RAI unit with headquarters at Okmulgee, OK. Conducted summer training at Fort Sill, OK. Withdrawn from the Eighth Corps Area 5 June 1936 and allotted to the Sixth Corps Area. Consolidated 11 September 1936 with the 34th Engineer Regiment (Supply And Shop) (a WWI unit organized in February 1918 at Camp Dix, NJ; demobilized 7 August 1919 at Newport News, VA; reconstituted 11 September 1936). Designated mobilization training station was the Georgia National Guard Reservation at Toccoa, GA, 1936-40. Reorganized and redesignated 16 December 1940 as the 34th Engineer Regiment (Combat). Assigned 23 January 1941 to the VIII Corps. Activated 17 October 1941 at Schofield Barracks, TH, relieved from the VIII Corps, and assigned to the Hawaiian Department. Location 7 December 1941—Schofield Barracks, TH.

Status: Regimental Headquarters and Headquarters & Service Company, 34th Engineer Regiment (GS) are inactive in the Regular Army as HHC, 34th Engineer Group; the 1st Battalion is inactive in the Regular Army as the 34th Engineer Battalion; the 2nd Battalion is inactive in the Regular Army as the 32nd Engineer Battalion.

Commanders, 34th Engineer Regiment

Maj. William P. Cowles	Feb 18-7 Apr 18	Unknown	28 Nov 34-15 Jan 35
Col. Arthur R. Ehrnbeck	7 Apr 18-16 Sep 18	Maj. Ewing L. Lusk**	16 Jan 35-5 Jun 36
Maj. Herbert W. Ferris	16 Sep 18-7 Aug 19	<i>Inactive</i>	5 Jun 36-17 Oct 41
<i>Demobilized/Inactive</i>	7 Aug 19-28 Nov 34	Unknown	17 Oct 41-7 Dec 41

** RAI Commanders: Organized Reserve officers.

35th Engineer Regiment (General Service) (First Army)

Regular Army Inactive

HQ-Fort Devens, MA, 1933-36; Baltimore, MD, 1936-41; Fort Snelling, MN, 1941; Camp Joseph T. Robinson, AR, 1941

Constituted in the Regular Army 1 October 1933, assigned to the First Army, and allotted to the First Corps Area. Organized about December 1933 with Organized Reserve personnel as a RAI unit with headquarters at Fort Devens, MA. Withdrawn from the First Corps Area 5 June 1936 and allotted to the Third Corps Area. Organized in July 1936 with Organized Reserve personnel as a RAI unit with headquarters at Baltimore, MD. Conducted summer training at Fort Belvoir, VA. Designated mobilization training station was Fort Belvoir 1936-40. Relieved from the First Army 23 January 1941 and assigned to the VII Corps. Activated 15 July 1941, less Reserve personnel, as the 35th Engineer Regiment (Combat) at Fort Snelling, MN. Transferred to Camp Joseph T. Robinson, AR, and arrived there 14 August 1941. Location 7 December 1941—Camp Joseph T. Robinson, AR.

Status: Regimental Headquarters and Headquarters & Service Company, 35th Engineer Regiment (GS) are inactive in the Regular Army as HHC, 35th Engineer Group; the 1st Battalion is inactive in the Regular Army as the 35th Engineer Battalion.

Commanders, 35th Engineer Regiment

Unknown	Dec 33-5 Jun 36	Capt. Frank J. Maguire**	Sep 37-ao Jun 40
<i>Inactive</i>	5 Jun 36-Jul 36	Unknown	ao Jun 40-15 Jul 41
Unknown	Jul 36-Sep 37	Lt. Col. Robert B. Engels	19 Jul 41-ao Jan 42

** RAI Commanders: Organized Reserve officers.

36th Engineer Regiment (General Service) (First Army)**Regular Army Inactive****HQ**-Albany, NY, 1933-38; Schenectady, NY, 1938-41; Plattsburg Barracks, NY, 1941

Constituted in the Regular Army 1 October 1933, assigned to the First Army, and allotted to the Second Corps Area. Organized 9 October 1933 with Organized Reserve personnel as a RAI unit with headquarters at Albany, NY. Personnel transferred from the inactivated 15th Engineer Regiment. Headquarters relocated in 1938 to Schenectady, NY. Typically conducted Inactive Training Period meetings at 5 Stark Avenue, 243 State Street, or the State Armory in Schenectady. Conducted summer training at Fort FuPont, DE. Designated mobilization training station was Camp Smith, NY, 1933-39 and Fort Belvoir, VA, 1939-40. Redesignated 13 January 1941 as the 36th Engineer Regiment (Combat). Relieved from the First Army 23 January 1941 and assigned to the VI Corps. Activated 1 June 1941, less Reserve personnel, at Plattsburg Barracks, NY. Location 7 December 1941—Plattsburg Barracks, NY.

Status: Regimental Headquarters, and Headquarters & Service Company, 36th Engineer Regiment are active in the Regular Army at Fort Benning, GA, as HHC, 36th Engineer Group; the 1st Battalion is inactive in the Regular Army as the 36th Engineer Battalion; the 3rd Battalion is inactive in the Regular Army as the 19th Engineer Battalion.

Events: 330**Commanders, 36th Engineer Regiment**

Lt. Col. Thomas F. Farrell**	9 Oct 33-19 Jul 37	Maj. Jay D. Moore**	13 Feb 39-16 Oct 39
Capt. William T. Wilkinson**	19 Jul 37-8 Nov 37	Maj. Arthur W. Wheeler**	16 Oct 39-8 Feb 41
Capt. Lowell J. Dow**	8 Nov 37-13 Feb 39	Maj. Harry J. Lemp **	8 Feb 41-2 Apr 41
	Col. William W. Thomas, Jr.	1 Jun 41-ao Dec 41	

** RAI Commanders: Organized Reserve officers.

37th Engineer Regiment (General Service) (First Army)**Regular Army Inactive****HQ**-*Not organized* 1933-34; Pittsburgh, PA, 1934-41; Camp Bowie, TX, 1941

Constituted in the Regular Army 1 October 1933, assigned to the First Army, and allotted to the Third Corps Area. Concurrently consolidated with the 37th Engineer Regiment (Electrical and Mechanical) (a WWI unit organized in January 1918 at Fort Myer, VA; demobilized in April 1919 at Camp Stuart, VA; reconstituted 1 October 1933). Organized 25 January 1934 with Organized Reserve personnel as a RAI unit with headquarters at Pittsburgh, PA. Typically conducted Inactive Training Period meetings at the New Federal Building in Pittsburgh. Conducted summer training at Fort Belvoir, VA. Primary R.O.T.C. feeder schools were the Carnegie Institute of Technology and Pennsylvania State College. Redesignated 13 January 1941 as the 37th Engineer Regiment (Combat). Relieved from the First Army 23 January 1941 and assigned to the VIII Corps. Activated

14 July 1941, less Reserve personnel, at Camp Bowie, TX. Location 7 December 1941—Camp Bowie, TX.

Status: Regimental Headquarters and Headquarters & Service Company, 37th Engineer Regiment (GS) are inactive in the Regular Army as HHC, 37th Engineer Group; the 1st Battalion is active in the Regular Army at Fort Bragg, NC, as the 37th Engineer Battalion; the 2nd Battalion is inactive in the Regular Army as the 27th Engineer Battalion.

Events: 328**Commanders, 37th Engineer Regiment**

Col. Ralph T. Ward	16 Jan 18-31 Jan 18	Maj. Eugene L. Messler**	Apr 34-21 Apr 37
Col. Theodore H. Dillon	1 Feb 18-7 Dec 18	Maj. Emmet H. Douglas**	21 Apr 37-22 Sep 38
Unknown	8 Dec 18-Apr 19	Capt. L. Herdman Harris, III**	22 Sep 37-Aug 38
<i>Demobilized/Inactive</i>	Apr 19-25 Jan 34	Capt. Ray S. Quick**	Aug 38-Jul 39
Capt. Clarence H. Kent**	25 Jan 34-29 Mar 34	Col. Harry P. Wilson**	Jul 39-Sep 39
Capt. Ray R. Ralston**	29 Mar 34-Apr 34	Capt. Ray S. Quick**	Sep 39-13 Jul 41
	Col. Douglas H. Gilette	14 Jul 41-Jan 42	

** RAI Commanders: Organized Reserve officers.

38th Engineer Regiment (General Service) (Second Army)**Regular Army Inactive****HQ-Not organized** 1933-34; Moundsville, WV 1934-37; Morgantown, WV 1937-41; Fort Jackson, SC, 1941

Constituted in the Regular Army 1 October 1933, assigned to the Second Army, and allotted to the Fifth Corps Area. Organized by June 1934 with Organized Reserve personnel as a RAI unit with headquarters at Moundsville, WV. Headquarters relocated 10 May 1937 to Morgantown, WV. Conducted summer training at Fort Knox, KY. Designated mobilization training station was the Georgia National Guard Reservation at Toccoa, GA. Redesignated 13 January 1941 as the 38th Engineer Regiment (Combat). Activated 28 May 1941, less Reserve personnel, as the 38th Engineer Combat Regiment at Fort Jackson, SC, and assigned to the I Corps. Location 7 December 1941—Fort Jackson, SC.

Status: Regimental Headquarters, and Headquarters & Service Company, 38th Engineer Regiment were consolidated with the 1st Battalion and are inactive in the Regular Army as the 538th Engineer Battalion (Construction).

Events: 330**Commanders, 38th Engineer Regiment**

Unknown	Jun 34-ao Jun 36	Unknown	ao Sep 37-ao Aug 38
Capt. Homer L. Smith**	ao Jun 36-ao Jul 36	Capt. Joseph C. Oxley**	ao Aug 38-ao Sep 38
Unknown	ao Jul 36-ao Jun 37	Unknown	ao Sep 38-28 May 41
Lt. Col. Eugene Reybold*	ao Jul 37-ao Sep 37	Lt. Col. Willis A. Teale	28 May 41-Jan 42

* RAI Commanders: Regular Army mobilization commander

** RAI Commanders: Organized Reserve officers.

39th Engineer Regiment (General Service) (Second Army)**Regular Army Inactive****HQ-Not organized** 1933-34; Chicago, IL, 1934-40, Camp Ord, CA, 1940

Constituted in the Regular Army 1 October 1933, assigned to the Second Army, and allotted to the Sixth Corps Area. Concurrently, consolidated with the 39th Regiment (Transportation Corps) (a WWI unit organized 18 February 1918 at Camp Upton, NY; demobilized 11-12 July 1919 at Camp Upton; reconstituted 1 October 1933). Organized by June 1934 with Organized Reserve personnel as a RAI unit with headquarters at Chicago, IL. Typically conducted Inactive Training Period meetings at the 202nd Coast Artillery armory or the Post Office Building in Chicago. Conducted summer training most years at Camp Custer, MI. Conducted summer training in 1937 with the 108th Engineer Regiment at Camp Grant, IL. Also conducted C.M.T.C. training some years at Camp Custer as an alternate form of annual training. Designated mobilization training station was Fort McClellan, AL, 1933-38 and the Georgia National Guard Reservation at Toccoa, GA, 1939-41. Activated 1 June 1940, less

Reserve personnel, at Camp Ord, CA. Redesignated 1 July 1940 as the 19th Engineer Regiment (Combat).

Status: Regimental Headquarters, and Headquarters & Service Company, 19th Engineer Regiment (Combat) are inactive in the Regular Army as HHC, 19th Engineer Group; 1st Battalion is active in the Regular Army at Fort Carson, CO, as the 52nd Engineer Battalion; 2nd Battalion inactive in the Regular Army as the 61st Engineer Battalion.

Commanders, 39th Engineer Regiment

Col. Herbert Deakne	9 May 17-21 Jan 18	Unknown	ao Jun 34-ao May 35
Col. H.H. Maxfield	21 Jan 18-12 Jul 19	Maj. Clarence A. DeCamp**	ao May 35-1 Jun 40
<i>Demobilized/Inactive</i>	12 Jul 19-ao Jun 34	Unknown	1 Jun 40-1 Jul 40

** RAI Commanders: Organized Reserve officers.

40th Engineers (Camouflage)**Organized Reserve New York****HQ**-Manhattan, NY, (1st Battalion only) 1922-33

Demobilized 18 February 1919 as Company A, 40th Engineers (Camouflage) at Washington Barracks, DC. Reconstituted in the Organized Reserve 28 December 1922 as the 1st Battalion, 40th Engineers, assigned to the General Headquarters Reserve, and allotted to the Second Corps Area. The 1st Battalion (consisting of HHC and Companies A, B, and C) organized at Manhattan, NY, on the same date with personnel from the 601st and 604th Engineer Camouflage Companies. Additional subordinate companies organized as follows: Company D organized from Company A, 502nd Engineer Camouflage Battalion at Boston, MA, and assigned to the First Army; Company E organized from B Company, 502nd Engineer Camouflage Battalion at Indianapolis, IN, and assigned to the Second Army; Company F organized from Company C, 502nd Engineer Camouflage Battalion at Los Angeles, CA, and assigned to the Third Army; Company G organized from Company D, 502nd Engineer Camouflage Battalion at Sunbury, PA, and assigned to the Fourth Army; Company H organized from the 602nd Engineer Camouflage Company at Wausau, WI, and assigned to the Fifth Army; Company I organized from 603rd Engineer Camouflage Company at Kansas City, MO, and assigned to the Sixth Army. The 1st Battalion conducted monthly meetings at the armory of the 71st Infantry in New York City. Company I withdrawn 5 September 1928; Companies D, E, F, G, and H withdrawn 31 March 1930 and demobilized. Concurrently 1st Battalion redesignated as the 605th Engineer Camouflage Battalion and assigned to the First Army (See 40th Engineer Battalion (Camouflage) [I]).

40th Engineer Regiment (General Service) (Second Army)**Regular Army Inactive****HQ**-Not organized 1933-34; Detroit, MI, 1934-38

Constituted in the Regular Army 1 October 1933, assigned to the Second Army, and allotted to the Sixth Corps Area. Organized in January 1935 with Organized Reserve personnel as a RAI unit with headquarters at Detroit, MI. Redesignated 1 January 1938 as the 340th Engineer Regiment (General Service).

Commanders, 40th Engineer Regiment

Maj. Eugene I. Van Antwerp**	Jan 35-Dec 36	Unknown	Dec 36-21 Mar 37
	Maj. Neal S. Kinsley **	21 Mar 37-1 Jan 38	

** RAI Commanders: Organized Reserve officers.

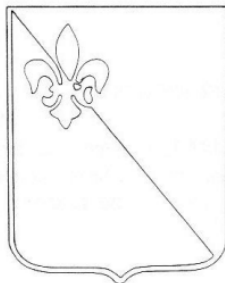
41st Engineer Regiment (General Service) (C) (Third Army)**Regular Army Inactive****HQ**-Not organized 1933-34; Vicksburg, MS, 1934-40; Fort Bragg, NC, 1940; Fort Jackson, SC, 1940-41

Constituted in the Regular Army 1 October 1933, assigned to the Third Army, and allotted to the Fourth Corps Area. Organized 6 December 1934 with Organized Reserve personnel as a RAI unit with headquarters at Vicksburg, MS. Designated mobilization training station was the Georgia National Guard Reservation at Toccoa, GA. Activated 1 August 1940, less Reserve personnel, as the 41st Engineer General Service Regiment at Fort Bragg, NC, and assigned to the First Army. Transferred to Fort Jackson, SC. Location 7 December 1941—Fort Jackson, SC.

Status: Inactive in the Regular Army as the 541st Engineer Battalion.

Events: 330

Commanders, 41st Engineer Regiment

1st Lt. French C. Brown**	6 Dec 34-ao Jan 35	Unknown	30 Jun 37-ao Aug 38
Unknown	ao Jan 35-ao Jun 36	Capt. William D. Morrison**	ao Aug 38-ao Sep 38
Capt. Smith C. Daniell**	ao Jun 36-1 Jul 36	Unknown	ao Sep 38-ao May 39
Col. DeWitt C. Jones*	1 Jul 36-30 Jun 37	Capt. Julian C. Lever**	ao May 39-1 Aug 40
	Lt. Col. John E. Wood	12 Aug 40-ao Aug 41	

* RAI Commanders: Regular Army mobilization commander

** RAI Commanders: Organized Reserve officers.

42nd Engineer Regiment (General Service) (Third Army)

Regular Army Inactive

HQ-Not organized 1933-34; Birmingham, AL, 1934-40; Fort Benning, GA, 1940

Constituted in the Regular Army 1 October 1933, assigned to the Third Army, and allotted to the Fourth Corps Area. Organized 6 December 1934 with Organized Reserve personnel as a RAI unit with headquarters at Birmingham, AL. Consolidated 4 September 1936 with the 42nd Engineer Battalion (Forestry) (a WWI unit organized in February 1918 at American University, Washington, DC; demobilized in October 1918 in France; reconstituted 4 September 1936). Activated 1 June 1940, less Reserve personnel, as the 42nd Engineer Regiment (General Service) at Fort Benning, GA, and assigned to the Third Army. Redesignated 1 July 1940 as the 20th Engineer Regiment (Combat).

Status: Regimental Headquarters and Headquarters & Service Company, 20th Engineer Regiment were consolidated with the 1st Battalion, redesignated as the 20th Engineer Battalion, and active in the Regular Army at Fort Hood, TX, as a component of the 1st Cavalry Division; the 2nd Battalion is active at Bamberg Germany, as the 54th Engineer Battalion (Corps, Mechanized).

Events: 328

Commanders, 42nd Engineer Regiment

Maj. Neil R. McKay**	6 Dec 34-27 Oct 37	Capt. Charles R. Dickenson**	27 Oct 37-1 Jun 40
----------------------	--------------------	------------------------------	--------------------

** RAI Commanders: Organized Reserve officers.

43rd Engineer Regiment (General Service) (Third Army)

Regular Army Inactive

HQ-Not organized 1933-34; San Antonio, TX, 1934-41; Fort Snelling, MN, 1941; Camp Joseph T. Robinson, AR, 1941



Constituted in the Regular Army 1 October 1933, assigned to the Third Army, and allotted to the Eighth Corps Area. Organized 26 November 1934 with Organized Reserve personnel as a RAI unit with headquarters at San Antonio, TX. Consolidated 15 September 1936 with the 43rd Engineer Battalion (Forestry) (a WWI unit organized in January 1918 at American University, Washington, DC; demobilized in October 1918 in France; reconstituted 15 September 1936). Conducted summer training in 1940 at Nacogdoches, TX. Designated mobilization training station was Fort Brown, TX. Assigned 24 January 1941 to the Second Army. Activated 10 February 1941, less Reserve personnel, at Fort Snelling, MN. Transferred 7 March 1941 to Camp Joseph T. Robinson, AR. Location 7 December 1941—Camp Joseph T. Robinson, AR.

Status: Inactive in the Regular Army as the 43rd Engineer Battalion.

Events: 316, 324, 328

Commanders, 43rd Engineer Regiment

Capt. Harvey W. Coleman**	26 Nov 34-ao Jan 35	Unknown	ao Sep 35-10 Feb 41
Maj. Roy W. Leibsley**	ao Aug 35-ao Sep 35	Lt. Col. Mason J. Young	10 Feb 41-21 Mar 41
	Col. Heston R. Cole	21 Mar 41-ao Jan 42	

** RAI Commanders: Organized Reserve officers.

44th Engineer Regiment (General Service) (Fourth Army)**Regular Army Inactive****HQ-Not organized** 1933-34; Council Bluffs, IA, 1934-41; Fort Belvoir, VA, 1941

Constituted in the Regular Army 1 October 1933, assigned to the Fourth Army, and allotted to the Seventh Corps Area. Organized by December 1934 with Organized Reserve personnel as a RAI unit with headquarters at Council Bluffs, IA. Consolidated 10 September 1936 with the 44th Engineer Battalion (Railway Maintenance of Way) (a WWI unit organized in May 1918 at Fort Benjamin Harrison, IN; redesignated 18 September 1918 as the 44th Regiment (Transportation Corps); reconstituted 10 September 1936). Typically conducted Inactive Training Period meetings at the Dodge Light Guard Armory in Council Bluffs. Conducted summer training at various locations to include Fort Riley, KS, Fort Snelling, MN, and Fort Des Moines, IA. Relieved from the Fourth Army 24 January 1941 and assigned to the First Army. Activated 10 June 1941, less Reserve personnel, at Fort Belvoir, VA, Location 7 December 1941—Fort Belvoir, VA.

Status: Regimental Headquarters and Headquarters & Service Company, 44th Engineer Regiment (General Service) are active in the U.S. Army Reserve at Pittsburgh, PA, as HHC, 308th Engineer Group (Combat).

Events: 330**Commanders, 44th Engineer Regiment**

Unknown	Dec 34-28 Feb 37	Capt. John A. Burris**	17 Oct 37-ao Nov 37
Capt. Leonard L. Kingsbury**	28 Feb 37-17 Oct 37	Unknown	ao Nov 37-1 Jun 41
	Lt. Col. Richard L. Smith	1 Jun 41-ao Dec 41	

** RAI Commanders: Organized Reserve officers.

45th Engineer Regiment (General Service) (Fourth Army)**Regular Army Inactive****HQ-Not organized** 1933-34; St. Louis, MO, 1934-41; Camp Blanding, FL, 1941

Constituted in the Regular Army 1 October 1933, assigned to the Fourth Army, and allotted to the Seventh Corps Area. Organized by December 1934 with Organized Reserve personnel as a RAI unit with headquarters at St. Louis, MO. Consolidated 10 September 1936 with the 45th Engineer Battalion (Railway Maintenance of Way) (a WWI unit organized in March 1918 at Camp Meade, MD; redesignated 18 September 1918 as the 45th Regiment (Transportation Corps); reconstituted 10 September 1936). Conducted summer training at Fort Knox, KY, or Fort Des Moines, IA. Relieved from the Fourth Army 24 January 1941 and assigned to the Third Army. Activated 15 July 1941, less Reserve personnel, as the 45th Engineer Regiment (General Service) (Colored) at Camp Blanding, FL. Location 7 December 1941—Camp Blanding, FL.

Status: Disbanded 17 February 1954.

Events: 330**Commanders, 45th Engineer Regiment**

Unknown	Dec 34-15 Jul 41	Lt. Col. Robert C. Williams	15 Jul 41-ao Aug 41
---------	------------------	-----------------------------	---------------------

46th Engineer Regiment (General Service) (Fourth Army)**Regular Army Inactive****HQ-Not organized** 1933-34; San Bernardino, CA, 1934-36; *Inactive* 1936-41; Camp Bowie, TX, 1941

Constituted in the Regular Army 1 October 1933, assigned to the Fourth Army, and allotted to the Ninth Corps Area. Organized by December 1934 with Organized Reserve personnel as a RAI unit with headquarters at San Bernardino, CA. Inactivated 27 May 1936 at San Bernardino by relief of personnel. Withdrawn from the Ninth Corps Area 5 June 1936 and allotted to the Seventh Corps Area. Consolidated 10 September 1936 with the 46th Engineer Battalion (Railway Maintenance of Way) (a WWI unit organized in March 1918 at Camp Sheridan, AL; redesignated 18 September 1918 as the 46th Regiment (Transportation Corps); reconstituted 10 September 1936). Relieved from the Fourth Army 24 January 1941 and assigned to the Third Army. Activated 14 July 1941 at Camp Bowie, TX. Location 7 December 1941—Camp Bowie, TX.

Status: Active in the Regular Army at Fort Polk, LA, as the 46th Engineer Battalion (Combat Heavy).

Events: 328

Commanders, 46th Engineer Regiment

Unknown	Dec 34-27 May 36	Lt. Col. Paul A. Hodgson	14 Jul 41-8 Aug 41
<i>Inactive</i>	27 May 36-14 Jul 41	Lt. Col. John H. Carruth	8 Aug 41-25 Nov 41

47th Engineer Regiment (General Service) (Fourth Army)

HQ-*Not organized* 1933-36; Kansas City, KS, 1936-41; Fort Ord, CA, 1941

Constituted in the Regular Army 1 October 1933 as the 47th Engineer Battalion (Separate) and allotted to the Seventh Corps Area. Consolidated 10 September 1936 with the 47th Engineer Battalion (Railway Maintenance of Way) (a WWI unit organized in March 1918 at Camp Sheridan, AL; redesignated 18 September 1918 as the 47th Regiment (Transportation Corps); reconstituted 10 September 1936). Organized by June 1936 with Organized Reserve personnel as a RAI unit at Kansas City, KS. Conducted summer training at Fort Riley, KS, or Fort Snelling, MN. Designated mobilization training station was Camp Ord, CA. Redesignated 16 December 1940 as the 47th Engineer Regiment (General Service). Assigned 24 January 1941 to the Fourth Army. Activated 1 August 1941, less Reserve personnel, at Fort Ord, CA. Ordered to reinforce the Philippine Islands in late 1941, but did not embark before the Pearl Harbor attack. Location 7 December 1941—Fort Ord, CA.

Status: Regimental Headquarters, and Headquarters & Service Company, 47th Engineer Regiment (General Service) are inactive as HHC, 1176th Engineer Construction Group; the 1st Battalion is inactive as the 47th Engineer Battalion; the 2nd Battalion is active at Camp Howze, Korea as the 44th Engineer Battalion (Corps Mechanized), a component of the 2nd Infantry Division.

Commanders, 47th Engineer Regiment

Unknown	Jun 36-1 Aug 41	Col. Holland L. Robb	21 Aug 41-7 Dec 42
---------	-----------------	----------------------	--------------------

101st Engineer Regiment (Combat) (26th Division)

Massachusetts National Guard

HQ-Cambridge, MA, 1920-41; Fort Devens, MA, 1941

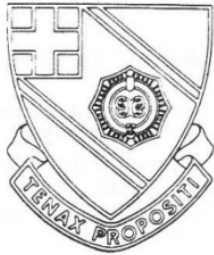

Constituted in the National Guard in 1921, assigned to the 26th Division, and allotted to the state of Massachusetts. Regimental headquarters organized 30 September 1921 by redesignation of the 1st Engineers, Massachusetts National Guard (demobilized 8 January 1919 at Camp Wadsworth, SC, as the 5th Pioneer Infantry Regiment; organized and Federally recognized 12 November 1920 as the 1st Engineers, Massachusetts National Guard with headquarters at Cambridge, MA) as the 101st Engineer Regiment. Regiment called out to perform hurricane relief duties in the vicinity of Wareham, MA, 21-24 September 1938. Conducted annual summer training at Hanover, MA, 1921-24, Camp Devens, MA, 1924-34, and at the Massachusetts Military Reservation at Falmouth, MA, 1935-38. Inducted into Federal service 16 January 1941 at Cambridge, MA. Transferred 21 January 1941 to Fort Devens, MA. Location 7 December

1941—Fort Devens, MA.

Status: Active in the Massachusetts National Guard at Reading, MA, as the 101st Engineer Battalion, a component of the 42nd Infantry Division.

Events: 190, 280, 301, 330

Commanders, 101st Engineer Regiment

Col. William H. Perry	ao Nov 17-8 Jan 19	Col. Melvin H. Leonard	28 Mar 27-9 May 29
<i>Demobilized/Inactive</i>	5 Apr 19-11 Nov 20	Col. Frank Gibbs	10 May 29-7 May 36
Col. John F. Osborn	12 Nov 20-27 Mar 27	Col. John J. Carew	18 May 36-3 Apr 42

102nd Engineer Regiment (Combat) (27th Division)**New York National Guard**

HQ-New York City, NY, 1920-40; Fort McClellan, AL, 1940-41



Arrived at the port of New York 28 February 1919 on the U.S.S. *Rochambeau* as the 102nd Engineers an element of the 27th Division. Demobilized 8 January 1919 at Camp Upton, NY. Reconstituted in the National Guard 30 December 1920, assigned to the 27th Division, and allotted to the state of New York. Reorganized 1 June 1921 by redesignation of the 22nd Engineers, New York National Guard (organized from former elements of the 102nd Engineers and Federally recognized 5 November 1920 with headquarters at New York City, NY) as the 102nd Engineer Regiment. Conducted annual summer training most years at Camp Smith, Peekskill, NY, 1921-38. Inducted into Federal service 15 October 1940 at New York City, NY. Transferred 25 October 1940 to Fort McClellan, AL. Location 7 December 1941—Fort McClellan, AL.

Status: Active in the New York National Guard at Bronx, NY, as the 102nd Engineer Battalion.**Events:** 190, 280, 301, 305, 316, 324, 328**Commanders, 102nd Engineer Regiment**

Col. Cornelius Vanderbilt, III	5 Aug 17-19 Jul 18	Col. Albert H. Acker	15 Oct 18-Jun 19
Lt. Col. William S. Conrow	19 Jul 18-29 Sep 18	<i>Demobilized/Inactive</i>	Jun 19-4 Nov 20
Col. George B. Pillsbury	29 Sep 18-10 Oct 18	Col. Frederic E. Humphreys	5 Nov 20-25 May 39
Lt. Col. William S. Conrow	10 Oct 18-15 Oct 18	Lt. Col. George E. Johnson	26 May 39-13 May 40
	Col. Brendan A. Burns	14 May 40-23 Aug 42	

103rd Engineer Regiment (Combat) (28th Division)**Pennsylvania National Guard**

HQ-Philadelphia, PA, 1921-41; Indiantown Gap, PA, 1941

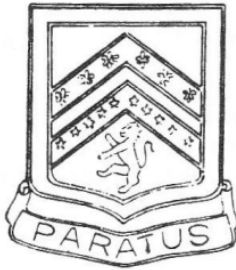

Constituted in the National Guard in 1921, assigned to the 28th Division, and allotted to the state of Pennsylvania. Organized 18 July 1921 by redesignation of the 1st Infantry, Pennsylvania National Guard (demobilized 17 May 1919 at Camp Dix, NJ, as elements of the 109th Infantry Regiment; organized and Federally recognized 16 October 1919 as the 1st Infantry, Pennsylvania National Guard with headquarters at Philadelphia, PA) as the 103rd Engineer Regiment. Regiment, or elements thereof, called up to perform the following state duties: elements called to perform fire fighting duties on South Mountain east of Cornwall, PA, 20-22 July 1930; entire regiment called up in April 1936 to perform relief duties in connection with the flooding of the Schuylkill and Susquehanna Rivers. Conducted annual summer training at Mount Gretna, PA, 1922-35 and Indiantown Gap, PA, 1936-38. Inducted into Federal service 17 February 1941 at Philadelphia, PA. Transferred 21 February

1941 to Indiantown Gap, PA. Location 7 December 1941—En route from the Carolina Maneuver Area to Indiantown Gap, PA.

Status: Active in the Pennsylvania National Guard at Philadelphia, PA, as the 103rd Engineer Battalion, a component of the 28th Infantry Division.**Events:** 191, 203, 281, 301, 330**Commanders, 103rd Engineer Regiment**

Col. Jackson W. Study	1 Apr 21-25 Apr 33	Col. Horace J. Inman	1 Mar 38-17 Feb 41
Col. John M. Gentner	25 Apr 33-28 Feb 38	Col. H. Wallis Anderson	17 May 41-4 Feb 42

104th Engineer Regiment (Combat) (44th Division)**New Jersey National Guard**

HQ-Englewood, NJ, 1922-38; Teaneck, NJ, 1938-40; Fort Dix, NJ, 1940-41



Constituted in the National Guard in 1921, assigned to the 44th Division, and allotted to the state of New Jersey. Regimental headquarters organized and Federally recognized 10 June 1922 at Englewood, NJ. Entire regiment relocated 2 March 1938 to Teaneck, NJ. Conducted annual summer training at Sea Girt, NJ, 1922-38. Inducted into Federal service 16 September 1940 at Teaneck. Transferred 23 September 1940 to Fort Dix, NJ. Location 7 December 1941—En route from the Carolina Maneuver Area to Fort Dix, NJ.

Status: Inactive in the New Jersey National Guard as the 104th Engineer Battalion.

Events: 190, 280, 301, 330

Commanders, 104th Engineer Regiment

Col. Orison M. Hurd

10 Jun 22-Sep 41

Lt. Col. William Firth

Sep 41- 20 Feb 42

105th Engineer Regiment (Combat) (30th Division) North Carolina and South Carolina National Guard

HQ-Inactive 1921-24; Durham, NC, 1924-36; Raleigh, NC, 1936-40; Fort Jackson, SC, 1940-41

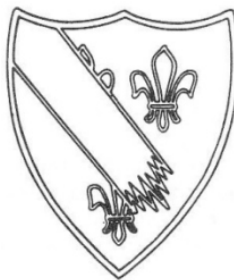

Constituted in the National Guard in 1921, assigned to the 30th Division, and allotted to the states of North and South Carolina. Regimental headquarters was organized and Federally recognized 28 January 1924 at Durham, NC. The 1st Battalion was allotted to the state of North Carolina, organized and Federally recognized 30 August 1923 with headquarters at Charlotte; relocated in 1929 to Durham, NC. The 2nd Battalion was organized and Federally recognized 5 July 1922 as the 1st Battalion, 133rd Engineers with headquarters at Spartanburg, SC; redesignated 5 December 1923 as the 2nd Battalion, 105th Engineers. Regiment, less 2nd Battalion, called up to perform the following state duties: riot control duty in connection with textile worker strikes at Marion, NC, 2-22 October 1922; Kannapolis, NC, in 1923; at Asheville, NC, in 1925; at Pittsboro, NC, in 1927; at Marion, NC, in August 1929; and at Shelby and Gastonia, NC, 6-24 September 1934. The 2nd Battalion called up to perform the following

state duties: presidential guard duties for President Hoover at the anniversary celebration of the Battle of Kings' Mountain 7 October 1930; riot control duty in connection with textile worker strikes at Spartanburg in September 1934. Regimental headquarters relocated 16 November 1936 to Raleigh, NC. The 2nd Battalion reorganized and redesignated 1 April 1938 as the 1st Battalion, 178th Field Artillery. Concurrently, the 2nd Battalion allotment was withdrawn from the state of South Carolina and allotted to the state of North Carolina. The new 2nd Battalion was organized with headquarters at Greenville, NC, from the 3rd Squadron, 109th Cavalry. Conducted annual summer training 1923-27 at Fort Bragg, NC, for North Carolina elements and at Camp Jackson, SC, for South Carolina elements. After 1928, summer training was conducted most years at Camp Jackson for the entire regiment. Inducted into Federal service 16 September 1940 at Raleigh, NC. Transferred 24 September 1940 to Fort Jackson. Location 7 December 1941—Fort Jackson, SC.

Events: 255, 300, 316, 330

Commanders, 105th Engineer Regiment

Col. Clarence E. Boesch (NC)

28 Jan 24-15 Mar 33

Col. John H. Trescot (NC)

15 Mar 33-16 Nov 36

Col. Graham K. Hobbs (NC)

16 Nov 36-3 Feb 42

106th Engineer Regiment (Combat) (31st Division) Mississippi and Florida National Guard

HQ-Not organized 1923-25; Jackson, MS, 1925-40; Camp Blanding, FL, 1940-41



Constituted in the National Guard 1 July 1923, assigned to the 31st Division, and allotted to the states of Mississippi and Florida. The regimental headquarters and 1st Battalion were allotted to the state of Mississippi and the 2nd Battalion was allotted to the state of Florida. Some elements concurrently organized by redesignation of companies from the withdrawn 114th Engineers. Headquarters, 1st Battalion was organized and Federally recognized 30 June 1924 with headquarters at West Point, MS. The regimental headquarters was organized and Federally recognized 2 July 1925 at Jackson, MS. Consolidated 9 October 1926 with the 106th Engineers (a WWI unit organized in September 1917 at Camp Sevier, SC; demobilized in April 1919 at Camp Jackson, SC; reconstituted 9 October 1926). The 2nd Battalion was organized and Federally recognized 11 August 1927 with headquarters at Haines City, FL. Conducted annual summer training most years 1923-35 at Camp

Beauregard, LA, or Benjamin F. McClellan, MS, for Mississippi elements, and at Camp Joseph E. Johnston, FL, (later redesignated Camp J. Clifford R. Foster) for Florida elements. After 1936, summer training was conducted for the entire regiment at a single location. Mississippi elements called up to perform flood duty at Vicksburg, MS, 26 April-14 May 1927. Florida elements called up to perform guard duties in connection with the Mediterranean Fruit Fly quarantine in South Florida in July 1928-June 1930. Inducted into Federal service 25 November 1940 at Jackson, NC. Transferred 22 December 1940 to Camp Blanding, FL. Location 7 December 1941—Camp Blanding, FL.

Status: The 106th Engineer Regiment, less 2nd Battalion, is active in the Mississippi National Guard as the 106th Engineer Battalion; the 2nd Battalion is inactive in the Mississippi National Guard as the 112th Military Police Battalion.

Events: 56, 255, 300, 325, 328, 330

Commanders, 106th Engineer Regiment

Col. Lytle Brown	25 Aug 17-2 May 18	Unknown	10 Nov 18-Jun 19
Col. DeWitt C. Jones	2 May 18-9 Nov 18	<i>Demobilized/Inactive</i>	Jun 19-1 Jul 25
	Col. Harry Hulen (MS)	2 Jul 25-26 Feb 42	

107th Engineer Regiment (Combat) (32nd Division)

Michigan and Wisconsin National Guard

HQ-*Inactive* 1921-39; Ann Arbor, MI, 1939-40; Detroit, MI, 1940; Camp Beauregard, LA, 1940-41; Camp Livingston, LA, 1941

Arrived at the port of Philadelphia 18 May 1919 on the S.S. *Haverford* as the 107th Engineers, an element of the 32nd Division. Demobilized in May 1919 at Camp Custer, MI. Reconstituted in the National Guard in 1921, assigned to the 32nd Division, and allotted to the states of Wisconsin and Michigan. The regimental headquarters and 1st Battalion were allotted to the state of Wisconsin and the 2nd Battalion was allotted to the state of Michigan. Company A, organized 6 December 1920 at Viroqua, WI, was the only active unit 1921-26. All Wisconsin elements were withdrawn in November 1926 and the entire regiment was allotted to the state of Michigan. The 1st Battalion was organized and Federally recognized 26 April 1937 at Ann Arbor, MI. Regimental headquarters was organized and Federally recognized 29 December 1939 at Ann Arbor. The 2nd Battalion was organized and Federally recognized 21 May 1940 with headquarters at Calumet, MI. Summer training typically conducted at Camp Douglas, WI, for A Company 1921-26 and at Camp Grayling, MI, for active Michigan elements 1937-39. Inducted into Federal service 15 October 1940 at Detroit, MI. Transferred 21 October 1940 to Camp Beauregard, LA. Transferred 15 February 1941 to Camp Livingston, LA. Location 7 December 1941—Camp Livingston, LA.

Status: Active in the Michigan National Guard at Ishpeming, MI, as the 107th Engineer Battalion, a component of the 38th Infantry Division.

Events: 302, 320, 328

Commanders, 107th Engineer Regiment

Col. Paul S. Bond	1 Sep 17-26 Feb 18	Lt. Col. Luke H. Callan	19 Oct 18-21 Jan 19
Col. Harold C. Fiske	27 Feb 18-5 Mar 18	Col. Richard C. Burleson	21 Jan 19-May 19
Lt. Col. Luke H. Callan	5 Mar 18-24 Jun 18	<i>Demobilized/Inactive</i>	May 19-28 Dec 39
Col. Harold C. Fiske	25 Jun 18-18 Oct 18	Col. Ralph A. Loveland (MI)	29 Dec 39-16 Jan 42

108th Engineer Regiment (Combat) (33rd Division)**Illinois National Guard****HQ-Inactive** 1921-29; Chicago, IL, 1929-41; Camp Forrest, TN, 1941

Arrived at the port of New York 25 May 1919 on the U.S.S. *Harrisburg* as the 108th Engineers, an element of the 33rd Division. Demobilized 9 June 1919 at Camp Grant, IL. Reconstituted in the National Guard in 1921, assigned to the 33rd Division, and allotted to the state of Illinois. The 1st Battalion was organized and Federally recognized 14 July 1924 at Chicago, IL. Regimental headquarters was organized and Federally recognized 25 March 1929 at Chicago. The 2nd Battalion was organized and Federally recognized 9 July 1931 at Chicago. Headquarters and Service Company and B and D Companies called up for flood relief work along the Ohio River in southern Illinois 21 January-5 April 1937. Conducted annual summer training most years at Camp Grant, IL, 1924-39. Conducted joint summer training at Camp Grant with the 311th Engineers in 1936. For at least one year, in 1937, the regiment also trained 30 company-grade engineer Reserve officers of the 10th and 39th Engineer Regiments (RAI) at Camp Grant. Inducted into Federal service 5 March 1941 at Chicago, IL. Transferred 12 March 1941 to Camp Forrest, TN. Location 7 December 1941—Camp Forrest, TN.

Status: Headquarters & Service Company active in the Illinois National Guard at Chicago, IL, as HHC, 44th Support Group (RAOC).

Events:**Commanders, 108th Engineer Regiment**

Col. Henry A. Allen	17 May 17-1 Jun 19	<i>Demobilized/Inactive</i>	2 Jun 19-24 Mar 29
	Col. Karl E. Hobart	25 Mar 29-12 Feb 42	

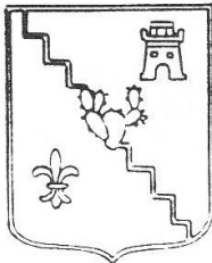
109th Engineer Regiment (Combat) (34th Division)**Minnesota and Iowa/South Dakota National Guard****HQ-Not organized** 1921-24; Rapid City, SD, 1924-41; Camp Claiborne, LA, 1941

Constituted in the National Guard in 1921, assigned to the 34th Division, and originally allotted to the states of Minnesota and Iowa. The regimental headquarters and 1st Battalion were allotted to the state of Iowa and 2nd Battalion was allotted to the state of Minnesota. Previous allotments withdrawn 1 January 1924 and regiment allotted entirely to the state of South Dakota. Concurrently, the 1st Battalion was organized by redesignation of the 2nd Battalion, 136th Engineer Regiment. Regimental headquarters was organized and Federally recognized 1 May 1924 at Rapid City, SD. Consolidated in 1926 with the 109th Engineers (a WWI unit organized in September 1917 at Camp Cody, NM; demobilized in July 1919 at Camp Dodge, IA; reconstituted in 1926). Conducted annual summer training most years at the South Dakota National Guard Camp, Rapid City, SD, 1924-39. For at least two years, in 1939 and 1940, the regiment also trained 16 company-grade officers of the 88th Division at Camp Rapid and

Camp Ripley, MN. Inducted into Federal service 10 February 1941 at Rapid City, SD. Transferred 20 February 1941 to Camp Claiborne, LA. Location 7 December 1941—Camp Claiborne, LA.

Status: Regimental Headquarters, and Headquarters Service Company are active in the South Dakota National Guard as HHC, 109th Engineer Group.

Events: 233, 303, 320, 328**Commanders, 109th Engineer Regiment**

Col. Edward H. Schulz	26 Aug 17-20 Apr 18	<i>Demobilized/Inactive</i>	Jul 19-30 Apr 24
Col. Frederick B. Downing	28 Apr 18-14 Oct 18	Col. Earle L. Lewis	1 May 24-17 Sep 41
Lt. Col. Warren B. Thompson	15 Oct 18-Jul 19	Lt. Col. Robert E. Coffey	17 Sep 41-1 Feb 42

110th Engineer Regiment (Combat) (35th Division)**Missouri National Guard**

HQ-Kansas City, MO, 1921-40; Camp Joseph T. Robinson, AR, 1940-41; Fort Ord, CA, 1941



Constituted in the National Guard in 1921, assigned to the 35th Division, and allotted to the state of Missouri. Organized 1 October 1921 by redesignation of the 3rd Engineers, Missouri National Guard (organized and Federally recognized 14 May 1918 as the 7th Infantry, Missouri National Guard; redesignated as the 3rd Engineers, Missouri National Guard 1 May 1921 with headquarters at Kansas City, MO) as the 110th Engineer Regiment. Consolidated 2 July 1923 with the 110th Engineers (a WWI unit organized 28 Jul-4 August 1917 at Kansas City, MO; arrived at the port of New York 19 April 1919 on the U.S.S. *Von Stueben*; demobilized 3 May 1919 at Fort Riley, KS; reconstituted 2 July 1923). Conducted annual summer training at Camp Clark, MO, 1921-39. For at least three years, 1938-40, the regiment also trained 39 company-grade officers of the 102nd Division at Camp Clark and Camp Ripley, MN. Inducted into Federal service 23 December 1940 at Kansas City, MO.

Transferred 29 December 1940 to Camp Joseph T. Robinson, AR. Transferred 23 October 1941 to Fort Ord, CA. Location 7 December 1941—Fort Ord, CA.

Status: Active in the Missouri National Guard at Kansas City, MO, as the 110th Engineer Battalion, a component of the 35th Infantry Division (Mechanized).

Events: 236, 303, 316, 324, 328

Commanders, 110th Engineer Regiment

Col. Sherwood A. Cheney	26 Sep 17-10 Jul 18	<i>Demobilized</i>	3 May 19-18 May 21
Col. Thomas C. Clarke	4 Aug 18-6 Feb 19	Col. Edward M. Stayton	19 May 21-18 Nov 32
Col. Edward M. Stayton	6 Feb 19-3 May 19	Col. Jesse F. Brown	18 Nov 32-6 Mar 42

111th Engineer Regiment (Combat) (36th Division)**Texas National Guard**

HQ-*Inactive* 1921-23; Fort Worth, TX, 1923-41; Camp Bowie, TX, 1940-41



Arrived at the port of New York 31 May 1919 on the U.S.S. *Great Northern* as the 1st Battalion, 111th Engineer Regiment, an element of the 36th Division. Demobilized 18 June 1919 at Camp Bowie, TX. Reconstituted in the National Guard in 1921, assigned to the 36th Division, and allotted to the state of Texas. Organized and Federally recognized 9 March 1923 as the 111th Engineer Regiment with headquarters at Fort Worth, TX. Conducted annual summer training at Camp Mabry, TX, Fort Crockett, TX, and Camp Hulen, TX, 1923-39. For at least one year, in 1933, the regiment also trained 7 company-grade engineer officers of the 90th Division at Camp Hulen. Inducted into Federal service 25 November 1940 at Fort Worth, TX. Transferred 14 December 1940 to Camp Bowie, TX. Location 7 December 1941—Camp Bowie, TX.

Status: The 1st Battalion is active in the Texas National Guard as the 111th Engineer Battalion; the 2nd Battalion is active in the Texas National Guard as the 386th Engineer Battalion.

Events: 258, 300, 317, 328

Commanders, 111th Engineer Regiment

Col. William J. Barden	5 Aug 17-21 Apr 18	<i>Demobilized/Inactive</i>	18 Jun 19-8 Mar 23
Col. William A. Johnson	21 Apr 18-25 Aug 18	Col. Richard B. Dunbar	9 Mar 23-24 Jan 41
Col. Horace S. Baker	Sep 18-18 Jun 19	Lt. Col. John Lansdale	24 Jan 41-31 Jan 42

112th Engineer Regiment (Combat) (37th Division)**Ohio National Guard**

HQ-Cleveland 1922-41; Camp Shelby, MS, 1941



Arrived at the port of New York 30 March 1919 on the S.S. *Aquitania* as the 112th Engineers an element of the 37th Division. Demobilized 17 April 1919 at Camp Sherman, OH. Reconstituted in the National Guard in 1921, assigned to the 37th Division, and allotted to the state of Ohio. Organized and Federally recognized 23 February 1922 with headquarters at Cleveland, OH. Conducted annual summer training at most years at Camp Perry, OH, 1922-39, and at Fort A. A. Humphreys, VA, in 1924. The regiment, or elements thereof, called up to perform the following state duties: tornado relief duty at Lorain and Sandusky, OH, 28 June-16 July 1924; martial law in connection with civil disorders and KKK riots in Niles, OH, 2-5 November 1924; flood relief duty during the Ohio River flood of January-February 1937; and riot control duties in connection with the Mahoning Valley steel workers strike 22 June-15 July 1937. Inducted into Federal service 15 October

1940 at Cleveland, OH. Transferred 20 December 1940 to Camp Shelby, MS. Location 7 December 1941—Camp Shelby, MS.

Status: Active in the Ohio National Guard at Brook Park, OH, as the 112th Engineer Battalion, a component of the 16th Engineer Brigade.

Events: 213, 220, 302, 320, 328

Commanders, 112th Engineer Regiment

Col. John R. McQuigg	5 Aug 17-25 Sep 18	Col. Andrew W. Lea	23 Feb 22-22 Jun 23
Col. William H. Sage, Jr.	25 Sep 18-Jan 19	Col. Ralph R. White	22 Jun 23-6 Jun 28
Lt. Col. George H. Canfield	Jan 19-Apr 19	Col. Elliot Whitlock	7 Jun 28-2 Oct 30
<i>Demobilized</i>	Apr 19-31 Mar 20	Col. Donald E. Pancoast	2 Oct 30-15 Oct 40
Col. John R. McQuigg	1 Apr 20-9 May 21	Col. Albert E. Henderson	15 Oct 40-16 Jan 42

113th Engineer Regiment (Combat) (38th Division)

Indiana National Guard

HQ-Gary, IN, 1922-25; Indianapolis 1925-39; Gary 1939-41; Camp Shelby, MS, 1941



Constituted in the National Guard 14 February 1921, assigned to the 38th Division, and allotted to the state of Indiana. The 1st Battalion was organized 28 May 1921 with headquarters at Gary, IN. Battalion expanded and redesignated 1 October 1921 as the 113th Engineer Regiment. Regimental headquarters was organized and Federally recognized 23 January 1922 at Gary. The 2nd Battalion was organized 6 June 1922 with headquarters at Gary. Regimental headquarters relocated in 1925 to Indianapolis, IN. Consolidated 30 June 1927 with the 113th Engineers (a WWI unit organized 16 September 1917 at Camp Shelby, MS; arrived at the port of New York 19 June 1919 on the U.S.S. *Great Northern* as the 1st Battalion, 113th Engineer Regiment; demobilized 24 June 1919 at Camp Sherman, OH; reconstituted 30 June 1927). The regiment, or elements thereof, called up to perform the following state duties: regimental headquarters and one battalion called to perform search and patrol duties for prisoners from

breakout at the Indiana State Prison at Michigan City, IN, 27-28 September 1933; elements for guard and security duties in connection with the visit of President Roosevelt to South Bend, IN, 9 December 1935; entire regiment called up to perform flood relief duty during the Ohio River flood of January-February 1937. Headquarters relocated in September 1939 to Gary, IN. Conducted annual summer training at Camp Knox, KY, 1922-39. Inducted into Federal service 17 January 1941 at Gary, IN. Transferred 26 January 1941 to Camp Shelby, MS. Location 7 December 1941—Camp Shelby, MS.

Status: Active in the Indiana National Guard at Gary, IN, as the 113th Engineer Battalion, a component of the 38th Infantry Division.

Events: 213, 220, 302, 320, 328

Commanders, 113th Engineer Regiment

Col. John C. Oakes	20 Aug 17-15 Jun 18	Col. Arthur P. Melton	23 Jan 22-28 Sep 32
Col. Henry A. Finch	15 Jun 18-12 Dec 18	Col. Earnest C. Simpson	29 Sep 32-1 Sep 33
Lt. Col. Willard S. Boyle	12 Dec 18-21 Jun 19	Col. Frank L. Gray	1 Sep 33-6 Sep 39
<i>Demobilized</i>	24 Jun 19-22 Jan 22	Lt. Col. Alex D. Torie	6 Sep 39-15 Nov 39
	Col. Lhon W. Wheeler	15 Nov 39-10 Feb 42	

114th Engineer Regiment (Combat) (39th Division)

Mississippi and Florida National Guard

HQ-Not organized 1921-23

Arrived at the port of Newport News 1 May 1919 on the U.S.S. *Köningen der Nederlanden* as the 114th Engineers, an element of the 39th Division. Demobilized in May 1919 at Camp Shelby, MS. Reconstituted in the National Guard in 1921, assigned to the 39th Division, and allotted to the states of Mississippi and Florida. Regimental headquarters and 1st Battalion were allotted to the state of Mississippi; 2nd Battalion was allotted to the state of Florida. Jackson, MS, designated as headquarters on organization, but the unit was never organized at that location. Headquarters and Service Company, and Companies A, B, D, and E organized 1922-23. Conducted annual summer training 1922-23 at Camp Benjamin F. McClellan, MS, for Mississippi elements, and at Camp Joseph E. Johnston, FL, for Florida elements. Designated mobilization station was Camp McClellan, AL. Regiment withdrawn from the 39th Division 1 July 1923 and organized companies redesignated as corresponding elements of the 106th Engineer Regiment.

Status: Inactive in the Mississippi National Guard as the 112th Military Police Battalion.

Commanders, 114th Engineer Regiment

Col. Michael J. McDonough

25 Aug 17-12 Jun 18

Col. James A. O'Connor

3 Jul 18-3 Sep 18

Col. Michael J. McDonough

4 Sep 18-May 19

115th Engineer Regiment (Combat) (40th Division)

Utah and Nevada National Guard

HQ-Inactive 1921-39; Salt Lake City, UT, 1939-41; Camp San Luis Obispo, CA, 1941



Constituted in the National Guard in 1922, assigned to the 40th Division, and allotted to the state of Utah. The 2nd Battalion was withdrawn from the state of Utah in November 1928 and allotted to the state of Nevada. The 2nd Battalion was organized and Federally recognized 1 May 1936 with headquarters at Reno, NV. Regimental headquarters was organized and Federally recognized 17 July 1939 at Salt Lake City, UT. The 1st Battalion was organized and Federally recognized 28 August 1939 with headquarters at Salt Lake City. Active elements of the regiment conducted annual summer training at Camp San Luis Obispo, CA, 1931-39. Inducted into Federal service 3 March 1941 at Salt Lake City. Transferred 10 March 1941 to Camp San Luis Obispo. Location 7 December 1941—Camp San Luis Obispo, CA.

Status: Regimental Headquarters, and Headquarters & Service Company are active in the Utah National Guard at Draper, UT, as HHC, 115th Engineer Group.

Events: 231, 304, 314, 326

Commander, 115th Engineer Regiment

Col. William F. Weiler (UT)

17 Jul 39-5 Feb 42

116th Engineer Regiment (Combat) (41st Division)

**Montana and Wyoming
Idaho and Oregon National Guard**

HQ-Inactive 1921-26; Boise, ID, 1926-40; Camp Murray, WA; 1940-41; Fort Lewis, WA, 1941

Constituted in the National Guard in 1921, assigned to the 41st Division, and allotted to the states of Montana, Wyoming, and Oregon. Regimental headquarters, H&S Company, and 1st Battalion (less Companies A and B) allotted to Montana; Companies A and B allotted to Oregon; and 2nd Battalion was allotted to the state of Wyoming. On 1 June 1926, all elements, less the 1st Battalion, were withdrawn and allotted to the state of Idaho; 1st Battalion was



allotted to the state of Oregon. Concurrently, the regimental H&S Company and 2nd Battalion were organized from 1st Battalion, 200th Infantry at Boise, ID. Regimental headquarters was organized and Federally recognized 8 August 1926 at Boise. The 1st Battalion was withdrawn from the state of Oregon in November 1928 and allotted to the state of Idaho. The 1st Battalion was organized 16 April 1936 with headquarters at Buhl, ID. Regiment conducted annual summer training most years at Boise Barracks, ID, 1926-39 and some years at Fort Lewis, WA, Camp Murray, WA, Del Monte, CA, or Camp Clatsop, OR. Inducted into Federal service 16 September 1940 at Boise, ID. Transferred 20 September 1940 to Camp Murray, WA. Transferred 20 March 1941 to Fort Lewis, WA. Location 7 December 1941—Fort Lewis, WA.

Status: Active in the Idaho National Guard at Lewiston, ID, as the 116th Engineer Battalion.

Events: 238, 304, 309, 314, 326

Commanders, 116th Engineer Regiment

Col. Frederick C. Hummel (ID)	8 Aug 26-12 Oct 40	Col. Herbert G. Lauterbach (ID)	12 Oct 40-17 Feb 42
-------------------------------	--------------------	---------------------------------	---------------------

118th Engineer Regiment (Combat) (43rd Division)

Rhode Island National Guard

HQ-*Not organized* 1921-29; Providence, RI, 1929-41; Camp Blanding, FL, 1941



Constituted in the National Guard 19 October 1920, assigned to the 43rd Division, and allotted to the state of Rhode Island. Subordinate elements organized 1926-29. Regimental headquarters was organized and Federally recognized 1 March 1929 at Providence, RI. Conducted annual summer training most years at Quonset Point, RI, 1927-39 and some years at Niantic, CT, or Camp Devens, MA. Regiment, or elements thereof, called up to perform the following state duties: riot control duty in connection with textile worker strikes at Saylesville and Woonsocket, RI, 10-14 September 1934; entire regiment for flood relief duties along the Pawtuxet River at Norwood, RI, 24-26 July 1938; entire regiment for hurricane relief duty at Westerly and Newport, RI, 21-25 September 1938. Inducted into Federal service 24 February 1941 at Providence, RI. Transferred 13 March 1941 to Camp

Blanding, FL. Location 7 December 1941—Camp Blanding, FL.

Events: 190, 280, 301, 325, 328, 330

Commanders, 118th Engineer Regiment

Col. Thomas H. Hammond	1 Mar 29-29 Oct 36	Col. Frederick S. Skinner	29 Oct 36-10 Feb 42
------------------------	--------------------	---------------------------	---------------------

120th Engineer Regiment (Combat) (45th Division)

New Mexico and Oklahoma National Guard

HQ-*Not organized* 1921-24; Las Cruces, NM, 1924-40; Fort Sill, OK, 1940-41; Camp Barkeley, TX, 1941



Constituted in the National Guard 19 October 1920, assigned to the 45th Division, and allotted to the state of Oklahoma. Headquarters and 2nd Battalion withdrawn from the state of Oklahoma 23 February 1923 and allotted to the state of New Mexico. Concurrently, the 2nd Battalion was organized with headquarters at Las Vegas, NM, by redesignation of the 2nd Battalion, 137th Engineer Regiment. Regimental headquarters was organized and Federally recognized 8 June 1924 at Las Cruces, NM. The 1st Battalion was organized and Federally recognized 3 July 1924 with headquarters at Oklahoma City, OK. Oklahoma elements called up in February 1938 to perform flood relief duty at Atoka, OK. Conducted annual summer training at Fort Bliss, TX, or Camp Maximiliano Luna, Las Vegas, NM, for New Mexico elements and at Fort Sill, OK, for the Oklahoma elements 1924-39. For at least one year, in 1933, the regiment also trained several

company-grade engineer officers of the 103rd Division at Camp Luna. Inducted into Federal service 16 September 1940 at Las Cruces, NM. Transferred 23 September 1940 to Fort Sill, OK. Transferred 23 February 1941 to Camp Barkeley, TX. Location 7 December 1941—Camp Barkeley, TX.

Events: 258, 300, 317, 328

Commanders, 120th Engineer Regiment

Col. Joseph W. Lowe (NM)

8 Jun 24-Jul 31

Col. Uil Lane (NM)

Jul 31-22 Feb 42

121st Engineer Regiment (Combat) (29th Division)

District of Columbia National Guard

HQ-*Not organized* 1921-24; Washington, DC 1924-41; Fort George G. Meade 1941



Constituted in the National Guard in 1921, assigned to the 29th Division, and allotted to the District of Columbia. Several subordinate elements organized 1918-1921 as elements of the 5th Infantry, District of Columbia National Guard; redesignated 1 January 1921 as elements of the Engineer Regiment, District of Columbia National Guard; redesignated 19 January 1922 as elements of the 121st Engineer Regiment. Regimental headquarters was organized and Federally recognized 5 February 1924 at Washington, DC. Conducted annual summer training at various locations to include Fort Washington, MD, Camp Simms, DC, Camp Humphreys, VA, Virginia Beach, VA, and at Camp Albert C. Ritchie, Cascade, MD. Inducted into Federal service 3 February 1941 at Washington, DC. Transferred 4 February 1941 to Fort George G. Meade, MD. Location 7 December 1941—Fort George G. Meade, MD.

Status: Active in the District of Columbia National Guard at Washington, DC, as the 163rd Military Police Battalion.

Events: 191, 281, 301, 330

Commanders, 121st Engineer Regiment

Col. John W. Oehmann

5 Feb 24-1 Dec 41

Col. Frank T. Lilich

1 Dec 41-11 Mar 42

122nd Engineer Regiment (Combat) (40th Division)

California and Nevada National Guard

HQ-*Not organized* 1921-22

Constituted in the National Guard in 1921, assigned to the 40th Division, and allotted to the states of California and Nevada. Regimental headquarters, H&S Company, and 1st Battalion were allotted to the state of California and 2nd Battalion was allotted to the state of Nevada. By agreement with both states, the regimental designation was withdrawn in 1922 and the 115th Engineer Regiment was allotted instead.

130th Engineer Regiment (Combat)

Puerto Rico National Guard

HQ-*Not organized* 1940-41

Constituted in the National Guard in 1940, assigned to the Puerto Rican Department, and allotted to the Commonwealth of Puerto Rico. The 1st Battalion was organized and Federally recognized 1 September 1940 at San Juan, PR. Inducted into Federal service 15 October 1940 and transferred 20 October 1940 to Camp Tortuguero, PR. Transferred 9 April 1941 to Fort Buchanan, PR. Location 7 December 1941—Fort Buchanan, PR (1st Battalion only).

Status: The 1st Battalion is active in the Puerto Rico National Guard at Vega Baja, PR, as the 130th Engineer Battalion.

Events: 329

131st Engineer Regiment (General Service) (II Corps)

New York National Guard

HQ-Not organized 1921-28

Constituted in the National Guard in 1921, assigned to the II Corps, and allotted to the state of New York. Placed on the deferred list 2 July 1923, unit requirement transferred to the Organized Reserve as a Deferred National Guard unit, and redesignated as the 332nd Engineer Regiment. Withdrawn from the National Guard 5 September 1928 and permanently allotted to the Organized Reserve.

132nd Engineer Regiment (General Service) (III Corps)

Pennsylvania National Guard

HQ-Not organized 1921-27

Constituted in the National Guard in 1921, assigned to the III Corps, and allotted to the state of Pennsylvania. Company A was organized 8 April 1922 at Altoona, PA, and redesignated 1 April 1923 as Company A, 125th Engineer Battalion (Mounted). Placed on the deferred list 2 July 1923, unit requirement transferred to the Organized Reserve as a Deferred National Guard unit, and redesignated as the 333rd Engineer Regiment. Withdrawn from the National Guard 17 September 1927 and demobilized.

133rd Engineer Regiment (General Service) (IV Corps)

**Alabama, South Carolina, and
Georgia National Guard**

HQ-Not organized 1921-33

Constituted in the National Guard in 1921, assigned to the IV Corps, and allotted to the states of South Carolina and Alabama. Regimental headquarters and 2nd Battalion were allotted to the state of Alabama and the 1st Battalion was allotted to the state of South Carolina. Florence, AL, designated as regimental headquarters on organization, but the unit was never organized at that location. The 1st Battalion was organized and Federally recognized 5 July 1922 with headquarters at Spartanburg, SC, (Company A was organized and Federally recognized 19 November 1921 at Lockhart, SC; Company B was organized and Federally recognized 22 February 1922 at Spartanburg; Company C was organized and Federally recognized 7 March 1922 at Lyman, SC). The 1st Battalion was redesignated 5 December 1923 as the 1st Battalion, 105th Engineers. Concurrently, the allotment for the 1st Battalion, 133rd Engineers was withdrawn from the state of South Carolina and allotted to the state of Georgia. Company D was organized 27 July 1922 at Huntsville, AL, and Company E was organized 14 January 1924 at Athens, AL. Companies D and E redesignated 15 February 1924 as Companies A and B respectively. Concurrently, 2nd Battalion withdrawn from the state of Alabama and allotted to the state of Georgia and 1st Battalion withdrawn from the state of Georgia allotted to the state of Alabama. New Company E was organized from Company A, 164th Engineers and Federally recognized 2 June 1924 at Springfield, GA. Companies A and B redesignated as elements of the 127th Engineer Battalion (Mounted) 1 February 1926 and 1st Battalion withdrawn from the state of Alabama. Concurrently entire regiment allotted to the state of Georgia. Company E redesignated 1 June 1928 as the 30th Military Police Company. Conducted annual summer training at locations as follows: Camp Jackson, SC, for South Carolina elements; Camp McClellan, AL, for Alabama elements; and St. Simons Island, GA, for Georgia elements. Withdrawn from the National Guard 1 October 1933 and demobilized.

134th Engineer Regiment (General Service) (V Corps)

Ohio National Guard

HQ-Not organized 1921-27

Constituted in the National Guard in 1921, assigned to the V Corps, and allotted to the state of Ohio. Placed on the deferred list 2 July 1923, unit requirement transferred to the Organized Reserve as a Deferred National Guard unit, and redesignated as the 335th Engineer Regiment. Withdrawn from the National Guard 17 September 1927 and demobilized.

135th Engineer Regiment (General Service) (VI Corps)**Illinois and Michigan National Guard****HQ-Not organized 1921-27**

Constituted in the National Guard in 1921, assigned to the VI Corps, and allotted to the states of Illinois and Michigan. Regimental headquarters and 2nd Battalion were allotted to the state of Illinois and 1st Battalion was allotted to the state of Michigan. Placed on the deferred list 2 July 1923, unit requirement transferred to the Organized Reserve as a Deferred National Guard unit, and redesignated as the 336th Engineer Regiment. Concurrently relieved from the VI Corps and assigned to the XVI Corps. Designated mobilization training station was Camp Grant, IL. Withdrawn from the National Guard 17 September 1927 and demobilized.

136th Engineer Regiment (General Service) (VII Corps)**Kansas and South Dakota National Guard****HQ-Not organized 1921-27**

Constituted in the National Guard in 1921, assigned to the VII Corps, and allotted to the states of Kansas and South Dakota. Regimental headquarters and 1st Battalion were allotted to the state of Kansas and 2nd Battalion was allotted to the state of South Dakota. The 2nd Battalion was organized and Federally recognized 10 November 1922 with headquarters at Brookings, SD, (Company D was organized and Federally recognized 15 March 1922 at Madison, SD; Company E was organized and Federally recognized 5 April 1922 at Brookings, SD; Company F was organized and Federally recognized 2 October 1922 at Huron, SD). Regiment, less 2nd Battalion, placed on the deferred list 2 July 1923. Unit requirement transferred to the Organized Reserve as a Deferred National Guard unit and redesignated as the 337th Engineer Regiment. The 2nd Battalion conducted annual summer training at Fort Meade, SD, in 1922 and at Pierre, SD, in 1923. The 2nd Battalion was redesignated as the 1st Battalion, 109th Engineers 1 January 1924 and the 2nd Battalion, 136th Engineers was placed on the deferred list with the remainder of the regiment. Withdrawn from the National Guard 17 September 1927 and demobilized.

Commander, 136th Engineer Regiment
(2nd Battalion)

Maj. Earle L. Lewis

10 Nov 22-1 Jan 24

137th Engineer Regiment (General Service) (VIII Corps)**New Mexico and Colorado National Guard****HQ-Not organized 1921-27**

Constituted in the National Guard in 1921, assigned to the VIII Corps, and allotted to the states of New Mexico and Colorado. Regimental headquarters and 2nd Battalion were allotted to the state of New Mexico and 1st Battalion was allotted to the state of Colorado. The 2nd Battalion was organized and Federally recognized 2 May 1922 with headquarters at Las Vegas, NM, (Regimental H&S Company was organized and Federally recognized 2 May 1922 at Las Cruces, NM; Company D was organized and Federally recognized 21 June 1921 at Albuquerque, NM; Company E was organized and Federally recognized 3 June 1921 at Socorro, NM; Company F was organized and Federally recognized 30 June 1921 at Las Vegas, NM). Called up to preserve order at a coal miner's strike at Gallup, NM, 7 April-30 June 1922. Active elements conducted annual summer training in 1922 at Fort Bliss, TX. The 2nd Battalion was redesignated 23 February 1923 as the 2nd Battalion, 120th Engineers. Regiment placed on the deferred list 2 July 1923, unit requirement transferred to the Organized Reserve as a Deferred National Guard unit, and redesignated as the 338th Engineer Regiment. Withdrawn as a Deferred National Guard unit 11 January 1927 and allotted permanently to the Organized Reserve as the 338th Engineer Regiment. Concurrently withdrawn from the Eighth Corps Area and allotted to the Seventh Corps Area.

Status: Regimental Headquarters and Headquarters & Service Company, 338th Engineer Regiment are inactive as HHC, 929th Engineer Aviation Group; the 1st Battalion is inactive as the 340th Engineer Battalion; the 2nd Battalion is inactive as the 410th Engineer Battalion.

138th Engineer Regiment (General Service) (IX Corps)

Utah and Montana National Guard

HQ-Not organized 1921-27

Constituted in the National Guard in 1921, assigned to the IX Corps, and allotted to the states of Utah and Montana. Regimental headquarters and 1st Battalion were allotted to the state of Utah and 2nd Battalion was allotted to the state of Montana. Placed on the deferred list 2 July 1923, unit requirement transferred to the Organized Reserve as a Deferred National Guard unit, and redesignated as the 339th Engineer Regiment. Withdrawn from the National Guard 17 September 1927 and demobilized.

151st Engineer Regiment (Combat) (V Corps)

Alabama National Guard

HQ-Huntsville, AL, 1940-41; Camp Shelby, MS, 1941

Constituted in the National Guard 1 November 1940 and allotted to the state of Alabama. Regimental headquarters concurrently organized and Federally recognized at Huntsville, AL. Subordinate elements organized from troops of the 127th Engineer Squadron and the 101st and 102nd Engineer Companies (Ponton). Assigned 30 December 1940 to the V Corps. Inducted into Federal service 27 November 1941 at Huntsville, AL. Transferred 5 February 1941 to Camp Shelby, MS. The 1st Battalion transferred 8 August 1941 to Camp Murray, WA; further transferred 2 September 1941 to Kodiak, TA. Location 7 December 1941—Camp Shelby, MS, (less 1st Battalion).

Status: The 1st Battalion is active in the Alabama National Guard as the 279th Signal Battalion with headquarters at Huntsville, AL.

Events: 328

Commander, 151st Engineer Regiment

Col. Edwin W. Jones

1 Nov 40-20 Aug 42

161st Engineer Regiment (General Service) (First Army)

New York National Guard

HQ-Not organized 1921-27

Constituted in the National Guard in 1921, assigned to the First Army, and allotted to the state of New York. Placed on the deferred list 2 July 1923, unit requirement transferred to the Organized Reserve as a Deferred National Guard unit, and redesignated as the 330th Engineer Regiment. Withdrawn from the National Guard 17 September 1927 and demobilized.

162nd Engineer Regiment (General Service) (First Army)

Pennsylvania National Guard

HQ-Not organized 1921-27

Constituted in the National Guard in 1921, assigned to the First Army, and allotted to the state of Pennsylvania. Placed on the deferred list 2 July 1923, unit requirement transferred to the Organized Reserve as a Deferred National Guard unit, and redesignated as the 340th Engineer Regiment. Withdrawn from the National Guard 17 September 1927 and demobilized.

163rd Engineer Regiment (General Service) (First Army)

Pennsylvania National Guard

HQ-Not organized 1921-27

Constituted in the National Guard in 1921, assigned to the First Army, and allotted to the state of Pennsylvania. Placed on the deferred list 2 July 1923, unit requirement transferred to the Organized Reserve as a Deferred National Guard unit, and redesignated as the 350th Engineer Regiment. Withdrawn from the National Guard 17 September 1927 and demobilized.

164th Engineer Regiment (General Service) (Second Army)**Georgia/Tennessee National Guard****HQ-Not organized 1921-38**

Constituted in the National Guard in 1921, assigned to the Second Army, and allotted originally to the state of Georgia. Atlanta, GA, was designated as headquarters on organization, but the unit was never organized at that location. Company A was organized 18 June 1921 at Springfield, GA, (redesignated 2 June 1924 as Company E, 133rd Engineers). Regiment withdrawn from the state of Georgia 7 May 1924 and allotted to the state of Tennessee. New Company A was organized 20 May 1924 at Nashville, TN. Company B was organized in 1927 at Lenoir City, TN. Conducted annual summer training at Camp McClellan, AL, and St. Simons Island, GA, for Georgia elements 1922-23, and at Camp Peay, TN, for Tennessee elements 1924-37. Regiment relieved from assignment to Second Army 1 October 1933 and assigned to the IV Corps. Designated mobilization training station was the Georgia National Guard Reservation at Toccoa, GA. Company B disbanded 30 March 1937. Company A redesignated 1 April 1938 as Troop I, 109th Cavalry. Remainder of the regiment concurrently withdrawn from the National Guard and demobilized.

Commanders, 164th Engineer Regiment

Col. Samuel L. Goldstein* Jun 21-7 May 24

* Designated commander for mobilization purposes; not Federally recognized as such.

165th Engineer Regiment (General Service) (Third Army)**Minnesota/Iowa National Guard****HQ-Not organized 1921-27**

Constituted in the National Guard in 1921, assigned to the Third Army, and allotted to the state of Minnesota. Placed on the deferred list 2 July 1923, unit requirement transferred to the Organized Reserve as a Deferred National Guard unit, and redesignated as the 369th Engineer Regiment. Withdrawn from the state of Minnesota and allotted to the state of Iowa. Fort Madison, IA, designated 29 August 1924 as headquarters on organization, but the unit was never organized at that location. Designated headquarters changed 26 May 1926 to Cedar Rapids, IA. Withdrawn from the National Guard 17 September 1927 and demobilized.

166th Engineer Regiment (General Service) (Third Army)**Nebraska/Missouri National Guard****HQ-Not organized 1921-27**

Constituted in the National Guard in 1921, assigned to the Third Army, and allotted to the state of Nebraska. Placed on the deferred list 2 July 1923, unit requirement transferred to the Organized Reserve as a Deferred National Guard unit, and redesignated as the 370th Engineer Regiment. Withdrawn from the state of Nebraska and allotted to the state of Missouri. Booneville, MO, designated 29 August 1924 as headquarters on organization, but the unit was never organized at that location. Designated headquarters changed 26 May 1926 to Jefferson City, MO. Withdrawn from the National Guard 17 September 1927 and demobilized.

185th Engineer Regiment (General Service) (GHQR)**West Virginia National Guard****HQ-Not organized 1921-27**

Constituted in the National Guard in 1921, assigned to the General Headquarters Reserve, and allotted to the state of West Virginia. Placed on the deferred list 2 July 1923, unit requirement transferred to the Organized Reserve as a Deferred National Guard unit, and redesignated as the 389th Engineer Regiment. Withdrawn from the National Guard 17 September 1927 and demobilized.

301st Engineer Regiment (Combat) (76th Division)**Organized Reserve Rhode Island and Connecticut**

HQ-Providence, RI, 1921-23; New Haven, CT, 1923-26; Bridgeport, CT, 1926-41



Arrived at the port of Boston about 12 June 1919 on the S.S. *Calamares* as the 301st Engineers, an element of the 76th Division. Demobilized 21 June 1919 at Camp Devens, MA. Reconstituted in the Organized Reserve 24 June 1921, assigned to the 76th Division, and allotted to the First Corps Area. Initiated 13 December 1921 with regimental headquarters at Providence, RI. Subordinate battalion headquarters concurrently organized as follows: 1st Battalion at Providence and 2nd Battalion at New Haven, CT. Regimental headquarters relocated 20 April 1923 to New Haven, CT. Regimental headquarters relocated 10 April 1926 to Bridgeport, CT. The regiment, less 1st Battalion, typically conducted Inactive Training Period meetings at the offices of the District Engineer in the Federal Building in New Haven. The 1st Battalion typically conducted Inactive Training Period meetings at the New Federal Building or the Benefit Street Arsenal in Providence. Conducted summer training most years at Camp Devens, MA, and some years with the 1st Engineer Regiment at Fort DuPont, DE. Primary R.O.T.C. feeder school was Yale University. Location 7 December 1941—Bridgeport, CT.

Status: Inactive in the U.S. Army Reserve as HHD, 3rd Brigade, 76th Division (Training).**Commanders, 301st Engineer Regiment**

Col. Francis A. Pope	22 Aug 17-15 Aug 18	Maj. James H. Johnston	Feb 22-Mar 23
Col. Robert L. Whipple	16 Aug 18-21 Jun 19	Col. William H. Sage, Jr.	Mar 23-7 Dec 24
<i>Demobilized</i>	21 Jun 19-Nov 21	Lt. Col. Wister H. Chubb	7 Dec 24-27 Jun 29
Col. Luke H. Callan	13 Dec 21-Feb 22	Col. Perrin C. Cothran	27 Jun 29-ao Jul 41
	Unknown	ao Jul 41-7 Dec 41	

302nd Engineer Regiment (Combat) (77th Division)**Organized Reserve New York**

HQ-Manhattan, NY, 1921-41



Arrived at the port of New York 2 May 1919 on the U.S.S. *Nieuw Amsterdam* as the 302nd Engineers, an element of the 77th Division. Demobilized about mid-May 1919 at Camp Upton, NY. Reconstituted in the Organized Reserve 24 June 1921, assigned to the 77th Division, and allotted to the Second Corps Area. Initiated 5 August 1921 with regimental headquarters at Manhattan, NY. Subordinate battalion headquarters concurrently organized as follows: 1st Battalion at Brooklyn, NY, and 2nd Battalion at Manhattan. Typically conducted Inactive Training Period meetings at the Cutler Hammer Company building at West 40th Street in Manhattan. Conducted summer training most years with the 1st Engineer Regiment at Fort DuPont, DE, and some years at Camp Dix, NJ. Also conducted C.M.T.C. training some years at Camp Dix as an alternate form of annual training. Participated in the 77th Division CPX at Camp Dix, NJ, in July 1938. Lt. Col. Brehon Somerville served as the Unit Instructor 23 August 1939 to about May 1940. Primary R.O.T.C. feeder school was New York University. Location 7 December 1941—Manhattan, NY.

Status: Active in the U. S. Army Reserve in Guam as the 302nd Engineer Battalion.**Commanders, 302nd Engineer Regiment**

Col. Clarence O. Sherrill	25 Aug 17-12 Oct 18	Col. Frank A. Geisting	5 Aug 21-6 Jan 23
Col. Frank A. Geisting	12 Oct 18-May 19	Col. Charles F. Lacombe	6 Jan 23-10 Sep 29
<i>Demobilized</i>	May 19-4 Aug 21	Col. Louis E. Robbe	11 Sep 29-30 Jul 41

303rd Engineer Regiment (Combat) (78th Division)**Organized Reserve New Jersey**

HQ-Paterson, NJ, 1921-41



Arrived at the port of New York 5 June 1919 on the U.S.S. *Santa Ana* as the 303rd Engineers, an element of the 78th Division. Demobilized in May 1919 at Camp Dix, NJ. Reconstituted in the Organized Reserve 24 June 1921, assigned to the 78th Division, and allotted to the Second Corps Area. Initiated 18 October 1921 with regimental headquarters at Paterson, NJ. Subordinate battalion headquarters concurrently organized as follows: 1st Battalion at East Orange, NJ, and 2nd Battalion at Camden, NJ. Typically conducted Inactive Training Period meetings at the Raymond-Commerce Building in Newark, NJ. Conducted summer training most years with the 1st Engineer Regiment at Fort DuPont, DE, and some years at Camp Dix, NJ, or Fort Wadsworth, NY, with the 16th Infantry. Designated mobilization training station was Sea Girt, NJ. Primary R.O.T.C. feeder school was Princeton University. Location 7 December 1941—Paterson, NJ.

Status: Active in the Regular Army at Fort Devens, MA, as HHD, 3rd Brigade, 78th Division (Training Support).**Events:** 298**Commanders, 303rd Engineer Regiment**

Edward M. Markham	1 Sep 17-30 Aug 18	Col. William S. Conrow	22 Oct 21-ao Sep 25
Col. James A. O'Connor	3 Sep 18-3 Apr 19	Unknown	ao Sep 25-ao Dec 26
<i>Demobilized/Inactive</i>	May 19-17 Oct 21	Lt. Col. Arthur G. Bouton	ao Dec 26-23 Oct 37
	Lt. Col. Edward A. MacMillan	23 Oct 37-8 Mar 41	

304th Engineer Regiment (Combat) (79th Division)**Organized Reserve Pennsylvania**

HQ-Philadelphia, PA, 1921-41

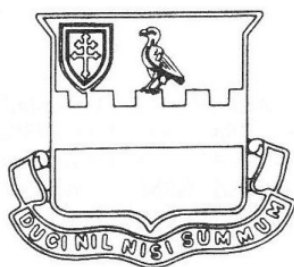

Arrived at the port of New York 29 May 1919 on the U.S.S. *Kroonland* as the 304th Engineers, an element of the 79th Division. Demobilized in June 1919 at Camp Dix, NJ. Reconstituted in the Organized Reserve 24 June 1921, assigned to the 79th Division, and allotted to the Third Corps Area. Initiated 17 September 1921 with the entire regiment at Philadelphia, PA. Band organized at Philadelphia in 1923; inactivated in 1926. Typically conducted Inactive Training Period meetings at the Society of American Military Engineers in Philadelphia. Conducted summer training most years with the 13th Engineer Regiment at Fort A. A. Humphreys, VA, 1924-35, and some years with the 5th Engineer Regiment at Fort Belvoir, VA, 1936-40. Primary R.O.T.C. feeder school was the Carnegie Institute of Technology. Location 7 December 1941—Philadelphia, PA.

Status: Inactive in the U. S. Army Reserve as the 304th Engineer Battalion, an element of the 79th Infantry Division.**Commanders, 304th Engineer Regiment**

Col. James P. Jervey	25 Aug 17-1 Oct 18	Col. Charles D. Young	10 Dec 29-1 Feb 37
Col. J. Frank Barber	1 Oct 18-May 19	Lt. Col. Lloyd A. Cross	1 Feb 37-15 Apr 39
<i>Demobilized</i>	Jun 19-16 Sep 21	Col. Franklin D. Shaw	15 Apr 39-ao Jun 39
Lt. Col. Charles D. Young	17 Sep 21-3 Oct 21	Col. J. Frank Barber	ao Jun 40-ao Sep 40
Col. J. Frank Barber	4 Oct 21-10 Dec 29	Lt. Col. Thomas Jenkins	ao Jan 41-7 Aug 41

305th Engineer Regiment (Combat) (80th Division)**Organized Reserve Virginia**

HQ-Richmond, VA, 1921-41



Arrived at the port of New York 3 June 1919 on the S.S. *Troy* as the 305th Engineers, an element of the 80th Division. Demobilized in June 1919 at Camp Dix, NJ. Reconstituted in the Organized Reserve 24 June 1921, assigned to the 80th Division, and allotted to the Third Corps Area. Initiated 18 October 1921 with regimental headquarters at Richmond, VA. Subordinate battalion headquarters concurrently organized as follows: 1st Battalion at Petersburg, VA, and 2nd Battalion at Norfolk, VA. Conducted summer training most years with the 13th Engineer Regiment at Fort A. A. Humphreys, VA, 1924-35, and some years with the 5th Engineer Regiment at Fort Belvoir, VA, 1936-40. Primary R.O.T.C. feeder schools were the Virginia Military Institute and the Virginia Polytechnic Institute. Location 7 December 1941—Richmond, VA.

Status: Active in the U.S. Army Reserve at Harrisburg, PA, as HHD, 3rd Brigade, 80th Division (Training).

Commanders, 305th Engineer Regiment

Col. George R. Spalding	5 Aug 17-4 Oct 18	Col. William Ira Lee	18 Oct 21-19 Oct 36
Col. Harry Burgess	4 Oct 18-8 Nov 18	Lt. Col. Fred B. Ryons	19 Oct 36-7 Oct 37
Col. Clarke S. Smith	31 Dec 18-2 Apr 19	Col. William A. Sullivan	7 Oct 37-ao Jan 40
<i>Demobilized</i>	Jun 19-17 Oct 21	Unknown	ao Jan 40-7 Dec 41

306th Engineer Regiment (Combat) (81st Division)

Organized Reserve Tennessee

HQ-*Not initiated* 1921-22; Columbia, TN, 1922-29; Knoxville, TN, 1929-41

Constituted in the Organized Reserve 24 June 1921, assigned to the 81st Division, and allotted to the Fourth Corps Area. Initiated in November 1921 with regimental headquarters at Columbia, TN. Regimental headquarters relocated 22 October 1929 to Knoxville, TN. Consolidated 13 August 1936 with the 306th Engineers (a WWI unit organized 24 August 1917 at Camp Jackson, SC; arrived at the port of Charleston 26 June 1919 on the U.S.S. *Zeelandia*; demobilized in June 1919 at Camp Jackson, SC; reconstituted 13 August 1936). Conducted summer training with A Company, 4th Engineer at Fort Bragg, NC, and later at Fort Benning, GA, with A Company, 7th Engineers. Primary R.O.T.C. feeder school was the University of Tennessee. Location 7 December 1941—Knoxville, TN.

Status: Inactive in the U. S. Army Reserve as the 306th Engineer Battalion, an element of the 81st Infantry Division.

Commanders, 306th Engineer Regiment

Col. Robert R. Ralston	24 Aug 17-6 Oct 18	Col. James B. Cress	10 Jul 23-ao Sep 25
Col. Charles R. Pettis	13 Dec 18-26 Mar 19	Col. Frederick W. Albert	ao Jul 26-ao Jul 31
<i>Demobilized</i>	Jun 19-Nov 21	Unknown	ao Jul 31-ao Jul 32
Lt. Col. Frederick F. Spencer	Nov 21-10 Jul 23	Lt. Col. Charles J. Chenworth	ao Jul 32-ao Sep 38
Unknown	10 Jul 23-ao Dec 23	Unknown	ao Sep 38-7 Dec 41

307th Engineer Regiment (Combat) (82nd Division)

Organized Reserve Florida

HQ-Jacksonville, FL, 1921-41

Arrived at the port of New York 9 May 1919 on the U.S.S. *Santa Cecilia* as the 307th Engineers, an element of the 82nd Division. Demobilized 12-17 May 1919 at Camp Dix, NJ. Reconstituted in the Organized Reserve 24 June 1921, assigned to the 82nd Division, and allotted to the Fourth Corps Area. Initiated 18 November 1921 with regimental headquarters at Jacksonville, FL. Conducted summer training with A Company, 4th Engineers at Fort Bragg, NC, and later at Fort Benning, GA, with A Company, 7th Engineers. Primary R.O.T.C. feeder school was the University of Florida. Location 7 December 1941—Jacksonville, FL, (Inactivated 16 March 1942).

Status: Regiment (less 2nd Battalion) active in the Regular Army at Fort Bragg, NC, as the 307th Engineer Battalion, an element of the 82nd Airborne Division; 2nd Battalion inactive in the US Army Reserve as the 868th Engineer Battalion (Aviation).

Commanders, 307th Engineer Regiment

Col. Earle I. Brown	24 Aug 17-28 Oct 17	Col. Clarence S. Coe	18 Nov 21-ao Sep 22
Col. Julian L. Schley	28 Oct 17-27 Oct 18	Unknown	ao Sep 22-ao Jun 26
Lt. Col. Harrison C. Mower	27 Oct 18-20 Dec 18	Col. John M. Johnson	ao Jun 26-30 Aug 28
Col. Henry A. Finch	20 Dec 18-18 Feb 19	Col. Otis M. Page	30 Aug 28-ao Sep 38
Col. W. Goff Caples	18 Feb 19-15 May 19	Lt. Col. Herbert D. Mendenhall	ao Jul 39-ao May 40
<i>Demobilized</i>	15 May 19-Nov 21	Unknown	ao May 40-7 Dec 41

308th Engineer Regiment (Combat) (83rd Division)

Organized Reserve Ohio

HQ-Columbus, OH, 1921-33; Cincinnati 1933-41



Arrived at the port of Charleston 26 June 1919 on the U.S.S. *Zeelandia* as the 308th Engineers, an element of the 83rd Division. Demobilized 4 July 1919 at Camp Sherman, OH. Reconstituted in the Organized Reserve 24 June 1921, assigned to the 83rd Division, and allotted to the Fifth Corps Area. Initiated 8 November 1921 with regimental headquarters at Columbus, OH. Entire regiment relocated 12 December 1931 to Cincinnati, OH. Conducted summer training at Fort A. A. Humphreys, VA, with the 13th Engineer Regiment in 1925. Conducted summer training most years at Camp Knox, KY, and some years at Fort Benjamin Harrison, IN. Also conducted C.M.T.C. training some years at Fort Benjamin Harrison as an alternate form of annual training. Primary R.O.T.C. feeder school was the University of Cincinnati. Location 7 December 1941—Cincinnati, OH.

Status: Inactive in the U. S. Army Reserve as the 308th Engineer Battalion, an element of the 83rd Infantry Division.

Events: 278

Commanders, 308th Engineer Regiment

Col. Warren T. Hannum	27 Aug 17-12 Aug 18	Unknown	ao Jan 23-ao Jun 24
Col. Harry M. Trippe	12 Aug 18-4 Jul 19	Col. Elliot H. Whitlock	ao Jun 24-7 Jun 28
<i>Demobilized</i>	4 Jul 19-7 Nov 21	Col. Maxwell W. Smith	7 Jun 28-ao Jan 38
Lt. Col. Clarence S. Smith	8 Nov 21-ao Jan 23	Unknown	ao Jan 38-ao Jun 39
	Col. Thomas B. Morris	ao Jun 39-Dec 41	

309th Engineer Regiment (Combat) (84th Division)

Organized Reserve Indiana

HQ-Indianapolis 1921-31; Terre Haute 1931-33; Indianapolis 1933-41

Constituted in the Organized Reserve 24 June 1921, assigned to the 84th Division, and allotted to the Fifth Corps Area. Initiated 23 November 1921 with regimental headquarters at Indianapolis, IN. Entire regiment relocated 22 October 1931 to Terre Haute, IN. Entire regiment relocated 21 December 1933 to Indianapolis, IN. Consolidated 13 August 1936 with the 309th Engineers (a WWI unit organized 27 August 1917 at Camp Zachary Taylor, KY; arrived at the port of New York 11 July 1919 on the U.S.S. *Walter A. Luckenbach*; demobilized 14 July 1919 at Camp Sherman, OH; reconstituted 13 August 1936). Conducted summer training most years at Camp Knox, KY, and some years at Fort Benjamin Harrison, IN. Also conducted C.M.T.C. training some years at Fort Benjamin Harrison as an alternate form of annual training. Primary R.O.T.C. feeder school was the Rose Polytechnic Institute. Location 7 December 1941—Indianapolis, IN.

Status: Active in the U.S. Army Reserve at Fort Snelling, MN, as HHD, 3rd Brigade, 84th Division (Training).

Commanders, 309th Engineer Regiment

Col. William L. Guthrie	27 Aug 17-8 Apr 18	<i>Demobilized</i>	14 Jul 19-22 Nov 21
Col. Jarvis J. Bain	8 Apr 18-31 Oct 18	Lt. Col. Ralph A. Feldes	23 Nov 21-ao Aug 27
Unknown	1 Nov 18-14 Jun 19	Unknown	ao Aug 27-ao Dec 30
	Col. Clarence E. Chatfield	ao Dec 30-Dec 41	

310th Engineer Regiment (Combat) (85th Division)**Organized Reserve Michigan**

HQ-Detroit, MI, 1921-41



Demobilized in June 1919 at Camp Sherman, OH, as the 310th Engineers, an element of the 85th Division. Reconstituted in the Organized Reserve 24 June 1921, assigned to the 85th Division, and allotted to the Sixth Corps Area. Initiated 20 October 1921 with regimental headquarters at Detroit, MI. Conducted summer training at Camp Custer, MI, with elements of the 13th Engineers. Primary R.O.T.C. feeder school was the Michigan College of Mining and Technology. Location 7 December 1941—Detroit, MI.

Status: Active in the Regular Army at Fort Benjamin Harrison, IN, as HHD, 3rd Brigade, 85th Division (Training Support).

Commanders, 310th Engineer Regiment

Col. William G. Caples	25 Aug 17-19 Aug 18	Col. Joseph V. Birch	1 Oct 24-ao Sep 29
Unknown	20 Aug 18-Jun 19	Unknown	ao Sep 29-ao Sep 30
<i>Demobilized</i>	Jun 19-9 Oct 21	Col. Joseph H. Wasson	ao Sep 30-ao Jun 33
Maj. Richard B. Hewitt	10 Oct 21-15 Nov 21	Unknown	ao Jun 33-ao Jun 37
Col. Alfred H. Lovell	15 Nov 21-1 Oct 24	Maj. Henry W. Jones	ao Jun 37-ao Jun 38
	Unknown	ao Jun 38-7 Dec 41	

311th Engineer Regiment (Combat) (86th Division)**Organized Reserve Illinois**

HQ-Urbana, IL, 1921-30; Chicago, IL, 1930-41



Demobilized in July 1919 at Camp Grant, IL, as the 311th Engineers, an element of the 86th Division. Reconstituted in the Organized Reserve 24 June 1921, assigned to the 86th Division, and allotted to the Sixth Corps Area. Initiated in November 1921 with regimental headquarters at Urbana, IL. Subordinate battalion headquarters concurrently organized as follows: 1st Battalion at Decatur, IL, and 2nd Battalion at Peoria, IL. Entire regiment relocated 3 December 1930 to Chicago, IL. Typically conducted Inactive Training Period meetings at the 202nd Coast Artillery armory or the Post Office Building in Chicago. Conducted summer training at Camp Custer, MI, with elements of the 13th Engineers. Conducted summer training with the 108th Engineer Regiment at Camp Grant, IL, in 1931. Provided a number of officers to the 108th Engineer Regiment at Camp Custer, MI, for the

1936 Second Army Maneuver. Primary R.O.T.C. feeder school was the University of Illinois. Location 7 December 1941—Chicago, IL.

Status: Inactive in the U. S. Army Reserve as the 311th Engineer Battalion, an element of the 86th Infantry Division.

Events: 162, 211**Commanders, 311th Engineer Regiment**

Col. Clarke S. Smith	25 Aug 17-26 Dec 18	Col. Albert E. Pierce	20 Jan 26-Nov 28
Unknown	27 Dec 18-Jun 19	Col. Edward J. Blair	Nov 28-8 Jan 30
<i>Demobilized</i>	Jun 19-Nov 21	Col. Wilbur M. Wilson	8 Jan 30-ao Sep 30
Lt. Col. Wilbur M. Wilson	Nov 21-20 Jan 26	Col. Harris P. Ralston	ao Jul 31-ao Apr 41
	Unknown	ao Apr 41-7 Dec 41	

312th Engineer Regiment (Combat) (87th Division) Organized Reserve Mississippi, Louisiana, and Alabama

HQ-Not initiated 1921-22; Meridian, MS, 1922-29; New Orleans, LA, 1929-41

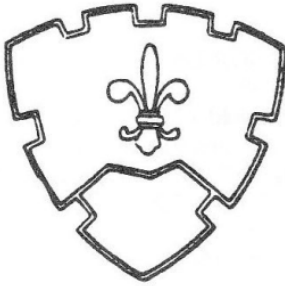

Constituted in the Organized Reserve 24 June 1921, assigned to the 87th Division, and allotted to the Fourth Corps Area. Initiated in January 1922 with regimental headquarters at Meridian, MS. Entire regiment relocated 11 September 1929 to New Orleans, LA. Concurrently consolidated with the 312th Engineers (a WWI unit organized 15 August 1917 at Camp Pike, AR; demobilized 28 June 1919 at Camp Dix, NJ; reconstituted 11 September 1929). Typically conducted Inactive Training Period meetings at the New Federal Building and the St. Charles Hotel in New Orleans. Conducted summer training with A Company, 4th Engineers at Fort Bragg, NC, and later at Fort Benning, GA, with A Company, 7th Engineers. Also conducted C.M.T.C. training at Camp Beauregard, LA, in 1936. Primary R.O.T.C. feeder school was the Alabama Polytechnic Institute and the Louisiana State University. Location 7 December 1941—New Orleans, LA.

Status: Active in the Regular Army at Camp Shelby, MS, as HHD, 3rd Brigade, 87th Division (Training Support).**Commanders, 312th Engineer Regiment**

Col. John R. Slattery	27 Aug 17-30 Sep 18	Unknown	Jan 22-17 May 22
Unknown	1 Oct 18-28 Jun 19	Col. Marcel Garsaud	17 May 22-2 Jan 23
Demobilized	28 Jun 19-Jan 22	Col. John S. Sewell	2 Jan 23-3 Nov 30
	Col. Edward S. Bres	3 Nov 30-Aug 41	

313th Engineer Regiment (Combat) (88th Division)**Organized Reserve Minnesota**

HQ-Not initiated 1921-22; Minneapolis, MN, 1922-41

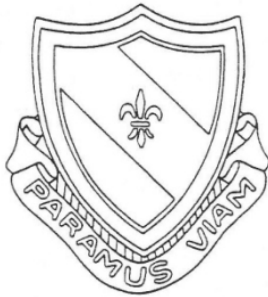

Demobilized 25 June 1919 at Camp Dodge, IA, as the 313th Engineers, an element of the 88th Division. Reconstituted in the Organized Reserve 24 June 1921, assigned to the 88th Division, and allotted to the Seventh Corps Area. Originally allotted to the geographical area of North Dakota for organization. Reallotted 8 December 1921 to the geographical area of Minnesota. Initiated 11 March 1922 with regimental headquarters at Minneapolis, MN. Typically conducted Inactive Training Period meetings at the Union Building, University of Minnesota in Minneapolis. Conducted summer training at various locations to include Fort Riley, KS, Fort Snelling, MN, and Fort Logan CO. Also conducted C.M.T.C. training some years at Fort Snelling as an alternate form of annual training. Primary R.O.T.C. feeder school was the University of Minnesota. Location 7 December 1941—Minneapolis, MN, (Inactivated 22 January 1942).

Status: Inactive in the U. S. Army Reserve as the 313th Engineer Battalion, an element of the 88th Infantry Division.**Commanders, 313th Engineer Regiment**

Lt. Col. Clarke S. Smith	25 Aug 17-3 Sep 17	Demobilized	25 Jun 19-10 Mar 22
Col. Robert R. Raymond	3 Sep 17-29 Dec 17	Col. Ora M. Leland	11 Mar 22-28 Jun 40
Col. Robert P. Howell	31 Aug 18-15 Nov 18	Col. William N. Carey	28 Jun 40-May 41
Col. Charles R. Pettis	27 Nov 18-11 Dec 18	Lt. Col. George Geib	May 41-Aug 41
Col. Robert P. Howell	27 Apr 19-25 Jun 19	Maj. Harry D. Lovering	Aug 41-22 Jan 42

314th Engineer Regiment (Combat) (89th Division)**Organized Reserve Kansas and Nebraska**

HQ-Lawrence, KS, 1921-26; Grand Island, NE, 1926-41



Arrived at the port of Boston 26 May 1919 on the U.S.S. *Montana* as the 314th Engineers, an element of the 89th Division. Demobilized in June 1919 at Camp Funston, KS. Reconstituted in the Organized Reserve 24 June 1921, assigned to the 89th Division, and allotted to the Seventh Corps Area. Initiated 10 October 1921 with regimental headquarters at Lawrence, KS. Subordinate battalion headquarters concurrently organized as follows: 1st Battalion at Lawrence and 2nd Battalion at Lincoln, NE. Regimental headquarters relocated 26 May 1926 to Grand Island, NE. Entire regiment relocated 3 April 1928 to Grand Island. Conducted summer training at various locations to include Fort Des Moines, IA, Fort Riley, KS, Fort Snelling, MN, Fort McIntosh, TX, Fort Logan, CO, and Fort Crook, NE. Primary R.O.T.C. feeder schools were the University of Kansas 1922-28 and the University of Nebraska 1928-41. Location 7 December 1941—Grand Island, NE.

Status: Inactive in the U. S. Army Reserve as the 314th Engineer Battalion, an element of the 89th Infantry Division.

Commanders, 314th Engineer Regiment

Col. William B. Ladue	25 Aug 17-25 Feb 18	Col. Daniel D. Pullen	7 Jan 19-Jun 19
Maj. Lawrence E. Curfman	25 Feb 18-13 Mar 18	<i>Demobilized/Inactive</i>	Jun 19-10 Oct 21
Col. William B. Ladue	13 Mar 18-21 Apr 18	Maj. Oscar Van P. Stout	10 Oct 21-17 Nov 21
Col. Daniel D. Pullen	21 Apr 18-19 Jun 18	Col. Perley F. Walker	17 Nov 21-17 Oct 27
Col. Robert P. Johnston	19 Jun 18-16 Nov 18	Col. Charles R. Fisher	17 Oct 27-9 Aug 38
Lt. Col. Brehon B. Somervell	13 Nov 18-26 Nov 18	Lt. Col. Kenneth H. Talbot	9 Aug 38-21 Sep 38
Lt. Col. Ora M. Leland	26 Nov 18-7 Jan 19	Unknown	21 Sep 38-Dec 41

315th Engineer Regiment (Combat) (90th Division)

Organized Reserve Texas

HQ-San Antonio, TX, 1921-41



Demobilized in June 1919 at Camp Dodge, IA, as the 315th Engineers, an element of the 90th Division. Reconstituted in the Organized Reserve 24 June 1921, assigned to the 90th Division, and allotted to the Eighth Corps Area. Initiated 19 October 1921 with regimental headquarters at San Antonio, TX. Subordinate battalion headquarters concurrently organized as follows: 1st Battalion at Dallas, TX, and 2nd Battalion at Houston, TX. Typically conducted Inactive Training Period meetings at the Bexar County Courthouse, the Smith-Young Tower, and the Gunter Building in San Antonio. Conducted summer training most years with the 8th Engineer Squadron at Fort McIntosh, TX, and some years with the 2nd Engineer Regiment at Fort Sam Houston, TX, or Camp Bullis, TX. Primary R.O.T.C. feeder schools were the Agricultural and Mechanical College of Texas and the Texas Technological College. Location 7 December 1941—San Antonio, TX.

Status: Inactive in the U. S. Army Reserve as the 315th Engineer Battalion, an element of the 90th Infantry Division.

Commanders, 315th Engineer Regiment

Col. Frank C. Boggs	23 Aug 17-1 Aug 18	Maj. William B. Tuttle	19 Oct 21-26 Nov 21
Col. Francis A. Pope	15 Aug 18-5 Nov 18	Lt. Col. Orman N. Powell	26 Nov 21-12 Dec 21
Col. Jarvis J. Bain	5 Nov 18-7 Feb 19	Col. Samuel F. Crecelius	12 Dec 21-Oct 23
Col. William H. Sage, Jr.	7 Feb 19-May 19	Col. William B. Tuttle	Oct 23-31 Jul 38
<i>Demobilized</i>	Jun 19-18 Oct 21	Col. William W. Holden	31 Jul 38-Dec 41

316th Engineer Regiment (Combat) (91st Division)

Organized Reserve California

HQ-Los Angeles, CA, 1921-41

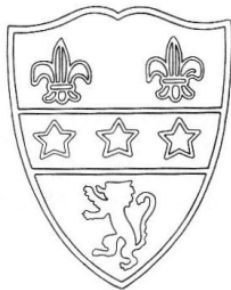

Arrived at the port of New York on 16 April 1919 on the U.S.S. *Calamares* as the 316th Engineers, an element of the 91st Division. Demobilized in May 1919 at the Presidio of San Francisco, CA. Reconstituted in the Organized Reserve 24 June 1921, assigned to the 91st Division, and allotted to the Ninth Corps Area. Initiated 25 November 1921 with regimental headquarters at Los Angeles, CA. Conducted summer training with most years at Del Monte, CA, and some years at the Presidio of Monterey, CA. Primary R.O.T.C. feeder schools were the University of California, Los Angeles and the California Institute of Technology. Location 7 December 1941—Los Angeles, CA, (Inactivated 21 January 1942).

Status: Active in the Regular Army at Travis AFB, CA, as HHD, 3rd Brigade, 91st Division (Training Support).

Commanders, 316th Engineer Regiment

Col. Henry C. Jewett	Aug 17-26 Sep 18	<i>Demobilized</i>	May 19-24 Nov 21
Col. George R. Goethals	10 Dec 18-12 Feb 19	Col. John H. Poole	1 Dec 21-29 Dec 21
Maj. Herman S. Bonte	13 Feb 19-May 19	Col. George H. Canfield	29 Dec 21-ao Jan 40
	Unknown	ao Jan 40-7 Dec 41	

319th Engineer Regiment (Combat) (94th Division)**Organized Reserve Massachusetts**

HQ-Boston, MA, 1921-41



Constituted in the Organized Reserve 24 June 1921, assigned to the 94th Division, and allotted to the First Corps Area. Initiated 7 October 1921 with regimental headquarters at Boston, MA. Consolidated 10 May 1923 with the 319th Engineers (a WWI unit organized in December 1917 Camp Fremont, CA; demobilized 10 May 1919 at the Presidio of San Francisco, CA; reconstituted 10 May 1923). Typically conducted Inactive Training Period meetings at the Custom House Tower in Boston. Conducted summer training most years at Camp Devens, MA, and some years with the 1st Engineer Regiment at Fort DuPont, DE. Conducted summer training in 1925 at Hanover, MA, at the estate of Col. John F. Osborn, Commander, 101st Engineer Regiment. Primary R.O.T.C. feeder schools were Harvard University and the Massachusetts Institute of Technology. Location 7 December 1941—Boston, MA.

Status: Inactive in the U. S. Army Reserve as the 319th Engineer Battalion, an element of the 94th Infantry Division.

Commanders, 319th Engineer Regiment

Col. Curtis W. Otwell	5 Feb 18-21 Dec 18	<i>Demobilized</i>	10 May 19-6 Oct 21
Col. Robert P. Johnston	21 Dec 18-17 Feb 19	Col. William H. Root	7 Oct 21-ao Jun 36
Unknown	16 Dec 18-10 May 19	Unknown	ao Jun 36-7 Dec 41

320th Engineer Regiment (Combat) (95th Division)**Organized Reserve Oklahoma**

HQ-*Not initiated* 1921-22; Oklahoma City, OK, 1922-25; Guthrie, OK, 1925-32; Oklahoma City, OK, 1932-38; Enid, OK, 1938-40; Tulsa, OK, 1940-41

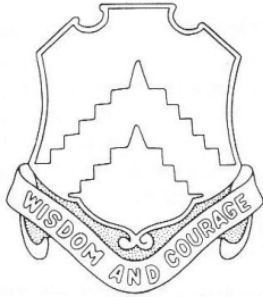

Constituted in the Organized Reserve 24 June 1921, assigned to the 95th Division, and allotted to the Eighth Corps Area. Initiated 6 March 1922 with regimental headquarters at Oklahoma City, OK. Regimental headquarters relocated 10 July 1925 to Guthrie, OK. Subordinate battalions concurrently relocated as follows: 1st Battalion to Guthrie, OK, and 2nd Battalion to Cushing, OK. Regimental headquarters successively relocated as follows: to Oklahoma City, OK, 20 July 1932; to Enid, OK, 31 March 1938; and to Tulsa, OK, 31 March 1940. Conducted summer training at various locations to include with the 2nd Engineer Regiment at Fort Sam Houston and Fort Logan, CO; with the 8th Engineer Squadron at Fort Bliss, TX, and Fort McIntosh, TX; and at Fort Sill, OK. Conducted summer training with elements of the 120th Engineer Regiment at Fort Sill in 1935 and 1939, and at Camp Maximiliano Luna, NM, in 1937. Also conducted summer training at Nacogdoches, TX, in 1940. Primary R.O.T.C. feeder school was the Oklahoma Agricultural and Mechanical College. Location 7 December 1941—Tulsa, OK.

Status: Active in the U.S. Army Reserve at Broken Arrow, OK, as HHD, 3rd Brigade, 95th Division (Training).

Commanders, 320th Engineer Regiment

Unknown	Aug 17-1 Oct 18	Col. Frank B. King	6 Mar 22-ao Aug 31
Col. Charles J. Taylor	1 Oct 18-6 Oct 18	Unknown	ao Aug 31-ao Nov 37
Lt. Col. Dabney O. Elliot	6 Nov 18-May 19	Col. Alfred B. Carson	ao Nov 37-ao Jan 38
<i>Demobilized</i>	May 19-6 Mar 22	Unknown	ao Jan 38-7 Dec 41

321st Engineer Regiment (Combat) (96th Division)**Organized Reserve Washington and Oregon**

HQ-Seattle, WA, 1921-41

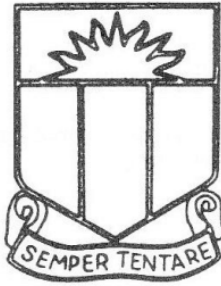

Constituted in the Organized Reserve 24 June 1921, assigned to the 96th Division, and allotted to the Ninth Corps Area. Initiated in January 1922 with regimental headquarters at Seattle, WA. Subordinate battalion headquarters concurrently organized as follows: 1st Battalion at Seattle and 2nd Battalion at Portland, OR. Conducted summer training most years with the 6th Engineer Regiment at Fort Lewis, WA, 1924-35 and at Fort Lawton, WA, 1936-39. Typically conducted Inactive Training Period meetings at the Offices of the District Engineer, Burke Building, or at the Central Building in Seattle. Primary R.O.T.C. feeder school was the State College of Washington. Roland F. Hartley, Governor of Washington, was a captain in the regiment in the 1920s. Location 7 December 1941—Seattle, WA.

Status: Active in the U.S. Army Reserve at Boise, ID, as the 321st Engineer Battalion.**Commanders, 321st Engineer Regiment**

Unknown	Aug 17-18 Nov 18	Lt. Col. William H. Nelson	Jul 25-ao Aug 29
Col. Gilbert Van B. Wilkes	18 Nov 18-31 Jan 19	Unknown	ao Aug 29-ao Jun 31
Unknown	1 Feb 19-May 19	Col. Joseph V. Birch	ao Jun 31-ao Nov 38
<i>Demobilized</i>	May 19-Jan 22	Unknown	ao Nov 38-ao Jun 39
Lt. Col. Kenneth D. Hauser	Jan 22-Jul 25	Col. Kenneth D. Hauser	ao Jun 39-ao May 40
	Unknown	ao May 40-7 Dec 41	

322nd Engineer Regiment (Combat) (97th Division)**Organized Reserve Vermont and Maine**

HQ-Proctor, VT 1921-41

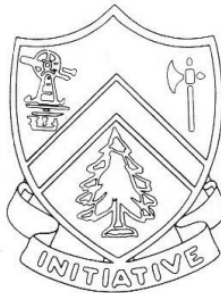

Constituted in the Organized Reserve 24 June 1921, assigned to the 97th Division, and allotted to the First Corps Area. Initiated in November 1921 with regimental headquarters at Proctor, VT. Subordinate battalion headquarters concurrently organized as follows: 1st Battalion at Proctor and 2nd Battalion at Portland, ME. Conducted summer training at various locations to include with the 1st Engineer Regiment at Fort DuPont, DE, Fort Ethan Allen, VT, Fort A. A. Humphreys, VA, Fort McKinley, ME, and Camp Devens, MA. Primary R.O.T.C. feeder school was the University of Vermont. Col. Redfield Proctor, Governor of Vermont (1923-25), was the regimental commander in the 1920s and early 30s. Location 7 December 1941—Proctor, VT.

Status: Inactive in the U. S. Army Reserve as the 322nd Engineer Battalion, an element of the 97th Infantry Division.**Commanders, 322nd Engineer Regiment**

Unknown	Aug 17-13 Nov 18	Col. Redfield Proctor, Jr.	Jan 24-ao Jan 33
Col. Clarence R. Sturdevant	14 Nov 18-20 Dec 18	Unknown	ao Jan 33-ao Jun 34
Unknown	21 Dec 18-May 19	Lt. Col. Nathaniel C. Peterson	ao Jun 34-ao Jun 37
<i>Demobilized</i>	May 19-Nov 21	Unknown	ao Jun 37-ao Dec 38
Maj. Nathaniel C. Peterson	Nov 21-Jan 24	Col. David E. Hayes	ao Dec 38-ao Mar 40
	Unknown	ao Mar 40-7 Dec 41	

323rd Engineer Regiment (Combat) (98th Division)**Organized Reserve New York**

HQ-Rochester, NY, 1921-41



Constituted in the Organized Reserve 24 June 1921, assigned to the 98th Division, and allotted to the Second Corps Area. Initiated 21 October 1921 with regimental headquarters at Rochester, NY. Subordinate battalion headquarters concurrently organized as follows: 1st Battalion at Albany, NY, and 2nd Battalion at Buffalo, NY. Typically conducted Inactive Training Period meetings at the Federal Building in Syracuse. Conducted summer training most years with the 1st Engineer Regiment at Fort DuPont, DE, and some years at Camp Dix, NJ, or Fort Wadsworth, NY, with the 16th Infantry. Also conducted C.M.T.C. training some years at Camp Dix as an alternate form of annual training. Primary R.O.T.C. feeder school was Clarkson College of Technology. Location 7 December 1941—Rochester, NY.

Commanders, 323rd Engineer Regiment

Col. Herbert H. Adams	21 Oct 21-ao Sep 22	Col. Carey H. Brown	5 Nov 30-27 Jan 37
Col. Carleton W. Sturtevant	3 Apr 26-23 Feb 27	Lt. Col. Ernest F. Robinson	27 Jan 37-ao Feb 38
Col. Edwin Van R. Payne	23 Feb 27-5 Nov 30	Lt. Col. Hubert E. Snyder	ao Dec 38-19 Feb 41
	Lt. Col. Ernest F. Robinson	19 Feb 41-ao Dec 41	

324th Engineer Regiment (Combat) (99th Division)**Organized Reserve Pennsylvania**

HQ-Pittsburgh, PA, 1921-41



Constituted in the Organized Reserve 24 June 1921, assigned to the 99th Division, and allotted to the Third Corps Area. Initiated 7 December 1921 with the entire regiment at Pittsburgh, PA. Typically conducted Inactive Training Period meetings at the 176th Field Artillery armory in Pittsburgh. Conducted summer training most years with the 13th Engineer Regiment at Fort A. A. Humphreys, VA, 1924-35, and some years with the 5th Engineer Regiment at Fort Belvoir, VA, 1936-40. Primary R.O.T.C. feeder school was the Carnegie Institute of Technology. Location 7 December 1941—Pittsburgh, PA.

Status: Inactive in the U. S. Army Reserve as the 324th Engineer Battalion, an element of the 99th Infantry Division.**Commanders, 324th Engineer Regiment**

Col. Cleveland C. Gee	26 Aug 18-29 Sep 18	Col. Elbert A. Gibbs	7 Dec 21-7 Jan 32
Col. Earl North	7 Nov 18-16 Nov 18	Lt. Col. William M. McKee	7 Jan 32-12 Dec 33
Unknown	16 Nov 18-May 19	Lt. Col. James L. Taylor, Jr.	12 Dec 33-ao Jul 40
<i>Demobilized</i>	May 19-7 Dec 21	Unknown	ao Jul 40-ao Jul 41
	Lt. Col. Harold F. Bucher	ao Jul 41-9 Aug 41	

325th Engineer Regiment (Combat) (100th Division)**Organized Reserve West Virginia**

HQ-Huntington, WV 1921-31; Charleston, WV 1931-41



Constituted in the Organized Reserve 24 June 1921, assigned to the 100th Division, and allotted to the Fifth Corps Area. Initiated 30 November 1921 with regimental headquarters at Huntington, WV. Subordinate battalion headquarters concurrently organized as follows: 1st Battalion at Charleston, WV, and 2nd Battalion at Clarksburg, WV. Entire regiment relocated 9 July 1931 to Charleston, WV. Typically conducted Inactive Training Period meetings at the Masonic Temple or the Charleston Public Library in Charleston. Conducted summer training most years at Camp Knox, KY, and some years at Fort A. A. Humphreys, VA, or Fort Benjamin Harrison, IN. Primary R.O.T.C. feeder school was the West Virginia University. Location 7 December 1941—Charleston, WV.

Status: Active in the U.S. Army Reserve at Huntsville, AL, as HHD, 3rd Brigade, 100th Division (Training).

Commanders, 325th Engineer Regiment

Col. Camden P. Fortney	30 Nov 21-ao Oct 39	Col. Donald B. Adams	ao Mar 40-1 Feb 41
------------------------	---------------------	----------------------	--------------------

326th Engineer Regiment (Combat) (101st Division)

Organized Reserve Wisconsin

HQ-Milwaukee, WI, 1921-41

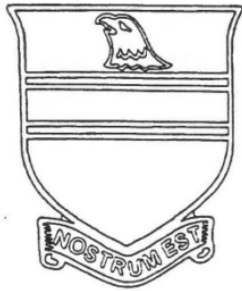

Constituted in the Organized Reserve 24 June 1921, assigned to the 101st Division, and allotted to the Sixth Corps Area. Initiated 14 October 1921 with the entire regiment at Milwaukee, WI. Conducted summer training most years at Camp Custer, MI, and some years at Fort Sheridan, IL. Conducted summer training most years at Camp Williams, WI. Participated in summer training with units of the 32nd Division in 1932. Primary R.O.T.C. feeder school was the University of Wisconsin. Location 7 December 1941—Milwaukee, WI.

Status: Active in the Regular Army at Fort Campbell, KY, as the 326th Engineer Battalion, an element of the 101st Airborne Division (Air Assault).

Commanders, 326th Engineer Regiment

Lt. Col. Arthur P. Christophel	14 Oct 21-11 Mar 26	Col. William E. Haseltine	3 Oct 30-17 Oct 31
Col. Carl R. Gray, Jr.	11 Mar 26-30 Jul 29	Col. Joseph J. Ring	17 Oct 31-ao Jun 36
Col. James B. Cress	30 Jul 29-28 Nov 29	Unknown	ao Jun 36-ao Jun 37
Col. Arthur P. Christophel	29 Nov 29-3 Oct 30	Col. Arthur P. Christophel	ao Jun 37-ao Nov 39
	Unknown	ao Nov 39-7 Dec 41	

327th Engineer Regiment (Combat) (102nd Division)

Organized Reserve Missouri

HQ-St. Louis, MO, 1921-41



Constituted in the Organized Reserve 24 June 1921, assigned to the 102nd Division, and allotted to the Seventh Corps Area. Initiated 12 October 1921 with regimental headquarters at St. Louis, MO. Subordinate battalion headquarters concurrently organized as follows: 1st Battalion at Webster Groves, MO, and 2nd Battalion at St. Louis. Typically conducted Inactive Training Period meetings at the University Club or Knights of Columbus Building on Liddell Boulevard in St. Louis. Conducted summer training most years at various locations to include Fort Leavenworth, KS, Fort Riley, KS, Fort Logan CO, and Fort Des Moines, IA. Conducted summer training with the 110th Engineer Regiment at Camp Clark, MO, in 1930 and 1938. Primary R.O.T.C. feeder school was the Missouri School of Mines. Location 7 December 1941—St. Louis, MO.

Status: Inactive in the U. S. Army Reserve as the 327th Engineer Battalion, an element of the 102nd Infantry Division.

Commanders, 327th Engineer Regiment

Col. William G. Atwood	12 Oct 21-3 Nov 21	Col. Albert T. Perkins	11 Mar 22-Sep 30
Lt. Col. Dickens S. Adams	3 Nov 21-11 Mar 22	Col. Huriosco Austill	Sep 30-ao Aug 36
	Unknown	ao Aug 36-7 Dec 41	

328th Engineer Regiment (Combat) (103rd Division)**Organized Reserve Colorado**

HQ-Denver, CO, 1921-41



Constituted in the Organized Reserve 24 June 1921, assigned to the 103rd Division, and allotted to the Eighth Corps Area. Initiated 24 October 1921 with regimental headquarters at Denver, CO. Subordinate battalion headquarters concurrently organized as follows: 1st Battalion at Denver and 2nd Battalion at Colorado Springs, CO. Conducted summer training with the 8th Engineer Battalion at Fort Bliss, TX, 1922-26 and with the 2nd Engineer Regiment at Fort Logan, CO, 1927-35. Typically conducted Inactive Training Period meetings at the State Office Building in Denver. Conducted summer training with the 120th Engineer Regiment at Fort Sill in 1939. Conducted C.M.T.C. training at Fort Logan 1936-39 as an alternate form of annual training. Also conducted summer training at Nacogdoches, TX, in 1940. Primary R.O.T.C. feeder school was the Colorado State School of Mines. Location 7 December 1941—Denver, CO.

Status: Inactive in the U. S. Army Reserve as the 328th Engineer Battalion, an element of the 103rd Infantry Division.**Commanders, 328th Engineer Regiment**

Col. Joseph C. Taylor	24 Oct 21-ao Oct 25	Col. Charles Larson	5 Sep 30-ao Mar 34
Lt. Col. Charles Larson	ao Mar 26-2 Mar 27	Unknown	ao Mar 34-ao Aug 38
Col. Charles H. Rankin	2 Mar 27-5 Sep 30	Lt. Col. James G. L. Howard	ao Aug 38-ao Sep 38
	Unknown	ao Sep 38-7 Dec 41	

329th Engineer Regiment (Combat) (104th Division)**Organized Reserve Utah, Montana,
Nevada, Wyoming and, Idaho**

HQ-Salt Lake City, UT, 1921-41



Constituted in the Organized Reserve 24 June 1921, assigned to the 104th Division, and allotted to the Ninth Corps Area. Initiated in November 1921 with regimental headquarters at Salt Lake City, UT. The remainder of the regiment was organized as follows: 1st Battalion headquarters in Salt Lake City with subordinate companies in Utah, Nevada, and Wyoming; 2nd Battalion headquarters in Helena MT with subordinate companies in Montana and Idaho. By 1937 the regiment was located, less 2nd Battalion, entirely in Salt Lake City; the 2nd Battalion was located in Helena, MT, except F Company which was located in Boise, ID. Typically conducted Inactive Training Period meetings at the Federal Building in Salt Lake City. Conducted summer training at various locations to include Fort Douglas, UT, Fort Lewis, WA, Fort Logan, CO, and Fort Lawton, WA. Location 7 December 1941—Salt Lake City, UT.

Lewis, WA, Fort Logan, CO, and Fort Lawton, WA. Location 7 December 1941—Salt Lake City, UT.

Status: Active in the U.S. Army Reserve at Vancouver Barracks, WA, as HHD, 3rd Brigade, 104th Division (Training).**Commanders, 329th Engineer Regiment**

Maj. C. V. Taylor	Nov 21-Sep 22	Unknown	ao Jan 40-ao Nov 41
Col. George F. Weisel	Sep 22-ao Jan 40	Lt. Col. James C. Long	ao Nov 41-Jan 42

330th Engineer Regiment (General Service) (First Army)**Organized Reserve New York**

HQ-Not organized 1923-27

Constituted in the National Guard in 1921 as the 161st Engineer Regiment. Assigned to the First Army and allotted to the state of New York. Placed on the deferred list 2 July 1923, unit requirement transferred to the Organized Reserve as a Deferred National Guard unit, and redesignated as the 330th Engineer Regiment. Buffalo, NY, designated as headquarters location on organization, but the unit was never organized at that location. Withdrawn from the National Guard 17 September 1927 and demobilized.

331st Engineer Regiment (General Service) (Second Army)

Organized Reserve Georgia

HQ-Not organized 1923-40

Constituted in the National Guard in 1921 as the 164th Engineer Regiment, assigned to the Second Army, and allotted originally to the state of Georgia. Placed on the deferred list 2 July 1923, unit requirement, less active companies, transferred to the Organized Reserve as a Deferred National Guard unit, and redesignated as the 331st Engineer Regiment. Designated mobilization training station was Fort Bragg, NC. Disbanded 1 October 1940.

332nd Engineer Regiment (General Service) (II Corps)

Organized Reserve New York/Massachusetts

HQ-Not organized 1923-29; Boston, MA, 1929-34; *Inactive* 1934-41

Constituted in the National Guard in 1921 as the 131st Engineer Regiment. Assigned to the II Corps and allotted to the state of New York. Placed on the deferred list 2 July 1923, unit requirement transferred to the Organized Reserve as a Deferred National Guard unit, and redesignated as the 332nd Engineer Regiment. Manhattan, NY, designated as headquarters location on organization, but the unit was never organized at that location. Withdrawn from the National Guard 5 September 1928 and allotted to the Organized Reserve. Concurrently withdrawn from the Second Corps Area and allotted to the First Corps Area. Initiated in April 1929 with regimental headquarters at Boston, MA. Subordinate battalion headquarters concurrently organized as follows: 1st Battalion at Arlington, MA, and 2nd Battalion at Chelsea, MA. Assigned to the XI Corps 1 October 1933. Conducted summer training with the 1st Engineer Regiment at Fort DuPont, DE. Primary R.O.T.C. feeder schools were Harvard University and the Massachusetts Institute of Technology. Inactivated by May 1934 at Boston by relief of personnel. Location 7 December 1941—*Inactive*.

Status: Regimental Headquarters, and Headquarters & Service Company, 332nd Engineer Regiment are inactive in the U. S. Army Reserve as HHC, 369th Engineer Group; the 1st Battalion is inactive as the 975th Engineer Battalion; the 2nd Battalion is inactive as the 976th Engineer Battalion.

Commander, 332nd Engineer Regiment

Unknown Apr 29-May 34

333rd Engineer Regiment (General Service) (I) (III Corps)

Organized Reserve Pennsylvania

HQ-Not organized 1923-27

Constituted in the National Guard in 1921 as the 132nd Engineer Regiment. Assigned to the III Corps and allotted to the state of Pennsylvania. Placed on the deferred list 2 July 1923, unit requirement transferred to the Organized Reserve as a Deferred National Guard unit, and redesignated as the 333rd Engineer Regiment. Withdrawn from the National Guard 17 September 1927 and demobilized.

333rd Engineer Regiment (General Service) (II) (II Corps)

Organized Reserve New York

HQ-Not initiated 1928-29; Manhattan, NY, 1929-41

Constituted in the Organized Reserve 5 September 1928, assigned to the II Corps, and allotted to the Second Corps Area. Initiated in August 1929 with regimental headquarters at Manhattan, NY. Redesignated as a “Colored” unit 9 March 1937. Primary R.O.T.C. feeder school was New York University. Location 7 December 1941—Manhattan, NY.

Status: Disbanded 22 August 1942.

Commanders, 333rd Engineer Regiment

Unknown Aug 29-7 Dec 41

334th Engineer Regiment (General Service) (IV Corps)

**Organized Reserve Alabama,
South Carolina, and Georgia**

HQ-Not initiated 1923-24

Constituted in the National Guard in 1921 as the 133rd Engineer Regiment. Assigned to the IV Corps and allotted to the states of Alabama, South Carolina, and Georgia. Placed on the deferred list 2 July 1923, unit requirement transferred to the Organized Reserve as a Deferred National Guard unit, and redesignated as the 334th Engineer Regiment. Unit requirement transferred back to the National Guard in 1924 as the 133rd Engineer Regiment. Demobilized 1 October 1940.

335th Engineer Regiment (General Service) (XV Corps)

Organized Reserve New Jersey and Delaware

HQ-Not initiated 1923-29; Newark, NJ, 1929-37; *Inactive* 1937-41

Constituted in the National Guard in 1921 as the 134th Engineer Regiment. Assigned to the V Corps and allotted to the state of Ohio. Placed on the deferred list 2 July 1923, unit requirement transferred to the Organized Reserve as a Deferred National Guard unit, and redesignated as the 335th Engineer Regiment. Concurrently assigned to the XV Corps. Withdrawn from the National Guard 5 September 1928 and allotted to the Organized Reserve. Concurrently withdrawn from the Fifth Corps Area and allotted to the Second Corps Area. Assigned to the General Headquarters Reserve. Initiated in June 1929 with regimental headquarters at Newark, NJ. Inactivated in February 1937 at Newark by relief of personnel. Englewood, NJ, designated as headquarters location on reorganization, but the unit was never organized at that location. Conducted summer training with the 1st Engineer Regiment at Fort DuPont, DE, or at Fort A. A. Humphreys, VA. Primary R.O.T.C. feeder school was Princeton University. Location 7 December 1941—*Inactive*.

Status: Regimental Headquarters, and Headquarters & Service Company are inactive in the U.S. Army Reserve as HHC, 415th Engineer Brigade.

Commanders, 335th Engineer Regiment

Unknown

Jun 29-Feb 37

Inactive

Feb 37-7 Dec 41

336th Engineer Regiment (General Service) (I) (XVI Corps)

Organized Reserve Illinois

HQ-Not initiated 1923-27

Constituted in the National Guard in 1921 as the 135th Engineer Regiment. Assigned to the VI Corps and allotted to the states of Illinois and Michigan. Placed on the deferred list 2 July 1923, unit requirement transferred to the Organized Reserve as a Deferred National Guard unit, and redesignated as the 336th Engineer Regiment. Concurrently assigned to the XVI Corps. Designated mobilization training station was Camp Grant, IL. Withdrawn from the National Guard 17 September 1927 and demobilized.

336th Engineer Regiment (General Service) (II)

Organized Reserve Pennsylvania

HQ-Not initiated 1928-41

Constituted in the Organized Reserve 5 September 1928 and allotted to the Third Corps Area. Reading, PA, designated as headquarters location on organization, but the unit was never organized at that location. Location 7 December 1941—*Not initiated*.

Status: Regimental Headquarters, and Headquarters & Service Company, 336th Engineer Regiment are inactive in the U. S. Army Reserve as HHC, 5th Engineer Command (Amphibious Support); 1st Battalion is inactive in the U. S. Army Reserve as the 336th Engineer Battalion (Combat); 2nd Battalion is inactive in the U. S. Army Reserve as the 234th Engineer Battalion (Combat).

337th Engineer Regiment (General Service) (I) VII Corps)**Organized Reserve Minnesota****HQ-Not initiated** 1923-27

Constituted in the National Guard in 1921 as the 136th Engineer Regiment. Assigned to the VII Corps and allotted to the states of Kansas and South Dakota. Placed on the deferred list 2 July 1923, unit requirement transferred to the Organized Reserve as a Deferred National Guard unit, and redesignated as the 337th Engineer Regiment. Austin, MN, designated as headquarters location on organization, but the unit was never organized at that location. Withdrawn from the National Guard 17 September 1927 and demobilized.

337th Engineer Regiment (General Service) (II) (XV Corps)**Organized Reserve West Virginia/Indiana****HQ-Not initiated** 1928-41

Constituted in the Organized Reserve 5 September 1928, assigned to the XV Corps, and allotted to the Fifth Corps Area. Huntington, WV, designated as headquarters on organization, but the unit was never organized at that location. Designated headquarters location changed 21 December 1933 to Terre Haute, IN. Location 7 December 1941—*Not initiated*.

Status: Regimental Headquarters, and Headquarters & Service Company, 337th Engineer Regiment are active in the U. S. Army Reserve at Des Moines, IA, as HHC, 372nd Engineer Group.

338th Engineer Regiment (General Service) (XVIII Corps)**Organized Reserve Iowa/Minnesota****HQ-Not initiated** 1923-30; Waterloo, IA, 1930-31; St. Paul, MN, 1931-41

Constituted in the National Guard in 1921 as the 137th Engineer Regiment, assigned to the VIII Corps, and allotted to the states of New Mexico and Colorado. Regiment placed on the deferred list 2 July 1923, unit requirement transferred to the Organized Reserve as a Deferred National Guard unit, and redesignated as the 338th Engineer Regiment. Concurrently relieved from the VIII Corps and assigned to the XVIII Corps. Withdrawn as a Deferred National Guard unit 13 January 1927 and allotted permanently to the Organized Reserve as the 338th Engineer Regiment. Concurrently withdrawn from the Eighth Corps Area, allotted to the Seventh Corps Area, and assigned to the XVII Corps. Initiated 27 December 1930 with regimental headquarters at Waterloo, IA. Headquarters relocated 12 October 1931 to St. Paul, MN. Typically conducted Inactive Training Period meetings at the Union Building, University of Minnesota in Minneapolis. Conducted summer training at various locations to include Fort Riley, KS, Fort Logan, CO, Fort Snelling, MN, and Fort Des Moines, IA. Primary R.O.T.C. feeder school was the University of Minnesota. Location 7 December 1941—St. Paul, MN.

Status: Regimental Headquarters, and Headquarters & Service Company, 338th Engineer Regiment are inactive in the U. S. Army Reserve as HHC, 929th Engineer Aviation Group; the 1st Battalion is inactive as the 340th Engineer Battalion; the 2nd Battalion is inactive as the 410th Engineer Battalion.

Commanders, 338th Engineer Regiment

Unknown	27 Dec 30-ao Jul 35	Col. Norman D. Dean	ao Jan 36-15 Nov 36
Maj. Richard C. Greenland	ao Jul 35-ao Aug 35	Col. James A. Grant	15 Nov 36-16 May 37
	Col. Norman D. Dean	16 May 37-ao Jan 41	

339th Engineer Regiment (General Service) (I) (XIX Corps)**Organized Reserve California****HQ-Not initiated** 1923-26; California 1926-27

Constituted in the National Guard in 1921 as the 138th Engineer Regiment, assigned to the IX Corps, and allotted to the state of California. Placed on the deferred list 2 July 1923, unit requirement transferred to the Organized Reserve as a Deferred National Guard unit, and redesignated as the 339th Engineer Regiment. Concurrently assigned to the XIX Corps. Initiated by June 1926 with regimental headquarters in California. Conducted summer training at Del Monte, CA. Withdrawn from the National Guard 17 September 1927 and demobilized.

Commander, 339th Engineer Regiment (I)

Unknown ao Jun 26-17 Sep 27

339th Engineer Regiment (General Service) (II) (XIX Corps)

Organized Reserve Washington/Texas

HQ-Not initiated 1928-36; San Antonio, TX, 1936-41

Constituted in the Organized Reserve 5 September 1928, assigned to the XIX Corps, and allotted to the Ninth Corps Area. Seattle, WA, designated 14 February 1929 as headquarters location on organization, but the unit was never organized at that location. Withdrawn from the Ninth Corps Area 1 October 1933, allotted to the Eighth Corps Area, and assigned to the XVIII Corps. Initiated 2 July 1936 with regimental headquarters at San Antonio, TX. Conducted summer training with the 8th Engineer Squadron at Fort McIntosh, TX. Also conducted summer training in 1940 at Nacogdoches, TX. Primary R.O.T.C. feeder schools were the Agricultural and Mechanical College of Texas and the Texas Technological College. Location 7 December 1941—San Antonio, TX.

Commander, 339th Engineer Regiment (II)

Unknown 2 Jul 36-7 Dec 41

340th Engineer Regiment (General Service) (I) (First Army)

Organized Reserve

HQ-Not initiated 1923-27

Constituted in the National Guard in 1921 as the 162nd Engineer Regiment, assigned to the First Army, and allotted to the state of Pennsylvania. Placed on the deferred list 2 July 1923, unit requirement transferred to the Organized Reserve as a Deferred National Guard unit, and redesignated as the 340th Engineer Regiment. Withdrawn from the National Guard 17 September 1927 and demobilized.

340th Engineer Regiment (General Service) (II) (Second Army)

Regular Army Inactive

HQ-Not initiated 1933-37; Detroit, MI, 1937-41

Constituted in the Regular Army 1 October 1933 as the 40th Engineer Regiment (General Service), assigned to the Second Army, and allotted to the Sixth Corps Area. Regiment organized 21 March 1937 with Organized Reserve personnel as a RAI unit with headquarters at Detroit, MI. Redesignated 1 January 1938 as the 340th Engineer Regiment (General Service). Primary R.O.T.C. feeder school was the Michigan College of Mining and Technology. Location 7 December 1941—Detroit, MI.

Commanders, 340th Engineer Regiment

Maj. Neal S. Kinsley

21 Mar 37-ao Jun 39

Unknown

Jun 39-7 Dec 41

341st Engineer Regiment (General Service) (XI Corps)

Organized Reserve Massachusetts

HQ-Boston, MA, 1921-41



Constituted in the Organized Reserve 29 July 1921, assigned to the XI Corps, and allotted to the First Corps Area. Initiated 3 November 1921 with regimental headquarters at Boston, MA. Subordinate battalion headquarters concurrently organized as follows: 1st Battalion at West Roxbury, MA, and 2nd Battalion at Cambridge, MA. Withdrawn from the Organized Reserve 1 October 1933 and allotted to the Regular Army. Concurrently relieved from the XI Corps and assigned to the General Headquarters Reserve. Conducted summer training most years at Camp Devens, MA, and some years with the 1st Engineer Regiment at Fort DuPont, DE. Primary R.O.T.C. feeder schools were Harvard University and the Massachusetts Institute of Technology. Location 7 December 1941—Boston, MA.

Status: Regimental Headquarters and Headquarters & Service Company disbanded 22 August 1942; 1st Battalion inactive in the Regular Army as the 77th Engineer Battalion.

Commanders, 341st Engineer Regiment

Maj. Fred E. Hanson	3 Nov 21-Oct 22	Col. William H. Sage, Jr.	7 Dec 24-Jan 25
Lt. Col. Percival M. Churchill	Oct 22-7 Dec 24	Col. Percival M. Churchill	Jan 25-ao Sep 36
	Unknown	ao Sep 36-7 Dec 41	

342nd Engineer Regiment (General Service) (XII Corps)
HQ-Manhattan, NY, 1921-41

Organized Reserve New York



Constituted in the Organized Reserve 29 July 1921, assigned to the XII Corps, and allotted to the Second Corps Area. Initiated 9 August 1921 with regimental headquarters at Manhattan, NY. Subordinate battalion headquarters concurrently organized as follows: 1st Battalion at Manhattan and 2nd Battalion at Brooklyn, NY. Participated in the annual Army Day Parades in New York City in the 1930s. Typically conducted Inactive Training Period meetings at the Engineer Societies building on 39th Street or at the 7th Regiment armory in Manhattan. Conducted summer training with the 1st Engineer Regiment at Fort DuPont, DE. Also conducted C.M.T.C. training some years at Fort DuPont as an alternate form of annual training. Primary R.O.T.C. feeder school was New York University. Location 7 December 1941—Manhattan, NY.

Status: Regimental Headquarters, and Headquarters & Service Company, 342nd Engineer Regiment are inactive in the U. S. Army Reserve as HHC, 385th Engineer Group; 1st Battalion active in the U.S. Army Reserve as the 969th Engineer Battalion; 2nd Battalion inactive in the U.S. Army Reserve as the 998th Engineer Battalion.

Commanders, 342nd Engineer Regiment

Col. Thacher T. P. Luquer	9 Aug 21-29 May 22	Col. Frederic A. Snyder	11 Dec 34-10 Apr 36
Col. Roger D. Black	29 May 22-Aug 31	Col. Roger D. Black	10 Apr 36-12 Apr 36
Lt. Col. Percy E. Barbour	Aug 31-Feb 32	Maj. Frank Willetts	13 Apr 36-11 Sep 36
Col. Roger D. Black	Feb 32-11 Dec 34	Col. Arthur B. Kratz	11 Sep 36-15 Jun 41
	Col. James A. Greer	17 Sep 41-ao Dec 41	

343rd Engineer Regiment (General Service) (XIII Corps)
HQ-Washington, DC 1921-41

**Organized Reserve
 District of Columbia and Maryland**



Constituted in the Organized Reserve 29 July 1921, assigned to the XIII Corps, and allotted to the Third Corps Area. Initiated in November 1921 with regimental headquarters at Washington, DC. Subordinate battalion headquarters concurrently organized as follows: 1st Battalion at Washington and 2nd Battalion at Baltimore, MD. Band organized in April 1923 at Washington. Relieved from the XIII Corps 13 November 1928 and assigned to the III Corps. The 2nd Battalion relocated by January 1930 to Washington, DC. Relieved from the III Corps 1 October 1933 and assigned to the XIII Corps. Maj. Brehon B. Somerville served as the unit instructor in 1928-29. Typically conducted Inactive Training Period meetings at the Graham Building, 1402 E Street, NW, in Washington. The band typically conducted its Inactive Training Period meetings at the Army Music School at Washington

Barracks. Conducted summer training most years with the 13th Engineer Regiment at Fort A. A. Humphreys, VA, 1924-35, and some years with the 5th Engineer Regiment at Fort Belvoir, VA, 1936-40. For summer training 16-28 August 1925, officers of the regiment conducted a staff ride to Fredericksburg, Chancellorsville, Spotsylvania, and the Wilderness in Virginia. Primary R.O.T.C. feeder schools were the Virginia Military Institute and the Virginia Polytechnic Institute. Location 7 December 1941—Washington, DC.

Status: Regimental Headquarters, and Headquarters & Service Company are inactive in the U.S. Army Reserve as HHC, 408th Engineer Brigade; the 1st Battalion is active in the U.S. Army Reserve as the 379th Engineer Battalion at Fort Missoula, MT.

Commanders, 343rd Engineer Regiment

Lt. Col. Harrison Brand, Jr.	Nov 21-3 Jan 22	Col. John Stewart	3 Jan 22-31 Mar 40
	Col. Harrison Brand, Jr.	31 Mar 40-Jun 41	

344th Engineer Regiment (General Service) (XIV Corps)

Organized Reserve Alabama

HQ-Tuscaloosa, AL, 1921-29; Birmingham, AL, 1929-41

Constituted in the Organized Reserve 29 July 1921, assigned to the XIV Corps, and allotted to the Fourth Corps Area. Initiated 12 December 1921 with regimental headquarters at Tuscaloosa, AL. Relocated 22 October 1929 to Birmingham, AL. Conducted summer training with A Company, 4th Engineers at Fort Bragg, NC, and later at Fort Benning, GA, with A Company, 7th Engineers. Conducted summer training with the 13th Engineer Regiment at Fort A. A. Humphreys, VA, in 1926. Primary R.O.T.C. feeder school was the Alabama Polytechnic Institute. Designated mobilization station was Camp Jackson, SC.

Location 7 December 1941—Birmingham, AL.

Status: Regimental Headquarters, and Headquarters & Service Company, 344th Engineer Regiment are inactive in the U. S. Army Reserve as HHC, 386th Engineer Construction Group; the 1st Battalion is inactive as the 930th Engineer Construction Battalion; the 2nd and 3rd Battalions were disbanded 15 March 1949.

Commanders, 344th Engineer Regiment

Col. Woolsey Finnell	12 Dec 21-8 Nov 30	Col. Frank E. Estes	8 Nov 30-16 Oct 38
	Col. Woolsey Finnell	16 Oct 38-Jul 41	

345th Engineer Regiment (General Service) (XV Corps)

Organized Reserve Ohio

HQ-*Not initiated* 1921-22; Mansfield, OH, 1922-31; Cleveland, OH, 1931-41

Constituted in the Organized Reserve 29 July 1921, assigned to the XV Corps, and allotted to the Fifth Corps Area. Initiated in November 1921 with regimental headquarters at Mansfield, OH. Relieved from the XV Corps 2 July 1923 and assigned to the V Corps. Entire regiment relocated 9 July 1931 to Cleveland, OH. Withdrawn from the Organized Reserve 1 October 1933 and allotted to the Regular Army. Concurrently relieved from the V Corps and assigned to the Second Army. Typically conducted Inactive Training Period meetings at the Cleveland Grays Armory or the Bulkey Building in Cleveland. Conducted summer training most years at Camp Knox, KY, and some years at Fort Benjamin Harrison, IN, or Camp Custer, MI. Primary R.O.T.C. feeder school was the University of Cincinnati. Location 7 December 1941—Cleveland, OH.

Status: Regimental Headquarters, and Headquarters & Service Company are inactive in the Regular Army as HH&SC, 49th Engineer General Service Regiment; the 1st Battalion is inactive in the Regular Army as the 83rd Engineer Battalion.

Commanders, 345th Engineer Regiment

Lt. Col. Joseph T. Kelley	Nov 21-1 Mar 22	Unknown	ao Jun 28-ao Jun 30
Lt. Col. Edward M. Graves	1 Mar 22-21 Apr 28	Col. Theodore S. Pattison	ao Jun 30-ao Jul 37
Maj. Fred P. Troyan	21 Apr 28-ao Jun 28	Unknown	ao Jul 37-7 Dec 41

346th Engineer Regiment (General Service) (XVI Corps)**Organized Reserve Wisconsin****HQ-Not initiated** 1921-23; Madison, WI, 1923-37; Milwaukee, WI, 1937-41

Constituted in the Organized Reserve 29 July 1921, assigned to the XVI Corps, and allotted to the Sixth Corps Area. Initiated in February 1923 with regimental headquarters at Madison, WI. Subordinate battalion headquarters concurrently organized as follows: 1st Battalion at Waukesha, WI, and 2nd Battalion at Lancaster, WI. Relieved from the XVI Corps 2 July 1923 and assigned to the VI Corps. Relieved from the VI Corps 1 October 1933 and assigned to the XVI Corps. Entire regiment relocated 28 July 1937 to Milwaukee, WI. Typically conducted Inactive Training Period meetings at the Engineering Building at the University of Wisconsin in Madison and at the Conway Hotel in Appleton, WI. Conducted summer training most years at Camp Custer, MI, with elements of the 13th Engineers. Conducted summer training with units of the 32nd Division at Camp Williams, WI, in 1931. Location 7 December 1941—Milwaukee, WI.

Status: Regimental Headquarters, and Headquarters & Service Company are inactive in the U.S. Army Reserve as HHC, 413th Engineer Brigade.

Commanders, 346th Engineer Regiment

Vacant	Feb 23-11 Mar 23	Col. Joseph J. Ring	29 Nov 29-3 Oct 30
Lt. Col. William E. Haseltine	11 Mar 23-29 Mar 27	Col. Arthur P. Christophel	3 Oct 30-ao Jun 36
Col. Arthur P. Christophel	29 Mar 27-29 Nov 29	Col. Joseph J. Ring	ao Jun 37-ao Nov 39
	Unknown	ao Nov 39-7 Dec 41	

347th Engineer Regiment (General Service) (XVII Corps)**Organized Reserve Missouri/Iowa****HQ-Not initiated** 1921-22; Kansas City, MO, 1922-31; Des Moines, IA, 1931-41

Constituted in the Organized Reserve 29 July 1921, assigned to the XVII Corps, and allotted to the Seventh Corps Area. Initiated in November 1921 with regimental headquarters at Kansas City, MO. Subordinate battalion headquarters concurrently organized as follows: 1st Battalion at Sedalia, MO, and 2nd Battalion at Springfield, MO. Entire regiment relocated 12 October 1931 to Des Moines, IA. Relieved from the XVII Corps 1 October 1933 and assigned to the General Headquarters Reserve. Typically conducted Inactive Training Period meetings at the 110th Engineers armory or the Organized Reserve Center building in Kansas City. Conducted summer training at various locations to include Fort Riley, KS, Fort Snelling, MN, Fort Logan CO, and Fort Des Moines, IA. Location 7 December 1941—Des Moines, IA, (Inactivated 22 January 1942).

Status: Regimental Headquarters, and Headquarters & Service Company are active in the Regular Army in Germany as HHC, 18th Engineer Brigade.

Commanders, 347th Engineer Regiment

Lt. Col. Dickens S. Adams	Nov 21-ao Sep 25	Col. James A. Grant	16 May 37-ao Jun 37
Unknown	ao Sep 25-16 May 37	Unknown	ao Jan 37-ao Jun 39
	Col. Alfred C. Whitney	ao Jun 39-22 Jan 42	

348th Engineer Regiment (General Service) (XVIII Corps)**Organized Reserve Colorado****HQ-Not initiated** 1921-22; Boulder, CO, 1922-24; Denver, CO, 1924-27; *Inactive* 1927-29; Birmingham, AL, 1929-41

Constituted in the Organized Reserve 29 July 1921, assigned to the XVIII Corps, and allotted to the Eighth Corps Area. Initiated 12 September 1922 with regimental headquarters at Boulder, CO. Subordinate battalion headquarters concurrently organized as follows: 1st Battalion at Telluride, CO, and 2nd Battalion at Leadville, CO. Entire regiment relocated 26 July 1924 to Denver, CO. Withdrawn from the Eighth Corps Area 11 January 1927 and allotted to the Fourth Corps Area as a “Colored” unit. Inactivated 2 March 1927 at Denver by relief of personnel. Redesignated as a “White” unit 5 September 1928. Reorganized 1 October 1929 at Birmingham, AL. Withdrawn from the Organized Reserve 1 January 1938 and allotted to the Regular Army. Typically conducted Inactive Training Period meetings at the State Office Building in Denver 1922-27. Conducted summer training with the 8th Engineer Squadron at Fort Bliss, TX, 1922-26 and with Company A, 4th Engineer Regiment at Fort Benning, GA, 1930-40. Primary R.O.T.C.

feeder schools were the Colorado State School of Mines and the Alabama Polytechnic Institute. Location 7 December 1941—Birmingham, AL.

Status: 1st Battalion is active in the Regular Army at Baumholder, Germany, as the 40th Engineer Battalion; the 2nd Battalion is inactive in the U. S. Army Reserve as the 553rd Engineer Battalion.

Commanders, 348th Engineer Regiment

Col. Charles H. Rankin <i>Inactive</i>	12 Sep 22-2 Mar 27 2 Mar 27-30 Sep 29	Lt. Col. Dalton B. Shourds Maj. De Loss H. Barber	30 May 33-ao Jun 33 ao May 34-ao Jan 35
Col. William O. Gloster	1 Oct 29-11 Apr 33 Unknown	Col. Tenney C. DeSollar ao Feb 37-7 Dec 41	ao Jul 35-ao Feb 37

349th Engineer Regiment (General Service) (XIX Corps)

Organized Reserve California

HQ-Los Angeles, CA, 1921-41

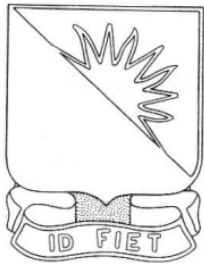

Constituted in the Organized Reserve 29 July 1921, assigned to the XIX Corps, and allotted to the Ninth Corps Area. Initiated 22 December 1921 with regimental headquarters at Los Angeles, CA. Relieved from the XIX Corps 2 July 1923 and assigned to the IX Corps. Relieved from the IX Corps 1 October 1933 and assigned to the XIX Corps. Conducted summer training at most years at Del Monte, CA, and some years at the Presidio of Monterey. Primary R.O.T.C. feeder schools were the University of California, Los Angeles and the California Institute of Technology. Location 7 December 1941—Los Angeles, CA, (Inactivated 21 January 1942).

Status: Regimental Headquarters, and Headquarters & Service Company are inactive in the U.S. Army Reserve as HHC, 414th Engineer Brigade.

Commanders, 349th Engineer Regiment

Col. Harrison C. Mower Unknown	22 Dec 21-ao Jun 29 ao Jun 29-ao Jul 33	Col. Leroy Foster Unknown	ao Jul 33-ao Aug 39 ao Aug 39-7 Dec 41
-----------------------------------	--	------------------------------	---

350th Engineer Regiment (General Service) (First Army)

Organized Reserve

HQ-Not initiated 1923-27

Constituted in the National Guard in 1921 as the 163rd Engineer Regiment. Assigned to the First Army and allotted to the state of Pennsylvania. Placed on the deferred list 2 July 1923, unit requirement transferred to the Organized Reserve as a Deferred National Guard unit, and redesignated as the 350th Engineer Regiment. Withdrawn from the National Guard 17 September 1927 and demobilized.

351st Engineer Regiment (General Service) (Fourth Army)

Organized Reserve New Jersey

HQ-Elizabeth, NJ, 1921-29; *Inactive* 1929-33

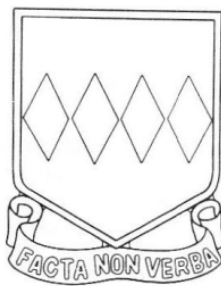

Constituted in the Organized Reserve 15 October 1921, assigned to the Fourth Army, and allotted to the Second Corps Area. Initiated 2 November 1921 with regimental headquarters at Elizabeth, NJ. Subordinate battalion headquarters concurrently organized as follows: 1st Battalion at Irvington, NJ, and 2nd Battalion at Princeton, NJ. Organized the first regimental band in the Organized Reserve at Elizabeth in 1922. Band ordered to active duty with the regiment at Camp Dix, NJ, in 1923. Conducted summer training with the 1st Engineer Regiment at Fort DuPont, DE. Also conducted C.M.T.C. training some years at Fort DuPont as an alternate form of annual training. Inactivated 18 November 1929 at Elizabeth. Primary R.O.T.C. feeder school was Princeton University. Demobilized 1 October 1933.

Commanders, 351st Engineer Regiment

Col. Henry Keep

2 Nov 21-18 Nov 29

Inactive

18 Nov 29-1 Oct 33

352nd Engineer Regiment (General Service) (Fourth Army)

Organized Reserve New York

HQ-Troy, NY, 1921-41

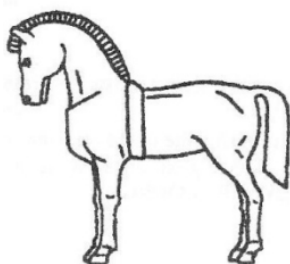

Constituted in the Organized Reserve 15 October 1921, assigned to the Fourth Army, and allotted to the Second Corps Area. Initiated 3 December 1921 with regimental headquarters at Troy, NY. Subordinate battalion headquarters concurrently organized as follows: 1st Battalion at New Hartford, NY, and 2nd Battalion at Seneca Falls, NY. Relieved from the Fourth Army 1 October 1933 and assigned to the General Headquarters Reserve. Withdrawn from the Organized Reserve 1 January 1938 and allotted to the Regular Army. Typically conducted Inactive Training Period meetings at 5 Stark Avenue, 243 State Street, or the State Armory in Schenectady. Conducted summer training with the 1st Engineer Regiment at Fort DuPont, DE. Primary R.O.T.C. feeder school was Clarkson College of Technology. Location 7 December 1941—Troy, NY.

Status: Inactive in the Regular Army as the 75th Engineer Battalion.

Commanders, 352nd Engineer Regiment

Maj. Theodore H. Skinner
Col. Frederic A. Molitor
Lt. Col. Roy W. Gausmann

3 Dec 21-10 Dec 21
10 Dec 21-ao Jun 24
ao Aug 24-14 May 28
Maj. Harry J. Lemp

Col. Thatcher T. P. Luquer
Col. Herbert S. Wilgus
Lt. Col. Thomas F. Farrell
3 Apr 41-ao Jun 41

12 Jun 28-17 Sep 30
17 Sep 30-7 Jul 37
19 Jul 37-1 Apr 41

353rd Engineer Regiment (General Service) (Fourth Army)

Organized Reserve Pennsylvania

HQ-Johnstown, PA, 1921-29; *Inactive* 1929-33

Constituted in the Organized Reserve 15 October 1921, assigned to the Fourth Army, and allotted to the Third Corps Area. Initiated 28 November 1921 with regimental headquarters at Johnstown, PA. Subordinate battalion headquarters concurrently organized as follows: 1st Battalion at Greensburg, PA, and 2nd Battalion at Altoona, PA. Inactivated 14 August 1929 at Johnstown by relief of personnel. Conducted summer training at Fort A. A. Humphreys, VA. Primary R.O.T.C. feeder school was the Carnegie Institute of Technology. Demobilized 1 October 1933.

Commanders, 353rd Engineer Regiment

Lt. Col. Elmer W. Clark
Col. Peter M. Anderson

28 Nov 21-1 Mar 24
1 Mar 24-15 Jan 29

Lt. Col. Elmer W. Clark
Inactive

15 Jan 29-14 Aug 29
14 Aug 29-1 Oct 33

354th Engineer Regiment (General Service) (Fifth Army)

Organized Reserve Pennsylvania

HQ-Pittsburgh, PA, 1921-22; Butler, PA, 1922-29; *Inactive* 1929-33

Constituted in the Organized Reserve 15 October 1921, assigned to the Fifth Army, and allotted to the Third Corps Area. Initiated 28 November 1921 with regimental headquarters at Pittsburgh, PA. Subordinate battalions concurrently relocated as follows: 1st Battalion to New Castle, PA, and 2nd Battalion to DuBois, PA. Headquarters relocated by September 1922 to Butler, PA. Inactivated 14 August 1929 at Butler by relief of personnel. Conducted summer training at Camp George G. Meade, MD. Primary R.O.T.C. feeder school was the Carnegie Institute of Technology. Demobilized 1 October 1933.

Commanders, 354th Engineer Regiment

Capt. Charles N. Bell
Lt. Col. Herbert S. Wilgus

2 Dec 21-22 Dec 21
22 Dec 21-24 Nov 24

Col. George E. A. Fairley
Inactive

ao Oct 25-14 Aug 29
14 Aug 29-1 Oct 33

355th Engineer Regiment (General Service) (Fifth Army)**Organized Reserve North Carolina/Tennessee****HQ-Not initiated** 1921-22; Chapel Hill, NC, 1922-30; Greensboro, NC, 1930-34; Nashville, TN, 1934-41

Constituted in the Organized Reserve 15 October 1921, assigned to the Fifth Army, and allotted to the Fourth Corps Area. Initiated 18 January 1922 with regimental headquarters at Chapel Hill, NC. Subordinate battalion headquarters concurrently organized as follows: 1st Battalion at Wilmington, NC, and 2nd Battalion at Asheville, NC. Regimental headquarters relocated 8 February 1930 to Greensboro, NC. Entire regiment relocated 26 December 1934 to Nashville, TN. Conducted summer training some years with A Company, 4th Engineers at Fort Bragg, NC, and most years at Fort Benning, GA. Primary R.O.T.C. feeder school was the University of Tennessee. Designated mobilization training station was Fort Bragg, NC. Location 7 December 1941—Nashville, TN.

Status: Regimental Headquarters, and Headquarters & Service Company, 355th Engineer Regiment are active in the U. S. Army Reserve at New Windsor, NY, as HHC, 411th Engineer Brigade; the 1st Battalion is inactive as the 928th Engineer Battalion; the 2nd Battalion is inactive as the 929th Engineer Battalion; the 3rd Battalion was disbanded 9 July 1953.

Commanders, 355th Engineer Regiment

Col. Joseph H. Pratt	18 Jan 22-ao Sep 25	Lt. Col. Walter L. Simpson	15 Jan 31-16 Nov 35
Lt. Col. Frederick W. Albert	ao Apr 26-26 Oct 26	Unknown	16 Nov 35-ao Jul 37
Col. James B. Cress	26 Oct 26-28 Nov 29	Lt. Col. Thomas C. McEwen	ao Jul 37-ao May 40
Lt. Col. Raymond E. Benedict	21 Dec 29-15 Jan 31	Unknown	ao May 40-7 Dec 41

356th Engineer Regiment (General Service) (Fifth Army)**Organized Reserve Ohio****HQ-Not initiated** 1921-22; Akron, OH, 1922-30; *Inactive* 1930-33

Constituted in the Organized Reserve 15 October 1921, assigned to the Fifth Army, and allotted to the Fifth Corps Area. Initiated in November 1921 with regimental headquarters at Akron, OH. Inactivated by March 1930 at Akron by relief of personnel. Steubenville, OH, designated 9 July 1931 as headquarters on reorganization, but the unit was never organized at that location. Conducted summer training most years at Camp Knox, KY, and some years at Fort Benjamin Harrison, IN. Primary R.O.T.C. feeder school was the University of Cincinnati. Demobilized 1 October 1933.

Commanders, 356th Engineer Regiment

Maj. Charles G. Carothers	Nov 21-5 Apr 23	Lt. Col. Joseph T. Kelly	5 Apr 23-Mar 30
	<i>Inactive</i>	Mar 30-1 Oct 33	

357th Engineer Regiment (General Service) (Sixth Army)**Organized Reserve Michigan****HQ-Not initiated** 1921-22; Escanaba, MI, 1922-24; Ann Arbor, MI, 1924-25; Jackson, MI, 1925-28; *Inactive* 1928-34; Jackson, MI, 1934-37; Detroit, MI, 1937-41

Constituted in the Organized Reserve 15 October 1921, assigned to the Sixth Army, and allotted to the Sixth Corps Area. Initiated 14 January 1922 with regimental headquarters at Escanaba, MI. Subordinate battalion headquarters concurrently organized as follows: 1st Battalion was at Houghton, MI, and 2nd Battalion at Escanaba. Headquarters successively relocated to Ann Arbor, MI, in 1924 and to Jackson, MI, 2 June 1925. Inactivated 4 December 1928 at Jackson by relief of personnel. Relieved from the Sixth Army 1 October 1933 and assigned to the General Headquarters Reserve. Reorganized by June 1934 with the entire regiment at Jackson, MI. Entire regiment relocated 28 July 1937 to Detroit, MI. Conducted summer training with elements of the 13th Engineer Regiment at Camp Custer, MI. Primary R.O.T.C. feeder school was the Michigan College of Mining and Technology. Location 7 December 1941—Detroit, MI.

Status: Disbanded 22 August 1942.

Commanders, 357th Engineer Regiment

Maj. Charles E. Good	14 Jan 22-ao Dec 23	Lt. Col. Thomas L. Donnelly	ao Jun 34-ao Jun 35
Unknown	ao Dec 23-31 Mar 24	Unknown	ao Jun 35-ao Mar 37
Maj. Ralph A. Loveland	31 Mar 25-11 Mar 26	Lt. Col. Ralph A. Loveland	ao Mar 37-26 Apr 37
Col. Henry A. Allen	11 Mar 26-4 Dec 28	Unknown	26 Apr 37-ao May 39
<i>Inactive</i>	4 Dec 28-Jun 34	Lt. Col. Thomas L. Donnelly	ao May 39-ao Aug 39
	Unknown	ao Aug 39-7 Dec 41	

358th Engineer Regiment (General Service) (Sixth Army)

Organized Reserve Illinois

HQ-Not initiated 1921-22; Chicago, IL, 1922-24; East St. Louis, IL, 1924-37; Belleville, IL, 1937-41

Constituted in the Organized Reserve 15 October 1921, assigned to the Sixth Army, and allotted to the Sixth Corps Area. Initiated 16 January 1922 with regimental headquarters at Chicago, IL. Headquarters relocated in 1924 to East St. Louis, IL. Entire regiment relocated in 28 July 1937 to Belleville, IL. Conducted summer training most years at Camp Custer, MI. Conducted summer training with the 108th Engineer Regiment at Camp Grant, IL, in 1932. Also conducted C.M.T.C. training some years at Camp Custer as an alternate form of annual training. Primary R.O.T.C. feeder school was the University of Illinois. Location 7 December 1941—Belleville, IL.

Commanders, 358th Engineer Regiment

Col. Edward J. Blair	16 Jan 22-18 Mar 24	Lt. Col. Horace T. Warren	Apr 36-17 May 37
Col. Orie T. Dunlap	15 Apr 24-4 Dec 28	Maj. Sylvester F. Wilson	17 May 37-31 Oct 38
Col. Samuel C. Jump	4 Dec 28-Apr 36	Capt. George B. Wilson	31 Oct 38-ao Jan 40
	Unknown	ao Jan 40-7 Dec 41	

359th Engineer Regiment (General Service) (Sixth Army)

Organized Reserve Kansas/Missouri

HQ-Not initiated 1921-22; Topeka, KS, 1922-31; St. Louis, MO, 1931-41



Constituted in the Organized Reserve 15 October 1921, assigned to the Sixth Army, and allotted to the Seventh Corps Area. Initiated in November 1921 with regimental headquarters at Topeka, KS. Subordinate battalion headquarters concurrently organized as follows: 1st Battalion at Topeka and 2nd Battalion at Fort Scott, KS. Entire regiment relocated 12 October 1931 to St. Louis, MO. Relieved from the Sixth Army 1 October 1933 and assigned to the General Headquarters Reserve. Conducted summer training at various locations to include Fort Sam Houston, TX, Fort Riley, KS, and Fort Des Moines, IA. Conducted summer training with the 110th Engineer Regiment at Camp Clark, MO, in 1930, 1932, and 1936. Primary R.O.T.C. feeder schools were the University of Kansas and the Missouri School of Mines. Location 7 December 1941—St. Louis, MO, (Inactivated 6 January 1942).

Status: Regimental Headquarters, and Headquarters & Service Company are inactive in the U.S. Army Reserve as HHC, 347th Engineer Group (Construction).

Commanders, 359th Engineer Regiment

Lt. Col. R. E. Cameron	Nov 21-ao Jan 23	Col. James W. Skelly	ao Aug 30-ao Aug 36
Col. A. D. Akin	ao Oct 23-ao Jun 27	Unknown	ao Aug 36-ao Jul 38
Unknown	ao Jun 27-ao Aug 30	Col. J. R. Crocker	ao Jul 38-ao Sep 38
	Unknown	ao Sep 38-7 Dec 41	

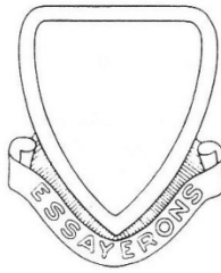
360th Engineer Regiment (General Service) (GHQR)**Organized Reserve New York****HQ**-Brooklyn, NY, 1921-41

Constituted in the Organized Reserve 15 October 1921, assigned to the General Headquarters Reserve and allotted to the Second Corps Area. Initiated 2 November 1921 with regimental headquarters at Brooklyn, NY. Subordinate battalion headquarters concurrently organized as follows: 1st Battalion at Brooklyn and 2nd Battalion at Syracuse, NY. Typically conducted Inactive Training Period meetings at the Engineer Societies building on 39th Street in New York City. Conducted summer training with the 1st Engineer Regiment at Fort DuPont, DE. Primary R.O.T.C. feeder school was New York University. Location 7 December 1941—Brooklyn, NY.

Status: Regimental Headquarters, and Headquarters & Service Company are inactive in the U.S. Army Reserve as HHC, 927th Engineer Group (Construction); the 2nd Battalion is inactive in the U. S. Army Reserve as the 290th Engineer Battalion.

Events: 298**Commanders, 360th Engineer Regiment**

Lt. Col. William O. Hickok	2 Nov 21-24 Sep 24	Col. Charles H. Nichols	25 Feb 31-20 Jul 34
Col. Francis W. Perry	24 Sep 24-25 Feb 31	Col. William C. Lancaster	20 Jul 34-ao Aug 40
	Unknown	ao Aug 40-7 Dec 41	

361st Engineer Regiment (General Service) (GHQR)**Organized Reserve Florida/South Carolina****HQ**-Jacksonville, FL, 1921-29; Columbia, SC, 1929-41

Constituted in the Organized Reserve 15 October 1921, assigned to the General Headquarters Reserve, and allotted to the Fourth Corps Area. Initiated 12 December 1921 with regimental headquarters at Jacksonville, FL. Entire regiment relocated 22 October 1929 to Columbia, SC. Conducted summer training with A Company, 7th Engineers at Fort Benning, GA. Designated mobilization training station was Camp Joseph E. Johnston, FL, (later redesignated Camp J. Clifford R. Foster) 1922-30, and later, Camp Wheeler, GA. Location 7 December 1941—Columbia, SC, (Inactivated 16 March 1942).

Status: Regimental Headquarters, and Headquarters & Service Company, 361st Engineer Regiment were inactive in the U.S. Army Reserve as HHC, 376th Engineer Group (Construction); 1st Battalion is inactive in the U. S. Army Reserve as the 981st Engineer Battalion (Construction); the 2nd Battalion is inactive as the 982nd Engineer Battalion.

Commanders, 361st Engineer Regiment

Maj. Herbert D. Mendenhall	12 Dec 21-5 May 22	Col. James A. Grant	ao Jun 30-2 Aug 32
Lt. Col. George H. Bunker	6 May 22-30 Aug 22	Lt. Col. George E. Brown	9 Aug 32-6 Dec 34
Col. John M. Johnson	31 Aug 22-ao Sep 26	Lt. Col. Orman N. Powell	6 Dec 34-ao Sep 39
Unknown	ao Sep 26-ao Jun 30	Unknown	ao Sep 39-7 Dec 41

362nd Engineer Regiment (General Service) (GHQR) Organized Reserve Minnesota and Arkansas/Missouri**HQ**-Moorhead, MN, 1921-26; Fergus Falls, MN, 1926-31; Kansas City, MO, 1931-41

Constituted in the Organized Reserve 15 October 1921, assigned to the General Headquarters Reserve, and allotted to the Seventh Corps Area. Initiated in November 1921 with regimental headquarters at Moorhead, MN. Subordinate battalion headquarters concurrently organized as follows: 1st Battalion at Moorhead and 2nd Battalion at Little Rock, AR. Entire regiment relocated 26 May 1926 to Fergus Falls, MN. Entire regiment relocated 12 October 1931 to Kansas City, MO. Typically conducted Inactive Training Period meetings at the 110th Engineers armory or the Organized Reserve Center building in Kansas City. Conducted summer training most years at Fort Riley, KS, and some years at Fort Des Moines, IA. Conducted summer training in 1935 with the 110th Engineer Regiment at Camp Clark, MO. Location 7 December 1941—Kansas City, MO, (Inactivated 7 January 1942).

Commanders, 362nd Engineer Regiment

Maj. Frank R. Allen	Nov 21-15 Apr 24	Unknown	ao May 26-ao Jul 32
Lt. Col. C. W. Good	15 Apr 24-ao May 26	Col. Dickens S. Adams	ao Jul 32-ao Jul 40
	Unknown	ao Jul 40-7 Dec 41	

363rd Engineer Regiment (General Service) (Second Army)
HQ-Manhattan, NY, 1921-41

Organized Reserve New York



Constituted in the Organized Reserve 15 October 1921, assigned to the Second Army, and allotted to the Second Corps Area. Initiated 15 October 1921 with regimental headquarters at Manhattan, NY. Subordinate battalion headquarters concurrently organized as follows: 1st Battalion at Manhattan and 2nd Battalion at Bronx, NY. Relieved from the Second Army 1 October 1933 and assigned to the General Headquarters Reserve. Authorized by the War Department 21 July 1934 to share jointly with the 11th Engineer Regiment (Combat) the WWI battle honors of the 11th Engineers (Railway). Typically conducted Inactive Training Period meetings at the Engineer Societies building on 39th Street in New York City. Conducted summer training with the 1st Engineer Regiment at Fort DuPont, DE. Primary R.O.T.C. feeder school was New York University. Location 7 December 1941—Manhattan, NY.

Commanders, 363rd Engineer Regiment

Col. William B. Parsons	15 Sep 21-7 Mar 22	Col. Percy E. Barbour	6 Oct 33-31 Jul 39
Col. Willard T. Chevalier	7 Mar 22-5 Oct 33	Lt. Col. John B. Snider	31 Jul 39-23 Apr 41
	Lt. Col. Matthew F. Quinn	23 Apr 41-ao May 41	

364th Engineer Regiment (General Service) (C) (Second Army)
HQ-Not initiated 1921-22; Columbus, OH, 1922-30; Inactive 1930-33

Organized Reserve Ohio/Kentucky

Constituted in the Organized Reserve 15 October 1921, assigned to the Second Army, and allotted to the Fifth Corps Area. Organized in July 1922 with regimental headquarters at Columbus, OH. Inactivated by March 1930 at Columbus by relief of personnel. Louisville, KY, designated 9 July 1931 as headquarters on reorganization, but the unit was never organized at that location. Conducted summer training at Camp Knox, KY, or Fort Benjamin Harrison, IN. Primary R.O.T.C. feeder school was the University of Cincinnati. Demobilized 1 October 1933.

Commanders, 364th Engineer Regiment

Maj. James L. Taylor	Jul 22-ao Oct 23	Unknown	ao Oct 23- Mar 30
	<i>Inactive</i>	Mar 30-1 Oct 33	

365th Engineer Regiment (General Service) (Third Army)
HQ-Des Moines, IA, 1921-26; Sioux City, IA, 1926-29; Inactive 1929-33

Organized Reserve Iowa/Kansas

Constituted in the Organized Reserve 15 October 1921, assigned to the Third Army, and allotted to the Seventh Corps Area. Initiated 20 October 1921 with regimental headquarters at Des Moines, IA. Subordinate battalion headquarters concurrently organized as follows: 1st Battalion at Des Moines and 2nd Battalion at Cedar Rapids, IA. Headquarters relocated 26 May 1926 to Sioux City, IA. Subordinate battalions concurrently relocated as follows: 1st Battalion to Sheldon, IA, and 2nd Battalion to Fort Dodge, IA. Inactivated 18 October 1929 at Sioux City by relief of personnel. Lawrence, KS, designated 12 October 1931 as headquarters on reorganization, but the unit was never organized at that location. Conducted summer training at Fort Des Moines, IA, and with Troop A, 9th Engineer Squadron at Fort Riley, KS. Primary R.O.T.C. feeder schools were the Iowa State College of Agriculture and Mechanic Arts and the University of Kansas. Demobilized 1 October 1933.

Commanders, 365th Engineer Regiment

Col. George C. Parsons	20 Oct 21-18 Oct 29	<i>Inactive</i>	18 Oct 29-1 Oct 33
------------------------	---------------------	-----------------	--------------------

366th Engineer Regiment (General Service) (C) (GHQR)**Organized Reserve Kentucky/Ohio****HQ-Not initiated** 1921-25; Richmond, KY, 1925-29; *Inactive* 1929-33

Constituted in the Organized Reserve 15 October 1921, assigned to the General Headquarters Reserve, and allotted to the Fifth Corps Area. Initiated in August 1925 with regimental headquarters at Richmond, KY. Inactivated by December 1929 at Richmond by relief of personnel. Toledo, OH, designated 9 July 1931 as headquarters on reorganization, but the unit was never organized at that location. Conducted summer training at Camp Knox, KY, and Fort Benjamin Harrison, IN. Primary R.O.T.C. feeder school was the University of Cincinnati. Demobilized 1 October 1933.

Commanders, 366th Engineer Regiment

Unknown	Aug 25-Dec 29	<i>Inactive</i>	Dec 29-1 Oct 33
---------	---------------	-----------------	-----------------

367th Engineer Regiment (General Service) (C) (GHQR)**Organized Reserve Missouri and Arkansas****HQ-Kansas City, MO, 1921-26; St. Louis, MO, 1926-31; Little Rock, AR, 1931-33**

Constituted in the Organized Reserve 15 October 1921, assigned to the General Headquarters Reserve, and allotted to the Seventh Corps Area. Initiated 20 December 1921 with regimental headquarters at Kansas City, MO. Subordinate battalion headquarters concurrently organized as follows: 1st Battalion at Springfield, MO, and 2nd Battalion at Fort Smith, AR. Entire regiment, less three line companies, relocated 26 May 1926 to St. Louis, MO. Entire regiment relocated 12 October 1931 to Little Rock, AR. Conducted summer training with Troop A, 9th Engineer Squadron at Fort Riley, KS. Demobilized 1 October 1933.

Commanders, 367th Engineer Regiment

Lt. Col. J. Stewart Elwell	20 Dec 21-ao Feb 22	Col. John A. Laird	ao Jun 25-22 Jul 25
Unknown	ao Feb 22-ao Jun 25	Col. J. Stewart Elwell	22 Jul 25-ao Jun 27
	Unknown	ao Jun 27-1 Oct 33	

368th Engineer Regiment (General Service) (C) (GHQR)**Organized Reserve New York****HQ-Not initiated** 1921-22; Manhattan, NY, 1922-41

Constituted in the Organized Reserve 15 October 1921, assigned to the General Headquarters Reserve, and allotted to the Second Corps Area. Initiated 14 June 1922 with regimental headquarters at Manhattan, NY. Subordinate battalion headquarters concurrently organized as follows: 1st Battalion at Manhattan and 2nd Battalion at Brooklyn, NY. Redesignated as a "White" unit 9 March 1937. Typically conducted Inactive Training Period meetings at the Engineer Societies building on 39th Street or at the 102nd Engineer armory in Manhattan. Conducted summer training with the 1st Engineer Regiment at Fort DuPont, DE. Primary R.O.T.C. feeder school was New York University. Location 7 December 1941—Manhattan, NY.

Status: Regimental Headquarters, and Headquarters & Service Company are inactive in the U.S. Army Reserve as HHC, 414th Engineer Brigade.

Commanders, 368th Engineer Regiment

Col. Carleton W. Sturtevant	14 Jun 22-May 25	Col. Harrison D. Emerson	May 25-27 May 31
	Col. Achille O. Van Suetendael	27 May 31-Aug 41	

369th Engineer Regiment (General Service) (Third Army)**Organized Reserve Iowa****HQ-Not initiated** 1923-27

Constituted in the National Guard 15 October 1921 as the 165th Engineer Regiment. Assigned to the Third Army and allotted to the state of Minnesota. Placed on the deferred list 2 July 1923, unit requirement transferred to the Organized Reserve as a Deferred National Guard unit, and redesignated as the 369th Engineer Regiment. Fort Madison, IA,

designated 29 August 1924 as headquarters location on organization, but the unit was never organized at that location. Designated headquarters location changed 26 May 1926 to Cedar Rapids, IA. Withdrawn from the National Guard 17 September 1927 and demobilized.

370th Engineer Regiment (General Service) (Third Army)

Organized Reserve Missouri

HQ-Not initiated 1923-27

Constituted in the National Guard 15 October 1921 as the 166th Engineer Regiment. Assigned to the Third Army and allotted to the state of Nebraska. Placed on the deferred list 2 July 1923, unit requirement transferred to the Organized Reserve as a Deferred National Guard unit, and redesignated as the 370th Engineer Regiment. Booneville, MO, designated 29 August 1924 as headquarters location on organization, but the unit was never organized at that location. Designated headquarters location changed 26 May 1926 to Jefferson City, MO. Withdrawn from the National Guard 17 September 1927 and demobilized.

371st Engineer Regiment (General Service) (CZ)

Organized Reserve Massachusetts

HQ-Not initiated 1923-24; Boston, MA, 1924-41

Constituted in the Organized Reserve 2 July 1923, assigned to the Communications Zone, and allotted to the First Corps Area. Initiated 15 December 1924 with regimental headquarters at Boston, MA. Subordinate battalion headquarters concurrently organized as follows: 1st Battalion at Lynn, MA, and 2nd Battalion at Lawrence, MA. Withdrawn from the Organized Reserve 1 October 1933, allotted to the Regular Army, and assigned to the I Corps. Conducted summer training most years at Camp Devens, MA, and some years with the 1st Engineer Regiment at Fort DuPont, DE. Primary R.O.T.C. feeder schools were Harvard University and the Massachusetts Institute of Technology. Location 7 December 1941—Boston, MA.

Commanders, 371st Engineer Regiment

Lt. Col. Alexander McComber	15 Dec 24-May 28 Unknown	Col. Lewis E. Moore ao Jul 39-7 Dec 41	May 28-ao Jul 39
-----------------------------	-----------------------------	---	------------------

372nd Engineer Regiment (General Service) (CZ)

**Organized Reserve Massachusetts/
South Carolina/New York**

HQ-Not initiated 1923-24; Boston, MA, 1924-27; Inactive 1927-29; Florence, SC, 1929-36; Inactive 1936-37; New York City, NY, 1937-41



Constituted in the Organized Reserve 2 July 1923, assigned to the Communications Zone, and allotted to the First Corps Area. Initiated in November 1924 with regimental headquarters at Boston, MA. Withdrawn from the First Corps Area 11 January 1927 and allotted to the Fourth Corps Area as a “Colored” unit. Inactivated 5 February 1927 at Boston by relief of personnel. Redesignated as a “White” unit 5 September 1928. Reorganized by October 1929 with headquarters at Florence, SC. Withdrawn from the Fourth Corps Area 5 June 1936 and allotted to the Second Corps Area. Concurrently relieved from the Communications Zone and assigned to the General Headquarters Reserve. Reorganized 2 June 1937 with headquarters at New York City, NY. Typically conducted Inactive Training Period meetings at the Engineer Societies building on 39th Street in New York City. The officers of the regiment conducted inactive training with the 360th Engineer Regiment during September 1937-May 1938 due to the business absence of Lt. Col. Adams, the regimental commander and only field officer assigned during that period. Conducted summer training at Camp Devens, MA, 1925-26. Primary R.O.T.C. feeder school was New York University 1937-41. Location 7 December 1941—New York City, NY.

Status: Regimental Headquarters, and Headquarters & Service Company, 372nd Engineer Regiment are active in the U. S. Army Reserve at Vicksburg, MS, as HHC, 412th Engineer Command; the subordinate battalions were disbanded 9 July 1953.

Events: 298

1754

Commanders, 372nd Engineer Regiment

Col. George W. Bunnell, Jr. <i>Inactive</i>	Nov 24-5 Feb 27	<i>Inactive</i>	30 Aug 36-2 Jun 37
Unknown	5 Feb 27-Oct 29	Col. Harry P. Wilson	29 Jun 37-21 Dec 37
Lt. Col. William G. Lockwood	Oct 29-6 Dec 34	Lt. Col. Donald B. Adams	21 Dec 37-1 Sep 38
Lt. Col. Percival S. Moses	6 Dec 34-15 May 35	Lt. Col. Arthur L. L. Martin	1 Sep 38-31 Aug 39
	11 Jan 36-30 Aug 36	Lt. Col. Norman D. Richardson	31 Aug 39-13 Jun 41

373rd Engineer Regiment (General Service) (CZ)

Organized Reserve New Jersey

HQ-*Not initiated* 1923-24; Jersey City, NJ, 1924-41



Constituted in the Organized Reserve 2 July 1923, assigned to the Communications Zone, and allotted to the Second Corps Area. Initiated 3 April 1924 with regimental headquarters at Jersey City, NJ. Participated in the annual Army Day Parades in New York City in the 1930s. Typically conducted Inactive Training Period meetings at the 113th Infantry Armory in Jersey City or at the Raymond-Commerce Building in Newark, NJ. Conducted summer training with the 1st Engineer Regiment at Fort DuPont, DE. Primary R.O.T.C. feeder school was Princeton University. Location 7 December 1941—Jersey City, NJ.

Status: The 1st Battalion is inactive in the U. S. Army Reserve as the 973rd Engineer Battalion; 2nd Battalion inactive as the 974th Engineer Battalion.

Commanders, 373rd Engineer Regiment

Col. Philander Betts	3 Apr 24-3 Jun 32	Lt. Col. Freeland P. Townsley	3 Jun 32-19 Feb 41
----------------------	-------------------	-------------------------------	--------------------

374th Engineer Regiment (General Service) (CZ)

Organized Reserve New York

HQ-*Not initiated* 1923-24; Syracuse, NY, 1924-29; *Inactive* 1929-33

Constituted in the Organized Reserve 2 July 1923, assigned to the Communications Zone, and allotted to the Second Corps Area. Initiated 10 April 1924 with regimental headquarters at Syracuse, NY. Conducted summer training with the 1st Engineer Regiment at Fort DuPont, DE. Primary R.O.T.C. feeder school was Clarkson College of Technology. Inactivated 15 November 1929 at Syracuse by relief of personnel. Demobilized 1 October 1933.

Commanders, 374th Engineer Regiment

Lt. Col. William McC. Acheson	10 Apr 24-18 Aug 26	Lt. Col. William McC. Acheson	22 Jan 29-15 Nov 29
Col. George J. Richers	18 Aug 26-22 Jan 29	<i>Inactive</i>	15 Nov 29-1 Oct 33

375th Engineer Regiment (General Service) (C) (CZ)

Organized Reserve Maryland

HQ-*Not initiated* 1923-25; Baltimore, MD, 1925-41



Constituted in the Organized Reserve 2 July 1923, assigned to the Communications Zone, and allotted to the Third Corps Area. Initiated 14 April 1925 with regimental headquarters at Baltimore, MD. Redesignated as a “white” unit 13 November 1928 and assigned to the XIII Corps. Typically conducted Inactive Training Period meetings at the Post Office Building in Baltimore. Conducted summer training with the 13th Engineer Regiment at Fort A. A. Humphreys, VA, 1926-34, and some years with the 5th Engineer Regiment at Fort Belvoir, VA, 1935-40. Primary R.O.T.C. feeder school was the Johns Hopkins University and the Virginia Polytechnic Institute. Location 7 December 1941—Baltimore, MD.

Status: Disbanded 22 December 1942.

Commanders, 375th Engineer Regiment

Col. John Carmichael	14 Apr 25-24 Aug 35	Lt. Col. Herman F. Doeleman	18 Jan 37-3 Sep 38
Col. Walter McI. Wolfe	24 Aug 35-18 Jan 37	Unknown	3 Sep 38-7 Dec 41

376th Engineer Regiment (General Service) (CZ) Organized Reserve Virginia/District of Columbia

HQ-Not initiated 1923-25; Norfolk, VA, 1925-32; Washington, DC 1932-41



Constituted in the Organized Reserve 2 July 1923, assigned to the Communications Zone, and allotted to the Third Corps Area. Initiated in February 1925 with regimental headquarters at Norfolk, VA. Subordinate battalion headquarters concurrently organized as follows: 1st Battalion at Charlottesville, VA, and 2nd Battalion at Staunton, VA. Headquarters relocated 6 December 1932 to Washington, DC. Withdrawn from the Organized Reserve 1 October 1933 and allotted to the Regular Army. Typically conducted Inactive Training Period meetings at the Woodward Building or the Munitions Building in Washington. Conducted summer training with the 13th Engineer Regiment at Fort A. A. Humphreys, VA, 1926-34, and some years with the 5th Engineer Regiment at Fort Belvoir, VA, 1935-40. Primary R.O.T.C. feeder schools were the Virginia Military Institute and the Virginia Polytechnic Institute. Location 7 December 1941—Washington, DC.

Commanders, 376th Engineer Regiment

Lt. Col. Samuel A. Tubman	Feb 25-9 Jun 26	Lt. Col. Luther R. Maddux	24 Aug 35-12 Jan 36
Col. Claude E. Lester	9 Jun 26-29 Aug 29	Col. Clarence O. Sherrill	12 Jan 36-ao Feb 36
Lt. Col. Samuel A. Tubman	Feb 25-19 Dec 31	Col. John J. Phelan	ao Aug 36-2 Feb 40
Col. Walter McI. Wolfe	19 Dec 31-24 Aug 35	Lt. Col. Luther R. Maddux	2 Feb 40-ao Aug 41

377th Engineer Regiment (General Service) (C) (CZ) Organized Reserve Georgia/Florida

HQ-Not initiated 1923-24; Macon, GA, 1924-28; *Inactive* 1928-29; Tampa, FL, 1929-37; *Inactive* 1937-40; Tampa, FL, 1940-41

Constituted in the Organized Reserve 2 July 1923, assigned to the Communications Zone, and allotted to the Fourth Corps Area. Initiated 12 April 1924 with regimental headquarters at Macon, GA. Subordinate battalion headquarters concurrently organized as follows: 1st Battalion at Albany, GA, and 2nd Battalion at Fitzgerald, GA. Redesignated as a "White" unit 5 September 1928. Inactivated 25 October 1928 at Macon by relief of personnel. Reorganized 1 October 1929 with regimental headquarters at Tampa, FL. Inactivated 14 February 1937 at Tampa by relief of personnel. Reorganized by May 1940 with regimental headquarters at Tampa. Conducted summer training with Company A, 4th Engineers at Fort Bragg, NC, with Company A, 7th Engineers at Fort Benning, GA, and some years at Fort McPherson, GA. Designated mobilization training station was Camp Jackson, SC. Location 7 December 1941—Tampa, FL.

Status: Disbanded 22 December 1942.

Commanders, 377th Engineer Regiment

Lt. Col. Perrin C. Cothran	12 Apr 24-25 Feb 27	Col. Claude E. Lester	ao Dec 33-10 Feb 34
Lt. Col. Theodore H. Skinner	25 Feb 27-30 Aug 28	Lt. Col. George H. Heakes	10 Feb 34-1 Jul 35
Col. Clarence S. Coe	7 Nov 27-25 Oct 28	Maj. Blake R. Van Leer	26 Aug 35-16 Nov 35
Unknown	25 Oct 28-1 Oct 29	Lt. Col. Walter L. Simpson	16 Nov 35-14 Feb 37
Lt. Col. William G. Lockwood	1 Oct 29-ao Jun 32	<i>Inactive</i>	14 Feb 37-ao May 40
Unknown	ao Jun 32-ao Dec 33	Unknown	ao May 40-7 Dec 41

378th Engineer Regiment (General Service) (CZ)**Organized Reserve Louisiana/Florida****HQ-Not initiated** 1923-24; Alexandria, LA, 1924-29; Miami, FL, 1929-41

Constituted in the Organized Reserve 2 July 1923, assigned to the Communications Zone, and allotted to the Fourth Corps Area. Initiated in April 1924 with regimental headquarters at Alexandria, LA. Subordinate battalion headquarters concurrently organized as follows: 1st Battalion at Opelousas, LA, and 2nd Battalion at Baton Rouge, LA. Entire regiment relocated 22 October 1929 to Miami, FL. Withdrawn from the Organized Reserve 1 October 1933 and allotted to the Regular Army. Conducted summer training with Company A, 4th Engineers at Fort Benning, GA, and some years at Camp Beauregard, LA, or Camp McClellan, AL. Designated mobilization station was Camp Beauregard. Location 7 December 1941—Miami, FL.

Commanders, 378th Engineer Regiment

Lt. Col. Frank E. Estes	Apr 24-25 Oct 26	Lt. Col. George E. Brown	11 Oct 36-28 Nov 37
Col. Edward S. Bres	27 Oct 26-3 Nov 30	Col. Harry P. Wilson	28 Nov 37-29 Jan 39
Unknown	3 Nov 30-ao Jun 32	Lt. Col. Lloyd H. Grandy	29 Jan 39-ao Jan 40
Col. Theodore H. Skinner	ao Jun 32-11 Oct 36	Unknown	ao Jan 40-7 Dec 41

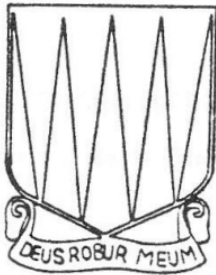
379th Engineer Regiment (General Service) (CZ)**Organized Reserve Ohio****HQ-Not initiated** 1923-24; Toledo, OH, 1924-40; Cleveland, OH, 1940-41

Constituted in the Organized Reserve 2 July 1923, assigned to the Communications Zone, and allotted to the Fifth Corps Area. Initiated in September 1924 with regimental headquarters at Toledo, OH. Headquarters relocated 23 February 1940 to Cleveland, OH. Typically conducted Inactive Training Period meetings at the Valentine Building in Toledo. Conducted summer training most years at Camp Knox, KY, and some years at Fort Benjamin Harrison, IN, or Camp Custer, MI. Primary R.O.T.C. feeder school was the University of Cincinnati. Location 7 December 1941—Cleveland, OH.

Status: Disbanded 22 December 1942.**Commanders, 379th Engineer Regiment**

Unknown	Sep 24-ao Aug 27	Maj. Leonard F. Wood	ao Jul 32-ao Aug 32
Lt. Col. W. L. Glazier	ao Aug 27-ao Aug 28	Unknown	ao Aug 32-ao Jun 34
Unknown	ao Aug 28-ao Jul 32	Lt. Col. Elmer G. Fulmer	ao Jun 34-ao Jun 37
	Unknown	ao Jun 37-7 Dec 41	

380th Engineer Regiment (General Service) (CZ)**Organized Reserve Kentucky****HQ-Not initiated** 1923-24; Louisville, KY, 1924-31; Covington, KY, 1931-41

Constituted in the Organized Reserve 2 July 1923, assigned to the Communications Zone, and allotted to the Fifth Corps Area. Initiated in September 1924 with regimental headquarters at Louisville, KY. Headquarters relocated 9 July 1931 to Covington, KY. Withdrawn from the Organized Reserve 1 October 1933 and allotted to the Regular Army. Conducted summer training most years at Camp Knox, KY, and some years at Fort Benjamin Harrison, IN, or Camp Custer, MI. Location 7 December 1941—Covington, KY.

Commanders, 380th Engineer Regiment

Unknown	Sep 24-ao Jun 34	Col. William J. Carrel	Jun 35-ao Jun 38
Maj. Floyd H. Compton	ao Jun 34-Jun 35	Unknown	ao Jun 38-7 Dec 41

381st Engineer Regiment (General Service) (CZ)**Organized Reserve Illinois****HQ-Not initiated** 1923-24; Chicago, IL, 1924-30; Urbana, IL, 1930-37; Champaign, IL, 1937-41

Constituted in the Organized Reserve 2 July 1923, assigned to the Communications Zone, and allotted to the Sixth Corps Area. Initiated 18 March 1924 with regimental headquarters at Chicago, IL. Subordinate battalion headquarters concurrently organized as follows: 1st Battalion at Bloomington, IL, and 2nd Battalion at Decatur, IL. Headquarters relocated 3 December 1930 to Urbana, IL. Entire regiment relocated 28 July 1937 to Champaign, IL. Typically conducted Inactive Training Period meetings at the Post Office Building in Champaign. Conducted summer training at Camp Custer, MI. Also conducted C.M.T.C. training some years at Camp Custer as an alternate form of annual training. Primary R.O.T.C. feeder school was the University of Illinois. Location 7 December 1941—Champaign, IL.

Status: Disbanded 22 December 1942.**Commanders, 381st Engineer Regiment**

Col. Edward J. Blair	18 Mar 24-12 Oct 27	Lt. Col. Byron K. Coghlan	ao Jul 31-ao Sep 31
Col. Christopher Van Deventer	12 Oct 27-20 Nov 28	Col. Wilbur M. Wilson	ao Mar 32-ao Feb 34
Lt. Col. Henry L. Kellogg	20 Nov 28-13 Jan 30	Lt. Col. Byron K. Coghlan	ao Jun 34-8 Mar 35
Col. Harris P. Ralston	13 Jan 30-ao Aug 30	Col. Chester R. Logan	8 Mar 35-ao Jan 40
	Unknown	ao Jan 40-7 Dec 41	

382nd Engineer Regiment (General Service) (CZ)**Organized Reserve Michigan****HQ-Not initiated** 1923-24; Escanaba, MI, 1924-29; *Inactive* 1929-34; Escanaba, MI, 1934-41

Constituted in the Organized Reserve 2 July 1923, assigned to the Communications Zone, and allotted to the Sixth Corps Area. Initiated 9 April 1924 with regimental headquarters at Escanaba, MI. Subordinate battalion headquarters concurrently organized as follows: 1st Battalion at Houghton, MI, and 2nd Battalion at Neguamee, MI. Inactivated 17 October 1929 at Escanaba by relief of personnel. Reorganized by June 1934 with regimental headquarters at Escanaba. Conducted summer training most years at Camp Custer, MI, and some years at Fort Sheridan, IL. Primary R.O.T.C. feeder school was the Michigan College of Mining and Technology. Location 7 December 1941—Detroit, MI.

Status: Disbanded 22 December 1942.**Commanders, 382nd Engineer Regiment**

Lt. Col. Charles E. Good	9 Apr 24-9 Feb 26	Col. Henry A. Allen	4 Dec 28-17 Oct 29
Col. Charles L. Whiting	9 Feb 26-12 Oct 27	<i>Inactive</i>	17 Oct 29-ao Jun 34
Lt. Col. Harris P. Ralston	12 Oct 27-20 Nov 28	Lt. Col. Irl D'Arcy Brent	ao Jun 34-ao Jun 39
Lt. Col. James C. Roop	3 Dec 28-4 Dec 28	Unknown	ao Jun 39-7 Dec 41

383rd Engineer Regiment (General Service) (CZ)**Organized Reserve Arkansas/Kansas****HQ-Not initiated** 1923-24; Little Rock, AR, 1924-37; Kansas City, KS, 1937-41

Constituted in the Organized Reserve 2 July 1923, assigned to the Communications Zone, and allotted to the Seventh Corps Area. Initiated in December 1924 with the entire regiment at Little Rock, AR. Headquarters relocated 1 November 1937 to Kansas City, KS. Conducted summer training at various locations to include Fort Riley, KS, Fort Snelling, MN, Fort Des Moines, IA, and Fort Crook, NE. Location 7 December 1941—Kansas City, KS.

Status: Disbanded 22 December 1942.**Commanders, 383rd Engineer Regiment**

Unknown	Dec 24-ao Dec 35	Maj. Conrad W. Kline	26 Sep 37-9 Aug 38
Col. Lawrence E. Curfman	ao Dec 35-5 Jan 36	Col. Ivan C. Crawford	9 Aug 38-ao Jan 40
	Unknown	ao Jan 40-7 Dec 41	

384th Engineer Regiment (General Service) (CZ)**Organized Reserve Texas/Tennessee****HQ**-*Not initiated* 1923-26; San Antonio, TX, 1926-27; *Inactive* 1927-29; Brownsville, TN, 1929-41

Constituted in the Organized Reserve 2 July 1923, assigned to the Communications Zone, and allotted to the Eighth Corps Area. Initiated 6 May 1926 with regimental headquarters at San Antonio, TX. Withdrawn from the Eighth Corps Area 11 January 1927 and allotted to the Fourth Corps Area as a “Colored” unit. Inactivated 1 February 1927 at San Antonio by relief of personnel. Redesignated as a “White” unit 5 September 1928. Headquarters organized 22 October 1929 at Brownsville, TN. Withdrawn from the Organized Reserve 1 January 1938 and allotted to the Regular Army. Conducted summer training with the 2nd Engineer Regiment at Fort Sam Houston, TX. Primary R.O.T.C. feeder schools were the Agricultural and Mechanical College of Texas and the University of Tennessee. Location 7 December 1941—Brownsville, TN.

Commanders, 384th Engineer Regiment

Lt. Col. Fidelio G. Chamberlain	6 May 26-1 Feb 27	Unknown	22 Oct 29-6 Dec 34
<i>Inactive</i>	1 Feb 27-22 Oct 29	Maj. Duncan P. Shaw	6 Dec 34-ao Jan 35
	Unknown	ao Jan 35-7 Dec 41	

385th Engineer Regiment (General Service) (CZ)**Organized Reserve California****HQ**-*Not initiated* 1923-25; San Francisco, CA, 1925-41

Constituted in the Organized Reserve 2 July 1923, assigned to the Communications Zone, and allotted to the Ninth Corps Area. Initiated 16 January 1925 with regimental headquarters at San Francisco, CA. Conducted summer training most years at Del Monte, CA, and some years at the Presidio of Monterey. Primary R.O.T.C. feeder schools were the University of California, Los Angeles and the California Institute of Technology. Location 7 December 1941—San Francisco, CA.

Status: Disbanded 22 December 1942.**Commanders, 385th Engineer Regiment**

Col. Joseph W. Williams	16 Jan 25-ao Jun 29	Col. Laurence J. Corbett	ao Jul 34-ao Aug 39
Unknown	ao Jun 29-ao Jul 34	Unknown	ao Aug 39-7 Dec 41

386th Engineer Regiment (General Service) (CZ)**Organized Reserve California****HQ**-*Not initiated* 1923-25; Los Angeles, CA, 1925-41

Constituted in the Organized Reserve 2 July 1923, assigned to the Communications Zone, and allotted to the Ninth Corps Area. Initiated 16 January 1925 with regimental headquarters at Los Angeles, CA. Withdrawn from the Organized Reserve 1 October 1933 and allotted to the Regular Army. Concurrently assigned to the Fourth Army. Conducted summer training most years at Del Monte, CA, and some years at the Presidio of Monterey. Primary R.O.T.C. feeder schools were the University of California, Los Angeles and the California Institute of Technology. Location 7 December 1941—Los Angeles, CA.

Commanders, 386th Engineer Regiment

Lt. Col. John A. Griffith	16 Jan 25-11 Apr 25	Col. Ernest H. Wilcox	11 Apr 25-ao Jul 41
	Unknown	ao Jul 41-7 Dec 41	

387th Engineer Regiment (General Service) (CZ)**Organized Reserve Arkansas/Kansas****HQ-Not initiated** 1923-24; Pine Bluff, AR, 1924-26; Little Rock, AR, 1926-31; Topeka, KS, 1931-33

Constituted in the Organized Reserve 2 July 1923, assigned to the Communications Zone, and allotted to the Seventh Corps Area. Initiated in December 1924 with the entire regiment at Pine Bluff, AR. Headquarters relocated 26 May 1926 to Little Rock, AR. Subordinate battalions relocated as follows: 1st Battalion to Pine Bluff, AR, and 2nd Battalion to Hot Springs, AR. Entire regiment relocated 12 October 1931 to Topeka, KS. Conducted summer training with Troop A, 9th Engineer Squadron at Fort Riley, KS. Demobilized 1 October 1933.

Commander, 387th Engineer Regiment

Unknown Dec 24-1 Oct 33

388th Engineer Regiment (General Service) (CZ)**Organized Reserve Texas/Alabama****HQ-Not initiated** 1923-26; Fort Clark, TX, 1926-27; *Inactive* 1927-29; Bessemer, AL, 1929-33

Constituted in the Organized Reserve 2 July 1923, assigned to the Communications Zone, and allotted to the Eighth Corps Area. Initiated 6 May 1926 with regimental headquarters at Fort Clark, TX. Withdrawn from the Eighth Corps Area 11 January 1927 and allotted to the Fourth Corps Area as a "Colored" unit. Inactivated 1 February 1927 at Fort Clark by relief of personnel. Redesignated as a "White" unit 5 September 1928. Reorganized 22 October 1929 with regimental headquarters at Bessemer, AL. Conducted summer training with the 2nd Engineer Regiment at Fort Sam Houston, TX, 1926-27 and Company A, 4th Engineers at Fort Benning, GA. Primary R.O.T.C. feeder school was the Alabama Polytechnic Institute. Demobilized 1 October 1933.

Commanders, 388th Engineer Regiment

Lt. Col. Dwight Horton	6 May 26-1 Feb 27	<i>Inactive</i>	1 Feb 27-22 Oct 29
	Unknown	22 Oct 29-1 Oct 33	

389th Engineer Regiment (General Service) (GHQR)**Organized Reserve****HQ-Not initiated** 1923-27

Constituted in the National Guard in 1921, assigned to the General Headquarters Reserve and allotted to the state of West Virginia. Placed on the deferred list 2 July 1923, unit requirement transferred to the Organized Reserve as a Deferred National Guard unit, and redesignated as the 389th Engineer Regiment. Withdrawn from the National Guard 17 September 1927 and demobilized.

400th Engineer Regiment (General Service)**Organized Reserve Iowa****HQ-Not initiated** 1928-33

Constituted in the Organized Reserve 5 September 1928, assigned to the General Headquarters Reserve, and allotted to the Seventh Corps Area. Ames, IA, designated 12 October 1931 as headquarters location on organization, but the unit was never organized at that location. Demobilized 1 October 1933.

900th Engineer Regiment (Z.I.)

Organized Reserve Pennsylvania

HQ-Philadelphia, PA, 1940-41

Constituted in the Organized Reserve in 1940, assigned to the Zone of the Interior, and allotted to the Third Corps Area. Initiated 29 August 1940 at Philadelphia, PA. Mobilization mission was to function as a training regiment for the Engineer School at Fort Belvoir, VA. Location 7 December 1941—Philadelphia, PA.

Commander, 900th Engineer Regiment

Maj. John Baker

29 Aug 40-7 Aug 41

Chapter 36

Engineer Battalions and Squadrons



Engineers of Troop A, 9th Engineer Squadron watch as men and horses of the 13th Cavalry ride by on their newly constructed bridge, Fort Riley, KS, circa 1937.

Engineer battalions and squadrons provided both routine and specialized engineer support to mobile units of the field army, corps, and division. Several also provided services to commands in the Communications Zone and the Zone of the Interior.

Organization

The organization and types of engineer battalions in the post-war Army were modified versions of many of the types of units that served in World War I. During the war, there were at least nineteen different kinds of specialized battalions, of which six were related to railroad operations and three were general or specialized construction units. After the war, the Army reduced the number to ten. This was accomplished by consolidating the functions of the railroad battalions into two standardized multifunctional units; consolidating the construction, forestry, and trades functions into auxiliary battalions (later redesignated as engineer battalions, separate); and transferring the sound and flash mission to the field artillery. The following table illustrates the allotment of the types of units to the various components through 1940.

Allotment of the types of units to the various components through 1940.

Bat-talions	Aux/Sep	Rwy Opn	Rwy Shop	Camo	Topo	WS	HP	LP	Map Repro	Mtd
RA	0	1	0	0	2	0	0	1	0	1
RAI	32	11	1	2	0	3	10	2	0	2
NG	30	7	0	0	3	0	3	1	0	4
OR	108	37	5	7	8	12	24	0	1	6
Totals	160	56	6	9	13	15	37	4	1	13

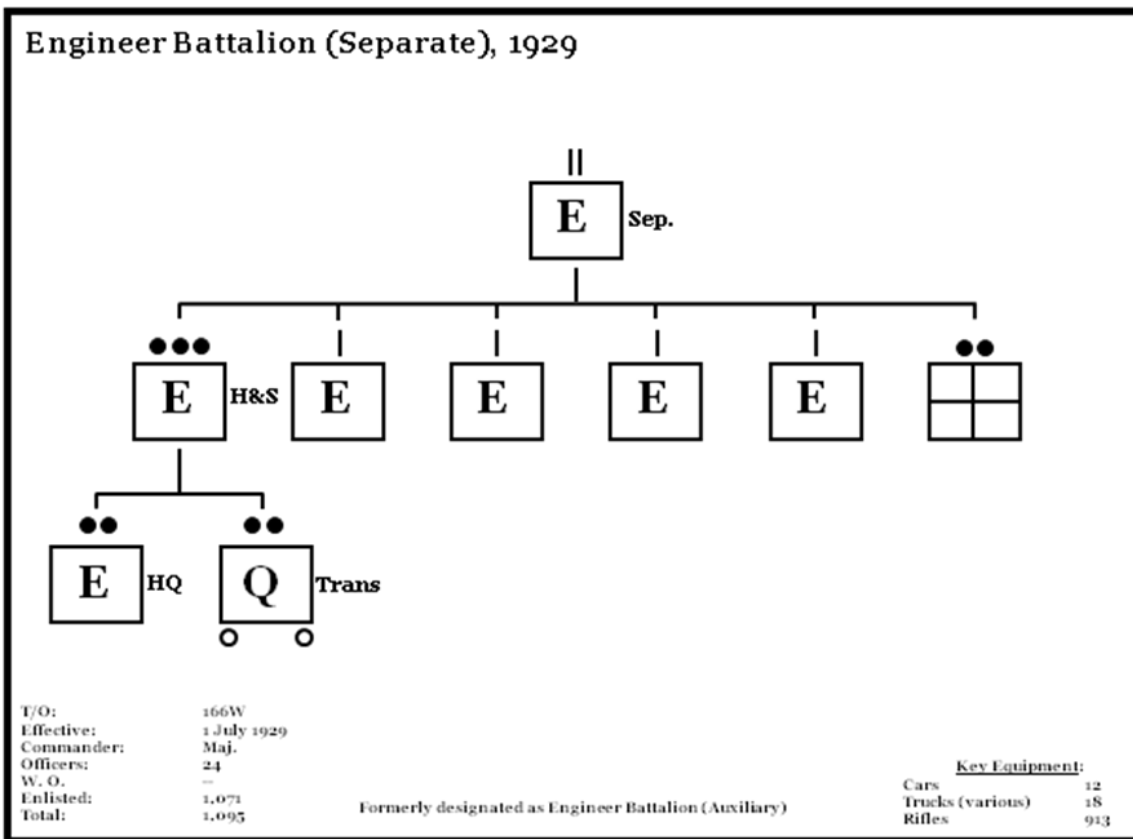
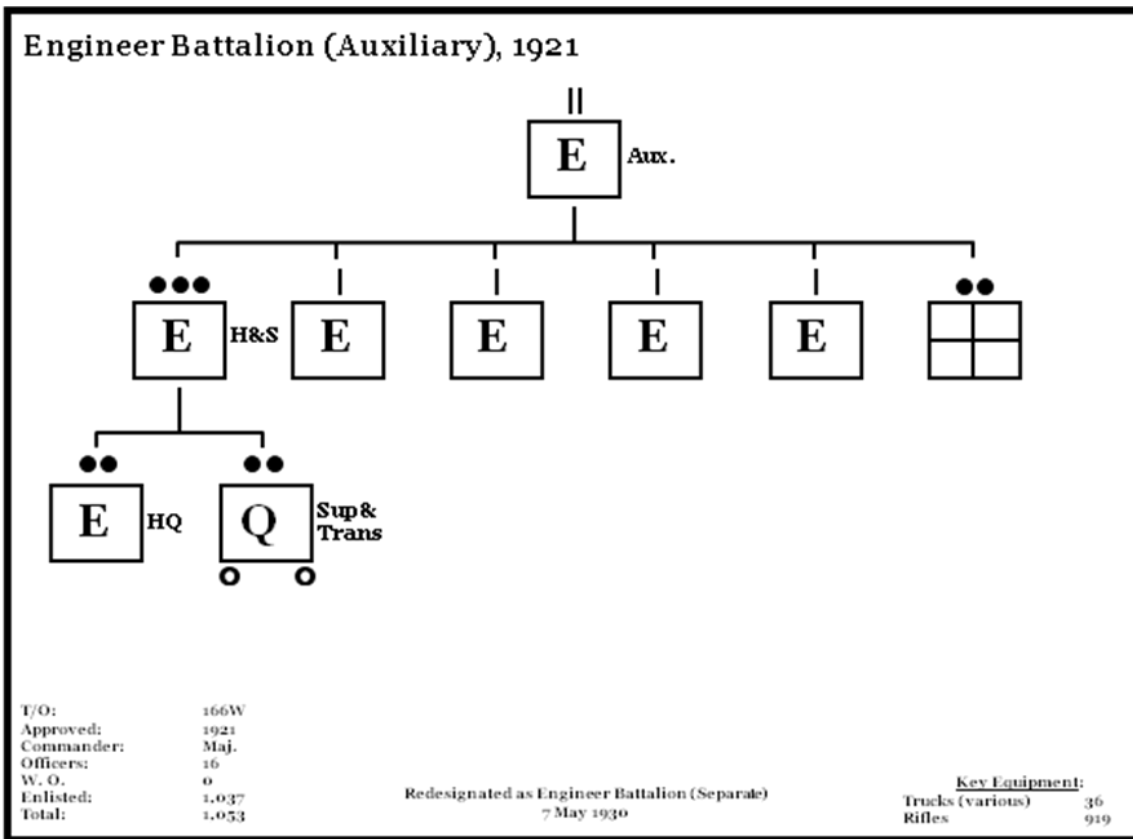

Auxiliary and Separate Engineer Battalion TOEs.

Engineer Battalion (Railway Operating), 1927

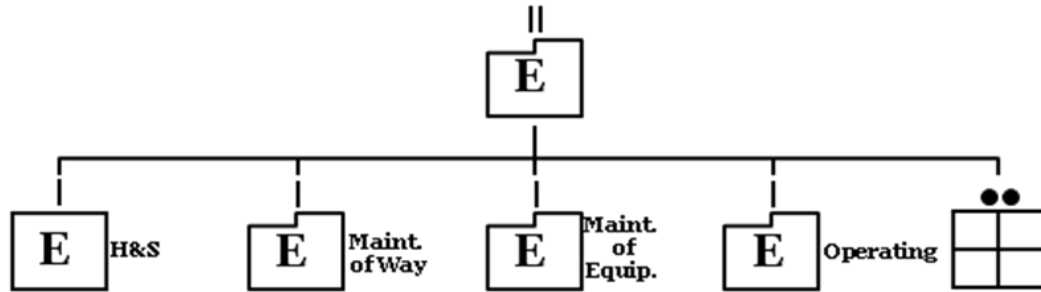

T/O: 563W
 Approved: 2 July 1927
 Commander: Maj.
 Officers: 21
 W. O.: -
 Enlisted: 638
 Total: 659

Key Equipment:
 Locomotives (various) 3
 Cars, Box 30
 Cars, Flat 3
 Trucks (various) 8
 Rifles 274

Engineer Battalion (Railway Shop), 1933

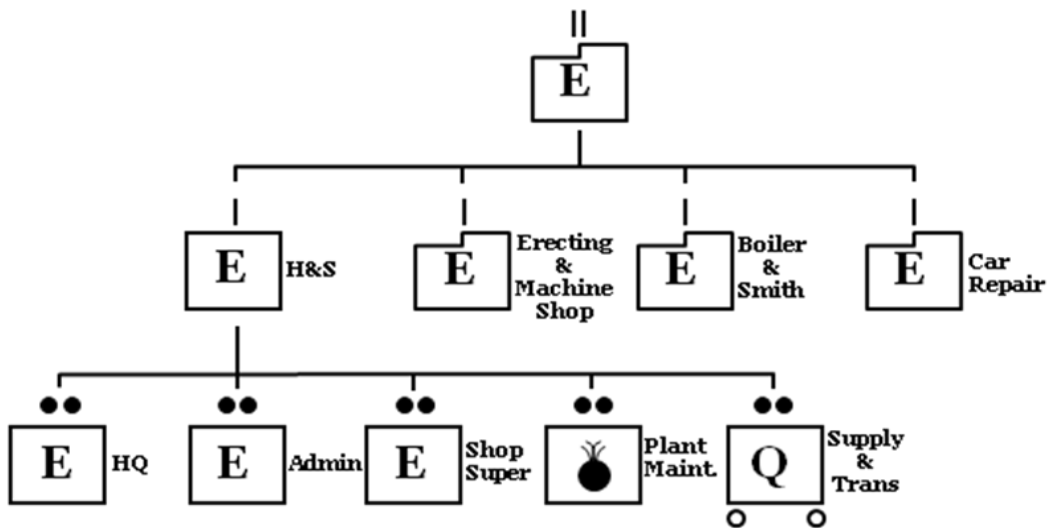

T/O: 668W
 Effective: 1 July 1933
 Commander: Maj.
 Officers: 21
 W. O.: -
 Enlisted: 638
 Total: 659

Key Equipment:
 Trucks (various) 4
 Rifles 548

Railway Operating and Shop Battalion TOEs.

The auxiliary engineer battalion was a general purpose organization. It consisted of a headquarters, a headquarters and service platoon, and four line companies. The battalion could perform basic construction, road improvement, and trade tasks such as logging, milling, electricity, and mechanics. There were six such battalions in each field army and three in each corps. These battalions underwent a minor T/O change in 1929 and were redesignated as "separate" battalions the following year. A significant number of these battalions were constituted in the Regular Army in 1927 and 1933 to replace National Guard and Organized Reserve battalions withdrawn from the field army and corps orders of battle and concurrently demobilized.

Railway operating battalions performed three basic functions: operation of railroad transportation equipment; routine maintenance of locomotives, cars, and other railroad equipment; and maintenance of tracks, sidings, and other structures of the railway. In light of those missions, the battalion consisted of a headquarters, a headquarters and service company, and three line companies consisting of one maintenance of way company, one maintenance of equipment company, and one operating company. The railway shop battalion performed the heavy maintenance and repairs of railway equipment. Its organization consisted of a headquarters, a headquarters and service company, and three line companies consisting of one machine shop company, one boiler repair company, and one car repair company. Both of these organizations were assigned to the Communications Zone or the General Headquarters Reserve. For mobilization and manpower purposes, the Organized Reserve battalions were affiliated with various railroad companies around the United States from which they would draw their personnel. The RAI battalions, however, were non-affiliated.

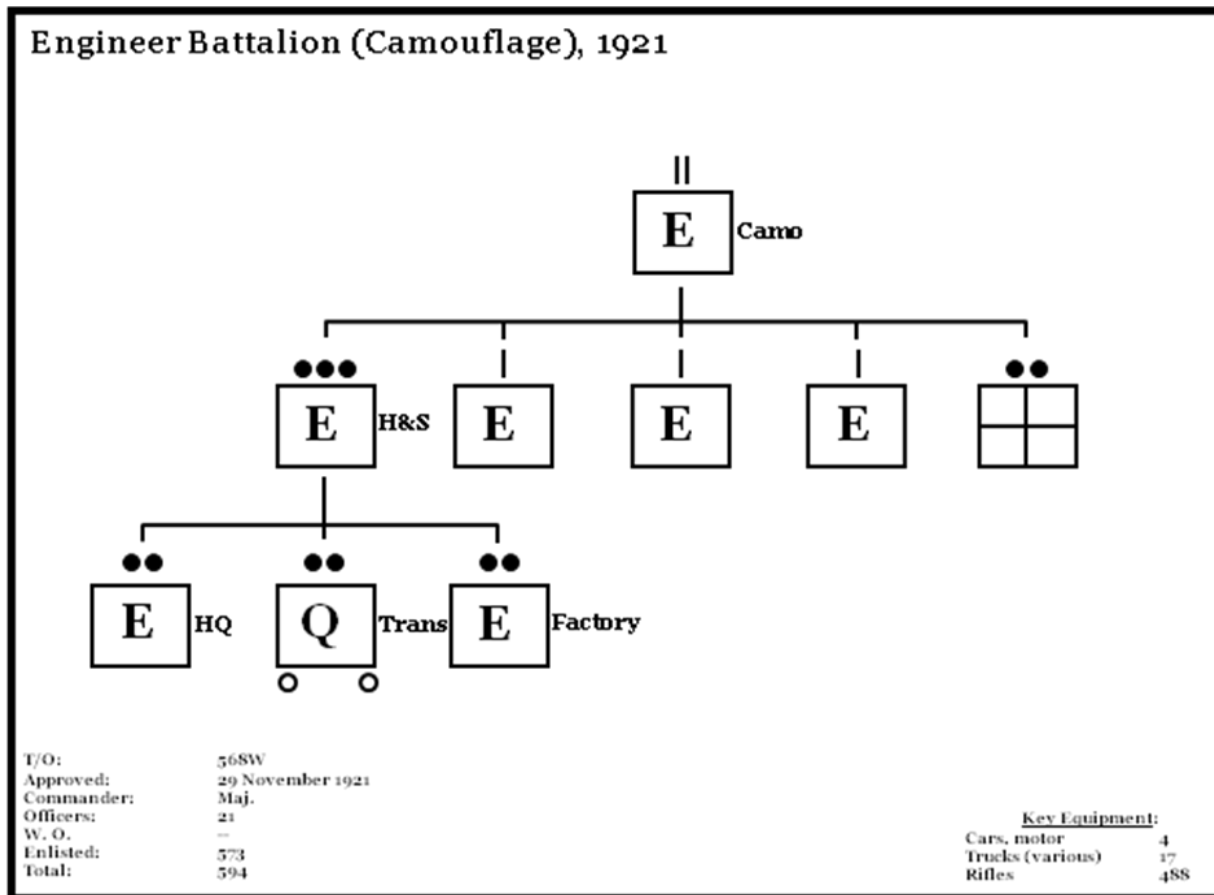

Camouflage Battalion TOE.

Camouflage battalions performed their missions for various purposes. Typically these battalions were used to hide large facilities and key locations, such as major headquarters and communications nodes, from enemy observation. The camouflage battalion consisted of a headquarters, a headquarters and service company, and three camouflage companies. One of these battalions was assigned to each of the field armies. One, the 40th Engineer Battalion, was assigned to the General Headquarters Reserve.

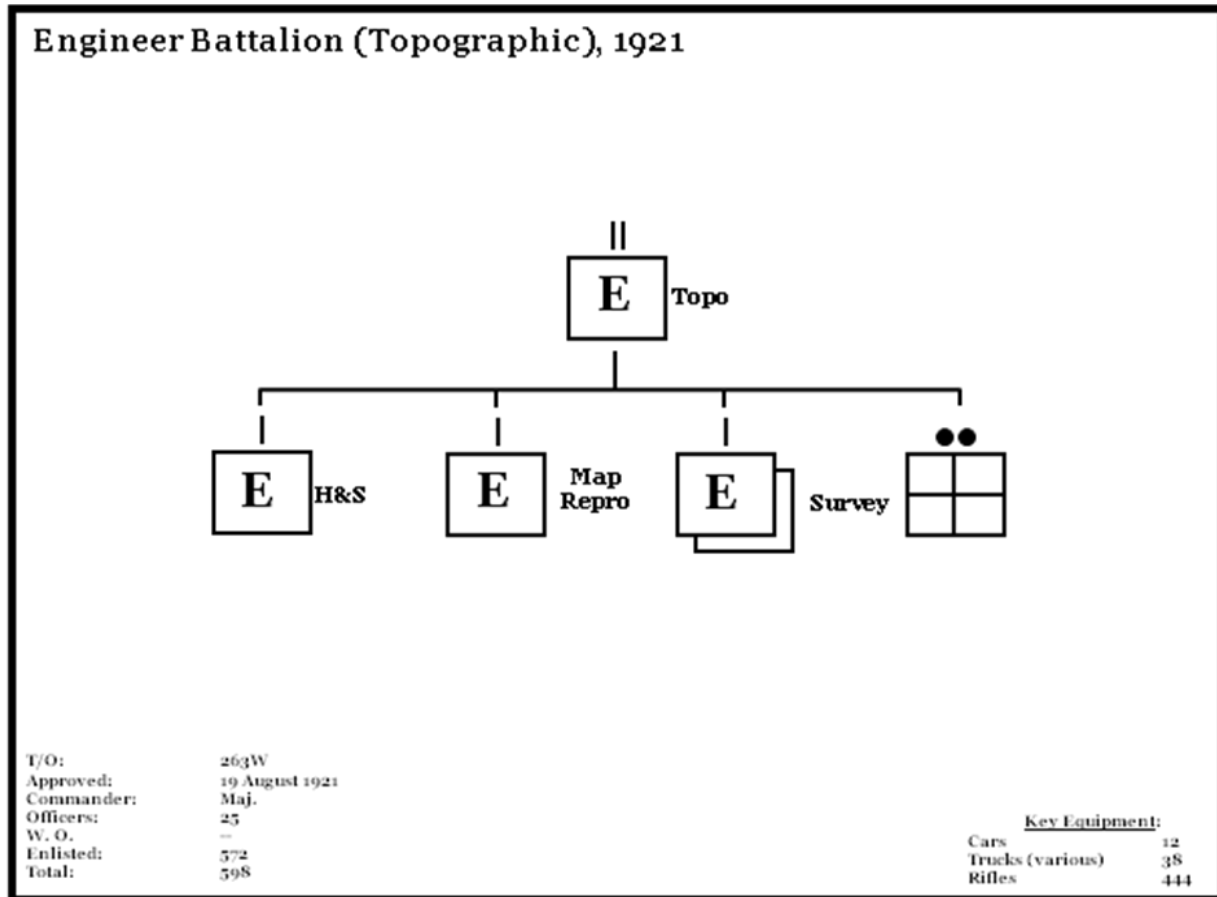

Topographic Battalion TOE.

Topographic battalions conducted topographic surveys and produced or reproduced maps for use by major command headquarters and mobile units. The battalion was composed of a headquarters, a headquarters and service company, one map reproduction company, and two survey companies. One of these battalions was assigned to each field army. Additional battalions were assigned to the Communications Zone and to the General Headquarters Reserve.

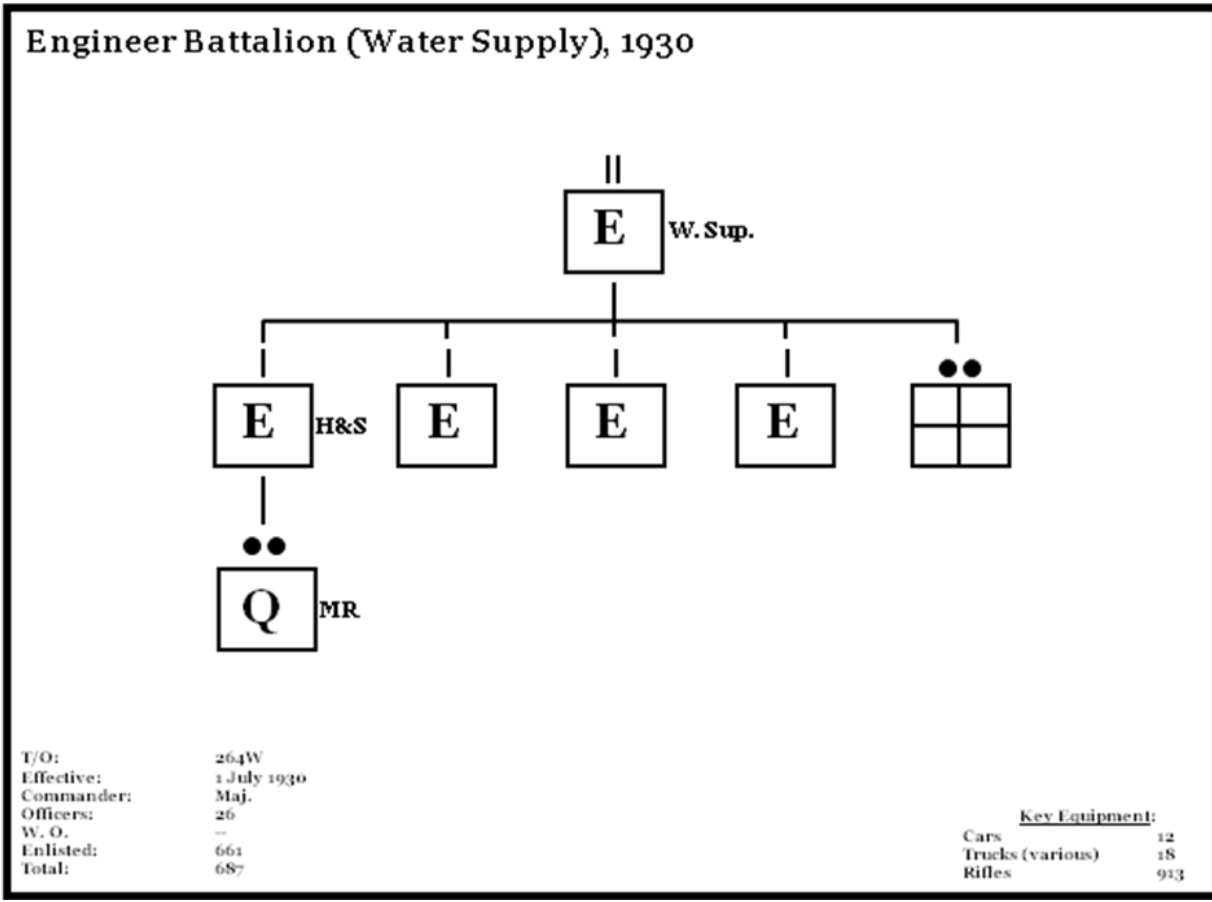

Water Supply Battalion TOE.

As its name implies, the water supply battalion provided water resupply to mobile units of the field army. The battalion was composed of a headquarters, a headquarters and service company, and three water resupply companies. One of these battalions was assigned to each field army. Additional battalions were assigned to the General Headquarters Reserve.

Engineer Battalion (Heavy Ponton), 1929

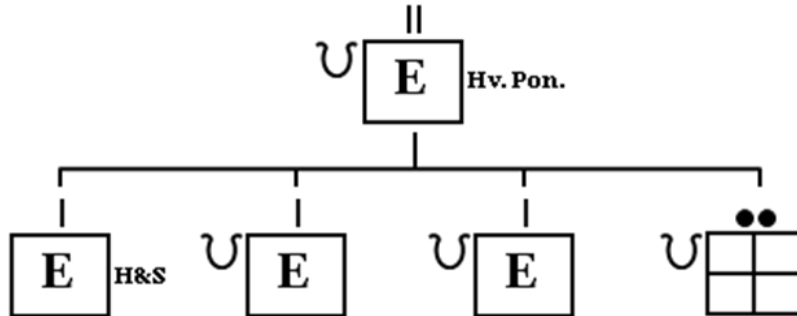

T/O: 266-1W
 Approved: 27 March 1929
 Commander: Maj.
 Officers: 14
 W. O.: -
 Enlisted: 445
 Total: 459

Total bridging length: 864 feet

Key Equipment:
 Horses & Mules 952
 Bridges 4
 Cars 4
 Wagons (various) 151
 Trucks (various) 25
 Rifles 379

Heavy Ponton Battalion TOE.

Heavy ponton battalions provided bridging capabilities to span rivers and streams up to about 850 feet in width. These battalions were organized with a headquarters, a headquarters and service company, and two bridging companies. Each company could build two 216-foot bridges or one 432-foot bridge. These battalions were assigned to the General Headquarters Reserve and were to be attached to armies, corps, and divisions for specific operations. They would then be pulled back for refitting and reattachment for follow-on operations.

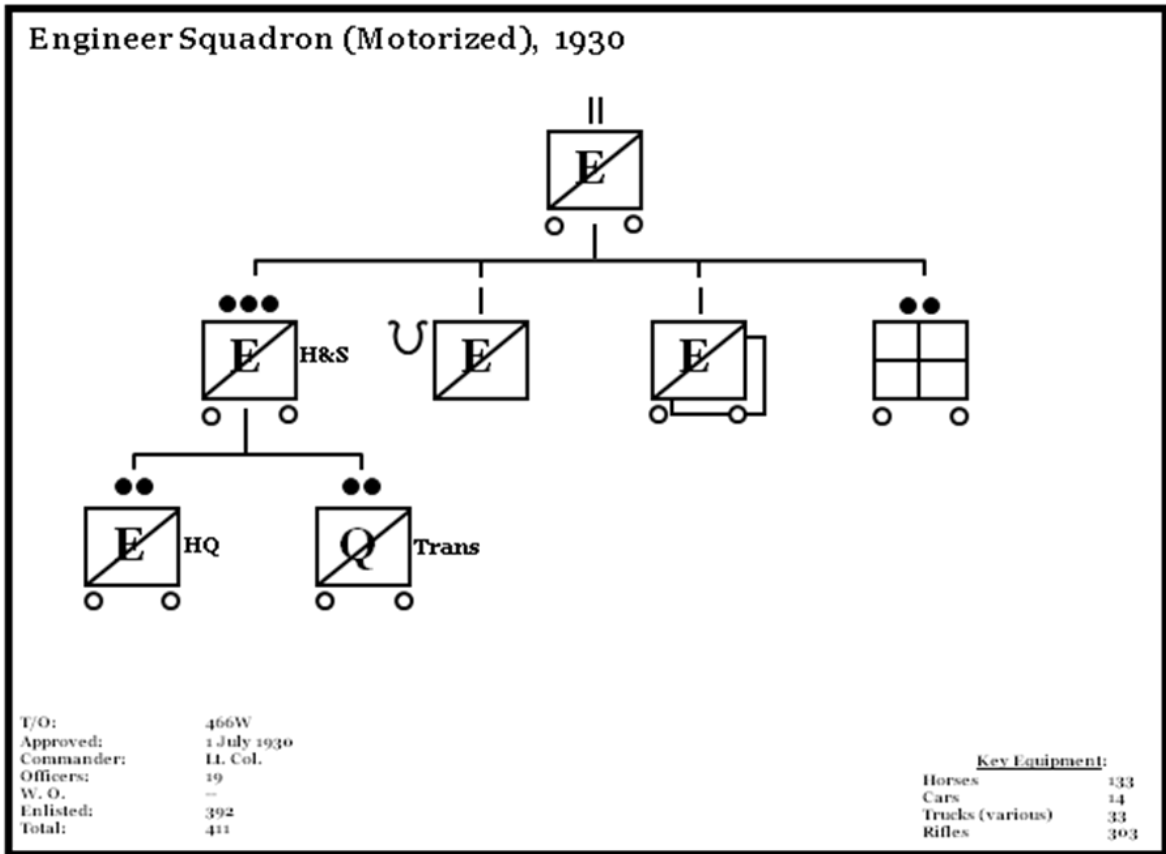
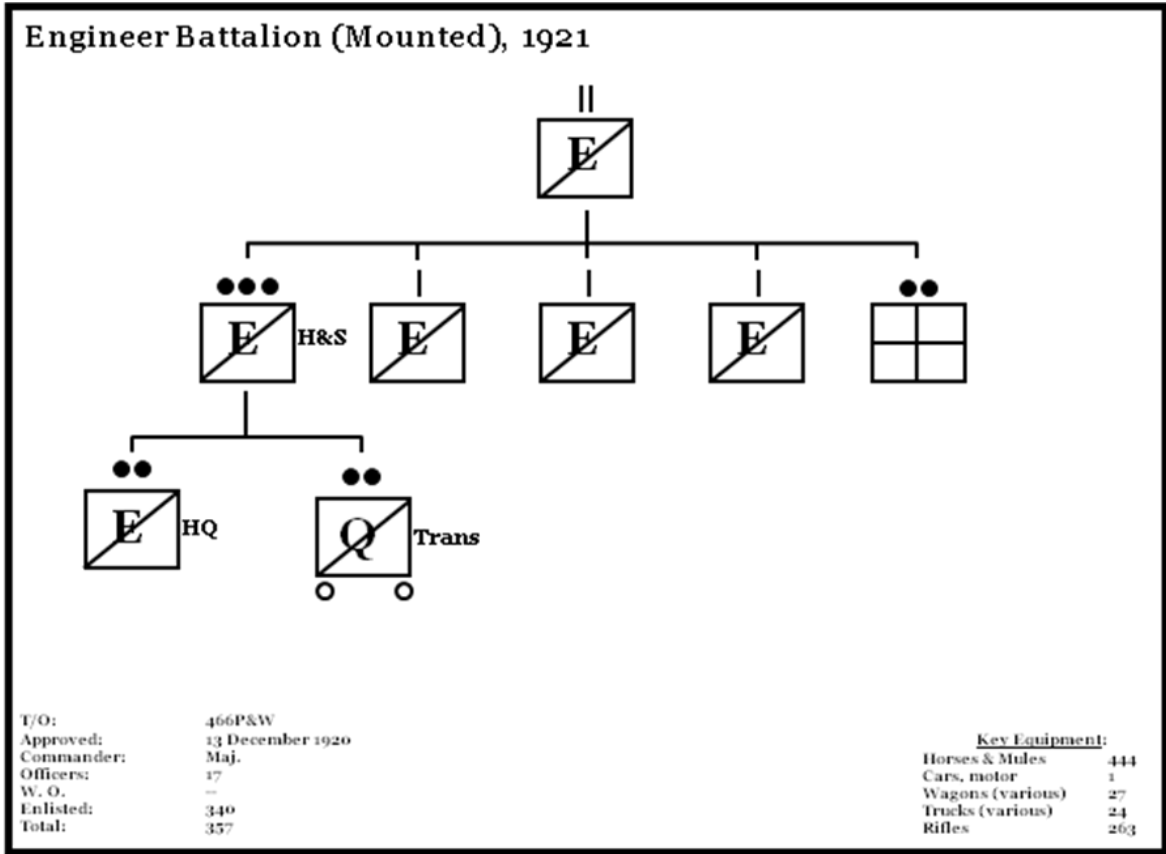

Mounted and Engineer Squadron TOEs.

The mounted engineer battalion provided light engineer capabilities to cavalry divisions. These battalions were originally organized with a headquarters, a headquarters and service platoon, and three mounted engineer companies. The battalion was reorganized in 1930 to consist of one animal-drawn company and the remainder of the battalion was motorized. Concurrently the battalion was redesignated as an engineer squadron. One of these units was assigned to each cavalry division.

Training

Only five of these specialized engineer battalions were active at any time in the Regular Army in the interwar period up to 1940. Only two, the 8th Engineer Battalion (Mounted) and the 29th Engineer Battalion (Topographic), were active for any lengthy period. By 1922, only these two battalions remained in the active force. Additionally, one troop of the 9th Engineer Battalion (Mounted) was active for the entire period. The two mounted units frequently participated in training exercises with the cavalry organizations that they supported. They both participated in various other key events as well. In some instances, they performed construction tasks, such as the flood wall around Marshall Field at Fort Riley, or other duties, such as the 8th Engineers' mapping activities in the Big Bend district of Texas. Both of the units also helped train the RAI and OR engineer units of the Seventh and Eighth Corps Areas. The 29th Engineers were involved in numerous mapping projects as well, to include the Nicaraguan Canal survey in 1931 and the mapping of the Cascade region of Washington state. This battalion also assisted the training of OR topographic units from time to time.

The vast majority of the much more numerous RAI battalions were organized with Reserve personnel during this period. About half of them appear to have been functional units. The 40th Engineer Battalion, in particular, was a very active unit and in the 1930s frequently conducted joint training exercises with other OR and Guard units. Additionally, most of the RAI battalions were ordered to attend summer training as a unit at least one or more times during their period of existence.

Only one battalion and a few companies from some of the other battalions were ever organized in the National Guard. With the exception of the 127th Engineer Battalion (later Squadron) in Alabama, the remainder of these units were all relatively short-lived. The 127th Engineers participated in the usual armory drills and summer training periods typical of Guard units. It also survived long enough to participate in two Army-level maneuvers in 1938 and 1940.

The great majority of the specialized OR engineer battalions were initiated sometime in the interwar period. Only about thirty percent of them, however, were functional. Most were too geographically separated to assemble for the Inactive Training Period. Some of the more active units, however, were the six mounted battalions/squadrons, a number of the corps auxiliary battalions, and most of the railway operating battalions. By the late 1920s, the six mounted battalions and many of the corps auxiliary battalions were concentrated in and around a single city making assembly for training meetings much easier. Due to their affiliation with civilian railroad companies, the members of the Reserve railway battalions, could assemble for training more easily than most Reserve or RAI units. The fact that they performed their wartime mission on an almost daily basis in their civilian occupations made them some of the more mobilization-ready organizations in the Army. About half of the Reserve engineer battalions were ordered to camp at least once during this period. Many of the functional battalions were ordered to camp about every other year. The personnel of those units not ordered to camp were usually attached as individuals to other engineer organizations.

1st Camouflage Battalion, Corps of Engineers (GHQR)**Regular Army Inactive****HQ-Not organized** 1927-29; Manhattan, NY, 1929-30

Constituted in the Regular Army 18 August 1927 as the 1st Engineer Camouflage Company, Corps of Engineers, assigned to the General Headquarters Reserve, and allotted to the First Corps Area. Withdrawn from the First Corps Area 22 August 1928 and allotted to the Second Corps Area. Organized 7 April 1929 with Organized Reserve personnel as a RAI unit with headquarters at New York City, NY. Expanded, reorganized, and redesignated 1 July 1929 as the 1st Camouflage Battalion, Corps of Engineers. Conducted summer training with the 1st Engineer Regiment at Fort DuPont, DE. Redesignated 31 March 1930 as the 40th Camouflage Battalion, Corps of Engineers.

Commanders, 1st Camouflage Battalion, Corps of Engineers

Capt. Nathan Harris**	7 Apr 29-1 Jul 19	Maj. Gilmore D. Clark**	1 Jul 29-31 Mar 30
-----------------------	-------------------	-------------------------	--------------------

** Organized Reserve officers.

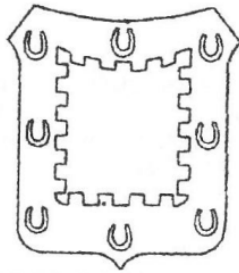
8th Engineer Battalion (Mounted) (1st Cavalry Division)**HQ-Camp Newton D. Baker, TX, 1919-21; Fort Bliss, TX, 1921-27; Fort McIntosh, TX, 1927-41; Fort Bliss, TX, 1941**

Stationed at Camp Newton D. Baker, TX, as of June 1919. Transferred to Fort Bliss, TX, and arrived there in February 1920. Assigned 15 September 1921 to the 1st Cavalry Division. Conducted topographical surveys of the Arizona-Mexico border areas during the summer of 1922, and of the Texas and New Mexico border areas with Mexico October 1922 to February 1923. Transferred to Fort McIntosh, TX, and arrived there 13 May 1928. Reorganized and redesignated 1 June 1930 as the 8th Engineer Squadron. Troop C inactivated 4 June 1930. Squadron motorized in January 1934. Assisted the summer training of Organized Reserve engineer units of the Eighth Corps Area at Fort Bliss 1922-27 and at Fort McIntosh, TX, 1928-40. Reserve officers assigned to the squadron conducted summer training with the squadron at Fort McIntosh. Transferred in February 1941 to Fort Bliss to join the 1st Cavalry Division in post-mobilization training. Location 7 December 1941—Fort Bliss, TX.

Organization Day: 1 August.**Status:** The 8th Engineer Battalion is active in the Regular Army at Fort Hood, TX, as a component of the 1st Cavalry Division.**Events:** 30, 65, 83, 97, 105, 125, 127, 147, 183, 206, 242, 250, 258, 282, 284, 288, 295, 296, 300, 315**Commanders, 8th Engineer Battalion/Squadron**

Maj. Dwight F. Johns	14 Apr 18-28 Aug 18	1st Lt. Walter E. Lorence	1 Nov 31-2 Dec 31
Maj. Robert R. Neyland	4 Oct 18-18 Mar 20	1st Lt. Amos B. Shattuck	2 Dec 31-13 Jan 32
Maj. Albert L. Waldron	18 Mar 20-29 Nov 20	Maj. Lincoln B. Chambers	13 Jan 32-31 Jul 33
Capt. Wilburn H. Henderson	29 Nov 20-1 Jan 21	Capt. Ralph Millis	31 Jul 33-10 Aug 33
Maj. Paul Reisinger	1 Jan 21-1 Aug 22	Maj. William Lanahan	10 Aug 33-26 Jun 35
Capt. Lewis T. Ross	1 Aug 22-14 Sep 22	Capt. Robert C. Hunter	26 Jun 35-31 Jul 35
Maj. Paul A. Hodgson	14 Sep 22-26 Nov 22	Lt. Col. Fred W. Herman	31 Jul 35-11 Jul 37
Maj. Elihu H. Ropes	26 Nov 22-31 Jul 25	Lt. Col. Henry Hutchings	12 Jul 37-16 Jun 40
Maj. Creswell Garlington	31 Jul 25-14 Aug 27	Capt. John C. Colonna	16 Jun 40-1 Jul 40
Maj. Charles F. Williams	15 Aug 27-14 Aug 29	Maj. Edward H. Coe	1 Jul 40-2 Aug 40
Maj. William F. Tompkins	21 Aug 29-1 Jun 31	Lt. Col. William D. Styer	3 Aug 40-24 Nov 40
Maj. Elihu H. Ropes	1 Jun 31-1 Nov 31	Maj. David M. Dunne	11 Dec 40-22 Dec 41

9th Engineer Battalion (Mounted) (2nd Cavalry Division)**Regular Army Inactive**

HQ-Camp Cody, NM, 1919; Camp Courchesne, TX, 1919-20; Fort Sam Houston, TX, 1920-21; *Inactive* 1921-27; Golden, CO, 1927-33; Seventh Corps Area at large 1933-41; Fort Riley, KS, 1941



Stationed at Camp Cody, NM, as of January 1919. Transferred to Camp Courchesne, TX, and arrived there 18 April 1919. Transferred to Fort Sam Houston, TX, and arrived there 22 May 1920. Battalion, less Troop A, inactivated 1 October 1921 at Fort Sam Houston, and personnel and equipment transferred to the 18th Engineer Train (Light Bridge). Troop A conducted a 45-day march from Fort Sam Houston and arrived 29 October 1921 at Fort Riley, KS. For the period 1921-40, Troop A performed duties as an engineer support and demonstration unit for the Cavalry School. Battalion assigned 24 March 1923 to the 2nd Cavalry Division. Affiliated with the Colorado School of Mines R.O.T.C. 10 June 1927 and organized, less Troop A, at Golden, CO, with Regular Army personnel from the R.O.T.C. detachment and Reserve officers commissioned from the program. Reorganized and redesignated 1 June 1930 as the 9th Engineer Squadron.

Withdrawn from the Eighth Corps Area 1 March 1933 (less Troop A) and allotted to the Seventh Corps Area. Concurrently, affiliation with Colorado School of Mines R.O.T.C. terminated. Organized, less Troop A, in late 1933 as a RAI unit with Organized Reserve personnel in the Seventh Corps Area. Squadron motorized 12 January 1934. Troop A performed rescue and reconstruction work during the flood of the Republican River 3-8 June 1935. Using motorboats loaned from the Kansas City Engineer District, the troop rescued 30 people in the Junction City-Ogden-Manhattan area. The troop also operated a ferry at Manhattan after the highway and railroad bridges were washed out. Troop A constructed the flood dike around Marshall Field during 1936-37. Battalion, less Troop A, conducted summer training with the 2nd Engineer Regiment at Fort Logan, CO, 1927-34 and with Troop A at Fort Riley 1935-40. Troop A also assisted the summer training of Organized Reserve engineer units of the Seventh Corps Area at Fort Riley 1922-40. Squadron, less Troop A already active, activated 1 November 1941, less Reserve personnel, at Fort Riley, KS. Location 7 December 1941—Fort Riley, KS.

Organization Day: 21 May. Chosen to commemorate the squadron's initial organization 21 May 1919/17.

Status: The 9th Engineer Battalion is active in the Regular Army at Schweinfurt, Germany, as a component of the 1st Infantry Division (Mechanized).

Events: 171, 177, 188, 236, 269, 285, 303, 328

Commanders, 9th Engineer Battalion/Squadron

Lt. Col. Cleveland C. Gee	26 Jun 18-3 Sep 18	Capt. Henry Hutchings*	10 Jun 27-18 Jan 30
Maj. Layson E. Atkins	12 Oct 18-Sep 19	Capt. Frank M. S. Johnson*	18 Jan 28-1 Mar 33
Maj. Raymond G. Moses	Sep 19-12 May 20	Unknown	1 Mar 33-ao Jan 39
Maj. Raymond F. Fowler	12 May 20-1 Oct 21	Capt. John D. Heavey**	ao Jan 39-16 Jun 39
<i>Inactive</i>	1 Oct 21-10 Jun 27	Unknown	16 Jun 39-1 Nov 41
	Maj. Harry O. Paxson	1 Nov 41-ao Jan 42	

* RAI Commanders: Regular Army officers who were concurrently PMS&T at Colorado School of Mines.

** RAI Commanders: Organized Reserve officers.

12th Engineer Battalion (Mounted) (3rd Cavalry Division)**Regular Army Inactive**

HQ-Camp Grant, IL, 1919-21; *Inactive* 1921-26; Chicago, IL, 1926-33; St. Louis, MO, 1933-40



Arrived at Newport News 11 June 1919 on the U.S.S. *Orizaba* as the 318th Engineer Regiment, an element of the 6th Division. Transferred to Camp Grant, IL, and arrived there 17 June 1919. Redesignated 1 December 1920 as the 12th Engineer Regiment. Inactivated at Camp Grant 7 September 1921 and allotted to the Sixth Corps Area. Active Associate was the 1st Engineer Regiment, 1921-23. Assigned 24 August 1923 to the 6th Division. The 13th Engineer Regiment designated as the Active Associate 1923-27. Organized 17 April 1926 with Organized Reserve personnel as a RAI unit with headquarters at Chicago, IL. Relieved from the 6th Division 15 August 1927, reorganized and redesignated as the 12th Engineer Battalion (Mounted), and assigned to the 3rd Cavalry Division. Redesignated 1 June 1930 as the 12th Engineer Squadron.

Attached 3 November 1930 to the 86th Division for administrative control. Withdrawn from the Sixth Corps Area 1 October 1933 and allotted to the Seventh Corps Area. Organized in late 1933 as a RAI unit with

Organized Reserve personnel at St. Louis, MO. Affiliated in 1934 with the Missouri School of Mines R.O.T.C. Reorganized as a motorized squadron 12 January 1934. Typically conducted Inactive Training Period meetings at the Post Office Building in Chicago. Conducted summer training at Camp Custer, MI, 1927-33, less 1930 when the squadron conducted training at Fort A. A. Humphreys, VA, with the 13th Engineers. Conducted engineer C.M.T.C. training at Camp Custer in 1928 as an alternate form of annual training. Conducted summer training at Fort Riley, KS, 1934-39 with Troop A, 9th Engineer Squadron. Disbanded 15 July 1940.

Commanders, 12th Engineer Battalion/Squadron

Lt. Col. Harris P. Ralston**	15 Aug 27-12 Oct 27	Capt. Harold L. Agee**	ao Jun 30-1 Oct 33
Capt. Jerome J. Cerny**	12 Oct 27-ao Jun 29	Unknown	1 Oct 33-15 Jul 40

16th Engineer Battalion (Railway)

HQ-Coblenz, GE 1921; Camp Dix, NJ 1921

Constituted in the Regular Army 28 January 1921 and organized with personnel from B Company, 1st Engineer Regiment at Engineer Barracks No. 2, Coblenz, Germany. Concurrently assigned to U.S. Army Forces in Germany. Operated standard gauge railway lines between Kreuzberg and Mayen, Germany, 1921-22. Inactivated 1 November 1921, less Company A, at Coblenz. Company A inactivated 31 October 1922. Active Associate was the 17th Engineer Battalion 1922-23. Demobilized 8 April 1924.

Commanders, 16th Engineer Battalion (Railway)

Maj. Edwin A. Bethel	20 Sep 20-28 Jan 21	Maj. Edwin A. Bethel	3 Mar 21-1 Nov 21
Capt. Harry O. Tunis	28 Jan 21-3 Mar 21	<i>Inactive</i>	1 Nov 21-8 Apr 24

17th Engineer Battalion (Topographic) (Second Army)

HQ-Camp A. A. Humphreys, MD, 1921-23

Constituted in the Regular Army 25 August 1921. Organized 19 September 1921 with personnel from the 5th and 13th Engineer Regiments at Camp A. A. Humphreys, VA. Company A transferred to Fort George G. Meade, MD. Assigned 24 March 1923 to the Second Army. Consolidated 18 July 1923 with the 29th Engineer Regiment (a WWI unit organized in October 1917; demobilized 14 July 1919; reconstituted 14 July 1923). Consolidated unit redesignated as the 29th Engineer Battalion (Topographic).

Status: Active in the Regular Army at Fort Shafter, HI, as the 29th Engineer Battalion (Topographic).

Commanders, 17th Engineer Battalion (Topographic)

Maj. Dabney O. Elliot	30 Nov 21-1 Aug 22	Capt. Robert A. Laird	1 Aug 22-22 Sep 22
	Maj. Harold R. Richards	22 Sep 22-18 Jul 23	

17th Engineer Battalion (Heavy Ponton) (Motorized) (GHQR)

Regular Army Inactive

HQ-*Not organized* 1933-38; Jamestown, NY, 1938-40; Fort Benning, GA, 1940-41



Constituted in the Regular Army 1 October 1933 and allotted to the Second Corps Area. Organized 4 January 1938 with Organized Reserve personnel as a RAI unit at Jamestown, NY. Occasionally conducted Inactive Training Period meetings at the Everson Building in Syracuse, NY. Designated mobilization training station was Fort Belvoir, VA. Reorganized and redesignated 1 July 1940 as the 17th Armored Engineer Battalion, assigned to the 2nd Armored Division, and activated, less Reserve personnel, at Fort Benning, GA. Location 7 December 1941—Fort Benning, GA.

Status: Inactive in the Regular Army as the 17th Engineer Battalion, a component of the 2nd Armored Division.

18th Engineer Train (Light Ponton)

HQ-Fort Sam Houston, TX, 1921-22; Marlin, TX, 1922

Constituted in the Regular Army 25 August 1921. Organized 1 October 1921 at Fort Sam Houston, TX, by transfer of personnel and equipment from the inactivated 9th Engineer Battalion (Mounted). Transferred to Marlin, TX, and arrived there 21 May 1922. Inactivated 11 August 1922 at Marlin and personnel and equipment transferred to the 2nd Engineer Regiment. Active Associate was the 2nd Engineer Regiment 1922-24. Demobilized 30 April 1924.

19th Engineer Battalion (Heavy Ponton) (Motorized) (GHQR)

Regular Army Inactive

HQ-Cleveland, OH, 1933-40

Constituted in the Regular Army 1 October 1933 and allotted to the Fifth Corps Area. Organized in late 1933 with Organized Reserve personnel at Cleveland, OH. Conducted summer training at Fort Knox, KY, in 1938. Redesignated 1 July 1940 as the 88th Engineer Battalion (Heavy Ponton).

20th Engineer Battalion (Heavy Ponton) (Motorized) (GHQR)

Regular Army Inactive

HQ-*Not organized* 1933-34; Wausau, WI 1934-40

Constituted in the Regular Army 1 October 1933 and allotted to the Sixth Corps Area. Organized by June 1934 with Organized Reserve personnel as a RAI unit at Wausau, WI. Redesignated 1 July 1940 as the 89th Engineer Battalion (Heavy Ponton).

27th Engineer Battalion (Combat) (Puerto Rican Department)

HQ-Fort DuPont, DE, 1939-40; Borinquen Field, PR 1940; Post of San Juan, PR 1940-41



Arrived at the port of New York 3 September 1919 on the U.S.S. *Orizaba* as the 2nd Battalion, 1st Engineer Regiment, an element of the 1st Division. Transferred 4 October 1919 to Camp Zachary Taylor, KY. Transferred 16 September 1920 to Camp Dix, NJ. Transferred in September 1922 to Fort DuPont, DE. Assisted the summer training of Organized Reserve engineer units of the First, Second, and Third Corps Areas at Fort DuPont 1922-39. Reorganized and redesignated 9 October 1939 as the 27th Engineer Battalion at Fort DuPont, DE. Transferred to Borinquen Field, PR, 15 October 1939 and assigned to the Puerto Rican Department. Performed construction of Borinquen Army Air Field from October 1939 to July 1940. Transferred 10 July 1940 to the Post of San Juan. Location 7 December 1941—Post of San Juan, PR.

Status: Disbanded 22 December 1942.

Events: 329

29th Engineer Battalion (Topographic) (Second Army)

HQ-Fort A. A. Humphreys, VA, 1923-29; Nicaragua 1929-31; Fort Schuyler, NY, 1931-34; Port Angeles, WA, 1934-37; Portland, OR, 1937-41

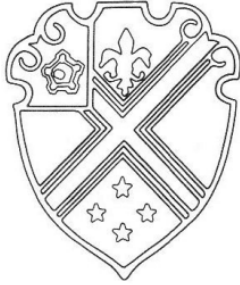

Arrived at the port of Boston 6 July 1919 on the U.S.S. *Mongolia* as the 29th Engineer Regiment. Demobilized 13 July-2 September 1919 by individual companies at Camp Upton, New York, and Camp Humphreys, Virginia. Reconstituted 14 July 1923 in the Regular Army as the 29th Engineer Battalion. Reconstituted in the Regular Army 14 July 1923. Consolidated 18 July 1923 with the 17th Engineer Battalion (Topographic) (constituted 25 August 1921; organized 19 September 1921 at Camp A. A. Humphreys, VA) at Fort A. A. Humphreys, VA, and consolidated unit redesignated as the 29th Engineer Battalion (Topographic). Battalion participated in the funeral of President Warren G. Harding at Washington, DC, in August 1923. Conducted topographical surveys of eastern Virginia July-October 1926. Transferred, less Company C, (reinforced by Company A, 1st Engineers and Company F, 11th Engineers attached), to Grenada, Nicaragua, and arrived there on 25 October 1929 on the U.S.A.T.

Chateau Thierry. Concurrently, Company C transferred to the Army War College in Washington, DC. Conducted surveys in Nicaragua 25 October 1929-15 July 1931 for possible canal routes across Central America. Battalion ordered home and arrived 25 July 1931 on the U.S.A.T. *Chateau Thierry*. Transferred to Fort Schuyler, NY, and arrived there 28 July 1931. Relieved from the Second Army 1 October 1933 and assigned to the General Headquarters Reserve. Departed the New York Port of Embarkation on the U.S.A.T. *Republic* on 4 May 1934 and arrived at Port Angeles, WA, 24 May 1934. Mapped the Olympic Peninsula in Washington state 1934-37. Transferred to Portland, OR, and arrived there 4 June 1937. Company C disbanded 1 September 1939 and personnel transferred to the newly activated 30th Engineer Battalion (Topographic). Redesignated 7 November 1941 as the 29th Engineer Topographic Battalion and assigned to the Fourth Army. Location 7 December 1941—Portland, OR.

Status: Active in the Regular Army at Fort Shafter, HI, as the 29th Engineer Battalion.

Events: 99, 304

Commanders, 29th Engineer Battalion (Topographic)

Capt. Harold R. Richards	19 Jul 23-3 Mar 24	Maj. Charles P. Gross	30 Aug 29-21 Aug 31
Capt. Peter E. Bermel	3 Mar 24-16 Jun 24	Capt. Bartley M. Harloe	31 Aug 31-10 Jul 32
Capt. Robert A. Laird	16 Jun 24-15 Aug 24	Maj. Notley Y. DuHamel	10 Jul 32-16 Jul 35
Maj. James W. Bagley	15 Aug 24-25 Jun 28	Capt. John B. Wade	16 Jul 35-28 Aug 35
Capt. Russel McK. Herrington	25 Jun 28-17 Aug 28	Lt. Col. Gordon R. Young	28 Aug 35-13 Jun 37
Maj. Lunsford E. Oliver	17 Aug 28-31 Jul 29	Maj. Russel McK. Herrington	13 Jun 37-6 Jul 40
Capt. Russel McK. Herrington	31 Jul 29-30 Aug 29	Lt. Col. Walter D. Luplow	6 Jul 40-3 Nov 41
Lt. Col. Wendell P. Trower	3 Nov 41-20 Jul 42		

30th Engineer Battalion (Topographic) (First Army)

HQ-Portland, OR, 1939; Fort Belvoir, VA, 1939-41



Constituted in the Regular Army 1 September 1939, assigned to the First Army, and allotted to the Ninth Corps Area. Organized at Portland, OR, with assets and personnel from Company C, 29th Engineer Battalion (Topographic). Assigned 2 October 1939 to the General Headquarters Reserve. Transferred to Fort Belvoir, VA, and arrived there 23 October 1939 where it was assigned to the First Army. Relieved from the First Army 7 November 1941 and assigned to the Office of the Chief of Engineers. Location 7 December 1941—Fort Belvoir, VA.

Status: Active in the Regular Army at Fort Bragg, NC, as the 30th Engineer Battalion.

Events: 301, 302, 328, 330

Commanders, 30th Engineer Battalion (Topographic)

Lt. Col. Russell McK. Herrington	19 Aug 40-ao May 41
----------------------------------	---------------------

33rd Engineer Battalion (Topographic) (Sixth Army)

HQ-Lincoln, NE, 1922-26; Hutchison, KS, 1926-31; St. Louis, MO, 1931-41; Camp Claiborne, LA, 1941

Constituted in the Organized Reserves 15 October 1921 as the 459th Engineer Battalion (Topographic), assigned to the Sixth Army, and allotted to the Seventh Corps Area. Organized in February 1922 with headquarters at Lincoln, NE. Headquarters relocated 26 May 1926 to Hutchison, KS. Headquarters relocated in October 1931 to St. Louis, MO. Withdrawn from the Organized Reserve 1 January 1938 and allotted to the Regular Army. Redesignated 13 January 1941 as the 33rd Engineer Battalion (Topographic) (GHQR). Redesignated as the 648th Engineer Topographic Battalion (Army) 7 November 1941 and activated, less Reserve personnel, at Camp Claiborne, LA. Location 7 December 1941—Camp Claiborne, LA.

Status: Disbanded 20 January 1945.

40th Engineer Battalion (Camouflage) (I) (First Army)

Regular Army Inactive

HQ-Manhattan, NY, 1922-41



Reconstituted in the Organized Reserve 28 December 1922 (constituted in the National Army as Company F, 25th Engineers (Camouflage); organized 8 October 1917 at Camp Leach, DC; demobilized 18 February 1919 as Company A, 40th Engineers (Camouflage) at Washington Barracks, DC) as the 1st Battalion, 40th Engineers, assigned to the General Headquarters Reserve, and allotted to the Second Corps Area. Concurrently organized with headquarters at Manhattan, NY with personnel from the 601st and 604th Engineer Camouflage Companies. Redesignated as the 605th Engineer Camouflage Battalion 31 March 1930 and assigned to the First Army. Redesignated 20 August 1931 as the 605th Engineer Battalion (Camouflage). Redesignated as the 40th Engineer Battalion (Camouflage) 30 June 1932, withdrawn from the Organized Reserve, and allotted to the Regular Army. Inactivated in November 1933 at New York City, NY, (unit listed as

demobilized 1 October 1933, however the Adjutant General issued a letter dated 30 June 1934 to the Quartermaster General to correct the record. The correction demobilized the existing 605th Engineer Battalion [Camouflage] (II) [see separate lineage of this unit below] to allow preservation of the lineage of the World War I 40th Engineers). Withdrawn from the Regular Army 15 January 1934 and allotted to the Organized Reserve. Reorganized in March 1934 at New York City, NY, with Organized Reserve personnel of the demobilized 605th Engineers. Relieved from the First Army 30 June 1934 and assigned to the General Headquarters Reserve. Withdrawn from the Organized Reserve 1 January 1938 and allotted to the Regular Army. Typically conducted Inactive Training Period meetings at the armory of the 71st Infantry or the Columbia University Club on West 43rd Street in New York City. Conducted summer training with the 1st Engineer Regiment at Fort Du Pont, DE, and with the 62nd Coast Artillery at Fort Totten, NY. Often performed camouflage training with the 62nd Coast Artillery at Fort Totten during non-camp training periods. Designated mobilization training station was Fort Belvoir, VA. Location 7 December 1941—Manhattan, NY.

Status: Disbanded 22 December 1942.

Events: 187, 229, 244

Commanders, 40th Engineer Battalion (Camouflage)

Unknown	28 Dec 22-5 Feb 23	Maj. John H. Buckley**	30 Jun 32-1 Nov 32
Maj. Aymar Embury, II**	5 Feb 23-24 Jan 27	Capt. Charles Crane**	1 Nov 32-19 Feb 34
Maj. Harold R. Richards**	24 Jan 27-ao Feb 27	Maj. John H. Buckley**	19 Feb 34-3 Mar 35
Unknown	ao Feb 27-ao Oct 29	Capt. Peter Rodyenko**	3 Mar 35-6 Apr 39
Maj. Gilmore D. Clark **	ao Oct 29-15 Dec 30	Maj. Frank Hastie**	6 Apr 39-27 Jul 41
Capt. Charles Crane**	5 Feb 31-30 Jun 32	Maj. Donald P. Barnes**	27 Jul 41-9 Aug 41

** RAI Commanders: Organized Reserve officers.

40th Engineer Battalion (Camouflage) (II) (GHQR)**Regular Army Inactive****HQ**-Manhattan, NY, 1929-32

Constituted in the Regular Army 18 August 1927 as the 1st Engineer Camouflage Company, Corps of Engineers, assigned to the General Headquarters Reserve, and allotted to the First Corps Area. Withdrawn from the First Corps Area 22 August 1928 and allotted to the Second Corps Area. Headquarters organized by 1929 at New York City, NY, as an RAI unit. Expanded, reorganized, and redesignated 1 July 1929 as the 1st Camouflage Battalion, Corps of Engineers. Redesignated 31 March 1930 as the 40th Camouflage Battalion, Corps of Engineers. Redesignated 20 August 1931 as the 40th Engineer Battalion (Camouflage). Redesignated 30 June 1932 as the 605th Engineer Battalion (Camouflage), withdrawn from the Organized Reserve, and allotted to the Regular Army. Conducted monthly meetings at the armory of the 71st Infantry in New York City. Demobilized 1 October 1933.

Events: 149**45th Engineer Battalion (Separate) (V Corps)****Regular Army Inactive****HQ**-*Not organized* 1933-34; Terre Haute, IN, 1934-38

Constituted in the Regular Army 1 October 1933, assigned to the V Corps, and allotted to the Fifth Corps Area. Organized in 1934 with Organized Reserve personnel as a RAI unit at Terre Haute, IN. Redesignated 1 January 1938 as the 85th Engineer Battalion (Separate).

Status: Disbanded 25 April 1941 as the 85th Engineer Battalion (Separate).**46th Engineer Battalion (Separate) (VI Corps)****Regular Army Inactive****HQ**-*Not organized* 1933-35; Milwaukee, WI 1935-41

Constituted in the Regular Army 1 October 1933, assigned to the VI Corps, and allotted to the Sixth Corps Area. Organized by May 1935 with Organized Reserve personnel as a RAI unit at Milwaukee, WI. Location 7 December 1941—Milwaukee, WI.

47th Engineer Battalion (Separate) (VII Corps)**Regular Army Inactive****HQ**-*Not organized* 1933-36; Kansas City, KS, 1936-41

Constituted in the Regular Army 1 October 1933, assigned to the VII Corps, and allotted to the Seventh Corps Area. Organized in March 1936 with Organized Reserve personnel as a RAI unit at Kansas City, KS. Consolidated 10 September 1936 with the 47th Engineer Battalion (Railway Maintenance of Way) (a WWI unit organized in March 1918 at Camp Sheridan, AL; redesignated 18 September 1918 as the 47th Regiment [Transportation Corps]; reconstituted 10 September 1936). Conducted summer training at Fort Riley, KS, or Fort Snelling, MN. Designated mobilization training station was Camp Ord, CA. Reorganized and redesignated 16 December 1940 as the 47th Engineer Regiment (General Service). Location 7 December 1941—Kansas City, KS.

Status: Regimental Headquarters, and Headquarters & Service Company, 47th Engineer Regiment (General Service) is inactive in the Regular Army as HHC, 2nd Engineer Group; the 1st Battalion is inactive as the 47th Engineer Battalion; the 2nd Battalion is active at Camp Howze, Korea as the 44th Engineer Battalion (Corps Mechanized), a component of the 2nd Infantry Division.

47th Engineer Battalion (Heavy Ponton) (Motorized) (GHQR)

Regular Army Inactive

HQ-*Not organized* 1933-38

Constituted in the Regular Army 1 October 1933 as the 47th Engineer Battalion (Heavy Ponton), assigned to the General Headquarters Reserve, and allotted to the Seventh Corps Area. Redesignated as the 87th Engineer Battalion (Heavy Ponton) 1 January 1938.

Status: Active in the Regular Army at Fort Leonard Wood, MO, as the 87th Engineer Battalion.

48th Engineer Battalion (Separate) (Third Army)

Regular Army Inactive

HQ-*Not organized* 1933-34; San Antonio, TX, 1934-41

Constituted in the Regular Army 1 October 1933, assigned to the Third Army, and allotted to the Eighth Corps Area. Organized 26 November 1934 with Organized Reserve personnel as a RAI unit at San Antonio, TX. Consolidated 10 September 1936 with the 48th Engineer Battalion (Railway Maintenance of Way) (a WWI unit organized in May 1918 at Fort Benjamin Harrison, IN; redesignated 18 September 1918 as the 48th Regiment [Transportation Corps]; demobilized 12 November 1918 in France; reconstituted 10 September 1936). Designated mobilization training station was Fort Ringgold, TX. Location 7 December 1941—San Antonio, TX.

Status: Disbanded 22 December 1942.

49th Engineer Battalion (Railway) (GHQR)

Regular Army Inactive

HQ-New York City, NY, 1928-41; *Inactive* 1941

Constituted in the Regular Army 18 October 1927, assigned to the General Headquarters Reserve, and allotted to the Second Corps Area. Organized in June 1928 with Organized Reserve personnel as a RAI unit at New York City, NY. Inactivated by June 1941 at New York City by relief of Reserve personnel. Location 7 December 1941—*Inactive*.

Status: Disbanded 22 December 1942.

49th Engineer Battalion (Separate) (IX Corps)

Regular Army Inactive

HQ-*Not organized* 1933-36; Los Angeles, CA, 1936-41

Constituted in the Regular Army 1 October 1933, assigned to the IX Corps, and allotted to the Ninth Corps Area. Organized 17 March 1936 with Organized Reserve personnel as a RAI unit at Los Angeles, CA. Consolidated 10 September 1936 with the 49th Engineer Battalion (Railway Maintenance of Way) (a WWI unit organized in March 1918 at Fort Myer, VA; redesignated 18 September 1918 as the 49th Regiment [Transportation Corps]; demobilized 2-12 July 1919 as separate engineer companies; reconstituted 10 September 1936). Conducted summer training at Camp Ord, CA. Designated mobilization training station was Fort Ringgold, TX. Location 7 December 1941—Los Angeles, CA.

Status: Disbanded 22 December 1942.

50th Engineer Battalion (Railway) (GHQR)

Regular Army Inactive

HQ-*Not organized* 1933-30; New York City, NY, 1930-33; Jersey City, NJ 1933-41

Constituted in the Regular Army 18 October 1927, assigned to the General Headquarters Reserve, and allotted to the Second Corps Area. Organized 9 January 1930 with Organized Reserve personnel as a RAI unit at New York City, NY. Redesignated as the 50th Engineer Railway Operation Battalion 23 September 1933 and relocated to Elizabeth, NJ. Consolidated 24 September 1936 with the 50th Engineer Battalion (Railway Maintenance of Way) (a WWI unit

organized in April 1918 at Camp Laurel, MD; redesignated 18 September 1918 as the 50th Regiment [Transportation Corps]; reconstituted 24 September 1936). Conducted summer training at Fort DuPont, DE. Designated mobilization training station was Camp Smith, NY, 1933-38 and Fort Belvoir, VA, 1939-40. Redesignated 21 February 1941 as the 715th Engineer Battalion (Railway Operating). Affiliated with the Illinois Central Railroad 27 November 1941.

50th Engineer Battalion (Separate) (GHQR)

Regular Army Inactive

HQ-Not organized 1933-38

Constituted in the Regular Army 1 October 1933, assigned to the General Headquarters Reserve, and allotted to the Second Corps Area. Newark, NJ, designated as headquarters on organization, but the unit was never organized at that location. Designated mobilization training station Camp Smith, NY. Redesignated 1 January 1938 as the 91st Engineer Battalion (Separate).

51st Engineer Battalion (Railway) (GHQR)

Regular Army Inactive

HQ-Not organized 1927-30; Philadelphia, PA, 1928-41

Constituted in the Regular Army 18 October 1927, assigned to the General Headquarters Reserve, and allotted to the Third Corps Area. Organized 20 January 1930 with Organized Reserve personnel as a RAI unit at Philadelphia, PA. Typically conducted Inactive Training Period meetings at the Society of American Military Engineers in Philadelphia. Redesignated 21 February 1941 as the 712th Engineer Battalion (Railway Operating). Affiliated with the Reading and Central of New Jersey Railroads 27 November 1941.

51st Engineer Battalion (Separate) (I Corps)

Regular Army Inactive

HQ-Not organized 1933-34; Fort Devens, MA, 1934-38

Constituted in the Regular Army 1 October 1933, assigned to the I Corps, and allotted to the First Corps Area. Organized by April 1934 with Organized Reserve personnel as a RAI unit at Fort Devens, MA. Conducted summer training at Fort Devens, MA. Redesignated 1 January 1938 as the 92nd Engineer Battalion (Separate).

52nd Engineer Battalion (Railway) (GHQR)

Regular Army Inactive

HQ-Not organized 1927-29; Philadelphia, PA, 1929-41

Constituted in the Regular Army 18 October 1927, assigned to the General Headquarters Reserve, and allotted to the Third Corps Area. Organized 10 December 1929 with Organized Reserve personnel as a RAI unit at Philadelphia, PA. Typically conducted Inactive Training Period meetings at the Society of American Military Engineers in Philadelphia. Redesignated 21 February 1941 as the 717th Engineer Battalion (Railway Operating). Affiliated with the Reading Railroad 27 November 1941.

Status: Inactive as the 717th Transportation Battalion (Railway Operating).

52nd Engineer Battalion (Separate) (II Corps)

Regular Army Inactive

HQ-Not organized 1933-38

Constituted in the Regular Army 1 October 1933, assigned to the II Corps, and allotted to the Second Corps Area. New York City, NY, designated as headquarters on organization, but the unit was never organized at that location. Designated mobilization training station Camp Smith, NY. Redesignated 1 January 1938 as the 93rd Engineer Battalion (Separate) (Colored).

53rd Engineer Battalion (Railway) (GHQR)**Regular Army Inactive****HQ**-Cincinnati, OH, 1928-34; Canton, OH, 1934-41

Constituted in the Regular Army 18 October 1927, assigned to the General Headquarters Reserve, and allotted to the Fifth Corps Area. Organized about 1928 with Organized Reserve personnel as a RAI unit at Cincinnati, OH. Consolidated 24 September 1936 with the 53rd Engineer Railway Operating Battalion (organized in March 1918 at Camp Dix, NJ; redesignated 18 September 1918 as the 53rd Regiment [Transportation Corps]; reconstituted 24 September 1936). Conducted summer training at Camp Knox, KY. Redesignated 21 February 1941 as the 718th Engineer Battalion (Railway Operating). Affiliated with the Cleveland, Cincinnati, Chicago, and St. Louis Railroad 27 November 1941.

Status: Inactive as the 718th Transportation Battalion (Truck).**53rd Engineer Battalion (Separate) (III Corps)****Regular Army Inactive****HQ**-*Not organized* 1933-34; Fort Belvoir, VA, 1934-37; Chambersburg, PA, 1937-38

Constituted in the Regular Army 1 October 1933 as the 53rd Engineer Battalion (Separate), assigned to the III Corps, and allotted to the Third Corps Area. Organized by August 1934 with Organized Reserve personnel as a RAI unit at Fort Belvoir, VA. Relocated by December 1937 to Chambersburg, PA. Conducted summer training at Fort Belvoir. Redesignated 1 January 1938 as the 94th Engineer Battalion (Separate) (Colored).

Status: Inactive as the 94th Engineer Battalion.**54th Engineer Battalion (Railway) (GHQR)****Regular Army Inactive****HQ**-*Not organized* 1927-28; Chicago, IL, 1928-40; *Inactive* 1940-41

Constituted in the Regular Army 18 October 1927, assigned to the General Headquarters Reserve, and allotted to the Sixth Corps Area. Organized 5 November 1928 with Organized Reserve personnel as a RAI unit at Chicago, IL. Attached to the 86th Division for administrative control 3 November 1930. Consolidated 24 September 1936 with the 54th Engineer Battalion (Railway Operation) (a WWI unit organized in March 1918 at Camp Dix, NJ; redesignated 18 September 1918 as the 54th Regiment [Transportation Corps]; reconstituted 24 September 1936). Designated mobilization training station was Fort McClellan, AL, 1927-38 and the Georgia National Guard Reservation at Toccoa, GA, 1938-41. Withdrawn from the Sixth Corps Area 14 November 1940 and allotted to the Fourth Corps Area. Disbanded 21 February 1941.

54th Engineer Battalion (Separate) (GHQR)**Regular Army Inactive****HQ**-*Not organized* 1933-37; Jersey City, NJ 1937-38

Constituted in the Regular Army 1 October 1933, assigned to the General Headquarters Reserve, and allotted to the Second Corps Area. Organized about August 1937 with Organized Reserve personnel as a RAI unit at Jersey City, NJ. Designated mobilization training station was Camp Smith, NY. Redesignated 1 January 1938 as the 95th Engineer Battalion (Separate).

55th Engineer Battalion (Railway) (GHQR)**Regular Army Inactive****HQ**-*Not organized* 1927-28; Chicago, IL, 1928-41

Constituted in the Regular Army 18 October 1927, assigned to the General Headquarters Reserve, and allotted to the Sixth Corps Area. Organized 5 November 1928 with Organized Reserve personnel as a RAI unit at Chicago, IL. Designated mobilization training stations were Fort McClellan, AL, 1927-38 and the Georgia National Guard Reservation at Toccoa, GA, 1938-41. Redesignated 21 February 1941 as the 713th Engineer Battalion (Railway Operating). Affiliated with the Atchison, Topeka, and Santa Fe Railroad 27 November 1941. Location 7 December 1941—Chicago, IL.

Status: Inactive as the 713th Transportation Railway Operating Battalion.**55th Engineer Battalion (Separate) (GHQR)****Regular Army Inactive****HQ**-*Not organized* 1933-35; Second Corps Area 1935-38

Constituted in the Regular Army 1 October 1933, assigned to the General Headquarters Reserve, and allotted to the Second Corps Area. Organized by April 1935 with Organized Reserve personnel as a RAI unit with headquarters in southern New York. Designated mobilization training station was Camp Smith, NY. Redesignated 1 January 1938 as the 96th Engineer Battalion (Separate).

Status: Inactive in the Regular Army as the 96th Engineer Battalion.**56th Engineer Battalion (Railway) (GHQR)****Regular Army Inactive****HQ**-*Not organized* 1927-32; Omaha, NE, 1932-40

Constituted in the Regular Army 18 October 1927, assigned to the General Headquarters Reserve, and allotted to the Seventh Corps Area. Organized by May 1932 with Organized Reserve personnel as a RAI unit at Omaha, NE. Designated mobilization training station was Camp Ord, CA. Redesignated 21 February 1941 as the 714th Engineer Battalion (Railway Operating). Affiliated with the Chicago, St. Paul, and Omaha Railroad. Location 7 December 1941—Omaha, NE.

56th Engineer Battalion (Separate) (GHQR)**Regular Army Inactive****HQ**-*Not organized* 1933-34; Chicago, IL, 1934-37; Springfield, IL, 1937-41; Camp Blanding, FL, 1941

Constituted in the Regular Army 1 October 1933, assigned to the General Headquarters Reserve, and allotted to the Sixth Corps Area. Organized by April 1934 with Organized Reserve personnel as a RAI unit at Chicago, IL. Relocated 7 April 1937 to Springfield, IL. Conducted summer training at Camp Custer, MI. Designated mobilization training station was the Georgia National Guard Reservation at Toccoa, GA. Redesignated 1 January 1938 as the 97th Engineer Battalion (Separate) (Colored).

57th Engineer Battalion (Railway) (GHQR)**Regular Army Inactive****HQ**-*Not organized* 1927-30; St. Louis, MO, 1930-36; Omaha, NE, 1936-41

Constituted in the Regular Army 18 October 1927, assigned to the General Headquarters Reserve, and allotted to the Seventh Corps Area. Organized 20 January 1930 with Organized Reserve personnel as a RAI unit at St. Louis, MO. Redesignated as 21 February 1941 the 716th Engineer Battalion (Railway Operating). Affiliated with the Southern Pacific Railroad. Location 7 December 1941—Omaha, NE.

57th Engineer Battalion (Separate) (GHQR)**Regular Army Inactive****HQ**-*Not organized* 1933-34; Milwaukee, WI 1934-40; *Inactive* 1940-41

Constituted in the Regular Army 1 October 1933, assigned to the General Headquarters Reserve, and allotted to the Sixth Corps Area. Organized by May 1934 with Organized Reserve personnel as a RAI unit at Milwaukee, WI. Designated mobilization training station was the Georgia National Guard Reservation at Toccoa, GA. Redesignated 1 January 1938 as the 98th Engineer Battalion (Separate) (Colored). Inactivated by October 1940 at Milwaukee by relief of Reserve personnel.

Location: 7 December 1941—*Inactive*.**58th Engineer Battalion (Railway) (GHQR)****Regular Army Inactive****HQ**-*Not organized* 1927-29; Fort Logan, CO, 1929-36; Wichita Falls, TX, 1936-41

Constituted in the Regular Army 18 October 1927, assigned to the General Headquarters Reserve, and allotted to the Eighth Corps Area. Organized 12 April 1929 with Organized Reserve personnel as a RAI unit at Fort Logan, CO. Consolidated 24 September 1936 with the 58th Engineer Battalion (Railway Operation) (a WWI unit organized in January 1918 at Washington Barracks, DC; demobilized in September 1919 at Camp A. A. Humphreys, VA). Relocated 25 November 1936 to Wichita Falls, TX. Affiliated with the Southern Pacific Railroad 2 January 1941. Conducted summer training with the 2nd Engineer Regiment at Fort Logan, CO. Designated mobilization training station was Fort Logan. Redesignated 21 February 1941 as the 719th Engineer Battalion (Railway Operating). Location 7 December 1941—Wichita Falls, TX.

Status: Inactive as the 719th Transportation Battalion (Railway Operating).**58th Engineer Battalion (Separate) (C) (GHQR)****Regular Army Inactive****HQ**-*Not organized* 1933-34; Birmingham, AL, 1934-38

Constituted in the Regular Army 1 October 1933, assigned to the General Headquarters Reserve, and allotted to the Fourth Corps Area. Organized 6 December 1934 with Organized Reserve personnel as a RAI unit at Birmingham, AL. Redesignated 1 January 1938 as the 99th Engineer Battalion (Separate).

59th Engineer Battalion (Separate) (C) (IV Corps)**Regular Army Inactive****HQ**-*Not organized* 1933-34; Knoxville, TN, 1934-41

Constituted in the Regular Army 1 October 1933, assigned to the IV Corps, and allotted to the Fourth Corps Area. Organized 6 December 1934 with Organized Reserve personnel as a RAI unit at Knoxville, TN. Designated mobilization training station was Fort Benning, GA. Location 7 December 1941—Knoxville, TN.

Status: Disbanded 22 December 1942.

60th Engineer Battalion (Auxiliary) (GHQR)**Regular Army Inactive****HQ**-*Not organized* 1927-28; Salem, MA, 1928-36; *Inactive* 1936-41

Constituted in the Regular Army 18 October 1927, assigned to the General Headquarters Reserve, and allotted to the First Corps Area. Organized by June 1928 with Organized Reserve personnel as a RAI unit at Salem, MA. Redesignated 7 May 1930 as the 60th Engineer Battalion (Separate). Battalion affiliated with Yale University R.O.T.C. and organized as a RAI unit in 1930 with Regular Army personnel assigned to the R.O.T.C. detachment and Reserve officers commissioned from the program. Conducted summer training various times at Camp Devens, MA, Fort A. A. Humphreys, VA, and Fort Du Pont, DE. Designated mobilization training station Camp Devens, MA. Withdrawn from the First Corps Area 5 June 1936 and allotted to the Sixth Corps Area. Chicago, IL, designated as headquarters on organization, but the unit was never organized at that location. Location 7 December 1941—*Inactive*.

Status: Disbanded 22 December 1942; reconstituted 4 January 1943; inactive in the U.S. Army Reserve as the 491st Engineer Battalion.

61st Engineer Battalion (Auxiliary) (C) (II Corps)**Regular Army Inactive****HQ**-*Not organized* 1927-28; New York City, NY, 1928-41

Constituted in the Regular Army 18 October 1927, assigned to the II Corps, and allotted to the Second Corps Area. Organized 24 April 1928 with Organized Reserve personnel as a RAI unit at New York City, NY. Redesignated 7 May 1930 as the 61st Engineer Battalion (Separate). Relieved from the II Corps 1 October 1933 and assigned to the General Headquarters Reserve. Typically conducted Inactive Training Period meetings at the Port Authority Building, 111 Eighth Avenue in New York City. Conducted summer training with the 1st Engineer Regiment at Fort Du Pont, DE. Designated mobilization training station was Fort Belvoir, VA. Location 7 December 1941—New York City, NY.

Status: Disbanded 22 December 1942.

62nd Engineer Battalion (Auxiliary) (C) (III Corps)**Regular Army Inactive****HQ**-*Not organized* 1927-29; Norfolk, VA, 1929-41

Constituted in the Regular Army 18 October 1927, assigned to the III Corps, and allotted to the Third Corps Area. Organized 22 October 1929 with Organized Reserve personnel as a RAI unit at Norfolk, VA. Redesignated 7 May 1930 as the 62nd Engineer Battalion (Separate). Relieved from the III Corps 1 October 1933 and assigned to the General Headquarters Reserve. Typically conducted Inactive Training Period meetings at the US Court House or the Post Office Building in Norfolk. Conducted summer training at Fort Belvoir, VA. Designated mobilization training station was Fort Belvoir. Primary R.O.T.C. feeder school was the Virginia Polytechnic Institute. Location 7 December 1941—Norfolk, VA.

Status: Disbanded 22 December 1942.

63rd Engineer Battalion (Auxiliary) (C) (GHQR)**Regular Army Inactive****HQ**-*Not organized* 1927-28; Nashville, TN, 1928-41

Constituted in the Regular Army 18 October 1927, assigned to the General Headquarters Reserve, and allotted to the Fourth Corps Area. Organized 17 March 1928 with Organized Reserve personnel as a RAI unit at Nashville, TN. Redesignated 7 May 1930 as the 63rd Engineer Battalion (Separate). Conducted summer training with Company A, 4th Engineers at Fort Benning, GA. Designated mobilization training station was the Georgia National Guard Reservation at Toccoa, GA. Location 7 December 1941—Nashville, TN.

Status: Disbanded 22 December 1942.

64th Engineer Battalion (Auxiliary) (C) (Third Army)**Regular Army Inactive****HQ**-*Not organized* 1927-28; Memphis, TN, 1928-36; Huntington, WV 1936-41

Constituted in the Regular Army 18 October 1927, assigned to the Third Army, and allotted to the Fourth Corps Area. Organized 4 April 1928 with Organized Reserve personnel as a RAI unit at Memphis, TN. Redesignated 7 May 1930 as the 64th Engineer Battalion (Separate). Relieved from the Third Army 1 October 1933 and assigned to the General Headquarters Reserve. Conducted summer training with Company A, 4th Engineers at Fort Benning, GA, 1927-36. Withdrawn from the Fourth Corps Area 5 June 1936 and allotted to the Fifth Corps Area. Organized in late 1936 as a RAI unit with Organized Reserve personnel at Huntington, WV. Designated mobilization training station was the Georgia National Guard Reservation at Toccoa, GA. Location 7 December 1941—Huntington, WV.

Status: Disbanded 22 December 1942.**65th Engineer Battalion (Auxiliary) (C) (GHQR)****Regular Army Inactive****HQ**-*Not organized* 1927-28; Miami, FL, 1928-36; Fairmont, WV 1936-41; Schofield Barracks, TH

Constituted in the Regular Army 18 October 1927, assigned to the General Headquarters Reserve, and allotted to the Fourth Corps Area. Organized 4 April 1928 with Organized Reserve personnel as a RAI unit at Miami, FL. Redesignated 7 May 1930 as the 65th Engineer Battalion (Separate). Withdrawn from the Fourth Corps Area 5 June 1936 and allotted to the Fifth Corps Area. Organized in late 1936 as a RAI unit with Organized Reserve personnel at Fairmont, WV. Conducted summer training with Company A, 4th Engineers at Fort Benning, GA, 1927-35. Designated mobilization training station Camp Smith, NY, 1927-36, and the Georgia National Guard Reservation at Toccoa, GA, 1936-41. Activated 1 October 1941, less Reserve personnel, as the 65th Engineer Battalion (Combat) at Schofield Barracks, TH, and assigned to the 25th Infantry Division. Location 7 December 1941—Schofield Barracks, TH.

Status: Active in the Regular Army at Schofield Barracks, HI, as a component of the 25th Infantry Division (Light).**66th Engineer Battalion (Auxiliary) (C) (GHQR)****Regular Army Inactive****HQ**-*Not organized* 1927-28; Montgomery, AL, 1928-40; *Inactive* 1940-41

Constituted in the Regular Army 18 October 1927, assigned to the General Headquarters Reserve, and allotted to the Fourth Corps Area. Organized 20 April 1928 with Organized Reserve personnel as a RAI unit at Montgomery, AL. Redesignated 7 May 1930 as the 66th Engineer Battalion (Separate). Conducted summer training with Company A, 4th Engineers at Fort Benning, GA. Designated mobilization training station was Fort Benning, GA. Inactivated 25 August 1940 at Montgomery by relief of Reserve personnel. Location 7 December 1941—*Inactive*.

Status: Disbanded 22 December 1942.**67th Engineer Battalion (Auxiliary) (C) (GHQR)****Regular Army Inactive****HQ**-*Not organized* 1927-28; Vicksburg, MS, 1928-40; *Inactive* 1940-41

Constituted in the Regular Army 18 October 1927, assigned to the General Headquarters Reserve, and allotted to the Fourth Corps Area. Organized 4 April 1928 with Organized Reserve personnel as a RAI unit at Vicksburg, MS. Redesignated 7 May 1930 as the 67th Engineer Battalion (Separate). Conducted summer training with Company A, 4th Engineers at Fort Benning, GA. Designated mobilization training station was the Georgia National Guard Reservation at Toccoa, GA. Inactivated 1 September 1940 at Vicksburg by relief of Reserve personnel. Location 7 December 1941—*Inactive*.

Status: Disbanded 22 December 1942.

68th Engineer Battalion (Auxiliary) (C)**Regular Army Inactive**

HQ-*Not organized* 1927-28; Cincinnati, OH, 1928-33; Birmingham, AL, 1933-39; Montgomery, AL, 1939-40; *Inactive* 1940-41

Constituted in the Regular Army 18 October 1927 and allotted to the Fifth Corps Area. Organized 18 April 1928 with Organized Reserve personnel as a RAI unit at Cincinnati, OH. Redesignated 7 May 1930 as the 68th Engineer Battalion (Separate). Conducted summer training at Camp Knox, KY. Withdrawn from the Fifth Corps Area 1 October 1933 and allotted to the Fourth Corps Area. Concurrently assigned to the IV Corps and organized as a RAI unit with Organized Reserve personnel at Birmingham, AL. Relocated about 1939 to Montgomery, AL. Inactivated 20 August 1940 at Montgomery by relief of Reserve personnel. Location 7 December 1941—*Inactive*.

Status: Disbanded 22 December 1942.

69th Engineer Battalion (Auxiliary) (C) (GHQR)**Regular Army Inactive**

HQ-*Not organized* 1927-28; Covington, KY, 1928-34; Terre Haute, IN, 1934-41

Constituted in the Regular Army 18 October 1927, assigned to the General Headquarters Reserve, and allotted to the Fifth Corps Area. Organized 20 March 1928 with Organized Reserve personnel as a RAI unit at Covington, KY. Redesignated 7 May 1930 as the 69th Engineer Battalion (Separate). Relocated about 1934 to Terre Haute, IN. Conducted summer training at Camp Knox, KY. Designated mobilization training station was the Georgia National Guard Reservation at Toccoa, GA. Location 7 December 1941—Terre Haute, IN.

Status: Disbanded 22 December 1942.

70th Engineer Battalion (Auxiliary) (C) (GHQR)**Regular Army Inactive**

HQ-Detroit, MI, 1927-36; *Inactive* 1936-37; Springfield, MA, 1937-41



Constituted in the Regular Army 18 October 1927, assigned to the General Headquarters Reserve, and allotted to the Sixth Corps Area. Organized 7 November 1927 with Organized Reserve personnel as a RAI unit at Detroit, MI. Redesignated 7 May 1930 as the 70th Engineer Battalion (Separate). Withdrawn from the Sixth Corps Area 5 June 1936 and allotted to the First Corps Area. Organized by April 1937 as a RAI unit with Organized Reserve personnel at Springfield, MA. Conducted summer training at Camp Custer, MI, 1928-35. Designated mobilization training stations were Fort McClellan, AL, 1927-38, and the Georgia National Guard Reservation at Toccoa, GA, 1938-41. Location 7 December 1941—Springfield, MA.

Status: Disbanded 22 December 1942.

71st Engineer Battalion (Auxiliary) (C) (GHQR)**Regular Army Inactive**

HQ-*Not organized* 1927-29; St. Paul, MN, 1929-41; *Inactive* 1941

Constituted in the Regular Army 18 October 1927, assigned to the General Headquarters Reserve, and allotted to the Seventh Corps Area. Organized by May 1929 with Organized Reserve personnel as a RAI unit at St. Paul, MN. Redesignated 7 May 1930 as the 71st Engineer Battalion (Separate). Typically conducted Inactive Training Period meetings at the Union Building, University of Minnesota in Minneapolis. Conducted summer training at Fort Riley, KS, Fort Logan, CO, or Fort Snelling, MN. Designated mobilization training station was Camp Ord, CA. Inactivated by September 1941 at St. Paul by relief of Reserve personnel. Location 7 December 1941—*Inactive*.

Status: Disbanded 22 December 1942.

72nd Engineer Battalion (Auxiliary) (C) (GHQR)**Regular Army Inactive****HQ-Not organized** 1927-30; St. Paul, MN, 1930-34; Omaha, NE, 1934-41

Constituted in the Regular Army 18 October 1927, assigned to the General Headquarters Reserve, and allotted to the Seventh Corps Area. Redesignated 7 May 1930 as the 72nd Engineer Battalion (Separate). Organized in 1930 with Organized Reserve personnel as a RAI unit at St. Paul, MN. Relocated in October 1934 to Omaha, NE. Conducted summer training at Fort Snelling, MN. Location 7 December 1941—Omaha, NE.

Status: Disbanded 22 December 1942.**73rd Engineer Battalion (Auxiliary) (C) (GHQR)****Regular Army Inactive****HQ-Not organized** 1927-28; Albuquerque, NM, 1928-30; Denver, CO, 1930-41

Constituted in the Regular Army 18 October 1927, assigned to the General Headquarters Reserve, and allotted to the Eighth Corps Area. Organized 5 November 1928 with Organized Reserve personnel as a RAI unit at Albuquerque, NM. Redesignated 7 May 1930 as the 73rd Engineer Battalion (Separate). Relocated 30 June 1930 to Denver, CO. Conducted summer training most years at Fort Logan, CO, and some years at Fort Riley, KS. Conducted infantry C.M.T.C. training at Fort Huachuca, AZ, in 1937 as an alternate form of annual training. Designated mobilization training station was Fort Logan. Location 7 December 1941—Denver, CO.

Status: Disbanded 22 December 1942.**74th Engineer Battalion (Auxiliary) (GHQR)****Regular Army Inactive****HQ-Not organized** 1927-29; Portland, OR, 1929-36; *Inactive* 1936-39; Davenport, IA, 1939-41; *Inactive* 1941

Constituted in the Regular Army 18 October 1927, assigned to the General Headquarters Reserve, and allotted to the Ninth Corps Area. Redesignated 7 May 1930 as the 74th Engineer Battalion (Separate). Organized by April 1929 with Organized Reserve personnel as a RAI unit at Portland, OR. Withdrawn from the Ninth Corps Area 5 June 1936 and allotted to the Seventh Corps Area. Organized by early 1939 as a RAI unit with Organized Reserve personnel at Davenport, IA. Typically conducted Inactive Training Period meetings at the Post Office building in Davenport. Conducted summer training at Fort Lewis, WA, 1928-36 and Fort Snelling, MN, 1939-40. Inactivated by September 1941 at Portland by relief of Reserve personnel. Location 7 December 1941—*Inactive*.

Status: Disbanded 22 December 1942.**75th Engineer Battalion (Separate)****Regular Army Inactive****HQ-Not organized** 1935-41

Constituted in the Regular Army 11 December 1935 and allotted to the Panama Canal Department. Unit never organized. Location 7 December 1941—*Not organized*.

Status: Disbanded 22 December 1942.**76th Engineer Battalion (Water Supply) (Fourth Army)****Regular Army Inactive****HQ-Not organized** 1927-29; Portland, OR, 1929-37; Los Angeles, CA, 1937-41

Constituted in the Regular Army 18 October 1927, assigned to the General Headquarters Reserve, and allotted to the Ninth Corps Area. Organized by May 1929 with Organized Reserve personnel as a RAI unit at Portland, OR. Relocated by 1937 to Los Angeles, CA. Conducted summer training with the 6th Engineer Regiment at Fort Lewis, WA. Relieved from the Fourth Army 1 October 1933 and assigned to the General Headquarters Reserve. Designated mobilization training station was Camp Ord, CA. Location 7 December 1941—Los Angeles, CA.

77th Engineer Battalion (Water Supply) (GHQR)**Regular Army Inactive****HQ**-St. Paul, MN, 1927-33; *Inactive* 1933-34; Dallas, TX, 1934-36; *Inactive* 1936-38; Chicago, IL, 1938-41

Constituted in the Regular Army 18 October 1927, assigned to the General Headquarters Reserve, and allotted to the Seventh Corps Area. Organized in late 1927 with Organized Reserve personnel as a RAI unit at St. Paul, MN. Withdrawn from the Seventh Corps Area 1 October 1933 and allotted to the Eighth Corps Area. Organized 20 October 1934 with Organized Reserve personnel as a RAI unit at Dallas, TX. Withdrawn from the Eighth Corps Area 5 June 1936 and allotted to the Sixth Corps Area. Organized 11 July 1938 with Organized Reserve personnel as a RAI unit at Chicago, IL. Designated mobilization training station was Fort McClellan, AL, 1927-38, and the Georgia National Guard Reservation at Toccoa, GA, 1938-41. Location 7 December 1941—*Inactive*.

Status: Disbanded 22 December 1942.**80th Engineer Battalion (Water Supply) (GHQR)****Regular Army Inactive****HQ**-Newport, KY, 1922-33; Columbia, SC, 1934-40; *Inactive* 1940-41; Camp Livingston, LA, 1941

Constituted in the Organized Reserves 15 October 1921 as the 520th Engineer Train (Water Tank), assigned to the General Headquarters Reserve, and allotted to the Fifth Corps Area. Organized in January 1922 with headquarters at Newport, KY. Redesignated as the 520th Engineer Battalion (Water Supply). Conducted summer training at Camp Knox, KY. Withdrawn from the Fifth Corps Area 1 October 1933 and allotted to the Fourth Corps Area. Headquarters organized 12 June 1934 at Columbia, SC. Withdrawn from the Organized Reserve 1 January 1938 and allotted to the Regular Army. Inactivated 15 August 1940 at Columbia by relief of Reserve personnel. Redesignated 16 December 1940 as the 80th Engineer Battalion (Water Supply). Assigned 24 January 1941 to the Third Army. Activated 28 July 1941 at Camp Livingston, LA. Location 7 December 1941—Camp Livingston, LA.

Events: 328, 330**81st Engineer Battalion (Railway Shop) (GHQR)****Regular Army Inactive****HQ**-*Not organized* 1933-35; Third Corps Area 1935-37; *Inactive* 1937-41; Bucyrus, OH, 1941

Constituted in the Regular Army 1 July 1933, assigned to the General Headquarters Reserve, and allotted to the Third Corps Area. Organized by April 1935 in the Third Corps Area. Consolidated 24 September 1936 with the 81st Engineer Battalion (Locomotive Repair) (a WWI unit organized in September 1918 at Fort Benjamin Harrison, IN; demobilized in December 1918 at Fort Benjamin Harrison, IN). Inactivated by June 1937 in the Third Corps Area by relief of personnel. Designated mobilization training station was Fort Belvoir, VA. Redesignated 21 February 1941 as the 753rd Engineer Battalion (Railway Shop). Concurrently, withdrawn from the Third Corps Area and allotted to the Fifth Corps Area. Affiliated 27 November 1941 with the Cleveland, Cincinnati, Chicago, and St. Louis Railroad. Organized about November 1941 with Organized Reserve personnel as a RAI unit at Bucyrus, OH. Location 7 December 1941—Bucyrus, OH.

82nd Engineer Battalion (Railway Operating) (GHQR)**Regular Army Inactive****HQ**-Fort Belvoir, VA, 1941

Constituted in the Regular Army 21 January 1941, assigned to the General Headquarters Reserve, and allotted to the Third Corps Area. Attached 24 January 1941 to the Third Army. Redesignated 2 February 1941 as the 711th Engineer Battalion (Railway Operating). Activated 18 June 1941 at Fort Belvoir, VA. Location 7 December 1941—Fort Belvoir, VA.

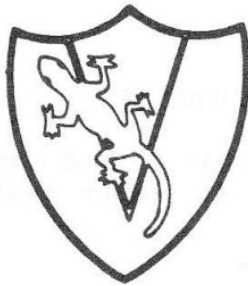
84th Engineer Battalion (Camouflage) (Army)**Regular Army Inactive****HQ**-Columbus, OH, 1930-41; Fort Belvoir, VA, 1941

Constituted in the Organized Reserves 31 March 1930, as the 602nd Camouflage Battalion, Corps of Engineers, assigned to the General Headquarters Reserve, and allotted to the Fifth Corps Area. Organized about 1930 with headquarters at Columbus, OH. Redesignated 20 August 1931 as the 602nd Engineer Battalion (Camouflage). Withdrawn from the Organized Reserve 1 January 1938 and allotted to the Regular Army. Designated mobilization training station was Camp Smith, NY. Redesignated as the 84th Engineer Battalion (Camouflage) (Army) 1 July 1940. Concurrently, Company A activated at Fort Belvoir, VA. Assigned 24 January 1941 to the First Army. The remainder of the battalion activated 4 June 1941, less Reserve personnel, at Fort Belvoir, VA, and assigned to the First Army. Location 7 December 1941—Fort Belvoir, VA.

Status: Active in the Regular Army at Schofield Barracks, HI, as the 84th Engineer Battalion (Combat Heavy).**Events:** 330**85th Engineer Battalion (Separate) (V Corps)****Regular Army Inactive****HQ**-Terre Haute, IN, 1934-41

Constituted in the Regular Army 1 October 1933 as the 45th Engineer Battalion (Separate), assigned to the V Corps, and allotted to the Fifth Corps Area. Organized in 1934 with Organized Reserve personnel as a RAI unit at Terre Haute, IN. Redesignated 1 January 1938 as the 85th Engineer Battalion (Separate). Disbanded 25 April 1941.

85th Engineer Battalion (Heavy Ponton) (GHQR)**HQ**-Pulaski, TN, 1929-39; Chattanooga, TN, 1939-41; Fort Belvoir, VA, 1941

Constituted in the Organized Reserve 5 September 1928 as the 958th Engineer Battalion (Heavy Ponton), assigned to the General Headquarters Reserve, and allotted to the Fourth Corps Area. Organized 1 October 1929 with headquarters at Pulaski, TN. Withdrawn from the Organized Reserve 1 October 1933 and allotted to the Regular Army. Relocated in 1939 to Chattanooga, TN. Redesignated as the 85th Engineer Battalion (Heavy Ponton) 13 January 1941. Assigned 24 January 1941 to the First Army. Activated 10 June 1941, less Reserve personnel, at Fort Belvoir, VA. Location 7 December 1941—Fort Belvoir, VA.

Status: Inactive in the Regular Army as the 85th Engineer Battalion.**Events:** 328, 330**86th Engineer Battalion (Separate)****Regular Army Inactive****HQ**-*Not organized* 1933-40

Constituted in the Regular Army 1 October 1933 and allotted to the Sixth Corps Area. Designated mobilization training station was Fort McClellan, AL, 1936-38, Georgia National Guard Reservation at Toccoa, GA, 1939-41. Redesignated 15 July 1940 as the 100th Engineer Battalion.

Status: Disbanded 22 December 1942.

86th Engineer Battalion (Heavy Ponton) (Second Army)

HQ-*Not organized* 1940-41; Fort Knox, KY, 1941

Constituted in the Regular Army 15 July 1940 and allotted to the Fifth Corps Area. Assigned 24 January 1941 to the Second Army. Activated 9 July 1941 at Fort Knox, KY, and assigned to the First Army. Designated mobilization station was Fort McClellan, AL. Location 7 December 1941—Fort Knox, KY.

Status: Inactive in the Regular Army as the 86th Engineer Battalion.

Events: 324, 328

87th Engineer Battalion (Heavy Ponton) (Motorized)

Regular Army Inactive

HQ-*Not organized* 1933-39; St. Louis, MO, 1939-40; Fort Benning, GA, 1940-41



Constituted in the Regular Army 1 October 1933 as the 47th Engineer Battalion (Heavy Ponton), assigned to the General Headquarters Reserve, and allotted to the Seventh Corps Area. Redesignated as the 87th Engineer Battalion (Heavy Ponton) 1 January 1938. Organized by April 1939 with Organized Reserve personnel as a RAI unit at St. Louis, MO. Conducted summer training at Fort Snelling, MN. Designated mobilization training station was Camp Ord, CA. Activated 1 August 1940, less Reserve personnel, at Fort Benning, GA, and assigned to the VIII Corps. Relieved from the VIII Corps in September 1941 and assigned to the Third Army. Location 7 December 1941—Fort Benning, GA.

Status: Active in the Regular Army at Fort Leonard Wood, MO, as the 87th Engineer Battalion.

Events: 316, 323, 328

88th Engineer Battalion (Heavy Ponton) (Motorized)

Regular Army Inactive

HQ-Cleveland, OH, 1933-41; Camp Beauregard, LA, 1941



Constituted in the Regular Army 1 October 1933 as the 19th Engineer Battalion (Heavy Ponton) and allotted to the Fifth Corps Area. Organized in late 1933 with Organized Reserve personnel as a RAI unit at Cleveland, OH. Conducted summer training at Fort Knox, KY, in 1938. Redesignated 1 July 1940 as the 88th Engineer Battalion (Heavy Ponton). Assigned 24 January 1941 to the Third Army. Activated 2 June 1941, less Reserve personnel, at Camp Beauregard, LA, and assigned to the V Corps. Location 7 December 1941—Camp Beauregard, LA.

Status: Inactive in the Regular Army as the 88th Supply and Service Battalion.

89th Engineer Battalion (Heavy Ponton) (Motorized)

Regular Army Inactive

HQ-Wausau, WI 1934-41; Fort Leonard Wood, MO, 1941

Constituted in the Regular Army 1 October 1933 as the 20th Engineer Battalion (Heavy Ponton) and allotted to the Sixth Corps Area. Organized by June 1934 with Organized Reserve personnel as a RAI unit at Wausau, WI. Redesignated 1 July 1940 as the 89th Engineer Battalion (Heavy Ponton). Activated 1 November 1940, less Reserve personnel, at Fort Leonard Wood, MO. Assigned 24 January 1941 to the Second Army. Location 7 December 1941—Fort Leonard Wood, MO.

Status: Disbanded 26 October 1944.

1790

90th Engineer Battalion (Heavy Ponton) (Motorized) (GHQR)**Regular Army Inactive****HQ**-*Not organized* 1927-29; Pittsburgh, PA, 1928-41; Fort Lewis, WA, 1941

Constituted in the Regular Army 18 October 1927 as the 90th Engineer Train (Heavy Bridge), assigned to the General Headquarters Reserve, and allotted to the Third Corps Area. Redesignated 14 January 1929 as the 90th Engineer Battalion (Heavy Ponton). Organized 29 October 1929 with Organized Reserve personnel as a RAI unit at Pittsburgh, PA. Typically conducted Inactive Training Period meetings at the 176th Field Artillery armory or the New Federal Building in Pittsburgh. Conducted summer training at Fort Belvoir, VA. Activated 20 January 1941, less Reserve personnel, at Fort Lewis, WA. Assigned 24 January 1941 to the Fourth Army. Location 7 December 1941—Fort Lewis, WA.

Status: Disbanded 26 October 1944.**91st Engineer Battalion (Separate) (C)****Regular Army Inactive****HQ**-*Not organized* 1933-39; East Orange, NJ 1939-41; Camp Shelby, MS, 1941

Constituted in the Regular Army 1 October 1933 as the 50th Engineer Battalion (Separate) (Colored) and allotted to the Second Corps Area. Designated mobilization training station Camp Smith, NY. Redesignated 1 January 1938 as the 91st Engineer Battalion (Separate). Organized by April 1939 with Organized Reserve personnel as a RAI unit with headquarters at East Orange, NJ. Activated 10 January 1941, less Reserve personnel, at Camp Shelby, MS. Assigned 24 January 1941 to the Third Army. Reserve personnel concurrently transferred to the 515th Engineer Battalion. Location 7 December 1941—Camp Shelby, MS.

Status: Active in the Regular Army at Fort Hood, TX, as a component of the 1st Cavalry Division.**Events:** 328**91st Engineer Battalion (Heavy Ponton) (Motorized)****Regular Army Inactive****HQ**-Tampa, FL, 1928-29

Constituted in the Regular Army 18 October 1927 as the 91st Engineer Train (Heavy Bridge) and allotted to the Fourth Corps Area. Organized about 1928 with Organized Reserve personnel as a RAI unit at Tampa, FL. Redesignated 14 January 1929 as the 91st Engineer Battalion (Heavy Ponton). Demobilized 1 February 1929.

92nd Engineer Battalion (Separate) (C) (I Corps)**Regular Army Inactive****HQ**-*Not organized* 1933-34; Fort Devens, MA, 1934-41; Fort Leonard Wood, MO, 1941

Constituted in the Regular Army 1 October 1933 as the 51st Engineer Battalion (Separate), assigned to the I Corps, and allotted to the First Corps Area. Organized by April 1934 with Organized Reserve personnel as a RAI unit at Fort Devens, MA. Redesignated 1 January 1938 as the 92nd Engineer Battalion (Separate) (Colored). Assigned 24 January 1941 to the Second Army. Activated 2 May 1941, less Reserve personnel, as 92nd Engineer Battalion (Separate) (Colored) at Fort Leonard Wood, MO. Location 7 December 1941—Fort Leonard Wood, MO.

Status: Active in the Regular Army at Fort Stewart, GA, as the 92nd Engineer Battalion (Combat Heavy).**Events:** 324

92nd Engineer Battalion (Heavy Ponton) (Motorized)**Regular Army Inactive****HQ**-Monroe, LA, 1927-29

Constituted in the Regular Army 18 October 1927 as the 94th Engineer Train (Heavy Bridge) and allotted to the Fourth Corps Area. Organized in December 1927 with Organized Reserve personnel as a RAI unit at Monroe, LA. Redesignated 14 January 1929 as the 92nd Engineer Battalion (Heavy Ponton). Demobilized 1 February 1929.

93rd Engineer Battalion (Separate) (C) (II Corps)**Regular Army Inactive****HQ**-*Not organized* 1933-41; Camp Livingston, LA, 1941

Constituted in the Regular Army 1 October 1933 as the 52nd Engineer Battalion (Auxiliary), assigned to the II Corps, and allotted to the Second Corps Area. New York City, NY, designated as headquarters on organization, but the unit was never organized at that location. Designated mobilization training station Camp Smith, NY. Redesignated 1 January 1938 as the 93rd Engineer Battalion (Separate) (Colored). Designated mobilization training station was Fort Belvoir, VA. Relieved from the II Corps 24 January 1941 and assigned to the Third Army. Activated 10 February 1941 at Camp Livingston, LA, and assigned to the Third Army. Location 7 December 1941—Camp Livingston, LA.

Status: Inactive in the Regular Army as the 93rd Engineer Battalion (Construction).

93rd Engineer Battalion (Heavy Ponton) (Motorized)**Regular Army Inactive****HQ**-*Not organized* 1927-29

Constituted in the Regular Army 18 October 1927 as the 93rd Engineer Train (Heavy Bridge) and allotted to the Fifth Corps Area. Redesignated 14 January 1929 as the 93rd Engineer Battalion (Heavy Ponton). Demobilized 1 February 1929.

94th Engineer Battalion (Separate) (C) (III Corps)**Regular Army Inactive****HQ**-*Not organized* 1933-34; Fort Belvoir, VA, 1934-37; Chambersburg, PA, 1937-40; *Inactive* 1940-41; Fort Custer, MI, 1941

Constituted in the Regular Army 1 October 1933 as the 53rd Engineer Battalion (Separate), assigned to the III Corps, and allotted to the Third Corps Area. Organized by August 1934 with Organized Reserve personnel as a RAI unit at Fort Belvoir, VA. Relocated by December 1937 to Chambersburg, PA. Conducted summer training at Fort Belvoir. Redesignated 1 January 1938 as the 94th Engineer Battalion (Separate) (Colored). Inactivated 27 July 1940 at Chambersburg by relief of personnel. Assigned 24 January 1941 to the Second Army. Activated 12 February 1941, less Reserve personnel, at Fort Custer, MI. Location 7 December 1941—Fort Custer, MI.

Status: Active in the Regular Army at Vilseck, Germany, as the 94th Engineer Battalion (Combat Heavy).

Events: 316, 324, 328

94th Engineer Battalion (Heavy Ponton) (Motorized)**Regular Army Inactive****HQ**-Philadelphia, PA, 1927-29

Constituted in the Regular Army 18 October 1927 as the 94th Engineer Train (Heavy Bridge) and allotted to the Third Corps Area. Organized in December 1927 with Organized Reserve personnel as a RAI unit at Philadelphia, PA. Redesignated 14 January 1929 as the 94th Engineer Battalion (Heavy Ponton). Demobilized 1 February 1929.

95th Engineer Battalion (Separate)**Regular Army Inactive**

HQ-Jersey City, NJ 1933-41; Fort Belvoir, VA, 1941



Constituted in the Regular Army 1 October 1933 as the 54th Engineer Battalion (Separate), and allotted to the Second Corps Area. Organized in 1933 with Organized Reserve personnel as a RAI unit at Jersey City, NJ. Designated mobilization training station was Camp Smith, NY. Redesignated 1 January 1938 as the 95th Engineer Battalion (Separate). Typically conducted Inactive Training Period meetings at the Post Office Building in Elizabeth, NJ. Inactivated 10 January 1941 by transfer of Organized Reserve personnel to the 303rd Engineer Regiment. Assigned 24 January 1941 to the First Army. Activated 15 April 1941 at Fort Belvoir, VA. Location 7 December 1941—Fort Belvoir, VA.

Status: Inactive in the Regular Army as the 595th Engineer Battalion.**Events:** 328,330**95th Engineer Battalion (Light Ponton)****Regular Army Inactive**HQ-*Not organized* 1927-41

Constituted in the Regular Army 18 October 1927 as the 95th Engineer Train (Light Bridge) and allotted to the Seventh Corps Area. Redesignated 14 January 1929 as the 95th Engineer Battalion (Light Ponton). Location 7 December 1941—*Not organized*.

96th Engineer Battalion (Separate) (C)**Regular Army Inactive**HQ-*Not organized* 1933-35; Second Corps Area 1935-41; Fort Bragg, NC, 1941

Constituted in the Regular Army 1 October 1933 as the 55th Engineer Battalion (Separate), assigned to the General Headquarters Reserve, and allotted to the Second Corps Area. Organized by April 1935 with Organized Reserve personnel as a RAI unit with headquarters in southern New York. Designated mobilization training station was Camp Smith, NY. Redesignated 1 January 1938 as the 96th Engineer Battalion (Separate) (Colored). Assigned 24 January 1941 to the First Army. Activated 15 June 1941, less Reserve personnel, at Fort Bragg, NC. Location 7 December 1941—Fort Bragg, NC.

Status: Inactive in the Regular Army as the 96th Engineer Battalion.**Events:** 330**97th Engineer Battalion (Light Ponton)****Regular Army Inactive**HQ-*Not organized* 1927-41

Constituted in the Regular Army 18 October 1927 as the 97th Engineer Train (Light Bridge) and allotted to the Second Corps Area. Redesignated 14 January 1929 as the 97th Engineer Battalion (Light Ponton). Location 7 December 1941—*Not organized*.

Status: Disbanded 23 July 1951.

97th Engineer Battalion (Separate)**Regular Army Inactive**

HQ—*Not organized* 1933-34; Chicago, IL, 1934-37; Springfield, IL, 1937-41; Camp Blanding, FL, 1941; Eglin Field, FL, 1941

Constituted in the Regular Army 1 October 1933 as the 56th Engineer Battalion (Separate) and allotted to the Sixth Corps Area. Organized by April 1934 with Organized Reserve personnel as a RAI unit at Chicago, IL. Relocated 7 April 1937 to Springfield, IL. Conducted summer training at Camp Custer, MI. Designated mobilization training station was the Georgia National Guard Reservation at Toccoa, GA. Redesignated 1 January 1938 as the 97th Engineer Battalion (Separate). Assigned in 1939 to the IV Corps. Conducted summer training at Camp Custer, MI. Designated mobilization training station was the Georgia National Guard Reservation at Toccoa, GA. Relieved from the IV Corps 24 January 1941 and assigned to the Third Army. Activated 1 June 1941, less Reserve personnel, at Camp Blanding, FL, and assigned to the Third Army. Transferred to Eglin Field, FL, and arrived there 15 November 1941. Location 7 December 1941—Eglin Field, FL.

Status: Inactive in the Regular Army as the 97th Engineer Construction Battalion.

98th Engineer Battalion (Separate) (C)**Regular Army Inactive**

HQ—*Not organized* 1933-34; Milwaukee, WI 1934-40; *Inactive* 1940-41; Camp Bowie, TX, 1941

Constituted in the Regular Army 1 October 1933 as the 57th Engineer Battalion (Separate) and allotted to the Sixth Corps Area. Organized by May 1934 with Organized Reserve personnel as a RAI unit at Milwaukee, WI. Designated mobilization training station was the Georgia National Guard Reservation at Toccoa, GA. Redesignated as 1 January 1938 the 98th Engineer Battalion (Separate) (Colored). Inactivated in October 1940 at Milwaukee by relief of Reserve personnel. Activated 17 August 1941 at Camp Bowie, TX, and assigned to the Third Army. Location 7 December 1941—Camp Bowie, TX.

Status: Inactive in the Regular Army as the 98th Engineer General Service Regiment.

99th Engineer Battalion (Separate) (C)**Regular Army Inactive**

HQ—Birmingham, AL, 1934-40; *Inactive* 1940-41

Constituted in the Regular Army 1 October 1933 as the 58th Engineer Battalion (Auxiliary) and allotted to the Fourth Corps Area. Organized 6 December 1934 with Organized Reserve personnel as a RAI unit at Birmingham, AL. Redesignated 1 January 1938 as the 99th Engineer Battalion (Separate) (Colored). Designated mobilization training station was the Georgia National Guard Reservation at Toccoa, GA. Inactivated 7 September 1940 at Birmingham by relief of Reserve personnel. Location 7 December 1941—*Inactive*.

Status: Disbanded 22 December 1942.

100th Engineer Battalion (Separate)**Regular Army Inactive**

HQ—*Not organized* 1933-41

Constituted in the Regular Army 1 October 1933 as the 86th Engineer Battalion (Separate) and allotted to the Sixth Corps Area. Designated mobilization training station was Fort McClellan, AL, 1936-38 and the National Guard Reservation at Toccoa, GA, 1939-41. Redesignated 15 July 1940 as the 100th Engineer Battalion (Separate). Location 7 December 1941—*Not organized*.

Status: Disbanded 22 December 1942.

125th Engineer Battalion (Mounted) (21st Cavalry Division)

Pennsylvania/New York National Guard

HQ-Not organized 1921-40

Constituted in the National Guard in 1921, assigned to the 21st Cavalry Division, and allotted to the state of Pennsylvania. Company A was organized 1 April 1923 by redesignation of Company A, 132nd Engineers at Altoona, PA. Company B was organized 23 May 1927 by redesignation of Troop A, 104th Cavalry at Newcastle, PA. Active elements conducted annual summer training at Mount Gretna, PA, 1924-28. Company A redesignated C Troop, 104th Cavalry 1 April 1929. Concurrently B Company redesignated K Troop, 103rd Cavalry. Redesignated 1 June 1931 as the 125th Engineer Squadron. Allotment withdrawn from the state of Pennsylvania 1 January 1939, but remained allotted to the Third Corps Area. Withdrawn from the Third Corps Area 12 October 1939 and allotted to the state of New York, but never organized. Disbanded 1 November 1940.

Events:

126th Engineer Battalion (Mounted) (22nd Cavalry Division)

West Virginia/Wisconsin/Pennsylvania National Guard

HQ-Not organized 1921-40

Constituted in the National Guard in 1921, assigned to the 22nd Cavalry Division, and allotted to the state of West Virginia. Allotment withdrawn from the West Virginia National Guard 30 April 1923 and allotted to the Wisconsin National Guard. Racine, WI, designated as headquarters on organization, but the unit was never organized at that location. Redesignated 1 June 1931 as the 126th Engineer Squadron. Designated headquarters changed by April 1935 to Milwaukee, WI. Allotment withdrawn from the Wisconsin National Guard in 1939 and allotted to the Pennsylvania National Guard. Disbanded 1 November 1940.

127th Engineer Battalion (Mounted) (23rd Cavalry Division)

Wisconsin/West Virginia/Alabama National Guard

HQ-Not organized 1921-26; Huntsville, AL, 1926-40



Constituted in the National Guard in 1921, assigned to the 23rd Cavalry Division, and allotted to the state of Wisconsin. Company A was organized 29 June 1921 at Sheboygan, WI. Company A reorganized and redesignated as Service Battery, 120th Field Artillery 30 April 1923. Concurrently, battalion allotment withdrawn from the Wisconsin National Guard and allotted to the West Virginia National Guard. Allotment withdrawn from the West Virginia National Guard in December 1925 and allotted to the Alabama National Guard. Battalion headquarters organized and Federally recognized 22 August 1926 at Huntsville, AL. The battalion or elements thereof, called up to perform the following state duties: Troops A and B to perform riot control duty in connection with a trial at Huntsville, AL, during September-October 1930; entire battalion to provide storm relief and guard Federal property at Paint Rock and Cullman, AL, 22 March-12 April 1932; Troop C to perform prisoner guard duties in connection with the famous "Scottsboro Boys" trial in Morgan County, AL, 27 March-10 April 1933 and 28 August-5 September 1933. Redesignated 1 June 1931 as the 127th Engineer Squadron. Reorganized and redesignated as the 127th Squadron (Motorized), Corps of Engineers 7 July 1936. Redesignated as the 127th Engineer Squadron (Motorized) 13 July 1936. Conducted annual summer training at Fort Oglethorpe, GA, or Camp McClellan, AL. Designated mobilization training station was Fort Bliss, TX. Relieved from the 23rd Cavalry Division 1 October 1940. Reorganized and redesignated as the 1st Battalion, 151st Engineer Regiment 1 November 1940.

Status: Active in the Alabama National Guard at Huntsville, AL, as the 279th Signal Battalion.

Events: 255, 300

Commanders, 127th Engineer Squadron

Maj. Raymond W. Jones

22 Aug 26-Aug 31

Maj. Edwin W. Jones

Aug 31-1 Nov 40

128th Engineer Battalion (Mounted) (24th Cavalry Division)

Minnesota/Colorado National Guard

HQ-Not organized 1921-40

Constituted in the National Guard in 1921, allotted to the state of Minnesota, and assigned to the 24th Cavalry Division. Allotment withdrawn from the Minnesota National Guard in December 1925 and allotted to the Colorado National Guard. Redesignated 1 June 1931 as the 128th Engineer Squadron. Disbanded 1 November 1940.

139th Engineer Battalion (Auxiliary) (II Corps)

New York National Guard

HQ-Not organized 1921-27

Constituted in the National Guard in 1921, assigned to the II Corps, and allotted to the state of New York. Placed on the deferred list 2 July 1923, unit requirement transferred to the Organized Reserve as a Deferred National Guard unit, and redesignated as the 626th Engineer Battalion (Auxiliary). Withdrawn from the National Guard 17 September 1927 and demobilized.

140th Engineer Battalion (Auxiliary) (III Corps)

Pennsylvania/Maryland National Guard

HQ-Not organized 1921-27

Constituted in the National Guard in 1921, assigned to the III Corps, and allotted to the state of Pennsylvania. Withdrawn from the Pennsylvania National Guard 26 December 1921 and allotted to the Maryland National Guard. Company A was organized 7 June 1922 at Baltimore, MD; converted and redesignated 26 June 1923 as 1st Separate Infantry Company, Maryland National Guard. Placed on the deferred list 2 July 1923, unit requirement transferred to the Organized Reserve as a Deferred National Guard unit, and redesignated as the 627th Engineer Battalion (Auxiliary). Withdrawn from the National Guard 17 September 1927 and demobilized.

141st Engineer Battalion (Auxiliary) (III Corps)

Virginia National Guard

HQ-Not organized 1921-27

Constituted in the National Guard in 1921, assigned to the III Corps, and allotted to the state of Virginia 23 August 1921. Placed on the deferred list 2 July 1923, unit requirement transferred to the Organized Reserve as a Deferred National Guard unit, redesignated as the 628th Engineer Battalion (Auxiliary). Withdrawn from the National Guard 17 September 1927 and demobilized.

142nd Engineer Battalion (Auxiliary) (III Corps)

District of Columbia National Guard

HQ-Not organized 1921-27

Constituted in the National Guard in 1921, assigned to the III Corps, and allotted to the District of Columbia 20 August 1921. Company A was organized 19 April 1921 at Washington, DC. Battalion withdrawn from allotment to the District of Columbia 17 February 1923. Company A reorganized and redesignated 1 April 1923 as Company A, 1st Separate Infantry Battalion. Placed on the deferred list 2 July 1923, unit requirement transferred to the Organized Reserve as a Deferred National Guard unit, and redesignated as the 629th Engineer Battalion (Auxiliary). Withdrawn from the National Guard 17 September 1927 and demobilized.

143rd Engineer Battalion (Auxiliary) (IV Corps)

Georgia National Guard

HQ-Not organized 1921-27

Constituted in the National Guard in 1921, assigned to the IV Corps, and allotted to the state of Georgia. Placed on the deferred list 2 July 1923 and unit requirement transferred to the Organized Reserve as a Deferred National Guard unit. Concurrently, redesignated as the 630th Engineer Battalion (Auxiliary), relieved from the IV Corps and assigned to the XIV Corps. Withdrawn from the National Guard 17 September 1927 and demobilized.

144th Engineer Battalion (Auxiliary) (IV Corps)

Tennessee National Guard

HQ-Not organized 1921-27

Constituted in the National Guard in 1921, assigned to the IV Corps, and allotted to the state of Tennessee. Nashville, TN, designated as headquarters on organization, but the unit was never organized at that location. Placed on the deferred list 2 July 1923 and unit requirement transferred to the Organized Reserve as a Deferred National Guard unit. Concurrently, redesignated as the 631st Engineer Battalion (Auxiliary), relieved from the IV Corps and assigned to the XIV Corps. Withdrawn from the National Guard 17 September 1927 and demobilized.

145th Engineer Battalion (Auxiliary) (IV Corps)

Ohio National Guard

HQ-Not organized 1921-27

Constituted in the National Guard in 1921, assigned to the V Corps, and allotted to the state of Ohio. Placed on the deferred list 2 July 1923, unit requirement transferred to the Organized Reserve as a Deferred National Guard unit. Concurrently redesignated as the 632nd Engineer Battalion (Auxiliary), relieved from the V Corps and assigned to the XV Corps. Withdrawn from the National Guard 17 September 1927 and demobilized.

146th Engineer Battalion (Auxiliary) (V Corps)

Ohio National Guard

HQ-Not organized 1921-27

Constituted in the National Guard in 1921, assigned to the IV Corps, and allotted to the state of Ohio. Placed on the deferred list 2 July 1923, unit requirement transferred to the Organized Reserve as a Deferred National Guard unit. Concurrently redesignated as the 633rd Engineer Battalion (Auxiliary), relieved from the V Corps and assigned to the XV Corps. Withdrawn from the National Guard 17 September 1927 and demobilized.

147th Engineer Battalion (Auxiliary) (V Corps)

Ohio National Guard

HQ-Not organized 1921-27

Constituted in the National Guard in 1921, assigned to the IV Corps, and allotted to the state of Ohio. Placed on the deferred list 2 July 1923, unit requirement transferred to the Organized Reserve as a Deferred National Guard unit. Concurrently redesignated 634th Engineer Battalion (Auxiliary), relieved from the V Corps and assigned to the XV Corps. Withdrawn from the National Guard 17 September 1927 and demobilized.

148th Engineer Battalion (Auxiliary) (VI Corps)

Illinois National Guard

HQ-Not organized 1921-27

Constituted in the National Guard in 1921, assigned to the VI Corps, and allotted to the state of Illinois. Placed on the deferred list 2 July 1923, unit requirement transferred to the Organized Reserve as a Deferred National Guard unit. Concurrently redesignated as the 635th Engineer Battalion (Auxiliary), relieved from the VI Corps and assigned to the XVI Corps. Withdrawn from the National Guard 17 September 1927 and demobilized.

149th Engineer Battalion (Auxiliary) (VI Corps)

Illinois National Guard

HQ-Not organized 1921-27

Constituted in the National Guard in 1921, assigned to the VI Corps, and allotted to the state of Illinois. Placed on the deferred list 2 July 1923, unit requirement transferred to the Organized Reserve as a Deferred National Guard unit. Concurrently redesignated as the 636th Engineer Battalion (Auxiliary), relieved from the VI Corps and assigned to the XVI Corps. Withdrawn from the National Guard 17 September 1927 and demobilized.

150th Engineer Battalion (Auxiliary) (VI Corps)

Illinois National Guard

HQ-Not organized 1921-27

Constituted in the National Guard in 1921, assigned to the VI Corps, and allotted to the state of Illinois. Placed on the deferred list 2 July 1923, unit requirement transferred to the Organized Reserve as a Deferred National Guard unit. Concurrently redesignated as the 637th Engineer Battalion (Auxiliary), relieved from the VI Corps and assigned to the XVI Corps. Withdrawn from the National Guard 17 September 1927 and demobilized.

151st Engineer Battalion (Auxiliary) (VII Corps)

Iowa/Nebraska/Minnesota National Guard

HQ-Not organized 1921-27

Constituted in the National Guard in 1921, assigned to the VII Corps, and allotted to the state of Iowa. Placed on the deferred list 2 July 1923, unit requirement transferred to the Organized Reserve as a Deferred National Guard unit, and redesignated as the 638th Engineer Battalion (Auxiliary). Withdrawn from the state of Iowa and allotted to the state of Nebraska. Omaha, NE, designated 29 August 1924 as headquarters on organization, but the unit was never organized at that location. Designated headquarters changed 26 May 1926 to Minneapolis, MN. Withdrawn from the National Guard 17 September 1927 and demobilized.

152nd Engineer Battalion (Auxiliary) (VII Corps)

Missouri/Nebraska/Iowa National Guard

HQ-Not organized 1921-27

Constituted in the National Guard in 1921, assigned to the VII Corps, and allotted to the state of Missouri. Placed on the deferred list 2 July 1923, unit requirement transferred to the Organized Reserve as a Deferred National Guard unit, and redesignated as the 639th Engineer Battalion (Auxiliary). Withdrawn from the state of Missouri and allotted to the state of Nebraska. Wahoo, NE, designated 29 August 1924 as headquarters on organization, but the unit was never organized at that location. Designated headquarters changed 26 May 1926 to Waterloo, IA. Withdrawn from the National Guard 17 September 1927 and demobilized.

153rd Engineer Battalion (Auxiliary) (VII Corps)**Missouri/Minnesota National Guard****HQ-Not organized 1921-27**

Constituted in the National Guard in 1921, assigned to the VII Corps, and allotted to the state of Missouri. Placed on the deferred list 2 July 1923, unit requirement transferred to the Organized Reserve as a Deferred National Guard unit, and redesignated as the 640th Engineer Battalion (Auxiliary). Booneville, MO, designated 29 August 1924 as headquarters on organization, but the unit was never organized at that location. Withdrawn from the state of Missouri and allotted to the state of Minnesota. Designated headquarters changed 26 May 1926 to Bemidji, MN. Withdrawn from the National Guard 17 September 1927 and demobilized.

154th Engineer Battalion (Auxiliary) (VIII Corps)**Oklahoma National Guard****HQ-Not organized 1921-27**

Constituted in the National Guard in 1921, assigned to the VIII Corps, and allotted to the state of Oklahoma. Norman, OK, designated as headquarters on organization, but the unit was never organized at that location. Placed on the deferred list 2 July 1923, unit requirement transferred to the Organized Reserve as a Deferred National Guard unit. Concurrently redesignated as the 641st Engineer Battalion (Auxiliary) and assigned to the XVIII Corps. Withdrawn as a Deferred National Guard unit 13 January 1927 and allotted permanently to the Organized Reserve as the 641st Engineer Battalion (Auxiliary).

Status: Demobilized 22 December 1942.**155th Engineer Battalion (Auxiliary) (VIII Corps)****Texas National Guard****HQ-Not organized 1921-27**

Constituted in the National Guard in 1921, assigned to the VIII Corps, and allotted to the state of Texas. El Paso, TX, designated as headquarters on organization, but the unit was never organized at that location. Placed on the deferred list 2 July 1923, unit requirement transferred to the Organized Reserve as a Deferred National Guard unit. Concurrently redesignated as the 642nd Engineer Battalion (Auxiliary) and assigned to the XVIII Corps. Withdrawn as a Deferred National Guard unit 13 January 1927 and allotted permanently to the Organized Reserve as the 642nd Engineer Battalion (Auxiliary).

Status: Demobilized 22 December 1942.**156th Engineer Battalion (Auxiliary) (VIII Corps)****Texas/Arizona National Guard****HQ-Not organized 1921-27**

Constituted in the National Guard in 1921, assigned to the VIII Corps, and allotted to the state of Texas. Port Arthur, TX, designated as headquarters on organization, but the unit was never organized at that location. Placed on the deferred list 2 July 1923, unit requirement transferred to the Organized Reserve as a Deferred National Guard unit. Concurrently redesignated as the 643rd Engineer Battalion (Auxiliary) and assigned to the XVIII Corps. Allotment withdrawn from the state of Texas by November 1926 and allotted to the state of Arizona. Withdrawn as a Deferred National Guard unit 13 January 1927 and allotted permanently to the Organized Reserve as the 643rd Engineer Battalion (Auxiliary).

Status: Demobilized 22 December 1942.

157th Engineer Battalion (Auxiliary) (IX Corps)

National Guard

HQ-Not organized 1921-27

Constituted in the National Guard in 1921, assigned to the IX Corps, and allotted to the Ninth Corps Area. Placed on the deferred list 2 July 1923, unit requirement transferred to the Organized Reserve as a Deferred National Guard unit. Withdrawn from the National Guard 17 September 1927 and demobilized.

158th Engineer Battalion (Auxiliary) (IX Corps)

National Guard

HQ-Not organized 1921-27

Constituted in the National Guard in 1921, assigned to the IX Corps, and allotted to the Ninth Corps Area. Placed on the deferred list 2 July 1923, unit requirement transferred to the Organized Reserve as a Deferred National Guard unit. Withdrawn from the National Guard 17 September 1927 and demobilized.

159th Engineer Battalion (Auxiliary) (IX Corps)

National Guard

HQ-Not organized 1921-27

Constituted in the National Guard in 1921, assigned to the IX Corps, and allotted to the Ninth Corps Area. Placed on the deferred list 2 July 1923, unit requirement transferred to the Organized Reserve as a Deferred National Guard unit. Withdrawn from the National Guard 17 September 1927 and demobilized.

167th Engineer Battalion (Auxiliary) (First Army)

Virginia National Guard

HQ-Not organized 1921-27

Constituted in the National Guard in 1921, assigned to the First Army, and allotted to the state of Virginia. Placed on the deferred list 2 July 1923, unit requirement transferred to the Organized Reserve as a Deferred National Guard unit. Concurrently redesignated as the 644th Engineer Battalion (Auxiliary) and assigned to the First Army. Withdrawn from the National Guard 17 September 1927 and demobilized.

168th Engineer Battalion (Auxiliary) (Third Army)

Florida National Guard

HQ-Not organized 1921-22

Constituted in the National Guard in 1921, assigned to the Third Army, and allotted to the state of Florida. Withdrawn from the National Guard in 1922 and demobilized.

169th Engineer Battalion (Auxiliary) (Second Army)

Mississippi National Guard

HQ-Not organized 1921-27

Constituted in the National Guard in 1921, assigned to the Second Army, and allotted to the state of Mississippi. Placed on the deferred list 2 July 1923, unit requirement transferred to the Organized Reserve as a Deferred National Guard unit. Concurrently redesignated as the 645th Engineer Battalion (Auxiliary) and assigned to the Second Army. Withdrawn from the National Guard 17 September 1927 and demobilized.

170th Engineer Battalion (Auxiliary) (Second Army)

Louisiana National Guard

HQ-Not organized 1921-27

Constituted in the National Guard in 1921, assigned to the Second Army, and allotted to the state of Louisiana. Placed on the deferred list 2 July 1923, unit requirement transferred to the Organized Reserve as a Deferred National Guard unit. Concurrently redesignated as the 646th Engineer Battalion (Auxiliary) and assigned to the Second Army. Withdrawn from the National Guard 17 September 1927 and demobilized.

171st Engineer Battalion (Auxiliary) (Second Army)

Alabama National Guard

HQ-Not organized 1921-27

Constituted in the National Guard in 1921, assigned to the Second Army, and allotted to the state of Alabama. Montgomery, AL, designated as headquarters on organization, but the unit was never organized at that location. Placed on the deferred list 2 July 1923, unit requirement transferred to the Organized Reserve as a Deferred National Guard unit. Concurrently redesignated as the 647th Engineer Battalion (Auxiliary) and assigned to the Second Army. Withdrawn from the National Guard 17 September 1927 and demobilized.

172nd Engineer Battalion (Auxiliary) (Second Army)

South Carolina National Guard

HQ-Not organized 1921-27

Constituted in the National Guard in 1921, assigned to the Second Army, and allotted to the state of South Carolina. Placed on the deferred list 2 July 1923, unit requirement transferred to the Organized Reserve as a Deferred National Guard unit. Concurrently redesignated as the 648th Engineer Battalion (Auxiliary) and assigned to the Second Army. Withdrawn from the National Guard 17 September 1927 and demobilized.

173rd Engineer Battalion (Auxiliary) (Second Army)

North Carolina National Guard

HQ-Not organized 1921-27

Constituted in the National Guard in 1921, assigned to the Second Army, and allotted to the state of North Carolina. Placed on the deferred list 2 July 1923, unit requirement transferred to the Organized Reserve as a Deferred National Guard unit. Concurrently redesignated as the 649th Engineer Battalion (Auxiliary) and assigned to the Second Army. Withdrawn from the National Guard 17 September 1927 and demobilized.

174th Engineer Battalion (Auxiliary) (Third Army)

Arkansas/Iowa National Guard

HQ-Not organized 1921-27

Constituted in the National Guard in 1921, assigned to the Third Army, and allotted to the state of Arkansas. Placed on the deferred list 2 July 1923, unit requirement transferred to the Organized Reserve as a Deferred National Guard unit. Concurrently redesignated as the 650th Engineer Battalion (Auxiliary) and assigned to the Third Army. Withdrawn from the state of Arkansas and allotted to the state of Iowa. Sioux City, IA, designated 29 August 1924 as headquarters on organization, but the unit was never organized at that location. Designated headquarters changed 26 May 1926 to Chariton, IA. Withdrawn from the National Guard 17 September 1927 and demobilized.

175th Engineer Battalion (Topographic) (First Army)

New York National Guard

HQ-Not organized 1921-27

Constituted in the National Guard in 1921, assigned to the First Army, and allotted to the state of New York. Placed on the deferred list 2 July 1923, unit requirement transferred to the Organized Reserve as a Deferred National Guard unit. Concurrently redesignated as the 653rd Engineer Battalion (Topographic) and assigned to the First Army. Withdrawn from the National Guard 17 September 1927 and demobilized.

176th Engineer Battalion (Topographic) (Third Army)

Iowa National Guard

HQ-Not organized 1921-27

Constituted in the National Guard in 1921, assigned to the Third Army, and allotted to the state of Iowa. Placed on the deferred list 2 July 1923, unit requirement transferred to the Organized Reserve as a Deferred National Guard unit. Concurrently redesignated as the 654th Engineer Battalion (Topographic) and assigned to the Third Army. Withdrawn from the National Guard 17 September 1927 and demobilized.

177th Engineer Train (Heavy Bridge) (First Army)

Pennsylvania National Guard

HQ-Not organized 1921-27

(Heavy Bridge) was Constituted in the National Guard in 1921, assigned to the First Army, and allotted to the state of Pennsylvania. Placed on the deferred list 2 July 1923, unit requirement transferred to the Organized Reserve as a Deferred National Guard unit. Concurrently redesignated as the 655th Engineer Train (Heavy Bridge) and assigned to the First Army. Withdrawn from the National Guard 17 September 1927 and demobilized.

178th Engineer Train (Light Bridge) (First Army)

New York National Guard

HQ-Not organized 1921-27

Constituted in the National Guard in 1921, assigned to the First Army, and allotted to the state of New York. Placed on the deferred list 2 July 1923, unit requirement transferred to the Organized Reserve as a Deferred National Guard unit. Concurrently redesignated as the 658th Engineer Train (Light Bridge) and assigned to the First Army. Withdrawn from the National Guard 17 September 1927 and demobilized.

179th Engineer Company (Camouflage) (GHQR)

Minnesota National Guard

HQ-Not organized 1921-27

Constituted in the National Guard in 1921, assigned to the General Headquarters Reserve, and allotted to the state of Minnesota. Placed on the deferred list 2 July 1923, unit requirement transferred to the Organized Reserve as a Deferred National Guard unit. Withdrawn from the National Guard 17 September 1927 and demobilized.

181st Engineer Battalion (Topographic) (GHQR)

Ohio National Guard

HQ-Not organized 1921-27

Constituted in the National Guard in 1921, assigned to the General Headquarters Reserve, and allotted to the state of Ohio. Placed on the deferred list 2 July 1923, unit requirement transferred to the Organized Reserve as a Deferred National Guard unit. Withdrawn from allotment to the Ohio National Guard in March 1926. Withdrawn from the National Guard 17 September 1927 and demobilized.

183rd Engineer Train (Heavy Bridge) (GHQR)

Indiana National Guard

HQ-Not organized 1921-27

Constituted in the National Guard in 1921, assigned to the General Headquarters Reserve, and allotted to the state of Indiana. Placed on the deferred list 2 July 1923, unit requirement transferred to the Organized Reserve as a Deferred National Guard unit. Concurrently redesignated as the 656th Engineer Train (Heavy Bridge) and assigned to the General Headquarters Reserve. Withdrawn from the National Guard 17 September 1927 and demobilized.

184th Engineer Train (Heavy Bridge) (GHQR)

Indiana National Guard

HQ-Not organized 1921-27

Constituted in the National Guard in 1921, assigned to the General Headquarters Reserve, and allotted to the state of Indiana. Placed on the deferred list 2 July 1923, unit requirement transferred to the Organized Reserve as a Deferred National Guard unit. Concurrently redesignated as the 657th Engineer Train (Heavy Bridge) and assigned to the General Headquarters Reserve. Withdrawn from the National Guard 17 September 1927 and demobilized.

186th Engineer Battalion (Railway) (GHQR)

Kentucky National Guard

HQ-Not organized 1921-27

Constituted in the National Guard in 1921, assigned to the General Headquarters Reserve, and allotted to the state of Kentucky. Placed on the deferred list 2 July 1923. Withdrawn from the National Guard 17 September 1927 and demobilized.

187th Engineer Battalion (Railway) (GHQR)

West Virginia National Guard

HQ-Not organized 1921-27

Constituted in the National Guard in 1921, assigned to the General Headquarters Reserve, and allotted to the state of West Virginia. Placed on the deferred list 2 July 1923. Withdrawn from the National Guard 17 September 1927 and demobilized.

188th Engineer Battalion (Railway) (GHQR)

Iowa National Guard

HQ-Not organized 1921-27

Constituted in the National Guard in 1921, assigned to the General Headquarters Reserve, and allotted to the state of Iowa. Placed on the deferred list 2 July 1923. Withdrawn from the National Guard 17 September 1927 and demobilized.

189th Engineer Battalion (Railway) (GHQR)

Minnesota National Guard

HQ-Not organized 1921-27

Constituted in the National Guard in 1921, assigned to the General Headquarters Reserve, and allotted to the state of Minnesota. Placed on the deferred list 2 July 1923. Withdrawn from the National Guard 17 September 1927 and demobilized.

190th Engineer Battalion (Railway) (GHQR)

Kansas National Guard

HQ-Not organized 1921-27

Constituted in the National Guard in 1921, assigned to the General Headquarters Reserve, and allotted to the state of Kansas. Placed on the deferred list 2 July 1923. Withdrawn from the National Guard 17 September 1927.

191st Engineer Battalion (Railway) (GHQR)

Missouri National Guard

HQ-Not organized 1921-27

Constituted in the National Guard in 1921, assigned to the General Headquarters Reserve, and allotted to the state of Missouri. Placed on the deferred list 2 July 1923. Withdrawn from the National Guard 17 September 1927.

192nd Engineer Battalion (Auxiliary) (GHQR)

Kentucky National Guard

HQ-Not organized 1921-27

Constituted in the National Guard in 1921, assigned to the General Headquarters Reserve and allotted to the state of Kentucky. Placed on the deferred list 2 July 1923, unit requirement transferred to the Organized Reserve as a Deferred National Guard unit. Concurrently redesignated as the 651st Engineer Battalion (Auxiliary) and assigned to the General Headquarters Reserve. Withdrawn from the National Guard 17 September 1927.

193rd Engineer Battalion (Railway) (GHQR)

Michigan National Guard

HQ-Not organized 1921-27

Constituted in the National Guard in 1921 and assigned to the General Headquarters Reserve. Allotted 20 April 1921 to the state of Michigan. Placed on the deferred list 2 July 1923, unit requirement transferred to the Organized Reserve as a Deferred National Guard unit. Concurrently redesignated as the 652nd Engineer Battalion (Auxiliary) and assigned to the General Headquarters Reserve. Withdrawn from the National Guard 17 September 1927.

401st Engineer Battalion (Mounted) (61st Cavalry Division)

Organized Reserve New York

HQ-Schenectady, NY, 1921-29; New York City, NY, 1929-41



Constituted in the Organized Reserve 15 October 1921, assigned to the 61st Cavalry Division, and allotted to the Second Corps Area. Initiated 29 December 1921 with headquarters at Schenectady, NY. Relocated 2 July 1929 to New York City, NY. Redesignated 1 July 1930 as the 401st Engineer Squadron. Typically conducted Inactive Training Period meetings at the Sivin Franklin & Company at 200 West 34th Street in New York City. Conducted summer training most years with the 1st Engineer Regiment at Fort Du Pont, DE, and some years at Camp Blauvelt, NY, or Fort Ethan Allen, VT. Location 7 December 1941—New York City, NY.

Status: Disbanded 11 February 1943 as the 894th Engineer Battalion (Aviation).

Commanders, 401st Engineer Battalion (Mounted)

Capt. Walter B. Grigsby	29 Dec 21-20 Jan 22	Lt. Col. David M. Oltarsh	29 Jul 37-15 Jun 39
Maj. Ernest K. Dewey	20 Jan 22-15 Feb 24	Maj. Jamieson Marshall	15 Jun 39-7 Jun 41
Maj. George B. Gordon	15 Feb 24-29 Jul 37	Maj. Clark W. Pennington	7 Jun 41-ao Dec 41

402nd Engineer Battalion (Mounted) (62nd Cavalry Division)

Organized Reserve Maryland

HQ-Not initiated 1921-22; Hagerstown, MD, 1922-29; Baltimore, MD, 1929-36; Towson, MD, 1936-41



Constituted in the Organized Reserve 15 October 1921, assigned to the 62nd Cavalry Division, and allotted to the Third Corps Area. Initiated 1 February 1922 with headquarters at Hagerstown, MD. Relocated 12 December 1929 to Baltimore, MD, and in 1936 to Towson, MD. Redesignated 1 July 1930 as the 402nd Engineer Squadron. Conducted summer training most years with the 13th Engineer Regiment at Fort A. A. Humphreys, VA, (later redesignated Fort Belvoir), and some years at Fort Myers, VA. Location 7 December 1941—Towson, MD.

Status: Disbanded 11 February 1943 as the 895th Engineer Battalion (Aviation).

Commanders, 402nd Engineer Battalion (Mounted)

Maj. Alexander C. Knight	1 Feb 22-27 Apr 29	Lt. Col. John S. Doyle	28 Oct 31-1 Apr 35
Capt. Charles E. Ellicot, Jr.	27 Apr 29-27 Nov 29	Maj. Charles E. Ellicot, Jr.	1 Apr 35-28 Jan 36
Maj. Stuart H. Anderson	27 Nov 29-28 Oct 31	Capt. Edward M. Killough	28 Jan 36-18 Feb 38
	Lt. Col. Walter W. Gruber		18 Feb 38-Jan 41

403rd Engineer Battalion (Mounted) (63rd Cavalry Division)

Organized Reserve Louisiana

HQ-Not initiated 1921-22; New Orleans, LA, 1922-41

Constituted in the Organized Reserve 15 October 1921, assigned to the 63rd Cavalry Division, and allotted to the Fourth Corps Area. Initiated 20 March 1922 with headquarters at New Orleans, LA. Redesignated 1 July 1930 as the 403rd Engineer Squadron. Conducted summer training most years at Fort Oglethorpe, GA, and some years with A Company, 7th Engineer Regiment at Fort Benning, GA. Designated mobilization training station was Fort Oglethorpe, GA. Location 7 December 1941—New Orleans, LA.

Commanders, 403rd Engineer Battalion (Mounted)

Maj. Edwin O. Cook	20 Mar 22-ao Sep 25	Lt. Col. Hamilton H. Howry	11 Jul 33-11 Apr 37
Unknown	ao Sep 25-ao Jul 28	Lt. Col. De Loss H. Barber	18 Jul 37-Feb 38
Maj. Albert W. Higley	ao Jul 28-11 Jul 33	Maj. Reinhard A. Stinemayer	Feb 38-7 Dec 41

404th Engineer Battalion (Mounted) (64th Cavalry Division)

Organized Reserve Kentucky

HQ-Not initiated 1921-22; Lexington, KY, 1922-25; Corbin, KY, 1925-31; Bowling Green, KY, 1931-33; Richmond, KY, 1933-41

Constituted in the Organized Reserve 15 October 1921, assigned to the 64th Cavalry Division, and allotted to the Fifth Corps Area. Initiated 21 January 1922 with headquarters at Lexington, KY. Headquarters successively relocated as follows: to Corbin, KY, 15 April 1925; to Bowling Green, KY, 9 July 1931; and to Richmond, KY, 21 December 1933. Redesignated 1 July 1930 as the 404th Engineer Squadron. Conducted summer training most years at Camp Knox, KY, and some years at Fort Benjamin Harrison, IN, Fort Thomas, KY, or with the 13th Engineer Regiment at Fort A. A. Humphreys, VA. Location 7 December 1941—Richmond, KY.

Status: Disbanded 11 February 1943 as the 897th Engineer Battalion (Aviation).

Commanders, 404th Engineer Battalion (Mounted)

Maj. William J. Carrel	21 Jan 22-ao Jul 28	Maj. Frederick H. Cornfield	ao Jun 37-17 Sep 37
Unknown	ao Jul 28-ao Jul 30	Unknown	17 Sep 37-ao Aug 38
Maj. Henry de B. Forbes	ao Jul 30-ao Jun 34	Capt. Carroll S. Carter	ao Aug 38-ao Sep 38
Unknown	ao Jun 34-ao Jun 37	Unknown	ao Sep 38-7 Dec 41

405th Engineer Battalion (Mounted) (65th Cavalry Division)

Organized Reserve Illinois

HQ-*Not initiated* 1921-22; Chicago, IL, 1922-41

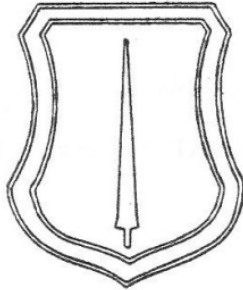

Constituted in the Organized Reserve 15 October 1921, assigned to the 65th Cavalry Division, and allotted to the Sixth Corps Area. Initiated 6 June 1922 with headquarters at Chicago, IL. Redesignated 1 July 1930 as the 405th Engineer Squadron. Typically conducted Inactive Training Period meetings at the armory of the 202nd Coast Artillery or the Post Office Building in Chicago. Conducted summer training most years with elements of the 13th Engineer Regiment at Camp Custer, MI, and some years at Fort Sheridan, IL. Conducted Engineer CMTC at Camp Custer in 1928 and 1939 as an alternate form of summer training. Location 7 December 1941—Chicago, IL.

Status: Disbanded 11 February 1943 as the 869th Engineer Battalion (Aviation).

Commanders, 405th Engineer Battalion (Mounted)

Lt. Col. Chester A. Logan	6 Jun 22-10 Sep 24	Lt. Col. Chester A. Logan	ao Dec 29-8 Mar 35
Capt. Walter R. Jeffrey	10 Sep 24-20 May 25	Lt. Col. Albert J. Bain	8 Mar 35-ao Jan 41
Maj. Frederick N. Wildish	20 May 25-ao Jun 29	Unknown	ao Jan 41-7 Dec 41

406th Engineer Battalion (Mounted) (66th Cavalry Division)

Organized Reserve Iowa

HQ-*Not initiated* 1921-22; Des Moines, IA, 1922-41

Constituted in the Organized Reserve 15 October 1921, assigned to the 66th Cavalry Division, and allotted to the Seventh Corps Area. Initiated in May 1922 with headquarters at Des Moines, IA. Redesignated 1 July 1930 as the 406th Engineer Squadron. Conducted summer training most years with A Troop, 9th Engineer Squadron at Fort Riley, KS, and some years at Fort Logan, CO, or Fort Snelling, MN. Location 7 December 1941—Des Moines, IA.

Status: Disbanded 11 February 1943 as the 899th Engineer Battalion (Aviation).

Commanders, 406th Engineer Battalion (Mounted)

Unknown	May 22-ao Mar 26	Maj. Frederick N. Hatch	Mar 31-ao Jan 32
Maj. Bernard J. Callahan	ao Mar 26-ao Jun 27	Unknown	ao Nov 31-20 Dec 36
Unknown	ao Jun 27-Mar 31	Maj. John H. Thompson, jr.	20 Dec 36-26 Sep 37
	Unknown	26 Sep 37-7 Dec 41	

411th Engineer Battalion (Auxiliary) (XI Corps)

**Organized Reserve Massachusetts/
Florida/Pennsylvania**

HQ-*Not initiated* 1921-22; Boston, MA, 1922-27; *Inactive* 1927-33; Orlando, FL, 1933; Philadelphia, PA, 1933-37; Chester, PA, 1937-41

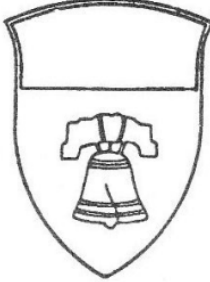

Constituted in the Organized Reserve 29 July 1921, assigned to the XI Corps, and allotted to the First Corps Area. Initiated 3 November 1921 with headquarters at Boston, MA. Withdrawn from the First Corps Area 11 January 1927 and allotted to the Fourth Corps Area as a “Colored” unit. Inactivated 2 February 1927 at Boston by relief of personnel. Redesignated 7 May 1930 as the 411th Engineer Battalion (Separate). Reorganized in 1933 at Orlando, FL. Withdrawn from the Fourth Corps Area 1 October 1933 and allotted to the Third Corps Area. Concurrently, relieved from the XI Corps and assigned to the III Corps. Reorganized in late 1933 at Philadelphia, PA. Relocated 20 September 1937 to Chester, PA. Withdrawn from the Organized Reserve 1 January 1938 and allotted to the Regular Army. Inactivated 29 July 1940 at Chester by relief of personnel. Typically conducted Inactive Training Period meetings at the Society of

American Military Engineers in Philadelphia. Conducted summer training with the 1st Engineer Regiment at Fort Du Pont, DE. Location 7 December 1941—*Inactive*.

Status: Disbanded 22 December 1942

412th Engineer Battalion (Auxiliary) (XI Corps)

**Organized Reserve Massachusetts/
Florida/Virginia**

HQ-*Not initiated* 1921-22; Lowell, MA, 1922-27; West Palm Beach, FL, 1927-33; Norfolk, VA, 1933-37; Lynchburg, VA, 1937-41

Constituted in the Organized Reserve 29 July 1921, assigned to the XI Corps, and allotted to the First Corps Area. Initiated 5 August 1922 with headquarters at Lowell, MA. Withdrawn from the First Corps Area 11 January 1927 and allotted to the Fourth Corps Area as a “Colored” unit. Inactivated 3 February 1927 at Lowell by relief of personnel. Reorganized in 1927 at West Palm Beach, FL. Redesignated 7 May 1930 as the 412th Engineer Battalion (Separate). Withdrawn from the Fourth Corps Area 1 October 1933 and allotted to the Third Corps Area. Reorganized in 1933 at Norfolk, VA. Relocated 27 September 1937 to Lynchburg, VA. Withdrawn from the Organized Reserve 1 January 1938 and allotted to the Regular Army. Typically conducted Inactive Training Period meetings at the US Court House or the Post Office Building in Norfolk. Conducted summer training with the 1st Engineer Regiment at Fort Du Pont, DE. Location 7 December 1941—Lynchburg, VA.

Status: Disbanded 22 December 1942

413th Engineer Battalion (Auxiliary) (XI Corps)

Organized Reserve Massachusetts

HQ-*Not initiated* 1921-22; Worcester, MA, 1922-41

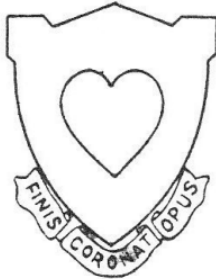

Constituted in the Organized Reserve 29 July 1921, assigned to the XI Corps, and allotted to the First Corps Area. Initiated 17 December 1921 with headquarters at Worcester, MA. Redesignated 7 May 1930 as the 413th Engineer Battalion (Separate). Relieved from the XI Corps 1 October 1933 and assigned to the I Corps. Withdrawn from the Organized Reserve 1 January 1938 and allotted to the Regular Army. Typically held Inactive Training Period meetings at the Hotel Kimball or the Federal Building in Springfield, MA. Conducted summer training most years at Camp Devens, MA, and some years with the 1st Engineer Regiment at Fort Du Pont, DE. Location 7 December 1941—Worcester, MA.

Status: Disbanded 22 December 1942

414th Engineer Battalion (Auxiliary) (XII Corps)**Organized Reserve New York****HQ**-Manhattan, NY, 1921-41

Constituted in the Organized Reserve 29 July 1921, assigned to the XII Corps, and allotted to the Second Corps Area. Initiated 15 December 1921 with headquarters at Manhattan, NY. Redesignated 7 May 1930 as the 414th Engineer Battalion (Separate). Relieved from the XII Corps 1 October 1933 and assigned to the II Corps. Withdrawn from the Organized Reserve 1 January 1938 and allotted to the Regular Army. Typically conducted Inactive Training Period meetings at the Engineer Societies building on 39th Street in New York City. Conducted summer training with the 1st Engineer Regiment at Fort Du Pont, DE. Designated mobilization training station was Camp Smith, NY. Location 7 December 1941—Manhattan, NY.

415th Engineer Battalion (Auxiliary) (XII Corps)**Organized Reserve New Jersey****HQ**-Jersey City, NJ 1921-41

Constituted in the Organized Reserve 29 July 1921, assigned to the XII Corps, and allotted to the Second Corps Area. Initiated 23 November 1921 with headquarters at Jersey City, NJ. Redesignated 7 May 1930 as the 415th Engineer Battalion (Separate). Relieved from the XII Corps 1 October 1933 and assigned to the II Corps. Consolidated 21 August 1936 with 415th Engineer Depot Detachment (a WW I unit). Relieved from the II Corps 9 March 1937 and assigned to the First Army. Concurrently redesignated as a “Colored” unit. Conducted summer training with the 1st Engineer Regiment at Fort Du Pont, DE. Designated mobilization training station was Camp Smith, NY. Location 7 December 1941—Jersey City, NJ.

Status: Disbanded 22 December 1942**416th Engineer Battalion (Auxiliary) (XII Corps)****Organized Reserve New York/Delaware****HQ**-*Not initiated* 1921-22; Schenectady, NY, 1922-37; Wilmington, DE, 1937-41

Constituted in the Organized Reserve 29 July 1921, assigned to the XII Corps, and allotted to the Second Corps Area. Initiated 20 January 1922 with headquarters at Schenectady, NY. Redesignated 7 May 1930 as the 416th Engineer Battalion (Separate). Designated mobilization training station was Camp Smith, NY. Inactivated in February 1937 at Schenectady by relief of personnel. Reorganized 5 April 1937 at Wilmington, DE. Conducted summer training with the 1st Engineer Regiment at Fort Du Pont, DE. Location 7 December 1941—Wilmington, DE.

417th Engineer Battalion (Auxiliary) (XIII Corps)**Organized Reserve Virginia/
Florida/Pennsylvania****HQ**-Christianburg, VA, 1921-27; *Inactive* 1927-29; Opelika, AL, 1929-33; *Inactive* 1933-37; Pittsburgh, PA, 1937-41

Constituted in the Organized Reserve 29 July 1921, assigned to the XIII Corps, and allotted to the Third Corps Area. Initiated 30 December 1921 with headquarters at Christianburg, VA. Withdrawn from the Third Corps Area 7 January 1927 and allotted to the Fourth Corps Area as a “Colored” unit. Inactivated 17 January 1927 at Christianburg by relief of personnel. Reorganized 22 October 1929 with headquarters at Opelika, AL. Redesignated 7 May 1930 as the 417th Engineer Battalion (Separate). Withdrawn from the Fourth Corps Area 1 October 1933 and allotted to the Third Corps Area. Reorganized 22 September 1937 with headquarters at Pittsburgh, PA. Typically conducted Inactive Training Period meetings at the New Federal Building in Pittsburgh. Location 7 December 1941—Pittsburgh, PA.

Status: Disbanded 22 December 1942

418th Engineer Battalion (Auxiliary) (XIII Corps)**Organized Reserve Pennsylvania/
Florida/Indiana**

HQ-Not initiated 1921-22; Lebanon, PA, 1922-23; Reading, PA, 1923-27; *Inactive* 1927-29; Tuscaloosa, AL, 1929-33; Gary, IN, 1933-41

Constituted in the Organized Reserve 29 July 1921, assigned to the XIII Corps, and allotted to the Third Corps Area. Initiated 12 January 1922 with headquarters at Lebanon, PA. Relocated 28 March 1923 to Reading, PA. Withdrawn from the Third Corps Area 7 January 1927 and allotted to the Fourth Corps Area as a “Colored” unit. Inactivated 17 January 1927 at Reading by relief of personnel. Reorganized 22 October 1929 with headquarters at Tuscaloosa, AL. Redesignated 7 May 1930 as the 418th Engineer Battalion (Separate). Withdrawn from the Fourth Corps Area 1 October 1933 and allotted to the Fifth Corps Area. Reorganized in December 1933 with headquarters at Gary, IN. Conducted summer training at Fort Knox, KY. Location 7 December 1941—Gary, IN.

Status: Disbanded 22 December 1942

419th Engineer Battalion (Auxiliary) (XIII Corps)**Organized Reserve Virginia**

HQ-Not initiated 1921-22; Charlottesville, VA, 1922-37; Richmond, VA, 1937-41

Constituted in the Organized Reserve 29 July 1921, assigned to the XIII Corps, and allotted to the Third Corps Area. Initiated 21 February 1922 with headquarters at Charlottesville, VA. Redesignated 7 May 1930 as the 419th Engineer Battalion (Separate). Relocated 16 September 1937 to Richmond, VA. Location 7 December 1941—Richmond, VA.

Status: Disbanded 22 December 1942

420th Engineer Battalion (Auxiliary) (C) (XIV Corps)**Organized Reserve Alabama**

HQ-Not initiated 1921-22; Auburn, AL, 1922-29; Decatur, AL, 1929-35; Mobile, AL, 1935-40; *Inactive* 1940-41

Constituted in the Organized Reserve 29 July 1921 as the 720th Engineer Battalion (Auxiliary) (C), assigned to the XIV Corps, and allotted to the Fourth Corps Area. Initiated 30 June 1922 with headquarters at Auburn, AL. Redesignated 2 July 1923 as the 420th Engineer Battalion (Auxiliary) (C). Relocated 22 October 1929 to Decatur, AL. Redesignated 7 May 1930 as the 420th Engineer Battalion (Separate). Relieved from the XIV Corps 1 October 1933 and assigned to the IV Corps. Relocated 29 January 1935 to Mobile, AL. Withdrawn from the Organized Reserve 1 January 1938 and allotted to the Regular Army. Conducted summer training with Company A, 7th Engineers and Company A, 4th Engineers at Fort Benning, GA. Designated mobilization training station was Camp McClellan, AL. Inactivated 7 September 1940 at Mobile by relief of personnel. Location 7 December 1941—*Inactive*.

421st Engineer Battalion (Auxiliary) (C) (XIV Corps)**Organized Reserve Georgia/Tennessee**

HQ-Not initiated 1921-22; Savannah, GA, 1922-35; Nashville, TN, 1935-41

Constituted in the Organized Reserve 29 July 1921 as the 721st Engineer Battalion (Auxiliary) (C), assigned to the XIV Corps, and allotted to the Fourth Corps Area. Initiated 28 March 1922 with headquarters at Savannah, GA. Redesignated 2 July 1923 as the 421st Engineer Battalion (Auxiliary) (C). Redesignated 7 May 1930 as the 421st Engineer Battalion (Separate). Relieved from the XIV Corps 1 October 1933 and assigned to the IV Corps. Relocated 29 January 1935 to Nashville, TN. Withdrawn from the Organized Reserve 1 January 1938 and allotted to the Regular Army. Conducted summer training with Company A, 7th Engineers and Company A, 4th Engineers at Fort Benning, GA. Designated mobilization training station was Camp Wheeler, GA. Location 7 December 1941—Nashville, TN.

422nd Engineer Battalion (Auxiliary) (C) (XIV Corps)**Organized Reserve Tennessee/Alabama****HQ-Not initiated** 1921-22; Memphis, TN, 1922-29; Anniston, AL, 1929-41

Constituted in the Organized Reserve 29 July 1921 as the 722nd Engineer Battalion (Auxiliary), assigned to the XIV Corps, and allotted to the Fourth Corps Area. Initiated in April 1922 with headquarters at Memphis, TN. Redesignated 2 July 1923 as the 422nd Engineer Battalion (Auxiliary) (C). Relocated 1 October 1929 to Anniston, AL. Redesignated 7 May 1930 as the 422nd Engineer Battalion (Separate). Conducted summer training with Company A, 7th Engineers and Company A, 4th Engineers at Fort Benning, GA. Designated mobilization training station was Camp Jackson, SC. Location 7 December 1941—Anniston, AL.

Status: Disbanded 22 December 1942**423rd Engineer Battalion (Auxiliary) (C) (XV Corps)****Organized Reserve Ohio****HQ-Not initiated** 1921-22; Columbus, OH, 1922-31; Youngstown, OH, 1931-41

Constituted in the Organized Reserve 29 July 1921 as the 723rd Engineer Battalion (Auxiliary), assigned to the XV Corps, and allotted to the Fifth Corps Area. Initiated in January 1922 with headquarters at Columbus, OH. Relieved from the XV Corps 2 July 1923 and assigned to the V Corps. Redesignated 2 July 1923 as the 423rd Engineer Battalion (Auxiliary) (C). Redesignated 7 May 1930 as the 423rd Engineer Battalion (Separate). Relocated 9 July 1931 to Youngstown, OH. Location 7 December 1941—Youngstown, OH

Status: Disbanded 22 December 1942**424th Engineer Battalion (Auxiliary) (XV Corps)****Organized Reserve Ohio/West Virginia****HQ-Not initiated** 1921-22; Dover, OH, 1922-31; Beckley, WV 1931-41

Constituted in the Organized Reserve 29 July 1921 as the 724th Engineer Battalion (Auxiliary), assigned to the XV Corps, and allotted to the Fifth Corps Area. Initiated in July 1922 with headquarters at Dover, OH. Relieved from the XV Corps 2 July 1923 and assigned to the V Corps. Concurrently redesignated 424th Engineer Battalion (Auxiliary) (C). Redesignated 7 May 1930 as the 424th Engineer Battalion (Separate). Relocated 9 July 1931 to Beckley, WV. Location 7 December 1941—Beckley, WV.

Status: Disbanded 22 December 1942**425th Engineer Battalion (Auxiliary) (XV Corps)****Organized Reserve Ohio****HQ-Not initiated** 1921-22; Cleveland, OH, 1922-30; *Inactive* 1930-41

Constituted in the Organized Reserve 29 July 1921, assigned to the XV Corps, and allotted to the Fifth Corps Area. Initiated in January 1922 with headquarters at Cleveland, OH. Relieved from assignment to the XV Corps July 1923 and assigned to the V Corps. Redesignated 2 July 1923 as the 425th Engineer Battalion (Auxiliary) (C). Inactivated by March 1930 at Akron by relief of personnel. Redesignated 7 May 1930 as the 425th Engineer Battalion (Separate). Akron, OH, designated 21 December 1933 as headquarters on reorganization, but the unit was never organized at that location. Typically conducted Inactive Training Period meetings at the Bulkey Building in Cleveland. Conducted summer training at Camp Knox, KY. Location 7 December 1941—*Inactive*.

426th Engineer Battalion (Auxiliary) (XVI Corps)**Organized Reserve Illinois****HQ-Not initiated** 1921-23; Peoria, IL, 1923-24; Aurora, IL, 1924-37; Rock Island, IL, 1937-41

Constituted in the Organized Reserve 29 July 1921, assigned to the XVI Corps, and allotted to the Sixth Corps Area. Initiated in September 1923 with headquarters at Peoria, IL. Redesignated 2 July 1923 as the 426th Engineer Battalion (Auxiliary) (C). Relieved from the XVI Corps 2 July 1923 and assigned to the VI Corps. Relocated 18 April 1924 to

Aurora, IL. Redesignated 7 May 1930 as the 426th Engineer Battalion (Separate). Consolidated 21 August 1936 with 426th Engineer Depot Detachment (a WW I unit). Relocated 28 July 1937 to Rock Island, IL. Conducted summer training most years at Camp Custer, MI, or some years at Fort Sheridan, IL. Designated mobilization training station was Fort McClellan, AL. Location 7 December 1941—Rock Island, IL.

427th Engineer Battalion (Auxiliary) (XVI Corps)

Organized Reserve Illinois

HQ-Not initiated 1921-22; Chicago, IL, 1922-37; Rockford, IL, 1937-41

Constituted in the Organized Reserve 29 July 1921, assigned to the XVI Corps, and allotted to the Sixth Corps Area. Initiated 22 June 1922 with headquarters at Chicago, IL. Relieved from the XVI Corps July 1923 and assigned to the VI Corps. Redesignated 7 May 1930 as the 427th Engineer Battalion (Separate). Relocated 28 July 1937 to Rockford, IL. Withdrawn from the Organized Reserve 1 January 1938 and allotted to the Regular Army. Typically conducted Inactive Training Period meetings at the Post Office Building in Chicago. Conducted summer training most years at Camp Custer, MI, or some years at Fort Sheridan, IL. Designated mobilization training station was Fort McClellan, AL. Location 7 December 1941—Rockford, IL.

428th Engineer Battalion (Auxiliary) (XVI Corps)

Organized Reserve Wisconsin/Alabama

HQ-Not initiated 1921-23; Racine, WI 1923-27; *Inactive* 1927-29; Birmingham, AL, 1929-41

Constituted in the Organized Reserve 29 July 1921, assigned to the XVI Corps, and allotted to the Sixth Corps Area. Initiated in July 1923 with headquarters at Racine, WI. Relieved from the XVI Corps July 1923 and assigned to the VI Corps. Designated mobilization training station was Camp Grant, IL. Withdrawn from the Sixth Corps Area 11 January 1927 and allotted to the Fourth Corps Area as a “Colored” unit. Reorganized in October 1929 at Birmingham, AL. Redesignated 7 May 1930 as the 428th Engineer Battalion (Separate). Conducted summer training with Company A, 7th Engineers and Company A, 4th Engineers at Fort Benning, GA. Location 7 December 1941—Birmingham, AL.

Status: Disbanded 22 December 1942

429th Engineer Battalion (Auxiliary) (XVII Corps)

Organized Reserve Arkansas

HQ-Not initiated 1921-22; Jonesboro, AR, 1922-28; Little Rock, AR, 1928-41

Constituted in the Organized Reserve 29 July 1921, assigned to the XVII Corps, and allotted to the Seventh Corps Area. Initiated in April 1922 with headquarters at Jonesboro, AR. Relocated 3 April 1928 to Little Rock, AR. Redesignated 7 May 1930 as the 429th Engineer Battalion (Separate). Relieved from the XVII Corps by 1939 and assigned to the Fourth Army. Conducted summer training most years at Fort Riley, KS. Location 7 December 1941—Little Rock, AR.

Status: Disbanded 22 December 1942

430th Engineer Battalion (Auxiliary) (XVII Corps)

**Organized Reserve Iowa/
Nebraska/Missouri**

HQ-Not initiated 1921-22; Des Moines, IA, 1922-26; North Platte, NE, 1926-31; St. Louis, MO, 1931-41

Constituted in the Organized Reserve 29 July 1921, assigned to the XVII Corps, and allotted to the Seventh Corps Area. Initiated in May 1922 with headquarters at Des Moines, IA. Relocated 26 May 1926 to North Platte, NE. Redesignated 7 May 1930 as the 430th Engineer Battalion (Separate). Relocated 12 October 1931 to St. Louis, MO. Withdrawn from the Organized Reserve 1 January 1938 and allotted to the Regular Army as a “Colored” unit. Conducted summer training most years at Fort Snelling, MN. Location 7 December 1941—St. Louis, MO.

431st Engineer Battalion (Auxiliary) (XVII Corps)**Organized Reserve Minnesota/Arkansas**

HQ-Not initiated 1921-22; Minneapolis, MN, 1922-26; Mankato, MN, 1926-31; Pine Bluff, AR, 1931-41

Constituted in the Organized Reserve 29 July 1921, assigned to the XVII Corps, and allotted to the Seventh Corps Area. Initiated in May 1922 with headquarters at Minneapolis, MN. Relocated 26 May 1926 to Mankato, MN. Redesignated 7 May 1930 as the 431st Engineer Battalion (Separate). Relocated 12 October 1931 to Pine Bluff, AR. Conducted summer training most years at Fort Snelling, MN. Location 7 December 1941—Pine Bluff, AR.

432nd Engineer Battalion (Auxiliary) (XVIII Corps)**Organized Reserve Arizona/
Georgia/New York**

HQ-Not initiated 1921-22; Phoenix, AZ, 1922-27; *Inactive* 1927-29; La Grange, GA, 1929-33; *Inactive* 1933-37; Syracuse, NY, 1937-41

Constituted in the Organized Reserve 29 July 1921, assigned to the XVIII Corps, and allotted to the Eighth Corps Area. Initiated 12 September 1922 with headquarters at Phoenix, AZ. Withdrawn from the Eighth Corps Area 7 January 1927 and allotted to the Fourth Corps Area as a “Colored” unit. Inactivated 31 January 1927 at Phoenix by relief of personnel. Reorganized by 1929 at La Grange, GA. Redesignated 7 May 1930 as the 432nd Engineer Battalion (Separate). Withdrawn from the Fourth Corps Area 1 October 1933 and allotted to the Second Corps Area. Concurrently assigned to the XII Corps. Reorganized in April 1937 at Syracuse, NY. Typically conducted Inactive Training Period meetings at the Luhrs Building in Phoenix. Conducted summer training most years at Fort Bliss, TX, or some years at Fort Logan, CO. Primary R.O.T.C. feeder school was the Clarkson College of Technology 1937-41. Location 7 December 1941—Syracuse, NY.

Status: Disbanded 22 December 1942

433rd Engineer Battalion (Auxiliary) (XVIII Corps)**Organized Reserve Colorado/
Louisiana/New York**

HQ-Not initiated 1921-22; Walsenburg, CO, 1922-27; *Inactive* 1927-29; Lake Charles, LA, 1929-33; *Inactive* 1933-37; Rochester, NY, 1937-41

Constituted in the Organized Reserve 29 July 1921, assigned to the XVIII Corps, and allotted to the Eighth Corps Area. Initiated 12 September 1922 with headquarters at Walsenburg, CO. Conducted summer training at Fort Bliss, TX, in 1926. Withdrawn from the Eighth Corps Area 7 January 1927 and allotted to the Fourth Corps Area as a “Colored” unit. Inactivated 9 February 1927 at Walsenburg by relief of personnel. Reorganized by 1929 at Lake Charles, LA. Redesignated 7 May 1930 as the 433rd Engineer Battalion (Separate). Withdrawn from the Fourth Corps Area 1 October 1933 and allotted to the Second Corps Area. Concurrently assigned to the XII Corps. Reorganized in April 1937 at Rochester, NY. Location 7 December 1941—Rochester, NY.

Status: Disbanded 22 December 1942

434th Engineer Battalion (Auxiliary) (XVIII Corps)**Organized Reserve New Mexico/
North Carolina/New York**

HQ-Not initiated 1921-22; Las Vegas, NM, 1922-27; *Inactive* 1927-29; Charlotte, NC, 1929-33; *Inactive* 1933-37; Buffalo, NY, 1937-41

Constituted in the Organized Reserve 29 July 1921, assigned to the XVIII Corps, and allotted to the Eighth Corps Area. Initiated 12 September 1922 with headquarters at Las Vegas, NM. Conducted summer training most years at Fort Bliss, TX, or some years at Fort Logan, CO. Withdrawn from the Eighth Corps Area 7 January 1927 and allotted to the

Fourth Corps Area as a “Colored” unit. Inactivated 29 January 1927 at Las Vegas by relief of personnel. Reorganized by 1929 at Charlotte, NC. Redesignated 7 May 1930 as the 434th Engineer Battalion (Separate). Withdrawn from the Fourth Corps Area 1 October 1933 and allotted to the Second Corps Area. Concurrently assigned to the First Army. Reorganized in April 1937 at Buffalo, NY. Location 7 December 1941—Buffalo, NY.

Status: Disbanded 22 December 1942

435th Engineer Battalion (Auxiliary) (XIX Corps)

Organized Reserve California/Ohio

HQ-*Not initiated* 1921-22; San Diego, CA, 1922-30; *Inactive* 1930-37; Columbus, OH, 1937-41

Constituted in the Organized Reserve 29 July 1921, assigned to the XIX Corps, and allotted to the Ninth Corps Area. Initiated in 1922 with headquarters at San Diego, CA. Relieved from the XIX Corps 2 July 1923 and assigned to the IX Corps. Redesignated 7 May 1930 as the 435th Engineer Battalion (Separate). Conducted summer training at Fort Bliss, TX, and later at Del Monte, CA. Inactivated 30 January 1930 at San Diego by relief of personnel. Withdrawn from the Ninth Corps Area 1 October 1933 and allotted to the Fifth Corps Area. Reorganized in April 1937 at Columbus, OH. Location 7 December 1941—Columbus, OH.

436th Engineer Battalion (Auxiliary) (XIX Corps)

Organized Reserve Washington/California

HQ-*Not initiated* 1921-22; Seattle, WA, 1922-37; San Francisco, CA, 1937-41

Constituted in the Organized Reserve 29 July 1921, assigned to the XIX Corps, and allotted to the Ninth Corps Area. Initiated 26 May 1922 with headquarters at Seattle, WA. Relieved from the XIX Corps 2 July 1923 and assigned to the IX Corps. Redesignated 7 May 1930 as the 436th Engineer Battalion (Separate). Inactivated 2 March 1937 at Seattle by relief of personnel. Reorganized in April 1937 at San Francisco, CA. Conducted summer training most years at Fort Lewis, WA. Location 7 December 1941—San Francisco, CA.

Status: Disbanded 22 December 1942

437th Engineer Battalion (Auxiliary) (XIX Corps)

Organized Reserve Oregon/California

HQ-*Not initiated* 1921-22; Medford, OR, 1922-37; Los Angeles, CA, 1937-41

Constituted in the Organized Reserve 29 July 1921, assigned to the XIX Corps, and allotted to the Ninth Corps Area. Initiated 26 May 1922 with headquarters at Medford, OR. Relieved from the XIX Corps 2 July 1923 and assigned to the IX Corps. Redesignated 7 May 1930 as the 437th Engineer Battalion (Separate). Inactivated 2 March 1937 at Medford by relief of personnel. Reorganized in April 1937 at Los Angeles, CA. Conducted summer training most years at Fort Lewis, WA. Location 7 December 1941—Los Angeles, CA.

Status: Disbanded 22 December 1942

438th Engineer Battalion (Auxiliary) (I Corps)

Organized Reserve New York

HQ-Brooklyn, NY, 1921-41

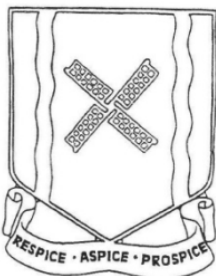

Constituted in the Organized Reserve 29 July 1921, assigned to the I Corps, and allotted to the Second Corps Area. Initiated 23 November 1921 with headquarters at Brooklyn, NY. Redesignated 7 May 1930 as the 438th Engineer Battalion (Separate) (Colored) 7 May 1930, relieved from the I Corps, and assigned to the II Corps. Relieved from the II Corps 1 October

1933 and assigned to the First Army. Typically conducted Inactive Training Period meetings at 1860 Broadway in New York City. Conducted summer training with the 1st Engineer Regiment at Fort Du Pont, DE. Location 7 December 1941—Brooklyn, NY.

Status: Disbanded 22 December 1942.

Events: 298

439th Engineer Battalion (Auxiliary) (C) (I Corps)

Organized Reserve New York/New Jersey

HQ—Not initiated 1921-22; Bronx, NY, 1922-25; Jersey City, NJ 1925-41



Constituted in the Organized Reserve 29 July 1921, assigned to the I Corps, and allotted to the Second Corps Area. Initiated 10 January 1922 with headquarters at Bronx, NY. Relocated 2 March 1925 to Jersey City, NJ. Redesignated 7 May 1930 as the 439th Engineer Battalion (Separate) (Colored) 7 May 1930, relieved from the I Corps, and assigned to the II Corps. Relieved from the II Corps 1 October 1933 and assigned to the First Army. Relieved from the First Army 9 March 1937 and assigned to the II Corps. Concurrently redesignated as a “White” unit. Withdrawn from the Organized Reserve 1 January 1938 and allotted to the Regular Army. Typically conducted Inactive Training Period meetings at the Engineer Societies building at 39th Street in New York City. Conducted summer training with the 1st Engineer Regiment at Fort Du Pont, DE. Location 7 December 1941—Jersey City, NJ.

Status: Disbanded 22 December 1942.

440th Engineer Battalion (Auxiliary) (I Corps)

**Organized Reserve Pennsylvania/
District of Columbia/Virginia**

HQ—Not initiated 1921-22; Philadelphia, PA, 1922-29; Washington, DC 1929-36; Norfolk, VA, 1936-41

Constituted in the Organized Reserve 29 July 1921, assigned to the I Corps, and allotted to the Third Corps Area. Initiated 5 January 1922 with headquarters at Philadelphia, PA. Relocated 11 December 1929 to Washington, DC. Redesignated 7 May 1930 as the 440th Engineer Battalion (Separate) (Colored). Relieved from the I Corps 1 October 1933 and assigned to the XIII Corps. Relocated in 1936 to Norfolk, VA. Typically conducted Inactive Training Period meetings at the US Court House or the Post Office Building in Norfolk and at the Society of American Military Engineers in Philadelphia. Conducted summer training most years at Fort Belvoir, VA, and some years with the 1st Engineer Regiment at Fort Du Pont, DE. Primary R.O.T.C. feeder school was the Virginia Polytechnic Institute. Location 7 December 1941—Norfolk, VA.

Status: Disbanded 22 December 1942.

441st Engineer Battalion (Auxiliary) (C) (II Corps)

**Organized Reserve Indiana/
Louisiana/Kentucky**

HQ—Fort Wayne, IN, 1922-27; Inactive 1927-29; Bastrop, LA, 1929-33; Versailles, KY, 1933-41

Constituted in the Organized Reserve 29 July 1921 as the 741st Engineer Battalion (Auxiliary), assigned to the II Corps, and allotted to the Fifth Corps Area. Initiated 23 November 1921 with headquarters at Fort Wayne, IN. Redesignated 2 July 1923 as the 441st Engineer Battalion (Auxiliary) (C). Relieved from the II Corps by 1926 and assigned to the I Corps. Withdrawn from the Fifth Corps Area 11 January 1927 and allotted to the Fourth Corps Area as a “Colored” unit. Reorganized by 1929 with headquarters at Bastrop, LA. Redesignated 7 May 1930 as the 441st Engineer Battalion (Separate). Withdrawn from the Fourth Corps Area 1 October 1933 and allotted to the Fifth Corps Area. Reorganized 21 December 1933 with headquarters at Versailles, KY. Location 7 December 1941—Versailles, KY.

Status: Disbanded 22 December 1942.

442nd Engineer Battalion (Auxiliary) (C) (II Corps)**Organized Reserve Kentucky/
Mississippi/West Virginia**

HQ-Not initiated 1921-22; Louisville, KY, 1922-27; Starkville, MS, 1927-33; Parkersburg, WV 1933-41

Constituted in the Organized Reserve 29 July 1921 as the 742nd Engineer Battalion (Auxiliary), assigned to the II Corps, and allotted to the Fifth Corps Area. Initiated in July 1922 with headquarters at Louisville, KY. Redesignated 2 July 1923 as the 442nd Engineer Battalion (Auxiliary) (C). Relieved from the II Corps by 1926 and assigned to the I Corps. Withdrawn from the Fifth Corps Area 11 January 1927 and allotted to the Fourth Corps Area as a “Colored” unit. Reorganized by 1929 at Starkville, MS. Redesignated 7 May 1930 as the 441st Engineer Battalion (Separate). Withdrawn from the Fourth Corps Area 1 October 1933 and allotted to the Fifth Corps Area. Reorganized 21 December 1933 at Parkersburg, WV. Location 7 December 1941— Parkersburg, WV.

Status: Disbanded 22 December 1942.

443rd Engineer Battalion (Auxiliary) (C) (IV Corps)**Organized Reserve Louisiana**

HQ-Not initiated 1921-22; New Iberia, LA, 1922-29; Shreveport, LA, 1929-41

Constituted in the Organized Reserve 29 July 1921 as the 743rd Engineer Battalion (Auxiliary), assigned to the IV Corps, and allotted to the Fourth Corps Area. Initiated 20 March 1922 with headquarters at New Iberia, LA. Redesignated 2 July 1923 as the 443rd Engineer Battalion (Auxiliary) (C). Relocated 22 October 1929 to Shreveport, LA. Relieved from the IV Corps by May 1930 and assigned to the XIV Corps. Redesignated 7 May 1930 as the 443rd Engineer Battalion (Separate). Conducted summer training with Company A, 7th Engineers and Company A, 4th Engineers at Fort Benning, GA. Designated mobilization training station was Camp Beauregard, LA, 1922-30 and Camp McClellan, AL, 1931-41. Location 7 December 1941—Shreveport, LA.

Status: Disbanded 22 December 1942.

444th Engineer Battalion (Auxiliary) (IX Corps)**Organized Reserve California**

HQ-Not initiated 1921-22; San Francisco, CA, 1922-37; Los Angeles, CA, 1937-41

Constituted in the Organized Reserve 29 July 1921, assigned to the IX Corps, and allotted to the Ninth Corps Area. Initiated 29 June 1922 with headquarters at San Francisco, CA. Relieved from the IX Corps 2 July 1923 and assigned to the XIX Corps. Redesignated 7 May 1930 as the 444th Engineer Battalion (Separate). Relieved from the XIX Corps 1 October 1933 and assigned to the IX Corps. Relocated 10 April 1937 to Los Angeles, CA. Conducted summer training most years at Del Monte, CA, and some years at the Presidio of Monterey or Fort Ord, CA. Location 7 December 1941—Los Angeles, CA.

Status: Disbanded 22 December 1942.

445th Engineer Battalion (Auxiliary) (IX Corps)**Organized Reserve Minnesota/Missouri**

HQ-Not initiated 1921-22; Duluth, MN, 1922-26; Jefferson City, MO, 1926-31; Hannibal, MO, 1931-41

Constituted in the Organized Reserve 29 July 1921, assigned to the IX Corps, and allotted to the Seventh Corps Area. Initiated 8 November 1921 with headquarters at Duluth, MN. Relieved from the IX Corps 2 July 1923 and assigned to XIX Corps. Relocated 26 May 1926 to Jefferson City, MO. Redesignated 7 May 1930 as the 444th Engineer Battalion (Separate). Relocated 12 October 1931 to Hannibal, MO. Designated mobilization training station was Camp Dodge, IA. Location 7 December 1941—Hannibal, MO.

Status: Disbanded 22 December 1942.

446th Engineer Battalion (Auxiliary) (IX Corps)**Organized Reserve Minnesota/North Dakota**

HQ-Not initiated 1921-22; St. Paul, MN, 1922-26; Fargo, ND, 1926-31; Minneapolis, MN, 1931-41

Constituted in the Organized Reserve 29 July 1921, assigned to the IX Corps, and allotted to the Seventh Corps Area. Initiated 8 November 1921 with headquarters at St. Paul, MN. Relieved from the IX Corps 2 July 1923 and assigned to XIX Corps. Relocated 26 May 1926 to Fargo, ND. Redesignated 7 May 1930 as the 446th Engineer Battalion (Separate). Relocated 12 October 1931 to Minneapolis, MN. Relieved from the XIX Corps by 1939 and assigned to the XVII Corps. Conducted summer training at Fort Logan, CO, or Fort Snelling, MN. Designated mobilization training station was Camp Dodge, IA. Location 7 December 1941—Minneapolis, MN.

Status: Disbanded 22 December 1942.

447th Engineer Battalion (Topographic) (Fourth Army)**Organized Reserve New York**

HQ-Brooklyn, NY, 1921-33

Constituted in the Organized Reserve 15 October 1921, assigned to the Fourth Army, and allotted to the Second Corps Area. Initiated 2 November 1921 with headquarters at Brooklyn, NY. Conducted summer training at Fort A. A. Humphreys, VA, Fort DuPont, DE, or Fort Dix, NJ. Demobilized 1 October 1933.

448th Engineer Battalion (Auxiliary) (C) (Fourth Army)**Organized Reserve North Carolina/Florida**

HQ-Not initiated 1921-22; Durham, NC, 1922-29; Pensacola, FL, 1929-41

Constituted in the Organized Reserve 15 October 1921 as the 748th Engineer Battalion (Auxiliary), assigned to the Fourth Army, and allotted to the Fourth Corps Area. Initiated in October 1922 with headquarters at Durham, NC. Redesignated 2 July 1923 as the 448th Engineer Battalion (Auxiliary) (C). Relocated 1 October 1929 to Pensacola, FL. Redesignated 7 May 1930 as the 448th Engineer Battalion (Separate). Conducted summer training at Fort Benning, GA. Designated mobilization training station was Fort Bragg, NC. Location 7 December 1941—Pensacola, FL.

Status: Disbanded 22 December 1942.

449th Engineer Battalion (Auxiliary) (C) (Fourth Army)**Organized Reserve Tennessee/Florida**

HQ-Not initiated 1921-22; Chattanooga, TN, 1922-29; Lakeland, FL, 1929-35; Tampa, FL, 1935-41

Constituted in the Organized Reserve 15 October 1921 as the 749th Engineer Battalion (Auxiliary), assigned to the Fourth Army, and allotted to the Fourth Corps Area. Initiated in May 1922 with headquarters at Chattanooga, TN. Redesignated 2 July 1923 as the 449th Engineer Battalion (Auxiliary) (C). Relocated 1 October 1929 to Lakeland, FL. Redesignated 7 May 1930 as the 449th Engineer Battalion (Separate). Relocated 29 January 1935 to Tampa, FL. Conducted summer training at Fort Benning, GA. Designated mobilization training station was the Memphis Mobilization Area. Location 7 December 1941—Tampa, FL.

Status: Disbanded 22 December 1942.

450th Engineer Battalion (Auxiliary) (C) (Fourth Army) Organized Reserve South Carolina/Florida

HQ-*Not initiated* 1921-22; Darlington, SC, 1922-29; St. Petersburg, FL, 1929-41

Constituted in the Organized Reserve 15 October 1921 as the 750th Engineer Battalion (Auxiliary), assigned to the Fourth Army, and allotted to the Fourth Corps Area. Initiated 22 December 1921 with headquarters at Darlington, SC. Redesignated 2 July 1923 as the 450th Engineer Battalion (Auxiliary) (C). Relocated 1 October 1929 to St. Petersburg, FL. Redesignated 7 May 1930 as the 450th Engineer Battalion (Separate). Conducted summer training at Fort Benning, GA. Designated mobilization training station was Camp Jackson, SC. Location 7 December 1941—St. Petersburg, FL.

Status: Disbanded 22 December 1942.

451st Engineer Battalion (Auxiliary) (C) (Fourth Army) Organized Reserve Georgia/North Carolina

HQ-Albany, GA, 1922-29; Raleigh, NC, 1929-41

Constituted in the Organized Reserve 15 October 1921 as the 751st Engineer Battalion (Auxiliary), assigned to the Fourth Army, and allotted to the Fourth Corps Area. Initiated in December 1922 with headquarters at Albany, GA. Redesignated 2 July 1923 as the 451st Engineer Battalion (Auxiliary) (C). Relocated 1 October 1929 to Raleigh, NC. Redesignated 7 May 1930 as the 451st Engineer Battalion (Separate). Withdrawn from the Organized Reserve 1 January 1938 and allotted to the Regular Army. Conducted summer training at Fort Benning, GA. Designated mobilization training station was Camp Wheeler, GA. Location 7 December 1941—Raleigh, NC.

Status: Disbanded 22 December 1942.

452nd Engineer Battalion (Auxiliary) (C) (Fourth Army) Organized Reserve Georgia

HQ-*Not initiated* 1921-22; Tifton, GA, 1922-29; Macon, GA, 1929-40; *Inactive* 1940-41

Constituted in the Organized Reserve 15 October 1921 as the 752nd Engineer Battalion (Auxiliary), assigned to the Fourth Army, and allotted to the Fourth Corps Area. Initiated in May 1922 with headquarters at Tifton, GA. Redesignated 2 July 1923 as the 452nd Engineer Battalion (Auxiliary) (C). Relocated 1 October 1929 to Macon, GA. Redesignated 7 May 1930 as the 452nd Engineer Battalion (Separate). Withdrawn from the Organized Reserve 1 January 1938 and allotted to the Regular Army. Conducted summer training at Fort Benning, GA. Designated mobilization training station was Camp Wheeler, GA. Inactivated 7 August 1940 at Macon by relief of personnel. Location 7 December 1941—*Inactive*.

Status: Disbanded 22 December 1942.

**453rd Engineer Battalion (Auxiliary) (C) (Fourth Army) Organized Reserve Georgia/
South Carolina/Alabama**

HQ-*Not initiated* 1921-22; Waycross, GA, 1922-29; Greenville, SC, 1929-35; Tuscaloosa, AL, 1935-40; *Inactive* 1940-41

Constituted in the Organized Reserve 15 October 1921 as the 753rd Engineer Battalion (Auxiliary), assigned to the Fourth Army, and allotted to the Fourth Corps Area. Initiated 28 March 1922 with headquarters at Waycross, GA. Redesignated 2 July 1923 as the 453rd Engineer Battalion (Auxiliary) (C). Relocated 1 October 1929 to Greenville, SC. Redesignated 7 May 1930 as the 453rd Engineer Battalion (Separate). Relocated 29 January 1935 to Tuscaloosa, AL. Withdrawn from the Organized Reserve 1 January 1938 and allotted to the Regular Army. Conducted summer training at Fort Benning, GA. Designated mobilization training station was Camp Joseph E. Johnston, FL, (later redesignated Camp J. Clifford R. Foster) 1922-29 and later Camp Wheeler, GA. Inactivated 25 August 1940 at Tuscaloosa by relief of personnel. Location 7 December 1941—*Inactive*.

Status: Disbanded 22 December 1942.

454th Engineer Battalion (Auxiliary) (C) (Fifth Army)**Organized Reserve Alabama/Georgia**

HQ-Not initiated 1921-22; Huntsville, AL, 1922-29; Atlanta, GA, 1929-41

Constituted in the Organized Reserve 15 October 1921 as the 754th Engineer Battalion (Auxiliary), assigned to the Fifth Army, and allotted to the Fourth Corps Area. Initiated 31 March 1922 with headquarters at Huntsville, AL. Redesignated 2 July 1923 as the 454th Engineer Battalion (Auxiliary) (C). Relocated 1 October 1929 to Atlanta, GA. Redesignated 7 May 1930 as the 454th Engineer Battalion (Separate). Relieved from the Fifth Army 1 October 1933. Conducted summer training at Fort Benning, GA. Designated mobilization training station was Camp McClellan, AL. Location 7 December 1941—Atlanta, GA.

Status: Disbanded 22 December 1942.

455th Engineer Battalion (Auxiliary) (C) (Fifth Army)**Organized Reserve Mississippi/Louisiana/Alabama**

HQ-Not initiated 1921-22; Tupelo, MS, 1922-29; Alexandria, LA, 1929-35; Florence, AL, 1935-41

Constituted in the Organized Reserve 15 October 1921 as the 755th Engineer Battalion (Auxiliary), assigned to the Fifth Army, and allotted to the Fourth Corps Area. Initiated in December 1922 with headquarters at Tupelo, MS. Redesignated 2 July 1923 as the 455th Engineer Battalion (Auxiliary) (C). Relocated 1 October 1929 to Alexandria, LA. Redesignated 7 May 1930 as the 455th Engineer Battalion (Separate). Relieved from the Fifth Army 1 October 1933. Relocated 29 January 1935 to Florence, AL. Conducted summer training at Fort Benning, GA. Designated mobilization training station was the Memphis Mobilization Area. Location 7 December 1941—Florence, AL.

Status: Disbanded 22 December 1942.

456th Engineer Battalion (Auxiliary) (C) (Fifth Army)**Organized Reserve Mississippi**

HQ-Not initiated 1921-22; Marks, MS, 1922-29; New Orleans, LA, 1929-35; Montgomery, AL, 1935-41

Constituted in the Organized Reserve 15 October 1921 as the 756th Engineer Battalion (Auxiliary), assigned to the Fifth Army, and allotted to the Fourth Corps Area. Initiated about February 1922 with headquarters at Marks, LA. Redesignated 2 July 1923 as the 456th Engineer Battalion (Auxiliary) (C). Relocated 1 October 1929 to New Orleans, LA. Redesignated 7 May 1930 as the 456th Engineer Battalion (Separate). Relieved from the Fifth Army 1 October 1933. Relocated 29 January 1935 to Montgomery, AL. Conducted summer training at Fort Benning, GA. Designated mobilization training station was the Memphis Mobilization Area. Location 7 December 1941—Montgomery, AL.

Status: Disbanded 22 December 1942.

457th Engineer Battalion (Auxiliary) (C) (Fifth Army)**Organized Reserve Louisiana**

HQ-Not initiated 1921-22; Minden, LA, 1922-29; Baton Rouge, LA, 1929-41

Constituted in the Organized Reserve 15 October 1921 as the 757th Engineer Battalion (Auxiliary), assigned to the Fifth Army, and allotted to the Fourth Corps Area. Initiated in March 1922 with headquarters at Minden, LA. Redesignated 2 July 1923 as the 457th Engineer Battalion (Auxiliary) (C). Relocated 1 October 1929 to Baton Rouge, LA. Redesignated 7 May 1930 as the 457th Engineer Battalion (Separate). Relieved from the Fifth Army 1 October 1933. Conducted summer training at Fort Benning, GA. Designated mobilization training station was Camp Beauregard, LA, and later, Camp Shelby, MS. Location 7 December 1941—Baton Rouge, LA.

Status: Disbanded 22 December 1942.

458th Engineer Battalion (Topographic) (Fifth Army)**Organized Reserve Wisconsin/Illinois**

HQ-Not initiated 1921-22; Madison, WI 1922-25; Chicago, IL, 1925-33

Constituted in the Organized Reserve 15 October 1921, assigned to the Fifth Army, and allotted to the Sixth Corps Area. Initiated by 1922 with headquarters at Madison, WI. Relocated 28 July 1925 to Chicago, IL. Relieved from the Fifth Army 1 October 1933. Conducted summer training most years at Camp Custer, MI, and some years at Fort Sheridan, IL. Designated mobilization training station was the State Fairgrounds, Springfield, IL. Demobilized 1 October 1933.

459th Engineer Battalion (Topographic) (Sixth Army)**Organized Reserve Nebraska/Kansas/Missouri**

HQ-Not initiated 1921-22; Lincoln, NE, 1922-26; Hutchison, KS, 1926-31; St. Louis, MO, 1931-41; Camp Beauregard, LA, 1941

Constituted in the Organized Reserve 15 October 1921, assigned to the Sixth Army, and allotted to the Seventh Corps Area. Initiated in February 1922 with headquarters at Lincoln, NE. Relocated 26 May 1926 to Hutchison, KS. Relocated 12 October 1931 to St. Louis, MO. Withdrawn from the Organized Reserve 1 January 1938 and allotted to the Regular Army. Redesignated 13 January 1941 as the 33rd Engineer Battalion (Topographic) (GHQR). Redesignated as the 648th Engineer Topographic Battalion (Army) 7 November 1941 and activated at Camp Beauregard, LA. Location 7 December 1941— Camp Beauregard, LA.

Status: Inactive in the Regular Army as the 48th Engineer Battalion.

460th Engineer Battalion (Auxiliary) (Fifth Army)**Organized Reserve Oklahoma**

HQ-Not initiated 1921-23; Stillwater, OK, 1923-25; Tulsa, OK, 1925-41

Constituted in the Organized Reserve 15 October 1921, assigned to the Fifth Army, and allotted to the Eighth Corps Area. Initiated in May 1923 with headquarters at Stillwater, OK. Redesignated 2 July 1923 as the 460th Engineer Battalion (Auxiliary). Relocated 10 July 1925 to Tulsa, OK. Redesignated 7 May 1930 as the 460th Engineer Battalion (Separate). Relieved from the Fifth Army 1 October 1933 and assigned to the VIII Corps. Withdrawn from the Organized Reserve 1 January 1938 and allotted to the Regular Army as a “Colored” unit. Withdrawn from the Regular Army 1 July 1940 and reallocated to the Organized Reserve. Conducted summer training with the 2nd Engineer Regiment at Fort Sam Houston, TX, 1925-27 and at Fort Logan, CO, 1928-35. Designated mobilization training station was the Waco Concentration Camp, Waco, TX. Location 7 December 1941—Tulsa, OK.

Status: Disbanded 22 December 1942.

461st Engineer Battalion (Auxiliary) (Fifth Army)**Organized Reserve Texas**

HQ-Not initiated 1921-23; El Paso, TX, 1923-41

Constituted in the Organized Reserve 15 October 1921, assigned to the Fifth Army, and allotted to the Eighth Corps Area. Initiated 5 March 1923 with headquarters at El Paso, TX. Redesignated 2 July 1923 as the 461st Engineer Battalion (Auxiliary). Redesignated 7 May 1930 as the 461st Engineer Battalion (Separate). Relieved from the Fifth Army 1 October 1933 and assigned to the VIII Corps. Withdrawn from the Organized Reserve 1 January 1938 and allotted to the Regular Army as a “Colored” unit. Withdrawn from the Regular Army 1 July 1940 and reallocated to the Organized Reserve. Conducted summer training with the 8th Engineer Squadron at Fort Bliss, TX, 1925-27 and at Fort McIntosh, TX, 1928-35. Designated mobilization training station was the Waco Concentration Camp, Waco, TX. Location 7 December 1941—El Paso, TX.

Status: Disbanded 22 December 1942.

462nd Engineer Battalion (Auxiliary) (Sixth Army)**Organized Reserve Texas****HQ-Not initiated** 1921-23; Dallas, TX, 1923-41

Constituted in the Organized Reserve 15 October 1921, assigned to the Sixth Army, and allotted to the Eighth Corps Area. Initiated 5 March 1923 with headquarters at Dallas, TX. Redesignated 2 July 1923 as the 462nd Engineer Battalion (Auxiliary). Redesignated 7 May 1930 as the 462nd Engineer Battalion (Separate). Relieved from the Sixth Army 1 October 1933. Conducted summer training with the 2nd Engineer Regiment at Fort Sam Houston, TX, 1925-27 and with the 8th Engineer Squadron Fort McIntosh, TX, 1928-35. Designated mobilization training station was the Waco Concentration Camp, Waco, TX. Location 7 December 1941—Dallas, TX.

Status: Disbanded 22 December 1942.**463rd Engineer Battalion (Auxiliary) (Sixth Army)****Organized Reserve Texas****HQ-Not initiated** 1921-23; Houston, TX, 1923-41

Constituted in the Organized Reserve 15 October 1921, assigned to the Sixth Army, and allotted to the Eighth Corps Area. Initiated 5 March 1923 with headquarters at Houston, TX. Redesignated 2 July 1923 as the 463rd Engineer Battalion (Auxiliary). Redesignated 7 May 1930 as the 463rd Engineer Battalion (Separate). Conducted summer training with the 2nd Engineer Regiment at Fort Sam Houston, TX, 1925-27 and with the 8th Engineer Squadron at Fort McIntosh, TX, 1928-35. Designated mobilization training station was the Waco Concentration Camp, Waco, TX. Location 7 December 1941—Houston, TX.

Status: Disbanded 22 December 1942.**464th Engineer Battalion (Auxiliary) (Sixth Army)****Organized Reserve Texas/California****HQ-Not initiated** 1921-23; Fort Worth, TX, 1923-24; *Inactive* 1924-25; Los Angeles, CA, 1925-41

Constituted in the Organized Reserve 15 October 1921, assigned to the Sixth Army, and allotted to the Eighth Corps Area. Initiated 18 February 1923 with headquarters at Fort Worth, TX. Redesignated 2 July 1923 as the 464th Engineer Battalion (Auxiliary). Withdrawn from the Eighth Corps Area 31 March 1924 and allotted to the Ninth Corps Area. Reorganized in February 1925 at Los Angeles, CA. Redesignated 7 May 1930 as the 464th Engineer Battalion (Separate). Relieved from the Sixth Army 1 October 1933. Assigned to the Fourth Army by 1937. Conducted summer training most years at Del Monte, CA, and some years at the Presidio of Monterey or Fort Ord, CA. Location 7 December 1941—Los Angeles, CA.

Status: Disbanded 22 December 1942.**465th Engineer Battalion (Auxiliary) (Sixth Army)****Organized Reserve Texas/California****HQ-Not initiated** 1921-23; Galveston, TX, 1923-24; *Inactive* 1924-25; Alhambra, CA, 1925-41

Constituted in the Organized Reserve 15 October 1921, assigned to the Sixth Army, and allotted to the Eighth Corps Area. Initiated 21 April 1923 with headquarters at Galveston, TX. Redesignated 2 July 1923 as the 465th Engineer Battalion (Auxiliary). Withdrawn from the Eighth Corps Area 31 March 1924 and allotted to the Ninth Corps Area. Reorganized 3 February 1925 at Alhambra, CA. Redesignated 7 May 1930 as the 465th Engineer Battalion (Separate). Relieved from the Sixth Army 1 October 1933 and assigned to the IX Corps. Withdrawn from the Organized Reserve 1 January 1938 and allotted to the Regular Army. Conducted summer training most years at Del Monte, CA, and some years at the Presidio of Monterey or Fort Ord, CA. Withdrawn from the Regular Army 1 July 1940 and reallocated to the Organized Reserve. Location 7 December 1941—Alhambra, CA.

Status: Disbanded 22 December 1942.

466th Engineer Battalion (Auxiliary) (Sixth Army)**Organized Reserve Texas/California**

HQ-*Not initiated* 1921-23; Beaumont, TX, 1923-24; *Inactive* 1924-25; San Francisco, CA, 1925-29; *Inactive* 1929-41

Constituted in the Organized Reserve 15 October 1921, assigned to the Sixth Army, and allotted to the Eighth Corps Area. Initiated 5 March 1923 with headquarters at Beaumont, TX. Redesignated 2 July 1923 as the 466th Engineer Battalion (Auxiliary). Withdrawn from the Eighth Corps Area 31 March 1924 and allotted to the Ninth Corps Area. Reorganized 21 January 1925 at San Francisco, CA. Inactivated 12 November 1929 at San Francisco by relief of personnel. Redesignated 7 May 1930 as the 466th Engineer Battalion (Separate). Relieved from the Sixth Army 1 October 1933. Assigned to the XIX Corps by 1937. Conducted summer training most years at Del Monte, CA. Location 7 December 1941—*Inactive*.

Status: Disbanded 22 December 1942.

467th Engineer Battalion (Auxiliary) (Sixth Army)**Organized Reserve Texas/California**

HQ-*Not initiated* 1921-23; Austin, TX, 1923-24; *Inactive* 1924-25; Los Angeles, CA, 1925-30; *Inactive* 1930-33

Constituted in the Organized Reserve 15 October 1921, assigned to the Sixth Army, and allotted to the Eighth Corps Area. Initiated 5 March 1923 with headquarters at Austin, TX. Redesignated 2 July 1923 as the 467th Engineer Battalion (Auxiliary). Withdrawn from the Eighth Corps Area 31 March 1924 and allotted to the Ninth Corps Area. Reorganized in April 1925 at Los Angeles, CA. Conducted summer training at Del Monte, CA, in 1926. Inactivated 28 January 1930 at Los Angeles by relief of personnel. Redesignated 7 May 1930 as the 464th Engineer Battalion (Separate). Demobilized 1 October 1933.

473rd Engineer Train (Water Tank) (Fourth Army)**Organized Reserve Pennsylvania**

HQ-*Not initiated* 1921-22; Wilkes-Barre, PA, 1922-37; Pittsburgh, PA, 1937-41

Constituted in the Organized Reserve 15 October 1921, assigned to the Fourth Army, and allotted to the Third Corps Area. Initiated 4 February 1922 with headquarters at Wilkes-Barre, PA. Redesignated 18 May 1925 as the 473rd Engineer Battalion (Water Supply). Relocated 1 October 1937 to Pittsburgh, PA. Reorganized at Pittsburgh with personnel from the inactivated 955th Engineer Battalion. Typically conducted Inactive Training Period meetings at the New Federal Building in Pittsburgh. Conducted summer training at Fort DuPont, DE. Location 7 December 1941—Pittsburgh, PA.

486th Engineer Train (Water Tank) (Fifth Army)**Organized Reserve Wisconsin**

HQ-*Not initiated* 1921-22; Fond du Lac, WI 1922-25; Wausau 1925-28

Constituted in the Organized Reserve 15 October 1921, assigned to the Fifth Army, and allotted to the Sixth Corps Area. Initiated in November 1922 with headquarters at Fond du Lac, WI. Redesignated 18 May 1925 as the 486th Engineer Battalion (Water Supply). Relocated 2 June 1925 to Wausau, WI. Designated mobilization training station was Camp Douglas, WI. Withdrawn from the Sixth Corps Area 6 October 1928.

487th Engineer Train (Water Tank) (Sixth Army)**Organized Reserve South Dakota**

HQ-*Not initiated* 1921-22; Rapid City, SD, 1922-26; Bismarck, ND, 1926-31; Iowa City, IA, 1931-41

Constituted in the Organized Reserve 15 October 1921, assigned to the Sixth Army, and allotted to the Seventh Corps Area. Initiated in May 1922 with headquarters at Rapid City, SD. Redesignated 18 May 1925 as the 487th Engineer Battalion (Water Supply). Relocated 26 May 1926 to Bismarck, ND. Relocated 12 October 1931 to Iowa City, IA. Relieved from the Sixth Army 1 October 1933. Location 7 December 1941—Iowa City, IA.

489th Engineer Battalion (Railway Operating) (GHQR)

Organized Reserve New Jersey/New York

HQ-Newark, NJ 1921-23; New York City, NY, 1923-41

Constituted in the Organized Reserve 15 October 1921, assigned to the General Headquarters Reserve, and allotted to the Second Corps Area. Initiated 4 November 1921 with headquarters at Newark, NJ. Relocated in 1923 to New York City, NY. Redesignated 21 February 1941 as the 721st Engineer Battalion (Railway Operating). Affiliated with the New York Central Railroad (New York to Albany). Transferred 20 March 1941 to control of the Office of the Chief Engineer. Location 7 December 1941—New York City, NY.

490th Engineer Battalion (Railway Operating) (GHQR)

Organized Reserve New Jersey/New York

HQ-Hoboken, NJ 1921-23; Buffalo, NY, 1923-41

Constituted in the Organized Reserve 15 October 1921, assigned to the General Headquarters Reserve, and allotted to the Second Corps Area. Initiated 23 November 1921 with headquarters at Hoboken, NJ. Relocated in 1923 to Buffalo, NY. Redesignated 21 February 1941 as the 736th Engineer Battalion (Railway Operating). Affiliated with the New York Central Railroad (Albany to Buffalo). Transferred 20 March 1941 to control of the Office of the Chief Engineer. Location 7 December 1941—Buffalo, NY.

491st Engineer Battalion (Railway Operating) (GHQR)

Organized Reserve New York/New Jersey

HQ-*Not initiated* 1921-22; Buffalo, NY, 1922-23; Hoboken, NJ 1923-41



Constituted in the Organized Reserve 15 October 1921, assigned to the General Headquarters Reserve, and allotted to the Second Corps Area. Initiated 4 November 1921 with headquarters at Buffalo, NY. Relocated in 1923 to Hoboken, NJ. Redesignated 21 February 1941 as the 735th Engineer Battalion (Railway Operating). Affiliated with the Erie and Lackawanna Railroad. Transferred 20 March 1941 to control of the Office of the Chief Engineer. Location 7 December 1941—Hoboken, NJ.

492nd Engineer Battalion (Railway Operating) (GHQR)

Organized Reserve Pennsylvania

HQ-*Not initiated* 1921-22; Forest City, PA, 1922-23; Philadelphia, PA, 1923-41

Constituted in the Organized Reserve 15 October 1921, assigned to the General Headquarters Reserve, and allotted to the Third Corps Area. Initiated 2 February 1922 with headquarters at Forest City, PA. Relocated in April 1923 to Philadelphia, PA. Typically conducted Inactive Training Period meetings at the Society of American Military Engineers in Philadelphia. Conducted summer training at Fort A. A. Humphreys, VA. Redesignated 21 February 1941 as the 730th Engineer Battalion (Railway Operating). Affiliated with the Pennsylvania Railroad (eastern section). Location 7 December 1941—Philadelphia, PA.

493rd Engineer Battalion (Railway Operating) (GHQR)

Organized Reserve Pennsylvania

HQ-*Not initiated* 1921-22; Danville, PA, 1922-23; Pittsburgh, PA, 1923-41

Constituted in the Organized Reserve 15 October 1921, assigned to the General Headquarters Reserve, and allotted to the Third Corps Area. Initiated 5 January 1922 with headquarters at Danville, PA. Relocated in April 1923 to Pittsburgh, PA. Affiliated with the Pennsylvania Railroad (Central). Redesignated 21 February 1941 as the 724th Engineer Battalion (Railway Operating). Location 7 December 1941—Pittsburgh, PA.

494th Engineer Battalion (Railway Operating) (CZ)**Organized Reserve Pennsylvania/Maryland****HQ-Not initiated** 1921-22; Mahaney City, PA, 1922-23; Baltimore, MD, 1923-28

Constituted in the Organized Reserve 15 October 1921, assigned to the Communications Zone, and allotted to the Third Corps Area. Initiated 25 January 1922 with headquarters at Mahaney City, PA. Relocated in April 1923 to Baltimore, MD. Affiliated with the Baltimore and Ohio—Eastern Line. Withdrawn from the Third Corps Area 6 October 1928 and demobilized.

495th Engineer Battalion (Auxiliary) (C) (GHQR)**Organized Reserve South Carolina/North Carolina****HQ-Not initiated** 1921-22; Beaufort, NC, 1922-29; Asheville, NC, 1929-41

Constituted in the Organized Reserve 15 October 1921 as the 795th Engineer Battalion (Auxiliary), assigned to the General Headquarters Reserve, and allotted to the Fourth Corps Area. Initiated in September 1922 with headquarters at Beaufort, SC. Redesignated 2 July 1923 as the 495th Engineer Battalion (Auxiliary) (C). Relocated 1 October 1929 to Asheville, NC. Redesignated 7 May 1930 as the 495th Engineer Battalion (Separate). Conducted summer training at Fort Benning, GA. Designated mobilization station was Fort Bragg, NC. Location 7 December 1941—Asheville, NC.

Status: Disbanded 22 December 1942.**496th Engineer Battalion (Railway Operating) (GHQR)****Organized Reserve Tennessee/Georgia****HQ-Not initiated** 1921-22; Chattanooga, TN, 1922-34; Macon, GA, 1934-41

Constituted in the Organized Reserve 15 October 1921, assigned to the General Headquarters Reserve, and allotted to the Fourth Corps Area. Initiated in December 1922 with headquarters at Chattanooga, TN. Affiliated with the Louisville and Nashville Railroad 1922-34. Affiliation changed to the Central of Georgia Railroad 5 November 1934. Relocated 29 January 1935 to Macon, GA. Redesignated 21 February 1941 as the 733rd Engineer Battalion (Railway Operating). Designated mobilization training station was Fort Oglethorpe, GA. Location 7 December 1941—Macon, GA.

497th Engineer Battalion (Auxiliary) (C) (GHQR)**Organized Reserve Georgia****HQ-Not initiated** 1921-22; Gainesville, GA, 1922-41

Constituted in the Organized Reserve 15 October 1921 as the 797th Engineer Battalion (Auxiliary), assigned to the General Headquarters Reserve, and allotted to the Fourth Corps Area. Initiated in February 1922 with headquarters at Gainesville, GA. Redesignated 2 July 1923 as the 497th Engineer Battalion (Auxiliary) (C). Redesignated 7 May 1930 as the 497th Engineer Battalion (Separate). Designated mobilization station was Camp Wheeler, GA. Location 7 December 1941—Gainesville, GA.

Status: Disbanded 22 December 1942.**498th Engineer Battalion (Auxiliary) (C) (GHQR)****Organized Reserve Alabama/Tennessee****HQ-Not initiated** 1921-22; Birmingham, AL, 1922-29; Knoxville, TN, 1929-41

Constituted in the Organized Reserve 15 October 1921 as the 798th Engineer Battalion (Auxiliary), assigned to the General Headquarters Reserve, and allotted to the Fourth Corps Area. Initiated 25 March 1922 with headquarters at Birmingham, AL. Redesignated 2 July 1923 as the 498th Engineer Battalion (Auxiliary) (C). Redesignated 7 May 1930 as the 498th Engineer Battalion (Separate). Relocated 1 October 1929 to Knoxville, TN. Conducted summer training at Fort Benning, GA. Designated mobilization station was Camp McClellan, AL. Location 7 December 1941—Knoxville, TN.

Status: Disbanded 22 December 1942.

499th Engineer Battalion (Auxiliary) (C) (GHQR)**Organized Reserve Mississippi/Tennessee**

HQ-Not initiated 1921-22; Belzoni, MS, 1922-29; Chattanooga, TN, 1929-41

Constituted in the Organized Reserve 15 October 1921 as the 799th Engineer Battalion (Auxiliary), assigned to the General Headquarters Reserve, and allotted to the Fourth Corps Area. Initiated about February 1922 with headquarters at Belzoni, MS. Redesignated 2 July 1923 as the 499th Engineer Battalion (Auxiliary) (C). Redesignated 7 May 1930 as the 499th Engineer Battalion (Separate). Relocated 1 October 1929 to Chattanooga, TN. Conducted summer training at Fort Benning, GA. Designated mobilization station was Camp Shelby, MS. Location 7 December 1941—Knoxville, TN.

Status: Disbanded 22 December 1942.

500th Engineer Battalion (Auxiliary) (C) (GHQR)**Organized Reserve Louisiana/Tennessee**

HQ-Not initiated 1921-22; Bastrop, LA, 1922-29; Jackson, TN, 1929-41

Constituted in the Organized Reserve 15 October 1921 as the 800th Engineer Battalion (Auxiliary), assigned to the General Headquarters Reserve, and allotted to the Fourth Corps Area. Initiated 15 March 1922 with headquarters at Bastrop, LA. Redesignated 2 July 1923 as the 500th Engineer Battalion (Auxiliary). Relocated 1 October 1929 to Jackson, TN. Redesignated 7 May 1930 as the 500th Engineer Battalion (Separate). Conducted summer training at Fort Benning, GA. Designated mobilization station was Camp Beauregard, LA, and later, Camp Shelby, MS. Location 7 December 1941—Jackson, TN.

Status: Disbanded 22 December 1942.

501st Engineer Battalion (Auxiliary) (C) (GHQR)**Organized Reserve South Carolina**

HQ-Orangeburg, SC, 1921-29; Chester, SC, 1929-41

Constituted in the Organized Reserve 15 October 1921 as the 801st Engineer Battalion (Auxiliary), assigned to the General Headquarters Reserve, and allotted to the Fourth Corps Area. Initiated in December 1921 with headquarters at Orangeburg, SC. Redesignated 2 July 1923 as the 501st Engineer Battalion (Auxiliary). Relocated 1 October 1929 to Chester, SC. Redesignated 7 May 1930 as the 501st Engineer Battalion (Separate). Designated mobilization station was Camp Jackson, SC. Location 7 December 1941—Chester, SC.

Status: Disbanded 22 December 1942.

502nd Engineer Battalion (Camouflage) (GHQR)**Organized Reserve Kentucky**

HQ-Not initiated 1921-22; Richmond, KY, 1922

Constituted in the Organized Reserve 15 October 1921, assigned to the General Headquarters Reserve, and allotted to the Fifth Corps Area. Initiated in January 1922 with headquarters at Richmond, KY. Withdrawn from the Organized Reserve 28 December 1922 and demobilized. Personnel concurrently transferred to Companies D, E, F, and G, 40th Engineer Regiment (Camouflage).

503rd Engineer Battalion (Railway) (GHQR)**Organized Reserve West Virginia/Ohio**

HQ-Not initiated 1921-22; Huntington, WV 1922-23; Akron, OH, 1923-28

Constituted in the Organized Reserve 15 October 1921, assigned to the General Headquarters Reserve, and allotted to the Fifth Corps Area. Initiated in July 1922 with headquarters at Huntington, WV. Relocated 31 May 1923 to Akron, OH. Affiliated with the Baltimore and Ohio Railroad. Withdrawn from the Fifth Corps Area 6 October 1928 and demobilized.

504th Engineer Battalion (Topographic) (GHQR)

Organized Reserve Indiana

HQ-Not initiated 1921-23; La Porte, IN, 1923-31; Fort Wayne, IN, 1931-37; South Bend, IN, 1937-40

Constituted in the Organized Reserve 15 October 1921, assigned to the General Headquarters Reserve, and allotted to the Fifth Corps Area. Initiated in October 1923 with headquarters at La Porte, IN. Relocated 9 July 1931 to Fort Wayne, IN. Relocated 5 April 1937 to South Bend, IN. Withdrawn from the Organized Reserve 1 January 1938 and allotted to the Regular Army. Conducted summer training at Fort Benning, GA. Disbanded 1 July 1940.

505th Engineer Battalion (Railway Operating) (GHQR)

Organized Reserve Illinois

HQ-Not initiated 1921-22; Chicago, IL, 1922-41

Constituted in the Organized Reserve 15 October 1921, assigned to the General Headquarters Reserve, and allotted to the Sixth Corps Area. Initiated 14 January 1922 with headquarters at Chicago, IL. Affiliated with the Illinois Central Railroad. Redesignated 21 February 1941 as the 743rd Engineer Battalion (Railway Operating). Location 7 December 1941—Chicago, IL.

506th Engineer Battalion (Railway Operating) (CZ)

Organized Reserve Illinois

HQ-Not initiated 1921-22; Chicago, IL, 1922-41

Constituted in the Organized Reserve 15 October 1921, assigned to the Communications Zone, and allotted to the Sixth Corps Area. Initiated 4 February 1922 with headquarters at Chicago, IL. Affiliated with the Chicago and Great Western, the Chicago and Eastern, and the Michigan Central Railroads. Redesignated 21 February 1941 as the 783rd Engineer Battalion (Railway Operating). Conducted summer training with elements of the 13th Engineer Regiment at Camp Custer, MI. Conducted Engineer CMTC at Camp Custer in 1928. Location 7 December 1941—Chicago, IL.

507th Engineer Battalion (Railway Operating) (CZ)

Organized Reserve Illinois

HQ-Not initiated 1921-24; Chicago, IL, 1924-41

Constituted in the Organized Reserve 15 October 1921, assigned to the Communications Zone, and allotted to the Sixth Corps Area. Initiated in April 1924 with headquarters at Chicago, IL. Affiliated with the Chicago & Northwestern Railroad. Redesignated 21 February 1941 as the 720th Engineer Battalion (Railway Operating). Location 7 December 1941—Chicago, IL.

508th Engineer Battalion (Railway Operating) (GHQR)

Organized Reserve Kansas

HQ-Not initiated 1921-22; Dodge City, KS, 1922-41

Constituted in the Organized Reserve 15 October 1921, assigned to the General Headquarters Reserve, and allotted to the Seventh Corps Area. Initiated in March 1922 with headquarters at Dodge City, KS. Affiliated with the Chicago, Rock Island, and Pacific Railroad. Redesignated 21 February 1941 as the 725th Engineer Battalion (Railway Operating). Location 7 December 1941—Dodge City, KS.

509th Engineer Battalion (Auxiliary) (GHQR)**Organized Reserve North Dakota/
Missouri/Minnesota****HQ-Not initiated** 1921-22; Bismarck, ND, 1922-26; St. Joseph, MO, 1926-31; Duluth, MN, 1931-41

Constituted in the Organized Reserve 15 October 1921, assigned to the General Headquarters Reserve, and allotted to the Seventh Corps Area. Initiated in April 1922 with headquarters at Bismarck, ND. Relocated 26 May 1926 to St. Joseph, MO. Redesignated 7 May 1930 as the 509th Engineer Battalion (Separate). Relocated 12 October 1931 to Duluth, MN. Location 7 December 1941—Duluth, MN.

Status: Disbanded 22 December 1942.**510th Engineer Battalion (Auxiliary) (GHQR)****Organized Reserve South Dakota/Missouri****HQ-Not initiated** 1921-22; Sioux Falls, SD, 1922-26; Moberly, MO, 1926-31; Aberdeen, SD, 1931-41

Constituted in the Organized Reserve 15 October 1921, assigned to the General Headquarters Reserve, and allotted to the Seventh Corps Area. Initiated in May 1922 with headquarters at Sioux Falls, SD. Relocated 26 May 1926 to Moberly, MO. Redesignated 7 May 1930 as the 510th Engineer Battalion (Separate). Relocated 12 October 1931 to Aberdeen, SD. Assigned to XVII Corps by 1939. Conducted summer training at Fort Riley, KS, or Fort Snelling, MN. Location 7 December 1941—Aberdeen, SD.

Status: Disbanded 22 December 1942.**511th Engineer Battalion (Auxiliary) (GHQR)****Organized Reserve Oklahoma/Texas****HQ-Not initiated** 1921-23; Norman, OK, 1923-27; San Antonio, TX, 1927-41

Constituted in the Organized Reserve 15 October 1921, assigned to the General Headquarters Reserve, and allotted to the Eighth Corps Area. Initiated in May 1923 with headquarters at Norman, OK. Assigned to the Sixth Army 2 July 1923. Relocated 22 August 1927 to San Antonio, TX. Redesignated 7 May 1930 as the 511th Engineer Battalion (Separate) (C). Relieved from the Sixth Army 1 October 1933 and assigned to the Third Army. Consolidated 24 August 1936 with the 511th Engineer Service Battalion (a WW I unit organized in January 1918 at Camp Lee, VA; demobilized in June 1919 at Camp Alexander, VA; reconstituted 24 August 1936). Conducted summer training with the 2nd Engineer Regiment at Fort Sam Houston, TX, 1925-27; at Fort Logan, CO, 1928; and with the 8th Engineer Squadron at Fort McIntosh, TX, 1929-34. Designated mobilization training station was the Waco Concentration Camp, Waco, TX. Location 7 December 1941—San Antonio, TX.

Status: Disbanded 22 December 1942.**512th Engineer Battalion (Auxiliary) (GHQR)****Organized Reserve Texas/Alabama****HQ-Not initiated** 1921-23; San Antonio, TX, 1923-27; *Inactive* 1927-29; Andalusia, AL, 1929-41

Constituted in the Organized Reserve 15 October 1921, assigned to the General Headquarters Reserve, and allotted to the Eighth Corps Area. Initiated 26 February 1923 with headquarters at San Antonio, TX. Assigned to the Sixth Army 2 July 1923. Withdrawn from the Eighth Corps Area 11 January 1927 and allotted to the Fourth Corps Area as a "Colored" unit. Inactivated 1 February 1927 at San Antonio by relief of personnel. Reorganized in October 1929 at Andalusia, AL. Redesignated 7 May 1930 as the 512th Engineer Battalion (Separate) (C). Consolidated 24 August 1936 with the 512th Engineer Service Battalion (a WW I unit organized in January 1918 at Camp Pike, AR; demobilized in June 1919 at Camp Pike; reconstituted 24 August 1936). Conducted summer training with the 2nd Engineer Regiment at Fort Sam Houston, TX. Location 7 December 1941—Andalusia, AL.

Status: Disbanded 22 December 1942.

513th Engineer Battalion (Auxiliary) (GHQR)**Organized Reserve Texas****HQ**-*Not initiated* 1921-23; Dallas, TX, 1923-41

Constituted in the Organized Reserve 15 October 1921, assigned to the General Headquarters Reserve, and allotted to the Eighth Corps Area. Initiated in March 1923 with headquarters at Dallas, TX. Assigned to the Sixth Army 2 July 1923. Redesignated 7 May 1930 as the 513th Engineer Battalion (Separate) (C). Consolidated 24 August 1936 with the 513th Engineer Service Battalion (a WW I unit organized in January 1918 at Camp Travis, TX; demobilized in June 1919 at Camp Bowie, TX; reconstituted 24 August 1936). Conducted summer training with the 2nd Engineer Regiment at Fort Sam Houston, TX, 1926-27 and with the 8th Engineer Squadron at Fort McIntosh, TX, 1928-34. Designated mobilization training station was Waco Concentration Camp, Waco, TX. Location 7 December 1941—Dallas, TX.

Status: Disbanded 22 December 1942.**514th Engineer Battalion (Auxiliary) (GHQR)****Organized Reserve Texas/Alabama****HQ**-*Not initiated* 1921-23; Wichita Falls, TX, 1923-25; Corsicana, TX, 1925-27; *Inactive* 1927-29; Opelousas, AL, 1929-41

Constituted in the Organized Reserve 15 October 1921, assigned to the General Headquarters Reserve, and allotted to the Eighth Corps Area. Initiated 8 March 1923 with headquarters at Wichita Falls, TX. Relocated 15 April 1925 to Corsicana, TX. Withdrawn from the Eighth Corps Area 11 January 1927 and allotted to the Fourth Corps Area as a “Colored” unit. Inactivated 1 February 1927 at Wichita Falls by relief of personnel. Reorganized 1 October 1929 at Opelousas, AL. Redesignated 7 May 1930 as the 514th Engineer Battalion (Separate) (C). Consolidated 24 August 1936 with the 514th Engineer Service Battalion (a WW I unit organized in February 1918 at Camp Gordon, GA; demobilized in June 1919 at Camp Gordon; reconstituted 24 August 1936). Location 7 December 1941—Opelousas, AL.

Status: Disbanded 22 December 1942.**515th Engineer Train (Water Tank) (GHQR)****Organized Reserve New Jersey****HQ**-Summit, NJ 1921-37; Jersey City, NJ 1937-41

Constituted in the Organized Reserve 15 October 1921, assigned to the General Headquarters Reserve, and allotted to the Second Corps Area. Initiated in December 1921 with headquarters at Summit, NJ. Redesignated 18 May 1925 as the 515th Engineer Battalion (Water Supply). Assigned to First Army 1 October 1933. Relocated in 1937 to Jersey City, NJ. Conducted summer training with the 1st Engineer Regiment at Fort Du Pont, DE. Designated mobilization training station was Camp Smith, NY. Location 7 December 1941—Jersey City, NJ.

Events: 298**516th Engineer Train (Water Tank) (GHQR)****Organized Reserve New York/New Jersey****HQ**-*Not initiated* 1921-22; Gilboa, NY, 1922-29; Schenectady, NY, 1929-37; *Inactive* 1937-41

Constituted in the Organized Reserve 15 October 1921, assigned to the General Headquarters Reserve, and allotted to the Second Corps Area. Initiated 25 January 1922 with headquarters at Gilboa, NY. Redesignated 18 May 1925 as the 516th Engineer Battalion (Water Supply). Relocated 2 July 1929 to Schenectady, NY. Inactivated by January 1937 at Schenectady by relief of personnel. Camden, NJ, designated 5 April 1937 as headquarters on reorganization, but the unit was never organized at that location. Conducted summer training with the 1st Engineer Regiment at Fort Du Pont, DE. Designated mobilization training station was Camp Smith, NY. Location 7 December 1941—*Inactive*.

520th Engineer Train (Water Tank) (GHQR)**Organized Reserve Kentucky/South Carolina**

HQ-Not initiated 1921-22; Newport, KY, 1922-33; *Inactive* 1933-34; Columbia, SC, 1934-40; *Inactive* 1940-41

Constituted in the Organized Reserve 15 October 1921, assigned to the General Headquarters Reserve, and allotted to the Fifth Corps Area. Initiated in January 1922 with headquarters at Newport, KY. Redesignated 18 May 1925 as the 520th Engineer Battalion (Water Supply). Withdrawn from the Fifth Corps Area 1 October 1933 and allotted to the Fourth Corps Area. Reorganized 4 April 1934 at Columbia, SC. Withdrawn from the Organized Reserve 1 January 1938 and allotted to the Regular Army. Inactivated 15 August 1940 at Columbia by relief of personnel. Redesignated 16 December 1940 as the 80th Engineer Battalion (Water Supply). Location 7 December 1941—*Inactive*.

Status: Inactive in the Regular Army as the 80th Engineer Battalion.

523rd Engineer Train (Water Tank) (GHQR)**Organized Reserve Minnesota/Iowa**

HQ-Not initiated 1921-22; Minneapolis, MN, 1922-26; Crookston, MN, 1926-31; Iowa City, IA, 1931-41

Constituted in the Organized Reserve 15 October 1921, assigned to the General Headquarters Reserve, and allotted to the Seventh Corps Area. Initiated in March 1922 with headquarters at Minneapolis, MN. Redesignated 18 May 1925 as the 523rd Engineer Battalion (Water Supply). Relocated 26 May 1926 to Crookston, MN. Relocated 12 October 1931 to Iowa City, IA. Withdrawn from the Seventh Corps Area 29 September 1941 and placed under control of the Chief of Engineers. Location 7 December 1941—Iowa City, IA.

Status: Disbanded 27 November 1943.

524th Engineer Battalion (Auxiliary) (C) (First Army)**Organized Reserve North Carolina/Tennessee**

HQ-Not initiated 1921-22; Raleigh, NC, 1922-29; Memphis, TN, 1929-41

Constituted in the Organized Reserve 15 October 1921 as the 824th Engineer Battalion (Auxiliary), assigned to the General Headquarters Reserve, and allotted to the Fourth Corps Area. Initiated in September 1922 with headquarters at Raleigh, NC. Redesignated 2 July 1923 as the 524th Engineer Battalion (Auxiliary). Relocated 1 October 1929 to Memphis, TN. Redesignated 7 May 1930 as the 524th Engineer Battalion (Separate). Consolidated 24 August 1936 with the 524th Engineer Service Battalion (C) (a WW I unit organized in April 1918 at Camp A. A. Humphreys, VA; demobilized in July 1919 at Camp Jackson, SC; reconstituted 24 August 1936). Conducted summer training at Fort Benning, GA. Designated mobilization station was Fort Bragg, NC. Location 7 December 1941—Memphis, TN.

Status: Disbanded 22 December 1942.

525th Engineer Battalion (Auxiliary) (C) (First Army)**Organized Reserve Tennessee/Alabama**

HQ-Not initiated 1921-22; Memphis, TN, 1922-29; Mobile, AL, 1929-41

Constituted in the Organized Reserve 15 October 1921 as the 825th Engineer Battalion (Auxiliary), assigned to the First Army, and allotted to the Fourth Corps Area. Initiated in October 1922 with headquarters at Memphis, TN. Redesignated 2 July 1923 as the 525th Engineer Battalion (Auxiliary). Relocated 1 October 1929 to Mobile, AL. Redesignated 7 May 1930 as the 525th Engineer Battalion (Separate). Consolidated 24 August 1936 with the 525th Engineer Service Battalion (C) (a WW I unit organized in April 1918 at Camp Pike, AR; demobilized in July 1919 at Camp Shelby, MS; reconstituted 24 August 1936). Conducted summer training at Fort Benning, GA. Designated mobilization station was the Memphis Mobilization Area. Location 7 December 1941—Memphis, TN.

Status: Disbanded 22 December 1942.

526th Engineer Battalion (Auxiliary) (C) (First Army)**Organized Reserve South Carolina/New Jersey****HQ**-Greenville, SC, 1921-29; Aiken, SC, 1929-36; *Inactive* 1936-41

Constituted in the Organized Reserve 15 October 1921 as the 826th Engineer Battalion (Auxiliary), assigned to the First Army, and allotted to the Fourth Corps Area. Initiated 22 December 1921 with headquarters at Greenville, SC. Redesignated 2 July 1923 as the 526th Engineer Battalion (Auxiliary). Relocated 1 October 1929 to Aiken, SC. Redesignated 7 May 1930 as the 526th Engineer Battalion (Separate) (C). Withdrawn from the Fourth Corps Area 5 June 1936 and allotted to the Second Corps Area. Consolidated 24 August 1936 with the 526th Engineer Service Battalion (C) (a WW I unit organized in May 1918 at Camp Pike, AR; demobilized in July 1919 at Camp Shelby, MS; reconstituted 24 August 1936) Newark, NJ, designated 5 April 1937 as headquarters on reorganization, but the unit was never organized at that location. Designated mobilization station was Camp Jackson, SC. Location 7 December 1941—*Inactive*.

Status: Disbanded 22 December 1942.**527th Engineer Battalion (Auxiliary) (C) (First Army)****Organized Reserve Georgia****HQ**-*Not initiated* 1921-22; Atlanta, GA, 1922-29; Albany, GA, 1929-40

Constituted in the Organized Reserve 15 October 1921 as the 827th Engineer Battalion (Auxiliary), assigned to the First Army, and allotted to the Fourth Corps Area. Initiated 28 March 1922 with headquarters at Atlanta, GA. Redesignated 2 July 1923 as the 527th Engineer Battalion (Auxiliary). Relocated 1 October 1929 to Albany, GA. Redesignated 7 May 1930 as the 527th Engineer Battalion (Separate). Consolidated 24 August 1936 with the 527th Engineer Service Battalion (C) (a WW I unit organized in March 1918 at Camp Dodge, IA; demobilized in July 1919 at Camp Gordon, GA; reconstituted 24 August 1936). Designated mobilization station was Camp Wheeler, GA. Disbanded 1 July 1940.

528th Engineer Battalion (Auxiliary) (C) (Second Army)**Organized Reserve Alabama/
Georgia/New Jersey****HQ**-*Not initiated* 1921-22; Troy, AL, 1922-29; Columbus, GA, 1929-36; *Inactive* 1936-37; Elizabeth, NJ 1937-40

Constituted in the Organized Reserve 15 October 1921 as the 828th Engineer Battalion (Auxiliary), assigned to the Second Army, and allotted to the Fourth Corps Area. Initiated in March 1922 with headquarters at Troy, AL. Redesignated 2 July 1923 as the 528th Engineer Battalion (Auxiliary). Relocated 1 October 1929 to Columbus, GA. Redesignated 7 May 1930 as the 528th Engineer Battalion (Separate) (C). Conducted summer training at Fort Benning, GA, 1931-33. Designated mobilization training station was Camp Jackson, SC, 1922-36. Withdrawn from the Fourth Corps Area 5 June 1936 and allotted to the Second Corps Area. Consolidated 24 August 1936 with the 528th Engineer Service Battalion (C) (a WW I unit organized in April 1918 at Camp Dodge, IA; demobilized in June 1919 at Camp Gordon, GA; reconstituted 24 August 1936). Reorganized 5 April 1937 at Elizabeth, NJ. Disbanded 1 July 1940.

529th Engineer Battalion (Auxiliary) (C) (Third Army)**Organized Reserve Alabama/Illinois****HQ**-*Not initiated* 1921-22; Mobile, AL, 1922-29; Selma, AL, 1929-33; *Inactive* 1933-34; Chicago, IL, 1934-41

Constituted in the Organized Reserve 15 October 1921 as the 829th Engineer Battalion (Auxiliary), assigned to the Third Army, and allotted to the Fourth Corps Area. Initiated 25 March 1922 with headquarters at Mobile, AL. Redesignated 2 July 1923 as the 529th Engineer Battalion (Auxiliary). Relocated 1 October 1929 to Selma, AL. Redesignated 7 May 1930 as the 529th Engineer Battalion (Separate) (C). Withdrawn from the Fourth Corps Area 1 October 1933 and allotted to the Sixth Corps Area. Concurrently, relieved from the Third Army and assigned to the Second Army. Reorganized by June 1934 at Chicago, IL. Consolidated 31 August 1936 with the 529th Engineer

Service Battalion (C) (a WW I unit organized in April 1918 at Camp Funston, KS; demobilized in June 1919 at Camp Upton, NY; reconstituted 31 August 1936). Withdrawn from the Organized Reserve 1 January 1938 and allotted to the Regular Army as a “White” unit. Reallotted to the Organized Reserve 1 July 1940. Designated mobilization training station was Camp McClellan, AL. Location 7 December 1941—Chicago, IL.

Status: Disbanded 22 December 1942.

530th Engineer Battalion (Auxiliary) (C) (Third Army)

**Organized Reserve Mississippi/
Louisiana/Michigan/Illinois**

HQ-*Not initiated* 1921-22; Canton, MS, 1922-29; Monroe, LA, 1929-33; *Inactive* 1933-34; Detroit, MI, 1934-37; Chicago, IL, 1937-41

Constituted in the Organized Reserve 15 October 1921 as the 830th Engineer Battalion (Auxiliary), assigned to the Third Army, and allotted to the Fourth Corps Area. Initiated in May 1922 with headquarters at Canton, MS. Redesignated 2 July 1923 as the 530th Engineer Battalion (Auxiliary). Relocated 1 October 1929 to Monroe, LA. Redesignated 7 May 1930 as the 530th Engineer Battalion (Separate) (C). Withdrawn from the Fourth Corps Area 1 October 1933 and allotted to the Sixth Corps Area. Concurrently, relieved from the Third Army and assigned to the Second Army. Reorganized by June 1934 at Detroit, MI. Consolidated 31 August 1936 with the 530th Engineer Service Battalion (C) (a WW I unit organized in April 1918 at Camp Funston, KS; demobilized in June 1919 at Camp Upton, NY; reconstituted 31 August 1936). Relocated 28 July 1937 to Chicago, IL. Withdrawn from the Organized Reserve 1 January 1938 and allotted to the Regular Army as a “White” unit. Withdrawn from the Regular Army 1 July 1940 and allotted to the Organized Reserve. Designated mobilization training station was Camp McClellan, AL. Location 7 December 1941—Chicago, IL.

Status: Disbanded 22 December 1942.

531st Engineer Battalion (Auxiliary) (Third Army)

**Organized Reserve Missouri/
Georgia/Illinois/Wisconsin**

HQ-*Not initiated* 1921-22; Kansas City, MO, 1922-27; *Inactive* 1927-29; Rome, GA, 1929-33; *Inactive* 1933-34; Milwaukee, WI 1934-37; Chicago, IL, 1937-40

Constituted in the Organized Reserve 15 October 1921, assigned to the Third Army, and allotted to the Seventh Corps Area. Initiated in March 1922 with headquarters at Kansas City, MO. Withdrawn from the Seventh Corps Area 7 January 1927 and allotted to the Fourth Corps Area as a “Colored” unit. Reorganized by 1929 at Rome, GA. Redesignated 2 July 1923 as the 7 May 1930 as the 531st Engineer Battalion (Separate). Withdrawn from the Fourth Corps Area 1 October 1933, allotted to the Sixth Corps Area, and concurrently assigned to the Second Army. Reorganized by June 1934 at Milwaukee, WI. Consolidated 31 August 1936 with the 531st Engineer Service Battalion (C) (a WW I unit organized in April 1918 at Camp Travis, TX; demobilized in October 1918 in France; reconstituted 31 August 1936). Relocated 28 July 1937 to Chicago, IL. Withdrawn from the Organized Reserve 1 January 1938 and allotted to the Regular Army as a “White” unit. Disbanded 1 July 1940.

532nd Engineer Battalion (Auxiliary) (Third Army)

Organized Reserve South Dakota/Missouri

HQ-*Not initiated* 1921-22; Pierre, SD, 1922-26; Redfield, SD, 1926-31; Kansas City, MO, 1931-40

Constituted in the Organized Reserve 15 October 1921, assigned to the Third Army, and allotted to the Seventh Corps Area. Initiated in February 1922 with headquarters at Pierre, SD. Relocated 26 May 1926 to Redfield, SD. Redesignated 7 May 1930 as the 532nd Engineer Battalion (Separate). Relocated 12 October 1931 to Kansas City, MO. Withdrawn from the Organized Reserve 1 January 1938 and allotted to the Regular Army. Disbanded 1 July 1940.

533rd Engineer Battalion (Auxiliary) (Third Army)

Organized Reserve North Dakota/Arkansas

HQ-*Not initiated* 1921-22; Grand Forks, ND, 1922-26; Devil's Lake, ND, 1926-31; Little Rock, AR, 1931-40

Constituted in the Organized Reserve 15 October 1921, assigned to the Third Army, and allotted to the Seventh Corps Area. Initiated in April 1922 with headquarters at Grand Forks, ND. Relocated 26 May 1926 to Devil's Lake, ND. Redesignated 7 May 1930 as the 533rd Engineer Battalion (Separate). Relocated 12 October 1931 to Little Rock, AR. Withdrawn from the Organized Reserve 1 January 1938 and allotted to the Regular Army. Disbanded 1 July 1940.

534th Engineer Train (Water Tank) (First Army)

Organized Reserve New York

HQ-*Not initiated* 1921-22; Brooklyn, NY, 1922-27; Syracuse, NY, 1927-37; New York City, NY, 1937-41

Constituted in the Organized Reserve 15 October 1921, assigned to the First Army, and allotted to the Second Corps Area. Initiated 17 January 1922 with headquarters at New York City, NY. Redesignated 18 May 1925 as the 534th Engineer Battalion (Water Supply). Relocated 18 November 1927 to Syracuse, NY. Relocated 20 November 1937 to New York City, NY. Conducted summer training with the 1st Engineer Regiment at Fort Du Pont, DE. Designated mobilization training station was Camp Smith, NY. Location 7 December 1941—New York City, NY.

Status: Disbanded 22 December 1942.

544th Engineer Train (Water Tank) (Second Army)

Organized Reserve Kentucky/Ohio

HQ-*Not initiated* 1921-22; Louisville, KY, 1922-28; Akron, OH, 1928-30; *Inactive* 1930-41

Constituted in the Organized Reserve 15 October 1921, assigned to the Second Army, and allotted to the Fifth Corps Area. Initiated in January 1922 with headquarters at Louisville, KY. Redesignated 18 May 1925 as the 544th Engineer Battalion (Water Supply). Relieved from the Second Army by 1926 and assigned to the Fifth Army. Headquarters relocated 15 October 1928 to Akron, OH. Inactivated by March 1930 at Akron by relief of personnel. Toledo, OH, designated 9 October 1931 as headquarters on reorganization, but the unit was never organized at that location. Designated headquarters changed 21 December 1933 to Cleveland, OH. Typically conducted Inactive Training Period meetings at the Bulkey Building in Cleveland. Location 7 December 1941—*Inactive*.

Status: Disbanded 22 December 1942.

548th Engineer Train (Water Tank) (Third Army)

Organized Reserve Minnesota/Kansas

HQ-St. Paul, MN, 1921-26; Marshall, MN, 1926-31; Dodge City, KS, 1931-41

Constituted in the Organized Reserve 15 October 1921, assigned to the Third Army, and allotted to the Seventh Corps Area. Initiated 19 December 1921 with headquarters at St. Paul, MN. Redesignated 18 May 1925 as the 548th Engineer Battalion (Water Supply). Relocated 26 May 1926 to Marshall, MN, and to Dodge City, KS, on 12 October 1931. Location 7 December 1941—Dodge City, KS.

Status: Disbanded 22 December 1942.

553rd Engineer Battalion (Railway Operating) (GHQR)**Organized Reserve New York/New Jersey****HQ**-New York City, NY, 1921-34; Jersey City, NJ 1934-41

Constituted in the Organized Reserve 15 October 1921, assigned to the General Headquarters Reserve, and allotted to the Second Corps Area. Initiated 4 November 1921 with headquarters at New York City, NY. Affiliated with the Lehigh Valley and Central of New Jersey Railroad. Reassigned to the Communications Zone in July 1923. Relocated 3 November 1934 to Jersey City, NJ. Affiliation concurrently modified to include only the sections of the Lehigh Valley and Central of New Jersey Railroads between Buffalo and Rochester on the Lehigh Valley Line and from Jersey City to the end of the Central of New Jersey Line. Redesignated 21 February 1941 as the 739th Engineer Battalion (Railway Operating). Conducted summer training with the 1st Engineer Regiment at Fort Du Pont, DE. Transferred 20 March 1941 to control of the Office of the Chief Engineer. Location 7 December 1941—Jersey City, NJ.

554th Engineer Battalion (Auxiliary) (GHQR)**Organized Reserve New York****HQ**-*Not initiated* 1921-22; Rochester, NY, 1922-37; New York City, NY, 1937-41

Constituted in the Organized Reserve 15 October 1921, assigned to the General Headquarters Reserve, and allotted to the Second Corps Area. Initiated 20 January 1922 with headquarters at Rochester, NY. Redesignated 7 May 1930 as the 554th Engineer Battalion (Separate). Relocated 5 April 1937 to New York City, NY. Conducted summer training with the 1st Engineer Regiment at Fort Du Pont, DE. Location 7 December 1941—New York City, NY.

Status: Disbanded 22 December 1942.**555th Engineer Battalion (Auxiliary) (C) (GHQR)****Organized Reserve Pennsylvania/New York****HQ**-Philadelphia, PA, 1921-36; *Inactive* 1936-37; New York City, NY, 1937-41

Constituted in the Organized Reserve 15 October 1921, assigned to the General Headquarters Reserve, and allotted to the Third Corps Area. Initiated 30 December 1921 with headquarters at Philadelphia, PA. Redesignated 27 April 1922 as the 855th Engineer Battalion (Auxiliary) (C) and again redesignated 2 July 1923 as the 555th Engineer Battalion (Auxiliary). Redesignated 7 May 1930 as the 555th Engineer Battalion (Separate). Typically conducted Inactive Training Period meetings at the Society of American Military Engineers building in Philadelphia. Withdrawn from the Third Corps Area 5 June 1936 and allotted to the Second Corps Area. Reorganized 5 April 1937 at New York City, NY. Conducted summer training at Fort Belvoir, VA. Primary R.O.T.C. feeder school was the Virginia Polytechnic Institute. Location 7 December 1941—New York City, NY.

Status: Disbanded 22 December 1942.**556th Engineer Battalion (Auxiliary) (C) (GHQR)****Organized Reserve North Carolina****HQ**-*Not initiated* 1921-22; Winston-Salem, NC, 1922-40

Constituted in the Organized Reserve 15 October 1921 as the 856th Engineer Battalion (Auxiliary), assigned to the General Headquarters Reserve, and allotted to the Fourth Corps Area. Initiated in 1922 with headquarters at Winston-Salem, NC. Redesignated 2 July 1923 as the 556th Engineer Battalion (Auxiliary) (C). Redesignated 7 May 1930 as the 556th Engineer Battalion (Separate). Designated mobilization training station was Fort Bragg, NC. Disbanded 1 July 1940.

557th Engineer Battalion (Auxiliary) (C) (GHQR)**Organized Reserve South Carolina/Tennessee****HQ**-Charleston, SC, 1921-29; Union City, TN, 1929-33

Constituted in the Organized Reserve 15 October 1921 as the 857th Engineer Battalion (Auxiliary), assigned to the General Headquarters Reserve, and allotted to the Fourth Corps Area. Initiated 22 December 1921 with headquarters at Charleston, SC. Redesignated 2 July 1923 as the 557th Engineer Battalion (Auxiliary) (C). Relocated 1 October 1929 to Union City, TN. Redesignated 7 May 1930 as the 557th Engineer Battalion (Separate). Designated mobilization training station was Camp Jackson, SC. Demobilized 1 October 1933.

558th Engineer Battalion (Auxiliary) (C) (GHQR)**Organized Reserve South Carolina/North Carolina****HQ**-Florence, SC, 1921-29; Goldsboro, NC, 1929-33

Constituted in the Organized Reserve 15 October 1921 as the 858th Engineer Battalion (Auxiliary), assigned to the General Headquarters Reserve, and allotted to the Fourth Corps Area. Initiated 22 December 1921 with headquarters at Florence, SC. Redesignated 2 July 1923 as the 558th Engineer Battalion (Auxiliary) (C). Relocated 1 October 1929 to Goldsboro, NC. Redesignated 7 May 1930 as the 558th Engineer Battalion (Separate). Designated mobilization training station was Camp Jackson, SC. Demobilized 1 October 1933.

559th Engineer Battalion (Auxiliary) (C) (GHQR)**Organized Reserve Georgia****HQ**-*Not initiated* 1921-22; Monticello, GA, 1922-29; Waycross, GA, 1929-33

Constituted in the Organized Reserve 15 October 1921 as the 859th Engineer Battalion (Auxiliary), assigned to the General Headquarters Reserve, and allotted to the Fourth Corps Area. Initiated in 1922 with headquarters at Monticello, GA. Redesignated 2 July 1923 as the 559th Engineer Battalion (Auxiliary) (C). Relocated 1 October 1929 to Waycross, GA. Redesignated 7 May 1930 as the 559th Engineer Battalion (Separate). Designated mobilization training station was Camp Wheeler, GA. Demobilized 1 October 1933.

560th Engineer Battalion (Auxiliary) (C) (GHQR)**Organized Reserve Georgia/Florida****HQ**-*Not initiated* 1921-22; Hawkinsville, GA, 1922-29; Gainesville, FL, 1929-33

Constituted in the Organized Reserve 15 October 1921 as the 860th Engineer Battalion (Auxiliary), assigned to the General Headquarters Reserve, and allotted to the Fourth Corps Area. Initiated in May 1922 with headquarters at Hawkinsville, GA. Redesignated 2 July 1923 as the 560th Engineer Battalion (Auxiliary) (C). Relocated 1 October 1929 to Gainesville, FL. Redesignated 7 May 1930 as the 560th Engineer Battalion (Separate). Designated mobilization training station was Camp Wheeler, GA. Demobilized 1 October 1933.

561st Engineer Battalion (Auxiliary) (C) (GHQR)**Organized Reserve Alabama/Mississippi****HQ**-*Not initiated* 1921-22; Montgomery, AL, 1922-29; Meridian, MS, 1929-33

Constituted in the Organized Reserve 15 October 1921 as the 861st Engineer Battalion (Auxiliary), assigned to the General Headquarters Reserve, and allotted to the Fourth Corps Area. Initiated 25 March 1922 with headquarters at Montgomery, AL. Redesignated 2 July 1923 as the 561st Engineer Battalion (Auxiliary) (C). Relocated 1 October 1929 to Meridian, MS. Redesignated 7 May 1930 as the 561st Engineer Battalion (Separate). Designated mobilization training station was Camp McClellan, AL. Demobilized 1 October 1933.

562nd Engineer Battalion (Auxiliary) (C) (GHQR)**Organized Reserve Mississippi/Alabama**

HQ-Not initiated 1921-22; Hattiesburg, MS, 1922-29; Gadsden, AL, 1929-33

Constituted in the Organized Reserve 15 October 1921 as the 862nd Engineer Battalion (Auxiliary), assigned to the General Headquarters Reserve, and allotted to the Fourth Corps Area. Initiated in 1922 with headquarters at Hattiesburg, MS. Redesignated 2 July 1923 as the 562nd Engineer Battalion (Auxiliary) (C). Relocated 1 October 1929 to Gadsden, AL. Redesignated 7 May 1930 as the 562nd Engineer Battalion (Separate). Designated mobilization training station was Camp McClellan, AL, and later, Camp Shelby, MS. Demobilized 1 October 1933.

563rd Engineer Battalion (Auxiliary) (C) (GHQR)**Organized Reserve Mississippi**

HQ-Not initiated 1921-22; Natchez, MS, 1922-33

Constituted in the Organized Reserve 15 October 1921 as the 863rd Engineer Battalion (Auxiliary), assigned to the General Headquarters Reserve, and allotted to the Fourth Corps Area. Initiated in May 1922 with headquarters at Natchez, MS. Redesignated 2 July 1923 as the 563rd Engineer Battalion (Auxiliary) (C). Redesignated 7 May 1930 as the 562nd Engineer Battalion (Separate). Designated mobilization training station was Camp Shelby, MS. Demobilized 1 October 1933.

564th Engineer Battalion (Auxiliary) (C) (GHQR)**Organized Reserve Louisiana/Tennessee**

HQ-Not initiated 1921-22; Baton Rouge, LA, 1922-29; Tullahoma, TN, 1929-33

Constituted in the Organized Reserve 15 October 1921 as the 864th Engineer Battalion (Auxiliary), assigned to the General Headquarters Reserve, and allotted to the Fourth Corps Area. Initiated 15 March 1922 with headquarters at Baton Rouge, LA. Redesignated 2 July 1923 as the 564th Engineer Battalion (Auxiliary) (C). Relocated 1 October 1929 to Tullahoma, TN. Redesignated 7 May 1930 as the 564th Engineer Battalion (Separate). Designated mobilization training station was Camp Shelby, MS. Demobilized 1 October 1933.

565th Engineer Battalion (Auxiliary) (C) (GHQR)**Organized Reserve Ohio/Kentucky**

HQ-Not initiated 1921-22; Findlay, OH, 1922-31; Louisville, KY, 1931-41

Constituted in the Organized Reserve 15 October 1921 as the 865th Engineer Battalion (Auxiliary), assigned to the General Headquarters Reserve, and allotted to the Fifth Corps Area. Initiated in March 1922 with headquarters at Findlay, OH. Redesignated 2 July 1923 as the 565th Engineer Battalion (Auxiliary) (C). Redesignated 7 May 1930 as the 565th Engineer Battalion (Separate) (C). Relocated 9 July 1931 to Louisville, KY. Consolidated 24 August 1936 with the 565th Engineer Service Battalion (C) (a WW I unit organized in October 1918 at Camp Shelby, MS; demobilized in December 1918 at Camp Shelby; reconstituted 24 August 1936). Withdrawn from the Organized Reserve 1 January 1938 and allotted to the Regular Army. Location 7 December 1941—Louisville, KY.

Status: Disbanded 22 December 1942.

566th Engineer Battalion (Auxiliary) (GHQR)**Organized Reserve Michigan**

HQ-Flint, MI, 1921-25; Marquette, MI, 1925-32; Houghton, MI, 1932-41

Constituted in the Organized Reserve 15 October 1921, assigned to the General Headquarters Reserve, and allotted to the Sixth Corps Area. Initiated 12 December 1921 with headquarters at Flint, MI. Relocated 2 June 1925 to Marquette, MI. Redesignated 7 May 1930 as the 566th Engineer Battalion (Separate) (C). Relocated 27 September 1932 to Houghton, MI. Assigned to the XVI Corps 1 October 1933. Conducted summer training most years at Camp Custer, MI, and some years at Fort Sheridan, IL. Location 7 December 1941—Houghton, MI.

Status: Disbanded 22 December 1942.

567th Engineer Battalion (Auxiliary) (GHQR)

Organized Reserve Kansas/Minnesota

HQ-Not initiated 1921-22; Pittsburgh, KS, 1922-31; Minneapolis, MN, 1931-40

Constituted in the Organized Reserve 15 October 1921, assigned to the General Headquarters Reserve, and allotted to the Seventh Corps Area. Initiated in May 1922 with headquarters at Pittsburgh, KS. Redesignated 7 May 1930 as the 567th Engineer Battalion (Separate) (C). Relocated 12 October 1931 to Minneapolis, MN. Disbanded 1 July 1940.

568th Engineer Battalion (Railway Operating) (CZ)

Organized Reserve Virginia

HQ-Not initiated 1921-23; Richmond, VA, 1923-41

Constituted in the Organized Reserve 15 October 1921, assigned to the General Headquarters Reserve, and allotted to the Third Corps Area. Initiated in August 1923 with headquarters at Richmond, VA. Affiliated with the Chesapeake and Ohio Railroad. Redesignated 21 February 1941 as the 740th Engineer Battalion (Railway Operating). Concurrently withdrawn from the Third Corps Area and allotted to the Fifth Corps Area.

571st Engineer Train (Water Tank) (GHQR)

Organized Reserve Tennessee

HQ-Not initiated 1921-22; Nashville, TN, 1922-28

Constituted in the Organized Reserve 15 October 1921, assigned to the General Headquarters Reserve, and allotted to the Fourth Corps Area. Initiated in April 1922 with headquarters at Nashville, TN. Redesignated 18 May 1925 as the 571st Engineer Battalion (Water Supply). Withdrawn from the Fourth Corps Area 6 October 1928.

574th Engineer Train (Water Tank) (GHQR)

Organized Reserve Michigan

HQ-Not initiated 1921-22; Kalamazoo, MI, 1922-31; *Inactive* 1931-32; Ann Arbor, MI, 1932-37; Jackson, MI, 1937-41

Constituted in the Organized Reserve 15 October 1921, assigned to the General Headquarters Reserve, and allotted to the Sixth Corps Area. Initiated 14 January 1922 with headquarters at Kalamazoo, MI. Redesignated 18 May 1925 as the 574th Engineer Battalion (Water Supply). Relocated 27 September 1932 to Ann Arbor, MI. Assigned to the Second Army 1 October 1933. Relocated 7 April 1937 to Jackson, MI. Withdrawn from the Organized Reserve 1 January 1938 and allotted to the Regular Army. Conducted summer training at Camp Custer, MI. Designated mobilization training station was Camp Custer, MI. Location 7 December 1941—Jackson, MI.

Status: Disbanded 27 November 1943.

590th Engineer Battalion (Auxiliary) (C) (First Army)

Organized Reserve Connecticut

HQ-Not initiated 1921-22; New Haven, CT, 1922-40

Constituted in the Organized Reserve 15 October 1921, assigned to the First Army, and allotted to the First Corps Area. Initiated in October 1922 with headquarters at New Haven, CT. Redesignated 7 May 1930 as the 590th Engineer Battalion (Separate) (C). Relieved from the First Army 1 October 1933 and assigned to the I Corps. Withdrawn from the Organized Reserve 1 January 1938 and allotted to the Regular Army. Conducted summer training with the 1st Engineer Regiment at Fort Du Pont, DE. Disbanded 1 July 1940.

591st Engineer Battalion (Railway Operating) (CZ)**Organized Reserve Massachusetts/Vermont**

HQ-Not initiated 1921-25; Boston, MA, 1925-26; Rutland, VT, 1926-31; Burlington, VT, 1931-41

Constituted in the Organized Reserve 15 October 1921, assigned to the Communications Zone, and allotted to the First Corps Area. Initiated in September 1925 with headquarters at Boston, MA. Affiliated with the New Haven Railroad. Affiliation changed 3 May 1926 to the Rutland Railroad, Delaware and Hudson Railroad and the Central Vermont Railroad. Relocated 28 May 1926 to Rutland, VT. Relocated 13 March 1931 to Burlington, VT. Affiliation changed 29 October 1934 to the New York, New Haven, and Hartford Railroad. Redesignated 21 February 1941 as the 729th Engineer Battalion (Railway Operating). Conducted summer training at Fort Devens, MA. Location 7 December 1941—Burlington, VT.

Status: Active in the U.S. Army Reserve at Middletown, CT, as the 1205th Transportation Railway Operating Battalion.

592nd Engineer Battalion (Railway Operating) (CZ)**Organized Reserve Massachusetts**

HQ-Not initiated 1921-23; Boston, MA, 1923-36; *Inactive* 1936-41

Constituted in the Organized Reserve 15 October 1921, assigned to the Communications Zone, and allotted to the First Corps Area. Initiated in October 1923 with headquarters at Boston, MA. Affiliated with the Boston and Maine Railroad. Withdrawn from the First Corps Area 5 June 1936 and allotted to the Sixth Corps Area. No affiliation designated. Chicago, IL, designated as headquarters on reorganization, but the unit was never organized at that location. Redesignated 21 February 1941 as the 752nd Engineer Battalion (Railway Operating). Location 7 December 1941—*Inactive*.

593rd Engineer Battalion (Railway Operating) (GHQR)**Organized Reserve Tennessee**

HQ-Not initiated 1921-24; Memphis, TN, 1924-41

Constituted in the Organized Reserve 15 October 1921, assigned to the General Headquarters Reserve, and allotted to the Fourth Corps Area. Initiated in November 1924 with headquarters at Memphis, TN. Affiliated with the Illinois Central Railroad. Redesignated 21 February 1941 as the 741st Engineer Battalion (Railway Operating). Location 7 December 1941—Memphis, TN.

594th Engineer Battalion (Railway Operating) (CZ)**Organized Reserve Georgia**

HQ-Not initiated 1921-24; Atlanta, GA, 1924-41

Constituted in the Organized Reserve 15 October 1921, assigned to the Communications Zone, and allotted to the Fourth Corps Area. Initiated in July 1924 with headquarters at Atlanta, GA. Affiliated with the Southern Railway Lines. Redesignated 21 February 1941 as the 727th Engineer Battalion (Railway Operating). Location 7 December 1941—Atlanta, GA.

595th Engineer Battalion (Railway Operating) (CZ)**Organized Reserve Georgia**

HQ-Not initiated 1921-24; Savannah, GA, 1924-41; *Inactive* 1941

Constituted in the Organized Reserve 15 October 1921, assigned to the Communications Zone, and allotted to the Fourth Corps Area. Initiated in November 1924 with headquarters at Savannah, GA. Affiliated with the Atlantic Coast Line. Affiliation changed 19 March 1926 to the Seaboard Air Line Railway Company. Redesignated 21 February 1941 as the 722nd Engineer Battalion (Railway Operating). Concurrently withdrawn from the Fourth Corps Area and allotted to the Third Corps Area. Location 7 December 1941—*Inactive*.

596th Engineer Battalion (Railway Operating) (CZ)**Organized Reserve Illinois/Nebraska**

HQ-Not initiated 1921-25; Chicago, IL, 1925-39; Omaha, NE, 1939-41

Constituted in the Organized Reserve 15 October 1921, assigned to the Communications Zone, and allotted to the Sixth Corps Area. Initiated in August 1925 with headquarters at Chicago, IL. Affiliated with the Chicago, Milwaukee, and St. Paul Railroad. Withdrawn from the Sixth Corps Area 9 February 1939, allotted to the Seventh Corps Area, and Organized at Omaha, NE. Concurrently, affiliation changed to the Chicago, Burlington, and Quincy Railroad (east and west of Omaha). Redesignated 21 February 1941 as the 745th Engineer Battalion (Railway Operating). Location 7 December 1941—Omaha, NE.

597th Engineer Battalion (Railway Operating) (CZ)**Organized Reserve Kentucky**

HQ-Not initiated 1921-24; Louisville, KY, 1924-41

Constituted in the Organized Reserve 15 October 1921, assigned to the Communications Zone, and allotted to the Fifth Corps Area. Initiated in February 1924 with headquarters at Louisville, KY. Affiliated with the Louisville and Nashville Railroad. Reorganized with personnel from those sections north of Atlanta, Memphis, and Nashville. Redesignated 21 February 1941 as the 728th Engineer Battalion (Railway Operating). Location 7 December 1941—Louisville, KY.

598th Engineer Battalion (Railway Operating) (CZ)**Organized Reserve Indiana/Ohio**

HQ-Not initiated 1921-24; Indianapolis, IN, 1924-31; Cleveland, OH, 1931-41

Constituted in the Organized Reserve 15 October 1921, assigned to the Communications Zone, and allotted to the Fifth Corps Area. Initiated in October 1924 with headquarters at Indianapolis, IN. Affiliated with the Big Four Railroad (later the New York Central). Relocated 9 July 1931 to Cleveland, OH. Redesignated 21 February 1941 as the 737th Engineer Battalion (Railway Operating). Typically conducted Inactive Training Period meetings at the Bulkey Building in Cleveland. Location 7 December 1941—Cleveland, OH.

599th Engineer Battalion (Railway Operating) (CZ)**Organized Reserve Ohio**

HQ-Not initiated 1921-24; Columbus, OH, 1924-31; Canton, OH, 1931-35; Akron, OH, 1935-41

Constituted in the Organized Reserve 15 October 1921, assigned to the Communications Zone, and allotted to the Fifth Corps Area. Initiated by 1924 with headquarters at Columbus, OH. Affiliated with the Pennsylvania Railroad. Relocated 9 July 1931 to Canton, OH. Relocated June 1935 to Akron, OH. Redesignated 21 February 1941 as the 742nd Engineer Battalion (Railway Operating). Location 7 December 1941—Akron, OH.

600th Engineer Battalion (Combat) (Puerto Rican Division)**Organized Reserve Puerto Rico**

HQ-Not initiated 1921-23; San Juan, PR 1923-27

Constituted in the Organized Reserve 15 October 1921, assigned to the Puerto Rican Division, and allotted to the Second Corps Area. Initiated in February 1923 with headquarters at San Juan, PR. Attached to the 211th Infantry Brigade for administrative control. Withdrawn from allotment to Puerto Rico 16 March 1927 and demobilized.

600th Engineer Battalion (Camouflage) (GHQR)**Organized Reserve Massachusetts****HQ**-Boston, MA, 1930-33

Constituted in the Organized Reserve 31 March 1930 as the 600th Camouflage Battalion, Corps of Engineers, assigned to the General Headquarters Reserve, and allotted to the First Corps Area. Initiated 25 April 1930 with headquarters at Boston, MA. Redesignated 20 August 1931 as the 600th Engineer Battalion (Camouflage). Demobilized 1 October 1933.

601st Engineer Battalion (Camouflage) (GHQR)**Organized Reserve Pennsylvania****HQ**-Reading, PA, 1930-32; Philadelphia, PA, 1932-41

Constituted in the Organized Reserve 31 March 1930, as the 601st Camouflage Battalion, Corps of Engineers, assigned to the General Headquarters Reserve, and allotted to the Third Corps Area. Initiated 9 April 1930 with headquarters at Reading, PA. Redesignated 20 August 1931 as the 601st Engineer Battalion (Camouflage). Relocated 15 December 1932 to Philadelphia, PA. Assigned to the First Army 1 October 1933. Typically conducted Inactive Training Period meetings at the Society of American Military Engineers building in Philadelphia. Conducted summer training at Fort Belvoir, VA. Designated mobilization training station was Camp Smith, NY. Location 7 December 1941—Philadelphia, PA.

Status: Inactive in the U.S. Army Reserve as the 341st Engineer Camouflage Battalion.

602nd Engineer Battalion (Camouflage) (GHQR)**Organized Reserve Ohio****HQ**-Columbus, OH, 1930-40

Constituted in the Organized Reserve 31 March 1930, as the 602nd Camouflage Battalion, Corps of Engineers, assigned to the General Headquarters Reserve, and allotted to the Fifth Corps Area. Initiated in 1930 with headquarters at Columbus, OH. Redesignated 20 August 1931 as the 602nd Engineer Battalion (Camouflage). Assigned to the Second Army 1 October 1933. Withdrawn from the Organized Reserve 1 January 1938 and allotted to the Regular Army. Designated mobilization training station was Camp Smith, NY. Redesignated 1 July 1940 as the 84th Engineer Battalion (Camouflage) (Army).

Status: Inactive in the Regular Army as the 84th Engineer Battalion.

603rd Engineer Battalion (Camouflage) (GHQR)**Organized Reserve Michigan/Georgia****HQ**-*Not initiated* 1930-30; Detroit, MI, 1930-33; *Inactive* 1933-4; Waycross, GA, 1934-37; Savannah, GA, 1937-41

Constituted in the Organized Reserve 31 March 1930, as the 603rd Camouflage Battalion, Corps of Engineers, assigned to the General Headquarters Reserve, and allotted to the Sixth Corps Area. Initiated by December 1930 at Detroit, MI. Redesignated 20 August 1931 as the 603rd Engineer Battalion (Camouflage). Withdrawn from the Sixth Corps Area 1 October 1933 and allotted to the Fourth Corps Area. Concurrently assigned to the Third Army. Organized 6 December 1934 with headquarters at Waycross, GA. Relocated in March 1937 to Savannah, GA. Withdrawn from the Organized Reserve 1 January 1938 and allotted to the Regular Army. Inactivated 7 August 1940 at Savannah by relief of personnel. Designated mobilization training station was Camp Smith, NY. Location 7 December 1941—*Inactive*.

604th Engineer Battalion (Camouflage) (GHQR)

Organized Reserve California

HQ-San Francisco, CA, 1930-34; Los Angeles, CA, 1934-41



Constituted in the Organized Reserve 31 March 1930, as the 604th Camouflage Battalion, Corps of Engineers, assigned to the General Headquarters Reserve, and allotted to the Ninth Corps Area. Initiated 30 April 1930 at San Francisco, CA. Redesignated 20 August 1931 as the 604th Engineer Battalion (Camouflage). Assigned to the Fourth Army 1 October 1933. Relocated 5 April 1934 to Los Angeles, CA. Conducted summer training at Fort Ord, CA. Designated mobilization training station was Camp Smith, NY. Location 7 December 1941—Los Angeles, CA.

Status: Inactive in the U.S. Army Reserve as the 604th Engineer Camouflage Battalion.

605th Engineer Battalion (Camouflage) (I) (GHQR)

Organized Reserve New York

HQ-New York City, NY, 1922-32

Reconstituted in the Organized Reserve 28 December 1922 as the 1st Battalion, 40th Engineers (Camouflage), assigned to the General Headquarters Reserve, and allotted to the Second Corps Area. Initiated 28 December 1922 at New York City, NY. Redesignated 20 August 1931 as the 605th Engineer Battalion (Camouflage). Conducted monthly meetings at the armory of the 71st Infantry in New York City. Conducted summer training at Fort DuPont, DE. Redesignated 30 June 1932 as the 40th Engineer Battalion (Camouflage), withdrawn from the Organized Reserve, and allotted to the Regular Army as an RAI unit.

605th Engineer Battalion (Camouflage) (II) (GHQR)

Organized Reserve New York

HQ-*Not initiated* 1927-29; New York City, NY, 1929-33

Constituted in the Regular Army 18 August 1927, as the 1st Engineer Camouflage Company, Corps of Engineers, assigned to the General Headquarters Reserve, and allotted to the First Corps Area. Withdrawn from the First Corps Area 22 August 1928 and allotted to the Second Corps Area. Organized by 1929 with Organized Reserve personnel as a RAI unit with headquarters at New York City, NY. Expanded, reorganized, and redesignated 1 July 1929 as the 1st Camouflage Battalion, Corps of Engineers. Redesignated 31 March 1930 as the 40th Camouflage Battalion, Corps of Engineers. Conducted monthly meetings at the armory of the 71st Infantry in New York City. Conducted summer training with the 1st Engineer Regiment at Fort Du Pont, DE. Redesignated 20 August 1931 as the 40th Engineer Battalion (Camouflage). Redesignated 30 June 1932 as the 605th Engineer Battalion (Camouflage), withdrawn from the Organized Reserve, and allotted to the Regular Army. Demobilized 1 October 1933.

606th Engineer Battalion (Railway Operating) (GHQR)

Organized Reserve Texas

HQ-Dallas, TX, 1923-41

Constituted in the Organized Reserve 2 July 1923, assigned to the General Headquarters Reserve, and allotted to the Eighth Corps Area. Initiated 17 September 1923 with headquarters at Dallas, TX. Affiliated with the Missouri, Kansas, and Texas Railroad. Conducted summer training with the 2nd Engineer Regiment at Fort Sam Houston, TX, 1925-27 and at Fort Logan, CO, 1930-36. Designated mobilization training station was the Waco Concentration Camp, Waco, TX. Redesignated 21 February 1941 as the 746th Engineer Battalion (Railway Operating). Concurrently, withdrawn from the Eighth Corps Area and allotted to the Seventh Corps Area. Location 7 December 1941—*Inactive*.

607th Engineer Battalion (Railway Operating) (Communications Zone)

Organized Reserve Texas

HQ-Houston, TX, 1923-41

Constituted in the Organized Reserve 2 July 1923, assigned to the General Headquarters Reserve, and allotted to the Eighth Corps Area. Initiated 18 October 1923 with headquarters at Houston, TX. Affiliated with the Southern Pacific Railroad. Conducted summer training with the 2nd Engineer Regiment at Fort Sam Houston, TX, 1925-27 and with the 8th Engineer Squadron at Fort McIntosh, TX, 1928-36. Designated mobilization training station was the Waco Concentration Camp, Waco, TX. Redesignated 21 February 1941 as the 734th Engineer Battalion (Railway Operating). Concurrently, withdrawn from the Eighth Corps Area and allotted to the Seventh Corps Area. Location 7 December 1941—*Inactive*.

608th Engineer Battalion (Railway Operating) (Communications Zone)

Organized Reserve Texas

HQ-Not initiated 1923-24; Amarillo, TX, 1924-41

Constituted in the Organized Reserve 2 July 1923, assigned to the General Headquarters Reserve, and allotted to the Eighth Corps Area. Initiated 12 June 1924 with headquarters at Amarillo, TX. Affiliated with the Santa Fe Railroad. Conducted summer training with the 2nd Engineer Regiment at Fort Sam Houston, TX, 1925-27 and at Fort Logan, CO, 1928-36. Designated mobilization training station was the Waco Concentration Camp, Waco, TX. Redesignated 21 February 1941 as the 747th Engineer Battalion (Railway Operating). Concurrently, withdrawn from the Eighth Corps Area and allotted to the Seventh Corps Area. Location 7 December 1941—*Inactive*.

609th Engineer Battalion (Railway Operating) (Communications Zone)

Organized Reserve Illinois

HQ-Not initiated 1923-24; Chicago, IL, 1924-41

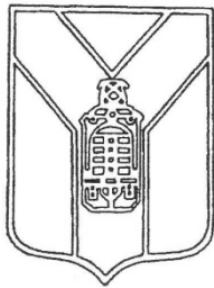

Constituted in the Organized Reserve 2 July 1923, assigned to the General Headquarters Reserve, and allotted to the Sixth Corps Area. Initiated 9 April 1924 with headquarters at Chicago, IL. Affiliated with the Chicago, Milwaukee, and St. Paul Railroad. Affiliation later changed to the Chicago, Burlington, and Quincy Railroad. Redesignated 21 February 1941 as the 753rd Engineer Battalion (Railway Operating). Location 7 December 1941—Chicago, IL.

611th Engineer Battalion (Railway Operating) (GHQR)

Organized Reserve Minnesota

HQ-Not initiated 1923-24; Saint Paul, MN, 1924-41

Constituted in the Organized Reserve 2 July 1923, assigned to the General Headquarters Reserve, and allotted to the Seventh Corps Area. Initiated in May 1924 with headquarters at St. Paul, MN. Affiliated with the Chicago, St. Paul, Minnesota, and Omaha Railroad. Redesignated 21 February 1941 as the 750th Engineer Battalion (Railway Operating). Location 7 December 1941—St. Paul, MN.

612th Engineer Battalion (Railway Operating) (Communications Zone)

**Organized Reserve Kansas/
Missouri**

HQ—*Not initiated* 1923-24; Topeka, KS, 1924-31; Marcelene, MO, 1931-41

Constituted in the Organized Reserve 2 July 1923, assigned to the General Headquarters Reserve, and allotted to the Seventh Corps Area. Initiated in March 1924 with headquarters at Topeka, KS. Affiliated with the Atchison, Topeka, and Santa Fe Railroad. Relocated 12 October 1931 to Marcelene, MO. Redesignated 21 February 1941 as the 747th Engineer Battalion (Railway Operating). Concurrently, withdrawn from the Seventh Corps Area and allotted to the First Corps Area. Location 7 December 1941—*Inactive*.

613th Engineer Battalion (Railway Operating) (Communications Zone)

Organized Reserve Missouri

HQ—*Not initiated* 1923-24; St. Louis, MO, 1924-41

Constituted in the Organized Reserve 2 July 1923, assigned to the General Headquarters Reserve, and allotted to the Seventh Corps Area. Initiated in November 1924 with headquarters at St. Louis, MO. Affiliated with the Missouri Pacific Railroad. Redesignated 21 February 1941 as the 748th Engineer Battalion (Railway Operating). Concurrently, withdrawn from the Eighth Corps Area and allotted to the Seventh Corps Area. Location 7 December 1941—*Inactive*.

614th Engineer Battalion (Railway Operating) (Communications Zone)

Organized Reserve Nebraska

HQ—*Not initiated* 1923-24; Omaha, NE, 1924-41

Constituted in the Organized Reserve 2 July 1923, assigned to the General Headquarters Reserve, and allotted to the Seventh Corps Area. Initiated in July 1924 with headquarters at Omaha, NE. Affiliated with the Union Pacific Railroad. Redesignated 21 February 1941 as the 748th Engineer Battalion (Railway Operating). Location 7 December 1941—Omaha, NE.

615th Engineer Battalion (Railway Operating) (Communications Zone)

Organized Reserve Missouri

HQ—*Not initiated* 1923-24; St. Paul, MN, 1924-31; St. Louis, MO, 1931-39; Decatur, IL, 1939-41

Constituted in the Organized Reserve 2 July 1923, assigned to the General Headquarters Reserve, and allotted to the Seventh Corps Area. Initiated in July 1924 with headquarters at St. Paul, MN. Affiliated with the Northern Pacific Railroad. Relocated 12 October 1931 to St. Louis, MO. Affiliation changed 14 November 1935 to the Wabash Railroad. Withdrawn from the Seventh Corps Area 9 February 1939 and allotted to the Sixth Corps Area. Reorganized 14 February 1939 at Decatur, IL. Redesignated 21 February 1941 as the 726th Engineer Battalion (Railway Operating). Location 7 December 1941—Decatur, IL.

616th Engineer Battalion (Railway Operating) (Communications Zone)

Organized Reserve California

HQ—San Francisco, CA, 1927-41; *Inactive* 1941

Constituted in the Organized Reserve 11 March 1927, assigned to the Communications Zone, and allotted to the Ninth Corps Area. Initiated 11 March 1927 at San Francisco, CA, with personnel previously assigned to the 618th Engineer Battalion (Railway Operating). Affiliated with the Southern Pacific Railroad. Conducted summer training at Del Monte, CA, or at the Presidio of Monterey, CA. Redesignated 21 February 1941 as the 751st Engineer Battalion (Railway Operating). Concurrently, withdrawn from the Ninth Corps Area and allotted to the Eighth Corps Area. Inactivated 31 July 1941 at San Francisco by relief of personnel. Location 7 December 1941—*Inactive*.

617th Engineer Battalion (Railway Operating) (GHQR)

Organized Reserve Washington

HQ-*Not initiated* 1923-26; Seattle, WA, 1926-41

Constituted in the Organized Reserve 2 July 1923, assigned to the General Headquarters Reserve, and allotted to the Ninth Corps Area. Initiated in April 1926 with headquarters at Seattle, WA. Affiliated with the Southern Pacific Railroad. Affiliation withdrawn 10 October 1934. Affiliated with the Great Northern Railroad 18 November 1940. Conducted summer training at Fort Lewis, WA. Redesignated 21 February 1941 as the 732nd Engineer Battalion (Railway Operating). Location 7 December 1941—Seattle, WA.

618th Engineer Battalion (Railway Operating) (Communications Zone)

**Organized Reserve California/
Minnesota**

HQ-*Not initiated* 1923-25; San Francisco, CA, 1925-26; *Inactive* 1926-27; St. Paul, MN, 1927-28

Constituted in the Organized Reserve 2 July 1923, assigned to the General Headquarters Reserve, and allotted to the Ninth Corps Area. Initiated in March 1925 with headquarters at San Francisco, CA. Affiliated with the Southern Pacific Railroad. Withdrawn from the Ninth Corps Area 5 November 1926 and allotted to the Seventh Corps Area. Reorganized 11 March 1927 at St. Paul, MN. Affiliated with the Great Northern Railroad. Withdrawn from the Seventh Corps Area 6 October 1928.

619th Engineer Battalion (Railway Operating) (Communications Zone)

Organized Reserve Utah

HQ-*Not initiated* 1923-26; Salt Lake City, UT, 1926-41; *Inactive* 1941

Constituted in the Organized Reserve 2 July 1923, assigned to the General Headquarters Reserve, and allotted to the Ninth Corps Area. Initiated in February 1926 with headquarters at Salt Lake City, UT. Affiliated with the Union Pacific Railroad. Redesignated 21 February 1941 as the 731st Engineer Battalion (Railway Operating). Inactivated 9 May 1941 at Salt Lake City by relief of personnel. Location 7 December 1941—*Inactive*.

620th Engineer Battalion (Railway Operating) (Communications Zone)

Organized Reserve Washington

HQ-*Not initiated* 1923-26; Seattle, WA, 1926-28

Constituted in the Organized Reserve 2 July 1923, assigned to the General Headquarters Reserve, and allotted to the Ninth Corps Area. Initiated in April 1926 with headquarters at Seattle, WA. Affiliated with the Northern Pacific Railroad. Withdrawn from the Ninth Corps Area 6 October 1928.

626th Engineer Battalion (Auxiliary) (I) (II Corps)

Organized Reserve New York

HQ-*Not initiated* 1923-27

Constituted in the National Guard 29 July 1921 as the 139th Engineer Battalion (Auxiliary). Assigned to the II Corps and allotted to the state of New York. Placed on the deferred list 2 July 1923, unit requirement transferred to the Organized Reserve as a Deferred National Guard unit, and redesignated as the 626th Engineer Battalion (Auxiliary). Withdrawn from the National Guard 17 September 1927.

626th Engineer Battalion (Auxiliary) (C) (II) (GHQR)

Organized Reserve Virginia

HQ-Not initiated 1928-32; Roanoke, VA, 1932-36; Richmond, VA, 1936-41

Constituted in the Organized Reserve 5 September 1928, assigned to the General Headquarters Reserve, and allotted to the Third Corps Area. Redesignated 7 May 1930 as the 626th Engineer Battalion (Separate). Initiated 21 January 1932 with headquarters at Roanoke, VA. Assigned to the First Army 1 October 1933. Relocated in 1936 to Richmond, VA. Conducted summer training at Fort Belvoir, VA. Primary R.O.T.C. feeder school was the Virginia Polytechnic Institute. Location 7 December 1941—Richmond, VA.

Status: Disbanded 22 December 1942.

627th Engineer Battalion (Auxiliary) (C) (I) (III Corps)

Organized Reserve District of Columbia

HQ-Not initiated 1923-27

Constituted in the National Guard 29 July 1921 as the 140th Engineer Battalion (Auxiliary). Assigned to the III Corps and allotted to the District of Columbia. Placed on the deferred list 2 July 1923, unit requirement transferred to the Organized Reserve as a Deferred National Guard unit, and redesignated as the 627th Engineer Battalion (Auxiliary). Withdrawn from the National Guard 17 September 1927.

627th Engineer Battalion (Auxiliary) (C) (II) (GHQR)

Organized Reserve District of Columbia

HQ-Not initiated 1928-32; Washington, DC 1932-40

Constituted in the Organized Reserve 5 September 1928, assigned to the General Headquarters Reserve, and allotted to the Third Corps Area. Initiated 21 January 1932 with headquarters at Washington, DC. Redesignated 7 May 1930 as the 627th Engineer Battalion (Separate). Assigned to the First Army 1 October 1933. Disbanded 1 July 1940.

628th Engineer Battalion (Auxiliary) (C) (I) (III Corps)

Organized Reserve Virginia

HQ-Not initiated 1923-27

Constituted in the National Guard 29 July 1921 as the 141st Engineer Battalion (Auxiliary). Assigned to the III Corps and allotted to the state of Virginia. Placed on the deferred list 2 July 1923, unit requirement transferred to the Organized Reserve as a Deferred National Guard unit, and redesignated as the 628th Engineer Battalion (Auxiliary). Withdrawn from the National Guard 17 September 1927.

628th Engineer Battalion (Auxiliary) (C) (II) (GHQR)

Organized Reserve Florida

HQ-Not initiated 1928-29; Lakeland, FL, 1929-33

Constituted in the Organized Reserve 5 September 1928, assigned to the General Headquarters Reserve, and allotted to the Fourth Corps Area. Initiated 1 October 1929 with headquarters at Lakeland, FL. Redesignated 7 May 1930 as the 628th Engineer Battalion (Separate). Demobilized 1 October 1933.

629th Engineer Battalion (Auxiliary) (I) (III Corps)

Organized Reserve Maryland

HQ-Not initiated 1923-27

Constituted in the National Guard 29 July 1921 as the 142nd Engineer Battalion (Auxiliary). Assigned to the III Corps and allotted to the state of Maryland. Placed on the deferred list 2 July 1923, unit requirement transferred to the Organized Reserve as a Deferred National Guard unit, and redesignated as the 629th Engineer Battalion (Auxiliary). Withdrawn from the National Guard 17 September 1927.

629th Engineer Battalion (Auxiliary) (C) (II) (GHQR)

Organized Reserve Indiana

HQ-Not initiated 1928-31; Indianapolis, IN, 1931-33; South Bend, IN, 1933-40

Constituted in the Organized Reserve 5 September 1928, assigned to the General Headquarters Reserve, and allotted to the Fifth Corps Area. Redesignated 7 May 1930 as the 629th Engineer Battalion (Separate). Initiated 9 July 1931 with headquarters at Indianapolis, IN. Relocated 31 December 1933 to South Bend, IN. Disbanded 1 July 1940.

630th Engineer Battalion (Auxiliary) (XIV Corps)

Organized Reserve Louisiana

HQ-Not initiated 1923-27

Constituted in the National Guard 29 July 1921 as the 143rd Engineer Battalion (Auxiliary). Assigned to the IV Corps and allotted to the state of Georgia. Placed on the deferred list 2 July 1923 and unit requirement transferred to the Organized Reserve as a Deferred National Guard unit. Concurrently redesignated as the 630th Engineer Battalion (Auxiliary) and assigned to the XIV Corps. Designated mobilization station was Camp Beauregard, LA. Withdrawn from the National Guard 17 September 1927.

631st Engineer Battalion (Auxiliary) (XIV Corps)

Organized Reserve South Carolina

HQ-Not initiated 1923-27

Constituted in the National Guard 29 July 1921 as the 144th Engineer Battalion (Auxiliary). Assigned to the IV Corps and allotted to the state of Tennessee. Placed on the deferred list 2 July 1923 and unit requirement transferred to the Organized Reserve as a Deferred National Guard unit. Concurrently redesignated as the 631st Engineer Battalion (Auxiliary) and assigned to the XIV Corps. Hartsville, SC, designated as headquarters on organization, but the unit was never organized at that location. Designated mobilization station was Camp Jackson, SC. Withdrawn from the National Guard 17 September 1927.

632nd Engineer Battalion (Auxiliary) (I) (XV Corps)

Organized Reserve

HQ-Not initiated 1923-27

Constituted in the National Guard 29 July 1921 as the 145th Engineer Battalion (Auxiliary). Assigned to the V Corps and allotted to the state of Ohio. Placed on the deferred list 2 July 1923 and unit requirement transferred to the Organized Reserve as a Deferred National Guard unit. Concurrently redesignated as the 632nd Engineer Battalion (Auxiliary) and assigned to the XV Corps. Withdrawn from the National Guard 17 September 1927.

632nd Engineer Battalion (Auxiliary) (C) (II) (GHQR)

Organized Reserve Nebraska

HQ-Not initiated 1928-40

Constituted in the Organized Reserve 5 September 1928, assigned to the General Headquarters Reserve, and allotted to the Seventh Corps Area. Redesignated 7 May 1930 as the 632nd Engineer Battalion (Separate). Omaha, NE, designated 12 October 1931 as headquarters on organization, but the unit was never organized at that location. Disbanded 1 July 1940.

633rd Engineer Battalion (Auxiliary) (I) (XV Corps)

Organized Reserve

HQ-Not initiated 1923-27

Constituted in the National Guard 29 July 1921 as the 146th Engineer Battalion (Auxiliary). Assigned to the V Corps and allotted to the state of Ohio. Placed on the deferred list 2 July 1923 and unit requirement transferred to the Organized Reserve as a Deferred National Guard unit. Concurrently redesignated as the 633rd Engineer Battalion (Auxiliary) and assigned to the XV Corps. Withdrawn from the National Guard 17 September 1927.

633rd Engineer Battalion (Auxiliary) (II) (GHQR)

Organized Reserve Nebraska

HQ-Not initiated 1928-40

Constituted in the Organized Reserve 5 September 1928, assigned to the General Headquarters Reserve, and allotted to the Seventh Corps Area. Redesignated 7 May 1930 as the 633rd Engineer Battalion (Separate). Omaha, NE, designated 12 October 1931 as headquarters on organization, but the unit was never organized at that location. Disbanded 1 July 1940.

634th Engineer Battalion (Auxiliary) (I) (XV Corps)

Organized Reserve

HQ-Not initiated 1923-27

Constituted in the National Guard 29 July 1921 as the 147th Engineer Battalion (Auxiliary). Assigned to the V Corps and allotted to the state of Ohio. Placed on the deferred list 2 July 1923 and unit requirement transferred to the Organized Reserve as a Deferred National Guard unit. Concurrently redesignated as the 634th Engineer Battalion (Auxiliary) and assigned to the XV Corps. Withdrawn from the National Guard 17 September 1927.

634th Engineer Battalion (Auxiliary) (II) (GHQR)

Organized Reserve Minnesota

HQ-Not initiated 1928-40

Constituted in the Organized Reserve 5 September 1928, assigned to the General Headquarters Reserve, and allotted to the Seventh Corps Area. Redesignated 7 May 1930 as the 634th Engineer Battalion (Separate). Hibbing, MN, designated 12 October 1931 as headquarters on organization, but the unit was never organized at that location. Disbanded 1 July 1940.

635th Engineer Battalion (Auxiliary) (I) (XVI Corps)**Organized Reserve****HQ-Not initiated** 1923-27

Constituted in the National Guard 29 July 1921 as the 148th Engineer Battalion (Auxiliary). Assigned to the VI Corps and allotted to the state of Illinois. Placed on the deferred list 2 July 1923 and unit requirement transferred to the Organized Reserve as a Deferred National Guard unit. Concurrently redesignated as the 635th Engineer Battalion (Auxiliary) and assigned to the XVI Corps. Designated mobilization training station was Camp Grant, IL. Withdrawn from the National Guard 17 September 1927.

635th Engineer Battalion (Auxiliary) (C) (II) (GHQR)**Organized Reserve Oklahoma****HQ-Not initiated** 1928-29; Okmulgee, OK, 1929; *Inactive* 1929-41

Constituted in the Organized Reserve 5 September 1928, assigned to the General Headquarters Reserve, and allotted to the Eighth Corps Area. Initiated 4 May 1929 with headquarters at Okmulgee, OK. Inactivated 21 August 1929 at Okmulgee by relief of personnel. Redesignated 7 May 1930 as the 635th Engineer Battalion (Separate) (C). Conducted summer training at Fort Sill, OK. Designated mobilization training station was the Waco Concentration Camp, Waco, TX. Location 7 December 1941—*Inactive*.

Status: Disbanded 22 December 1942.**636th Engineer Battalion (Auxiliary) (I) (XVI Corps)****Organized Reserve****HQ-Not initiated** 1923-27

Constituted in the National Guard 29 July 1921 as the 149th Engineer Battalion (Auxiliary). Assigned to the VI Corps and allotted to the state of Illinois. Placed on the deferred list 2 July 1923 and unit requirement transferred to the Organized Reserve as a Deferred National Guard unit. Concurrently redesignated as the 636th Engineer Battalion (Auxiliary) and assigned to the XVI Corps. Designated mobilization training station was Camp Grant, IL. Withdrawn from the National Guard 17 September 1927.

636th Engineer Battalion (Auxiliary) (C) (II) (GHQR)**Organized Reserve Texas****HQ-San Antonio, TX, 1928-29; Inactive** 1929-33

Constituted in the Organized Reserve 5 September 1928, assigned to the General Headquarters Reserve, and allotted to the Eighth Corps Area. Initiated 12 October 1928 with headquarters at San Antonio, TX. Inactivated 21 August 1929 at San Antonio by relief of personnel. Redesignated 7 May 1930 as the 636th Engineer Battalion (Separate) (C). Designated mobilization training station was the Waco Concentration Camp, Waco, TX. Demobilized 1 October 1933.

637th Engineer Battalion (Auxiliary) (XVI Corps)**Organized Reserve****HQ-Not initiated** 1923-27

Constituted in the National Guard 29 July 1921 as the 150th Engineer Battalion (Auxiliary). Assigned to the VI Corps and allotted to the state of Illinois. Placed on the deferred list 2 July 1923 and unit requirement transferred to the Organized Reserve as a Deferred National Guard unit. Concurrently redesignated as the 637th Engineer Battalion (Auxiliary) and assigned to the XVI Corps. Designated mobilization training station was Camp Grant, IL. Withdrawn from the National Guard 17 September 1927.

638th Engineer Battalion (Auxiliary) (VII Corps)**Organized Reserve Nebraska/Minnesota**

HQ-Not initiated 1923-24; Omaha, NE, 1924-26; Minneapolis, MN, 1926-27

Constituted in the National Guard 29 July 1921 as the 151st Engineer Battalion (Auxiliary). Assigned to the VII Corps and allotted to the state of Iowa. Placed on the deferred list 2 July 1923, unit requirement transferred to the Organized Reserve as a Deferred National Guard unit, and redesignated as the 638th Engineer Battalion (Auxiliary). Initiated 29 August 1924 at Omaha, NE. Relocated 26 May 1926 to Minneapolis, MN. Withdrawn from the National Guard 17 September 1927.

639th Engineer Battalion (Auxiliary) (VII Corps)**Organized Reserve Nebraska/Iowa**

HQ-Not initiated 1923-24; Wahoo, NE, 1924-26; Waterloo, IA, 1926-27

Constituted in the National Guard 29 July 1921 as the 152nd Engineer Battalion (Auxiliary). Assigned to the VII Corps and allotted to the state of Missouri. Placed on the deferred list 2 July 1923, unit requirement transferred to the Organized Reserve as a Deferred National Guard unit, and redesignated as the 639th Engineer Battalion (Auxiliary). Initiated 12 October 1924 at Wahoo, NE. Relocated 26 May 1926 to Waterloo, IA. Withdrawn from the National Guard 17 September 1927.

640th Engineer Battalion (Auxiliary) (VII Corps)**Organized Reserve Missouri/Minnesota**

HQ-Not initiated 1923-24; Booneville, MO, 1924-26; Bemidji, MN, 1926-27

Constituted in the National Guard 29 July 1921 as the 153rd Engineer Battalion (Auxiliary). Assigned to the VII Corps and allotted to the state of Missouri. Placed on the deferred list 2 July 1923, unit requirement transferred to the Organized Reserve as a Deferred National Guard unit, and redesignated as the 640th Engineer Battalion (Auxiliary). Initiated 12 October 1924 at Booneville, MO. Relocated 26 May 1926 to Bemidji, MN. Withdrawn from the National Guard 17 September 1927.

641st Engineer Battalion (Auxiliary) (XVIII Corps)**Organized Reserve Minnesota/Nebraska**

HQ-Not initiated 1923-31; Lincoln, NE, 1931-41

Constituted in the National Guard 29 July 1921 as the 154th Engineer Battalion (Auxiliary). Assigned to the VIII Corps and allotted to the state of Oklahoma. Placed on the deferred list 2 July 1923, unit requirement transferred to the Organized Reserve as a Deferred National Guard unit. Concurrently redesignated as the 641st Engineer Battalion (Auxiliary) and assigned to the XVIII Corps. Withdrawn as a Deferred National Guard unit 13 January 1927 and allotted permanently to the Organized Reserve as the 641st Engineer Battalion (Auxiliary). Concurrently withdrawn from the Eighth Corps Area and allotted to the Seventh Corps Area. Fergus Falls, MN, designated as headquarters on organization, but the unit was never organized at that location. Redesignated 7 May 1930 as the 641st Engineer Battalion (Separate). Initiated 12 October 1931 at Lincoln, NE. Conducted summer training at Fort Logan, CO, Fort Riley, KS, or Fort Snelling, MN. Location 7 December 1941—Lincoln, NE.

Status: Disbanded 22 December 1942.

642nd Engineer Battalion (Auxiliary) (XVIII Corps)**Organized Reserve Texas/Kansas****HQ-Not initiated 1923-40**

Constituted in the National Guard 29 July 1921 as the 155th Engineer Battalion (Auxiliary). Assigned to the VIII Corps and allotted to the state of Texas. Placed on the deferred list 2 July 1923, unit requirement transferred to the Organized Reserve as a Deferred National Guard unit. Concurrently redesignated as the 642nd Engineer Battalion (Auxiliary) and assigned to the XVIII Corps. Withdrawn as a Deferred National Guard unit 13 January 1927 and allotted permanently to the Organized Reserve as the 642nd Engineer Battalion (Auxiliary). Concurrently withdrawn from the Eighth Corps Area and allotted to the Seventh Corps Area. Parsons, KS, designated as headquarters on organization, but the unit was never organized at that location. Redesignated 7 May 1930 as the 642nd Engineer Battalion (Separate). Withdrawn from the Seventh Corps Area 1 October 1933 and allotted to the First Corps Area. Concurrently assigned to the XI Corps. Disbanded 1 July 1940.

643rd Engineer Battalion (Auxiliary) (XVIII Corps)**Organized Reserve Texas/Iowa****HQ-Not initiated 1923-40**

Constituted in the National Guard 29 July 1921 as the 156th Engineer Battalion (Auxiliary). Assigned to the VIII Corps and allotted to the state of Texas. Placed on the deferred list 2 July 1923, unit requirement transferred to the Organized Reserve as a Deferred National Guard unit. Concurrently redesignated as the 643rd Engineer Battalion (Auxiliary) and assigned to the XVIII Corps. Withdrawn as a Deferred National Guard unit 13 January 1927 and allotted permanently to the Organized Reserve as the 643rd Engineer Battalion (Auxiliary). Concurrently withdrawn from the Eighth Corps Area and allotted to the Seventh Corps Area. Fort Dodge, IA, designated as headquarters on organization, but the unit was never organized at that location. Redesignated 7 May 1930 as the 643rd Engineer Battalion (Separate). Withdrawn from the Seventh Corps Area 1 October 1933 and allotted to the First Corps Area. Concurrently assigned to the XI Corps. Disbanded 1 July 1940.

644th Engineer Battalion (Auxiliary) (First Army)**Organized Reserve Virginia****HQ-Not initiated 1923-27**

Constituted in the National Guard 29 July 1921 as the 167th Engineer Battalion (Auxiliary). Assigned to the First Army and allotted to the state of Virginia. Placed on the deferred list 2 July 1923, unit requirement transferred to the Organized Reserve as a Deferred National Guard unit. Concurrently redesignated as the 644th Engineer Battalion (Auxiliary) and assigned to the First Army. Withdrawn from the National Guard 17 September 1927.

645th Engineer Battalion (Auxiliary) (Second Army)**Organized Reserve****HQ-Not initiated 1923-27**

Constituted in the National Guard 29 July 1921 as the 169th Engineer Battalion (Auxiliary). Assigned to the Second Army and allotted to the state of Mississippi. Placed on the deferred list 2 July 1923, unit requirement transferred to the Organized Reserve as a Deferred National Guard unit. Concurrently redesignated as the 645th Engineer Battalion (Auxiliary) and assigned to the Second Army. Designated mobilization training station was Fort Bragg, NC. Withdrawn from the National Guard 17 September 1927.

646th Engineer Battalion (Auxiliary) (Second Army)

Organized Reserve

HQ-Not initiated 1923-27

Constituted in the National Guard 29 July 1921 as the 170th Engineer Battalion (Auxiliary). Assigned to the Second Army and allotted to the state of Louisiana. Placed on the deferred list 2 July 1923, unit requirement transferred to the Organized Reserve as a Deferred National Guard unit. Concurrently redesignated as the 646th Engineer Battalion (Auxiliary) and assigned to the Second Army. Designated mobilization training station was Fort Bragg, NC. Withdrawn from the National Guard 17 September 1927.

647th Engineer Battalion (Auxiliary) (Second Army)

Organized Reserve Alabama

HQ-Not initiated 1923-27

Constituted in the National Guard 29 July 1921 as the 171st Engineer Battalion (Auxiliary). Assigned to the Second Army and allotted to the state of Alabama. Placed on the deferred list 2 July 1923, unit requirement transferred to the Organized Reserve as a Deferred National Guard unit. Concurrently redesignated as the 647th Engineer Battalion (Auxiliary) and assigned to the Second Army. Montgomery, AL, designated as headquarters on organization, but the unit was never organized at that location. Designated mobilization training station was Fort Bragg, NC. Withdrawn from the National Guard 17 September 1927.

648th Engineer Battalion (Auxiliary) (Second Army)

Organized Reserve Georgia

HQ-Not initiated 1923-27

Constituted in the National Guard 29 July 1921 as the 172nd Engineer Battalion (Auxiliary). Assigned to the Second Army and allotted to the state of South Carolina. Placed on the deferred list 2 July 1923, unit requirement transferred to the Organized Reserve as a Deferred National Guard unit. Concurrently redesignated as the 648th Engineer Battalion (Auxiliary) and assigned to the Second Army. Valdosta, GA, designated as headquarters on organization, but the unit was never organized at that location. Designated mobilization training station was Fort Bragg, NC. Withdrawn from the National Guard 17 September 1927.

649th Engineer Battalion (Auxiliary) (Second Army)

Organized Reserve Mississippi

HQ-Not initiated 1923-27

Constituted in the National Guard 29 July 1921 as the 173rd Engineer Battalion (Auxiliary). Assigned to the Second Army and allotted to the state of North Carolina. Placed on the deferred list 2 July 1923, unit requirement transferred to the Organized Reserve as a Deferred National Guard unit. Concurrently redesignated as the 646th Engineer Battalion (Auxiliary) and assigned to the Second Army. Natchez, MS, designated as headquarters on organization, but the unit was never organized at that location. Designated mobilization training station was Fort Bragg, NC. Withdrawn from the National Guard 17 September 1927.

650th Engineer Battalion (Auxiliary) (Third Army)

Organized Reserve Iowa

HQ-Not initiated 1923-24; Sioux City, IA, 1924-26; Chariton, IA, 1926-27

Constituted in the National Guard 29 July 1921 as the 174th Engineer Battalion (Auxiliary). Assigned to the Third Army and allotted to the state of Arkansas. Placed on the deferred list 2 July 1923, unit requirement transferred to the Organized Reserve as a Deferred National Guard unit. Concurrently redesignated as the 650th Engineer Battalion (Auxiliary) and assigned to the Third Army. Initiated 12 October 1924 at Sioux City, IA. Relocated 26 May 1926 to Chariton, IA. Withdrawn from the National Guard 17 September 1927.

651st Engineer Battalion (Auxiliary) (GHQR)**Organized Reserve****HQ-Not initiated 1923-27**

Constituted in the National Guard 29 July 1921 as the 192nd Engineer Battalion (Auxiliary). Assigned to the General Headquarters Reserve and allotted to the state of Kentucky. Placed on the deferred list 2 July 1923, unit requirement transferred to the Organized Reserve as a Deferred National Guard unit. Concurrently redesignated as the 651st Engineer Battalion (Auxiliary) and assigned to the General Headquarters Reserve. Withdrawn from the National Guard 17 September 1927.

652nd Engineer Battalion (Auxiliary) (GHQR)**Organized Reserve Michigan****HQ-Not initiated 1923-27**

Constituted in the National Guard 29 July 1921 as the 193rd Engineer Battalion (Auxiliary). Assigned to the General Headquarters Reserve and allotted to the state of Michigan. Placed on the deferred list 2 July 1923, unit requirement transferred to the Organized Reserve as a Deferred National Guard unit. Concurrently redesignated as the 652nd Engineer Battalion (Auxiliary) and assigned General Headquarters Reserve. Designated mobilization training station was Camp Custer, MI. Withdrawn from the National Guard 17 September 1927.

653rd Engineer Battalion (Topographic) (I) (First Army)**Organized Reserve New Jersey/New York****HQ-Not initiated 1923-27**

Constituted in the National Guard 29 July 1921 as the 175th Engineer Battalion (Topographic). Assigned to the First Army and allotted to the state of New York. Placed on the deferred list 2 July 1923, unit requirement transferred to the Organized Reserve as a Deferred National Guard unit. Concurrently redesignated as the 653rd Engineer Battalion (Topographic) and assigned to the First Army. Trenton, NJ, designated as headquarters on organization, but the unit was never organized at that location. Designated headquarters location changed 2 March 1925 to Rochester, NY. Withdrawn from the National Guard 17 September 1927.

653rd Engineer Battalion (Topographic) (II) (CZ)**Organized Reserve Connecticut/Virginia****HQ-Not initiated 1928-30; Hartford, CT, 1930-36; Inactive 1936-37; Norfolk, VA, 1937-41**

Constituted in the Organized Reserve 5 September 1928, assigned to the Communication Zone, and allotted to the Second Corps Area. Withdrawn from the Second Corps Area 30 November 1929 and allotted to the First Corps Area. Initiated by June 1930 at Hartford, CT. Assigned to the First Army 1 October 1933. Withdrawn from the First Corps Area 5 June 1936 and allotted to the Third Corps Area. Reorganized 23 September 1937 with headquarters at Norfolk, VA. Typically conducted Inactive Training Period meetings at the US Court House or the Post Office Building in Norfolk. Location 7 December 1941—Norfolk, VA.

654th Engineer Battalion (Topographic) (I) (Third Army)**Organized Reserve Iowa****HQ-Not initiated 1923-27**

Constituted in the National Guard 29 July 1921 as the 176th Engineer Battalion (Topographic). Assigned to the Third Army and allotted to the state of Iowa. Placed on the deferred list 2 July 1923, unit requirement transferred to the Organized Reserve as a Deferred National Guard unit. Concurrently redesignated as the 654th Engineer Battalion (Topographic) and assigned to the Third Army. Marengo, IA, designated as headquarters on organization, but the unit was never organized at that location. Withdrawn from the National Guard 17 September 1927.

654th Engineer Battalion (Topographic) (II) (CZ)

Organized Reserve Ohio/Texas

HQ-*Not initiated* 1928-35; San Antonio, TX, 1935-41

Constituted in the Organized Reserve 5 September 1928, assigned to the Communication Zone, and allotted to the Fifth Corps Area. Akron, OH, designated as headquarters on reorganization, but the unit was never organized at that location. Withdrawn from the Fifth Corps Area 1 October 1933 and allotted to the Eighth Corps Area. Initiated 1 April 1935 with headquarters at San Antonio, TX. Location 7 December 1941—San Antonio, TX.

661st Engineer Battalion (Railway Shop) (GHQR)

Organized Reserve New Jersey

HQ-*Not initiated* 1933-37; Jersey City, NJ 1937; Englewood, NJ 1937-40; *Inactive* 1940-41

Constituted in the Organized Reserve 1 July 1933, assigned to the General Headquarters Reserve, and allotted to the Second Corps Area. Initiated by January 1937 with headquarters at Jersey City, NJ. Relocated 5 April 1937 to Englewood, NJ. Inactivated in 1940 at Englewood by relief of personnel. Redesignated 21 February 1941 as the 754th Engineer Battalion (Railway Shop). Concurrently, withdrawn from the Second Corps Area and allotted to the Ninth Corps Area. Location 7 December 1941—*Inactive*.

Status: Inactive in the U.S. Army Reserve as the 754th Transportation Battalion (Railway Shop).

662nd Engineer Battalion (Railway Shop) (GHQR)

Organized Reserve Virginia

HQ-*Not initiated* 1933-41

Constituted in the Organized Reserve 1 July 1933, assigned to the General Headquarters Reserve, and allotted to the Third Corps Area. Redesignated 21 February 1941 as the 755th Engineer Battalion (Railway Shop). Location 7 December 1941—*Inactive*.

663rd Engineer Battalion (Railway Shop) (GHQR)

Organized Reserve Indiana

HQ-Indianapolis, IN, 1933-41; *Inactive* 1941

Constituted in the Organized Reserve 1 July 1933, assigned to the General Headquarters Reserve, and allotted to the Fifth Corps Area. Initiated 21 December 1933 with headquarters at Indianapolis, IN. Affiliated with the Cleveland, Cincinnati, Chicago, and St. Louis Railroad 23 April 1934. Withdrawn from the Fifth Corps Area 21 February 1941, allotted to the Third Corps Area, and redesignated as the 756th Engineer Battalion (Railway Shop). Location 7 December 1941—*Inactive*.

664th Engineer Battalion (Railway Shop) (GHQR)

Organized Reserve Michigan

HQ-*Not initiated* 1933-41

Constituted in the Organized Reserve 1 July 1933, assigned to the General Headquarters Reserve, and allotted to the Sixth Corps Area. Detroit, MI, designated as headquarters on organization, but the unit was never organized at that location. Redesignated 21 February 1941 as the 757th Engineer Battalion (Railway Shop). Concurrently, withdrawn from the Sixth Corps Area and allotted to the Seventh Corps Area. Location 7 December 1941—*Inactive*.

Status: Active in the U.S. Army Reserve at West Ellis, WI, as the 757th Transportation Battalion.

665th Engineer Battalion (Railway Shop) (GHQR)**Organized Reserve Michigan/California****HQ-Not initiated** 1933-41

Constituted in the Organized Reserve 1 July 1933, assigned to the General Headquarters Reserve, and allotted to the Sixth Corps Area. Detroit, MI, designated as headquarters on organization, but the unit was never organized at that location. Withdrawn from the Sixth Corps Area 1 March 1937 and allotted to the Ninth Corps Area. Sacramento, CA, designated 14 May 1937 as headquarters on organization, but the unit was never organized at that location. Redesignated 21 February 1941 as the 758th Engineer Battalion (Railway Shop). Location 7 December 1941—*Inactive*.

691st Engineer Battalion (Auxiliary) (C) (Communications Zone)**Organized Reserve Maine/
South Carolina/Michigan****HQ-Not initiated** 1923-24; Portland, ME, 1924-27; *Inactive* 1927-34; Detroit, MI, 1934-40

Constituted in the Organized Reserve 2 July 1923, assigned to the Communications Zone, and allotted to the First Corps Area. Initiated in December 1924 with headquarters at Portland, ME. Withdrawn from the First Corps Area 11 January 1927 and allotted to the Fourth Corps Area. Inactivated 7 February 1927 at Portland by relief of personnel. Sumter, SC, designated as headquarters on organization, but the unit was never organized at that location. Redesignated 7 May 1930 as the 691st Engineer Battalion (Separate). Withdrawn from the Fourth Corps Area 1 October 1933, allotted to the Sixth Corps Area, and concurrently assigned to the XVI Corps. Reorganized by June 1934 at Detroit, MI. Disbanded 1 July 1940.

692nd Engineer Battalion (Auxiliary) (Communications Zone)**Organized Reserve Massachusetts****HQ-Not initiated** 1923-40

Constituted in the Organized Reserve 2 July 1923, assigned to the Communications Zone, and allotted to the Second Corps Area. Redesignated 7 May 1930 as the 692nd Engineer Battalion (Separate). Withdrawn from the Second Corps Area 1 October 1933, allotted to the First Corps Area, and assigned to the XI Corps. Disbanded 1 July 1940.

693rd Engineer Battalion (Auxiliary) (Communications Zone)**Organized Reserve Virginia****HQ-Not initiated** 1923-25; Big Stone Gap, VA, 1925-40

Constituted in the Organized Reserve 2 July 1923, assigned to the Communications Zone, and allotted to the Third Corps Area. Initiated in March 1925 with headquarters at Big Stone Gap, VA. Redesignated 7 May 1930 as the 693rd Engineer Battalion (C) (Separate). Disbanded 1 July 1940.

694th Engineer Battalion (Auxiliary) (Communications Zone)**Organized Reserve Alabama/Mississippi****HQ-Not initiated** 1923-24; Florence, AL, 1924-25; Jackson, MS, 1925-40

Constituted in the Organized Reserve 2 July 1923, assigned to the Communications Zone, and allotted to the Fourth Corps Area. Initiated 30 April 1924 with headquarters at Florence, AL. Battalion relocated in 1925 to Jackson, MS. Redesignated 7 May 1930 as the 694th Engineer Battalion (Separate). Conducted summer training with A Company, 7th Engineer Regiment at Fort Benning, GA. Disbanded 1 July 1940.

695th Engineer Battalion (Auxiliary) (Communications Zone)

Organized Reserve Ohio

HQ-Not initiated 1923-25; Cleveland, OH, 1925-30; *Inactive* 1930-33

Constituted in the Organized Reserve 2 July 1923, assigned to the Communications Zone, and allotted to the Fifth Corps Area. Initiated in August 1925 with headquarters at Cleveland, OH. Inactivated by March 1930 at Cleveland by relief of personnel. Redesignated 7 May 1930 as the 695th Engineer Battalion (Separate). Typically conducted Inactive Training Period meetings at the Bulkey Building in Cleveland. Demobilized 1 October 1933.

696th Engineer Battalion (Auxiliary) (Communications Zone)

Organized Reserve Illinois

HQ-Not initiated 1923-25; Chicago, IL, 1925; Highland Park, IL, 1925-30; *Inactive* 1930-41

Constituted in the Organized Reserve 2 July 1923, assigned to the Communications Zone, and allotted to the Sixth Corps Area. Initiated in February 1925 with headquarters at Chicago, IL. Relocated 28 July 1925 to Highland Park, IL. Redesignated 7 May 1930 as the 696th Engineer Battalion (Separate). Inactivated by December 1930 at Highland Park by relief of personnel. Assigned to the XVI Corps 1 October 1933. Location 7 December 1941—Highland Park, IL.

Status: Disbanded 22 December 1942.

697th Engineer Battalion (Auxiliary) (Communications Zone)

**Organized Reserve Kansas/
/Missouri/Nebraska**

HQ-Not initiated 1923-25; Chanute, KS, 1925-26; Macon, MO, 1926-31; Omaha, NE, 1931-33

Constituted in the Organized Reserve 2 July 1923, assigned to the Communications Zone, and allotted to the Sixth Corps Area. Initiated in January 1925 with headquarters at Chanute, KS. Relocated 26 May 1926 to Macon, MO. Redesignated 7 May 1930 as the 697th Engineer Battalion (Separate). Relocated 12 October 1931 to Omaha, NE. Demobilized 1 October 1933.

698th Engineer Battalion (Auxiliary) (Communications Zone)

**Organized Reserve North Carolina/
Illinois/Michigan**

HQ-Not initiated 1923-26; Eighth Corps Area 1926-27; *Inactive* 1927-29; Wilson, NC, 1929-33; *Inactive* 1933-40

Constituted in the Organized Reserve 2 July 1923, assigned to the Communications Zone, and allotted to the Eighth Corps Area. Initiated 6 June 1926 with headquarters in the Eighth Corps Area. Withdrawn from the Eighth Corps Area 11 January 1927 and allotted to the Fourth Corps Area as a “Colored” unit. Inactivated 31 January 1927 by relief of personnel. Reorganized by 1929 at Wilson, NC. Redesignated 7 May 1930 as the 698th Engineer Battalion (Separate). Withdrawn from the Fourth Corps Area 1 October 1933 and allotted to the Sixth Corps Area. Evanston, IL, designated as headquarters on organization, but the unit was never organized at that location. Designated headquarters location changed 28 July 1937 to Detroit, MI. Location 7 December 1941—*Inactive*.

Status: Disbanded 22 December 1942.

699th Engineer Battalion (Auxiliary) (Communications Zone)

Organized Reserve California

HQ-Not initiated 1923-26; Oakland, CA, 1926-41

Constituted in the Organized Reserve 2 July 1923, assigned to the Communications Zone, and allotted to the Ninth Corps Area. Initiated in April 1926 with headquarters at Oakland, CA. Redesignated 7 May 1930 as the 699th Engineer Battalion (Separate). Assigned to Fourth Army 1 October 1933. Conducted summer training at Del Monte, CA, or at the Presidio of Monterey, CA. Location 7 December 1941—Oakland, CA.

Status: Disbanded 22 December 1942.

700th Engineer Battalion (Map Reproduction) (GHQR)

Organized Reserve District of Columbia

HQ-Not initiated 1923-29; Washington, DC 1929-30

Constituted in the Organized Reserve 2 July 1923, assigned to the Communications Zone, and allotted to the Ninth Corps Area. Initiated 22 October 1929 with headquarters at Washington, DC with personnel from the 717th, 718th, and 719th Map Reproduction Companies. Withdrawn from the Third Corps Area 5 August 1930 and demobilized.

Commanders, 700th Engineer Battalion

Maj. Edward A. Keyes 22 Oct 29-5 Aug 30

720th Engineer Battalion (Auxiliary). See 420th Engineer Battalion (Auxiliary) (C).

720th Engineer Battalion (Railway Operating). See 507th Engineer Battalion (Railway Operating).

721st Engineer Battalion (Auxiliary). See 421st Engineer Battalion (Auxiliary) (C).

721st Engineer Battalion (Railway Operating). See 489th Engineer Battalion (Railway Operating).

722nd Engineer Battalion (Auxiliary). See 422nd Engineer Battalion (Auxiliary) (C).

722nd Engineer Battalion (Railway Operating). See 595th Engineer Battalion (Railway Operating).

723rd Engineer Battalion (Auxiliary). See 423rd Engineer Battalion (Auxiliary) (C).

723rd Engineer Battalion (Railway Operating). See 614th Engineer Battalion (Railway Operating).

724th Engineer Battalion (Auxiliary). See 424th Engineer Battalion (Auxiliary) (C).

724th Engineer Battalion (Railway Operating). See 493rd Engineer Battalion (Railway Operating).

725th Engineer Battalion (Auxiliary). See 425th Engineer Battalion (Auxiliary) (C).

725th Engineer Battalion (Railway Operating). See 508th Engineer Battalion (Railway Operating).

726th Engineer Battalion (Railway Operating). See 615th Engineer Battalion (Railway Operating).

727th Engineer Battalion (Railway Operating). See 594th Engineer Battalion (Railway Operating).

728th Engineer Battalion (Railway Operating). See 597th Engineer Battalion (Railway Operating).

729th Engineer Battalion (Railway Operating). See 591st Engineer Battalion (Railway Operating).

730th Engineer Battalion (Railway Operating). See 492nd Engineer Battalion (Railway Operating).

731st Engineer Battalion (Railway Operating). See 619th Engineer Battalion (Railway Operating).

732nd Engineer Battalion (Railway Operating). See 617th Engineer Battalion (Railway Operating).

733rd Engineer Battalion (Railway Operating). See 496th Engineer Battalion (Railway Operating).

734th Engineer Battalion (Railway Operating). See 607th Engineer Battalion (Railway Operating).

735th Engineer Battalion (Railway Operating). See 491st Engineer Battalion (Railway Operating).

736th Engineer Battalion (Railway Operating). See 490th Engineer Battalion (Railway Operating).

737th Engineer Battalion (Railway Operating). See 598th Engineer Battalion (Railway Operating).

738th Engineer Battalion (Railway Operating). See 506th Engineer Battalion (Railway Operating).

739th Engineer Battalion (Railway Operating). See 553rd Engineer Battalion (Railway Operating).

740th Engineer Battalion (Auxiliary). See 440th Engineer Battalion (Auxiliary) (C).

740th Engineer Battalion (Railway Operating). See 568th Engineer Battalion (Railway Operating).

741st Engineer Battalion (Auxiliary). See 441st Engineer Battalion (Auxiliary) (C).

741st Engineer Battalion (Railway Operating). See 593rd Engineer Battalion (Railway Operating).

742nd Engineer Battalion (Auxiliary). See 442nd Engineer Battalion (Auxiliary) (C).

742nd Engineer Battalion (Railway Operating). See 599th Engineer Battalion (Railway Operating).

743rd Engineer Battalion (Auxiliary). See 443rd Engineer Battalion (Auxiliary) (C).

743rd Engineer Battalion (Railway Operating). See 505th Engineer Battalion (Railway Operating).

744th Engineer Battalion (Railway Operating). See 609th Engineer Battalion (Railway Operating).

745th Engineer Battalion (Railway Operating). See 596th Engineer Battalion (Railway Operating).

746th Engineer Battalion (Railway Operating). See 606th Engineer Battalion (Railway Operating).

747th Engineer Battalion (Railway Operating). See 608th Engineer Battalion (Railway Operating).

748th Engineer Battalion (Auxiliary). See 448th Engineer Battalion (Auxiliary) (C).

748th Engineer Battalion (Railway Operating). See 613th Engineer Battalion (Railway Operating).

749th Engineer Battalion (Auxiliary). See 449th Engineer Battalion (Auxiliary) (C).

749th Engineer Battalion (Railway Operating). See 612th Engineer Battalion (Railway Operating).

750th Engineer Battalion (Auxiliary). See 450th Engineer Battalion (Auxiliary) (C).

750th Engineer Battalion (Railway Operating). See 611th Engineer Battalion (Railway Operating).

751st Engineer Battalion (Auxiliary). See 451st Engineer Battalion (Auxiliary) (C).

751st Engineer Battalion (Railway Operating). See 616th Engineer Battalion (Railway Operating).

752nd Engineer Battalion (Auxiliary). See 452nd Engineer Battalion (Auxiliary) (C).

752nd Engineer Battalion (Railway Operating). See 592nd Engineer Battalion (Railway Operating).

753rd Engineer Battalion (Auxiliary). See 453rd Engineer Battalion (Auxiliary) (C).

753rd Engineer Battalion (Railway Operating). See 609th Engineer Battalion (Railway Operating).

754th Engineer Battalion (Auxiliary). See 454th Engineer Battalion (Auxiliary) (C).

754th Engineer Battalion (Railway Shop). See 661st Engineer Battalion (Railway Shop).

755th Engineer Battalion (Auxiliary). See 455th Engineer Battalion (Auxiliary) (C).

755th Engineer Battalion (Railway Shop). See 662nd Engineer Battalion (Railway Shop).

756th Engineer Battalion (Auxiliary). See 456th Engineer Battalion (Auxiliary) (C).

756th Engineer Battalion (Railway Shop). See 663rd Engineer Battalion (Railway Shop).

757th Engineer Battalion (Auxiliary). See 457th Engineer Battalion (Auxiliary) (C).

757th Engineer Battalion (Railway Shop). See 664th Engineer Battalion (Railway Shop).

758th Engineer Battalion (Auxiliary). See 458th Engineer Battalion (Auxiliary) (C).

758th Engineer Battalion (Railway Shop). See 665th Engineer Battalion (Railway Shop).

795th Engineer Battalion (Auxiliary). See 495th Engineer Battalion (Auxiliary) (C).

796th Engineer Battalion (Auxiliary). See 498th Engineer Battalion (Auxiliary) (C).

797th Engineer Battalion (Auxiliary). See 497th Engineer Battalion (Auxiliary) (C).

798th Engineer Battalion (Auxiliary). See 498th Engineer Battalion (Auxiliary) (C).

799th Engineer Battalion (Auxiliary). See 499th Engineer Battalion (Auxiliary) (C).

800th Engineer Battalion (Auxiliary). See 500th Engineer Battalion (Auxiliary) (C).

801st Engineer Battalion (Auxiliary). See 501st Engineer Battalion (Auxiliary) (C).

824th Engineer Battalion (Auxiliary). See 524th Engineer Battalion (Auxiliary) (C).

825th Engineer Battalion (Auxiliary). See 525th Engineer Battalion (Auxiliary) (C).

826th Engineer Battalion (Auxiliary). See 526th Engineer Battalion (Auxiliary) (C).

827th Engineer Battalion (Auxiliary). See 527th Engineer Battalion (Auxiliary) (C).

828th Engineer Battalion (Auxiliary). See 528th Engineer Battalion (Auxiliary) (C).

829th Engineer Battalion (Auxiliary). See 529th Engineer Battalion (Auxiliary) (C).

830th Engineer Battalion (Auxiliary). See 530th Engineer Battalion (Auxiliary) (C).

856th Engineer Battalion (Auxiliary). See 556th Engineer Battalion (Auxiliary) (C).

857th Engineer Battalion (Auxiliary). See 557th Engineer Battalion (Auxiliary) (C).

858th Engineer Battalion (Auxiliary). See 558th Engineer Battalion (Auxiliary) (C).

859th Engineer Battalion (Auxiliary). See 559th Engineer Battalion (Auxiliary) (C).

860th Engineer Battalion (Auxiliary). See 560th Engineer Battalion (Auxiliary) (C).

950th Engineer Battalion (Heavy Ponton) (GHQR)

Organized Reserve Massachusetts/Illinois

HQ-Not initiated 1928-29; Boston, MA, 1929-36; *Inactive* 1936-37; Chicago, IL, 1937-41

Constituted in the Organized Reserve 5 September 1928, assigned to the General Headquarters Reserve, and allotted to the First Corps Area. Initiated 8 April 1929 with headquarters at Boston, MA. Withdrawn from the First Corps Area 5 June 1936 and allotted to the Sixth Corps Area. Reorganized in July 1937 with headquarters at Chicago, IL. Location 7 December 1941—Chicago, IL.

Status: Disbanded 22 December 1942.

951st Engineer Battalion (Heavy Ponton) (GHQR)

Organized Reserve New York/New Jersey

HQ-Not initiated 1928-29; Bronx, NY, 1929-37; Trenton, NJ 1937-41

Constituted in the Organized Reserve 5 September 1928, assigned to the General Headquarters Reserve, and allotted to the Second Corps Area. Initiated 2 July 1929 with headquarters at Bronx, NY. Relocated by January 1937 to Trenton, NJ. Conducted summer training with the 1st Engineer Regiment at Fort Du Pont, DE. Mobilization station was Camp Smith, NY. Location 7 December 1941—Trenton, NJ.

Status: Disbanded 22 December 1942.

952nd Engineer Battalion (Heavy Ponton) (GHQR)

Organized Reserve New York

HQ-Not initiated 1928-29; Manhattan, NY, 1929-37; Buffalo, NY, 1937-41

Constituted in the Organized Reserve 5 September 1928, assigned to the General Headquarters Reserve, and allotted to the Second Corps Area. Initiated 2 July 1929 with headquarters at Manhattan, NY. Inactivated 11 February 1937 at Manhattan by relief of personnel. Reorganized 5 April 1937 at Buffalo, NY. Conducted summer training with the 1st Engineer Regiment at Fort Du Pont, DE. Designated mobilization station was Camp Smith, NY. Location 7 December 1941—Buffalo, NY.

Status: Disbanded 22 December 1942.

953rd Engineer Battalion (Heavy Ponton) (GHQR)

Organized Reserve New Jersey

HQ-Not initiated 1928-29; Hoboken, NJ 1929-33

Constituted in the Organized Reserve 5 September 1928, assigned to the General Headquarters Reserve, and allotted to the Second Corps Area. Initiated 2 July 1929 with headquarters at Hoboken, NJ. Demobilized 1 October 1933.

954th Engineer Battalion (Heavy Ponton) (GHQR)

Organized Reserve Pennsylvania

HQ—*Not initiated* 1928-29; Philadelphia, PA, 1929-33

Constituted in the Organized Reserve 5 September 1928, assigned to the General Headquarters Reserve, and allotted to the Third Corps Area. Initiated 19 September 1929 with headquarters at Philadelphia, PA. Typically conducted Inactive Training Period meetings at the Society of American Military Engineers building in Philadelphia. Demobilized 1 October 1933. Personnel transferred 18 December 1933 to the 411th Engineer Battalion.

955th Engineer Battalion (Heavy Ponton) (GHQR)

Organized Reserve Pennsylvania

HQ—*Not initiated* 1928-30; Pittsburgh, PA, 1930-37; *Inactive* 1937-41

Constituted in the Organized Reserve 5 September 1928, assigned to the General Headquarters Reserve, and allotted to the Third Corps Area. Initiated 10 September 1930 with headquarters at Pittsburgh, PA. Typically conducted Inactive Training Period meetings at the 176th Field Artillery armory in Pittsburgh. Conducted summer training with the 5th Engineer Regiment at Fort Belvoir, VA. Inactivated 1 October 1937 at Pittsburgh by relief of personnel. Location 7 December 1941—*Inactive*.

Status: Disbanded 22 December 1942.

956th Engineer Battalion (Heavy Ponton) (GHQR)

Organized Reserve Virginia

HQ—*Not initiated* 1928-29; Richmond, VA, 1929-32; Lynchburg, VA, 1932-33

Constituted in the Organized Reserve 5 September 1928, assigned to the General Headquarters Reserve, and allotted to the Third Corps Area. Initiated in December 1929 with headquarters at Richmond, VA. Relocated 5 December 1932 to Lynchburg, VA. Demobilized 1 October 1933. Personnel transferred 29 December 1933 to the 412th Engineer Battalion.

957th Engineer Battalion (Heavy Ponton) (GHQR)

Organized Reserve Tennessee

HQ—*Not initiated* 1928-29; Johnson City, TN, 1929-41

Constituted in the Organized Reserve 5 September 1928, assigned to the General Headquarters Reserve, and allotted to the Fourth Corps Area. Initiated 1 October 1929 with headquarters at Johnson City, TN. Conducted summer training at Fort Benning, GA. Location 7 December 1941—Johnson City, TN.

Status: Disbanded 22 December 1942.

958th Engineer Battalion (Heavy Ponton) (GHQR)

Organized Reserve Tennessee

HQ—*Not initiated* 1928-29; Pulaski, TN, 1929-34; Chattanooga, TN, 1934-41

Constituted in the Organized Reserve 5 September 1928, assigned to the General Headquarters Reserve, and allotted to the Fourth Corps Area. Initiated 1 October 1929 with headquarters at Pulaski, TN. Withdrawn from the Organized Reserve 1 October 1933 and allotted to the Regular Army. Relocated 6 December 1934 to Chattanooga, TN. Conducted summer training at Fort Benning, GA. Redesignated as the 85th Engineer Battalion (Heavy Ponton) 13 January 1941 and activated at Fort Belvoir, VA, 10 June 1941. Location 7 December 1941—Fort Belvoir, VA.

Status: Inactive in the Regular Army as the 85th Engineer Battalion.

959th Engineer Battalion (Heavy Ponton) (GHQR)

Organized Reserve Florida

HQ-Not initiated 1928-29; Tallahassee, FL, 1929-33

Constituted in the Organized Reserve 5 September 1928, assigned to the General Headquarters Reserve, and allotted to the Fourth Corps Area. Initiated 22 October 1929 with headquarters at Tallahassee, FL. Demobilized 1 October 1933.

960th Engineer Battalion (Heavy Ponton) (GHQR)

Organized Reserve Kentucky

HQ-Not initiated 1928-31; Covington, KY, 1931-33

Constituted in the Organized Reserve 5 September 1928, assigned to the General Headquarters Reserve, and allotted to the Fifth Corps Area. Initiated 9 July 1931 with headquarters at Covington, KY. Demobilized 1 October 1933.

961st Engineer Battalion (Heavy Ponton) (GHQR)

Organized Reserve Ohio

HQ-Not initiated 1928-31; Toledo, OH, 1931-33

Constituted in the Organized Reserve 5 September 1928, assigned to the General Headquarters Reserve, and allotted to the Fifth Corps Area. Initiated 9 July 1931 with headquarters at Toledo, OH. Demobilized 1 October 1933.

962nd Engineer Battalion (Heavy Ponton) (GHQR)

Organized Reserve Ohio

HQ-Not initiated 1928-31; Cincinnati, OH, 1931-33

Constituted in the Organized Reserve 5 September 1928, assigned to the General Headquarters Reserve, and allotted to the Fifth Corps Area. Initiated 9 July 1931 with headquarters at Cincinnati, OH. Demobilized 1 October 1933.

963rd Engineer Battalion (Heavy Ponton) (GHQR)

Organized Reserve Ohio

HQ-Not initiated 1928-31; Cincinnati, OH, 1931-33

Constituted in the Organized Reserve 5 September 1928, assigned to the General Headquarters Reserve, and allotted to the Fifth Corps Area. Initiated 9 July 1931 with headquarters at Cincinnati, OH. Demobilized 1 October 1933.

964th Engineer Battalion (Heavy Ponton) (GHQR)

Organized Reserve

HQ-Not initiated 1928-33

Constituted in the Organized Reserve 5 September 1928, assigned to the General Headquarters Reserve, and allotted to the Fifth Corps Area. Demobilized 1 October 1933.

965th Engineer Battalion (Heavy Ponton) (GHQR)

Organized Reserve Wisconsin

HQ-Not initiated 1928-30; Wausau, WI 1930-33

Constituted in the Organized Reserve 5 September 1928, assigned to the General Headquarters Reserve, and allotted to the Sixth Corps Area. Initiated 6 December 1930 with headquarters at Wausau, WI. Demobilized 1 October 1933.

966th Engineer Battalion (Heavy Ponton) (GHQR)

Organized Reserve District of Columbia

HQ-Not initiated 1928-31; Washington, DC 1931-33

Constituted in the Organized Reserve 5 September 1928, assigned to the General Headquarters Reserve, and allotted to the Seventh Corps Area. Withdrawn from the Seventh Corps Area 5 August 1930 and allotted to the Third Corps Area. Initiated 16 January 1931 with headquarters at Washington, DC. Demobilized 1 October 1933.

967th Engineer Battalion (Heavy Ponton) (GHQR)

Organized Reserve Kansas

HQ-Not initiated 1928-31; Kansas City, KS, 1931-33

Constituted in the Organized Reserve 5 September 1928, assigned to the General Headquarters Reserve, and allotted to the Seventh Corps Area. Initiated 12 October 1931 with headquarters at Kansas City, KS. Demobilized 1 October 1933.

968th Engineer Battalion (Heavy Ponton) (GHQR)

Organized Reserve Minnesota

HQ-Not initiated 1928-31; St. Paul, MN, 1931-33

Constituted in the Organized Reserve 5 September 1928, assigned to the General Headquarters Reserve, and allotted to the Seventh Corps Area. Initiated 12 October 1931 with headquarters at St. Paul, MN. Demobilized 1 October 1933.

969th Engineer Battalion (Heavy Ponton) (GHQR)

Organized Reserve Missouri

HQ-Not initiated 1928-31; Kansas City, MO, 1931-33

Constituted in the Organized Reserve 5 September 1928, assigned to the General Headquarters Reserve, and allotted to the Seventh Corps Area. Initiated 12 October 1931 with headquarters at Kansas City, MO. Demobilized 1 October 1933.

970th Engineer Battalion (Heavy Ponton) (GHQR)

Organized Reserve North Dakota

HQ-Not initiated 1928-31; Devil's Lake, ND, 1931-33

Constituted in the Organized Reserve 5 September 1928, assigned to the General Headquarters Reserve, and allotted to the Seventh Corps Area. Initiated 12 October 1931 with headquarters at Devil's Lake, ND. Demobilized 1 October 1933.

971st Engineer Battalion (Heavy Ponton) (GHQR)

Organized Reserve California

HQ-Not initiated 1928-29; Los Angeles, CA, 1929-41

Constituted in the Organized Reserve 5 September 1928, assigned to the General Headquarters Reserve, and allotted to the Ninth Corps Area. Initiated 12 November 1929 with headquarters at Los Angeles, CA. Conducted summer training at Del Monte, CA, or at the Presidio of Monterey, CA. Location 7 December 1941—Los Angeles, CA.

Status: Disbanded 22 December 1942.

972nd Engineer Battalion (Heavy Ponton) (GHQR)

Organized Reserve California

HQ-*Not initiated* 1928-29; San Francisco, CA, 1929-41

Constituted in the Organized Reserve 5 September 1928, assigned to the General Headquarters Reserve, and allotted to the Ninth Corps Area. Initiated 12 November 1929 with headquarters at San Francisco, CA. Location 7 December 1941—San Francisco, CA.

Status: Disbanded 22 December 1942.

973rd Engineer Battalion (Heavy Ponton) (GHQR)

Organized Reserve Oregon

HQ-*Not initiated* 1928-30; Portland, OR, 1930-33

Constituted in the Organized Reserve 5 September 1928, assigned to the General Headquarters Reserve, and allotted to the Ninth Corps Area. Initiated 28 January 1930 with headquarters at Portland, OR. Demobilized 1 October 1933.

Part VIII

Special Troops Organizations

1919-41

Chapter 37

Special Troops



US Army Signal Corps

An unidentified divisional tank company on maneuvers in 1940.

Special Troops headquarters provided command and control for a diverse assortment of units that did not otherwise fit easily into other commands. These headquarters commanded most of these units in the field, but frequently attached them to other commands to support specific operations. The special troops commander typically functioned as the headquarters commandant and provost marshal for the command to which his headquarters was assigned. As such he was responsible for terrain management, traffic control, discipline, and security in the command's rear areas. The special troops headquarters and staff also functioned as the rear command post for the command.

Organization

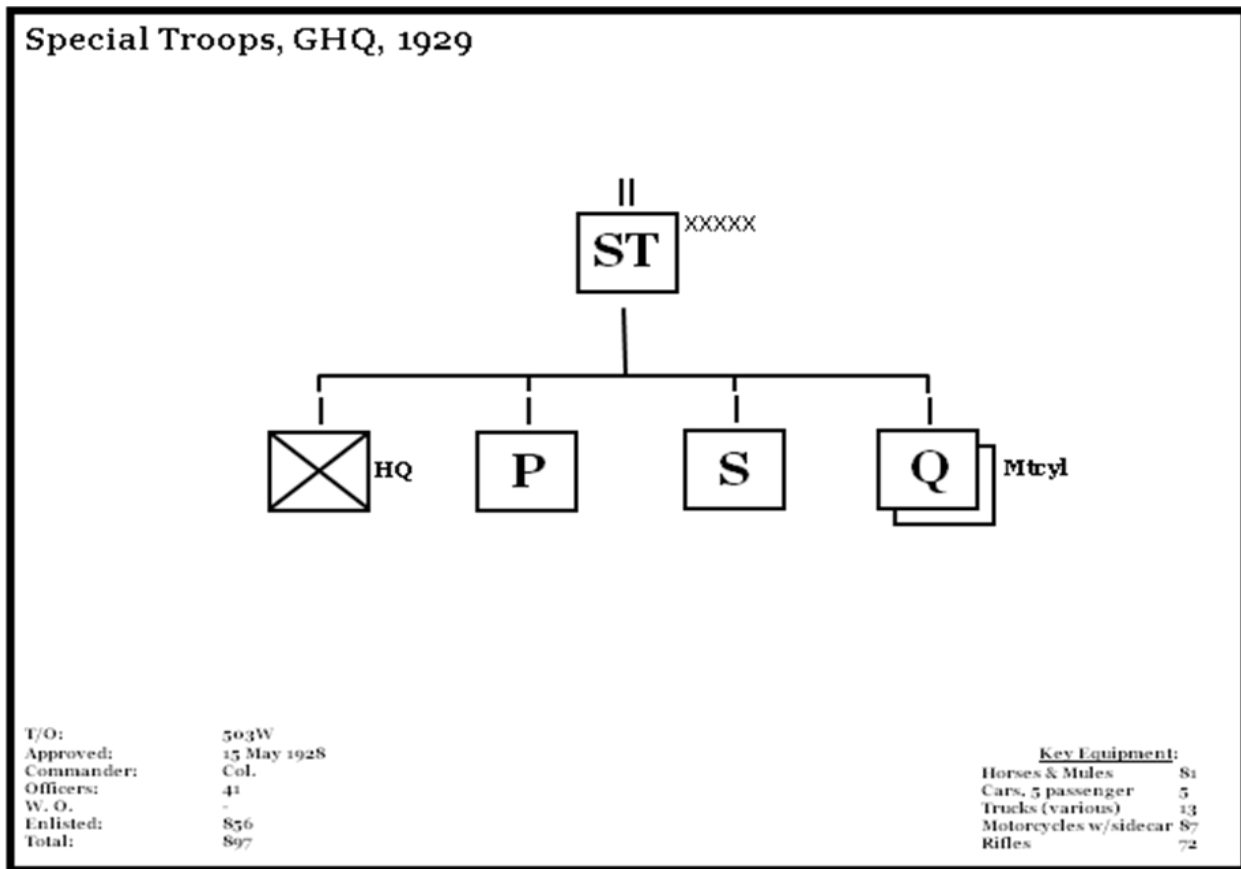

GHQ Special Troops TOE.

As its name implied, the Headquarters, Special Troops, GHQ, was constituted to provide command and control capability for the special troops units assigned or attached to the General Headquarters. This command primarily controlled only those assigned units that supported the day to day operations of the General Headquarters in the theater of operations.

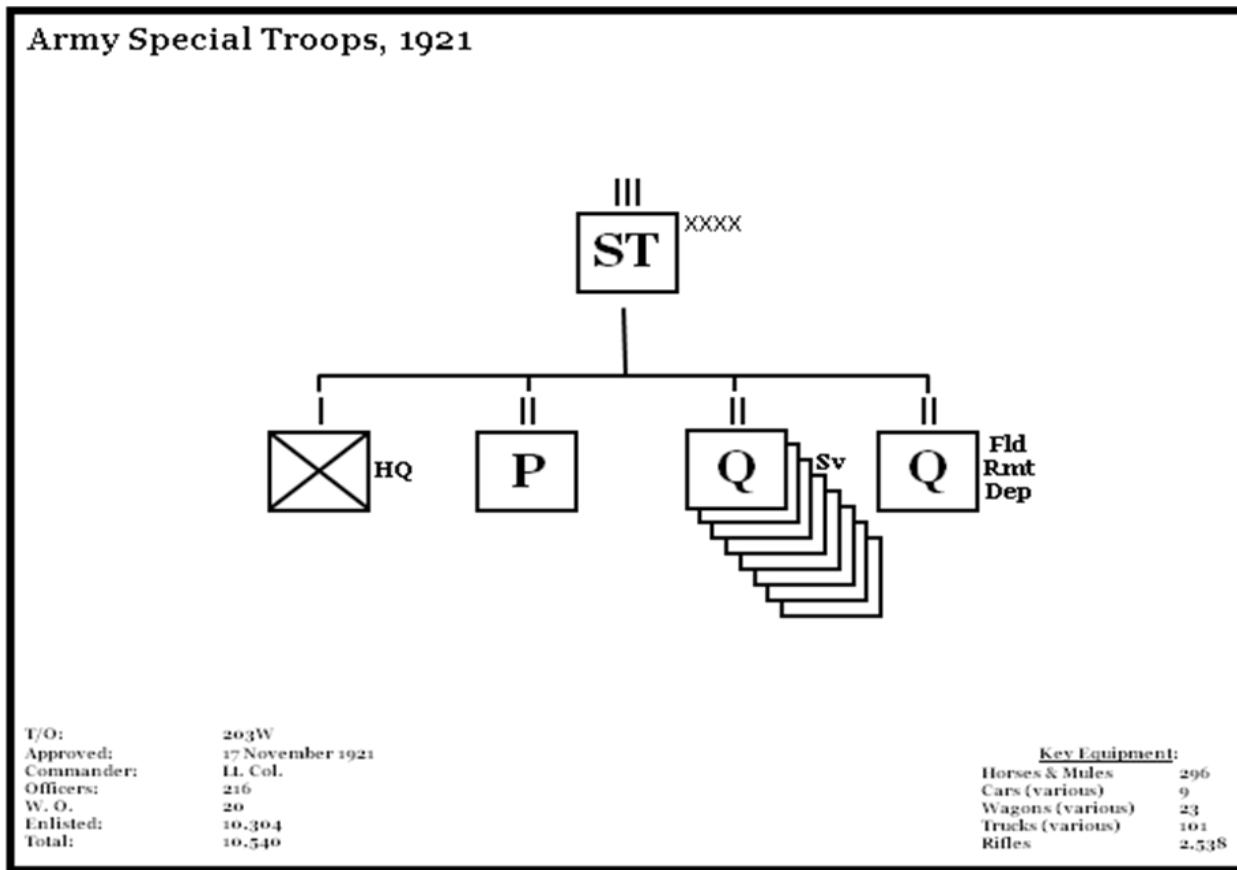

Army Special Troops TOE.

The Special Troops for the field armies as originally constituted in 1921 consisted of the following organizations:

- Headquarters, Special Troops, Army
- Headquarters Company, Army
- 1 Military Police Battalion (Army)
- 8 Service Battalions, Q.M.C.
- 1 Field Remount Depot, Q.M.C. (1,200 head)

With the reorganization of the US Army to the four-army plan in 1933, the eight service battalions were withdrawn from the army special troops and in 1936, reorganized into the army's quartermaster service regiment.

Corps Special Troops, 1921

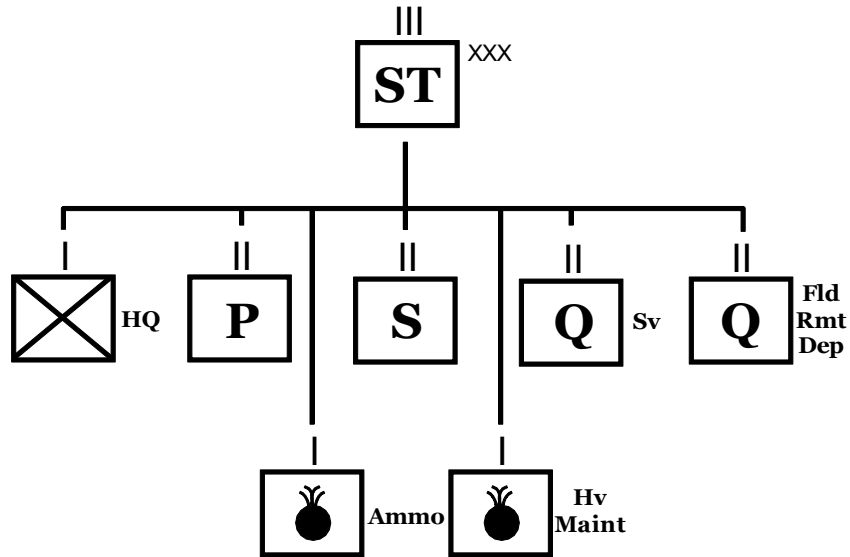

T/O: 103W
 Approved: 17 June 1921
 Commander: Lt. Col.
 Officers: 97
 W. O.: --
 Enlisted: 3,049
 Total: 3,146

Key Equipment:
 Horses & Mules 199
 Cars 2
 Wagons (various) 9
 Trucks (various) 79
 Rifles 1,548

Corps Special Troops TOE.

The Corps Special Troops originally consisted of the following organizations:

- Headquarters, Special Troops, Corps
- Headquarters Company, Corps
- 1 Signal Battalion
- 1 Military Police Battalion (Corps)
- 1 Ordnance Company (Heavy Maintenance)
- 1 Ordnance Company (Ammunition)
- 1 Service Battalion, Q.M.C.
- 1 Field Remount Depot, Q.M.C. (400 head)
- 1 Remount Troop

With the reorganization of quartermaster units in 1936, the service battalion and field remount depot were relieved from the corps special troops.

Division Special Troops, 1921

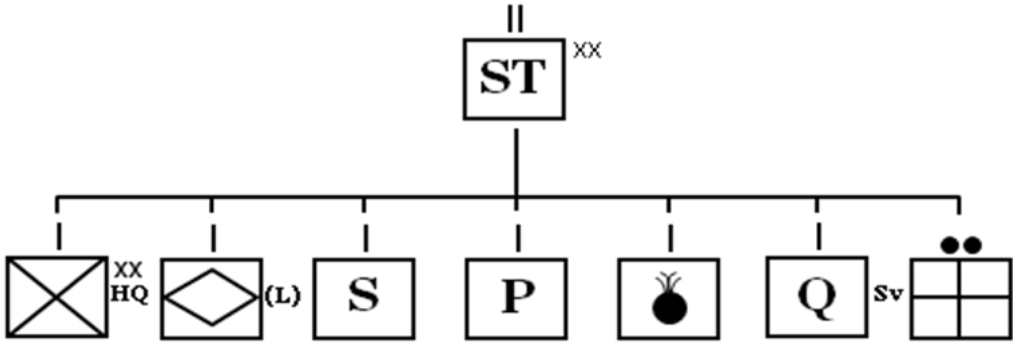

T/O: 3W
 Approved: 4 May 1921
 Commander: Maj. or Lt. Col.
 Officers: 35
 W. O.: 12
 Enlisted: 871
 Total: 918

For personnel and key equipment details see T/O 3w, Infantry Division

Division Special Troops TOE.

In 1921, the special troops for divisions consisted of the following organizations:

Infantry Divisions

- Headquarters, Special Troops, Division
- Headquarters Company, Division
- 1 Tank Company (Light)
- 1 Signal Company
- 1 Military Company
- 1 Ordnance Company (Light Maintenance)
- 1 Service Company, Q.M.C. (attached)
- 1 Motorcycle Company (attached)

Cavalry Divisions

- Headquarters, Special Troops, Cavalry Division
- Headquarters Troop, Cavalry Division
- 1 Signal Troop
- 1 Ordnance Company (Light Maintenance)
- 1 Veterinary Company
- 1 Ambulance Company (attached)

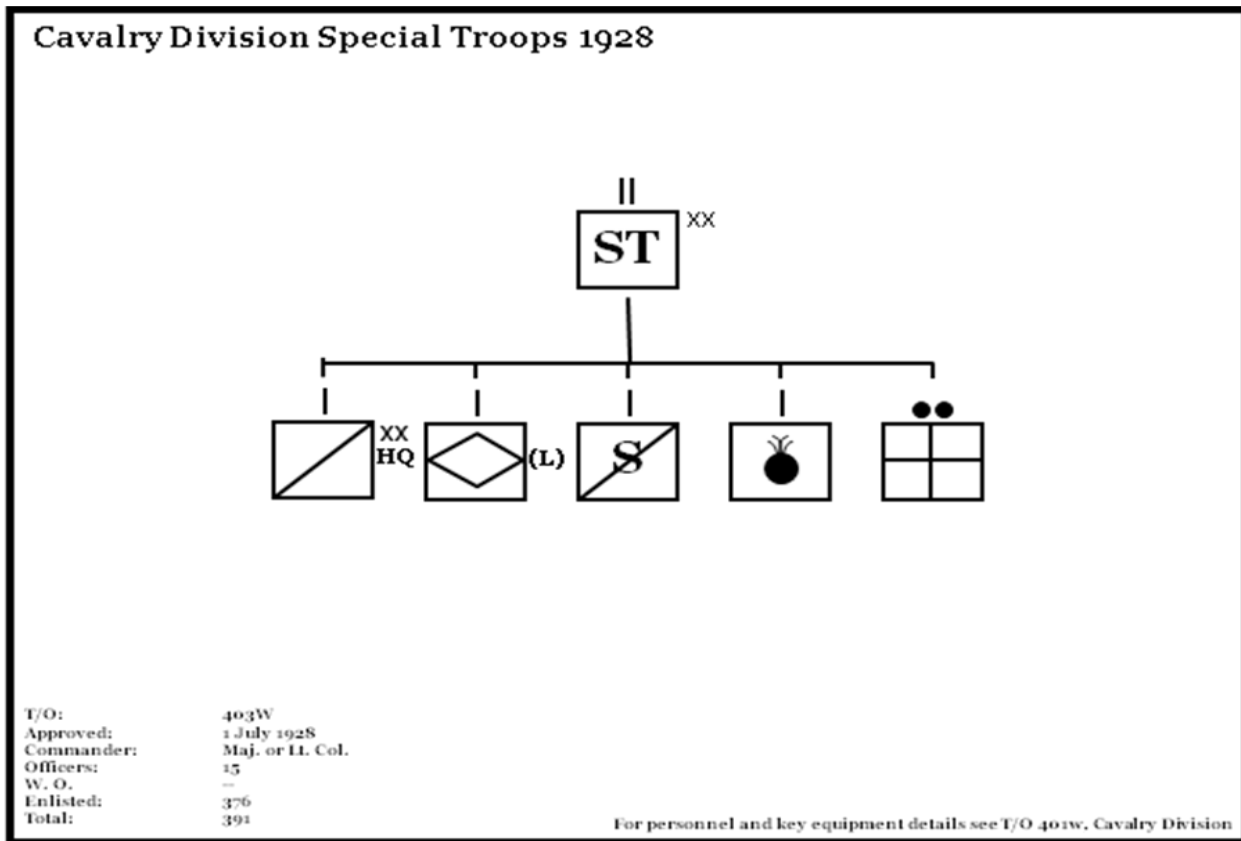

1928 Cavalry Division Special Troops TOE.

Though actually part of the infantry division quartermaster train, motorcycle companies were typically attached to the special troops due to their frequent use for courier duties for the division and brigade headquarters.

The special troops for both types of divisions underwent a number of changes during the interwar period. The first came on 15 August 1927 when a light tank company was added to the special troops for cavalry divisions. Concurrently the tank companies for the Panama Canal and Philippines Divisions were relieved from those divisions and assigned to the 1st and 2nd Cavalry Divisions, respectively.

Originally, the service companies for the National Guard and Organized Reserve infantry divisions were constituted as part of the division quartermaster trains in 1921, but like the motorcycle companies, were typically attached to the special troops. Those for the Regular Army, however, were not constituted until 18 October 1927 for some unknown reason. On 3 June 1932, the service companies were officially assigned to the special troops. These companies were again reassigned to the new division quartermaster regiments in 1936, this time as lettered companies. None of the service companies for the active Regular Army or National Guard divisions were ever organized. Those for the RAI and OR divisions were almost all organized at some point during the interwar period. Virtually all the other special troops units were organized in one of the three components between 1921 and 1940.

The tank companies remained components of the special troops until 1940 when all Regular Army and National Guard infantry division tank companies, less that of the 11th Tank Company assigned to the Hawaiian Division, were relieved from their parent commands and integrated into one of the new separate tank battalions or armored regiments. The cavalry division tank companies were all disbanded. Those companies assigned to the OR divisions remained so assigned until disbanded in 1942 when those divisions were triangularized.

Training

Regular Army special troops units were some of the best trained units of the interwar period, even if they were not the best equipped units. These separate companies were kept busy supporting various training events for other RA, NG, and OR units. The 1st Signal Company for example, supported training at the signal school at Fort Monmouth, for NG and OR signal companies, for the training activities of the 1st Division, and for various corps area and army CPXs in the 1920s and 1930s. The company's training support extended to reserve units from several other corps areas other than its own. The several Regular Army active tank and ordnance companies scattered across the United States performed similar duties for NG and OR divisional and non-divisional tank and ordnance organizations as well. Unfortunately, much of the equipment these units possessed was of World War I vintage up until the late 1930s.

The training experiences of National Guard special troops units were typical of those for other Guard units: weekend or week night drills during the inactive training period followed by a two-week camp in the summer. In a few instances some tank companies conducted training some years with Regular Army tank companies away from the division camp due to the lack of actual tanks at their home station or division training areas. Similarly, some ordnance companies did the same. Most special troops units, however, performed their summer training at the same time as the bulk of their parent divisions. In the case of multi-state special troops commands, the separate companies usually attended training with its state's other NG units.

Training for the special troops of OR divisions was uneven at best. For those instances where the command's units were concentrated in a single city, the special troops often organized some level of unit training during the inactive training period. Frequently, the personnel from the special troops would attend training sessions set up for their specific branch. In cases where the special troops were spread out over the division area, the units did no unit training during the inactive training period. These personnel usually attended training with other units, or troop schools for specialized or branch training conducted at, or near, their home location. During summer training, most companies, less the tank companies, usually attended branch training conducted at a Regular Army installation specifically set up for reserve personnel. In some instances they conducted training with Regular Army or National Guard special troops units. Tank companies almost always conducted summer training with Regular Army or National Guard tank units.

Headquarters, Special Troops, General Headquarters**Regular Army Inactive****HQ**-*Not organized* 1927-29; Baltimore, MD, 1929-41; Washington, DC, 1941**Subordinate elements**-Headquarters Company, G.H.Q. 1941; 13th Military Police Company (RAI) 1927-41; 13th Signal Company (RAI) 1927-41; *13th Motorcycle Company* 1927-36; *69th Motor Transport Company* 1927-36; *72nd Motor Transport Company* 1927-36; *7th General Dispensary* 1930-41; *7th Meteorological Company* 1927-41; *72nd Quartermaster Battalion (Car)* 1936-40

Constituted in the Regular Army 28 February 1927 as Headquarters, Special Troops, General Headquarters and allotted to the Adjutant General for mobilization responsibility. Allotted to the Third Corps Area 15 August 1927. Headquarters organized by May 1929 with Organized Reserve personnel as a RAI unit at Baltimore, MD. Mission was to provide command and control for special troops assigned to support operations of the U. S. Army General Headquarters. Personnel attended summer training as individuals in 1929 at Fort Hancock, NJ. Headquarters, Special Troops activated 1 July 1941, less Organized Reserve personnel, at the Army War College, Washington, DC. Location 7 December 1941—Washington, DC.

Status: Disbanded 12 February 1946.**Commanders, Special Troops, General Headquarters**

Unknown	May 29-1 Dec 29	Capt. Godfrey N. Wyke**	2 Dec 29-ao Jun 34
	Unknown	ao Jul 34-7 Dec 41	

** RAI Commanders: Organized Reserve officers.

Headquarters, Special Troops, Hawaiian Department**HQ**-Fort Shafter, TH, 1933-41**Subordinate elements**-Headquarters Detachment, Hawaiian Department 1933-41; 9th Signal Service Company 1933-41; Hawaiian Department Military Police Company 1933-41; A Company, 1st Chemical Battalion 1933-41

Organized in the Regular Army 1 August 1933 at Fort Shafter, TH, and allotted to the Hawaiian Department. Provided administration, command, and control of various non-divisional ground units assigned to the Hawaiian Department. Location 7 December 1941—Fort Shafter, TH.

Commanders, Special Troops, Hawaiian Department

Lt. Col. Henry W. T. Eglin	1 Aug 33-1 Jun 34	Col. Edgar S. Miller	8 Jul 36-15 Aug 37
Col. George H. Paine	1 Jun 34-18 Apr 36	Col. John P. Smith	15 Aug 37-20 Sep 39
Col. William B. Wallace	18 Apr 36-5 Jun 36	Lt. Col. Charles H. Corlett	20 Sep 39-Jul 40
Col. George H. Paine	5 Jun 36-8 Jul 36	Unknown	Jul 40-7 Dec 41

Headquarters, Special Troops, First Army (I)**Organized Reserve New York****HQ**-*Not initiated* 1921-23; Manhattan, NY, 1921-27**Subordinate elements**-Headquarters Company, First Army; 324th Military Police Battalion 1921-27; *116th Service Battalion, Q.M.C.* 1921-23; 375th-381st Service Battalions, Q.M.C. 1921-27; Field Remount Depot No. 39 1921-25; *First Army Field Remount Depot* 1925-27

Constituted in the Organized Reserve 15 October 1921 as Headquarters, Special Troops, First Army and allotted to the Second Corps Area. Headquarters organized in March 1923 at Manhattan, NY. Withdrawn from the Organized Reserve 15 August 1927 and demobilized.

Commanders, Special Troops, First Army (I)

Unknown	Mar 23-15 Aug 27
---------	------------------

Headquarters, Special Troops, First Army (II)**Regular Army Inactive****HQ**-*Not organized* 1927-32; Philadelphia, PA, 1932-33; *Inactive* 1933-41; Fort Jay, NY, 1941**Subordinate elements**-Headquarters Company, First Army, 324th Military Police Battalion 1927-33; 321st Military Police Battalion 1933-40; 375th-381st Service Battalions, Q.M.C. 1927-36; *Field Remount Depot No. 16* 1921-23; *Field Remount Depot No. 39* 1923-25; *First Army Remount Depot* 1925-27*1st Field Remount Depot (Army)* 1927-28; *First Army Remount Depot* 1928-36

Constituted in the Regular Army 15 August 1927 as Headquarters, Special Troops, Seventh Army. Redesignated 13 October 1927 as Headquarters, Special Troops, First Army and allotted to the Third Corps Area. Headquarters organized by September 1932 with Organized Reserve personnel as a RAI unit at Philadelphia, PA. Withdrawn from the Third Corps Area 1 October 1933 and allotted to the Second Corps Area. Activated 21 May 1941 at Fort Jay, NY. Location 7 December 1941—Fort Jay, NY.

Events: 234, 328, 330**Commanders, Special Troops, First Army (II)**

Unknown

Sep 32-1 Oct 33
Unknown*Inactive*
21 May 41-7 Dec 41

1 Oct 33-21 May 41

Headquarters, Special Troops, Second Army (I)**Organized Reserve Illinois****HQ**-*Not initiated* 1921-22; Chicago, IL, 1922-33**Subordinate elements**-Headquarters Company, Second Army; 325th Military Police Battalion 1921-33; 388th-395th Service Battalions, Q.M.C. 1921-33; 44th Field Remount Depot 1921-25; Second Army Field Remount Depot 1925-27; 2nd Field Remount Depot (Army) 1927-28; 402nd Field Remount Depot 1928-33

Constituted in the Organized Reserve 15 October 1921 as Headquarters, Special Troops, Second Army and allotted to the Sixth Corps Area. Headquarters organized in December 1922 at Chicago, IL. Attached 19 October 1925 to the 65th Cavalry Division for organization, administration, and training. Withdrawn from the Organized Reserve 1 October 1933 and demobilized.

Commanders, Special Troops, Second Army (I)

Unknown

Dec 22-1 Oct 33

Headquarters, Special Troops, Second Army (II)**Regular Army Inactive****HQ**-Chicago, IL, 1933-41; Memphis, TN, 1941**Subordinate elements**-Headquarters Company, Second Army; 325th Military Police Battalion 1933-40; 402nd Field Remount Depot 1933-36

Constituted in the Regular Army 1 October 1933 as Headquarters, Special Troops, Second Army and allotted to the Sixth Corps Area. Headquarters organized 1 October 1933 with Organized Reserve personnel as a RAI unit at Chicago, IL. Activated 15 November 1941, less Organized Reserve personnel, at Memphis, TN. Location 7 December 1941—Memphis, TN.

Commanders, Special Troops, Second Army (II)

Unknown

1 Oct 33-7 Dec 41

Headquarters, Special Troops, Third Army (I)**Organized Reserve Missouri/Nebraska**

HQ-*Not initiated* 1921-22; St. Louis, MO, 1922-24; Omaha, NE, 1924-33

Subordinate elements-Headquarters Company, Third Army; *112th Military Police Battalion* 1921-23; 319th Military Police Battalion 1923-33; 382nd-387th and 396th-397th Service Battalions, Q.M.C. 1921-33; 45th Field Remount Depot 1921-25; Third Army Field Remount Depot 1925-27; 3rd Field Remount Depot (Army) 1927-28; 403rd Field Remount Depot 1928-33.

Constituted in the Organized Reserve 15 October 1921 as Headquarters, Special Troops, Third Army and allotted to the Seventh Corps Area. Headquarters organized in May 1922 at St. Louis, MO. Headquarters relocated 25 February 1924 to Omaha, NE. Personnel attended summer training as individuals in 1929 at Fort Crook, NE. Withdrawn from the Organized Reserve 1 October 1933, allotted to the Regular Army, and redesignated Headquarters, Special Troops, Fourth Army.

Commanders, Special Troops, Third Army (I)

2nd Lt. Charles H. Hilmer
Capt. LeRoy S. Ward

May 22-12 Sep 22
13 Sep 22-16 Dec 22

Maj. Louis A. Boaning
Unknown

16 Dec 22-25 Feb 24
26 Feb 24-1 Oct 33

Headquarters, Special Troops, Third Army (II)**Regular Army Inactive**

HQ-*Not organized* 1933-34; San Antonio, TX, 1934-36; *Inactive* 1936-41; Fort Sam Houston, TX, 1941

Subordinate elements-Headquarters Company, Third Army 1933-41; 324th Military Police Battalion (RAI) 1933-41; 403rd Field Remount Depot 1933-36

Constituted in the Regular Army 1 October 1933 as Headquarters, Special Troops, Third Army and allotted to the Eighth Corps Area. Headquarters organized by December 1934 with Organized Reserve personnel as a RAI unit at San Antonio, TX. Withdrawn from the Eighth Corps Area 2 October 1936 and allotted to the Fourth Corps Area. Activated 1 June 1941, less Organized Reserve personnel, at Fort Sam Houston, TX. Location 7 December 1941—Fort Sam Houston, TX.

Commanders, Special Troops, Third Army (II)

Unknown Dec 34-7 Dec 41

Headquarters, Special Troops, Fourth Army (I)**Organized Reserve New York**

HQ-*Not initiated* 1921-22; Manhattan, NY, 1922-33

Subordinate elements-Headquarters Company, Fourth Army; 321st Military Police Battalion 1921-33; 351st-358th Service Battalions, Q.M.C. 1921-33; 41st Field Remount Depot 1921-25; Fourth Army Field Remount Depot 1925-27; 4th Field Remount Depot (Army) 1927-28; 404th Field Remount Depot 1928-33

Constituted in the Organized Reserve 15 October 1921 as Headquarters, Special Troops, Fourth Army and allotted to the Second Corps Area. Headquarters organized in 1922 at Manhattan, NY. Personnel attended summer training as individuals in 1926 at Fort Jay, NY. Withdrawn from the Organized Reserve 1 October 1933 and demobilized.

Commanders, Special Troops, Fourth Army (I)

No commander assigned

ao May 23
Unknown

Capt. William A. Ronalds
5 Sep 28-1 Oct 33

2 Mar 25-5 Sep 28

Headquarters, Special Troops, Fourth Army (II)**Regular Army Inactive**

HQ-*Not initiated* 1921-22; St. Louis, MO, 1922-26; Omaha, NE, 1926-33; *Inactive* 1933-37; Presidio of San Francisco, CA, 1937-38; *Inactive* 1938-41; Presidio of San Francisco, CA, 1941

Subordinate elements-Headquarters Company, Fourth Army; 323rd Military Police Battalion 1933-40; 404th Field Remount Depot 1933-36

Constituted in the Organized Reserve 15 October 1921 as Headquarters, Special Troops, Third Army and allotted to the Seventh Corps Area. Headquarters organized in May 1922 at St. Louis, MO. Headquarters relocated 26 May 1926 to Omaha, NE. Withdrawn from the Organized Reserve 1 October 1933, allotted to the Regular Army, and redesignated Headquarters, Special Troops, Fourth Army. Concurrently withdrawn from the Seventh Corps Area and allotted to the Ninth Corps Area. Headquarters organized 15 December 1937 with Organized Reserve personnel as a RAI unit at the Presidio of San Francisco, CA. Inactivated 6 August 1938 at the Presidio of San Francisco by relief of personnel. Activated 8 November 1941 at the Presidio of San Francisco, CA. Location 7 December 1941—Presidio of San Francisco, CA.

Commanders, Special Troops, Fourth Army (II)

Unknown	15 Dec 37-6 Aug 38 Unknown	<i>Inactive</i> 8 Nov 41-7 Dec 41	6 Aug 38-8 Nov 41
---------	-------------------------------	--------------------------------------	-------------------

Headquarters, Special Troops, Fifth Army**Organized Reserve Ohio**

HQ-*Not initiated* 1921-22; Columbus, OH, 1922-33

Subordinate elements-Headquarters Company, Fifth Army; 322nd Military Police Battalion 1921-33; 359th-366th Service Battalions, Q.M.C. 1921-33; 42nd Field Remount Depot 1921-25; Fifth Army Field Remount Depot 1925-27; 5th Field Remount Depot (Army) 1927-28; 405th Field Remount Depot 1928-33

Constituted in the Organized Reserve 15 October 1921 as Headquarters, Special Troops, Fifth Army and allotted to the Fifth Corps Area. Headquarters organized by December 1922 at Columbus, OH. Demobilized 1 October 1933.

Commanders, Special Troops, Fifth Army

Unknown	Dec 22 -1 Oct 33
---------	------------------

Headquarters, Special Troops, Sixth Army**Organized Reserve Arkansas/Missouri/Minnesota**

HQ-Little Rock, AR, 1922-24; St. Louis, MO, 1924-31; Minneapolis, MN, 1931-33

Subordinate elements-Headquarters Company, Sixth Army; 323rd Military Police Battalion 1921-33; *116th Service Battalion, Q.M.C.* 1921-23; 375th-381st Service Battalions, Q.M.C. 1921-33; 43rd Field Remount Depot 1921-25; Sixth Army Field Remount Depot 1925-27; 6th Field Remount Depot (Army) 1927-28; 406th Field Remount Depot 1928-33

Constituted in the Organized Reserve 15 October 1921 as Headquarters, Special Troops, Sixth Army and allotted to the Seventh Corps Area. Headquarters organized in June 1922 at Little Rock, AR. Headquarters relocated 25 February 1924 to St. Louis, MO. Personnel attended summer training as individuals in 1927 at Fort Leavenworth, KS. Headquarters relocated 12 October 1931 to Minneapolis, MN. Demobilized 1 October 1933.

Commanders, Special Troops, Sixth Army

Unknown	Jun 22-1 Oct 33
---------	-----------------

Headquarters, Special Troops, I Corps (I)**Organized Reserve Massachusetts****HQ**-Boston, MA, 1921-27

Subordinate elements-Headquarters Company, I Corps; *101st Military Police Battalion* 1921-23; 301st Military Police Battalion 1923-27; 51st Signal Battalion 1921-23; 53rd Signal Battalion (RAI) 1927-40; 510th Ordnance Company (HM) 1921-27; 610th Ordnance Company (Ammo) 1921-27; 330th Service Battalion, Q.M.C. 1921-23 & 1925-27; 30th Service Battalion, Q.M.C. 1923-25; Field Remount Depot No. 30 1921-25; I Corps Field Remount Depot 1925-27

Constituted in the Organized Reserve 29 October 1921 as Headquarters, Special Troops, I Corps and allotted to the First Corps Area. Headquarters initiated in November 1921 at Boston, MA. Withdrawn from the Organized Reserve 15 August 1927 and demobilized.

Commanders, Special Troops, I Corps (I)

Lt. Col. George E. Hall

Nov 21-17 Feb 25

Unknown

18 Feb 25-15 Aug 27

Headquarters, Special Troops, I Corps (II)**Regular Army Inactive**

HQ-*Not organized* 1927-32; Philadelphia, PA, 1932-33; *Inactive* 1933-37; First Corps Area 1937-41; Fort Jackson, SC, 1941

Subordinate elements-Headquarters Company, I Corps (RAI); 301st Military Police Battalion (RAI) 1927-40; 51st Signal Battalion 1921-27; 53rd Signal Battalion (RAI) 1927-40; 510th Ordnance Company (HM), 1927-33; 1st Ordnance Company (HM) (RAI) 1933-40; 610th Ordnance Company (Ammo) 1927-40; 330th Service Battalion, Q.M.C. 1927-36; I Corps Field Remount Depot 1927-28; 301st Field Remount Depot 1928-36.

Constituted in the Regular Army 15 August 1927 as Headquarters, Special Troops, XX Corps. Redesignated 13 October 1927 as Headquarters, Special Troops, I Corps and allotted to the Third Corps Area. Headquarters organized by September 1932 with Organized Reserve personnel as a RAI unit at Philadelphia, PA. Withdrawn from the Third Corps Area 1 October 1933 and allotted to the First Corps Area. Organized by May 1937 in the First Corps Area. Activated by September 1941, less Organized Reserve personnel, at Fort Jackson, SC. Location 7 December 1941—Fort Jackson, SC.

Status: Disbanded 26 October 1944.**Commanders, Special Troops, I Corps (II)**Unknown
*Inactive*Sep 32-1 Oct 33
1 Oct 33-ao May 371st Lt. Houston S. Felps
Unknownao May 37-ao Sep 38
ao Sep 38-7 Dec 41**Headquarters, Special Troops, I Cavalry Corps****Regular Army Inactive****HQ**-Des Moines, IA, 1927-40; *Inactive* 1940-41

Subordinate elements-Headquarters Troop, I Cavalry Corps (RAI); 4th Signal Troop (RAI)

Constituted in the Regular Army 15 August 1927 as Headquarters, Special Troops, I Cavalry Corps and allotted to the Seventh Corps Area. Headquarters organized by December 1927 with Organized Reserve personnel as a RAI unit at Des Moines, IA. Subordinate elements organized as follows: Headquarters Troop, I Cavalry Corps by August 1929 at Des Moines, IA; 4th Signal Troop by August 1929 at Omaha, NE. Inactivated about November 1940 at Des Moines by relief of personnel. Location 7 December 1941—*Inactive*.

Status: Disbanded 26 October 1944.**Commanders, Special Troops, I Cavalry Corps**

Unknown

Dec 27-Nov 40

Inactive

Nov 40-1941

Headquarters, Special Troops, II Corps (I)**New York National Guard****HQ**-*Not organized* 1921-27**Subordinate elements**-*Headquarters Company, II Corps*; 310th Military Police Battalion 1921-27; 101st Signal Battalion 1921-27; 511th Ordnance Company (HM) 1921-27; 611th Ordnance Company (Ammo) 1921-27; 331st Service Battalion, Q.M.C. 1921-23 & 1925-27; 31st Service Battalion, Q.M.C. 1923-25; Field Remount Depot No. 31 1921-25; II Corps Field Remount Depot 1925-27

Constituted in the National Guard 30 December 1920 as Headquarters, Special Troops, II Corps and allotted to the State of New York. Governor's Island, NY, designated as headquarters on organization, but the unit was never organized at that location. Withdrawn from the state of New York 6 December 1921. Further withdrawn from the National Guard 15 August 1927 and demobilized.

Headquarters, Special Troops, II Corps (II)**Regular Army Inactive****HQ**-*Not organized* 1927-32; Philadelphia, PA, 1932-33; *Inactive* 1933-41; Fort George G. Meade, MD, 1941**Subordinate elements**-*Headquarters Company, II Corps (RAI)*; 310th Military Police Battalion 1927-33; 302nd Military Police Battalion 1933-40; 101st Signal Battalion 1927-36; 51st Signal Battalion 1936-39; 511th Ordnance Company (HM) 1927-33; 31st Ordnance Company (HM) 1933-40; 611th Ordnance Company (Ammo) 1927-33; 51st Ordnance Company (Ammo) 1933-40; 331st Service Battalion, Q.M.C. 1927-36; II Corps Field Remount Depot 1927-28; 302nd Field Remount Depot 1928-36

Constituted in the Regular Army 15 August 1927 as Headquarters, Special Troops, XXI Corps. Redesignated 13 October 1927 as Headquarters, Special Troops, II Corps and allotted to the Third Corps Area. Headquarters organized by July 1932 with Organized Reserve personnel as a RAI unit at Philadelphia, PA. Withdrawn from the Third Corps Area 1 October 1933 and allotted to the Second Corps Area. Activated in 1941 at Fort George G. Meade, MD. Location 7 December 1941—Fort George G. Meade, MD.

Status: Disbanded 26 October 1944.**Commanders, Special Troops, II Corps (II)**

Unknown

Jul 32-1 Oct 33

Inactive

1 Oct 33-ao Jan 41

Headquarters, Special Troops, III Corps (I)**Organized Reserve Pennsylvania****HQ**-*Not initiated* 1921-22; Lansdale, PA, 1922-27**Subordinate elements**-*Headquarters Company, III Corps*; 102nd Military Police Battalion 1921-23; 312th Military Police Battalion 1923-27; 102nd Signal Battalion 1921-23; 310th Signal Battalion 1923-27; 512th Ordnance Company (HM), 612th Ordnance Company (Ammo), 332nd Service Battalion, Q.M.C. 1921-23 & 1925-27; 32nd Service Battalion, Q.M.C. 1923-25; *Field Remount Depot No. 38* 1921-25; *III Corps Field Remount Depot* 1925-27

Constituted in the Organized Reserve 29 October 1921 as Headquarters, Special Troops, III Corps and allotted to the Third Corps Area. Headquarters initiated 12 April 1922 at Lansdale, PA. Withdrawn from the Organized Reserve 15 August 1927 and demobilized.

Commanders, Special Troops, III Corps (I)

Unknown

12 Apr 22-15 Aug 27

Headquarters, Special Troops, III Corps (II)**Regular Army Inactive****HQ**-Lansdale, PA, 1927-40; *Inactive* 1940-41; Presidio of Monterrey, CA, 1941**Subordinate elements**-Headquarters Company, III Corps (RAI); 303rd Military Police Battalion 1927-40; 52nd Signal Battalion (RAI) 1927-33; 50th Signal Battalion (RAI) 1933-40; 512th Ordnance Company (HM), 612th Ordnance Company (Ammo), 332nd Service Battalion, Q.M.C. 1927-36; *III Corps Field Remount Depot 1927-28*; 303rd Field Remount Depot 1928-36

Constituted in the Regular Army 15 August 1927 as Headquarters, Special Troops, XXII Corps and organized with Reserve personnel of the inactivated Headquarters, Special Troops, III Corps at Lansdale, PA. Redesignated 13 October 1927 as Headquarters, Special Troops, III Corps and allotted to the Third Corps Area. Inactivated 26 July 1940 at Lansdale by relief of personnel. Activated in 1941 at the Presidio of Monterrey, CA. Location 7 December 1941—Presidio of Monterrey, CA.

Status: Disbanded 26 October 1944.**Commanders, Special Troops, III Corps (II)**

Unknown	16 Aug 27-6 Nov 29	Unknown	ao Jun 34-26 Jul 40
Capt. Athol E. Later**	7 Nov 29-ao Jun 34	<i>Inactive</i>	26 Jul 40-ao Jan 41

** RAI Commanders: Organized Reserve officers.

Headquarters, Special Troops, IV Corps**Organized Reserve Georgia****HQ**-*Not initiated* 1921-23; Atlanta, GA, 1923-41; Fort Benning, GA, 1941**Subordinate elements**-Headquarters Company, IV Corps (RAI); *103rd Military Police Battalion 1921-23*; 313th Military Police Battalion 1923-28; 304th Military Police Battalion 1928-40; *103rd Signal Battalion 1921-23*; 304th Signal Battalion 1923-27; 56th Signal Battalion (RAI) 1927-40; 34th Ordnance Company (HM) 1921-40; 51st Ordnance Company (Ammo) 1921-23; 604th Ordnance Company (Ammo) 1923-40; *111th Service Battalion, Q.M.C.*; 1921-23; 24th Service Battalion, Q.M.C. 1923-25; 324th Service Battalion, Q.M.C. 1925-36; Field Remount Depot No. 32 1921-25; IV Corps Field Remount Depot 1925-28; *304th Field Remount Depot 1928-36*

Constituted in the Organized Reserve 29 October 1921 as Headquarters, Special Troops, IV Corps and allotted to the Fourth Corps Area. Headquarters initiated in February 1923 at Atlanta, GA. Withdrawn from the Organized Reserve 1 October 1933 and allotted to the Regular Army. Activated in 1941, less Organized Reserve personnel, at Fort Benning, GA. Location 7 December 1941—Fort Benning, GA.

Status: Disbanded 26 October 1944.**Commanders, Special Troops, IV Corps**

Lt. Col. Franklin S. Chalmers	3 Jan 22-ao Sep 25	Unknown	ao Sep 27-22 Feb 36
Unknown	ao Sep 25-ao Jun 27	Lt. Col. Howard Parrish	22 Feb 36-ao May 40
Maj. Frank Rosenthal	ao Jun 27-ao Sep 27	Unknown	ao May 40-7 Dec 41

Headquarters, Special Troops, V Corps**Indiana National Guard/Organized Reserve Ohio****HQ**-*Not organized* 1921-23; Cincinnati, OH, 1923-31; Columbus, OH, 1931-40; Camp Beauregard, LA, 1941**Subordinate elements**-Headquarters Company, V Corps (RAI); *104th Military Police Battalion 1921-23*; 314th Military Police Battalion 1923-27; 305th Military Police Battalion 1928-40; *104th Signal Battalion 1921-23*; 305th Signal Battalion 1923-27; 57th Signal Battalion (RAI) 1927-40; *131st Ordnance Company (HM) 1921-23*; 505th Ordnance Company (HM) 1923-33; 32nd Ordnance Company (HM) 1933-40; 58th Ordnance Company (Ammo) 1923-33; 37th Ordnance Company (Ammo) 1933-40; *112th Service Battalion, Q.M.C.* 1921-23; 25th Service Battalion, Q.M.C. 1923-25; 325th Service Battalion, Q.M.C. 1925-36; Field Remount Depot No. 33 1921-25; V Corps Field Remount Depot 1925-28; 305th Field Remount Depot 1928-36

Constituted in the National Guard 29 October 1921 as Headquarters, Special Troops, V Corps and allotted to the state of Indiana. Placed on the Deferred List 2 July 1923 and requirement transferred to the Organized Reserve as a Deferred National Guard unit. Headquarters initiated by December 1923 with Organized Reserve personnel at Cincinnati, OH. Withdrawn from the National Guard 22 June 1927 and permanently allotted to the Organized Reserve. Withdrawn from the Organized Reserve 1 October 1933 and allotted to the Regular Army. Activated in 1941, less Organized Reserve personnel, at Camp Beauregard, LA. Location 7 December 1941—Camp Beauregard, LA.

Status: Disbanded 26 October 1944.

Commanders, Special Troops, V Corps

Unknown Dec 23-7 Dec 41

Headquarters, Special Troops, VI Corps

Organized Reserve Illinois

HQ-Not initiated 1921-22; Chicago, IL, 1922-41; Fort Devens, MA, 1941

Subordinate elements-Headquarters Company, VI Corps (RAI); *105th Military Police Battalion* 1921-23; 306th Military Police Battalion 1923-40; 50th Signal Battalion (RAI) 1921-23; 306th Signal Battalion 1923-27; 58th Signal Battalion (RAI) 1927-40; 33rd Ordnance Company (HM) 1921-40; 613th Ordnance Company (Ammo) 1921-33; 38th Ordnance Company (Ammo) 1933-40; 333rd Service Battalion, Q.M.C. 1921-23 & 1925-36; 33rd Service Battalion, Q.M.C. 1923-25; Field Remount Depot No. 34 1921-25; VI Corps Field Remount Depot 1925-28; 306th Field Remount Depot 1928-36

Constituted in the Organized Reserve 29 October 1921 as Headquarters, Special Troops, VI Corps and allotted to the Sixth Corps Area. Headquarters initiated in February 1922 at Chicago, IL. Attached to Headquarters, Artillery Group, Sixth Corps Area on 19 October 1925 for organization, administration, and training. Withdrawn from the Organized Reserve 1 October 1933 and allotted to the Regular Army. Activated in 1941, less Organized Reserve personnel, at Fort Devens, MA. Location 7 December 1941—Fort Devens, MA.

Status: Disbanded 26 October 1944.

Commanders, Special Troops, VI Corps

Lt. Col. Watts C. Valentine	4 Feb 22-ao Jun 29	Capt. Robert P. Pomeroy	31 Oct 36-ao Jun 39
Unknown	ao Jul 29-31 Oct 36	Unknown	ao Jun 39-7 Dec 41

Headquarters, Special Troops, VII Corps

Organized Reserve Iowa/Missouri

HQ-Not initiated 1921-22; Des Moines, IA, 1922-31; St. Louis, MO, 1931-41; Fort McClellan, AL, 1941

Subordinate elements-Headquarters Company, VII Corps (RAI); *106th Military Police Battalion* 1921-23; 316th Military Police Battalion 1923-27; 307th Military Police Battalion 1927-40; *117th Signal Battalion* 1921-23; 313th Signal Battalion 1923-27; 55th Signal Battalion (RAI) 1927-40; *132nd Ordnance Company (HM)* 1921-23; 514th Ordnance Company (HM) 1923-33; *35th Ordnance Company (HM)* 1933-40; 52nd Ordnance Company (Ammo) 1921-33; 36th Ordnance Company (Ammo) 1933-40; 334th Service Battalion, Q.M.C. 1921-23 & 1925-36; 34th Service Battalion, Q.M.C. 1923-25; Field Remount Depot No. 35 1921-25; VII Corps Field Remount Depot 1925-28; 307th Field Remount Depot 1928-36

Constituted in the Organized Reserve 29 October 1921 as Headquarters, Special Troops, VII Corps and allotted to the Seventh Corps Area. Headquarters initiated in March 1922 at Des Moines, IA. Headquarters relocated 12 October 1931 to St. Louis, MO. Withdrawn from the Organized Reserve 1 October 1933 and allotted to the Regular Army. Personnel attended summer training as individuals in 1927 at Fort Leavenworth, KS. Activated 1 January 1941, less Organized Reserve personnel, at Fort McClellan, AL. Location 7 December 1941—Fort McClellan, AL.

Status: Disbanded 26 October 1944.

Commanders, Special Troops, VII Corps

Unknown	Mar 22-ao Mar 27	Capt. John C. Colwell	ao Mar 27-Jul 27
	Unknown	Jul 27-7 Dec 41	

Headquarters, Special Troops, VIII Corps**Organized Reserve Texas****HQ**-*Not initiated* 1921-22; San Antonio, TX, 1922-41; Camp Bowie, TX, 1941**Subordinate elements**-Headquarters Company, VIII Corps (RAI); *107th Military Police Battalion* 1921-23; 308th Military Police Battalion 1923-33; 316th Military Police Battalion 1933-40; *106th Signal Battalion* 1921-23, 1927-40; 314th Signal Battalion 1923-27; 35th Ordnance Company (HM) 1921-40; 55th Ordnance Company (Ammo) 1921-40; 335th Service Battalion, Q.M.C. 1921-23 & 1925-36; 35th Service Battalion, Q.M.C. 1923-25; Field Remount Depot No. 36 1921-25; VIII Corps Field Remount Depot 1925-28; 308th Field Remount Depot 1928-36

Constituted in the Organized Reserve 29 October 1921 as Headquarters, Special Troops, VIII Corps and allotted to the Eighth Corps Area. Headquarters initiated in August 1922 at San Antonio, TX. Withdrawn from the Organized Reserve 1 October 1933 and allotted to the Regular Army. Personnel attended summer training as individuals at Fort Sam Houston, TX, in 1927. Designated mobilization training station was Fort Sam Houston. Activated in 1941, less Organized Reserve personnel, at Camp Bowie, TX. Location 7 December 1941—Camp Bowie, TX.

Status: Disbanded 26 October 1944.**Commanders, Special Troops, VIII Corps**

Capt. Robert B. Banks	12 Aug 22-ao Jan 24	Lt. Col. Richard J. Meskill	ao Feb 26-ao Nov 26
Unknown	ao Feb 24-ao Mar 25	Unknown	ao Nov 26-ao Nov 35
Capt. William D. Smith	ao Mar 25-ao Sep 25	Capt. William N. Balfour	ao Nov 35-4 Dec 35
Unknown	ao Sep 25-ao Feb 26	Unknown	5 Dec 35-7 Dec 41

Headquarters, Special Troops, IX Corps**Organized Reserve California/Washington****HQ**-San Francisco, CA, 1921-28; Inactive 1928-37; San Francisco, CA, 1937-41; Fort Lewis, WA, 1941**Subordinate elements**-Headquarters Company, IX Corps (RAI); *108th Military Police Battalion* 1921-23; 309th Military Police Battalion 1923-27; 17th Military Police Battalion (RAI) 1927-33; 308th Military Police Battalion 1933-40; *107th Signal Battalion* 1921-23; 315th Signal Battalion 1923-27; 59th Signal Battalion (RAI) 1927-40; *133rd Ordnance Company (HM)* 1921-23; 515th Ordnance Company (HM) 1923-33; 3rd Ordnance Company (HM) 1933-40; 59th Ordnance Company (Ammo) 1921-33; 621st Ordnance Company (Ammo) 1933-40; 336th Service Battalion, Q.M.C. 1921-23 & 1925-36; 36th Service Battalion, Q.M.C. 1923-25; Field Remount Depot No. 37 1921-25; IX Corps Field Remount Depot 1925-28; 309th Field Remount Depot 1928-36

Constituted in the Organized Reserve 29 October 1921 as Headquarters, Special Troops, IX Corps and allotted to the Ninth Corps Area. Headquarters initiated 28 June 1922 at San Francisco, CA. Inactivated 15 October 1928 at San Francisco, CA, by relief of personnel. Seattle, WA, designated 7 April 1930 as headquarters on reorganization, but the unit was never organized at that location. Withdrawn from the Organized Reserve 1 October 1933 and allotted to the Regular Army. Headquarters reorganized 15 November 1937 at San Francisco, CA. Designated mobilization training station was Fort Lewis, WA, 1933-40. Activated in 1941, less Organized Reserve personnel, at Fort Lewis, WA. Location 7 December 1941—Fort Lewis, WA.

Status: Disbanded 26 October 1944.**Commanders, Special Troops, IX Corps**

Capt. Ernest M. Smith	7 Jun 22-15 Feb 23	<i>Inactive</i>	15 Oct 28-15 Nov 37
Lt. Col. William D. Barbee	15 Feb 23-15 Oct 28	Maj. Gustaf A. Enstrom	15 Nov 37-ao Jan 38
	Unknown	ao Jan 38-7 Dec 41	

Headquarters, Special Troops, XI Corps**Organized Reserve Massachusetts****HQ**-Boston, MA, 1921-41**Subordinate elements**-Headquarters Company, XI Corps; 301st Military Police Battalion 1921-23; 314th Military Police Battalion 1923-40; 301st Signal Battalion 1921-41; 501st Ordnance Company (HM) 1921-41; 601st Ordnance Company (Ammo) 1921-33; 610th Ordnance Company (Ammo) 1933-40; 321st Service Battalion, Q.M.C. 1921-23 & 1925-36; 21st Service Battalion, Q.M.C. 1923-25; Field Remount Depot No. 21 1921-25; XI Corps Field Remount Depot 1925-28; 311th Field Remount Depot 1928-36

Constituted in the Organized Reserve 29 October 1921 as Headquarters, Special Troops, XI Corps and allotted to the First Corps Area. Headquarters initiated 3 November 1921 at Boston, MA. Location 7 December 1941—Boston, MA.

Commanders, Special Troops, XI Corps

Unknown	3 Nov 21-Apr 22 Unknown	Lt. Col. Duncan M. Stewart ao Jan 30-7 Dec 41	Apr 22-ao Jan 30
---------	----------------------------	--	------------------

Headquarters, Special Troops, XII Corps

Organized Reserve New York

HQ-*Not initiated* 1921-22; Manhattan, NY, 1922-41

Subordinate elements-Headquarters Company, XII Corps; 302nd Military Police Battalion 1921-33; 310th Military Police Battalion 1933-40; 302nd Signal Battalion 1921-41; 502nd Ordnance Company (HM) 1921-41; 602nd Ordnance Company (Ammo) 1921-41; 322nd Service Battalion, Q.M.C. 1921-23 & 1925-36; 32nd Service Battalion, Q.M.C. 1923-25; Field Remount Depot No. 22 1921-25; XII Corps Field Remount Depot 1925-28; 312th Field Remount Depot 1928-36

Constituted in the Organized Reserve 29 October 1921 as Headquarters, Special Troops, XII Corps and allotted to the Second Corps Area. Headquarters initiated 27 January 1922 at Manhattan, NY. Designated mobilization training station was Camp Dix, NJ. Location 7 December 1941—Manhattan, NY.

Commanders, Special Troops, XII Corps

Capt. Jason M. Downs	27 Jan 22-ao May 22	Unknown	ao May 22-7 Dec 41
----------------------	---------------------	---------	--------------------

Headquarters, Special Troops, XIII Corps

Organized Reserve Pennsylvania

HQ-*Not initiated* 1921-22; York, PA, 1922-29; *Inactive* 1929-41

Subordinate elements-Headquarters Company, XIII Corps; 303rd Military Police Battalion 1921-33; 303rd Signal Battalion 1921-23; 322nd Signal Battalion 1923-41; 503rd Ordnance Company (HM) 1921-41; 603rd Ordnance Company (Ammo) 1921-41; 323rd Service Battalion, Q.M.C. 1921-23 & 1925-36; 23rd Service Battalion, Q.M.C. 1923-25; Field Remount Depot No. 23 1921-25; XIII Corps Field Remount Depot 1925-28; 313th Field Remount Depot 1928-36

Constituted in the Organized Reserve 29 October 1921 as Headquarters, Special Troops, XIII Corps and allotted to the Third Corps Area. Headquarters initiated 12 April 1922 at York, PA. Inactivated 2 August 1929 at York by relief of personnel. Location 7 December 1941—*Inactive*.

Commanders, Special Troops, XIII Corps

Unknown	12 Apr 22-ao Sep 25	Lt. Col. Moses T. Barlow	13 Feb 28-2 Aug 29
Capt. Joseph Savage	ao Sep 25-13 Feb 28	<i>Inactive</i>	2 Aug 29-7 Dec 41

Headquarters, Special Troops, XIV Corps

Organized Reserve Alabama

HQ-*Not initiated* 1921-22; Birmingham, AL, 1922-41

Subordinate elements-Headquarters Company, XIV Corps; 304th Military Police Battalion 1921-28; 312th Military Police Battalion 1928-40; 304th Signal Battalion 1921-23, 1927-40; 311th Signal Battalion 1923-27; 504th Ordnance Company (HM) 1921-40; 604th Ordnance Company (Ammo) 1921-23; 324th Service Battalion, Q.M.C. 1921-23; 37th Service Battalion, Q.M.C. 1923-25; 337th Service Battalion, Q.M.C. 1925-36; Field Remount Depot No. 24 1921-25; XIV Corps Field Remount Depot 1925-28; 314th Field Remount Depot 1928-36

Constituted in the Organized Reserve 29 October 1921 as Headquarters, Special Troops, XIV Corps and allotted to the Fourth Corps Area. Headquarters initiated 27 December 1922 at Birmingham, AL. Location 7 December 1941—Birmingham, AL.

Commanders, Special Troops, XIV Corps

Lt. Col. Joseph B. Duke

27 Dec 22-Jan 26
Unknown

Maj. Leonce R. Legendre
ao May 30-7 Dec 41

Jan 26-ao Apr 30

Headquarters, Special Troops, XV Corps

Organized Reserve Ohio

HQ-*Not initiated* 1921-24; Columbus, OH, 1924-33; Indianapolis, IN, 1933-41

Subordinate elements-Headquarters Company, XV Corps; 305th Military Police Battalion 1921-27; 311th Military Police Battalion 1927-40; 305th Signal Battalion 1921-23; 312th Signal Battalion 1923-27; 305th Signal Battalion 1927-40; 505th Ordnance Company (HM) 1921-23; 513th Ordnance Company (HM) 1923-33; 605th Ordnance Company (Ammo) 1921-40; 325th Service Battalion, Q.M.C. 1921-23; 38th Service Battalion, Q.M.C. 1923-25; 338th Service Battalion, Q.M.C. 1925-36; Field Remount Depot No. 25 1921-25; XV Corps Field Remount Depot 1925-28; 315th Field Remount Depot 1928-36

Constituted in the Organized Reserve 29 October 1921 as Headquarters, Special Troops, XV Corps and allotted to the Fifth Corps Area. Headquarters initiated by December 1924 at Columbus, OH. Headquarters relocated 21 December 1933 to Indianapolis, IN. Location 7 December 1941—Indianapolis, IN.

Commanders, Special Troops, XV Corps

Unknown Dec 24-7 Dec 41

Headquarters, Special Troops, XVI Corps

Organized Reserve Michigan

HQ-*Not initiated* 1921-22; Saginaw, MI, 1922-25; Detroit, MI, 1925-30; *Inactive* 1930-41

Subordinate elements-Headquarters Company, XVI Corps; 306th Military Police Battalion 1921-23; 315th Military Police Battalion 1923-27; 313th Military Police Battalion 1928-40; 306th Signal Battalion 1921-23 & 1927-40; 506th Ordnance Company (HM) 1921-33; 532nd Ordnance Company (HM) 1933-40; 606th Ordnance Company (Ammo) 1921-33; 613th Ordnance Company (Ammo) 1933-40; 326th Service Battalion, Q.M.C. 1921-23 & 1925-36; 26th Service Battalion, Q.M.C. 1923-25; Field Remount Depot No. 26 1921-25; XVI Corps Field Remount Depot 1925-28; 316th Field Remount Depot 1928-36

Constituted in the Organized Reserve 29 October 1921 as Headquarters, Special Troops, XVI Corps and allotted to the Sixth Corps Area. Headquarters initiated in April 1922 at Saginaw, MI. Headquarters relocated 2 June 1925 to Detroit, MI. Attached to the 85th Division 19 October 1925 for organization, administration, and training. Headquarters inactivated by December 1930 at Detroit by relief of personnel. Location 7 December 1941—*Inactive*.

Commanders, Special Troops, XVI Corps

Unknown
Lt. Col. J. T. Franch

Apr 22-Mar 26
Mar 26-ao May 26

Unknown
Inactive

ao May 26-Dec 30
Dec 30-7 Dec 41

Headquarters, Special Troops, XVII Corps

Organized Reserve Missouri/Iowa

HQ-*Not initiated* 1921-22; Kansas City, MO, 1922-26; Des Moines, IA, 1926-41

Subordinate elements-Headquarters Company, XVII Corps; 307th Military Police Battalion 1921-27; 317th Military Police Battalion 1927-40; 307th Signal Battalion 1921-40; 507th Ordnance Company (HM) 1921-40; 607th Ordnance Company (Ammo) 1921-40; 327th Service Battalion, Q.M.C. 1921-23 & 1925-36; 27th Service Battalion, Q.M.C. 1923-25; Field Remount Depot No. 27 1921-25; XVII Corps Field Remount Depot 1925-28; 317th Field Remount Depot 1928-36

Constituted in the Organized Reserve 29 October 1921 as Headquarters, Special Troops, XVII Corps and allotted to the Seventh Corps Area. Headquarters initiated 22 May 1922 at Kansas City, MO. Headquarters relocated 26 May 1926 to Des Moines, IA. Location 7 December 1941—Des Moines, IA.

Commanders, Special Troops, XVII Corps

Unknown	22 May 22-13 Jun 22 Unknown	Capt. Robert K. Kernodle ao Oct 25-7 Dec 41	14 Jun 22-ao Oct 25
---------	--------------------------------	--	---------------------

Headquarters, Special Troops, XVIII Corps

Organized Reserve Texas

HQ-Not initiated 1921-22; San Antonio, TX, 1922-35; Fort Sam Houston, TX, 1935-41

Subordinate elements-Headquarters Company, XVIII Corps; 308th Military Police Battalion 1921-23; 317th Military Police Battalion 1923-28; 315th Military Police Battalion 1928-40; 308th Signal Battalion 1921-40; 508th Ordnance Company (HM) 1921-40; 608th Ordnance Company (Ammo) 1921-40; 328th Service Battalion, Q.M.C. 1921-23 & 1925-36; 28th Service Battalion, Q.M.C. 1923-25; Field Remount Depot No. 28 1921-25; XVIII Corps Field Remount Depot 1925-28; 318th Field Remount Depot 1928-36

Constituted in the Organized Reserve 29 October 1921 as Headquarters, Special Troops, XVIII Corps and allotted to the Eighth Corps Area. Headquarters initiated 23 September 1922 at San Antonio, TX. Headquarters relocated 29 March 1935 to Fort Sam Houston, TX. Personnel attended summer training as individuals in 1927 at Fort Sam Houston. Designated mobilization training station was Fort Sam Houston. Location 7 December 1941—Fort Sam Houston, TX.

Commanders, Special Troops, XVIII Corps

1st Lt. Herman L. Arterberry	23 Sep 22-1 Jun 23 Unknown	Capt. Warren S. Guy ao Jun 25-7 Dec 41	1 Jun 23-ao Jun 25
------------------------------	-------------------------------	---	--------------------

Headquarters, Special Troops, XIX Corps

Organized Reserve California

HQ-Not initiated 1921-22; San Francisco, CA, 1922-41

Subordinate elements-Headquarters Company, XIX Corps; 309th Military Police Battalion 1921-23 & 1927-40; 318th Military Police Battalion 1923-27; 309th Signal Battalion 1921-40; 509th Ordnance Company (HM) 1921-33; 535th Ordnance Company (HM) 1933-40; 609th Ordnance Company (Ammo) 1921-33; 646th Ordnance Company (Ammo) 1933-40; 329th Service Battalion, Q.M.C. 1921-23 & 1925-36; 29th Service Battalion, Q.M.C. 1923-25; Field Remount Depot No. 29 1921-25; XIX Corps Field Remount Depot 1925-28; 319th Field Remount Depot 1928-36

Constituted in the Organized Reserve 29 October 1921 as Headquarters, Special Troops, XIX Corps and allotted to the Ninth Corps Area. Headquarters initiated 28 June 1922 at San Francisco, CA. Location 7 December 1941—San Francisco, CA.

Commanders, Special Troops, XIX Corps

Maj. Harry E. Boies	7 Jun 22-ao Jun 29	Unknown	ao Jul 29-7 Dec 41
---------------------	--------------------	---------	--------------------

Headquarters, Special Troops, 1st Division

HQ-Camp Dix, NJ, 1921-26; Miller Field, NY, 1926-31; Fort Hamilton, NY, 1931-39

Subordinate elements-Headquarters and Military Police Company, 1st Division 1921-39; 1st Signal Company 1921-39; 1st Ordnance Company (M) 1921-39; 1st Tank Company (L) 1921-39; 1st Motorcycle Company 1921-36; 1st Service Company, Q.M.C. (RAI) 1927-36



Constituted in the Regular Army and organized 10 March 1921 at Camp Dix, NJ, with personnel from the demobilized 1st Division Train Headquarters. Subordinate elements organized, assigned, or redesignated at Camp Dix as follows: Headquarters and Military Police Company, 1st Division 13 February 1921; 1st Signal Company 23 April 1921; 1st Tank Company 8 January 1921; 1st Ordnance Company 15 February 1921; and 1st Motorcycle Company 21 March 1921. Subordinate elements, less the Headquarters and Military Police Company, 1st Division, transferred in 1922 to the following locations: 1st Signal Company to Fort Monmouth, NJ; 1st Ordnance Company and 1st Tank Company to Miller Field, NY; and 1st Motorcycle Company to Fort Wadsworth, NY. Headquarters, Special Troops, 1st Division transferred 1 April 1926 to Miller Field, NY. Headquarters and Military Police Company transferred in 1926 to Fort Wood on Liberty Island and assumed the responsibility for the maintenance of the Statue Of Liberty during the period 1926-33. The 1st Service Company was constituted 18 October 1927 and organized 11 February 1930 as a RAI unit with Organized Reserve personnel at Brooklyn, NY. Headquarters, Special Troops, 1st Division transferred 1 October 1931 to Fort Hamilton, NY. Maintained habitual summer training relationships with the Special Troops units of the 77th, 78th, and 98th Divisions and 61st Cavalry Division. Disbanded 26 October 1939.

Organization Day: 1 December. Chosen to commemorate the unit's initial organization as the Headquarters, 1st Division Trains on 1 December 1917 at Montier-sur-Saulte, France. Adopted 21 March 1938.

Events: 60, 63, 72, 89, 106, 153, 190, 246, 266, 280

Commanders, Special Troops, 1st Division

Maj. Goodwin Compton	8 Feb 21-12 Sep 21	Lt. Col. Torrey B. Maghee	1 Aug 31-1 Apr 34
Maj. Warren Shields	12 Sep 21-Oct 21	Lt. Col. William S. Woodruff	1 Apr 34-12 Aug 34
Maj. Fred C. Miller	17 Nov 21-16 Sep 22	Maj. Holmes E. Dager	16 Aug 34-May 35
Col. Chauncey B. Humphrey	16 Sep 22-9 Mar 25	Maj. Edward G. Sherburne	May 35-14 Aug 35
Lt. Col. James T. Watson	9 Mar 25-16 Jan 26	Capt. Ben R. Jones	16 Aug 35-1 Oct 35
Col. James Justice	16 Jan 26-17 Dec 27	Maj. Norman Randolph	1 Oct 35-28 Dec 35
Lt. Col. John S. Upham	17 Dec 17-5 Jul 28	Lt. Col. Kenneth P. Lord	29 Dec 35-13 Apr 36
Lt. Col. Henry W. Fleet	5 Jul 28-16 Aug 29	Maj. Raymond R. Tourtillott	14 Apr 36-16 May 38
Col. Adolphe H. Huguet	16 Aug 29-1 Aug 31	Maj. Joseph A. Nichols	16 May 38-3 Sep 39
	Maj. John N. Johnson, Jr.	3 Sep 39-11 Oct 39	

Headquarters, Special Troops, 1st Cavalry Division

HQ-Fort Bliss, TX, 1921-40

Subordinate elements-Headquarters Troop, 1st Cavalry Division; 13th Signal Troop 1921-23; 1st Signal Troop 1923-40; 27th Ordnance Company (M) 1921-40; 10th Tank Company (L) (RAI) 1927-40; 15th Veterinary Company 1921-25

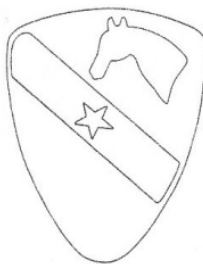

Constituted in the Regular Army and organized 13 September 1921 at Fort Bliss, TX, as Headquarters, Special Troops, 1st Cavalry Division. Subordinate elements organized at Fort Bliss as follows: Headquarters Troop, 1st Cavalry Division 13 September 1921; 13th Signal Troop 16 September 1921 (redesignated 1st Signal Troop 13 December 1923); 27th Ordnance Company 21 September 1921. The 10th Tank Company (organized 19 November 1921 at Camp George G. Meade, MD, and assigned to the Panama Canal Division; inactivated 1 September 1922 at Corozol, CZ; relieved 15 August 1927 from the Panama Canal Division) assigned 15 August 1927 to the 1st Cavalry Division. The 10th Tank Company was organized as an RAI unit by 1928 with Organized Reserve personnel at El Paso, TX; conducted summer training at Fort Bliss, TX, or Fort Sam Houston, TX, with the 2nd Tank Company. In April 1933, the Headquarters, Special Troops, 1st Cavalry Division assumed command and control of the El Paso and Flagstaff C.C.C. areas until October 1933. The Special Troops continued to support C.C.C. activities in the states of Texas and Arizona until 1939. Disbanded 28 August 1940.

Events: 30, 65, 83, 97, 127, 146, 206, 250, 259, 284, 295, 296, 300, 315, 328

Commanders, Special Troops, 1st Cavalry Division

Lt. Col. Albert S. Fuger	9 Sep 21-17 Oct 21	Maj. Paul R. Davison	23 Jul 29-1 Oct 29
Capt. William B. McCollum	17 Oct 21-Dec 21	Maj. Cuyler L. Clark	1 Oct 29-25 Aug 31
Maj. Pearl L. Thomas	Dec 21-31 Jan 22	Lt. Col. George B. Hunter	25 Aug 31-24 Aug 32
Capt. Herbert F. Featherston	31 Jan 22-26 Feb 22	Lt. Col. Alexander M. Milton	24 Aug 32-14 Sep 32
Maj. Victor W. B. Wales	26 Feb 22-5 Sep 22	Lt. Col. Frederick Gilbreath	15 Sep 32-1 Jun 34
Maj. William W. Erwin	5 Sep 22-11 Jun 24	Maj. Duncan Richart	1 Jun 34-1 Jul 35
Lt. Col. William H. Cowles	21 Jun 24-10 Jul 27	Col. Stephen W. Winfree	1 Jul 35-31 Mar 39
Lt. Col. Julian E. Gaugot	12 Aug 27-7 Jan 28	Col. Francis W. Glover	31 Mar 39-31 Jul 39
Lt. Col. Kenyon A. Joyce	9 Jan 28-23 Jul 29	Maj. Percy S. Haydon	31 Jul 39-28 Aug 40

Headquarters, Special Troops, 2nd Division

HQ-Fort Sam Houston, TX, 1921-39

Subordinate elements-Headquarters and Military Police Company, 2nd Division 1921-39; 2nd Signal Company 1921-39; 2nd Ordnance Company (M) 1921-39; 2nd Tank Company (L) 1921-39; 2nd Motorcycle Company 1921-36; *2nd Service Company, Q.M.C.* 1927-36

Constituted in the Regular Army and organized in March 1921 at Fort Sam Houston, TX. Subordinate elements organized, assigned, or redesignated at Fort Sam Houston as follows: Headquarters and Military Police Company 18 February 1921; 2nd Signal Company 23 April 1921; 2nd Tank Company 8 January 1921; 2nd Ordnance Company in March 1921; and 2nd Motorcycle Company 18 February 1921. Maintained habitual summer training relationships with the Special Troops units of the 90th, 95th, and 103rd Divisions. Disbanded 16 October 1939.

Events: 45, 47, 55, 70, 74, 105, 125, 147, 163, 258

Commanders, Special Troops, 2nd Division

Capt. Roland Wilkins	Mar 21-Jan 22	Maj. Lester L. Lampert	1 Nov 26-1 Jun 28
Maj. William T. Pigott, Jr.	Jan 22-19 Nov 22	Maj. Alfred W. Bloor	1 Jun 28-5 Nov 30
Lt. Col. Frederick R. de Funiak, Jr.	19 Nov 22-23 Sep 23	Lt. Col. William J. Connelly	6 Nov 30-7 Sep 32
Lt. Col. Philip W. Corbusier	23 Sep 23-Dec 23	Maj. Robert K. Whitson	7 Sep 32-31 Jul 33
Lt. Col. Laurin L. Lawson	Dec 23-20 Sep 24	Maj. Richard D. Daugherty	1 Aug 33-9 Jul 34
Col. Charles B. Clark	20 Sep 24-14 Sep 25	Capt. William Fisk	9 Jul 34-1 Mar 35
Lt. Col. Parker Hitt	14 Sep 25-15 Sep 26	Lt. Col. Alfred W. Bloor	1 Mar 35-1 Aug 37
Maj. Carroll B. Hodges	15 Sep 26-ao Feb 28	Maj. Lewis A. Page	1 Aug 37-30 Aug 38
	Maj. Ernest A. Kindervater	30 Aug 38-1 Oct 39	

Headquarters, Special Troops, 2nd Cavalry Division

Regular Army Inactive

HQ-*Not organized* 1923-27; El Paso, TX, 1927; Kansas City, KS, 1927-40

Subordinate elements-Headquarters Troop, 2nd Cavalry Division; 2nd Signal Troop (RAI) 1923-40; 13th Ordnance Company (M) 1923-27; 14th Ordnance Company (M) 1927-40; 12th Tank Company (RAI) (L) 1928-38

Constituted in the Regular Army 24 March 1923 and assigned to the 2nd Cavalry Division. Designated active associate was the 6th Cavalry. Allotted to the Eighth Corps Area 15 February 1927. Headquarters and all subordinate companies organized by April 1927 with Organized Reserve personnel as a RAI units at El Paso, TX. All units withdrawn from the Eighth Corps Area 15 August 1927 and allotted to the Seventh Corps Area, less the 12th Tank Company. Concurrently the 12th Tank Company allotted to the Sixth Corps Area. All elements inactivated 30 September 1927 at El Paso by relief of personnel. Headquarters reorganized in late 1927 with Organized Reserve personnel as a RAI unit at Kansas City, KS. Subordinate elements organized as RAI units at the locations indicated: Headquarters Troop, 2nd Cavalry Division at Kansas City, KS; 2nd Signal Troop at Des Moines, IA; and 12th Tank Company at Peoria, IL. The 14th Ordnance Company (M) was active in the Regular Army at Fort Riley, KS. Headquarters and subordinate companies conducted summer training at locations as follows: Headquarters, Special Troops, 2nd Cavalry Division and Headquarters Troop, 2nd Cavalry Division at Fort Riley, KS; 2nd Signal Troop at Fort Crook NE; and 12th Tank Company at the Peoria Tank Training Center, IL, or the Arcadia Target Range, MO. Designated mobilization training station was originally Fort Bliss, TX, and later Fort Riley, KS. Disbanded 28 August 1940.

Commanders, Special Troops, 2nd Cavalry Division

Unknown	Apr 27-30 Sep 27	Unknown	ao Dec 27-ao Mar 31
<i>Inactive</i>	30 Sep 27-ao Dec 27	1st Lt. Isaac G. McQueen**	ao Mar 31-ao Apr 31
	Unknown	ao Apr 31-28 Aug 40	

** RAI Commanders: Organized Reserve officers.

Headquarters, Special Troops, 3rd Division

HQ-Fort Lewis, WA, 1921-39

Subordinate elements-Headquarters and Military Police Company, 3rd Division 1921-39; 3rd Signal Company 1921-39; 3rd Ordnance Company (M) 1921-39; 3rd Tank Company (L) 1921-39; 3rd Motorcycle Company 1921-36; *3rd Service Company, Q.M.C.* 1927-36

Constituted in the Regular Army and organized in March 1921 at Camp Lewis, WA. Subordinate elements organized, assigned, or redesignated at Camp Lewis as follows: Headquarters and Military Police Company, 3rd Division 12 May 1921; 3rd Signal Company 14 February 1921; 3rd Tank Company 8 January 1921; 3rd Ordnance Company in March 1921; and 3rd Motorcycle Company 26 March 1921. The 3rd Signal Company was inactivated 1 February 1925 and organized as an RAI unit with Organized Reserve personnel at the Presidio of San Francisco, CA. The 3rd Service Company was constituted 18 October 1927 but never organized. As an RAI unit the 3rd Signal Company conducted summer training at Del Monte, CA. The 3rd Signal Company was reactivated 1 July 1935, less Organized Reserve personnel, at Fort Lewis. Maintained habitual summer training relationships with the Special Troops units of the 91st, 96th, and 104th Divisions. Disbanded 16 October 1939.

Events: 57, 114, 135, 145, 161, 204, 208, 226, 238, 273

Commanders, Special Troops, 3rd Division

Unknown	Mar 21-25 Jul 21	Capt. Millard S. Curtis	22 May 33-15 Sep 33
Maj. Sidney G. Brown	25 Jul 21-1 Sep 21	1st Lt. Fay W. Smith	15 Sep 33-5 Aug 34
Maj. Roland W. Boughton	7 Aug 22-5 Oct 22	Maj. Charles N. Stevens	5 Aug 34-20 May 36
Maj. Ralph C. Holliday	4 Aug 24-24 Jul 25	Capt. James J. Hea	20 May 36-1 Jul 36
Col. Patrick H. Mullay	1 Feb 25-24 Jul 25	Maj. Raymond Miller	1 Jul 36-22 Mar 37
Maj. Ralph C. Holliday	24 Jul 25-22 Mar 26	Capt. John T. Keeley	23 Mar 37-9 Aug 37
Lt. Col. Maxon S. Lough	23 Mar 26-23 Jul 29	Col. Henry Hossfeld	10 Aug 37-9 Jul 38
Maj. Willis J. Tack	24 Jul 29-22 May 33	Lt. Col. Abraham Tabachnik	9 Jul 38-1 Oct 39

Headquarters, Special Troops, 3rd Cavalry Division

Regular Army Inactive

HQ-Kansas City, MO, 1927-36; Des Moines, IA, 1936-40

Subordinate elements-Headquarters Troop, 3rd Cavalry Division (RAI); 3rd Signal Troop (RAI) 1927-40; 16th Ordnance Company (M) 1927-40; 13th Tank Company (L) (RAI) 1928-40.

Constituted in the Regular Army 15 August 1927, assigned to the 3rd Cavalry Division, and allotted to the Seventh Corps Area, less the 13th Tank Company. Concurrently the 13th Tank Company was allotted to the Sixth Corps Area. Headquarters organized by December 1927 with Organized Reserve personnel as a RAI unit at Kansas City, KS. Subordinate elements organized as RAI units at the locations indicated: 3rd Signal Troop at Des Moines, IA; 16th Ordnance Company at Little Rock, AR; and 13th Tank Company 16 December 1927 at Oshkosh, WI. The 13th Tank Company was relocated 15 April 1929 to Peoria, IL; withdrawn from the Sixth Corps Area 1 October 1933 and allotted to the Seventh Corps Area; organized by 1934 at St. Louis, MO. Headquarters relocated about 1936 to Des Moines, IA. Headquarters and subordinate companies conducted summer training at locations as follows: Headquarters, Special Troops, 3rd Cavalry Division at Fort Riley, KS; 3rd Signal Troop at Fort Crook NE; and 13th Tank Company at the Peoria Tank Training Center or the Arcadia Target Range, MO. Disbanded 10 October 1940.

Commanders, Special Troops, 3rd Cavalry Division

Unknown	ao Dec 27-10 Aug 40
---------	---------------------

Headquarters, Special Troops, 4th Division**Regular Army Inactive****HQ-Not organized** 1921-26; Atlanta, GA, 1926-39**Subordinate elements**-Headquarters and Military Police Company, 4th Division 1921-39; 4th Signal Company (RAI) 1921-39; 4th Ordnance Company (M) (RAI) 1921-27; 17th Ordnance Company (M) 1927-39; 4th Tank Company (L) 1921-39; 4th Motorcycle Company (RAI) 1921-36; *4th Service Company, Q.M.C.* 1927-36

Constituted in the Regular Army in March 1921, assigned to the 4th Division, and organized at Camp Lewis, WA. Headquarters and all subordinate elements inactivated 27 September 1921 at Camp Lewis. Concurrently allotted to the Fourth Corps Area. Designated Active Associate was HHC, 8th Infantry Brigade 1923-27. Headquarters organized 12 August 1926 with Organized Reserve personnel as a RAI unit at Atlanta, GA. Subordinate elements organized as RAI units as follows: Headquarters Company, 4th Division 12 August 1926 at Atlanta; 4th Military Police 12 August 1926 at Atlanta; 4th Signal Company 17 March 1927 at Atlanta; 4th Tank Company 25 October 1926 at Atlanta; 4th Ordnance Company 23 March 1927 at Atlanta; and 4th Motorcycle Company by September 1927 at Atlanta. The 4th Ordnance Company was relieved from the 4th Division in March 1927; concurrently the 17th Ordnance Company, active at Fort Benning, GA, was assigned. The 4th Service Company was constituted 18 October 1927 but apparently never organized. The 4th Tank Company was activated 15 September 1931, less Organized Reserve personnel, at Fort McClellan, AL. The 4th Signal Company was activated in early 1939, less Organized Reserve personnel, at Fort Des Moines, IA,. Headquarters and subordinate companies conducted summer training at locations as follows: Special Troops, 4th Division, less 4th Tank Company, at Fort McPherson, GA. Reserve officers assigned to the 4th Tank Company conducted summer training with the company at Fort Benning. Designated mobilization training station was Fort McClellan. Reserve personnel relieved 12 August 1939 from all 4th Division Special Troops elements. Disbanded 10 November 1939.

Commanders, Special Troops, 4th Division

1st Lt. Charles M. Smith**	19 Jul 26-24 Jul 27	Capt. George C. C. Boteler**	26 Jan 28-ao Feb 28
Capt. Eugene C. Callahan**	25 Jul 27-30 Sep 27	Unknown	ao Feb 28-30 Jun 36
Capt. James R. Dudley**	1 Oct 27-25 Jan 28	Capt. Nicholas D. Woodward**	1 Jul 36-30 Jun 37
	Unknown	30 Jun 37-12 Aug 39	

**RAI Commanders: Organized Reserve officers.

Headquarters, Special Troops, 5th Division**Regular Army Inactive****HQ-Not organized** 1921-27; Columbus, OH, 1927-39**Subordinate elements**-Headquarters and Military Police Company, 5th Division 1921-39; 5th Signal Company (RAI) 1921-39; *5th Ordnance Company (M)* 1921-27; 15th Ordnance Company (M) 1927-33; 19th Ordnance Company (M) 1933-39; 5th Tank Company (L) 1921-39; *5th Motorcycle Company* 1921-36; *5th Service Company, Q.M.C.* 1927-36

Constituted in the Regular Army in March 1921, assigned to the 5th Division, and organized at Camp Jackson, SC. Headquarters and all subordinate elements, less the 5th Tank Company, inactivated in September 1921 at Camp Jackson. Concurrently allotted to the Fifth Corps Area. Designated Active Associate was HHC, 10th Infantry Brigade 1923-27. The 5th Ordnance Company was relieved from the 5th Division 11 October 1927 and assigned to the 9th Division. Concurrently the 19th Ordnance Company at Watervliet Arsenal, NY, was assigned to the 5th Division. Headquarters organized 8 November 1927 with Organized Reserve personnel as a RAI unit at Columbus, OH. Subordinate elements organized as RAI units at the locations indicated: Headquarters and Military Police Company and 5th Signal Company 25 January 1928 at Columbus, OH. Other subordinate elements were already active in the Regular Army at the locations indicated: 19th Ordnance Company at Fort Knox, KY, and 1st Platoon, 5th Tank Company at Fort Benjamin Harrison, IN. The 5th Service Company was constituted 18 October 1927 but apparently never organized. Headquarters and subordinate companies conducted summer training at Fort Knox. Designated mobilization training station was Fort Knox. Disbanded 16 October 1939.

Commanders, Special Troops, 5th Division

1st Lt. Ralph H. Ware**	8 Nov 27-10 Jan 28	Capt. E. R. Thorpe**	ao Jul 37-ao Aug 37
Capt. Jerry B. Garland**	10 Jan 28-ao Jun 28	Unknown	ao Aug 37-ao Jun 38
Unknown	ao Jul 28-ao Jul 37	Capt. LeGrand H. Hedington**	ao Jun 38-ao Sep 38
	Unknown	ao Sep 38-16 Oct 39	

**RAI Commanders: Organized Reserve officers.

Headquarters, Special Troops, 6th Division**Regular Army Inactive****HQ-Not organized** 1921-26; Chicago, IL, 1926-39**Subordinate elements**-Headquarters and Military Police Company, 6th Division 1921-39; 6th Signal Company (RAI) 1921-39; 6th Ordnance Company (M) 1921-27; 9th Ordnance Company (M) 1927-39; 13th Ordnance Company (M) (RAI) 1933-39; 6th Tank Company (L) 1921-39; 6th Motorcycle Company (RAI) 1921-36; 6th Service Company, Q.M.C. (RAI) 1927-33

Constituted in the Regular Army in March 1921, assigned to the 6th Division, and organized at Camp Grant, IL. Headquarters and all subordinate elements inactivated in September 1921 at Camp Grant. Concurrently allotted to the Sixth Corps Area. Designated Active Associate was HHC, 12th Infantry Brigade 1923-27. Headquarters organized 9 September 1926 with Organized Reserve personnel as a RAI unit at Chicago, IL. Subordinate elements organized at Chicago as RAI units as follows: Headquarters Company in May 1926; 6th Military Police Company in May 1926; 6th Ordnance Company in May 1926; 6th Signal Company 8 May 1926; 6th Motorcycle Company 9 June 1926; and 6th Tank Company 8 May 1926 (less 2nd Platoon). The 2nd Platoon, 6th Tank Company was active in the Regular Army at Jefferson Barracks, MO. The 6th Ordnance Company was relieved from the 6th Division 11 October 1927. Concurrently the 9th Ordnance Company, at Fort Sill, OK, was assigned to the 6th Division. The 6th Service Company was constituted 18 October 1927 and subsequently organized as a RAI unit. Headquarters and subordinate companies conducted summer training at locations as follows: Headquarters, Special Troops, 6th Division, Headquarters Company, 6th Division, and 6th Service Company at Fort Sheridan, IL; 6th Signal Company at Fort Sheridan or Camp Custer, MI; 6th Military Police Company at Jefferson Barracks, MO; and 6th Tank Company at Peoria, IL, or Jefferson Barracks. Designated mobilization training station was Camp Grant. Disbanded 16 October 1939.

Commanders, Special Troops, 6th Division

Unknown	Mar 21-19 Jul 21	Unknown	17 Apr 27-5 Nov 28
Maj. C. Stockmar Bendel	19 Jul 21-21 Sep 21	1st Lt. Thomas F. Meagher**	5 Nov 28-ao Jan 29
<i>Inactive</i>	22 Sep 21-8 Sep 26	Unknown	ao Jan 29-ao Jun 29
Capt. Charles Conley**	9 Sep 26-17 Apr 27	Capt. Scott A. Burnam**	ao Jun 29-ao Jul 31
	Unknown	ao Jun 31-16 Oct 39	

**RAI Commanders: Organized Reserve officers.

Headquarters, Special Troops, 7th Division**Regular Army Inactive****HQ-Not organized** 1921-27; Lincoln, NE, 1927-39**Subordinate elements**-Headquarters and Military Police Company, 7th Division 1921-39; 7th Signal Company (RAI) 1921-39; 7th Ordnance Company (M) (RAI) 1921-39; 7th Tank Company (L) (RAI) 1921-39; *7th Motorcycle Company* 1921-36; *7th Service Company, Q.M.C.* 1927-36

Constituted in the Regular Army in March 1921, assigned to the 7th Division, and organized at Camp George G. Meade, MD. Headquarters and all subordinate elements inactivated 6 September 1921 at Camp Meade. Concurrently allotted to the Seventh Corps Area. Designated Active Associate was HHC, 14th Infantry Brigade 1923-27. Headquarters organized about February 1927 with Organized Reserve personnel as a RAI unit at Lincoln, NE. Subordinate elements organized as RAI units as follows: Headquarters Police Company at Lincoln, NE, by May 1929; Military Police Company at Vermillion, SD, by May 1929 and affiliated with the University of South Dakota R.O.T.C.; 7th Signal Company at St. Paul, MN, by May 1929; 7th Tank Company at Fort Snelling, MN, by May 1929; and 7th Ordnance Company at St. Paul, MN, by December 1930. The 7th Service Company was constituted 18 October 1927 and subsequently organized as a RAI unit. Headquarters and subordinate companies conducted summer training at locations as follows: Headquarters, Special Troops, 7th Division, Headquarters Company, 7th Division, 7th Military Police Company, and 7th Signal Company at Fort Crook, NE; 7th Ordnance Company at Rock Island Arsenal, IL; and 7th Tank Company at Fort Snelling, MN. The 7th Military Police Company conducted CMTC training in 1938 at Fort Crook, NE, as an alternate form of annual training. Designated mobilization training station was Fort Snelling. Disbanded 16 October 1939.

Commanders, Special Troops, 7th Division

Unknown	Feb 27-10 Mar 38	2nd Lt. William F. V. Baeder, Jr.**	10 Mar 38-16 Oct 39
---------	------------------	-------------------------------------	---------------------

**RAI Commanders: Organized Reserve officers.

Headquarters, Special Troops, 8th Division**Regular Army Inactive****HQ-Not organized** 1923-1926; Washington, DC, 1926-39**Subordinate elements**-Headquarters and Military Police Company, 8th Division 1923-39; 8th Signal Company (RAI) 1923-39; 15th Ordnance Company (M) 1923-27; 4th Ordnance Company (M) (RAI) 1927-33; 15th Ordnance Company (M) 1933-39; 8th Tank Company (L) (RAI) 1923-39; 8th Motorcycle Company (RAI) 1923-28; *8th Service Company, Q.M.C.* 1927-36

Constituted in the Regular Army 24 March 1923, assigned to the 8th Division, and allotted to the Third Corps Area. Designated Active Associate was HHC, 16th Infantry Brigade 1923-27. Headquarters organized 13 April 1926 with Organized Reserve personnel as a RAI unit at Washington, DC. Subordinate elements organized as RAI units as follows: Headquarters Company, 8th Division 13 April 1926 at Washington, DC; 8th Military Police Company 13 April 1926 at Washington, DC; 8th Tank Company (L) 13 April 1926 at Camp George G. Meade, MD; 8th Motorcycle Company 23 April 1926 at Washington, DC; and 8th Signal Company 23 April 1926 at Fort Monmouth, NJ. The 15th Ordnance Company was active at Frankford Arsenal, PA. The 8th Service Company was constituted 18 October 1927 and organized 12 March 1928 at Washington, DC. The 15th Ordnance Company was relieved in 1927 from the 8th Division. The 4th Ordnance Company was concurrently assigned. The 4th Ordnance Company was relieved 1 October 1933 from the 8th Division. The 15th Ordnance Company was concurrently reassigned. The 8th Signal Company conducted CMTC at Fort George G. Meade, MD, for summer training in 1938 and 1939. Special Troops headquarters and the 8th Military Police Company inactivated about April 1939 by relief of personnel. Designated mobilization training station was Camp George G. Meade. Disbanded 2 October 1939.

Commanders, Special Troops, 8th Division

2nd Lt. Carl N. Priode**	13 Apr 26-28 Feb 27	Unknown	ao Apr 27-1 Dec 29
Lt. Col. Augustus F. Dannemiller*	28 Feb 27-ao Mar 27	Capt. James W. Anderson**	2 Dec 29-ao Aug 34
	Unknown	ao Sep 34-2 Oct 39	

* RAI Commanders: Regular Army officers assigned as mobilization commanders.

** RAI Commanders: Organized Reserve officers.

Headquarters, Special Troops, 9th Division**Regular Army Inactive****HQ-Not organized** 1923-27; Boston, MA, 1927-40**Subordinate elements**-Headquarters and Military Police Company, 9th Division 1923-39; 9th Signal Company (RAI) 1923-39; 9th Ordnance Company (M) 1923-27; 5th Ordnance Company (M) (RAI) 1927-39; 9th Tank Company (L) (RAI) 1923-39; 9th Motorcycle Company (RAI) 1923-28; 9th Service Company, Q.M.C. (RAI) 1927-33

Constituted in the Regular Army 24 March 1923, assigned to the 9th Division, and allotted to the First Corps Area. Designated Active Associate was HHC, 18th Infantry Brigade 1923-27. Headquarters organized by May 1927 with Organized Reserve personnel as a RAI unit at Boston, MA. Subordinate elements organized as RAI units as follows: Headquarters Company, 9th Military Police Company, and 9th Signal Company in October 1926 at Boston; 5th Ordnance Company 8 February 1928 at Cincinnati, OH; 9th Motorcycle Company by June 1928 at Boston; and 9th Tank Company 6 September 1927 at Boston. The 9th Ordnance Company was relieved from the 9th Division 11 October 1927 and assigned to the 6th Division. The 9th Service Company was constituted 18 October 1927 and subsequently organized by July 1929 at Boston as a RAI unit. Concurrently the 5th Ordnance Company (allotted to the Fifth Corps Area) was assigned to the 9th Division. Designated mobilization training station was originally Camp Devens, MA, and later Camp Dix, NJ. The 9th Signal Company conducted summer training at Fort Ethan Allen, VT, and the 9th Service Company at Camp Custer, MI. Disbanded 1 June 1940.

Commanders, Special Troops, 9th Division

Capt. Joseph McK. Driscoll**	May 27-ao Jun 31	Capt. Donald A. Heath**	ao Dec 34-ao Jan 35
Unknown	ao Jun 31-ao Dec 34	Unknown	ao Jan 35-1 Jun 40

** RAI Commanders: Organized Reserve officers.

Headquarters, Special Troops, Panama Canal Division

HQ-Quarry Heights, CZ, 1921-32; *Inactive* 1932-38

Subordinate elements-Headquarters and Military Police Company, Panama Canal Division 1921-41; 10th Signal Company 1921-38; 10th Ordnance Company (M) 1921-38; 10th Tank Company (L) 1921-27; 10th Motorcycle Company 1921-36

Constituted in the Regular Army 2 June 1921, assigned to the Panama Canal Division, and allotted to the Panama Canal Department. Headquarters organized 3 July 1921 at Quarry Heights, CZ, with personnel from Companies A and B, Military Police, Panama Canal Department. Subordinate elements organized as follows: Headquarters and Military Police Company, Panama Canal Division 3 July 1921 at Quarry Heights, CZ, from Companies A and B, Military Police, Panama Canal Department; 10th Signal Company 3 July 1921 at Corozal, CZ; 10th Ordnance Company (M) 3 July 1921 at Corozal, CZ; 10th Tank Company (L) 18 November 1921 at Camp George G. Meade, MD; 10th Motorcycle Company in 1922 at Corozal, CZ. The 10th Tank Company was transferred to Corozal, CZ, in July 1922 and was inactivated there 1 September 1922. Upon inactivation of the 10th Tank Company, the 10th Ordnance Company assumed maintenance and manning responsibility for the tank company's Renault tanks. The 10th Tank Company was relieved from the Panama Canal Division 15 August 1927 and assigned to the 1st Cavalry Division. All active elements inactivated 15 April 1932 at Quarry Heights. Disbanded 10 October 1938.

Events: 26, 31, 35, 40, 43, 53, 58, 69, 81, 101, 119, 140

Commanders, Special Troops, Panama Canal Division

1st Lt. Williston B. Palmer	3 Jul 21-Oct 21	Maj. Stewart C. MacDonald	1 Jul 25-24 Mar 26
Capt. Herbert F. E. Bultman	Oct 21-2 Apr 23	Maj. John R. Mendenhall	24 Mar 26-Oct 28
Capt. Benjamin W. Venable	2 Apr 23-1 Jul 25	Maj. Merritt E. Olmstead	28 Oct 30-5 Aug 31
	Capt. George A. Murray	6 Aug 31-15 Apr 32	

Headquarters, Special Troops, Hawaiian Division

HQ-*Not organized* 1921-22; Schofield Barracks, TH, 1922-41

Subordinate elements-Headquarters and Military Police Company, Hawaiian Division 1921-41; 11th Signal Company 1921-41; 11th Ordnance Company (M) 1921-41; 11th Tank Company (L) 1921-41; 11th Motorcycle Company 1921-36; Hawaiian Division Pack Train 1938-41.

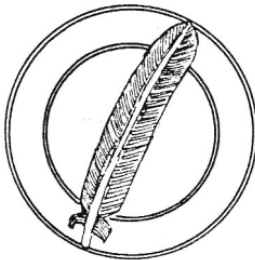

Constituted in the Regular Army 1 February 1921, assigned to the Hawaiian Division, and allotted to the Hawaiian Department. Headquarters organized 1 February 1922 at Schofield Barracks, TH. Subordinate elements organized as follows: Headquarters and Military Police Company, Hawaiian Division 1 February 1922 at Schofield Barracks, TH; 11th Signal Company 1 July 21 with personnel from B Company, 3rd Field Signal Battalion at Schofield Barracks, TH; 11th Tank Company (L) 18 November 1921 at Camp George G. Meade, MD; 11th Ordnance Company (M) 12 April 1921 at Schofield Barracks; and 11th Motorcycle Company 1 February 1922 at Schofield Barracks. Provisional Athletic Training Company was attached to Special Troops, Hawaiian Division on 1 February 1922. The 11th Tank Company arrived 15 June 1922 at Schofield Barracks from Camp Meade. The 11th Motorcycle

Company inactivated 31 May 1931 at Schofield Barracks. Hawaiian Division Pack Train attached 1 December 1938. Disbanded 1 October 1941.

Events: 33, 37, 75, 88, 120, 138, 141, 158, 189, 211, 225, 248, 276, 297, 312

Commanders, Special Troops, Hawaiian Division

Maj. Leland S. Devore	1 Feb 22-22 Aug 22	Maj. Roger B. Harrison	10 Aug 29-24 Jun 30
Lt. Col. Laurence P. Butler	22 Aug 22-14 Aug 23	Maj. Walter R. McClure	25 Jun 30-1 Mar 32
Lt. Col. Charles W. Weeks	3 Sep 23-27 Jun 24	Lt. Col. Anton C. Cron	1 Mar 32-31 May 34
Maj. William R. Schmidt	28 Jun 24-9 Jan 28	Lt. Col. Edwin Gunner	31 May 34-24 Jan 36
Lt. Col. John W. Pruyon	9 Jan 28-13 Apr 28	Lt. Col. Patrick J. Hurley	24 Jan 36-May 38
Maj. Josiah Kemp	13 Apr 28-10 Aug 29	Lt. Col. Charles H. Corlett	May 38-20 Sep 39
	Lt. Col. Jacob J. Gerhardt	21 Sep 39-12 Aug 41	

Headquarters, Special Troops, Philippine Division

HQ-*Not organized* 1921-22; Fort McKinley, PI, 1922-41

Subordinate elements-Headquarters and Military Police Company, Philippine Division 1921-41; 12th Signal Company (PS) 1921-41; 12th Ordnance Company (M) (PS) 1921-41; 12th Motorcycle Company (PS) 1921-36.

Constituted in the Regular Army 7 December 1921, assigned to the Philippine Division, and allotted to the Philippine Department. Headquarters organized 10 April 1922 at Fort McKinley, PI. Subordinate elements organized as follows: Headquarters and Military Police Company, Philippine Division 3 July 1921 at Fort McKinley; 12th Signal Company (PS) 21 June 1921 from the 1st Philippine Field Signal Battalion at Fort McKinley; 12th Ordnance Company (PS) (M) 10 April 1922 at Fort McKinley; and 12th Motorcycle Company (PS) 5 January 1922 at Manila, PI, (transferred in March 1922 to Fort McKinley). Location 7 December 1941—Fort McKinley, PI.

Events: 27, 35, 41, 52, 68, 82, 100, 118, 139, 169, 179, 198, 224, 245, 270

Commanders, Special Troops, Philippine Division

Capt. John D. Cook	14 Apr 22-15 Apr 22	Maj. Abraham Garfinkel	5 Oct 27-21 Feb 31
Maj. Hugh Straughn	15 Apr 22-6 Aug 22	Maj. Charles H. Lantz	21 Feb 31-26 Aug 33
Maj. Edward Parfitt	6 Aug 22-ao Nov 22	Maj. Conrad Skladal	26 Aug 33-31 Mar 36
Unknown	ao Nov 22-ao Mar 25	Lt. Col. Graham Garfinkel	1 Apr 36-28 Mar 38
Maj. Hugh Straughn	ao Mar 25-12 Jul 27	Lt. Col. Conrad Skladal	28 Mar 38-1 Jul 39
Capt. William A. Peterson	12 Jul 27-5 Oct 27	Maj. Archibald R. MacKechnie	1 Jul 39-ao Jan 40

Headquarters, Special Troops, 21st Cavalry Division

New York National Guard

HQ-*Not organized* 1921-39; West New Brighton, NY, 1939-40

Subordinate elements-Headquarters Troop, 21st Cavalry Division 1921-40; 21st Signal Troop 1921-40; *125th Ordnance Company (M)* 1921-40; *21st Tank Company (L)* 1928-40; *125th Veterinary Company* 1921-28.

Constituted in the National Guard in 1921, assigned to the 21st Cavalry Division, but not allotted to a state. Headquarters Troop was allotted to the state of Rhode Island in 1922, but subsequently withdrawn. All other elements allotted to the Second Corps Area until January 1939. Special Troops headquarters, division headquarters troop, and the 21st Signal Troop allotted in January 1939 to the state of New York. Elements organized as follows: Headquarters, Special Troops 1 October 1939 at West New Brighton, NY; Headquarters Troop, 21st Cavalry Division 6 December 1939 at West New Brighton; and 21st Signal Troop 13 December 1939 at West New Brighton. The 125th Ordnance Company and 21st Tank Company were allotted 12 October 1939 to the state of Connecticut, but not organized. Disbanded 30 September 1940.

Commanders, Special Troops, 21st Cavalry Division

Capt. Rolf Dallmer	1 Oct 39-30 Sep 40
--------------------	--------------------

Headquarters, Special Troops, 22nd Cavalry Division

Wisconsin/Pennsylvania National Guard

HQ-*Not organized* 1921-40; Harrisburg, PA, 1940

Subordinate elements-Headquarters Troop, 22nd Cavalry Division 1921-40; 22nd Signal Troop 1921-40; *126th Ordnance Company (M)* 1921-40; *22nd Tank Company (L)* 1928-40; *126th Veterinary Company* 1921-28.

Constituted in the National Guard in 1921 and assigned to the 22nd Cavalry Division. All subordinate elements, less the 22nd Signal Troop and the 126th Veterinary Company, allotted to the state of Wisconsin. Concurrently, the 22nd Signal Troop was allotted to the state of Indiana and the 126th Veterinary Company was allotted to the state of Ohio. Milwaukee, WI, designated 1922-29 as headquarters on organization, but the unit was never organized at that location. The only active element, Headquarters Troop, was organized and Federally recognized in 1922 at Madison, WI, and subsequently inactivated in 1926. Headquarters Troop conducted summer training at Camp Douglas, WI,

1922-25. The 22nd Tank Company, constituted in 1928, was allotted to the state of Ohio. All elements withdrawn from allotment to the states of Wisconsin and Indiana in February 1939 and allotted to the state of Pennsylvania, less the 126th Ordnance Company which was allotted to the state of Ohio. Subordinate elements organized as follows: 22nd Signal Troop 18 June 1939 at Philadelphia, PA; Headquarters Troop 20 November 1939 at Bloomsburg, PA, (relocated 3 January 1940 to Harrisburg, PA); Headquarters 3 January 1940 at Harrisburg. Disbanded 1 November 1940.

Commanders, Special Troops, 22nd Cavalry Division

Unknown 3 Jan 40-1 Nov 40

Headquarters, Special Troops, 23rd Cavalry Division

Alabama/Louisiana National Guard

HQ-*Not organized* 1921-40; New Orleans, LA, 1940

Subordinate elements-Headquarters Troop, 23rd Cavalry Division 1921-40; 23rd Signal Troop 1921-40; *127th Ordnance Company (M)* 1921-40; *23rd Tank Company (L)* 1928-40; *127th Veterinary Company* 1921-28.

Constituted in the National Guard in 1921, assigned to the 23rd Cavalry Division, and allotted to the state of Alabama. Subordinate elements allotted as follows: Headquarters Troop, 23rd Cavalry Division and 127th Veterinary Company allotted to the state of Alabama; 127th Ordnance Company and 23rd Signal Troop not allotted. Headquarters Troop, 23rd Cavalry Division organized 12 April 1921 and Federally recognized at Birmingham, AL. The 23rd Signal Troop allotted to the state of North Carolina in December 1925. Headquarters Troop, 23rd Cavalry Division called up to perform the following state duties: escort duty in connection with protecting negro prisoners against race riots in Birmingham 2-4 October 1931 and tornado relief duties at Northport, AL, 21-23 March 1932. Headquarters Troop redesignated Headquarters Troop, 55th Cavalry Brigade 15 April 1933. Allotments withdrawn in 1939 and reallocated as follows: Headquarters, Special Troops and Headquarters Troop, 23rd Cavalry Division allotted to the state of Louisiana; 23rd Signal Troop allotted to the state of Alabama; 127th Ordnance Company allotted to the state of Wisconsin; and the 23rd Tank Company allotted to the state of Illinois. The 23rd Signal Troop organized 1 October 1939 at Birmingham, AL. Headquarters, Special Troops organized in 1940 at New Orleans, LA. Headquarters Troop, 23rd Cavalry Division conducted summer training at Fort Oglethorpe, GA, or Fort McClellan, AL. Disbanded 1 November 1940.

Commanders, Special Troops, 23rd Cavalry Division

Unknown ao Jun 40-1 Nov 40

Headquarters, Special Troops, 24th Cavalry Division

Washington/Iowa National Guard

HQ-*Not organized* 1921-40

Subordinate elements-Headquarters Troop, 24th Cavalry Division 1921-40; 24th Signal Troop 1921-40; *128th Ordnance Company (M)* 1921-40; *24th Tank Company (L)* 1928-40; *128th Veterinary Company* 1921-28.

Constituted in the National Guard in 1921, assigned to the 24th Cavalry Division, and allotted to the state of Iowa. Subordinate elements allotted to the state of Iowa. Headquarters Troop, 24th Cavalry Division withdrawn from the state of Iowa in 1924 and allotted to the state of Washington. Headquarters Troop organized 1 November 1924 at Tacoma, WA, by redesignation of A Troop, 58th Machine Gun Squadron. Concurrently, the 24th Signal Troop was withdrawn from the state of Iowa and allotted to the state of South Dakota. The 24th Signal Troop withdrawn from the state of South Dakota 1 January 1939 and allotted to the state of Iowa. The 24th Signal Troop was organized 7 April 1939 at Sioux City, IA. Headquarters Troop conducted summer training at Camp Murray, WA. Disbanded 1 November 1940.

Events: 238, 303

Headquarters, Special Troops, 26th Division

Massachusetts National Guard

HQ-Not organized 1921-24; Allston, MA, 1924-40; Charlestown, MA, 1940-41; Camp Edwards, MA, 1941

Subordinate elements-Headquarters Company, 26th Division 1921-41; 26th Military Police Company 1921-41; 26th Signal Company 1921-41; 101st Ordnance Company (M) 1921-41; 26th Tank Company (L) 1921-40; *101st Motorcycle Company* 1921-36; *26th Service Company, Q.M.C.* 1927-36



Constituted in the National Guard in 1921, assigned to the 26th Division, and allotted to the state of Massachusetts. Headquarters organized and Federally recognized 20 May 1924 at Allston, MA. Subordinate elements organized and Federally recognized as follows: Headquarters Company, 26th Division 22 May 1924 at Boston, MA; 26th Military Police Company 1 April 1932 at Boston, MA, by redesignation of the 101st Wagon Company; 26th Signal Company 25 January 1921 at Charlestown, MA; 101st Ordnance Company (M) 20 May 1936 at Natick, MA; and 26th Tank Company (L) 11 March 1924 at Boston, MA. The 26th Military Police Company and 101st Ordnance Company called up for hurricane relief duty on Cape Cod in September 1938. Headquarters relocated 1 April 1940 to Charlestown.

The 26th Tank Company relieved 1 September 1940, redesignated B Company, 191st Tank Battalion, and assigned to the General Headquarters Reserve. Conducted summer training at Camp Devens, MA, or Camp Edwards, MA. Headquarters inducted 16 January 1941 into active Federal service at Charlestown. Transferred 21 January 1941 to Camp Edwards, MA. Location 7 December 1941—Camp Edwards, MA.

Status: Disbanded 3 February 1942.

Events: 91, 190, 280, 301, 330

Commanders, Special Troops, 26th Division

Maj. Roland H. Choate	20 May 24-6 May 30	Maj. Samuel E. Murray	25 Nov 31-18 Oct 36
Maj. William McGinnis	7 May 30-24 Nov 31	Maj. John F. Downing	19 Oct 36-3 Feb 42

Headquarters, Special Troops, 27th Division

New York National Guard

HQ-New York City, NY, 1921-40; Fort McClellan, AL, 1940-41

Subordinate elements-Headquarters Company, 27th Division 1921-41; 27th Military Police Company 1921-41; 27th Signal Company 1921-41; 102nd Ordnance Company (M) 1921-41; 27th Tank Company (L) 1921-40; 102nd Motorcycle Company 1921-36; *27th Service Company, Q.M.C.* 1927-36



Constituted in the National Guard 30 December 1920, assigned to the 27th Division, and allotted to the state of New York. Headquarters organized and Federally recognized 23 December 1921 at New York City, NY. Subordinate elements organized and Federally recognized as follows: Headquarters Company, 27th Division 15 November 1921 at New York City, NY; 27th Military Police Company 10 November 1921 at Yonkers, NY; 27th Signal Company 1 September 1921 at Brooklyn, NY; 102nd Ordnance Company (M) 15 November 1921 at New York City, NY; 27th Tank Company (L) 6 September 1921 at New York City, NY; and 102nd Motorcycle Company 23 December 1921 at Yonkers, NY. The 27th Signal Company laid 25 miles of wire to support the 27th Division and II Corps Headquarters during the 1929 Second Corps Area CPX at Camp Dix, NJ. Conducted summer training at Camp

Smith, NY, and Pine Camp, NY, less the 27th Tank Company which conducted summer training some years at Fort George G. Meade, MD. The 102nd Ordnance Company attended camp some years at Fort George G. Meade and Raritan Arsenal, NJ. The 27th Tank Company relieved 1 September 1940, redesignated A Company, 191st Tank Battalion, and assigned to the General Headquarters Reserve. Headquarters inducted 15 October 1940 into active Federal service at New York City. Transferred 25 October 1940 to Fort McClellan, AL. Location 7 December 1941—Fort McClellan, AL.

Status: Disbanded 25 February 1942.

Events: 190, 280, 301, 316, 324, 328

Commanders, Special Troops, 27th Division

Maj. John C. Mansfield

23 Dec 21-15 Oct 40

Maj. Harold S. Gould

15 Oct 40-Feb 41

Maj. George B. Barth (RA)

Feb 41-25 Feb 42

Headquarters, Special Troops, 28th Division

Pennsylvania National Guard

HQ-Philadelphia, PA, 1921-41; Indiantown Gap Military Reservation, PA, 1941

Subordinate elements-Headquarters Company, 28th Division 1921-41; 28th Military Police Company 1921-41; 28th Signal Company 1921-41; 103rd Ordnance Company (M) 1921-41; 28th Tank Company (L) 1921-40; 103rd Motorcycle Company 1921-36; *28th Service Company, Q.M.C.* 1927-36



Constituted in the National Guard in 1921, assigned to the 28th Division, and allotted to the state of Pennsylvania. Headquarters organized and Federally recognized 22 December 1921 at Philadelphia, PA. Subordinate elements organized and Federally recognized as follows: Headquarters Company, 28th Division 6 June 1922 at Philadelphia, PA; 28th Military Police Company 18 November 1921 at York, PA; 28th Signal Company 16 December 1921 at Pittsburgh, PA; 103rd Ordnance Company (M) 12 April 1922 at Philadelphia, PA; 28th Tank Company (L) 22 October 1921 at Norristown, PA; and 103rd Motorcycle Company 24 February 1921 at Philadelphia, PA. Conducted summer training at Mount Gretna and Indiantown Gap, less the 28th Tank Company which conducted summer training some years at Fort George G. Meade, MD. The 28th Tank Company relieved 1 September 1940. Headquarters inducted 17 January 1941 into active Federal

service at Philadelphia. Transferred 21 February 1941 to Indiantown Gap Military Reservation, PA. Location 7 December 1941—Indiantown Gap Military Reservation, PA.

Status: Disbanded 7 February 1942.

Events: 191, 203, 281, 301, 330

Commanders, Special Troops, 28th Division

Maj. David P. Simpson

22 Dec 21-24 Jan 28

Lt. Col. Charles H. Middleton

16 Jun 36-4 Dec 41

Maj. James B. Cousart

25 Jan 28-May 36

Maj. Kenneth F. Bowen

4 Dec 41-7 Feb 42

Headquarters, Special Troops, 29th Division

District of Columbia National Guard

HQ-Not organized 1921-26; Washington, DC, 1926-41; Fort George G. Meade, MD, 1941

Subordinate elements-Headquarters Company, 29th Division 1921-41; 29th Military Police Company 1921-41; 29th Signal Company 1921-41; 104th Ordnance Company (M) 1921-41; 29th Tank Company (L) 1921-40; *104th Motorcycle Company* 1928-36; *29th Service Company, Q.M.C.* 1927-36



Constituted in the National Guard in 1921, assigned to the 29th Division, and allotted to the District of

Columbia. Headquarters organized and Federally recognized 28 January 1926 at Washington, DC. Subordinate elements organized and Federally recognized as follows: Headquarters Company, 29th Division 7 April 1936 at Washington, DC; 29th Military Police Company 5 February 1924 at Washington, DC; 29th Signal Company 22 August 1924 at Norfolk, VA; 104th Ordnance Company (M) 1 April 1939 at Washington, DC; and 29th Tank Company (L) 17 October 1921 at Danville, VA. Conducted summer training, less the 29th Tank Company, at Camp Ritchie, Virginia Beach, VA, or some years at Indiantown Gap, PA. The 29th Tank Company conducted summer training at Fort George G. Meade, MD. The 29th Military Police Company conducted summer training at Camp Simms, DC, in 1924. Conducted the War Department-directed week of winter training at Fort George G. Meade 25 November-2 December 1939. The 29th Tank Company relieved 1 September 1940, redesignated C Company, 191st Tank Battalion, and assigned to the General Headquarters Reserve.

Headquarters inducted 3 February 1941 into active Federal service at Washington, DC. Transferred 5 February 1941 to Fort George G. Meade. Location 7 December 1941—Fort George G. Meade, MD.

Status: Disbanded 28 February 1942.

Events: 191, 281, 301

Commanders, Special Troops, 29th Division

Maj. Edward H. Grove
Lt. Col. William T. Roy

28 Jan 26-21 Jul 32
22 Jul 32-31 Dec 40

Maj. Louis M. Gosoran
Lt. Col. Phillip K. Moisan

1 Jan 41-8 Feb 41
8 Feb 41-11 Mar 42

Headquarters, Special Troops, 30th Division

Georgia National Guard

HQ-Not organized 1921-28; Forsyth, GA, 1928-30; Griffin, GA, 1930-40; Camp Jackson, SC, 1940-41

Subordinate elements-Headquarters Company, 30th Division 1921-41; 30th Military Police Company 1921-41; 30th Signal Company 1921-41; 105th Ordnance Company (M) 1921-41; 30th Tank Company (L) 1921-40; 105th Motorcycle Company 1921-36; *30th Service Company, Q.M.C.* 1927-36



Constituted in the National Guard in 1921, assigned to the 30th Division, and allotted to the state of Georgia. Headquarters organized and Federally recognized 8 June 1928 at Forsyth, GA. Headquarters relocated 12 December 1930 to Griffin, GA. Subordinate elements organized and Federally recognized as follows: Headquarters Company, 30th Division 9 October 1923 at Griffin, GA; 30th Military Police Company 1 June 1928 at Springfield, GA; 30th Signal Company 12 April 1921 at Canton, NC; 105th Ordnance Company (M) 8 May 1936 at Nashville, TN; 30th Tank Company (L) 15 August 1924 at Forsyth, GA; and 105th Motorcycle Company 20 June 1924 at Knoxville, TN. The 30th Tank Company called up to provide riot control during the textile workers' strike in Griffin, GA, 16-24 September 1934. Most elements conducted summer training at Camp Jackson, SC. The 30th Tank Company conducted summer training at Camp McClellan, AL; the 105th Motorcycle

Company conducted summer training some years at Camp Peay, TN. The 30th Tank Company relieved 1 September 1940, redesignated A Company, 193rd Tank Battalion, and assigned to the General Headquarters Reserve. Headquarters inducted 15 September 1940 into active Federal service at Griffin. Transferred 20 September 1940 to Camp Jackson. Location 7 December 1941—Camp Jackson, SC.

Status: Disbanded 7 February 1942.

Events: 255, 300, 316, 330

Commanders, Special Troops, 30th Division

Maj. Benjamin O. Childs

8 Jun 28-11 Dec 30
Maj. Roy LeCraw

Maj. Arthur K. Maddox
30 Sep 39-16 Feb 42

12 Dec 30-29 Sep 39

Headquarters, Special Troops, 31st Division

Alabama National Guard

HQ-Not organized 1923-25; Montgomery, AL, 1925-29; Mobile, AL, 1929-41; Camp Blanding, FL, 1941

Subordinate elements-Headquarters Company, 31st Division 1923-41; 31st Military Police Company 1923-41; 31st Signal Company 1923-41; 31st Ordnance Company (M) 1923-41; 31st Tank Company (L) 1923-40; 106th Motorcycle Company 1923-28; *31st Service Company, Q.M.C.* 1926-36



Constituted in the National Guard in 1921, assigned to the 31st Division, and allotted to the state of Alabama. Headquarters organized and Federally recognized 22 February 1925 at Montgomery, AL. Subordinate elements organized and Federally recognized as follows: Headquarters Company, 31st Division 19 April 1922 at Mobile, AL, as Headquarters Company, 39th Division and redesignated as Headquarters Company, 31st Division 1 July 1923; 31st Military Police Company 24 April 1936 at Prichard, AL; 31st Signal Company 26 April 1924 at Mobile, AL; 106th Ordnance Company (M) 22 December 1926 at Mobile, AL; 31st Tank Company (L) 1 July 1923 at Ozark, AL, by redesignation of the 39th Tank Company; and 106th Motorcycle Company 1 July 1923 at Jacksonville, FL, by redesignation of the 114th Motorcycle Company. Headquarters relocated by 1929 to Mobile, AL.

Subordinate elements were called up to perform the following state duties: 31st Signal Company for flood relief duty in Elba, AL, in March 1929; 31st Division Headquarters Company, 31st Signal Company, and 106th Ordnance Company for the protection of negro prisoners in the Mobile city jail 30 April 1931; 31st Signal Company for hurricane relief duty in south Alabama 28-31 March 1932. Elements conducted summer training at Camp McClellan, AL, Fort Oglethorpe, GA, Camp Beauregard, LA, or Camp Joseph E. Johnston, FL. The 31st Tank Company relieved 1 September 1940, redesignated B Company, 193rd Tank Battalion, and assigned to the General Headquarters Reserve. Headquarters inducted 25 November 1940 into active Federal service at Mobile. Transferred 22 December 1940 to Camp Blanding, FL. Location 7 December 1941—Camp Blanding, FL.

Status: Disbanded 10 February 1942.

Events: 56, 255, 300, 325, 328, 330

Commanders, Special Troops, 31st Division

Maj. James J. Alvarez

22 Feb 25-ao Nov 39

Lt. Col. George A. Haas

ao Nov 40-Feb 42

Headquarters, Special Troops, 32nd Division

Michigan National Guard

HQ-Not organized 1921-22; Detroit, MI, 1922-40; Camp Beauregard, LA, 1940-41; Camp Livingston, LA, 1941

Subordinate elements-Headquarters Company, 32nd Division 1921-41; 32nd Military Police Company 1921-41; 32nd Signal Company 1921-41; 107th Ordnance Company (M) 1921-41; 32nd Tank Company (L) 1921-40; 107th Motorcycle Company 1921-36; *32nd Service Company, Q.M.C.* 1927-36



Constituted in the National Guard in 1921, assigned to the 32nd Division, and allotted to the state of Michigan. Headquarters organized and Federally recognized 7 April 1922 at Detroit, MI. Subordinate elements organized and Federally recognized as follows: Headquarters Company, 32nd Division 7 April 1922 at Detroit, MI; 32nd Military Police Company 1 July 1923 at Arcadia, WI; 32nd Signal Company 1 July 1921 at Ypsilanti, MI; 107th Ordnance Company (M) 16 February 1922 at Pontiac, MI; 32nd Tank Company (L) 30 November 1921 at Janesville, WI; and 107th Motorcycle Company 31 January 1922 at Midland, MI. Michigan elements conducted summer training at Camp Grayling, MI, and Wisconsin elements at Camp Williams, WI. The 32nd Tank Company relieved 1 September 1940, redesignated A Company, 192nd Tank Battalion, and assigned to the General Headquarters Reserve. Headquarters inducted 15 October 1940 into active Federal service at Detroit.

Transferred 21 October 1940 to Camp Beauregard, LA. Transferred 15 February 1941 to Camp Livingston, LA. Location 7 December 1941—Camp Livingston, LA.

Status: Disbanded 16 January 1942.

Events: 214, 302, 320

Commanders, Special Troops, 32nd Division

Lt. Col. John J. Ostrander

7 Apr 22-16 Jan 42

Headquarters, Special Troops, 33rd Division**Illinois National Guard**

HQ-Not organized 1921-24; Chicago, IL, 1924-41; Camp Forrest, TN, 1941

Subordinate elements-Headquarters Company, 33rd Division 1921-41; 33rd Military Police Company 1921-41; 33rd Signal Company 1921-41; 108th Ordnance Company (M) 1921-41; 33rd Tank Company (L) 1921-40; 108th Motorcycle Company 1921-36; *33rd Service Company, Q.M.C.* 1927-36



Constituted in the National Guard in 1921, assigned to the 33rd Division, and allotted to the state of Illinois. Headquarters organized and Federally recognized 25 February 1924 at Chicago, IL. Subordinate elements organized and Federally recognized as follows: Headquarters Company, 33rd Division 17 December 1923 at Chicago; 33rd Military Police Company 29 October 1923 at Chicago; 33rd Signal Company 8 June 1922 at Chicago; 108th Ordnance Company (M) 29 October 1923 at Chicago; 33rd Tank Company (L) 13 December 1921 at Evanston, IL, disbanded 12 April 1929 and reorganized 3 May 1929 at Maywood, IL; and 108th Motorcycle Company 11 October 1923 at Chicago. Headquarters, 33rd Military Police Company, 33rd Signal Company and Headquarters Company, 33rd Division called up to perform disaster relief duties in connection with the Ohio River floods 29 January-16 February 1937. Conducted summer training at Camp

Grant, IL. For at least one year, in 1937, the unit also trained company-grade officers of the Special Troops, 86th Division at Camp Grant. The 33rd Tank Company relieved 1 September 1940, redesignated B Company, 192nd Tank Battalion, and assigned to the General Headquarters Reserve. Headquarters inducted 5 March 1941 into active Federal service at Chicago. Transferred 12 March 1941 to Camp Forrest, TN. Location 7 December 1941—Camp Forrest, TN.

Status: Disbanded 12 February 1942.

Events: 214, 302, 316, 324, 328

Commanders, Special Troops, 33rd Division

Maj. John E. Wolfe
Maj. James U. Sammis

25 Feb 24-14 Jun 27
15 Jun 27-4 Mar 36

Maj. Englebert J. Schmitz
Lt. Col. Herbert W. Carnwright

5 Mar 36-11 Nov 40
12 Nov 40-21 Feb 42

Headquarters, Special Troops, 34th Division**Iowa National Guard**

HQ-Not organized 1921-37; Council Bluffs, IA, 1937-41; Camp Claiborne, LA, 1941

Subordinate elements-Headquarters Company, 34th Division 1921-41; 34th Military Police Company 1921-41; 34th Signal Company 1921-41; *109th Ordnance Company (M)* 1921-41; 34th Tank Company (L) 1921-40; *109th Motorcycle Company* 1928-36; *34th Service Company, Q.M.C.* 1926-36



Constituted in the National Guard in 1921, assigned to the 34th Division, and allotted to the state of Iowa. Headquarters organized and Federally recognized 1 April 1937 at Council Bluffs, IA. Subordinate elements organized and Federally recognized as follows: Headquarters Company, 34th Division 21 May 1921 at Council Bluffs as Headquarters Company, 168th Infantry, redesignated Headquarters Company, 34th Division 4 November 1926; 34th Military Police Company 14 August 1939 at Aitkin, MN; 34th Signal Company 18 July 1929 at Watertown, SD; 109th Ordnance Company (M) 8 November 1939 at Minneapolis, MN; and 34th Tank Company (L) 25 May 1920 at Duluth, MN. Conducted summer training at Camp Dodge, IA. The 34th Tank Company relieved 1 September 1940, redesignated A Company, 194th Tank Battalion, and assigned to the General Headquarters Reserve. Headquarters inducted 10 February 1941 into active Federal service at Council

Bluffs. Transferred 20 February 1941 to Camp Claiborne, LA. Location 7 December 1941—Camp Claiborne, LA.

Status: Disbanded 30 January 1942.

Events: 233, 303, 320, 328

Commanders, Special Troops, 34th Division

Maj. Willard M. Gaines

1 Apr 37-ao Nov 39

Unknown

ao Nov 39-30 Jan 42

Headquarters, Special Troops, 35th Division**Missouri National Guard**

HQ-Not organized 1921-36; St. Joseph, MO, 1936-40; Camp Joseph T. Robinson, AR, 1940-41; Fort Ord, CA, 1941

Subordinate elements-Headquarters Company, 35th Division 1921-41; 35th Military Police Company 1921-41; 35th Signal Company 1921-41; 110th Ordnance Company (M) 1921-41; 35th Tank Company (L) 1921-40; *110th Motorcycle Company* 1928-36; *35th Service Company, Q.M.C.* 1927-36

Constituted in the National Guard in 1921, assigned to the 35th Division, and allotted to the state of Missouri. Headquarters, Special Troops, 35th Division organized and Federally recognized 25 April 1936 at St. Joseph, MO. Subordinate elements organized and Federally recognized as follows: Headquarters Company, 35th Division 8 December 1921 at Warrensburg, MO, as Headquarters Company, 70th Infantry Brigade, redesignated Headquarters Company, 35th Division 1 June 1923; 35th Military Police Company 29 June 1936 at Garden City, KS; 35th Signal Company 1 July 1921 at Kansas City, KS; 110th Ordnance Company (M) 10 November 1939 at Wichita, KS; and 35th Tank Company (L) 2 March 1923 at St. Joseph, MO. The 35th Signal Company called up to perform communications duties in connection with a coal miners' strike at Columbus, KS, 17 June-6 August 1935. Subordinate elements, less the 35th Signal Company, conducted summer training at Camp Clark, MO, 1923-39; 35th Signal Company conducted summer training at Fort Riley, KS. For at least two years, in 1939 and 1940, the unit also trained company-grade officers of the Special Troops, 102nd Division at Camp Clark. The 35th Tank Company relieved 1 September 1940, redesignated B Company, 194th Tank Battalion, and assigned to the General Headquarters Reserve. Headquarters inducted 23 December 1940 into active Federal service at St. Joseph. Transferred 29 December 1940 to Camp Joseph T. Robinson, AR. Transferred in November 1941 to Fort Ord, CA. Location 7 December 1941—Fort Ord, CA.

Status: Disbanded 3 February 1942.

Events: 236, 303, 316, 324, 328

Commanders, Special Troops, 35th Division

Maj. Paul T. Swenson 25 Apr 36-3 Feb 42

Headquarters, Special Troops, 36th Division**Texas National Guard**

HQ-Not organized 1921-37; San Antonio, TX, 1937-40; Camp Bowie, TX, 1940-41

Subordinate elements-Headquarters Company, 36th Division 1921-41; 36th Military Police Company 1921-41; 36th Signal Company 1921-41; 111th Ordnance Company (M) 1921-41; 36th Tank Company (L) 1921-40; *111th Motorcycle Company* 1928-36; *36th Service Company, Q.M.C.* 1927-36



Constituted in the National Guard in 1921, assigned to the 36th Division, and allotted to the state of Texas. Headquarters, Special Troops, 36th Division organized and Federally recognized 1 April 1937 at San Antonio, TX. Subordinate elements organized and Federally recognized as follows: Headquarters Company, 36th Division 8 March 1937 at San Antonio; 36th Military Police Company 23 May 1939 at San Antonio; 36th Signal Company 19 September 1922 at Denison, TX; 111th Ordnance Company (M) 15 March 1937 at San Antonio; and 36th Tank Company (L) 19 April 1937 at Houston, TX. The 36th Signal Company called up to perform crowd control duties in connection with a race riot at Sherman, TX, 9-12 May 1930. Conducted summer training at Camp Hulen, TX. The 36th Tank Company relieved 1 September 1940, redesignated C Company, 193rd Tank Battalion, and assigned to the General Headquarters Reserve. Headquarters inducted 24 November 1940 into active Federal service at San Antonio. Transferred 14 December 1940 to Camp

Bowie, TX. Location 7 December 1941—Camp Bowie, TX.

Status: Disbanded 31 January 1942.

Events: 258, 300, 317, 328

Commanders, Special Troops, 36th Division

Lt. Col. Henry L. Taylor

1 Apr 37-1 Jan 42

Maj. Van W. Pyland

1 Jan 42-31 Jan 42

Headquarters, Special Troops, 37th Division

Ohio National Guard

HQ-Not organized 1921-22; Chillicothe, OH, 1922-38; Columbus, OH, 1938-40; Camp Shelby, MS, 1940-41

Subordinate elements-Headquarters Company, 37th Division 1921-41; 37th Military Police Company 1921-41; 37th Signal Company 1921-41; 112th Ordnance Company (M) 1921-41; 37th Tank Company (L) 1921-40; 112th Motorcycle Company 1921-36; *37th Service Company, Q.M.C.* 1927-36



Constituted in the National Guard in 1921, assigned to the 37th Division, and allotted to the state of Ohio. Headquarters organized and Federally recognized 12 April 1922 at Chillicothe, OH. Subordinate elements organized and Federally recognized as follows: Headquarters Company, 37th Division (I) 12 July 1922 at Alliance, OH, redesignated 112th Ordnance Company (M) 1 January 1927; Headquarters Company, 37th Division (II) 7 April 1926 at Columbus, OH, as the 37th Military Police Company, redesignated Headquarters Company, 37th Division 1 January 1927; 37th Military Police Company (I) 7 April 1926 at Columbus, redesignated Headquarters Company, 37th Division 1 January 1927; 37th Military Police Company (II) 15 January 1921 at Columbus as the 112th Motorcycle Company; redesignated 37th Military Police Company 1 December 1928; 37th Signal Company 6 May 1921 at Columbus; 112th Ordnance Company (M)

12 July 1922 at Alliance, OH, as Headquarters Company, 37th Division; redesignated 112th Ordnance Company (M) 1 January 1927; 37th Tank Company (L) 1 July 1921 at Port Clinton, OH; and 112th Motorcycle Company 15 January 1921 at Columbus; redesignated 37th Military Police Company 1 January 1928; new 112th Motorcycle Company organized 27 December 1935 at St. Marys, OH. Subordinate elements were called up to perform the following state duties: 37th Tank Company to perform relief duties after a tornado disaster at Lorain-Sandusky OH, 28 June-11 July 1924; headquarters and subordinate companies to perform riot control during the Ohio State Penitentiary riot and fire 21-24 April 1930 and disaster relief duties in connection with the Ohio River floods of January-March 1937; 37th Signal Company to perform riot control during a workers' strike at the Mahoning Valley steel plants 22 June -15 July 1937. Headquarters relocated 1 January 1938 to Columbus. Conducted summer training at Camp Perry, OH. The 37th Tank Company conducted summer training many years at Fort George G. Meade, MD, and the 37th Military Police and 112th Ordnance Companies conducted summer training at Fort Knox, KY. Headquarters relocated 18 January 1938 to Columbus. The 37th Tank Company relieved 1 September 1940, redesignated C Company, 192nd Tank Battalion, and assigned to the General Headquarters Reserve. Headquarters inducted 15 October 1940 into active Federal service at Columbus. Transferred 20 October 1940 to Camp Shelby, MS. Location 7 December 1941—Camp Shelby, MS.

Status: Disbanded 16 January 1942.

Events: 213, 220, 302, 320, 328

Commanders, Special Troops, 37th Division

Maj. Louis S. Houser	12 Apr 22-18 Jan 38	Lt. Col. Willard H. Crawford	18 Feb 41-21 May 41
Maj. Simon P. Dunkle	18 Jan 38-18 Feb 41	Lt. Col. Loucks B. Brown	21 May 41-1 Feb 42

Headquarters, Special Troops, 38th Division

Indiana National Guard

HQ-Not organized 1921-24; Indianapolis, IN, 1924-41; Camp Shelby, MS, 1941

Subordinate elements-Headquarters Company, 38th Division 1921-41; 38th Military Police Company 1921-41; 38th Signal Company 1921-41; 113th Ordnance Company (M) 1921-41; 38th Tank Company (L) 1921-40; 113th Motorcycle Company 1921-36; *38th Service Company, Q.M.C.* 1927-36



Constituted in the National Guard 14 February 1921, assigned to the 38th Division, and allotted to the state of Indiana. Headquarters organized and Federally recognized 7 July 1924 at Indianapolis, IN. Subordinate elements organized and Federally recognized as follows: Headquarters Company, 38th Division 7 July 1924 at Indianapolis, IN; 38th Military Police Company 19 December 1921 at Jackson, KY; 38th Signal Company 10 June 1921 at Gary, IN; 113th Ordnance Company (M) 22 June 1936 at Bardstown, KY; 38th Tank Company (L) 29 March 1921 at Covington, KY; and 113th Motorcycle Company 1 July 1935 at Indianapolis. Subordinate elements were called up to perform the following state duties: 38th Tank Company to perform riot control duties in connection with a coal miners' strike at Newport, KY, 25 December 1921-30 April 1922; 38th Tank and 38th

Military Police Companies to perform riot control duties in connection with a trial at Lexington, KY, 1-2 April 1926; 38th Tank Company to perform riot control duties in connection with a coal miners' strike at the Straight Creek mining district 4 April-1 May 1929; 38th Tank Company to perform riot control duties in connection with a coal miners' strike at Harlan County, KY, 6 May-30 June 1931; headquarters and subordinate companies to perform disaster relief duties in connection with the Ohio River floods of January-March 1937. Conducted summer training at Camp Knox, KY. The 38th Tank Company relieved 1 September 1940, redesignated D Company, 192nd Tank Battalion, and assigned to the General Headquarters Reserve. Headquarters inducted 17 January 1941 into active Federal service at Indianapolis. Transferred 26 January 1941 to Camp Shelby, MS. Location 7 December 1941—Camp Shelby, MS.

Status: Disbanded 10 February 1942.

Events: 213, 220, 302, 320, 328

Commanders, Special Troops, 38th Division

Maj. Louis J. Koster	3 Jul 24-31 May 28	Maj. Robert M. Brewer	7 Sep 32-3 Oct 39
Maj. Ferdinand J. Huffman	1 Jun 28-6 Sep 32	Lt. Col. William R. Kester	4 Oct 39-1 Mar 42

Headquarters, Special Troops, 39th Division

Alabama National Guard

HQ-*Not organized* 1921-23

Subordinate elements-Headquarters Company, 39th Division 1921-23; *39th Military Police Company* 1921-23; *39th Signal Company* 1921-23; 114th Ordnance Company (M) 1921-23; 39th Tank Company (L) 1921-23; 114th Motorcycle Company 1921-23.

Constituted in the National Guard in 1921, assigned to the 39th Division, and allotted to the state of Alabama. Mobile, AL, designated as headquarters on organization, but the unit was never organized at that location. Subordinate elements organized and Federally recognized as follows: Headquarters Company, 39th Division 19 April 1922 at Mobile, AL; 114th Ordnance Company (M) in 1922 at Jacksonville, FL; 39th Tank Company (L) 11 May 1921 at Ozark, AL; and 114th Motorcycle Company 28 September 1921 at Jacksonville. Designated mobilization station was Camp McClellan, AL. Headquarters withdrawn from the State of Alabama 1 July 1923 and demobilized. Concurrently, subordinate elements redesignated as elements of the 31st Division.

Headquarters, Special Troops, 40th Division

California National Guard

HQ-*Not organized* 1921-36; Berkeley, CA, 1936-41; San Luis Obispo, CA, 1941

Subordinate elements-Headquarters Company, 40th Division 1921-41; 40th Military Police Company 1921-41; 40th Signal Company 1921-41; 115th Ordnance Company (M) 1921-41; 40th Tank Company (L) 1921-40; *115th Motorcycle Company* 1928-36; *40th Service Company, Q.M.C.* 1927-36



Constituted in the National Guard in 1921, assigned to the 40th Division, and allotted to the state of California. Headquarters organized and Federally recognized 10 April 1936 at Berkeley, CA. Subordinate elements organized and Federally recognized as follows: Headquarters Company, 40th Division 23 May 1939 at Los Angeles, CA; 40th Military Police Company 21 June 1928 at Reno, NV; 40th Signal Company 8 April 1921 at San Francisco, CA; 115th Ordnance Company (M) 28 April 1939 at Ogden, UT; and 40th Tank Company (L) 18 June 1924 at Salinas, CA. Subordinate elements were called up to perform the following state duties: 40th Tank Company to perform riot control duty at the Folsom State Prison 24-29 November 1927; 40th Tank Company to perform riot control duties in connection with the San Francisco street car workers' strike 5-21 July 1934. Conducted summer training at Camp San Luis Obispo, CA. The 40th Tank

Company relieved 1 September 1940, redesignated C Company, 194th Tank Battalion, and assigned to the General Headquarters Reserve. Headquarters inducted 3 March 1941 into active Federal service at Berkeley. Transferred 10 March 1941 to Camp San Luis Obispo, CA. Location 7 December 1941—Camp San Luis Obispo, CA.

Status: Disbanded 5 February 1942.

Events: 231, 304, 314, 326

Commanders, Special Troops, 40th Division

Lt. Col. Leonard H. Service

10 Apr 36-20 Sep 41

Maj. Eugene T. Severin

20 Sep 41-18 Feb 42

Headquarters, Special Troops, 41st Division

Washington National Guard

HQ-*Not organized* 1921-37; Centralia, WA, 1937-40; Camp Murray, WA, 1940-41; Fort Lewis, WA, 1941

Subordinate elements-Headquarters Company, 41st Division 1921-41; 41st Military Police Company 1921-41; 41st Signal Company 1921-41; 116th Ordnance Company (M) 1921-41; 41st Tank Company (L) 1921-40; *116th Motorcycle Company* 1928-36; *41st Service Company, Q.M.C.* 1927-36



Constituted in the National Guard in 1921, assigned to the 41st Division, and allotted to the state of Washington. Headquarters, Special Troops, 41st Division organized and Federally recognized 1 April 1937 at Centralia, WA. Subordinate elements organized and Federally recognized as follows: Headquarters Company, 41st Division 16 April 1936 at Blackfoot, ID; 41st Military Police Company 2 April 1939 at Green River, WY; 41st Signal Company (allotted in 1921 to the state of Washington, withdrawn and allotted to the state of Oregon in April 1936) 11 May 1936 at Portland, OR; 116th Ordnance Company (M) 1 April 1939 at Jerome, ID; and 41st Tank Company (L) 16 May 1922 at Centralia. The 41st Tank Company called up to perform riot control duty at the I. W. W. strike at Centralia 24-25 November 1927. Subordinate elements conducted summer training at Camp Murray, WA. The 41st Tank Company (inactive) relieved 1 September 1940,

redesignated D Company, 194th Tank Battalion, and assigned to the General Headquarters Reserve. Headquarters inducted 16 September 1940 into active Federal service at Centralia. Transferred 20 September 1940 to Camp Murray. Transferred 20 March 1941 to Fort Lewis, WA. Location 7 December 1941—Fort Lewis, WA.

Status: Disbanded 14 February 1942.

Events: 238, 304, 309, 314, 326

Commanders, Special Troops, 41st Division

Maj. Archer S. Kresky

1 Apr 37-ao Jul 40

Unknown

ao Jul 40-14 Feb 42

Headquarters, Special Troops, 43rd Division

Connecticut National Guard

HQ-Not organized 1921-25; Danielson, CT, 1925-41; Camp Blanding, FL, 1941

Subordinate elements-Headquarters Company, 43rd Division 1921-41; 43rd Military Police Company 1921-41; 43rd Signal Company 1921-41; 118th Ordnance Company (M) 1921-41; 43rd Tank Company (L) 1921-40; 118th Motorcycle Company 1921-36; *43rd Service Company, Q.M.C. 1926-36*

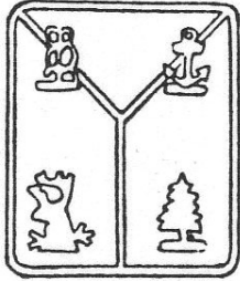

Constituted in the National Guard in 1921, assigned to the 43rd Division, and allotted to the state of Connecticut. Headquarters organized and Federally recognized 24 March 1925 at Danielson, CT. Subordinate elements organized and Federally recognized as follows: Headquarters Company, 43rd Division 6 June 1924 at Putnam, CT; 43rd Military Police Company (I) 4 March 1924 at Branford, CT, as 118th Motorcycle Company, redesignated 43rd Military Police Company 21 September 1927, further redesignated 43rd Tank Company 1 May 1931 and relocated to Hartford, CT; new 43rd Military Police Company (II) organized 1 May 1931 at Danielson, CT; 43rd Signal Company 21 March 1923 at Providence, RI; 118th Ordnance Company (M) 4 April 1939 at Providence; 43rd Tank Company (L) (I) organized 8 July 1921 at Branford as Battery A, 173rd FA, redesignated 43rd Tank Company (L) 28 March 1924, redesignated

Service Battery, 192nd FA 1 May 1931; 43rd Tank Company (L) (II) organized 4 March 1924 at Branford as 118th Motorcycle Company, redesignated 43rd Military Police Company 21 September 1927, redesignated 43rd Tank Company (L) 1 May 1931 and relocated to Hartford; and 118th Motorcycle Company organized 4 March 1924 at Hartford redesignated Military Police Company 21 September 1927. Elements were called up to perform the following state duties: headquarters, 43rd Military Police Company, and Headquarters Company, 43rd Division for riot control at the textile workers strike at Putnam and Danielson, CT, in September 1934; headquarters, 43rd Military Police Company, and Headquarters Company, 43rd Division for flood relief at Hartford, CT, 19 March-1 April 1936; headquarters, 43rd Military Police Company, and Headquarters Company, 43rd Division for hurricane relief at the vicinity of Rockville, CT, 22-27 September 1938. Conducted summer training at Niantic, CT. The 43rd Tank Company relieved 1 September 1940, redesignated D Company, 191st Tank Battalion, and assigned to the General Headquarters Reserve. Headquarters inducted 24 February 1941 into active Federal service at Danielson. Transferred 13 March 1941 to Camp Blanding, FL. Location 7 December 1941—Camp Blanding, FL.

Status: Disbanded 10 February 1942.

Events: 190, 280, 301, 325, 328, 330

Commanders, Special Troops, 43rd Division

Maj. Elbert L. Darbie

24 Mar 25-15 Jan 40

Maj. Arthur V. Williams

22 Jan 40-19 Feb 42

Headquarters, Special Troops, 44th Division

New Jersey National Guard

HQ-Not organized 1921-26; Orange, NJ, 1926-40; Fort Dix, NJ, 1940-41

Subordinate elements-Headquarters Company, 44th Division 1921-41; 44th Military Police Company 1921-41; 44th Signal Company 1921-41; 119th Ordnance Company (M) 1921-41; 44th Tank Company (L) 1921-40; 119th Motorcycle Company 1921-36; *44th Service Company, Q.M.C. 1927-36*



Constituted in the National Guard in 1921, assigned to the 44th Division, and allotted to the state of New Jersey. Headquarters organized and Federally recognized 25 February 1926 at Orange, NJ. Subordinate elements organized and Federally recognized as follows: Headquarters Company, 44th Division 3 April 1925 at Plainfield, NJ; 44th Military Police Company 16 March 1926 at Passaic, NJ; 44th Signal Company 3 December 1921 at Orange; 119th Ordnance Company (M) 25 February 1926 at Trenton, NJ; 44th Tank Company (L) (allotted to the state of Delaware in 1921, withdrawn in August 1935 and allotted to the state of New Jersey) 21 September 1939 at Orange, by redesignation of A Company, 119th Quartermaster Regiment; and 119th Motorcycle Company 8 February 1924 at Flemington, NJ. Elements called up to perform duties in connection with the following state emergencies:

guard and security duties in connection with the visit of President Franklin D. Roosevelt to Sea Girt, NJ, on 27 August 1932; entire special troops set up and operated a makeshift morgue at Sea Girt after the sinking of the S. S. *Morro Castle* in September 1934. Conducted summer training at Sea Girt. The 44th Tank Company disbanded 1 September 1940. Headquarters inducted 16 September 1940 into active Federal service at Orange. Transferred 26 September 1940 to Fort Dix, NJ. Location 7 December 1941—Fort Dix, NJ.

Status: Disbanded 20 February 1942

Events: 91, 190, 280, 301

Commanders, Special Troops, 44th Division

Lt. Col. Joseph B. Leimer 28 Mar 27-20 Feb 42

Headquarters, Special Troops, 45th Division

Oklahoma National Guard

HQ-Not organized 1921-24; Stillwater, OK, 1924-26; Oklahoma City, OK, 1926-34; Stillwater, OK, 1934-40; Fort Sill, OK, 1940-41; Camp Barkeley, TX, 1941

Subordinate elements-Headquarters Company, 45th Division 1921-41; 45th Military Police Company 1921-41; 45th Signal Company 1921-41; 120th Ordnance Company (M) 1921-41; 45th Tank Company (L) 1921-40; 120th Motorcycle Company 1921-36; *45th Service Company, Q.M.C.* 1927-36



Constituted in the National Guard in 1921, assigned to the 45th Division, and allotted to the state of Oklahoma. Headquarters organized and Federally recognized 20 February 1924 at Stillwater, OK. Headquarters successively relocated to Oklahoma City, OK, 2 July 1926 and back to Stillwater 18 June 1934. Subordinate elements organized and Federally recognized as follows: Headquarters Company, 45th Division (I) 11 April 1924 at Stillwater, OK, redesignated I Company, 179th Infantry 1 November 1934; Headquarters Company, 45th Division (II) 1 November 1934 at Wetumka, OK, by redesignation of I Company, 179th Infantry; 45th Military Police Company 11 February 1924 at Maud, OK; 45th Signal Company 27 April 1923 at Alva, OK; 120th Ordnance Company (M) 19 April 1923 at Claremore, OK; 45th Tank Company (L) 1 November 1921 at Denver, CO; and 120th Motorcycle Company in 1922 at Muskogee, OK.

Conducted summer training at Fort Sill, OK. The 45th Tank Company called up to perform duties in connection with the following state emergencies: Columbine Mine Strike, Boulder, CO, 21 November 1927-6 April 1928; grasshopper depredations in eastern Colorado 28 June-26 August 1937; and the Green Mountain Mine strike, Kremmling County, 3-31 August 1939. The 45th Tank Company relieved 1 September 1940, redesignated D Company, 193rd Tank Battalion, and assigned to the General Headquarters Reserve. Headquarters inducted 16 September 1940 into active Federal service at Stillwater. Transferred 23 September 1940 to Fort Sill, OK. Transferred 28 February 1941 to Camp Barkeley, TX. Location 7 December 1941—Camp Barkeley, TX.

Status: Disbanded 11 February 1942.

Events: 258, 300, 317, 328

Commanders, Special Troops, 45th Division

Maj. Turner Roack	20 Feb 24-15 Mar 25	Maj. James E. Berry	18 Jun 34-14 Sep 40
Maj. Otis M. Smith	16 Mar 25-16 Jul 26	Lt. Col. Joe J. Miller	15 Sep 40-Jan 41
Maj. Harry B. Gilstrap	17 Jul 26-14 Jun 34	Maj. Lee Gilstrap	Jan 41-17 Mar 41
	Lt. Col. Earl A. Taylor	17 Mar 41-22 Feb 42	

Headquarters, Special Troops, 61st Cavalry Division

Organized Reserve New York

HQ-Rochester, NY, 1921-41

Subordinate elements-Headquarters Troop, 61st Cavalry Division 1921-41-41; 61st Signal Troop 1921-41; 581st Ordnance Company (M) 1921-41; 461st Tank Company (L) 1928-41; 501st Veterinary Company 1921-28.

Constituted in the Organized Reserve 24 June 1921, assigned to the 61st Cavalry Division, and allotted to the Second Corps Area. Headquarters initiated 27 January 1922 at Rochester, NY. Subordinate elements organized as follows: Headquarters Troop, 61st Cavalry Division 7 April 1922 at Manhattan, NY; 61st Signal Troop 6 February 1922 at Buffalo, NY; 501st Veterinary Troop 6 February 1922 at Salamanca, NY; 581st Ordnance Company (M) 6 February 1922 at Oleon, NY; and the 461st Tank Company in early 1929 at New York City, NY. Conducted summer training at Miller Field, NY, with Special Troops, 1st Division, less 61st Signal Troop which conducted summer training at Fort Monmouth, NJ, or Camp Dix, NJ. Location 7 December 1941—Rochester, NY.

Status: Disbanded 30 January 1942.

Commanders, Special Troops, 61st Cavalry Division

Maj. Ernest Miller	27 Jan 22-27 Jun 22	Lt. Col. Richard N. Armstrong	11 May 37-24 Aug 38
Lt. Col. Carl H. Loeb	8 Nov 22-11 May 37	Maj. Ernest S. Knowlton	24 Aug 38-1 Mar 39
	Maj. James B. Spaulding	1 Mar 39-30 Aug 41	

Headquarters, Special Troops, 62nd Cavalry Division

Organized Reserve Maryland

HQ-Not initiated 1921-22; Hagerstown, MD, 1922-24; Towson, MD, 1924-41

Subordinate elements-Headquarters Troop, 62nd Cavalry Division 1921-41; 62nd Signal Troop 1921-41; 582nd Ordnance Company (M) 1921-41; 462nd Tank Company (L) 1928-41; 502nd Veterinary Company 1921-28.

Constituted in the Organized Reserve 24 June 1921, assigned to the 62nd Cavalry Division, and allotted to the Third Corps Area. Headquarters initiated by September 1922 at Hagerstown, MD. Subordinate elements organized as follows: Headquarters Troop, 62nd Cavalry Division in 1922 at Hagerstown; 62nd Signal Troop 7 December 1921 at Washington, DC; 502nd Veterinary Troop in 1922 at Hagerstown; 582nd Ordnance Company (M) in 1922 at Washington, DC; and the 462nd Tank Company in early 1929 at Baltimore, MD. Headquarters relocated 30 June 1924 to Towson, MD. Conducted summer training at Fort George G. Meade, MD, less 62nd Signal Troop which conducted summer training at Fort Monmouth, NJ. The 62nd Signal Troop conducted C.M.T.C. training some years at Fort George G. Meade as an alternate form of annual training. Location 7 December 1941—Towson, MD.

Status: Disbanded 30 January 1942.

Commanders, Special Troops, 62nd Cavalry Division

Maj. John Carmichael	ao Sep 22-ao Jan 23	Maj. J. M. Simpson	ao May 24-ao Jun 27
Unknown	ao Jan 23-ao May 24	Unknown	ao Jun 27-7 Dec 41

Headquarters, Special Troops, 63rd Cavalry Division

Organized Reserve Tennessee

HQ-Not initiated 1921-22; Chattanooga, TN, 1922-41

Subordinate elements-Headquarters Troop, 63rd Cavalry Division 1921-41; 63rd Signal Troop 1921-41; 583rd Ordnance Company (M) 1921-41; 463rd Tank Company (L) 1928-41; 503rd Veterinary Company 1921-28.

Constituted in the Organized Reserve 24 June 1921, assigned to the 63rd Cavalry Division, and allotted to the Fourth Corps Area. Headquarters initiated by December 1922 at Chattanooga, TN. Subordinate elements organized as follows: Headquarters Troop, 63rd Cavalry Division 6 May 1922 at Chattanooga; 63rd Signal Troop 5 April 1922 at New Orleans, LA; 503rd Veterinary Troop in 1922 at Jasper, TN; 583rd Ordnance Company (M) 10 April 1922 at Rome, GA; and the 463rd Tank Company in early 1929 at Anniston, AL. Conducted summer training at Fort Oglethorpe, GA, less 583rd Ordnance Company which conducted summer training at Fort Bragg, NC. Special Troops, 63rd Cavalry Division conducted C.M.T.C. training at Fort Oglethorpe in 1939 as an alternate form of annual training. Designated mobilization station for all elements, less the 63rd Signal Troop, was Fort Oglethorpe, GA; the 63rd Signal Troop's mobilization station was Camp Beauregard, LA. Location 7 December 1941—Chattanooga, TN.

Status: Disbanded 30 January 1942.

Commanders, Special Troops, 63rd Cavalry Division

Unknown	ao Dec 22-ao Nov 29	Maj. Howard Gaillard	ao Nov 29-ao Jan 30
	Unknown	ao Jan 30-7 Dec 41	

Headquarters, Special Troops, 64th Cavalry Division**Organized Reserve Kentucky/West Virginia**

HQ-Not initiated 1921-22; Louisville KY, 1922-37; Hinton, WV 1937-41

Subordinate elements—Headquarters Troop, 64th Cavalry Division 1921-41; 64th Signal Troop 1921-41; 584th Ordnance Company (M) 1921-41; 464th Tank Company (L) 1928-41; 504th Veterinary Company 1921-28.

Constituted in the Organized Reserve 24 June 1921, assigned to the 64th Cavalry Division, and allotted to the Fifth Corps Area. Headquarters initiated in January 1922 at Louisville, KY. Subordinate elements organized as follows: Headquarters Troop, 64th Cavalry Division in 1922 at Louisville; 64th Signal Troop in 1922 at Louisville; 504th Veterinary Troop in 1922 at Cox Creek, KY; 584th Ordnance Company (M) in 1922 at Covington, KY; and the 464th Tank Company in early 1929 at Harrodsburg, KY. Headquarters relocated 10 May 1937 to Hinton, WV. Conducted summer training at Fort Knox, KY. Location 7 December 1941—Hinton, WV.

Status: Disbanded 30 January 1942.

Commanders, Special Troops, 64th Cavalry Division

Maj. William H. Meadows	Jan 22-10 Jan 28 Unknown	Maj. Cornelius R. Lisanby 20 Jun 35-7 Dec 41	10 Jan 28-19 Jun 35
-------------------------	-----------------------------	---	---------------------

Headquarters, Special Troops, 65th Cavalry Division**Organized Reserve Illinois**

HQ-Not initiated 1921-22; Chicago, IL, 1922-41

Subordinate elements—Headquarters Troop, 65th Cavalry Division 1921-41; 65th Signal Troop 1921-41; 585th Ordnance Company (M) 1921-41; 465th Tank Company (L) 1928-41; 505th Veterinary Company 1921-28.

Constituted in the Organized Reserve 24 June 1921, assigned to the 65th Cavalry Division, and allotted to the Sixth Corps Area. Headquarters initiated 17 April 1922 at Chicago, IL. Subordinate elements organized as follows: Headquarters Troop, 65th Cavalry Division 6 June 1922 at Wilmette, IL; 65th Signal Troop 22 February 1922 at Evanston, IL; 505th Veterinary Troop in 1922 at Chicago; 585th Ordnance Company (M) in March 1922 at Evanston; and the 465th Tank Company in early 1929 at Chicago. Conducted summer training at Fort Sheridan, IL. The 465th Tank Company conducted summer training some years at Jefferson Barracks, MO, with the 6th Tank Company. Location 7 December 1941—Chicago, IL.

Status: Disbanded 30 January 1942.

Events: 156

Commanders, Special Troops, 65th Cavalry Division

Maj. Richmond A. Mead	17 Apr 22-Jan 26	Unknown	ao Jul 30-10 Oct 35
Maj. Lawrence M. Graham	Jan 26-ao Sep 27	Capt. Raymond D. Meade	10 Oct 35-13 Jan 36
Unknown	ao Sep 27-ao Jun 30	Capt. Irvine W. Barnett	13 Jan 36-ao Mar 36
Capt. Daniel M. Hollinshade	ao Jun 30-ao Jul 30	Unknown	ao Mar 36-7 Dec 41

Headquarters, Special Troops, 66th Cavalry Division**Organized Reserve Nebraska/Missouri**

HQ-Not initiated 1921-22; Omaha, NE, 1922-33; Kansas City, MO, 1933-41

Subordinate elements—Headquarters Troop, 66th Cavalry Division 1921-41; 66th Signal Troop 1921-41; 586th Ordnance Company (M) 1921-41; 466th Tank Company (L) 1928-41; 506th Veterinary Company 1921-28.

Constituted in the Organized Reserve 24 June 1921, assigned to the 66th Cavalry Division, and allotted to the Seventh Corps Area. Headquarters initiated by December 1922 at Omaha, NE. Subordinate elements organized as follows: Headquarters Troop, 66th Cavalry Division in 1922 at Omaha; 66th Signal Troop in 1922 at Omaha; 506th Veterinary Troop in 1922 at Omaha; 586th Ordnance Company (M) in 1922 at Omaha; and the 466th Tank Company in early 1929 at St. Paul, MN. Headquarters and all subordinate elements, less the 466th Tank Company, relocated in August 1933 to Kansas City, MO. Conducted summer training at Fort Riley, KS. The 466th Tank Company conducted summer training some years at Fort Snelling, MN, with the 7th Tank Company. Location 7 December 1941—Kansas City, KS.

Status: Disbanded 30 January 1942.

Commanders, Special Troops, 66th Cavalry Division

Unknown	ao Dec 22-ao Sep 25 Unknown	Maj. Emil Wolbach ao Aug 32-7 Dec 41	ao Sep 25-ao Aug 32
---------	--------------------------------	---	---------------------

Headquarters, Special Troops, 76th Division

Organized Reserve Connecticut

HQ-*Not initiated* 1921-22; Hartford, CT, 1922-41

Subordinate elements-Headquarters Company, 76th Division 1921-41; 76th Military Police Company 1921-41; 76th Signal Company 1921-41; 301st Ordnance Company (M) 1921-41; 76th Tank Company (L) 1921-40; 301st Motorcycle Company 1921-36; 76th Service Company, Q.M.C. 1921-36

Constituted in the Organized Reserve 24 June 1921, assigned to the 76th Division, and allotted to the First Corps Area. Headquarters initiated in February 1922 at Hartford, CT. Subordinate elements organized as follows: Headquarters Company, 76th Division in 5 May 1922 Hartford; 76th Military Police Company 5 August 1922 at Providence, RI; 76th Signal Company 5 August 1922 at New Haven, CT; 76th Tank Company (L) 6 August 1922 at Providence; 301st Ordnance Company in February 1922 at Bridgeport, CT; 301st Motorcycle Company in December 1922 at Bridgeport; and 76th Service Company 5 August 1922 at Bridgeport. The 76th Division Special Troops did not conduct unit meetings during the Inactive Training Period due to the wide scattering of personnel across the states of Connecticut and Rhode Island. Members attended meetings as individuals with other units of the division. Conducted summer training at Fort Devens, MA. The 76th Signal Company conducted summer training some years at Fort Monmouth, NJ, and the 301st Ordnance Company conducted summer training some years at the Springfield Armory, MA. Location 7 December 1941—Hartford, CT.

Status: Disbanded 30 January 1942.

Commanders, Special Troops, 76th Division

Lt. Col. William J. Shanahan Unknown	Feb 22-ao Jun 28 ao Jun 28-ao Jun 30 Unknown	Maj. John G. Mahoney Maj. David Fleming ao Jan 40-7 Dec 41	ao Jun 30-18 Sep 35 18 Sep 35-ao Jan 40
---	--	--	--

Headquarters, Special Troops, 77th Division

Organized Reserve New York

HQ-Manhattan, NY, 1921-41

Subordinate elements-Headquarters Company, 77th Division 1921-41; 77th Military Police Company 1921-41; 77th Signal Company 1921-41; 302nd Ordnance Company (M) 1921-41; 77th Tank Company (L) 1921-40; 302nd Motorcycle Company 1921-36; 77th Service Company, Q.M.C. 1921-36

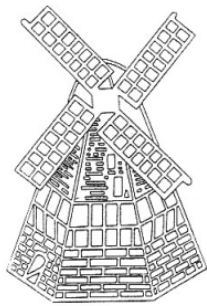

Constituted in the Organized Reserve 24 June 1921, assigned to the 77th Division, and allotted to the Second Corps Area. Headquarters initiated 30 August 1921 at Manhattan, NY. Subordinate elements organized at Manhattan as follows: Headquarters Company, 77th Division in September 1921; 77th Military Police Company 28 October 1921; 77th Signal Company 10 September 1921; 77th Tank Company (L) 24 October 1921; 302nd Ordnance Company 1 October 1921; 302nd Motorcycle Company 15 October 1921; and 77th Service Company 10 September 1921. Subordinate units conducted summer training at locations as follows: headquarters and 77th Tank Company at Miller Field, NY, with Special Troops, 1st Division; 77th Signal Company at Fort Monmouth, NJ; 77th Military Police Company at Fort Dix, NJ, Fort Niagara, NY, or Plattsburg Barracks, NY; 302nd Ordnance Company at Raritan Arsenal, NJ; and 302nd Motorcycle Company and 77th Service Company at Fort Hancock, NJ. Designated mobilization training station was Camp Dix, NJ. Location 7 December 1941—Manhattan, NY.

Status: Disbanded 30 January 1942.

Commanders, Special Troops, 77th Division

Lt. Col. Latham R. Reed	30 Aug 21-17 Jan 22	Lt. Col. William H. Draper, Jr.	ao Jan 31-16 Jun 34
Lt. Col. Harold A. Herrick	22 Apr 22-11 Aug 23	Lt. Col. Henry C. Turner	ao Jan 37-ao Jun 38
Lt. Col. Edward J. Robbins	11 Aug 23-ao Feb 24	Unknown	ao Jun 38-ao Jul 39
Lt. Col. Harold A. Herrick	ao Sep 27-6 Jan 29	Lt. Col. William H. Draper, Jr.	ao Jul 39-10 Nov 39
	Lt. Col. Harold A. Herrick	10 Nov 39-15 Jun 41	

Headquarters, Special Troops, 78th Division**Organized Reserve New Jersey****HQ**-*Not initiated* 1921-22; Newark, NJ, 1922-41**Subordinate elements**-Headquarters Company, 78th Division 1921-41; 78th Military Police Company 1921-41; 78th Signal Company 1921-41; 303rd Ordnance Company (M) 1921-41; 78th Tank Company (L) 1921-40; 303rd Motorcycle Company 1921-36; 78th Service Company, Q.M.C. 1921-36

Constituted in the Organized Reserve 24 June 1921, assigned to the 78th Division, and allotted to the Second Corps Area. Headquarters organized by December 1922 at Newark, NJ. Subordinate elements organized as follows: Headquarters Company, 78th Division in September 1921 at Newark; 78th Military Police Company 28 October 1921 at Newark; 78th Signal Company 19 September 1921 at Newark; 78th Tank Company (L) 24 October 1921 at Elizabeth; 303rd Ordnance Company 23 September 1921 at New Brunswick, NJ; 303rd Motorcycle Company 24 October 1921 at New Brunswick, NJ; and 78th Service Company 31 January 1922. Subordinate units conducted summer training at locations as follows: headquarters and 78th Tank Company at Miller Field, NY, with Special Troops, 1st Division; 78th Signal Company at Fort Monmouth, NJ; 78th Military Police Company at Fort Dix, NJ, Fort Niagara, NY, or Plattsburg Barracks, NY; 303rd Ordnance Company at Raritan Arsenal, NJ; and 303rd Motorcycle Company and 78th Service Company at Fort Hancock, NJ. Designated mobilization training station was Camp Dix, NJ. Location 7 December 1941—Newark, NJ.

Status: Disbanded 30 January 1942.**Commanders, Special Troops, 78th Division**

Unknown	ao Dec 22-12 Mar 23	Capt. Levon H. Shirvanian	17 May 37-19 Nov 37
Lt. Col. Henry S. Hildreth	12 Mar 23-May 29	Maj. Ridley M. Enslow	19 Nov 37-25 Aug 38
Maj. James L. Callaghan	May 29- ao Jun 34	Capt. Levon H. Shirvanian	26 Aug 38-19 Jul 39
Unknown	ao Jun 34-ao Jun 36	Maj. Ridley M. Enslow	20 Jul 39-28 Sep 39
Lt. Col. John H. M. Dudley	ao Jun 36-14 May 37	Lt. Col. William D. Sherman	28 Sep 39-9 Nov 40
	Lt. Col. Marion B. Richardson	9 Nov 40-ao Mar 41	

Headquarters, Special Troops, 79th Division**Organized Reserve Pennsylvania****HQ**-Philadelphia, PA, 1921-41**Subordinate elements**-Headquarters Company, 79th Division 1921-41; 79th Military Police Company 1921-41; 79th Signal Company 1921-41; 304th Ordnance Company (M) 1921-41; 79th Tank Company (L) 1921-40; 304th Motorcycle Company 1921-36; 79th Service Company, Q.M.C. 1921-36

Constituted in the Organized Reserve 24 June 1921, assigned to the 79th Division, and allotted to the Third Corps Area. Headquarters initiated 22 October 1921 at Philadelphia, PA. Subordinate elements organized as follows: Headquarters Company, 79th Division by September 1922 at Philadelphia; 79th Military Police Company in December 1921 at Columbia, PA; 79th Signal Company 13 December 1921 at Doylestown, PA; 79th Tank Company (L) in 1922 at Gettysburg, PA; 304th Ordnance Company 2 November 1921 at Pottstown, PA; 303rd Motorcycle Company in October 1921 at Pottstown, PA; and 79th Service Company by September 1922 at West Chester, PA.

Conducted summer training at Fort George G. Meade, MD. The 79th Signal Company conducted C.M.T.C. training many years at Fort George G. Meade as an alternate form of annual training. Designated mobilization training station was Fort George G. Meade. Location 7 December 1941—Philadelphia, PA.

Status: Disbanded 30 January 1942.**Commanders, Special Troops, 79th Division**

Maj. Edward V. Madeira	22 Oct 21-ao Sep 25	Unknown	ao Jun 30-ao Dec 31
Unknown	ao Sep 25-ao Mar 27	Lt. Col. Merle M. Burkhart	ao Dec 31- 6 Feb 40
Maj. James B. Anderson	ao Mar 27-ao Jun 30	Unknown	6 Feb 40-7 Dec 41

Headquarters, Special Troops, 80th Division**Organized Reserve Virginia****HQ**-Richmond, VA, 1921-41**Subordinate elements**-Headquarters Company, 80th Division 1921-41; 80th Military Police Company 1921-41; 80th Signal Company 1921-41; 305th Ordnance Company (M) 1921-41; 80th Tank Company (L) 1921-40; 305th Motorcycle Company 1921-36; 80th Service Company, Q.M.C. 1921-36

Constituted in the Organized Reserve 24 June 1921, assigned to the 80th Division, and allotted to the Third Corps Area. Headquarters initiated 22 October 1921 at Richmond, VA. Subordinate elements organized as follows: Headquarters Company, 80th Division by September 1922 at Richmond; 80th Military Police 12 December 1921 at Alexandria, VA; 80th Signal Company 16 December 1921 at Washington, DC; 80th Tank Company (L) by September 1922 at Richmond; 305th Ordnance Company 2 November 1921 at Richmond; 305th Motorcycle Company in December 1921 at Richmond; and 80th Service Company by September 1922 at Norfolk, VA. Conducted summer training at Fort George G. Meade, MD. The 80th Signal Company conducted C.M.T.C. training many years at Fort George G. Meade as an alternate form of annual training. Designated mobilization training station was Fort George G. Meade. Location 7 December 1941—Richmond, VA.

Status: Disbanded 30 January 1942.**Commanders, Special Troops, 80th Division**

Capt. B. L. Jenkins	28 Oct 21-22 May 22	Capt. Jack D. Thompson	ao Apr 33-May 34
Lt. Col. George E. Hoppe	22 May 22-ao May 32	Maj. Julian A. S. Meyer	May 34-ao Jun 41
Unknown	ao May 32-ao Apr 33	Unknown	ao Jun 41-7 Dec 41

Headquarters, Special Troops, 81st Division**Organized Reserve Tennessee****HQ**-Knoxville, TN, 1921-41**Subordinate elements**-Headquarters Company, 81st Division 1921-41; 81st Military Police Company 1921-41; 81st Signal Company 1921-41; 306th Ordnance Company (M) 1921-41; 81st Tank Company (L) 1921-40; 306th Motorcycle Company 1921-36; 81st Service Company, Q.M.C. 1921-36

Constituted in the Organized Reserve 24 June 1921, assigned to the 81st Division, and allotted to the Fourth Corps Area. Headquarters initiated 23 October 1921 at Knoxville, TN. Subordinate elements organized as follows: Headquarters Company, 81st Division 23 October 1921 at Knoxville; 81st Military Police Company in February 1922 at Raleigh, NC; 81st Signal Company 21 December 1921 at Nashville, TN; 81st Tank Company (L) in 1922 at Charlotte, NC; 306th Ordnance Company in 1922 at Winston-Salem, NC; 306th Motorcycle Company in 1922 at Brownsville, TN, and 81st Service Company in 1922 at Memphis, TN. Conducted summer training, less the 81st Signal Company, 306th Ordnance Company, and 81st Tank Company, at Fort McClellan, AL. Other elements conducted summer training at locations as follows: 81st Signal Company at Forts Monmouth, Bragg, or Benning; 306th Ordnance Company at Fort Bragg, NC; and 81st Tank Company at Fort Benning, GA, with the 4th Tank Company. Location 7 December 1941—Knoxville, TN.

Status: Disbanded 30 January 1942.**Commanders, Special Troops, 81st Division**

Unknown	23 Oct 21-ao Dec 23	Unknown	ao Feb 24-ao Apr 38
Lt. Col. William C. Gloster	ao Dec 23-ao Feb 24	Maj. Roy W. Rochelle	ao Apr 38-ao Jul 38
	Unknown	ao Aug 38-7 Dec 41	

Headquarters, Special Troops, 82nd Division**Organized Reserve South Carolina****HQ**-*Not initiated* 1921-22; Columbia, SC, 1922-41**Subordinate elements**-Headquarters Company, 82nd Division 1921-41; 82nd Military Police Company 1921-41; 82nd Signal Company 1921-41; 307th Ordnance Company (M) 1921-41; 82nd Tank Company (L) 1921-40; 307th Motorcycle Company 1921-36; 82nd Service Company, Q.M.C. 1921-36

Constituted in the Organized Reserve 24 June 1921, assigned to the 82nd Division, and allotted to the Fourth Corps Area. Headquarters initiated 14 January 1922 at Columbia, SC. Subordinate elements organized as follows: Headquarters Company, 82nd Division 14 January 1922 at Columbia; 82nd Military Police Company 14 January 1922 at Columbia; 82nd Signal Company 18 November 1921 at Macon, GA; 82nd Tank Company (L) 14 January 1922 at Columbus, GA; 307th Ordnance Company 18 November 1921 at Savannah, GA; 307th Motorcycle Company in November 1921 at Lawrenceville, GA; and 82nd Service Company in 1922 at Columbia. Conducted summer training, less the 82nd Signal Company, 307th Ordnance Company and 82nd Tank Company, at Fort McClellan, AL. Other elements conducted summer training at locations as follows: 82nd Signal Company at Forts Monmouth, NJ, Bragg, NC, or Benning, GA; 307th Ordnance Company at Fort Bragg, NC; and 82nd Tank Company at Fort Benning with the 4th Tank Company. Location 7 December 1941—Columbia, SC.

Status: Disbanded 30 January 1942.

Commanders, Special Troops, 82nd Division

Maj. William Lykes, Jr. Unknown	14 Jan 22-ao May 24 ao May 24-ao May 36 Unknown	Lt. Col. Roy T. Quick Capt. Barney L. Bickley ao Feb 38-7 Dec 41	ao May 36-2 May 37 2 May 37-ao Feb 38
------------------------------------	---	--	--

Headquarters, Special Troops, 83rd Division

Organized Reserve Ohio

HQ-*Not initiated* 1921-22; Columbus, OH, 1922-41

Subordinate elements-Headquarters Company, 83rd Division 1921-41; 83rd Military Police Company 1921-41; 83rd Signal Company 1921-41; 308th Ordnance Company (M) 1921-41; 83rd Tank Company (L) 1921-40; 308th Motorcycle Company 1921-36; 83rd Service Company, Q.M.C. 1921-36

Constituted in the Organized Reserve 24 June 1921, assigned to the 83rd Division, and allotted to the Fifth Corps Area. Headquarters initiated by Aug 22 at Columbus, OH. Subordinate elements organized as follows: Headquarters Company, 83rd Division in 1922 at Columbus; 83rd Military Police Company in August 1922 at Hicksville, OH; 83rd Signal Company 28 December 1921 at Columbus; 83rd Tank Company (L) in 1922 at Cincinnati, OH; 308th Ordnance Company in 1922 at Newton, OH; 308th Motorcycle Company in 1922 at Newton, OH; and 83rd Service Company in 1922 at Cincinnati. Conducted summer training, less the 83rd Signal Company and 308th Ordnance Company, at Fort Benjamin Harrison, IN, and some years at Fort Thomas, KY. Other elements conducted summer training at locations as follows: 83rd Signal Company at Fort Knox, KY, and 308th Ordnance Company at Rock Island Arsenal or Fort Knox. The 83rd Signal Company participated as a unit in the 1936 Second Army Maneuver at Fort Knox. Location 7 December 1941—Columbus, OH.

Status: Disbanded 30 January 1942.

Commanders, Special Troops, 83rd Division

Unknown ao Aug 22-7 Dec 41

Headquarters, Special Troops, 84th Division

Organized Reserve Indiana

HQ-Indianapolis, IN, 1921-41

Subordinate elements-Headquarters Company, 84th Division 1921-41; 84th Military Police Company 1921-41; 84th Signal Company 1921-41; 309th Ordnance Company (M) 1921-41; 84th Tank Company (L) 1921-40; 309th Motorcycle Company 1921-36; 84th Service Company, Q.M.C. 1921-36

Constituted in the Organized Reserve 24 June 1921, assigned to the 84th Division, and allotted to the Fifth Corps Area. Headquarters initiated 28 September 1921 at Indianapolis, IN. Subordinate elements organized as follows: Headquarters Company, 84th Division in 1922 at Indianapolis; 84th Military Police Company 3 November 1921 at Vincennes, IN; 84th Signal Company 25 January 1922 at Bloomington, IN; 84th Tank Company 24 October 1921 at Kokomo, IN; 309th Ordnance Company 24 October 1921 at Huntington, IN; 309th Motorcycle Company in October 1921 at Huntington; and 84th Service Company 24 October 1921 at Peru, IN. Conducted summer training, less the 84th Signal Company and 309th Ordnance Company, at Fort Benjamin Harrison, IN. Other elements conducted

summer training at locations as follows: 84th Signal Company and 309th Ordnance Company at Fort Knox, KY, or Rock Island Arsenal, IL. Location 7 December 1941—Indianapolis, IN.

Status: Disbanded 30 January 1942.

Commanders, Special Troops, 84th Division

Maj. Ruel E. Davenport	28 Sep 21-ao Jan 23	Capt. George M. Hann	ao Jun 35-ao Jul 36
Unknown	ao Jan 23-ao Jun 35	Unknown	ao Jul 37-7 Dec 41

Headquarters, Special Troops, 85th Division

Organized Reserve Michigan

HQ-*Not initiated* 1921-22; Detroit, MI, 1922-41

Subordinate elements—Headquarters Company, 85th Division 1921-41; 85th Military Police Company 1921-41; 85th Signal Company 1921-41; 310th Ordnance Company (M) 1921-41; 85th Tank Company (L) 1921-40; 310th Motorcycle Company 1921-36; 85th Service Company, Q.M.C. 1921-36

Constituted in the Organized Reserve 24 June 1921, assigned to the 85th Division, and allotted to the Sixth Corps Area. Headquarters initiated 25 March 1922 at Detroit, MI. Subordinate elements organized as follows: Headquarters Company, 85th Division 25 March 1922 at Detroit; 85th Military Police 5 January 1922 at Detroit; 85th Signal Company 22 February 1922 at Owasso, MI; 85th Tank Company (L) 14 January 1922 at Dearborn, MI; 310th Ordnance Company 30 December 1921 at Highland Park, MI; 310th Motorcycle Company 25 January 1922 at Mount Pleasant, MI; and 85th Service Company 19 December 1921 at Grand Rapids, MI. Conducted summer training, less the 85th Tank Company and 310th Ordnance Company, at Fort Sheridan, IL, or Camp Custer, MI. Other elements conducted summer training at locations as follows: 85th Tank Company at Peoria Tank Training Center, IL, and 310th Ordnance Company at Rock Island Arsenal, IL. Location 7 December 1941—Detroit, MI.

Status: Disbanded 30 January 1942.

Commanders, Special Troops, 85th Division

Capt. William L. Love	25 Mar 22-20 Apr 23	Lt. Col. Leslie N. Conger	Nov 25-ao Jul 32
Maj. Allen C. Tiffany	20 Apr 23-Nov 25	Unknown	ao Jul 32-7 Dec 41

Headquarters, Special Troops, 86th Division

Organized Reserve Illinois

HQ-*Not initiated* 1921-22; Chicago, IL, 1922-41

Subordinate elements—Headquarters Company, 86th Division 1921-41; 86th Military Police Company 1921-41; 86th Signal Company 1921-41; 311th Ordnance Company (M) 1921-41; 86th Tank Company (L) 1921-40; 311th Motorcycle Company 1921-36; 86th Service Company, Q.M.C. 1921-36

Constituted in the Organized Reserve 24 June 1921, assigned to the 86th Division, and allotted to the Sixth Corps Area. Headquarters initiated 6 May 1922 at Chicago, IL. Subordinate elements organized as follows: Headquarters Company, 86th Division 22 February 1922 at Chicago; 86th Military Police 21 March 1922 at Waukegan, IL; 86th Signal Company 10 March 1922 at Waukegan; 86th Tank Company (L) 28 December 1921 at Peoria Tank Training Center, IL; 311th Ordnance Company 6 March 1922 at Rock Island Arsenal, IL; 311th Motorcycle Company in 1922 at Chicago; and 86th Service Company 6 March 1922 at Chicago. Conducted summer training, less the 86th Tank Company and 311th Ordnance Company, at Fort Sheridan, IL, or Camp Custer, MI. Other elements conducted summer training at locations as follows: 86th Tank Company at Peoria Tank Training Center, IL, and 311th Ordnance Company at Rock Island Arsenal, IL. Location 7 December 1941—Chicago, IL.

Status: Disbanded 30 January 1942.

Commanders, Special Troops, 86th Division

Lt. Col. Watts C. Valentene	6 May 22-ao Jul 22	Unknown	ao Jul 29-ao Sep 30
Maj. Grover S. Sexton	ao Dec 22-3 Mar 23	Lt. Col. Henry C. Campbell	ao Sep 30-18 Nov 35
Maj. Mateo S. Game	3 Mar 23-ao Apr 23	Maj. Clarence J. Primm	18 Nov 35-27 Feb 36
Unknown	ao Apr 23-ao Jul 26	Maj. Holmes T. McFadden	29 Feb 36-21 Oct 37
Lt. Col. Alexander R. Brodie	ao Jul 26-ao Jul 29	Lt. Col. Henry J. Kleinhenn	21 Oct 37-Aug 41

Headquarters, Special Troops, 87th Division**Organized Reserve Louisiana****HQ**-*Not initiated* 1921-22; New Orleans, LA, 1922-41**Subordinate elements**-Headquarters Company, 87th Division 1921-41; 87th Military Police Company 1921-41; 87th Signal Company 1921-41; 312th Ordnance Company (M) 1921-41; 87th Tank Company (L) 1921-40; 312th Motorcycle Company 1921-36; 87th Service Company, Q.M.C. 1921-36

Constituted in the Organized Reserve 24 June 1921, assigned to the 87th Division, and allotted to the Fourth Corps Area. Headquarters initiated 14 February 1922 at New Orleans, LA. Subordinate elements organized as follows: Headquarters Company, 87th Division in 1922 at New Orleans; 87th Military Police 19 December 1921 at Jackson, MS; 87th Signal Company 28 December 1921 at New Orleans; 87th Tank Company (L) 28 December 1921 at Durant, MS; 312th Ordnance Company in 1922 at Birmingham, AL; 312th Motorcycle Company in December 1921 at Ville Platte, LA; and 87th Service Company 14 December 1921 at Lumberton, MS. Conducted summer training, less the 87th Signal Company, 312th Ordnance Company, and 87th Tank Company, at Fort McClellan, AL. Other elements conducted summer training at locations as follows: 87th Signal Company at Fort Monmouth, NJ, Fort Bragg, NC, or Fort Benning, GA; 312th Ordnance Company at Fort Bragg; and 87th Tank Company at Fort Benning with the 4th Tank Company. Location 7 December 1941—New Orleans, LA.

Status: Disbanded 30 January 1942.**Commanders, Special Troops, 87th Division**

Lt. Col. L. Kemper Williams	14 Feb 22-ao Sep 25	Maj. Leonce R. Legendre	ao Apr 37-7 Mar 37
Unknown	ao Sep 25-ao Apr 37	Unknown	8 Mar 37-7 Dec 41

Headquarters, Special Troops, 88th Division**Organized Reserve Minnesota****HQ**-Minneapolis, MN, 1921-41**Subordinate elements**-Headquarters Company, 88th Division 1921-41; 88th Military Police Company 1921-41; 88th Signal Company 1921-41; 313th Ordnance Company (M) 1921-41; 88th Tank Company (L) 1921-40; 313th Motorcycle Company 1921-36; 88th Service Company, Q.M.C. 1921-36

Constituted in the Organized Reserve 24 June 1921, assigned to the 88th Division, and allotted to the Seventh Corps Area. Headquarters organized 20 October 1921 at Minneapolis, MN. Subordinate elements organized as follows: Headquarters Company, 88th Division 26 April 1922 at Minneapolis; 88th Military Police 6 January 1922 at Minneapolis; 88th Signal Company 10 October 1921 at St. Paul, MN; 88th Tank Company (L) in 1922 at Allison, IA; 313th Ordnance Company in 1922 at Manchester, IA; 313th Motorcycle Company 9 May 1922 at Waterloo, IA; and 88th Service Company in 1922 at St. Paul. Conducted summer training, less the 88th Signal Company and 313th Ordnance Company, at Fort Snelling, MN. The 88th Signal Company conducted summer training at Fort Crook, NE, or Fort Leavenworth, KS. The 313th Ordnance Company conducted summer training at Rock Island Arsenal, IL. Location 7 December 1941—Minneapolis, MN.

Status: Disbanded 30 January 1942.**Commanders, Special Troops, 88th Division**

Unknown	20 Oct 21-26 Nov 21	Lt. Col. Minot J. Brown	Mar 27-Mar 34
Lt. Col. Paul S. Bliss	26 Nov 21-Mar 27	Col. William D. Nettleton	Mar 34-30 Jan 42

Headquarters, Special Troops, 89th Division**Organized Reserve Nebraska****HQ**-Omaha, NE, 1921-41**Subordinate elements**-Headquarters Company, 89th Division 1921-41; 89th Military Police Company 1921-41; 89th Signal Company 1921-41; 314th Ordnance Company (M) 1921-41; 89th Tank Company (L) 1921-40; 314th Motorcycle Company 1921-36; 89th Service Company, Q.M.C. 1921-36

Constituted in the Organized Reserve 24 June 1921, assigned to the 89th Division, and allotted to the Seventh Corps Area. Headquarters initiated 22 December 1921 at Omaha, NE. Subordinate elements organized as follows: Headquarters Company, 89th Division in 1922 at Omaha; 89th Military Police Company in February 1922 at Omaha; 89th Signal Company in January 1922 at Omaha; 89th Tank Company (L) in 1922 at Scottsbluff, NE; 314th Ordnance Company 6 January 1922 at Winfield, NE; 314th Motorcycle Company in January 1922 at Winfield; and 89th Service Company in 1922 at Omaha. Conducted summer training at Fort Crook, NE, less the 89th Signal Company which conducted summer training at Fort Leavenworth, KS. Location 7 December 1941—Omaha, NE.

Status: Disbanded 30 January 1942.

Commanders, Special Troops, 89th Division

Maj. John W. Haskell	22 Dec 21-ao Sep 25	Capt. Vern L. Cadwell	ao Mar 38-13 Jun 38
Unknown	ao Sep 25-ao Mar 38	Capt. Herbert C. Cass	13 Jun 38-27 Aug 38
	Unknown	27 Aug 38-7 Dec 41	

Headquarters, Special Troops, 90th Division

Organized Reserve Texas

HQ-San Antonio, TX, 1921-41

Subordinate elements—Headquarters Company, 90th Division 1921-41; 90th Military Police Company 1921-41; 90th Signal Company 1921-41; 315th Ordnance Company (M) 1921-41; 90th Tank Company (L) 1921-40; 315th Motorcycle Company 1921-36; 90th Service Company, Q.M.C. 1921-36

Constituted in the Organized Reserve 24 June 1921, assigned to the 90th Division, and allotted to the Eighth Corps Area. Headquarters initiated 12 December 1921 at the Bexar County Courthouse in San Antonio, TX. Subordinate elements organized as follows: Headquarters Company, 90th Division 29 December 1921 at San Antonio; 90th Military Police 23 January 1922 at San Antonio; 90th Signal Company 29 December 1921 at San Antonio; 90th Tank Company (L) 12 December 1921 at San Antonio; 315th Ordnance Company 23 January 1922 at San Antonio; 315th Motorcycle Company 23 January 1922 at Dallas, TX; and 90th Service Company 29 December 1921 at San Antonio. Typically conducted Inactive Training Period meetings at the Bexar County Courthouse and later at the Smith-Young Tower in San Antonio. Conducted summer training at Fort Sam Houston, TX, with Special Troops, 2nd Division. Location 7 December 1941—San Antonio, TX.

Status: Disbanded 30 January 1942.

Events: 147, 163

Commanders, Special Troops, 90th Division

Lt. Col. Ralph H. Durkee	12 Dec 21-4 Jan 30	Lt. Col. Sigmund M. Ekdahl	3 Jan 30-ao Jun 34
	Unknown	ao Jun 34-7 Dec 41	

Headquarters, Special Troops, 91st Division

Organized Reserve California

HQ-*Not initiated* 1921-22; San Francisco, CA, 1922-41; *Inactive* 1941

Subordinate elements—Headquarters Company, 91st Division 1921-41; 91st Military Police Company 1921-41; 91st Signal Company 1921-41; 316th Ordnance Company (M) 1921-41; 91st Tank Company (L) 1921-40; 316th Motorcycle Company 1921-36; 91st Service Company, Q.M.C. 1921-36

Constituted in the Organized Reserve 24 June 1921, assigned to the 91st Division, and allotted to the Ninth Corps Area. Headquarters initiated 1 March 1922 at San Francisco, CA. Subordinate elements organized as follows: Headquarters Company, 91st Division in 1922 at San Francisco; 91st Military Police 20 March 1922 at Alameda, CA; 91st Signal Company 20 December 1921 at Los Angeles, CA; 91st Tank Company (L) in 1922 at Stockton, CA; 316th Ordnance Company 30 December 1921 at San Francisco; 316th Motorcycle Company 30 December 1921 at Los Angeles, CA; and 91st Service Company 24 January 1922 at San Francisco. Conducted summer training, less the 316th Ordnance Company and the 91st Tank Company, at the Presidio of San Francisco or Del Monte, CA. The 316th Ordnance Company conducted summer training at Benecia Arsenal, CA. The 91st Tank Company conducted summer training at Fort Lewis, WA, with the 3rd Tank Company, at Del Monte with the 40th Tank Company, or at the Presidio of

Monterey, CA. Some years the 91st Signal Company at conducted summer training at the Presidio of Monterey and later at Fort Ord, CA. Headquarters inactivated 31 July 1941 at San Francisco by relief of personnel.

Location 7 December 1941—*Inactive*.

Status: Disbanded 30 January 1942.

Commanders, Special Troops, 91st Division

Capt. Cecil N. Dickinson	1 Mar 22-ao Apr 22	Unknown	ao Jun 28-ao Jun 32
Unknown	ao Apr 22-ao Nov 23	Lt. Col. Walter K. Knox	ao Jun 32-25 Jul 35
Maj. James R. Montgomery	ao Nov 23-ao Sep 25	Lt. Col. William G. Muldoon	25 Jul 35-16 Nov 35
Unknown	ao Sep 25-ao Jun 27	Lt. Col. Walter K. Knox	16 Nov 35-10 Jun 37
Lt. Col. Leo A. Strome	ao Jun 27-ao Jun 28	Capt. Paul B. Malone, Jr.	10 Jun 37-31 Jul 41

Headquarters, Special Troops, 94th Division

Organized Reserve Massachusetts

HQ-*Not initiated* 1921-22; Boston, MA, 1922-41

Subordinate elements-Headquarters Company, 94th Division 1921-41; 94th Military Police Company 1921-41; 94th Signal Company 1921-41; 319th Ordnance Company (M) 1921-41; 94th Tank Company (L) 1921-40; 319th Motorcycle Company 1921-36; 94th Service Company, Q.M.C. 1921-36

Constituted in the Organized Reserve 24 June 1921, assigned to the 94th Division, and allotted to the First Corps Area. Headquarters initiated 28 November 1921 at Boston, MA. Subordinate elements organized as follows: Headquarters Company, 94th Division in 5 May 1922 at Boston; 94th Military Police Company 5 May 1922 at Boston; 94th Signal Company 23 December 1921 at Boston; 94th Tank Company (L) 27 October 1921 at Worcester, MA; 319th Ordnance Company 5 August 1922 at Springfield, MA; 319th Motorcycle Company in November 1921 at Springfield, MA; and 94th Service Company 23 December 1921 at Boston. The 94th Division Special Troops did not conduct unit meetings during the Inactive Training Period due to the wide scattering of personnel across the state of Massachusetts. Members attended meetings as individuals with other units of the division. Conducted summer training at Fort Devens, MA. The 319th Ordnance Company conducted summer training some years at the Springfield Armory, MA, or Aberdeen Proving Ground, MD. The 94th Signal Company conducted summer training some years at Fort Monmouth, NJ. The 94th Signal Company also conducted C.M.T.C. in 1932 at Fort Devens as an alternate form of annual training. Location 7 December 1941—Boston, MA.

Status: Disbanded 30 January 1942.

Commanders, Special Troops, 94th Division

Unknown	28 Nov 21-14 Jan 22	Maj. Sherman O. Haight	Jun 27-ao Jan 31
Maj. Clarence A. Stearns	14 Jan 22-19 Apr 24	Unknown	ao Jan 31-8 Apr 36
Maj. George H. McCaffrey	19 Apr 24-Mar 25	Maj. Joseph McK. Driscoll	8 Apr 36-ao Jul 38
Maj. James N. McClure	Mar 25-Jun 27	Unknown	ao Jul 38-7 Dec 41

Headquarters, Special Troops, 95th Division

Organized Reserve Oklahoma

HQ-Oklahoma City, OK, 1921-41

Subordinate elements-Headquarters Company, 95th Division 1921-41; 95th Military Police Company 1921-41; 95th Signal Company 1921-41; 320th Ordnance Company (M) 1921-41; 95th Tank Company (L) 1921-40; 320th Motorcycle Company 1921-36; 95th Service Company, Q.M.C. 1921-36

Constituted in the Organized Reserve 24 June 1921, assigned to the 95th Division, and allotted to the Eighth Corps Area. Headquarters initiated 26 November 1921 at the Tradesman National Bank Building in Oklahoma City, OK. Subordinate elements organized as follows: Headquarters Company, 95th Division 26 November 1921 at Oklahoma City; 95th Military Police 26 November 1921 at Oklahoma City; 95th Signal Company 26 November 1921 at Oklahoma City; 95th Tank Company (L) 14 March 1922 at Oklahoma City; 320th Ordnance Company 26 November 1921 at Oklahoma City; 320th Motorcycle Company in December 1921 at Oklahoma City; and 95th Service 7 July 1922 at Oklahoma City. Conducted summer training at Fort Sam Houston, TX, with Special Troops, 2nd Division until 1933. Beginning in 1934, all 95th Division Special Troops trained at Fort Sill, OK. All elements conducted C.M.T.C. at Fort Sill in 1938. Location 7 December 1941—Oklahoma City, OK.

Commanders, Special Troops, 95th Division

Capt. Fred L. Ballein	26 Nov 21-26 Feb 23	Unknown	ao Jan 27-ao Sep 27
Lt. Col. Orval J. Johnson	27 Feb 23-ao Jan 27	Lt. Col. Fred L. Ballein	ao Sep 27-ao Nov 31
	Unknown	ao Nov 31-7 Dec 41	

Headquarters, Special Troops, 96th Division

Organized Reserve Washington

HQ-*Not initiated* 1921-22; Seattle, WA, 1922-41

Subordinate elements-Headquarters Company, 96th Division 1921-41; 96th Military Police Company 1921-41; 96th Signal Company 1921-41; 321st Ordnance Company (M) 1921-41; 96th Tank Company (L) 1921-40; 321st Motorcycle Company 1921-36; 96th Service Company, Q.M.C. 1921-36

Constituted in the Organized Reserve 24 June 1921, assigned to the 96th Division, and allotted to the Ninth Corps Area. Headquarters initiated in March 1922 at Portland, OR. Subordinate elements organized as follows: Headquarters Company, 96th Division in 1922 at Portland; 96th Military Police Company in March 1922 at Seattle, WA; 96th Signal Company 14 March 1922 at Seattle, WA; 96th Tank Company (L) 17 April 1922 at Portland; 321st Ordnance Company in 1922 at Seattle, WA; 321st Motorcycle Company in 1922 at Vancouver, WA; and 96th Service Company in 1922 at Seattle, WA. Conducted summer training at Fort Lewis, WA, with Special Troops, 3rd Division. Location 7 December 1941—Seattle, WA.

Status: Disbanded 30 January 1942.

Commanders, Special Troops, 96th Division

Maj. Dwight D. Hartman	Mar 22-ao May 24	Unknown	ao Jun 31-ao Jun 33
Unknown	ao May 24-ao Apr 29	Maj. Francis C. Fitzgerald	ao Jun 33-22 Mar 37
Maj. Edwin W. Elliot	ao Apr 29-ao Jun 31	Lt. Col. Archibald W. Melchior	22 Mar 37-ao Jul 39
	Unknown	ao Jul 39-7 Dec 41	

Headquarters, Special Troops, 97th Division

Organized Reserve Maine

HQ-*Not initiated* 1921-22; Augusta, ME, 1922-30; Manchester, NH, 1930-41

Subordinate elements-Headquarters Company, 97th Division 1921-41; 97th Military Police Company 1921-41; 97th Signal Company 1921-41; 322nd Ordnance Company (M) 1921-41; 97th Tank Company (L) 1921-40; 322nd Motorcycle Company 1921-36; 97th Service Company, Q.M.C. 1921-36

Constituted in the Organized Reserve 24 June 1921, assigned to the 97th Division, and allotted to the First Corps Area. Headquarters initiated by December 1922 at Augusta, ME. Subordinate elements organized as follows: Headquarters Company, 97th Division in 1922 at Augusta; 97th Military Police Company 5 August 1922 at Portland, ME; 97th Signal Company 6 July 1922 at Claremont, NH; 97th Tank Company (L) in 1922 at Pittsfield, NH; 322nd Ordnance Company 5 August 1922 at Claremont, NH; 322nd Motorcycle Company 6 August 1922 at Claremont, NH; and 97th Service Company in 5 August 1922 at Peterboro, NH. Headquarters relocated 28 November 1930 to Manchester, NH. The 97th Division Special Troops did not conduct unit meetings during the Inactive Training Period due to the wide scattering of personnel across the states of Maine and New Hampshire. Members attended meetings as individuals with other units of the division. Conducted summer training at Fort Devens, MA. The 97th Signal Company conducted summer training some years at Fort Monmouth, NJ. The 97th Tank Company conducted training with the 1st Tank Company in 1937 at Miller Field, NY. Location 7 December 1941—Manchester, NH.

Status: Disbanded 30 January 1942.

Commanders, Special Troops, 97th Division

Unknown	ao Dec 22-ao Sep 24	Unknown	ao Oct 24-ao Jul 35
Capt. Emery O. Beane	ao Sep 24-ao Oct 24	Capt. Eugene L. Tougas	ao Jul 35-ao Jul 38
	Unknown	ao Jul 38-7 Dec 41	

Headquarters, Special Troops, 98th Division**Organized Reserve New York****HQ**-Syracuse, NY, 1921-41**Subordinate elements**-Headquarters Company, 98th Division 1921-41; 98th Military Police Company 1921-41; 98th Signal Company 1921-41; 323rd Ordnance Company (M) 1921-41; 98th Tank Company (L) 1921-40; 323rd Motorcycle Company 1921-36; 98th Service Company, Q.M.C. 1921-36

Constituted in the Organized Reserve 24 June 1921, assigned to the 98th Division, and allotted to the Second Corps Area. Headquarters initiated 3 December 1921 at Syracuse, NY. Subordinate elements organized as follows: Headquarters Company, 98th Division in December 1921 at Syracuse; 98th Military Police Company 10 December 1921 at Buffalo, NY; 98th Signal Company 23 December 1921 at Schenectady, NY; 98th Tank Company (L) 3 December 1921 at Buffalo, NY; 323rd Ordnance Company (M) 23 December 1921 at Troy, NY; 323rd Motorcycle Company 8 October 1921 at Syracuse, NY; and 98th Service Company 25 January 1922 at Syracuse, NY. Subordinate units conducted summer training at locations as follows: headquarters and 98th Tank Company at Miller Field, NY, or Fort Dix, NJ, with Headquarters, Special Troops, 1st Division and the 1st Tank Company respectively; 98th Signal Company at Fort Monmouth, NJ, or Fort Dix with the 1st Signal Company; 98th Military Police Company at Fort Niagara, NY, or Plattsburg Barracks, NY; 323rd Ordnance Company at Raritan Arsenal, NJ, Miller Field, or Fort Dix; and 323rd Motorcycle Company and 98th Service Company at Fort Hancock, NJ. The 98th Signal Company conducted C.M.T.C. training at Fort Monmouth in 1926 as an alternate form of annual training. Location 7 December 1941—Syracuse, NY.

Status: Disbanded 30 January 1942.**Commanders, Special Troops, 98th Division**

Maj. J. C. Bronner	3 Dec 21-26 Mar 22	Unknown	11 Dec 27-23 Mar 35
Maj. F. E. Toy	26 Mar 22-10 Nov 24	Maj. Benjamin T. Rogers	22 Mar 35-8 Jul 37
Maj. Frederick C. Robbins	11 Nov 24-10 Mar 26	Maj. Ernest S. Knowlton	8 Jul 37-23 Aug 38
Lt. Col. William D. F. Leushner	11 Mar 26-10 Dec 27	Lt. Col. Clayton J. Herman	23 Aug 38-19 Sep 40
	Unknown	20 Sep 40-7 Dec 41	

Headquarters, Special Troops, 99th Division**Organized Reserve Pennsylvania****HQ**-*Not initiated* 1921-22; Pittsburgh, PA, 1922-41**Subordinate elements**-Headquarters Company, 99th Division 1921-41; 99th Military Police Company 1921-41; 99th Signal Company 1921-41; 324th Ordnance Company (M) 1921-41; 99th Tank Company (L) 1921-40; 324th Motorcycle Company 1921-36; 99th Service Company, Q.M.C. 1921-36

Constituted in the Organized Reserve 24 June 1921, assigned to the 99th Division, and allotted to the Third Corps Area. Headquarters initiated by September 1922 at Pittsburgh, PA. Subordinate elements organized at Pittsburgh as follows: Headquarters Company, 99th Division in 1922; 99th Military Police in February 1922; 99th Signal Company in December 1921; 99th Tank Company (L) in 1922; 324th Ordnance Company 12 December 1921; 324th Motorcycle Company in 1922; and 99th Service Company in 1922. Conducted summer training at Fort George G. Meade, MD. The 99th Signal Company conducted C.M.T.C. training at Fort George G. Meade as an alternate form of annual training. Location 7 December 1941—Pittsburgh, PA.

Status: Disbanded 30 January 1942.**Commanders, Special Troops, 99th Division**

Maj. Raymond P. Pennoyer	ao Sep 22-11 Jan 26	Maj. W. A. Kimble	ao Jun 31-ao Jan 37
Maj. John K. Stotz	11 Jan 26-ao Feb 27	Unknown	ao Jan 37-ao May 38
Unknown	ao Feb 27-ao Jun 31	Maj. Charles F. Knobloch	ao May 38-7 Sep 39
	Col. Harry D. McCluskey	7 Sep 39-5 May 41	

Headquarters, Special Troops, 100th Division**Organized Reserve West Virginia****HQ**-*Not initiated* 1921-22; Huntington, WV, 1922-41**Subordinate elements**-Headquarters Company, 100th Division 1921-41; 100th Military Police Company 1921-41; 100th Signal Company 1921-41; 325th Ordnance Company (M) 1921-41; 100th Tank Company (L) 1921-40; 325th Motorcycle Company 1921-36; 100th Service Company, Q.M.C. 1921-36

Constituted in the Organized Reserve 24 June 1921, assigned to the 100th Division, and allotted to the Fifth Corps Area. Headquarters initiated 30 November 1921 at Huntington, WV. Subordinate elements organized as follows: Headquarters Company, 100th Division in 1922 at Charleston, WV; 100th Military Police 22 December 1921 at Bluefield, WV; 100th Signal Company 30 November 1921 at Charleston, WV; 100th Tank Company (L) 30 November 1921 at Wheeling, WV; 325th Ordnance Company 30 November 1921 at South Charleston, WV; 325th Motorcycle Company in December 1921 at South Charleston, WV; and 100th Service Company 30 November 1921 at Charleston, WV. Conducted summer training, less the 100th Signal Company and 325th Ordnance Company, at Fort Benjamin Harrison, IN, or Fort Thomas, KY. Other elements conducted summer training at locations as follows: 100th Signal Company at Fort Knox, KY, and the 325th Ordnance Company at Fort Knox or Rock Island Arsenal, IL. Location 7 December 1941—Huntington, WV.

Status: Disbanded 30 January 1942.

Commanders, Special Troops, 100th Division

Capt. Ira M. Nickell	30 Nov 21-ao Jan 23	Capt. James L. Harvey	ao Jun 30-ao Jul 30
Unknown	ao Jan 23-ao Feb 24	Unknown	ao Jul 30-ao Jun 37
Maj. Walter C. Smith	ao Feb 24-ao Sep 24	Capt. George N. Biggs	ao Jun 37-ao Jun 38
Unknown	ao Sep 24-ao Jun 30	Unknown	ao Jun 38-7 Dec 41

Headquarters, Special Troops, 101st Division

Organized Reserve Wisconsin

HQ-Not initiated 1921-22; Milwaukee, WI, 1922-41

Subordinate elements-Headquarters Company, 101st Division 1921-41; 101st Military Police Company 1921-41; 101st Signal Company 1921-41; 326th Ordnance Company (M) 1921-41; 101st Tank Company (L) 1921-40; 326th Motorcycle Company 1921-36; 101st Service Company, Q.M.C. 1921-36

Constituted in the Organized Reserve 24 June 1921, assigned to the 101st Division, and allotted to the Sixth Corps Area. Headquarters initiated in June 1922 at Milwaukee, WI. Subordinate elements organized as follows: Headquarters Company, 101st Division by July 1922 at Milwaukee; 101st Military Police in May 1922 at Milwaukee; 101st Signal Company 27 October 1921 at Milwaukee; 101st Tank Company (L) 15 October 1921 at Milwaukee; 326th Ordnance Company 15 February 1922 at Milwaukee; 326th Motorcycle Company 20 February 1922 at Eau Claire, WI; and 101st Service Company 22 June 1922 at Milwaukee. Conducted summer training, less the 101st Tank Company and 326th Ordnance Company, at Fort Sheridan, IL, or Camp Custer, MI. Other elements conducted summer training at locations as follows: 101st Tank Company at Peoria Tank Training Center, IL, and 326th Ordnance Company at Rock Island Arsenal, IL. Location 7 December 1941—Milwaukee, WI.

Status: Disbanded 30 January 1942.

Commanders, Special Troops, 101st Division

Capt. Elmer G. Meyer	Jun 22-ao Jul 22	Unknown	ao Jul 29-ao Jul 32
Unknown	ao Jul 22-9 Jun 24	Lt. Col. Severin Swensen	ao Jul 32-ao Jun 39
Maj. William J. MacNeil	10 Jun 24-ao Jul 29	Unknown	ao Jun 39-7 Dec 41

Headquarters, Special Troops, 102nd Division

Organized Reserve Missouri

HQ-Not initiated 1921-22; St. Louis, MO, 1922-41

Subordinate elements-Headquarters Company, 102nd Division 1921-41; 102nd Military Police Company 1921-41; 102nd Signal Company 1921-41; 327th Ordnance Company (M) 1921-41; 102nd Tank Company (L) 1921-40; 327th Motorcycle Company 1921-36; 102nd Service Company, Q.M.C. 1921-36

Constituted in the Organized Reserve 24 June 1921, assigned to the 102nd Division, and allotted to the Seventh Corps Area. Headquarters initiated 12 October 1921 at St. Louis, MO. Subordinate elements organized at St. Louis as follows: Headquarters Company, 102nd Division in 1922; 102nd Military Police 8 November 1921; 102nd Signal Company 25 October 1921; 102nd Tank Company (L) 8 November 1921; 327th Ordnance Company 3 November 1921; 327th Motorcycle Company 8 November 1921; and 102nd Service Company 20 December 1921. Conducted summer training, less the 327th Ordnance Company, at Fort Leavenworth, KS. The 327th Ordnance Company

conducted summer training at Rock Island Arsenal, IL. Location 7 December 1941—St. Louis, MO.

Status: Disbanded 30 January 1942.

Commanders, Special Troops, 102nd Division

Lt. Col. Stephen E. Lowe	12 Oct 21-Jan 26	Unknown	ao Jan 32-ao Jul 38
Unknown	Jan 26-ao Mar 31	Capt. George N. Biggs	ao Jul 38-ao Aug 38
Maj. John R. Hundley	ao Mar 31-ao Jan 32	Unknown	ao Aug 38-7 Dec 41

Headquarters, Special Troops, 103rd Division

Organized Reserve Colorado

HQ-Denver, CO, 1921-41

Subordinate elements-Headquarters Company, 103rd Division 1921-41; 103rd Military Police Company 1921-41; 103rd Signal Company 1921-41; 328th Ordnance Company (M) 1921-41; 103rd Tank Company (L) 1921-40; 328th Motorcycle Company 1921-36; 103rd Service Company, Q.M.C. 1921-36

Constituted in the Organized Reserve 24 June 1921, assigned to the 103rd Division, and allotted to the Eighth Corps Area. Headquarters initiated 9 November 1921 at Room 515, Kittredge Building in Denver, CO. Subordinate elements organized at Denver as follows: Headquarters Company, 103rd Division 26 November 1921; 103rd Military Police 9 September 1921; 103rd Signal Company 9 September 1921; 103rd Tank Company (L) 26 November 1921; 328th Ordnance Company 26 November 1921; 328th Motorcycle Company 26 November 1921; and 103rd Service Company 26 November 1921. Typically conducted Inactive Training Period meetings at the Kittredge Building in Denver. Conducted summer training at Fort Sam Houston, TX, with Special Troops, 2nd Division until 1929. Beginning in 1930, all 103rd Division Special Troops trained most years at Fort Francis E. Warren, WY. Elements conducted C.M.T.C. at Fort Logan, CO, in 1936 and at Fort Huachuca, AZ, in 1938. Location 7 December 1941—Denver, CO.

Status: Disbanded 30 January 1942.

Events: 166

Commanders, Special Troops, 103rd Division

Capt. Daniel B. Miller	26 Nov 21-5 May 22	Maj. John C. Teichner	Nov 25-ao Jan 26
Maj. John D. Seerie	8 May 22-24 Dec 24	Lt. Col. August P. Hann	ao May 26-ao May 31
Maj. Virgil M. Kimbrow	24 Dec 24-Nov 25	Maj. Lawrence W. Mitchell	ao Dec 31-ao Sep 33
	Unknown	ao Sep 33-7 Dec 41	

Headquarters, Special Troops, 104th Division

Organized Reserve Utah

HQ-*Not initiated* 1921-22; Salt Lake City, UT, 1922-41

Subordinate elements-Headquarters Company, 104th Division 1921-41; 104th Military Police Company 1921-41; 104th Signal Company 1921-41; 329th Ordnance Company (M) 1921-41; 104th Tank Company (L) 1921-40; 329th Motorcycle Company 1921-36; 104th Service Company, Q.M.C. 1921-36

Constituted in the Organized Reserve 24 June 1921, assigned to the 104th Division, and allotted to the Ninth Corps Area. Headquarters organized by December 1922 at Salt Lake City, UT. Subordinate elements organized as follows: Headquarters Company, 104th Division in 1922 at Salt Lake City; 104th Military Police Company in 1922 in Idaho; 104th Signal Company in October 1922 at Great Falls, MT; 104th Tank Company (L) in 1922 at Casper, WY; 329th Ordnance Company in 1922 at Great Falls; 329th Motorcycle Company in September 1922 at Great Falls; and 104th Service Company in 1922 at Salt Lake City. Conducted summer training at Fort Douglas, UT, or Fort Lewis, WA, with Special Troops, 3rd Division. Location 7 December 1941—Salt Lake City, UT.

Status: Disbanded 30 January 1942.

Commanders, Special Troops, 104th Division

Unknown	ao Dec 22-7 Dec 41	Capt. Harold E. Wientsch	28 May 37-23 Mar 37
	Unknown	23 Mar 37-7 Dec 41	

