

Space Flight Operations Contract

Contingency Aborts 21007/31007

CONT ABT BR 21001 Student Handout
CONT ABT BR 31001 Student Handout
CONT ABT BR 32001 Student Handout
(OI-32)

February 14, 2007

Contract NAS9-20000

Copyright © 2004 by United Space Alliance, LLC. These materials are sponsored by the National Aeronautics and Space Administration under Contract NAS9-20000. The U.S. Government retains a paid-up, nonexclusive, irrevocable worldwide license in such materials to reproduce, prepare derivative works, distribute copies to the public, and to perform publicly and display publicly, by or on behalf of the U.S. Government. All other rights are reserved by the copyright owner.



Contingency Aborts 21007/31007

Lesson Name: Contingency Aborts 21007/31007
Instructors: DT34/Henry Lampazzi and Susan Crippen

Purpose: To introduce and demonstrate contingency abort profiles and procedures.

Training Scope: This handout is intended to provide the student with required contingency abort information, both as an introduction and a reference. It is used at both the Ascan training level (21007) and the crew training level (31007). Following this reading, the student will receive classroom briefings and a simulator session(s).

- The Ascan will receive an introductory 21070 simulator lesson in the Ascent/Entry Trainer (AET) or 21011 lesson in the Shuttle Mission Simulator (SMS).
- Flight specific crews will receive both 31011 and 32011 simulator lessons at either the SMS Motion Base. The simulator sessions will demonstrate a subset of the procedures introduced in this handout.

Additional Training: Contingency abort profiles have been animated and incorporated into a Computer-Based Training (CBT) lesson, CONT ABT 21057. This CBT is located on-line at http://usa10.unitedspacealliance.com/tx/ta_cbtlauncher/ under *Flight Operations - Shuttle - Flight Design*. Also the AET can be used for self-study to maintain proficiency with contingency procedures and profiles.



Contingency Aborts 21007/31007

Objective: The objective of the contingency abort lesson series is to demonstrate the various contingency abort procedures via classroom training, Flight Data File (FDF), and simulation. At the completion of this lesson the student will have been introduced to contingency aborts and will have the appropriate requisites to train for flight specific contingency aborts in an assigned crew environment.

Contents: Introduction
(also see table of contents next page) Ascent Elements
Entry Elements
Contingency Operations
Supplement Information

The focus of the lesson: Instructing how and why contingency abort procedures are executed.
Illustrating cockpit indications.
Demonstrating vehicle attitude for MECO, ET SEP, and entry.
Developing situational awareness concerning when a runway is achievable, when a runway is *not* achievable but attempted, and when the bailout procedure will be executed in lieu of a landing attempt.
Crew actions required for the best possible outcome.

Contingency Aborts 21007/31007

Table of Contents

SECTION 1	INTRODUCTION	7
1.1	Overview	7
1.1.1	Potential Contingency Abort (CA) Outcomes.....	7
1.1.2	Development of Contingency Abort Procedures	7
1.1.3	Contingency Abort Cue Card Physical Description.....	8
1.2	Generic Profile.....	9
1.2.1	Contingency Single-Engine Thrust Attitudes	9
1.2.2	Basic Contingency ET SEP/Entry Sequence	10
1.2.3	Nz Hold.....	11
1.2.4	Alpha Transition.....	11
1.3	BFS Limitations	12
1.4	Survivability	12
1.4.1	Survivable Zones:	12
1.4.2	Black Zones:.....	13
SECTION 2	ASCENT ELEMENTS	15
2.1	Contingency Software	15
2.2	Two-Engine-Out Contingency Guidance.....	15
2.2.1	Yaw Steering.....	16
2.3	Three-Engine-Out Contingency Guidance	17
2.3.1	Three-Engine-Out Guidance Activation	17
2.4	Droop Guidance	18
2.4.1	Droop Modes	18
2.4.2	How To Interpret The Droop Field	18
2.4.3	Droop Guidance Facts.....	19
2.4.4	Droop for 1 Engine Out (1 EO)	19
2.5	Control Stick Steering (CSS)	20
2.5.1	Powered Flight (MM 102, MM 103, or MM 601).....	20
2.5.2	Entry (MM 602, MM 603, MM 304, or MM 305)	20
2.5.3	Panel F2/F4	20
2.6	How To Activate MAN THROT	21
2.6.1	SBTC	21
2.7	How To Activate MAX THROT.....	22
2.7.1	MAX Throttle Logic	22
2.7.2	OVERRIDE Display (SPEC 51).....	23
2.8	SPEC 51 OMS dump	24
2.9	Fast ET Separation (Fast SEP)	25
2.9.1	Fast SEP Procedure.....	25

Contingency Aborts 21007/31007

2.9.2	Fast ET Sep times	25
2.9.3	Types of Fast ET SEP	26
2.10	Single Engine Roll Control (SERC)	29
2.10.1	First Stage	29
2.10.2	Second Stage	29
2.10.3	SERC Overview	30
SECTION 3	ENTRY ELEMENTS	31
3.1	Alpha Recovery	31
3.2	Nz Hold	31
3.2.1	Target Nz.....	32
3.2.2	Calculation of Target Nz	32
3.2.3	Cockpit Display of Target Nz.....	33
3.2.4	Target Nz and Alpha Trap.....	33
3.3	Adverse Aileron Trim.....	34
3.4	Speedbrake/Body Flap	36
3.5	Bailout Autopilot	36
SECTION 4	CONTINGENCY OPERATIONS	37
4.1	General Techniques.....	37
4.1.1	SFRM (Space Flight Resource Management)	37
4.2	FDF Requirements	37
4.3	Flight Instruments.....	38
4.3.1	A/E PFD - MM 601 - 2 EO ECAL Contingency Yaw Maneuver	39
4.3.2	A/E PFD - MM 602 - Nz Hold Phase With 20° Prebank.....	40
4.4	Two-Engine-Out Contingency Regions	41
4.4.1	Two-Engine-Out Contingency Abort (OPS 1)	41
4.4.2	RTLS Two-Engine-Out Contingency Abort (OPS 6).....	42
4.5	Two-Engine-Out Abort Cue Card Operations	43
4.5.1	Manual Two-Engine-Out Contingency Software Selection	43
4.5.2	Two-Engine-Out Contingency Software Termination	45
4.5.3	RTLS Two-Engine-Out Automated	45
4.5.4	RTLS Two-Engine-Out CSS Required	46
4.6	Three-Engine-Out Contingency Regions.....	47
4.6.1	Three-Engine-Out Contingency Abort (OPS 1).....	47
4.6.2	RTLS Three-Engine-Out Contingency Abort (OPS 6)	48
4.7	Three-Engine-Out Abort Cue Card Operations	49
4.7.1	Three-Engine-Out Contingency Software Selection	49
4.7.2	Three-Engine-Out Contingency Software Operations	49
4.7.3	Three-Engine-Out Contingency Software Termination.....	50
4.7.4	Three-Engine-Out Contingency Capabilities	50

Contingency Aborts 21007/31007

4.8	Droop Procedures.....	51
4.9	Stuck Procedures.....	55
	4.9.1 STUCK FIRST	55
	4.9.2 STUCK RTLS	55
	4.9.3 STUCK DROOP.....	56
	4.9.4 STUCK TAL.....	56
4.10	CONT ENTRY Procedures (MM 602 Entry).....	56
	4.10.1 Inhibiting ECAL/BDA Entry Guidance	56
	4.10.2 Adverse AIL Trim LOC Check	57
	4.10.3 Manual Speedbrake Requirement.....	57
	4.10.4 Target Nz and Nz Hold Verification.....	58
	4.10.5 Mach-Alpha Schedule.....	59
	4.10.6 Subsonic Stall	59
	4.10.7 Air Data Incorporation	60
4.11	Bailout Procedures	61
	4.11.1 BAILOUT Software Activation.....	61
	4.11.2 Report Position	61
4.12	2 EO ECAL/BDA Aborts.....	62
	4.12.1 2 EO ECAL/BDA "Yaw" Window Conditions	63
	4.12.2 2 EO ECAL/BDA "Yaw" Procedure	64
	4.12.3 POWERED ECAL/BDA Procedure	65
4.13	3 EO ECAL/BDA Aborts.....	66
	4.13.1 3 EO ECAL/BDA Site Selection	66
4.14	ECAL/BDA ENTRY Procedure.	67
	4.14.1 ECAL/BDA Entry Software Enable.....	67
	4.14.2 ECAL/BDA Basic Entry Profile.....	67
	4.14.3 Nz Hold Prebank.....	68
	4.14.4 ECAL/BDA Entry Bank.....	68
	4.14.5 ECAL/BDA Entry High Energy Control.....	70
	4.14.6 ECAL/BDA Entry Energy Management - Alpha, Bank.....	71
	4.14.7 ECAL/BDA Entry Energy Assessment	72
	4.14.8 ECAL/BDA Entry Navaid Management.....	73
	4.14.9 ECAL/BDA TAEM transition	73
	4.14.10 ECAL/BDA Entry Bailout Assessment	73
SECTION 5	SUPPLEMENTAL INFORMATION	74
5.1	Numbers/Gauges	74
5.2	Acronyms and Abbreviations	75
5.3	Index.....	76
5.4	Your Personal Notes.....	78

Contingency Aborts 21007/31007

Section 1 Introduction

1.1 Overview

Contingency abort procedures are executed when multiple main engines fail or suffer a performance degradation that results in the loss of all other intact abort options.

1.1.1 Potential Contingency Abort (CA) Outcomes

Contingency aborts may touchdown at an Emergency Landing Site (ELS), including Bermuda (BDA) or East Coast Abort Landing (ECAL) sites as well as sites across the Atlantic, at a Transoceanic Abort Landing (TAL) site, or at Kennedy Space Center (KSC).

A bailout from gliding flight and subsequent ditching of the orbiter may be the only available option.

Some CA regions are not survivable. These CA regions are known as **black zones**.

1.1.2 Development of Contingency Abort Procedures

Much of our learning has been accomplished through analysis of various simulations.

Some learning has been gained through extrapolation of the known; some engineering judgments of the unknown have been calculated and/or hypothesized.

Contingency Aborts 21007/31007

1.1.3 Contingency Abort Cue Card Physical Description

Each procedure is shown on a two-sided cue card with color-coded references.

The CONTINGENCY ABORT side contains procedures that are used when entering contingency abort software from OPS 1 after multiple Space Shuttle Main Engine (SSME) failures. Thus the CONTINGENCY ABORT side is used after multiple SSME failures are experienced while on uphill or TAL profiles.

The RTLS CONTINGENCY side contains the procedures that are used when entering contingency abort software from OPS 6 after multiple SSME failures. Thus the RTLS CONTINGENCY side is used for multiple SSME failures during Return to Launch Site (RTLS) profiles.

Each side of the card is composed of procedural blocks, which require crew action to properly activate the contingency abort software, and monitor blocks, which describe the contingency maneuver in progress.

CONTINGENCY ABORT	Three-Engine-Out (3 OUT) scenarios	Three Procedure Blocks Five Colored Monitor Blocks
	Two-Engine-Out (2 OUT) scenarios	Three Procedure Blocks Two Colored Monitor Blocks
	STUCK MIN THROTTLE and One-Engine-Out (STUCK) scenarios	Flight Specific - Up to as many as five procedural paths
	Contingency Entry (CONT ENTRY)	One Procedure Block
RTLS CONTINGENCY	RTLS Three-Engine-Out (3 OUT) scenarios	Two Procedure Blocks Four Colored Monitor Blocks
	RTLS Two-Engine-Out (2 OUT) scenarios	Two Procedure Blocks Five Colored Monitor Blocks
	Contingency Entry (CONT ENTRY)	One Procedure Block

Contingency Aborts 21007/31007

1.2 Generic Profile

The primary function of contingency abort software and procedures is to recover the space shuttle vehicle from a poor thrust versus attitude situation into safe glided flight in preparation for either bailout or landing. In doing so, the primary events during two- and three-engine-out contingency aborts are as follows.

1.2.1 Contingency Single-Engine Thrust Attitudes

In two-engine-out situations, contingency guidance will fly a single engine thrust attitude that will minimize the pullout severity post Main Engine Cutoff (MECO).

For high \dot{H} (vertical velocity) ($> +1850$ fps for high or $> +1330$ fps for mid and low inclinations), low velocity profiles, a more horizontal profile will be flown to minimize the pullout. A horizontal attitude will use the remaining thrust to increase the horizontal component of velocity and thus shallow the flight path angle.

For low \dot{H} ($\leq +1850$ fps for high or $\leq +1330$ fps for mid and low inclinations), high altitude profiles, a more vertical attitude is flown ("stand on the tail") in order to minimize the sink rate. In this case, the profile already has a larger horizontal than vertical velocity component. Hence, a vertical attitude is used to minimize the downward trend generated by loss of thrust.

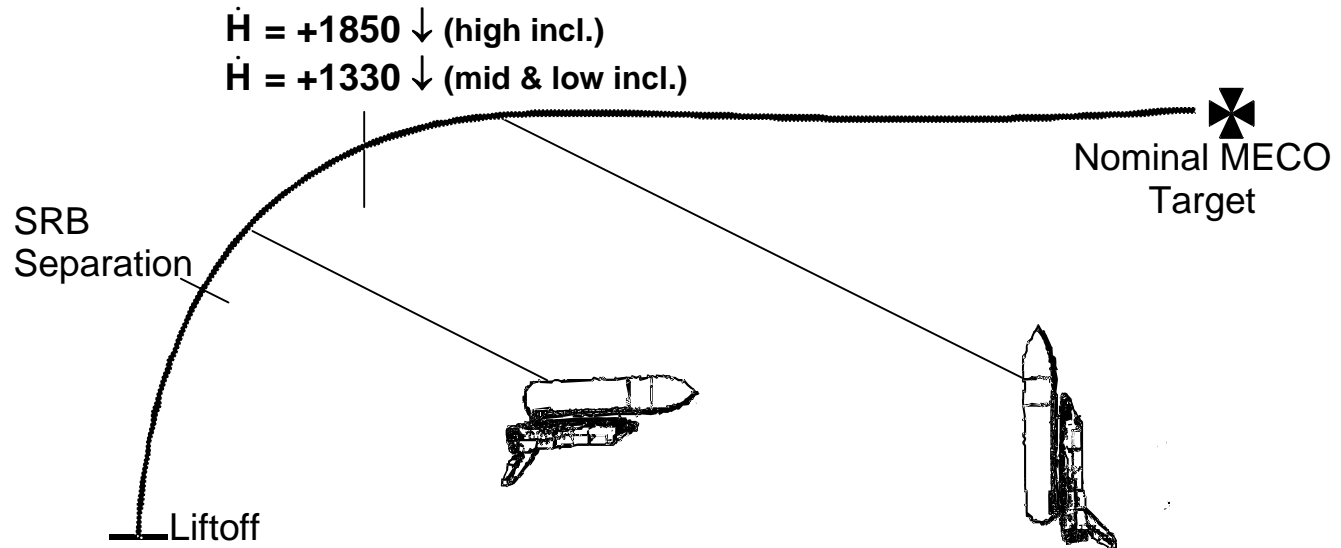

Contingency Aborts 21007/31007

Early in second stage, when first passing through $\dot{H} = +1850/1330$ fps, contingency guidance may require a “combined” maneuver which initially pitches horizontal to increase the horizontal velocity component, then pitches vertical to reduce the sink rate. By combining both aspects, the “combined” maneuver will more effectively reduce the entry pullout.

1.2.2 Basic Contingency ET SEP/Entry Sequence

In both two- and three-engine-out situations, contingency guidance will maneuver to a safe External Tank separation (ET SEP) and entry attitude as follows:

- a. Dependent upon current trajectory conditions, one of six possible set-ups/maneuvers (described in [Section 2.9](#)) will be performed to prepare for ET separation.
- b. MECO will be commanded (for two-engine-out situations).
- c. Some contingency maneuvers (RTLS two-engine-out near $V_{rel} = 0$) will have an extended Mated Coast (still attached to the ET) to allow further alpha reduction with a brief Orbital Maneuvering System (OMS) burn during Mated Coast, which will reduce ET propellant slosh dynamics. The reduced alpha is required to improve ET separation dynamics.
- d. A safe separation from the ET will be performed using the **Fast SEP** portion of the ET SEP sequence software once the appropriate attitude is achieved.
- e. A -Z translation will be commanded in order to provide a safe separation distance from the ET.
- f. Post ET SEP, the vehicle maneuvers to a predetermined alpha (α) for entry via the shortest path (**α recovery**).

The post ET SEP attitude is heads up, wings level, and flying a specific α with the nose pointed into the wind.

- g. Once in entry attitude, an automatic transition from MM 601 to MM 602 will occur.
- h. Once in MM 602, a dump of OMS propellant through the Orbital Maneuvering Engines (OMEs) and Aft Reaction Control System (ARCS) jets is accomplished to decrease weight and improve the X c.g. for entry (if required).

Contingency Aborts 21007/31007

1.2.3 Nz Hold

Once in the entry flight phase, the pullout must be managed by controlling g's or acceleration normal to the Z-axis (N_z) and Equivalent Airspeed (EAS). N_z is decreased by reducing α . However, reducing α will also increase the EAS. Thus guidance will select a target N_z g-level to balance the trade between N_z and EAS constraints and the vehicle gradually pitches down accordingly to hold that g-level. This is referred to as Nz Hold (see [Section 3.2](#)).

1.2.4 Alpha Transition

During the Nz hold phase the orbiter's descent rate (\dot{H}) can be quite high (much greater than -1000 fps). As the vehicle descends into the atmosphere, this descent rate quickly slows, becoming less negative. When the \dot{H} is -320 and climbing, that is becoming less negative ($\dot{H} = -320 \uparrow$), the Nz Hold phase is complete and the Alpha Transition phase starts. Here, the vehicle flies a wings-level attitude and an α based on Mach number. It is not uncommon for the vehicle to actually gain altitude (\dot{H} goes positive) during this Alpha Transition phase. This is known as a phugoid.

The objective of the Alpha Transition phase is to protect thermal, g, and EAS constraints as the vehicle comes in contact with the thicker atmosphere. Post-pullout contingency abort profiles sometimes create a subsequent phugoid that require thermal, g, and EAS considerations. The canned Mach-alpha (M/α) profile fills this requirement.

ECAL or BDA contingency profiles must also protect thermal, g, and EAS constraints. However, the Mach-alpha profile flown in these scenarios is not canned. For ECAL and BDA aborts, contingency entry guidance will actively manage alpha within a specified range to control energy to the designated landing site (see [Section 4.14](#)).

Once the Alpha Transition phase is complete, the orbiter is ready to be positioned for either landing or bailout.

Contingency Aborts 21007/31007

1.3 BFS Limitations

Contingency abort procedures are supported only in the Primary Avionics Software System (PASS) due to several Backup Flight Software (BFS) limitations. These limitations are a result of a programmatic decision concerning BFS requirements. Low probability directs that total PASS failure together with multiple SSME failures requiring contingency software is “too many failures deep”. Therefore contingency software is not a necessary addition to BFS requirements. Training philosophy follows program philosophy, and no scenarios will be presented to illustrate the following BFS limitations:

- No single engine roll control
- No contingency guidance
- No flight instrument tapes in MM 601
- No Control Stick Steering (CSS) pre MECO (MM 102, MM 103 and MM 601)
- No OMS dump post MECO
- No AUTO Flight Control System (FCS) post MM 602
- No bailout autopilot

1.4 Survivability

1.4.1 Survivable Zones:

All two-engine-out and stuck throttle procedures are generally survivable, either to landing or bailout. There are some RTLS cases, such as two engines out near $V_{rel} = 0$, where aerodynamic effects are uncertain and survivability is questionable for some orbiter weight and c.g. combinations. As a result, 2 EO RTLS aborts near $V_{rel} = 0$ have enhanced maneuvering to increase safe ET separation dynamics, alleviating ET recontact and increasing survivability.

When not in **black zones**, as defined below, three-engine-out procedures have regions survivable to either landing or bailout.

Contingency Aborts 21007/31007

1.4.2 Black Zones:

These are regions along the ascent trajectory that may not be survivable. These will also be affected (widening or narrowing the zone) by mass properties, i.e. orbiter weight and c.g. combinations. Mass properties are improved considerably if the MPS dump post MECO through the three main engine bells occurs as expected, which will move the X c.g. forward by approximately 4 in.

Black zones for loss of three engines are embedded within the established contingency abort regions. Contingency abort guidance does not acknowledge black zones. CA guidance will always attempt to fly the maneuver most appropriate to the current orbiter state.

Black zones exist when:

- 1) Exceeding 470 Knots Equivalent Airspeed (KEAS) ($750 \text{ psf } \bar{q}$) during entry

NOTE: 470 kts is a known engineering constraint. The FCS is certified to 333 kts. However, a Loss of Control (LOC) will probably not occur unless the EAS is in excess of 470 kts, which will lead to an LOC due to over-gained and under-damped FCS gains.

- 2) Exceeding 4.2 g during entry

NOTE: 4.2 g is based on an engineering analysis for the OMS pod sheer limit (when 75% full). Also Nz Hold software for contingency aborts will attempt to hold a maximum of 3.9 g.

- 3) Three engines fail during first stage. For most or all of first stage, the three-engine-out contingency maneuver may not be survivable due to structural failure at the ET/SRB attach points. The aft orbiter/ET attach points have been enhanced; however there are still design load exceedences on the remaining attach points, both forward orbiter/ET and SRB/ET. In addition, the alpha and/or dynamic pressure profile will lead to adverse conditions at staging, which would lead poor separation dynamics. Although overshadowed by ascent black zone criteria, after separation, the X c.g. will most likely be outside the contingency limit resulting in an LOC.
- 4) Experiencing high \bar{q} during mated coast. LOC can occur during mated coast when high \bar{q} aerodynamics exceed RCS control authority.
- 5) There are high hinge moments on elevons or bodyflap or there are wing leading edge or vertical tail thermal exceedences.

Probable black zones for three-engine-out scenarios are illustrated below, but are also analyzed extensively for various known flight mass property scenarios.

Contingency Aborts 21007/31007

Three Out Black Zones

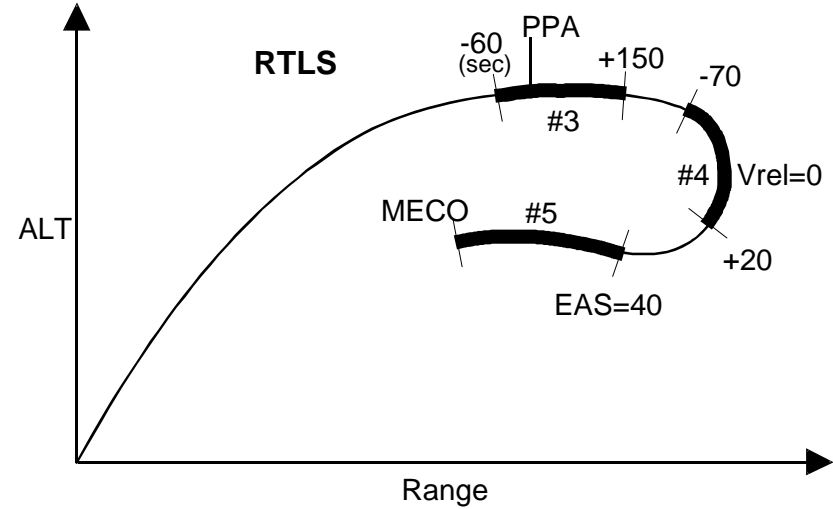
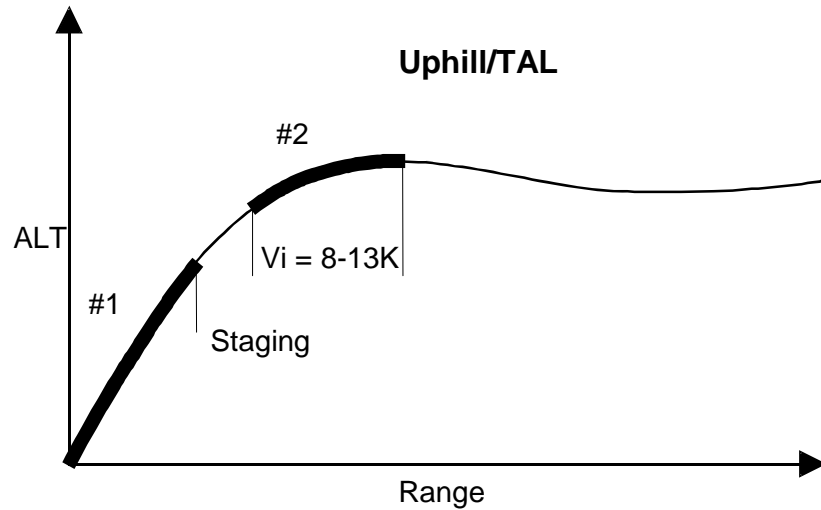

3 OUT BLACK ZONES

RATIONALE

#1 FIRST STAGE:

Structural failure, separation dynamics, or c.g. outside limits

#2 SECOND STAGE:

Excessive EAS (>470 kts) during pull-out

#3 RTLs PPA:

Excessive EAS during pull-out

#4 RTLs VREL=0:

Failure to achieve alpha recovery, loss of directional control, or excessive EAS during pull-out

#5 RTLs EAS ≥ 40:

Aerodynamics cause loss of control prior to MM 602

Contingency Aborts 21007/31007

Section 2 Ascent Elements

2.1 Contingency Software

Contingency software contains the instructions required to fly the automated portions of Contingency Abort trajectories. Powered flight contingency software (pre MECO) is available in either OPS 1 or OPS 6. Post MECO all contingency software for ET SEP and entry is part of OPS 6 software. RTLS OPS 6 has been modified to accommodate Contingency Abort situations. The contingency software contains the instructions required for successful completion of extreme attitude versus thrust to weight and situations.

Contingency software can be accessed in either OPS 1 (MM 102, MM 103) or RTLS OPS 6 (MM 601) as follows:

- 1) For two-engine-out contingency situations, the crew usually invokes the transition from OPS 1 ascent or from RTLS OPS 6 to contingency software manually as part of the two-engine-out contingency procedures. For RTLS OPS 6, there are some conditions that will automatically activate contingency software (see [Section 4.5](#)).
- 2) For three-engine-out contingency situations, whether in OPS 1 or RTLS OPS 6, contingency software will automatically transition to OPS 6 (MM 601) upon recognition of the MECO Confirmed flag (see [Section 4.7](#)).
- 3) Transition to MM 601 is possible from MM 102 or MM 103. However, once in MM 104, the transition must be directly to MM 602. These are the only legal transitions to OPS 6.

2.2 Two-Engine-Out Contingency Guidance

Contingency guidance is part of contingency software whether in OPS 1 or OPS 6.

Contingency guidance selects and displays the proper color-coded contingency region to fly in the two-engine-out (2 E/O) field on the TRAJ display. See TRAJ on next page.

Two-engine-out guidance is typically manually activated via <ITEM 2 EXEC> <ITEM 4 EXEC> to the ASCENT or RTLS TRAJ display. As mentioned, some regions in OPS 6 will activate automatically (see [Section 4.5](#)).

Contingency Aborts 21007/31007

2.2.1 Yaw Steering

Item 5 on the ASCENT or RTLS TRAJ enables yaw steering for East Coast Abort Landing (ECAL) and Bermuda (BDA) contingency abort profiles. Executing an Item 5 *prior* to contingency abort initiation will toggle this field between inhibit (INH) and enable (ENA). INH or ENA will appear adjacent to the Item 5 field to indicate the status.

With the yaw steer function enabled and two-engine-out contingency guidance initiated (with an <ITEM 2 EXEC> and <ITEM 4 EXEC>) in the ECAL or BDA window, the vehicle will yaw 45° toward the abort site. This yaw steering increases the chances for the orbiter to make an East Coast or Bermuda landing. The ECAL or BDA window is dictated in OPS 1 by I-loaded minimum and maximum inertial velocities and in OPS 6 when prior to Power Pitch Around (PPA) by I-loaded **H** and EAS constraints (see [Section 4.12](#)).

With the yaw steer inhibited, the vehicle will continue on its color-coded contingency abort trajectory at the initiation of the contingency abort. Attempting to enable yaw steering with an <ITEM 5 EXEC> *after* initiating the contingency software will result in an “ILLEGAL ENTRY” message.

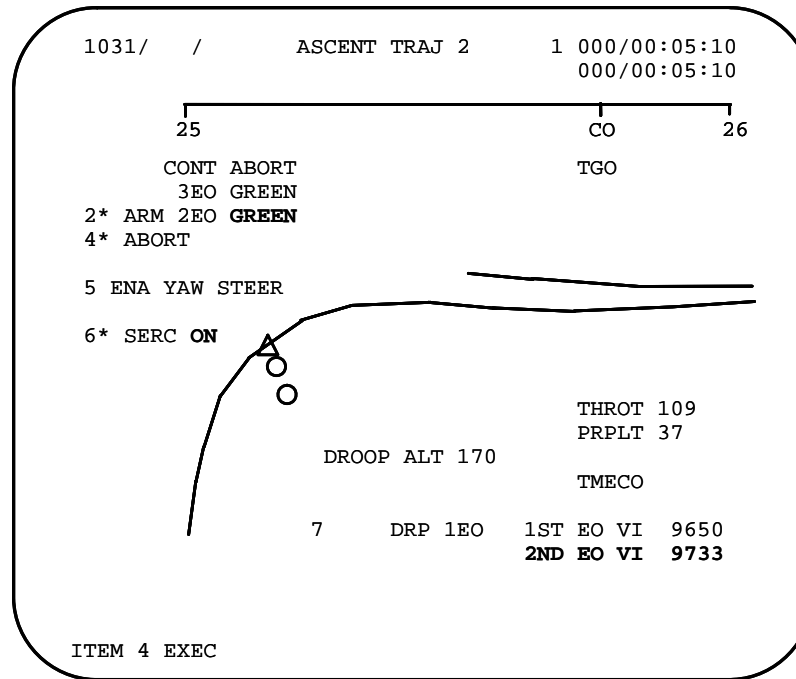

Contingency Aborts 21007/31007

2.3 Three-Engine-Out Contingency Guidance

Contingency guidance software selects and displays the proper contingency procedure to fly in the three-engine-out (3 E/O) field on the TRAJ display.

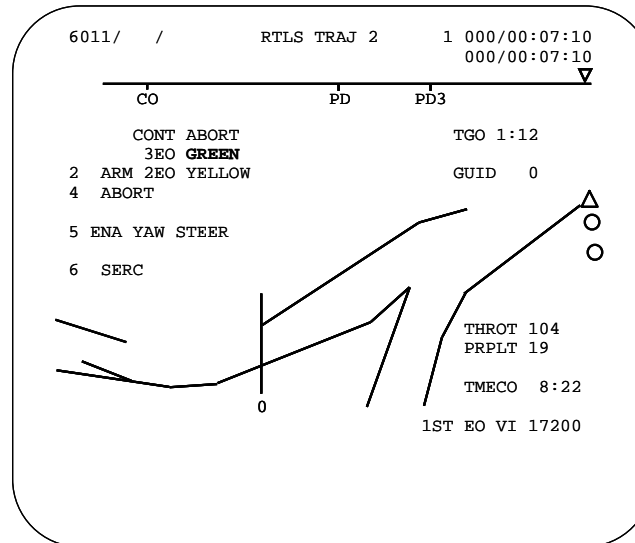

2.3.1 Three-Engine-Out Guidance Activation

If a 3 E/O color-coded contingency region is displayed, most methods of setting the MECO Confirmed software flag will automatically activate the three-engine-out auto contingency software. These are:

- 1) Three main engine push-buttons - pushed (CA cue card method)
- 2) Three SSME Pc's less than 30%
- 3) Two SSME Pc's less than 30% and a data path failure
- 4) Manual Fast SEP (ET SEP pushbutton)

CAUTION: Executing <OPS 104 PRO> will also set MECO Confirmed, but will not activate the three-engine-out contingency software since it can only be activated in MM 102, 103 and 601.

Contingency Aborts 21007/31007

2.4 Droop Guidance

Droop guidance is automatically engaged if OPS 1 second stage ascent guidance cannot keep the vehicle above the minimum droop altitude of 265,000 feet (265K feet) in powered flight. It is important that the vehicle altitude not droop below 265K feet during powered ascent because ET heating at high Mach numbers and altitudes below 265K feet could create an explosive situation.

2.4.1 Droop Modes

Hypothetical Mode: In MM 103, prior to droop guidance activation, the DROOP ALT field shows the minimum altitude (in thousands of feet) to which droop guidance would fly the vehicle given the current throttle setting *if* two engines were lost.

Actual Mode: Once droop guidance is engaged, the DROOP ALT field will display the minimum altitude to which the vehicle will actually fly given its current status.

2.4.2 How To Interpret The Droop Field

The "DROOP ALT XXX" field in the middle of the PASS ASCENT TRAJ 2 shall only be displayed in MM 103 and only when two-engine-out contingency guidance is not active. There are three possible states for this display as follows:

- 1) Only the "DROOP ALT XXX" text is displayed and at normal brightness: indicates the hypothetical mode is active, and droop guidance is NOT engaged
- 2) "**DROOP ENGAGED**" appears at overbright intensity immediately below the "DROOP ALT XXX" text which is still normal intensity: indicates that the actual mode is active and droop guidance is engaged

NOTE: Overbright is represented on the Multifunction Electronic Display Subsystem (MEDS) displays with yellow text.

- 3) "**DROOP ENGAGED**" is displayed and the "**DROOP ALT XXX**" text is overbright and flashing: indicates that the actual mode is active and predicting the vehicle will droop below 265K feet. In this case droop guidance cannot keep the vehicle from descending below 265K feet and alternative actions must be taken (i.e., select a higher throttle setting or downmode to a contingency abort).

Contingency Aborts 21007/31007

2.4.3 Droop Guidance Facts

Both hypothetical and actual display modes are based on the current thrust situation including OMS DUMP.

After engaging, droop guidance will automatically disengage if and when it is no longer needed. Once the droop software is disengaged the droop altitude will be frozen and the droop guidance software can no longer be re-engaged.

2.4.4 Droop for 1 Engine Out (1 EO)

Item 7 on the PASS ASCENT TRAJ 2 display will inhibit or enable droop guidance logic when only one SSME is failed.

If enabled and one-engine-out (1 EO) early, then guidance may incorrectly predict that the current altitude will droop too low, and then the droop actual mode would engage to keep the vehicle above 265K feet, primarily by increasing the pitch. However, once droop guidance has achieved this objective, the logic will disengage and then cannot be re-engaged. This would prevent a subsequent second engine failure from activating the droop logic, even if the predicted droop altitude fell below 265K feet.

To prevent an undesired droop engage-disengage for 1 EO, the logic will initially be inhibited. Item 7 reads "INH DRP 1EO".

If droop logic were required with only one-engine-out, then the crew would need to enable the 1EO droop logic with an <ITEM 7 EXEC>. This will be the case in the STUCK DROOP contingency region if one SSME is stuck at minimum throttles and another SSME has failed, as discussed later (see [Section 4.8](#)).

If two engines have failed and/or droop logic is engaged, then the INH/ENA field for DRP 1EO will blank.

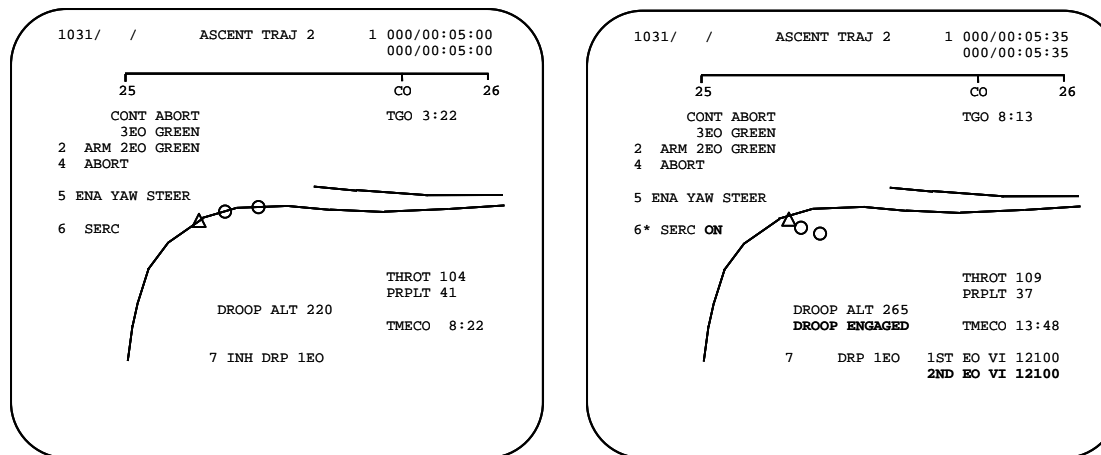

Contingency Aborts 21007/31007

2.5 Control Stick Steering (CSS)

2.5.1 Powered Flight (MM 102, MM 103, or MM 601)

CSS mode for the Digital Auto Pilot (DAP) is selected in powered flight by depressing any one of the four (two on each of panels F2 and F4) PITCH and ROLL/YAW CSS eyebrow panel pushbuttons.

Depressing any of these four pushbuttons will mode all three Rotational Hand Controller (RHC) axes to CSS on both RHCs.

Independent moding of pitch or roll/yaw axes in powered flight is not possible. Either all are AUTO or all are CSS.

NOTE: The DAP status field in the upper left corner of the A/E PFD (Ascent/Entry Primary Flight Display) will read “CSS” instead of “AUTO” and be surrounded by a yellow box.

Hot-stick downmoding from AUTO to CSS, by just deflecting the RHC, is not possible in powered flight.

2.5.2 Entry (MM 602, MM 603, MM 304, or MM 305)

Either axis, pitch or roll/yaw, can be moded independently to CSS by depressing the appropriate pushbutton on panels F2 or F4, or by deflecting the RHC (hot-stick downmode) in the proper axis.

NOTE: The PITCH and R/Y status fields in the upper left corner of the A/E PFD will read “CSS” instead of “AUTO” and be surrounded by a yellow box.

2.5.3 Panel F2/F4

AUTO and CSS pushbuttons will illuminate to indicate the selected DAP mode.

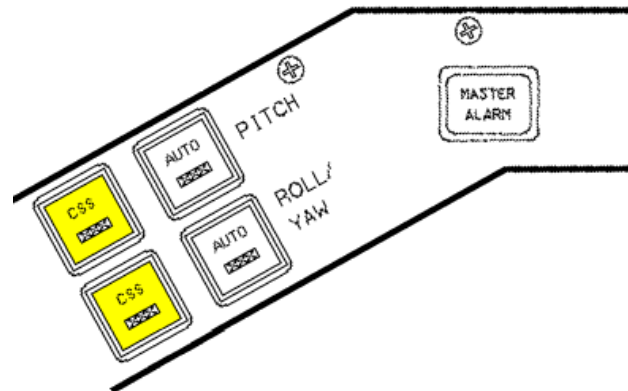

Contingency Aborts 21007/31007

2.6 How To Activate MAN THROT

The following steps are required to activate manual throttle control (MAN THROT). MAN THROT is available only from the Pilot's (PLT's) Speed Brake/Throttle Controller (SBTC). The Commander's (CDR's) SBTC does not function as a throttle controller.

- STEP 1 PLT depresses and holds the red takeover pushbutton on the SBTC.
- Both PLT and CDR speed brake/throttle "AUTO" PBI on eyebrow panels will extinguish.
- STEP 2 PLT moves SBTC to within 4% of the last commanded throttle position.
- PLT's speed brake/throttle "MAN" light will illuminate; CDR's light remains extinguished.

CAUTION: The "Throt" status field in the upper left corner of the A/E PFD will read "MAN" instead of "AUTO" and be surrounded by a yellow box while the PLT's SBTC takeover pushbutton is being pushed, regardless of whether the throttle command has been matched within 4%.

- STEP 3 PLT releases SBTC takeover button.
- PLT's light and A/E PFD "Throt" status field still read "MAN".
- STEP 4 PLT can now move SBTC to throttle SSMEs; no constraints on speed of movement as software will control actual rate of throttle change (10% per second).
- Full forward – 104% (109% if max throttles are selected).
 - Full aft – 67%.

2.6.1 SBTC

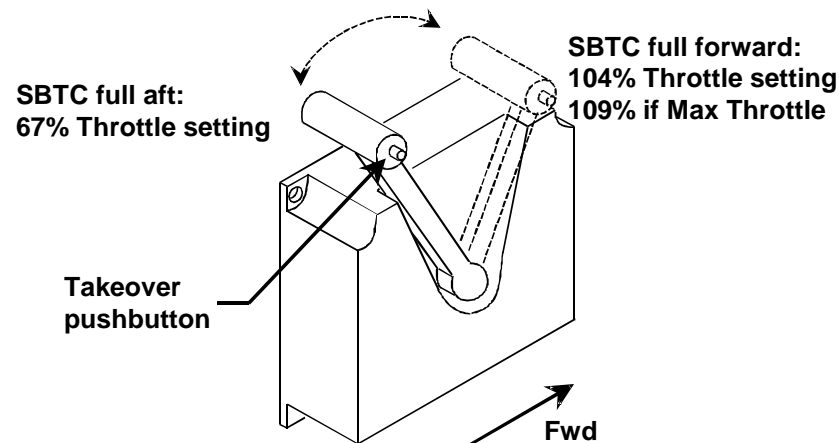

Contingency Aborts 21007/31007

2.7 How To Activate MAX THROT

To select maximum throttles (MAX THROT) requires an <ITEM 4 EXEC> on SPEC 51 (as shown on the following page).

Once selected, 109% throttles will be commanded according to the following logic (also see MAX Throttle Logic table):

- 1) If the throttle is in AUTO, SSME Pc will advance to 109% if one of the following conditions is met
 - a. In MM 102 and at least one SSME is failed.
 - b. In MM 103 and not in 3g throttling.
 - c. In MM 601 prior to PPA and at least one SSME is failed.
 - d. In MM 601 post PPA and guidance requires a throttle setting greater than 104% for mass dissipation. Guidance will command whatever throttle setting is required up to 109%.
- 2) If the throttle is in MAN, SSME Pc will advance to 109% if the SBTC is full forward.

2.7.1 MAX Throttle Logic

	If AUTO throttle	If MAN throttle
MM 102:	109% only if an SSME has failed.	With SBTC full forward 109% is commanded regardless of major mode or SSME configuration. <ul style="list-style-type: none"> • SBTC is re-scaled: Full forward = 109% Full aft = 67%
MM 103:	109% if not in g-limiting.	
MM 601 (pre PPA):	109% only if an SSME has failed.	
MM 601 (post PPA):	Enables settings higher than 104% if guidance commands it.	

Contingency Aborts 21007/31007

2.7.2 OVERRIDE Display (SPEC 51)

There are three throttle-selection item entries available in the upper left corner of SPEC 51. Once selected, they cannot be toggled off, but one of the other item entries could be used to reset the maximum allowed throttle setting. These three item entries are mutually exclusive.

ITEM 4 enables Max Throttles of 109%.

ITEM 51 returns to Nominal Throttles of 104% (if required).

ITEM 50 selects the Abort Throttle setting, which is currently I-loaded to 104% and thus effectively the same as Nominal Throttles.

1031/051/		OVERRIDE		1 000/00:03:12		000/00:03:12	
ABORT MODE		ENTRY FCS					
TAL	1	ELEVON	FILTER	ATMOSPHERE			
ATO	2	AUTO 17*	NOM 20*	NOM 22*			
ABORT	3	FIXED 18	ALT 21	N POLE 23			
THROT MAX	4*	SSME REPOS	19	S POLE 24			
ABT	50	IMU STAT	ATT DES	PRL			
NOM	51	1	1 25	SYS AUT DES			
PRPLT DUMP		2	26	1 28* 31			
ENA ICNCT	5	3	27	2 29* 32			
OMS DUMP				3 30* 33			
ARM	6	ADTA	H	a	M	DES	
START	7	L	1	34			
STOP	8	3		35			
9 QUAN/SIDE	83	R	2	36			
OMS DUMP TTG	423	4		37			
		ET SEP		ROLL MODE AUTO			
		AUTO	38	AUTO SEL 42			
AFT RCS 13	ENA	SEP	39	WRAP MODE 45 INH			
14 TIME	---	ET UMB DR		VENT DOOR CNTL			
		CLOSE	40	OPEN 43			
FWD RCS 15	INH	RCS RM MANF		CLOSE 44			
16 TIME	---	CL OVRD	41				
ITEM 4 EXEC							

Contingency Aborts 21007/31007

2.8 SPEC 51 OMS dump

For two- and three-engine-out scenarios, contingency software will typically automatically start an OMS dump to decrease mass and to keep the orbiter X c.g. within the contingency limits and, if possible, within the nominal limits for entry.

OMS propellant is interconnected to ARCS jets for a dump pre-MECO. Post MECO the dump is straight-feed (OME's only), unless the interconnect is enabled on SPEC 51 by <ITEM 5 EXEC>.

If started pre MECO, then the dump and interconnect will terminate just prior to MECO.

NOTE: The OMS engine bell was designed to burn in a vacuum, thus there is an altitude constraint of greater than 70K ft applied to starting an OMS dump on ascent. This is only applicable during first-stage.

When an OMS dump is required by the 2 OUT DROOP procedure, which does not activate contingency software, then the dump must be manually initiated by the crew (see [Section 4.8](#)).

To manually start a SPEC 51 OMS dump, <ITEM 6 EXEC> and <ITEM 7 EXEC> will arm and start the dump respectively.

1031/051/	OVERRIDE	1	000/00:03:12
			000/00:03:12
ABORT MODE	ENTRY FCS		
TAL 1	ELEVON FILTER	ATMOSPHERE	
ATO 2	AUTO 17* NOM 20*	NOM 22*	
ABORT 3	FIXED 18 ALT 21	N POLE 23	
THROT MAX 4*	SSME REPOS 19	S POLE 24	
ABT 50	IMU STAT ATT DES	PRL	
NOM 51	1 1 25	SYS AUT DES	
PRPLT DUMP	2 26	1 28* 31	
ENA ICNCT 5	3 27	2 29* 32	
OMS DUMP		3 30* 33	
ARM 6*	ADTA H a	M DES	
START 7*	L 1	34	
STOP 8	3	35	
9 QUAN/SIDE 83	R 2	36	
OMS DUMP TTG 423	4	37	
	ET SEP	ROLL MODE AUTO	
	AUTO 38	AUTO SEL 42	
AFT RCS 13 ENA	SEP 39	WRAP MODE 45 INH	
14 TIME	ET UMB DR	VENT DOOR CNTL	
	CLOSE 40	OPEN 43	
FWD RCS 15 INH	RCS RM MANF	CLOSE 44	
16 TIME	CL OVRD 41		
ITEM 7 EXEC			

Contingency Aborts 21007/31007

2.9 Fast ET Separation (Fast SEP)

The Fast ET SEP sequence bypasses most of the nominal ET SEP sequence in order to achieve a rapid separation during contingency abort operations.

The type of Fast SEP maneuver is a function of trajectory conditions.

2.9.1 Fast SEP Procedure

- a. For two-and three-engines-out CA's, a Fast ET SEP occurs automatically following MECO Confirmed.
- b. Current procedures no longer require it, but a Fast SEP can still be performed manually:
 1. ET SEP switch to MAN.
 2. Depress ET SEP pushbutton

NOTE: Manual Fast SEP is available in MM 102, MM 103, and MM 601.
In MM 103, a manual Fast SEP requires that at least two SSMEs have been recognized as failed.

2.9.2 Fast ET Sep times

Two-engine-out CA: SSME shutdown occurs in four seconds of the MECO Command, and the tank typically separates 1 second later for a total of 5 seconds from the MECO command to SEP.

For RTLS two-engine-out CA's near $V_{rel} = 0$, the Mated Coast is extended while pitching down to allow alpha reduction, which alleviates ET recontact. This will delay the ET SEP depending upon the alpha and dynamic pressure conditions at MECO. Typical delays between MECO and ET SEP are from 10 to 20 seconds in these cases.

Three-engine-out CA: Fast ET SEP time is variable as a function of trajectory conditions and ET separation maneuver.

Manual: Fast ET SEP time is 1 second when performed manually with no engines running.

Contingency Aborts 21007/31007

2.9.3 Types of Fast ET SEP

2.9.3.1 Pc < 50 SEP

Used for three-engine-out CA in first stage only (MM 102).

Entire stack separates – Solid Rocket Boosters (SRBs) and ET separate as one.

Fast SEP is commanded when left and right SRB Pc < 25 psia, which corresponds to SRB Pc < 50 psia + ~2 seconds.

NOTE: The SRB SEP sequence terminates in the PASS with an early MECO in MM 102. Consequently, the “PC < 50” cue is displayed only on the BFS ASCENT TRAJ display.

2.9.3.2 Attitude-Independent SEP

Used for three-engine-out CA when EAS is either low or rapidly increasing.

Separates at current attitude.

Rates will be nulled before separation.

Will execute the standard RTLS ET SEP sequence unless rapid descent rate and time to maneuver to entry attitude require a Fast SEP.

Will command the “early” Fast SEP if EAS is rapidly increasing, or even for low EAS cases if it is predicted to be > 9 kts within 45 seconds.

Contingency Aborts 21007/31007

2.9.3.3 High-Rate SEP

Used for ET separations with EAS from 9 to 25 kts and increasing.

Also known as “Rate SEP”.

Vehicle pitches down at 3 °/sec except for an RTLS two-engine-out CA near $V_{rel} = 0$.

RTLS two-engine-out CA's near $V_{rel} = 0$ will pitch at either 8 °/sec or 5 °/sec depending upon the downrange horizontal velocity, which helps reduce α prior to ET SEP. 8 °/sec is used prior to $V_{rel} = 0$ (RTLS 2 OUT YELLOW) and 5 °/sec is used at and after $V_{rel} = 0$ (RTLS 2 OUT ORANGE).

For two-engine-out CA, MECO is commanded when within 1 °/sec of the desired pitch rate.

The pitch rate continues post MECO through the Fast SEP and is extended for 8 seconds.

The pitch rate assists the separation maneuver as the tank is tossed away from the vehicle.

The high pitch rate for RTLS two-engine-out CA near $V_{rel} = 0$ will be gradually reduced throughout the Mated Coast phase, but still continues after the Fast SEP for 8 seconds.

2.9.3.4 Alpha -2° SEP

Used for ET separations with EAS from 25-55 kts and increasing.

Also known as “Alpha SEP”.

Vehicle pitches to obtain $\alpha = -2^\circ$.

For two-engine-out CA, MECO is commanded when within 2° of the targeted α .

Fast SEP is commanded when $\alpha = -2^\circ$ and the separation maneuver is assisted by high \bar{q} along with negative α .

Contingency Aborts 21007/31007

2.9.3.5 Alpha 125° SEP

Used for three-engine-out CA at high EAS when -2° alpha cannot be achieved (3 OUT RED).

When CA guidance finds that \bar{q} is too high (excessive EAS) to achieve the required pitch down rate for the Alpha -2° SEP, the vehicle pitches back up to an α of 125° .

Fast SEP commanded at $\sim 125^\circ$ alpha ($\pm 20^\circ$).

This is a black zone where high \bar{q} will most likely result in aerodynamic forces that exceed RCS control authority and cause loss of control prior to achieving the desired entry attitude for MM 602. There are no guarantees that this maneuver will actually work.

2.9.3.6 Emergency SEP

Immediate Fast SEP commanded if EAS > 77 kts and three engines out.

Fast SEP occurs without regard to attitude or rates.

Contingency Aborts 21007/31007

2.10 Single Engine Roll Control (SERC)

2.10.1 First Stage

SRB Thrust Vector Control (TVC) has sufficient roll authority with any number of engines running. Therefore, SERC is not required in first stage until SRB Pc tail-off.

In first stage, a manual request for SERC via <ITEM 6 EXEC> on the PASS ASCENT TRAJ 1 will:

1. Immediately establish the OMS to RCS interconnect
2. Activate SERC if/when SRB's are tailing-off (left and right SRB Pc < 380 psia).

NOTE: When SERC is active, an overbright **ON** is displayed next to "SERC" on the TRAJ display.

2.10.2 Second Stage

SERC is automatically and permanently invoked when the General Purpose Computers (GPCs) recognize two SSMEs failed (SSME fail flags set).

In addition, SERC AUTO recognition is a sub-task resident in guidance software that will invoke SERC when a loss of acceleration equal to two SSME failures is sensed and either one SSME fail flag or one SSME data path flag was previously set.

In second stage, SERC can be manually invoked any time via <ITEM 6 EXEC> to the PASS ASCENT TRAJ 2.

- ITEM 6 can be toggled until two SSME fail flags are set, then SERC is locked on.
- An asterisk by ITEM 6 indicates SERC has been requested.
- About 3 seconds later, an overbright **ON** next to "SERC" indicates SERC is active.

In second stage, SERC is also activated automatically with two-engine-out CA software (TRAJ: <ITEM 2 EXEC>, <ITEM 4 EXEC>).

Contingency Aborts 21007/31007

2.10.3 SERC Overview

SERC changes TVC flight control gains to single-engine in pitch and yaw. RCS jets will then be used for nearly all roll control.

Generally, SERC uses OMS propellant interconnected to the RCS jets. However, if the interconnect fails due to valve or GPC commanding problems, RCS propellant will be used.

From the time SERC is requested, about 3 seconds are required for interconnect valve configuration before SERC is available.

CAUTION: In second stage, if SERC AUTO recognition is invoked due to a loss of acceleration and the GPCs have not recognized the second SSME as failed (no SSME FAIL flag), executing an ITEM 6 on the TRAJ 2 will toggle SERC off which could lead to an immediate loss of control (LOC). However, once the GPCs recognize the second SSME failure, SERC cannot be revoked. Procedurally, the two failed SSME's pushbuttons will be always depressed in the 2 OUT procedures, which should set the second SSME fail flag in the GPCs.

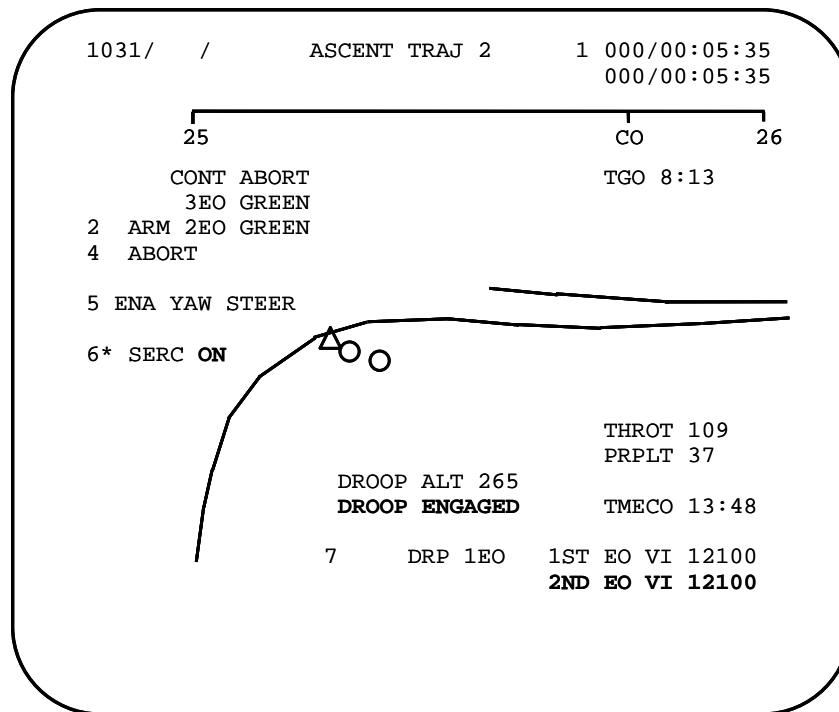

Contingency Aborts 21007/31007

Section 3 Entry Elements

3.1 Alpha Recovery

Post MECO and post ET SEP, while driving toward MM 602 conditions, guidance will target an alpha that is appropriate to the current Mach number. This is known as the Alpha Recovery phase. During this phase expect $20^\circ \leq \alpha \leq 58^\circ$.

PASS will automatically transition to MM 602 once entry attitude and rate conditions are met after a minimum time post ET SEP or if EAS > 77 kts.

- MM 602 contingency attitude limits: alpha within 5° of the targeted alpha, beta < $\pm 2.5^\circ$, roll < $\pm 20^\circ$
- MM 602 contingency rate limits: pitch < $5^\circ/\text{sec}$, roll/yaw < $3^\circ/\text{sec}$

3.2 Nz Hold

Nz Hold software avoids exceeding the 470 kts EAS constraint during the entry pullout by managing the g-level and limiting it to $\leq 3.9g$. A more detailed description follows.

Nz Hold software is available in MM 602 only.

In OPS 6, after MECO and ET SEP, the α recovery phase maneuvered the orbiter to a predetermined α . While settling into the atmosphere this high α gathers lift and drag, which translates to high g-forces. If the vehicle is allowed to maintain a constant α , the Nz constraint of $3.9g$ will be exceeded. In order to avoid an over-g, the nose must be lowered.

However, lowering the nose leads to a higher EAS and may lead to an overspeed, whereby the max EAS constraint of 470 kts is exceeded.

Hence, it is the objective of the Nz Hold software to select and fly an acceptable g-level that will maintain this delicate balance between excessive g's and excessive EAS. **Nz Hold software selects and holds a constant g-load by lowering the nose in order to hold an acceptable g-level during the pullout and in order to achieve an acceptable EAS after free-fall.** The Nz that guidance selects and holds during this phase is known as **Target Nz**.

Contingency Aborts 21007/31007

3.2.1 Target Nz

Target Nz (TGT Nz) is calculated during the alpha recovery phase for use in the Nz hold phase. It is a function of the maximum sink rate, \dot{H} , reached during the alpha recovery phase. This will occur at the start of the entry pullout, when \dot{H} transitions from negative to positive values followed by a corresponding decrease in the sink rate. This is also at the same time that 1g is achieved while gathering lift as the vehicle hits the atmosphere.

Hence, the magnitude of Target Nz during Nz Hold is directly proportional to \dot{H} at exactly 1g, when $\ddot{H} = \text{zero}$.

Target Nz is calculated automatically in MM 602. In rare circumstances, a manually calculated Target Nz could be required to manually fly Nz Hold

3.2.2 Calculation of Target Nz

Measuring 1g: When at 1g, the G-meter shows Nz = 1.0g and the \ddot{H} tape reads 0.

Calculation: When Nz = 1g, 0.65 is added to the absolute value of \dot{H} divided by 1000 in order to arrive at TGT Nz.

Example: At 1g, $\dot{H} = -2150$ fps.

$$\text{TGT Nz} = 0.65 + 2150/1000 = 0.65 + 2.15,$$

so TGT Nz = 2.8g.

Contingency Aborts 21007/31007

3.2.3 Cockpit Display of Target Nz

Target Nz is displayed on the VERT SIT once it is calculated at the end of the alpha recovery phase. It remains on VERT SIT for the rest of entry. Although Target Nz is displayed, if time permits, it is a good technique to manually calculate Target Nz in order to back up guidance.

Target Nz is also indicated on the flight instrument G-meter by a magenta-colored line once it has been calculated. The magenta Target Nz line will remain until the end of the Nz Hold phase (see [Section 4.3](#)).

3.2.4 Target Nz and Alpha Trap

Alpha Trap logic is part of MM 602 guidance software that forces a transition from the alpha recovery to the Nz Hold phase. This logic is tripped during alpha recovery if the vehicle pitches to $\alpha > 35^\circ$ and then pitches to $\alpha < 35^\circ$. Alpha Trap was included to preclude some manual flying scenarios where the crew imposed an early pitch down and the g-loads never built sufficiently to trip into the Nz Hold phase. Alpha Trap logic is disabled for most contingency and ECAL aborts, but is active for RTLS aborts and also for late RTLS contingency aborts where the downrange velocity back toward the launch site is greater than 2500 fps.

Thus, if Alpha Trap is triggered, the software could transition to Nz Hold without having first calculated a Target Nz.

In this situation, the Target Nz will remain "0.0" on the VERT SIT display and Auto flight control would maintain its targeted alpha recovery α until increasing lift and drag create an over-g and subsequent LOC.

If Target Nz is ever displayed as "0.0", then Nz Hold must be flown manually as Target Nz has not been calculated by guidance.

Contingency Aborts 21007/31007

3.3 Adverse Aileron Trim

Both Aileron and Rudder trims (A/R Trim) are displayed on VERT SIT and provide feedback required to avoid a Loss of Control due to incorrect adverse Aileron trim in low Mach regions with high angle of attack (α).

1. VERT SIT display is the ONLY location in cockpit to determine A/R trim (AIL and RUD) values.
2. Surface Position Indicator (SPI) and GNC Sys Summ 2 show total aerosurface position, but NOT the trim value.

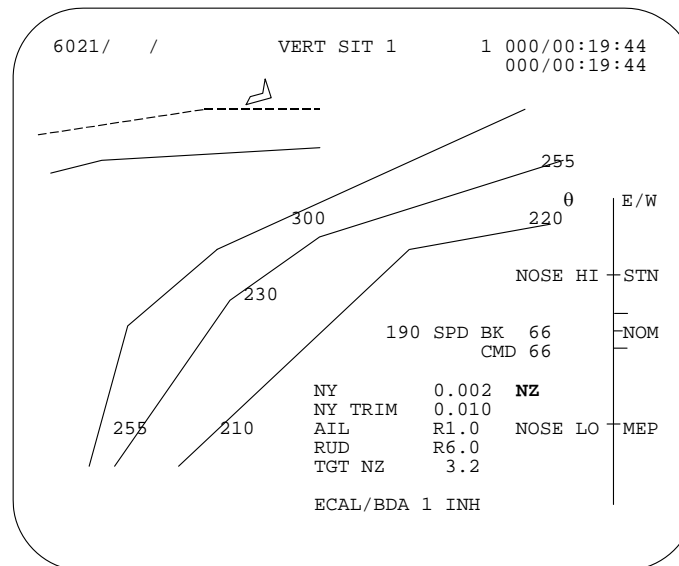

Adverse aileron trim leading to a Loss of Control (LOC) starts as a consequence of excessive beta (β) during entry with Mach < 5. This is particularly true if the MM 602 transition occurs below Mach 5. The rudder is active in flight control on entry below Mach 5 and the rudder is commanded to trim to counter β . However, at high angles of attack (> 50°) the rudder aerosurface is not effective. As a result the RUD trim will be saturated (Left or Right 6°).

Contingency Aborts 21007/31007

Thus the aileron trim is then commanded in an attempt to counter the existing β . However the aileron trim is a function of a flight control gain (GALR) which was designed as a function of Mach, assuming a nominal entry alpha to mach profile. The GALR is intended to determine the sign of the primary aileron control term, and is used to transition from the early entry adverse aileron to the late entry proverse aileron which Mach < 4. However, the Contingency Abort entry profiles (particularly at low mach) follow a much different alpha to mach profile. Thus at low Mach, with high alpha, the GALR gain is incorrect, causing adverse AIL trim which is opposite the trim actually required to null the existing β . Trimming the wrong direction with the aileron exacerbates β even further, quickly leading to an LOC.

If the rudder trim is saturated at 6° , and the aileron trim is moving in the same direction, this is symptomatic of an incorrect adverse aileron trim due to incorrect GALR gain and may result in a subsequent LOC. So, if the rudder trim = 6° and aileron trim $\geq 1^\circ$ in the SAME direction, the crew should move the roll panel trim switch (on either panel L2 or C3) opposite the direction of the aileron trim, taking aileron trim to zero. If AIL and RUD are both saturating trim RIGHT, as shown above, then the crew must move the roll panel trim to the LEFT until AIL = 0. Correcting the AIL trim in this manner forces the flight control to accept more sideslip and/or use RCS to assist with vehicle trim.

LOC situations due to incorrect adverse AIL trim are most likely to occur during steeper entries into the atmosphere which occur at lower Mach numbers, and/or when large beta is present at the MM 602 transition, or when control problems exist.

Contingency Aborts 21007/31007

3.4 Speedbrake/Body Flap

Both speedbrake and bodyflap are set prior to the Nz Hold phase because they may not move in the presence of high g's and aerodynamic loads.

The speedbrake opens to generate a nose-up pitching moment, contributing to lateral-directional stability by causing elevons to move down into the relative wind.

The bodyflap position reduces aero loads on the elevons.

1. Speedbrake (S/B)

If Mach is less than 3 upon transition to entry, then the crew should open the speedbrake manually to 65%. This gets the S/B open faster than leaving it in AUTO because the S/B will be needed as soon as possible (ASAP).

Once set, the Speedbrake is left in MAN until the checklist calls for AUTO as part of the BAILOUT procedure.

2. Bodyflap (BF)

Flight control software improvements (Smart Bodyflap), which automatically balance the loads between the elevons and the bodyflap, are such that current flights no longer require manual BF steps. In past flights, a flight specific scale of BF position vs. Mach was included in the CA entry procedures. Future flights with extreme weights and c.g. may warrant the return of the BF position vs. Mach scale to FDF.

3.5 Bailout Autopilot

This software enables crew bailout by keeping the orbiter in a stable glide. It will hold airspeed and roll attitude upon engagement. Bailout is available in MM 603 and MM 305 when below Mach 0.95 (it cannot be armed when supersonic).

Contingency Aborts 21007/31007

Section 4 Contingency Operations

4.1 General Techniques

4.1.1 SFRM (Space Flight Resource Management)

The Mission Specialist (MS) 2 will call out, track, and verify contingency procedures to aid situational awareness.

- a. Prior to any failures, MS 2 should monitor contingency regions on the TRAJ display and abort mode boundaries as they change during powered flight.
- b. MS 2 can confirm the specific block to execute once the contingency is required.
Example: "We're Two Out Second".
- c. MS 2 should also call out and track the individual procedural steps.

If control problems arise MS 1 and/or MS 2 should stick with the procedure. The answer to the problem may be in a subsequent or missed step.

The crew should be expeditious in the contingency procedures, but not rushed. EAS, \dot{H} , and g's should be crosschecked during each maneuver for cues on atmospheric entry and proper CA guidance sequencing.

4.2 FDF Requirements

Please refer to current CONTINGENCY ABORT, RTLS CONTINGENCY, and BAILOUT cue cards, and to the Ascent Checklist ECAL/BDA procedures in conjunction with the following discussions.

Contingency Aborts 21007/31007

4.3 Flight Instruments

Of the many features embedded within the flight instruments on the Ascent/Entry Primary Flight Display (A/E PFD), a few items are singled out here with respect to contingency operations:

1. Many contingency procedures will direct the crew to put the Attitude Direction Indicator (ADI) in the “REF” (Reference) mode in order to view vehicle yaw on the ADI as well as the Horizontal Situation Indicator (HSI). When the ADI is in the “LVLH” (Local Vertical/ Local Horizontal) mode in MM 102, MM 103 and MM 601, the vehicle yaw is not displayed (yaw is pegged at 0°).
2. The ADI Pitch rate pointer is monitored in particular for contingency Fast SEP, Rate SEP maneuvers.
3. The “ α ” tape displays alpha in OPS 1, OPS 6 and OPS 3 which is used for contingency Fast SEP, Alpha SEP maneuvers, and also on entry while flying Alpha Recovery phase and the Alpha/Mach schedule.
4. In MM 601, Beta (sideslip) is displayed digitally in a box below the “ α ” tape. “L” or “R” is also indicated as the direction required to yaw to null Beta.
5. In MM 602 and MM 603, the G-meter in the lower left corner of the A/E PFD displays g's in Nz, from the Accelerometer Assembly (AA) selection filter, which is particularly needed during the Nz Hold flight phase. While in the Nz Hold phase in MM 602, the Target Nz will be indicated by a magenta line on the G-meter.

Contingency Aborts 21007/31007

4.3.1 A/E PFD - MM 601 - 2 EO ECAL Contingency Yaw Maneuver



Contingency Aborts 21007/31007

4.3.2 A/E PFD - MM 602 - Nz Hold Phase With 20° Prebank



Contingency Aborts 21007/31007

4.4 Two-Engine-Out Contingency Regions

4.4.1 Two-Engine-Out Contingency Abort (OPS 1)

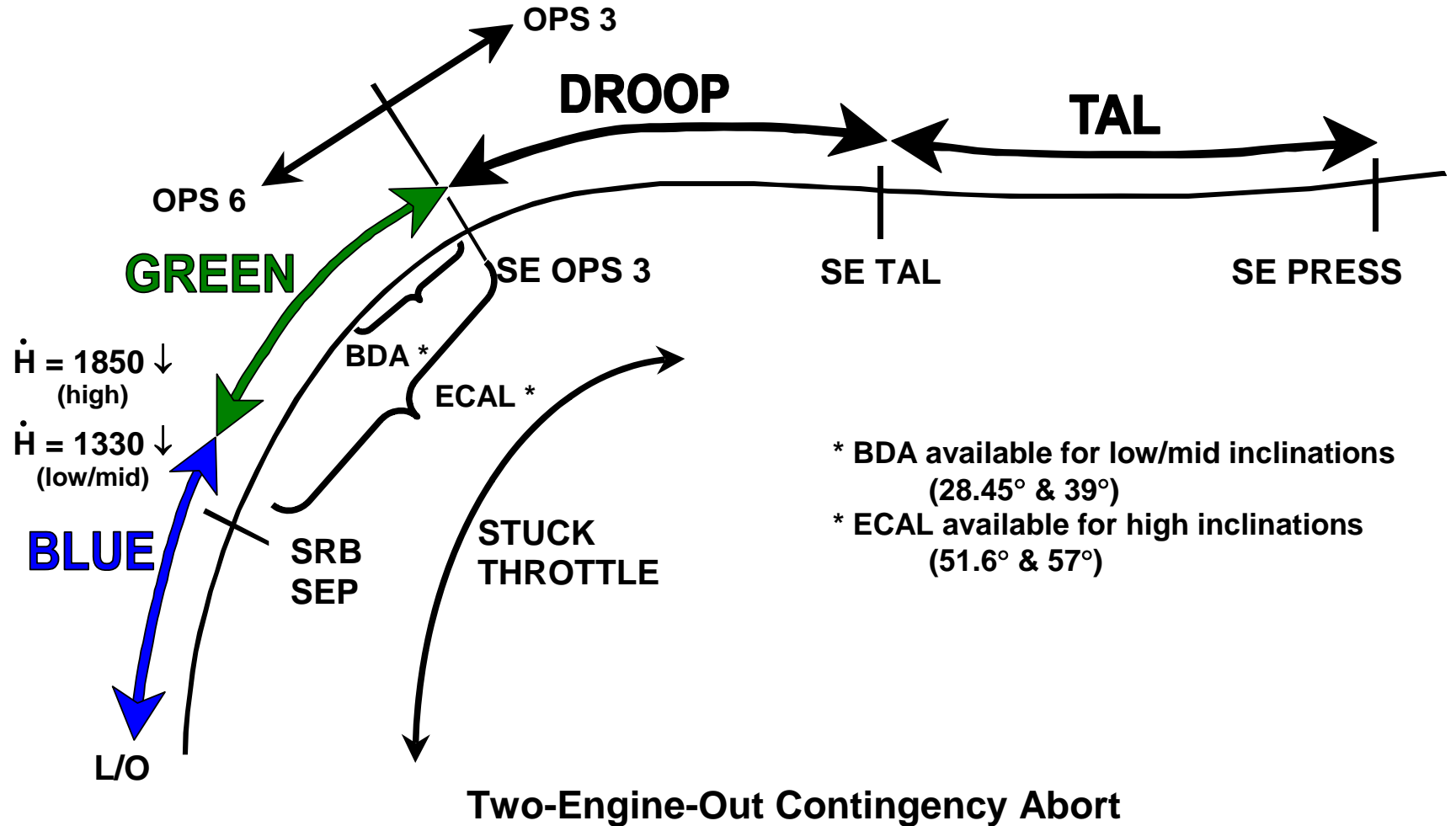

Contingency Aborts 21007/31007

4.4.2 RTLS Two-Engine-Out Contingency Abort (OPS 6)

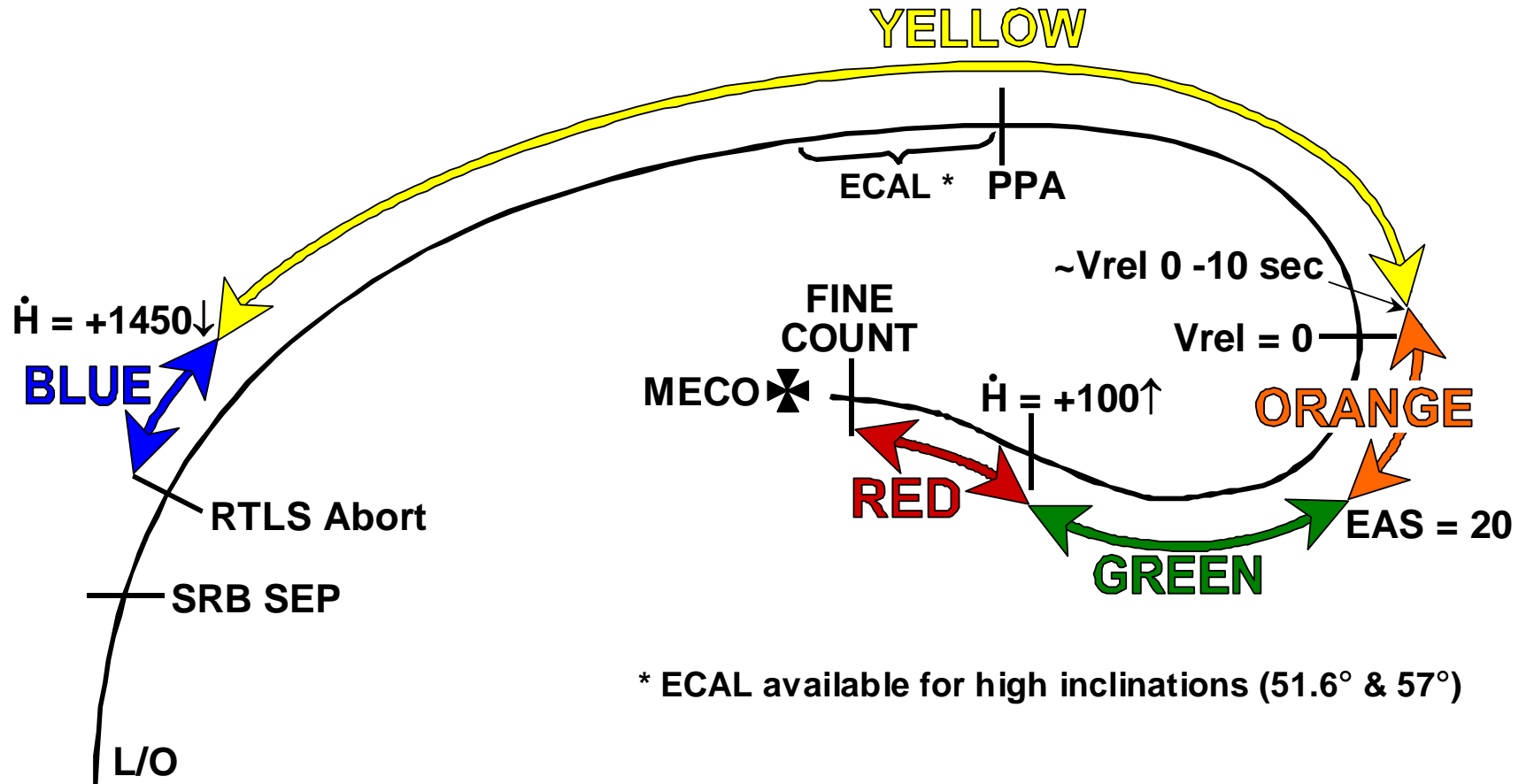

RTLS Two-Engine-Out Contingency Abort

Contingency Aborts 21007/31007

4.5 Two-Engine-Out Abort Cue Card Operations

4.5.1 Manual Two-Engine-Out Contingency Software Selection

As directed by the "ABORT – ITEM 2(*), 4(*)" step in most of the 2 EO procedural blocks of the contingency abort cue card (both sides), selection of the two-engine-out contingency software is typically done via item entries to the PASS TRAJ display.

CAUTION: Since the OMS engine bell was designed to burn in a vacuum, 2 EO contingency guidance should not be activated until above the altitude constraint of 70K ft. This is only applicable during first-stage.

- a. <ITEM 2 EXEC> "arms" the contingency software to be flown
 - (1) An asterisk (*) will appear next to the 2.
 - (2) The color field becomes highlighted or overbright on the display.
 - (3) This freezes the 2 EO color region in the guidance software and determines the maneuver to be flown.
 - (4) This item entry is revocable with a toggle of ITEM 2.
- b. <ITEM 4 EXEC> "fires" the contingency software
 - (1) An asterisk (*) will appear next to the 4.
 - (2) Guidance will fly the selected 2 EO maneuver (assuming AUTO FCS). The maneuver can be monitored per the appropriate color block on the cue card or the Powered ECAL/BDA procedure, as appropriate.
 - (3) This item entry is not revocable.
- c. Always ensure AUTO FCS and AUTO Throttle to allow the contingency guidance to work as designed.

NOTE: Exceptions to the manual activation are some RTLS 2 EO regions, where contingency guidance activation is automated, and the 2 OUT DROOP procedure, which uses Droop guidance software rather than 2 EO contingency guidance software.

Contingency Aborts 21007/31007

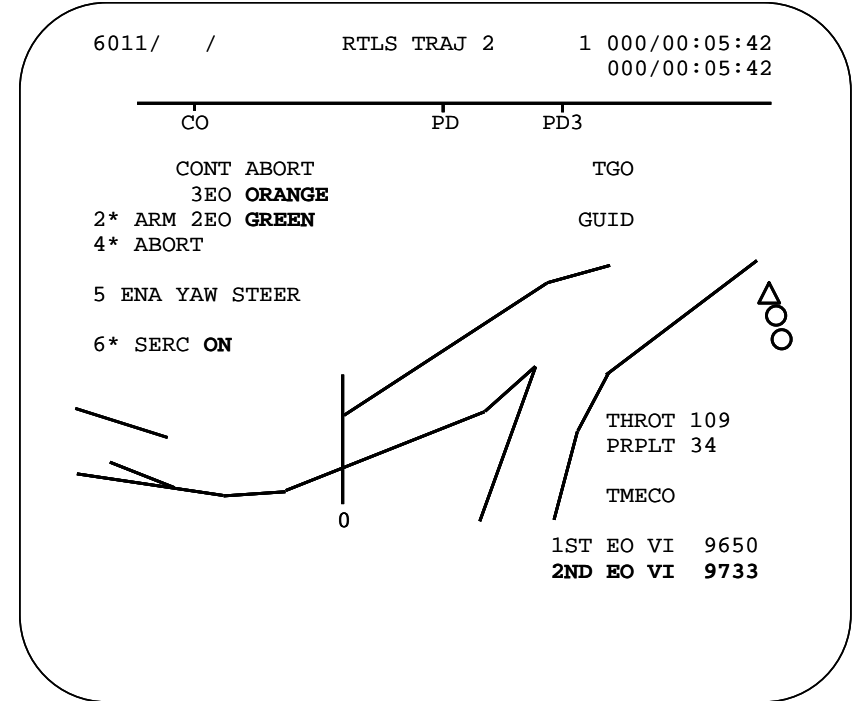
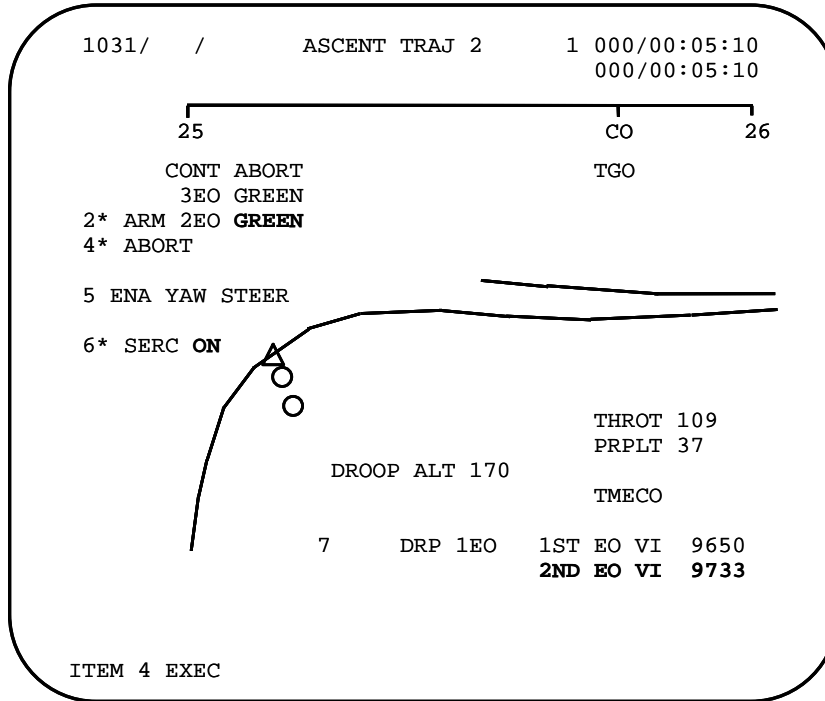

NOTE: Two-engine-out contingency guidance hands over to three-engine-out contingency guidance at MECO (where both two- and three-engine-out contingency regions have the same Fast Sep maneuver). Thus at MECO, both "2 EO and 3 EO" fields on the TRAJ will be displayed overbright (per the second TRAJ display above). Procedurally, the crew should stay in the current 2 EO monitor block.

Contingency Aborts 21007/31007

4.5.2 Two-Engine-Out Contingency Software Termination

When/if the two-engine-out color field blanks on the TRAJ display, then an auto single engine completion is possible and contingency software is no longer required. Selection of ITEM 2 and ITEM 4 would not invoke contingency software after that point, but would give an “ILLEGAL ENTRY” message.

In OPS 1, the 2 EO color field never actually blanks prior to MECO. However, although still available, procedurally 2 EO contingency guidance is no longer used once single-engine (SE) capability for either an OPS 3 entry or uphill is attained. Both single engine TAL capability and single engine press to MECO capability are available well prior to a nominal MECO, as noted in the Ascent Checklist FDF (FB 2-4) NO COMM MODE BOUNDARIES and the TAL REDESIGNATION cards. Thus Droop guidance software will be used instead of 2 EO contingency guidance, as soon as the 265K ft minimum can be protected and, if available, either a ECAL/BDA landing can no longer be achieved or Emergency Landing Site (ELS) for a site across the Atlantic ocean can be achieved using TAL OPS 3 software. This procedural boundary is marked by the SE OPS 3 (109) abort boundary.

In OPS 6, the 2 EO color field does blank at SSME fine count. Once in fine count in route to an RTLS MECO, the energy state is such that one engine can carry the orbiter though powered pitch-down to a healthy MECO condition with standard RTLS guidance.

4.5.3 RTLS Two-Engine-Out Automated

For some regions of RTLS 2 EO, it is critical to start the contingency maneuver as soon as possible after the second engine out is recognized. For these situations, ITEM 2 and ITEM 4 are not required. Upon recognizing two engines out (SSME FAIL flag annunciated for both engines), RTLS 2 EO guidance will activate automatically. This is indicated by the RTLS 2 EO color region turning overbright on the RTLS TRAJ 2 display and asterisks already in place next to Items 2 and 4.

When this occurs, <ITEM 2 EXEC> and <ITEM 4 EXEC> would give the crew an “ILLEGAL ENTRY” message. However, as long as AUTO FCS is maintained, the 2 EO contingency software is working as designed.

1. The automation is required for RTLS 2 EO near the $V_{rel} = 0$ boundary where the vehicle has a very negative sink rate and thus a very high alpha. Automation helps ensure the best possible conditions for ET SEP. As discussed earlier, this region also implements a higher pitch-rate for the Rate SEP and an extended mated coast to reduce the alpha and alleviate ET SEP recontact. 2 EO RTLS near $V_{rel} = 0$ includes:
 - The RTLS 2 OUT YELLOW region after PPA once the downrange velocity away from the launch site has fallen to less than 3200 fps
 - The RTLS 2 OUT ORANGE region entirely, which encompasses $V_{rel} = 0$ until the EAS is greater than 20 kts, allowing an Alpha SEP maneuver

Contingency Aborts 21007/31007

2. Automation is also used for RTLS 2 OUT RED where a quick response time will ensure MECO conditions that allow an intact abort landing back at KSC.

4.5.4 RTLS Two-Engine-Out CSS Required

On an RTLS, if the 2 EO region on the TRAJ display does NOT go overbright indicating activation, then CSS should be selected immediately if a second engine failure is suspected (one engine remains running). While in CSS, holding the current attitude, <ITEM 2 EXEC> and <ITEM 4 EXEC> are needed to activate the RTLS 2 EO contingency guidance and then the crew must return to AUTO FCS ASAP.

While in CSS temporarily, no RHC inputs are required to hold the current attitude.

If CSS is inadvertently selected when the abort was automated (2 EO region already overbright on the TRAJ), then the crew should also return to AUTO FCS ASAP.

WARNING: If CSS is not selected immediately for some 2 EO RTLS contingency abort situations, the vehicle may pitch up and out of control, due to the low thrust-to-weight situation and relatively high dynamic pressure. When a second engine fails, the vehicle will pitch up and try to maintain its trajectory at a lower thrust to weight. However, the dynamic pressure may be too high to maintain this attitude at this angle of attack and the flight control system will quickly become saturated, resulting in LOC.

NOTE: The RTLS three-engine-out procedures assume AUTO FCS and do not call for CSS selection. Two- versus three-engine-out verification should be clear, as there will be zero-g in a three-engine-out situation.

Contingency Aborts 21007/31007

4.6 Three-Engine-Out Contingency Regions

4.6.1 Three-Engine-Out Contingency Abort (OPS 1)

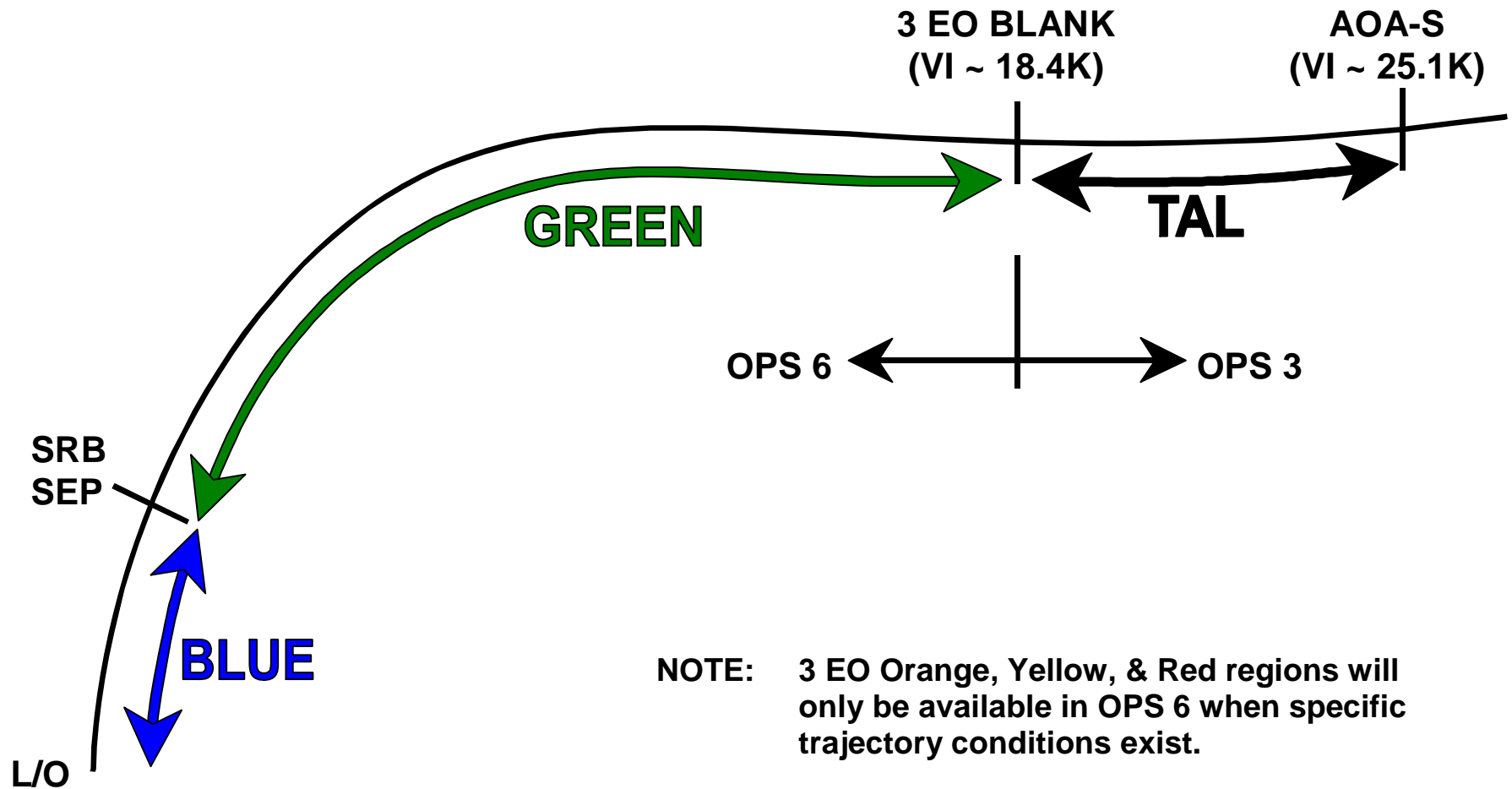

Three-Engine-Out Contingency Abort

Contingency Aborts 21007/31007

4.6.2 RTLS Three-Engine-Out Contingency Abort (OPS 6)

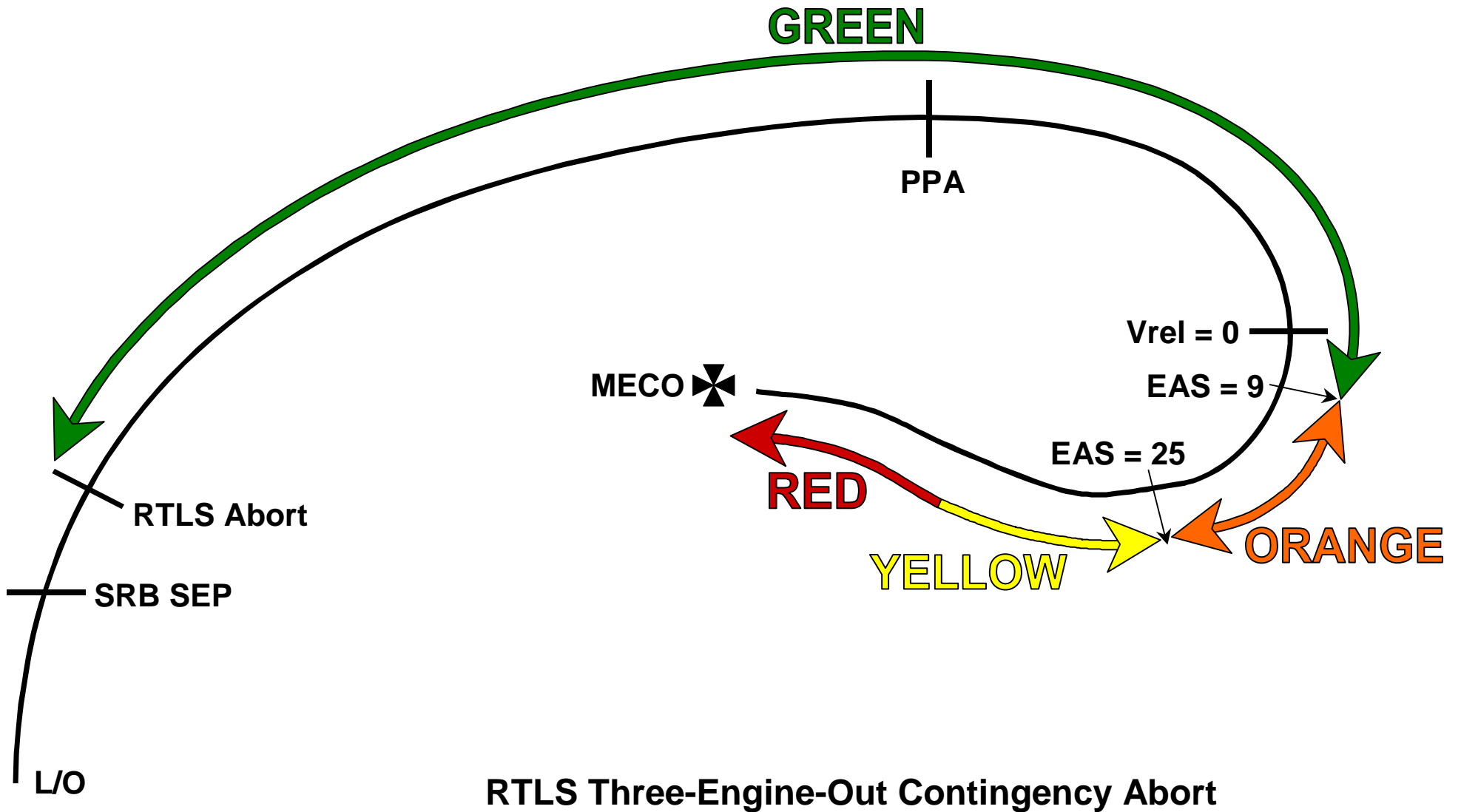

RTLS Three-Engine-Out Contingency Abort

Contingency Aborts 21007/31007

4.7 Three-Engine-Out Abort Cue Card Operations

4.7.1 Three-Engine-Out Contingency Software Selection

Three-engine-out contingency software is initiated automatically upon recognition of the MECO Confirmed flag if a 3 EO contingency region (color) is present on the PASS TRAJ display. Thus the only crew procedure required to activate a three-engine-out contingency is to verify and/or set MECO Confirmed with depression of all three SSME shutdown pushbuttons on panel C3. No item entries are required for abort selection.

4.7.2 Three-Engine-Out Contingency Software Operations

The following sequence of events will occur automatically as long as a color is displayed overbright in the 3 EO field on the TRAJ display. Major events will also be noted in the monitor (color) blocks on the CA cue card.

1. RTLS abort declaration for transition to MM 601 (may have been previously selected)
2. Maneuver to ET SEP attitude (if required)
3. ET separation
4. Post separation -Z translation
5. MM 601 multi-axis Alpha Recovery maneuver to entry attitude (shortest path to attitude)
6. If EAS > 77 kts, entry attitude maneuver will be completed in MM 602
7. MM 602 when close to entry attitude (or EAS > 77 kts)

Contingency Aborts 21007/31007

4.7.3 Three-Engine-Out Contingency Software Termination

When the three-engine-out color field blanks on the PASS TRAJ display, then contingency software has determined that 3 EO contingency guidance is no longer required. Accessing 3 EO contingency guidance is not possible once this has occurred.

In OPS 1, the 3 EO color field either blanks once predictions for the current flight dynamics show that an OPS 3 entry will not exceed over 3.5 g during the entry pullout or blanks at an Inertial Velocity (V_i) = 22K.

NOTE: After 2 EO guidance is activated, it is procedural policy to immediately transition to OPS 6 (Abort RTLS) such that OPS 6 3 EO contingency guidance color regions are available in the event of loss of the third engine, regardless of the 3.5 g pullout constraint which could blank the 3 EO field if remaining in OPS 1.

In OPS 6, the 3 EO color field blanks when within 35 nm of the desired RTLS MECO range as specified by the RTLS Range-Velocity (R-V) target line. Thus the RTLS runway can be achieved without contingency maneuvering.

4.7.4 Three-Engine-Out Contingency Capabilities

3 EO contingency regions were designed for three engines out simultaneously but can handle staggered engine failures.

Situations involving high EAS or high rates or vehicle c.g.'s outside controllability limits may not be survivable (see [Black Zones](#)).

Contingency Aborts 21007/31007

4.8 Droop Procedures

2 OUT DROOP and STUCK DROOP procedures do not actually use contingency software. The entry portion of flight will be executed in OPS 3 rather than OPS 6.

1. First and foremost, Maximum Throttles of 109% must be enabled via <ITEM 4 EXEC> on SPEC 51 to help arrest the droop.
2. Also, TAL abort is executed (if not already selected), will start an OMS dump that further reduces the droop effect.
3. Next, also on SPEC 51, ITEM 6 and ITEM 7 are executed in order to complete the DUMP steps. This will invoke the contingency dump timer and an interconnected OMS dump.
 - a. The contingency dump timer is most likely longer than the TAL dump time.
 - b. The RCS portion of the interconnected TAL dump is terminated due to SERC. Therefore, an ITEM 6 and ITEM 7 must be executed on SPEC 51 in order to reestablish the RCS portion of the dump.
 - (1) The objective is to get mass off of the vehicle as soon as possible.
 - (2) RCS jets will now turn off as needed for SERC in mirror image logic fashion.
4. If STUCK DROOP for only one engine out, rather than two, then it is necessary to also enable the Droop guidance for 1 EO via <ITEM 7 EXEC> to the PASS TAL TRAJ 2 display.

Contingency Aborts 21007/31007

5. After enabling max throttles and enhancing the OMS dump, if the droop altitude on the ASCENT TRAJ display is overbright and flashing (below 265K ft), then a downmode to the two-engine-out second stage procedural block is required. 2 EO contingency guidance software will be required to avoid exceeding the droop constraint, and OPS 6 contingency entry guidance with Nz Hold will be required for the entry pullout.

Contingency Aborts 21007/31007

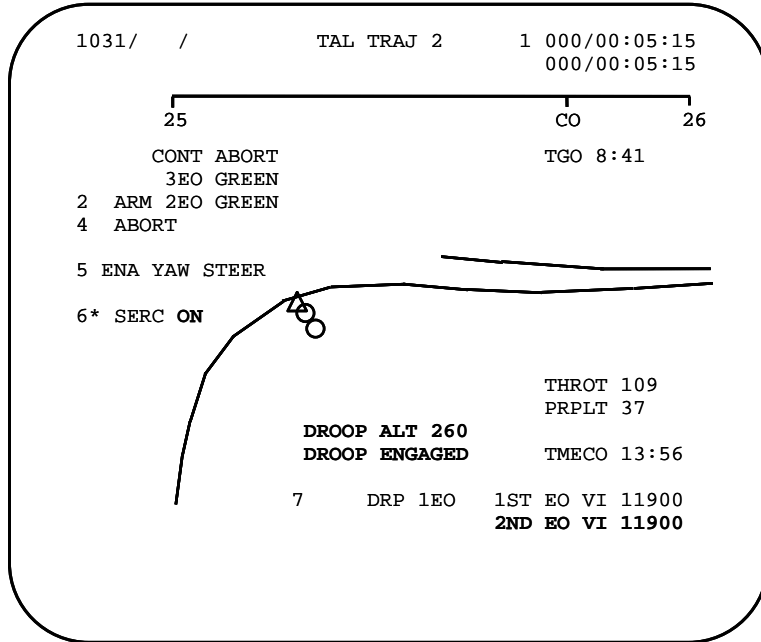

Contingency Aborts 21007/31007

1031/051/	OVERRIDE	1 000/00:03:12
		000/00:03:12
ABORT MODE	ENTRY FCS	
TAL 1	ELEVON FILTER ATMOSPHERE	
ATO 2	AUTO 17* NOM 20* NOM 22*	
ABORT 3	FIXED 18 ALT 21 N POLE 23	
THROT MAX 4*	SSME REPOS 19 S POLE 24	
ABT 50	IMU STAT AT DES PRL	
NOM 51	1 1 25 SYS AUT DES	
PRPLT DUMP	2 26 1 28* 31	
ENA ICNCT 5	3 27 2 29* 32	
OMS DUMP	3 30* 33	
ARM 6*	ADTA H a M DES	
START 7*	L 1 34	
STOP 8	3 35	
9 QUAN/SIDE 83	R 2 36	
OMS DUMP TTG 423	4 37	
AFT RCS 13 ENA	ET SEP ROLL MODE AUTO	
14 TIME	AUTO 38 AUTO SEL 42	
	SEP 39 WRAP MODE 45 INH	
FWD RCS 15 INH	ET UMB DR VENT DOOR CNTL	
16 TIME	CLOSE 40 OPEN 43	
	RCS RM MANF CLOSE 44	
	CL OVRD 41	
ITEM 7 EXEC		

Contingency Aborts 21007/31007

4.9 Stuck Procedures

The STUCK procedure timeline on the CONTINGENCY ABORT side of the cue card assumes one engine stuck at the bottom of the thrust bucket (nominally 67% or 72%) and another GOOD engine subsequently failing (titled STUCK MIN THROTTLE + 1 ENG OUT).

This timeline may be broken into as many as five different regions which are flight specific. These consist of STUCK FIRST, STUCK RTLS, STUCK TAL, and then from none to two possible regions which require STUCK DROOP depending upon the flight specific capability for the other three STUCK possibilities.

With an engine stuck in the bucket CAPCOM will call the “One and two-thirds (1 2/3)” boundaries for these regions in addition to the nominal boundary calls.

- The 1 2/3 boundary calls assume that one of the good, throttling engines fails. Normal two-engine (2E) boundary calls will be made assuming that the stuck engine fails.
- 1 2/3 boundaries are given on the card in terms of MET, assuming the stuck engine is actually at the nominal thrust bucket power level. If stuck other than the nominal bucket thrust level for that flight, the calls will differ from the times on the cue card.

4.9.1 STUCK FIRST

Procedure required is identical to that for two engines lost in first stage, except the SERC check and pushing two main engines pushbuttons is skipped. Although the STUCK FIRST region may continue into second-stage flight, “FIRST” links it to the procedure for 2 OUT FIRST.

4.9.2 STUCK RTLS

The nominal RTLS guidance will not be sufficient to counter the loss of thrust. Thus maximum throttles (109%) are required. MAN THROT is also taken because RTLS guidance may restrict 109% throttles while in AUTO. Also CSS is required to fly the vehicle to a “stand on the tail” attitude until the RTLS guidance pitch command has recovered sufficiently to fly the vehicle back toward the launch site. Once RTLS guidance is recovered and in the flyback phase (post-PPA), both DAP and throttles should be returned to AUTO and nominal RTLS procedures can be followed.

Contingency Aborts 21007/31007

4.9.3 STUCK DROOP

Maximum throttles (109%) are now sufficient to ensure that the vehicle will not droop below the 265K altitude constraint during powered flight, but either an intact RTLS or a nominal TAL site cannot be achieved. STUCK DROOP will both ensure that the 265K altitude constraint is protected and may provide sufficient downrange capability to make an ELS site with OPS 3 entry guidance, depending upon flight specific trajectory conditions. This is a subset of the 2 OUT DROOP procedure, having skipped the steps to check SERC and push two main engines pushbuttons

4.9.4 STUCK TAL

TAL MECO to a nominal site can be achieved if with the use of Maximum Throttles (109%) and low-energy logic on entry.

4.10 CONT ENTRY Procedures (MM 602 Entry)

The Contingency Entry (CONT ENTRY) procedure is found on both sides of the CA cue card. This procedure follows contingency entry guidance maneuvering thru the entry pullout until in steady glided flight in preparation for Bailout. Contingency procedures which may be able to attempt landing at an ELS will use the ECAL/BDA Entry procedures rather than CONT ENTRY.

4.10.1 Inhibiting ECAL/BDA Entry Guidance

At the MM 602 transition if the contingency flag is set in software, the VERT SIT 1 display will have ITEM 1 automatically enabled (ENA) for steering toward ECAL/BDA on entry.

For contingency abort and RTLS contingency abort scenarios that will ultimately lead to Bailout, the first step will be to inhibit ECAL/BDA steering upon entry into MM 602 via <ITEM 1 EXEC> to the VERT SIT display.

With ECAL/BDA set to INH, contingency entry guidance will remain in MM 602 until the crew manually does an OPS 603 PRO as part of the BAILOUT procedure. Thus the nominal RTLS TAEM (Terminal Area Energy Management) guidance in MM 603 is bypassed.

CAUTION: For late RTLS contingency scenarios where the velocity vector is already pointing back to the landing site and the downrange velocity is greater than 2500 fps at MECO, then the contingency flag will NOT be set and ITEM 1 will be initialized in MM 602 as INH. Executing ITEM 1 in this instance will not toggle the item entry to ENA, but will result in an "ILLEGAL ENTRY". In such cases or if the ITEM 1 is inadvertently left ENA, then the OPS 6 entry software will automatically transition to MM 603 at Mach 3.2 for TAEM. TAEM will not only try to fly to achieve a landing site (which isn't possible), but also requires Air Data incorporation below Mach 1.5 or the vehicle will LOC.

Contingency Aborts 21007/31007

4.10.2 Adverse AIL Trim LOC Check

These steps are critical, particularly when transitioning to MM 602 below Mach 5, as they will guard against an LOC due to incorrect aileron trim.

The first requirement is for RHC/PNL TRIM to ENA ASAP. Since the roll panel trim switch may be required after MM 602 transition to counter the incorrect aileron trim. Enabling TRIM for RHC/PNL allows the software to process panel trim switch requests.

Immediately upon MM 602 transition, if Mach is less than 5, the rudder is active. Closely monitor aileron and rudder trims, AIL and RUD on the VERT SIT display, in order to determine when RUD trim is ineffective and AIL trim is incorrect (could occur within seconds). Rudder trim is demonstratively ineffective if RUD is saturated (6.0°) and AIL is in the same direction greater than 1° . To counter the situation, move the roll panel trim switch AWAY from aileron trim direction until aileron trim = 0° , then maintain aileron trim less than 1° (see [Section 3.3](#)).

Loss of Control (LOC) due to adverse aileron trim is most likely when transitioning to MM 602 at low Mach (such that the rudder is already active) and with large beta and high alpha.

4.10.3 Manual Speedbrake Requirement

The Speedbrake (S/B) step for Mach less than 3 is a one-pass action item. It should be checked at the MM 602 transition or whenever the steps are reached prior to Nz Hold. At that point, if Mach is already less than 3, then manual speedbrake should be taken to set the S/B to 65%.

Setting the speedbrake to 65% for low speed contingency aborts is crucial to maintain longitudinal stability through the pullout. It is time critical and must be complete before entering Nz hold to avoid mechanical failure. If the pullout is begun above Mach 3, sufficient longitudinal control is available without the speedbrake (i.e., leave it in AUTO) (see also [Section 3.4](#)).

Contingency Aborts 21007/31007

4.10.4 Target Nz and Nz Hold Verification

There is no a procedural callout, but if time permits, it is prudent to backup and verify the Target Nz that is flown in AUTO.

Ensure the Target Nz is displayed on the VERT SIT display and the G-Meter on the A/E PFD.

Ensure the vehicle flies to the guidance calculated Target Nz.

If Target Nz is not displayed (reads "0.0") within ~ 5 seconds of passing 1 g, or if vehicle is not flying the guidance calculated Target Nz, then Nz hold needs to be flown manually. If Target Nz was not calculated manually at 1g, then pick one and fly to it.

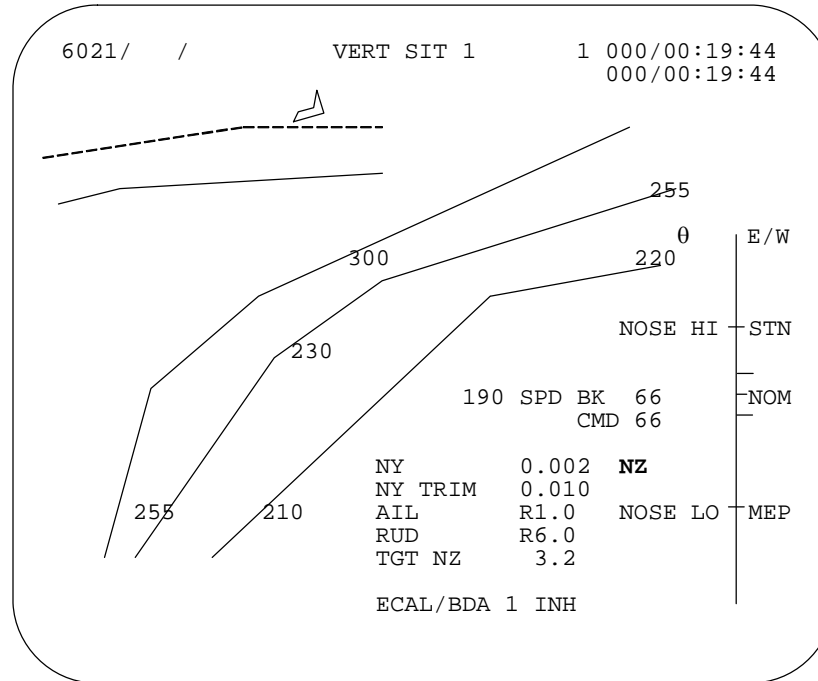

The Nz Hold phase is terminated when \dot{H} decreases to less than -320 ($\dot{H} = 320\uparrow$). At that time the overbright Nz in the lower right quadrant of the VERT SIT display disappears. Procedurally Nz Hold is considered complete once Nz is less than 2 g.

Contingency Aborts 21007/31007

4.10.5 Mach-Alpha Schedule

After Nz Hold, contingency guidance will enter the alpha transition flight phase and fly a Mach-Alpha schedule. The M/α profile (example below) is a canned routine that insures a safe attitude in hypersonic and supersonic flight, and is usually good for subsonic flight. However, this canned M/α profile will be maintained by flight software even when it leads to a subsonic aerodynamic stall attitude for the current trajectory. The Mach-alpha (M/α) profile table flies the orbiter to an α based upon Mach number independent of EAS. Therefore, there is a potential for arriving at subsonic flight in a stall attitude.

M	>12	9	6	3	1
α	40	35	26	18	12

4.10.6 Subsonic Stall

When in transition to subsonic flight the CDR should check that the vehicle is pitching down to the horizon and that airspeed is not too slow, ($M2 \rightarrow 1$: $\theta = 0^\circ$ by $M = 1.0$). That is, if velocity during and after Nz Hold is relatively slow (seen typically in RTLS yellow, orange, and green regions), watch theta and EAS carefully when approaching Mach 1.

It is critical to not allow EAS to get slower than 185 kts. If theta is greater than about 10° , and EAS is decreasing through about 200, then the CDR should take Pitch CSS and push to the horizon, $\theta = 0^\circ$. This will hold 185 to 195 KEAS, which is the bailout recommended airspeed.

If manual action is required to achieve EAS ~ 190 , maintain a positive α throughout this push-over. Continue the M/α crosscheck to keep α within limits.

Contingency Aborts 21007/31007

4.10.7 Air Data Incorporation

When Nz Hold is terminated and the Nz has decreased to less than 2 g and Mach < 5, it is safe to deploy the air data probes.

Air data incorporation is important for flight control gains. No Theta Limit concerns exist in MM 602 with the contingency flag set because closed loop guidance is not available and thus not dependent upon the ADTA (Air Data Transducer Assembly) incorporation. It will instead use Navigation-Derived air data feedback to safely fly the Mach-Alpha schedule described above. Also with the contingency flag set, the software will not automatically transition to MM 603 and TAEM guidance where ADTA incorporation to G&C is critical.

However, Air Data should be incorporated on SPEC 50 prior to going to BAILOUT procedures, which will require MM 603 and valid air data in order to properly maintain an airspeed.

Contingency Aborts 21007/31007

4.11 Bailout Procedures

When Mach is less than 1.0 the CONT ENTRY procedure is exited for the BAILOUT procedure. The BAILOUT procedure may also be entered from the ECAL/BDA ENTRY procedure if there is insufficient ranging capability to make the desired runway.

4.11.1 BAILOUT Software Activation

BAILOUT software may be activated when MACH < 1.0 as follows:

1. BOTH pitch (P) and roll/yaw (R/Y) axes are taken to CSS.
2. OPS 603 PRO may be required to access bailout software (or OPS 305 if bailout from nominal entry or TAL profile).
CAUTION: If FCS is left in AUTO, then TAEM guidance will steer the vehicle to the selected landing site.
3. Both Speedbrake and Body Flap are returned to AUTO, if previously in MAN.
4. The airspeed should be stabilized between 185 and 195 kts with the wings level (bank = 0°).
5. To arm the bailout autopilot, the abort rotary switch and pushbutton are used to select ATO (SPEC 51 will not work).
NOTE: A flashing "BAILOUT" on VERT SIT (upper left corner) indicates the bailout autopilot is **armed**.
6. When airspeed is 185-195 KEAS and wings are level, to engage the bailout autopilot, AUTO is reselected in all axes.
NOTE: A steady, overbright "BAILOUT" on VERT SIT indicates the bailout autopilot is **engaged**.

CAUTION: If the BAILOUT autopilot fails to engage, cycle BOTH pitch and roll/yaw axes back to CSS then AUTO. The most likely cause of failure to engage is because only one axis was cycled from CSS to AUTO.

Flight controller power is turned off to avoid an inadvertent RHC deflection during egress, which would trigger a hot stick downmode to CSS and disengage the bailout autopilot.

4.11.2 Report Position

Report vehicle position on guard frequency, including current radial and range from selected site, altitude, heading, and airspeed. Radial and range can be found first on the HSI, using the tail of the Heading Alignment Cone (HAC) or "H" bearing pointer and range to the HAC-Center, which available only in MM 305/603. Note that the Runway range shown on the A/E PFD actually includes distance to be flown around the HAC, so the HAC-C range is more accurate for a straight-line distance. Radial and range can also be obtained on SPEC 50 by selecting absolute TACAN mode, if within TACAN range. In addition, the GPS latitude and longitude as displayed on SPEC 55 may be used for reporting position.

Contingency Aborts 21007/31007

4.12 2 EO ECAL/BDA Aborts

Depending upon inclination, a window exists on most uphill trajectories and some RTLS and TAL trajectories that allows a landing on the East Coast of North America (ECAL), or in Bermuda (BDA) after two (or three) SSME failures. In the 2 EO ECAL/BDA window on ascent, contingency abort software will yaw steer **unguided** toward the 2 EO ECAL sites or BDA.



Contingency Aborts 21007/31007

4.12.1 2 EO ECAL/BDA “Yaw” Window Conditions

Once 2 EO contingency guidance has been activated, software checks conditions to determine whether to allow yaw steering with the remaining engine on ascent to an ECAL site or BDA.

1. First YAW STEER, ITEM 5 on ASCENT/RTLIS TRAJ 2, must be enabled when the 2 EO contingency guidance is activated.

NOTE: This is nominally I-loaded to ENA and checked pre-launch (see [Section 2.2.1](#)).

2. If in OPS 1 second stage, then the current V_i must be within the minimum and maximum I-loaded values for yaw steering.
 - a. For ECAL, at 51.6° and 57° inclinations, this window is open after a $V_i = 4.5K$. The yaw window closes at $V_i = 23K$, but procedurally ends at the SE OPS 3 boundary.
 - b. For BDA, at 28.5°, the V_i window is from 9.4K to 12.2K and at 39°, from 9.2K to 11.2K.
3. On high inclination flights, if an RTLIS abort was declared and in OPS 6 prior to PPA, then there is a window for ECAL, based on the following I-loaded constraints:
 - a. \dot{H} must be greater than zero.
 - b. EAS must be less than 6 kts.

NOTE: There is no window for BDA from an RTLIS profile for low and mid inclination flights.

Contingency Aborts 21007/31007

4.12.2 2 EO ECAL/BDA “Yaw” Procedure

2 EO ECAL/BDA procedures for powered flight are initially embedded within some of the 2 OUT procedure blocks on the CA cue card, including 2 OUT FIRST (ECAL only), 2 OUT SECOND, and RTLS 2 OUT COLOR (ECAL only).

If a large yaw angle is displayed on ADI REF ball (and the HSI) after executing ITEM 2 and ITEM 4 on the PASS TRAJ (per the 2 OUT contingency abort cue card procedure block), then a two-engine-out Powered ECAL/BDA abort has been declared and the required yaw maneuver is in progress.

For ECAL/BDA powered flight if in the “yaw” window with YAW STEER enabled, 2 EO contingency guidance will command an UNGUIDED 45° yaw toward either the East Coast or Bermuda. This maneuver reduces crossrange by turning the velocity vector more toward the landing site. However, most of the crossrange is still flown out later in thicker atmosphere during glided flight. Once the EAS starts building greater than 4 kts, the vehicle will yaw back into the velocity vector in preparation for MECO and an ET (rate) SEP at 3 °/sec.

Single engine performance does not yield a large velocity vector turn prior to MECO. This yaw maneuver is unguided toward the site.

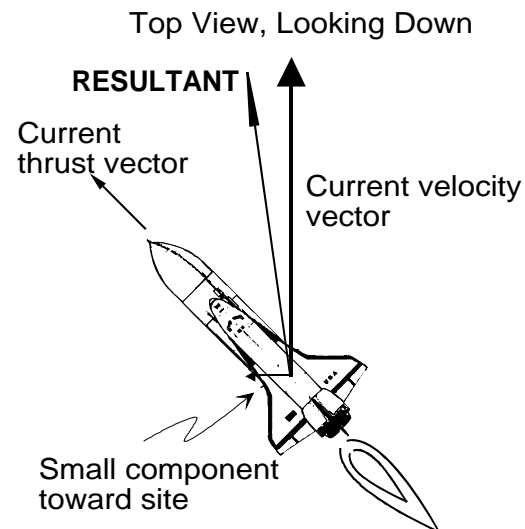

IMPORTANT: If the yaw maneuver is observed, it is critical to enable Max throttles (109%) on the remaining engine (SPEC 51, ITEM 4) ASAP. This will not only improve steering toward the landing site, but will extend the powered flight time as long as possible until EAS builds up and MECO and ET SEP are required. For this reason, this procedural step is included in the 2 OUT procedure blocks prior to transitioning to the POWERED ECAL/BDA procedure.

Contingency Aborts 21007/31007

4.12.3 POWERED ECAL/BDA Procedure

If conditions are met and the Yaw is observed, each of the 2 OUT CA procedural blocks leads to the POWERED ECAL/BDA procedure (found in the Ascent Flipbook for CDR and PLT and the Ascent Checklist for MS).

Initial checks are that maximum throttles have been selected and the vehicle is flying a modified “stand on the tail” with yaw procedure, $\theta = 60^\circ$ and Yaw = 45° , and has rolled Heads Up.

4.12.3.1 2 EO ECAL/BDA Site Selection

For 2 EO BDA, the site selection is self-evident and is spelled out in the procedure.

For 2 EO ECAL, the sequence of engine failures dictate which site is selected and which selection table is used in the FDF.

1. If the engine failures are simultaneous, the site is selected using tables on the POWERED ECAL flipbook page as a function of engine out velocity (V_i). For vehicles with a rendezvous target, this may also vary depending upon where in the window the vehicle launched. V_i ranges are provided for In Plane or $\pm 2:30$ minutes.
2. If the engine failures are staggered, the site is selected using the ECAL tables on the back of the appropriate TAL REDESIGNATION cue card as a function of 1st and 2nd engine out velocities.
 - a. The engine fail velocity is rounded to the nearest 100 fps.

4.12.3.2 MECO and ET SEP

For POWERED ECAL/BDA a rate SEP is required once EAS conditions are met ($EAS > 10$ kts and increasing). The vehicle will yaw back in plane to the Earth-Relative velocity vector bearing pointer on the HSI just prior at $EAS > 4$ kts. Once back in plane, the pitch rate is commanded. When at the target rate, MECO will be commanded on the remaining engine, followed by ET SEP 1 second later.

CSS is required for the alpha recovery phase post ET SEP. After 8 seconds of -Z translation while the pitch rate continues, Pitch CSS will be taken to achieve a $4^\circ/\text{sec}$ rate in reaching $\alpha = 58^\circ$. The concern is that if AUTO pitches the nose below the horizon (after 8 sec), high q_{bar} may saturate flight control and prevent the positive pitch rate required to reach $\alpha = 58^\circ$.

Contingency Aborts 21007/31007

4.13 3 EO ECAL/BDA Aborts

An ECAL window exists on most high (51.6° and 57°) inclination trajectories that will allow a landing on the northeast coast of the US or in Canada after three engines go down simultaneous or nearly simultaneously.

A BDA window also exists on low and mid (28.5° and 39°) inclination trajectories that will allow a landing in Bermuda after three engines go down simultaneous or nearly simultaneously.

For 3 EO in OPS 1, a ECAL/BDA entry is attempted following all second stage three-engine-out monitor blocks, 3 OUT GREEN, ORANGE, YELLOW or RED.

No option exists for a 3 EO ECAL or BDA entry from an RTLS profile.

If there is a chance for an ECAL or BDA landing, then the three-engine-out monitor block proceeds directly to the ECAL/BDA ENTRY procedure. Otherwise the CONT ENTRY procedure is followed in preparation for Bailout.

4.13.1 3 EO ECAL/BDA Site Selection

Site selection is determined once in MM 602 on the ECAL/BDA ENTRY procedure. For BDA the site selection is self-evident and is spelled out in the procedure. However, for ECAL, the site selection table is actually located beneath the POWERED ECAL procedure on the facing page.

CAUTION: 3 EO ECAL site selection is a function of VREL upon entry into MM 602. This is unlike 2 EO ECAL, which is selected as a function of V_i during powered flight. The difference lies in the fact that the velocity tape on the A/E PFD displays V_i in powered flight (MM 103 and MM 601 prior to PPA), and then displays VREL in glided flight (MM 602 and MM 603).

Contingency Aborts 21007/31007

4.14 ECAL/BDA ENTRY Procedure.

The ECAL/BDA ENTRY procedure is found in the Ascent Flipbook for CDR and PLT and the Ascent Checklist for MS. It is used after working the POWERED ECAL/BDA for 2 EO and also for some 3 EO cases and 2 EO GREEN, which will attempt landing at an ELS site instead of immediately preparing for bailout.

If transitioning to ECAL/BDA ENTRY directly from the CA cue card, then initial steps are needed to select the desired site on SPEC 50. It may also be necessary to manually transition the BFS to OPS 602.

NOTE: If the BFS is still in MM 103, it will be necessary to first transition to MM 104 to allow a legal transition to MM 602

4.14.1 ECAL/BDA Entry Software Enable

Upon entry into MM 602, the crew should first ensure that the automatic ECAL/BDA entry software is enabled.

At the MM 602 transition, if the contingency flag is set in software, then the ECAL/BDA flag will automatically be initialized ON. This is indicated on the VERT SIT display with ITEM 1 showing the ECAL/BDA status as ENA. No action should be required to ENA this feature.

When ECAL/BDA is ENA, then the standard OPS 6 entry software is modified to accommodate steering toward ECAL/BDA on entry.

NOTE: Execution of ITEM 1 is only legal in MM 602 when the contingency abort flag is set ON. If inadvertently toggled to INH on an ECAL/BDA abort, then another ITEM 1 is needed to toggle back to ENA.

4.14.2 ECAL/BDA Basic Entry Profile

Post MECO the standard CA profile will be flown in preparation for both 2 EO ECAL/BDA and 3 EO ECAL/BDA entries with some modifications. The post MECO free fall is broken first by the α recovery phase just prior to Nz Hold. Then the Nz Hold and Alpha/Mach schedule are modified to accommodate steering and manage energy to reach the selected ELS site.

Standard actions to avoid an LOC due to adverse AIL Trim are included, identical to those on the CONT ENTRY cue card. Most profiles that would allow ECAL/BDA transition to MM 602 at velocities well above where the rudder becomes active at Mach 5. However, there are some profiles, either early in second stage or from a 2 EO RTLS, which will start at low Mach numbers and have a greater potential for incorrect aileron trim. See also sections on [Adverse Aileron Trim](#) and [Adverse AIL Trim LOC Check](#).

Contingency Aborts 21007/31007

4.14.3 Nz Hold Prebank

If the ECAL/BDA flag is ENA, then during Nz Hold a bank toward the site may be accomplished automatically to reduce ΔAZ .

At 1g, when Target Nz is calculated, if ΔAZ is greater than 20° and if the initial Target Nz is calculated to be < 3.2 g, then 0.2 g will automatically be added to Target Nz and the vehicle will prebank 20° toward the site during Nz Hold.

NOTE: The Target Nz displayed on both VERT SIT and on the G-meter on the A/E PFD will include the 0.2 g bias.

The added 0.2 g to Target Nz allows a higher angle of attack to be maintained during the Nz Hold phase, thereby negating the lost lift due to the 20° prebank. The increase in g's is accepted since the g-level should be no more than ~ 3.3 g and it prevents an increase in first pullout dynamic pressure due to the roll.

4.14.4 ECAL/BDA Entry Bank

For ECAL/BDA aborts, toward the end of Nz Hold, once $\dot{H} = -600$ and is moving toward zero ($\dot{H} = -600\uparrow$), then contingency entry software will perform a bank toward the site that is twice the current ΔAZ , where the maximum bank is 70° .

This bank is accomplished prior to the top of the phugoid in order to reduce the severity of the second pullout.

$H\dot{d}ot = -600\uparrow$ was chosen as the earliest point toward the end of the first pullout where banking can begin without causing a significant increase in the loads on the vehicle, or creating controllability problems.

NOTE: The ECAL/BDA Automation logic actually banks $2.2 \times \Delta AZ$; the procedures are simplified to state $2x\Delta AZ$.

For ECAL/BDA, the Nz Hold phase is complete once the bank at $\dot{H} = -600\uparrow$ is accomplished and the \ddot{H} has gone negative once more.

Contingency Aborts 21007/31007

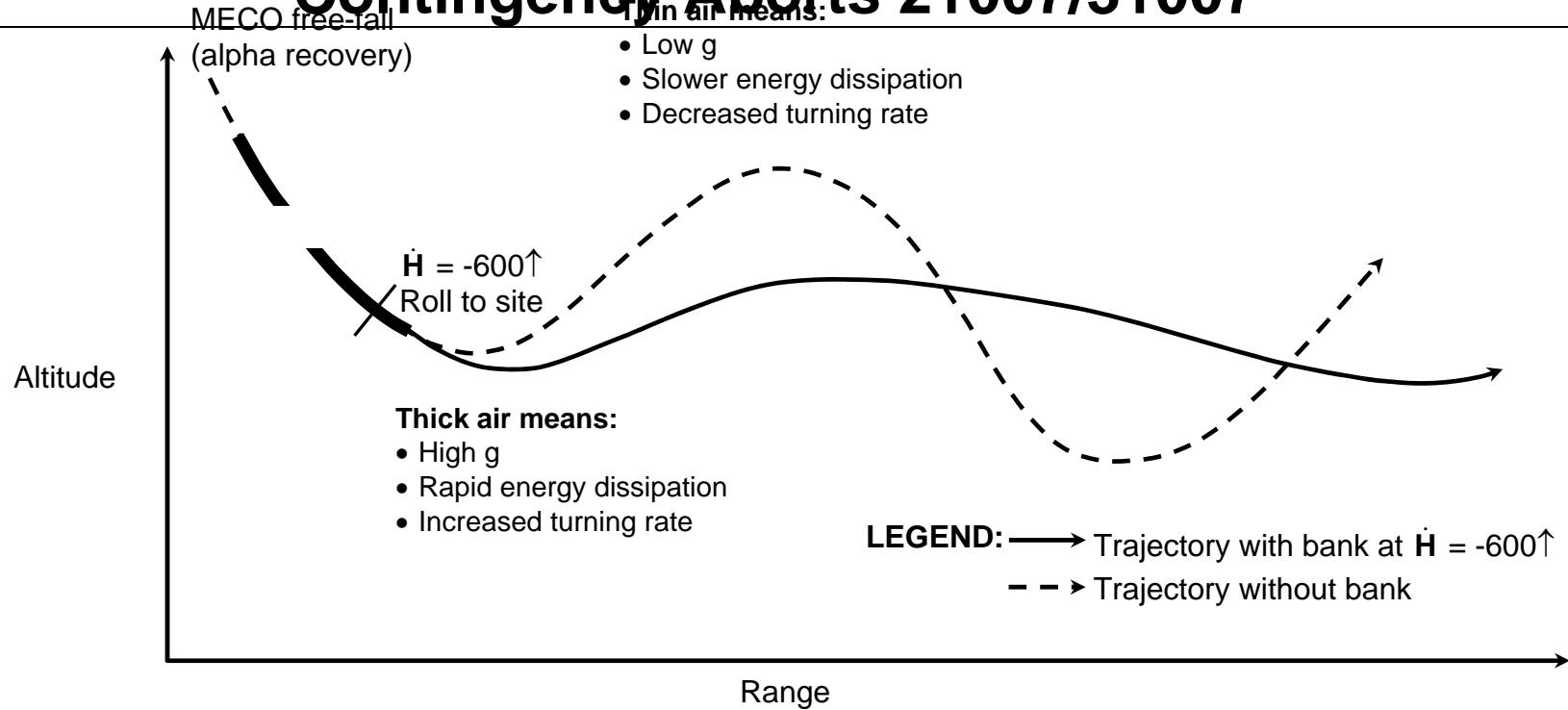

The bank at $\dot{H} = -600$ decreases the magnitude of the phugoid and allows the orbiter to sink into thicker air. While in thicker air g's will increase, energy will be dissipated more rapidly, and an increased turning rate will be accommodated. So then, thicker air is a benefit for high ΔAz (Azimuth delta) and/or high-energy situations. However, for low energy situations, the bank maneuver is a detriment. Bank will be reduced in order to increase lift, find thinner air, lower g's, and slow energy dissipation. Unfortunately, turning rate may also decrease to the point of allowing ΔAz to increase too rapidly to manage.

Contingency Aborts 21007/31007

4.14.5 ECAL/BDA Entry High Energy Control

After Nz hold, the ECAL/BDA Entry automation logic actively works to control energy.

After Nz Hold, the current state of energy over weight (E/W) is displayed on the VERT SIT E/W scale on the right-hand side. E/W scale from high to low energy includes total range to the runway, including flying out the current heading error (ΔAz). Although E/W may initially indicate low energy immediately after Nz Hold, the subsequent phugoid can easily increase ranging capability until the current E/W is nominal, or even high energy.

If high energy is detected as indicated by $E/W \geq STN$ on the VERT SIT display, then bank will be increased, if required, to a maximum of 70°

1. The best single on-board cue for determining current ECAL/BDA energy state is the E/W Bug on VERT SIT. If the E/W Bug shows high energy above the S-turn (STN) mark, expect a 70° bank toward the site.
2. 70° bank will be held until ΔAz has crossed through 0° and increased to between 15° and 30° on the other side.

NOTE: Accepted ΔAz heading error ramps from 30° at Mach 8 to 15° at Mach 3.2 since large heading errors in TAEM will lead to low-energy situations

3. Once the heading error has reached its limit, bank will be reversed and return to the normal $2.2 \times \Delta AZ$ value.
4. If the E/W Bug descends below the ECAL/BDA S-turn Termination line prior to reaching its ΔAz heading limit, guidance will also return to its normal $2.2 \times \Delta AZ$ banking technique.

During the 2nd and subsequent phugoids the roll commands are limited to protect g's and dynamic pressure. Thus it is common to see a smaller bank than the 70° high energy roll command or the normal $2.2 \times \Delta AZ$ roll command.

Contingency Aborts 21007/31007

4.14.6 ECAL/BDA Entry Energy Management - Alpha, Bank

In MM 602, post Nz Hold, ECAL/BDA Entry automation logic manages energy on entry by flying a bounded Mach-Alpha schedule and controlling bank as follows:

	Low g (< 2.5 g)	High g (≥ 2.5 g)
High Energy	Increase α (max per schedule) Bank = 2 x ΔAz (70° max) or, if E/W \geq STN, bank = 70°	Decrease α to hold 2.5 g Bank = 2 x ΔAz (70°) max or, if E/W \geq STN, bank = 70°
Low Energy	Decrease α (min per schedule) Bank = 2 x ΔAz (70° max)	Decrease α (min per schedule) Bank = 2 x ΔAz (70° max)

Where the Mach-Alpha schedule is bounds α by maximum and minimum limits as follows:

α max	50°	50°	50°	50°	32°	17.5°
Mach	>14	>11	>6	5	4	3.2
α min	31°	27°	24°	21.5°	19°	17°

NOTE: Min α is optimized to increase ranging capability, while protecting Vertical Tail Thermal Indicator (VTTI) limits.

Thus high and low energy is managed, including the following constraints:

1. If E/W \geq STN, bank = 70° until ΔAZ increased to 15° to 30° heading error limit, then 2x ΔAZ ,
2. If low energy, α may not decrease until $\Delta AZ < 25^\circ$.

For high-energy cases, the angle of attack will be increased to maximize drag and kill off energy. Also, if high enough energy exists, the high-energy S-turn bank logic will be initiated. The angle of attack will also be reduced to protect for g's if necessary.

For low energy cases the angle of attack will be reduced to fly closer to the max L/D while still protecting VTTI limits. If large heading errors exist, the angle of attack will not be reduced further until the heading error is below 25°. It is better to keep the nose up and more g's on the vehicle to converge the heading error quicker. The quicker heading error is reduced, the less range that has to be flown.

Contingency Aborts 21007/31007

VERT SIT E/W scale: Up and down TREND information on the VERT SIT E/W scale is as important as bug location.

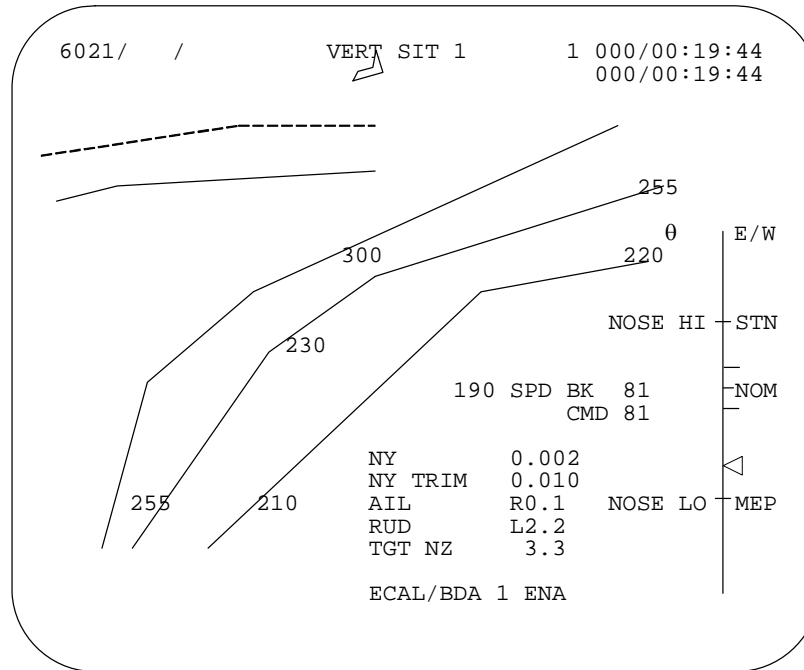

4.14.7 ECAL/BDA Entry Energy Assessment

1. \dot{H} tape: Consult the \dot{H} tape for INDIRECT energy TREND assessment. If \dot{H} is on the rise, air will be getting thinner and the energy state will soon dissipate at a slower rate. The inverse is true for decreasing \dot{H} .
2. Runway Range vs. Entry Alpha cue card: Consult Runway range on the A/E PFD for range comparison with Entry Alpha cue card. This should be used as supporting information when evaluating energy.
3. ΔAZ : Check ΔAZ in order to factor crossrange into the total energy assessment. While evaluating energy state, keep in mind the bank required to reduce ΔAZ . A large ΔAZ is usually a cue to conserve energy. The bank required to reduce ΔAZ may be in conflict with the bank required to manage range.

Contingency Aborts 21007/31007

4.14.8 ECAL/BDA Entry Navaid Management

In preparation for landing at an ELS site and for TAEM guidance requirements, nav aids such as TACAN and ADTA probes must be managed like a typical RTLS entry.

As soon as TACAN data is available, it should be incorporated to both PASS and BFS. When approaching an ELS runway, there is also greater potential for TACAN co-channel interference, particularly when still at a high altitude. Other TACAN stations transmitting on the same frequency may be picked up instead of the desired TACAN. This will be evident by the large ratio and residual error on SPEC 50. Waiting until at a lower altitude when only the desired TACAN is within line-of-sight should fix this problem

The ADTA Probes should be deployed once below Mach 5 as long as the g's are less than 2. ADTA should be incorporated to Guidance & Control (G&C) on SPEC 50 in order for TAEM guidance to effectively limit airspeed. If ADTA is not taken to G&C by Mach 2.0, then Theta Limits would need to be flown manually, which is an undesired additional workload burden when flying to an emergency landing.

4.14.9 ECAL/BDA TAEM transition

With the ECAL/BDA flag set to ENA, guidance will automatically transition to TAEM (MM 603) at Mach 3.2. At that point the ECAL/BDA and Contingency flags are set to OFF and TAEM guidance works exactly the same as a standard RTLS abort.

4.14.10 ECAL/BDA Entry Bailout Assessment

At 70k ft altitude, a Bailout assessment is made. Runway range is evaluated to ensure that range is NOT < 28 nm (for the high energy check) and range is NOT > 54 nm (for the low energy check).

SPEC 50 should be used to change runway approach geometry as necessary to pass these criteria. Downmode from overhead (OVHD) to straight-in (STIN) HAC and/or use Nominal or Minimum Entry Point (NEP/MEP) as required.

If the Range is < 28 nm or the Range is > 54 nm, then BAILOUT will be required.

After completing the ECAL/BDA ENTRY procedure, the crew will transition to the RTLS (POST-MECO at M = 2.7) entry procedure or the BAILOUT procedure as appropriate, based on the energy-range assessment.

Contingency Aborts 21007/31007

Section 5 Supplemental Information

5.1 Numbers/Gauges

Auto SERC recognition	Accel < 2 eng at min throttle setting with at ≤ one fail flag or data path flag set
Manual takeover throttle match	Within 4% of guidance command
KEAS	$\sqrt{q} \times 17.2$
Max pullout, g's in OPS 6	3.9
Max pullout, g's in OPS 3	3.5
Max EAS CA	470 kts
Max certified EAS	333 kts
Black zone definition	> 4.2 g's, > 470 kts EAS, LOC, or break-up
Min subsonic EAS	185 kts
Nz Hold initiation	1.8 g or $\alpha \geq 45^\circ$
Nz Hold terminate	$\dot{H} = -320 \uparrow$ (procedurally < 2 g)
Minimum droop altitude	265,000 ft.
Throttle rate of change allowable by software	10% per second
3 engine out emergency sep criteria	77 kts
MAN TGT Nz Hold calculation	Add 0.65 to $\dot{H}/1000$ when at one g
AIL Trim LOC	Counter when rudder saturated (6°) and aileron > 1° (in same direction)
Crossrange target	~500 nm
Low crossrange target	~375 nm
CA Blank matrix:	When post MECO pullout < 3.5 g
CA / OPS 1, 3 E/O	Not blanked, but not used after SE OPS 3
CA / OPS 1, 2 E/O	When guidance calculates 35 nm short of nominal RTLS R-V
RTLS CA / OPS 6, 3 E/O	SSME fine count
RTLS CA / OPS 6, 2 E/O	Entry attitude achieved or 77kts
CA MM 602 transition requirements	

Contingency Aborts 21007/31007

5.2 Acronyms and Abbreviations

1 EO	One-engine-out	ENA	Enable	PLT	Pilot
1 OUT	One-engine-out	ET	External Tank	PPA	Powered Pitch Around
2 E/O	Two-engine-out	ET SEP	External Tank Separation	R-V	Range-Velocity
2 EO	Two-engine-out	Fast SEP	Fast External Tank Separation	R/Y	Roll/Yaw
2 OUT	Two-engine-out	FCS	Flight Control System	RCS	Reaction Control System
3 E/O	Three-engine-out	FDF	Flight Data File	REF	Reference
3 EO	Three-engine-out	G&C	Guidance & Control	RHC	Rotational Hand Controller
3 OUT	Three-engine-out	GNS	Guidance, Navigation Simulator	RTLS	Return to Launch Site
Δ Az	Delta Azimuth	GPC	General Purpose Computer	RUD	Rudder trim
A/E PFD	Ascent/Entry Primary Flight Display	HAC	Heading Alignment Cone	S/B	Speedbrake
A/R	Aileron/Rudder	HSI	Horizontal Situation Indicator	SBTC	Speed Brake/Throttle Controller
AA	Accelerometer Assembly	INH	Inhibit	SE	Single-Engine
ADI	Attitude Direction Indicator	KEAS	Knots Equivalent Airspeed	SERC	Single Engine Roll Control
ADTA	Air Data Transducer Assembly	KSC	Kennedy Space Center	SFRM	Space Flight Resource Management
AET	Ascent/Entry Trainer	LOC	Loss of Control	SMS	Shuttle Mission Simulator
AIL	Aileron trim	LO XRNG	Low Crossrange	SPI	Surface Position Indicator
ARCS	Aft Reaction Control System	LVLH	Local Vertical/Local Horizontal	SRB	Solid Rocket Booster
ASAP	As Soon As Possible	M	Mach	SRB SEP	Solid Rocket Booster Separation
BDA	Bermuda	M/ α	Mach-alpha	SSME	Space Shuttle Main Engine
BF	Bodyflap	MECO	Main Engine Cutoff	STIN	Straight-In
BFS	Backup Flight Software	MEDS	Multifunction Electronic Display Subsystem	STN	S-Turn
c.g.	Center-of-gravity	MEP	Minimum Entry Point	TAEM	Terminal Area Energy Management
CA	Contingency Abort	MS	Mission Specialist	TAL	Transoceanic Abort Landing
CBT	Computer-Based Training	NEP	Nominal Entry Point	TGT Nz	Target Nz
CDR	Commander	Nz	Acceleration Normal to Z-axis	TVC	Thrust Vector Control
CONT	Contingency	OME	Orbital Maneuvering Engine	Vi	Inertial Velocity
CSS	Control Stick Steering	OMS	Orbital Maneuvering System	Vrel	Relative Velocity
DAP	Digital Auto Pilot	OVHD	Overhead	VTTI	Vertical Tail Thermal Indicator
EAS	Equivalent Airspeed	P	Pitch		
ECAL	East Coast Abort Landing	PASS	Primary Avionics Software System		
ELS	Emergency Landing Site				

Contingency Aborts 21007/31007

5.3 Index

A

A/R Trim, 34
Actual DROOP mode, 18
Adverse AIL Trim, 34, 55
Aileron and rudder trim display, 34
Air Data, 58
Alpha 125 deg SEP, 28
Alpha -2° SEP, 27
Alpha Recovery, 10, 31, 63
Alpha SEP, 27
Alpha Transition, 11
Alpha Trap, 33
ASCENT TRAJ display, 16
Attitude independent SEP, 26

B

Bailout, 71
Bailout autopilot, 36
Bailout Procedures, 59
BDA conditions, 2 EO, 61
BDA, 2 EO, 60
BDA, 3 EO, 64
BFS Limitations, 12
Black zones, 13
BLANK, 2 EO, 45
BLANK, 3 EO, 50
Body flap, 36

C

CA cue card, 8
CONT ENTRY Procedures, 54
Contingency guidance, 15
Contingency guidance 2 EO, 15

Contingency guidance, 3 EO, 17
Contingency Software, 15
CRM, 37
CSS, 20

D

Development, 7
Droop, 18
Droop Field Interpretation, 18
Droop guidance, 18
Droop Modes, 18
Droop Procedures, 51
Droop, Actual, 18
Droop, Hypothetical, 18
Dump, OMS, 24

E

E/W bug, 68
E/W scale, 70
ECAL conditions, 2 EO, 61
ECAL, 2 EO, 60
ECAL, 3 EO, 64
ECAL/BDA Energy Management, 65
ECAL/BDA ENTRY, 65
ECAL/BDA Entry Energy, 69, 70
ECAL/BDA High Energy, 68
Emergency SEP, 28
Energy Control, Entry, 68, 69, 70
Energy Management, 65
Entry procedures, MM 602, 54
Entry, ECAL/BDA, 65
ET SEP, 25
ET SEP (types), 26
ET Sep times, 25

F

Fast ET SEP, 10, 25
Fast ET SEP types, 26
Flight Instruments, 38

G

General Techniques, 37
Gauges, 72

H

H-dot formula, 32
H-dot scale, 32
High-rate SEP, 27
Hot-stick downmode, 20
Hypothetical DROOP mode, 18

I

ITEM 2, 43
ITEM 4, 43

L

Limitations, BFS, 12

M

M/ α profile, 57
MAN Throttles, 21
MAX Throttles, 22, 51, 62

Contingency Aborts 21007/31007

MECO Confirmed, 17
Monitor (color) block, 43, 49, 64

N

Nz calculation, manual, 32
Nz formula, 32
Nz Hold, 11, 31

O

OMS dump, 24
OPS 6 Contingency Software, 15
Outcome, 7
OVERRIDE display, SPEC 51, 23
Overview, 7

P

Panel F2/F4, 20
Pc < 50 SEP, 26
Phugoid, 11
Position Report, 59
POWERED BDA, 63

POWERED ECAL, 63
Procedure block, 43, 49, 62
Procedures, 2 EO BDA, 62
Procedures, 2 EO ECAL, 62
Profile, generic, 9

R

Rate SEP, 27, 63
Report Position, 59
RTLS 2 EO Automated, 45
RTLS 2 EO CSS, 46
RTLS 2 EO near VREL=0, 45
Rules of thumb, 72

S

SBTC, 21
SERC, 29, 51
SERC (Not available), 12
SERC AUTO recognition, 29
SFRM, 37
SPEC 51, 23
SPEC 51 OMS Dump, 24
Speedbrake, 36, 55

Stuck Procedures, 53
S-turn, 68
Subsonic Stall, 57
Survivability, 12

T

Target Nz, 31, 32, 56
Three-Engine-Out Procedures, 49
Thumb rules, 72
Two-Engine-Out Procedures, 43

V

VERT SIT display, 33
VREL=0, 45

Y

Yaw Steering, 16

Contingency Aborts 21007/31007

5.4 Your Personal Notes

Contingency Aborts 21007/31007

Revision Log

Rev. letter	Change no.	Description	Date
Basic		Baseline Issue. Supersedes TD350.	05/05/2003
A		OI-30 Updates primarily for SCR 92504G & 92672B to Alleviate ET Recontact for RTLS 2 EO Yellow and Orange Regions, SCR 92668C to Prevent Erroneous Droop Guidance Engagement, and SCR 92550B & 92685A for ECAL Automation Updates; Editorial Updates; and Copyright statement added to the cover.	09/10/2004
B		Updated Alpha Trap description to change the I-load for the alpha switch (ALPSW) from 45° to 35°	06/27/2006
C		Updated the adverse Aileron trim Loss of Control description (formerly known as Aileron/Rudder Force Fight)	10/04/2006
D		Updated for OI-32, including PASS TRAJ display changes and elimination of single-engine completion procedure for NPSP protection. Minor editorial and formatting changes. Updated Spaceflight Training logo. Updates to 3 EO First Stage black zone based on assessment presented at Ascent/Entry Flight Techniques Panel #226 (1/19/07).	2/14/2007