

SCHEELS[®] arena

Facility Guide 2017

TABLE OF CONTENTS

What to Expect in Fargo-Moorhead.....	3-4	Box Office/Ticketing.....	11	Permits.....	28
Things to Do.....	3-4	Box Office Hours.....	11	Ambulance.....	28
Bringing Events to Scheels Arena.....	5	Seating Layout Examples.....	12	Security.....	28
Building Specifications.....	5	Seating Capacities.....	13	First Aid.....	28
Building Size & Space.....	5	Standing Room Only Floor.....	13	ADA Information.....	28
Facility Basics.....	6-10	Reserved Seating.....	13	Make Your Stop in Fargo a Success.....	29
Building Layout.....	6-7	Technical Specifications.....	14-15	Event Services.....	29
Arena Floor Dimensions.....	8	Load In Area.....	14	In-House Event Marketing Services.....	29
Meeting Rooms.....	8	Electrical Power.....	14	House Rules & Regulations.....	30
Backstage.....	8	Audio System.....	14	Parking Information.....	30
Dressing/Locker Rooms.....	8	House Lighting.....	14	Accommodations & Hospitality.....	31
Load In Area.....	9	Video Production.....	15	Services & Attractions.....	32
Ice Floor Covering.....	9	House Equipment.....	15		
Concessions.....	10	Rigging Grid.....	16-25		
Catering.....	10	Maps & Directions.....	26-27		
Merchandise.....	10	Security & Safety.....	28		

STAFF DIRECTORY

JON KRAM | General Manager
jkram@scheelsarena.com | 701.356.7650

ALISON BEAL | Assistant GM/Booking
abeal@scheelsarena.com | 701.356.4349

NICOLE FRED | VP of Ticketing
nfred@scheelsarena.com | 701.356.4390

BRYCE LAWRENCE | VP of Operations
blawrence@scheelsarena.com | 701.356.7640

STEVEN RATTI | VP of Sales
sratti@scheelsarena.com | 701.356.4393

PAUL HAUGEN | Concessions Manager
phaugen@scheelsarena.com | 701.356.7644

WHAT TO EXPECT IN FARGO–MOORHEAD

Lying on opposite banks of the Red River of the North is Fargo-Moorhead, a twin-city community that offers an aesthetic and progressive environment unique to cities of its size. The metropolitan area reaches surrounding communities in western Minnesota and eastern North Dakota for a total population of over 233,000,¹ the largest metropolitan area between Minneapolis and Spokane, WA.

With a thriving economy and diverse culture, Fargo-Moorhead hosts three major universities, advanced health care facilities, exceptional parks and recreational facilities, extensive youth sports activities, a symphony, museums, a ballet company, and live theatre groups.

“Quietly, subversively, Fargo has gone trendy,” writes Los Angeles Times.² Fargo ranked #9 on Forbes list of best small places for businesses³ and careers. It’s an urban, active community with the means to support the arts and live entertainment.

Things to Do

Local attractions range from conferences on the latest technologies to museums and events dedicated to the rich history of the plains. Multiple art galleries, yoga studios, and coffee shops pepper the award-winning, revitalized downtown area, while sprawling parks and golf courses offer an escape into the prairie landscape for which the area is known.

¹ US Census Bureau, 2015 estimate. <http://quickfacts.census.gov/qfd/states/38.html>

Greater Fargo-Moorhead Economic Development Corporation <http://www.gfmedc.com/demographics>

² Los Angeles Times. “Fargo Hip? You Betcha.” March 10, 2004. <http://articles.latimes.com/2004/mar/10/nation/na-fargo10>

³ Forbes magazine’s Best Small Places for Businesses and Careers. April 14, 2010. http://www.forbes.com/lists/2010/5/business-places-10_Fargo-ND_6147.html

Fargo-Moorhead was placed in the 100 Hot-City Guide

~ *Cosmopolitan Magazine.*

Fargo-Moorhead was number 15 on the list of Best US Cities for Doing Business

~ *Inc.com*

Fargo-Moorhead ranked number one on the list of U.S. cities ranked on 200 environmental, health and quality of life indicators

~ *Earth Day Network*

FAST FACTS Population

Fargo-Moorhead
233,836

Estimated
Metro-Area
338,500

Estimated
College Pop.
41,500

Metro & College estimates are based on the following cities: Fargo, Moorhead, Grand Forks & Valley City.

Median Age: 32.6

Male: 49.8%

HH Income: \$52,583

Female: 50.2%

Education: 31.4% B.A.



Fargo ranked #15 among best college towns.

-American Institute for Economic Research

Several community events occur annually, like the Fargo Film Festival, Fargo Marathon, Red River Valley Fair, RibFest, Cruisn'Broadway, RiverArts, Downtown Street Fair, Red River Valley Sportsman's Show, Streets Alive, and Holiday Lights Parade. An active community offers many cross-promotional opportunities with other concerts and events coming to the area.

Book your next concert or event in Fargo-Moorhead at Scheels Arena. It's a state-of-the-art venue on 15 acres of land in south Fargo that seats up to 6,000 for concerts and over 5,000 for sporting events like ice hockey and basketball.

Scheels Arena opened in 2008 and has already hosted several major concerts and events, including Alan Jackson, Foreigner, Snowstorm Music Tour (Nelly, 3OH!3), Wiz Khalifa, 2015 and 2017 NCAA Men's Ice Hockey Regionals and the Fargo Youth Hockey Squirt International Hockey Tournament. Scheels Arena is also home to the USHL's Fargo Force hockey team. It will also play home to the 2018 Olympic curling nationals.

Traffic charts of higher-education consortiums in this region show heavy student migration toward North Dakota.

~ Wall Street Journal; July 16, 2011

BOOKING EVENTS AT SCHEELS ARENA

Scheels Arena is a multi-purpose facility with up to 6,000 seating capacity, the latest event technology, and accommodations that ensure each event is a success for agents, artists, promoters, and attendees alike.



Building Specifications

Offering flexible configurations depending on event & audience needs.

Building Size & Space

Total Square Feet:

- Floor - 17,000
- Concourse – 17,830
- Upper Lobby – 7,585
- Lower Lobby – 3,845

The facility consists of:

- 15 locker/dressing rooms
- 38 luxury suites
- 1 club lounge
- 300 club seats
- Athletic training facility
- Meeting/conference/family room
- Offices
- Restaurant/concessions
- On-site parking
- Flexible arena configurations

SCHEELS ARENA | Facility Info

Broke Ground:

June 2007

Opened:

October 2008

Operator:

Metro Sports Foundation

Design Architect:

ICON Architectural Group

Structural Engineer:

Sandman & Assoc., PC

General Contractor:

Anderson & Sons, Inc.

Construction Cost:

\$25 Million

Total Site Area:

15 Acres

Main Arena Floor:

17,000 Sq. ft.

Seating Capacity:

6,000

Location:

Located in the Urban Plains development, just off I-94

Address:

5225 31st Ave. S.
Fargo, ND 58104

Phone:

701.356.7656



FACILITY B

Building Layout | Lower Level

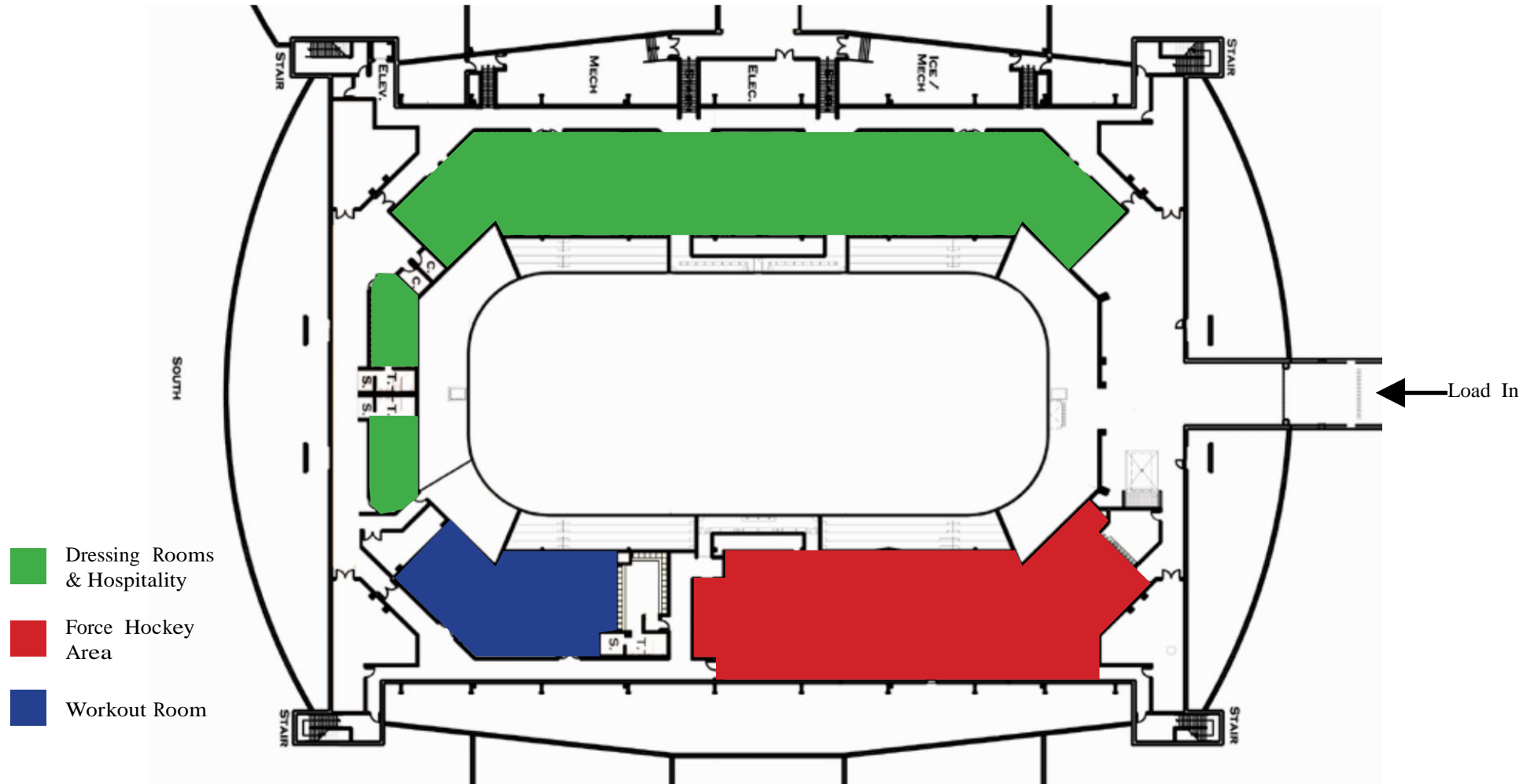

Building Layout | Concourse Level

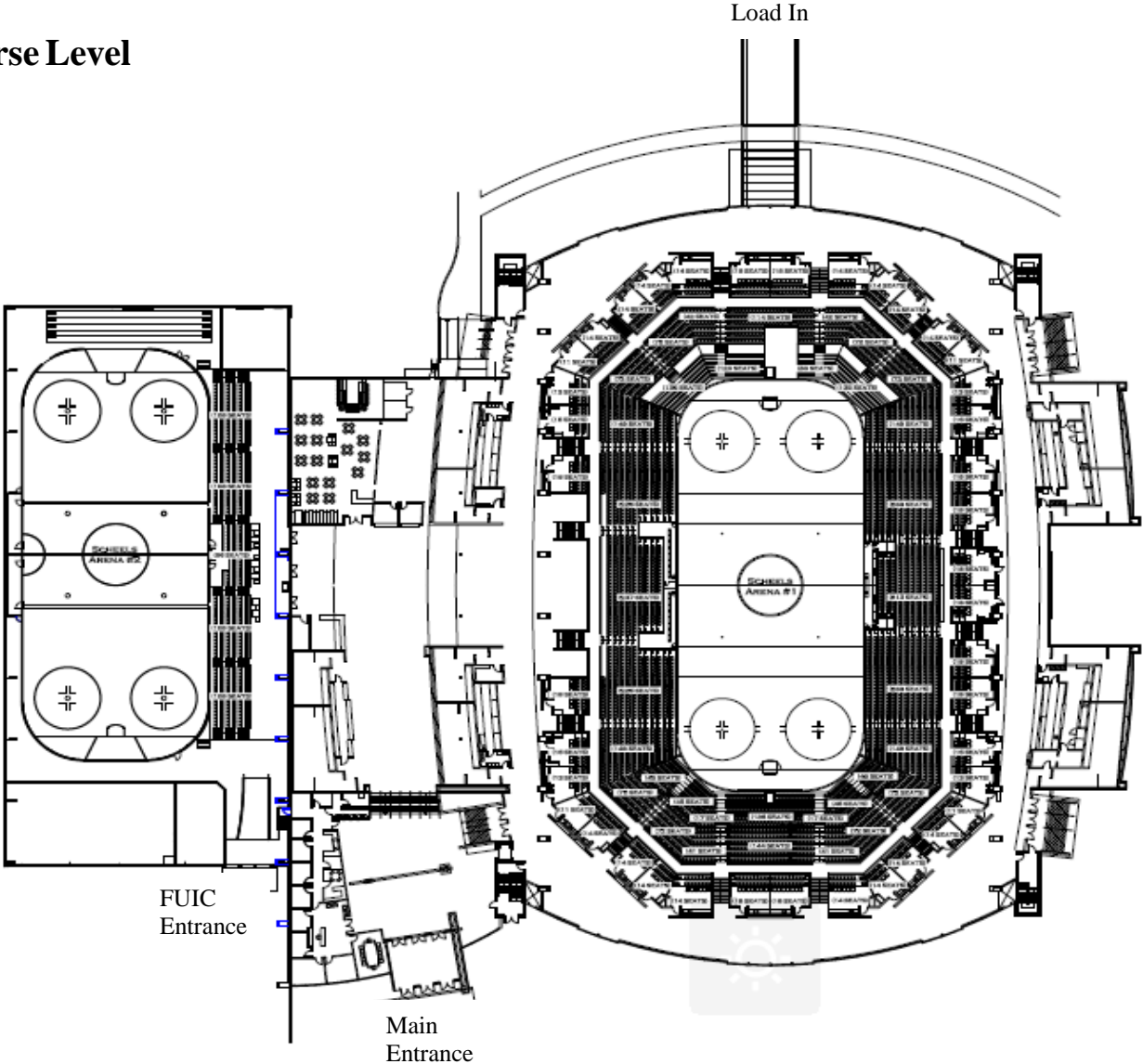

Arena Floor Dimensions

- Main arena floor is 200 ft. x 85 ft. (17,000 sq. ft.)



Meeting Rooms

- High Point Bar & Grill
 - 100 people classroom set up
 - 80 people banquet set up
 - 60 people bar set up
- Event-Level Media Room
 - 70 people classroom set up
 - 60 people banquet set up

Backstage

- 7 – Dressing/Locker room
- Green room
- Production offices with phone, fax & internet lines available.
- 4 large dressing rooms & coaches offices have CAT5 lines with up to 13mbps speeds.

Dressing Rooms/Locker Rooms

There are several locker room style dressing rooms located throughout the lower level of the arena, equipped with showers and restrooms. Four double rooms with offices and three single rooms with external offices can be equipped with phones, fax, and all have wired & wireless internet access.



Load In Area

- Ice Level Loading Door — (1) Ice level access door, 15' H x 18' W
- Arena Floor Access — (1) Arena floor access with clearance of 11.5' H x 9' W
- Loading ramp grade — 8%

Bus and truck parking is available along 30th Ave S next to load in. This street is closed to the public during events/concerts.

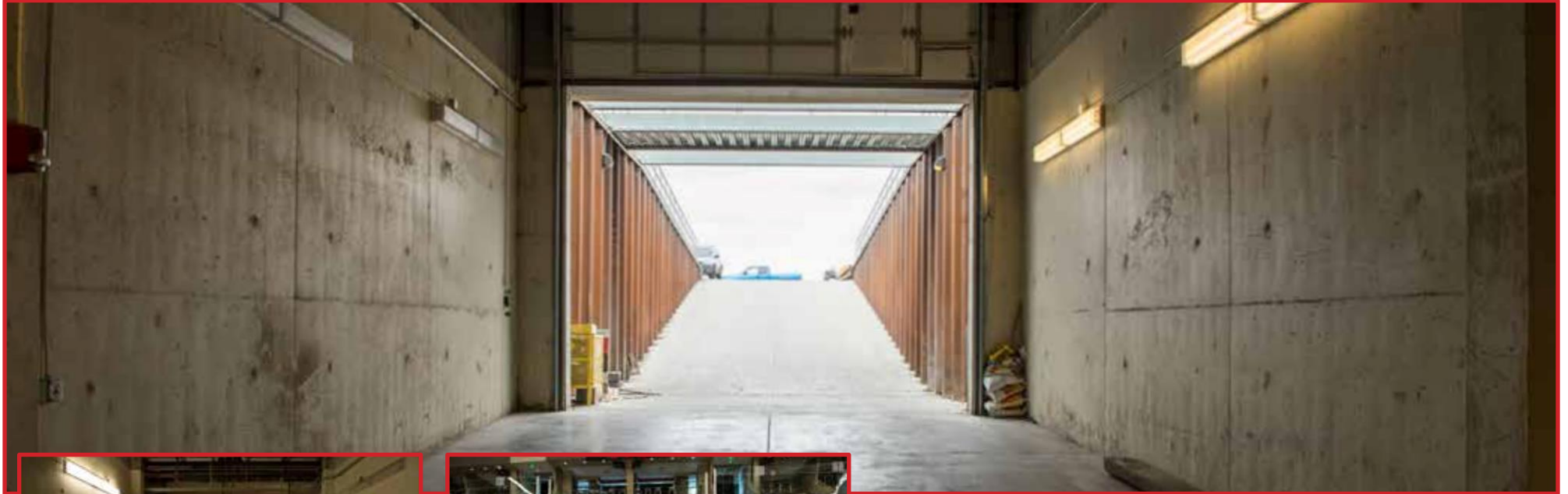

Ice Floor Covering

A portable, insulated arena deck covering is provided from Space Age Synthetics.

Concessions

All concessions and liquor services are owned and operated by Concessions Management.



Catering

Catering is selected and booked by lessee. The team at Scheels Arena is happy to provide recommendations. Scheels Arena recommends the following catering services:

Concessions Management

701.356.7644 | ScheelsArena.com

Spitfire

701.478.8667 | SpitfireBarAndGrillFargo.com

Chef's Table Catering

701.566.3473 | www.chefstablefargo.com

Holiday Inn Fargo Hotel

701.277.7304 | www.fargohi.com

Catering by Concordia

218.299.4271 |

Brewtus' Brickhouse

701.532.1397 | brickhousetaverns.com

Merchandise

Merchandise is sold on the upper concourse closest to the public doors. These services will be handled on a case-by-case basis. Commission is 80/20 and 90/10 recorded if lessee sells merchandise, and 75/25 if Scheels Arena runs merchandising.

BOX OFFICE/TICKETING

Scheels Arena utilizes TicketMaster for all ticketed events, which may be purchased through the following channels:

- Scheels Arena box office (in person or via phone 701.364.3672)
- ScheelsArena.com OR Ticketmaster.com
- TicketMaster charge by phone 1-800-745-3000



Box Office Hours

The Scheels Arena box office has four windows, and it's open Monday – Friday from 10:00 am – 5:00 pm. It also opens at noon on event weekends.

Summer hours run from May 15 – September 15, when the box office is open Monday – Friday from 11:00 am – 1:00 pm. Extended hours will be utilized during event weeks in the summer.

All ticketing questions may be directed to the box office at 701.364.3672.



SEATING CONFIGURATIONS

End Stage Reserved Seating



End Stage General Admission

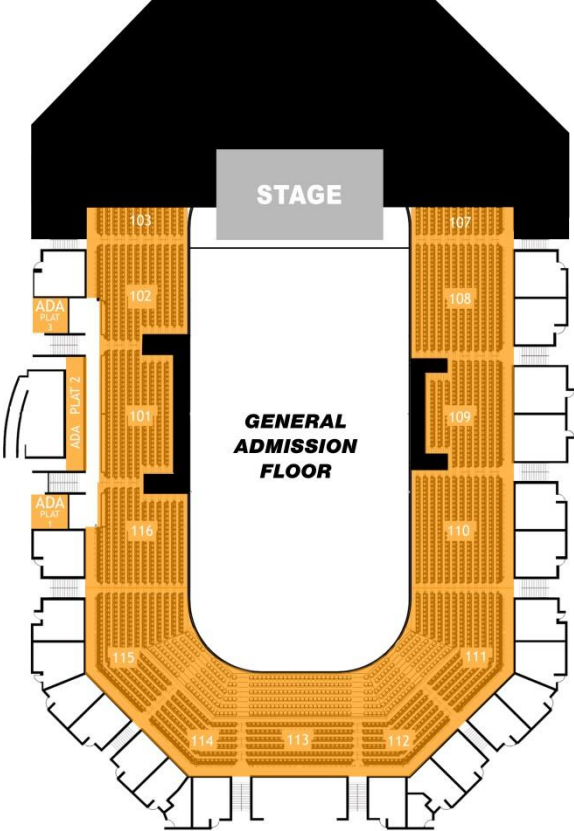

Conference Layout

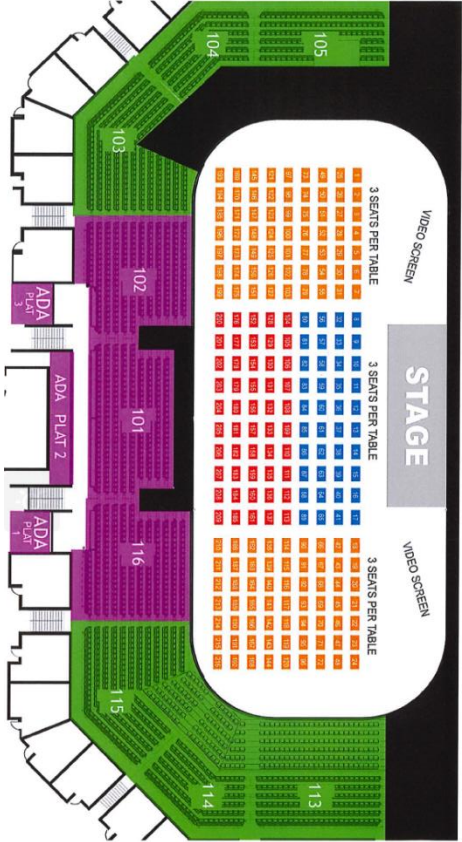

SEATING CAPACITIES

Scheels Arena can host up to 6,000 fans for concerts, and 5,000 – 6,000 for sporting events like hockey, basketball, and wrestling.

Standing Room Only Floor

Standing Room Only (SRO) floor size fluctuates based on size of stage. With a 60' wide x 40' deep stage, the arena can accommodate up to 5,433 SRO guests and offer the following seating options:

- **END STAGE – GA 180**
- Total Arena Capacity – 5,433
- Floor GA – 2,400
- Bowl Reserved Seating – 1,954
- ADA Reserved Seating – 26
- Club Seating – 172
- Club Lounge Seating – 48
- Suite Seating – 658



Reserved Seating

With end stage at 180 & 270 degrees, Scheels Arena offers the following capacities, with 40' x 60' stage with 10' upstage area and 10' front of stage clearance.

- | | |
|----------------------------------|----------------------------------|
| • END STAGE – 180 | • END STAGE – 270 |
| • Total Arena Capacity – 4,435 | • Total Arena Capacity – 5,251 |
| • Floor Reserved Seating – 1,402 | • Floor Reserved Seating – 1,402 |
| • Bowl Reserved Seating – 1,954 | • Bowl Reserved Seating – 2,709 |
| • ADA Reserved Seating – 26 | • ADA Reserved Seating – 26 |
| • Club Seating – 172 | • Club Seating – 233 |
| • Club Lounge Seating – 48 | • Club Lounge Seating – 48 |
| • Suite Seating – 658 | • Suite Seating – 658 |

TECHNICAL SPECIFICATIONS

A live event is only as good as its production. Ensure yours is a success.

Load In Area

- Concourse – (1) Door in northwest corner on main concourse level.
7.5' H x 8' W
- Ice Level – (1) Ice level access door.
15' H x 18' W
- Arena Floor – (1) Arena floor access area clearance.
11.5' H x 9' W
- Lower Lobby – front entrance access to lower lobby.
7.5' H x 6.5' W

Electrical Power

- (1) 400 & (2) 200 Amp / 3 Phase Disconnects located backstage.
- (1) 200 Amp panel is available in NW corner of event level.



Audio System

Scheels Arena's sound system uses a combination of QSC and innovox speakers throughout the concourses and over the surface, allowing for 100 dB to all seats and 100% building coverage.

The sound system is equipped with 2 hard-wired microphones, 2 wireless microphones, 16 channel audio mixer, audio XLR and video connections (SDI & Triax) on media deck, truck dock, penalty box, and production room.

House Lighting

- Florescent lighting situated above arena bowl provides instant lighting and black-out conditions. Fluorescents rate at 600 lux.
- Sport lighting around main arena ensures maximum lighting exposure and increases lighting to 1500 lux.
- An 8-minute time period is required for sport lighting to hit full capacity once on.

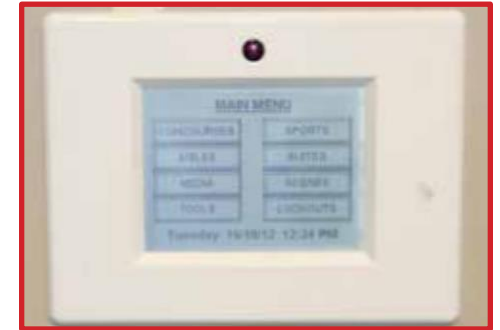

Video Production

Scheels Arena is equipped with a Panasonic video system with 10' x 18' jumbotrons on the north and south ends of ice area, 2' x 190' fascia ring, and two smaller fascia rings 2' X 160'.

The system feeds live video to all televisions in the building with an in-house channel (Channel 94 or HD channel 120-1). The system has the ability to interface with outside equipment.

Video Equipment

- Four Prosumer Cameras - Canon XL2. No complex, triax, tally, or CCUs.
- 8-input Video Switcher - One framesync, no MMEs or DVE.
- Multi-media server/character generator, single-channel.
- Replay machines – BUF Technology.
- Wireless video/audio transmitter – 9 frame delay.
- Headsets are 4-pin connectors. Anchor Intercom System with one wireless belt pack. Nine hard-wired locations throughout the arena.
- Six hard-wired locations – coax video cable, intercom, and outlet for power.
- DVD recorders and a 2-disc duplicator.
- No audio mixing capabilities.

File Output Requirements

Bowl Area Media:

- Long fascia board: 6080 W x 64 H (Export as PNG or TIF. AVI 30 fps.)
- Short fascia board: 1664 W x 64 H (Export as PNG or TIF. AVI 30 fps.)
- Video board graphic: 720 W x 486 H (Export as PNG or TIF.)

- Video board: 720 W x 480 H. Audio 48khz. (Export as MOV with codec DVCPPro, Sorenson or Sorenson 3, or Pro-Res 422 and 29.97 fps)

Lobby Televisions: (4 are equipped for event information, sponsors, etc.)

- Video containers: 720 W x 486 H (Export as MPEG2, AVI, ASF, WMV, MKV, MOV (H.264), MP4 or RMP4.)
- Video codecs: 720 W x 486 H (Export as XVID SD/HD, MPEG-4.2, WMV9, H.264, or VC-1.)
- Audio codecs: 720 W x 486 H (Export as WMA, WMA Pro, AAC, MP1, MP2, MP3, or LPCM.)
- Photo images/slides: 720 W x 486 H (Export as JPEG, BMP, PNG, or GIF)

House Equipment:

- (2) pallet jacks
- (16) 4' plastic tables
- (10) 60" round plastic tables
- 40 feet of 8' black pipe and drape
- 950 Clarin chairs by Hussey
- 50 8' heavy wooden tables
- 5 dasher board tables/podiums
- 15 blue tableskirts for 8' tables
- Black board drape
- Ice covering system
- Twenty tensa barrier stanchions

Area Production Companies

HB Sound & Light

701.775.1150
HBSound.com

Sound Central, LLC

715.392.4553
SoundCentralServices.com

Slamhammer Audio

612.724.5395
SlamHammer.com

DMM Systems

605.362.8327
DMMSystems.com

SCHEELS arena RIGGING GRID

12/11/12

DRAWING INDEX

ARCHITECTURAL

A101B - RIGGING PLAN OVERALL
A102B - RIGGING PLAN ENLARGED
A301B - RIGGING SECTION

STRUCTURAL

S001B - STRUCTURAL NOTES
S002B - RIGGING BEAM LOADING TABLE
S101B - RIGGING PLAN
S201B - CROSS SECTION AT FRAME LINE "8"
S202B - CROSS SECTION AT FRAME LINE "9"
S203B - CROSS SECTION AT FRAME LINE "10 & 11"
S501B - RIGGING DETAILS

MECHANICAL/ELECTRICAL

ARCHITECTURAL/STRUCTURAL
ICON ARCHITECTURAL GROUP
GARDEN VIEW DRIVE SUITE 101
GRAND FORKS, ND 58201
VOICE: 701.772.4266
FAX: 701.772.4275

DECEMBER 12, 2012

SET NUMBER _____

ICON
ARCHITECTURAL GROUP

SCHEELS ARENA
RIGGING GRID
12/11/2012 | PROJECT # 12-090

GENERAL CONSTRUCTION NOTES

1. OWNER SHALL VERIFY THAT THE CONSTRUCTION, INCLUDING ALL APPROVED BY THE STATE OF NORTH DAKOTA, IS OF THIS DATE.
2. THE CONTRACTOR SHALL VERIFY ALL CONTRACT DOCUMENTS, INCLUDING PROVISIONS AND CONDITIONS, BEFORE BEGINNING WORK AND SHALL NOTIFY THE ARCHITECT IMMEDIATELY IN WRITING OF ANY DISCREPANCIES.
3. SPECIAL NOTES AND DETAILS SHALL TAKE PRECEDENCE OVER GENERAL NOTES.
4. THE CONTRACTOR SHALL MAINTAIN ACCESS TO ALL UTILITIES AND SHALL BE RESPONSIBLE FOR THE PROTECTION OF THE SAME AND SHALL MAINTAIN ACCESS TO ALL UTILITIES AT ALL TIMES.
5. THE CONTRACTOR SHALL MAINTAIN ACCESS TO ALL UTILITIES AND SHALL BE RESPONSIBLE FOR THE PROTECTION OF THE SAME AND SHALL MAINTAIN ACCESS TO ALL UTILITIES AT ALL TIMES.
6. THE CONTRACTOR SHALL MAINTAIN ACCESS TO ALL UTILITIES AND SHALL BE RESPONSIBLE FOR THE PROTECTION OF THE SAME AND SHALL MAINTAIN ACCESS TO ALL UTILITIES AT ALL TIMES.
7. THE CONTRACTOR SHALL MAINTAIN ACCESS TO ALL UTILITIES AND SHALL BE RESPONSIBLE FOR THE PROTECTION OF THE SAME AND SHALL MAINTAIN ACCESS TO ALL UTILITIES AT ALL TIMES.
8. THE CONTRACTOR SHALL MAINTAIN ACCESS TO ALL UTILITIES AND SHALL BE RESPONSIBLE FOR THE PROTECTION OF THE SAME AND SHALL MAINTAIN ACCESS TO ALL UTILITIES AT ALL TIMES.
9. THE CONTRACTOR SHALL MAINTAIN ACCESS TO ALL UTILITIES AND SHALL BE RESPONSIBLE FOR THE PROTECTION OF THE SAME AND SHALL MAINTAIN ACCESS TO ALL UTILITIES AT ALL TIMES.
10. THE CONTRACTOR SHALL MAINTAIN ACCESS TO ALL UTILITIES AND SHALL BE RESPONSIBLE FOR THE PROTECTION OF THE SAME AND SHALL MAINTAIN ACCESS TO ALL UTILITIES AT ALL TIMES.

STEELWORK DETAIL NOTES

1. STEELWORK SHALL BE FABRICATED AND ERected IN ACCORDANCE WITH THE LATEST REQUIREMENTS OF THE AISC 360 STEEL CONSTRUCTION MANUAL.
2. STEELWORK SHALL BE FABRICATED AND ERected IN ACCORDANCE WITH THE LATEST REQUIREMENTS OF THE AISC 360 STEEL CONSTRUCTION MANUAL.
3. STEELWORK SHALL BE FABRICATED AND ERected IN ACCORDANCE WITH THE LATEST REQUIREMENTS OF THE AISC 360 STEEL CONSTRUCTION MANUAL.
4. STEELWORK SHALL BE FABRICATED AND ERected IN ACCORDANCE WITH THE LATEST REQUIREMENTS OF THE AISC 360 STEEL CONSTRUCTION MANUAL.
5. STEELWORK SHALL BE FABRICATED AND ERected IN ACCORDANCE WITH THE LATEST REQUIREMENTS OF THE AISC 360 STEEL CONSTRUCTION MANUAL.
6. STEELWORK SHALL BE FABRICATED AND ERected IN ACCORDANCE WITH THE LATEST REQUIREMENTS OF THE AISC 360 STEEL CONSTRUCTION MANUAL.
7. STEELWORK SHALL BE FABRICATED AND ERected IN ACCORDANCE WITH THE LATEST REQUIREMENTS OF THE AISC 360 STEEL CONSTRUCTION MANUAL.
8. STEELWORK SHALL BE FABRICATED AND ERected IN ACCORDANCE WITH THE LATEST REQUIREMENTS OF THE AISC 360 STEEL CONSTRUCTION MANUAL.
9. STEELWORK SHALL BE FABRICATED AND ERected IN ACCORDANCE WITH THE LATEST REQUIREMENTS OF THE AISC 360 STEEL CONSTRUCTION MANUAL.
10. STEELWORK SHALL BE FABRICATED AND ERected IN ACCORDANCE WITH THE LATEST REQUIREMENTS OF THE AISC 360 STEEL CONSTRUCTION MANUAL.

FALL PROTECTION NOTES

1. FALL PROTECTION SHALL BE PROVIDED FOR ALL WORKERS ON ALL SCAFFOLDING AND OTHER STRUCTURES.
2. FALL PROTECTION SHALL BE PROVIDED FOR ALL WORKERS ON ALL SCAFFOLDING AND OTHER STRUCTURES.
3. FALL PROTECTION SHALL BE PROVIDED FOR ALL WORKERS ON ALL SCAFFOLDING AND OTHER STRUCTURES.

SPECIAL NOTATIONS

1. SPECIAL NOTATIONS SHALL BE PROVIDED FOR ALL WORKERS ON ALL SCAFFOLDING AND OTHER STRUCTURES.
2. SPECIAL NOTATIONS SHALL BE PROVIDED FOR ALL WORKERS ON ALL SCAFFOLDING AND OTHER STRUCTURES.
3. SPECIAL NOTATIONS SHALL BE PROVIDED FOR ALL WORKERS ON ALL SCAFFOLDING AND OTHER STRUCTURES.
4. SPECIAL NOTATIONS SHALL BE PROVIDED FOR ALL WORKERS ON ALL SCAFFOLDING AND OTHER STRUCTURES.
5. SPECIAL NOTATIONS SHALL BE PROVIDED FOR ALL WORKERS ON ALL SCAFFOLDING AND OTHER STRUCTURES.
6. SPECIAL NOTATIONS SHALL BE PROVIDED FOR ALL WORKERS ON ALL SCAFFOLDING AND OTHER STRUCTURES.
7. SPECIAL NOTATIONS SHALL BE PROVIDED FOR ALL WORKERS ON ALL SCAFFOLDING AND OTHER STRUCTURES.
8. SPECIAL NOTATIONS SHALL BE PROVIDED FOR ALL WORKERS ON ALL SCAFFOLDING AND OTHER STRUCTURES.
9. SPECIAL NOTATIONS SHALL BE PROVIDED FOR ALL WORKERS ON ALL SCAFFOLDING AND OTHER STRUCTURES.
10. SPECIAL NOTATIONS SHALL BE PROVIDED FOR ALL WORKERS ON ALL SCAFFOLDING AND OTHER STRUCTURES.

SPECIAL OBSERVATIONS

1. SPECIAL OBSERVATIONS SHALL BE PROVIDED FOR ALL WORKERS ON ALL SCAFFOLDING AND OTHER STRUCTURES.
2. SPECIAL OBSERVATIONS SHALL BE PROVIDED FOR ALL WORKERS ON ALL SCAFFOLDING AND OTHER STRUCTURES.

ITEM	DESCRIPTION	DATE	BY
1	REVISION		
2	REVISION		
3	REVISION		
4	REVISION		
5	REVISION		
6	REVISION		
7	REVISION		
8	REVISION		
9	REVISION		
10	REVISION		

1. THE CONTRACTOR SHALL MAINTAIN ACCESS TO ALL UTILITIES AND SHALL BE RESPONSIBLE FOR THE PROTECTION OF THE SAME AND SHALL MAINTAIN ACCESS TO ALL UTILITIES AT ALL TIMES.
2. THE CONTRACTOR SHALL MAINTAIN ACCESS TO ALL UTILITIES AND SHALL BE RESPONSIBLE FOR THE PROTECTION OF THE SAME AND SHALL MAINTAIN ACCESS TO ALL UTILITIES AT ALL TIMES.
3. THE CONTRACTOR SHALL MAINTAIN ACCESS TO ALL UTILITIES AND SHALL BE RESPONSIBLE FOR THE PROTECTION OF THE SAME AND SHALL MAINTAIN ACCESS TO ALL UTILITIES AT ALL TIMES.
4. THE CONTRACTOR SHALL MAINTAIN ACCESS TO ALL UTILITIES AND SHALL BE RESPONSIBLE FOR THE PROTECTION OF THE SAME AND SHALL MAINTAIN ACCESS TO ALL UTILITIES AT ALL TIMES.
5. THE CONTRACTOR SHALL MAINTAIN ACCESS TO ALL UTILITIES AND SHALL BE RESPONSIBLE FOR THE PROTECTION OF THE SAME AND SHALL MAINTAIN ACCESS TO ALL UTILITIES AT ALL TIMES.
6. THE CONTRACTOR SHALL MAINTAIN ACCESS TO ALL UTILITIES AND SHALL BE RESPONSIBLE FOR THE PROTECTION OF THE SAME AND SHALL MAINTAIN ACCESS TO ALL UTILITIES AT ALL TIMES.
7. THE CONTRACTOR SHALL MAINTAIN ACCESS TO ALL UTILITIES AND SHALL BE RESPONSIBLE FOR THE PROTECTION OF THE SAME AND SHALL MAINTAIN ACCESS TO ALL UTILITIES AT ALL TIMES.
8. THE CONTRACTOR SHALL MAINTAIN ACCESS TO ALL UTILITIES AND SHALL BE RESPONSIBLE FOR THE PROTECTION OF THE SAME AND SHALL MAINTAIN ACCESS TO ALL UTILITIES AT ALL TIMES.
9. THE CONTRACTOR SHALL MAINTAIN ACCESS TO ALL UTILITIES AND SHALL BE RESPONSIBLE FOR THE PROTECTION OF THE SAME AND SHALL MAINTAIN ACCESS TO ALL UTILITIES AT ALL TIMES.
10. THE CONTRACTOR SHALL MAINTAIN ACCESS TO ALL UTILITIES AND SHALL BE RESPONSIBLE FOR THE PROTECTION OF THE SAME AND SHALL MAINTAIN ACCESS TO ALL UTILITIES AT ALL TIMES.



4870 Mainway Drive
Suite 100
Grand Forks, ND 58001
P: 701.775.4444
F: 701.775.4444
www.icon-nd.com

SCHIELS ARENA
Rigging Grid Option B
5220 30th Avenue South
Fargo, North Dakota 58104

No.	Description	Date



Construction Documents
DATE
12/11/22
Structural Notes
S001B

RIGGING BEAM LOADING TABLE		
LOADING (EVENLY SPACED)	30' BAY	24' BAY
1 POINT LOAD (MIDSPAN)		
1 POINT LOAD (ANYWHERE)		
2 POINT LOADS		
3 POINT LOADS		

TABLE NOTES: 1. LOADS SHOWN ARE EQUALLY SPACED WITH THE ABILITY TO SHIFT EITHER DIRECTION 25% OF THE SPACE BETWEEN LOADS OR END OF BEAM. SHADED AREA REPRESENTS ALLOWABLE RANGE.

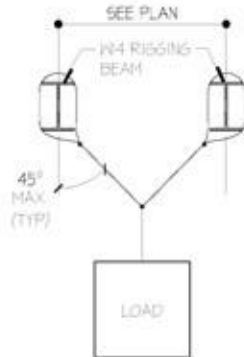

BRIDLING DIAGRAM

RIGGING NARRATIVE:

THE TOTAL APPLIED LOAD CAPACITY OF THE RIGGING SYSTEM IS 50000 LBS. THIS LOADING CAN BE APPLIED TO THE PROVIDED RIGGING SYSTEM IN A NUMBER OF ACCEPTABLE CONFIGURATIONS. THE RIGGING SYSTEM IS DESIGNED FOR THE MOST CONSERVATIVE CASE OF SIX CORRELATIVE BEAMS SUPPORTING THE TOTAL 50000 LBS. THE POINT LOADS TO THE RIGGING BEAMS ARE ALLOWED TO BE BRIDLED WITH A MAXIMUM SLING ANGLE FROM VERTICAL OF FORTY FIVE DEGREES. BRIDLING SHALL BE DONE IN A MANNER TO CREATE A ZERO NET APPLIED LATERAL LOAD TO THE SYSTEM. THE 50000 LB TOTAL RIGGING LOAD CAN BE DISTRIBUTED THROUGHOUT THE SYSTEM IN ANY NUMBER OF BAYS WITHIN THE RIGGING BEAM LOAD TABLE ABOVE, NOT EXCEEDING THE MAXIMUM POINT LOADS PER BEAM. DO NOT RIG FROM THE 4022B STRUT BEAMS. THESE ARE BRACING MEMBERS ONLY. RIGGING PLANS ARE TO BE SUBMITTED TO ARENA-MANAGEMENT FOR APPROVAL PRIOR TO APPLICATION OF LOADS.



48700 Granite Valley Drive
North, ND
58005-7400
A DIV. OF ILLINOIS TOOL WORKS
www.illinois.com

PRODUCTS
5000 Architectural Group
48700 Granite Valley Drive, North, ND 58005
701.771.4200
701.771.4211 Fax
www.illinois.com

MECHANICAL
NO
ELECTRICAL
NO
PLUMBING
NO

SHEELS ARENA
Rigging Grid Option B
5220 30th Avenue South
Fargo, North Dakota 58104

No.	Description	Date



Construction Documents
DATE: 12/1/13
Rigging Beam Loading Table
S002B

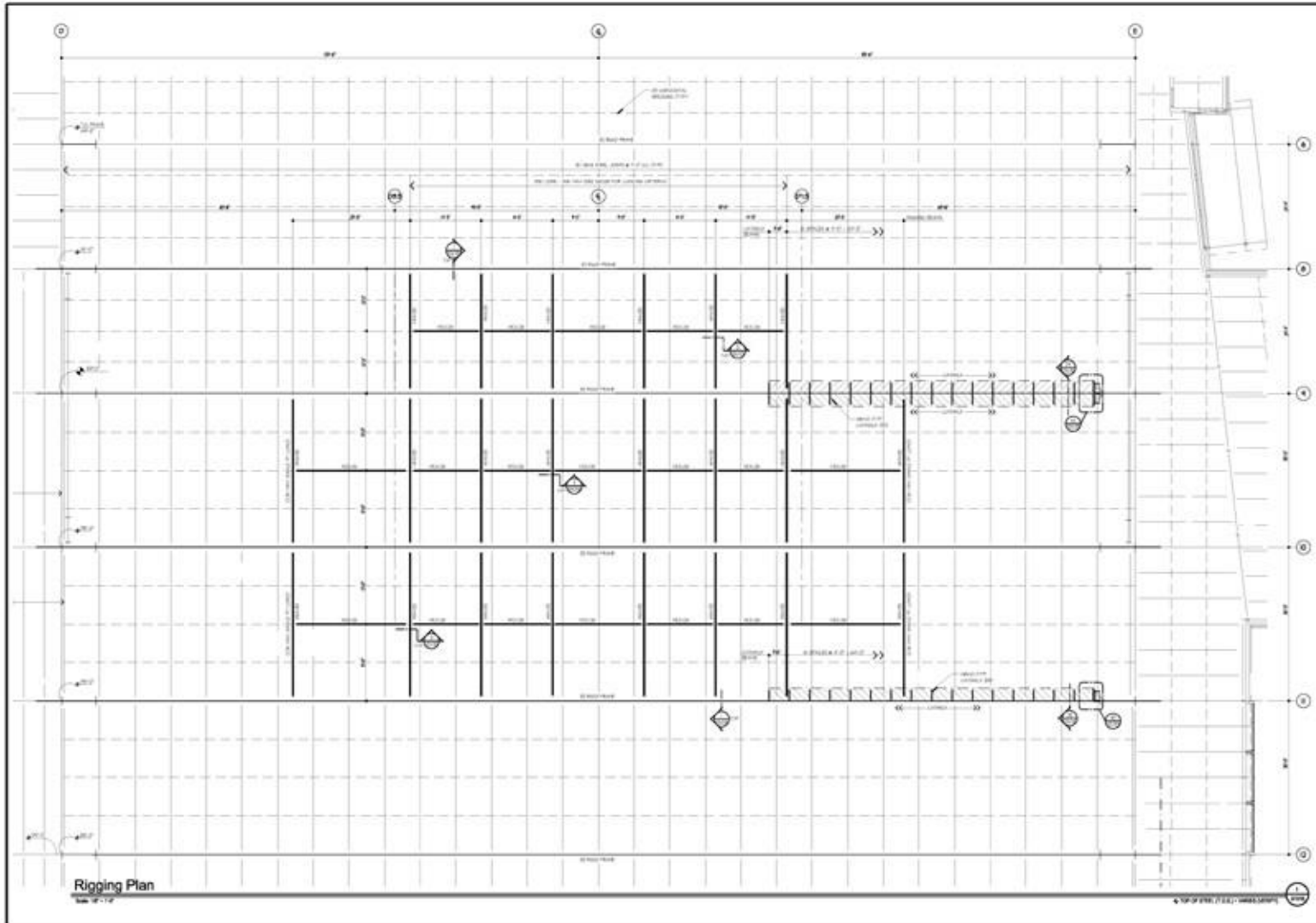

Rigging Plan
Scale: 1/8" = 1'-0"



48700 Broadway Blvd. Suite 100
Fargo, ND 58103
701.735.4211
www.scheelsarena.com

ARCHITECT
Scheels Arena
48700 Broadway Blvd. Suite 100
Fargo, ND 58103
701.735.4211
www.scheelsarena.com

MECHANICAL	NA
ELECTRICAL	NA
PLUMBING	NA
STRUCTURAL	NA

SCHEELS ARENA
Rigging Grid Option B
5220 30th Avenue South
Fargo, North Dakota 58104

No.	Description	Date



Construction Documents
DATE: 12/11/12
Rigging Plan
S101B

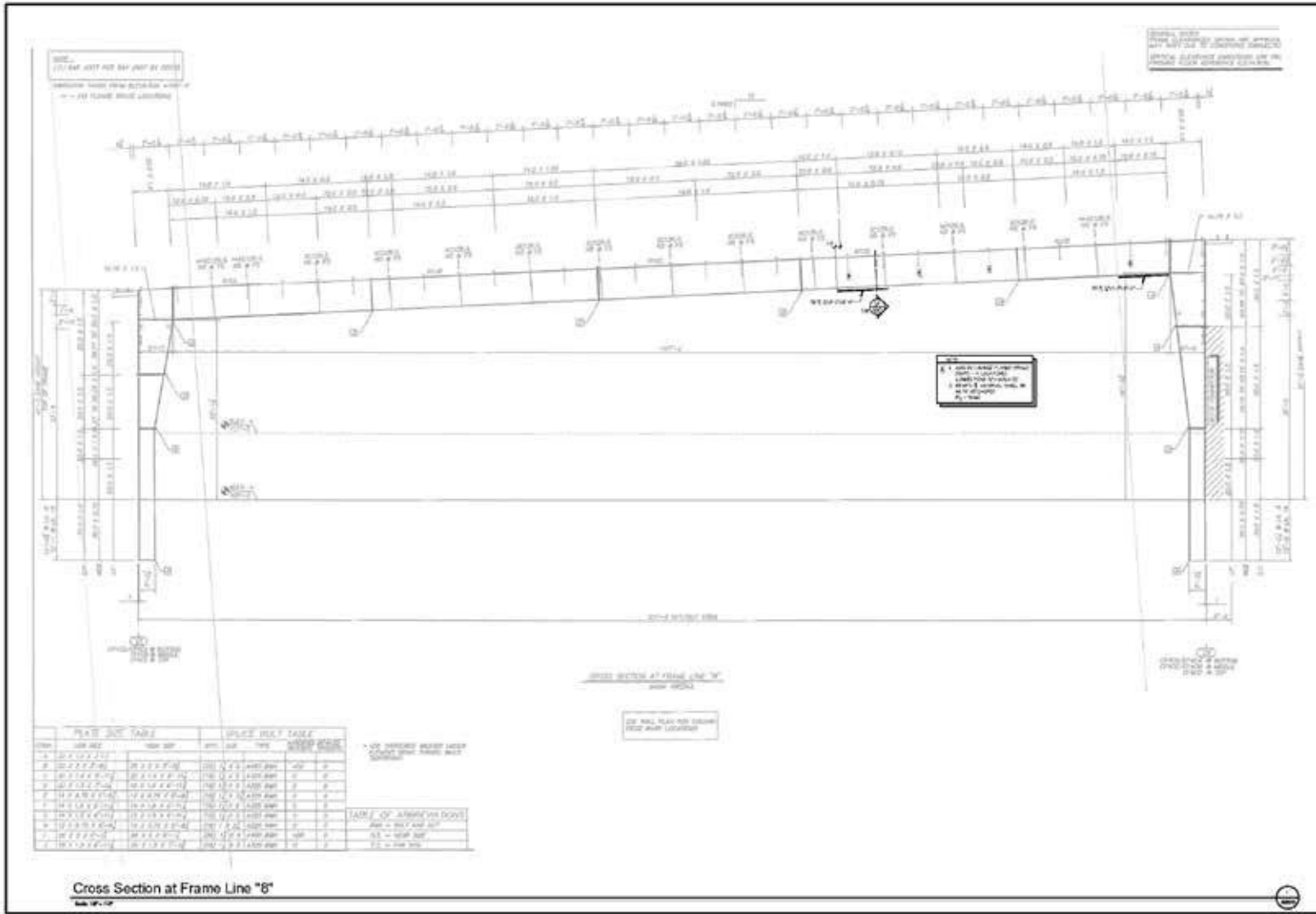

ICON
ARCHITECTURAL CONSULTANTS

4101 Century Boulevard
Suite 111
Bismarck, ND 58103
701.265.5555

PROJECT
Scheels Arena
5220 30th Avenue South
Fargo, ND 58104

SCHEELS ARENA
Rigging Grid Option B
5220 30th Avenue South
Fargo, North Dakota 58104

No.	Description	Date

Scale: 1/4" = 1'-0"

Contractor: [Redacted]
Date: 10/20/17
Checked Section at Frame Line "8"

S201B

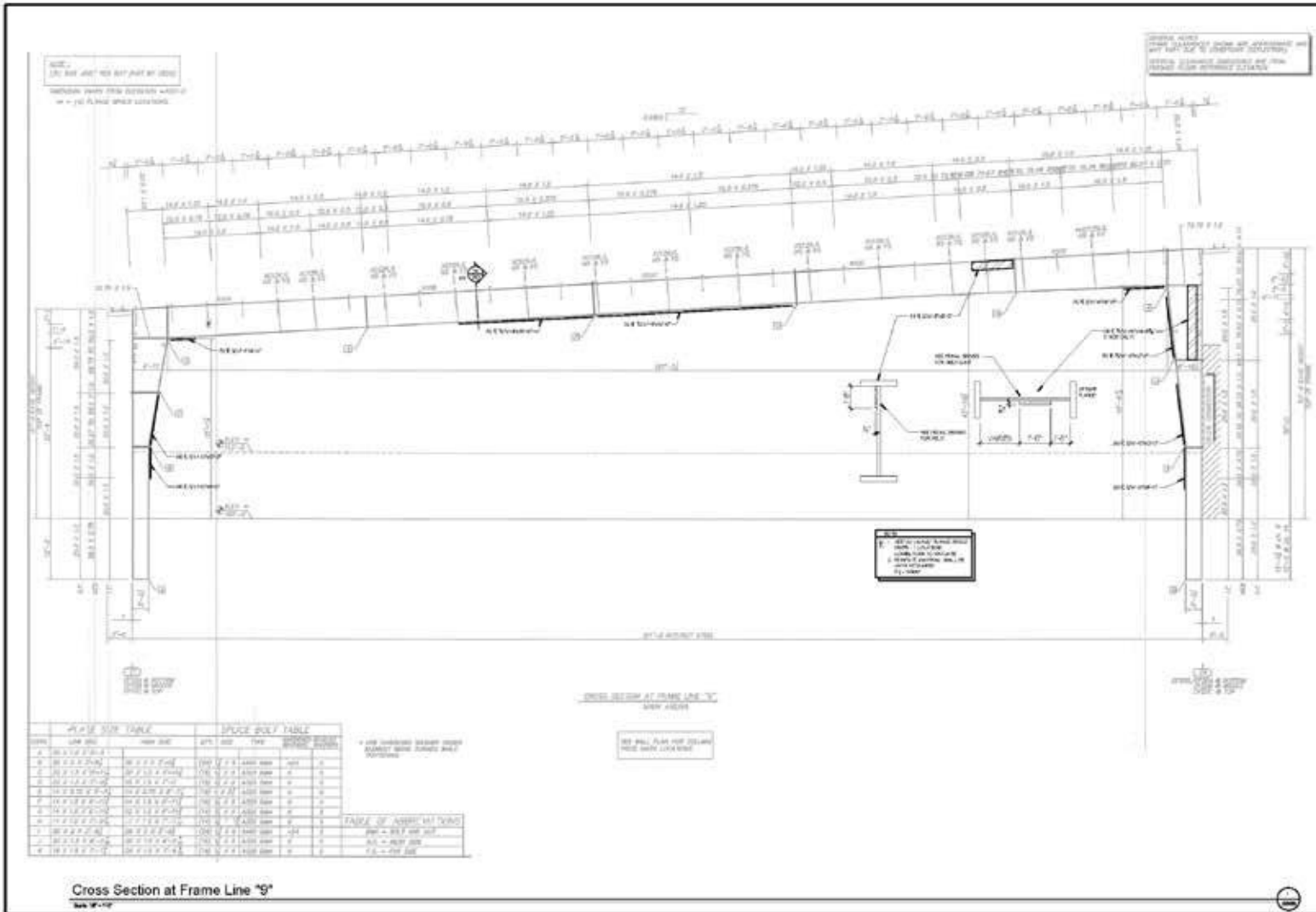

NOTE:
 1. ALL JOIST AND BEAM JOINTS SHALL BE WELDED TO THE MAIN MEMBERS.
 2. ALL JOIST AND BEAM JOINTS SHALL BE WELDED TO THE MAIN MEMBERS.

SECTION 902B
 OVER SECTION AT FRAME LINE '9'
 OVER AREA

MEMBER	SIZE	TYPE	SPACING	NOTES
1	W12x14	Beam	12'-0"	
2	W10x12	Beam	12'-0"	
3	W10x12	Beam	12'-0"	
4	W10x12	Beam	12'-0"	
5	W10x12	Beam	12'-0"	
6	W10x12	Beam	12'-0"	
7	W10x12	Beam	12'-0"	
8	W10x12	Beam	12'-0"	
9	W10x12	Beam	12'-0"	
10	W10x12	Beam	12'-0"	
11	W10x12	Beam	12'-0"	
12	W10x12	Beam	12'-0"	
13	W10x12	Beam	12'-0"	
14	W10x12	Beam	12'-0"	
15	W10x12	Beam	12'-0"	
16	W10x12	Beam	12'-0"	
17	W10x12	Beam	12'-0"	
18	W10x12	Beam	12'-0"	
19	W10x12	Beam	12'-0"	
20	W10x12	Beam	12'-0"	
21	W10x12	Beam	12'-0"	
22	W10x12	Beam	12'-0"	
23	W10x12	Beam	12'-0"	
24	W10x12	Beam	12'-0"	
25	W10x12	Beam	12'-0"	
26	W10x12	Beam	12'-0"	
27	W10x12	Beam	12'-0"	
28	W10x12	Beam	12'-0"	
29	W10x12	Beam	12'-0"	
30	W10x12	Beam	12'-0"	
31	W10x12	Beam	12'-0"	
32	W10x12	Beam	12'-0"	
33	W10x12	Beam	12'-0"	
34	W10x12	Beam	12'-0"	
35	W10x12	Beam	12'-0"	
36	W10x12	Beam	12'-0"	
37	W10x12	Beam	12'-0"	
38	W10x12	Beam	12'-0"	
39	W10x12	Beam	12'-0"	
40	W10x12	Beam	12'-0"	
41	W10x12	Beam	12'-0"	
42	W10x12	Beam	12'-0"	
43	W10x12	Beam	12'-0"	
44	W10x12	Beam	12'-0"	
45	W10x12	Beam	12'-0"	
46	W10x12	Beam	12'-0"	
47	W10x12	Beam	12'-0"	
48	W10x12	Beam	12'-0"	
49	W10x12	Beam	12'-0"	
50	W10x12	Beam	12'-0"	
51	W10x12	Beam	12'-0"	
52	W10x12	Beam	12'-0"	
53	W10x12	Beam	12'-0"	
54	W10x12	Beam	12'-0"	
55	W10x12	Beam	12'-0"	
56	W10x12	Beam	12'-0"	
57	W10x12	Beam	12'-0"	
58	W10x12	Beam	12'-0"	
59	W10x12	Beam	12'-0"	
60	W10x12	Beam	12'-0"	
61	W10x12	Beam	12'-0"	
62	W10x12	Beam	12'-0"	
63	W10x12	Beam	12'-0"	
64	W10x12	Beam	12'-0"	
65	W10x12	Beam	12'-0"	
66	W10x12	Beam	12'-0"	
67	W10x12	Beam	12'-0"	
68	W10x12	Beam	12'-0"	
69	W10x12	Beam	12'-0"	
70	W10x12	Beam	12'-0"	
71	W10x12	Beam	12'-0"	
72	W10x12	Beam	12'-0"	
73	W10x12	Beam	12'-0"	
74	W10x12	Beam	12'-0"	
75	W10x12	Beam	12'-0"	
76	W10x12	Beam	12'-0"	
77	W10x12	Beam	12'-0"	
78	W10x12	Beam	12'-0"	
79	W10x12	Beam	12'-0"	
80	W10x12	Beam	12'-0"	
81	W10x12	Beam	12'-0"	
82	W10x12	Beam	12'-0"	
83	W10x12	Beam	12'-0"	
84	W10x12	Beam	12'-0"	
85	W10x12	Beam	12'-0"	
86	W10x12	Beam	12'-0"	
87	W10x12	Beam	12'-0"	
88	W10x12	Beam	12'-0"	
89	W10x12	Beam	12'-0"	
90	W10x12	Beam	12'-0"	
91	W10x12	Beam	12'-0"	
92	W10x12	Beam	12'-0"	
93	W10x12	Beam	12'-0"	
94	W10x12	Beam	12'-0"	
95	W10x12	Beam	12'-0"	
96	W10x12	Beam	12'-0"	
97	W10x12	Beam	12'-0"	
98	W10x12	Beam	12'-0"	
99	W10x12	Beam	12'-0"	
100	W10x12	Beam	12'-0"	

ICON
 CONSULTING ENGINEERS

400 North 1st Avenue
 Fargo, ND 58102
 (701) 785-1100
 www.icon-engineers.com

PROJECT
 SCHEELS ARENA
 RIGGING GRID OPTION B
 5225 31st Avenue South
 Fargo, North Dakota 58104

DATE
 12/14/12

CROSS SECTION AT FRAME LINE "9"

S202B

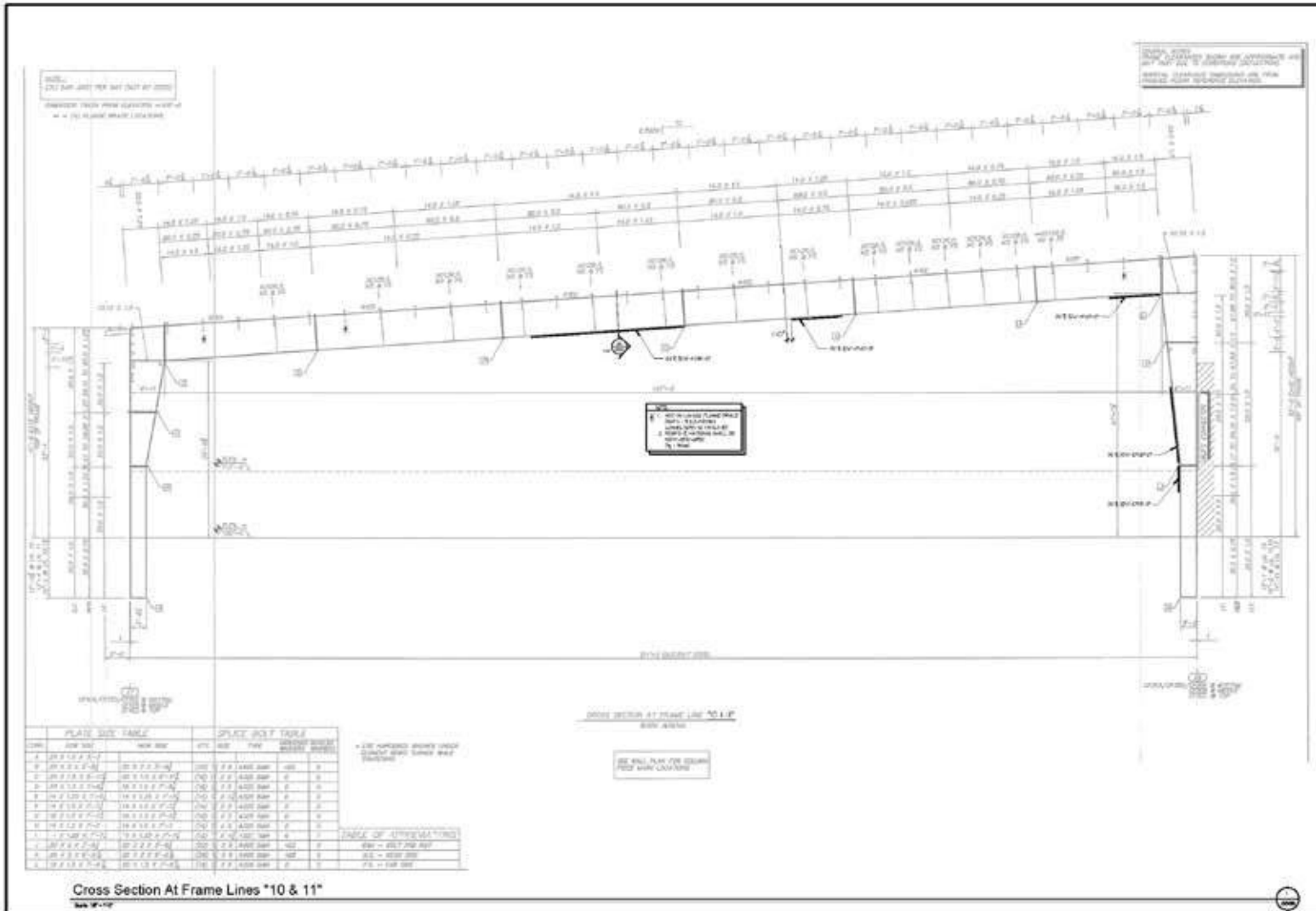

LINE	TOP SURF	NEW SURF	HTC	HTC	TYPE	DEPTH	DEPTH
1	10' 0" 0" 0"	10' 0" 0" 0"	0.00	0.00	ASPH. CONC.	4.00	0
2	10' 0" 0" 0"	10' 0" 0" 0"	0.00	0.00	ASPH. CONC.	4.00	0
3	10' 0" 0" 0"	10' 0" 0" 0"	0.00	0.00	ASPH. CONC.	4.00	0
4	10' 0" 0" 0"	10' 0" 0" 0"	0.00	0.00	ASPH. CONC.	4.00	0
5	10' 0" 0" 0"	10' 0" 0" 0"	0.00	0.00	ASPH. CONC.	4.00	0
6	10' 0" 0" 0"	10' 0" 0" 0"	0.00	0.00	ASPH. CONC.	4.00	0
7	10' 0" 0" 0"	10' 0" 0" 0"	0.00	0.00	ASPH. CONC.	4.00	0
8	10' 0" 0" 0"	10' 0" 0" 0"	0.00	0.00	ASPH. CONC.	4.00	0
9	10' 0" 0" 0"	10' 0" 0" 0"	0.00	0.00	ASPH. CONC.	4.00	0
10	10' 0" 0" 0"	10' 0" 0" 0"	0.00	0.00	ASPH. CONC.	4.00	0
11	10' 0" 0" 0"	10' 0" 0" 0"	0.00	0.00	ASPH. CONC.	4.00	0
12	10' 0" 0" 0"	10' 0" 0" 0"	0.00	0.00	ASPH. CONC.	4.00	0
13	10' 0" 0" 0"	10' 0" 0" 0"	0.00	0.00	ASPH. CONC.	4.00	0
14	10' 0" 0" 0"	10' 0" 0" 0"	0.00	0.00	ASPH. CONC.	4.00	0
15	10' 0" 0" 0"	10' 0" 0" 0"	0.00	0.00	ASPH. CONC.	4.00	0

ICON
 800 NORTH 10TH AVENUE
 FARGO, ND 58104
 701.356.7656

PROJECT
 SCHEELS ARENA
 RIGGING GRID OPTION B
 5220 30TH AVENUE SOUTH
 FARGO, NORTH DAKOTA 58104

DATE
 10/1/12

DESCRIPTION
 CROSS SECTION AT
 FRAME LINES *10*

SCALE
 1/8" = 1'-0"

PROJECT NO.
 S203B

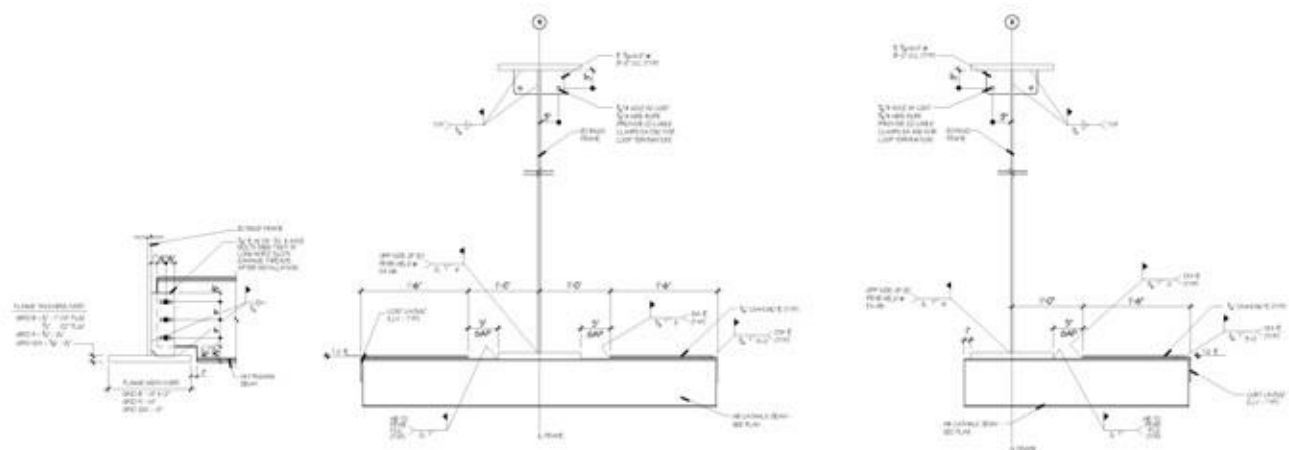

Rigging Beam Connection
Scale 1/2" = 1'-0"

Catwalk Section
Scale 1/2" = 1'-0"

Catwalk Section
Scale 1/2" = 1'-0"

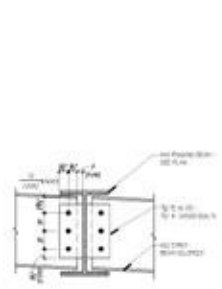

Beam Connection
Scale 1/2" = 1'-0"

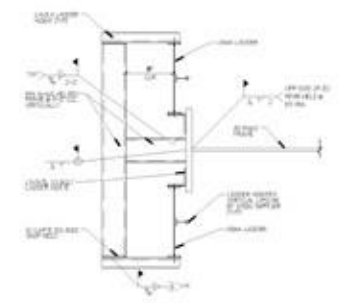

Ladder Framing
Scale 1/2" = 1'-0"

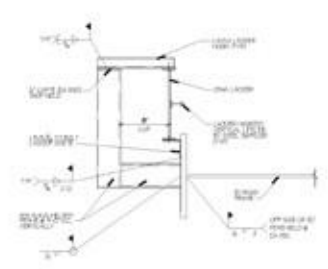

Ladder Framing
Scale 1/2" = 1'-0"

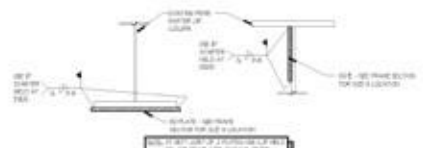

FLANGE PL DETAIL 5A **WEB PL DETAIL 5B**
Scale 1/2" = 1'-0"



4870 Cassin Drive SE
Suite 100
Fargo, ND 58104
701.735.4400
www.iconinc.com

PROJECT
Scheels Arena
5220 30th Avenue South
Fargo, ND 58104
701.735.4400
www.scheelsarena.com

NO
NO
NO
NO

Scheels Arena
Rigging Grid Option B
5220 30th Avenue South
Fargo, North Dakota 58104

No.	Description	Date



Construction Documents
Date: 12/1/13
Rigging Details

S501B

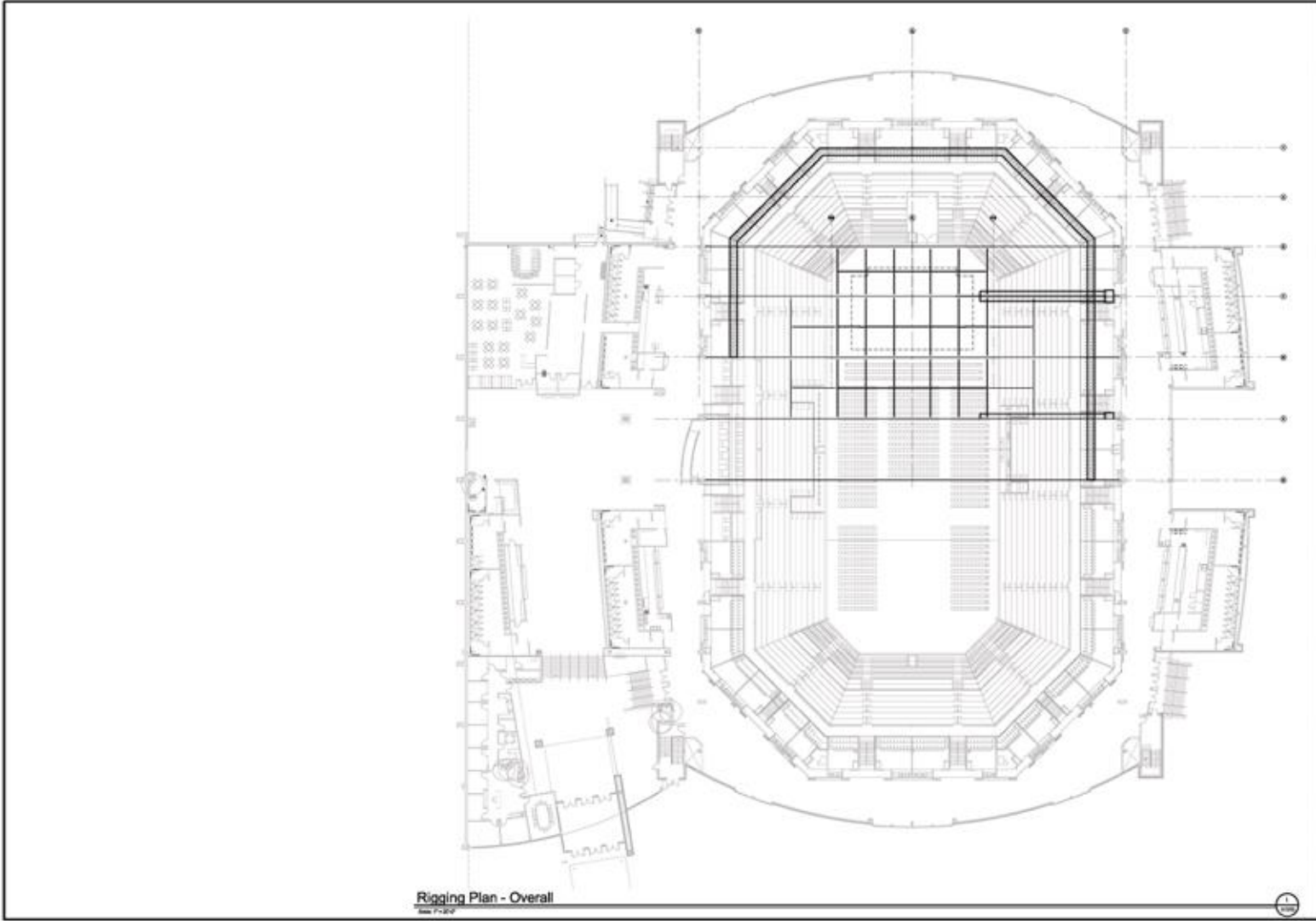

Rigging Plan - Overall
 Date: 12/11/12

ICON
 ARCHITECTURAL GROUP
 4075 Broadway Drive South
 Suite 110
 Grand Forks, ND 58505
 P: 701.785.3333
 F: 701.785.3334
 www.iconarchitect.com

PROJECT:
 SCHEELS ARENA
 4000 30th Avenue South, Suite 100
 Grand Forks, ND 58505
 P: 701.785.3333
 F: 701.785.3334
 www.iconarchitect.com

NO
 ELECTRICAL
 NO
 ME
 NO

SCHEELS ARENA
 Rigging Grid Option B
 5220 30th Avenue South
 Fargo, North Dakota 58104

No.	Description	Date



DATE
 Construction Documents
 DATE
 12/11/12

Rigging Plan - Overall

A101B

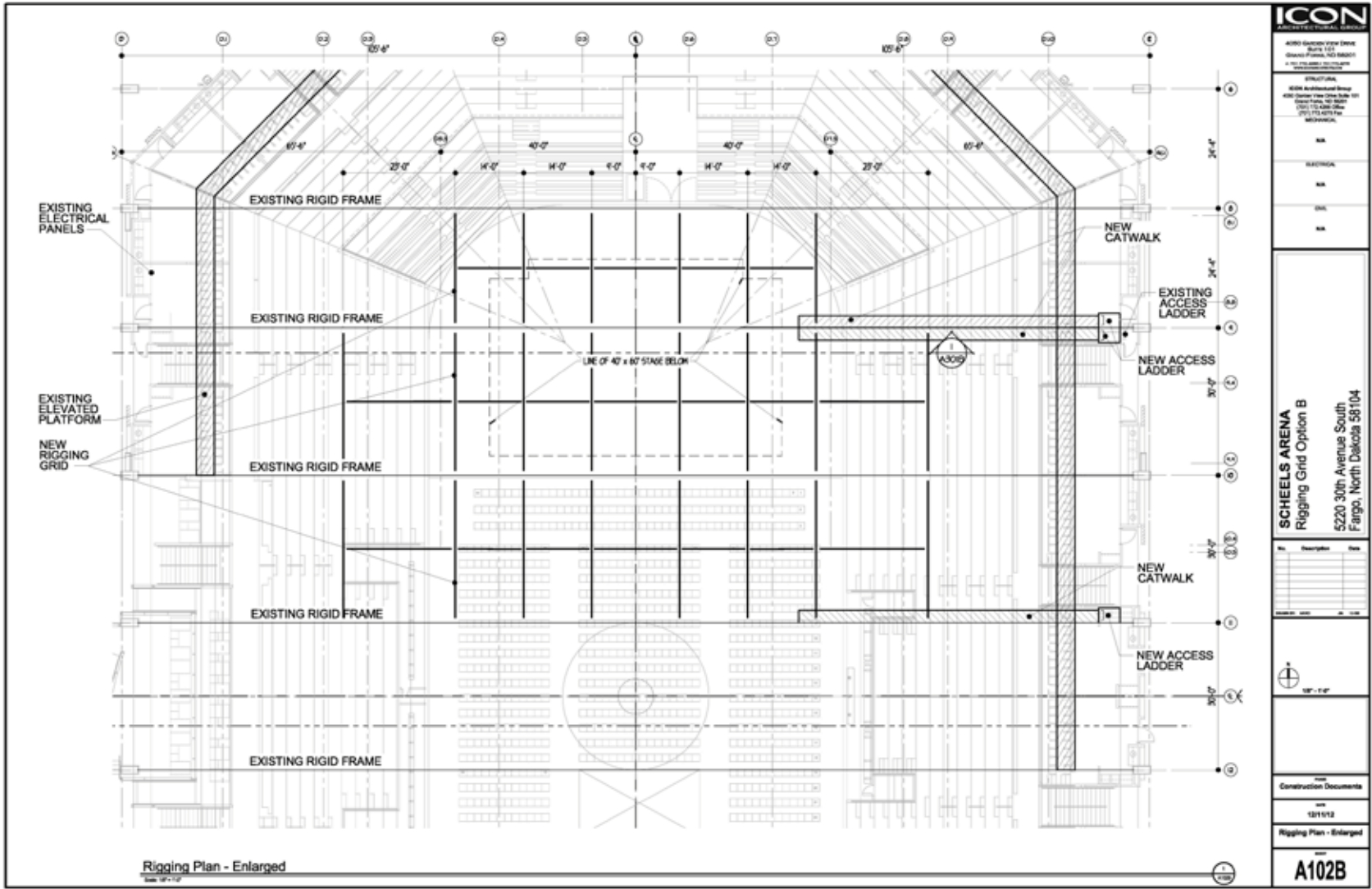

4070 Broadway Drive South
Suite 112
Bismarck, ND 58501
A NEB LICENSED ARCHITECT
www.iconarch.com

PROJECT NAME
Scheels Arena
4070 Broadway Drive South Suite 112
Bismarck, ND 58501
1/21/12
2011.112 ARCH.Plan
1/21/12

NO. DESCRIPTION DATE
1
2
3
4
5
6
7
8
9
10
11
12

SCHEELS ARENA
Rigging Grid Option B
5220 30th Avenue South
Fargo, North Dakota 58104

No.	Description	Date



Construction Documents
12/1/12

Rigging Plan - Enlarged

A102B

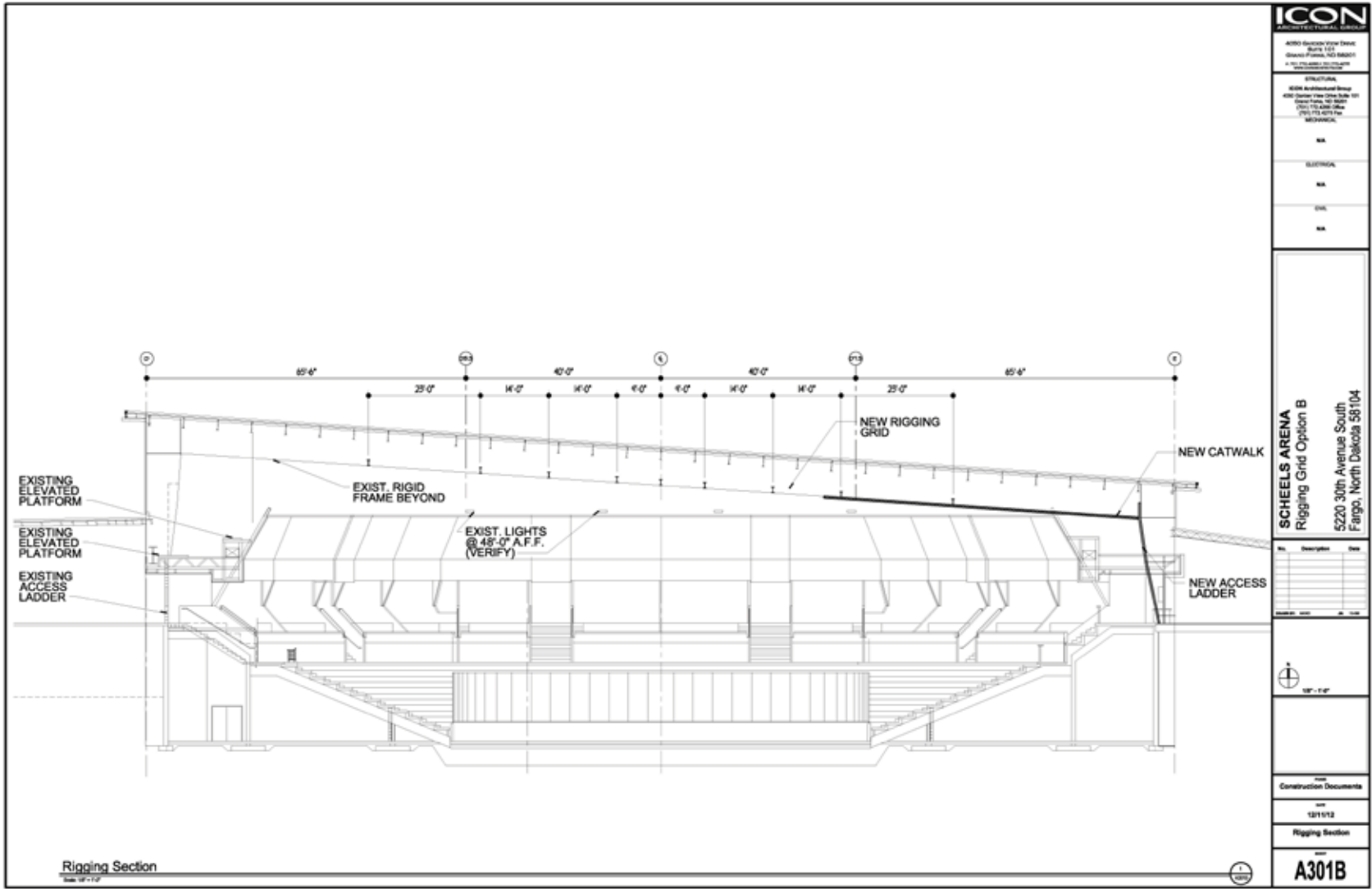

ICON
ARCHITECTURAL GROUP

4070 Broadway Drive South
Suite 112
Bismarck, ND 58103
P: 701.225.4444
www.iconarchitect.com

PROJECT
Scheels Arena
4070 Broadway Drive South, Suite 112
Bismarck, ND 58103
100% Design
7/21/12
7/21/12
7/21/12

MECHANICAL
NA
ELECTRICAL
NA
PLUMBING
NA

SCHEELS ARENA
Rigging Grid Option B
5220 30th Avenue South
Fargo, North Dakota 58104

No.	Description	Date



Construction Documents
12/11/12
Rigging Section
A301B

Rigging Section
Scale: 1/8" = 1'-0"

MAPS & DIRECTIONS

Scheels Arena is conveniently located off Interstate 94 (5225 31st Ave S, Fargo) and is within a mile of several popular hotels and restaurants.

Travelling from the north

1. Drive south on I-29 and take exit 62 for 32nd Ave S.
2. Turn right on 32nd Ave S and travel 1.5 miles.
3. Turn right on 51st St S and travel .2 miles.
4. Turn left on 30th Ave S and arrive at destination on right.

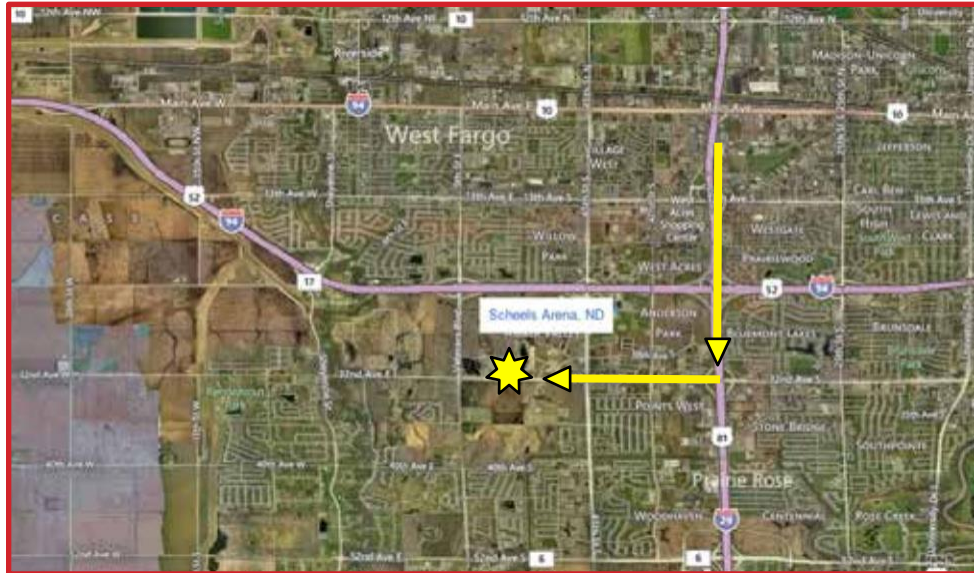

Travelling from the south

1. Drive north on I-29 and take exit 62 for 32nd Ave S
2. Turn left on 32nd Ave S and travel 1.5 miles
3. Turn right on 51st St S and travel .2 miles
4. Turn left on 30th Ave S and arrive at destination on right.

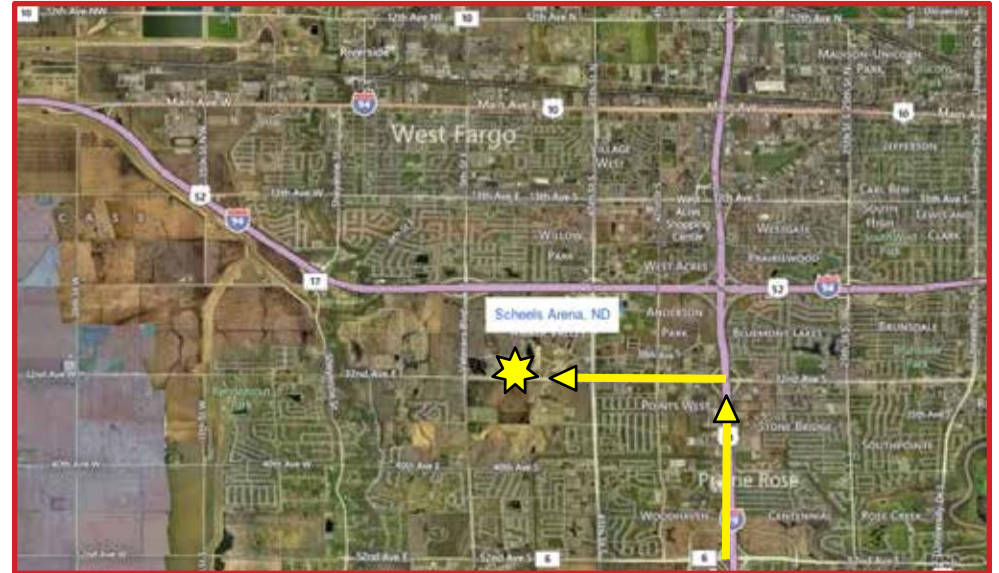

Travelling from the east

1. Drive west on I-94 and take exit 349A for I-29 south.
2. Travel 1 mile and take exit 62 for 32nd Ave S.
3. Turn right on 32nd Ave South and travel 1.5 miles.
4. Turn right on 51st St S and travel .2 miles.
5. Turn left on 30th Ave S and arrive at destination on right.

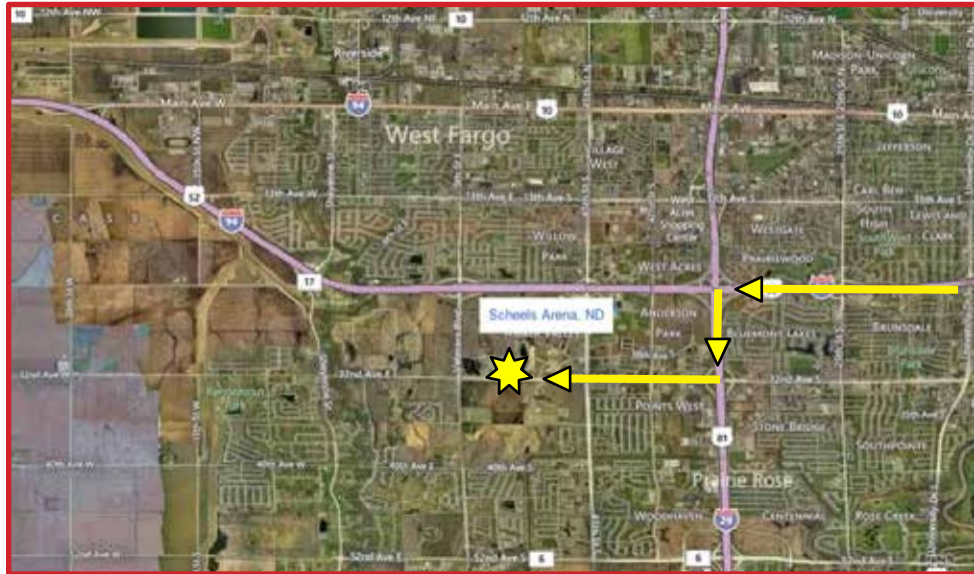

Travelling from the west

1. Drive east on I-94 and take exit 347 for Veterans Blvd.
2. Turn right and travel 1 mile to 32nd Ave S.
3. Turn left on 32nd Ave South and travel .6 miles.
4. Turn left on 51st St S and travel .2 miles.
5. Turn left on 30th Ave S and arrive at destination on right.

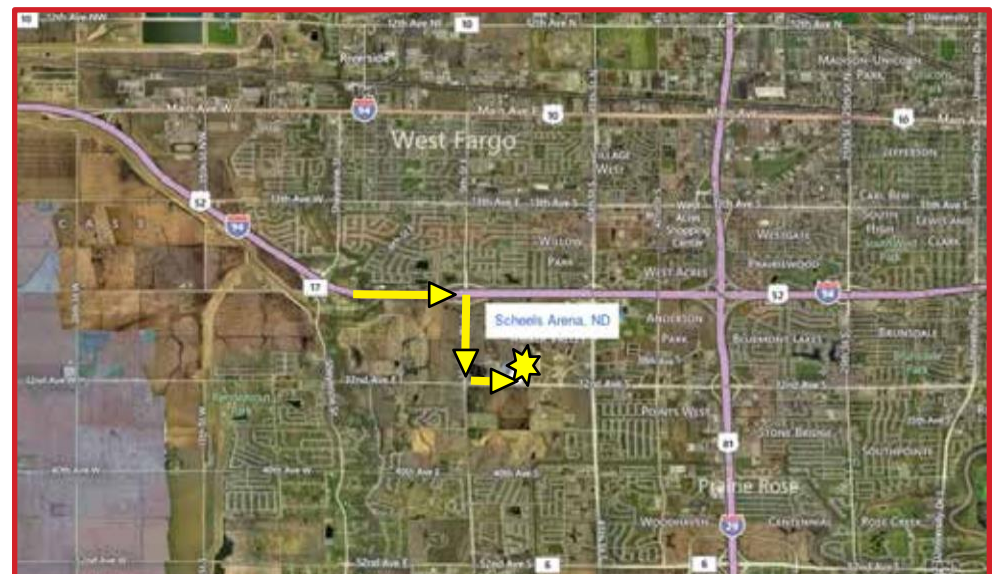

SECURITY & SAFETY

The safety of guests, artists, staff, and crew is paramount. The following guidelines and services ensure the safety and security of everyone present.

Permits

Lessee must notify Scheels Arena of any pyrotechnics, animals, lasers, or parking needs at least 20 business days prior to move in.

Ambulance

Ambulance needs may be booked through FM Ambulance. Rates average \$40-50 per hour and include 1 paramedic and the ambulance.

FM Ambulance

3148 Fiechtner Dr. South
701.364.1777

Fargo Police Department

222 4th St.
701.241.1427

Security

Basic event security is managed by the Scheels Arena security office. Additional security may be supplied by the promoter. Depending on the type of event, uniformed police may be required. Mandatory searches of bags and pat downs by Scheels Arena security personnel is required for certain events.

First Aid

Scheels Arena has basic first aid supplies available for guests in need. Any additional medical requirements must be addressed by lessee. For emergency services, these general and urgent care service providers are recommended:

Sanford Medical

2801 University Dr. South
701.234.2000 | 4.1 Miles

ADA Information

Scheels Arena welcomes guests with special needs and provides the services, seating, and accommodations to make the visit to our facility a pleasant and comfortable experience. If you need additional services, please contact guest services located in the lobby, we will be happy to assist.

Cameras

Point and shoot cameras (without flash) are allowed. All other cameras, including professional grade, are not allowed.

Pets

Scheels Arena welcomes service animals into our building. Unfortunately, no other animals are allowed inside the building.

Parking Information



MAKING YOUR STOP A SUCCESS

From marketing assistance to day-of-show services like merchandising and comfortable dressing rooms, Scheels Arena is your partner in ensuring the success of your event.

Scheels Arena is conveniently located near several popular hotels and restaurants. It's close to the Interstate, so it's easy to hit the road and check out one of the local attractions. Like the Woodchipper.



Event Services

Scheels Arena seats up to 6,000 people. Let the team at Scheels Arena help fill those seats and keep customers happy the day of the event.

In-House Event Marketing Services

The in-house marketing team at Scheels Arena will work in consultation with you to advise and assist in the placement of local advertising and marketing in Fargo-Moorhead and outlying areas to reach the target audience for your event.

The following Scheels Arena marketing channels are made available, depending on availability, to aid in the successful promotion of your event:

- Fascia Video Ribbon – One static ribbon to be played at available events.
- Commercial/Jumbotron Spot – One commercial or jumbotron static ad.
- PA Announcement – One 15-second public address announcement.
- E-blasts – Current database of approximately 6,000 subscribers plus season ticket, club, and suite holders.
- Lobby LCD Televisions – One static spot to be included in the arena's sponsor rotator. These are located near the ticket office.
- Graphic Design – For a fee, Scheels Arena will work with you to produce artwork for all in-house marketing channels and/or external advertising.
- Posters around the arena, provided by the promoter.
- Listing and link on Scheels Arena Facebook page and website
- Digital Billboard: 928 pixels wide by 288 pixels tall (exports as .jpg or .png) RG color, 72 ppi. Located on the corner of Veteran's Blvd. and 32nd Ave. S
- Media list for publicity.

ACCOMMODATIONS & HOSPITALITY

Hotels

Holiday Inn

3803 13th Avenue South
701.282.2700 | 3.7 Miles

Element Fargo

925 19th Avenue East
701.478.5333 | 1.5 Miles

Cambria Hotel & Suites

825 East Beaton Drive
701.551.0120 | 1.5 Miles

MainStay Suites

1901 44th Street Southwest
701.277.4627 | 2.1 Miles

Laquinta Inn & Suites

2355 46th Street South
701.499.2000 | 1.5 Miles

Radisson Hotel

201 5th Street North
701.232.7363 | 8.2 Miles

Ramada Plaza

1635 42nd Street South
701.277.9000 | 2.9 Miles

Hotel Donaldson

101 North Broadway
701.478.1000 | 8.2 Miles

Restaurants

Buffalo Wild Wings

1501 42nd Street South
701.356.9464

Old Chicago

2551 45th Street South
701.356.8277

Firehouse Subs

5675 26th Ave. S
701.205.1268

McDonalds

3220 39th Street South
701.281.0481

Spicy Pie

745 31st Ave. E West Fargo
701.356.0206

Deek's Pizza

755 33rd Ave E West Fargo
701.235.0708

Granite City

1636 42nd Street South
701.293.3000

Blvd Pub (21+)

3147 Blue Stem Dr.
701.552.7798

HoDo

101 North Broadway
701.478.1000

Monte's

220 North Broadway
701.526.0149

Brewtus' Brickhouse

635 32nd Ave E West Fargo
701.532.1397

The Blarney Stone Pub (21+)

1910 9th Str. E
701.532.1500

SERVICES & ATTRACTIONS

Services

Maytag Laundry

3011 13th Ave South
701.280.0339 | 4.9 Miles

Cloud 9 Salon

3330 Sheyenne St. Ste. 100
701.277.9772 | 2.0 Miles

Revive Massage Therapy

4955 17th Avenue South
701.893.3888 | 2.6 Miles

Brenan's Dry Cleaning-Laundry

4265 45th Street South
701.373.2010 | 1.9 Miles

The Source Salon

1801 45th Street South
701.356.1023 | 2.4 Miles

Loosen Up Massage

4554 38th Avenue South
701.412.1978 | 1.6 Miles

Attractions

West Acres Shopping Center

The largest shopping mall in Fargo Moorhead, West Acres has national & locally owned shops.
3902 13th Avenue South, Fargo | WestAcres.com

Red River Zoo

4255 23rd Ave. S Fargo, ND | 701.277.4248 | redriverzoo.org

Roger Maris Museum

Memorabilia, exhibits, and footage of Yankee baseball hero and local legend Roger Maris.
3902 13th Avenue South, Fargo | 701.282.2222 | RogerMarisMuseum.com

“The Woodchipper”

See the original wood chipper from the movie FARGO!
2001 44th Street South, Fargo | 701.282.3653

Historic Fargo Theatre

Built in 1926, the Fargo Theatre is an art deco movie theatre in downtown Fargo.
314 Broadway, Fargo | 701.235.4152 | FargoTheatre.org

Fargo-Moorhead RedHawks (Baseball)

Fargo Moorhead's Professional Baseball Team (May-Sept)
1515 15th Avenue North, Fargo | 701.235.6161 | fmredhawks.com

Thunder Road Family Park

Mini golf, go-carts, batting cage, and arcade provides outdoor fun for the whole family.
2902 Thunder Road, Fargo | 701.282.5151 | ThunderRoadFargo.com

SCHEELS[®] arena

5225 31st Ave S | Fargo, ND 58104 | 701.356.7656 | ScheelsArena.com