

## Chapter 3

# Aircraft Fabric Covering

### General History

Fabric-covered aircraft play an important role in the history of aviation. The famous Wright Flyer utilized a fabric-covered wood frame in its design, and fabric covering continued to be used by many aircraft designers and builders during the early decades of production aircraft. The use of fabric covering on an aircraft offers one primary advantage: light weight. In contrast, fabric coverings have two disadvantages: flammability and lack of durability.

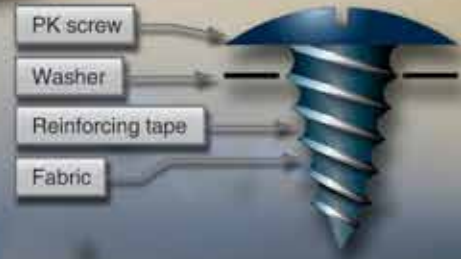
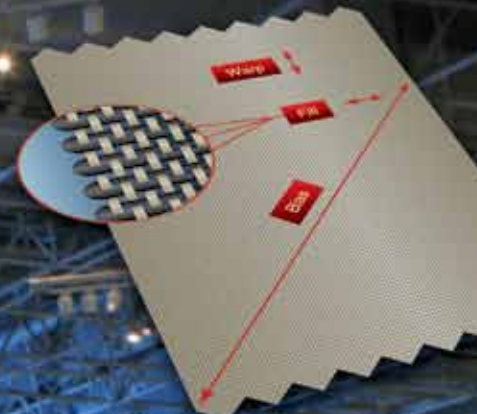

Approved Aircraft Fabric

Fabric Name or Type	Weight (oz/sq yd)	Count (warp x weft)	New Breaking Strength (lb) (warp, weft)	Minimum Breakage
Corbin™ 101	2.9	60 x 60	525, 118	70% of original strength
Corbin™ 102	3.18	60 x 60	585, 113	70% of original strength
Fiber™ Heavy Duty 1	3.3	60 x 60	625, 118	70% of original specified fabric
Fiber™ Medium 2	3.18	60 x 60	605, 113	70% of original specified fabric
Fiber™ UltraLight	1.87	60 x 26	65, 72	uncertified
Savign™ SF 101	3.1	70 x 51	60, 120	70% of original specified fabric
Savign™ SF 102	2.7	72 x 64	90, 80	70% of original specified fabric
Aviation™	1.8	64 x 31	90, 80	70% of original specified fabric
Aviation™	4.5	60 x 34		



Finely woven organic fabrics, such as Irish linen and cotton, were the original fabrics used for covering airframes, but their tendency to sag left the aircraft structure exposed to the elements. To counter this problem, builders began coating the fabrics with oils and varnishes. In 1916, a mixture of cellulose dissolved in nitric acid, called nitrate dope, came into use as an aircraft fabric coating. Nitrate dope protected the fabric, adhered to it well, and tautened it over the airframe. It also gave the fabric a smooth, durable finish when dried. The major drawback to nitrate dope was its extreme flammability.

To address the flammability issue, aircraft designers tried a preparation of cellulose dissolved in butyric acid called butyrate dope. This mixture protected the fabric from dirt and moisture, but it did not adhere as well to the fabric as nitrate dope. Eventually, a system combining the two dope coatings was developed. First, the fabric was coated with nitrate dope for its adhesion and protective qualities. Then, subsequent coats of butyrate dope were added. Since the butyrate dope coatings reduced the overall flammability of the fabric covering, this system became the standard fabric treatment system.

The second problem, lack of durability, stems from the eventual deterioration of fabric from exposure to the elements that results in a limited service life. Although the mixture of nitrate dope and butyrate dope kept out dirt and water, solving some of the degradation issue, it did not address deterioration caused by ultraviolet (UV) radiation from the sun. Ultraviolet radiation passed through the dope and degraded not only the fabric, but also the aircraft structure underneath. Attempts to paint the coated fabric proved unsuccessful, because paint does not adhere well to nitrate dope. Eventually, aluminum solids were added to the butyrate coatings. This mixture reflected the sun's rays, prevented harmful UV rays from penetrating the dope, and protected the fabric, as well as the aircraft structure.

Regardless of treatments, organic fabrics have a limited lifespan; cotton or linen covering on an actively flown aircraft lasts only about 5–10 years. Furthermore, aircraft cotton has not been available for over 25 years. As the aviation industry developed more powerful engines and more aerodynamic aircraft structures, aluminum became the material of choice. Its use in engines, aircraft frames, and coverings revolutionized aviation. As a covering, aluminum protected the aircraft structure from the elements, was durable, and was not flammable.

Although aluminum and composite aircraft dominate modern aviation, advances in fabric coverings continue to be made because gliders, home-built, and light sport aircraft, as well as some standard and utility certificated aircraft, are still



**Figure 3-1.** Examples of aircraft produced using fabric skin.

produced with fabric coverings. [Figure 3-1] The nitrate/butyrate dope process works well, but does not mitigate the short lifespan of organic fabrics. It was not until the introduction of polyester fabric as an aircraft covering in the 1950s that the problem of the limited lifespan of fabric covering was solved. The transition to polyester fabric had some problems because the nitrate and butyrate dope coating process is not as suitable for polyester as it is for organic fabrics. Upon initial application of the dopes to polyester, good adhesion and protection occurred; as the dopes dried, they would eventually separate from the fabric. In other words, the fabric outlasted the coating.

Eventually, dope additives were developed that minimized the separation problem. For example, plasticizers keep the dried dope flexible and nontautening dope formulas eliminate separation of the coatings from the fabric. Properly protected and coated, polyester lasts indefinitely and is stronger than cotton or linen. Today, polyester fabric coverings are the standard and use of cotton and linen on United States certificated aircraft has ceased. In fact, the long staple cotton from which grade-A cotton aircraft fabric is made is no longer produced in this country.

Re-covering existing fabric aircraft is an accepted maintenance procedure. Not all aircraft covering systems include the use of dope coating processes. Modern aircraft covering systems that include the use of nondope fabric treatments show no signs of deterioration even after decades of service. In this

chapter, various fabrics and treatment systems are discussed, as well as basic covering techniques.

## Fabric Terms

To facilitate the discussion of fabric coverings for aircraft, the following definitions are presented. *Figure 3-2* illustrates some of these items.

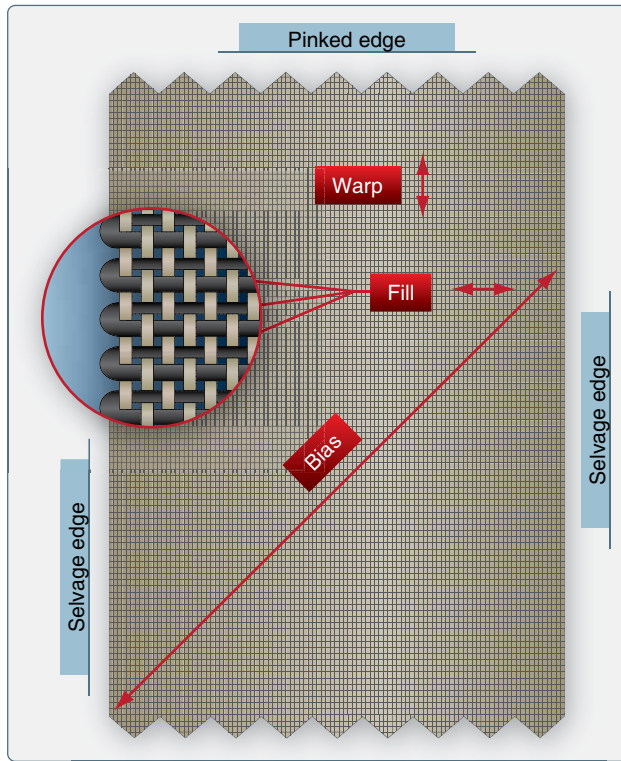

**Figure 3-2.** Aircraft fabric nomenclature.

- Warp—the direction along the length of fabric.
- Fill or weave—the direction across the width of the fabric.

- Count—the number of threads per inch in warp or filling.
- Ply—the number of yarns making up a thread.
- Bias—a cut, fold, or seam made diagonally to the warp or fill threads.
- Pinked edge—an edge which has been cut by machine or special pinking shears in a continuous series of Vs to prevent raveling.
- Selvage edge—the edge of cloth, tape, or webbing woven to prevent raveling.
- Greige—condition of polyester fabric upon completion of the production process before being heat shrunk.
- Cross coat—brushing or spraying where the second coat is applied 90° to the direction the first coat was applied. The two coats together make a single cross coat. [Figure 3-3]

## Legal Aspects of Fabric Covering

When a fabric-covered aircraft is certificated, the aircraft manufacturer uses materials and techniques to cover the aircraft that are approved under the type certificate issued for that aircraft. The same materials and techniques must be used by maintenance personnel when replacing the aircraft fabric. Descriptions of these materials and techniques are in the manufacturer's service manual. For example, aircraft originally manufactured with cotton fabric can only be re-covered with cotton fabric unless the Federal Aviation Administration (FAA) approves an exception. Approved exceptions for alternate fabric-covering materials and procedures are common. Since polyester fabric coverings deliver performance advantages, such as lighter weight, longer life, additional strength, and lower cost, many older aircraft originally manufactured with cotton fabric have received approved alteration authority and have been re-covered with polyester fabric.

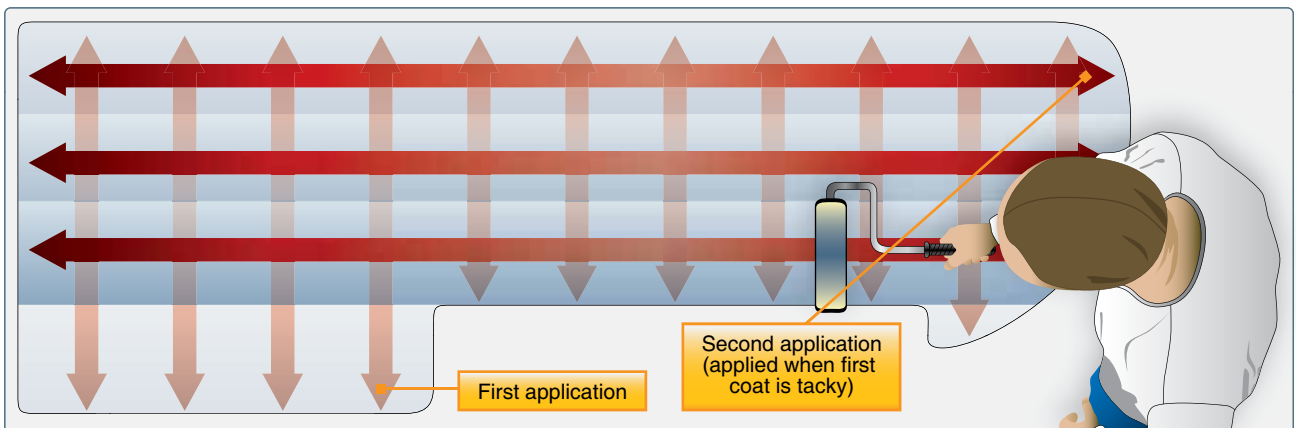

**Figure 3-3.** A single cross coat is made up of two coats of paint applied 90° to each other.

There are three ways to gain FAA approval to re-cover an aircraft with materials and processes other than those with which it was originally certificated. One is to do the work in accordance with an approved supplemental type certificate (STC). The STC must specify that it is for the particular aircraft model in question. It states in detail exactly what alternate materials must be used and what procedure(s) must be followed. Deviation from the STC data in any way renders the aircraft unairworthy. The holder of the STC typically sells the materials and the use of the STC to the person wishing to re-cover the aircraft.

The second way to gain approval to re-cover an aircraft with different materials and processes is with a field approval. A field approval is a one-time approval issued by the FAA Flight Standards District Office (FSDO) permitting the materials and procedures requested to replace those of the original manufacturer. A field approval request is made on FAA Form 337. A thorough description of the materials and processes must be submitted with proof that, when the alteration is completed, the aircraft meets or exceeds the performance parameters set forth by the original type certificate.

The third way is for a manufacturer to secure approval through the Type Certificate Data Sheet (TCDS) for a new process. For example, Piper Aircraft Co. originally covered their PA-18s in cotton. Later, they secured approval to recover their aircraft with Dacron fabric. Recovering an older PA-18 with Dacron in accordance with the TCDS would be a major repair, but not an alteration as the TCDS holder has current approval for the fabric.

Advisory Circular (AC) 43.13.1, Acceptable Methods, Techniques, and Practices—Aircraft Inspection and Repair, contains acceptable practices for covering aircraft with fabric. It is a valuable source of general and specific information on fabric and fabric repair that can be used on Form 337 to justify procedures requested for a field approval. Submitting an FAA Form 337 does not guarantee a requested field approval. The FSDO inspector considers all aspects of the procedures and their effect(s) on the aircraft for which the request is being filed. Additional data may be required for approval.

Title 14 of the Code of Federal Regulations (14 CFR) part 43, Appendix A, states which maintenance actions are considered major repairs and which actions are considered major alterations. Fabric re-covering is considered a major repair and FAA Form 337 is executed whenever an aircraft is re-covered with fabric. Appendix A also states that changing parts of an aircraft wing, tail surface, or fuselage when not listed in the aircraft specifications issued by the FAA is a major alteration. This means that replacing cotton fabric with polyester fabric is a major alteration. A properly executed FAA Form 337 also needs to be approved in order for this alteration to be legal.

FAA Form 337, which satisfies the documentation requirements for major fabric repairs and alterations, requires participation of an FAA-certificated Airframe and Powerplant (A&P) mechanic with an Inspection Authorization (IA) in the re-covering process. Often the work involved in re-covering a fabric aircraft is performed by someone else, but under the supervision of the IA (IA certification requires A&P certification). This typically means the IA inspects the aircraft structure and the re-cover job at various stages to be sure STC or field approval specifications are being followed. The signatures of the IA and the FSDO inspector are required on the approved FAA Form 337. The aircraft logbook also must be signed by the FAA-certificated A&P mechanic. It is important to contact the local FSDO before making any major repair or alteration.

## Approved Materials

There are a variety of approved materials used in aircraft fabric covering and repair processes. In order for the items to legally be used, the FAA must approve the fabric, tapes, threads, cords, glues, dopes, sealants, coatings, thinners, additives, fungicides, rejuvenators, and paints for the manufacturer, the holder of an STC, or a field approval.

### Fabric

A Technical Standard Order (TSO) is a minimum performance standard issued by the FAA for specified materials, parts, processes, and appliances used on civil aircraft. For example, TSO-15d, Aircraft Fabric, Grade A, prescribes the minimum performance standards that approved aircraft fabric must meet. Fabric that meets or exceeds the TSO can be used as a covering. Fabric approved to replace Grade-A cotton, such as polyester, must meet the same criteria. TSO-15d also refers to another document, Society of Automotive Engineers (SAE) Aerospace Material Specification (AMS) 3806D, which details properties a fabric must contain to be an approved fabric for airplane cloth. Lighter weight fabrics typically adhere to the specifications in TSO-C14b, which refers to SAE AMS 3804C.

When a company is approved to manufacture or sell an approved aviation fabric, it applies for and receives a Parts Manufacturing Approval (PMA). Currently, only a few approved fabrics are used for aircraft coverings, such as the polyester fabrics Ceconite™, Stits/Polyfiber™, and Superflite™. These fabrics and some of their characteristics are shown in *Figure 3-4*. The holders of the PMA for these fabrics have also developed and gained approval for the various tapes, chords, threads, and liquids that are used in the covering process. These approved materials, along with the procedures for using them, constitute the STCs for each particular fabric covering process. Only the approved materials can be used. Substitution of other materials is forbidden and results in the aircraft being unairworthy.

Approved Aircraft Fabrics					
Fabric Name or Type	Weight (oz/sq yd)	Count (warp x fill)	New Breaking Strength (lb) (warp, fill)	Minimum Deteriorated Breaking Strength	TSO
Ceconite™ 101	3.5	69 x 63	125,116	70% of original specified fabric	C-15d
Ceconite™ 102	3.16	60 x 60	106,113	70% of original specified fabric	C-15d
Polyfiber™ Heavy Duty-3	3.5	69 x 63	125,116	70% of original specified fabric	C-15d
Polyfiber™ Medium-3	3.16	60 x 60	106,113	70% of original specified fabric	C-15d
Polyfiber™ Uncertified Light	1.87	90 x 76	66,72	uncertified	
Superflight™ SF 101	3.7	70 x 51	80,130	70% of original specified fabric	C-15d
Superflight™ SF 102	2.7	72 x 64	90,90	70% of original specified fabric	C-15d
Superflight™ SF 104	1.8	94 x 91	75,55	uncertified	
Grade A Cotton	4.5	80 x 84	80,80	56 lb/in (70% of New)	C-15d

Figure 3-4. Approved fabrics for covering aircraft.

### Other Fabric Covering Materials

The following is an introduction to the supplemental materials used to complete a fabric covering job per manufacturer's instruction or a STC.

#### Anti-Chafe Tape

Anti-chafe tape is used on sharp protrusions, rib caps, metal seams, and other areas to provide a smoother surface to keep the fabric from being torn. It is usually self-adhesive cloth tape and is applied after the aircraft is cleaned, inspected, and primed, but before the fabric is installed.

#### Reinforcing Tape

Reinforcing tape is most commonly used on rib caps after the fabric covering is installed to protect and strengthen the area for attaching the fabric to the ribs.

#### Rib Bracing

Rib bracing tape is used on wing ribs before the fabric is installed. It is applied spanwise and alternately wrapped around a top rib cap and then a bottom rib cap progressing from rib to rib until all are braced. [Figure 3-5] Lacing the ribs in this manner holds them in the proper place and alignment during the covering process.

#### Surface Tape

Surface tape, made of polyester material and often pre-shrunk, is obtained from the STC holder. This tape, also known as finishing tape, is applied after the fabric is installed.

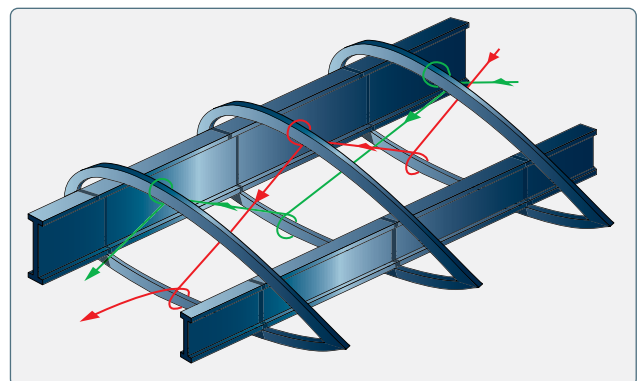

Figure 3-5. Inter-rib bracing holds the ribs in place during the covering process.

It is used over seams, ribs, patches, and edges. Surface tape can have straight or pinked edges and comes in various widths. For curved surfaces, bias cut tape is available, which allows the tape to be shaped around a radius.

#### Rib Lacing Cord

Rib lacing cord is used to lace the fabric to the wing ribs. It must be strong and applied as directed to safely transfer in-flight loads from the fabric to the ribs. Rib lacing cord is available in a round or flat cross-section. The round cord is easier to use than the flat lacing, but if installed properly, the flat lacing results in a smoother finish over the ribs.

### Sewing Thread

Sewing of polyester fabric is rare and mostly limited to the creation of prefitted envelopes used in the envelope method covering process. When a fabric seam must be made with no structure underneath it, a sewn seam could be used. Polyester threads of various specifications are used on polyester fabric. Different thread is specified for hand sewing versus machine sewing. For hand sewing, the thread is typically a three-ply, uncoated polyester thread with a 15-pound tensile strength. Machine thread is typically four-ply polyester with a 10-pound tensile strength.

### Special Fabric Fasteners

Each fabric covering job involves a method of attaching the fabric to wing and empennage ribs. The original manufacturer's method of fastening should be used. In addition to lacing the fabric to the ribs with approved rib lacing cord, special clips, screws, and rivets are employed on some aircraft. [Figure 3-6] The first step in using any of these fasteners is to inspect the holes into which they fit. Worn holes may have to be enlarged or re-drilled according to the manufacturer's instructions. Use of approved fasteners is mandatory. Use of unapproved fasteners can render the covering job unairworthy if substituted. Screws and rivets often incorporate the use of a plastic or aluminum washer. All fasteners and rib lacing are covered with finishing tape once installed to provide a smooth finish and airflow.

### Grommets

Grommets are used to create reinforced drain holes in the aircraft fabric. Usually made of aluminum or plastic, they are glued or doped into place on the fabric surface. Once secured, a hole is created in the fabric through the center of the grommet. Often, this is done with a hot soldering pencil that also heat seals the fabric edge to prevent raveling. Seaplane grommets have a shield over the drain hole to prevent splashed water from entering the interior of the covered structure and to assist in siphoning out any water from within. [Figure 3-7] Drain holes using these grommets must be made before the grommets are put in place. Note that some drain holes do not require grommets if they are made through two layers of fabric.

### Inspection Rings

The structure underneath an aircraft covering must be inspected periodically. To facilitate this in fabric-covered aircraft, inspection rings are glued or doped to the fabric. They provide a stable rim around an area of fabric that can be cut to allow viewing of the structure underneath. The fabric remains uncut until an inspection is desired. The rings are typically plastic or aluminum with an approximately three-inch inside diameter. Spring clip metal panel covers can be

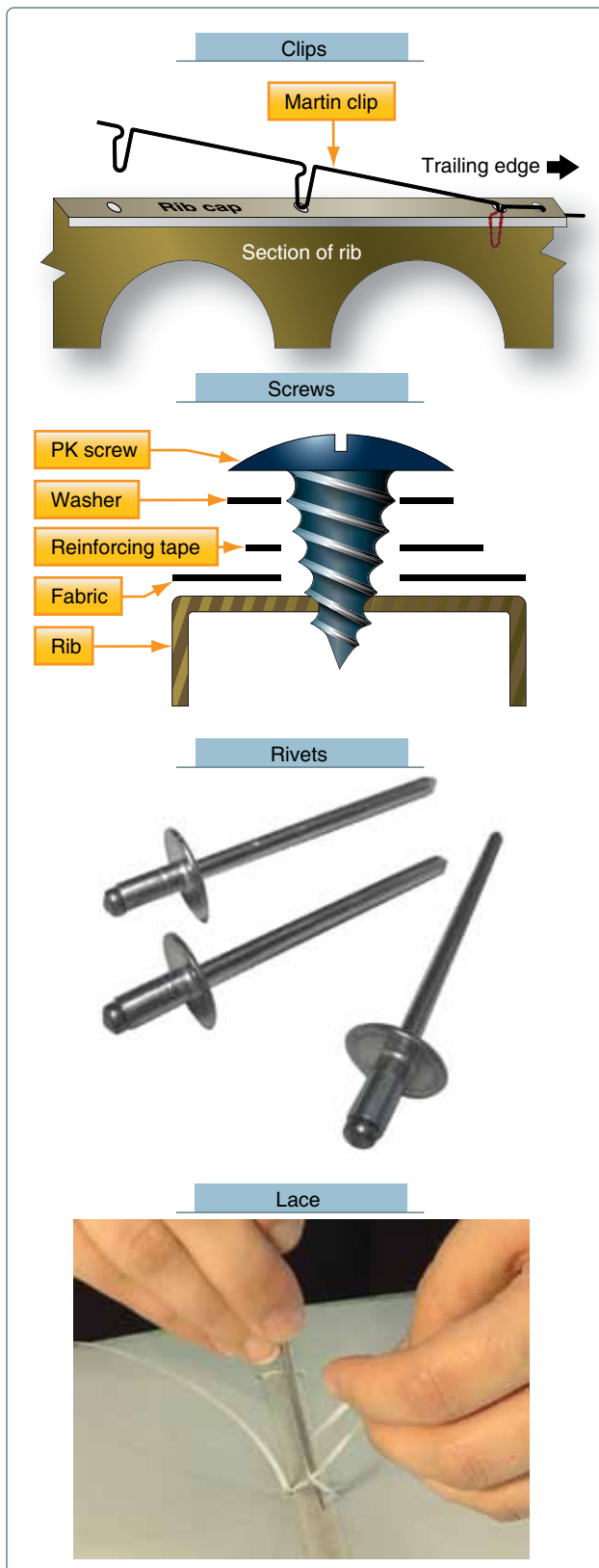
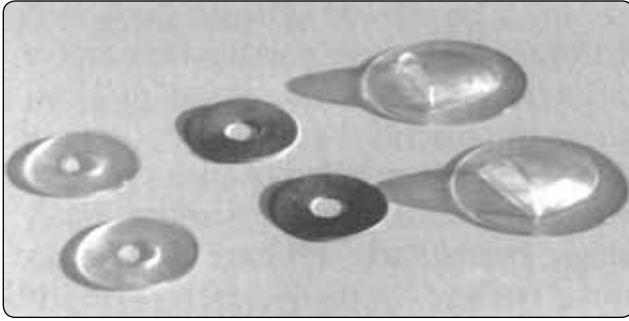

Figure 3-6. Clips, screws, rivets, or lace are used to attach the fabric to wing and empennage ribs.

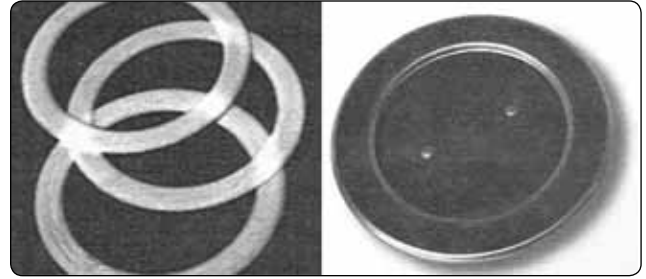

**Figure 3-7.** Plastic, aluminum, and seaplane grommets are used to reinforce drain holes in the fabric covering.

fitted to close the area once the fabric inside the inspection ring has been cut for access. [Figure 3-8] The location of the inspection rings are specified by the manufacturer. Additional rings are sometimes added to permit access to important areas that may not have been fitted originally with inspection access.

**Primer**

The airframe structure of a fabric covered aircraft must be cleaned, inspected, and prepared before the fabric covering process begins. The final preparation procedure involves



**Figure 3-8.** Inspection rings and an inspection cover.

priming the structure with a treatment that works with the adhesive and first coats of fabric sealant that are to be utilized. Each STC specifies which primers, or if a wood structure, which varnishes are suitable. Most often, two-part epoxy primers are used on metal structure and two-part epoxy varnishes are used on wood structure. Utilize the primer specified by the manufacturer’s or STC’s instructions.

**Fabric Cement**

Modern fabric covering systems utilize special fabric cement to attach the fabric to the airframe. There are various types of cement. [Figure 3-9] In addition to good adhesion qualities, flexibility, and long life, fabric cements must be compatible

Aircraft Covering Systems							
APPROVED PROPRIETARY PRODUCT NAME							
Covering System	STC #	Allowable Fabrics	Base	Cement	Filler	UV Block	Topcoats
Air-Tech	SA7965SW	Ceconite™ Poly-Fiber™ Superflite™	Urethane	UA-55	PFU 1020 PFU 1030	PFU 1020 PFU 1030	CHSM Color Coat
			Water				
Ceconite™/ Randolph System	SA4503NM	Ceconite™	Dope	New Super Seam	Nitrate Dope	Rand-O-Fill	Colored Butyrate Dope Ranthane Polyurethane
Stits/Poly-Fiber™	SA1008WE	Poly-Fiber™	Vinyl	Poly-tak	Poly-brush	Poly-spray	Vinyl Poly-tone, Aero-Thane, or Ranthane Polyurethane
Stewart System	SA01734SE	Ceconite™ Poly-Fiber™	Water-borne	EkoBond	EkoFill	EkoFill	EkoPoly
Superflite™ • System 1 • System VI	SA00478CH and others	Superflite™ 101,102 Superflite™ 101,102	Dope	U-500	Dacproofer	SrayFil	Tinted Butyrate Dope
			Urethane	U-500	SF6500	SF6500	Superflite™ CAB

**Figure 3-9.** Current FAA-approved fabric covering processes.

with the primer and the fabric sealer that are applied before and after the cement.

### ***Fabric Sealer***

Fabric sealer surrounds the fibers in the fabric with a protective coating to provide adhesion and keep out dirt and moisture. The sealer is the first coat applied to the polyester fabric after it is attached to the airframe and heat shrunk to fit snugly. Dope-based fabric coating systems utilize nontautening nitrate dope as the primary fabric sealant. The application of tautening dope may cause the fabric to become too taut resulting in excess stress on the airframe that could damage it. Nondope coating systems use proprietary sealers that are also nontautening. [Figure 3-9]

### ***Fillers***

After the fabric sealer is applied, a filler is used. It is sprayed on in a number of cross coats as required by the manufacturer or the fabric covering process STC. The filler contains solids or chemicals that are included to block UV light from reaching the fabric. Proper fill coating is critical because UV light is the single most destructive element that causes polyester fabric to deteriorate. Dope-based processes use butyrate dope fillers while other processes have their own proprietary formulas. When fillers and sealers are combined, they are known as fabric primers. Aluminum pastes and powders, formerly added to butyrate dope to provide the UV protection, have been replaced by premixed formulas.

### ***Topcoats***

Once the aircraft fabric has been installed, sealed, and fill-coat protected, finishing or topcoats are applied to give the aircraft its final appearance. Colored butyrate dope is common in dope-based processes, but various polyurethane topcoats are also available. It is important to use the topcoat products and procedures specified in the applicable STC to complete an airworthy fabric re-covering job.

The use of various additives is common at different stages when utilizing the above products. The following is a short list of additional products that facilitate the proper application of the fabric coatings. Note again that only products approved under a particular STC can be used. Substitution of similar products, even though they perform the same basic function, is not allowed.

- A catalyst accelerates a chemical reaction. Catalysts are specifically designed for each product with which they are mixed. They are commonly used with epoxies and polyurethanes.
- A thinner is a solvent or mixture of solvents added to a product to give it the proper consistency for application, such as when spraying or brushing.

- A retarder is added to a product to slow drying time. Used mostly in dope processes and topcoats, a retarder allows more time for a sprayed coating to flow and level, resulting in a deeper, glossier finish. It is used when the working temperature is elevated slightly above the ideal temperature for a product. It also can be used to prevent blushing of a dope finish when high humidity conditions exist.
- An accelerator contains solvents that speed up the drying time of the product with which it is mixed. It is typically used when the application working temperature is below that of the ideal working temperature. It can also be used for faster drying when airborne contaminants threaten a coating finish.
- Rejuvenator, used on dope finishes only, contains solvents that soften coatings and allow them to flow slightly. Rejuvenator also contains fresh plasticizers that mix into the original coatings. This increases the overall flexibility and life of the coatings.
- Fungicide and mildewicide additives are important for organic fabric-covered aircraft because fabrics, such as cotton and linen, are hosts for fungus and mildew. Since fungus and mildew are not concerns when using polyester fabric, these additives are not required. Modern coating formulas contain premixed anti-fungal agents, providing sufficient insurance against the problem of fungus or mildew.

## **Available Covering Processes**

The covering processes that utilize polyester fabric are the primary focus of this chapter. The FAA-approved aircraft covering processes are listed in Figure 3-9. The processes can be distinguished by the chemical nature of the glue and coatings that are used. A dope-based covering process has been refined out of the cotton fabric era, with excellent results on polyester fabric. In particular, plasticizers added to the nitrate dope and butyrate dopes minimize the shrinking and tautening effects of the dope, establish flexibility, and allow esthetically pleasing tinted butyrate dope finishes that last indefinitely. Durable polyurethane-based processes integrate well with durable polyurethane topcoat finishes. Vinyl is the key ingredient in the popular Poly-Fiber covering system. Air Tech uses an acetone-thinned polyurethane-compatible system.

The most recent entry into the covering systems market is the Stewart Finishing System that uses waterborne technology to apply polyurethane coatings to the fabric. The glue used in the system is water-based and nonvolatile. The Stewart Finishing System is Environmental Protection Agency (EPA) compliant and STC approved. Both the Stewart and Air Tech systems operate with any of the approved polyester fabrics as stated in their covering system STCs.



All the modern fabric covering systems listed in *Figure 3-9* result in a polyester fabric covered aircraft with an indefinite service life. Individual preferences exist for working with the different approved processes. A description of basic covering procedures and techniques common to most of these systems follows later in this chapter.

Ceconite™, Polyfiber™, and Superflight™ are STC approved fabrics with processes used to install polyester fabric coverings. Two companies that do not manufacture their own fabric have gained STC approval for covering accessories and procedures to be used with these approved fabrics. The STCs specify the fabrics and the proprietary materials that are required to legally complete the re-covering job.

The aircraft fabric covering process is a three-step process. First, select an approved fabric. Second, follow the applicable STC steps to attach the fabric to the airframe and to protect it from the elements. Third, apply the approved topcoat to give the aircraft its color scheme and final appearance.

Although Grade-A cotton can be used on all aircraft originally certificated to be covered with this material, approved aircraft cotton fabric is no longer available. Additionally, due to the shortcomings of cotton fabric coverings, most of these aircraft have been re-covered with polyester fabric. In the rare instance the technician encounters a cotton fabric covered aircraft that is still airworthy, inspection and repair procedures specified in AC 43.13-1, Chapter 2, Fabric Covering, should be followed.

### **Determining Fabric Condition—Repair or Recover?**

Re-covering an aircraft with fabric is a major repair and should only be undertaken when necessary. Often a repair to the present fabric is sufficient to keep the aircraft airworthy. The original manufacturer's recommendations or the covering process STC should be consulted for the type of repair required for the damage incurred by the fabric covering. AC 43.13-1 also gives guidelines and acceptable practices for repairing cotton fabric, specifically when stitching is concerned.

Often a large area that needs repair is judged in reference to the overall remaining lifespan of the fabric on the aircraft. For example, if the fabric has reached the limit of its durability, it is better to re-cover the entire aircraft than to replace a large damaged area when the remainder of the aircraft would soon need to be re-covered.

On aircraft with dope-based covering systems, continued shrinkage of the dope can cause the fabric to become too tight. Overly tight fabric may require the aircraft to be re-covered

rather than repaired because excess tension on fabric can cause airframe structural damage. Loose fabric flaps in the wind during flight, affecting weight distribution and unduly stressing the airframe. It may also need to be replaced because of damage to the airframe.

Another reason to re-cover rather than repair occurs when dope coatings on fabric develop cracks. These cracks could expose the fabric beneath to the elements that can weaken it. Close observation and field testing must be used to determine if the fabrics are airworthy. If not, the aircraft must be re-covered. If the fabric is airworthy and no other problems exist, a rejuvenator can be used per manufacturer's instructions. This product is usually sprayed on and softens the coatings with very powerful solvents. Plasticizers in the rejuvenator become part of the film that fills in the cracks. After the rejuvenator dries, additional coats of aluminum-pigmented dope must be added and then final topcoats applied to finish the job. While laborious, rejuvenating a dope finish over strong fabric can save a great deal of time and money. Polyurethane-based finishes cannot be rejuvenated.

### **Fabric Strength**

Deterioration of the strength of the present fabric covering is the most common reason to re-cover an aircraft. The strength of fabric coverings must be determined at every 100-hour and annual inspection. Minimum fabric breaking strength is used to determine if an aircraft requires re-covering.

Fabric strength is a major factor in the airworthiness of an aircraft. Fabric is considered to be airworthy until it deteriorates to a breaking strength less than 70 percent of the strength of the new fabric required for the aircraft. For example, if an aircraft was certificated with Grade-A cotton fabric that has a new breaking strength of 80 pounds, it becomes unairworthy when the fabric strength falls to 56 pounds, which is 70 percent of 80 pounds. If polyester fabric, which has a higher new breaking strength, is used to re-cover this same aircraft, it would also need to exceed 56 pounds breaking strength to remain airworthy.

In general, an aircraft is certified with a certain fabric based on its wing loading and its never exceed speed ( $V_{NE}$ ). The higher the wing loading and  $V_{NE}$ , the stronger the fabric must be. On aircraft with wing loading of 9 pounds per square foot and over, or a  $V_{NE}$  of 160 miles per hour (mph) or higher, fabric equaling or exceeding the strength of Grade A cotton is required. This means the new fabric breaking strength must be at least 80 pounds and the minimum fabric breaking strength at which the aircraft becomes unairworthy is 56 pounds.

On aircraft with wing loading of 9 pounds per square foot or less, or a  $V_{NE}$  of 160 mph or less, fabric equaling or exceeding

the strength of intermediate grade cotton is required. This means the new fabric breaking strength must be at least 65 pounds and the minimum fabric breaking strength at which the aircraft becomes unairworthy is 46 pounds.

Lighter weight fabric may be found to have been certified on gliders or sailplanes and may be used on many uncertificated aircraft or aircraft in the Light Sport Aircraft (LSA) category. For aircraft with wing loading less than 8 pounds per square foot or less, or  $V_{NE}$  of 135 mph or less, the fabric is considered unairworthy when the breaking strength has deteriorated to below 35 pounds (new minimum strength of 50 pounds). *Figure 3-10* summarizes these parameters.

### How Fabric Breaking Strength is Determined

Manufacturer’s instructions should always be consulted first for fabric strength inspection methodology. These instructions are approved data and may not require removal of a test strip to determine airworthiness of the fabric. In some cases, the manufacturer’s information does not include any fabric inspection methods. It may refer the IA to AC 43.13-1, Chapter 2, Fabric Covering, which contains the approved FAA test strip method for breaking strength.

The test strip method for the breaking strength of aircraft covering fabrics uses standards published by the American Society for Testing and Materials (ASTM) for the testing of various materials. Breaking strength is determined by cutting a 1¼ inch by 4–6 inch strip of fabric from the aircraft covering. This sample should be taken from an area that is exposed to the elements—usually an upper surface. It is also wise to take the sample from an area that has a dark colored finish since this has absorbed more of the sun’s UV rays and degraded faster. All coatings are then removed and the edges raveled to leave a 1-inch width. One end of the strip is clamped into a secured clamp and the other end is clamped such that a suitable container may be suspended from it. Weight is added to the container until the fabric breaks. The breaking strength of the fabric is equal to the weight of the lower clamp, the container, and the weight added to it. If the breaking strength is still in question, a sample should be sent

to a qualified testing laboratory and breaking strength tests made in accordance with ASTM publication D5035.

Note that the fabric test strip must have all coatings removed from it for the test. Soaking and cleaning the test strip in methyl ethyl ketone (MEK) usually removes all the coatings.

Properly installed and maintained polyester fabric should give years of service before appreciable fabric strength degradation occurs. Aircraft owners often prefer not to have test strips cut out of the fabric, especially when the aircraft or the fabric covering is relatively new, because removal of a test strip damages the integrity of an airworthy component if the fabric passes. The test strip area then must be repaired, costing time and money. To avoid cutting a strip out of airworthy fabric, the IA makes a decision based on knowledge, experience, and available nondestructive techniques as to whether removal of a test strip is warranted to ensure that the aircraft can be returned to service.

An aircraft made airworthy under an STC is subject to the instructions for continued airworthiness in that STC. Most STCs refer to AC 43.13-1 for inspection methodology. Poly-Fiber™ and Ceconite™ re-covering process STCs contain their own instructions and techniques for determining fabric strength and airworthiness. Therefore, an aircraft covered under those STCs may be inspected in accordance with this information. In most cases, the aircraft can be approved for return to service without cutting a strip from the fabric covering.

The procedures in the Poly-Fiber™ and Ceconite™ STCs outlined in the following paragraphs are useful when inspecting any fabric covered aircraft as they add to the information gathered by the IA to determine the condition of the fabric. However, following these procedures alone on aircraft not covered under these STCs does not make the aircraft airworthy. The IA must add his or her own knowledge, experience, and judgment to make a final determination of the strength of the fabric and whether it is airworthy.

Fabric Performance Criteria				
IF YOUR PERFORMANCE IS. . .		FABRIC STRENGTH MUST BE. . .		
Loading	$V_{NE}$ Speed	Type	New Breaking Strength	Minimum Breaking Strength
> 9 lb/sq ft	> 160 mph	≥ Grade A	> 80 lb	> 56
< 9 lb/sq ft	< 160 mph	≥ Intermediate	> 65 lb	> 46
< 8 lb/sq ft	< 135 mph	≥ Lightweight	> 50 lb	> 35

**Figure 3-10.** Aircraft performance affects fabric selection.

Exposure to UV radiation appreciably reduces the strength of polyester fabric and forms the basis of the Poly-Fiber™ and Ceconite™ fabric evaluation process. All approved covering systems utilize fill coats applied to the fabric to protect it from UV. If installed according to the STC, these coatings should be sufficient to protect the fabric from the sun and should last indefinitely. Therefore, most of the evaluation of the strength of the fabric is actually an evaluation of the condition of its protective coating(s).

Upon a close visual inspection, the fabric coating(s) should be consistent, contain no cracks, and be flexible, not brittle. Pushing hard against the fabric with a knuckle should not damage the coating(s). It is recommended the inspector check in several areas, especially those most exposed to the sun. Coatings that pass this test can move to a simple test that determines whether or not UV light is passing through the coatings.

This test is based on the assumption that if visible light passes through the fabric coatings, then UV light can also. To verify whether or not visible light passes through the fabric coating, remove an inspection panel from the wing, fuselage, or empennage. Have someone hold an illuminated 60-watt lamp one foot away from the exterior of the fabric. No light should be visible through the fabric. If no light is visible, the fabric has not been weakened by UV rays and can be assumed to be airworthy. There is no need to perform the fabric strip strength test. If light is visible through the coatings, further investigation is required.

### Fabric Testing Devices

Mechanical devices used to test fabric by pressing against or piercing the finished fabric are not FAA approved and are used at the discretion of the FAA-certificated mechanic to form an opinion on the general fabric condition. Punch test accuracy depends on the individual device calibration, total coating thickness, brittleness, and types of coatings and fabric. If the fabric tests in the lower breaking strength range with the mechanical punch tester or if the overall fabric cover conditions are poor, then more accurate field tests may be made.

The test should be performed on exposed fabric where there is a crack or chip in the coatings. If there is no crack or chip, coatings should be removed to expose the fabric wherever the test is to be done.

The Maule punch tester, a spring-loaded device with its scale calibrated in breaking strength, tests fabric strength by pressing against it while the fabric is still on the aircraft. It roughly equates strength in pounds per square inch (psi) of resistance to breaking strength. The tester is pushed squarely against the fabric until the scale reads the amount

of maximum allowable degradation. If the tester does not puncture the fabric, it may be considered airworthy. Punctures near the breaking strength should be followed with further testing, specifically the strip breaking strength test described above. Usually, a puncture indicates the fabric is in need of replacement.

A second type of punch tester, the Seyboth, is not as popular as the Maule because it punctures a small hole in the fabric when the mechanic pushes the shoulder of the testing unit against the fabric. A pin with a color-coded calibrated scale protrudes from the top of the tester and the mechanic reads this scale to determine fabric strength. Since this device requires a repair regardless of the strength of the fabric indicated, it is not widely used.

Seyboth and Maule fabric strength testers designed for cotton- and linen-covered aircraft, not to be used on modern Dacron fabrics. Mechanical devices, combined with other information and experience, help the FAA-certificated mechanic judge the strength of the fabric. [Figure 3-11]

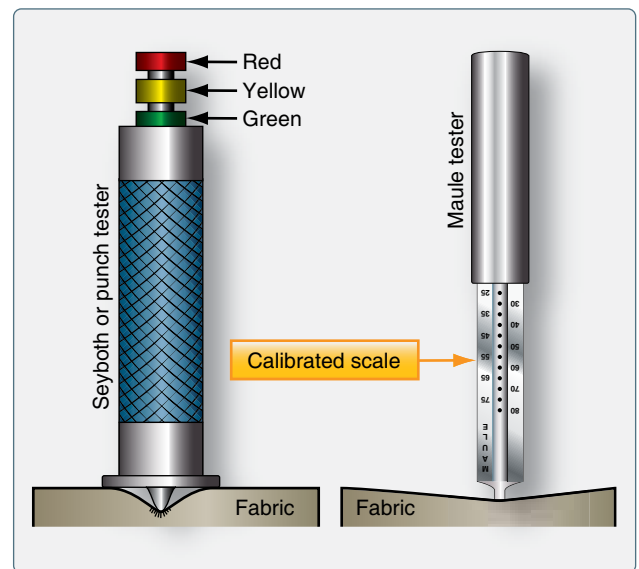

Figure 3-11. Seyboth and Maule fabric strength testers.

### General Fabric Covering Process

It is required to have an IA involved in the process of re-covering a fabric aircraft because re-covering is a major repair or major alteration. Signatures are required on FAA Form 337 and in the aircraft logbook. To ensure work progresses as required, the IA should be involved from the beginning, as well as at various stages throughout the process.

This section describes steps common to various STC and manufacturer covering processes, as well as the differences of some processes. To aid in proper performance of fabric

covering and repair procedures, STC holders produce illustrated, step-by-step instructional manuals and videos that demonstrate the correct covering procedures. These training aids are invaluable to the inexperienced technician.

Since modern fabric coverings last indefinitely, a rare opportunity to inspect the aircraft exists during the re-covering process. Inspectors and owner-operators should use this opportunity to perform a thorough inspection of the aircraft before new fabric is installed.

The method of fabric attachment should be identical, as far as strength and reliability are concerned, to the method used by the manufacturer of the aircraft being recovered or repaired. Carefully remove the old fabric from the airframe, noting the location of inspection covers, drain grommets, and method of attachment. Either the envelope method or blanket method of fabric covering is acceptable, but a choice must be made prior to beginning the re-covering process.

### Blanket Method vs. Envelope Method

In the blanket method of re-covering, multiple flat sections of fabric are trimmed and attached to the airframe. Certified greige polyester fabric for covering an aircraft can be up to 70 inches in width and used as it comes off the bolt. Each aircraft must be considered individually to determine the size and layout of blankets needed to cover it. A single blanket cut for each small surface (i.e., stabilizers and control surfaces) is common. Wings may require two blankets that overlap. Fuselages are covered with multiple blankets that span between major structural members, often with a single blanket for the bottom. Very large wings may require more than two blankets of fabric to cover the entire top and bottom surfaces. In all cases, the fabric is adhered to the airframe using the approved adhesives, following specific rules for the covering process being employed. [Figure 3-12]



**Figure 3-12.** Laying out fabric during a blanket method re-covering job.

An alternative method of re-covering, the envelope method, saves time by using pre-cut and pre-sewn envelopes of fabric to

cover the aircraft. The envelopes must be sewn with approved machine sewing thread, edge distance, fabric fold, etc., such as those specified in AC 43.13-1 or an STC. Patterns are made and fabric is cut and stitched so that each major surface, including the fuselage and wings, can be covered with a single, close-fitting envelope. Since envelopes are cut to fit, they are slid into position, oriented with the seams in the proper place, and attached with adhesive to the airframe. Envelope seams are usually located over airframe structure in inconspicuous places, such as the trailing edge structures and the very top and bottom of the fuselage, depending on airframe construction. Follow the manufacturer's or STC's instructions for proper location of the sewn seams of the envelope when using this method. [Figure 3-13]

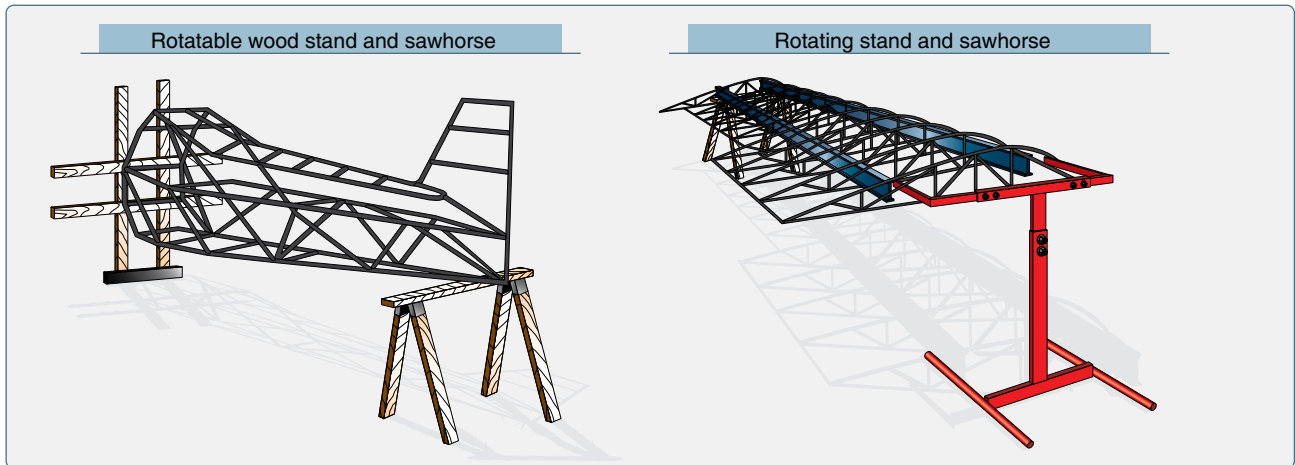

**Figure 3-13.** A custom-fit pre-sewn fabric envelope is slid into position over a fuselage for the envelope method of fabric covering. Other than fitting, most steps in the covering process are the same as with the blanket covering method.

### Preparation for Fabric Covering Work

Proper preparation for re-covering a fabric aircraft is essential. First, assemble the materials and tools required to complete the job. The holder of the STC usually supplies a materials and tools list either separately or in the STC manual. Control of temperature, humidity, and ventilation is needed in the work environment. If ideal environmental conditions cannot be met, additives are available that compensate for this for most re-covering products.

Rotating work stands for the fuselage and wings provide easy, alternating access to the upper and lower surfaces while the job is in progress. [Figure 3-14] They can be used with sawhorses or sawhorses can be used alone to support the aircraft structure while working. A workbench or table, as well as a rolling cart and storage cabinet, are also recommended. Figure 3-15 shows a well conceived fabric covering workshop. A paint spray booth for sprayed-on coatings and space to store components awaiting work is also recommended.



**Figure 3-14.** Rotating stands and sawhorses facilitate easy access to top and bottom surfaces during the fabric covering process.

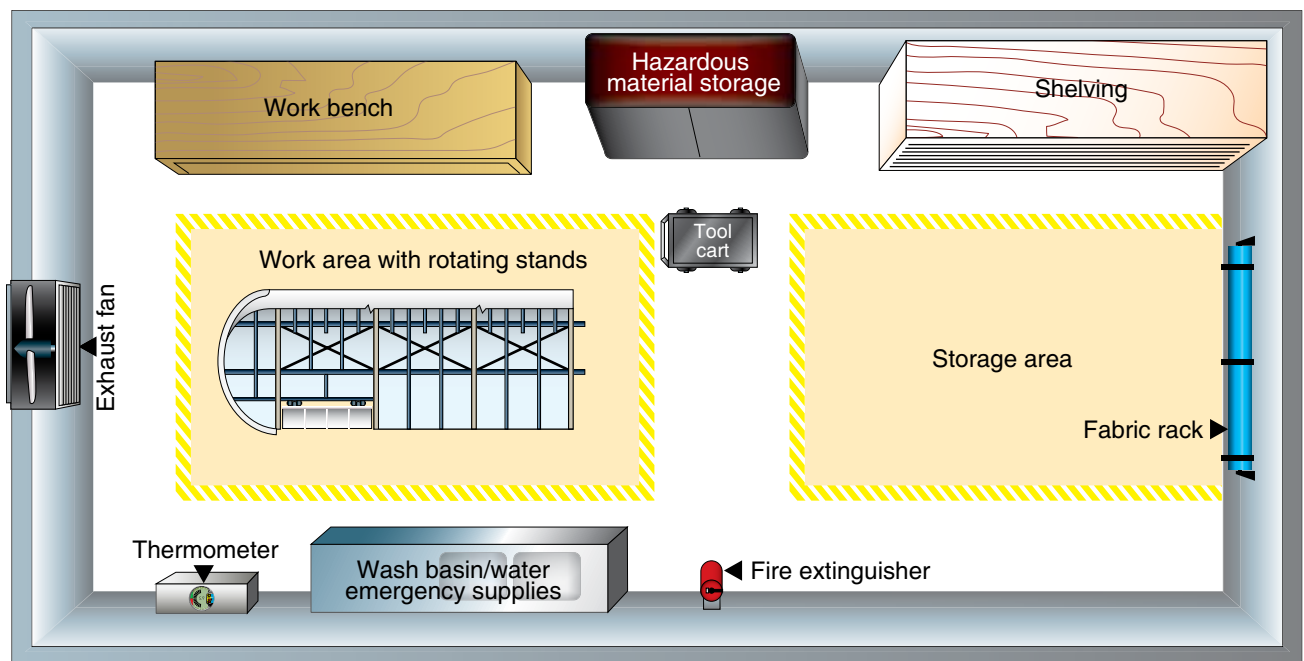
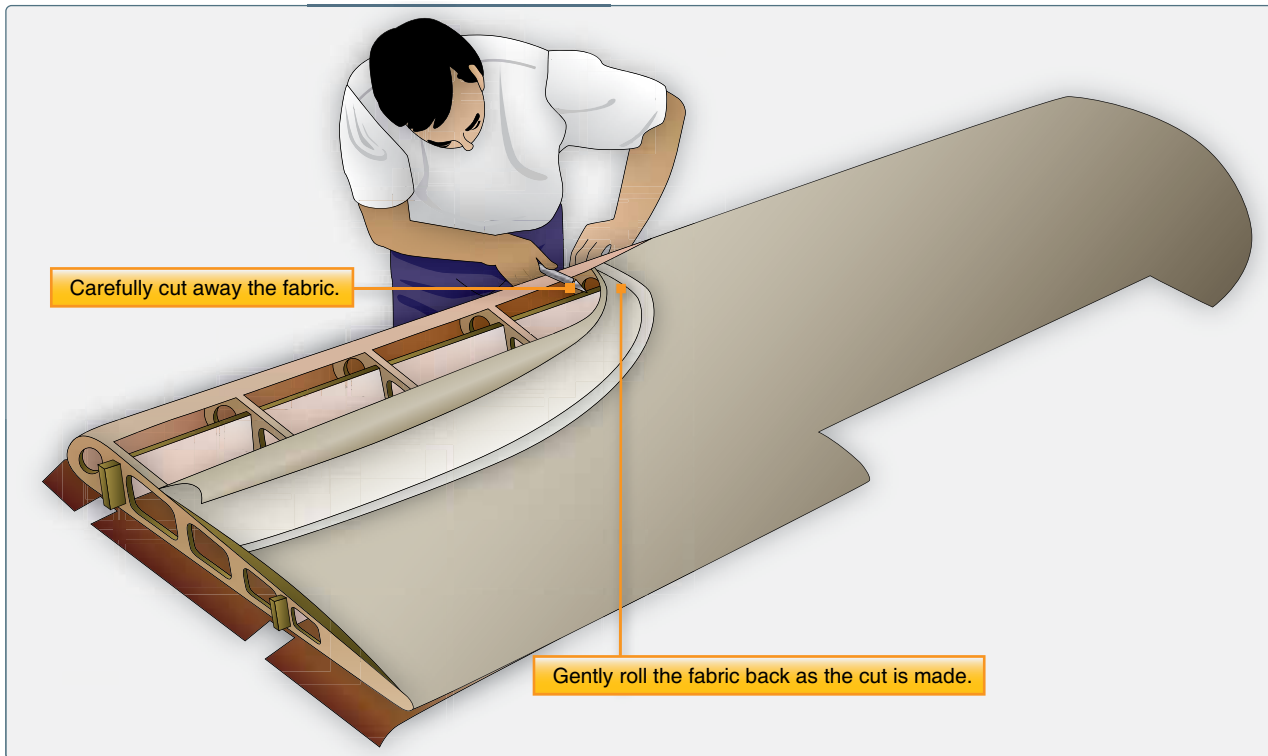

**Figure 3-15.** Some components of a work area for covering an aircraft with fabric.

Many of the substances used in most re-covering processes are highly toxic. Proper protection must be used to avoid serious short and long term adverse health effects. Eye protection, a proper respirator, and skin protection are vital. As mentioned in the beginning of this chapter, nitrate dope is very flammable. Proper ventilation and a rated fire extinguisher should be on hand when working with this and other covering process materials. Grounding of work to prevent static electricity build-up may be required. All fabric re-covering processes also involve multiple coats of various products that are sprayed onto the fabric surface. Use of a high-volume, low-pressure (HVLP) sprayer is recommended. Good ventilation is needed for all of the processes.

### Removal of Old Fabric Coverings

Removal of the old covering is the first step in replacing an aircraft fabric covering. Cut away the old fabric from the airframe with razor blades or utility knife. Care should be taken to ensure that no damage is done to the airframe. [Figure 3-16] To use the old covering for templates in transferring the location of inspection panels, cable guides, and other features to the new covering, the old covering should be removed in large sections. NOTE: any rib stitching fasteners, if used to attach the fabric to the structure, should be removed before the fabric is pulled free of the airframe. If fasteners are left in place, damage to the structure may occur during fabric removal.



**Figure 3-16.** Old fabric coverings are cut off in large pieces to preserve them as templates for locating various airframe features. Sharp blades and care must be used to avoid damaging the structure.

### Preparation of the Airframe Before Covering

Once the old fabric has been removed, the exposed airframe structure must be thoroughly cleaned and inspected. The IA collaborating on the job should be involved in this step of the process. Details of the inspection should follow the manufacturer's guidelines, the STC, or AC 43.13-1. All of the old adhesive must be completely removed from the airframe with solvent, such as MEK. A thorough inspection must be done and various components may be selected to be removed for cleaning, inspection, and testing. Any repairs that are required, including the removal and treatment of all corrosion, must be done at this time. If the airframe is steel tubing, many technicians take the opportunity to grit blast the entire airframe at this stage.

The leading edge of a wing is a critical area where airflow diverges and begins its laminar flow over the wing's surfaces, which results in the generation of lift. It is beneficial to have a smooth, regular surface in this area. Plywood leading edges must be sanded until smooth, bare wood is exposed. If oil or grease spots exist, they must be cleaned with naphtha or other specified cleaners. If there are any chips, indentations, or irregularities, approved filler may be spread into these areas and sanded smooth. The entire leading edge should be cleaned before beginning the fabric covering process.

To obtain a smooth finish on fabric-covered leading edges of aluminum wings, a sheet of felt or polyester padding may be applied before the fabric is installed. This should only be done with the material specified in the STC under which the technician is working. The approved padding ensures compatibility with the adhesives and first coatings of the covering process. When a leading edge pad is used, check the STC process instructions for permission to make a cemented fabric seam over the padding. [Figure 3-17]

When completely cleaned, inspected, and repaired, an approved primer, or varnish if it is a wood structure, should be applied to the airframe. This step is sometimes referred to as dope proofing. Exposed aluminum must first be acid etched. Use the product(s) specified by the manufacturer or in the STC to prepare the metal before priming. Two part epoxy primers and varnishes, which are not affected by the fabric adhesive and subsequent coatings, are usually specified. One part primers, such as zinc chromate and spar varnish, are typically not acceptable. The chemicals in the adhesives dissolve the primers, and adhesion of the fabric to the airframe is lost.

Sharp edges, metal seams, the heads of rivets, and any other feature on the aircraft structure that might cut or wear through the fabric should be covered with anti-chafe tape. As



**Figure 3-17.** *The use of specified felt or padding over the wing leading edges before the fabric is installed results in a smooth regular surface.*

described above, this cloth sticky-back tape is approved and should not be substituted with masking or any other kind of tape. Sometimes, rib cap strips need to have anti-chafe tape applied when the edges are not rounded over. [Figure 3-18]

Inter-rib bracing must also be accomplished before the fabric is installed. It normally does not have an adhesive attached to it and is wrapped only once around each rib. The single wrap around each rib is enough to hold the ribs in place during the covering process but allows small movements during the fabric shrinking process. [Figure 3-19]

### **Attaching Polyester Fabric to the Airframe**

Inexperienced technicians are encouraged to construct a test panel upon which they can practice with the fabric and various substances and techniques to be used on the aircraft. It is often suggested to cover smaller surfaces first, such as the empennage and control surfaces. Mistakes on these can be corrected and are less costly if they occur. The techniques employed for all surfaces, including the wings and fuselage, are basically the same. Once dexterity has been established, the order in which one proceeds is often a personal choice.

When the airframe is primed and ready for fabric installation, it must receive a final inspection by an A&P with IA.



**Figure 3-18.** *Anti-chafe tape is applied to all features that might cut or wear through the fabric.*

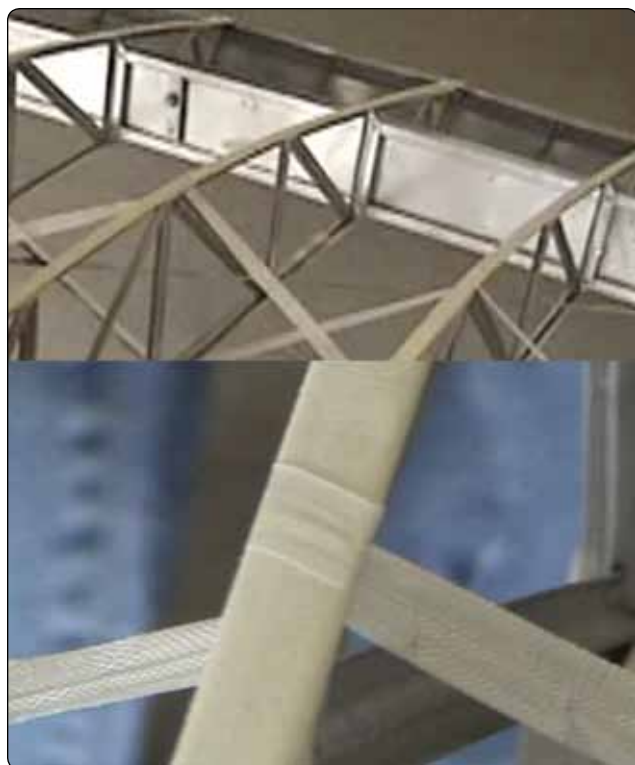

**Figure 3-19.** *Inter-rib bracing holds the ribs in place during the re-covering process.*

When approved, attachment of the fabric may begin. The manufacturer's or STC's instructions must be followed without deviation for the job to be airworthy. The following are the general steps taken. Each approved process has its own nuances.

### Seams

During installation, the fabric is overlapped and seamed together. Primary concerns for fabric seams are strength, elasticity, durability, and good appearance. Whether using the blanket method or envelope method, position all fabric seams over airframe structure to which the fabric is to be adhered during the covering process, whenever possible. Unlike the blanket method, fabric seam overlap is predetermined in the envelope method. Seams sewn to the specifications in AC 43.13-1, the STC under which the work is being performed, or the manufacturer's instructions should perform adequately.

Most covering procedures for polyester fabric rely on doped or glued seams as opposed to sewn seams. They are simple and easy to make and provide excellent strength, elasticity, durability, and appearance. When using the blanket method, seam overlap is specified in the covering instructions and the FAA-certificated A&P mechanic must adhere to these specifications. Typically, a minimum of two to four inches of fabric overlap seam is required where ends of fabric are joined in areas of critical airflow, such as the leading edge of a wing. One to two inches of overlap is often the minimum in other areas.

When using the blanket method, options exist for deciding where to overlap the fabric for coverage. Function and the

final appearance of the covering job should be considered. For example, fabric seams made on the wing's top surface of a high wing aircraft are not visible when approaching the aircraft. Seams on low wing aircraft and many horizontal stabilizers are usually made on the bottom of the wing for the same reason. [Figure 3-20]

### Fabric Cement

A polyester fabric covering is cemented or glued to the airframe structure at all points where it makes contact. Special formula adhesives have replaced nitrate dope for adhesion in most covering processes. The adhesive (as well as all subsequent coating materials) should be mixed for optimum characteristics at the temperature at which the work is being performed. Follow the manufacturer's or STC's guidance when mixing.

To attach the fabric to the airframe, first pre-apply two coats of adhesive to the structure at all points the fabric is to contact it. (It is important to follow the manufacturer's or STC's guidance as all systems are different.) Allow these to dry. The fabric is then spread over the surface and clamped into position. It should not be pulled tighter than the relaxed but not wrinkled condition it assumes when lying on the structure. Clamps or clothespins are used to attach the fabric completely around the perimeter. The Stewart System STC does not need clamps because the glue assumes a tacky condition when pre-coated and dried. There is sufficient adhesion in the precoat to position the fabric.

The fabric should be positioned in all areas before undertaking final adhesion. Final adhesion often involves lifting the fabric,

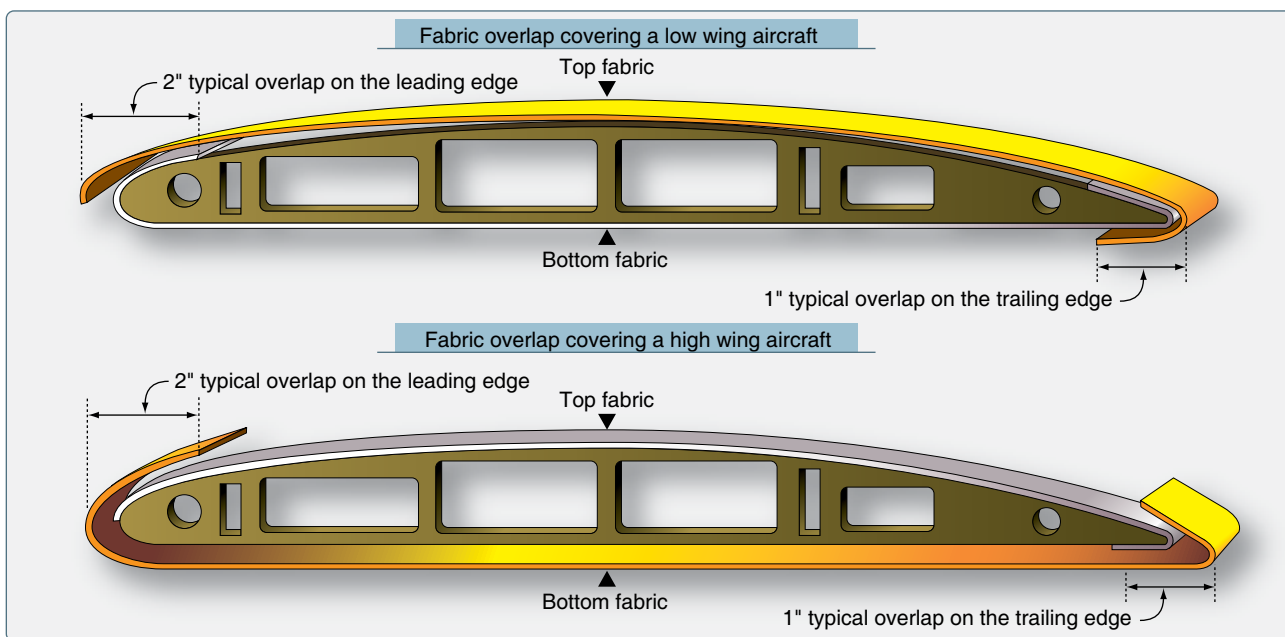

Figure 3-20. For appearance, fabric can be overlapped differently on high wing and low wing aircraft.



applying a wet bed of cement, and pressing the fabric into the bed. An additional coat of cement over the top of the fabric is common. Depending on the process, wrinkles and excess cement are smoothed out with a squeegee or are ironed out. The Stewart System calls for heat activation of the cement precoats through the fabric with an iron while the fabric is in place. Follow the approved instructions for the covering method being used.

### ***Fabric Heat Shrinking***

Once the fabric has been glued to the structure, it can be made taut by heat shrinking. This process is done with an ordinary household iron that the technician calibrates before use. A smaller iron is also used to iron in small or tight places. [Figure 3-21] The iron is run over the entire surface of the fabric. Follow the instructions for the work being performed. Some processes avoid ironing seams while other processes begin ironing over structure and move to spanned fabric or visa-versa. It is important to shrink the fabric evenly. Starting on one end of a structure and progressing sequentially to the other end is not recommended. Skipping from one end to the other, and then to the middle, is more likely to evenly draw the fabric tight. [Figure 3-22]

The amount polyester fabric shrinks is directly related to the temperature applied. Polyester fabric can shrink nearly 5 percent at 250 °F and 10 percent at 350 °F. It is customary to shrink the fabric in stages, using a lower temperature first, before finishing with the final temperature setting. The first shrinking is used to remove wrinkles and excess fabric. The final shrinking gives the finished tautness desired. Each



**Figure 3-21.** Irons used during the fabric covering process.

process has its own temperature regime for the stages of tautening. Typically ranging from 225 °F to 350 °F, it is imperative to follow the process instructions. Not all fabric covering processes use the same temperature range and maximum temperature. Ensure irons are calibrated to prevent damage at high temperature settings.

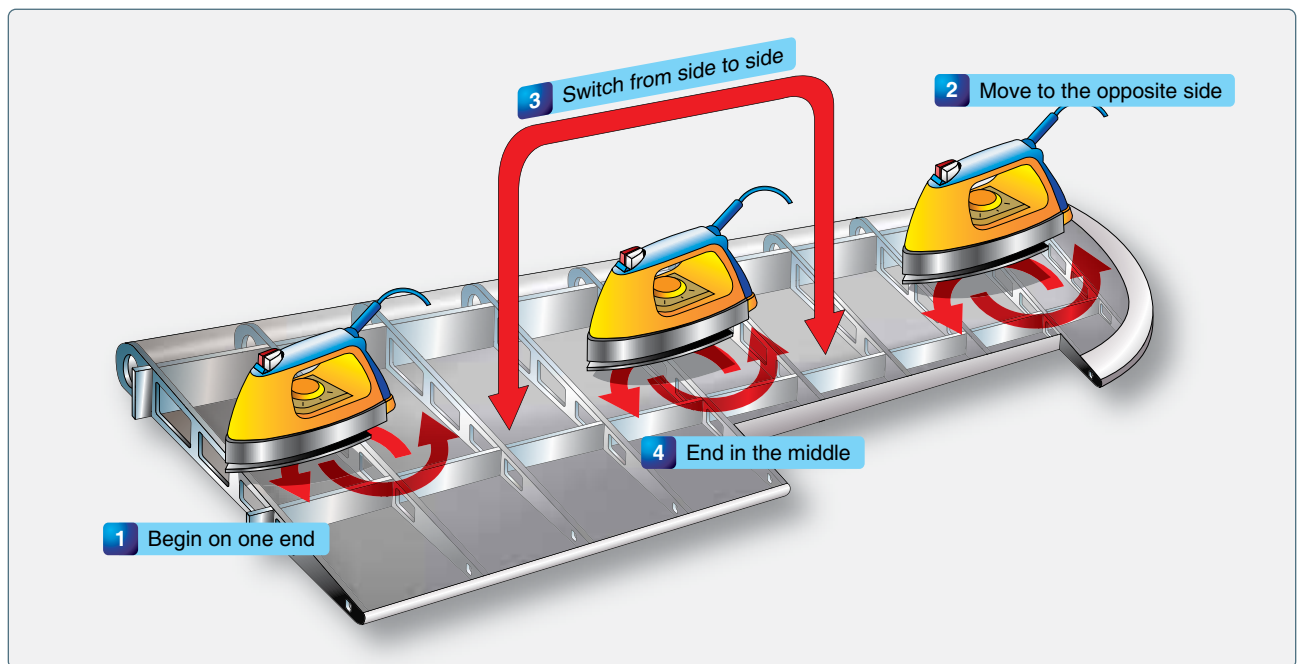
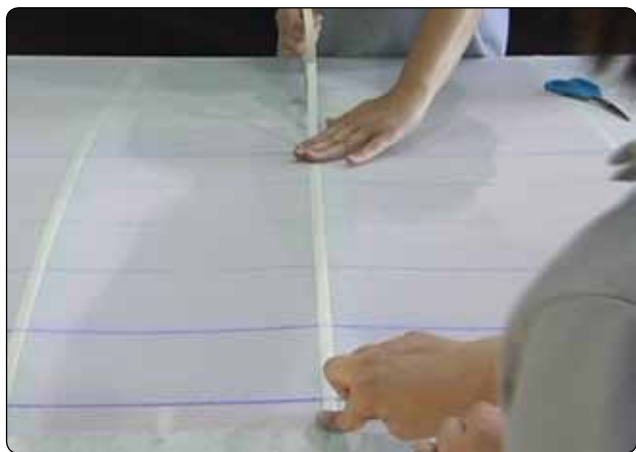

**Figure 3-22.** An example of a wing fabric ironing procedure designed to evenly tauten the fabric.

## Attaching Fabric to the Wing Ribs

Once the fabric has been tautened, covering processes vary. Some require a sealing coat be applied to the fabric at this point. It is usually put on by brush to ensure the fibers are saturated. Other processes seal the fabric later. Whatever the process, the fabric on wings must be secured to the wing ribs with more than just cement. The forces caused by the airflow over the wings are too great for cement alone to hold the fabric in place. As described in the materials section, screws, rivets, clips and lacing hold the fabric in place on manufactured aircraft. Use the same attach method as used by the original aircraft manufacturer. Deviation requires a field approval. Note that fuselage and empennage attachments may be used on some aircraft. Follow the methodology for wing rib lacing described below and the manufacturer's instructions for attach point locations and any possible variations to what is presented here.

Care must always be taken to identify and eliminate any sharp edges that might wear through the fabric. Reinforcing tape of the exact same width as the rib cap is installed before any of the fasteners. This approved sticky-back tape helps prevent the fabric from tearing. [Figure 3-23] Then, screws, rivets, and clips simply attach into the predrilled holes in the rib caps to hold the fabric to the caps. Rib lacing is a more involved process whereby the fabric is attached to the ribs with cord.



**Figure 3-23.** Reinforcing tape the same width as the wing ribs is applied over all wing ribs.

## Rib Lacing

There are two kinds of rib lacing cord. One has a round cross-section and the other flat. Which to use is a matter of preference based on ease of use and final appearance. Only approved rib lacing cord can be used. Unless a rib is unusually deep from top to bottom, rib lacing uses a single length of cord that passes completely through the wing from the upper surface to the lower surface thereby attaching the top and bottom skin to the rib simultaneously.

Holes are laid out and pre-punched through the skin as close to the rib caps as possible to accept the lacing cord. [Figure 3-24] This minimizes leverage the fabric could develop while trying to pull away from the structure and prevents tearing. The location of the holes is not arbitrary. The spacing between lacing holes and knots must adhere to manufacturer's instructions, if available. STC lacing guidance refers to manufacturer's instructions or to that shown on the chart in Figure 3-25 which is taken from AC 43.13-1. Notice that because of greater turbulence in the area of the propeller wash, closer spacing between the lacing is required there. This slipstream is considered to be the width of the propeller plus one additional rib. Ribs are normally laced from the leading edge to the trailing edge of the wing. Rib lacing is done with a long curved needle to guide the cord in and out of holes and through the depth of the rib. The knots are designed not to slip under the forces applied and can be made in a series out of a single strand of lacing. Stitching can begin at the leading edge or trailing edge. A square knot with a half hitch on each side is typically used for the first knot when lacing a rib. [Figure 3-26] This is followed by a series of modified seine knots until the final knot is made and secured with a half hitch. [Figure 3-27] Hidden modified seine knots are also used. These knots are placed below the fabric surface so only a single strand of lacing is visible across the rib cap. [Figure 3-28]



**Figure 3-24.** A premarked location for a lacing hole, which is punched through the fabric with a pencil.

Structure and accessories within the wing may prevent a continuous lacing. Ending the lacing and beginning again can avoid these obstacles. Lacing that is not long enough to complete the rib may be ended and a new starting knot can be initiated at the next set of holes. The lacing can also be extended by joining it with another piece of lacing using the splice knot shown in Figure 3-29.

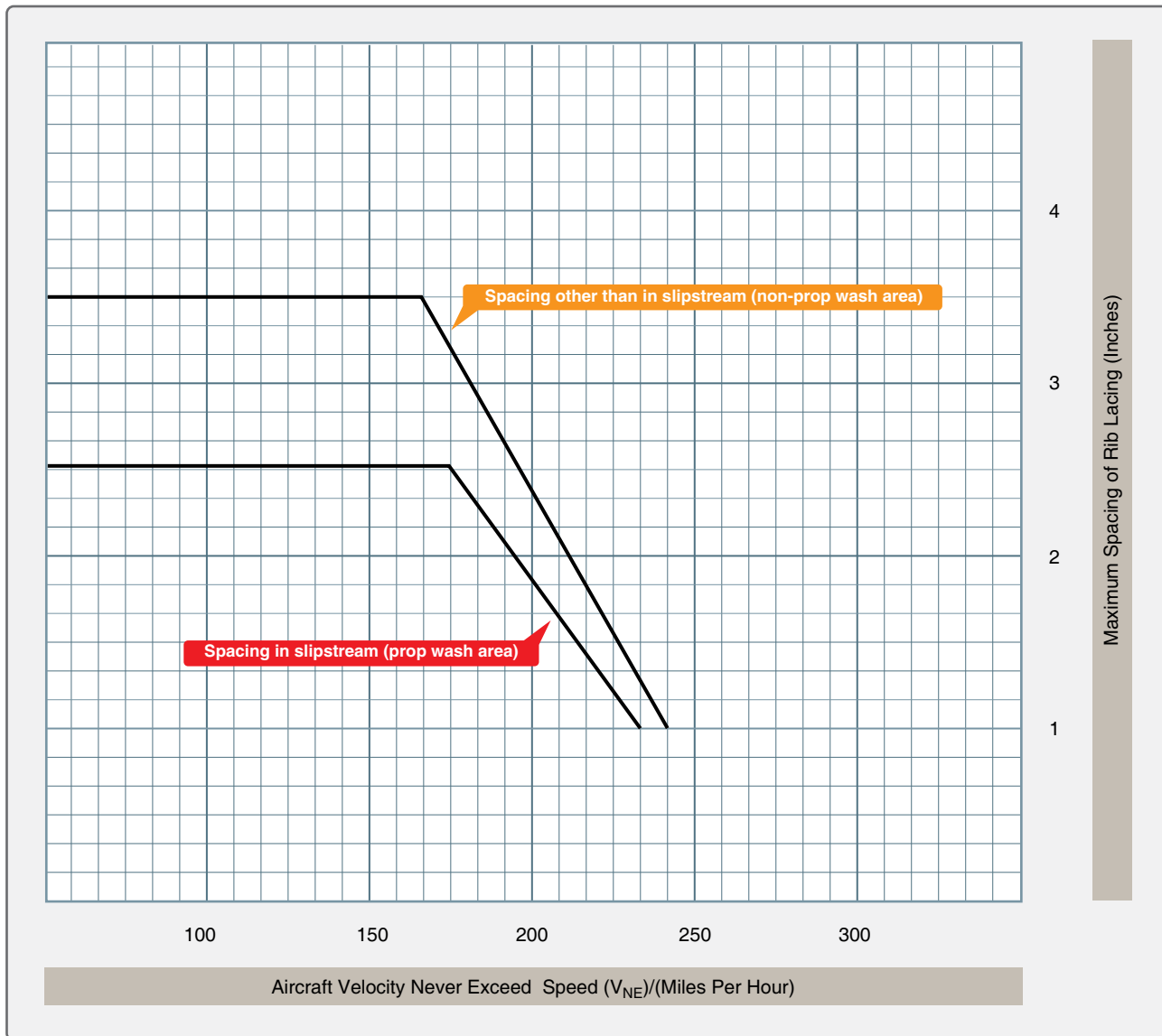

**Figure 3-25.** A rib lacing spacing chart. Unless manufacturer data specifies otherwise, use the spacing indicated.

Occasionally, lacing to just the rib cap is employed without lacing entirely through the wing and incorporating the cap on the opposite side. This is done where ribs are exceptionally deep or where through lacing is not possible, such as in an area where a fuel tank is installed. Changing to a needle with a tighter radius facilitates threading the lacing cord in these areas. Knotting procedures remain unchanged.

Technicians inexperienced at rib lacing should seek assistance to ensure the correct knots are being tied. STC holder videos are invaluable in this area. They present repeated close-up visual instruction and guidance to ensure airworthy lacing. AC 43.13-1, Chapter 2, Fabric Covering, also has in-depth instructions and diagrams as do some manufacturer’s manuals and STC’s instructions.

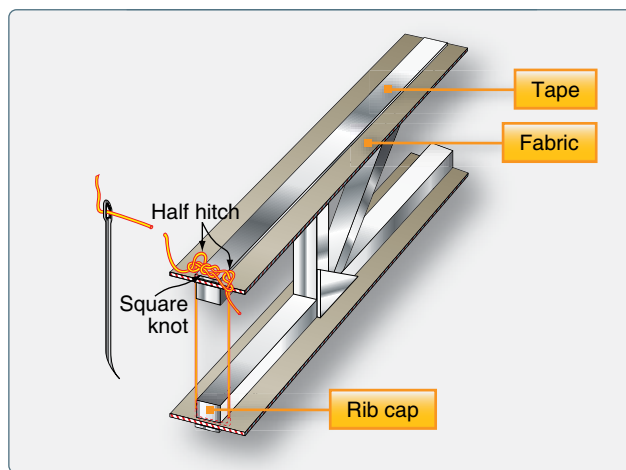

**Figure 3-26.** A starter knot for rib lacing can be a square knot with a half hitch on each side.

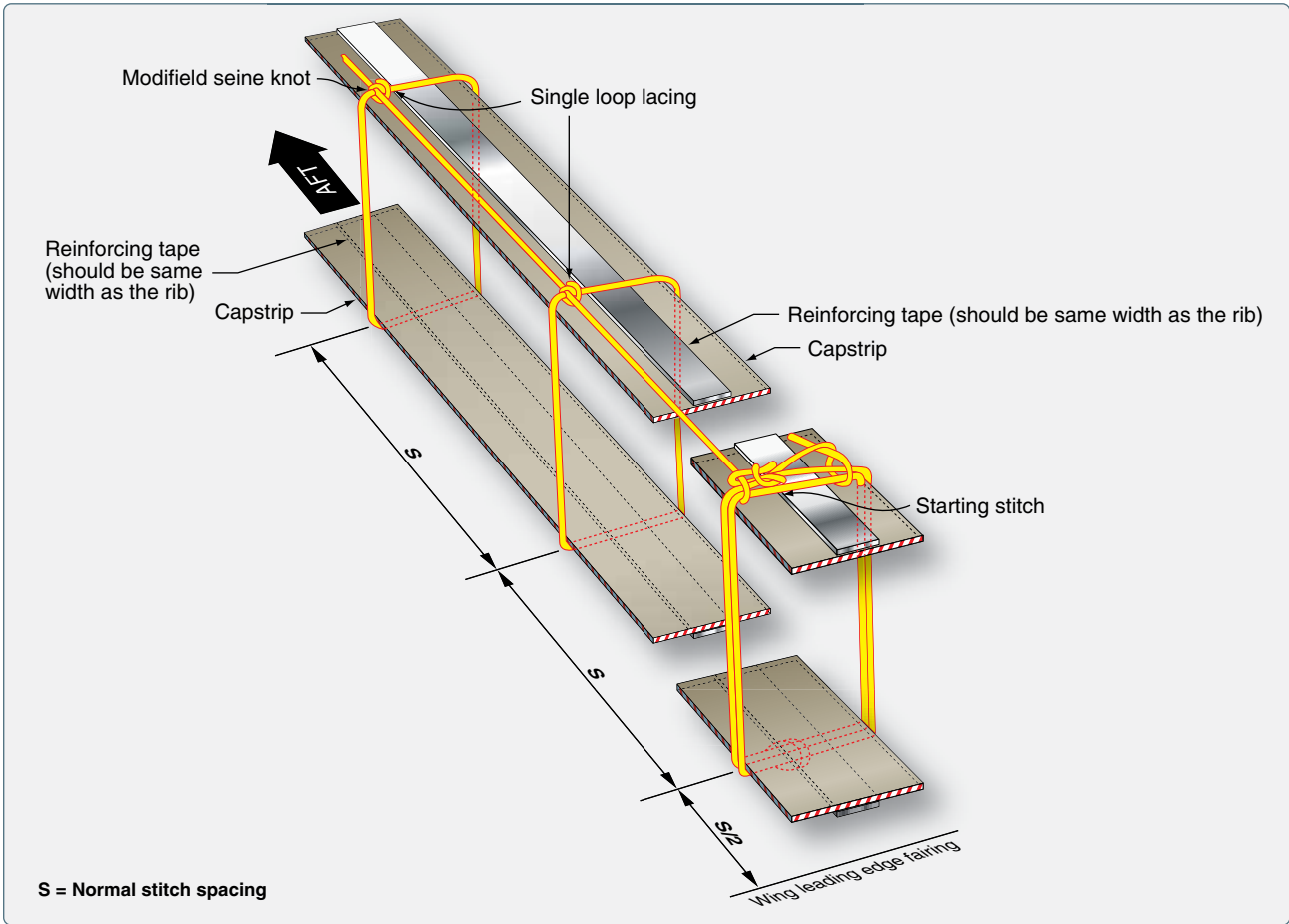

**Figure 3-27.** In this example of rib lacing, modified seine knots are used and shown above the fabric surface. Hidden modified seine knots are common. They are made so that the knots are pushed or pulled below the fabric surface.

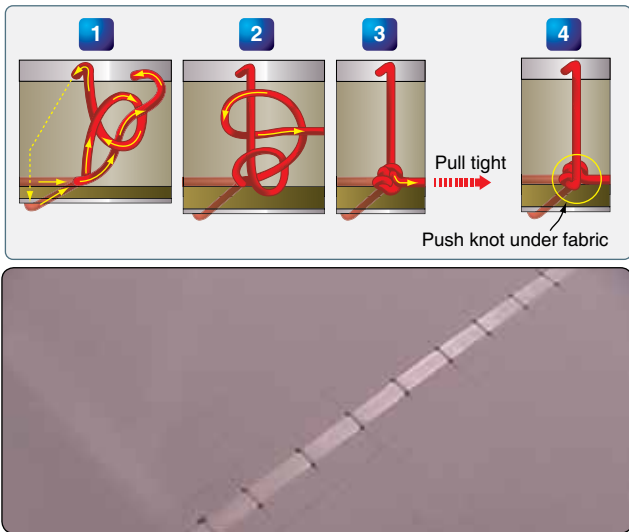

**Figure 3-28.** Hiding rib lacing knots below the fabric surface results in a smooth surface.

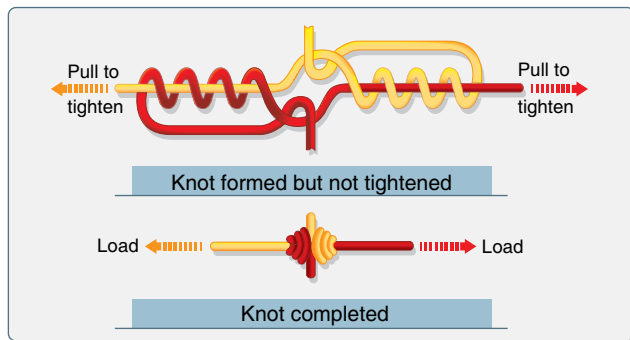

**Figure 3-29.** The splice knot can be used to join two pieces of rib lacing cord.

### ***Rings, Grommets, and Gussets***

When the ribs are laced and the fabric covering completely attached, the various inspection rings, drain grommets, reinforcing patches, and finishing tapes are applied. Inspection rings aid access to critical areas of the structure (pulleys, bell cranks, drag/anti-drag wires, etc.) once the fabric skin is in place. They are plastic or aluminum and normally cemented to the fabric using the approved cement and procedures. The area inside the ring is left intact. It is removed only when inspection or maintenance requires access through that ring. Once removed, preformed inspection panels are used to close the opening. The rings should be positioned as specified by the manufacturer. Lacking that information, they should be positioned as they were on the previous covering fabric. Additional rings should be installed by the technician if it is determined a certain area would benefit from access in the future. [Figure 3-30]



**Figure 3-30.** This inspection ring was cemented into place on the fabric covering. The approved technique specifies the use of a fabric overlay that is cemented over the ring and to the fabric.

Water from rain and condensation can collect under the fabric covering and needs a way to escape. Drain grommets serve this purpose. There are a few different types as described in the materials section above. All are cemented into position in accordance with the approved process under which the work is being performed. Locations for the drain grommets should be ascertained from manufacturer's data. If not specified, AC 43.13-1 has acceptable location information. Each fabric covering STC may also give recommendations. Typically, drain grommets are located at the lowest part of each area of the structure (e.g., bottom of the fuselage, wings, empennage). [Figure 3-31] Each rib bay of the wings is usually drained with one or two grommets on the bottom of the trailing edge. Note that drain holes without grommets are sometimes approved in reinforced fabric.

It is possible that additional inspection rings and drain grommets have been specified after the manufacture of the

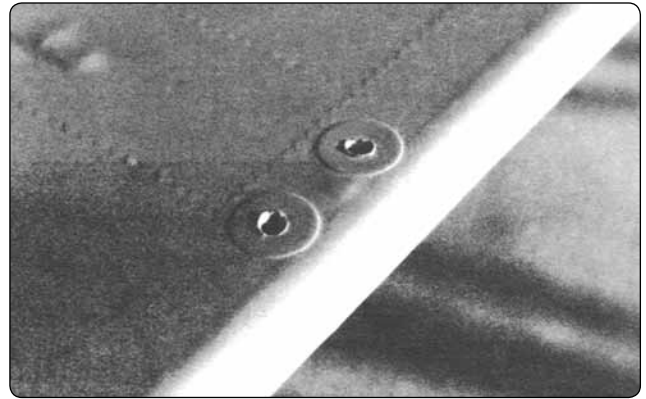

**Figure 3-31.** Drain grommets cemented into place on the bottom side of a control surface.

aircraft. Check the Airworthiness Directives (ADs) and Service Bulletins for the aircraft being re-covered to ensure required rings and grommets have been installed.

Cable guide openings, strut-attach fitting areas, and similar features, as well as any protrusions in the fabric covering, are reinforced with fabric gussets. These are installed as patches in the desired location. They should be cut to fit exactly around the feature they reinforce to support the original opening made in the covering fabric. [Figure 3-32] Gussets made to keep protrusions from coming through the fabric should overlap the area they protect. Most processes call for the gusset material to be preshrunk and cemented into place using the approved covering process cementing procedures.

### ***Finishing Tapes***

Finishing tapes are applied to all seams, edges, and over the ribs once all of the procedures above have been completed. They are used to protect these areas by providing smooth aerodynamic resistance to abrasion. The tapes are made from the same polyester material as the covering fabric. Use of lighter weight tapes is approved in some STCs. Preshrunk tapes are preferred because they react to exposure to the environment in the same way the as the fabric covering. This minimizes stress on the adhesive joint between the two. Straight edged and pinked tapes are available. The pinking provides greater surface area for adhesion of the edges and a smoother transition into the fabric covering. Only tapes approved in the STC under which work is being accomplished may be used to be considered airworthy.

Finishing tapes from one to six inches in width are used. Typically, two inch tapes cover the rib lacing and fuselage seams. Wing leading edges usually receive the widest tape with four inches being common. [Figure 3-33] Bias cut tapes are often used to wrap around the curved surfaces of the airframe, such as the wing tips and empennage surface edges. They lay flat around the curves and do not require notching.



**Figure 3-32.** A strut fitting and cable guide with reinforcing fabric gussets cemented in place.



**Figure 3-33.** Cement is brushed through a four-inch tape during installation over the fabric seam on a wing leading edge. Two-inch tapes cover the wing ribs and rib lacing.

Finishing tapes are attached with the process adhesive or the nitrate dope sealer when using a dope-based process. Generally, all chordwise tapes are applied first followed by the span-wise tapes at the leading and trailing edges. Follow the manufacturer's STC or AC 43.13-1 instructions.

### **Coating the Fabric**

The sealer coat in most fabric covering processes is applied after all finishing tapes have been installed unless it was applied prior to rib lacing as in a dope-based finishing process. This coat saturates and completely surrounds the

fibers in the polyester fabric, forming a barrier that keeps water and contaminants from reaching the fabric during its life. It is also used to provide adhesion of subsequent coatings. Usually brushed on in a cross coat application for thorough penetration, two coats of sealer are commonly used but processes vary on how many coats and whether spray coating is permitted.

With the sealer coats installed and dried, the next step provides protection from UV light, the only significant cause of deterioration of polyester fabric. Designed to prevent UV light from reaching the fabric and extend the life of the fabric indefinitely, these coating products, or fill coats, contain aluminum solids premixed into them that block the UV rays. They are sprayed on in the number of cross coats as specified in the manufacturer's STC or AC 43.13-1 instructions under which work is done. Two to four cross coats is common. Note that some processes may require coats of clear butyrate before the blocking formula is applied.

Fabric primer is a coating used in some approved covering processes that combines the sealer and fill coatings into one. Applied to fabric after the finishing tapes are installed, these fabric primers surround and seal the fabric fibers, provide good adhesion for all of the following coatings, and contain UV blocking agents. One modern primer contains carbon solids and others use chemicals that work similarly to sun block for human skin. Typically, two to four coats of fabric primer are sufficient before the top coatings of the final finish are applied. [Figure 3-34]



**Figure 3-34.** Applying a primer with UV blocking by spraying cross coats.

The FAA-certificated mechanic must strictly adhere to all instructions for thinning, drying times, sanding, and cleaning. Small differences in the various processes exist and what

works in one process may not be acceptable and could ruin the finish of another process. STCs are issued on the basis of the holder having successfully proven the effectiveness of both the materials and the techniques involved.

When the fill coats have been applied, the final appearance of the fabric covering job is crafted with the application of various topcoats. Due to the chemical nature of the fill coating upon which topcoats are sprayed, only specified materials can be used for top coating to ensure compatibility. Colored butyrate dope and polyurethane paint finishes are most common. They are sprayed on according to instructions.

Once the topcoats are dry, the trim (N numbers, stripes, etc.) can be added. Strict observation of drying times and instructions for buffing and waxing are critical to the quality of the final finish. Also, note that STC instructions may include insight on finishing the nonfabric portions of the airframe to best match the fabric covering finish.

## Polyester Fabric Repairs

### Applicable Instructions

Repairs to aircraft fabric coverings are inevitable. Always inspect a damaged area to ensure the damage is confined to the fabric and does not involve the structure below. A technician who needs to make a fabric repair must first identify which approved data was used to install the covering that needs to be repaired. Consult the logbook where an entry and reference to manufacturer data, an STC, or a field approval possibly utilizing practices from AC 43.13-1 should be recorded. The source of approved data for the covering job is the same source of approved data used for a repair.

This section discusses general information concerning repairs to polyester fabric. Thorough instructions for repairs made to cotton covered aircraft can be found in AC 43.13-1. It is the responsibility of the holder of an STC to provide maintenance instructions for the STC alteration in addition to materials specifications required to do the job.

### Repair Considerations

The type of repair performed depends on the extent of the damage and the process under which the fabric was installed. The size of the damaged area is often a reference for whether a patch is sufficient to do the repair or whether a new panel should be installed. Repair size may also dictate the amount of fabric-to-fabric overlap required when patching and whether finishing tapes are required over the patch. Many STC repair procedures do not require finishing tapes. Some repairs in AC 43.13-1 require the use of tape up to six inches wide.

While many cotton fabric repairs involve sewing, nearly all repairs of polyester fabric are made without sewing. It

is possible to apply the sewing repair techniques outlined in AC 43.13-1 to polyester fabric, but they were developed primarily for cotton and linen fabrics. STC instructions for repairs to polyester fabric are for cemented repairs which most technicians prefer as they are generally considered easier than sewn repairs. There is no compromise to the strength of the fabric with either method.

Patching or replacing a section of the covering requires prepping the fabric area around the damage where new fabric is to be attached. Procedures vary widely. Dope-based covering systems tend toward stripping off all coatings to cement raw fabric to raw fabric when patching or seaming in a new panel. From this point, the coatings are reapplied and finished as in the original covering process. Some polyurethane-based coating processes require only a scuffing of the topcoat with sandpaper before adhering small patches that are then refinished. [Figure 3-35] Still, other processes may remove the topcoats and cement a patch into the sealer or UV blocking coating. In some repair processes, preshrunk fabric is used and in others, the fabric is shrunk after it is in place. Varying techniques and temperatures for shrinking and gluing the fabric into a repair also exist.

These deviations in procedures underscore the critical nature of identifying and strictly adhering to the correct instructions from the approved data for the fabric covering in need of repair. A patch or panel replacement technique for one covering system could easily create an unairworthy repair if used on fabric installed with a different covering process.

Large section panel repairs use the same proprietary adhesives and techniques and are only found in the instructions for the process used to install the fabric covering. A common technique for replacing any large damaged area is to replace all of the fabric between two adjacent structural members (e.g., two ribs, two longerons, between the forward and rear spars). Note that this is a major repair and carries with it the requirement to file an FAA Form 337.

## Cotton-Covered Aircraft

You may encounter a cotton fabric-covered aircraft. In addition to other airworthiness criterion, the condition of the fabric under the finished surface is paramount as the cotton can deteriorate even while the aircraft is stored in a hanger. Inspection, in accordance with the manufacturer maintenance manual or AC 43.13-1, should be diligent. If the cotton covering is found to be airworthy, repairs to the fabric can be made under those specifications. This includes sewn-in and doped-in patches, as well as sewn-in and doped-in panel repairs. Due to the very limited number of airworthy aircraft that may still be covered with cotton, this handbook does not cover specific information on re-covering with cotton or



**Figure 3-35.** A patch over this small hole on a polyurethane top coat is repaired in accordance with the repair instructions in the STC under which the aircraft was re-covered. It requires only a two-inch fabric overlap and scuffing into the top coat before cementing and refinishing. Other STC repair instructions may not allow this repair.

cotton fabric maintenance and repair procedures. Refer to AC 43.13-1, Chapter 2, Fabric Covering, which thoroughly addresses these issues.

### **Fiberglass Coverings**

References to fiberglass surfaces in aircraft covering STCs, AC 43.13-1, and other maintenance literature address techniques for finishing and maintaining this kind of surface. However, this is typically limited to fiberglass ray domes and fiberglass reinforced plywood surfaces and parts that are still in service. Use of dope-based processes on fiberglass is well established. Repair and apply coatings and finishes on fiberglass in accordance with manufacturer data, STC instructions, or AC 43.13-1 acceptable practices.