

UNCLASSIFIED

AD NUMBER
ADB067783
NEW LIMITATION CHANGE
TO Approved for public release, distribution unlimited
FROM Distribution limited to U.S. Gov't. agencies only; Proprietary Info.; 4 Jun 82. Other requests for this document must be referred to Commander, US Army Combined Arms Center & Fort Leavenworth, Attn: ATZL-PTS-IS. Fort Leavenworth, KS 66027.
AUTHORITY
USACGSC ltr, 2 May 2001

THIS PAGE IS UNCLASSIFIED

AD E 7-1 021

2

ARRACOURT -- SEPTEMBER 1944

A thesis presented to the Faculty of the U.S. Army  
Command and General Staff College in partial  
fulfillment of the requirements for the  
degree  
MASTER OF MILITARY ART AND SCIENCE

by

RICHARD H. BARNES, MAJ, FA  
B.A., Temple University, 1966  
B.S., University of Michigan, 1969  
M.F., University of Michigan, 1969  
M.A., Middlebury College, 1974

Fort Leavenworth, Kansas  
1982

DTIC  
ELECTE  
SEP 22 1982

S

B

D

DISTRIBUTION LIMITED TO U.S. GOV'T AGENCIES  
ONLY. PROPRIETARY INFO. 4 Jun 82.  
OTHER REQUESTS FOR THIS DOCUMENT MUST BE  
REFERRED TO: HQ TRADOC, ATTN: ATCS-D,  
FORT MONROE, VA 23651

82-4652

82 09 21 034

AD B 0 6 7 7 8 8

DTIC FILE COPY

UNCLAS

SECURITY CLASSIFICATION OF THIS PAGE (When Data Entered)

REPORT DOCUMENTATION PAGE		READ INSTRUCTIONS BEFORE COMPLETING FORM	
1. REPORT NUMBER	2. GOVT ACCESSION NO. AD-B667 7834	3. RECIPIENT'S CATALOG NUMBER	
4. TITLE (and Subtitle) ARRACOURT--SEPTEMBER 1944		5. TYPE OF REPORT & PERIOD COVERED	
7. AUTHOR(s) Major Richard H. Barnes		6. PERFORMING ORG. REPORT NUMBER	
9. PERFORMING ORGANIZATION NAME AND ADDRESS Command and General Staff College Ft Leavenworth, KS 66027		8. CONTRACT OR GRANT NUMBER(s)	
11. CONTROLLING OFFICE NAME AND ADDRESS Headquarters, TRADOC Ft Monroe, VA 23651		10. PROGRAM ELEMENT, PROJECT, TASK AREA & WORK UNIT NUMBERS	
14. MONITORING AGENCY NAME & ADDRESS (if different from Controlling Office) Headquarters, TRADOC Ft Monroe, VA 23651		12. REPORT DATE 4 June 1982	
		13. NUMBER OF PAGES 207	
		15. SECURITY CLASS. (of this report) UNCLAS	
		15a. DECLASSIFICATION/DOWNGRADING SCHEDULE	
16. DISTRIBUTION STATEMENT (of this Report) DISTRIBUTION LIMITED TO U.S. GOVT AGENCIES ONLY; PROPRIETARY INFO. 45 un 82. OTHER REQUESTS FOR THIS DOCUMENT MUST BE REFERRED TO: HQ TRADOC, ATTN: ATCS-D, FORT MONROE, VA 23651			
17. DISTRIBUTION STATEMENT (of the abstract entered in Block 20, if different from Report)			
18. SUPPLEMENTARY NOTES			
19. KEY WORDS (Continue on reverse side if necessary and identify by block number)			
20. ABSTRACT (Continue on reverse side if necessary and identify by block number) This battle study investigates operational and tactical considerations of the battles of Arracourt, which took place in September 1944 as the 4th Armored Division of Patton's Third Army clashed with the Fifth Panzer Army in the French province of Lorraine on the U.S. drive to the German West Wall.  By examining detailed German and American unit histories, logs, and summaries, as well as personal papers, this study illuminates differences and similarities			

DD FORM 1 JAN 73 1473 EDITION OF 1 NOV 65 IS OBSOLETE

UNCLAS

SECURITY CLASSIFICATION OF THIS PAGE (When Data Entered)

in reporting the U.S. penetration from the Nancy Bridgehead to Arracourt, the German offensive at Luneville as a prelude to Arracourt, and the two German offensives at Arracourt, as the Fifth Panzer Army attempted to link up with a German unit cut off at Nancy.

Arracourt exemplifies penetration and mobile defense and illustrates the demand for good intelligence and flexible command and control. It shows the inherent risks of piecemeal commitment of reserves, the need for timely orders and good logistical support, as well as the tactical advantages of air superiority.

UNCLAS

ARRACOURT -- SEPTEMBER 1944.

A thesis presented to the Faculty of the U.S. Army  
Command and General Staff College in partial  
fulfillment of the requirements for the  
degree  
MASTER OF MILITARY ART AND SCIENCE

by

RICHARD H. BARNES, MAJ, FA  
B.A., Temple University, 1966  
B.S., University of Michigan, 1969  
M.F., University of Michigan, 1969  
M.A., Middlebury College, 1974

Fort Leavenworth, Kansas  
1982

DISTRIBUTION LIMITED TO U.S. GOV'T AGENCIES  
ONLY; PROPRIETARY INFO. 4 Jan 82.  
OTHER REQUESTS FOR INFO TO GOVT MUST BE  
REFERRED TO: HQ TRADOC, ATTN: ATCS-D,  
FORT MONROE, VA 23681

82-4652

MASTER OF MILITARY ART AND SCIENCE

THESIS APPROVAL PAGE

Name of candidate: Major Richard H. Barnes

Title of thesis: Arracourt--September 1944

Approved by:

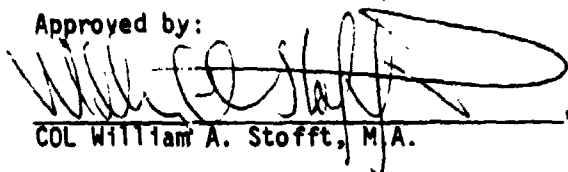
 , Thesis Committee Chairman  
COL William A. Stofft, M.A.

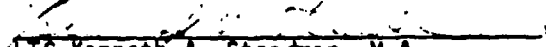
 , Member, Graduate Faculty  
LTC Kenneth A. Steadman, M.A.

 , Member, Consulting Faculty  
Dr. Roger S. Spiller, Ph. D.

Accepted this 3rd day of June 1982 by Philip J. Brookes  
Director, Graduate Degree Programs.

The opinions and conclusions expressed herein are those of the student author and do not necessarily represent the views of the U.S. Army Command and General Staff College or any other governmental agency. (References to this study should include the foregoing statement.)

Accession For	
MTIS CRA&I	<input type="checkbox"/>
TTIC TAB	<input checked="" type="checkbox"/>
Unannounced	<input type="checkbox"/>
Justification	
By	
Distribution/	
Availability Codes	
Dist	Avail and/or Special
<b>B</b>	

DTIC  
COPY  
INSPECTED  
3

## ABSTRACT

ARRACOURT--SEPTEMBER 1944, by Major Richard H. Barnes, USA, 207 pages.

This battle study investigates operational and tactical considerations of the battles of Arracourt, which took place in September 1944 as the 4th Armored Division of Patton's Third Army clashed with the Fifth German Panzer Army in the French province of Lorraine on the U.S. drive to the German West Wall.

By examining detailed German and American unit histories, logs, and summaries, as well as personal papers, this study illuminates differences and similarities in reporting the U.S. penetration from the Nancy Bridgehead to Arracourt, the German offensive at Luneville as a prelude to Arracourt, and the two German offensives at Arracourt, as the Fifth Panzer Army attempted to link up with a German unit cut off at Nancy.

Arracourt exemplifies penetration and mobile defense and illustrates the demand for good intelligence and flexible command and control. It shows the inherent risks of piecemeal commitment of reserves, the need for timely orders and good logistical support, as well as the tactical advantages of air superiority.

## ACKNOWLEDGEMENTS

I received much help in the preparation of this thesis. I gratefully acknowledge the able assistance of my thesis committee. COL William A. Stofft, chairman, guided me through the entire project from initial research through the subsequent stages of writing and editing. LTC Kenneth A. Steadman provided valuable insights into the tactical and intelligence aspects of the battle. Dr. Roger J. Spiller enabled me to maintain my focus on the central problem and directed me to pertinent literature and reports.

I gathered much of the primary source material outside of Fort Leavenworth. I am grateful to John Slonaker and Dennis Vetock of the Military History Institute at Carlisle and to Herbert Pankratz of the Dwight D. Eisenhower Library, Abilene, KS, for selflessly locating pertinent documents for me. George Wagner of the Modern History Branch of the National Archives located four microfilm rolls of captured German documents, which formed the backbone of this study.

Gathering information and writing it down is only the beginning; it must be presented in such a way as to be understandable to the reader. I am indebted to LTC David M. Glantz of the Combat Studies Institute, who carefully reviewed the manuscript and checked for inconsistencies. Marjorie Christine Collier-Trevino and Greg Smith of the Media Support Center expertly prepared the maps. The typists of the Word Processing Center carried out the tedious business of typing and retyping the manuscript. Elizabeth R. Snoke and Alice M. McCart painstakingly arranged and edited the notes and bibliography.

I am indebted to GEN Bruce C. Clarke for his valuable letters and other pertinent literature. Samuel Schenker, Secretary-Treasurer of the 4th Armored Division Association, provided names and addresses of former members of the Division who served at Arracourt. I am also indebted to the following who provided key insights for this study: Thomas J. Cooke, William A. Dwight, Thomas J. Evans, Lawrence E. Fleischman, GEN Paul D. Harkins, Charles L. Kimsey, Kenneth R. Lamison, Merwin A. Marston, MG Delk M. Oden, Robert M. Parker, and James Turner.

Most of all, I acknowledge the contribution of my wife Linda, without whose moral support, advice and devotion I could never have completed this project.



## TABLE OF CONTENTS

Abstract . . . . .	i
Acknowledgements . . . . .	ii
Table of Contents . . . . .	iii
List of Maps . . . . .	iv
Introduction . . . . .	vi
Chapter 1 - Background . . . . .	1
Chapter 2 - Advance of CCA to Arracourt and the Luneville Diversion . . . . .	43
Chapter 3 - First Arracourt Tank Battle 19-22 September 1944 . . . . .	69
Chapter 4 - The Battle Continues . . . . .	105
Chapter 5 - Significance of Arracourt . . . . .	150
Appendix 1 - German Land Command in the West . . . . .	165
Appendix 2 - Organic and Attached Units of the 4th Armored Division . . . . .	167
Appendix 3 - TO&E's of Fifth Panzer Army Divisions . . . . .	170
Appendix 4 - Fifth Panzer Army Order of Battle . . . . .	173
Appendix 5 - Tanks used at Arracourt . . . . .	176
Notes . . . . .	178
Bibliography . . . . .	208

LIST OF MAPS - ARRACOURT

CHAPTER 1 - BACKGROUND

PAGE

Map 1 - Broad vs Narrow Front. . . . . 2  
Map 2 - German Eastern and Western Front. . . . . 12  
Map 3 - Allied and German Forces in Western Europe, September 1944. . . 15  
Map 4 - Lorraine. . . . . 18  
Map 5 - Arracourt Area of Operations. . . . . 20

CHAPTER 2 - ADVANCE OF CCA TO ARRACOURT AND THE LUNEVILLE DIVERSION

Map 6 - Mission of 4th Armored Division. . . . . 45  
Map 7 - Route of CCA, 4th Armored Division, 13-14 September 1944. . . . 47  
Map 8 - 37th Tank Battalion attack on 16 September to assist CCB  
over Canal . . . . . 55  
Map 9 - CCR to Luneville, 15-18 September 1944. . . . . 57  
Map 10 - Battle of Luneville - 18 September 1944. . . . . 62

CHAPTER 3 - FIRST ARRACOURT BATTLE (19-22 SEPTEMBER 1944)

Map 11 - Disposition of 4th Armored Division, 18/19 September 1944 . . . 68  
Map 12 - Disposition of CCA, 4th Armored Division, 18/19 September 1944 . 71  
Map 13 - LVIII Panzer Corps Attack, 19 September 1944 . . . . . 75  
Map 14 - CCA Operations on 20 September 1944 . . . . . 85  
Map 15 - CCA Operations on 21 September 1944 . . . . . 93  
Map 16 - 111th Panzer Brigade Attack, 22 September 1944 . . . . . 98  
Map 17 - Unit Positions on 22/23 September 1944 . . . . . 104

CHAPTER 4 - THE BATTLE CONTINUES (25-29 SEPTEMBER 1944)

PAGE

Map 18 - LVIII Panzer Corps attack - 25 September 1944 . . . . .	110
Map 19 - Movement of CCB to Arracourt, 25/26 September 1944 . . . . .	116
Map 20 - Redrawn battle lines, 25-26 September 1944 . . . . .	119
Map 21 - 11th Panzer Division Attack on Arracourt Salient, 27-29 September 1944 . . . . .	125
Map 22 - Disposition of forces on 30 September 1944 . . . . .	148

## INTRODUCTION

The area around Arracourt, a small farming town of Lorraine, France, was the site of a series of battles in September 1944, fought by the 4th Armored Division, spearheading Patton's Third Army six week race across France into Germany against Germany's Fifth Panzer Army. Over extended supply lines and critical fuel shortages forced the 4th Armored Division to halt two weeks at the Moselle, thereby gaining time for Fifth Panzer Army to strengthen its defenses, maneuver into position, and launch a series of bitter attacks against the assembled American forces.

This study examines the tactics both sides used at Arracourt, tactics set against a backdrop of the Allied broad front strategy and the dominant personalities of Montgomery, Patton, Wood, and Clarke. Chapter 1 provides the strategic and operational context for the battles at Arracourt. Chapter 2 outlines the 4th Armored Division's breaching of strong German positions at Dieulouard, the subsequent advance to Arracourt by CCA of the 4th Armored Division, CCB's and CCR's Moselle crossing south of Nancy, CCB's advance to Fresnes (north of Arracourt), and CCR's battle at Luneville as a prelude to Arracourt. The focus then shifts to Arracourt, as elements of Fifth Panzer Army, attempting to link up with a Nancy-based unit, attacked the Arracourt salient in two phases (19-22 September in Chapter 3 and 25-29 September in Chapter 4), where the Allied victory ultimately forced the Germans to go on the defensive. Chapter 5 assesses the significance of the battles and the lessons learned.

The detailed German and American unit histories, logs and summaries, and personal diaries and letters illuminate differences and similarities in reporting the same incidents. German microfilm records show the Germans' careful planning, their unflinching obedience to orders, and their ability to launch an attack in spite of severe manpower, tank, ammunition, equipment, and other shortages. And they did this when morale was low in the mud and fog of September in France. The American records show that the 4th Armored Division innovatively used tanks (at night, concealed by smoke, with tank destroyers), carefully applied tanks, artillery, infantry, and air support in combined arms operations and adapted to the flexibility requirements of offensive and defensive combat operations.

Arracourt illustrates the demand for good intelligence and flexible command and control. It shows the inherent risks of piecemeal commitment of reserves, the need for timely orders and good logistical support, and the tactical advantages of air superiority.

Arracourt was a critical battle in Patton's drive to Germany. The carefully orchestrated tank, artillery, infantry, and air power tied sufficient German forces to allow Montgomery's 21st Army Group to attack in the north. Arracourt denied the Germans a successful counterattack, prevented their regaining any lost ground, and then became a bastion from which Third Army launched its Ardennes winter offensive in November 1944. A brilliant example of the 360-degree mobile defense, Arracourt is a model in defensive tactics and combined operations for the future.

ATZL-SWI-R

## CHAPTER 1

### BACKGROUND

The battles of Arracourt during September 1944 were part of Patton's Lorraine Campaign. The U.S. 4th Armored Division not only spearheaded an advance through France in its drive to Germany, but also conducted a mobile defense against major German counterattacks. Employing both traditional fire and maneuver tactics and some newly recycled techniques, units at Arracourt clashed in "the greatest tank battle on the Western front."<sup>1</sup>

#### Strategic Objectives

Arracourt must be studied in both its strategic and tactical contexts. The Allied military strategy in Western Europe was to advance through France along two principal avenues of approach and defeat German forces (see map 1).<sup>2</sup> The main avenue of approach was given to British Field Marshal Sir Bernard Law Montgomery's 21st Army Group.<sup>3</sup> He was to invade Germany through the low countries and capture the Ruhr industrial area from the north. General Courtney Hodges' First Army was to make a Rhine crossing and capture the southern Ruhr area along the northern avenue while General

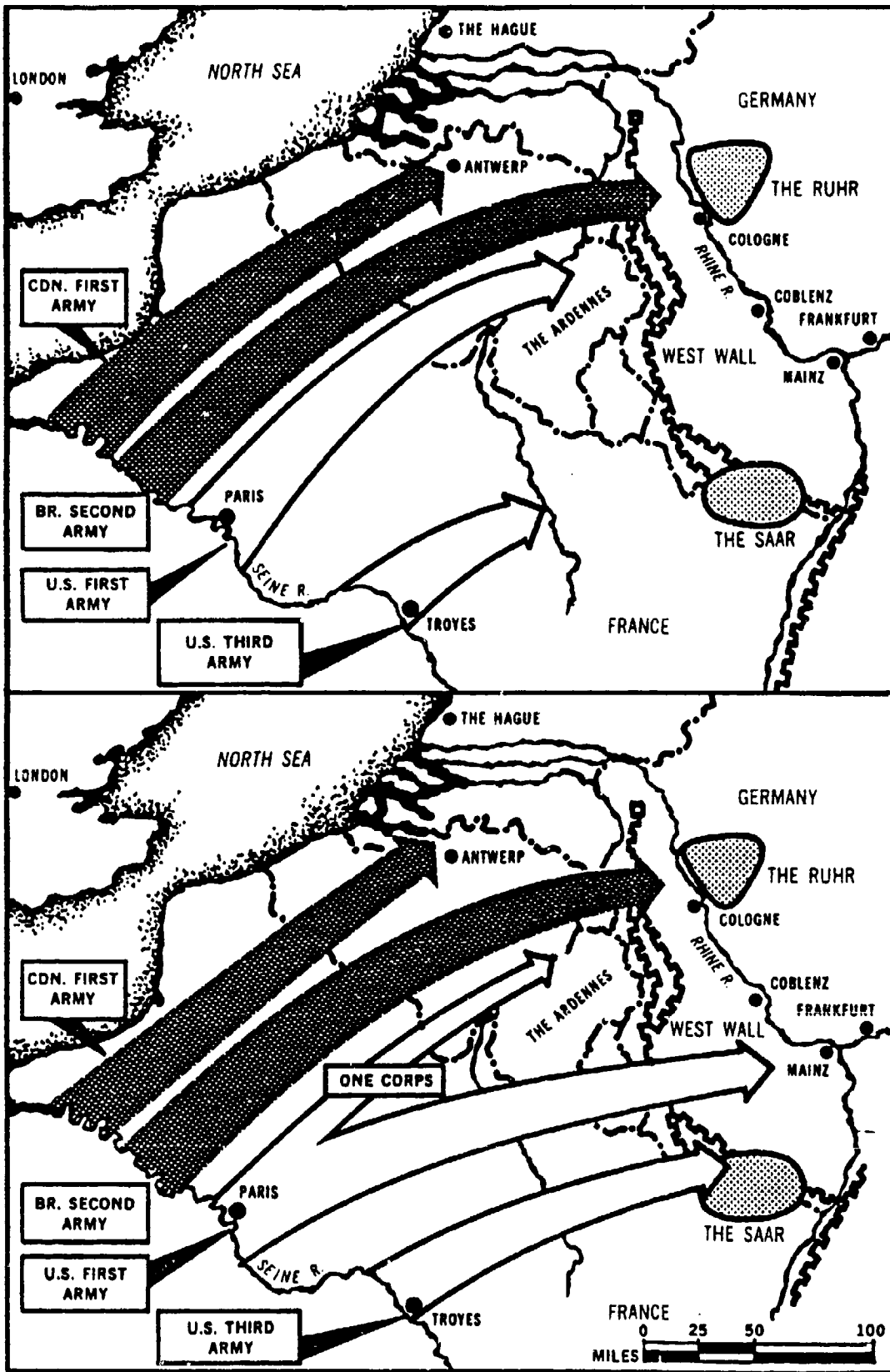

Map 1 - Broad vs Narrow Front

George S. Patton's Third Army was to move along the secondary avenue of approach, cross the Moselle River near Nancy, advance through Alsace-Lorraine and make Rhine crossings in the area of Mannheim and Mainz.<sup>4</sup> Thus, 12th Army Group, commanded by Lt. Gen. Omar N. Bradley, was split along both avenues of approach. This "broad front" advance had not been planned from the outset. During early August 1944 Montgomery and Bradley debated the pros and cons of a two-pronged or single-thrust advance. Montgomery proposed that the Allies concentrate all strength on a drive through the low countries by way of Amiens and Brussels over a path almost twice as long as the route through Alsace-Lorraine.<sup>5</sup>

The Allies needed strong forces in the north where Montgomery's 21st Army Group still faced German divisions isolated along the English Channel at the port of Calais. If Montgomery could move quickly, he could capture Antwerp and the channel ports and seize the Belgian air fields, which would be used for short-range fighter support of heavy bombers engaged in daylight raids. In addition, such a move by Montgomery would clear the rocket belt from which the Germans were consistently harassing London.<sup>6</sup>

Bradley argued for a modified double thrust whereby the Third Army in the south would carry the 12th Army Group past Metz's fortifications and penetrate the as yet unmanned defenses of the West Wall.<sup>7</sup> If the southern thrust went all the way to the Rhine, it would deprive the Germans of the industrially important Saar basin. Additionally, it would force them to



spread their resources over a wider area, thereby reducing resistance to both advances.

On 23 August Eisenhower decided tentatively in favor of the single thrust: Montgomery making the main effort along the channel coast; Bradley supporting the British effort with all nine divisions of the First Army; and only the Third Army in the south with First Army having first priority on supplies. Bradley vigorously opposed the decision, and in a directive issued on 29 August Eisenhower amended the plan, leaving control of First Army under Bradley.<sup>8</sup>

On 2 September Eisenhower went to Versailles to meet with Bradley, Hodges, and Patton to plan their advances. At Versailles, Patton convinced Eisenhower that the opportunities on his front were too good to pass up, and the supreme commander agreed to allocate additional gasoline stocks to Third Army. In addition, he shifted the direction of First Army's advance from northeast to due east, resuming the broad front advance.

Two days later, SHEAF found that Montgomery was moving easily after capturing Brussels and the port of Antwerp intact. So they decided not to stop Patton's drive toward the Saar, because he could be supplied without handicapping Montgomery.<sup>9</sup>

On 5 September, Eisenhower was still confident that his armies could capture both the Ruhr and the Saar; that they could overrun the West Wall

and cross the Rhine on a wide front before the Germans could recover; and, while this broad advance was in progress, that the ports of Antwerp and Le Havre could be opened in readiness for a final offensive into the heart of Germany. He still intended to give priority to the northern route of advance, but he did not think that redistribution of the existing supplies would enable the Allies to maintain a thrust to Berlin. This infuriated Montgomery, who felt he should get all available supplies.

To mollify Montgomery, Eisenhower flew to Brussels on 10 September. There, Eisenhower and Montgomery agreed on a combined airborne and ground attack, code named MARKET GARDEN, to cross the Lek River at Arnhem, seize a bridgehead over the Rhine, and flank the defenses of the West Wall. The British Second Army was designated to link up with the paratroopers near Arnhem. This would provide a bridgehead over the Rhine before the momentum of the offensive would be lost. The airborne troops could be supplied without further straining the overburdened transport lines.

Several problems surfaced. First, by concentrating on MARKET GARDEN, Montgomery could not immediately free Antwerp for much needed logistical support. Second, moving Second Army to the north would open a gap between its right flank and First Army's left flank, and Hodges would have to slide his First Army divisions to his left to cover the gap. Third, the direction of the attack would carry Montgomery away from the Ruhr and give him another river to cross.

MARKET GARDEN was moved up from 26 September to 17 September. Although the airborne units achieved their objectives at Nijmegen and Arnhem, determined German resistance coupled with bad weather prevented reinforcement. The 9th SS Panzer Division and the Army Group B commander (Field Marshal Walther von Model) were in the Arnhem area on the 17th, so Montgomery lost his element of surprise. Operation MARKET GARDEN fell short of Montgomery's expectations, resulted in the slowing down of Patton and delayed the opening of the Port of Antwerp. In mid-October, when Montgomery gave up on operations against the Ruhr and decided to give Antwerp first priority, a full month had been lost. The Germans had since strengthened their lines, laid mines, built fortifications, and established a formidable barrier, so that a major campaign cleared the estuary northwest of Antwerp only by 28 November, having tied up tremendous resources in the process.

Meanwhile, Patton had advanced faster than anyone had imagined. Thus far his offensive had been spectacular. Following activation in England on 28 July, Third Army participated in Operation COBRA<sup>10</sup> in Normandy and then moved swiftly through France to the banks of the Moselle, where critical supply shortages forced them to stop. Patton's supply line stretched 313 miles from Verdun to Saarbourg, and the trucks of his Red Ball Express simply could not keep up. When the main supply center was moved to Nancy, the distance increased to 461 miles.<sup>11</sup> Only 3500 tons of supplies per day were supplied to the Third Army (including fuel), 1500 tons of which had to be diverted for use of Paris civilians.<sup>12</sup> This resulted in a shortage of

1600 tons per day. An underwater channel pipeline (nicknamed Pluto) was still 200 miles behind the Allied front and ineffective for Third Army use. Patton's trucks were taken the end of August to replace those of First Army given to Montgomery. C-47 aircraft continued to supply much needed fuel until they, too, were diverted for a planned airborne operation on 3 September at Tournai, Belgium, which blocked the withdrawal of the German Fifteenth Army from the port of Calais. These aircraft were also used as part of Operation MARKET GARDEN.<sup>13</sup>

Patton wanted to maintain this momentum and continued to press Bradley for permission to do so. Meanwhile, captured supplies enabled him to move forward.<sup>14</sup> As a result of a meeting with his Army commanders on 12 September, Bradley wrote Eisenhower that Patton could continue all the way to Germany based on present and anticipated supplies. His letter read:

Third Army states that they have enough ammunition on hand or in immediate sight for about four days' fighting and enough petrol to carry them to the Rhine....

Patton has already launched a strong attack to force a crossing of the Moselle, which he believes will not only force this crossing but will open up the way for his rapid advance to the Rhine with his thrust directed on the axis Metz-Frankfurt.<sup>15</sup>

In a more realistic vein, Bradley gave Patton two more days (until the evening of 14 September) to get across the Moselle; otherwise he would have to assume the defensive. This was explained in the same letter:

...I have told Patton to continue his attack, that if by Thursday night (14 September) he has not been able to force a crossing of the Moselle with the mass of his forces, that he will discontinue that attack, assume the defensive along the southern flank and along the front from Nancy to the vicinity of Luxembourg, and make his main effort north of the Moselle River in conjunction with the attack now being carried out by the V Corps (of First Army)....<sup>16</sup>

Unlike Bradley, Eisenhower, was convinced that the northern route was the way to go and did not want Patton to forge ahead of the 12th Army Group. Thus, he permitted Patton to push only far enough to hold adequate bridgeheads beyond the Moselle and thus create a constant threat to the German forces, preventing the enemy from reinforcing farther north.<sup>17</sup> Only after Montgomery's forces and the First Army had succeeded in establishing a bridgehead across the Rhine would Eisenhower unleash Third Army to advance through the Saar and over the Rhine.

Montgomery had priority in supplies which infuriated Patton. After the capture of Antwerp on 4 September, Montgomery had demonstrated the Ruhr was vulnerable and convinced that if only Eisenhower would abandon his broad front and concentrate on a single thrust to the Ruhr, 10,000 tons a day could be provided for the First American and Second British Armies. This could maintain 20 divisions which would take him to the Ruhr and then on to Berlin.<sup>18</sup>

Eisenhower appeared indecisive, vacillating between single thrust and broad front strategy. But he had good reasons for his broad front policy.

Under his direction no army would take heavy casualties, no general would lose his reputation, and credit for the victory could be shared by all. There was also less chance of the Germans reversing the situation by surrounding, sabotaging, and destroying an advance force. Additionally, it was important to get the northern German ports, seal off the Danish peninsula, seize the industrial area of Leipzig-Dresden, and take the political center at Munich. Lastly, secondary attacks on the shoulders would support the main effort. Only by pressing the Germans on a broad front could he keep them from massing forces against the main attack.<sup>19</sup>

Eisenhower was more a military statesman than a dictatorial commander. He was content to determine broad objectives and policies, arbitrate and coordinate them. Conscious of his lack of experience of tactical handling of armies, Eisenhower allowed Montgomery to coordinate the land battle but always under plans of campaign he personally approved.<sup>20</sup>

Eisenhower, as supreme commander, tended to see the opinion of all concerned and to work out the best compromise. He had an ability to tie divergent ideas together and come up with a workable solution. However, because his commanders were scattered all over France, he was open to persuasion by the last influential man who spoke to him; hence, the impression of indecisiveness.<sup>21</sup>

There were political considerations as well. Eisenhower could not give all the glory to either Montgomery or to Bradley. Montgomery lacked

confidence in the fine art of persuasion and always wanted things his way. He antagonized the American generals by his haughty attitude--while Eisenhower doubted Montgomery's abilities.<sup>22</sup> If Montgomery were to lead the advance into Germany, Eisenhower would have to answer to U.S. Army Chief of Staff Marshall and President Roosevelt, besides sustaining a bad press at home.<sup>23</sup> On the other hand, Eisenhower could not let Bradley and Patton push ahead of Montgomery. If he did, then Montgomery (who was actually Eisenhower's senior) would be rebuffed and Churchill might put pressure on the United States to change the plan.

These, then, are some of the factors which impacted on the broad front strategy decision--a decision for the overall good of the Alliance, but a decision which would cause a fatal two-week delay in the 4th Armored Division advance, thereby allowing the Germans to stiffen their defenses in Lorraine.

In spite of Montgomery's displeasure with the broad front strategy, once Eisenhower decided, he stuck with it. This is borne out in a letter he wrote to Bradley on 15 September:

...My whole purpose is to get our main bodies concentrated across the Rhine with secure and adequate crossings and there prepare, logistically and otherwise, for a sustained drive into Germany that will not have to stop because of maintenance. For a number of reasons I have decided that in driving our way forward to the Rhine, the left should take preference over the right when we could not operate simultaneously. Two of these reasons were, the necessity for clearing up the channel ports

to get adequate deep water harbors (Antwerp or Rotterdam or both), and to clean out the V-2 sites, presumably in Holland. Obviously, if Monty can go ahead with what we have now promised him, which includes about 1000 tons a day, delivered partly by air lift and partly by other U.S. resources, and you can keep Hodges fully supplied up the moment of his attaining his first principal objectives, then there is no reason why Patton should not keep acting offensively if the conditions for offensive action are right.<sup>24</sup>

Based on this last sentence in Eisenhower's directive, Bradley and Patton planned to advance beyond the Nancy bridgehead, which thus formed the basis for operations in and around Arracourt during September 1944.

While the strategic objectives of the United States and Great Britain were offensively oriented, the strategic objectives of Germany were defensive. Germany would continue the fight on both the Eastern and Western Fronts. In the East, the Germans would hold the Russians in the Balkans, the Carpathians, and East Poland (see map 2).<sup>25</sup> In the West, Hitler intended to halt the Allies at the West Wall, on the Moselle, and in the Vosges Mountains, and wait for winter. This would give him a chance to regroup, reinforce, and launch a counteroffensive, where "fog, night, and snow" would provide him "great opportunity".<sup>26</sup> It would also be harder for the Allies to maneuver their Sherman tanks and launch air attacks. Under no circumstances was any more ground to be given up, especially in Alsace-Lorraine. To stem the tide of the Allied advance, the Wehrmacht was to advance deep into the American east flank, attacking in a northwesterly direction from the Epinal area against the right flank of Allied forces (Third U.S. Army).<sup>27</sup> This should give Hitler time to move additional



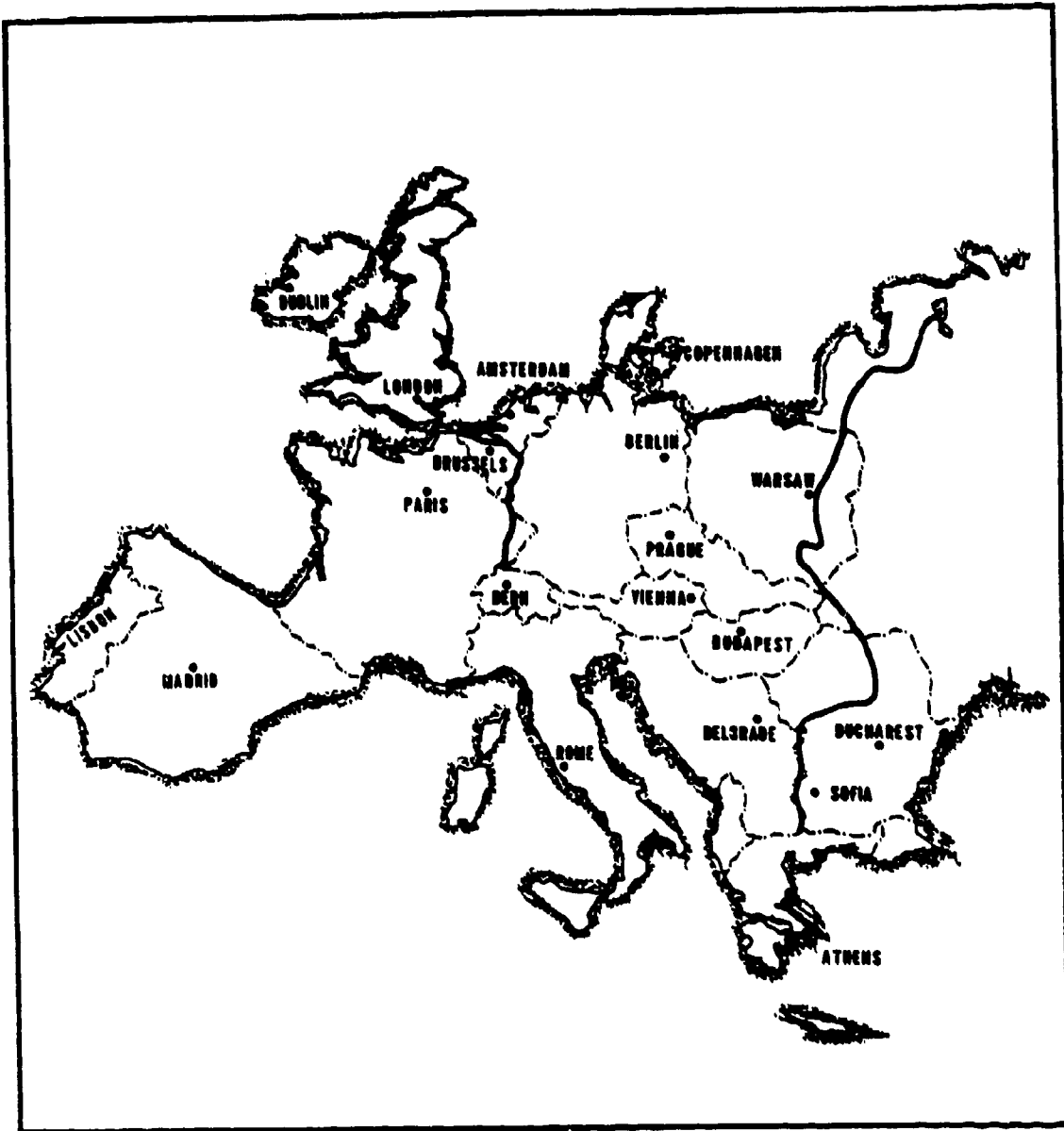

MAP 2

Map 2 - German Eastern and Western Front

equipment and personnel to reinforce the West Wall. He was well aware of Patton's presence and on 3 September, personally ordered a concentration of armor opposite Patton's Third Army on the Moselle.<sup>28</sup> Hitler to the very end hoped that by holding he could break the Allied coalition.

However, it took time to move troops and equipment from East to West. He had to delay the Allied advance, to withdraw wrecked armored units from both East and West, reconstitute them, and send them to Lorraine. Such units included 12 brigades of multiple-rocket launchers and the Fifth Panzer Army, which had been withdrawn to Strassbourg from Belgium to form the backbone for this counteroffensive in Alsace-Lorraine.<sup>29</sup>

The farther eastward the Allies pushed, the more strained their supply lines became. By keeping pressure on Antwerp, the Allied advance could be slowed and the price for forward movement could become very costly. At the same time, Germany's supply lines were getting shorter, so that resupply times and distances were decreasing. Increased arms production would then have a chance to be moved directly to the West Wall. Moreover, the Allied advance into Germany would have to be through relatively narrow corridors.<sup>30</sup> Once the Allies were stopped and sufficient personnel and materiel reinforcements were on hand, Hitler's intention was to push them back and regain the territory he had lost.

Holding the Allies at the West Wall would not be easy. There were serious problems with the West Wall Line, which hadn't been used since

1940. The blockhouses were not large enough to house the larger 77 and 88mm guns needed to deal with 1944 armor. Refugees, living in the bunkers, had to be relocated and the remaining bunkers containing war supplies had to be emptied.<sup>31</sup>

Allied forces in the West were divided into three Army Groups (see map 3). In the north was the 21st British Army Group, commanded by Montgomery and consisting of Lieutenant General D. G. Crerar's First Canadian Army and Lieutenant General Miles Dempsey's Second British Army. The 6th U.S. Army Group was in the south (Marseilles), commanded by General Jacob L. Devers, and consisted of Lieutenant General Alexander M. Patch's Seventh U.S. Army and De Lattre de Tassigny's First French Army. In the center was Bradley's 12th U.S. Army Group, consisting of Lieutenant General Courtney Hodges' First U.S. Army, Lieutenant General William H. Simpson's Ninth U.S. Army, and Patton's Third U.S. Army. The First Allied Airborne Army, commanded by Lieutenant General Lewis H. Brereton, was later placed under the 21st Army Group. Altogether Eisenhower had 50 divisions in Europe which consisted of 23 infantry divisions and the equivalent of 17 armored divisions. Of this total 17 were British and 23 American (approximately 2,200,000 soldiers).<sup>32</sup>

Opposing Eisenhower was Field Marshal Gerd von Rundstedt, Commander-in-Chief-West, who had his forces divided between two Army Groups (see map 3). Army Group B in Belgium, commanded by Field Marshal Walther von Model, consisted of General Gustav von Zangen's Fifteenth Army,

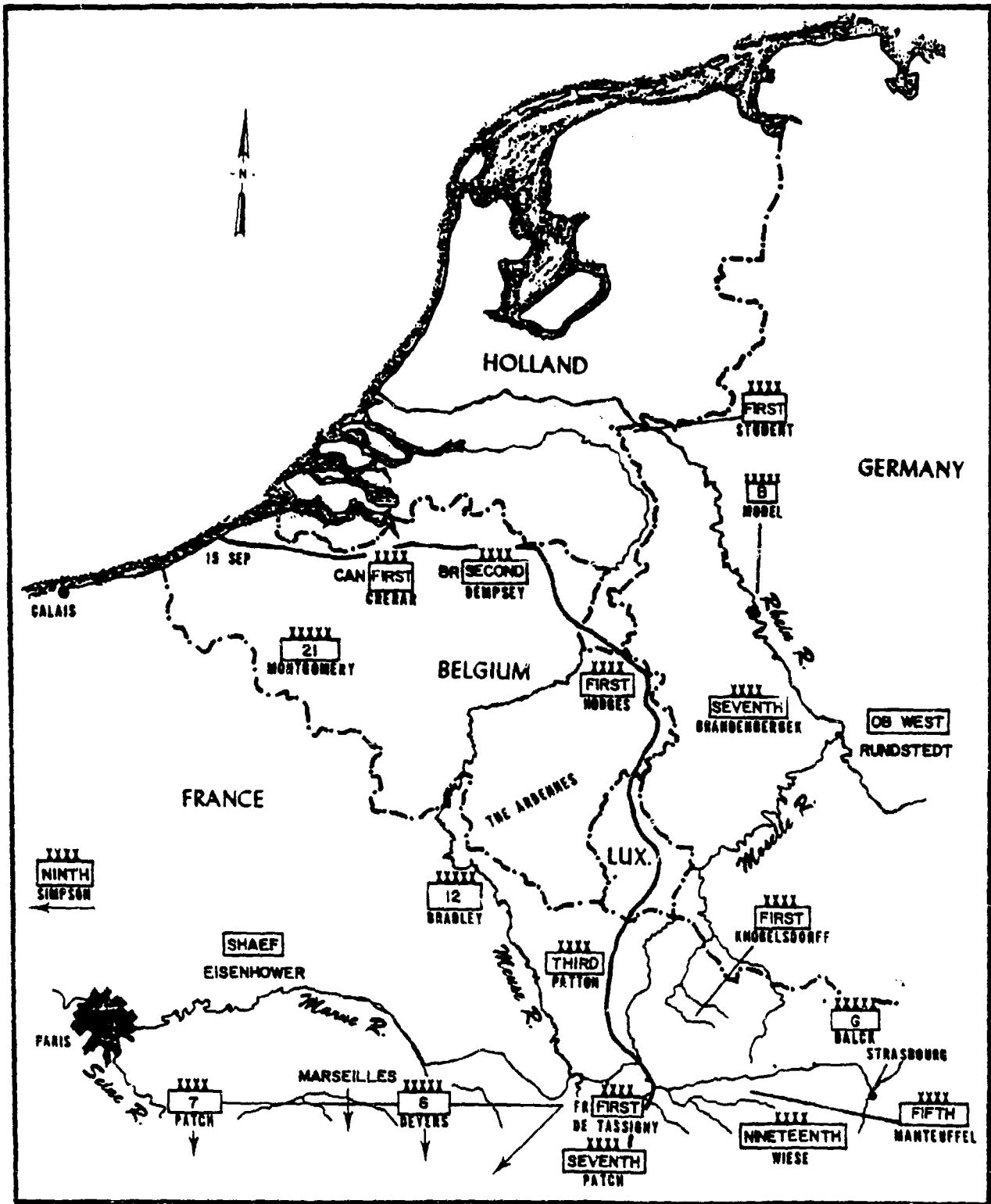

Map 3 - Allied and German Forces in Western Europe, September 1944

Lieutenant General Kurt Student's First Parachute Army and General Erich Brandenberger's Seventh Army. Army Group G in Molsheim, Alsace, commanded by General Johannes Blaskowitz and later by General Hermann Balck, consisted of General Otto von Knobelsdorff's First Army, General Friedrich Wiese's Nineteenth Army, and later, General Hasso von Manteuffel's Fifth Panzer Army (see Appendix 1).<sup>33</sup>

It is difficult to pin down exactly how many German units were on the Western front at any one time because some were being withdrawn and other were being brought forward. The newly constituted Volksgrenadier divisions (people's divisions) were authorized 10,000, but seldom had over 8,000. Von Rundstedt estimated his true unit strength at 26 infantry (authorized 12,700 soldiers) and 6 or 7 armored divisions (authorized 11,400 soldiers).<sup>34</sup> Six parachute regiments in the area, with two additional possible, formed an additional force of 20,000 men. Altogether, German troop strength on the Western front in early September was 750,000.<sup>35</sup>

Because of the strategic breach developing on the Ardennes sector of the West Wall and the gateway into northwestern Germany opening on the Albert Canal in Holland, the First German Army was being rebuilt to a strength of 8 divisions. The Germans had been pushed back through France and had taken a terrible beating. They had lost 500,000 men and a tremendous amount of equipment. With their backs against the West Wall, they now had one last chance to put up a stiff defense.

Although the Allies had over 50 division-sized units in Western Europe, only a portion of them were involved in the Lorraine Campaign. Specifically during the Luneville and Arracourt battles, the 4th Armored Division of Third U.S. Army faced elements of the First German Army and two divisions and three Panzer Brigades of the Fifth Panzer Army.<sup>36</sup>

#### Area of Operations

The Lorraine province in France is a traditional route of invasion between Germany and France because it is the most direct route (map 4). It is also the crossroads for travelers among the head waters of the Seine, the Rhine, and the Rhone Rivers. Lorraine is a plateau varying in elevation between 600 and 1300 feet, consisting of rolling farmlands, and interspersed with lakes. The gray-brown podzolic and brown forest soils are heavy and retain water making maneuver difficult in wet weather.<sup>37</sup> Observations and fields of fire are limited by dense woods or towns and criss-crossed with many streams.

The forests of the area include the Foret de Bezange La Grande, Foret de Parroy, Foret de Grebecy, Foret de Chateau Salins, Foret Dom de Mondon, and Bois de Benamont, which impacted directly or indirectly upon Arracourt as assembly areas and artillery locations. Besides the forests, there are large cultivated areas and pastureland, belonging to farmers who resided in Arracourt and other small towns of Lorraine.

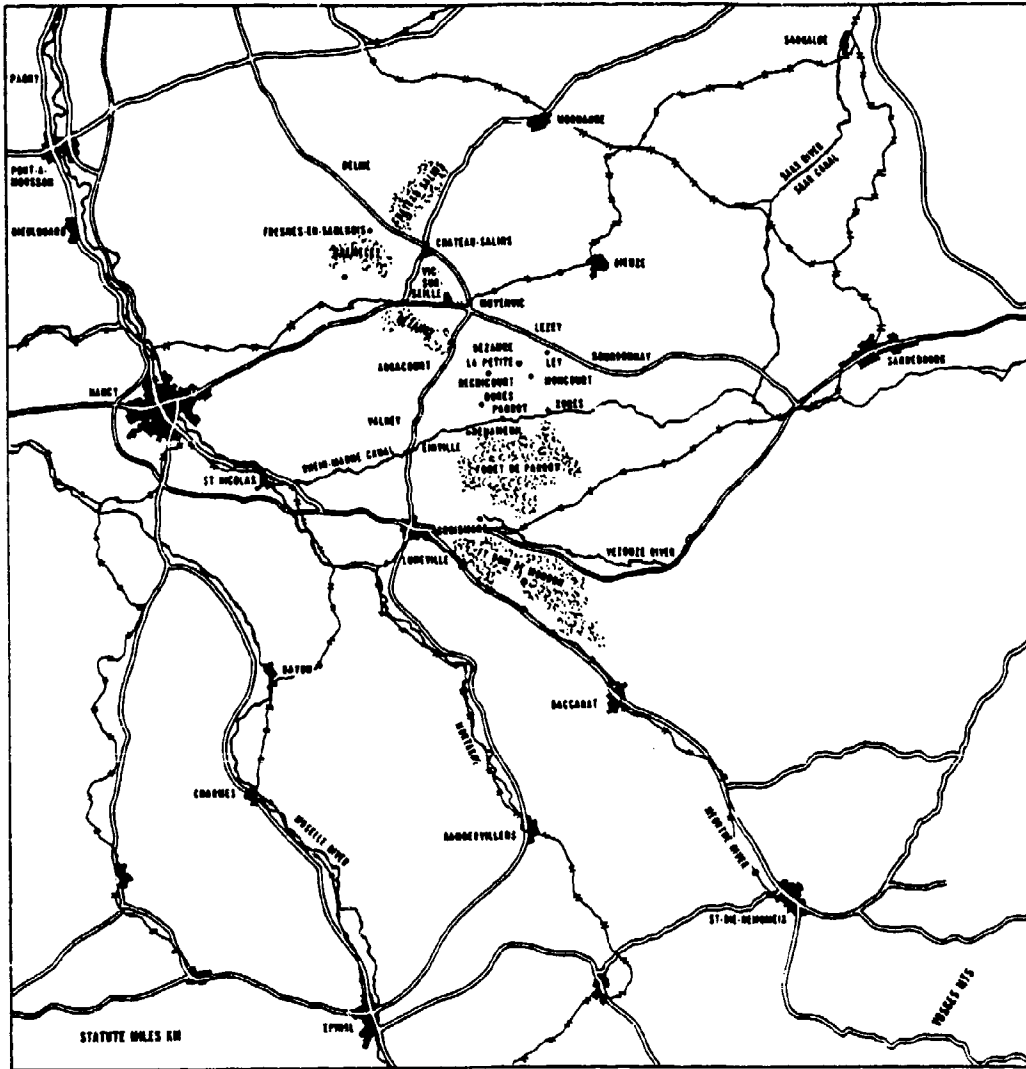

Map 4 - Lorraine

The principal river of the area is the Moselle, which rapidly flows northwestward through Nancy and Metz into Luxembourg. The Muerthe River also flows northwestward, but through St, Die, Luneville and Nancy, and empties into the Moselle north of Nancy. Another major river obstacle is the Rhein-Marne Canal, which flows east-westward from Strasbourg (Rhine) through Nancy to Epernay (Marne). Other rivers in the area are the Mortagne and Vezouze, which flow into the Muerthe near Luneville. All of these rivers and the canal are unfordable and require bridging. The majority of river obstacles are south of the Rhein-Marne Canal. To the north is the Seille, and to the east are the Saar River and the Saar Canal.

Although there are no large mountain ranges in the immediate Arracourt area, there are differences of relief. Arracourt, a town of 5,000, sits atop a ridge which extends to the northeast, and is the last high ground between the German border and Nancy. Key hills in the area are shown on map 5.

The climate also could impact on military operations. The major air flow over France is part of the circulation around the semi-permanent North Atlantic or Azores high. The winds reach France after a long over water trajectory, which brings a preponderance of maritime conditions to the area, moderate temperature, frequent cloudiness, and fairly evenly distributed precipitation over the area. The mean annual cloudiness is 69 percent with September having 63 percent. The mean daily maximum temperature for September is 68 degrees with a mean minimum of 32 degrees. Mean annual relative humidity is 74 percent and for September 76 percent.



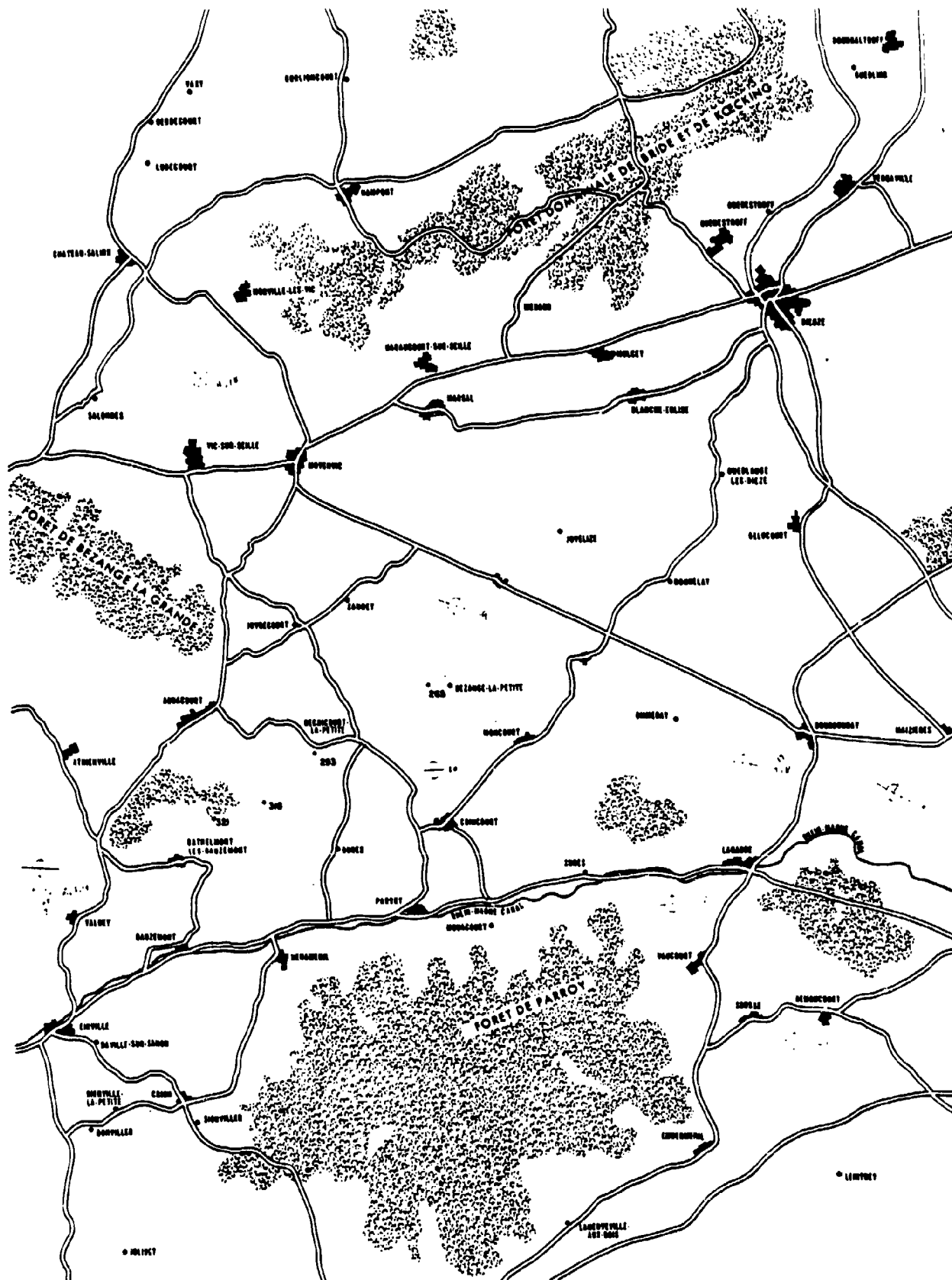

Map 5 - Arracourt Area of Operations  
 -20-

Precipitation averages 26.5 inches per year with an average monthly precipitation in Lorraine between 2.4 and 3.0 inches. September 1944 was one of the wettest and foggiest on record, and Lorraine received two to three times its normal precipitation.<sup>38</sup> Fifteen days of fog, 20 days and approximately 5 inches of rain, marred operations there.<sup>39</sup>

Lorraine possessed a moderately well-developed communications network. The major city of the area is Nancy (population 300,000), important as a communications center. Luneville and Baccarat, with populations of 100,000 and 50,000, respectively, are the only other large cities of the area. Arracourt and other small villages in the area east of Nancy have fewer than 5,000 inhabitants. In 1944, most small villages of Lorraine consisted of clusters of stone farmhouses, which housed families and animals alike.<sup>40</sup>

Two major east/west highways link Nancy with Germany. One runs south along the Muerthe through Luneville, then turns northeastward to Sarrebourg. The other heads northeast from Nancy to Moyenvic, then turns generally southeastward through Lezey and Ley, joining the other main highway at Heming and into Sarrebourg. A third major highway links Moyenvic with Luneville and passes through Arracourt. Only by using secondary roads is travel east or west from Arracourt possible. Although the main roads were paved, the secondary roads lacked shoulders, had holes, and were difficult to use, especially in rainy weather.

An extensive rail network serves Lorraine (which the Germans exploited to the maximum extent). Nancy, a major rail center, was on the double-track main line from Paris to Strassbourg. Other double-track main lines from Nancy led north to Metz, northeast to Sarreguemines, and south to Dijon. The branches coming up from the south through Epinal and from the southeast through St. Die were also important detraining stations for the Germans as they moved into position prior to the Arracourt battle.

Supplies were moved primarily by rail when available, or by horse. Systematic bombing by the Allies and sabotage by the French resistance seriously impeded their resupply efforts. German tanks, heavy weapons, and prime movers, once committed to battle were being knocked out so quickly, production and transport could not keep up with the losses.

#### Opposing Forces

General Patton organized his Army into two Corps--XXth Corps in the north with the 5th, 83d, and 90th Infantry Divisions, and the XIIth Corps in the south, commanded by Major General Manton S. Eddy. General Eddy's XIIth Corps consisted of the 80th Mechanized Infantry Division, the 35th Infantry Division, the 4th and 6th Armored Divisions, and the 2d Cavalry Group.

A U.S. TO&E armored division at that time was relatively small, lean and flexible, and consisted of three tank battalions, each with one light and

three medium tank companies for a total of 263 tanks, three armored infantry battalions, three armored self propelled field artillery battalions and a cavalry reconnaissance squadron. In addition to its organic elements, additional battalions of tanks, tank destroyers, antiaircraft machine guns, and engineers could be attached. These units were then tailored to two combat commands and a reserve command (comparable to the modern brigade) which also has a variable structure based on mission.<sup>41</sup>

The armored division was equipped with a light 16-ton tank with a four-man crew and a 37mm gun. However, the main tank was the 35-ton American Sherman M-4 medium tank which had a short tube 75mm gun. The full tank crew consisted of five men and the tanks could fire either high explosive or white phosphorus. The Sherman had rubber-block tracks, which had five times the life of the Panther's steel tracks.<sup>42</sup> On dry ground the American tanks were more maneuverable than the German tanks, but in the mud they were not (the case in September 1944). Another Sherman advantage was the power-driven tank turret, which gave the Americans a decided advantage over the hand-driven turret of the more heavily armored German tank.<sup>43</sup>

Within the 4th Armored Division, the three artillery battalions (three batteries of six tubes each of 105mm) were organized under Division Artillery. In addition, XII Corps assigned a field artillery group (three battalions) the mission of general support-reinforcing the 4th Armored Division Artillery.<sup>44</sup>

Attached to the 4th Armored Division was a tank destroyer battalion of 36-76mm self-propelled guns capable of destroying German armor.<sup>45</sup> Tank destroyers had no machine guns, no turret covers, and light armor plate, and were vulnerable to dismounted infantry and artillery as a result. (A complete listing of organic and attached units of the 4th Armored Division is at Appendix 2.) The total strength of the 4th Armored Division was 15,700 men, 263 tanks and 144 guns. A complete listing of organic and attached units of the 4th Armored Division is at Appendix 2.

Previous performance of the 4th Armored Division under combat conditions had been exemplary. After arriving in England in January 1944 and becoming part of the Third U.S. Army in July 1944, they participated in Operation COBRA, fought against limited German resistance at Avranches (30 July), Rennes (3 August), Orleans (16 August), Troyes (25 August), and arrived in the vicinity of Nancy in early September.<sup>46</sup>

Air support provided by the XIX Tactical Air Command was of paramount assistance in the Arracourt battles. During September, priority of air support went to Third Army. Bad weather was a major drawback, however, the P-47 fighter aircraft simply could not fly because they were unable to see the target. Flying below cloud cover, they were vulnerable to any enemy antiaircraft fire.<sup>47</sup> U.S. air supremacy was a major factor in turning the tide of battle once the weather cleared.

Opposing the 4th Armored Division of Third U.S. Army were the elements of Fifth Panzer Army and German First Army. Reactivated in February 1944 in France, Fifth Panzer Army underwent a series of name changes. In early September, Fifth Panzer Army was brought from Belgium to Strassburg for reorganization, prior to launching an attack against Patton's Third Army. Fifth Panzer Army consisted of two tactical corps headquarters: the LVIII Panzer Corps, from Lemans, commanded by General Walther Krueger, and the XLVII Panzer Corps (brought in from the Nineteenth Army), commanded by General von Luetwitz. Subordinate units included the 11th Panzer Division, (which had suffered heavy losses in men and equipment during the Nineteenth Army retreat through France), the 21st Panzer Division, the 15th Mechanized Infantry Division, and the 111th, 112th and 113th Panzer Brigades.<sup>48</sup> Only a portion of the German First Army (located to the North of Fifth Panzer Army) opposed the 4th Armored Division. Major subordinate units of German First Army were:<sup>49</sup>

3d Mechanized Infantry Division  
48th Volksgrenadier Division  
553d Volksgrenadier Division  
558th Volksgrenadier Division  
462d Infantry Division  
17th Mechanized SS Division  
106th Panzer Brigade

The German Panzer division by TO&E had a tank regiment, a motorized infantry regiment, an artillery regiment, and a cavalry squadron. The motorized infantry division had two motorized infantry regiments, a self-propelled artillery battalion, and an artillery regiment.<sup>50</sup> TO&Es are graphically portrayed at Appendix 3.

Several unusual German unit designations need clarification. The 17th Mechanized SS Division was an elite division with some 17,000 troops. Within the weaker divisions, OKW habitually formed battle groups, and used available personnel and equipment to form new units instead of reconstituting veteran divisions. These battle groups contained ten Mark IV tanks, one scout car, one scout cavalry company, one pioneer company, and one artillery battalion.<sup>51</sup>

Another of these new formations was the Volksgrenadier Division, three examples of which could be found in the First Army. These units consisted of leftover manpower found throughout Germany and therefore varied greatly in quality. These divisions were established with a strength of about 10,000 men including six infantry battalions, a bicycle-mounted fusilier battalion, two battalions of artillery, and a few self-propelled assault guns. The leaders were often wounded veterans who had been previously considered unfit for service. They represented the last reserves of German manpower. They had neither the firepower nor the mobility to compete in open warfare against armored and mechanized divisions.<sup>52</sup>

New Panzer brigades, formed by order of Hitler during the summer of 1944, consisted of armored division remnants which had been rendered ineffective on the Eastern Front. The commanding officers and men came from many different garrisons, met for the first time after detraining in the combat zone, and were thrown into battle just 48 hours after arrival.<sup>53</sup> The Panzer brigades consisted of one battalion of 45 Mark IV tanks and one battalion of 45 Mark V tanks for a total of 90 tanks. These improvised brigades lacked artillery, sufficient reconnaissance elements, engineers and effective communications. They also had one antitank company with twelve assault guns.<sup>54</sup>

Because of combat losses and personnel shortages Fifth Panzer Army and German First Army units were not up to TO&E strength. For example, the 111th Panzer Brigade lost 11 panthers to air attack and mechanical failures. The 112th Panzer Brigade had been prematurely committed against U.S. Forces and was not of little combat value. The 113th Panzer Brigade was scattered by an air attack while still on the train enroute to Arracourt. A detailed breakdown of Fifth Panzer Army units is at Appendix 4.<sup>55</sup>

German-produced equipment was technically superior to that of the Americans, but suffered from a lower rate of production and frequent changes in design. The Germans had the Mark IV and Mark V Panzer. They had larger, higher velocity main guns, thicker armor, and better off-road trafficability



in the mud than Allied tanks. However, the hand turret crank put them at a decided disadvantage against the mechanical turret crank of the Sherman. They also had the 20mm assault gun. Characteristics of the Sherman, Mark IV and Mark V tanks and assault gun are at Appendix 5.

A table summarizing tanks, artillery, and personnel of Fifth Panzer Army units follows:<sup>56</sup>

	Mark IV Tanks	Mark V Tanks	20mm Assault Guns	Artillery Tubes (all calibers)	Personnel
111 PZ Bde	17	45	12	4	2,000
112 PZ Bde	4	0	0	3	1,200
113 PZ Bde	4	12	4	3	2,000
11th PZ Div	35	35	100	55	3,000
21st PZ Div	0	0	10	0	2,000
15th PZ Gren Div	<u>15</u>	<u>15</u>	<u>0</u>	<u>125</u>	<u>3,500</u>
	75	107	126	190	13,700

German air power for the ground forces was scarce and generally ineffective. Those planes which could be brought to bear were used primarily with Student's Parachute Army in Army Group B in Belgium, and thus did not play a significant role in the Arracourt tank battles. In sum, the 4th Armored Division outnumbered the 1st German and 5th Panzer Armies by 1.5 to 1 in manpower, 2 to 1 in tanks, 2 to 1 in artillery tubes, and 50 to 1 in the air.<sup>57</sup>

## Personnel

Manpower replenishment within these units was a problem for both sides. U.S. replacements were being brought in but not fast enough to replace all those killed, wounded, or injured. However, during the latter part of September, this gradual depletion did not significantly influence 4th Armored Division's mission.

In the Wehrmacht, manpower was perhaps the most difficult and urgent problem. General von Rundstedt had lost over 500,000 men in his withdrawal through France. The priority of manpower had gone to the Eastern Front and it was difficult to shift manpower quickly to the West. Moreover, the front line leaders were aware of the seriousness of this shortage of units, as brought out by Model's request on 4 September for 25 fresh divisions and 4 to 5 Panzer Divisions as reserves.<sup>58</sup> However, they had less appreciation for Germany's overall manpower problems.

To meet this shortage, ten Panzer Brigades were being formed from the remnants of armored divisions which had been designated on the Eastern Front. Hitler converted garrisons and fortress battalions, training regiments and school of officer cadets into operational units and dispatched them to the West Wall.

In addition, the four Wehrkreise (Military districts) in Western Germany were told to organize their depot staffs into divisional headquarters and to

mobilize every man they could find, to include men on leave or convalescing in hospitals, men from ordnance depots and training establishments, from engineer and signal units, from coastal and anti-aircraft batteries, from the Navy, and from the police. This resulted in the collecting of 135,000 soldiers to garrison and rebuild the Western defenses.<sup>59</sup> Because they did not have the proper equipment, they could not be used outside the defenses in open warfare.

### Logistical Support

Logistical support was a major problem on both sides. Logistical support in the Third Army was limited because the priority of support was to Montgomery's 21st Army Group in the North. The overriding shortage was fuel, which forced Patton's forces to halt his advance at the Moselle the end of August 1944. Although supplies were once again flowing from the Normandy beaches and the channel ports by the second week of September, this supply line was overextended, difficult to maintain, and soon subject to the ever-changing autumn weather.

Patton tried many techniques to maintain his forward momentum. He emptied fuel into a few of his tanks and severely restricted his other vehicles so he could move forward. He used captured German fuel, and double-loaded gas trucks. His officers posed as members of Hodges' First

Army and got fuel from their POL dump. Even when visiting Bradley's headquarters, he would drive in with an empty tank and fill it out of 12th Army Group resources.<sup>60</sup> Combat Command Alpha (CCA) of the 4th Armored Division, spearheading the attack across the Moselle toward Sarreguemines, benefitted most from this extra fuel.

The state of logistical support was even worse for the Germans. Priority of effort was to the Eastern Front, and only in special cases did new tanks and other materiel come to the Western Front.<sup>61</sup> Whereas the Americans were completely motorized, the Germans were not. Resupply was dependent on rail and horse-drawn vehicles, which led to even greater delays.<sup>62</sup> Those items of resupply which did get to the West frequently had been intended for the Eastern Front.<sup>63</sup>

Resupply of artillery was almost nonexistent and seriously hampered operations. Due to insufficient ammo, as well as inadequate wire and radio communications, German artillery was not strong enough to be employed for flank protection or counterbattery operations. During the disastrous defeat of the Nineteenth Army in Southern France, 1316 of its 1481 artillery pieces had been destroyed.<sup>64</sup> In early September, replacement tanks started moving to the West, the priority going to the newly formed Panzer brigades, two of which faced the 4th Armored Division at Arracourt at that time.<sup>65</sup>

## Leadership

The respective unit commanders were well-suited to their positions. Major General John S. Wood, Jr., commanded the 4th Armored Division. A 1912 graduate of West Point, he became known as "P" (Professor) Wood because he was a natural and willing teacher. He enforced high standards and always backed his chain of command. His men would follow him anywhere. General Eisenhower described Wood as "a natural leader." Wood, known as "Tiger Jack" to the Germans, was as hated and feared by them as he was loved by his own men.<sup>66</sup>

The CCA commander was another natural leader. Colonel (later general) Bruce C. Clarke aggressively and compassionately led his men, instilling great pride in them.<sup>67</sup> He was directly responsible for the planning, execution and success of the Nancy Bridgehead exploitation and the Arracourt defensive battles.<sup>68</sup>

On the German side, the Fifth Panzer Army was commanded by Major General Hasso von Manteuffel, who had just arrived in early September from having commanded an armored division on the Eastern Front, where he had fought brilliantly in the battles in the Kiev salient.<sup>69</sup>

Lieutenant General Wend von Wietersheim commanded the 11th Panzer Division, also known as the "Ghost Division." It had captured Belgrade, fought

continuously on the Eastern Front, and was cited there three times for their distinguished performance. After a humiliating defeat during the Korsun encirclement in February 1944, von Wietersheim led his unit to France, where it covered the Nineteenth Army retreat (being the only armored division in Southern France). On 18 September, the division moved to Belfort Gap to reinforce Fifth Panzer Army.<sup>70</sup>

### Command and Control

Good command and control is essential to any military operation. American and German forces differed in their command and control setups. On the Allied front, General Dwight D. Eisenhower was the Supreme Allied Commander who oversaw operations of the 21st, 12th, and 6th Army Groups. General Omar Bradley, Commanding General of the 12th Army Group in the center was responsible for First Army (Hodges) in the north, Third U.S. Army (Patton) in the south, and Ninth U.S. Army (Simpson) in Brittany. Allied command and control at the highest levels was not as responsive as it could have been. Eisenhower's headquarters at Granville on the Normandy coast was situated too far from the front. Eisenhower had little contact with his main headquarters in London and could communicate with Montgomery and Bradley only by letter or wireless telegraphy. No telephone or radio telephone link was available between his headquarters and theirs. For example, situation reports were taking 24 hours to reach him and an additional 24

hours for his instructions to get back to the field. Even after Eisenhower moved his headquarters to Versailles, he still did not get timely information to and from the front.<sup>71</sup>

Command and control within Third Army was achieved along clear lines. Patton expected his division commanders to exercise independent judgment and tactical daring, and granted them a freedom of action which permitted them to be virtually independent.<sup>72</sup> Patton gave mission-type orders and aggressive subordinates carried them out. For example, his only directive to the CCA commander of 4th Armored Division in early August was to "go east," which earned him several hundred miles.<sup>73</sup> In the 4th Armored Division, command and control was exercised through the three combat commands of CCA (Col Clarke), CCB (BG Holmes Dager), and CCR (Col Walter A. Bigby). They were tailored to particular missions, and exercised operational and direct command over subordinate units. Each combat command had its own staff, which functioned very much like the present day brigade. Standard Operating Procedures (SOP) permitted subordinate units to operate independently for days at a time. Aggressive leaders issued clear, concise orders, which allowed for a smooth-running operation. Attachments and detachments were conducted in an orderly manner, thereby eliminating the confusion of two concurrent controlling elements.

While the Allies enjoyed decentralized command and control, the German forces were extremely centralized and often confused. Hitler, through his

OKW (Oberkommando Wehrmacht) in Berlin, attempted to control movements of maneuver down to division level, thereby circumventing the authority of Commander-in-Chief West von Rundstedt, Army Group G commander Blaskowitz, and Fifth Panzer Army commander Manteuffel. Hitler was in constant touch with the headquarters of von Rundstedt and Model by teleprinter. However, because Hitler had to be personally involved in decisionmaking, and because he had to divide his efforts between two fronts, his responses to the maneuver commanders' requests were not timely. Hitler lacked the fundamental professional training and education of the military man and underestimated the enormous war potential of the western Allies.<sup>74</sup>

Generally, commanders lacked flexibility to make changes and were subject to court martial if they did so without first checking with Berlin. Orders were spelled out in great detail and subordinates had to follow them to the letter. They merely copied their operations orders from OKW orders without adding personal ideas, thereby displaying their lack of initiative. If they felt strongly enough about a decision, the commanders would leave their units and personally argue their case before Hitler in order to convince him their method was best.

One significant problem with German command and control was the constant rotation of leadership at higher levels. Rapid changes in the Commander-in-Chief West positions illustrates this. Von Rundstedt was succeeded by von Kluge on 2 July, replaced by Model on 17 August and again by von Rundstedt on 5 September.<sup>75</sup>



Leadership changes occurred at subordinate levels as well. Blaskowitz is commander of Army Group G until 21 September. General der Panzertruppen Hermann Balck replaced him and Colonel Friedrich von Mellenthin replaced Lieutenant General Heinz von Gyldenfeldt as chief of staff.<sup>76</sup> The 111th and 113th Panzer Brigades had only been recently formed and sent to Lorraine in late August 1944. Their commanders had to place themselves well forward in battle to motivate their soldiers thereby exposing themselves to greater danger of being killed. This did happen to both of them prior to the continuation of the Arracourt battle.

#### Morale

Morale in the 4th Armored Division was very high. The men knew their leaders were supporting them, as shown by frequent general officer visits to the front lines. Other factors contributing to high morale were rapid forward movement, reasonably good equipment, good mail service, and hot food as the situation permitted. Noncommissioned officers maintained strict discipline of their sections, which minimized problems and contributed to efficient operations.<sup>77</sup>

German morale, on the other hand, was very low. Subordinates were weary of fighting and now realized the situation was hopeless. Many surrendered to the Allies. Those caught by the Germans were shot.<sup>78</sup> The use of

battle groups, Panzer brigades, and Volksgrenadier Divisions did not enhance morale because the individuals had come from beaten units, had not worked together before, and experienced frustration and desperation by having to return to the war on the Western Front. These factors all contributed to lack of cohesiveness and low morale of officers and men alike.<sup>79</sup>

### Intelligence

Strategic intelligence was provided by a high level British based organization called ULTRA, which got its information by intercepted radio transmissions. There were many codes used to break messages, but the easiest to break was the Luftwaffe code, because of transmission frequency and scope, and operator inexperience, which led to carelessness. If liaison officers were present with ground units, transmissions were plentiful. However, as the personnel situation got desperate in September 1944, even those liaison officers and other ground based personnel were pulled out to form the nucleus of a Parachute Army. The Germans relied heavily on the telephone, which greatly reduced radio traffic.

From 15 August to 18 September an ULTRA recipient was present at Third Army. Knowledge of ULTRA at Third Army was extremely restricted: as only the Commander, Chief of Staff, Deputy Chief of Staff, the G3, the G2 and assistant G2 knew about it.<sup>80</sup> Intelligence had to be disseminated in such a way as not to compromise ULTRA.

The operational value of the service was so impressive that General Patton never missed a special briefing. ULTRA often had exact figures to the man and the gun, as in the case of the 15th Panzer Grenadier Regiment. They were also able to track the exact movements of the 11th Panzer Division.<sup>81</sup> Although Patton was extremely interested in these briefings, he tended to keep the information to himself and seemed to ignore it.<sup>82</sup> Patton was so intent on maintaining his forward momentum, he failed to consider the effects of increased resistance and deteriorating weather conditions.

There was no direct knowledge of ULTRA at division level, though information from ULTRA was often passed to divisions. Their most important source of intelligence was the FFI, or Forces Francaises de l'Interieur, the French freedom fighters, who also conducted terrorist and guerrilla activity in southern France. They gave information of the Germans, guided tankers, and harassed German communications. Their attacks were on individual cars, trucks, and horse drawn vehicles as well as on small units. They conducted the attacks in civilian clothes and fought from ambush. Demolition of tracks, bridges, and highways increasingly crippled rail traffic. The passenger and express trains were attacked but troop trains were left alone. Signal communications based on existing French installations were critically hampered. The radio net was an inadequate expedient. Thus, the FFI played a significant role in the Allied battle against the Germans.<sup>83</sup> Additional intelligence came from aircraft overflights, systematic

patrolling, captured POWs and documents, and the interception of radio messages.

German intelligence focused on captured prisoners and documents, which were carefully processed to provide detailed information. Local sympathizers spoke French. A glaring shortcoming of the German intelligence-gathering effort was the lack of air reconnaissance during September 1944. U.S. air supremacy prevented the Germans from tracking the majority of troop movements. Still, the Germans were well acquainted with 4th Armored Division order of battle, location of subordinate units, and capabilities.<sup>84</sup> This intelligence proved to be useless when the higher leaders were unwilling to accept unfavorable reports as facts, even though well documented. For this reason, intelligence personnel of lower headquarters withheld unfavorable items of information or exaggerated successes.<sup>85</sup>

#### U.S. Tactics

To understand combined arms employment and fire and maneuver in September 1944, it is necessary to examine the tactical doctrine of the day.

The 4th Armored Division initially employed both deep envelopments and penetrations, then utilized a mobile defense at Arracourt. The penetration was used to push through the German resistance along the Moselle, and the

envelopment was conducted to avoid the main line of resistance and seal off the escape from Nancy. The object of a river crossing was to get across quickly and economically, and establish a bridgehead which would protect the crossing of the remainder of the command. Tanks travelled with a white phosphorous round in the tube, and maneuvered to within 300-500 yards of German tanks.<sup>86</sup> Germans found tanks in their rear area most disturbing. CCA tried never to hit strength head on, but envelop it.

Artillery played a key role in the Arracourt battles. In march columns artillery was used to make reconnaissance by fire of suspected enemy positions ahead. One combat command had division artillery behind them which consisted of two organic 105 battalions plus one of the attached 155 howitzer battalions. The other combat command received the group headquarters one of the organic artillery battalions, and then the attached 105 self-propelled battalion and a 155 howitzer battalion. The 105 battalions were given direct support missions to task forces.

The artillery battalion commander and the task force commander conducted fire planning by personal liaison. Very little was done in the fire direction center. Registrations and 90 percent of observed fires were done with air observers. Forward observers were used to call in defensive fires.<sup>87</sup> During the Arracourt defensive battles, the three battalions of Division Artillery were laid on different azimuths for 360 degree coverage. Additional artillery support was coordinated through Division Artillery channels.

German tactics changed drastically during 1944, from offensive to defensive operations.<sup>68</sup> Because of his comparatively weak forces and little equipment, Balok immediately opted for the mobile or the elastic defense concept. Imitating trench warfare of WWI, he kept his front almost entirely empty of troops. Thus, artillery attacks caused very little equipment and minimal personnel losses. If an armored or infantry assault followed, the forward German positions were overrun but the secondary line of German defense would halt the enemy advance. The Germans would counter-attack using a mobile force deployed just to the rear of the secondary line of defense. Additionally, Germans would employ extensive mine fields (few live mines and lots of dummy ones) to slow and channel the enemy, so he could be enveloped with the mobile reserves.

The Germans used the Schwerpunkt, or point of main effort, as the main attack. This was usually a point where the enemy least expected an attack. They used secondary attacks as diversionary measures to deceive the Americans as to the real location of the main attack. By making use of speed, mobility, long marches, night attacks, terrain, surprise and deception, they believed the weaker force could defeat the stronger at the decisive point.<sup>69</sup> Because of critical shortages in German manpower and material, the secondary attack prevented them from concentrating their forces at the decisive point.

## Training

The level of training in the 4th Armored Division was very high. The 4th Armored Division had trained together for over two years, and had been together through six weeks of combat on the drive through France. In spite of long days and battle fatigue, morale was high because of personnel stability, as well as the charisma and leadership of Patton, Wood, Clarke and small unit leaders.

The level of training in German units, on the other hand, was spotty at best. Replacement personnel were either injured veterans who were called back into service, or young draftees who were inexperienced in the art of combat. In 1944, infantrymen received 12-14 weeks basic training, while armored personnel received 21 weeks.<sup>90</sup> Personnel forming the new Panzer Brigades had been gathered from all over Germany, put on trains for the front. Most engaged in combat just 48 hours after detraining. Frequent changes in leadership also contributed to turbulence.

These, then, are the units which faced one another at Luneville and Arracourt in September 1944.

CHAPTER 2

THE ADVANCE OF CCA TO ARRACOURT AND THE LUNEVILLE DIVERSION

The Luneville battle, which followed establishment of the Nancy bridgehead and CCA's advance toward Chateau-Salins, took place between 16 and 19 September 1944. This battle primarily involved elements of the Reserve Command (CCR). However, it also involved elements of Combat Command Alpha (CCA), 4th Armored Division, and elements of the 6th Armored Division. Luneville marks the first time in the Lorraine Campaign that the Germans made a coordinated tank attack against U.S. forces. That attack involved elements of CCA and ultimately ended with CCA on the field of Arracourt.

By the end of August, after a six week offensive covering some 500 miles, the Third U.S. Army came to a halt on the west bank of the Moselle River. The tactical mission of the XII U.S. Corps (of which the 4th Armored Division was a part) was to cross the Moselle River on a wide front, capture Nancy and continue on to the east to establish a bridgehead over the Saar River in the vicinity of Sarreguemines. The 4th Armored Division (with CCA in the north and CCB in the South) was to move to contact from the Moselle bridgeheads and envelop German forces at Nancy from the north and south, seize the high ground in the Chateau-Salins area to block the exits from Nancy and be prepared to continue the advance across the Saar River in the vicinity of Sarreguemines. The specific missions of the three 4th Armored Division



Combat Commands were to attack from the Moselle bridgeheads and envelop German forces at Nancy. CCA was to pass through the bridgehead of the 80th Infantry Division at Dieulouard (north of Nancy) with the objective of moving to contact to secure the high ground in the vicinity of Arracourt. There CCA would block the roads leading east from Nancy to prevent the escape of German forces. CCB was to cross near Charmes (south of Nancy) in conjunction with the advance of the 35th Infantry Division, cross several rivers, advance north to an area south of Arracourt, and complete the envelopment. The CRR was to follow CCB and assist in seizing the high ground in the Chateau-Salins area to block the exits from Nancy.<sup>1</sup> (See map 6.)

The tactical mission of the Fifth Panzer Army was to reduce the gap separating the First and Ninth Armies through flexible combat east of the Moselle River forcing the Americans as far back as possible. Luneville was to be held or retaken under any circumstances.<sup>2</sup> The immediate objectives for the Fifth Panzer Army were to hold Luneville and to hit Patton's Third Army in the right flank. Manteuffel, the Commanding General of Fifth Panzer Army, acting on Hitler's personal orders, felt he should attack as soon as possible, and, using the element of surprise, hit the Third Army in the right flank before they had a chance to consolidate their gains and further threaten German West Wall defenses.

80TH DIV BRIDGEHEAD, EVENING 13 SEPTEMBER  
 AXIS OF ADVANCE, ARMORED COLUMN  
 ENGAGEMENT WITH ENEMY  
 FORWARD INFANTRY POSITIONS, EVENING 14 SEPTEMBER

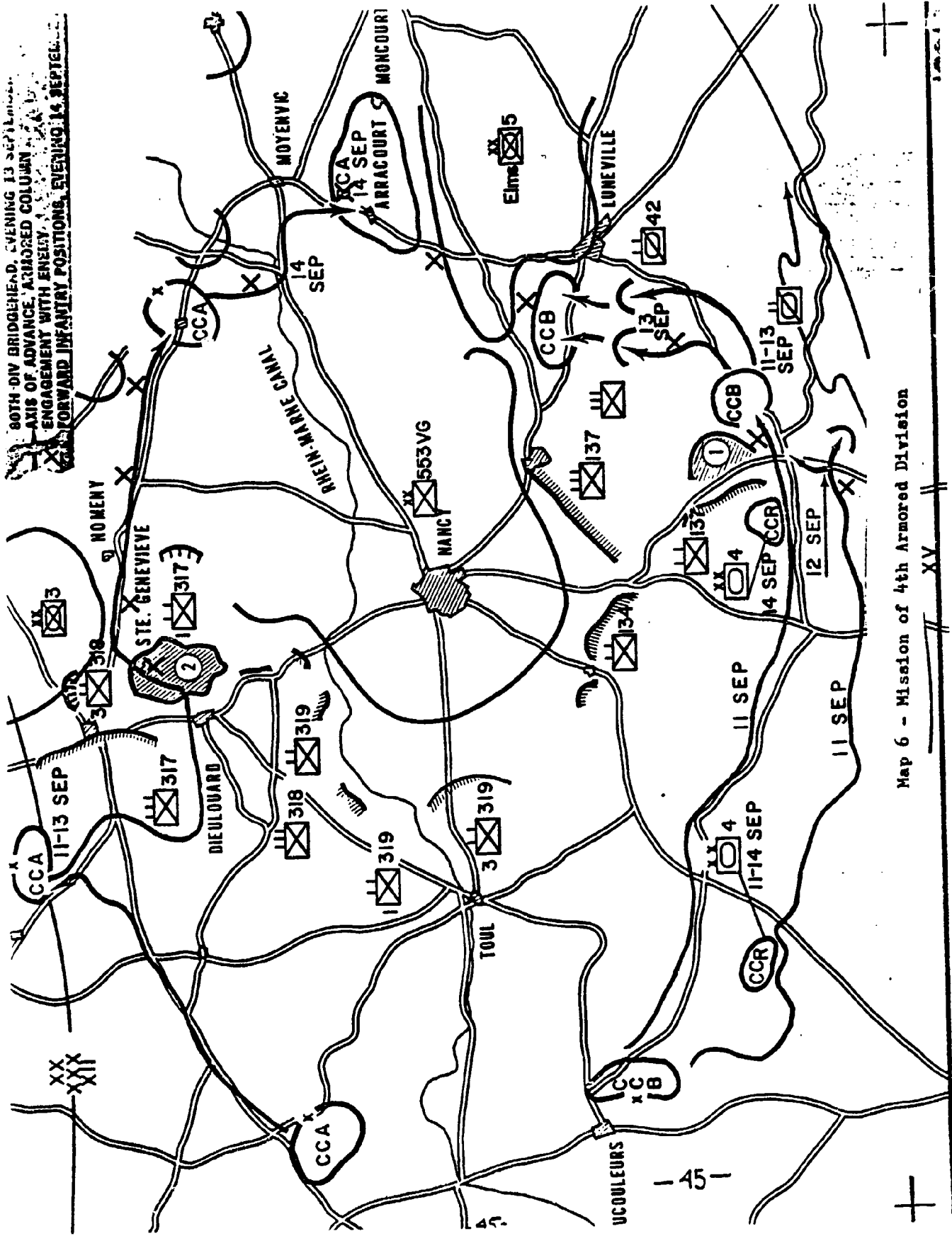

Map 6 - Mission of 4th Armored Division

For its movement to contact from the Dieulouard bridgehead north of Nancy, 4th Armored Division gave CCA the majority of combat power in the division.<sup>3</sup> By using captured German gasoline, and imposing stringent conservation measures, CCA resupplied in preparation for a flanking maneuver east and north of Nancy. After waiting from 1 to 12 September, CCA finally advanced on the morning of 13 September. (See map 7.)

Originally they were to cross the Moselle at Pagny, but the infantry bridge was not strong enough for tanks. To rebuild the bridge would take too long. Thus, the 4th Armored Division moved CCA to the 80th Infantry Division bridgehead at Dieulouard. Captain Charles Trover, commander of Troop Delta, 25th Cavalry Reconnaissance Squadron, was given the mission of moving his unit to the bridgehead and establishing liaison with the 80th Infantry Division. CCA liaison officer Captain Burns accompanied Captain Trover, as well as guides from each subordinate unit of CCA, to mark paths for the night march to the bridgehead. When they arrived at the bridgehead at 2100 hours, they briefed the 80th Infantry Division on their plans, and completed arrangements for moving through the bridgehead at 0600 hours the following morning. The move took place in three successive columns. The 37th Tank Battalion (-) led the first column, the 53d Armored Infantry Battalion the second, and the 166th Engineers the third. Troop D, 25th Cavalry Reconnaissance Squadron, provided forward reconnaissance.<sup>4</sup>

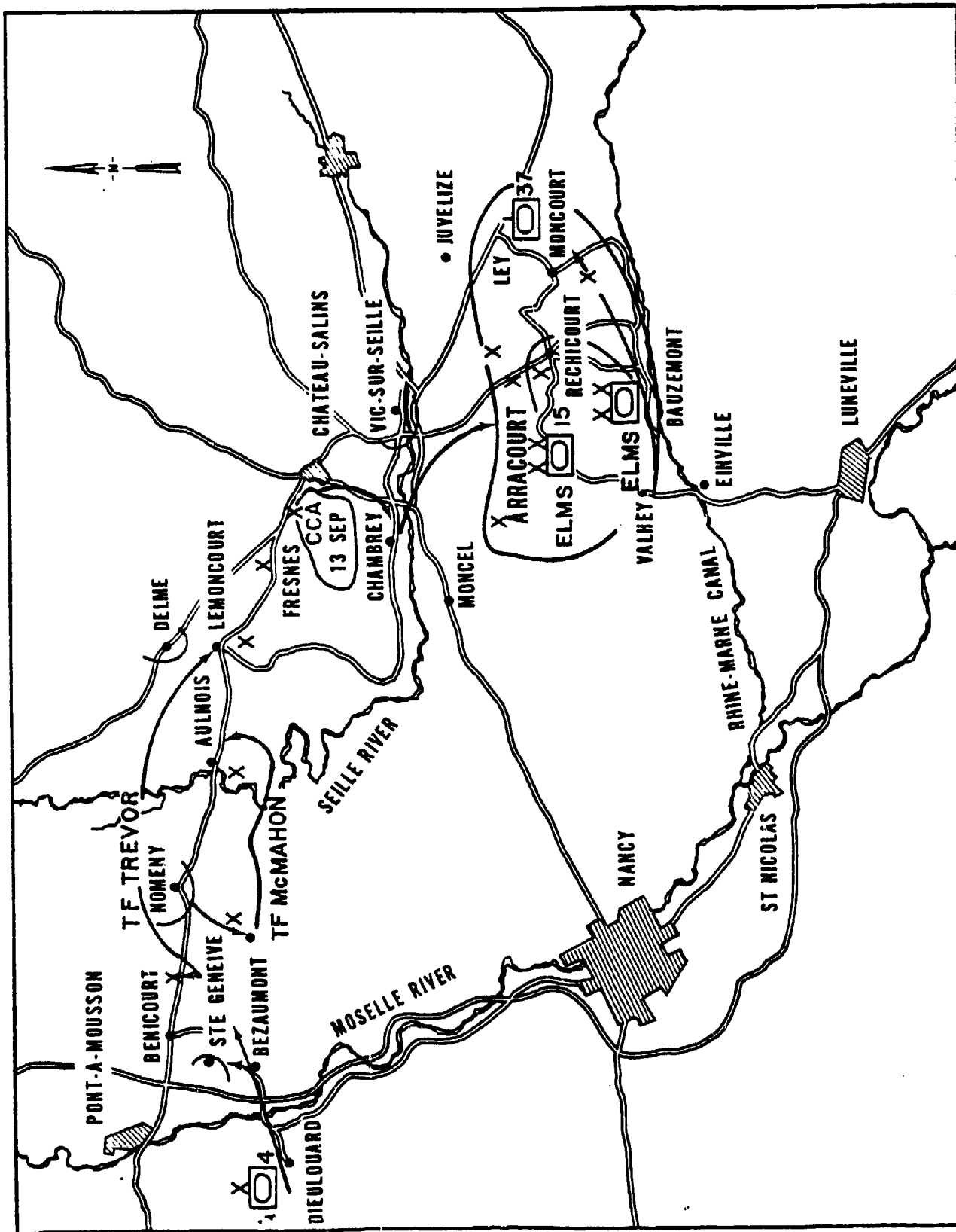

Map 7 - Route of CCA, 4th Armored Division, 13-14 September 1944

The 80th Infantry Division meanwhile was expanding the Dieulouard bridgehead on the Moselle heights west of Landremont. They succeeded in enlarging this bridgehead as far north as Pont-a-Mousson in the course of the coming day. Meanwhile, the German bridgehead held by the 553d Volksgrenadier Division, was sealed off tighter and tighter from the south and west while U.S. units continued to gain ground in the open flank of the First German Army.

At 0400 hours on the morning of the 13th the main body of CCA started its movement to the bridgehead. Shortly thereafter, a German force of infantry, reinforced by some light self-propelled (SP) guns firing from Genevieve Heights, launched an attack on the 80th Infantry Division at the bridgehead and forced them back to the river. By 0700 hours they were in the vicinity of Dieulouard. Lieutenant Colonel Creighton W. Abrams, commander of the 37th Tank Battalion (leading battalion of the first column) and Captain Trevor, proceeded to the bridgehead while the remainder of the column pulled off the road between Guscourt and Dieulouard to await further orders. The division artillery commander moved the rear artillery elements forward and put them in position on the west side of the river to support the attack if needed. Three separate bridges--two across separate channels of the Moselle and one across a large canal running parallel to the river--were at this site. This crossing site had fords on either side which could be used in addition to the engineer bridges.

Abrams, Trover, Colonel Bruce Clarke, Combat Command Alpha commander, General Eddy, the 12th Corps commander, and General Wood, the 4th Armored Division commander as well as General McBride, the 80th Infantry Division commander, held a council of war took place at the bridge. Only when Colonel Abrams and Colonel Clarke insisted on pressing the advance did General Eddy permit them to cross the river and proceed toward Chateau-Salins.

At 0800 hours, the 37th Tank Battalion, reinforced with a company of infantry from the 53d Armored Infantry Battalion, crossed the bridge, and cleared Genevieve Heights, Bezaumont and Loisy, thereby opening the bridgehead in the east side. German artillery and heavy mortars of the 3d Panzer Grenadier Division of the 1st German Army located near Pont-a-Mousson at a higher elevation than those at St. Genevieve continued firing on U.S. units as they crossed the Moselle. In addition to the 3d Panzer Grenadier Division, the Germans used elements of the 106th Panzer Brigade with Mark IV and V tanks and 75mm and 88mm antitank guns to counterattack the crossing American forces. Once the 37th had cleared the eastern part of the Dieulouard bridgehead, it prepared to continue on to Benicourt, clearing the way for the continued advance of the remainder of CCA while threatening the German positions at Pont-a-Mousson. Joined by the 66th Armored Field Artillery Battalion, the 37th Tank Battalion continued the attack at 1000 hours and cleared Benicourt by noon.

Meanwhile, German troops were moving east rapidly from Pont-a-Mousson toward Chateau-Salins, leaving their artillery behind to continue shelling the bridgehead. The CCA advance in the direction of Chateau-Salins was being made right across the rear of 13th SS Corps combat zone and threatened to cut German communications. In spite of continued German shelling, the remainder of CCA managed to get across the Moselle with only light damage to a few vehicles.

Forward elements of the 37th Tank Battalion proceeded toward Nomeny, but turned to Lixieres, three kilometers south when a cub liaison plane reported a force of German tanks near that location. There, elements of the 553d Volksgrenadier Division had a motor park, guarded with a few SP guns. CCA destroyed half the equipment and the remainder escaped to the south. Nomeny was heavily mined, so CCA bypassed it and moved through Aulnois Sur Seille, surprising and scattering soldiers of a German regimental supply installation and seizing intact a valuable bridge over the Seille River. Likewise at Lemoncourt, CCA surprised considerable numbers of German infantry in a close formation. The tanks, with guns firing, ran through and over them without stopping and few, if any, Germans escaped. At Fresnes, five kilometers west of Chateau-Salins, the 37th Tank Battalion came upon a German replacement battalion, which fled toward Chateau-Salins. Those who failed to escape hid in buildings in town, and were captured later. Around 1700 hours CCA reached the high ground just to the west of Chateau-Salins. Fifth Panzer Army daily summary accurately described CCA action:

"On 13 September, an American armored group made a surprise breakthrough from the bridgehead Dieulouard--Millery via Nomeny, Lemoncourt and Fresnes towards Arracourt and Valhey (on the Chateau-Salins--Luneville road), where contact was established with those American forces which had already advanced via Luneville . . . Chateau-Salins itself remained in our hands."<sup>5</sup>

While the main body of the command was advancing rapidly, two light forces were working on the flanks. Troop D, 25th Cavalry Recon Squadron under Captain Trevor, cleared the town of Benicourt, passed through Clemeney, Aboucourt, Letricourt, and Craincourt, and tried unsuccessfully to take heavily defended Delme. Trevor turned south to Lemoncourt, where he remained for the night. At the same time Captain McMahon led Company D of the 37th Tank Battalion, reinforced with the assault gun platoon of the battalion, east from Lixieres to the Seille River. Because of blown bridges and marshy terrain, he returned to the primary axis of advance at Aulnois and held the town and bridge until relieved by a platoon of Captain Trevor's troop about noon the next day.<sup>6</sup>

Meanwhile, the remaining CCA forces advanced slowly. The 191st Field Artillery Battalion crossed the Moselle around 1500 hours, took up bivouac positions on the east side of the high ground near St. Genevieve, then moved to Fresnes-en-Saulnois for the night. Some of the last elements still were not across the bridge by dark, so they were instructed to remain with the 80th Infantry Division until daylight. The 14th of September was cold, foggy, and rainy. CCA was resupplied from the trains about 0930, and continued its advance. Because of artillery fire coming from Chateau-Salins, a



rather large town of some 20,000 inhabitants, CCA decided to bypass it in its move toward Arracourt. Around noon, the columns turned south toward Chambrey, then turned east, bypassing Vic-sur-Seille, and finally south by trails and secondary roads through Arracourt to Valhey. In Arracourt and Valhey, CCA surprised and destroyed the headquarters of the 15th Panzer Division.<sup>7</sup> Colonel Clarke, in his L-4 oub plane, spotted this headquarters for the 37th Tank Battalion.

When Arracourt and Valhey were cleared, the 37th Tank Battalion headed to the Rhein-Marne canal at Einville and Bauzemont, then swung back east to Ley, where they spent the night. By 1900 hours the entire command had reached the Arracourt area and were disposed to carry out the assigned mission of exploitation: to block the roads of Nancy to prevent the escape of German defenders of that city. Assisting was a medium tank company from the 35th Tank Battalion, plus one infantry company from the 10th Armored Infantry Battalion, sent by the division commander. Troop D of the 25th Cavalry Recon Squadron, now relieved of its mission of guarding the supply routes, moved to rejoin the main body for reconnaissance to the east of Arracourt. CCA was dispersed in the area around Arracourt with companies sent to Xanray, Juvacourt, Moncourt, Rechicourt, and Bezange-la-Petite. Task Force Abrams was located in the vicinity of Moncourt, Task Force Curtis on the highground southwest of Arracourt and TF Jacques blocking route N 74 from vicinity of Chambrey and the high ground southeast of there.<sup>8</sup>

From 15 to 18 September, CCA carried out the exploitation. Strong outposts were established on all main roads from Chambrey on the north to the Rhein-Marne Canal on the south. Small infantry-tank teams made raids on towns in the east to the limit of supporting artillery range. Troop D, 25th Cavalry Recon Squadron provided reconnaissance 15 kilometers to the east of the Moyenvic-Bourdonnay highway. Additionally, they maintained a perimeter defense on the high ground surrounding Arracourt on the south, east and north. The drive to Arracourt resulted in 26 German armored vehicles, 135 unarmored vehicles, and 10-88mm guns destroyed, 230 Germans killed, and 187 captured by the 18th of September.<sup>9</sup>

On several occasions during the advance to and occupation of Arracourt, CCA had to furnish task forces to assist other units. The first of these occurred on 15 September, after CCA arrived in Arracourt, when a counter-attack by the reinforced 553d Volksgrenadier Division in the vicinity of Nancy put pressure on the 80th Infantry Division closing the supply lines. Major Kimsey led a task force of the 1st of the 318th Infantry (which was to be returned to the 80th Infantry Division), and Company C of the 35th Tank Battalion back to Dieulouard.<sup>10</sup> About 1830, TF Kimsey ran into antitank fire near Nomeny, which kept him pinned down through the night. By 1300 hours the next day, (16 September), the task force was successful in retaking St. Genevieve from a determined enemy, but with a loss of 12 men and 3 tanks against 7 enemy tanks destroyed and 150 PWs taken.<sup>11</sup> Company C, 35th Tank Battalion, after assisting the 80th Division in an

attack toward Pont-a-Mousson, returned by way of a circuitous route west of Nancy to Luneville.

A second task force of the 37th Tank Battalion was sent to the Rhein-Marne Canal to assist CCB (see map 8)<sup>12</sup>. CCB had moved under friendly artillery fire from Vaucouleurs across the Moselle river near Bayon to Crantenay, and then moved south around Nancy where they blocked retreating Germans with tanks and antitank guns. CCB attempted to cross the Rhein-Marne Canal in the vicinity of Maixe and Somerviller but stiff German resistance prevented them from doing so. Because of this resistance Division Headquarters ordered CCA to clear the north bank of the canal to assist Combat Command B in its crossing. After clearing the woods west of Einville, and firing on Athienville, Serres, and Drouville, the CCA task force linked up with CCB's 8th Tank Battalion west of Drouville at Haraucourt late in the morning. When the clearing operation was completed, CCB moved north, took up positions in the vicinity of Fresnes on the high ground west of Chateau-Salins, and the CCA task force returned to Arracourt.<sup>13</sup>

A third CCA task force (TF Hunter) was used to assist CCR at Luneville.<sup>14</sup> CCR, consisting of the 696th Armored Field Artillery Battalion, the 489th AAA Battalion (-) less Companies B and C, the 35th Tank Battalion less Companies B and C, and the 704th Tank Destroyer Battalion, had moved across the Moselle river to Crantenay, then occupied Luneville on

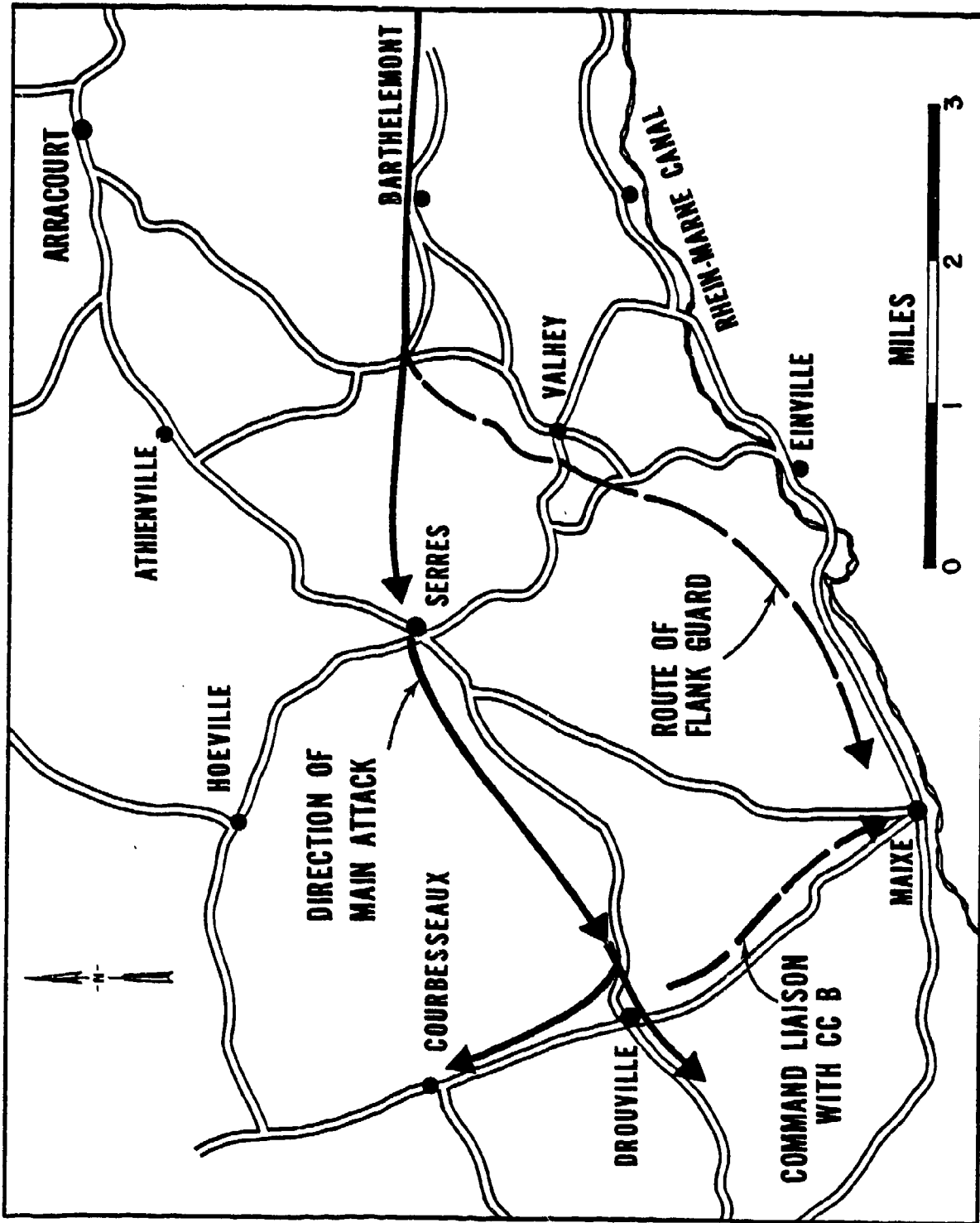

Map 8 - 37th Tank Battalion attack on 16 September to assist CCB over Canal

16 September after the 2d Cavalry Group had come under heavy fire from the German 11th Panzer Division.<sup>15</sup> Two troops of the 2d Cavalry Group, commanded by Colonel C. H. Reed, had tried on 15 September to enter Luneville from the south, but had been beaten off by the advance guard of the 15th Panzer Grenadier Division, LVIII Panzer Corps. T/4 Eugene Fehr, radio operator in one of the armored cars of the 2nd Cav Group, remembers it well:

"Something gave the M-8 a helluva jolt and my driver looked at me and yelled that he couldn't steer any more. We climbed out, saw that an 88 had blown off our right front wheel, and immediately dived into a ditch alongside the road. We were no more than on the ground when a second 88 drilled the car right through the middle. After that we did just what the rest of the dismounted men were doing--ran!"<sup>16</sup>

When CCR entered the city from the northwest on 16 September, the 42d Cavalry Squadron also returned. Sergeant James Hart's section of 1st Platoon, Troop B, 42d Squadron, occupied the high ground on the west side of the Muerthe River and watched a German armored column stream up the main road heading toward Luneville. They fired on groups of Panzer grenadiers who suddenly came into view 100 feet from his position. They killed the commander of a threatening tank, which subsequently withdrew. This section was separated from its unit for four days.<sup>17</sup>

The 35th Tank Battalion played a prominent role in the battle of Luneville. At 1300 hours on the 16th, the 35th Tank Battalion was alerted to move to the vicinity of Luneville where it took up positions at 1430 hours in Deuxville just as CCR pulled into position for an attack on

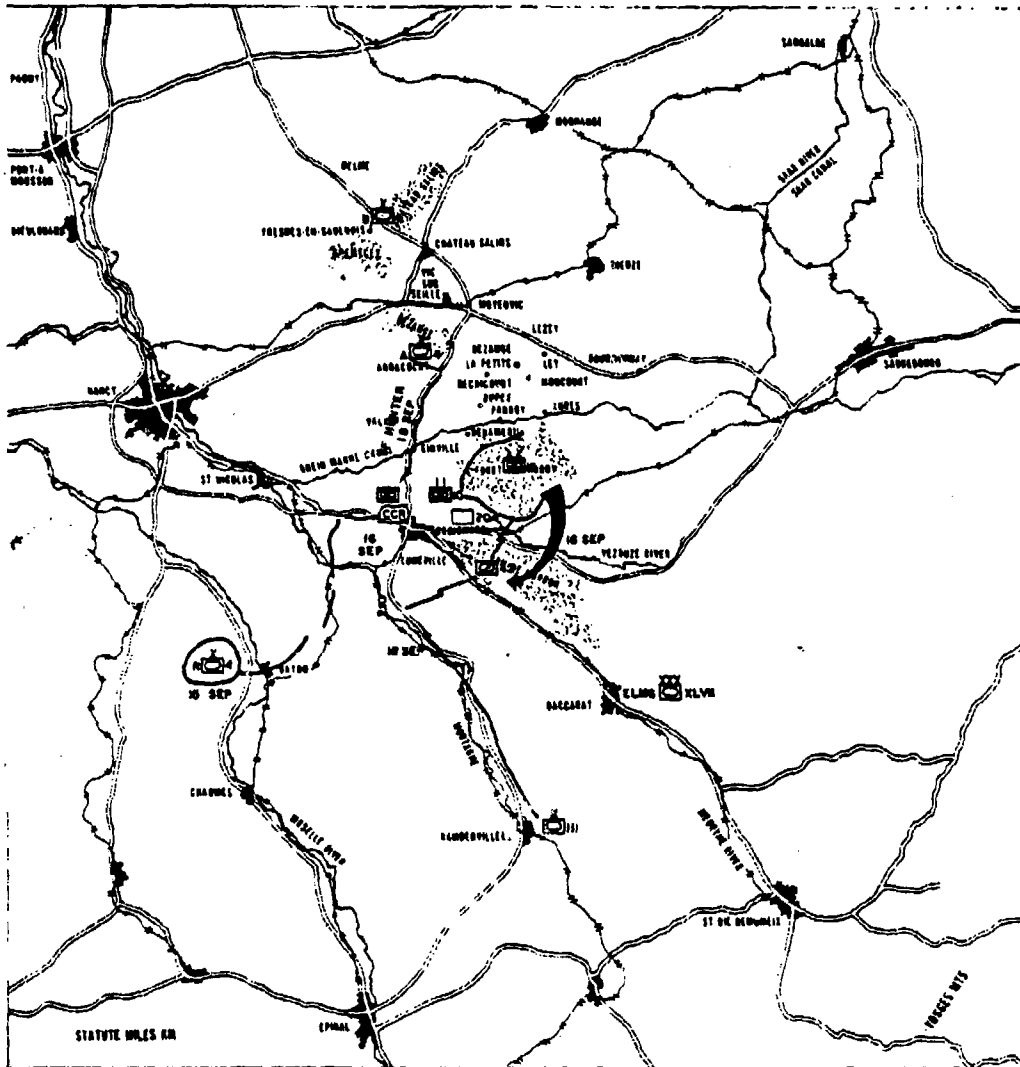

Map 9 - CCR to Luneville, 15-18 September 1944

Luneville. The 704th Tank Destroyer Battalion (-), consisting of the Headquarters and Company B, bivouacked 1445 hours, one and a half miles southeast of Luneville where they protected the left flank of CCR.<sup>18</sup> When informed that friendly troops already occupied the city, the battalion then took up positions on the high ground northwest of Luneville. Soon after their arrival, the 35th Tank Battalion beat off a German attack, destroying two half tracks and three antitank guns. On the 16th, the Germans lost 75 killed and 18 PWs. The 35th lost two men killed and 15 wounded and one medium tank destroyed.

German records clearly show their preparation for an attack on Luneville. At 2140 hours on 16 September, General Blaskowitz sent a message to General Manteuffel, commander of the Fifth Panzer Army, directing the attack against Luneville. The coordinated armor attacks were to be launched from an area north of Epinal on both sides of the Mortagne River in the direction of Luneville to eliminate the American penetration. They were to throw the Americans back onto the west bank of the Moselle and anchor their own position on the east bank. Units to be committed at Luneville included the 111th, 112th, and 113th Panzer Brigades and the 21st Panzer Division, arriving no later than 18 September. They were to continue on to Pont-a-Mousson. Blaskowitz also indicated that the 11th Panzer Division was not expected to be there on time. The XLVII Panzer Corps, coming from Baccarat, was to be attached to the Fifth Panzer Army effective 0600 on 17 September and to take up positions on the western edge of Forêt de Parroy.

Lastly, he was told that if all elements of the 113th Panzer Brigade were not on hand by the time the attack commenced, they should march without them. Here, then, is an excellent example of piecemeal commitment of troops. On the 17th of September, outpost troops northeast of Arracourt successfully resisted American attacks from Jolivet and the southeast edge of Forêt de Parroy. One platoon of Company A, 35th Tank Battalion, attacked German positions at Jolivet, knocking out two antitank guns and losing one tank. Company D, 35th Tank Battalion, made a rear sweep in the direction of Bondillers and the southeast. Although it received heavy artillery fire, it knocked out one antitank gun, one half track, killed an unknown number of enemy, and captured 15 prisoners of war from the reconnaissance battalion of the 15th Panzer Division.<sup>19</sup> Total German casualties of the 17th were three antitank guns, 75 killed, 81 PWs, one half track, and a half track probable. U.S. casualties were two killed, 15 wounded, and one medium tank destroyed.

Meanwhile, the Germans filtered into Luneville and there engaged the FFI and the small American contingent. On the night of 17 September, the 15th Panzer Grenadier Division had so many men left in the city that a German agent informed Luettwitz, commander of the XLVII Panzer Corps, that the Americans had left.<sup>20</sup> However, this was not the case as the Americans were mostly situated north and west of the town. The Americans did not seriously consider an armor threat building in the south, even though they had learned from prisoners that tanks were being loaded around St. Die. An



entry in the Third Army Journal of 12 September indicated enemy armor buildup at Epinal.<sup>21</sup> General Eddy noted in his diary on 15 September that another armor counterattack was possible.<sup>22</sup> Colonel Reed had reported this buildup on 15 September, but was told that the German armor would be used against 7th Army, to the south of the Third Army sector.<sup>23</sup> Although this threatened Patton's exposed flank, he felt he would resume his advance to the West Wall at any time, and thus not have to decisively engage the Germans.

On 18 September, Battle Group von Luetwitz (comprising elements of XLVII Panzer Corps) was scheduled to depart at 0600 hours from Baccarat to Luneville for the counterattack. (See map 10.) The 113th Panzer Brigade, in spite of severe vehicle and fuel shortages, was told to attack at 1100 hours in conjunction with the other elements, which were already en route. The 11th Panzer Division, meanwhile, had been moving up from the south through Rambervillers and Baccarat to Ogerviller. On 17 September they closed in the sector in front of Luneville and massed their tanks. The German buildup involved attempted concentration of a large number of units: Fifth Panzer Army assembled LVIII Panzer Corps (11th Panzer Grenadier Division and 113th Panzer Brigades), the XLVII Panzer Corps (111th and 112th Panzer Brigades and 21st Panzer Division), as well as portions of the 2d Panzer Division, the 130th Panzer Lehr Division, and the remainder of the 16th Panzer Division and the 102d and 106th Panzer Brigades. Thus the 300 tanks under Fifth Panzer Army control represented the greatest concentration

of German Panzers since the Germans had stopped Montgomery's 21st Army Group at Caen. This was to be the beginning of a major offensive against America's Nancy salient and an attempt to stabilize the line along the forts of Belfort, Epinal, Nancy, and Metz.<sup>24</sup>

Not all of these forces were available, however, at daylight on the 18th, when the Germans counterattacked against Luneville from the southeast. This force consisted of at least 40 vehicles, 15 tanks and about 200 infantry, including at least 15 Panzers and about 200 infantry of the 111th Panzer Brigade of XLVII Panzer Corps. This initially caused a withdrawal of the 2d Cavalry Group through Luneville.

Reaction to the German attack was swift. At 0900 hours on 18 September, Company A, 35th Tank Battalion was alerted for a move to the southeast of Deuxville in defense of Luneville against the counterattacking Germans. Colonel Oden arrived in town at 1100 hours and established a CP in the cellar of a house in the center of the town. At 1415 hours, the remainder of the 35th Tank Battalion moved to a new location one half mile northeast of Deuxville. Elements of the 2d Cavalry Squadron reinforced CCR on the east edge of town. CCR withdrew from the southeast portion of town but continued to hold the center and northern portion of the city. They prepared bridges on the west and north end of the city for demolition.

During this period, the 3d platoon of Company B, 704th Tank Destroyer Battalion, moved to Luneville in order to outpost the city against German

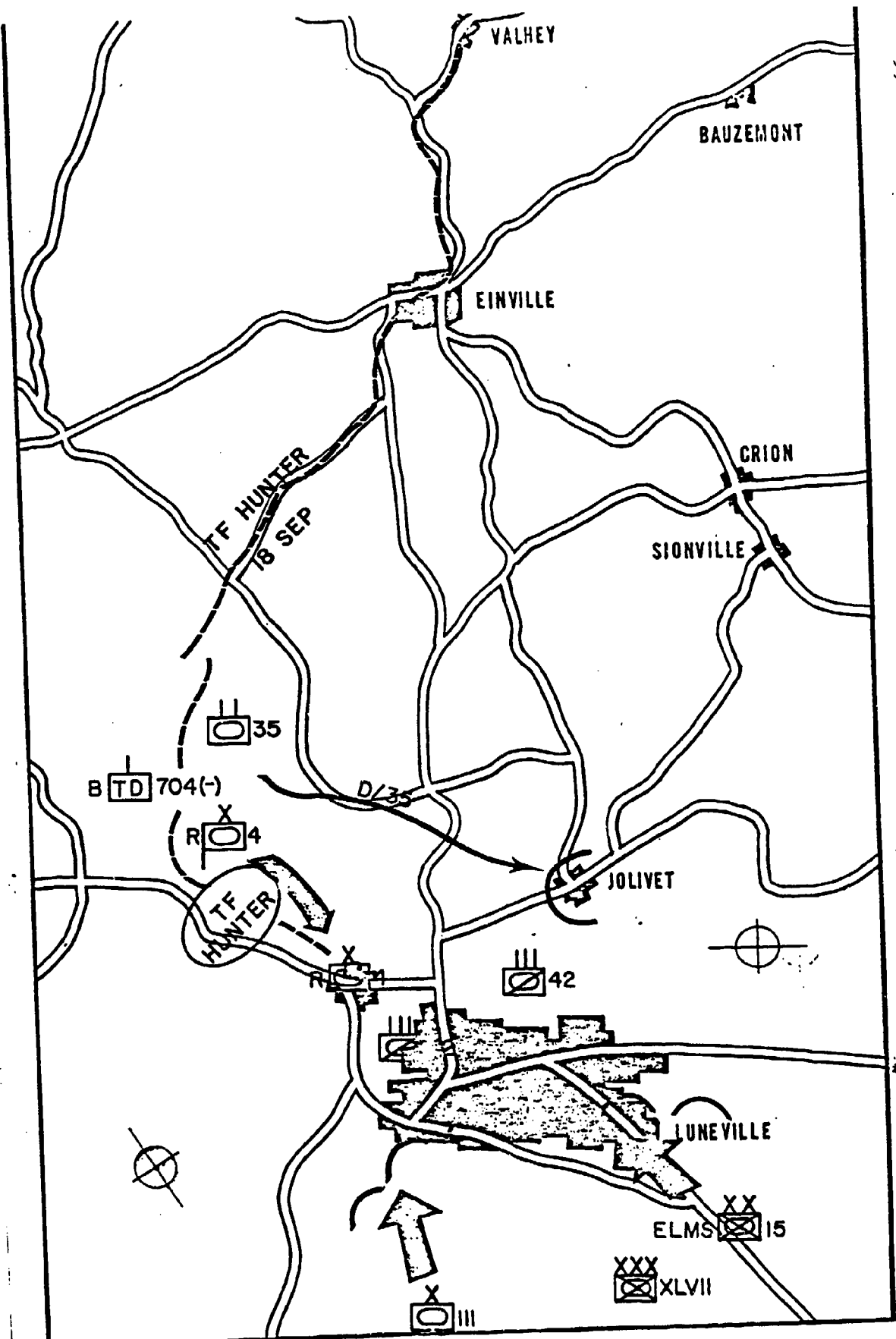

Map 10 - Battle of Luneville - 18 September 1944

MAP 10

marching columns approaching from the east. The 1st platoon of Company B, 704th, was given the mission of supporting the 10th Armored Infantry Battalion, located on the high ground north of the city.<sup>25</sup> To assist the CCR in driving off the German attack, Division ordered CCA to reinforce the CCR with a minimum force of one medium tank company, one infantry company, one field artillery battery, and a platoon of tank destroyers. TF Hunter began moving to Luneville about 1300, consisting of Company A, 37th Tank Battalion; Company B, 53D Infantry Battalion; Battery "C", 94th Armored Field Artillery Battalion; and 1st Platoon, Company E, 704th Tank Destroyer Battalion, 7th, and 1/E/704.<sup>25</sup> General Eddy then detached CCB, 6th Armored Division which had just closed to support the 35th Division east of Nancy, and started it for Luneville. At 1600 hours, TF Hunter arrived to reinforce CCR. Company C, 94th Armored Field Artillery was tied in by survey to the other supporting artillery, but fired direct support missions for the infantry and tank companies. Lieutenant Truitt, from his observation post in a house in town, fired on antitank guns and German vehicles during the street fighting.<sup>27</sup> Artillery fires from the 273d and 738th Field Artillery Battalions of 183d Field Artillery Group, forced the enemy back behind the railroad tracks in the southeast corner of the city, just as it was beginning to get dark.

TF Hunter moved to assembly areas in the vicinity of Hill 341 northwest of Luneville. Bravo/166th Engineer Battalion supported CCR, joining it at Deuxville. Elements of the 10th Armored Infantry Battalion of CCR entered

the city without resistance about 2000 hours simultaneously with the 42d Cav Reconnaissance Squadron, which entered from the south. The Germans left to seek shelter in the Foret de Parroy. Elements of the 10th Armored Infantry Battalion of CCR and the 704th Tank Destroyer Battalion (-) of TF Hunter established contact with one another established outposts northeast of the city against enemy forces in Jolivet and the Foret de Parroy. The remainder of CCR bivouacked northwest of Hill 341.<sup>28</sup>

The German account of Luneville battle corresponds closely to the 4th Armored Division narrative: The 111th Panzer Brigade of the XLVII Panzer Corps attacked Luneville from the south at 0750 and by afternoon was in the southern part of the city. According to locals, the German force numbered 40 Panzers and 40 half tracks supported by heavy artillery fire.<sup>29</sup> (This came from the artillery in the northern part). Prior to the arrival of TF Hunter, General Blaskowitz intervened and ordered Manteuffel to press the attack and take Luneville. A combined assault by the 111th Panzer Brigade and 15th Panzer Grenadier Division Detachments forced CCR and the 2d Cavalry back into the northern part of the city. At 1615 hours on the 18th, higher headquarters was informed that because of the 15th Panzer Division success under Luettwitz, further involvement of the 113th Panzer Brigade located north of the Vezouse river (east of Luneville) was no longer required. The 113th Panzer Brigade was given the mission to head north and to operate in the southern Dieuze area. LVIII Panzer Corps assumed that because of no further reports of enemy action, the Americans had been pushed northwest out

of Luneville, which was incorrect. The Germans only reported that all U.S. counterattacks during the day were repulsed. At night, Manteuffel ordered the 11th Panzer Brigade to disengage and proceed to an assembly area at Parroy north of the canal, for continuation of the general advance.

U.S. reaction to this counterattack was mild. General Eddy received a report of 12 tanks and two companies of infantry coming from the south toward Luneville. When General Patton came to the XII Corps Headquarters at 1630 hours, he didn't seem very much concerned about the situation. He was more concerned with the XII Corps attack against the West Wall than with the Luneville situation. On 18 September he wrote in his journal:

We got a message . . . that two columns of (German) infantry and tanks were attacking Luneville . . . I left at once for Nancy to see Eddy. He was a little worried, but not badly, so he is sending a combat command of the 6th Armored Division to stop the counterattack. It is just as well that I got this unit up last night. The attack by the XII Corps against the Siegfried Line (West Wall) will go as planned in the morning, (German) counterattack or not . . ."30

Infantry of the 53d Armored Infantry Battalion and tanks of the 35th Tank Battalion of CCR succeeded by nightfall in driving most of the Germans from the city. By nightfall dispositions were as follows: the 10th Armored Infantry Battalion (-) (CCR) held the high ground northeast of Luneville, the 35th Tank Battalion (-) (CCR), along with service elements was in the vicinity of the city holding bridges and supporting the infantry company of the 53d Armor Infantry Battalion (TF Hunter). Company D, 35th Tank Battalion (CCR) was located behind Hill 341 with tanks facing south. The

704th Tank Destroyer Battalion (TF Hunter) had elements with the 10th Armored Infantry Battalion (-) (CCR), with the remainder, (one platoon), in dug in positions east of Hill 341, and Company A, 37th Tank Battalion (TF Hunter) in reserve west of Deuxville.<sup>31</sup>

The fighting continued through the night and into the morning 19 September. East of Luneville, the 3d Platoon of Company B fought all night and destroyed three Mark V tanks. CCR remained in position until relieved by elements of CCA, 6th Armored Division. By 1600 hours on the 19th, after receiving artillery fire, CCR was relieved from the Luneville area approximately 1800 hours and marched north with Headquarters, 704th, at 1930 to an assembly area twelve miles north to the vicinity of Serres. CCR arrived around 0300 hours on the 20th, and remained there until 30 September.<sup>32</sup> During the fighting in Luneville (16-19 September), the Americans destroyed 13 tanks, 16 large caliber guns, and 232 miscellaneous vehicles. 1070 Germans were killed or captured. CCR casualties during the same period were 3 killed, 15 wounded and 4 tanks destroyed.<sup>33</sup>

Luneville was won largely by teamwork. Early warning and the vigorous delay by an alert cavalry unit broke the forward momentum of the Germans and gave the reinforced CCR the opportunity to drive them back. As the emphasis shifted from Luneville to Chateau-Salins, Luneville ceased to be a point of concentration for the Germans. Once the 6th Armored Division relieved the CCR and TF Hunter of CCA, the fighting continued at a low level, but the

emphasis now shifted to Arracourt, as CCA prepared to meet elements of Fifth Panzer Army. German intentions appeared in an entry on the log of the German high command of the German Group G Headquarters, which gave the Fifth Panzer Army a new mission.

The later attack from Luneville will not be in the (northerly) direction of Chateau-Salins, but in a north-westerly direction toward Nancy, to link up with the 553d Division, in order to attack the enemy located to the south of Chateau-Salins. Whether we first clean up the east bank of the Moselle between Nancy and Charms, or up to Pont-a-Mousson depends on the enemy situation. The objective must be to win back the Moselle line. 11th Panzer Division will be released from Nineteenth Army during the night of 18-19 September and will be attached to the LVIII Panzer Corps...<sup>34</sup>

The battle focus now shifted to Arracourt, where there would be bitter fighting for the next two weeks.



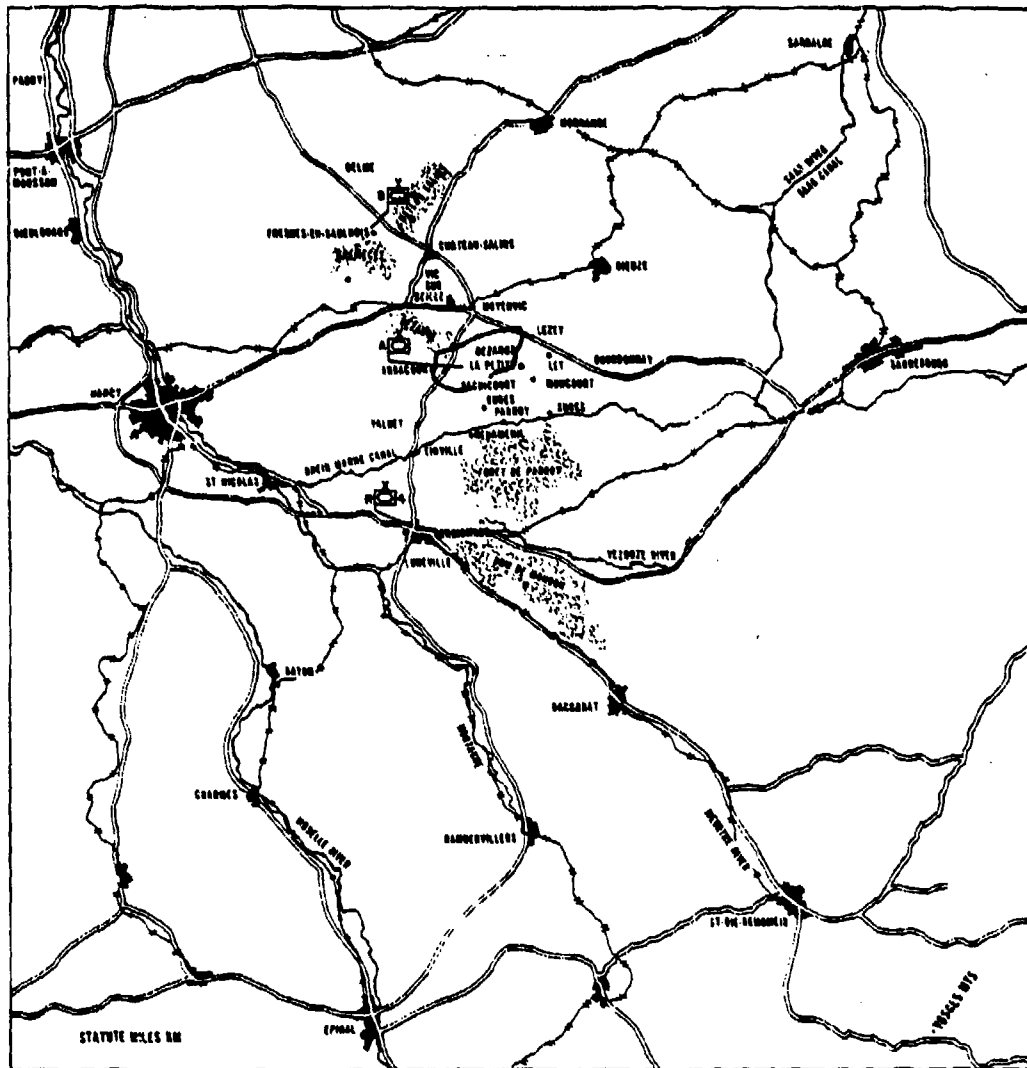

Map 11 - Disposition of 4th Armored Division, 18/19 September 1944  
 -68-

## CHAPTER 3

### FIRST ARRACOURT TANK BATTLE, 19-22 SEPTEMBER 1944

The first Arracourt battle took place from 19 and 22 September between Combat Command Alpha (CCA) of the 4th Armored Division, Third U.S. Army and the 111th and 113th Panzer Brigades of the LVIII Panzer Corps, Fifth Panzer Army.

At 0030 on 18 September General Wood of 4th Armored Division directed that CCB move to an assembly area near Delme in preparation for the advance to Saarbrücken, and CCA to move out from the Arracourt area along the center road in the XII Corps zone and by secondary road on the south flank toward Sarreguemines.

CCR, when relieved by CCA of the 6th Armored Division, would follow. On the night of 18 September, the 4th Armored Division was deployed as follows: CCR having beaten off an attack at Luneville, was relieved by CCA of the 6th Armored Division.

CCB, having crossed the Rhein-Marne Canal, was ready to continue the advance.<sup>1</sup> CCA, minus Task Force Hunter, was assembled about 12 miles southeast of Arracourt.<sup>2</sup> The division artillery CP was on the southern edge of CCA's almost circular defense as were most of the artillery units.

The sector assigned to CCA extended 15 kilometers from Chambrey south towards the Rhein-Marne canal. The protection of the north flank between Chambrey and Arracourt was the responsibility of the 53d Armored Infantry Battalion reinforced with a company of medium tanks (Company B, 37th Tank Battalion). Another medium tank company, Company C of the 37th Tank Battalion, was the combat outpost at the crossroad at Lezey, about four or five miles northeast of Arracourt. CCA headquarters, the attached field artillery, the division artillery CP, and a platoon of tank destroyers assembled in and around Arracourt. The attached engineers held the south flank, while the 25th Cavalry Squadron was screening to the north and east of Arracourt.<sup>3</sup> (See map 12.)

During the night of 18 September, CCA received the additional mission of protecting the city of Nancy. Reports from air observers and CCA ground reconnaissance patrols stated that elements of a German panzer division, the 11th Panzer Brigade, and units of the 15th Panzer Grenadier Division were concentrating to the southeast of Arracourt<sup>3</sup>. XII U.S. Corps thought the Germans were preparing an attack against the bridgehead at Nancy; hence, the additional mission for CCA.

The Germans were to use the 11th and 13th Panzer Brigades in the first Arracourt battle. The 11th Panzer Brigade had been involved in the attack in Luneville and was located southeast of Luneville.

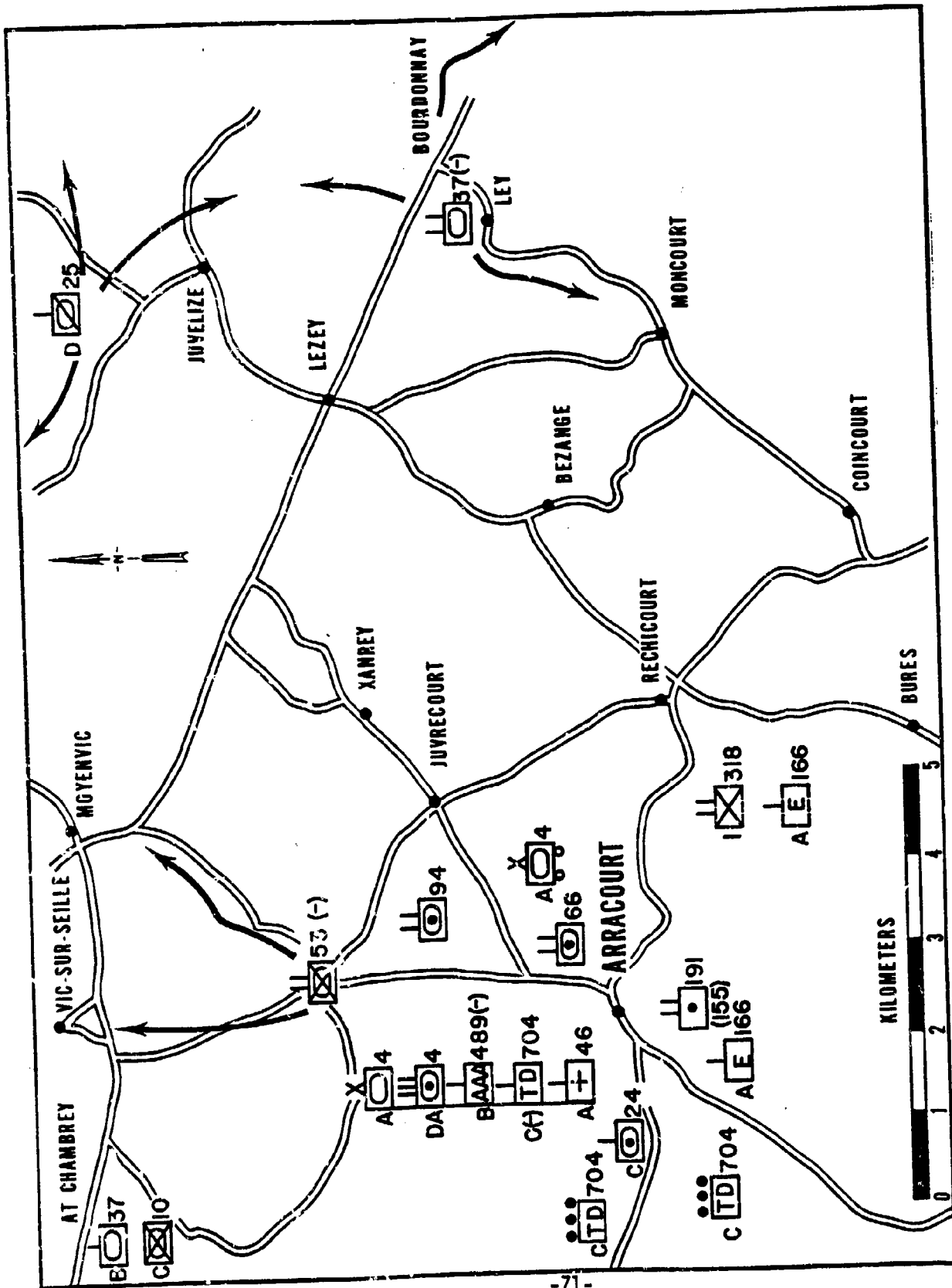

Map 12 - Disposition of CCA, 4th Armored Division, 18/19 September 1944

The 113th Panzer Brigade north of the Vezouse River was not required in the Luneville battle. Thus, the 113th Panzer Brigade was to be sent north and assembled in the area of Dieuze for a new mission.<sup>4</sup>

Later on 18 September, the LVIII Panzer Corps Commander (Krueger) asked the S3 of the Fifth Panzer Army what mission the Corps was to have when the 113th Panzer Brigade reached Marainviller, 12 kilometers east of Luneville. His message read:

"If there is no answer from Army, Corps will send 113th Panzer Brigade north at 1800 hours, in order to lead over the bridge Moussey into the area south Dieuze." (Fifth Panzer Army agreed.)<sup>5</sup>

#### The German Attack - 18 September

At 1800 hours on 18 September, LVIII Panzer Corps informed the 111th Panzer Brigade to move north. At 2015 hours, Manteuffel commanded the LVIII Panzer Corps commander to move the 111th Brigade over the Vezouze River bridge by Croismare, and attack to the west,<sup>6</sup> in order to link up with the surrounded 553d Jaeger Division at Nancy. Battle group von Luettwitz,<sup>7</sup> on the left flank, was to attack through St. Nicholas and also make contact with the 553d Jaeger Division. The 113th Panzer Brigade assembled in northwest Blamont, and moved in two battle groups toward the west. The northern battle group linked up with the 15th Panzer Grenadier Division and the southern group reached Marainviller with only light enemy

resistance. The 113th Panzer Brigade was to travel by way of Moussey, assemble in Dieuze, and join the 15th Panzer Grenadier Division, in an attack to the north. The attack would begin on the 19th at 0800 hours.

Later that night, Fifth Panzer Army gave the 113th Panzer Brigade, a new objective--Champenux--situated to the west.<sup>8</sup>

U.S. units did not expect the LVIII Panzer Corps' advance. Although 30 German tanks (2d Panzer Battalion of the 111th Panzer Brigade) had attacked east of Luneville, U.S. reinforcements there seemed to have the battle under control.<sup>9</sup>

However, isolated incidents in the Arracourt area gave warning of increasing German activity. The 25th Cavalry Reconnaissance Squadron captured five prisoners during the night as they reconnoitered north and east of Arracourt. The prisoners told them of German intentions. At 2330 hours on the 18th, Lieutenant Berard's Company C (37th Tank Battalion) outpost two kilometers east of Lezey reported a column of tanks moving along the road west toward Lezey and the outpost, and finally bivouacking at Ommeray. Lieutenant Berard reconnoitered with a few men and found tank tracks leading off the road. At the battalion CP, Captain Crook of the 94th Armored Field Artillery Battalion, planned to fire on the Germans. The assault guns were laid on the crossroads, ready to fire. Lieutenant Harris, with a section from the reconnaissance platoon, went out to try to get information on the Germans and captured four additional PWs.<sup>10</sup>

At 0130 hours on the 19th, the 94th Armored Field Artillery Battalion fired on the road junction, causing the German units to move from their bivouac. As the German tank column retreated, the assault gun platoon, which had registered on the road just north of Ley, opened up as it passed through the road junction. No one made a damage assessment that night.

The morning of 19 September was foggy. The 111th Panzer Brigade, less one battalion and a battery of assault guns and marched by way of St. Clement toward a new assembly area north of Parroy, where they were to linkup and support the 113th Panzer Brigade in its drive west.<sup>11</sup>

The 113th Panzer Brigade left the Bourdonnay area just after midnight, had and started toward Champenoux. The 58th Reconnaissance elements of the LVIII Panzer Corps were out in force, keeping track of U.S. movements. They reported that Americans occupied Moncourt, Ley, and Lezey.<sup>12</sup>

American reconnaissance elements were also active. In the morning, reports of German activities started to come in early. A German PW (motorcyclist) reported 21 Panzer tanks travelling from Ley to Lezey. Although the 25th Reconnaissance Squadron reported this information, it was impossible to strengthen the eastern defenses. There were no units available.

The light tank platoon of Staff Sergeant Mallon outposted at Moncourt made first contact. When five Panzer V tanks appeared Sergeant Mallon began

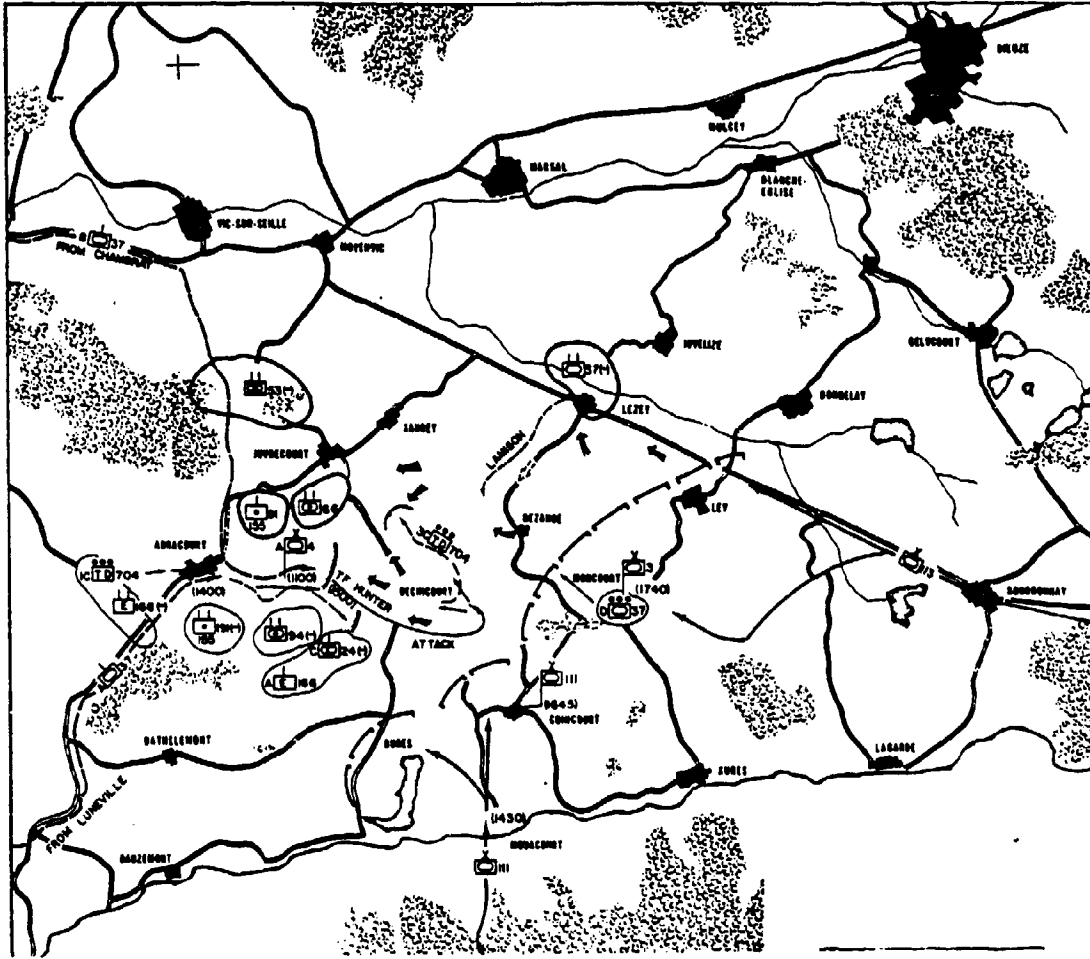

Map 13 - LVIII Panzer Corps Attack, 19 September 1944



a delaying action, falling back across country to Bezange-la-Petite and then up the road to Lezey and the 37th Battalion CP.<sup>13</sup>

The 113th Panzer Brigade (with 42 Panzer V tanks of which 37 could fire)<sup>14</sup> hindered by heavy fog continued its advance on a broad axis toward Bezange la Petite and Champenoux. Because of excellent wire communications, and despite poor visibility, Lieutenant Smith's C Company outpost near Lezey was able to provide timely warning to his platoon, so that two German tanks were knocked out as soon as they came into view.<sup>15</sup>

About 0700 hours on 19 September, just south of Lieutenant Smith's outpost, Captain William A. Dwight, a liaison officer was driving down the road near Bezange-la-Petite, on a routine liaison run north from Combat Command Alpha to the 37th Tank Battalion. Before reaching Bezange-la-Petite, he heard firing at Lieutenant Smith's outpost and called Colonel Abrams on the radio, informing him they were firing at German tanks. When Colonel Abrams told him to get out of there, Dwight returned to CCA where Colonel Clarke gave him a platoon of four tank destroyers to provide protection for the combat command from the west. Dwight then led the platoon of tank destroyers back to the firing.<sup>16</sup>

An eye witness report describes the action;

About 0730 of the 19th of September Lieutenant Webb, the communication officer of CCA, rushed into Lieutenant Leiper and told him to alert his platoon

immediately but could offer no explanation as to the reason for the emergency. A short time later, Captain Dwight, a liaison officer from the 37th Tank Battalion hurried in and asked if the platoon was ready. By this time Lieutenant Leiper was sure something big was up, and his thoughts were confirmed with the arrival of Colonel Clark, CCA commander, who ordered the platoon to follow Captain Dwight to a certain hill 279 and take up positions there as an outpost . . .

Lieutenant Leiper and his platoon followed Captain Dwight on the road to Rechicourt. It is interesting to note that Lieutenant Leiper, as platoon leader, did not ride in the tank destroyer, but rode at the head of his platoon in a jeep. This type of guidance had been decided upon by the tank destroyer battalion commander in England who had reasoned that it gave the platoon leader a better chance to direct the actions of his five tank destroyers; whereas, if he were squeezed in one of the tank destroyers he would be more apt to fight the one tank destroyer rather than the five.<sup>17</sup>

When Dwight reached Rechicourt, he came under enemy fire. Lieutenant Leiper thought it was direct fire, but the rain and fog made it impossible to determine exactly the source. The platoon continued through Rechicourt, then turned off the main road and started north on a narrow lane for about 1000 yards to the vicinity of Hill 246. There they went cross-country up toward Hill 279 with woods to their front and right. When they got close to the hill, Lieutenant Leiper, who was still leading the formation with his jeep, was startled to see the muzzle of a German tank sticking out through the trees at very close range.

He immediately gave the dispersal signal and the many months of continuous practice proved its worthiness as the platoon promptly deployed with perfect accord.

The lead tank destroyer, commanded by Sergeant Stacey, had evidently seen the German tank at the same time as Lieutenant Leiper, and opened fire immediately. Its first round scored a direct hit, exploding the German tank. The flames of the burning tank revealed others behind it in a V-formation, and Sergeant Stacey's next round hit the second German tank but immediately afterwards he had his own tank destroyer knocked out by fire from a third German tank. This enemy Mark IV was taken under fire by the number two tank destroyer, and was destroyed. The maneuver and fire of the third tank destroyer got another German tank as it tried to back out of the unhealthy situation, and a fifth enemy tank was destroyed almost immediately thereafter.<sup>18</sup>

This exchange of fire took just a few minutes, during which time they destroyed five German tanks while sustaining the loss of one tank destroyer. When the shooting had stopped, Lieutenant Leiper ordered the platoon to sweep the entire area to ensure all enemy tanks were out of action and to be certain that no more were there.

The platoon then withdrew about 500 yards to a position behind a small rise. Security sections were posted around the perimeter and the damaged tank was placed in defilade. The disabled tank was sent back under its own power so that the injured could get medical care immediately. The assistant driver had been instantly killed and the others except the gun sergeant had been wounded by the ricocheting shell.

The tank destroyers were placed in position oriented on the enemy. Fog and rain made reconnaissance difficult. A participant recorded:

Shortly after returning, they returned to the platoon defense area, Lieutenant Leiper and some of his men saw a number of tanks moving on the crest of a hill some 2500 yards away in the area between Bessingen and Rechicourt. They were able to see them because the fog was confined to the valleys and low spots. Because it was known that the 1st tank destroyer platoon of Company C was in the area, fire was withheld initially. However, when the sixth tank was counted it was obvious that they must be German, and the platoon opened fire. Either four or five of the tanks (they were Mark IVs) were knocked out. At this time the attached field artillery battalion under Lieutenant Colonel Parker opened fire on the tanks who were accompanied by infantry, and the enemy was dispersed.

More time of tense waiting went by. A liaison plane was seen overhead dodging in and out of the clouds. The plane was that of Major Carpenter, who had figured out a method of attaching bazookas to the wings. They saw him dive behind them into the fog and fire his bazookas.

The flash from the exploding bazooka shells revealed three German tanks that had obviously circled around the 3d platoon and were making their way up the back of the hill to their positions.

Lieutenant Leiper pulled a tank destroyer around and brought its fire on the tanks destroying two of them before the third one's fire hit the right sprocket of the tank destroyer knocking it out of action. Lieutenant Leiper signaled for another tank destroyer to come up with a tow to pull the damaged tank destroyer back, but before the plan could be put into action the second tank destroyer was also hit--this one through the gun shield. It was reported that most of the tank destroyers that were destroyed were knocked out by hits on the gun shield, and it was thought that this was probably due to the fact that the gun blast made it a good target point.

Lieutenant Leiper then pulled back his one remaining tank destroyer.<sup>19</sup>

Thus, Lieutenant Leiper's platoon was able to destroy nine tanks of the 29 scored for the battalion, but at a loss of three tank destroyers. It

should be noted that Company C, 37th Tank Battalion, was the only medium tank company at the disposition of the battalion commander at this time. (Company A was in Luneville with Task Force Hunter, and Company B was in Chambrey with the 53d Infantry Division.)<sup>20</sup>

At midmorning, when the Panzers of the 113th Panzer Brigade turned away after the abortive attack at Lezey, Captain Lamison led a platoon of four tanks from C Company and took up a position on a commanding ridge west of Bezange la Petite, some 3000 yards away. Lamison arrived a few minutes before the German tanks appeared, and proceeded to knock out four of the German tanks before they could return fire. Captain Lamison then withdrew over the crest of the ridge, moved south a short distance, and destroyed the remaining Panzers, for a total count of eight destroyed.<sup>21</sup> With his roving platoon, Captain Lamison, in a series of moves from Ley Moncourt, worked back and forth where the German tanks appeared, securing the whole southern and eastern front of the battalion. Until other elements of the battalion arrived, Company C alone knocked out 12 German tanks.<sup>22</sup>

In the late morning, the 113th Panzer Brigade advanced west between Lezey and Moncourt toward Rechicourt-la-Petite and attempted to drive around the town, first to the north and then to the south. American artillery, tanks and tank destroyers inflicted severe losses on German armor. A platoon of tank destroyers from the 70<sup>th</sup> Tank Destroyer Battalion netted eight panzers and succeeded in driving the rest of a German tank company

back in flight.<sup>23</sup> General Patton visited the battle area, and was able to see the action first hand.<sup>24</sup>

Meanwhile, Task Force Hunter in Luneville heard of the attack upon the battalion by way of an intercepted radio message in the S-1 tracked vehicle. General Eddy, XII Corps commander, who was present, granted a request for Hunter's release to return to Arracourt. An entry from his diary reads:

"Drove into Luneville, saw Reed (commander of CCB, 6th Armored Division) who was effecting the relief of elements of CCR of the 4th Armor. While I was there, a major (Hunter) came in and said the south column of CCA was being attacked by tanks and that the request had come down that the medium tank company in Luneville be returned as soon as possible. I talked with Reed and the commander commanding the forces in Luneville and we decided this could be effected immediately. I told the major to take his tanks and get on up to CCA . . ."<sup>25</sup>

This release from CCR came approximately 1100 hours. Leaving only Bravo of the 53d Armored Infantry Battalion at Luneville, Hunter hurried back to arracourt, remembering Colonel Abrams' radioed words: "Dust off the sights, wipe off the shot and breeze right on through."<sup>26</sup>

The Germans were having difficulty, however. At 1130, General Krueger of the LVIII Panzer Corps noted that the left wing of the attack planned to cross the Moyenvic/Arracourt road, but the right wing was being held up at Lezey due to considerable strengthening of U.S. forces.

American aggressive action continued. TF Hunter returned to Arracourt in the early afternoon, picked up Companies A and B about 1400 hours (Company B had just been released from the 53d Infantry at Chambrey in repulsing an attack on CCA), dropped off the artillery and linked up with Captain Dwight at 1400 hours one mile northeast of Rehicourt. The force assembled to the southwest of Rehicourt with Company A on the left, B on the right, then attacked east. Company A hit the Germans head on, opening fire at 400 yards. Lieutenant Turner's platoon turned full left, smashed into the Germans on the flank, opening fire at a range of 250 yards. Company B on the right came up on the other flank and finished off the rest of the German unit. Together Companies A and B knocked out eight tanks and an estimated 100 infantry, with Lieutenant Turner claiming five tanks for his own gun. U.S. losses were just three tanks.<sup>27</sup>

The Germans might have had greater success had the 111th Panzer Brigade linked up earlier with the 113th Panzer Brigade at Parroy. The 111th Panzer Brigade had been misoriented by one of the military police route guides who said the Vezouze River bridge at Croismare had been destroyed, thus delaying their arrival in Parroy until 1430. As the day ended, the 113th Panzer Brigade spent the night at Moncourt and the 111th Panzer Brigade at Coincourt, with LVIII Panzer Corps headquartered at Langenburg.<sup>28</sup>

Additional U.S. reinforcements were on their way to Arracourt. From a position one half mile northeast of Deuxville, the 35th Tank Battalion was

relieved of attachment to CCR at Luneville and sent to join CCA of the 4th Armored Division at Arracourt. The battalion bivouacked in the vicinity of Arracourt at about 2000 hours, and prepared to move to Sarreguemines at 0800 hours on 20 September to facilitate CCA's drive to the West Wall.<sup>29</sup>

About 1900 hours, 30 Shermans of CCA, supported by artillery fire, attacked and secured German positions at Rechicourt. The defensive line ended up one kilometer northeast of Ley, northwest of Bezange, and east Rechicourt to Bures. As of midnight, CCA consisted of: 37th Tank Battalion, 53d Armored Infantry Battalion, the 10th Armor Infantry Battalion, the 66th Armored Field Artillery Battalion, the 94th Armored Field Artillery Battalion, the 191st Armored Field Artillery Battalion, and the 35th Tank Battalion.<sup>30</sup> As a result of this action, CCA infantry destroyed one Panzer V tank in the vicinity of Ley.<sup>31</sup>

CCA claimed destruction of 43 German Panzer V tanks on 19 September, nine of which were knocked out by the tank destroyer battalion, and six other German vehicles destroyed.<sup>32</sup> CCA reported their losses as three tank destroyers and five Sherman M4 tanks.<sup>33</sup>

During the night of 19/20 September, American artillery hit six more tanks which burned, and upgraded the German tank destruction report to 20 by confirmed actual count.<sup>34</sup>



German loss reports are sketchy. The LVIII Panzer Corps reported "Erhebliche Ausfalle" (considerable losses) in its daily summary--probably as much as 50 percent. Five of the 43 damaged Panzer V tanks were returned to service the following day.<sup>35</sup>

In the early morning hours of 20 September, General Krueger, Commander of LVIII Panzer Corps, reported to Fifth Panzer Army that the attack planned by 113th Panzer Brigade supported by the 111th was no longer possible, since the U.S. had strengthened its forces in those areas. Nevertheless, Fifth Panzer Army ordered the two units to press the attack to relieve the 553rd Jaeger Division in Nancy even though they were outnumbered 200 to 45 in tanks.<sup>36</sup>

The Germans expected a strong counterattack against the 113th Panzer Brigade from the north and west. To hinder this attack, they planned their own attack to the west. The 111th Panzer Brigade was to move at 0700 hours in the direction of Moyenvic by way of Arracourt. They planned to draw the Americans into the German line from Bures to Ley then use flak to push them back.<sup>37</sup>

However, CCA on the following day planned to resume its designated mission to the northeast. At 0900 hours on the morning of 20 September, the movement would begin in two columns, with TF Oden on the left and TF Abrams on the right. TF Abrams planned to move along secondary roads on the southeast flank to protect TF Oden on the left.<sup>38</sup> Although the move was scheduled for 0900, the movement order did not come at the designated time. At

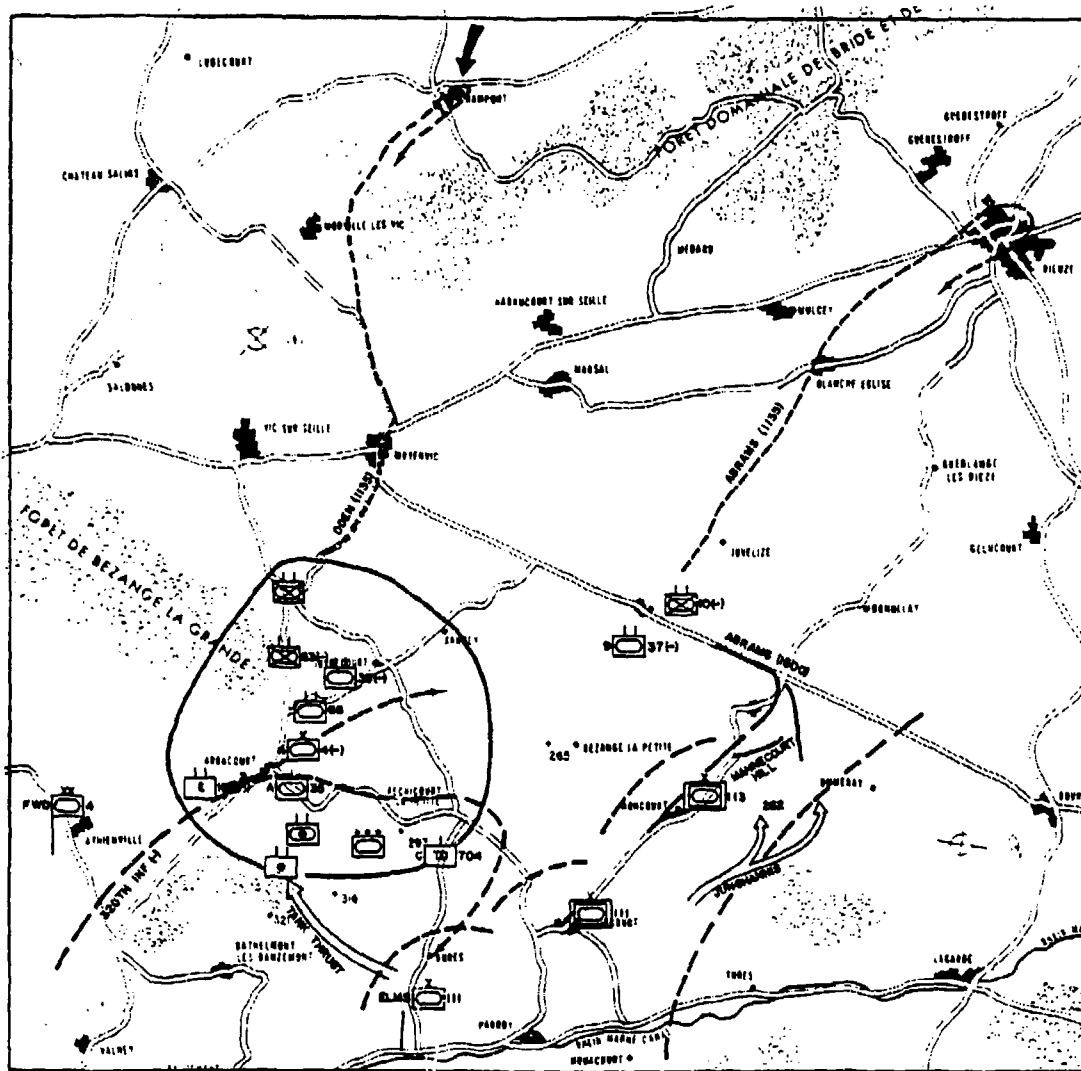

Map 14 - CCA Operations on 20 September 1944

0845 hours, 25th Recon Squadron elements reported 20 enemy tanks in the vicinity of Bures, although Rechicourt and Bezange-la-Petite were clear of enemy. At 0900 hours, the French resistance reported 150 to 180 enemy tanks massing south of the Rhein-Marne Canal. Abrams worked out a plan whereby the right flank would be secured against counterattack by one battalion of infantry from the 35th Infantry Division and two tank destroyer companies from the 704th Tank Destroyer Battalion. After completing his defensive plans, at 1040 hours he issued orders to begin the advance on Sarreguemines.

TF Abrams started out at 1135, initially encountering only enemy outposts at Blanche Eglise, which were easily brushed aside.<sup>39</sup> Task Force Oden moved out the same time as Task Force Abrams. Over half the elements managed to cross the starting point before the leading elements ran into a heavy mine field and stiffening German resistance in the vicinity of Hampont.

At 1225, even before all elements of the two task forces were on the road, 16 German tanks were reported south of Arracourt, in the rear of 4th Armored Division units.<sup>40</sup> Eight tanks of the German 111th Panzer Brigade enroute to Moyenvic to relieve the 113th Panzer Brigade bumped into the rear of CCA just as the SP howitzers of the 191st Armored Field Artillery Battalion were already joining Task Force Abrams' march column. The 191st fired high explosives at 1000 yards and none of the eight German tanks escaped. A journal entry in the Division after action report describes the action:

"While most of CCA's armor was engaged on the eastern flank, a force of 20 to 25 German tanks approached from the southeast. Only a thin screen of tanks and tank destroyers located along a ridge several hundred yards from the C.P. constituted the defenses in this area. Two Division Artillery concentrations were called for. The outer fringes of concentration landed almost in the C.P. area. They were successful in disrupting the formation of the enemy armor, after which they were an easy prey to our tank destroyer guns."<sup>41</sup>

The 53d Armored Infantry Battalion, about to follow the Task Force Oden march column, relates this story:

"The battalion was given the mission of rear guard for Task Force Oden, and left the bivouac area one mile north of Arracourt at 1200 hours. At 1300 hours the enemy moved tank and infantry up, just south of Arracourt, and opened fire. We went back into dispersed positions and prepared to meet the attack. Air support was requested and received at 1500, repulsing the attack. We then received orders from CCA that the entire combat command would remain in this area . . ."<sup>42</sup>

Informed of this attack, General Wood ordered the CCA commander to return the task force to Arracourt at once. Colonel Clarke then directed his entire combat command to return to Arracourt to clear the area once and for all.<sup>43</sup> At 1240, Colonel Abrams ordered his task force back to the original assembly area to assume original positions. The 25th Cavalry Recon Squadron, screening east and southeast from the vicinity of Blanche Eglise, returned to the vicinity of Juvelize.

By midafternoon, the clearing operation was underway. Colonel Abrams assembled a force consisting of three medium tank companies of the 37th Tank

Battalion and two companies of the 10th Armored Infantry Battalion near Lezey. While the artillery adjusted its supporting fires, Abrams' force advanced to Ley. At 1325, a 113th Panzer Brigade outpost observed a column of 12 vehicles with trailers, and six tanks, moving from Moyenvic to Lezey. This confirmation was passed to LVIII Panzer Corps. Thus, Abrams' advance was detected.<sup>44</sup>

Captain Junghannis and a group of Mark IV tanks and 88mm guns from Panzer Abteilung (a company sized unit) 2111 of the 11th Panzer Brigade Reserve moved into position on Hill 260 and Hill 241 west of Ommeroy to intercept the Americans. Company C, 37th Tank Battalion, covering Colonel Abrams' flank east of Ley, after crossing the crest of Mannecourt Ridge, ran head on into the German fire. Company C lost five to six tanks with relatively few losses in personnel. The Germans lost about the same. When Abrams reinforced with Company B, the two companies maneuvered into new positions, which brought the losses for both sides to 11 or 12 tanks each.<sup>45</sup>

When all elements of Task Force Abrams were reassembled and the artillery fires adjusted, they launched a counterattack. Companies A, B, and C, and two companies of the 10th Infantry Battalion assembled north and east of Lezey before the attack under heavy German artillery fire. The plan was to stay in defilade until the entire force reached a point north of Ley. The Task Force would then wheel and strike south to Ley. Companies A

and B were to attack Ley head on, one company on either side of the road into town. Company C was to hold the high ground to the east of Ley and protect the left flank. When Companies A and B attacked at 1700 hours supported by infantry, they knocked out several German tanks. Company A advanced through Ley. Meanwhile, Company C was heavily engaged with German tanks and antitank guns. Company B moved to assist Company C. Ley was taken by 1800 hours.<sup>46</sup> This bitter fight ended with the destruction of six German tanks and 3 antitank guns, while the 37th lost six tanks.<sup>47</sup>

While Task Force Abrams engaged the 113th Brigade on CCA's south flank, Major Kimsey and a small force had been sent during the afternoon to clear the canal area.<sup>48</sup> They destroyed five Panzers on patrol near Bures. When Kimsey tried to press his advantage, he was outranged by German tanks fighting from cover and had to give up the attack.

Although it was now getting dark, Colonel Abrams pressed the attack toward Moncourt. This was unusual since tank doctrine generally did not allow for tank employment in the dark. Prior to the attack, the artillery laid down a preparatory fire on Moncourt. TF Abrams attacked at about 1800 from west of the Ley/Moncourt road. Three tank companies and two infantry companies, in a tight and intermingled formation, attacked cross-country setting Moncourt on fire as the force moved in. Lieutenant Donnelly's platoon of Company A, 37th Tank Battalion went into town supported by Company A of the 10th Infantry, using bayonets, grenades, submachineguns, and rifles to eliminate enemy resistance.<sup>49</sup>

At 2130, Abrams left A/37th and A/10th to secure the town, and the rest of the force returned to Lezey and the battalion assembly area. That night action was characterized by destructive artillery fire--not all of it enemy. While bivouacked 1.5 miles north of Lezey, the 25th Cavalry Squadron received heavy artillery fire from 0030 to 0330 hours. Lieutenant Rolvaag and three men were injured. The artillery fire was determined to have been friendly artillery.<sup>50</sup>

German tank losses of 19 and 20 September seriously depleted their armor capability. A spot report at 1600 hours from the 111th Panzer Brigade to the LVIII Panzer Corps indicated they lost five Panzer tanks. However, these losses only applied to those sustained against Major Kimsey's task force. The Germans actually lost 18 tanks, as well as 15 PWs, 250 killed and four other vehicles destroyed. Three large caliber weapons were destroyed or captured. U.S. losses were 12 killed, 39 wounded, seven Sherman tanks and two miscellaneous vehicles destroyed.<sup>51</sup> Total German tank losses were not reported.

The commander of Fifth Panzer Army, General von Manteuffel, was very discouraged with the results of the day's action. Only by successful commitment of the 111th Panzer Brigade was it possible to prevent a clear cut American victory. His tank situation was desperate. At midnight, LVIII Panzer Corps reported 11 of their tanks had been destroyed, with just 13 combat ready tanks remaining, seven in the 113th and six in the 111th Panzer

Brigade. Only 45 additional tanks had been built and could be brought in by train as reinforcements.<sup>52</sup>

The Germans also experienced confusion in setting up positions for the night. Although Abrams had gone as far east as Moncourt, Manteuffel reported that the Americans had come up to the western approaches to Ommeray, some three kilometers east of Abrams' actual position. He requested defense lines be shortened to run through Gelucourt and Lagarde, accompanied by a general withdrawal in the XLVII Panzer Corps' sector to a position east of the Foret de Parroy and Foret de Mondon. This would place his front lines on more defensible terrain.<sup>53</sup> Blaskowitz, however, disapproved the request and told Manteuffel to prepare to counterattack the following day. Thus, the 113th Panzer Brigade spent the night south of Moncourt, the 111th in Parroy and the LVIII Corps headquarters near Langenbach, preparing for the next day's action.

The 21st of September was a relatively quiet day with no major German attacks. Commencing at 1015, CCA made additional sweeps to wipe out enemy pockets of resistance. The 25th Cavalry screened east and south from Blanche Eglise through Donnøley and Ley to Moncourt, maintaining contact with the 42d Cavalry south of the canal. Company B, 37th Tank Battalion had the mission of securing the trail from Lezey to Moncourt over which supplies were to be taken to Company A and the infantry at Moncourt, and of screening the left flank (see map 15).



At 1200 hours the 37th began a sweep around the west side of Bezange la Petite. Company C, 10th Armored Infantry, left in Moncourt, attacked the woods after a heavy artillery concentration, but found little opposition. Bezange-la-Petite and Coincourt were also taken.<sup>54</sup>

On orders of CCA, Company B of the 53d Armored Infantry Battalion, and one section of the reconnaissance platoon were sent out as part of a task force under Major Kimsey at 1120, with a mission to clear the enemy from Bathelemont east to Parroy and to destroy the bridge across the Rhine-Marne Canal in the vicinity of Parroy. They reported three German tanks and an unknown number of German soldiers in this area. Both forces then swung south and west as far as the canal, and blew up the bridge crossing. While the attack was progressing, C Company 35th Tank Battalion with some tank destroyers came in to Parroy from the west and completed the encirclement.<sup>55</sup>

These small probes tested General Patton's patience. He wanted to resume the advance to the West Wall as soon as possible, and pressed General Eddy to do so. General Eddy received reports from General Wood that Wood's pilot, Major Carpenter, had flown at treetop level over the area and had drawn no fire nor could he see any evidence of German tanks. Thus, Eddy told Wood to push east as soon as possible.<sup>56</sup>

U.S. tank losses on the 21st resulted only indirectly from tank fire. Around 2000 hours Kimsey's force returned from the day's operation less one

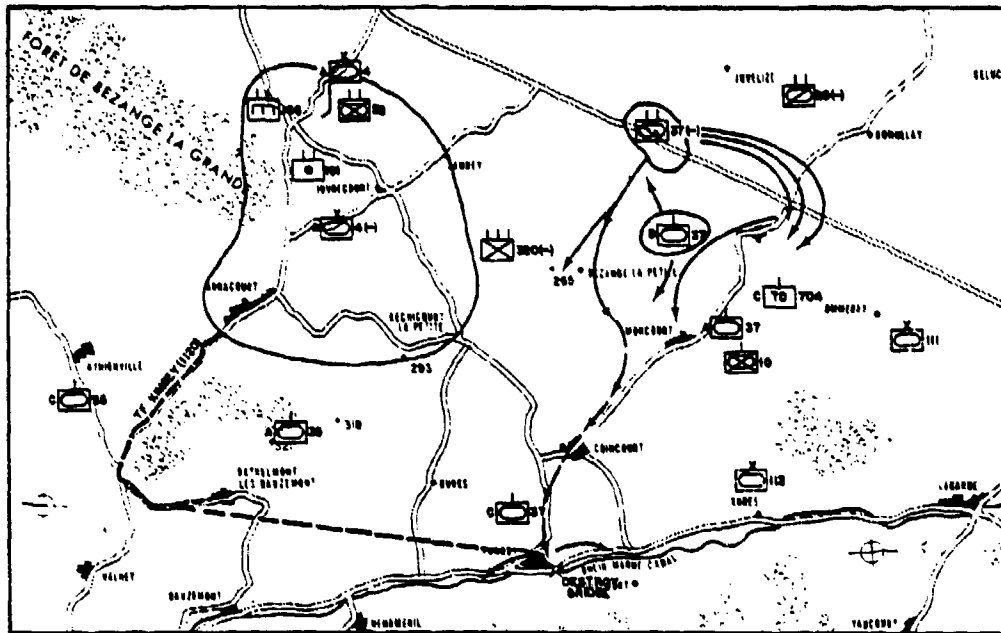

Map 15 - CCA Operations on 21 September 1944

platoon. The platoon had gotten bogged down and could not move. During the night, the Germans shelled the area occupied by the one platoon and one tank was lost.<sup>57</sup> Because of minimal contact, 4th Armored Division declared the next day a rest and maintenance day before the concentrated effort to clear out Chateau-Salins, still held by the Germans.<sup>58</sup>

On the German side, commanders took stock of their situation and regrouped. Colonel Heinrich Bronsart von Schellendorf, commander of the 111th Panzer Brigade, had all noncritical vehicles brought to the south of the canal, then destroyed the bridge at Parroy.<sup>59</sup> German losses in the withdrawal were one tank, one SP gun and one 88mm gun. The 113th Panzer Brigade spent the night at Xures, the 111th Panzer Brigade at Bourdonnay.

At the high command level the Germans were again shaken up by major personnel changes. On 21 September, Hitler replaced Blaskowitz as CG of Army Group G with General der Panzertruppen Hermann Balck. Colonel Friedrich von Mellenthin replaced Generalleutnant Heinz von Gyldenfeldt as Chief of Staff, with an effective date of the 24th.<sup>60</sup>

Balck had a reputation for success in the most trying of circumstances. He came from an old military family; his father had written a well-known textbook on tactics which had been translated and was used for instruction in the United States. As a young officer, Balck served in World War I and assisted in the early mechanization of the Reichswehr. Prior to his arrival

at Army Group G, Balok served with distinction in the Somme campaign of 1940 and in the Russian campaigns, he commanded the famous 11th Panzer Division, led the XLVIII Panzer Corps at Lemburg, and briefly commanded the Fourth Panzer Army. Although both Balok and von Mellenthin had no experience in the West, Balok was a trusted Nazi party member and his personal bravery well known.<sup>61</sup>

When Balok took over his new command on 21 September, he immediately ordered a two-pronged attack. First Army was to start its drive with 559 Volksgrenadier Division past Chateau-Salins (still in German hands), southwest toward Moyenvic, while the right wing of Fifth Panzer Army (LVIII Panzer Corps) was to seize the high grounds southeast of Juvelize and prepare to advance on Moyenvic when the 11th Panzer Division reinforced Fifth Panzer Army.<sup>62</sup>

At 1000 hours on the 21st the Fifth Panzer Army received a new mission-- to attack with 11th Panzer Division to secure Moyenvic and link up with 1st German Army. The Americans were to be hit in small flank attacks to keep them off balance, and if possible, destroy them. The commander of the LVIII Panzer Corps, however, saw no possibility for renewing the attack. Around midday the Fifth Panzer Army told Army Group G that they would hold the line. After the lead reinforced Panzer Grenadier regiment of the 11th Panzer Division arrived, they and the 11th Panzer Brigade were to attack the Americans southwest of Dieuze (in the Moyenvic-Arracourt area). Once the entire Panzer Division arrived, the attack would be expanded in scope.

Later, the Fifth Panzer Army plan of attack was sent to Army Group G:

"By holding the line from the south part of Lindresee (two kilometers southeast of Dieuze)--Gelacourt--Ommeray--Mouscourt, gathering of the XLVII Panzer links the 11th Panzer Division in Saarburg. After arrival of a reinforced Panzer Grenadier regiment with this one and 111th Panzer Brigade attack against enemy southwest Dieuze (approximately 22 September PM. After arrival of entire Panzer Division (except for elements remaining by Nineteenth Army) attack of the division with 111th Panzer Brigade depending on the situation out of the area south or northeast Dieuze toward Morhange--Chateau-Salins (approximately 25 September)."<sup>63</sup>

At 1500 hours, General Balck and his chief of staff, Colonel von Mellenthin, came to Fifth Panzer Army Headquarters for a briefing. The LVIII Panzer Corps had the mission to take the high ground west of Juvelize and thus facilitate the recapture of Moyenvic. The offensive would kick off at 0700 hours from Gueblange. During this meeting, General Balck made it very clear that those who took their vehicles to the rear without compelling reasons would be brought to trial and sentenced to death for cowardice. This order greatly reduced the movement of vehicles to Germany.<sup>64</sup>

At midnight on 21 September, the LVIII Panzer Corps had the following tanks available: The 111th Panzer Brigade had ten Panzer V (2 conditional) and eleven Panzer IV tanks for a total of twenty-one. The 113th Panzer Brigade had six Panzer V and thirteen Panzer IV tanks (one conditional) for a total of nineteen. The combined total was forty tanks.<sup>65</sup>

The 11th Panzer Division tank status was unknown.

22 September

The day of "rest and maintenance" opened up very foggy with very little visibility, and most of the morning operations took place under these conditions. At 0420, Fifth Panzer Army gave the order for the attack on Juvelize. The 11th Panzer Brigade in Gueblange prepared for a 0700 attack, which was delayed two and a half hours because of the delayed linkup of a Panzer Grenadier Battalion from 11 Panzer Division and complete exhaustion of troops (see map 16).<sup>66</sup>

At 0945, the battle group moved out of the area around Blanche Eglise with the subordinate battalion of the 11th Panzer Division for the attack on Juvelize and the high areas northwest of that town.<sup>67</sup> Minimal U.S. resistance enabled them to make good progress. The first phase of the assault was against the 25th Cavalry Squadron, which was screening CCA's left flank and observing the roads between Dieuze and Moyenvic. Although the German patrols had laid white marking tape up to the Cavalry lines, this went unobserved by the Cavalry outposts because of the fog.<sup>68</sup>

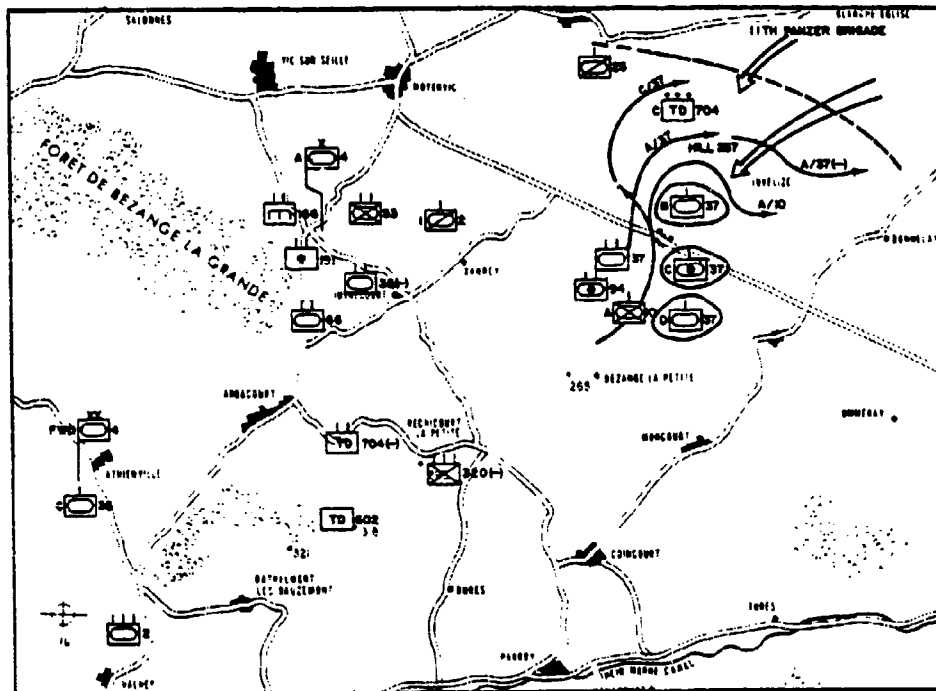

Map 16 - 11th Panzer Brigade Attack, 22 September 1944

At 0915, dismounted infantry attacked Troop D, 25th Cavalry Recon Squadron forcing them to withdraw just east of Juvelize. Company F sent out one platoon of tanks to repel the German infantry. Just northwest of Juvelize, twelve Panzer tanks fired on Company F tanks, which were supporting the infantry attack. (There were no journal entries to indicate any German activity in the Juvelize area.) The Germans continued to advance as the U.S. light tanks were unable to stop the heavier armored vehicles, though the men of the tank platoon under command of Captain Murray W. Farmer fired and fought them until seven of their own light tanks were knocked out by the heavier guns. The attack of the infantry with the Panzer tanks supporting it drove to within 200 yards of the Squadron Command Post, forcing the CP, service company, Troop E and the remainder of Company F to withdraw to a new position one mile to the southwest. Major Edward Bautz placed one platoon of tank destroyers from Company C (attached to the squadron at that time), in hull defilade behind the center of the cavalry lines, took up a flank position and destroyed two Panzer V tanks.<sup>69</sup> The withdrawal of the light tanks and squadron led the Germans into a position where the tank destroyers destroyed three additional Panzer tanks.<sup>70</sup>

At 1040 hours on 22 September the 11th Panzer Brigade came from the northeast and reached the high ground west of Juvelize after marching through the forest north of the village. The subordinate Panzer Grenadier Battalion attacked via Donneley. The weather improved, which brought out the dreaded P-47 fighter planes, but they were able to take Juvelize and the high ground to the northwest by 1230, with the loss of just ten tanks. The



right flank of the 113th Panzer Brigade meanwhile reached the road crossing northwest of Ley.<sup>71</sup>

At 1100 hours, Colonel Abrams led the 37th Tank Battalion, supported by the 10th Armored Infantry Battalion and artillery arrived to halt the German advance. Using accurate, well observed fire, they picked off the Panzer V tanks as they advanced. They drove off the supporting German infantry into Marsal where the air support bombed and strafed them, causing many casualties.<sup>72</sup>

As Company A, 37th Tank Battalion moved out, Company C, on the left flank, moved out farther to protect Company A's left flank. Company B, 37th Tank Battalion with Company A, 10th Infantry then attacked Juvelize itself, which was strongly occupied by enemy infantry and some tanks, cleaned it out and went on to the high ground to the south of town. Company C circled to the northwest of Juvelize and seized Les Trois Croix, where they were able to see German tanks coming in from Bois du Sorbier.<sup>73</sup>

The 111th Panzer Brigade reported having taken Juvelize and destroyed American tanks, but in the afternoon, their reports reflected the Americans having taken Juvelize and the heights. U.S. action was summed up in a spot report from the Fifth Panzer Army to Army Group G:

"Enemy counterattack from northeast captured Juvelize and the high ground to the east. Forest south of Blanche Eglise held by the enemy. Ninety enemy tanks recognized."<sup>74</sup>

Losses of Panzer and Panzer Grenadiers were reported as "high".

As a result of combat action, Colonel Heinrich Bronsart von Schellendorf, commander of the 111th Panzer Brigade, was mortally wounded. P-47 fighter aircraft with the assistance of armored field artillery, routed and destroyed the remaining attackers as they fled to the northeast.<sup>75</sup>

Manteuffel urgently needed reinforcements, and only a few tanks were available from the 113th Panzer Brigade east of Lezey, which were being used to hold the Moyenvic/Bourdonnay road. His desperation can be sensed in his report to higher headquarters:

"Enemy of 1555: at 1555, the LVIII Panzer Corps reported that the Americans attacked along the Moyenvic/Bourdonnay road with tanks and strongest close air support, and had reached the road crossing north of Ley. In the western part of Ley the enemy has already entered. In order to counter this attack, a Panzer group of Panzer Brigade 113th will be utilized. The pressing need of our own aircraft, which has need to free up our surrounded troops, which have suffered under the strongest enemy attack, cannot fly, since the airports still lie under heavy fog."<sup>76</sup>

At 2130, the 111th Panzer Brigade had ten Panzer V's and four Panzer IV's ready for action or double the number of tanks presently being employed along the new security line. Thus, they were so disorganized, they really didn't know exactly what they had. As a result of action on 22 September, 4th Armored Division reported 94 prisoners captured, 311 Germans killed, seventeen tanks and other vehicles destroyed. U.S. losses were seven light

tanks, one medium tank, one half-track, and one one-quarter truck. Seven were killed in action including Captain Farmer, and 13 seriously wounded.

In their summary for 22 September however, the Germans reported ten Sherman tanks destroyed by the 111th Panzer Brigade.<sup>77</sup>

Losses for the day dealt a devastating blow to the Germans. A scheduled continuation of the attack by the 111th Panzer Grenadier regiment, marching up from the 11th Panzer Division, was called off as useless, as shown in this LVIII Panzer Corps report of 1930 hours:

"At 1640, according to a report by the chief of staff of LVIII Panzer Corps, the Americans succeeded in bringing the attack of the 111th Panzer Brigade push toward Juvelize and captured the town as well as the heights southeast from it. Our own units fled under constant enemy air attack back to Blanche Eglise. Under these circumstances, LVIII Corps considers a continuation of the attack fruitless, even if one of the Panzer Grenadier regiments of 11th Panzer Division is brought in."<sup>78</sup>

Because the 111th Panzer Brigade commander was mortally wounded, and the brigade almost completely destroyed, the LVIII Corps requested under these circumstances to call off a further attack for the 23rd. The Fifth Panzer Army commander was of the same mind when he updated Army Group G by radio later that day.

The Fifth Panzer Army did lose two Panzer Brigades as fighting units, and failed to move any closer toward the Moselle to reach the 553d Volksgrenadier Division (see map 17).

In summary, the tank battles from 19 to 23 September had cost CCA fourteen medium tanks, seven light tanks totally destroyed, and a casualty list of 25 killed and 88 wounded. German losses were much heavier with 500 killed, 1200 wounded, 63 tanks lost.<sup>79</sup> Complete German loss figures are not available, but it is interesting to note that Fifth Panzer Army claimed over 50 U.S. Sherman Tanks destroyed for this same period.<sup>80</sup>

In spite of the heavy German losses and the desires of General Manteuffel and his commanders to stop the attack, higher headquarters did not agree. Berlin directed Manteuffel to reorganize and launch anew an attack to link up with the 553d Volksgrenadier Division at Nancy. Thus the stage was set for the launching of a second series of Arracourt tank battles.

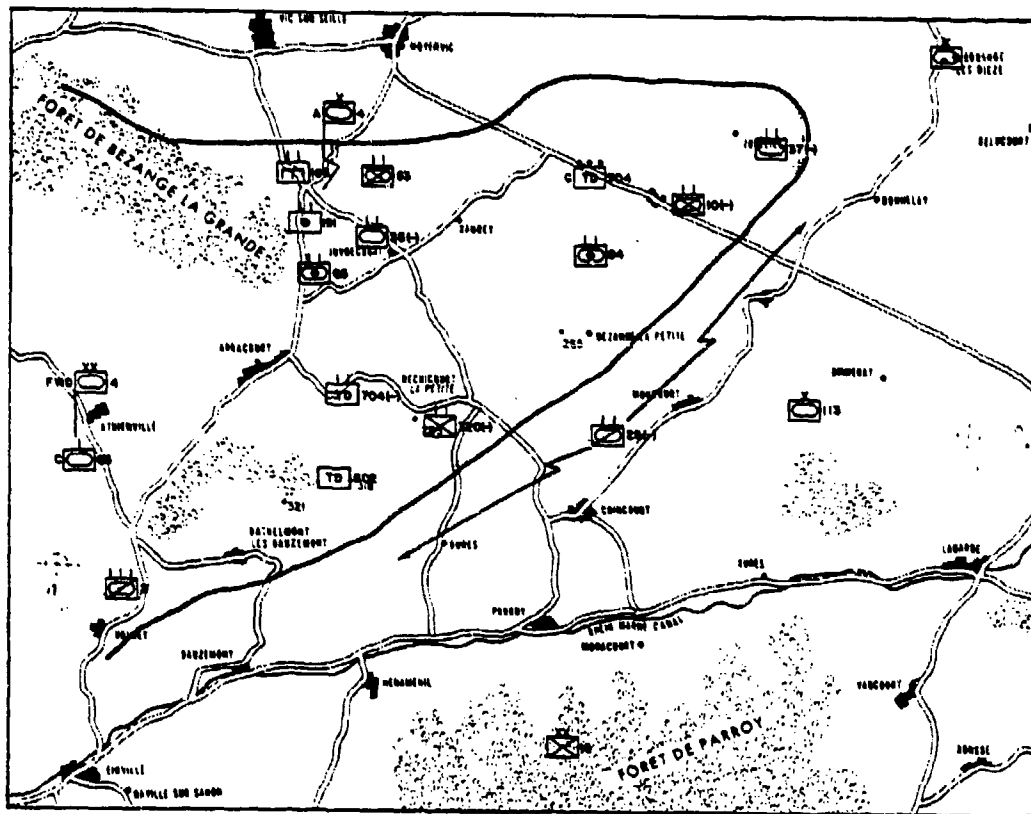

Map 17 - Unit Positions on 22/23 September 1944

## CHAPTER 4

### The Battle Continues

24-29 September

The second phase of the Arracourt tank battles took place from 24 to 29 September 1944. After the first series of battles at Arracourt, the combat value of the Panzer Brigades was questionable. In spite of the exemplary conduct of brigade commanders and individual troops they were powerless against an enemy well supported by air force and artillery. The brigades could not operate independently and could not be resupplied with troops and equipment. Thus, the 111th Panzer Brigade was incorporated into the 11th Panzer Division, the 112th Panzer Brigade into the 21st Panzer Division, and the 113th Panzer Brigade into the 15th Panzer Grenadier Division, resulting in a slight increase in personnel and equipment of those larger units. Numbers of cadre and special vehicles had to be allocated to the zone of the interior and a large proportion of the remaining personnel had to be assigned to the Ersatzheer (replacement Army) due to old age and poor fitness.<sup>1</sup>

On both 23 and 24 September, P-47 fighter aircraft were able to do some bombing before sundown, and German antiorcraft activity increased daily, which formed a horseshoe around the Arracourt salient to the east, south and north. CCA maintained its positions in and around Arracourt, and the 25th Cavalry

Squadron maintained the enemy under constant observation. There was little contact with the Germans during the day, although German patrol activity was accompanied by some artillery fire. Four German tanks and German infantry forced the 25th Cav outpost at Moncourt to withdraw. On the 23rd, the Americans attacked and took Omeray and Xures following an intensive artillery preparation, but were later pushed back. During this period Colonel von Seckendorff, 113th Panzer Brigade commander, was killed by an air attack.<sup>2</sup>

On the 24th, CCA observed more German tanks north and east of Arracourt. The Germans were digging in from Moncourt to Coincourt and their artillery sporadically fired on U.S. units. The Germans reported tanks moving in the Coincourt area. Other warnings of the impending attack came from various sources. At 2145 on 24 September, a French civilian reported a German division advance from Morhange and Dieuze with a mission to attack CCA. A captured SS soldier stated a division would attack along a line west of Chateau-Salins to Delme toward Nancy.<sup>3</sup> One of the vehicle buildup areas for the 11th Panzer Division was Dieuze, hit by tac air on the evening of 24 September with unconfirmed damage results. Corps radio intercepted reports of Germans sending aggressor parties south down the valley from Chateau-Salins. These reports were sent to the Division G2 and passed on to General Wood.

On 25 September, General Wood reorganized the combat commands of 4th Armored Division:<sup>4</sup>

CCA--35th Tank Battalion

53d Armor Infantry Battalion  
166th Engineers  
Troop A, 25th Cav Recon Squadron, Mech  
Headquarters Battery, Artillery Command  
66th Armor FA Battalion  
94th FA Battalion  
Battery B, 489th AAA (AW) Battalion  
Company A, 46th Medical Battalion, Armor  
Company A, 126th Ordnance Maintenance Battalion  
191st Armored FA Battalion  
704th Tank Destroyer Battalion  
Company, 602d Tank Destroyer Battalion (attached)

CCB, 8th Tank Battalion

10th Armored Infantry Battalion  
51st Armored Infantry Battalion  
24th Armored Engineer Battalion, plus the 995th Bridge Company  
25th Cavalry Recon Squadron minus Troop A  
691st Tank Destroyer Battalion (attached)  
22d Armor Field Artillery Battalion  
253d Field Artillery (Supporting)  
177th Field Artillery Group  
Battery A, 489th AAA (AW) Battalion  
Battery C, 46th Medical Battalion, Armor  
Company B, 126th Ordnance Maintenance Battalion  
179th FA (Supporting)

CCR

37th Tank Battalion  
489th AAA (AW) Battalion, (-)  
696th Armor FA Battalion (Supporting)

Meanwhile, German attack plans were being readied. The Fifth Panzer Army now planned to link up with the First German Army. To do this, they planned to attack at 0700 hours on 25 September in the direction of Moyenvic with the LVIII Panzer Corps on the right flank in order to take back the high ground south and southeast of Moyenvic on a line Moyenvic/Bures. The 11th Panzer Division, minus an antitank battery; the 111th Panzer Brigade,



minus one battalion and assault guns; and the 113th Panzer Brigade, minus one Panzer Company were available for the attack.

Details of the plan were confirmed and sent to Army Group G, who then gave more details on the attack. German attacking forces counted 54 tanks.<sup>5</sup>

The morning of 25 September, Army Group G Commander Balck gave the following order:

"Fifth Panzer Army attack group leads the attack with the 11th Panzer Division, 111th and 113th Panzer Brigade, using all available tanks with the left flank at the Rhine-Marne Canal--Nancy. First objective: Bezange la Grande Army 26 kilometers east-northeast of Nancy--Bauzemont. Concentrate right. Army command one closes on the left flank with an attack group (including two regiments of the 559th Infantry Division) and Panzer Brigade 106th, first objective: sector both sides of Moncel sur Seille. Main concentration on the left.<sup>6</sup>

The 11th Panzer Division planned to open the attack at 0700 on the 25th of September. A steady downpour continued all day as the result of a cold front moving in from the North Sea, bringing with it low ceilings, poor visibility, and intermittent rain. Weather conditions were so poor, aircraft could not fly the entire day. Because of the continuing rain, tanks and artillery were slow moving into position, resulting in an attack delay until 0900. Meanwhile, German reconnaissance determined that Marsal was weakly held and that Moyenvic was clear of enemy.

The German attack did not go unnoticed long, however. By 0930, elements of Troop A, 25th Cavalry reported seeing German infantry moving south in the vicinity of Marsal.

In spite of the resistance of small American tank/infantry teams, the Germans, assisted by a smokescreen, were able to reach the line Marsal-Hills 1 kilometer northeast of Juvelize, up to Hill 257 to the southeast of Juvelize, western Ley and the high ground south of Ley. CCA quickly reorganized itself in the face of the developing attack. The Cavalry reported 200 to 300 infantrymen advancing on Juvelize from the north, and then withdrew through the 37th Battalion lines.<sup>7</sup> The 35th Tank Battalion meanwhile moved to the ground northeast of Rechicourt to further strengthen the defense. Company B, 35th Tank Battalion, returned to the battalion from patrolling at 1000. At 1300 the company was alerted to protect the movement of the CP and Headquarters Company back to the area formerly occupied by the battalion north-east of Arracourt. Company A was employed on the road east of the battalion CP, Company D to the south, and Company B placed on the road west of the CP, while Company C deployed south and west of the CP.<sup>8</sup>

Meanwhile, an advance unit of the 11th Panzer Division pushed on toward Moyenvic where they were halted by Company C of the 53d Armored Infantry Battalion. Other elements of the 11th Panzer Division occupied Vic-sur-Seille, and finally linked up with elements of the 559th Volksgrenadier Division of the First German Army. In a briefing at 0950 on

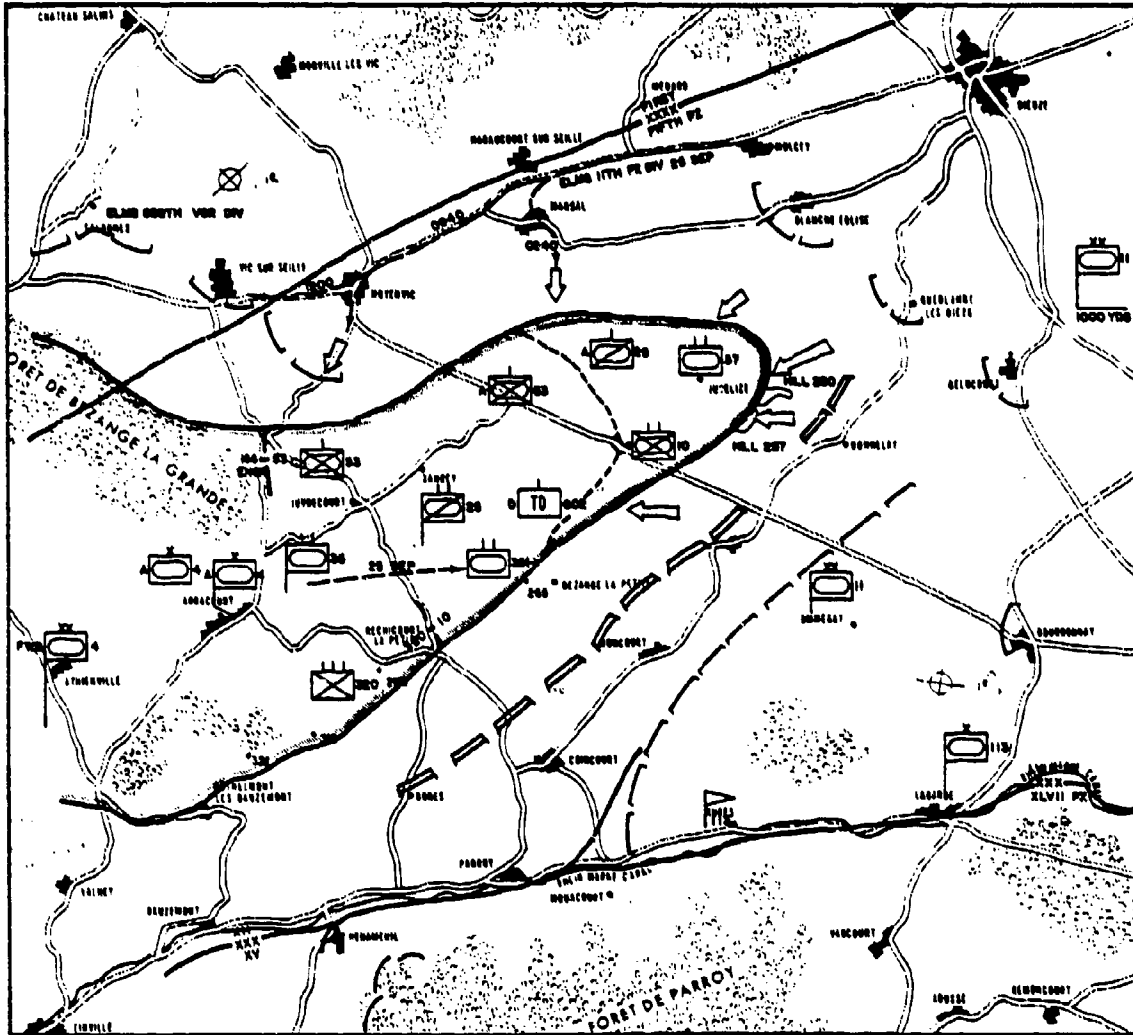

Map 18 - LVIII Panzer Corps Attack, 25 September 1944

the 25th, the Army Group G commander was astonished at the success of LVIII Panzer Corps. He had expected them to advance much more slowly. Thus, at 1010 General Balck extended the objective to the line Moncel/Bezange la Grande/Bathelemont/Henamenil, and sought to employ all the available Army combat power in a concerted attack. The attack was to be carried out in a spirited, enthusiastic manner.<sup>9</sup>

To assist the main thrust of LVIII Panzer Corps, Fifth Panzer Army Chief of Staff von Kahlden ordered the commander of XLVII Panzer Corps to secure the Army left flank to the southwest, to prevent an American attack from Blamont on the LVIII Panzer Corps. The XLVII Panzer Corps was given the mission to take the area northeast of Bathelemont under fire with all available artillery. To strengthen the right flank of the Army, the antiaircraft units of the 11th Panzer Division (still under the XLVII Panzer Corps) were brought forward to Maizieres to provide additional fire support in LVIII Panzer Corps zone. Thus, the German attack involved coordinated action of the LVIII Panzer Corps attacking to the east-northeast via Moyenvic, and XLVII Panzer Corps attacking to the northeast vis Arracourt.

CCA was beginning to feel the pressure of the attack. At 1220, Colonel Abrams reported to CCA: "My position is being attacked by an unknown number of infantry and five tanks; will keep you informed."<sup>10</sup> Company A, 37th Tank Battalion was given the mission of meeting the enemy threat and attacked north against heavy enemy resistance. Enemy infantry kept up the

pressure on Companies B and C. The tank destroyers west of Ley withdrew due to that pressure. Company C, 57th Infantry successfully repulsed a counter-attack 1.5 miles northwest of Juvrecourt. The 37th Tank Battalion now had no flank protection, as other CCA units were involved in mopping up operations. Only one bridge (leading into Lezey) could serve as an exit. Besides coming under increasingly heavy artillery fire, the battalion area was coming under the direct fire of tanks.

By 1530, while the spearhead of the German LVIII Panzer Corps attack was in the Vic-sur-Seille area, other corps units reached the high ground 1 kilometer north of Juvelize, Hill 260 (1.2 kilometers southeast of Juvelize), the area around Lezey and the high ground north of Moncourt (as indicated by the arrows on map 18). CCA responded by strengthening its defense, especially on the high ground north and southeast of Juvelize as well as near Lezey and Moncourt, and prepared for a counterattack with tank support from Juvelize against Hill 260.

In light of the increasing resistance to the advance of the 11th Panzer Division (LVIII Panzer Corps) on the right flank of the Army, Colonel von Kahlden gave the commander of the XLVII Panzer Corps the mission to prepare for an attack on 26 September in the area of Parroy and Coincourt, to divert American pressure on the LVIII Panzer Corps. Meanwhile, CCA, 4th Armored Division, was having difficulty maintaining a defense in depth in the Arracourt salient. Under pressure, CCA decided to withdraw to the

high ground to the west and establish a more secure and shorter line. The withdrawal was planned for 1900, while artillery fire was laid on all known or suspected enemy locations and ground unit feints diverted German attention. Diversionary attacks to cover CCA withdrawal began at 1900 toward the north and east. Company B and C feints permitted the infantry to disengage and retire. Before 1900, Company A moved south to outpost the Lezey-Bezange road, and Company D moved west of Lezey to prevent the Germans from breaking in from that direction. The 10th Infantry took positions to the east of Rechicourt along the Rechicourt-Bezange road.

German LVIII Panzer Corps noted these attacks. At 1855, Colonel Dingler, Chief of Staff of the LVIII Panzer Corps, was informed that CCA attacked with 40 tanks from Bezange-la-Petite to Lezey and were met with 17 German tanks from the Moyenvic and Marsal area. He further stated:

"It appears that the enemy is preparing for a larger attack against the front of the XLVII Panzer Corps, which has not yet begun, due to bad weather, which has been around for days."<sup>11</sup>

At 2215, the commander of the LVIII Panzer Corps reported that the Americans counterattacked with 80 tanks, and successfully retook Coincourt and Hill 257. After those German defeats, Colonel Dingler felt a larger attack on the morning of the 26th in this area had little chance for success, and requested that the main German attack for the 26th of September be shifted to the south, since the Americans had recognized the Schwerpunkt in the north and greatly strengthened their defenses against it.<sup>12</sup> At 2230, General Balck approved the request.

For the 26th, Balck ordered the LVIII Panzer Corps to continue the attack commencing at 0900 by massing all available power on the Corps' left flank. To cover the shift of the German main attack, a secondary attack would occur on the right flank of the Corps. To support the planned attack, Balck directed the XLVII Panzer Corps to retain the high ground southwest of Bures and use artillery fire on the area of Rechicourt and Bures.

The Americans realized the attack was not over. General Wood directed that CCB move down from Chateau-Salins to assist CCA in the Arracourt area. Elements of the 320th Infantry Regiment of the 35th Infantry Division occupied the former CCB's sector west of Chateau-Salins. CCB's combat units began their move south at 2100, and completed it under adverse weather and road conditions under the cover of darkness.<sup>13</sup>

CCB had also experienced considerable combat since crossing the Moselle at Vaucouleurs on 11 September. After bivouacking in Courbesseaux, they prepared for a coordinated movement east, and moved to Chateau-Salins area. At 0545 on 24 September, the XIII SS Corps attacked CCB in strength, supported by heavy artillery and approximately 30 tanks. That evening the 13th SS Corps reported that Chateau-Salins and Monville were in their hands. Only a coordinated air attack kept CCB from suffering excessive casualties. As it turned out, the Germans were routed, leaving eleven wrecked tanks and an estimated 300 dead. CCB sustained 120 soldier casualties.<sup>14</sup>

Casualties in the Arracourt area for 25 September were reported as follows: The 25th Cavalry destroyed two German Mark IV tanks and inflicted an estimated 40 German casualties. The 37th Tank Battalion counted six German tanks and 20 vehicles destroyed and 100 personnel killed. U.S. casualties were 16 KIA, 47 wounded, and 29 exhaustion cases.<sup>15</sup>

"The XIX Tac on armed Recco-Luneville-Saarburg area, destroyed railroad tracks, overpasses and rolling stock, motor transport and a gasoline dump. Their fighter planes, operating at a low level, encountered intense ground fire, and three were missing, two definitely to flak."<sup>16</sup>

The evening report of the LVIII Panzer Corps confirmed one P-47 fighter plane shot down. This entry further demonstrated the increase in anti-aircraft capability the Germans were bringing to bear against CCA at this time.



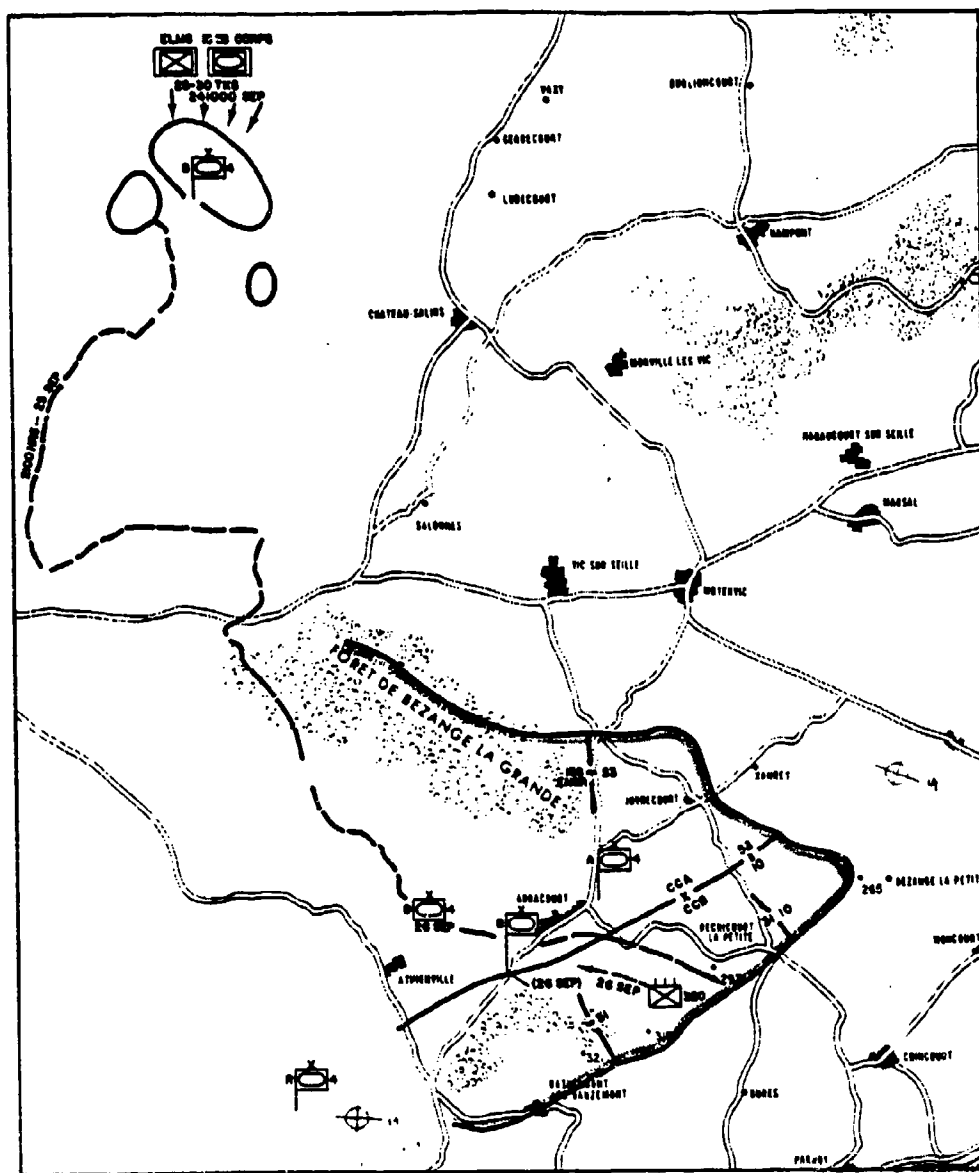

Map 19 - Movement of CCB to Arracourt, 25/26 September 1944

Activity in the Arracourt salient during 26 September was limited to an exchange of artillery fire and small operations, accompanied by considerable shuffling of units and boundaries. CCB, having arrived the night of the 25th, relieved CCA of the responsibility of the front south of the line Lezey-Arracourt. The 10th Infantry and the 25th Cavalry reverted to CCB control in position and the 8th Tank Battalion took over positions vacated by the 37th Tank Battalion. At 1545, the 37th Tank Battalion transferred from CCA to CCR, then moved to the vicinity of Serres, where it remained until 30 September. The 35th Tank Battalion was reinforced by one attached company of the 602d Tank Destroyer Battalion, sent to protect their right flank from the vicinity of Juvrecourt in case of a move to reduce Moyenvic. The new positions are shown on map 20.

When CCB headquarters began movement to Arracourt at 1230 hours 26 September from the Chateau-Salins area, they were attacked by a column of German Panzer V's. The German attack was frustrated by accurate fire of U.S. artillery, which knocked out three of them. About the same time, the 53d Armored Infantry Battalion CP, one half mile north of Arracourt, was subjected to a barrage of artillery. Meanwhile, the 25th Cavalry Squadron remained in the vicinity of Kanrey, and later in the day was assigned the mission of screening the southeast (right) flank of CCB. Released from CCA, the Squadron moved out under cover of darkness to an assembly area one mile southwest of Arracourt. Troops C and D moved individually to the same vicinity. Troop D was assigned the area from Bauzemont to La Fourasse Farm

and Troop C from La Fourasse Farm to Rechicourt. German artillery was particularly active during the day. Visibility had improved somewhat but was still very poor. The ground continued to be wet and very muddy, making movement slow and difficult.

The German LVIII Panzer Corps mission remained the same for 26th September: to take the high ground northwest of Bures and Rechicourt. At 0900, the 559th Volksgrenadier Division of German First Army started their attack to the southwest. By 1145, elements of the 11th Panzer Division of LVIII Panzer Corps seized Lezey and the high ground south of Marsal. After taking Juvelize and Lezey, the division elements reached the canal of Flot Salins. At 1400, they took Coincourt. Other elements pushed forward around the northern part of the pond east of Bures and entered Rechicourt at 1400. The 15th Panzer Grenadier Division of the XLVII Panzer Corps reached the high ground south of Bures by way of Parroy.

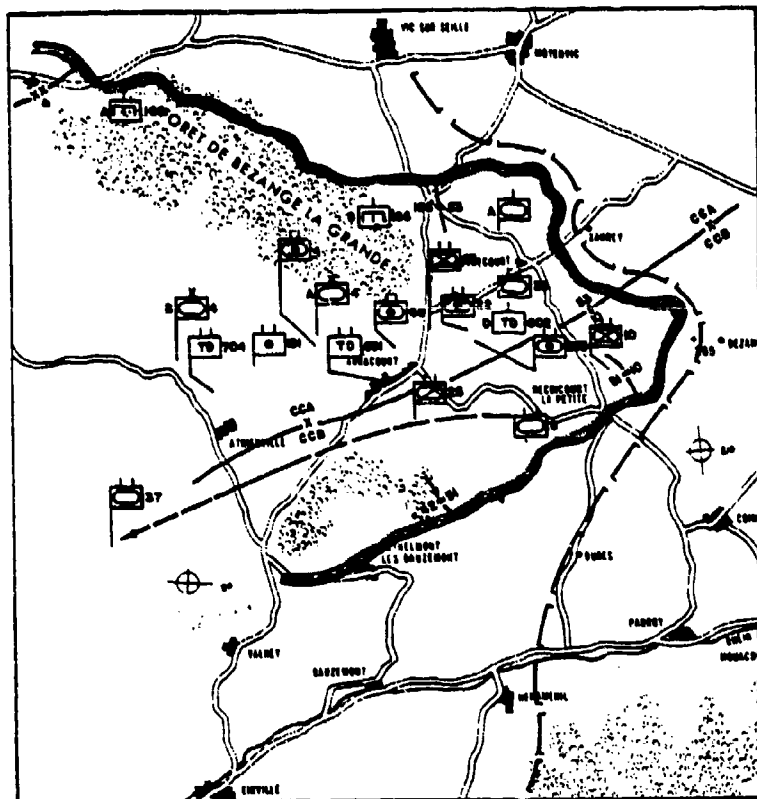

Map 20 - Redrawn Battle Lines, 25-26 September 1944

Meanwhile, CCA was taking steps to counter this attack. At 1510, the 602d Tank Destroyer Battalion moved to the vicinity of Juvrecourt to repulse attacks from the southeast. Company B of the 35th Tank Battalion moved out and contacted the 166th Engineers on Hill 301. A platoon of the 704th Tank Destroyer Battalion was relieved from the sector when Company B arrived. Company A was ordered to contact the 53d Armored Infantry and relieve another platoon of the 704th Tank Destroyer Battalion and send the platoon to the vicinity of Arracourt.<sup>17</sup> Colonel Clarke called off the proposed attack on Moyenvic. Higher headquarters believed the Germans were forming for an attack and it would be more feasible to await the attack and then counterattack from the south, and swing in on the west flank. Division artillery was split in support. The 66th Field Artillery Battalion supported 166th Engineers, the 22d Field Artillery Battalion supported CCB, the 191st and 696th Field Artillery Battalions were in general support, and the 704th Tank Destroyer Battalion was kept in Division reserve in case of counterattack. The tank destroyer battalion was to reconnoiter routes to best accomplish their mission.<sup>18</sup>

The German operations on the 26th were reflected in their journal. The Fifth Panzer Army ordered the XLVII Panzer Corps to further support the attack by LVIII Panzer Corps with a mixed artillery section and a Panzer Company. The attack scheduled for 1430 against Rechicourt got started only at 1630. The reason for the delay was that the rain caused the ground to be so soft that tanks had extreme difficulty moving forward.<sup>19</sup> Toward evening, the LVIII Panzer Corps pressed forward against a stubborn U.S. force

and reached a line along Hill 226 (11 kilometers south Moyenvic)--north of Hill 228 (1 kilometer southwest Lexey)--west edge Bezange-la-Petite-- (1 kilometer east of Rechicourt)--north edge of the lake near Bures--Hill 252 (10 kilometers south of Bures). American reports noted the attack.

"A German counterattack of infantry, supported by seven tanks, hit our position. The counterattack was repulsed, three enemy tanks were destroyed, several enemy infantry killed and one PW taken. No ground was given up."<sup>20</sup>

The LVIII Panzer Corps, supported by the XLVII Panzer Corps developed a Schwerpunkt with a mixed artillery battery, six Panzer IVs, and two Panzer JAEGER IVs. The Corps believed that the enemy had withdrawn its main forces back to the high plateau northwest of Bures--Juvrecourt-Moyenvic and the next day (27 September) would energetically defend that position. At 2215, the XLVII Panzer Corps received the order to send the artillery battery and Panzer Company on its way to Maizieres to assist the LVIII Panzer Corps.

General Manteuffel seized the opportunity offered by the American withdrawal to report the uncontested occupation of Juvelize and Coincourt as victories, even though the Americans had voluntarily pulled back.<sup>21</sup> He then prepared to resume the attack toward the west. Manteuffel would have continued the attack against the American south flank, but tank movement was extremely difficult and darkness fell on the Germans before they could get very far. At the close of 26 September, the LVIII Panzer Corps had 33 tanks available (24 Panzer V's, 3 additional Panzer V's (conditional); and 6

Panzer IV's). U.S. casualties were 107 wounded and 42 exhaustion cases. The surgeon carefully monitored exhaustion cases and made the following journal entry:

"Colonel Abrams has expressed concern over increase in combat exhaustion during this assignment. It is his opinion that combat exhaustions will continue to rise when we are in static positions. This is probably due to the fact that personnel of this division had been trained and fought in rapid movement and in spearhead assignments."22

The day ended with the 4th Armored Division occupying defensive positions, extending from Bathelemont to Rechicourt to the base of Hill 265 (west of Bezange-la-Petite) and west of Xanrey, as well as the forest north of Arracourt. In those positions, the Americans awaited further German moves.

The following day those moves became apparent. The LVIII Panzer Corps order for 27 September read as follows:

"LVIII Panzer Corps attacks on 27 September to take the ordered objective in the line Moncel-zur-Seille-Bezange la Grande-Bathelemont-Hamananil. 11th Panzer Division with the designated subordinate units attacks early on 27 September at the latest 0800 with Schwerpunkt left. An armored battle group from the general area south of Bures takes Hills 318-293 (northeast of Bathelemont). From there, attack into the flank and rear of the enemy west of Rechicourt. One battalion for flank protection to the west should stay close. The right attack group and the middle commence their attacks at the same time. Right groups: Hold the right wing vicinity Moyenvic,

Schwerpunkt direction Xanrey. Move the artillery in the night 26 to 27 September forward, so that the Schwerpunkt battle group can be supported with minimal distance."<sup>23</sup>

The Americans were aware of an impending attack. General Eddy, commander of XII Corps, noted in his diary that word from the Army G2 revealed the Germans had approximately three and one half to four divisions and 150 to 200 tanks against XII Corps, and U.S. forces could expect a thrust in considerable force soon.<sup>24</sup>

At first light on the 27th of September, the 25th Cavalry Squadron moved from their assembly area to screen along a line from Rechicourt-Bezange-Xanrey. Then at 0800 hours, the LVIII Panzer Corps (minus the armored task force) began a series of diversionary attacks against the left and center of the 4th Armored Division perimeter. The brunt of this attack was against elements of the 10th Infantry Battalion which occupied a front of 3500 yards between Bezange le Petite and Rechicourt. Their left flank extended beyond the edge of Hill 265, west of Bezange. Between their right flank and the 51st Armored Infantry Battalion there was a gap neither had the rifle strength to fill. An excerpt from the 10th Infantry Battalion unit diary states how they were dispersed:

"The companies were still in position forming an arc around the battalion area with Company A holding down the right flank, tying in with Company C, this unit, on its left, and Company B adjacent to Company C's left holding the left flank. The machinegun platoon of headquarters company occupying a forward position



in front of Company B, and the assault gun platoon of headquarters company was in a forward position with Company C.<sup>25</sup>

Enemy artillery was very active throughout the day. The counterfire did not dissuade the Germans from attempting seven sharp counterattacks against the right flank held by Company A, 10th Infantry, all of which were repelled. Although the 3d platoon was pinned down by machinegun and mortar fire, the rest of the company was able to repel the attacks. Company A took eight prisoners, who reported that 20 of their unit had already been killed. At Hill 265, on the left flank of the 10th Infantry Battalion, the 11th Panzer Division succeeded in getting a foothold, but at this point, Lieutenant James H. Fields inspired his men to stand fast, even though he was severely wounded. When two German machineguns caught the Americans in a deadly crossfire, Fields took the light machinegun from its dead crew and knocked out both the German weapons, for which he received the Congressional Medal of Honor.<sup>26</sup> The 10th Infantry Battalion requested and received air support; however, the enemy countered with heavy antiaircraft fire. In one of the rare Luftwaffe sightings, the 53d Armored Infantry Battalion reported two German planes over their area at 1330 which were driven off by heavy machinegun fire.<sup>27</sup>

Meanwhile the main thrust against the 4th Armored Division south flank occurred about 10 AM, some two hours behind schedule. Manteuffel's armored task force began the main attack, but its advance guard got only as far as the Fourasse Farm, some 1800 yards west of Bures, where American artillery brought the tanks to a halt (see map 21).

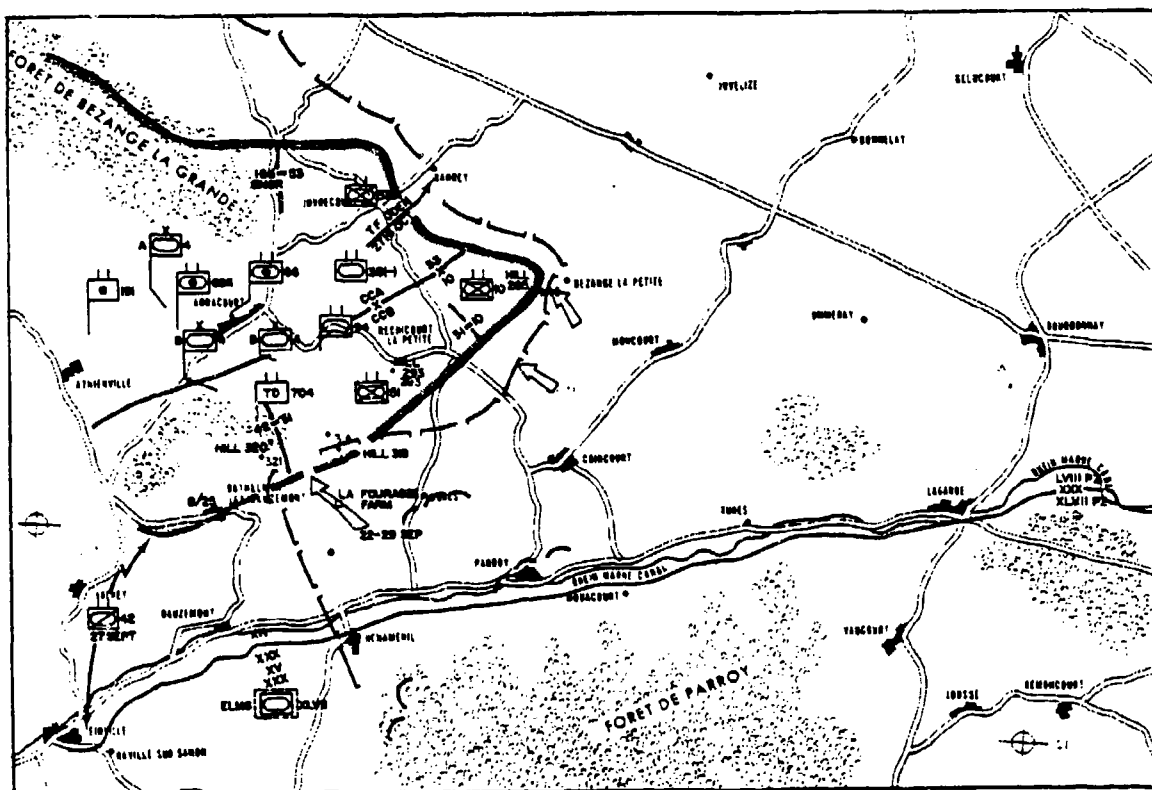

Map 21 - 11th Panzer Division Attack on Arracourt Salient, 27-29 September 1944

A German spot report confirms the action:

"After taking high ground 500 meters northeast of Bauzemont (3 kilometers northeast of Einville) by a superior enemy with tank support pushed us back. The entire Corps area strong artillery fire and air attacks."<sup>28</sup>

At a 1400 briefing, Manteuffel ordered that a battalion of the northern group immediately reinforce the southern attack group. At 1715, the LVIII Panzer Corps commander reported that the tank group offensive came under heavy artillery fire, but would still take Hills 293 and 318 that night.

One of the supporting attacks involved the 110th Panzer Grenadier Regiment of the 11th Panzer Division. Due to heavy artillery fire, they didn't reach their start point, the area 2 kilometers southeast of Xanrey until 10 AM. Unbeknown to them, Lieutenant Colonel Oden and the 35th Tank Battalion had planned a counterattack against them, as recorded in the unit journal:

"At 0800, the battalion CP was moved to a new position. The companies remained in their positions. The new position was situated north and slightly west of Arracourt. The commanding officer of CCA had given LTC Oden the mission of attacking Xanrey and reducing it. The 22d FA, the mortars of the 53d Armor Infantry Battalion, and the mortars of the 35th Tank Battalion were to place smoke on the area. The 22d Field Artillery was to drop harassing fire on the town until just prior to the attack. Altogether seven battalions of artillery participated. A

Company and B Company were to jump off at 1600 hours from the high ground southwest and southeast of the town. They were ordered to come down off the high ground, past the town and then swing back through the town. A Company to drop a platoon on the northeast of the town of Xanrey to protect the open flank of C Company so that company swung around and down through the town. The armor infantry was to closely follow the attacking tanks and clear the town. The attacking forces were protected from counterattack by two platoons of tank destroyers."29

At the completion of the successful counterattack against the 110th Panzer Grenadier Regiment of the 11th Panzer Division, the 25th Cavalry of the 4th Armored Division passed through the town and established outposts to the north and northeast. All units returned to their start point by 1700 hours, having killed about 135 Germans with the loss of only two tanks (by mines).

The U.S. success was confirmed by German records. At 1730, the S3 of the 11th Panzer Division reported that 15 tanks had broken in at Xanrey. Because forward observers had not yet been brought forward, German field artillery was not effective against 4th Armored Division positions, as indicated by an 11th Panzer Division spot report:

"Our artillery therefore cannot have an effect (as the artillery cannot be observed)."30

After dark on the 27th, two significant attacks took place. The first occurred at about 2200 hours when the Germans launched a forceful counter-attack against the right flank of 4th Armored Division near Rechicourt in

front of a platoon of Company A, 10th Infantry Battalion. Company A was forced to withdraw from the high ground in front of their company CP. To plug this vulnerable gap, a platoon of tank destroyers plus one platoon of engineers were dispatched to retake the position. After retaking the hill, they held on throughout the night and the following day.<sup>31</sup>

At 2150, General von Wietersheim, commander of the 11th Panzer Division, attempted to take the hill by assault.

"In case it doesn't work, depend on the 28th to take Hill 318 'brutal'."<sup>32</sup>

To support this move, he pulled troops from the middle portion of his line to support the assault troops on the left flank, and brought his artillery, 6 kilometers forward.

To further reinforce the attack, General von Wietersheim switched the 110th Panzer Grenadier Regiment from the north flank to his south flank. One of its combat patrols filtered through to the north of Fourasse Farm and captured Hill 318 after a sharp fight. Hill 318 and its defenders now became the focal point for the entire German effort.

At 2215, the LVIII Panzer Corps Chief of Staff reported that the southern group offensive was proceeding well. He thought the Americans, who had broken through on either side of Xanrey, could be pushed back in a successful counterattack. The old positions were back in German hands. At

this point German tank strength was twelve Mark IV tanks--eight with long tube and four with short tube, and two assault guns.<sup>33</sup> Further German intentions can be gleaned from a message from an Army Group G to O. B. West. First German Army and the Fifth Panzer Army were to take the line Moncel-sur Seille--Arracourt. They had available for use the 106th Panzer Brigade presently located behind the left flank of Nineteenth Army.<sup>34</sup>

At 2030, the commander of the Fifth Panzer Army briefed General Balck concerning a report that the 4th Armored Division was going over to the defensive and pulling back over the Muerthe river. (CCA's pullback onto better defensive positions conveyed this impression.) In response, Fifth Panzer Army commanded the XLVII Panzer Corps to increase their reconnaissance in order to recognize a withdrawal immediately and utilize the opportunity by an attack. Further, the XLVII Panzer Corps received the mission of supporting the LVIII Panzer Corps offensive to achieve the Army objective.

The Fifth Panzer Army estimate for the night of 27 September read:

"The estimate of the situation: the enemy must reckon to be cut up, and therefore retrenches. He wants to buy time with his counterattack on Xanrey, in order to build a new front line or to pull back altogether. Decision: it therefore depends, to maintain constant contact with the enemy and to launch the tank battle group into the enemy. Order: attack with the tank attack group, take Hills 293 and 318, then press farther toward the northwest in the direction of Arracourt."<sup>35</sup>

In addition, the German estimate reported that 200 soldiers of CCA lay dead, and German tank strength was 14 Panther V and seven Panther IV tanks. The German estimate of U.S. casualties was high. Fourth Armored Division reported their casualties as 9 KIA, 86 wounded, and 38 exhaustion cases.<sup>36</sup> Here was another example of an exaggerated casualty report.

On the 28th of September, the 25th Cavalry Squadron remained in bivouac one mile southwest of Arracourt, and Troops B, C, and D screened in their assigned zone. Weather continued to be fairly clear. Troops B and D of the 2d Cavalry Group were attached to the squadron to strengthen the screen.

Enemy artillery and machine gun fire was very heavy during the night, and German patrols attempted in several places to break through the screen but were repulsed by U.S. tanks, infantry, and artillery.

As planned, the main German thrust on 28 September was against the southern flank of 4th Armored Division toward Hill 318. Heavy fighting resulted. At daybreak, the 51st Armored Infantry Battalion retook Hill 318, which had been lost during the night. The fighting continued through the morning, surging back and forth on the crest.

German continuation of the attack was delayed by movement of artillery. A 1010 spot report revealed that:

"Artillery changed positions during the night. Forward observers need yet to get into position. There

is a running front from Hill 297 southeast Rechicourt to Hill 318. All artillery shoots together on 279 and 246. In 10 minutes Panzer Grenadier regiment 2111 arrives, in order to push forward in the middle front. Shortly the attack of a tank group will begin."37

At 1030, 11th Panzer Division reported supporting artillery was now in position. Fifteen minutes later, the S3 of the 11th Panzer Division reported to his commander:

"The situation at Hill 318 is clear again. Three attacks pushed back. One battalion of 113th Panzer Brigade, at the moment in Coincourt, will be brought forward, in order to relieve parts of antiaircraft. Inform neighbor that the artillery fire from the south side of the canal is ours."38

By noon, the 51st Infantry Battalion finally got a firm hold on Hill 318. Shell fire from American batteries to the northeast broke up one last German counterattack by severely punishing the flank of the German assault column. The Germans confirmed at 1130 that Hill 318 had been retaken by the Americans. Although the German counterattack on Hill 318 had been halted, Manteuffel massed his artillery and repeated the attack. When darkness came, the 11th Panzer Division sent a shock force, supported only by a few tanks, up the forward slope of Hill 318, pushing the Americans back down the hill into a well placed barrage laid down by German guns.

The pendulum then swung the other way. Just before midnight, the 51st Infantry Battalion regained the crest, after preparatory shelling by four



battalions of artillery had broken the German hold. German retaliation was swift and sure. CCB was hit by heavy caliber artillery fire lasting one hour, and causing 35 casualties in one company alone. Under the cover of this fire the 11th Panzer Division extended its hold on the camelback, took Hill 293, and drove on to the east edge of Bois du Benamont. However, the 51st Infantry, in foxholes near the crest of Hill 318, refused to give ground.<sup>39</sup>

While the main attack was taking place in and around Hill 318, south of Arracourt, a successful German supporting attack occurred during the night and Rechicourt fell into German hands. A German spot report stated:

"Own storm troops during the night broke into enemy positions 1 kilometer northeast of Rechicourt. In spite of strong enemy counterattack he could only remain in place. Taken: 10 Panzer Recon vehicles, seven usable and lots of apparatus. Thirteen PWs taken."<sup>40</sup>

The 53d Armored Infantry Battalion had been in a defensive position one half mile north Arracourt. The 11th Panzer attack at 0130 in the morning had managed to infiltrate CCB's right front flank. A German forward observer was believed to be located in the church steeple at Moyenvic and U.S. artillery was called on to fire upon it.

After some repositioning of artillery and infantry delayed the continuation of the German advance until after 0815.

Later in the morning of the 28th of September, the 11th Panzer Division and 113 Panzer Brigade launched several attacks against the right flank held by Company A, 10th Armored Infantry Battalion anchored on Hill 265. Under cover of a smoke screen, at about 0945, Company A observed several hundred German infantry and about six tanks taking up their position in the draw. The number increased until approximately a battalion could be seen there. German tanks placed direct fire on the machinegun platoon in the forward positions of Company A, pinning them down. Company A called for assistance. One tank company, and P-47 fighter aircraft of XIX TAC assisted the Company in knocking out several of the German tanks.<sup>41</sup>

This attack was confirmed by a German spot report:

"1245--opponent has attacked with tanks from Rechicourt to Bezange. Hill 265 in hands of the enemy. Division (11th) hopes to hold the village. Enemy assembly area in woods 500 meters north-northwest Juvrecourt destroyed. Commander commands, as quickly as possible to bring forward Kampfgruppe Bode, in order to hit the enemy in the rear."<sup>42</sup>

After four counterattacks, the Americans were able to regain Hill 318.

Early in the afternoon, the weather cleared up and about eight P-47s bombed and strafed the German gun emplacements and concentrations of German personnel. The 23d Squadron of the 36th Group made a strike at Bures which nearly leveled the village with 23-500 pound bombs, weakening the German ability to exploit their attack.<sup>43</sup> A German report on the afternoon of 28 September said:

"In spite of the greatest efforts it was not possible to breakthrough the enemy defense in depth at northeast and east of Juvrecourt. Supported by Jabo and artillery, the enemy counterattacked from Rechicourt in a northeast direction. Our own security was pushed back at Bezange."<sup>44</sup>

Thus, CCA was able to re-take and hold Hills 318 and 265 against aggressive German attacks.

Later that afternoon, the 11th Panzer Division's S3 determined that repeated German attacks in the direction of Rechicourt pushed the 4th Armored Division into strong built defenses, with strong antitank and artillery support, in particular in front of Hill 246. German reconnaissance elements were extremely accurate in determining 4th Armored Division's strength in the Arracourt salient.

At 1720, General von Wietersheim informed his S3 that the attack on Hill 318 was not going as planned. He wanted to know whether the fight should be rescheduled or be conducted from another direction. He also expressed a dire need of 3.7 centimeter flak ammunition.<sup>45</sup> His detailed answer came at 1730.

"At 1745 General von Luetwitz requested additional units to assist his south wing as a threatened enemy attack was causing him great concern. General Krueger, the 58th Panzer Corps commander, informed 11th Panzer Division commander "11th Panzer Division: stop until dark, hold all captured positions. Attack at the latest 2200 hours in order to regain Hill 318 with main concentration from La Fourasse

Farm to Hill 293, and continue the attack with both spearheads under the cover of darkness the attack by way of 283-320 to the road south of Arracourt. Units not being fully utilized for the protection of the western flank must be taken into consideration (for use in this attack).#46

The LVIII Panzer Corps initiated another counterattack at about 1900 hours against the left flank of Hill 265 near Bezange. Combined infantry and tank forces fired point blank at American foxholes. The third platoon of Company A, 10th Infantry Battalion was forced to withdraw from their position because of heavy casualties. The first platoon was shifted over to that position about 2100 hours to repulse another counterattack against Hill 265.

This German counterattack took possession of the high ground. Company A was forced to withdraw to new positions. The attached machinegun platoon of headquarters company became ineffective because of losses and remained in the battalion area to regroup. Supporting artillery immediately laid down a zone of fire on Hill 265, inflicting heavy losses on the German attackers. The U.S. losses for this day were nine halftracks destroyed or captured by the enemy, three halftracks damaged, one 57mm antitank gun destroyed, one 81mm mortar and nine rocket launchers destroyed. A German evening spot report summarized their action:

"Our own attack on the right flank against high ground northeast and southeast Juvrecourt was halted by enemy defense in depth. Enemy assembly area in the forest 1 kilometer northwest Juvrecourt destroyed

by artillery fire. In Juvrecourt 13 enemy tanks. Enemy counterattack in direction Bezange hard west of Bezange turned away. At the moment we have our own counterattack. A hard battle is being fought over Hill 318."<sup>47</sup>

Because of troop fatigue, the 11th Panzer Division commander asked for a postponement of further attacks. Manteuffel disapproved for two reasons. First, a postponement of the night attack because of troop fatigue would mean a delay of at least 24 hours, during which time the enemy would strengthen his defensive front. Second, the highest levels (namely, Berlin) attached the greatest value to the success of this attack.<sup>48</sup> Thus, the 11th Panzer Division was ordered to attack both hills and from there continue in a northwest direction. The attack would take place as soon as possible. At 2120 hours, Manteuffel briefed Balok:

"Terrain very difficult, completely uncovered. General von Wietersheim reports fatigue of troops in spite of this command, order on to both hills and forest behind. Proposal: If the people fight at night--during the day rest, or reversed. With the great difference in military power utilized at night as much as possible."<sup>49</sup>

General Manteuffel asked Balok for some aircraft support and also requested a definite time of aircraft arrival. The aircraft would suppress artillery fire from the other side of the canal. Balok responded that aircraft were not available. The suppression of enemy artillery fire was impossible, since the right wing of Luetwitz' XLVII Corps was being strongly attacked. This information was passed on to von Wietersheim. Manteuffel suggested he do most of his fighting by night, using darkness to

his advantage. Later that night, the commander of the 11th Panzer Division reported limited progress:

"1. Attacked Hill 318. 2. Beginning of attack on 293 dependent on retaking of Hill 318, in any case so, that 293 is taken by early morning. 3. Troops are fully fatigued."50

The same evening, Army Group G decided to reinforce Fifth Panzer Army with LXVI Army Corps. To allow time to get guidance from Berlin, Fifth Panzer Army reported the following:

"The attack, is to take place tonight by the 11th Panzer Division of the LVIII Panzer Corps. A further decision concerning the further direction of the attack will be given tomorrow."51

Meanwhile, LVIII Panzer Corps was unable to dislodge the Americans from their good defensive positions because of heavy American tank and artillery fires. General von Wietersheim noted that the 11th Regiment took Moncourt and Bezange-la-Petite, but could not capture Rechicourt la Petite for two reasons: one, the German artillery was too weak to support their attack because the Rechicourt area was out of range and signal communications were weak. Second, the 11th Panzer Division was too committed to launch an attack. However, a combat group consisting of remnants of the 113th Panzer Brigade and the 11th Panzer Division recon battalion, with elements of the 119th Panzer Artillery, assembled 2 kilometers northeast of Xures, and advanced against Rechicourt-la-Petite by way of Coincourt. Although they

did not meet strong U.S. resistance combat fatigue caused the advance inexplicably to stop after capturing Coincourt. This in turn, delayed the attack of the 11th Regiment against Rechicourt-la-Petite. Lead elements of the regiment in turn suffered heavy losses and had to be withdrawn a few hundred meters.<sup>52</sup>

At 2110, the 11th Panzer Division (of XLVII Panzer Corps) received the new mission of attacking the high ground near Arracourt during the night and retaking Hill 318. General Manteuffel ordered the advance to eliminate U.S. artillery emanating from the area.

In their daily composite report of 28 September, the Fifth Panzer Army summarized their operation:

"During the night our own storm troops attacked in the positions 1.5 kilometers northeast of Rechicourt and at 318 (2 kilometers southwest of Rechicourt). Only in the afternoon hours was the enemy successful, after repeated counterattacks with heavy artillery and aircraft support, to retake the hills close to northeast Rechicourt and Hill 318. An enemy attack during the afternoon on Bezange was thrown back through our own counterattack and bitter fighting. Our own attack to retake Hill 318 was halted with enemy fire, especially the flanks from the south of the canal. During the entire day very strong artillery and air activity."<sup>53</sup>

At the close of 28 September, LVIII Panzer Corps had 18 Panther IV, 20 Panther V, and 11 antiaircraft Panther IV's on hand. They reported two Shermans captured, two Panther recon vehicles, 10 wheeled recon vehicles

destroyed. U.S. personnel losses were 10 killed, 115 wounded and 89 exhaustion cases.<sup>54</sup>

On the 29th of September, fighting on Hills 318 and 265 further intensified. The 11th Panzer Division assembled Panzer Reconnaissance Regiment 110 (released from the north wing of the division), an armored engineer company, 25 tanks (from divisional assets), the 111th and 113th Panzer Brigades, and the 15th Panzer Grenadier Division to attack Arracourt.<sup>55</sup> During the morning of 29 September with a thick fog obscuring the battlefield, LVIII Panzer Corps continued its attacks against CCB. The first German attack on Hills 318 and 320 forced Troop C, 51st Infantry, and 24th Engineers to withdraw 500 yards. At 1130, a task force consisting of one platoon of Company F, Troop E, Troop C, and 24th Engineers counterattacked against Hill 320 while a platoon of medium tanks from the 8th Tank Battalion moved up Hill 318 in the fog. When the fog lifted the tank commander directed American planes to the German tanks which had assembled in the fog below. Thus, the German thrusts with armor and infantry supported by artillery fire were driven back by a combined arms team of air, artillery, tanks, tank destroyers, engineers, reconnaissance, and infantry.<sup>56</sup>

The German records provide an accurate picture of the results of the battle. At 0810 the 11th Panzer Division S3, reported that Hill 318 had again been taken by storm troops during the night and that heavy artillery and antitank fire was being brought onto Hill 320. Heavy fog hindered the



operation. At 0940 the S3 reported Hill 293 as taken. Since the Americans were employing so much antitank fire the battles on Hills 320 and 293 were continued by the infantry. By 1015 both Hills 318 and 293 were taken in spite of strong American defenses. 11th Panzer Division lead elements supported by tanks had reached Bois du Benamont. Von Wietersheim intended to continue the attack and take Hill 283. He also reported very heavy enemy air activity, and warned that if the 113th Panzer Brigade was withdrawn, the situation would get very bad.<sup>57</sup>

During these operations, U.S. air support was tardy. Initially, the planes dropped propaganda leaflets instead of bombs (as they were diverted from Metz).<sup>58</sup> Ultimately the fighter bomber/tank teams worked particularly well, flushing out and destroying the German tanks. The 405th Group was credited by the ground forces with 11 tanks destroyed and two damaged and with rendering inestimable aid in breaking up two enemy counterattacks. Additionally, the Group's 511th Squadron contributed by destroying six additional tanks by forcing them out into the open where artillery could hit them. The Germans still lacked their own aircraft support. At 1430, Lieutenant Colonel Wedding reported to General Manteuffel that air support from the Luftwaffe was not possible as they were being employed elsewhere.<sup>59</sup>

Later on the 29th, German attacks continued. At 1500 the S3 of the 11th Panzer Division reported that two attempts at retaking Hill 318 were halted,

but he was continuing attacks on Hills 320 and 318 against strong U.S. resistance. During this battle, the arrival of the American 8th Tank Battalion turned the tide. They attacked and took Hill 318 with the support of air power and destroyed eight enemy tanks with no tank losses of their own. The 11th Panzer Division S-3 reported that Major Bode, commander of one of the assault groups, had had a nervous breakdown. He also reported very strong air attacks against Hill 293.

By midafternoon the Germans were streaming back in retreat through the Fourasse Farm. At least 24 of their tanks had been knocked out. The rout was checked when a few 15th Panzer Grenadier Division tanks were brought up to form a straggler line east of Parroy. After dark, the German survivors on Hill 318 filtered south through American lines.

However, not all German soldiers were able to get back that night. Remnants of the 2d Battalion of the 110th Panzer Grenadier regiment (Captain Schneider) and a few tanks from the recon battalion, 11th Panzer Division, held bravely to their positions in the Bois du Benamont, all the while under heavy fire from American tank destroyers and cavalry assault guns.<sup>60</sup> A German report said:

"1530--Hill 320 occupied by enemy. People returning to La Fourasse and Parroy. HPTM Schneider with his battalion still on Hill 320, no commo. Opponent has again employed a Jabco (P-47 fighter). Flank fire from the south."<sup>61</sup>

Another report at 1717 provided more details:

"Extremely strong air activity. Just about all tanks of the Panzer group (14 of them) shot up. Captain Schneider not yet back from Hill 320. One platoon of II/2113 overrun by enemy tanks. Panzer AA 11 assembled in Parroy, the other parts in Bures."<sup>62</sup>

General Krueger ordered assault troops to advance up Hill 318 to determine if it was still occupied by Captain Schneider's unit. The LVIII Panzer commander then reported to Manteuffel:

"1735 determination: Hill triangle lost. Troops exhausted, need rest."<sup>63</sup>

The LVIII Panzer Corps summary of the day's action is remarkably consistent with U.S. accounts.

"The attacks which commenced last night by the 11th Panzer Division against the opponent led to the retaking of Hill 318 (2 west-southwest Rechicourt) as well as Hill 320 (2 kilometers northeast Bathelemont). When the considerable morning fog lifted, our opponent launched heavy air attacks and held the terrain under heavy artillery fire. With that he forced the 58th Panzer Corps to commence its attack. To utilize his material superiority, the enemy himself went over to the offensive.

All the territory won last night by the 11th Panzer Division has been again been lost during the course of the day. Supported by heavy artillery and fighter bombers, the opponent attacked and occupied Hill 283 and 293 in the late afternoon. The surrounded portion of a Panzer Grenadier regiment of the 11th Panzer Division defends itself on Hill 320 against overwhelming enemy. Breakthrough attempts, taken by the opponent with heavy tank support, could be intercepted in the line: Hill 269 (1 kilometer

north of Bures)--Hill 290 (2 kilometers east of Bathelemont). These counterattacks led to destruction of parts of the II Panzer Grenadier Regiment 110 on Hill 322.<sup>64</sup>

That night General von Wietersheim, commander of the 11th Panzer Division, informed General Krueger, commander of the LVIII Panzer Corps, that Major Bode, one of his attack group commanders, had had a nervous breakdown and it was neither practically or technically possible to expect success with hastily assembled forces.

Commander LVIII Panzer Corps reports, that under these conditions, the continuation of the attack is not to be considered. First the units must be reorganized and the new security line be held. In any case however, the goal has arrived to hold up the opponent for a long time in his attack on Saarburg and tie up his strong forces.<sup>65</sup>

Of the 19 tanks which had been employed, only four were still operational. P47 fighter aircraft had destroyed all abandoned Panzers. He recommended an attack tonight on Hill 320 in order to retrieve Captain Schneider's unit and on Hill 318, to "disturb" the enemy.<sup>66</sup> General Manteuffel subsequently submitted a request to discontinue the offensive:

Because of the lack of our own aircraft the soldiers had great losses, especially in tanks where 11 were shot up through enemy tanks. Because of the day long battle the troops are extremely fatigued.<sup>67</sup>

Besides the main German effort to take Hills 318 and 320, another battle took place in the area near Bezange la Petite against the 10th Armored

Infantry Battalion. During the night the Germans took the high ground west of Hill 293 (2 kilometers southwest of Rechicourt).

"Enemy artillery shelling our positions started early today and was answered effectively not only by our supporting artillery, but also by the air corps. The weather for the first time in many days was favorable to air activity throughout most of the day. They took full advantage of that fact and gave the enemy little rest until darkness fell."<sup>68</sup>

The right flank of the 10th Infantry battalion (Company A) again received the brunt of the German effort to break through. Bitter fighting occurred as U.S. troops supported by tanks inflicted heavy losses were inflicted on German troops. Lieutenants Fields and Lovell were wounded in this action after having carried on meritoriously against a vastly superior force. Lieutenant Fields, although seriously wounded and unable to speak, refused to be evacuated and directed operations by motions and writing out his instructions. His efforts saved the lives of many of the men and prevented a rout of our forces by the overpowering enemy strength. Under the cover of darkness he withdrew his platoon to the reverse slope of the hill and established a position there. In the 35th Tank Battalion area, the CCA commander, gave to Lieutenant Colonel Oden the mission of sweeping the high ground from about northeast of Xanrey to Lezey. Company C completed the mission while losing two tanks.<sup>69</sup>

Late in the afternoon the Germans reported capture of Bezange:

"Situation at Bezange restored again. Enemy lies on Hill 265 a short distance from our positions.

Thirty-six tracked recon vehicles observed from  
Vahley to Bathelemont.<sup>70</sup>

As a result of this German counterattack, the CCA CP displaced at 1630  
to Farm de Ranzey west of Arracourt.

While battles raged on 29 September, General Balck (Army Group G) visited  
General Rundstedt (OB West) at his headquarters in Bad Kreuznach. He told  
him he needed at least 93 light tanks, 46 heavy tanks, and 48 artillery  
pieces if he were to continue the offensive. Von Rundstedt said this was  
impossible under the present conditions.<sup>71</sup>

In light of von Rundstedt's response, Balck decided to approve  
Manteuffel's request to cease the attack of LVIII Panzer Corps in the  
Moyenvic/Bures area and to straighten out and hold a new line of defense.  
The left wing would be withdrawn to the west edge of the lake southeast of  
Bures. The majority of the 11th Panzer Division would be pulled out of the  
action and used as an attacking reserve on the right wing of the LVIII  
Panzer Corps. The area presently held the LXVI Army Corps would be taken  
over by the XLVII Panzer Corps.

"Situation: With the LVIII Panzer Corps the right  
wing and middle is basically unchanged. With the  
enemy attack in the area of Rechicourt our own troops  
individually surrendered which indicates what the  
situation is. In the area of Hill 318, undetermined  
strength Jabo attack, high losses. Committed parts  
of Panzer Grenadier regiment 110 have fallen. Units  
were gathered up and reorganized. According to

continuing reports 19 Panzer have been destroyed. Opponent has not broken through east Rechicourt, old lines remain.

Ammunition is getting in short supply in the ammo dumps. Ammo must be brought in from Baumholder."72

At 2300 hours the official word came down from the Manteuffel noting Balck's acceptance of his request to cease offensive action.

"Order: Division ceases the attack and changes over to the defense, in the line north point of Stiefelsee and the old line. Tonight pull back: the artillery unit. Get marching to Igney (without rest) and the tanks of the 15th Panzer Grenadier Division. Tomorrow night remove the remaining parts of the Brigade Seckendorff (Panzer Brigade 113)."73

The XLVII Panzer Corps also received the order to cease its attack as of the 30th of September, and take up defensive positions 1.5 kilometers west of Parroy. The disengaged artillery units (artillery ABT. III/33) and Panzer Company of the 50th Panzer Grenadier Division were to be returned to the 15th Panzer Grenadier Division. The 113th Panzer Brigade was to be pulled out of 11th Panzer Division, incorporated into the 15th Panzer Grenadier Division and sent to Igney located 5 kilometers northwest of Blamont. The 11th Panzer Division prepared to defend a line: from Parroy to Moyenvic. On the night of 29-30 September, U.S. and German units were disposed as shown on map 22.

The results of the battle on 29 September show the high price the Germans paid. 23 tanks were knocked out, 19 trucks and two halftracks destroyed,

one ammo dump was demolished, two gun emplacements neutralized, three miscellaneous vehicles destroyed, 50 PWs lost, an estimated 400 were killed and 300 wounded. U.S. losses amounted to 10 killed, 55 wounded, and 34 exhaustion cases.<sup>74</sup>

As a result of the actions from 26 to 29 September, the Germans lost a total of 22 Panther V and 14 Panther IV tanks for a total of 46 tanks. They also lost an estimated 700 killed and 300 wounded. The back of the Fifth Panzer Army attack had thus been broken by 29 September. There was no further possibility of creating a new force for a continued effort to reach the Moselle river.<sup>75</sup> Although minor skirmishes would take place on the next few days and the CCA and CCB would remain in the Arracourt area until the resumption of the drive to the West Wall, no significant actions would take place there.

Thus, the Arracourt tank battles had ended, except for a last American tank sweep on 30 September. The sector lapsed into quiet. The 4th Armored Division took up positions north and east of Arracourt while the German infantry dug in a few hundred yards away.<sup>76</sup> On 22 October Wood's 4th Armored Division was relieved by the 26th Division and went into Corps reserve. Thus ended a very intense battle in which the Americans made maximum use of the combined arms team. As a result, German manpower and firepower were so depleted, they were unable to offer any significant resistance





until the Battle of Metz later that year. Arracourt thus shows that maximum use of the combined arms team brings victory to him who employs it properly.

## CHAPTER 5

## SIGNIFICANCE OF ARRACOURT

During 3 weeks in September 1944, the 4th Armored Division distinguished itself in some of the toughest fighting of the war. After crossing the Moselle they breached strong enemy positions at Dieulouard, penetrated to a depth of 45 miles, destroyed German command installations at Arracourt controlling the Nancy sector, blocked the retreat of German forces from Nancy, fought one of the bitterest tank battles of the Western front, and conducted an aggressive defensive action against a determined German force to hold the Arracourt salient of the Nancy bridgehead from which point the Third Army would launch its Lorraine offensive in early November. The 4th Armored Division at Arracourt was able to contain and defeat a major German counter-attack, and prevent Fifth Panzer Army from linking up with the 553d Volksgrenadier Division at Nancy.

The Germans, in spite of a lack of manpower, ammunition, and tanks and despite low morale, conducted offensive operations and fought aggressively in the battles at Luneville and Arracourt. Only after all reserves were committed at the Arracourt salient on 29 September did OKW consent to change over to defensive operations. Their Arracourt offensive effectively broke the forward momentum of the 4th Armored Division, thereby gaining time for

the Germans to rebuild their West Wall defenses. Arracourt was significant for several reasons: It was the largest scale German counterattack other than the Ardennes on the Western Front. In addition, the Arracourt operation was a necessary prelude for further Third Army offensive operations.

Relative combat losses were indicative of the 4th Armored Division success. From the time of the Nancy bridgehead through the first Arracourt battle, the Germans lost an estimated 1589 killed, 1884 PWs, 107 tanks destroyed, 30 SPs guns destroyed, 32 other large caliber guns destroyed, and 491 other vehicles destroyed.<sup>1</sup> The tank battles fought from 19 to 22 September cost CCA 14 medium tanks, 7 light tanks, totally destroyed, and a casualty list of 25 killed and 88 wounded. German losses for the same period were 2 Panzer brigades, destroyed as combat units.<sup>2</sup> By the end of the Arracourt battles, the 4th Armored Division had destroyed or damaged 285 German tanks or other armored vehicles. The 4th Armored Division itself lost 181 killed, 394 wounded in action, 51 missing in action. All told CCA lost 25 medium tanks and 7 tank destroyers totally destroyed.<sup>3</sup>

Several features of the Arracourt battles were noteworthy. These battles were battles of maneuver and excellent examples of combined arms conducting an aggressive mobile defense. The U.S. combat commands were subdivided into task forces to deal with small pockets of German resistance. The mainstay of the task force were the tanks which were not only used on the defensive line but also were maneuvered up and back until they could get a clear shot

at the enemy. Surprise attacks were made from hull defilade, through smoke screens or under the cover of fog rising from the Moselle and Seille river basins. The tank destroyers were used to take out other tanks and because of their thin armor and extreme vulnerability, remained pretty much in position and did not maneuver as did the tanks.<sup>4</sup> The infantry occupied blocking positions. Cavalry screened the flanks with their light tanks. Field artillery batteries fired 360 degrees and three battalions had interlocking fields of fire. By use of an intelligence net and aerial OPs, artillery could quickly and flexibly mass fires.<sup>5</sup> P-47 fighter aircraft supplemented tank and artillery fires, and flushed out German tanks so ground units could destroy them.

Each side conducted defensive operations differently. On 25 and 26 September, the 4th Armored Division broke contact, pulled back and reinforced the Arracourt salient with CCB. The division gave ground in order to more firmly establish a defensive position as a springboard for future offensive operations. The Germans, on the other hand, refused to give any ground. When Manteuffel wanted to withdraw to more defensible terrain, (from Omeray to Gelucourt, 12 kilometers east of Arracourt) higher headquarters refused. Hitler personally directed that all ground be held no matter what the cost. Had their commanders been allowed to break contact to reorganize their units, they might have been able to launch a more aggressive initiative.

A second feature of Arracourt was leadership. American command and control was extremely decentralized and commanders had considerable flexibility to display initiative. This worked to the Americans' advantage. Personalities played a key role. General Bradley gave Patton free reign to accomplish his mission. Patton did the same with General Eddy and Eddy with Woods. Colonel Clarke, CCA commander and Lieutenant Colonel Abrams, 37th Tank Battalion commander, also enjoyed great freedom. An example of this freedom was at the 80th Infantry Division bridgehead at Dieulouard on 12 September when Patton and Eddy had gathered on the bridge with the commander of the 80th Infantry Division. Only because of Colonel Clarke's and Colonel Abrams' insistence were they allowed to proceed and begin the penetration which led to the movement of CCA from Dieulouard to Arracourt. Clarke implicitly trusted Abrams and believed no one would get by him. Clarke knew what Abrams was doing and knew his ability to shoot.<sup>6</sup> Within the battalion and company, decentralized command and control allowed the unit commander considerable latitude in engaging the enemy, the results of which were repeated again and again by recorded heroic action.

Command and control on the German side was much more centralized. For example, OKW or Supreme Command consistently disapproved von Rundstedt's recommendations, often without reasons. Army Group G directed operations down to division level. Commanders were not allowed to make their own decisions. When Blaskowitz wanted to go over to the defensive on 20 September against the orders of Berlin, he was relieved and replaced by Balck.

Because commands came from the highest levels, intervening events such as build-up and troop strength had no bearing on the execution. This lack of flexibility often led to disaster as it did at the Arracourt salient. German command and control depended greatly on the civilian telephone system during September 1944. However, due to systematic bombing and sabotage, the civilian telephone system was barely sufficient. They had repeated radio problems, due to considerable materiel losses from enemy air attacks. To help offset these shortages repairs were made very quickly. The lack of Ultra intercepts during this period demonstrated how extensively they used the telephone.<sup>7</sup>

The use of intelligence by both sides was noteworthy. U.S. intelligence efforts were mixed. The Corps G2 knew exactly when CCB was going to get hit at Chateau-Salins.<sup>8</sup> The 25th and 42d Reconnaissance Squadrons did remarkably well in determining German locations. However, such information was generally disregarded by Patton and by Eddy, as they fully expected to continue the advance any day. Moreover, intelligence from higher headquarters was not passed to subordinate units.<sup>9</sup> As a result of the lack of good U.S. intelligence, Patton did not realize the West Wall near Saarbruecken was undefended, and could easily have been pierced without a struggle. The route to the east through Strassbourg was equally open. U.S. forces failed to send recon patrols through the wide gap of both sides of Dieuze.<sup>10</sup>

German intelligence provided similar results. Reconnaissance forces were out and were able to give reports of moving U.S. units. However, they could not determine exact troop locations, which explained the 113th Panzer Brigade's maneuvering right and left around Rehicourt on 19 September looking for a breakthrough point in its drive to Champenoux. They were unable to locate the weak points in the 10th and the 53d Armored Infantry Battalion lines. Instead, they attacked head on.

U.S. air superiority also played a key role in the campaign. Thus, Clarke could lead the units in his L-4 aircraft, artillery could be adjusted by aircraft, and P-47s could make reconnaissance and RECCE flights over German positions. German lack of air power severely limited their capabilities.

Adverse weather had a major impact on the operation. September had been abnormally wet with over 5 inches of rain. The mud accompanying the rain made maneuvering difficult, if not impossible. Fog was prevalent in the early part of the day. The fog brought the battle to very short range enabling Sherman tanks to get close to German Panzers. U.S. tanks first shot white phosphorous to blind the opposing crew, then used armor-piercing ammunition to destroy German tanks. Since the U.S. was using mobile defense techniques, tanks did get bogged down when used as parts of task forces in mopping up operations. Adverse weather assisted the Germans by limiting Allied air attacks, but it hindered the Germans. They had extreme difficulty getting into positions to launch attacks and were consistently late



in meeting starting times. The bad weather put the Sherman tank at an advantage with maneuverability and thus the Panzer advantage of its longer range guns was lost. In the fog, the Germans lost their sense of direction while attacking, as indicated by the use of tape up to U.S. lines to insure that they would not get lost. The bad weather was also very demoralizing to the soldiers.

Supply limitations restricted both sides. The U.S. 4th Armored Division experienced shortages, particularly in gasoline. They had to use 55 gallon drums on the back of the Sherman tanks in order to have sufficient amounts to carry out the days' maneuvers.<sup>11</sup> Other supplies were not a problem as there were no critical shortages. The Germans, on the other hand, had serious shortages of all kinds. XIX TAC planes consistently bombed trains with tanks attack ammo and POL dumps. As XIX TAC noted:

"On the 28th of September, the second successive day of good flying weather, the 406th Group, on Armored Recon in the Strasbourg-Saarburg area, found excellent hunting, chiefly against military trains bearing tanks and ammunition. Its 512th Squadron hit the jackpot when it strafed the train and the resulting explosion blew up the whole countryside for 5 miles around. Another ammunition train, of 20 cars, was blown up and intense fires seen among Tiger tanks on flat cars in another train."<sup>12</sup>

Despite the bombings, the Germans managed to bring additional tanks forward against the 4th Armored Division at Arracourt. Most of the replacement tanks were repaired in LVIII Panzer Corps workshops with the greatest

possible speed as the tanks were urgently needed for reinforcement. Often over half of the knocked out tanks could be returned to the lines the following morning. Another significant shortage was that of German aircraft. Only on two occasions did the Luftwaffe appear against the XIX TAC. On the 29th of September, for the second time in two days, 30 ME-109 Luftwaffe aircraft engaged the 513d Squadron which was attacking RECCE targets. The German pilots appeared inexperienced, a fact which supported the belief that fuel shortage was seriously handicapping training in the Luftwaffe. It was reported that because of lack of fuel, combat training time in the German Luftwaffe had been sharply reduced and much of the instruction being given in gliders rather than powered planes.<sup>13</sup>

Artillery supply deserves a special note. The Germans had good ground observation and the field artillery observation battalions were well organized. Although the Germans knew how much artillery the U.S. had, they were unwilling to fire sufficient ammo on any but the most urgent front line targets due to ammunition shortages. The undoing of their artillery was due to a lack of air observation, the complete breakdown of ammo under the weight of U.S. prepared preparation and counterbattery fires, improvised unit organization, an unwillingness to expend ammo, too much reliance on the self-propelled and other high velocity guns, and the ineffectiveness of their harrassing fires by long range heavy weapons.<sup>14</sup> Mixed caliber weapons from (75-mm to 380-mm) within the same units posed severe resupply problems. Some 70 different types of weapons were employed against Third Army units.

Use of reserves varied on the two sides. The U.S. committed reserves in an orderly fashion. The combat command setup was tailored to provide the proper force mix at the proper time. For example, a task force was sent back to the bridge head at Dieulouard to assist in the operation there. A second task force was sent to assist CCB in its move across the canal. A third task force was sent to Luneville to assist the CCR. CCB subsequently joined forces with CCA at Arracourt during the second battle to hold the Arracourt salient. The Germans often committed their reserves piecemeal. The overall German situation had deteriorated to such a degree that when the Fifth Panzer Army became available, its commitment was more necessary elsewhere. Commitment of reinforcements thus involved putting out a series of brush fires. Therefore, the Germans could not concentrate on launching a successful counterattack.

In addition, German reserves were limited. The 15th Panzer Grenadier Division only arrived at Luneville on 17 September and were immediately pressed into battle without rest. The 113th Panzer Brigade was committed before the 111th Panzer Brigade could get into position with no available reserve. The 11th Panzer Division was employed against the Arracourt salient as soon as the first elements arrived, even though subordinate units were still not present in the battle area. To minimize combat losses, Germans learned to attack at night, because American aircraft did not fly at night. By the end of September, however, the Germans were forced to go on the defensive because they could not continue the attack.

A comparison of the soldiers also is important to consider at this time. The esprit of the U.S. soldier was high, in part due to the charisma of Patton, Bradley, Clarke, and Abrams, and their concern for the individual soldier. U.S. soldiers had spent 6 weeks on the offensive and were hoping to regain it. Although miserable due to rain, mud, and lack of sleep, U.S. soldiers knew they were far better off than the German soldiers, and were told this again and again by their commanders. They had trained together and had moved as a unit from the U.S. through England and then fought through France. They had captured a German headquarters and had damaged two German divisions. When the 4th Armored Division adopted a mobile defense, morale stayed high because they remained active.

The German soldier, on the other hand, had serious problems. There was little unit cohesion. Men were gathered from all over Germany, put on a train, and at the terminal, first met their leaders. Units consisted of injured from the eastern front, old men, and those who had already been discharged but called back to duty and sent to the front. They realized they were on the defensive, and being pushed back. Excuses to go back to the rear increased until Balck put an end to it with the threat of execution. Discipline was strict, the soldiers responded to this and fought courageously.<sup>15</sup>

The expectations of both sides differed, and this may have impacted on morale and performance. The U.S. soldier felt he could continue the march

and push without much resistance all the way to the West Wall. This is what he had been told over and over again. However, he found the German soldier could be a very determined fighter, often willing to die in place. The Germans were motivated by other means. Germans had been told that each individual soldier of the 4th Armored Division was chosen because he was a professional murderer in civilian life, that membership in the 4th Armored Division was only possible if the soldier had killed his mother, and he had been born out of wedlock. The Wehrmacht rank and file thus regarded the 4th Armored Division with respect and terror. They also believed that Colonel Abrams was Jewish, (even though he was a New England Methodist), and that vengeance played a part in his destructiveness.<sup>16</sup>

#### Lessons Learned.

U.S. lessons learned were numerous. The 4th Armored Division employed the tanks and infantry at night even though the books said it could not be done. This successful use of tank infantry teams surprised the Germans and enhanced American success. Careful integration of tank power with air power proved valuable. On several occasions the XIX Tactical Air Command was given credit by the ground forces for their role in destroying and flushing out tanks.<sup>17</sup> On the other hand, lack of adequate intelligence caused the 4th Armored Division to fight in the Arracourt area and not punch through to the north where there was weakness in the German lines. Because of the resultant inactivity of the 4th Armored Division from 1 to 12 September, the

Germans had a chance to reorganize units, to create local reserves, and organize a counterattack in the Arracourt-Luneville sector. This gained time for them to prevent the Americans from getting to the West Wall before winter. Had the 4th Armored Division not halted at the Moselle, Arracourt might never have been a battle, and the U.S. might have arrived at the West Wall and pushed through to Germany with minimal resistance. However, they had been ordered by the Supreme Allied Commander to stand fast, both in early and late September. Logistical lessons were learned as well. Had the Third Army had sufficient fuel to push through at Arracourt on 15 September instead of regrouping there, they might have gotten all the way to the West Wall.

Lessons can also be learned from the German experience. The problem of using makeshift units became apparent from German use of Panzer brigades. These units intended for service in the East had only slight combat value in France. They lacked a regimental staff, towing services, and armored force repair shop platoons. Moreover, artillery and engineers were lacking. Likewise other new units formed without equipment, training, or leadership were insufficient to stop the Allied advance. The attack of the LVIII Panzer Corps against the Dieulouard bridgehead didn't hold, as the 553d Volksgrenadier Division was outflanked by the enemy on two sides, and could not hold its ground.

Arracourt is an example of the futility of operating without adequate air support. The Germans failed to reinforce the Luftwaffe, ground reinforcements were late in arriving, and those that did were ineffective,

because all airfields near the front had been destroyed. Only on two occasions during September were German aircraft brought to bear against U.S. positions in Lorraine. On two other occasions in the latter part of September, aircraft had been requested, but they could not be brought in because they were either being used elsewhere (against Montgomery's 21st Army Group force in the north), or the planes couldn't get off the ground from airfields in Germany due to heavy fog.

The Germans also learned the disadvantages in wearing out Panzer type divisions by retaining them in front lines for purely defensive action. However, circumstances dictated it was not possible to do anything else. The Germans learned the cost of a "hold at any price" policy. They had to economize with their available forces. Interference by intervening headquarters in OKW directives was expressly forbidden. This interference from above did not allow the commander on the ground to make a decision. Hence, local commanders could not economize their units because they were not permitted to. Lack of timely communications made the situation even worse. Sometimes orders did not arrive until 12 to 24 hours later, which rendered them obsolete.

German commanders were often not prepared for operations against Americans. The majority of the commanders had been brought from the Eastern Front and were not familiar with the terrain or tactics practiced by the Americans. Compounding the effect of that ignorance was the tendency for

Berlin to force Eastern tactics in the West (i.e., massing of tanks), rather than being sensitive to a different enemy on different terrain. Hitler himself made a great mistake on insisting a counterattack be delivered before all available forces were assembled. This happened repeatedly throughout the Arracourt battles. A blatant example occurred after 30 September when LVIII Panzer Corps tried one more time to attack the Americans. When the weather cleared, P-47 fighter aircraft appeared and 18 of their own tanks and several armored personnel carriers were destroyed. This could have been prevented had they been satisfied with the line already gained, which was favorable for the defense.

In summary, the battles of Arracourt demonstrated the U.S. ability to maintain an aggressive mobile defense while retaining critical terrain to deny the Germans a chance to link up with the 553d Volksgrenadier Division in Nancy and to anchor their position on the east bank of the Moselle for the winter. The combined arms forces of the 4th Armored Division, coupled with air attacks, were orchestrated to maintain the Arracourt salient. All attempts to dislodge the 4th Armored Division from the hills around Arracourt eventually failed. Arracourt demonstrated the U.S. capability of maintaining a 360 degree mobile defense while deep within enemy lines, in spite of adverse weather conditions. It exemplified the determination of the American fighting man to resist wave after wave of assault at all times of the day or night even in the face of combat fatigue. Arracourt poignantly showed how the Wehrmacht, already pondering complete defeat,



nevertheless maintained its aggressive jabs until it was at last allowed to go on the defensive. Arracourt thus became a critical turning point in Patton's drive to Germany, and served to tie up enough forces to allow the main attack in the north to proceed. The German counterattack was repulsed and the Germans never regained the initiative. Arracourt became the base from which the Third Army winter offensive was launched in November. Arracourt--the greatest tank battle of the Western offensive to that time--became a model for defensive tactics and combined operations in the future.

APPENDIX 1

APPENDIX 1  
GERMAN LAND COMMAND IN THE WEST

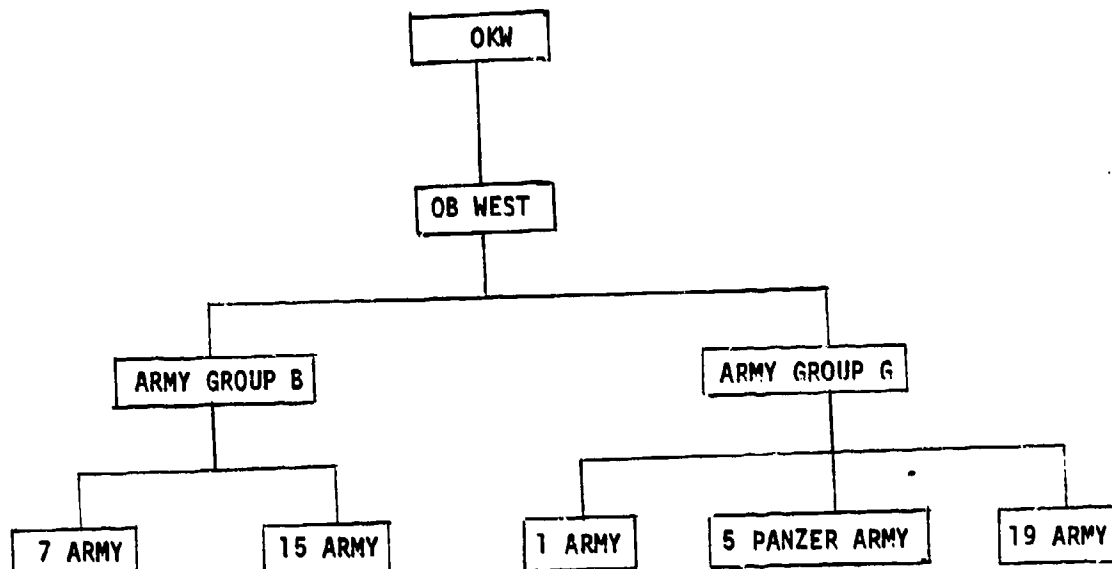

APPENDIX 2

APPENDIX 2

ORGANIC AND ATTACHED UNITS OF THE FOURTH ARMORED DIVISION

**ORGANIC UNITS OF THE  
FOURTH ARMORED DIVISION**

8th TANK BATTALION  
35th TANK BATTALION  
37th TANK BATTALION  
10th ARMORED INFANTRY BATTALION  
51st ARMORED INFANTRY BATTALION  
53rd ARMORED INFANTRY BATTALION  
24th ARMORED ENGINEER BATTALION  
22nd ARMORED FIELD ARTILLERY BATTALION  
66th ARMORED FIELD ARTILLERY BATTALION  
94th ARMORED FIELD ARTILLERY BATTALION  
25th CAVALRY RECONNAISSANCE SQUADRON,  
MECHANIZED  
126th ARMORED ORDNANCE MAINTENANCE  
BATTALION  
46th ARMORED MEDICAL BATTALION  
HEADQUARTERS AND HEADQUARTERS BATTERY,  
DIVISION ARTILLERY  
CC A HEADQUARTERS AND HEADQUARTERS  
COMPANY  
CC B HEADQUARTERS AND HEADQUARTERS  
COMPANY  
RESERVE COMMAND  
DIVISION HEADQUARTERS COMPANY  
144th ARMORED SIGNAL COMPANY  
TRAINS HEADQUARTERS AND HEADQUARTERS  
COMPANY  
FORWARD ECHELON, 4th ARMORED DIVISION  
HEADQUARTERS  
REAR ECHELON, 4th ARMORED DIVISION  
HEADQUARTERS  
4th ARMORED DIVISION MILITARY POLICE  
PLATOON  
4th ARMORED DIVISION BAND

\*From Baldwin, Tiger Jack, p. 170.

APPENDIX 2 (cont.)

**ATTACHED UNITS IN COMBAT**

704th TANK DESTROYER BATTALION  
489th ANTI-AIRCRAFT ARTILLERY (AW)  
BATTALION (SP)  
3804th QUARTERMASTER TRUCK COMPANY  
444th QUARTERMASTER TRUCK COMPANY  
995th ENGINEER TREADWAY BRIDGE COMPANY  
696th ARMORED FIELD ARTILLERY BATTALION  
1st PLATOON 16th FIELD HOSPITAL  
456th AMBULANCE COMPANY  
5th DETACHMENT, 166th SIGNAL PHOTO COMPANY  
COUNTERINTELLIGENCE CORPS DETACHMENT No. 504  
INTERROGATION OF PRISONERS OF WAR TEAMS  
No. 56 and 61  
ORDER OF BATTLE TEAM No. 24  
AIR SUPPORT PARTY No. 2, XIX TACTICAL  
AIR COMMAND  
PHOTO INTELLIGENCE TEAM No. 56  
ADVANCE SECTION COMMUNICATIONS ZONE,  
PROSTHETIC TEAM No. 4

\*From Baldwin, Tiger Jack, p. 190.

APPENDIX 3

### APPENDIX 3

## TABLES OF ORGANIZATION AND EQUIPMENT (TO&E's) OF FIFTH PANZER ARMY DIVISIONS

### 1944 GERMAN INFANTRY DIVISION

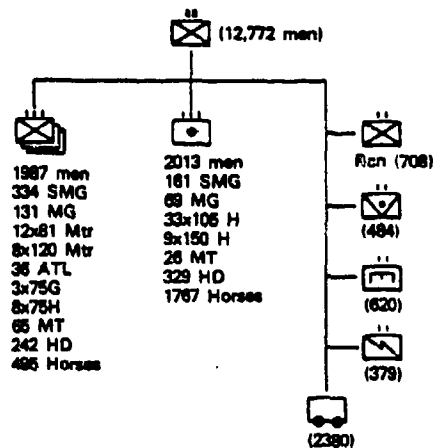

### GERMAN INFANTRY DIVISIONS

	1939	1944	LW	1945	VG	Mtn 1939	Lt	2nd & 3rd Mtn 1939
Men	17,734	12,772	9,800	11,909	10,000	24,956	14,500	17,188
Infantry	8,000	5,500	4,100	5,100	4,700	7,000	6,800	?
LMG	378	614	1200	462	2084	396	1100	275
HMG	138	102	549	74	423	96	517	72
ATL	90A	108	•	222	216	54A	54A	•
50 Mtr	93	•	•	•	•	81	63	66
81 Mtr	54	54	42	54	42	54	42	36
120 Mtr	•	32	24	25	24	•	28	•
20 Gun	12	13	12	10H	9H	12	63	•
75 AT Gun	75x37	22x75	20x75	31x75	9x75	12x37	60G	48x37
75 How	20	19	12	29	561	18	14	12
105 How	36	34	36L	25	24	36	36R	16
150 How	18C	15C	4M	18C	12	12	12	8
MT	1009	617	543	385	426	1140	1000	871
HD	918	1365	726	1273	1142	1007	700	659
Horses	4,842	3,979	2,734	3,608	3,002	7,405	3,300	4,845
AFV	3D	10	•	14	14	•	•	•
FPF	6.2	7.0	4.8	6.6	5.9	3.7	4.7	?
Raised	216	180U	21	•	13V	13W	16	2

#### ABBREVIATIONS:

Men = total "paper" [full] strength of unit; Infantry = all men in infantry, reconnaissance, and engineer battalions; LW = Luftwaffe infantry; VG = Volksgrenadier; Mtn = mountain infantry; Lt = light infantry; FJ = Fallschirmjäger (parachute light infantry); PG = Panzergrenadier; Arty = artillery; 50 mtr (81, 120) = 50mm (81mm, 120mm) mortar; 20 gun = 20mm anti-aircraft gun; 88 gun = 88mm gun; 75 AT gun = 75mm anti-tank

gun; 75 How (105, 150) = 75mm (105mm, 150mm) howitzer; FPF = fire power factor; % of Div (arty) = percent of divisional fire power generated by artillery regiment; MG (LMG, HMG) = machinegun (light, heavy); ATL = anti-tank rocket launchers; SMG = submachinegun; FT = flame thrower; AFV = armored fighting vehicle; AG = assault gun; AC = armored car; Pz III (IV, V, VI) = Panzer III (IV, V, VI) tank; MT = motor transport vehicle; HD = horse-drawn vehicle

\*From Strategy and Tactics Magazine, War in the East, pp. 141-42.



APPENDIX 3 (cont.)

1944 GERMAN ARMORED DIVISION

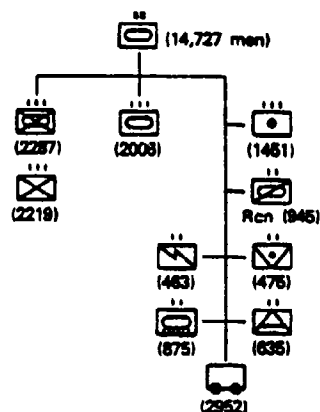

1944 MOTORIZED INFANTRY DIVISION (PG44)

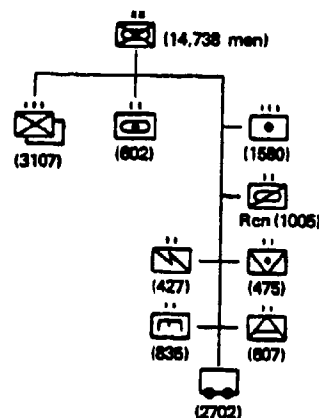

Figure V-4

GERMAN MOTORIZED DIVISIONS

	FJ	PG 1941	PG 1944	Pz 1941	Pz 1944	Pz 1945	SS Pz	Arty	Rifle	Tank
Men	15976	16400	14738	15800	14727	11422	17200	10900	9400	11900
Infantry	8400	7100	7000	5500	5200	4700	7100	860	6300	3800
LMG	3026	810	818	850	1239	2100	2050	1101	2200	2963
HMG	1010	712	106	1067	72	650	1565	613	647	517
ATL	250	63a	•	45a	•	88	•	•	212y	207y
50 Mtr	•	57	•	•	•	•	•	•	83	•
81 Mtr	125	36	64	30	52	36	58	6	83y	52y
120 Mtr	63	•	26	•	18	20	24	4	21	42
20 Gun	39	12	76	74	102	109	152	54	•	16y
75 AT Gun	21	63	19	76p	13	31	12	12	44z	94z
75 How IG	20	14	•	18	•	•	•	•	•	•
105 How	36r	36a	41	36a	29j	34	42n	56r	12y	8t
105 How	12	12f	20	160	26	16	30k	60s	•	•
MT	2141	2800	2746	2900	2427	2171	3329	2522	182	1610
HD	•	•	•	•	•	•	•	•	642	•
Horses	•	•	•	•	•	•	•	1840	?	?
AFV	14	82	105	165	503	182	231	93	•	240
FPF	8.7	7.4	9.1	9.6	10.0	8.1	14.2	13.0	4.0	9.3
Raised	8	16x	15	27	26	0(?)	7	1	790	26

\*From Strategy and Tactics Magazine, War in the East, pp. 144-45.

APPENDIX 4

APPENDIX 4

FIFTH PANZER ARMY ORDER OF BATTLE

XLVII Panzer Corps - General der Panzertruppen Heinrich Freiherr von Luettwitz

LVIII Panzer Corps - General der Panzertruppen Walter Krueger

11th Panzer Division - Generalleutnant Wend von Wietersheim

Pz Regt 15  
Pz Gren Regts 110, 111  
Pz Arty Regt 119  
Pz Rcn Bn 11  
Pz Engr Bn 209  
Pz Sig Bn 89  
Pz Obsn Btry  
Army AA Bn 277  
AT Bn 61  
Aux No. 61

15th Panzer Grenadier Division - Oberst Wolfgang Mauchke

Pz Bn 115  
Pz Gren Regts 104, 115  
Mtz Arty Regt 33  
Pz Rcn Bn 115  
Mtz Engr Bn 33  
Mtz Sig Bn 33  
AT Bn 33  
Aux No. 33

21st Panzer Division - Generalmajor Edgar Feuchtinger

Pz Regt 22  
Pz Gren Regt 125, 192  
Pz Arty Regt 155  
Pz Recon Bn 21  
Pz Engr Bn 220  
Pz Sig Bn 200  
AT Bn 200  
Pz Obsn Btry  
Army AA Bn 305  
Aux No. 200

APPENDIX 4 (cont.)

111th Panzer Brigade - 2000 men

2111 Pz Gr Regt - 2 Bns of 3 cos each  
7 heavy cos with 4-75 mm Inf How and 4-81 mm mortars  
2111 Pz Regt - 2 bns of tanks, one with Mk IV and one with Mk V tanks  
Mixed Pz Rcn Co  
Pz Engr Co

112th Panzer Brigade - 1200 men - Oberst von Usedow

2112 Pz Gr Regt - 2 bns with 3 cos ea  
2112 Pz Bn - 40 Mk IV tanks

113th Panzer Brigade - 2000 men - Oberst Freiherr von Seckendorf

2113 Pz Gr Regt - 2 bns each having 3 rifle cos  
2113 Pz Bn  
130th Pz Regt  
Pz Rcn Co

Compiled from U.S. Army, 6th Armored Division, "6th Armored Division  
Periodic Reports: Special G-2 Reports, 26 September 1944," France, 1944,  
Box 112 in the Dwight D. Eisenhower Library, Abilene, KS.

APPENDIX 5

## APPENDIX 5

### TANKS USED AT ARRACOURT\*

#### U.S. TANKS

##### Light Tank (Stuart)

weight: 16 tons  
crew: four  
armament: one 37 mm gun, two .30 inch machine guns  
armor: 44 mm (max)

##### Medium Tank (Sherman)

weight: 35 tons  
crew: five  
armament: short tube 75 mm gun (M3), one .30 inch MG in hull,  
one .50 cal MG in hull  
speed: 23 mph  
range: 80 miles

#### GERMAN TANKS

##### Mark IV

weight: 24 tons  
crew: five  
armament: one long barrelled 75 mm gun and two 7.92 mm machine guns  
speed: 25 mph  
range: 130 miles  
armor: 50 mm in front

##### Mark V (Panther)

weight: 43 tons  
crew: five  
armament: one 75 mm gun, two 7.92 mm machine guns  
speed: 30 mph  
range: 100 miles  
armor: 120 mm maximum

##### Assault Gun

weight: 11.8 tons  
crew: four  
armament: one 20 mm gun, one 7.92 mm machine gun  
speed: 40 mph  
range: 150 miles  
armor: 30 mm

\*Compiled from Andrew Kershaw, The Tank Story (London: Marshall Cavendish, 1973).

## NOTES

### Chapter 1

1. Hanson W. Baldwin, Tiger Jack (Fort Collins, CO: The Old Army Press, 1979), p. 85.
2. Eisenhower to CCS, 10 September 1944, SHRAF File, Post Overlord Planning, 381, I, cited by Hugh M. Cole, The Lorraine Campaign, U.S. Army in World War II (1950; reprint ed., Washington, DC: Historical Division, U.S. Army, 1970), p. 210.
3. Directive, Eisenhower to Commanders, FWD-14764, 13 September 1944, SHRAF Cable Log, cited by Cole, Lorraine Campaign, p. 211.
4. 12th Army Group AAR, V, cited by Cole, Lorraine Campaign, p. 212.
5. Omar N. Bradley, A Soldier's Story (New York: Henry Holt, 1952), p. 398.
6. Ibid., p. 399.
7. The German West Wall, or Siegfried Line, was a prepared defensive position consisting of pill boxes and concrete antitank obstacles that ran along the line from Basel to Karlsruhe, then west to Saarbruecken, and north along the Saar through Aachen and the Dutch border.
8. Stephen E. Ambrose, The Supreme Commander: The War Years of General Dwight D. Eisenhower (Garden City, NY: Doubleday and Co., 1970), p. 507.
9. Ibid., p. 493.
10. Operation COBRA was the code name for the Normandy beachhead breakout, which took place in July 1944.
11. Cole, The Lorraine Campaign, p. 211.
12. Ambrose, Supreme Commander, p. 531.
13. Dwight D. Eisenhower, Crusade in Europe (Garden City, NY: Doubleday and Co., 1948), p. 290. Eisenhower stated that a reinforced division in active operation consumed 600 to 700 tons of supplies per day. This amounted to 3600 tons needed per day, or a shortfall of 1600 tons per day for Third Army.
14. George S. Patton, War As I Knew It (Boston, MA: Houghton Mifflin Co., 1947), p. 124.
15. Bradley to Eisenhower, 12 September 1944, 12th A Gp File, Military Objectives 371.3, I, cited by Cole, Lorraine Campaign, p. 213.

16. Ibid.
17. Ambrose, Supreme Commander, p. 528.
18. Eisenhower, Crusade in Europe, p. 305. See also Chester Wilmot, Struggle for Europe (New York: Harper and Brothers, 1952), p. 476.
19. Wilmot, Struggle for Europe, p. 505.
20. Ambrose, Supreme Commander, p. 498.
21. Wilmot, Struggle for Europe, p. 468.
22. Ambrose, Supreme Commander, p. 527. For this reason, Montgomery insisted Eisenhower come to visit him, rather than vice versa.
23. Wilmot, Struggle for Europe, p. 468.
24. Dwight D. Eisenhower, (General), to Omar N. Bradley, (General), 15 September 1944, Eisenhower Library, Abilene, KS.
25. Jacques Nobécourt, Hitler's Last Gamble, translated from the French by R. H. Barry (New York: Schocken Books, 1967), p. 56.
26. Wilmot, Struggle for Europe, p. 478.
27. MS A-916, p. 2. MS numbers cited in these footnotes refer to unpublished monographs from the Foreign Military Studies series of the Historical Division, Headquarters, U.S. Army, Europe. The monographs were written in the years immediately after World War II by former German officers. Complete information on the monographs may be found in the bibliography of this paper.
28. MS A-999, p. 5.
29. Wilmot, Struggle for Europe, p. 478.
30. Ambrose, Supreme Commander, p. 496.
31. Wilmot, Struggle for Europe, p. 478.
32. Cole, Lorraine Campaign, p. 12. Cole states that a cumulative total of 2,152,297 soldiers had landed in the American and British zones by 31 August. After that time, three fresh divisions landed, bringing the strength to more than 2,200,000 soldiers.
33. Friedrich Wilhelm von Mellenthin, Panzer Battles (Norman: University of Oklahoma Press, 1955), p. 313.



34. Ambrose, Supreme Commander, p. 514.
35. Cole, Lorraine Campaign, p. 32. Cole explains how difficult it is to get German strength figures for the West.
36. Wilmot, Struggle for Europe, p. 482.
37. Cole, Lorraine Campaign, p. 27.
38. Ibid., p. 29.
39. This figure was compiled from the records of participating units.
40. Cole, Lorraine Campaign, p. 27.
41. Virgil Ney, Evolution of the U.S. Army Division, 1939-1968 (Fort Belvoir, VA: Prepared by Technical Operations, Combat Operations Research Group for Headquarters, U.S. Army Combat Developments Command, January 1969), p. 142. Ney obtained this figure from R. R. Palmer, Study Number 8, Army Ground Forces, 1946.
42. Baldwin, Tiger Jack, p. 22.
43. Cole, Lorraine Campaign, p. 243.
44. George Dyer, XII Corps, Spearhead of Patton's Third Army (Baton Rouge, LA: XII Corps History Association/Military Press of Louisiana, 1947), p. 227.
45. The tank destroyer force was organized at the outset of World War II, but was closed out after the war.
46. This information is from a chart on the inside cover of Kenneth Koyen, The Fourth Armored Division from the Beach to Bavaria (Munich, Germany: Herder-Druck, 1946).
47. U.S. Army, 3d Army, After Action Report, Third U.S. Army: 1 August 1944-9 May 1945, 2 vols. (Regensburg, Germany, 1945), vol. II, annex 3, XIX Tactical Air Command Report, p. ii. (Hereafter cited as XIX TAC Report.)
48. "Records of German Field Commands: Army Groups" (Washington, DC: American Historical Association Committee for the Study of War Documents, 1959). National Archives microfilm T-311, Roll 141. (Hereafter cited as "German Army Groups" with the microfilm roll number.)
49. Ibid.
50. Russell F. Weigley, History of the United States Army (New York: Macmillan Publishing Co., 1967), p. 468.

51. MS B-472, p. 4.
52. Wilmot, Struggle for Europe, p. 479.
53. MS B-037, p. 27.
54. MS B-548, p. 4.
55. Mellenthin, Panzer Battles, p. 316.
56. These figures were compiled from MS A-871, A-916, A-999, and B-037.
57. These are the combat ratios for comparing U.S. and German figures.
58. Wilmot, Struggle for Europe, p. 478.
59. Convalescing units were grouped according to malady, such as stomach battalion, ear battalion, etc. Ibid., p. 482.
60. Many sources show how Patton gleaned gasoline to push his advance forward. Most entries are in the log of the 4th Armored Division.
61. New Panzer V tanks were sent to outfit the new Panzer brigades, including the 111th and 113th Panzer Brigades, which fought at Arracourt.
62. MS B-472, p. 4.
63. Mellenthin, Panzer Battles, p. 318.
64. Ibid., p. 318.
65. During August and September 1944, Panzer V production totalled 1500 tanks.
66. Baldwin, Tiger Jack, p. 19.
67. Clarke was promoted to brigadier general and was sent to the 7th Armored Division in Holland after its generals had all been relieved. After reorganizing the division along 4th Armored Division lines, Clarke's unit fought brilliantly in the German Ardennes offensive in the St. Vith area.
68. Bruce C. Clarke, (General), to Barnes, 26 March 1982.
69. Mellenthin, Panzer Battles, p. 313. Manteuffel assumed command of Fifth Panzer Army on 11 September 1944.
70. Cole, Lorraine Campaign, p. 237.

71. Wilmot, Struggle for Europe, p. 483.
72. Baldwin, Tiger Jack, p. 39.
73. Clarke to Barnes, 26 March 1982.
74. MS B-037, p. 14.
75. In Army Group B, Rommel was removed on 17 July after he was injured, and the command of his army group was exercised directly by Commander in Chief West. When von Rundstedt replaced Model as Commander in Chief West on 5 September, Model became commander of Army Group B.
76. Cole, Lorraine Campaign, p. 230. Because the commander and his chief of staff generally moved together, command and control was strengthened.
77. U.S. Army, 4th Armored Division, Division Trains, "After Action Report for September 1944," Record Group 407, National Archives, Washington, DC.
78. Martin Van Creveld, Fighting Power: German Military Performance, 1914-1945, prepared by C and L Associates, Defense Consultants, Potomac, MD (Washington, DC: Office of Net Assessment, U.S. Department of Defense, December 1980), p. 131.
79. MS B-472, p. 4.
80. U.S. National Security Agency, "Report of Assignment with Third United States Army, 15 August - 18 September 1944," by Major Warrack Wallace, SRH-108, p. 2.
81. U.S. National Security Agency, "Third Army Radio Intelligence History in Campaign of Western Europe," prepared by Signal Intelligence Service of Headquarters, Third U.S. Army, SRH-042, p. A-9.
82. Paul D. Harkins, (General), to Barnes, 21 April 1982. "...But, as Gen Patton told 'Eddy' one night when Eddy complained about being overextended with 60000 Germans on his 'left' and 90,000 Germans on his 'right,' Gen 'P' replied, 'Ignore the bastards and go ahead.'"
83. General Clarke, in his letter to Barnes of 26 March 1982, notes that through the French resistance, he generally knew where the enemy was and in what strength, but that they were inclined to exaggerate information on the Germans ahead of him. He states he never received any enemy intelligence from division and higher headquarters.
84. Microfilm records of German war records are very detailed; however, situation maps for September 1944 are incomplete.

85. German Operational Intelligence (Washington, DC: Military Intelligence Division, U.S. War Department, April 1946), p. 123.

86. Clarke to Barnes, 26 March 1982. The use of white phosphorous blinded the German crew and caused them to abandon the tank, leaving it completely serviceable. CCA drove eighteen abandoned Mark V tanks off the Arracourt battlefield.

87. Letter and cassette tape, Robert M. Parker, (Colonel), to Barnes, 1 April 1982.

88. Among the defensive positions were the West Wall, the French Maginot Line, the Orscholz Switch Line, as well as the Weststellung--a new fortified line near Sarrebourg.

89. The Schwerpunkt, or point of main attack "will be formed wherever the enemy reveals weaknesses or the terrain offers possibilities of bringing the thrust of the combat troops and the fire of all weapons to bear in such a way that the attack can penetrate quickly into the enemy's depth. If a success is imminent at a point other than the expected one, this will be exploited without hesitation..." Germany, Heer, Command and Control in Battle, (Führung in Gefecht (TF/G)), Army Regulation 100/100 (Restricted), (HDV 100/100 VS ND), September 1973. Although this definition is taken from a current German regulation, the World War II meaning was the same.

90. Van Creveld, Fighting Power, p. 85.

## Chapter 2

For chapters 2, 3, and 4, I used 4th Armored Division G-2 reports, after action reports, summaries, and diaries. Besides the 4th Armored Division headquarters reports, I used reports prepared by the division artillery, the three combat command headquarters, key staff officers, and subordinate battalions. German sources consisted primarily of microfilm records of Oberkommando West, Fifth Panzer Army, and LVIII Panzer Corps, as well as translated manuscripts of postwar debriefings of key German general officers.

1. U.S. Army, 4th Armored Division, Combat Command A, The Establishment and Defense of the Nancy Bridgehead (Fort Knox, KY, 25 October 1946), p. 3. (Hereafter cited as Nancy Bridgehead.)

2. Mellenthin, Panzer Battles, p. 316.

3. CCA consisted of the 37th Tk Bn (-), 53d Armd Inf Bn (-), C Co, 10th Armd Inf Bn, 166th (C) Engr Bn, C Co, 24th Armd Engr Bn, C Co 704th TD Bn, the 66th and 94th (-) Armd FA Bns, and the 191st FA Bn. Cole, Lorraine Campaign, footnote p. 223.

4. Nancy Bridgehead, p. 4.

5. "Records of German Field Commands: Panzer Armies" (Washington, DC: The American Historical Association Committee for the Study of War Documents, 1959). National Archives microfilm T-313, Roll 420. (Hereafter cited as "Panzer Armies" with the microfilm roll number.)

6. Nancy Bridgehead, p. 9.

7. U.S. Army, 37th Tank Battalion, "Battalion Diary, September 1944" (APO 254, Germany, 15 October 1944), p. 5, Record Group 407, National Archives, Washington, DC. (Hereafter cited as "37th Tank Battalion Diary"). Clarke claims to have overrun a German corps headquarters. At this time, 15th Panzer Division came under the 13th SS Corps. Elements of that Corps headquarters were present at Arracourt; hence, Clarke's claim to have overrun a corps headquarters at Arracourt. Clarke to Barnes, 5 April 1982. This is also mentioned in Koyen, 4th Armored Division, p. 37.

8. U.S. Army, Armor School, The Employment of Four Tank Destroyer Battalions in the ETO, a report prepared by Committee 24, Officers Advanced Course, The Armor School (Fort Knox, KY, May 1950), p. 67. (Hereafter cited as Tank Destroyer Battalions.) TF Abrams included Company C, 37th Tank Battalion, and was located at a combat outpost at the crossroads at Lezey, four to five miles northeast of Arracourt. The composition of TF Curtis was Company C, 24th Engineers, and Company A, 166th Engineers, reinforced by two tank destroyer platoons. T. F. Curtis was located southwest of Arracourt. The composition of TF Jacques was the 53d Armored Infantry Battalion reinforced with a company of medium tanks (B/37) on north flank between Chambrey and Arracourt.

9. "37th Tank Battalion Diary," p. 5.
10. TF Abrams, less five tanks and Company C of 24th Engineers, pulled back to the vicinity of Rechicourt to take over the area vacated by 1/318.
11. U.S. Army, 4th Armored Division, Combat Command A, "After Action Report for September 1944" (APO 254, Germany, 6 March 1945), Record Group 407, National Archives, Washington, DC. Hereafter cited as "CCA After Action Report").
12. CCA sent a task force consisting of infantry and elements of the 37th Tank Battalion and the 191st Armored Field Artillery under LTC Abrams to assist CCB over the canal.
13. Nancy Bridgehead, p. 9.
14. TF Hunter sent to help CCR at Luneville consisted of Btry C, 94th Arm'd FA; Company A, 37th Tank Battalion; Company B, 53d Armored Infantry Battalion. U.S. Army, 94th Armored Field Artillery Battalion, History of the Ninety-Fourth Armored Field Artillery Battalion in the European Theater of Operations, 29 December 1943 to 9 May 1945 (Nuremberg, Germany: Sebaldus-Verlag, 1945), p. 34.
15. Nancy Bridgehead, p. 9.
16. A. L. Lambert and G. B. Layton, The Ghosts of Patton's Third Army: A History of the Second U.S. Cavalry (Munich, Germany: Munchner Graphische Kunstanstalten GMBH, 1945), p. 145.
17. Ibid., p. 156.
18. U.S. Army, 35th Tank Battalion, "After Action Report (for September 1944)" (APO 254, Germany, 20 November 1944), Record Group 407, National Archives, Washington, DC. Hereafter cited as "35th Tank Battalion After Action Report").
19. "Panzer Arrives," Roll 420, 17 September 1944.
20. Cole, Lorraine Campaign, p. 220, and "35th Tank Battalion After Action Report."
21. Third U.S. Army Diary entry in Cole, Lorraine Campaign, footnote, p. 220.
22. "Activities of General Eddy," 15 September 1944, Manton S. Eddy papers, Military History Institute, Carlisle Barracks, PA. (Hereafter cited as "Eddy Diary".)

23. Cole, Lorraine Campaign, p. 220.
24. Lambert, Ghosts, p. 157.
25. U.S. Army, 704th Tank Destroyer Battalion, "Battalion History - 704th Tank Destroyer Battalion - 5 September to 30 September 1944" (Lorraine, France, October 1944), Record Group 407, National Archives, Washington, DC.
26. "CCA After Action Report," 18 September 1944.
27. This is the only time a single field artillery battery was sent off as part of a task force. Parker to Barnes, 1 April 1982.
28. "704th Tank Destroyer Battalion History," 18 September 1944. See also U.S. Army, 4th Armored Division, Reserve Command Headquarters, "After Action Report - September 1944" (APO 254, Germany, 25 March 1945), entry for 18 September 1944, Record Group 407, National Archives, Washington, DC. (Hereafter cited as "Reserve Command After Action Report.")
29. "Panzer Armies," Roll 420, 18 September 1944.
30. Martin Blumenson, comp., The Patton Papers. Vol. 2. 1940-1945. (Boston: Houghton Mifflin, 1974), p. 550.
31. "Reserve Command After Action Report," entry for 18 September 1944.
32. "704th Tank Destroyer Battalion History," 19 September 1944, and "Reserve Command After Action Report," 19 September 1944.
33. Nancy Bridgehead, p. 17.
34. "Records of German Field Commands: Corps" (Washington, DC: National Archives and Records Service, General Services Administration, 1965). National Archives microfilm T-314, Roll 1497, 18 September 1944. (Hereafter cited as "German Corps," Roll 1497.)

### Chapter 3

1. U.S. Army, 4th Armored Division, Combat Command B, "After Action Report for September 1944," (APO 254, Germany, 6 March 1945), Record Group 407, National Archives, Washington, DC. (Hereafter cited as "CCB After Action Report.")
2. Cole, Lorraine Campaign, p. 223.
3. A spot report sent to the G-2, XII Corps, at 2235 hours on 18 September indicated 1500 German troops were in the Foret de Parroy, which was occupied by remnants of two German divisions that had come from Spinal and Belfort. U.S. Army, 4th Armored Division, "G-2 Periodic Reports, September 1944," report no. 62 of 19 September 1944, Record Group 407, National Archives, Washington, DC. (Hereafter cited as "G-2 Periodic Reports.")
4. "German Corps," Roll 1497, 18 September 1944.
5. Ibid.
6. The 111th Panzer Brigade was now attached to the LVIII Panzer Corps.
7. Battle Group von Luettwitz consisted of the 21st Panzer Division and the 111th and 112th Panzer Brigades.
8. "Panzer Armies," Roll 420, 18 September 1944.
9. Eddy pointed this matter out to Patton, who thought there were sufficient forces already there without committing additional units.
10. "37th Tank Battalion Diary," 19 September 1944.
11. "Panzer Armies," Roll 420, 19 September 1944.
12. Ibid., Roll 421, 19 September 1944.
13. "37th Tank Battalion Diary," 19 September 1944.
14. The Germans made general repairs enroute so that the tanks were operational and planned repair of the fire control equipment as soon as possible.
15. To improve observation because of the fog, each tank in position placed an observer approximately seventy-five yards forward of the tank's position, tied in by telephone. This enabled them to gain surprise by taking enemy tanks under direct fire.
16. William A. Dwight, (Colonel), to Barnes, 28 March 1982.



17. Tank Destroyer Battalions, p. 70.
18. Ibid., p. 72.
19. Ibid., p. 75.
20. "37th Tank Battalion Diary," 19 September 1944.
21. Cole, Lorraine Campaign, p. 225.
22. Lamison had sixteen tanks in his company--two platoons of five each and one platoon of four. Kenneth R. Lamison, (Colonel), to Barnes, 6 April 1982.
23. "704th Tank Destroyer Battalion History," 19 September 1944.
24. U.S. Army, 4th Armored Division, "Diary of Col. Hal Pattison, September 1944," Record Group 407, National Archives, Washington, DC., 19 September 1944.
25. "Eddy Diary," entry for 19 September 1944.
26. "37th Tank Battalion Diary," entry for 19 September 1944.
27. Ibid.
28. "Panzer Armies," Roll 420, entry for 19 September 1944.
29. "35th Tank Battalion After Action Report," entry for 19 September 1944.
30. U.S. Army, 4th Armored Division, "Journal of the Division Surgeon's Office from 1 to 30 September 1944, in France," (France, October 1944). Record Group 407, National Archives, Washington, DC. (Hereafter cited as 4th Armored Division, "Surgeon's Journal.")
31. Both German and American records confirm the attack, but only U.S. records show the tank losses.
32. Cited in "37th Tank Battalion Diary" as well as in Cole, Lorraine Campaign, p. 225.
33. Up to this point, 4th Armored Division has lost thirty-three tanks since crossing the Moselle. "Eddy Diary," 21 September 1944.
34. There is confusion as to whether there were thirty-nine or forty-three destroyed German tanks. The Division G-2 record, as well as a count within this narrative totals thirty-nine. The 37th Tank Battalion Diary records forty-three. Because no assessment was made during the night of 18/19 September following the artillery fire, it would be impossible to know

exactly how many tanks were totally destroyed, or how many could be repaired and subsequently used again.

35. "Panzer Armies," Roll 420, 20 September 1944.

36. Ibid.

37. Ibid. At noon that day, the Germans had the following tanks: 111th Panzer Brigade--nineteen Mark V's, six Mark IV's--total twenty-five; 113th Panzer Brigade--ten Mark V's, three Mark IV's--total thirteen tanks--for a grand total of thirty-six tanks.

38. Task Force Oden consisted of the 35th Tank Battalion, the 53d Armored Infantry Battalion and the 66th Field Artillery Battalion on the left. TF Abrams consisted of the 37th Tank Battalion, 10th Armored Infantry Battalion, and the 94th Field Artillery Battalion. 94th Armored FA Bn, History, p. 35.

39. "CCA After Action Report," entry for 20 September 1944, p. 6.

40. U.S. Army, 25th Cavalry Reconnaissance Squadron Mechanized, "Unit History" (APO 254, Germany, March 1945), entry for 20 September 1944, Record Group 407, National Archives, Washington, DC. (Hereafter cited as "25th Cavalry Squadron Unit History.")

41. U.S. Army, 4th Armored Division, Division Artillery, "After Action Report, 1 September to 30 September 1944," (Arracourt, France, 30 September 1944), entry for 20 September 1944, Record Group 407, National Archives, Washington, DC. (Hereafter cited as "Division Artillery After Action Report.")

42. U.S. Army, 53d Armored Infantry Battalion, "After Action Report - September 1944," (Lorraine, France, October 1944), entry for 20 September 1944, Record Group 407, National Archives, Washington, DC. (Hereafter cited as "53d Armored Infantry After Action Report.")

43. "37th Tank Battalion Diary," 20 September 1944.

44. "Panzer Armies," Roll 420, 20 September 1944.

45. Ibid., daily summary for 21 September 1944, cites CPT Junghannis for his aggressive action and bravery. The Germans did not mention the number of their own tanks destroyed, but did note they had fifteen Panzer V and eight assault guns ready for action. See also "37th Tank Battalion Diary," entry for 20 September 1944.

46. Ibid. The daily summary for 20 September reported Ley was taken by 1700 hours, but gave no losses.

47. Ibid. A morning journal entry of 21 September indicated the 4th Armored Division lost a total of eighteen tanks that day--fifteen to the 11th and three to the 113th Panzer Brigades--an exaggeration to make the Germans look good.
48. Task Force Kimsey consisted of a medium tank company and three tank destroyers. "CCA After Action Report," 20 September 1944, p. 6.
49. U.S. Army, 10th Armored Infantry Battalion, "Combat History, September 1944" (APO 254, Germany, October 1944), entry for 20 September 1944, Record Group 407, National Archives, Washington, DC. (Hereafter cited as "10th Armored Infantry Bn History.") See also "37th Tank Battalion Diary," 20 September 1944.
50. "25th Cavalry Squadron Unit History," 21 September 1944. This is one of the few recorded cases of amicide in the Lorraine Campaign.
51. German loss figures are cited in "37th Tank Battalion Diary," 20 September 1944.
52. "Panzer Armies," Roll 420, 20 September 1944.
53. Cole, Lorraine Campaign, p. 229. His accurate reporting is borne out in the German records. "German Corps," Roll 1497.
54. "37th Tank Battalion Diary," 21 September 1944.
55. "53d Armored Infantry After Action Report," 21 September 1944.
56. "Eddy Diary," entry for 21 September 1944.
57. "37th Tank Battalion Diary," 21 September 1944.
58. Ibid.
59. There is confusion as to who blew up the bridge at Parroy. Both TF Kimsey and the Germans made this claim.
60. "German Corps," Roll 1497. Although Balck took over on 21 September, all reports for 21 through 23 September are signed by the outgoing chief of staff, Gyldenfeldt. A document dated 1200 hours, 24 September, signed by both Gyldenfeldt and von Mellenthin officially transferred the responsibility for chief of staff, Army Group G.
61. Cole, Lorraine Campaign, p. 230.
62. "Panzer Armies," Roll 420, 21 September 1944.

63. Ibid.
64. Ibid.
65. "German Corps," Roll 1497, 21 September 1944.
66. "Panzer Armies," Roll 420, 22 September 1944.
67. At 23.0 hours on 22 September, 11th Panzer Division came under LVIII Panzer Corps control. "Panzer Armies," Roll 420, 22 September 1944.
68. Cole, Lorraine Campaign, p. 231.
69. "25th Cavalry Squadron Unit History," 22 September 1944.
70. "704th Tank Destroyer Battalion History," p. 1. The 2d Platoon of B Company destroyed three enemy tanks near Rechicourt.
71. "Panzer Armies," Roll 420, 22 September 1944.
72. "37th Tank Battalion Diary," 22 September 1944.
73. Cole's account is confirmed in a letter from Kenneth R. Lamison, to Barnes, 6 April 1982.
74. "Panzer Armies," Roll 421, 22 September 1944.
75. "37th Tank Battalion Diary," 22 September 1944.
76. "Panzer Armies," Roll 420, 22 September 1944.
77. Ibid.
78. Ibid.
79. Ibid.
80. "German Army Groups," Roll 141, 22 September 1944.

#### Chapter 4

1. "German Army Groups," Roll 141, frame 1129.
2. "Panzer Armies," Roll 420, journal entry 2100 hours, 23 September 1944.
3. Cole, Lorraine Campaign, p. 236. See also "CCA After Action Report" entry for 23 September 1944.
4. 4th Armored Division, "Surgeon's Journal," 25 September 1944. The division surgeon kept careful combat records which provided an additional check on unit reporting accuracy.

5. "Panzer Armies," Roll 421, summary for 24 September 1944.
6. Ibid., Roll 420, 25 September 1944.
7. "25th Cavalry Squadron Unit History," 25 September 1944.
8. "35th Tank Battalion After Action Report," 25 September 1944.
9. "Panzer Armies," Roll 421, 25 September 1944.
10. "CCA After Action Report," 25 September 1944.
11. "Panzer Armies," Roll 420, 25 September 1944.
12. "German Army Groups," Roll 141, Frame 1144, evening report of 25 September.
13. Ibid., daily report of 25 September 1944.
14. "CCB After Action Report," 25 September 1944.
15. 4th Armored Division, "Surgeon's Journal," 25 September 1944.
16. XIX TAC Report, p. 1.
17. "704th Tank Destroyer Battalion History," 26 September 1944.
18. "Division Artillery After Action Report," 26 September 1944. Also found in Robert M. Parker, (Colonel), to Barnes, 1 April 1982.
19. "German Army Groups," Roll 141, 26 September 1944.
20. "Panzer Armies," Roll 420, daily summary for 26 September.
21. Cole, Lorraine Campaign, p. 232.
22. 4th Armored Division, "Surgeon's Journal," 26 September 1944.
23. "German Army Groups," Roll 141, 26 September 1944.
24. "Eddy Diary," entry for 26 September 1944. This was a prisoner of war report that appeared in "G-2 Periodic Reports," Report no. 68, 25 September 1944.
25. "10th Armored Infantry Bn History," 27 September 1944.
26. Ibid.

27. "53d Armored Infantry After Action Report," 27 September 1944. In a 1330 hours spot report ("Panzer Armies," Roll 420), the Germans had been promised fifty MIG aircraft for supporting their attack, but they never appeared.
28. Ibid., 27 September spot report.
29. "35th Tank Battalion After Action Report," 27 September 1944. The Americans used smoke between Moyenvic-Lezey and Bezange-la-Petite--Lezey.
30. "Panzer Armies," Roll 420, 27 September 1944.
31. Ibid.
32. Long tube Panzers had greater range and velocity than short tube Panzers.
33. "Panzer Armies," Roll 420, 27 September 1944.
34. "German Corps," Roll 1497, Corps Order for 27 September, dated 26 September 1944.
35. Ibid., 27 September 1944.
36. 4th Armored Division, "Surgeon's Journal," 27 September 1944.
37. "German Army Groups," Roll 141, 28 September 1944.
38. Ibid.
39. U.S. Army, 51st Armored Infantry Battalion, "After Action Report for September 1944," (APO 254, Germany), 28 September 1944, Record Group 407, National Archives, Washington, DC.
40. "Panzer Armies," Roll 420, 28 September 1944.
41. "10th Armored Infantry Bn History," 28 September 1944.
42. "Panzer Armies," Roll 420, 28 September 1944.
43. XIX TAC Report, spot report, p. 5.
44. "Panzer Armies," Roll 420, 28 September 1944. "Jabo" was a German slang term used for U.S. fighter aircraft.
45. One concrete example of ammunition shortage at the time. The Germans did minimal firing so to preserve ammunition.
46. "Panzer Armies," Roll 420, 28 September 1944.
47. Ibid.

48. Ibid., spot report, 2100 hours, 28 September 1944.
49. Ibid.
50. Ibid.
51. Ibid.
52. MS B-364, p. 10.
53. "Panzer Armies," Roll 420, 28 September 1944.
54. "CCA After Action Report."
55. MS B-364, p. 10.
56. "CCB After Action Report," 29 September 1944.
57. "Panzer Armies," Roll 420, 29 September 1944.
58. Cole, Lorraine Campaign, p. 241.
59. "Panzer Armies," Roll 420, 29 September 1944.
60. Cole, Lorraine Campaign, p. 241.
61. "Panzer Armies," Roll 420, 29 September 1944.
62. Ibid.
63. Ibid.
64. Ibid.
65. Ibid.
66. The Germans had gone over to the defensive, but they still wanted to maintain contact. The word disturb rather than destroy, indicates this change of emphasis.
67. "Panzer Armies," Roll 420, 29 September 1944.
68. Ibid.
69. "35th Tank Battalion After Action Report," 29 September 1944.
70. "German Corps," Roll 1497, daily summary for 29 September 1944.
71. "German Army Groups," Roll 141, agenda for meeting with von Rundstedt, 29 September 1944.

72. Ibid.

73. "German Corps," Roll 1497, 29 September 1944.

74. "CCB After Action Report," and 4th Armored Division, "Surgeon's Journal," 29 September 1944.

75. These figures were obtained by totaling casualties from 25 to 29 September.

76. On 22 October, Wood's Division was relieved by the 26th Division, and 4th Armored Division went into corps reserve.

#### Chapter 5

1. U.S. Army, 4th Armored Division, "After Action Report, 1 September to 30 September 1944," 30 September 1944, Record Group 407, National Archives, Washington, DC.

2. Ibid.

3. Cole, Lorraine Campaign, footnote p. 243.

4. Clarke to Barnes, 26 March 1982.

5. Nancy Bridgehead, p. 10.

6. Clarke to Barnes, 26 March 1982.

7. ULTRA intercepts for Third Army are presently unavailable.

8. "CCA After Action Report" and "CCB After Action Report," 24 September 1944.

9. Clarke states he never received any intelligence from division or higher when he was CCA commander. Clarke to Barnes, 26 March 1982.

10. MS A-999, p. 10.

11. Clarke to Barnes, 26 March 1982.

12. XIX TAC Report, p. xiv.

13. Ibid.

14. Many of the artillery rounds landed as duds, which saved the U.S. defenders at Arracourt. Thomas J. Cooke, (Lieutenant Colonel), to Barnes, 7 April 1982.

15. Van Creveld, Fighting Power, p. 85.



16. Will Lang, "Colonel Abe," Life, 23 April 1945, p. 48.

17. In both the Third Army and CCA After Action Reports, 405th Group was given credit by the ground forces for eleven tanks destroyed and two damaged, and for having been an inestimable aid in breaking up two German counterattacks. The reports also lauded the 511th Squadron for destroying six additional tanks. Patton used every opportunity to publicly thank the XIX Commander, General Weyand.

## BIBLIOGRAPHY

### BOOKS

- Allied Forces. Supreme Headquarters. Report by the Supreme Commander to the Combined Chiefs of Staff on the Operations in Europe of the Allied Expeditionary Force, 6 June 1944 to 8 May 1945. Washington, DC: U.S. Government Printing Office, 1946.
- Ambrose, Stephen E. The Supreme Commander: The War Years of General Dwight D. Eisenhower. Garden City, NY: Doubleday and Co., 1970.
- Baldwin, Hanson W. Tiger Jack. Fort Collins, CO: The Old Army Press, 1979.
- Bennett, Ralph. Ultra in the West. New York: Charles Scribner's Sons, 1979.
- Blumenson, Martin, comp. The Patton Papers. Vol 2. 1940-1945. Boston: Houghton Mifflin, 1974.
- Bogen, Paul L., ed. Combat Record of the Sixth Armored Division in the European Theater of Operations, 18 July 1944-8 May 1945. Aschaffenburg, Germany: Steinbeck Druck, 1945.
- Bradley, Omar N. A Soldier's Story. New York: Henry Holt and Co., 1952.
- Cole, Hugh M. The Lorraine Campaign. U.S. Army in World War II: The European Theater of Operations. 1950. Reprint. Washington, DC: Historical Division, U.S. Army, 1970.
- Davies, W. J. K. German Army Handbook, 1939-1945. New York: Arco Publishing Co., 1975.
- Dyer, George. XII Corps, Spearhead of Patton's Third Army. Baton Rouge, LA: XII Corps History Association/Military Press of Louisiana, 1947.
- Eisenhower, Dwight D. Crusade in Europe. Garden City, NY: Doubleday and Co., 1948.
- Frankel, Nat, and Smith, Larry. Patton's Best. New York: Hawthorn Books, 1978.

- Hermann, Carl Hans. Deutsche Militärgeschichte. Frankfurt am Main: Bernard und Graefe Verlag für Wehrwesen, 1968.
- Kahn, David. Hitler's Spies: German Military Intelligence in World War II. New York: Macmillan Publishing Co., 1978.
- Kershaw, Andrew. The Tank Story. London: Marshall Cavendish, 1973.
- Koyen, Kenneth. The Fourth Armored Division from the Beach to Bavaria. Munich, Germany: Herder-Druck, 1946.
- Lambert, A. L., and Layton, G. B. The Ghosts of Patton's Third Army: A History of the Second U.S. Cavalry. Munich, Germany: Munchner Graphische Kunstanstalten GMBH, 1945.
- Macksey, K. J. Afrika Korps. New York: Ballantine Books, 1968.
- Mellenthin, Friedrich Wilhelm von. Panzer Battles. Norman: University of Oklahoma Press, 1955.
- Necker, Wilhelm. The German Army of Today. 1943. Reprint. East Ardsley, Wakefield, England: EP Publishing, 1973.
- Nobécourt, Jacques. Hitler's Last Gamble. Translated from the French by R. H. Barry. New York: Schocken Books, 1967.
- Patton, George S. War as I Knew It. Boston: Houghton Mifflin Co., 1947.
- Spiwoks, Erich, and Stöber, Hans-J. E. Endkampf zwischen Mosel und Inn: XIII. SS-Armeekorps. Osnabrück, Germany: Munin Verlag, 1976.
- Stoeber, Hans-J. E. Die Sturmflut und das Ende. Osnabrueck, Germany: Munin Verlag GMBH, 1979.
- Strategy & Tactics Magazine. War in the East: The Russo-German Conflict, 1941-45. Staff Study no. 1. New York: Simulations Publications, 1977.
- Story of the 320th Infantry. Hameln, Germany: C. W. Niemeyer, 1945.
- U.S. American Battle Monuments Commission. 35th Division, Summary of Operations in the World War. Washington, DC: U.S. Government Printing Office, 1944.
- U.S. Army. Armor School. Armor vs. Mud and Mines (4th Armored Division in the Saar-Moselle Area). Fort Knox, KY, 1949-50.
- U.S. Army. 4th Armored Division. Combat Command A. The Establishment and Defense of the Nancy Bridgehead. Fort Knox, KY, 25 October 1946.

- U.S. Army. 6th Armored Division. The Super Sixth: History of the 6th Armored Division in World War II and Its Post-War Association. Louisville, KY: Sixth Armored Division Association, 1975.
- U.S. Army. 94th Armored Field Artillery Battalion. History of the Ninety-Fourth Armored Field Artillery Battalion in the European Theater of Operations, 29 December 1943 to 9 May 1945. Nuremberg, Germany: Sebaldus-Verlag, 1945.
- U.S. Army. 704th Tank Destroyer Battalion. The History of the 704th Tank Destroyer Battalion from D Plus 36 to V-E Day. Landshut, Germany: Kratzsch & Co., 1945.
- Weigley, Russell F. Eisenhower's Lieutenants. Bloomington: Indiana University Press, 1981.
- \_\_\_\_\_. History of the United States Army. New York: Macmillan Publishing Co., 1967.
- Wilmot, Chester. Struggle for Europe. New York: Harper and Brothers, 1952.

#### PERIODICAL ARTICLES

- Balkoski, Joseph. "Patton's 3rd Army: The Lorraine Campaign, 8 Nov-1 Dec '44." Strategy & Tactics, no. 78 (January-February 1980): 4-15.
- Dunn, Walter S. "The Ultra Papers." Military Affairs, 42 (October 1978): 134-35.
- Isby, David C. "Panzer Battles: The Evolution of Mechanized Warfare, 1939-79." Strategy & Tactics, no. 73 (March-April 1979): 4-18.
- Kershaw, Andrew, ed. "The Tank Story." History of the World Wars. Special ed. New York: Marshall Cavendish, 1973.
- Lang, Will. "Colonel Abe." Life, 23 April 1945, pp. 47-50+.
- Rosengarten, Adolph G. "With Ultra from Omaha Beach to Weimar, Germany--A Personal View." Military Affairs, 42 (October 1978): 127-32.
- Spiller, Roger J. "Some Implications of ULTRA." Military Affairs, 40 (April 1976): 49-54.

## LETTERS

Bautz, Edward, (Major General), to Barnes, 7 April 1982.

Clarke, Bruce C., (General), to Barnes, 26 March, 5 April, and 7 April 1982.

Cooke, Thomas J., (Lieutenant Colonel), to Barnes, 7 April 1982.

Dwight, William A., (Colonel), to Barnes, 28 March 1982.

Evans, Thomas J., (Captain), to Barnes, 5 April 1982.

Fleischman, Lawrence E., (Major), to Barnes, 6 April 1982.

Harkins, Paul D., (General), to Barnes, 21 April 1982.

Kimsey, Charles L., (Colonel), to Barnes, 6 April 1982.

Lamison, Kenneth R., (Colonel), to Barnes, 6 April 1982.

Marston, Merwin A., to Barnes, 5 April 1982.

Oden, Delk M., (Major General), to Barnes, 3 April 1982.

Parker, Robert M., (Colonel), to Barnes, 1 April 1982. Letter and attached cassette tape.

Turner, James, to Barnes, 28 March 1982.

## DOCUMENTS

### PUBLISHED

Alexander, Arthur J. Armor Development in the Soviet Union and the United States. Santa Monica, CA: Prepared for the Director of Net

Assessment, Office of the Secretary of Defense, by Rand, September 1976. DTIC.

German Operational Intelligence. Washington, DC: Military Intelligence Division, U.S. War Department, April 1946.

Germany. Heer. Command and Control in Battle. (Führung in Gefecht (TF/G)). Army Regulations 100/100 (Restricted). (HDv 100/100 VS-NrD). September 1973.

Ney, Virgil. Evolution of the U.S. Army Division, 1939-1968. Fort Belvoir, VA: Prepared by Technical Operations, Combat Operations Research Group for Headquarters, U.S. Army Combat Developments Command, January 1969. DTIC.

U.S. Army. Armor School. The Employment of Four Tank Destroyer Battalions in the ETO. A report prepared by Committee 24, Officers Advanced Course, The Armor School. Fort Knox, KY, May 1950.

U.S. Army. 3d Army. After Action Report, Third U.S. Army: 1 August 1944-9 May 1945. 2 vols. Regensburg, Germany, 1945.

U.S. War Department. Field Service Regulations: Operations. FM 100-5. 15 June 1944.

Van Creveld, Martin. Fighting Power: German Military Performance, 1914-1945. (Prepared by) C and L Associates, Defense Consultants, Potomac, MD. Washington, DC: Office of Net Assessment, U.S. Department of Defense, December 1980.

UNPUBLISHED

Abilene, KS. National Archives. Dwight D. Eisenhower Library.

Bradley, Omar N., (General), to Eisenhower, Dwight D., (General), 24 September 1944.

Eisenhower, Dwight D., (General), to Bradley, Omar N., (General), 15 September 1944.

U.S. Army. 4th Armored Division. Division Artillery. "After Action Report, 1-30 Sep 44." France, October 1944. Box 83 in the Eisenhower Library.

U.S. Army. 6th Armored Division. "6th Armored Division Periodic Reports: Special G-2 Report, 26 September 1944." France, 1944. Box 112 in the Eisenhower Library.

U.S. Army. 80th Infantry Division. "Summary of Operations, 1-30 Sep 1944."  
France, October 1944. Box 1108 in the Eisenhower Library.

Carlisle Barracks, PA., Military History Institute.

Interview of General Bruce C. Clarke at Alexandria, VA, by an MHI staff  
member, 13 May 1972.

Manton S. Eddy papers. "Activities of General Eddy." Diary entries for  
3 September-1 October 1944.

Foreign Military Studies, Historical Division,  
Headquarters, United States Army, Europe

- MS A-871 Feuchtinger, Edgar. (Generalleutnant).  
"21st Panzer Division in Combat against  
American Troops in France and Germany."  
Translated by A. R. Christensen. 1947.
- MS A-916 Blaskowitz, Johannes. (Generaloberst).  
"Answers to Questions Directed to General  
Blaskowitz." (Operations in Lorraine--  
September 1944). 1945.
- MS A-999 Mellenthin, Friedrich-Wilhelm von.  
(Generalmajor). "Army Group G (20 Sep-  
8 Nov 44): Report of the Chief of  
Staff." Translated by E. W. Sprenger.  
11 March 1946.
- MS B-037 Manteuffel, Hasso von. (General der  
Panzertruppen). "Fifth Panzer Army (15  
Sep-12 Oct 1944)." Translated by J. J.  
Colombel. n.d.
- MS B-251 Stumpff, Horst. (General der Panzertruppen).  
"106th Panzer Brigade." 10 December 1946.
- MS B-308 Zimmerman, Bodo. (Generalleutnant).  
"OB West (Atlantic Wall to Siegfried  
Line--A Study in Command)." 1948.
- MS B-363 Emmerich, Albert. (Oberst im Generalstab).  
"The Fighting of the 1. Army in Lorraine  
and Northern Alsace from 15 September  
1944 to 15 February 1945. Part I.  
Covering Period from 15 September 1944 to  
7 November 1944." 1947.

- MS B-364 Wietersheim, Wend von. (Generalleutnant).  
"Rhineland Part I. The Employment of the  
11 Panzerdivision in Lorraine." Trans-  
lated by W. Stoffel. 10 January 1947.
- MS B-412 Eines, Kurt von. (Oberst). "Report on the  
Engagements of the XIII-SS-Corps in  
Lorraine During the Period from 1st  
September to 15th November 1944."  
29 October 1946.
- MS B-472 Kahlden, Wolf von. (Oberst). "Fifth Panzer  
Army (14 Sep-15 Oct 44)." Translated by  
R. J. Herman. 20 March 1947.
- MS B-548 Krueger, Walter. (General der Panzertruppen).  
"LVIII Panzer Corps, 15 Sep-5 Nov 1944."  
1947.
- MS B-589 Gyldenfeldt, Heinz von. (Generalleutnant).  
"Army Group G (15-25 September 1944)."  
1947.
- MS B-757 Manteuffel, Hasso von. (General der  
Panzertruppen). "Commitment of Fifth  
Panzer Army West of Vosges Within the  
Framework of Army Group G from 15  
September-15 October 1944." Translated  
by H. Wollmer. 1947.

Washington, DC. National Archives.

Microfilm

"Records of German Field Commands: Army Groups." Washington, DC: The  
American Historical Association Committee for the Study of War Docu-  
ments, 1959. Microfilm T-311, Roll 141.

"Records of German Field Commands: Corps." Washington, DC: National  
Archives & Records Service, General Services Administration, 1965.  
Microfilm T-314, Roll 1497.

"Records of German Field Commands: Panzer Armies." Washington, DC: The  
American Historical Association Committee for the Study of War Docu-  
ments, 1960. Microfilm T-313, Rolls 420-21.



Record Group 407

U.S. Army. 4th Armored Division. "After Action Report for September and October, 1944." APO 254, Germany, 12 November 1944.

\_\_\_\_\_  
"After Action Report, 1 September to 30 September 1944." France, October 1944.

\_\_\_\_\_  
"Combat History, 1-30 September 1944."  
Lorraine, France, 5 October 1944.

\_\_\_\_\_  
"Diary of Colonel Hal Pattison, September 1944."

\_\_\_\_\_  
"G-2 Periodic Reports, September 1944."  
France, September 1944.

\_\_\_\_\_  
"Journal of the Division Surgeon's Office from 1 to 30 September 1944, in France." (Prepared by) Daniel K. Kipner, Captain, MAC, Office Executive. France, October 1944.

\_\_\_\_\_  
"Liaison Officer's Report." APO 254,  
Germany, 29 September 1944.

\_\_\_\_\_  
"Record of Action of 4th Armored Division During Period 1 Sep 44 to 10 Oct 44." APO 254, Germany, 12 November 1944.

\_\_\_\_\_  
"Summary of Operations of the 4th Armored Division in France, 17 July through 7 December 1944." Germany, 14 August 1945.

U.S. Army. 4th Armored Division. Combat Command A. "After Action Report for September 1944." APO 254, Germany, 6 March 1945.

\_\_\_\_\_  
"Log of Events of CC  
"A" 4th Armd Div for Period of 13-26 September 1944 in Establishing and Holding the Arracourt Salient." APO 254, Germany, 1 October 1944.

U.S. Army. 4th Armored Division. Combat Command B. "After Action Report for September 1944." APO 254, Germany, 6 March 1945.

\_\_\_\_\_  
"Combat Command "B",  
4th Armd Div, History (Narrative Form) 1-30 Sept 1944, Incl." Lorraine,  
France, 1944.

U.S. Army. 4th Armored Division. Division Artillery. "After Action Report, 1 May to 8 May." APO 250, Germany, 5 July 1945.



U.S. Army. 166th Engineer Combat Battalion. "After Action Report." APO 403, Germany, 30 May 1945.

U.S. Army. 191st Field Artillery Battalion. "Unit Journal." Lorraine, France, September 1944.

U.S. Army. 8th Tank Battalion. "After Action Report - Month of September 1944." APO 254, Germany, 6 November 1944.

U.S. Army. 35th Tank Battalion. "After Action Report (for September 1944)." APO 254, Germany, 20 November 1944.

---

"S-2 Journal, September 1944." Arracourt and Deuxville, France, 1944.

U.S. Army. 37th Tank Battalion. "Battalion Diary, September 1944." APO 254, Germany, 15 October 1944.

U.S. Army. 704th Tank Destroyer Battalion. "Battalion History - 704th Tank Destroyer Battalion - 5 September to 30 September 1944." Lorraine, France, October 1944.

U.S. Army. 704th Tank Destroyer Battalion. Company C. "Combat Diary of C Company, 704th Tank Destroyer Battalion of the Fourth Armored Division of General George S. Patton, Jr's Third U.S. Army." Compiled by First Sergeant Walter E. Mullen, Jr., and T/4 Norman E. Macomber. Landshut, Germany, 27 May 1945.

#### U.S. National Security Agency

U.S. National Security Agency. "Report of Assignment with Third United States Army, 15 August - 18 September 1944." By Major Warrack Wallace. SRH-108. Declassified.

---

"Synthesis of Experiences in the Use of Ultra Intelligence by U.S. Army Field Commands in the European Theater of Operations." SRH-006. Declassified.

---

"Third Army Radio Intelligence History in Campaign of Western Europe." Prepared by Signal Intelligence Service of Headquarters, Third U.S. Army. SRH-042. Declassified.

---

"Use of (CX/MSS ULTRA) by the United States War Department (1943-1945)." SRH-005. Declassified 19 December 1978.

MISCELLANEOUS

House, Jonathan M. "The Lorraine Campaign: Introduction and Overview."  
Photocopied typescript. Fort Leavenworth, KS: Combat Studies  
Institute, U.S. Army Command and General Staff College, November 1981.

U.S. Army War College. "Observer Report, ETO, 11 August - 1 October 1944."  
A report prepared by Lt. Col. Elmer H. Droste for the Commanding  
General, Army Ground Forces, Army War College. Washington, DC, 13  
October 1944. Copy in the Combined Arms Research Library, U.S. Army  
Command and General Staff College, Fort Leavenworth, KS.

INITIAL DISTRIBUTION LIST

COL William A. Stofft  
Director, Combat Studies Institute  
Command and General Staff College  
Fort Leavenworth, Kansas 66027

LTC Kenneth A. Steadman  
Combat Studies Institute  
Command and General Staff College  
Fort Leavenworth, Kansas 66027

Dr. Roger J. Spiller  
Combat Studies Institute  
Command and General Staff College  
Fort Leavenworth, Kansas 66027

Combined Arms Research Library  
U.S. Army Command and General Staff College  
Fort Leavenworth, Kansas 66027

Defense Technical Information Center  
Cameron Station  
Alexandria, Virginia 22314

Commandant  
U.S.A. Missile and Munitions Center and School  
ATTN: ATSK-TDP-MU (Mr. Angeloff)  
Redstone Arsenal, Alabama 35897

Commandant  
U.S. A. Engineer School  
ATTN: ATZA-DTC-C  
Fort Belvoir, Virginia 22060

Commandant  
U.S. A. Armor School  
Command, Staff and Doctrine Department  
ATTN: ATZK-CSD  
Fort Knox, Kentucky 40121

Commandant  
U.S.A. Air Defense School  
ATTN: ATSA-DS  
Fort Bliss, Texas 79906

Commandant  
U.S.A. Chemical School  
ATTN: DOTD  
Fort McClellan, Alabama 36205

Commandant  
U.S.A. Ordnance Center and School  
ATTN: ATSL-DTC-A  
Aberdeen Proving Ground, Maryland 21005

Commandant  
U.S.A. Military Police School  
ATTN: ATZN-MP-TC (CPT Gienapp)  
Fort McClellan, Alabama 36205

Commandant  
U.S.A. Quartermaster School  
ATTN: ATSM-LCD  
Fort Lee, Virginia 23801

Commandant  
U.S.A. Aviation School  
ATTN: CTD/DOAT  
Ft Rucker, Alabama 36360

Commandant  
U.S.A. Intelligence Center and School  
ATTN: ATSL-DT-TI-MSD (CPT MacAdams)  
Fort Huachuca, Arizona 84613

Commandant  
U.S.A. Transportation School  
ATTN: ATSL-DT-TC-O  
Fort Eustis, Virginia 23604

Commandant  
U.S.A. Academy of Health Science  
ATTN: Combined Arms Branch/Mil Science Division  
Fort Sam Houston, Texas 78234

Commandant  
U.S.A. Institute of Personnel and Resource Management  
ATTN: DOTD (CPT Trahan)  
Fort Benjamin Harrison, Indiana 46216

Commandant  
U.S.A. Field Artillery School  
ATTN: ATSF-CA (CPT Volk)  
Fort Sill, Oklahoma 73503

Commandant  
U.S.A. Infantry School  
ATTN: ATSH-B (MAJ White)  
Fort Benning, Georgia 31905

Commandant  
U.S.A. Signal Center  
ATTN: ATZN-TDO-D (Mr. Mayberry)  
Fort Gordon, Georgia 30905

Richard H. Barnes, Sr.  
1035 W. Tabor Road  
Philadelphia, Pennsylvania 19141

Major Michael T. Byrnes  
Department of Tactics  
U.S. Army Command and General Staff College  
Fort Leavenworth, Kansas 66027

LTC Steven M. Butler  
Department of Joint and Combined Operations  
U.S. Army Command and General Staff College  
Fort Leavenworth, Kansas 66027

General Bruce C. Clarke  
Carl Vinson Hall  
6251 Old Dominion Drive  
McLean, Virginia 22101

Marjorie Christine Collier-Trevino  
Media Support Center  
Fort Leavenworth, Kansas 66027

LTC Peter J. Conway  
Department of Command  
U.S. Army Command and General Staff College  
Fort Leavenworth, Kansas 66027

LTC Thomas J. Cooke (USA, Ret)  
3406 Beach Drive  
Tampa, Florida 33609

Stanley M. Crow  
1127 East Gore Boulevard  
Lawton, Oklahoma 73501

COL William A. Dwight (USA, Ret)  
Route 4, Box 183  
Hope, Arkansas 71801

CPT Thomas J. Evans (USA, Ret)  
229 Morrison Avenue  
Greensburg, Pennsylvania 15601

LTC(P) Don J. Fritsche, Sr.  
Department of Tactics  
U.S. Army Command and General Staff College  
Fort Leavenworth, Kansas 66027

MAJ Lawrence E. Fleischman (USA, Ret)  
83-19 Charlecote Ridge  
Jamaica, New York 11432

Dr. Burdett S. Fuller  
10133 Forrester Drive  
Sun City, Arizona 85351

LTC David M. Glantz  
Combat Studies Institute  
U.S. Army Command and General Staff College  
Fort Leavenworth, Kansas 66027

COL Charles L. Kimsey (USA, Ret)  
Rural Route 1  
Pilot Mounds, Iowa 50223

COL Kenneth R. Lamison (USA, Ret)  
4347 Crestview Drive  
Harrisburg, Pennsylvania 17112

Merwin A. Marston  
Rural Route No. 3, Gunsight Hills Drive  
Sedona, Arizona 86336

Alice M. McCart  
Combat Studies Institute  
U.S. Army Command and General Staff College  
Fort Leavenworth, Kansas 66027

MG Delk M. Oden (USA, Ret)  
203 Yoakum Pkwy No. 426  
Alexandria, Virginia 22304

LTC Charles Owen  
Department of Combat Support  
U.S. Army Command and General Staff College  
Fort Leavenworth, Kansas 66027

Herbert Pankratz  
Dwight D. Eisenhower Library  
Abilene, Kansas 67410

COL Robert M. Parker (USA, Ret)  
7309 Dulanany Drive  
McLean, Virginia 22101

LTC Richard F. Rouse  
Department of Tactics  
U.S. Army Command and General Staff College  
Fort Leavenworth, Kansas 66027

Samuel A. Schenker, Sr.  
2440 Victoria Drive  
Sharon, Pennsylvania 16146

John Slonaker  
Military History Institute  
Carlisle Barracks, Pennsylvania 17013

Greg Smith  
Media Support Center  
Fort Leavenworth, Kansas 66027

Elizabeth R. Snoka  
Combat Studies Institute  
U.S. Army Command and General Staff College  
Fort Leavenworth, Kansas 66027

COL Clyde J. Tate  
Director, Department of Command  
U.S. Army Command and General Staff College  
Fort Leavenworth, Kansas 66027



Dennis Vetock  
Military History Institute  
Carlisle Barracks, Pennsylvania 17013

COL Walter von Hobe  
German Liaison Officer  
U.S. Army Command and General Staff College  
Fort Leavenworth, Kansas 66027

MAJ Joel E. Williamson  
Section 3, Student Detachment  
U.S. Army Command and General Staff College  
Fort Leavenworth, Kansas 66027

Major Marvin Wooten  
Office of the Secretary  
U.S. Army Command and General Staff College  
Fort Leavenworth, Kansas 66027



**DEPARTMENT OF THE ARMY**  
 U.S. ARMY COMMAND AND GENERAL STAFF COLLEGE  
 1 REYNOLDS AVENUE, BUILDING 111  
 FORT LEAVENWORTH, KANSAS 66027-1352

REPLY TO  
 ATTENTION OF

ATZL-SWY

2 May 2001

MEMORANDUM FOR ATTN: Larry Downing, DTIC-OCQ, Defense Technical Information Center, 8725 John J. Kingman Road, Suite 0944, Fort Belvoir, VA 22060-6218

SUBJECT: Request for Distribution Change

1. The following documents should be changed from distribution B to distribution A. The limitations have been removed and they are now publicly available.

THESIS	ACCESSION NO
Arracourt—September 1944	ADB067783 -
Criminal Investigative Activities, World War II and Vietnam, Battlefield Implications	ADB125460 -
Does the US Army Need a Full-Time Operations Other Than War Unit?	ADB225714 -
F-16 Low Altitude Navigation and Targeting Infrared System for Night and the Night Close Air S	ADB135971
Finite Element Analysis of Laser-Induced Damage to Mechanically Loaded Laminated Compo	ADB157706
Role of Army Intelligence in the Domestic Drug War	ADB149106
Should Members of the Military be Concerned about Television Coverage of Wartime Operation	ADB135563
Teaching Mission Orders in Officer Advance Course Instruction: Reality or Myth?	ADB135628
The Cut of the Scythe	ADB125547
The Light Infantry Division, Regionally Focused for Low Intensity Conflict	ADB150050
The Role of the Corps Air Defense Artillery Brigade	ADB148423
The Strategic Rationale for Special Operations Forces Employment	ADB157746

2. Thanks. Please let me know when they are done. My e-mail address is [burgesse@leavenworth.army.mil](mailto:burgesse@leavenworth.army.mil), and my phone number is (913) 758-3171.

EDWIN B. BURGESS  
 Chief, Public Services  
 Combined Arms Research Library



**DEPARTMENT OF THE ARMY**  
U.S. ARMY COMMAND AND GENERAL STAFF COLLEGE  
1 REYNOLDS AVENUE, BUILDING 111  
FORT LEAVENWORTH, KANSAS 66027-1352

REPLY TO  
ATTENTION OF

ATZL-SWY

10 May 2001

MEMORANDUM FOR Defense Technical Information Center, ATTN:  
DTIC-OMI (Bill Bush), 8725 John J Kingman Rd  
STE 0944, Fort Belvoir, VA 22060-6218

SUBJECT: Distribution Statement Change

1. Request a distribution statement change to the following document:  
ADB067783, Richard H. Barnes, "Arracourt--September 1944," dated 3 June 1982.
2. The distribution statement change, effective 11 April 2001 per Dr. Roger Spiller, Reviewer, George C. Marshall Professor of Military History should read the following: (A) Approved for Public Release: Distribution unlimited.
3. POC for this request is Mary Light, Documents Cataloger, DSN 585-3116 or COM 913-758-3116 or FAX: DSN 585-3014 or COM 913-758-3014.

Encl

*Martha A. Davis*

Martha A. Davis  
Director  
Combined Arms Research Library