

BROADCASTING TELECASTING

NEWSPAPER
Apr 56
Baker Hostetler & Patterson
1956 Union Commerce
Cleveland 14 Ohio
D 7-8
N436

1955

NARTB
CONVENTION
ISSUE

Complete Index
Page 10

IN THIS ISSUE:

ABC, CBS Assail
Pay-See Tv
Page 27

Advance Look at
NARTB Convention
Starts on Page 30

Westinghouse, NBC
Swap Stations
Page 65

CBS Radio Unveils
Single Rate Plan
Page 114

24TH
year

THE NEWSWEEKLY
OF RADIO AND TV

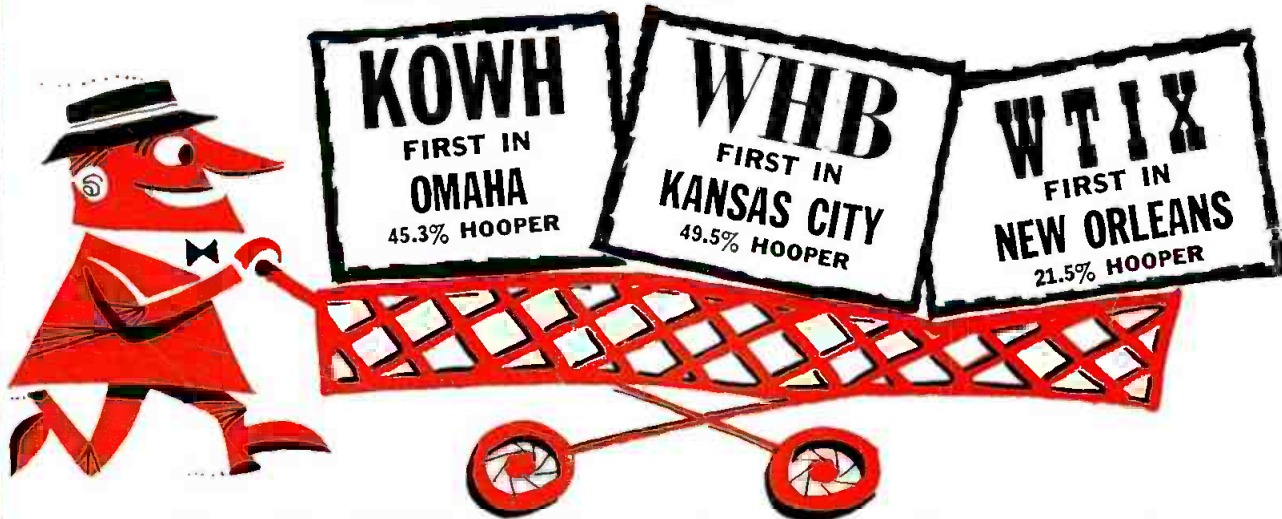

Buy the Mid-Continent Station and you get the biggest audience in each of these 3 markets



OMAHA. For 42 consecutive months KOWH has been No. 1 . . . March-April 1955 daytime average Hooper: 45.3%. KOWH "owns" every single daytime quarter hour in the Omaha air day. Wide coverage, too, on 660 kc. KOWH gets live results for its local and national advertisers. Get H-R or General Manager Virgil Sharpe to tell you about it.

KANSAS CITY. It's unanimous in Kansas City. WHB leads in all 3 major surveys — Hooper (49.5%, March-April 1955 daytime average) . . . Pulse and Trendex. And remember, WHB has been under Mid-Continent ownership management less than a year. 10,000 watts, on 710 kc. Talk to John Blair, or General Manager George W. Armstrong about K.C. sales.

NEW ORLEANS. From 11th to 1st among 11 stations in only a year—that's the record of WTIX, now first in New Orleans with a daytime Hooper of 21.5% (April, 1955). Second station, 15.1%. An old New Orleans tradition is giving way to a new one—for listening, for time-buying. Chat with Adam J. Young, Jr. or General Manager Fred Berthelson.



MID-CONTINENT BROADCASTING COMPANY

President: Todd Storz

KOWH, Omaha
Represented by
H-R Reprs., Inc.

WHB, Kansas City
Represented by
John Blair & Co.

WTIX, New Orleans
Represented by
Adam J. Young, Jr.

BAKER, HOSTETLER & PATTERSON
1956 UNION COMMERCE BLDG.
CLEVELAND 14, OHIO

MAY 23 1955



KELLOGG

Traditionally in the Public Confidence...

Kellogg's cereals are custom built for enjoying the finer things in life. Kellogg food scientists work constantly seeking new ways to make breakfast meals more enjoyable in taste, more beneficial in nutrition. In the field of broadcasting, the Havens & Martin, Inc., Stations are distinguished for programs scientifically tailored to the viewing and listening habits of a vast and loyal audience in one of the South's richest areas. The wide appeal of these "custom built" programs makes it easy for advertisers over Richmond's only complete broadcasting institution to convert an unusually responsive audience into sales. Join with confidence the growing list of advertisers who use the First Stations of Virginia—WMBG-AM, WCOD-FM and WTVR-TV—for their advertising needs.

PIONEER NBC OUTLETS FOR VIRGINIA'S FIRST MARKET

WMBG AM WCOD FM WTVR TV

MAXIMUM POWER 100,000 WATTS • MAXIMUM HEIGHT 1049 FEET

WTVR Represented Nationally by BLAIR TV, INC.
WMBG Represented Nationally by THE BOLLING CO.

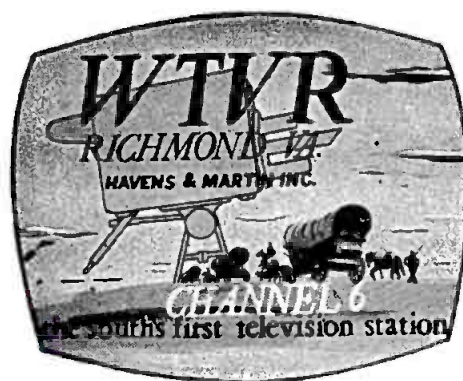

Q.

Station Accounts: -----Oldsmobile dealer Harlan Lane has bought all-night telethon on KGUL-TV May 6, running 10:30 p.m. to 7 a.m., with 2 hours of simulcasting on radio KNUZ and costing reported \$6000, besides fee for comic Jerry Colonna, m.c. Report isn't in yet whether he sold all 100 new & used cars on floor—but gimmick of having salesroom as "studio," letting customers be televised signing up, serving doughnuts & coffee, all heralded in full-page ads in city's newspapers, is unique in TV's commercial annals. -----

Television Digest May 9, 1955

a good question

needs a good answer

A.

AUTOTHON

Lane Sells 100 Cars On TV

The nation's first all-night TV Deal-O-Rama signed off the air at 8 a.m. Saturday, and weary but enthusiastic Lane Oldsmobile officials totaled up their sales.

Over 100 new and used cars hit the auction block in a night of televised buying and selling that Charles Lane, firm general manager, termed "nothing short of a tremendous success."

"It's wonderful," he beamed. "And what's more, we expect to sell 100 more cars by 10 o'clock tonight. We'll be here all day."

The Lane-sponsored autothon started at 11:30 p.m. Friday with Jerry Colonna as emcee and a host of local entertainers between sales. At 7 a.m. Saturday—sign off time—trading was so hot that Lane officials extended the telecast for an extra hour.

THE HOUSTON CHRONICLE

SATURDAY, MAY 7, 1955



KGUL-TV USED EXCLUSIVELY



GULF TELEVISION COMPANY GALVESTON, TEXAS

REPRESENTED NATIONALLY BY CBS TELEVISION SPOT SALES



KRLD'S STOCK IS GOING UP, TOO!

Again, KRLD DELIVERS MORE AUDIENCE in Dallas and Fort Worth combined, during the cumulative hours from 6:00 a.m. until 12:00 midnight, seven days a week, than any other station or frequency.

This is the February - March, 1955, report of Pulse, Incorporated, an independent audience measurement service subscribed to by five Dallas stations.

KRLD's month-in-and-month-out dominance of the Southwest's Largest and Most Responsive metropolitan market sets a new high in coverage efficiency. Equally, KRLD's leadership in its vast primary coverage area (3,303,700 population) is thus reliably indicated. Your advertising investment in KRLD is certain to produce proportionately Big Gains for you. The cost is lower than you think.

KRLD is the eighth largest CBS radio network station circulation-wise in the nation.

SAMS report, 1952.

KRLD
50,000 WATTS

**CBS OUTLET FOR THE DALLAS AND FORT WORTH AREA
OWNERS AND OPERATORS OF KRLD-TV, CHANNEL 4, MAXIMUM POWER
THE BIGGEST BUY IN THE BIGGEST MARKET IN THE BIGGEST STATE
THE DALLAS TIMES HERALD STATIONS**

Exclusive Representative: THE BRANHAM COMPANY

John W. Runyon, Chairman of the Board

Clyde W. Rembert, President

closed circuit.

FIVE FOR THREE • Being talked up by network affiliates is project for five-year broadcast licenses (both radio and tv), five-year network affiliation contracts, with one-year negotiating period. Present license period is three years; network affiliation contracts two years and negotiating period six months.

B•T

NARTB convention in Washington this week will be springboard for Chairman Magnuson (D-Wash.) of Senate Commerce Committee in announcing he is petitioning finance committees of Senate and House to eliminate 10% excise tax on manufacture of all-band receivers as first step toward giving relief to harassed uhf stations. Despite historic unwillingness of Congress to give special tax relief for fear it will open floodgates for others, Sen. Magnuson will make all-out effort and will urge support of all broadcasters in common cause. FCC Chairman George C. McConnaughey is expected to give project his wholehearted blessing when he addresses NARTB convention Tuesday.

B•T

"DO YOU OWN A TV?" Yes . . . No . . . If yes, how many? Those are questions being included in annual survey of nation's population of Bureau of the Census for Advertising Research Foundation. Survey is based on "stratified sample" projected to 100%. ARF foots bill on basis of computations desired (i.e., by metropolitan areas, income groups, rural vs. urban, etc.).

B•T

IT'S STILL Richard A. Mack as Administration's Democratic choice to succeed Comr. Frieda B. Hennock on FCC next June 30. Delay by White House in announcing nomination or "intention to appoint" Florida public utility commissioner occasioned by "security check" routine. It might be another week, according to White House sources, before check is completed.

B•T

TALENT FIRST • Look for Senate Magnuson Committee inquiry to open with study of programming-talent aspects rather than network practices and FCC administration. Sydney Davis, majority counsel, has been in New York making preliminary investigation and shortly will give committee his ideas on "constructive" course of action when hearings begin some weeks hence.

B•T

BEING studied by Magnuson Committee staff, it's learned, are complaints about program distribution which all but preclude transmission to secondary markets because of charges imposed by talent agencies (such as William Morris) to comply with union work requirements (Screen Actors Guild, Actors Equity, etc.) Contention is rates are jumped in ratio to num-

ber of markets used, making addition of tv outlets prohibitive for advertiser. For example, New York, Chicago and Los Angeles are computed as constituting seven markets each under union rules, with scale fixed accordingly.

B•T

MCCONNELL TO DUMONT? Joseph H. McConnell, who recently resigned as president of Colgate-Palmolive [B•T, May 9], reportedly is being considered for presidency of DuMont Laboratories under reorganized structure. Also mentioned as possibility is Seymour Mintz, who resigned last week as president of CBS-Columbia (story page 124). Before Mr. McConnell joined C-P two years ago, he was president of NBC and prior to that executive vice president of RCA.

B•T

SHIFT OF H. C. Bonfig, second man in Zenith, to CBS-Columbia, manufacturing division of CBS Inc., portends greater competition in set manufacturing field, with color upcoming, and may have bearing on toll tv fight. Mr. Bonfig, one of best known figures in manufacturing end, was Zenith's top spokesman on Phonevision. It's understood he has five-year contract with CBS, including stock options and retirement and pension privileges.

B•T

TWO YEARS FOR TAPE • While laboratory progress in tv tape recording is proceeding rapidly, equipment makers feel minimum of year, probably more, will be needed before system can be turned over to industrial designers. Another two years will be needed before equipment is ready for commercial use, they contend, adding that present stage of new art doesn't justify reluctance of stations to buy film projection gear.

B•T

AT ITS NARTB presentation Thursday afternoon, Television Bureau of Advertising will uncork results of hitherto secret survey showing television exerts more influence on buying decisions than other media. In survey, made in super markets in five U. S. cities, motivation researchers questioned customers after national brand purchases were made.

B•T

BARTER QUESTIONED • Certain station representatives are giving second look to "barter" deals whereby tv station trades time segments for sponsored film for which station obtains second run and residual rights. One such deal offers across-board strips on 52-week basis. Top representation firm has advised its stations it does not endorse bartering of time for sponsored film, questioning both principle and effect on station and industry structure. Spokesman for representative firm comments: "There's always somebody seeking a 'free time' ride on someone else's business."

IS REORGANIZATION of International Telemeter Co., 80% owned by Paramount Pictures, in offing? Paul A. Porter, Washington counsel for Paramount and former FCC chairman, was in Los Angeles last week in connection with pay-tv project.

B•T

RHUBARB BREWING? There may be full-scale fight brewing between major leagues and broadcasters over practice by some clubs of charging fee (usually \$50) for appearance by players in tape-recorded interviews at ballparks (not studios). John Harrington, sports director of CBS o&o WBBM Chicago, has taken initiative with open letter to ball representatives and may carry plea to Comr. Ford Frick. He charges inequality between press and radio and claims that without "exploitation" values of both media, parks would be empty.

B•T

FCC commissioners will give as well as take at question-answer session before NARTB convention tomorrow (May 24). At end of session each commissioner will submit sealed envelope containing question he would most like to have broadcasters answer. Questions will be read, but delegates will be spared ordeal of answering.

B•T

NOW IT CAN BE TOLD • That Mrs. Oveta Culp Hobby, first person to hold office of Secretary of Health, Education & Welfare and only woman member of Eisenhower cabinet, would resign this summer had been confided to intimates months ago. President Eisenhower, at last Wednesday's news conference, said Mrs. Hobby had notified him that conditions might arise to compel her to leave government. Former Texas Gov. William P. Hobby, it is known, has been insisting his wife resign because she was "working too hard." It's expected she will return to Houston sometime this summer to resume her duties as co-publisher of *Houston Post* which operates KPRC-AM-FM-TV.

B•T

WITHDRAWAL of Facts Forum's underwriting of Mutual's State of the Nation (see page 116) is not interpreted by close observers as meaning curtailment of other radio-tv activities by controversial, non-profit, public service FF. It's reported that Hardy Burt, producer of State of the Nation, will seek financial support for production costs of show from civic organizations, possibly American Legion, Elks and Knights of Pythias.

B•T

WHAT IT MEANS • Maybe it indicates Chairman McConnaughey's thinking—or maybe it was just too good a chance to quip—but when he spoke to Federal Communications Bar Assn. last Monday to pick up FCBA President Percy Russell's word play on vhf and uhf he referred to uhf as "unusually hopeful fellows."

"... It is rather for us to be here dedicated to the great task remaining before us—that from these honored dead we take increased devotion to that cause for which they gave the last full measure of devotion; that we here highly resolve that these dead shall not have died in vain; that this nation, under God, shall have a new birth of freedom; and that government of the people, by the people, for the people, shall not perish from the earth."

ABRAHAM LINCOLN

Speech at Gettysburg, Pennsylvania
November 19, 1863

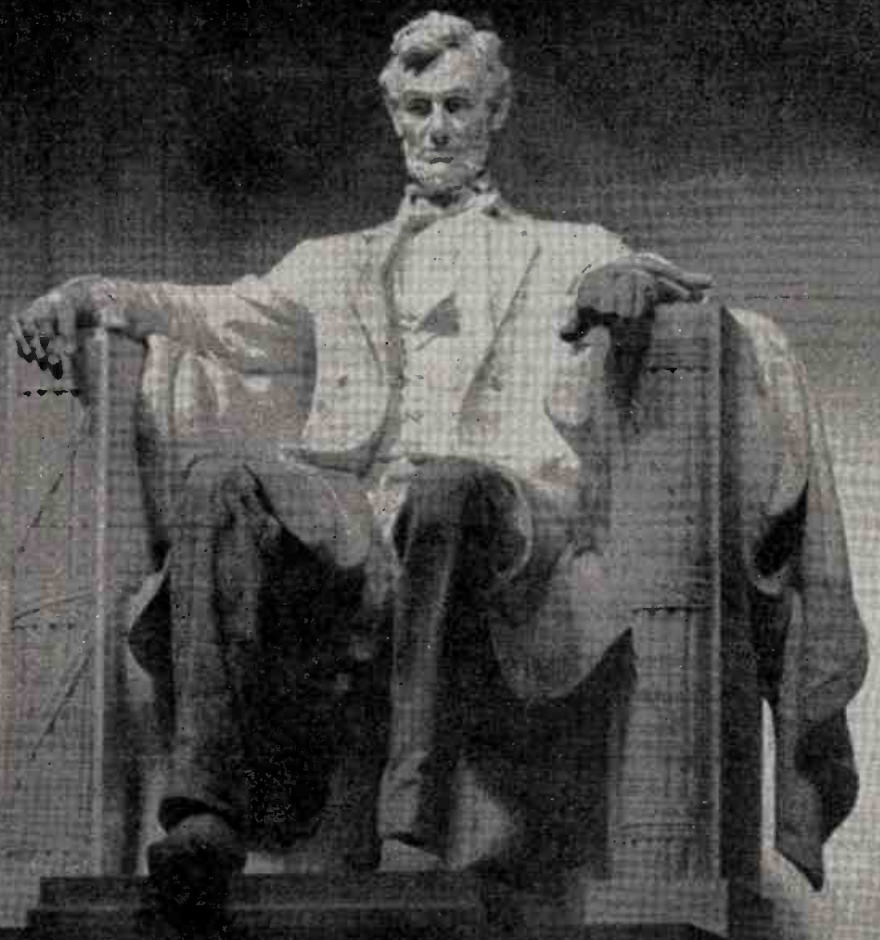

WGAL-TV

LANCASTER, PA.

NBC • CBS • DuMONT

Channel 8

316,000 Watts

STEINMAN STATION
Clair McCollough, Pres.

Network Study Favored By Chairman McConnaughey

FCC SHOULD conduct network study to learn "what makes them tick" but there's great difference between making study and "starting to criticize everybody," FCC Chairman George C. McConnaughey was quoted as telling CBS-TV affiliates at closed luncheon Friday during their first annual conference in New York (early story page 115).

He called CBS President Frank Stanton's February statement on this subject "significant." Dr. Stanton had said adoption of proposals in "Plotkin Report" (memorandum prepared by Harry M. Plotkin as Democratic counsel to Senate Commerce Committee) would mean that "network television as it is known today would be gravely crippled" and public investment of \$13.5 billion in receivers "substantially depreciated" [B•T, Feb. 7].

Chairman forecast FCC's backlog would be practically cleared by end of 1955. He conceded uhf television faces serious problems saying ways must be found to make this service survive and prosper. On subscription tv: While praising "freedom of the airwaves," he was said to have told audience that pay-see will receive serious study.

Question of amendment of Communications Act's Sec. 315, dealing with political broadcasts, had been raised before affiliates by Dr. Stanton, who suggested addition of paragraph to make clear that candidate's appearance on news, forum or debate programs does not require "equal facilities" for opposition candidates.

No Pay-Tv on Networks, Zenith Proposes to FCC

ZENITH RADIO Corp. will ask FCC to "adopt a policy that will prevent subscription tv from being used by existing networks or for regular network programs," E. F. McDonald Jr., Zenith president, asserted Friday. He said Zenith will seek "appropriate safeguards so that neither CBS nor anyone else having the intent to victimize the public will ever be given the chance to do so."

Comdr. McDonald charged that CBS' statement last week (text page 28) indicated that if toll tv is approved, it intends to "highjack" American public into paying for present programming. He further charged that CBS apparently fears competition of toll tv will affect its programs, claiming "three or four New York network executives enjoy the absolute monopoly of dictating" program fare. He attacked advertising on sponsored programs noting "there will be no commercials" on subscription tv.

Esau Quits NARTB Board

JOHN ESAU, formerly of KTVQ (TV) Oklahoma City, has resigned as tv member of NARTB board of directors. Mr. Esau has become business manager of *Television Age*, monthly. H. Quanten Cox, KQFM (FM) Portland, Ore., who has joined same publication as northwestern representative, continues to sit on board despite his magazine connection, it was stated.

BANQUET PROGRAM

WHILE it wasn't announced officially, program slated for Thursday night's annual NARTB convention banquet is to include Peter Lind Hayes and Mary Healy, Yma Sumac, Szonys (dance team) and Singing Sergeants and Air Force Band. The Hayes-Healy act has been well received this spring in Washington at several private events, including White House Correspondents Assn. annual dinner. BMI is in charge of banquet entertainment.

Nielsen Radio Study Shows Big Coverage, Low Cost

RADIO outstrips tv in U. S. coverage as far as percent of homes which can be reached and costs much less than tv on basis of cost-per-thousand of commercial minutes, according to new radio study, "Radio '55," being released today by A. C. Nielsen Co. Findings:

In Northeast part of country, radio could reach 96% of all homes compared to tv's 91%; in East Central area, radio 96%, tv 76%; in West Central, radio 96%, tv 63%; in South, radio 95%, tv 49%, and in Pacific, radio 99%, tv 66%.

Looking at network radio on cost basis, Nielsen finds that daytime radio's cost-per-thousand per commercial minute is 79¢ compared to \$1.47 for tv, and in nighttime \$2.26 compared to \$2.71 for tv.

Other conclusions: Radio's potential to advertisers is 111.4 million home-hours listening per day; radio delivers larger total daytime audience than tv from 8 a.m. to 3 p.m., reaching 8,346,000 homes peak at 1-2 p.m. (more than half daytime audience reached is in tv homes with average daytime network radio show reaching 842,000 tv homes and 809,000 non-tv homes); radio's "auto-plus" (ratio of automobile radio listening to in-home listening) is as high as 39% nationally with peak period in March on Saturdays, 2-2:15 p.m., when 2,160,000 families used car radios, or bonus of 32% to in-home listening level.

MULTIPLEX SNEAK

TWO-CARRIER fm system demonstrated early Friday morning by WGMS-FM Washington in sneak preview, using Halstead Multicast System and Muzak programming. During NARTB convention WGMS-FM is showing two-carrier operation, using Shoreham and Sheraton Park Muzak systems converted to multicast in cooperation with Multiplex Services Corp. Muzak programming will be fed into hotel public rooms via extra carrier. In 12:30-2 a.m. test Friday, listener response came as far as 100 miles away, according to M. Robert Rogers, WGMS president. Fm outlet's normal program was carried on main carrier. Multiplex Services Corp. is showing the operation in the Shoreham, F118.

• BUSINESS BRIEFLY

GOODYEAR CONSIDERS • Goodyear Tire & Rubber Co., New York, considering sponsoring half-hour film version of *Life of Christ*, without commercials, once a month on Sundays starting next fall. Advertiser considering lining up availabilities from 4-6 p.m. on Sundays. Agency, Kudner, New York.

CHESTERFIELD SIGNS • Liggett & Myers Tobacco Co. (Chesterfield) signs for 13-week sponsorship of CBS-TV's *Julius La Rosa Show* (Sat., 10-10:30 p.m.). Agency, Cunningham & Walsh, New York.

NEW RADIO DRIVE • Barbasol Co. (shaving cream) and Lucky Tiger (hair dressing), New York, through Erwin, Wasey, New York, placing radio spot campaign effective June 13 for 52 weeks in approximately eight markets. Early morning spots to be used. Campaign may be expanded to larger number of markets later.

PHILIP MORRIS ON TV • Philip Morris, New York, for first time in several years returning to spot television with cigarette campaign to start July 1 in about 50 markets. Nighttime spots will run for 52 weeks. Biow-Beirn-Toigo, New York, is agency.

FALSTAFF IN FALL • Falstaff Brewing Co., St. Louis, planning to start its fall television campaign in October with two half-hour tv series—*Rod Cameron, City Detective* and *Celebrity Theatre*. Dancer-Fitzgerald-Sample, New York, is lining up availabilities.

New RCA Uhf Transmitter

NEW 25 kw uhf transmitter—capable of being used to radiate million-watt signals—announced by RCA today. Heart of transmitter is improved standard tetrode tube, previously rated at 12.5 kw, now doubled in power. Transmitter will sell for \$186,000, compared to \$246,500 for dual 12.5 kw transmitters hitherto used by RCA to accomplish 1,000 kw output. Where stations have 12.5 kw transmitter in operation, RCA offers conversion kit to boost radiated power to million watts. Cost of conversion kit will be around \$70,000. For stations with 1 kw transmitter, RCA offers to convert to 25 kw for \$163,500. New unit being shown at NARTB convention.

Set Tax Relief Bill Offered

BILL to remove federal excise tax from non-entertainment-type radio and tv sets and from components of radio and tv sets (except cabinets and tubes) when such components are sold for incorporation in set at factory introduced last week by Sen. Edward Martin (R-Pa.) on behalf of himself and Sen. Everett M. Dirksen (R-Ill.).

Award to Earl Gammons

PRESENTATION by President Dwight D. Eisenhower of distinguished service certificate for service with President's Committee on Employment of the Physically Handicapped will be made to Earl H. Gammons, Washington vice president of CBS Inc., at committee's annual meeting today (Monday). Award is in recognition of Mr. Gammons' service as vice chairman of committee from July 1951 to October 1953.



You Can Make a MINT in FLINT!

**THE BIG MONEY MAKER IS
"RECORDS with ROCKWELL"**

Voted Flint's No. 1 Disc Jockey!

What a selling combination! The most popular radio station in Flint and Flint's best-loved, most-listened-to disc jockey . . . Jim Rockwell! Nothing could be sweeter to lure business your way in Michigan's 2nd biggest income city. Folks just naturally tune to WKMF . . . Flint's only 24 hour station devoted exclusively to News, Music and Sports.

*So, put your ad dollars where the listeners are!
"RECORDS WITH ROCKWELL"
is covering Flint's billion-dollar
market like a tent!*

WKMF

Flint, Michigan

Frederick A. Knorr, Pres.
Eldon Garner, Mg. Director
Represented by HEADLEY-REED

SAVE 10%

BUY ANY 2 OR MORE
OF THESE POWERFUL
STATIONS AND SAVE
10% FROM RATE CARD

WKMH DEARBORN-
DETROIT
WKMF FLINT,
MICHIGAN
WKHM JACKSON,
MICHIGAN
WSAM SAGINAW,
MICHIGAN

The Community Stations

KNORR Broadcasting CORP.

at deadline

FCC Shreveport Tv Grant Goes to Don George Group

FINAL decision upholding examiner's proposal to grant ch. 12 at Shreveport, La., to Shreveport Television Co., owned by local theatreman Don George and other businessmen, issued by FCC Friday. Competing bids of KRMD there and Southland Television Co. were denied. Shreveport Television is to take over KSLA (TV), interim station operated by all three contestants jointly under special FCC authority pending outcome of litigation.

Commission preferred Shreveport Television over KRMD and Southland on basis of assurance that program proposals would be carried out and diversification of mass media control. KRMD owner T. B. Lanford also has interests in KPLC-AM-TV Lake Charles, La., KALB-AM-TV Alexandria, La., WSLI Jackson, Miss., and KRRV Sherman, Tex. Southland principals own KCIJ Shreveport and WMRY and WCKG (TV) New Orleans.

In separate opinion concerning Shreveport ch. 3 case, FCC denied petition by KWKH there for reconsideration of final decision awarding ch. 3 to KTBS Shreveport. FCC admonished KWKH for "repetitious" charges that principal KTBS witness committed perjury, terming charges "reckless and unsupported." FCC also criticized "petitioner's assertions and insinuations" that Commission did not give "fair, impartial" consideration to evidence.

Second Television Outlet Authorized in Bismarck, N. D.

SECOND tv station for Bismarck, N. D., granted by FCC majority Friday to John W. Boler's North Dakota Bcstg. Co. over dissents by Comrs. Frieda B. Hennock and Robert T. Bartley. Facilities: ch. 12, ERP 13.2 kw visual, antenna 310 ft. above average terrain.

Originally planned as satellite to ch. 4 KXJB-TV Valley City, N. D., also Boler outlet, Bismarck station bid was amended May 13 to specify local live and networks (CBS, DuMont) after protest by ch. 5 KFYZ-TV Bismarck over newspaper ads by proposed Boler station concerning "live" program plans. In dissent, Comr. Bartley feared "public may have been imposed upon in this case" and concluded from lack of specific program details in amended application "it does not appear that the public . . . will be getting what they were promised by the applicant." Boler interests also include ch. 13 KCJB-TV Minot and KSJB Jamestown, N. D.

WAKE to Rounsaville

ROBERT W. ROUNSAVILLE, postwar broadcaster who has run up ownership string to seven ams and three tvs (only one of which is on air), has taken five-year option on CBS-affiliated WAKE Greenville, S. C. (5 kw on 1440 kc), with price \$125,000 as of now but variable over five years, B•T learned Friday. If he should exercise option, Mr. Rounsaville will have to sell one of his present ams—WQXI Atlanta, WLOU Louisville, WCIN Cincinnati, WMBM Miami Beach, WWOK Charlotte, WBAC Cleveland, Tenn., and 51% of WBEJ Elizabethton, Tenn. Mr. Rounsaville also owns ch. 36 WQXI-TV Atlanta, on air, and grants for ch. 41 WQXL (TV) Louisville and ch. 54 WQXN (TV) Cincinnati.

1.4 MILLION WORDS

AFTER compiling transcript of at least 1.4 million words, testimony and evidence in FCC's controversial license renewal hearing on Edward Lamb's WICU (TV) Erie, Pa., was concluded Friday morning and record may be closed this week after arguments on various technical pleadings, including motion by Lamb counsel to strike testimony of William Garfield Cummings, FCC's initial witness (early story page 104). Hearing started last September. Making final appearance Friday, Mr. Lamb firmly said, "I do not retract a single statement made to this Commission." He affirmed anew "with all the vigor at my command" his earlier anti-communist avowals.

Eastern Writers Guild Approves Freelance Pact

MEMBERSHIP of Writers Guild of America East approved contract covering freelance writers of "live" tv scripts for ABC-TV, NBC-TV and CBS-TV, and advertising agencies and program packagers. Contract will extend through March 31, 1958, and will become effective in "few weeks" when similar pact covering radio writers is expected to be approved.

Contract establishes certain minima for various types of programs. One-hour rates are: commercial, \$1,100; sustaining, \$785; commercial adaptation, \$815; sustaining adaptation, \$575. Half-hour rates are: commercial, \$700; sustaining, \$485; commercial adaptation, \$500; sustaining adaptation, \$375. Special rate is set up for serial program running more than week, with following minima for five-time, 15-minute weekly show: commercial, \$1,270; sustaining, \$890; commercial adaptation, \$750; sustaining adaptation, \$535. Other provisions specify schedule for comedy writers on term basis; payment for outlines of \$100 to be applied against script free, and re-opening of contract two years from effective date.

Case-by-Case Procedure Urged in Intercity Relays

LET station decide whether to use AT&T off-air transmission or build own intercity relay, both NARTB and RETMA told Commission Friday at deadline for filing comments on FCC proposal to relax rules regarding tv intercity connections [B•T, Sept. 27, 1954, *et seq.*].

UPCOMING

May 23-26: NARTB Convention, Shoreham and Sheraton-Park hotels, Washington.

May 23: Community Broadcasters Assn., Shoreham Hotel, Washington.

May 25: Senate Appropriations Subcommittee recall hearing on FCC budget for fiscal 1956, G-16 Capitol Bldg., 2 p.m.

For other Upcomings see page 155.

PEOPLE

ERNEST KOSS named director of sales for Mutual-WOR Recording Studios, N. Y. Before joining studios in 1949, Mr. Koss was with Muzak for four years and prior to that with World Broadcasting System as production executive. He will supervise sales activities of recording division.

AL RYLANDER, manager of exploitation, Columbia Pictures, appointed to new NBC post of director of exploitation.

DAVE GRIFFITH, sports and special events director, WTVU (TV) Scranton, Pa., to WQAN same city as account executive.

ARTHUR GODFREY, CBS radio and television personality, to start 10th year as nighttime network star with special one-hour simulcast July 13.

Tv Inc. Plans Meeting; Joe Floyd Heads Film Group

TV INC., station-owner collective film buying organization, will hold meeting Tuesday in Sheraton Park Hotel during NARTB Washington convention. Session scheduled in suite of KDUB-TV Lubbock for members unable to attend meetings in Chicago last week.

Joe Floyd, president of KELO-TV Sioux Falls, S. D., elected president and board chairman; W. D. (Dub) Rogers, KDUB-TV Lubbock, elected executive vice president and director; Ed Craney and Jim Manning, KXLF Butte, Mont., treasurer-director and secretary-director, respectively. Other directors: Gene De Young, KERO-TV Bakersfield, Calif.; Tom Bostic, KIMA-TV Yakima, Wash.; Mel Wheeler, WEAR-TV Pensacola, Fla., and Herb Jacobs, tv distributor, New York.

Membership comprises 62 stations signed or about to join, it was reported.

Wisconsin Merger Approved

APPROVAL to merger of ch. 5 WFRV-TV Green Bay with ch. 42 WNAM-TV Neenah-Menasha, Wis., as ch. 5 outlet was reaffirmed by FCC Friday in decision denying protest by ch. 11 WMBV-TV Marinette, Wis. Making effective transfer grant approved in February but postponed pending protest hearing [B•T, Feb. 28], FCC found WMBV-TV failed to prove that Valley Telecasting Co., WFRV-TV operator, was involved in harassment of WMBV-TV or trafficking in permit.

Services for Neubert

FUNERAL services for H. Norman Neubert, 39, product manager for Lever Bros. and former manager of sales development, advertising and promotion for NBC Spot Sales, were to be held Saturday morning in New York and Saturday afternoon at St. Mary the Virgin Episcopal Church in Chappaqua, N. Y., where he resided. Mr. Neubert died Thursday after illness of about six weeks. He joined NBC in 1950 to organize and manage merchandising department for o&o stations. He moved into spot sales department's sales development, advertising and promotion management in 1951, and following year joined Lever Bros. as advertising manager (later product manager) for Surf and Swan. He leaves his wife, former Katherin Faulkner; three daughters; two sons; brother, and parents.

Louis A. Connelly Dies

LOUIS A. CONNELLY, 59, manager, government dept., RCA Engineering Products Div., died of heart attack Friday morning in Camden, N. J.

the week in brief

ABC, CBS ATTACK TOLL TV

Networks voice opposition to subscription tv proposals 27
The text of Stanton's protest 28

THE NARTB CONVENTION

Pay-tv will be top corridor topic, and may burst onto the floor; record registration assured 30
Convention in a nutshell 33

WHERE TO GO, WHAT TO SEE

B•T compiles a non-official guidebook for Washington reconnoitering 35

PRESIDENTS AND THE NARTB

Eisenhower's address will be first 'in person' at a convention. Hoover gave one by remote control in 1931 40

WHERE TO FOR EXHIBITS?

A one-page directory 48

RINSO, PEPSODENT MOVE

Two Lever Bros. accounts pick new advertising agencies 57

THE BIGGEST STATION SWAP

NBC trades its Cleveland properties for Westinghouse's Philadelphia stations. It's a precedent setting deal. Official eyebrows may be raised 65

STORER REALIGNS

George Storer Sr. will assume only policy role in organization. Management will be in hands of Wailes, Kettler, Storer Jr. and McCoy 82

KATZ DROPS STATION FILMS

Filmbuying organization dissolved. Salk goes to Screen Gems 96

departments

Advertisers & Agencies	57	For the Record	147	On All Accounts	22
At Deadline	7	Government	104	Open Mike	18
Awards	140	In Review	14	Our Respects	20
Closed Circuit	5	In Public Interest	136	Professional Services	112
Editorial	156	Lead Story	27	Program Services	98
Education	142	International	140B	Programs & Promotion	144
Feature Section	35	Manufacturing	122	Stations	65
Film	96	Networks	114	Trade Associations	100

WEBB GETS THE JOB AT SRA

National sales manager of WLOK Lima, Ohio, named director of Station Representatives Assn., succeeding T. F. Flanagan 100

DE-INTERMIXTURE COMMENTS IN

For-and-against petitions reach FCC on Evansville, Hartford, Madison petitions 104

A MAYOR FOR LAMB

Lawrence of Pittsburgh steps forward voluntarily to testify for broadcaster-publisher 104

NATVIG FOUND GUILTY

Turnabout witness convicted on three counts of lying 104

CBS RADIO'S ONE-RATE PLAN

Network tells affiliates that new plan to simplify charge structure does not mean a rate cut 114

CBS-TV GETS GRID GAMES

Network arranges to carry Big Ten, Pacific Conference regionally 114

CBS-TV PLANS FOR FALL

Ten 90-minute shows, 17 new nighttime series on the agenda 115

THINGS LOOK UP FOR ABC

Goldenson tells stockholders that this year's profit figures are ahead of 1954 116

DUMONT INTRODUCES VITASCAN

Manufacturer comes up with a system of live color tv without cameras. It will be shown at the NARTB convention 122

Broadcasting Publications Inc.
Sol Taishoff
President
Maury Long
Vice President
H. H. Tash
Secretary
B. T. Taishoff
Treasurer

BROADCASTING TELECASTING

THE NEWSWEEKLY OF RADIO AND TELEVISION
Published Every Monday by Broadcasting Publications Inc.

Executive and Publication Headquarters
Broadcasting • Telecasting Bldg.
1735 DeSales St., N.W., Washington 6, D. C.
Telephone: METropolitan 8-1022

EDITOR & PUBLISHER
Sol Taishoff

MANAGING EDITOR
Edwin H. James

SENIOR EDITORS
Rufus Croter (New York), J. Frank Beatty, Bruce Robertson

NEWS EDITOR
Fred Fitzgerald

SPECIAL PROJECTS EDITOR
David Glickman

ASSOCIATE EDITORS
Earl B. Abrams, Lawrence Christopher

ASSISTANT NEWS EDITOR: Don West
ASSISTANT EDITOR: Harold Hopkins

STAFF WRITERS: Ray Ahearn, Jonah Gitlitz,
Louis Rosenman, Peter Pence.

LIBRARIAN: Norma Wootton

EDITORIAL ASSISTANTS: Jacqueline Eagle, Kathryn Ann Fisher, Eli Fritz, Joan Sheehon, Audrey Weston. SECRETARY TO THE PUBLISHER: Gladys L. Hall.

BUSINESS

VICE PRESIDENT & GENERAL MANAGER
Maury Long

SALES MANAGER
Winfield R. Levi (New York)

SOUTHERN SALES MANAGER: Ed Sellers
PRODUCTION MANAGER: George L. Dant

TRAFFIC MANAGER: Harry Stevens
CLASSIFIED ADVERTISING: Wilson D. McCarthy

Eleanor Schadi, M. Gwen Moore.

AUDITOR-OFFICE MANAGER: Irving C. Miller
ASSISTANT AUDITOR: Eunice Weston.

ART-LAYOUT: Duane McKenna

CIRCULATION & READERS' SERVICE
MANAGER

John P. Cosgrove

Frank N. Gentile, Joel H. Johnston, Sharleen Cappella,
Jean Weston, George Neitzey, William Phillips.

BUREAUS

NEW YORK
444 Madison Ave., Zone 22, Plaza 5-8355

Editorial

SENIOR EDITOR: Rufus Croter
AGENCY EDITOR: Florence Small

ASS'T NEW YORK EDITOR: David W. Berlyn
NEW YORK FEATURES EDITOR: Patricia Kilty

NEW YORK ASSIGNMENTS EDITOR: Rocco Famighetti
Selma Gersten, Sally Creley

Business

SALES MANAGER: Winfield R. Levi
SALES SERVICE MANAGER: Eleanor R. Manning

EASTERN SALES MANAGER: Kenneth Cowan
Dorothy Trantow

CHICAGO

360 N. Michigan Ave., Zone 1, Central 6-4115
MIDWEST NEWS EDITOR: John Osbon

MIDWEST SALES MANAGER: Warren W. Middleton
Barbara Kolar

HOLLYWOOD

6253 Hollywood Blvd., Zone 28, HOLLYWOOD 3-8181
WESTERN NEWS EDITOR: Leo Kovner

TV FILM EDITOR: Marjorie Ann Thomas
WESTERN SALES MANAGER: Wallace H. Engelhardt

Toronto: 32 Colin Ave., Hudson 9-2694. James Montagnes.

SUBSCRIPTION INFORMATION

Annual subscription for 52 weekly issues: \$7.00. Annual subscription including BROADCASTING Yearbook (53d issue): \$9.00, or TELECASTING Yearbook (54th issue): \$9.00. Annual subscription to BROADCASTING • TELECASTING, including 54 issues: \$11.00. Add \$1.00 per year for Canadian and foreign postage. Regular issues: 35¢ per copy; 53d and 54th issues: \$3.00 per copy.

ADDRESS CHANGE: Please send requests to Circulation Dept., BROADCASTING • TELECASTING, 1735 DeSales St., N.W., Washington 6, D. C. Give both old and new addresses, including postal zone numbers. Post office will not forward issues.

BROADCASTING* Magazine was founded in 1931 by Broadcasting Publications Inc., using the title: BROADCASTING*—The News Magazine of the Fifth Estate. Broadcast Advertising* was acquired in 1932, Broadcast Reporter in 1933 and Telecasting* in 1953.

*Reg. U. S. Patent Office
Copyright 1955 by Broadcasting Publications Inc.

BROADCASTING • TELECASTING



WDAY WINS— HANDS DOWN!

**PREFERRED 32 TO 1
IN RURAL SURVEY**

THE CITY FAVORITE, TOO!

November, 1954, Hoopers for Fargo-Moorhead show that WDAY gets more than three times as many day-time listeners as the next station!

WDAY—91.7%

STATION A—2.8%

STATION B—1.5%

STATION C—1.0%

A Rural Radio Survey of the Red River Valley Area was recently completed by the Northwest Audit Company of Fargo. A double postcard was mailed to 3,200 families living in the 41 counties within 150 miles of Fargo, in all directions.

Out of the 1681 replies, the amazing total of 1541 said that their families listened to *WDAY* most! That's 91.7% . . . and there were 25 stations mentioned in the survey! *WDAY* was the choice over the second-best station 32 to 1 . . . and 11 to 1 over all other stations *combined*.

Let a Free & Peters Colonel give you the break-down on these staggering facts, or write us if you wish.

WDAY

FARGO, N. D.

NBC • 5000 WATTS • 970 KILOCYCLES

FREE & PETERS, INC., *Exclusive National Representatives*



IT'S TV'S HOTTEST



NEW! FREE
"SCIENCE FICTION"
AMAZING BE
COMPELLING BE
THE

A WEEKLY SERIES

- STIRRING TV DRAMA!
 - DARING PHOTOGRAPHY!
 - AUTHENTIC STAGING!
- ... EVERYTHING to make this the most talked about show on Television!



WILLIAM LUNDIGAN



OTTO KRUGER



DON DE FORE

HOLLYWOOD STARS EVERY WEEK!



HOWARD DUFF



ELLEN DREW



WALTER KINGSFORD



ST NEW SHOW!

SH! DISTINGUISHED!

SCIENCE

CAUSE IT'S SCIENCE!

FICTION

CAUSE IT'S FICTION!

ATRE"

OF DRAMATIC HALF-HOURS!

Every story is based on scientific facts dramatically demonstrated by your host
TRUMAN BRADLEY

CINCINNATI
NEW YORK
HOLLYWOOD

DEMAND THAT ONLY
A BIG, NEW IDEA
COULD PRODUCE!

- **OLYMPIA BEER** 22 West Coast Markets
- **PICTSWEET** 13 Markets
- **BROMO-SELTZER** 17 Markets
- **WHITE KING SOAP** 5 Markets
- **GERITOL** 5 Markets
- **GENESSEE BEER** 3 Markets

- **BANKS** FIRST NATIONAL of Miami • FIRST NATIONAL of Atlanta • NATIONAL BANK of Tulsa • AMERICAN NATIONAL BANK & TRUST CO. of Chattanooga • SECURITY FED. SAVINGS & LOAN Columbia, S. Carolina.

- **UTILITIES** ARIZONA PUBLIC SERVICE in Phoenix, Yuma • NEW ENGLAND GAS & ELECTRIC in Boston • CENTRAL MAINE POWER CO. in Portland • NATURAL GAS COMPANIES in Pittsburgh • PROVIDENCE GAS CO. & BLACKSTONE VALLEY GAS & ELECTRIC in Providence • MANUFACTURERS LIGHT & HEAT CO. Wheeling, W. Virginia

- **FOODS** TOBIN PACKING CO. in Utica, Rochester, Buffalo • MARMAT PACKING in Charlotte • ACME SUPERMARKETS in Syracuse • PEVELY DAIRY in St. Louis • ASSOCIATED GROCERS in Billings • STRIETMANN BISCUIT in Huntington, W. Va. • KOTARIDES BAKING in Norfolk • HATHWAY BAKERIES in Providence • WOODHAVEN DAIRY in Mobile, Alabama • TEXAS COFFEE CO. Beaumont, Texas

- **GASOLINE** WISCONSIN OIL CO. in Milwaukee • CONTINENTAL OIL CO. in Dallas • BELL OIL CO. Ada, Oklahoma • PHILLIPS PETROLEUM in Greensboro, N. Carolina

- **AUTOS** FORD 5 Western Markets • PLYMOUTH 2 Big City Markets • PONTIAC 1 Market

AND MANY MORE

VISIT ZIV-TV CONVENTION EXHIBIT MAY 22-26
RM. A 209, SHOREHAM HOTEL, WASHINGTON, D. C.



AVAILABLE in Spanish, French, German and Italian

CAPITAL TYPES #2



THE UNIMPEACHABLE SOURCE

Started swearing early on a stack of Bibles. Tireless source of information ever since. In Washington today, however, listeners turn to WTOP Radio as their prime source of information. And they listen to such an extent that WTOP has the top-rated network and local news programs in Washington radio. In fact, WTOP is the only station with news programs that rank consistently in the Top Ten! No question that WTOP Radio can be your most reliable voice in Washington, too. We'll gladly give you details.

WTOP RADIO

Represented by CBS Radio Spot Sales

HIGH PITCH

A MUSICAL COMEDY dealing with what happens when an opera star buys a baseball team. That was the idea left by the advance publicity for "High Pitch," the May 12 program of CBS-TV's *Shower of Stars* colorcast series, and—to be honest—it sounded strictly from hunger. But, with Marguerite Piazza and Tony Martin as stars, there should have been some good singing, anyway. So we tuned in and were more than pleasantly surprised.

The hour-long telecast turned out to be a delightful show from start to finish, with lots of good singing, as might have been anticipated, and lots of laughs, which viewing other "original musical comedies" on television would not lead one to expect. Milton Lazarus provided a script that gave the stars full opportunity to fall in love, to part in anger and to be reunited in time for a final duet, in the best musical comedy tradition.

Miss Piazza, as the opera star she really is and the purchaser of a last place ball club she fortunately is not, made a beautiful and vivacious heroine who did right by opera lovers with her renditions of arias from *La Boheme* and *Carmen* and by the rest of her audience with sock delivery of "Dance With Me, Henry"



MARGUERITE AT THE BAT

and "Take Me Out to the Ball Game." Tony Martin, as the egotistical ball player who lifted the Hooligans to victory or dropped them to defeat as his emotions dictated, sang in a way to thrill all feminine viewers without offending the males, and what more could be desired of a musical comedy hero?

William Frawley and Vivian Vance, better known as Fred and Ethel Mertz, friends of the Ricardo family, effectively handled the show's chief comedy roles as the manager of the Hooligans and his long suffering wife. Mel Allen portrayed himself, reporting the crucial innings to a barroom audience in a couple of hilarious scenes. Top amusement was furnished by a low comedy sequence in which two opera singers learn about baseball from seats in the bleachers. Extra bows are merited by Mr. Lazarus and David Rose for an original song on the troubles of ball players' wives, and by Miss Vance, who put it over in fine style.

Comments have frequently been made about colorcasts which, however beautiful on color sets, were blurry and unsatisfactory when viewed on monochrome receivers. Let the record show that "High Pitch" as seen in black-and-white was first-rate viewing in every aspect, including the massing of the chorus groups.

Colorcast on CBS-TV May 12, 8:30-9:30 p.m., as part of monthly *Shower of Stars* series,

sponsored by Chrysler Corp. through McCann-Erickson.

Producer: Nat Perrin; associate producer and choreographer: James Starbuck; director: Seymour Berns; assistant director: Robert Adams.

Original musical comedy written by Milton Lazarus.

Musical conductor: David Rose, who also provided new musical material for the program.

Host: William Lundigan; announcer: Art Gilmore.

Stars: Marguerite Piazza, Tony Martin, Vivian Vance, William Frawley, Mel Allen.

★ ★ ★

BOOKS

COMMUNISM, CONFORMITY AND CIVIL LIBERTIES, by Samuel A. Stouffer. Doubleday & Co., Garden City, N. Y. 280 pp. \$4.

THIS volume is a detailed report of an attitude survey made of Americans in the summer of 1954 on the subjects of communism and civil liberties—a three-fold study comprising two separate surveys of cross-section public opinion and a 14-city survey of the opinions of community leaders. Findings, reported at great length and thoroughly analyzed, show that very few individuals were greatly concerned over either subject last summer. Specific questioning revealed greater tolerance of unorthodox beliefs by leaders of public opinion than by the average citizen. For example, the vast majority—86% of the leaders, 89% of the national cross-section—felt that an admitted communist should not be allowed to teach in a college, but when asked whether a radio singer who is a communist should be fired, only 48% of the leaders said yes, to 63% of the national cross-section. A further question as to whether the respondent would stop buying the product advertised on the program on which the communist singer performs revealed that 36% of the general public would do so, but only 27% of the community leaders. This report should be of interest and value to top station management, as well as to program executives.

ELSEVIER'S DICTIONARY OF TELEVISION, RADAR AND ANTENNAS, in Six Languages — English/American, French, Spanish, Italian, Dutch and German. Compiled by W. E. Clason. Elsevier Press, 402 Lovett Blvd., Houston, Tex. 760 pp. \$21.50.

ARRANGED on an English alphabetical base, this dictionary on the left-hand pages lists the words and their meanings in English/American and on the facing pages the same terms in the other five languages. It should be a valuable reference work for electronic scientists and engineers forced to keep abreast of developments abroad. The author is in charge of bibliographical documentation and translation at the N. V. Philips' Electrical Works in Eindhoven, Holland.

THE 1955 BASEBALL ALMANAC, edited by Hy Turkin. Pocket Books Inc., 630 Fifth Ave., New York 22, N. Y. 293 pp. 35¢ in paper.

THE sports broadcaster should find this handy guide book of particular interest. It contains information on the history of baseball from its beginning, all-time records, listings and data on current major and minor league clubs and flashbacks into significant events. Radio and tv data with respect to each major league club are included.



TED KEY
LOOK

"Commercial's on"

—a Sarra commercial, of course!

**People are looking at
Sarra Commercials for**

- | | |
|-------------------|-------------------|
| A&P | Jergens Lotion |
| Braun's Bread | Kraft |
| Bromo-Quinine | Lucky Strike |
| Bulova | Cigarettes |
| Cat-Tex | Lux Beauty Soap |
| Chase National | Lux Liquid |
| Bank | Detergent |
| Chrysler Airtemp | Pabst Blue Ribbon |
| Coors Beer | Beer |
| Cunard Steamship | Pet Milk |
| Lines | P.O.C. Beer |
| Helene Curtis | Ponds Angel Skin |
| Duncan Hines | Rinso |
| Cake Mixes | Ronson Fuel |
| Eastman Kodak | and Flints |
| Evinrude Motors | Stopette |
| Hoffman Mixers | Jane Wilson |
| Hostess Cup Cakes | Meat Pies |



Specialists in Visual Selling
 New York: 200 E. 56th Street
 Chicago: 16 E. Ontario Street

TELEVISION COMMERCIALS • PHOTOGRAPHIC ILLUSTRATION • MOTION PICTURES • SOUND SLIDE FILMS

RCA AMPLI



**50-KW AM
AIR COOLED!**

**New RCA 50-kilowatt
AM Transmitter BTA-50G**

**DESIGNED WITH
AMPLIPHASE MODULATION**

HOW IT WORKS!

To produce phase-to-amplitude modulation in the BTA-50G, a carrier wave is developed by a common exciter. This carrier wave is then split and fed to two separate amplifier chains through phase-shift networks that establish a carrier phase difference. These two signals are controlled so that each maintains a prescribed phase relationship with the other in accordance with the intensity of modulating signal. This controlled phase relationship enables the separate 25-kilowatt amplifiers, when feeding their outputs into a combining circuit, to produce a maximum level 50-kilowatt amplitude modulated signal.

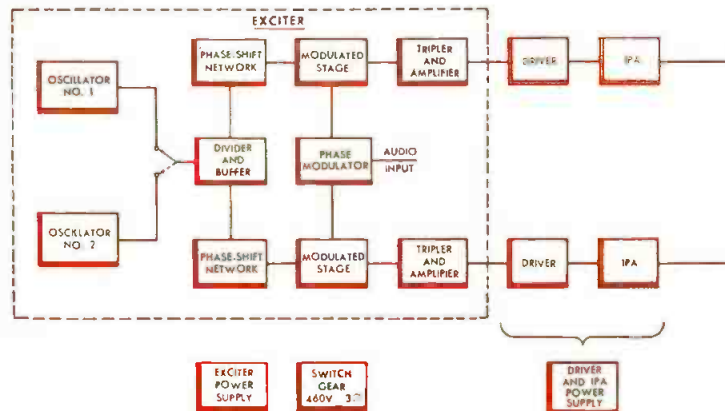

SIMPLIFIED BLOCK DIAGRAM—BTA-50G TRANSMITTER

PHASE

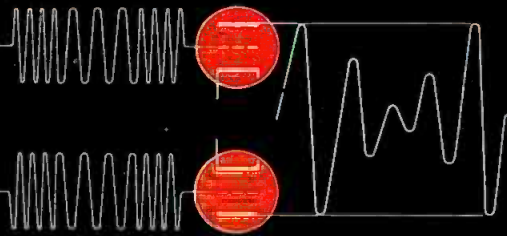

A new concept in AM Broadcasting!

... introduced in RCA's revolutionary new 50-KW AM transmitter

Here is the most significant forward step in AM transmitters since RCA introduced high level modulation—an entirely new 50-KW transmitter using Ampliphase Modulation. Newest and finest in RCA's long line of distinguished AM transmitter designs, it is further proof of RCA leadership in the broadcast equipment field.

Ampliphase cuts transmitter floor space and operating costs by substantial margins. The BTA-50G is housed in four cubicles. It does away with half of present power tubes . . . along with bulky components such as modulation transformers,

reactors and accessories. It requires no underfloor trenches, costly water cooling systems, external blowers. And there's no lost air-time—because the 50-KW Ampliphase is remarkably easy to install while your present transmitter is in operation. Then, in most cases, you may keep your old unit as a stand-by.

For complete technical details . . . and for information on the surprisingly low price . . . call your RCA Broadcast Sales Representative. In Canada, write RCA VICTOR Company Limited, Montreal.

FACTS ABOUT RCA'S NEW 50-KW AM

- Takes less than 80 square feet of floor space. No underfloor trenches required.
- Lowest operating cost of any 50-KW AM transmitter.
- Half the tube cost of other 50-KW AM transmitters.
- Uses famous Long-Life RCA 5671 P.A. tubes.
- No Modulation transformer required.
- Completely air-cooled with internal blowers—no air intake ducts necessary.
- Low distortion, excellent frequency response.
- Splatter-free modulation provided by new Ampliphase design.
- Designed to permit remote-control operation.
- New simplified circuitry. Extremely stable operation.

PIONEERS IN AM BROADCASTING FOR OVER 25 YEARS



RADIO CORPORATION of AMERICA
ENGINEERING PRODUCTS DIVISION

CAMDEN, N.J.

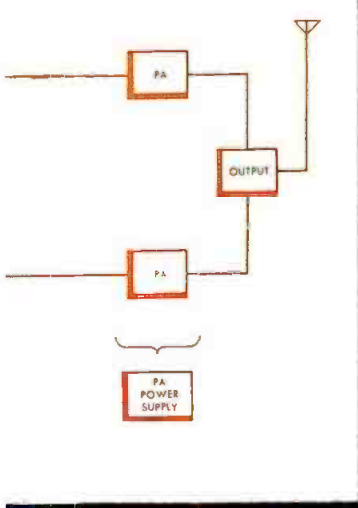

The CALIF.-ORE. TV TWINS

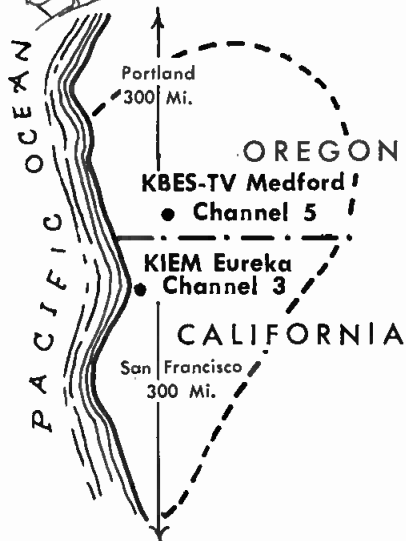

the *Smullin* TV Stations

KBIEM CHANNEL 3
Eureka, Calif.

KBIEM CHANNEL 5
Medford, Ore.

two markets
one billing

MARKET FACTS

POPULATION 291,906
FAMILIES 91,220
RETAIL SALES \$378,018,000
CONSUMER SPEND-
ABLE INCOME .. \$426,188,000

"The Calif.-Ore. TV TWINS bridge the gap between San Francisco & Portland with EXCLUSIVE VHF Coverage on Channels 3 & 5."



for CALIF.-ORE. TV TWINS
call Wm. Smullin, Gen. Mgr.

or ask national representatives

Code Commendation

EDITOR:

I do want to express my appreciation for the editorial page in the May 16 issue of B•T . . . partly for the generous phrases about me, in the second editorial, but more particularly for the fine lead editorial regarding the Code.

All the folks you mention have in fact been responsible for getting the Code over the hump; but "official" recognition and commendation from your "book" are most heartening to everyone concerned and should indeed be of valuable assistance in our constant campaign to increase subscription to the Code.

*Harold E. Fellows, President
NARTB, Washington, D. C.*

Timely Reminder

EDITOR:

It was particularly distressing to note in the first item of CLOSED CIRCUIT in the B•T issue of May 9 that the probable appointment of Richard Mack to succeed Commissioner Hennock "may provoke unrest in certain quarters."

Here in the land of the free our government leaders are continually reminding us that "all men are created equal." There is no room here for racial discrimination, etc. And yet, in these very circles, we hear that the appointment of a Protestant to a post formerly held by a person of another religious denomination "may provoke unrest."

I hope you will take the occasion to remind "certain quarters" that the brown eggs are just as good as the white, the black horses as good as the brown, the negroes as good as the whites, and the Protestants as good as anyone else.

*Ralph K. Lemay
WENY Elmira, N. Y.*

[EDITOR'S NOTE: In reporting the reaction "in certain quarters" to the news of Mr. Mack's anticipated appointment to succeed Miss Hennock on the FCC, B•T neither expressed nor intended any approval of it. Our personal views coincide with those expressed above by Mr. Lemay.]

Recommendation

EDITOR:

Young men who are trying to get into radio should read B•T. Many of them don't know about B•T, while others think it is for people in higher positions of the medium. I got my job from an ad that appeared in B•T. This is my second subscription and I am going to renew.

I have before, and I do now, recommend B•T to ambitious young men trying to get a lead in radio and television. I don't have to recommend it to the established people in the medium; they know its value.

*William Mullen
WSID Baltimore, Md.*

No Blues at KSON

EDITOR:

With all the controversy and discussion about falling radio revenues . . . we thought you might be interested in the fact that KSON for both the months of March and April has enjoyed the highest gross income from sales in the station's history. More important perhaps, our net profit in each month has reached a new high, despite the fact that we are paying our employees between 75% and 100% higher hourly wages than we did eight years ago.

The reason for the increase in net in the face of higher wages and salaries is the use of automatic operation in part and remote operation. This has, of course, necessitated an increase in capital investment but it has been well worth it.

As to gross sales, it is simply a matter of

aggressive selling with an alert, wide awake sales force. Also the fact that we have concentrated in programming to the out-of-home audience.

*Fred & Dorothy Rabell, Owners &
Operators
KSON-AM-FM San Diego, Calif.*

The Agencies Write

EDITOR:

. . . This volume [1955 BROADCASTING YEAR-BOOK] is a central source for a great deal of information related to the radio industry. It is extremely valuable for its what-where-and-who-to-go-to format.

*Edward A. Fonte
Ruthrauff & Ryan, New York*

EDITOR:

. . . We especially find the market data very helpful. We work closely with our merchandising department and feel that they can make good use of this information, too.

*Kenneth White, Vice President
Lennen & Newell, New York*

EDITOR:

I have always found these YEARBOOKS an invaluable source of information which always seems to be needed in a hurry and which is always there in a handy form.

*Lucian Chimene
J. Walter Thompson Co., New York*

EDITOR:

. . . In the short time it has been on my desk, I have had occasion to use it several times and have been amazed at the wealth of information it contains. It has proved to be an invaluable addition to my reference library.

*Marjorie Freeman
N. W. Ayer & Son, New York*

Still Another Entry

EDITOR:

With no particular desire to "top" anyone, KOMA is still among the "tops" in sports presentations.

During 1954 we presented 161 baseball games (Texas League) of the Tulsa Oilers; 28 basketball games of the U. of Tulsa (26 regular, 2 NCAA regionals) and 10 NBC Games of the Week plus 4 outstanding high school games, totaling 203 major sports broadcasts.

During 1955 we will do 162 Texas League games (161 regular Tulsa Oiler games plus the All-Star game), 10 U. of Tulsa football games (in addition about 5 outstanding high school games), and the full 26-game schedule of the U. of Tulsa basketball team. In addition we had access to the broadcasts of a major league team.

*E. William George, Gen. Mgr.
KOMA Tulsa, Okla.*

[EDITOR'S NOTE: WFOB-AM-FM Fostoria, Ohio, in a report published in B•T April 25, said it had broadcast 77 basketball games and is now broadcasting all Cleveland Indians baseball games and asked if any other station could post a better record. OPEN MIKE letters in subsequent issues have shown a number of stations willing to try.]

Monday Night Neglect

EDITOR:

. . . Incidentally, here is another unsolicited testimonial to add to your files. I find B•T very interesting and never fail to neglect my family on Monday evening while I read it from cover to cover.

*Charles K. Bloomquist
Film Director
WINT (TV) Fort Wayne, Ind.*

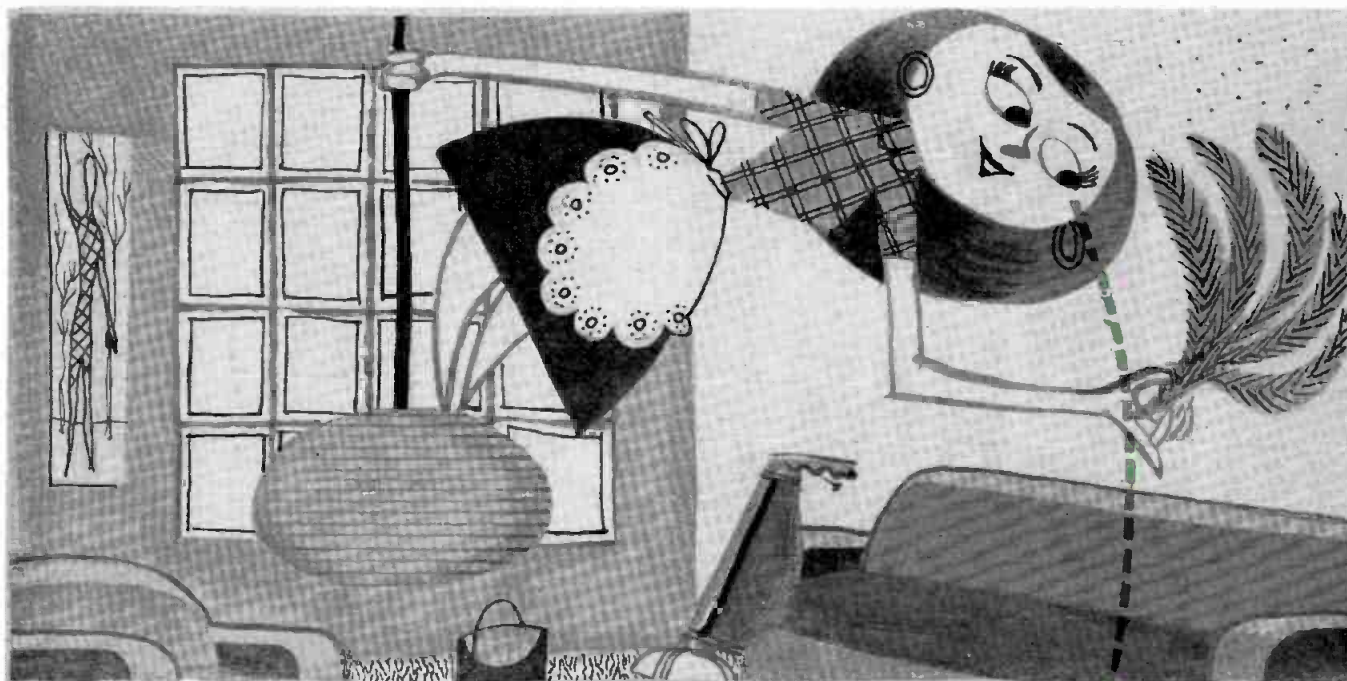

*greater
Nashville
watches
channel* **5**

the  station for 62 Tennessee and
Kentucky counties—a billion dollar market
reached by Nashville's highest towered,
maximum powered station

WLAC-TV

100,000 watts • channel 5
CBS Basic Affiliate
Nashville, Tenn.

For more availabilities, check our national reps, The Katz Agency.

To sell anything used in a kitchen use *Southern Cooking*.

Eudora, Nashville's leading cateress, provides just the right touch of cooking skill and Southern accent.

Monday thru Friday 4:00-4:30 p.m. Regular participating rate for one minute applies. Add \$5 per spot (commissionable) if Eudora does full or part commercial. With three-a-week schedule, product is stocked in Eudora's kitchen on exclusive-for-category basis.

P.O.P.

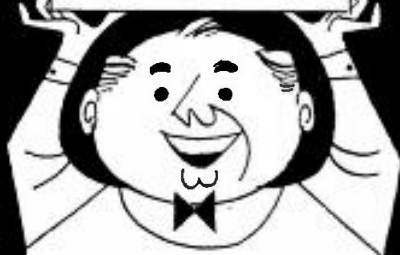

DURING 1954

26 companies with
238 supermarkets

grossing over
\$400,000,000

participated in
KRCA's great

KEY VALUE WEEK

merchandising
promotions.

KRCA advertisers
received from
these stores . . .

6,648 column inches

1,162 stack displays

7,819 shelf strips

1,952 wire hangers

JUNE 1, 1955

22 VON'S markets
Inaugurate

KEY VALUE MONTH

the first of the
new **30 DAY KRCA
MERCHANDISING
PROMOTIONS** with

the leading
markets in
LOS ANGELES . . .

for
P.O.P. . . . proof of

performance at
the point

of purchase, it's
KRCA in greater
L.A.

KRCA-4 Los Angeles
NBC SPOT SALES

our respects

to EARL HENDERSON GAMMONS



ON Christmas Eve 1926, WCCO Minneapolis and its young commercial manager, Earl Gammons, made radio—and advertising—history by introducing a new type of radio commercial which was not spoken by an announcer but sung by a male quartet. The product advertised was Wheaties, made by Washburn Crosby Co., owner of WCCO, which ordered the campaign largely to evaluate the effectiveness of its station.

James Gray, in his history of General Mills, "Business Without Boundary," tells the story this way: "As a lover of innovation and an experienced newsman, Gammons was pleased with the opportunity to explore the potentialities of the new medium. What he offered was the first 'singing commercial,' an appeal on behalf of Wheaties that seems a model of decorum, courtesy and effectiveness . . .

"Have you tried Wheaties?

They're whole wheat with all of the bran.
Won't you try Wheaties?

For wheat is the best food of man."

Mr. Gammons, now CBS Inc. Washington vice president and senior statesman, insists that the book gives him too much credit, that his main contribution to the first singing commercial was engaging the quartet at \$24 (for all four singers for a half-hour program). His friends say his modesty exceeds his memory.

Born July 23, 1893, in Edgewood, Iowa, the son of a Methodist minister, Earl Henderson Gammons grew up in Cresco, Iowa, and went on to Cornell College at Mt. Vernon, Iowa, where his journalistic efforts won him editorship of the school paper and, after an editorial which the faculty felt was lacking in respect for a visiting bishop, a suspension from academic life. Fortunately, the authorities relented and Earl graduated with his class in 1915.

Followed two years as a reporter for the *Cedar Rapids Republican & Times* and then Earl moved to the *Minneapolis Tribune*, but after only a few months there he left his typewriter to become a machine gunner with the AEF in France. After the armistice of November 1918, he stayed in Germany as news editor of *Wacht am Rhine*, an Army newspaper. He returned to the *Tribune* in 1919.

Again his *Tribune* stay lasted a few months. This time he left to start an employe paper, *Eventually News*, for the Washburn Crosby Co., whose best known product, Gold Medal Flour, was advertised with the slogan "Eventually, Why Not Now?" In addition to his editorial duties, Earl also wrote publicity for the company and speeches for its executives and, in 1924 when Washburn Crosby acquired WLAG Minneapolis and renamed it WCCO, he began handling publicity for the station as well. This naturally led to news broadcasting

over WCCO and that to sports announcing. By the end of 1925 Earl dropped his other work to devote full time to the station. Commercial radio was just beginning and he was named sales manager of WCCO.

It was not long after that that the young sales manager started another long-lived trend by getting the Watkins Remedy Co. of Winona, Minn., to sponsor radio's first daytime serial, *The Watkins Family*. Newsman Gammons also pioneered in special events broadcasting when he arranged with the Minnesota National Guard for coverage of an eclipse of the sun from the air, using a lightweight transmitter built for the occasion by the WCCO engineers, and then found himself handling the broadcast because all the other announcers refused.

In 1928 the Washburn Crosby Co. became General Mills and the following year sold a third interest in WCCO to CBS. Two years later CBS became full owner of the station and, in 1933 named Earl Gammons as WCCO manager. This post Earl held for nearly 10 years, building the station to an enviable position and also helping to build broadcasting as a director of NAB (now NARTB).

In 1942, CBS moved him to Washington as director of the network's office there. In 1946 he became vice president of CBS Inc., in charge of Washington operations for all divisions of the corporation, a position he has held since.

"A list of Earl Gammons' intimate friends includes a larger number of people prominent in public life than can be said for anyone else in Washington," a close friend told B•T. "Perhaps," he added thoughtfully, "it's because they have found, along with many others, that Earl is a mighty good friend to have."

Mr. Gammons and his wife, the former Ardelle Bergeson, live at Washington's Sheraton-Park Hotel, where their daughter, Jeanne Anne (Mrs. W. F. Merrill) and her three children are frequent visitors.

A raconteur *par excellence*, Mr. Gammons is famed for his seemingly inexhaustible supply of short quips, without which no Gammons conversation, face-to-face or on the phone, is complete. Always to the point and often barbed as well as pointed, these stories, as he relates them, might have been especially created for the particular occasion of the telling. One friend commented, "Earl's won more points with his stories than most Washington lawyers with their briefs."

Mr. Gammons' hobbies are hunting and fishing in the appropriate seasons and golf the year 'round at Burning Tree (where a fellow member is President Dwight D. Eisenhower), Chevy Chase or Columbia Country Club. He also belongs to the Metropolitan Club and the National Press Club.



For The Birds

We see by *The Carrier Pigeon Digest* that a movement is on wing, underwritten by the Carrier Pigeon Association, to challenge tv. A public relations campaign is to promote the use of pigeons for delivery of commercials, on the basis of (1) lower cost, and (2) pinker eyes.

Alert to our responsibilities, we turned the clipping over to Research. His report follows.

"Figured this up Army Signal Corps' alley. Sought cost data. Contacted Commanding Officer (a bird colonel) in Charge of Coops, Signal Corps Br., 2d Sv Comd., who refd me to Transportation Officer, who refd me to Message Center Maintenance Officer who refd me to Public Relations Officer of QM Depot who refd me to C.O. in chg of Coops, Sig C Br. (same bird). Started over. Got to Air Force Hq., Pentagon; told info. classified. Wrote Congressman. Invited me to lunch, next visit to Washington. Wrote Ed., *Carrier Pigeon Digest*. Had figs finger-tips. He quotes Sig C. on what it costs to keep one pigeon one day:

Feed23
Straw03
Loft rent10
Identification bands008
Coop maintenance75
Overhead (maintain army)	254.75
Depreciation (birds that don't make it) ..	.382
Bird maintenance (ground crew, bathing, clipping, worrying about stragglers)...	4.73
Recruiting program for pigeons13
Message containers01
	<hr/>
	261.12

"Throw out the overhead item (gotta have an army anyway) and the maintenance item (ditto) and its costs \$1.64 per pigeon per diem.

"A pigeon can do 200 miles daily, properly motivated. Got to be chauffeured to point of release, got to eat and drink en route, and needs a night off once in awhile. Assume he works 25 days a month and he's good for 5000 miles top a month. Allow 10¢ a working day for carfare and it works out to about 83¢ per thousand miles worked, give or take an army." —Bruce

The cost per thousand for WMT-TV can be shown to be as low as 72¢.* It's true that on WMT-TV you reach people, instead of travel miles, but what's a Research Dept. for, anyway?

What about pinker eyes?—Ed.

Ever see one of our announcer's eyes on a Monday morning?

WMT-TV Channel 2 100,000 watts
CBS for Eastern Iowa

Mail address: Cedar Rapids

National Reps: The Katz Agency

* There are about as many ways of figuring cost per thousand as there are pigeons and tv stations combined. Be glad to explain this one to any, like they say, interested party.

2 FACTS

Buffalo - Niagara Falls is the nation's 14th largest market.

WGR-TV completely dominates* this rich market, serving 465,545 U. S. sets and a bonus of 431,560 in Canada.

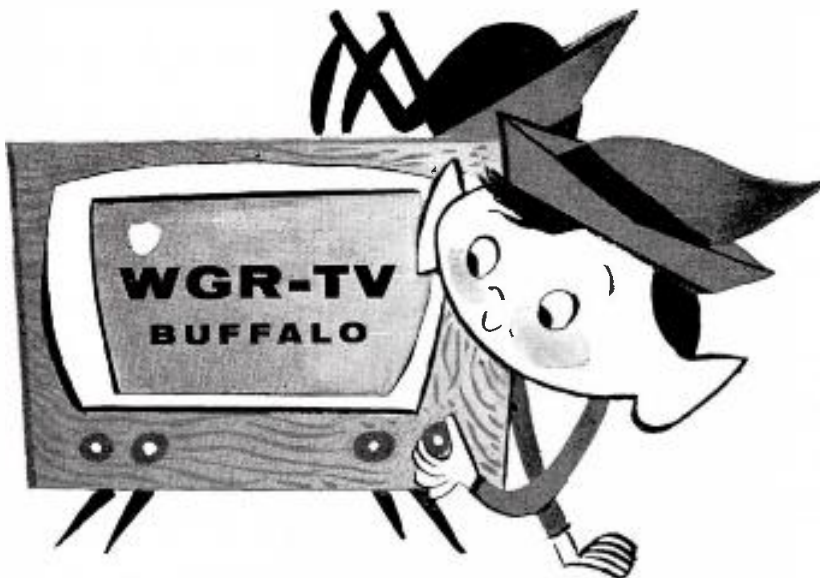

Channel 2

Buffalo's favorite station

REPRESENTATIVES — Headley-Reed
In Canada — Andy McDermott-Toronto

* **WGR-TV** leads in 21 of the 24 weekday quarter-hour segments between 6 PM and midnight. (Pulse)



ROLAND E. JACOBSON

on all accounts

ROLAND E. JACOBSON first became acquainted with tv in 1947, when his commercial copy was among the first to emanate from KTLA (TV) Hollywood, Paramount Tv Productions o&o station. He was then Los Angeles manager of Buchanan & Co., agency servicing Paramount Pictures.

Now vice president of William W. Harvey Inc., Hollywood, Mr. Jacobson was born in Havelock, N. D., in 1908, and grew up in Rochester, Minn. He graduated from the U. of Wisconsin with a B.A. in journalism in 1930 and became a newspaper reporter-feature writer, shifting to midwestern trade publications in 1934 as an editor.

Six years later, he entered radio as commercial manager of KWNO Winona, Minn., where he remained until Pearl Harbor. Then he moved to California and while working at Lockheed Aircraft, met Miss Virginia Morris, who became Mrs. Jacobson in 1947.

He entered the agency field with The McCarty Co., Los Angeles, as an account executive. In 1943 he joined Buchanan & Co. as copy chief, later becoming radio director and then vice president in charge of the Hollywood office. In 1949 he joined Ruthrauff & Ryan Inc. as an account executive, and two years later went to the Biow Co. as account executive in charge of the Maier Brewing Co. (Brew 102) account, a heavy radio-tv user.

In 1953 he joined the Harvey agency as an account executive, assuming his present position in a scant three months.

At least 90% of Harvey accounts use radio and tv, Mr. Jacobson points out, including Sunset Oil Co., Vitamin Div. of Thrifty Drug Co., Servisoft of California (soft water service) and General Electric Supply Co. (Southern California GE and Hotpoint distributors).

Commercials, especially singing jingles, are becoming more strident as their creators strive for new or unusual sounds, he comments. The Harvey Co., for the Thrifty Drug Vitamin Div.'s "Allen's Formula 25," has had its announcer use a straightforward sales pitch as a contrast and "it's working. The Allen's Formula people report their best business ever," Mr. Jacobson states. He also notes that Vitamin Div. has allocated its entire advertising budget to radio since last Jan. 1.

An ardent sportsman especially fond of skiing, tennis, swimming and strenuous games, Roland Jacobson admits a recent ankle fracture has slowed him down a bit. These days, he and Mrs. Jacobson do considerable reading in their home in the Hollywood Hills.

NOT A SHADOW OF A DOUBT

---about radio coverage in Mid-America

As our rotund friend, Mr. Mid-America indicates, it's a big, rich, expanding market, completely covered by one big station — KCMO Radio.

Take a look at radio listening in the November-December, 1954 *Area Pulse*. Or glance through the 1954 composite Conlan "Study of Listening Habits" for Mid-America. You'll see there's no doubt that KCMO is *the* radio buy for Mid-America.

Within KCMO-Radio's 1/2 mv. contour you reach 213 Mid-America counties . . . and with KCMO's 50,000 watts at 810 on the dial you get more Mid-America listening homes than any other Kansas City station. Take Mr. Mid-America's tip: Cover the *whole* market *better* with KCMO-Radio.



Kansas City's most powerful station for Mid-America

KCMO radio

**50,000 watts at 810 Kc.
Kansas City, Missouri**

National Representatives: The Katz Agency • Affiliated with Better Homes & Gardens and Successful Farming

Excited Sponsors are buy

"THE

Eddie Cantor Cantor RADIO SHOW"



STARRING
EDDIE CANTOR

WITH
JIMMY WALLINGTON
Eddie's favorite
radio clowning partner

NOW'S THE TIME TO

Enthusiastic reports are pouring in from stations all over the country . . . listing big, profit-boosting sales to local, regional and national advertisers.

Many report 5 half-hours weekly sold out to one sponsor . . . others excitedly tell us they've sold as many as 15, 20 and 30 spots weekly! All acclaim "The Eddie Cantor Show" as the Sales-happiest show on radio!

HURRY

VISIT ZIV RADIO CONVENTION EXHIBIT

5
**BIG BRIGHT
HALF-HOURS
EVERY WEEK**

For Single or
Participating
Sponsors!

- LOS ANGELES, CALIF. FARMERS INSURANCE GROUP AGENCY
- MIDLAND, TEXAS LEE HOUSING CONTRACTORS VOSATKO JEWELERS
- HOUSTON, TEXAS GREATER HOUSTON LINCOLN-MERCURY DEALERS
- JACKSONVILLE, FLA. JONES-CHAMBLISS MEAT PACKERS
- READING, PA. G. E. DELP CO. GROCERS
- 8 MIDWEST MARKETS BLUE STAR FOODS
- ALBANY, NEW YORK FRANKLIN SQUARE APPLIANCE DEALERS THE STOVE CENTER THE REGAN WASHER CO. MODERN HOME APPLIANCE CO. FROELICH'S, THE STOVE STORE
- 3 SOUTHERN MARKETS RIVERSIDE BEDDING CO.

KGO San Francisco, Calif.
KABC Los Angeles, Calif.
WCAU Philadelphia, Pa.
WAIT Chicago, Ill.
CKLW Detroit, Mich.
WMAL Washington, D. C.
WCKY Cincinnati, Ohio
WDGY Minneapolis—St. Paul, Minn.
KPRC Houston, Texas

**LOADED WITH
SIX A DAY . . . 30 A
WEEK . . . 1560 A YEAR**

ing-buying-buying



PROGRAM EDDIE CANTOR!

- HARTFORD, CONN. BIRNBAUM'S FURNITURE
- INDIANAPOLIS, IND. REGAL STORES EAST END DAIRIES ABEL'S WAREHOUSE KRAFT BAKING CO.
- AUGUSTA, MAINE J. S. WADLEIGH CO. (Fuel & Oil Bottled Gas)
- LEXINGTON, KY. DEBOOR LAUNDRY & DRY CLEANERS
- GOLDSBORO, N. C. HEILIG MYERS FURNITURE CO.
- THIBODEAUX, LA. G. E. SUPPLY CO.
- ATLANTA, GA. PURITAN MILLS
- ROCHESTER, N. Y. ROCHESTER GAS & ELECTRIC
- COATSVILLE, PA. BRANDYWINE VALLEY MEATS (PACKER) LEONARD'S (CHILDREN'S SHOP)
- COHEN'S DEPT. STORE GREEN'S APPLIANCE STORE RUBENSTEINS SPORTING GOODS EACHUS DAIRY
- CINCINNATI, OHIO DOT FOOD STORES
- E. ST. LOUIS, ILL. TRI-CITY GROCERY
- MIAMI, FLA. STAR SEAT COVER MIAMI LOCK & HARDWARE
- TAMPA, FLA. OCEAN PRODUCTS, INC.
- TIFTON, GA. TALLAHASSEE, FLA. STRIETMANN BISCUIT CO.
- WARRENTON, MO. CARSON UNION MAY STERN
- GAINESVILLE, GA. ATLANTA BAKING CO.
- HANOVER, PA. RIDDLE APPLIANCE CENTER (GENERAL ELECTRIC)
- MINNEAPOLIS, MINN. NORTHLAND DAIRY ANCHOR CASUALTY INS.
- SPRINGFIELD, VT. PONTIAC DEALER GULF OIL
- TERRE HAUTE, IND. NU-MAID MARGARINE
- LE MARS, IOWA CLEAR-VU TV GEORGE HATCHERY
- MADISON, WISC. GARDNER BAKING CO.
- ALEXANDER CITY, ALA. FAIR STORE S & R FOOD STORE
- REDDING, CALIF. LA FAVER HARDWARE ROY BROWN FURNITURE JACK'S TRADING POST (APPLIANCES) NYE & OXLEY INSURANCE McCOLL'S DAIRY RIVERVIEW MARKET
- LAWTON, OKLA. LONGBELL LUMBER CO. LEE'S UPHOLSTERY TOWN'S MEN'S WEAR SYDNEY'S DRIVE-IN THE THING SUPER MARKET

MUSIC!

SINGING!

COMEDY AND FUN!

SPONSORS LIKE THESE

ARE BUYING FROM

STATIONS LIKE THESE

- | | | |
|--------------------------------|-------------------------------|----------------------------------|
| KGNC Amarillo, Texas | WBOW Terre Haute, Ind. | WEEU Reading, Pa. |
| KFYO Lubbock, Texas | WNAC Boston, Mass. | WTMV East St. Louis, Ill. |
| WDAE Tampa, Florida | WSB Atlanta, Georgia | WDBQ Dubuque, Iowa |
| WGBS Miami, Florida | WKNB Hartford, Conn. | KOOL Phoenix, Arizona |
| WHEC Rochester, N. Y. | WOHO Toledo, Ohio | KOPO Tucson, Arizona |
| WPTR Albany, N. Y. | WNOX Knoxville, Tenn. | WHLD Buffalo, N. Y. |
| WXEL Indianapolis, Ind. | | WVLK Lexington, Ky. |
| | | WCVS Springfield, Ill. |
| | | WIBA Madison, Wisc. |

ROOM A 208 SHOREHAM HOTEL, WASHINGTON, D. C.

THE HOTTEST SPOTS IN RADIO...

EVERYBODY WITH AN EYE FOR PROFIT IS IN ON THE SHOUTING "WE WANT CANTOR" ... HOW ABOUT YOU!

FREDERIC W. **ZIV** COMPANY
Radio Productions
 1529 MADISON ROAD • CINCINNATI 6, OHIO
 NEW YORK HOLLYWOOD

WASHINGTON'S

**NBC
STATIONS**

welcome NARTB

*We are happy that ARB and Hooper
rate us Washington's favorite TV Station*

NARTB

WRC
AM·FM·TV **NBC** **Washington**

a service of 

represented by **NBC Spot Sales**

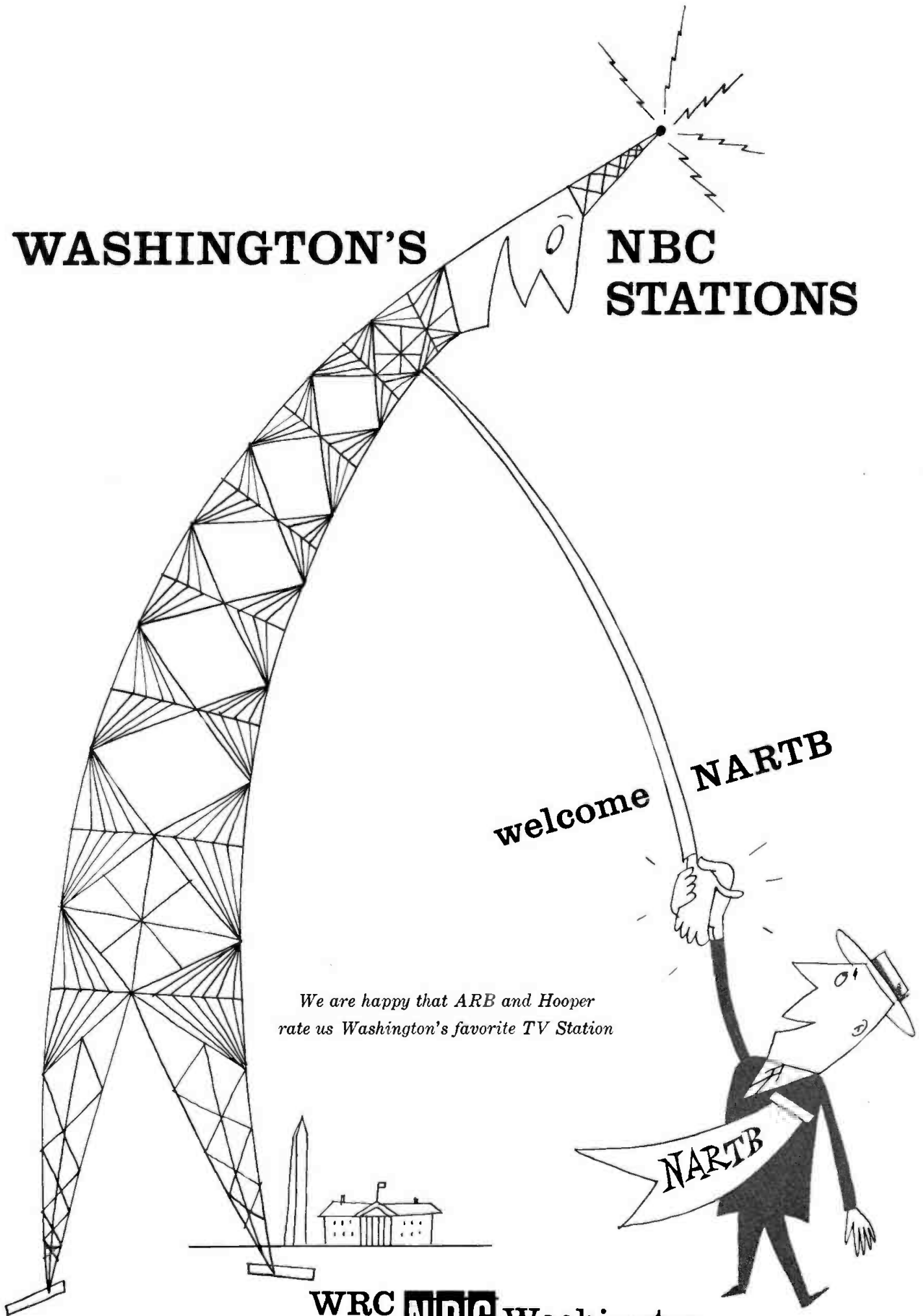

ABC, CBS OPPOSE TOLL TV AS CONTROVERSY HEATS UP

With most leading broadcasters in Washington this week for the NARTB convention, the Capital will be the scene of organized war between advocates and opponents of subscription television. Last week the opponents mounted some of their biggest guns.

THE subscription tv battle lines appeared ready to be joined at the NARTB convention in Washington this week as the until-now mostly silent broadcasters began to raise their voices on the subject.

The trend toward opposition to pay tv even began to show itself in the voluminous correspondence at the FCC (35 volumes of letters).

And heavy artillery from the American Legion landed at the FCC when the Legion's national committee voted to oppose the move to have the viewer pay for his programs.

There was even an implied reversal of sports writers' thinking on the subject; at least two nationally known sport scribes raised cynical eyebrows at some of the claims made by pay tv adherents.

But, it was the swelling articulation by broadcasters that made last week's pay-to-see-tv activity significant. Chief developments:

- CBS President Frank Stanton said pay tv would "hijack" American viewers into paying for the privilege of looking at their own tv sets. He also said that the toll tv is a "betrayal" of the 34 million families who have already spent \$13.5 billion for their sets. (See text of Stanton statement, page 28).

- CBS primary tv affiliates, meeting in New York last Thursday, backed up their network in a secret ballot by a vote of 107 to 2.

- American Broadcasting-Paramount Theatres President Leonard H. Goldenson told stockholders in New York that ABC would oppose pay tv and would uphold that position before the FCC.

- There was a growing sentiment, sparked by a few outspoken telecasters, that some sort of anti-pay tv broadcasters' organization must be established soon—and that the propitious time was this week when the broadcasters of the nation are gathered in Washington.

- Uhf telecasters, many of whom have been in the forefront of pro-pay tv, undoubtedly were prepared to take some stand on the "burning" question at their meeting last night at the Washington Hotel in Washington.

However, the pro-pay tv side was not barren last week. It saw *New York Herald Tribune* syndicated radio-tv critic John Crosby see good in sponsorless tv. It saw many, including Arthur Levey, president of Skiatron Electronics & Tv Corp., point to the blackout on home tv of the Marciano-Cockell fight (it was shown on theatre-tv) as an exhibit in favor of toll tv.

It saw the FCC issue experimental authority

to ch. 7 WMAL-TV Washington to broadcast scrambled signals during the NARTB convention. The grant was made to the *Washington Evening Star* station for May 25-June 24, but this was revised Friday when the starting date was changed to May 23. The station will telecast the jittered pictures from 8 a.m. to 12:30 p.m., which is before its regular broadcast day begins.

The Commission said that the tests "shall avoid any action which may create public impression that the FCC has or will approve any system of subscription tv." Comr. E. M. Webster dissented.

The WMAL-TV signals will be used in conjunction with an exhibit of Phonevision established by Zenith Radio Corp. at the Sheraton Park Hotel, to which it is inviting groups of broadcasters, congressmen, senators and government officials [CLOSED CIRCUIT, May 16].

The WMAL-TV-Zenith demonstrations will be the fourth time that off-the-air subscription tv has been authorized by the FCC. The first

was in 1951, when Zenith ran a 90-day test with 300 families in Chicago. It used its then experimental Chicago ch. 2 transmitter. The second was experimental tests between ch. 9 WOR-TV New York and Skiatron. The third was between WOR-TV again and Zenith.

Zenith's scrambling and unscrambling devices, basic elements of this toll tv method, will be shown for "interested parties" throughout the next four weeks, according to Dr. Alexander Ellett, Zenith vice president for research, and Pieter VanBeek, assistant to President E. F. McDonald Jr.

In announcing the demonstrations, Zenith noted that the "center of [its] campaign for the adoption of subscription television" moves to the nation's capital. Emphasis was placed on subscription tv generally rather than Phonevision in connection with the overall pay-as-you-see campaign. Zenith hailed the first public showing as a "milestone in the company's technical history."

A variety of sources, including special films, off-the-air telecasts, slides and other material, will be utilized. In contrast to its Chicago showing in 1951, Zenith will employ aircode systems instead of telephone wire lines.

A keyboard computer, about the size of a small spinet piano, will be one of the features shown this week, the purpose being to develop decoding data for subscribers. Zenith claims it stores up recollections of "decoder settings" for some 150,000 subscribers, or multiples of that figure, and relates it to codes used for the programs. Zenith engineers indicate that several operations with the Zenith decoder could be established within a year of FCC approval.

Circulating throughout the broadcast indus-

WHAT TV VIEWERS CAN SEE FREE



Under present system—big shows

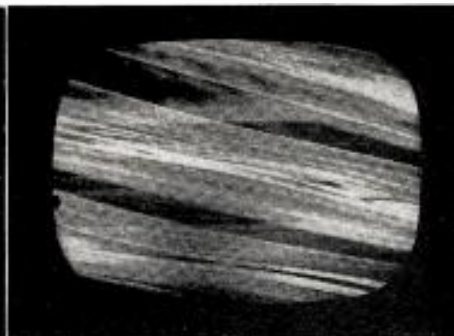

Under toll tv—senseless scramble

The effect subscription television would have on such shows as Ed Sullivan's *Toast of the Town* was described in the CBS policy statement last week: "... If only 5% of the families who now watch [Mr. Sullivan] would pay only 50¢ each to see the show, they would spend \$375,000—two and one-half times as much as the sponsor now pays to bring it to the public free. The other 95% would then have the 'free choice' of not watching *Toast of the Town* or paying to see it. It's the old story of letting the camel get his nose into the tent. Once this happens, the channel on which *Toast of the Town* is broadcast would be scrambled out for everyone who doesn't pay."

TV COULD NOT EXIST HALF FREE, HALF FEE

A *STAND* against subscription tv was taken last week by CBS Inc. Dr. Frank Stanton, president, voiced this opposition:

CBS opposes pay-television because it would highjack the American public into paying for the privilege of looking at its own television sets. This is a betrayal of the 34 million families who have already spent \$13½ billion for their sets in the expectation that they would be able to use them as much as they wanted without paying for the prerogative of watching.

Under pay-television, stations which are now broadcasting free programs would scramble the pictures and sound so that the set owner could not receive them unless he paid for each program. Such programs could be unscrambled only when a costly gadget, attached to the home receiver, is fed a coin or slug, a key or card for which the viewer pays. Since a station cannot televise two programs at once, any station broadcasting a scrambled pay program would necessarily have to eliminate its free program during that time period. Pay-television would black out the best of free television. In essence, this is a booby trap, a scheme to render the television owner blind, and then rent him a seeing eye dog at so much per mile—to restore to him, only very partially, what he had previously enjoyed as a natural right.

Pay-television promoters say they would be satisfied if they got \$100 a year from the average family. On this basis, today's television audience would pay some \$3½ billion a year—more than it pays for shoes or doctors or electricity—for viewing far fewer programs than it now watches without charge. This is three times the amount now being paid . . . for all spectator admissions.

Under the present system of American television, no set owner is deprived of a program because he is not as prosperous as his neighbor. But, once the turnstile of pay-television is placed in the living room, the families who rely most on television for their entertainment and information would be hit the hardest because they would be the ones who, for economic reasons, would have to restrict their viewing most severely. Television would no longer belong to all the people all the time.

One of the arguments made by the promoters of pay-television is that its introduction would hurt nobody. Try it out in the market place, they say. Surely this is in the American tradition. There would, they claim, be free television for those who want what they are now getting and there would be pay-television for those who want the unusual, the sort of entertainment and culture which free television cannot afford currently. But this is a specious claim, unsupported by the economic facts of life. It is the sheerest kind of sophistry and it is intellectual quicksand.

It is probable that pay-television would deliver an occasional heavyweight championship fight, and possibly such special entertainment as a multi-million dollar "first-run" movie, which the economics of present television cannot reach, at least as of today. On the other hand, the bulk of any programming for which pay-television would bid is bound to be the very kind of entertainment which already has found such high favor in present day free television. The result of this is that the public would be victimized into paying out billions of dollars a year for a programming service which they are now getting free.

If this scheme is authorized and becomes generally established, pay-television would be able to bid away from free television every kind of program which the public now enjoys. For example: For viewing the World Series at home, a tribute of some \$6,000,000 per game would be levied on the public if each family which watched the Series in 1954 were forced to put up the modest sounding sum of 50¢ for each game. Thus the people would pay 15 to 25 times as much as is now being paid by the sponsors who bring them the games free.

If only 5% of the families who now watch Ed Sullivan's *Toast of the Town* would pay only 50¢ each to see the show, they would spend \$375,000—two and one-half times as much as the sponsor now pays to bring it to the public free. The other 95% would then have the "free choice" that pay-television promoters want to give them: the free choice of *not* watching *Toast of the Town* or paying to see it. It's the old story of letting the camel get his nose into the tent. Once this happens, the channel on which *Toast of the Town* is broadcast would be scrambled out for everyone who doesn't pay.

What is true of these two examples is true of every one of the public's favorite programs. If pay-television is authorized, nobody could blame the owners of popular attractions for putting them where they could produce the most income. No one can be so naive as to believe that popular programs would be broadcast free if they could be charged for.

Thus television could not long remain half free and half fee. Either television programs belong to the public free or they belong to the highest bidder. During the hours when most people watch television, co-existence would be unlikely; it would be an economic improbability.

It is claimed that under pay-television there would be more cultural programs appealing to small minorities. We believe the reverse to be the fact. If, as the pay-television promoters say, installing a minimum service in a single major city will cost tens of millions of dollars, installing it throughout the total area now served by television will cost billions of dollars. People who make such an investment will have to get it back by putting on the type of shows which will attract the largest audiences. If a million families were willing to pay \$1 each to see a movie and 100,000 people would pay \$2 each to see a ballet, there would be no ballet.

It is difficult to believe that the Federal Communications Commission would authorize a scheme which seems to be so clearly contrary to the public interest. However, if pay-television should

become established, economic necessity will force CBS to participate. Unlike theatre owners, we have no economic axe to grind. We could expect to operate profitably under a system of pay-television. With our programming know-how, facilities and experience, we regard it as more than



probable that we would earn our share of the billions of pay-television dollars. But this is not where CBS believes its best interests lie.

We are proud of the progress the broadcasting industry has made in establishing a nationwide free television service. The pay-television promoters have continuously predicted the failure of free television at every point of its development; that it could never support itself without direct tribute from the public. They made these false prophecies 25 years ago and, as recently as 1946, the president of Zenith Radio Corp. flatly stated "the advertisers haven't sufficient money to pay for the type of continuous programs that will be necessary to make the public buy television receivers by the millions." Today there are 36 million television sets in daily use. Unlike these false prophets, we set no limits to the increased and continually increasing service to the public of free television.

During the past seven years, and at the cost of a refrigerator, the average family has been able to convert its home into a center of information and entertainment not even the wealthiest could have enjoyed ten short years ago. The finest talents of Broadway and Hollywood, the significant events of Washington, faces of Presidents and legislators, the art of museums and advances of science have become as familiar to television set owners as their neighbors down the street. And past advances are only a prelude to future accomplishments. We are unwilling to see the present system, under which everybody watches television as much as he wants, destroyed and a great and unifying medium of communication disrupted, with attendant dangers to our entire economy. The cost to the public in dollars and in the loss of free television far outweighs the potential gains of the pay-television scheme.

We believe, therefore, that the public's best interests and our best interests as well, lie in the continuing expansion of free television; that television channels now dedicated to all the public should not be used for the introduction of a system whose benefits to each viewer would be limited by his ability to pay.

Because the pay-television scheme would impose an unnecessary burden of billions of dollars on the American public; because it would charge the public for the popular programs it now enjoys free; because it would become a discriminatory service, available in large part to only those who could afford to pay; because it would endanger the scope and quality of nationwide news and public service programming, we shall oppose it before the Federal Communications Commission.

try was an attack on Harold Fellows, NARTB president, for his expressions on subscription tv. It was a 10-page booklet, using copious pen-and-ink sketches, entitled "Was Our Uncle Hal Scoopgoofed?" Its theme was that Mr. Fellows had permitted "big interests" to dictate the anti-pay tv resolution voted by the NARTB Tv Board last April. The booklet was sent out by Gene O'Fallon, KFEL-TV Denver ch. 12.

Mr. Stanton's strong stand against pay tv—"it would black out the best of free television . . . tv would no longer belong to all the people all the time . . . sheerest kind of sophistry . . . intellectual quicksand . . . television could not long remain half free and half fee"—made no bones about one thing:

If subscription tv is authorized, CBS will participate. "We regard it as more than probable," Dr. Stanton said, "that we would earn our share of the billions of pay-television dollars."

But, the CBS president continued, this is not where CBS believes its best interests lie. It lies, he said, "in the continuing expansion of free television; that television channels now dedicated to all the public should not be used for the introduction of a system whose benefits to each viewer would be limited by his ability to pay."

The resolution passed by the network's primary tv affiliates declared that any system which would require the public to pay for programs broadcast over the air "would be wholly inconsistent with the history of American broadcasting, would divide the American people by barring programs to those who could not afford them, would use the channels of free air which are currently broadcasting free programs to the public and would inevitably subtract from, if not fatally injure, present free service."

ABC Opposition Stated

Mr. Goldenson's statement at the AB-PT stockholders meeting called attention to the fact that its theatres subsidiaries had already joined with other theatre owners to combat pay-as-you-look tv.

"Our ABC division will also oppose subscription tv in the proceedings before the FCC," Mr. Goldenson said. "The subject is an extremely complicated one, and I do not think that any useful purpose would be served in setting forth here or in discussing at this meeting the various arguments pro and con which the division carefully considered in arriving at this decision. Basically, it was concluded that, at the very least, paid and free television could not co-exist without resulting in a great loss to the viewer of the availability of varied types of tv programming and that paid tv would not be in the general public interest and would not be a proper use of a public franchise."

In its resolution last month, the Tv Board of NARTB voted to oppose the request of subscription tv advocates for permission to use broadcast frequencies for their pay system of broadcasting. It was made clear then, and by Mr. Fellows subsequently, that the NARTB had not made a decision on pay tv as such [B•T INTERVIEW, May 2].

Only two other broadcasters have previously spoken out against pay tv.

RCA Chairman David Sarnoff said at the 1953 NARTB convention that toll tv was the "negation" of the American system of broadcasting. "I am convinced," he said, "that television broadcasting, like radio broadcasting, can solve its economic problems without a cash-box in the home."

Early in 1953, H. W. Slavick, general man-

ager of the Scripps-Howard WMCT (TV) Memphis, entered a vigorous objection to subscription tv. He called the scheme "disastrous." He said pay tv would cost the public \$7 billion a year. It is, he said, contrary to the concept that broadcast channels are natural resources belonging to the people.

For the first time since the first weeks following the FCC's invitation for comments by June 9 on the pay tv proposal [B•T, Feb. 14], Commission began receiving heavy indications of opposition. Up to now, the mail comments from Mr. and Mrs. John Q. Public have been running more than six to one in favor of subscription tv. Last week, the tide began to turn. The comments were about evenly divided, and indications were that anti-toll tv arguments were beginning to make themselves felt. It was also obvious that the theatre owners' campaign against this acknowledged threat to their box office was beginning to engender pen-in-hand activity by this industry.

The American Legion National Executive Committee asked the FCC to "make no rulings nor pass any legislation changing the funda-



LEONARD H. GOLDENSON
Announces ABC's stand

mental system of broadcasting and telecasting in the United States, hitherto devoted to free entertainment, information, educational and other programs which bring unlimited hours of enjoyment to millions of Americans, including the hospitalized veterans whose welfare has been and always will be the prime concern of the American Legion."

The sports scribes' doubts regarding pay tv—which has received increasing support from sports promoters—were exemplified by Hearst columnist Dan Parker and the *Washington Post* and *Times Herald's* Shirley Povich.

Mr. Parker concluded his skeptical piece in the May 8 *New York Mirror* by calling pay tv "a brazen attempt to put over the biggest air grab since the last midnight mosquito hunt by a blindfolded posse of stung-to-the-quick citizens of Secaucus, N. J."

Mr. Povich, writing in the May 19 *Washington Post* and *Times Herald*, referred to the reports of ad-less pay tv programs, but asked: "How to keep the pay-tv promoters honest after they have your dough might be a problem."

The caustic Mr. Crosby, writing in the May 16 *New York Herald Tribune*, found that the greatest blessing pay tv could bestow would be to put the advertiser "in the back seat."

"You'd no longer have to see a program just because the sponsor's wife likes the crooner

on it—and you'd be surprised how many programs you see for just that reason," Mr. Crosby snappishly concluded.

Mr. Levey, Skiatron president, declared last week that the need for pay tv was underlined by the presentation of the Marciano-Cockell championship fight last Monday on a limited, closed-circuit, theatre-tv network.

"If subscription tv were here," Mr. Levey said, "this bout would have been on home television. And it wouldn't have cost anything like \$3 or \$4 per person, but \$1 or less for the entire family." He estimated that the fight promoters would have grossed "at least 10 times as much or more, compared with what they are now getting from the theatres."

Public debate on pay tv continued last week, when over 100 members of the Hollywood Advertising Club heard proponents and opponents of subscription tv on the subject.

This marks the fourth debate between the two sides in recent months. The first was held at Washington's National Press Club, between Zenith's Millard Faught and Alfred Starr, co-chairman of the Organizations for Free Tv and Theatre Owners of America executive member. The second was on CBS-TV between W. Theodore Pierson, Washington attorney for Zenith, and Vic Sholis, WHAS-TV Louisville director. The third was on NBC with Zenith's H. C. Bonfig and Mr. Starr. Mr. Bonfig's resignation from Zenith and his joining CBS-Columbia as president (see story, page 124) was announced last week.

At Hollywood Debate

Representing anti-pay tv forces at the Hollywood debate were Alfred Starr and Robert S. Taplinger, president of the public relations firm, representing OFT.

Subscription tv supporters were Paul MacNamara, vice president, International Telemeter Corp., Hollywood, and Joseph Brenner, Hollywood broadcast attorney and former FCC regional counsel.

Readily admitting that he represents a selfish interest in the dispute, namely the film theatre owners, Mr. Starr challenged pay-tv proponents to deny that they, also, have a selfish interest.

"Pay-to-see tv can offer nothing creative—it can only destroy our current free programming," he said. What "new" attractions it may offer, such as "traditionally free baseball games, boxing matches, football games and the Kentucky Derby . . ." would be presented at the expense of "free" tv, the theatre executive warned.

Mr. MacNamara contended that subscription tv had at least four definite contributions to make to television generally:

Improvement of tv programming quality; return of sports programs, now lost to theatre tv, to home tv; reduction of present first-run feature film distribution cost (which he estimated at 85%) and the resultant increase in the public able to view them, and a greater number of tv stations and tv coverage.

He also revealed that at least one large advertiser had approached Telemeter with a proposition to include tokens for the Telemeter system in the advertisers' packages.

"Pay-as-you-see-tv will develop new advertising accounts that should be blockbusters and it may well be that the amount of advertising dollars that will be spent by these new entertainment accounts in the future will compare dollar-wise with some of the present enormous automotive accounts," he told the ad men.

He has station clients on both sides of the fence on the pay-tv question, Mr. Brenner noted, commenting that "If they're making money, they're opposed, and if they're losing money, they're in favor of subscription tv."

To make tv pay, advertisers and agencies must seek mass audiences with admittedly in-

TOLL TV: CORRIDOR GHOST OF THE NARTB CONVENTION

adequate tools, Mr. Brenner commented. With pay-tv, mass audiences and special groups alike could support the programs catering to their respective tastes.

"There is nothing in present pay-tv proposals to prevent advertising on these programs too," he continued. Many theatre owners, who are the strongest pay-tv opponents, also show commercials to their audiences, which "proves the practice can be acceptable to the public if handled properly," he declared.

Pay-tv adherents are talking out of both sides of their mouths when they promise the public relief from tv commercials, then tell the advertiser that commercials on subscription tv are still possible, Mr. Taplinger opened.

Speaking on what he termed the "opening night" fallacy, the New York publicist told Ad Club members he had asked 20 leading Broadway producers whether they would allow the opening nights of their plays to be telecast. "All said 'no,'" he declared. All felt it would create an "intolerable burden" on a cast already keyed up for a Broadway opening to ask them to undertake the necessary tv rehearsals, and the physical problems of installing tv equipment in a theatre for an opening night would only compound the problem, Mr. Taplinger noted.

In the question-and-answer period, Mr. Brenner admitted that there is some legal question whether the FCC has jurisdiction over pay tv. However, he noted that "pay radio," in the form of fm multiplexing, is already in existence under FCC control and might be a precedent.

Wide disagreement appeared between Mr. MacNamara and Mr. Taplinger on estimated costs to the consumer of installing pay tv equipment on present tv receivers. Mr. MacNamara estimated that Telemeter devices could be attached "for \$5 or \$10, or even nothing." Mr. Taplinger quoted estimates from \$45 to \$75 for the Zenith system.

Asked the effect on theatre owners if feature films were "premiered" on pay-tv for a single showing, both Mr. Starr and Mr. MacNamara were in agreement that they would "knock hell" out of subsequent theatrical runs. Mr. Starr rhetorically asked, "What producer is going to risk the fate of a \$10 million movie on a single showing?"

Kobak Asks: Will Radio-Tv Be Scrambled or Poached?

DON'T forget radio, when you consider pay tv, Edgar Kobak, former MBS president and present owner of WTWA Thomson, Ga., and broadcast consultant, reminded the FCC last week [CLOSED CIRCUIT, May 16].

Mr. Kobak raised the question regarding the possible approval of subscription tv. "If the World Series goes toll tv, will it be taken away from me on radio?" Mr. Kobak asked. "The same goes for the Metropolitan Opera and the great symphonies and other programs now available on radio. And, how about religious and educational programs? Also, should the long line rates be on a higher scale?"

One important element has been forgotten "in this hard drive to get the listener and viewer to pay for certain programs," Mr. Kobak said. "Radio broadcasting is also licensed by the FCC and radio is as 'free' as television. It is my feeling that any hearing held on toll tv should also include the subject of toll radio. Should one be 'free'—the other paid?"

Mr. Kobak concluded: "It is hard for me to figure out whether we are going to have our radio and tv scrambled, poached, fried, hard, soft or raw—and people can read what they want into this list of the future of the egg. What kind of an egg will be laid?"

It's not on the agenda, but it's on everybody's mind. A record turnout is certain for the Washington sessions, with advance registration at 1,611. Eisenhower's address will highlight the meeting.

PAY-TO-SEE television, not billed on the formal agenda, promises to spark delegate conversation and probably will burst into floor debate, judging by the talk of early arrivals for the annual NARTB convention in Washington.

Demonstrations, promotion, ballyhoo and anonymous propaganda with emphatic overtones—and undertones, too—were developing at the weekend on behalf of and against subscription tv (see pay-to-see roundup, page 27).

NARTB's 33d annual convention is certain to set an alltime attendance record. Advance registration for the Management Conference totaled 1,303 compared to 1,126 at Chicago last year and 1,020 at Los Angeles in 1953. Engineering registration this year ran 308 compared to 302 at Chicago last year and 268 in 1953.

As usual many delegates will appear without advance registration. The 1,611 advance total for management-engineering compares to 1,428 in 1954 and 1,227 in 1953.

At the weekend 135 women delegates had indicated they will attend the style show and take the Mt. Vernon trip, features of their agenda.

The exhibits [B•T, May 16] will be found in the Shoreham Exhibit Area, a short, winding stroll from the Main Ballroom and West Ballroom, where many of the management and engineering sessions will be held. Entertainment suites are at the Sheraton Park Hotel, a half-block airline but three uphill blocks from the Shoreham. NARTB is to operate shuttle bus service between the hotels.

The Tuesday morning opening meeting, with President Eisenhower and the keynote address by Mark Ethridge, WHAS-AM-TV Louisville, will be held in Sheraton Hall, largest hotel ballroom in the world, according to the Sheraton Park Hotel. The 3,000-seat ballroom will be converted Tuesday in 45 minutes to a 200-table luncheon room to seat 2,000. The President's talk will be on radio-tv.

Many unofficial side meetings are scheduled during the week (see list and summary of agenda, page 33). Monday's pre-opening schedule includes a morning fm meeting and afternoon tv membership business meeting, preceded by a tv film breakfast.

Four members of the NARTB Tv Board wind up their terms at the tv business meeting. They are Campbell Arnoux, WTAR-TV Norfolk, Va., board vice chairman; Kenneth L. Carter, WAAM (TV) Baltimore; William Fay, WHAM-TV Rochester, N. Y., and Ward L. Quaal, WLWT (TV) Cincinnati.

Judge Justin Miller, former board chairman of NARTB, will preside at the election of new tv directors. Clair R. McCollough, Steinman Stations, is chairman of the Tv Board.

Eight new members will take office on the Radio Board this week (see biographical story on page 44). They were elected during the spring elections.

Radio directors whose terms expire with the convention include George H. Clinton, WPAR Parkersburg, W. Va., District 3; John Fulton, WQXI Atlanta, District 5; F. Ernest Lackey, WHOP Hopkinsville, Ky., District 7, who

starts a new term as small-station director; Hugh K. Boice Jr., WEMP Milwaukee, District 9; Kenyon Brown, KWFT Wichita Falls, Tex., District 13; John H. DeWitt Jr., WSM Nashville, large stations; G. Richard Shafto, WIS Columbia, S. C., medium stations; Edgar Kobak, WTWA Thomson, Ga., small stations; Ben Strouse, WWDC-FM Washington, fm stations.

New directors representing radio networks, appointed by each network, were announced last week by NARTB President Harold E. Fellows. ABC, which joined the radio membership a week ago, named Charles T. Ayres, ABC Radio vice president in charge, as its radio director. Arthur Hull Hayes, new president of CBS Radio network, was named by that firm. Charles R. Denny, vice president in charge of NBC owned stations and NBC Spot Sales, is the NBC representative on the board. E. M. Johnson, vice president in charge of production, station relations and engineering, continues to represent MBS.

Heretofore, networks could have only one board member, selecting either radio or tv board. All four tv networks had tv directors, with MBS as the only network represented on the Radio Board until a recent change in association bylaws, approved in April.

Mr. Strouse will preside at the Monday morning fm meeting, to be held in the Shoreham's West Ballroom. Main topic will be multiplexing. Mr. Strouse will be succeeded on the board by Edward A. Wheeler, WEAW-FM Evanston, Ill. He continues as Fm Committee chairman. Opening speakers will be A. Prose Walker, manager, NARTB Engineering Dept.; William S. Halstead, Multiplex Engineering Corp., New York, and Dwight Harkins, KTYL Mesa, Ariz. Mr. Harkins has developed a new multiplex device which will be shown at the convention by Schafer Custom Engineering.

The opening speakers will join a panel discussion with Mr. Wheeler; Lloyd Jaquet, WGHF (FM) New York; Raymond S. Greene, WFLN (FM) Philadelphia; Donald K. DeNeuf, Rural Radio Network, Ithaca, N. Y.; Edward Davis, Musicast Stations, San Francisco; John H. Bose, Electronic Research Labs, Columbia U. A question-answer period will wind up the fm meeting.

Two management breakfasts will be held, at 8 a.m. Wednesday and Thursday. A wages and hours panel will be held Wednesday morning. At Thursday's management-labor relations panel breakfast, Stephen Dunn, labor authority of the law firm of McCobb, Heaney & Dunn, Grand Rapids, Mich., will be main speaker. Charles H. Tower, NARTB manager of employer-employee relations, is organizing the two breakfast meetings.

At its Wednesday afternoon portion of the radio management agenda, Radio Advertising Bureau will have basic presentations by Kevin Sweeney, president, and Joseph E. Baudino, RAB board chairman and Westinghouse Broadcasting Co. Washington vice president.

Three speakers will explain how radio advertising sold products for them: Emanuel

Katz, president, Doeskin Products Inc.; Irvin Feld, owner-operator of Super Music Enterprises, Washington, and Gailard Zink, owner of Zink's Super Market, Salem, Ind.

At the Tuesday morning meeting President Eisenhower will be escorted by Henry Clay, KWKH Shreveport, La., NARTB Radio Board chairman and co-chairman of the 1955 Convention Committee, and Clair R. McCollough, Steinman Stations, Tv Board chairman and convention co-chairman. President Fellows will introduce the President.

A feature of the Tuesday joint luncheon, at which FCC Chairman George C. McConaughy is principal speaker, will be the appearance of Catherine E. Styles, of Auckland, New Zealand, one of the Voice of Democracy Contest winners this year. Miss Styles, an exchange student, represented Minnesota in the contest.

Taking part in the Tuesday afternoon government meeting will be Chairman J. Percy Priest (D-Tenn.) of the House Interstate & Foreign Commerce Committee. Ralph W. Hardy, NARTB government relations vice president, will introduce Chairman Priest.

All FCC members will take part in a panel discussion to be moderated by Mr. Fellows.

Thursday's Management Conference program will be all-television and carry the theme, "Television: The 10th Anniversary." Speakers include Dr. Allen B. DuMont, president of DuMont Labs and DuMont Tv Network; Harold Hough, WBAP-TV Fort Worth; Robert E. Kintner, ABC president; John E. Fetzer, WKZO-TV Kalamazoo, retiring chairman of the NARTB Tv Code Review Board; Sylvester L. (Pat) Weaver, NBC president, and Dr. Frank Stanton, president of CBS Inc.

Dr. Norman Vincent Peale, noted clergyman, will be the Thursday luncheon speaker. The adoption of resolutions will wind up the luncheon. Resolutions are to be printed in advance, with the Resolutions Committee scheduled to hold its first meeting at breakfast Sunday.

Television Bureau of Advertising will program the final management discussion. Speakers will include Norman Cash, TvB director of station relations; Richard Moore, KTTV (TV) Los Angeles, TvB co-chairman, and Oliver E. Treyz, TvB president. Concluding the four-day agenda will be a film depicting the power of tv as an advertising medium. Titled "Strangers Into Customers," it will be introduced by Hugh M. Beville Jr., NBC director of research and planning.

Members of the Resolutions Committee are Otto Brandt, KING-TV Seattle, chairman; George D. Coleman, WGBI-TV Scranton, Pa.; Robert Enoch, WXLW Indianapolis; John Alexander, KODY North Platte, Neb.; D. Lennox Murdoch, KSL-TV Salt Lake City; Gaines Kelley, WFMY-TV Greensboro, N. C.; Robert Tincher, WNAX Yankton, S. D.

The Credentials Committee comprises F. C. Sowell, WLAC Nashville, Tenn., chairman; Ross Case, KWAT Watertown, S. D.; Ben Akerman, WGST Atlanta; Joe Bryant, KCBDTV Lubbock, Texas; Carleton Brown, WTVL Waterville, Me.; Mahlon Aldridge, KFRU Columbia, Mo.; Gilmore Nunn, WLAP Lexington, Ky.

NARTB will publish a daily booklet, *Transmitter*, carrying registration along with convention news developments.

Engineering delegates will join management in the Tuesday sessions. Their separate technical sessions run Wednesday and Thursday. Ross Beville, WWDC Washington, is chairman of the engineering conference committee. A. Prose Walker, NARTB manager of engineering,

INDUSTRY-GOVERNMENT UNDERSTANDING

CLOSER understanding between government and the industry provides a theme for the 1955 NARTB convention in Washington, first time in 17 years that broadcasters have met with legislators and regulators at the Nation's Capital. The three persons in charge of the convention were asked by B•T to summarize their ideas about the meeting. They are NARTB President Harold E. Fellows; Clair R. McCollough, Steinman Stations, and Henry Clay, KWKH Shreveport, La., tv and radio co-chairmen of the convention committee.

THE ASSOCIATION

THIS YEAR's convention promises to be the biggest and most important in NARTB's history. Principally, this is because Washington is the site of our meeting and broadcasters will have a golden opportunity to meet first-hand with legislators and other government officials.



MR. FELLOWS

The general theme of the convention relates to government - industry cooperation and understanding. Thus it is that we will hear from many government leaders, led by President Eisenhower, and meet scores of others at the various social and business functions.

This year, by popular demand, we have separated radio and television by devoting a day to a thorough discussion of each. We trust that this new format will be pleasing and rewarding to the members and their guests.

The exhibit display—largest ever—is a virtual world's fair of electronic developments. Many of the new devices will be shown for the first time and they merit careful perusal.

The engineers, who have contributed so much to the success of this industry, have a jam-packed agenda of technological advances.

Management, of course, will be presented with plenty of food for thought in the fields of programming, sales, public relations, labor relations, administration and others.

NARTB membership has grown this year, not only in size, but in its sense of unity, its understanding of the strength of common interests in spite of individual differences and its unrelaxing and conscientious regard for its responsibilities to the public.

TELEVISION

TELEVISION in 10 short years has become an indispensable part of American Life. Technologically and programwise, it is getting better and better, and by its very example is encouraging other media to perk up and improve themselves similarly. This is the spirit of competition at its finest. By its

nature, the television industry cannot rest without losing ground both to its own aspirations and to the competition of other media.



MR. MCCOLLOUGH

These inborn requirements for the television broadcaster bid fair to raise his costs, to enlarge the area of public comment on his efforts, to add—in short—quite a host of problems that need unscrambling and clarification. This is one of the main purposes of this convention and of NARTB itself. A pooling of knowledge, resources and energies by television broadcasters can help to bring order out of what might be chaos to the individual broadcaster.

Television Day will bring forth an outstanding group of speakers who know the industry from the days that seem remote to many of us today. Formal and informal sessions, where members can relate the general to the specific, add their own experience to that of their colleagues and work out effective means of meeting problems common to them all, will bring out the best in all of us.

RADIO

THE RADIO INDUSTRY, from its crystal-set beginnings to the present, had to grow with America or perish. That it is in many ways stronger today than ever before can be demonstrated by the ever growing number of radio stations and the yearly sets-in-use increase.



MR. CLAY

Over the years, radio has adapted itself to the newer needs of a rapidly growing population, a continually expanding economy, and to competition from other media.

This 33d annual convention of NARTB will conclusively demonstrate radio's continuing vitality as a part of American life, its unique characteristics for both listeners and advertisers that have established it so firmly that few Americans are without one or several radio sets. Radio accompanies so many of life's activities, allows so much individual freedom and mobility within its listening purview, tells its message so within the harmony of everyday living without imposing or intruding that people cannot completely replace it with any other medium or combination of media.

Radio keeps up to date with America itself. That's why "Radio in '55" is the theme of Radio Day at this convention. Radio, along with the American economy itself, is going places. That's the overriding mood as radio broadcasters arrive to exchange information this year.

THE NARTB CONVENTION COMMITTEE

WORKING for months with NARTB management and the Convention Committee co-chairmen (see statements page 31) were eight veteran broadcasters comprising membership of the committee. Serving on the Radio Subcommittee with Co-chairman Henry Clay, KWKH Shreveport, La., are E. K. Hartenbower, KCMO Kansas City; James H. Moore, WSLs Roanoke, Va., and Ben Strouse, WWDC-FM Washington. On the Television Subcommittee, serving with Co-chairman Clair R. McCollough, Steinman Stations, are Campbell Arnoux, WTAR-TV Norfolk, Va.; Kenneth L. Carter, WAAM (TV) Baltimore, and Frank M. Russell, NBC Washington. John H. DeWitt Jr., WSM Nashville, is engineering liaison. Kenyon Brown, KWFT Wichita Falls, Tex., is consulting member, having been chairman of the 1954 Convention Committee. All committee members are NARTB directors. Messrs. Hartenbower and Arnoux are Radio and Tv Board vice chairmen, respectively.



MR. STROUSE



MR. RUSSELL



MR. DE WITT

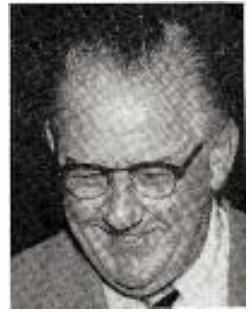

MR. CARTER



MR. BROWN



MR. MOORE



MR. ARNOUX



MR. HARTENBOWER

and Ruth Brewer, administrative assistant, are handling arrangements. John H. DeWitt Jr., WSM-TV Nashville, is board liaison with the conference and convention committees.

Serving on Mr. Beville's committee are James D. Russell, KKTU (TV) Colorado Springs, Colo.; Orrin W. Towner, WHAS-TV Louisville; Donald Weller, WISN Milwaukee; Frank L. Marx, ABC; William B. Lodge, CBS; Rodney D. Chipp, DuMont; Mr. Johnson, MBS; Raymond F. Guy, NBC.

Members of the main Convention Committee, besides the co-chairmen, are E. K. Hartenbower, KCMO Kansas City; James H. Moore, WSLs Roanoke, Va.; Mr. Strouse; Frank M. Russell, NBC Washington, and Messrs. Arnoux and Carter. Kenyon Brown is consulting member, having headed the committee in 1954. Robert K. Richards is convention consultant.

Heading convention arrangements is C. E. Arney Jr., NARTB secretary-treasurer and general manager, and Ella Nelson, administrative manager. Barry Freer is exhibit manager. William Walker heads the convention desk.

NARTB's news headquarters will be staffed by Joseph Sitrick, manager of the NARTB news department; Fran Riley, editor; Sally Kean, news; LaRue M. Courson, production manager, and Don Frifield, promotion manager.

The station relations staff will maintain message and service centers for delegates, operating at main meeting spots. In charge will be William K. Treynor, station relations manager, aided by Jack Barton, assistant manager; William Carlisle and Alvin King, field representatives, and Jean Levy, secretary. Christine Chadwell is secretary at the membership certification desk.

'Radio in Every Room' Theme Highlighted at Convention

NEWEST radio receiver models are being demonstrated at the NARTB convention by 17 member companies of Radio-Electronics-Tv Mfrs. Assn. The display is on the main lobby floor of the Shoreham Hotel. It emphasizes the growth of outdoor listening through pop-

ularity of portable and personal radios as well as auto sets. Clock and table models, including am-fm sets, highlight the "Radio in Every Room" theme.

In charge of the display are C. Erick Isgrig, Zenith Radio Corp., chairman of RETMA's Public Relations & Advertising Committee; Jack Williams, RCA, and Jack Frietsch, Philco Corp.

Manufacturers whose radios are displayed include: Arvin Industries; Capehart-Farnsworth Co.; CBS-Columbia; Emerson Radio & Phonograph Corp.; General Electric Co.; Hallicrafters Co.; Hoffman Electronics Corp.; Industrial Development Engineering Assoc.; Magnavox Co.; Motorola Inc.; Philco Corp.; Radio Corp. of America; Raytheon Manufacturing Co.; Stromberg-Carlson Co.; Sylvania Electric Products Inc.; Westinghouse Electric Corp., and Zenith Radio Corp.

Meet Your Representative

RADIO and television station representatives will have suites at the following hotels (room numbers are listed where available):

SHERATON PARK—Avery-Knodel, 489; John Blair & Co., Blair-Tv, C200; Bolling, A611-15-07-09; Branham Co., A211-15; Henry I. Christal Co., 656-58-60; Harrington, Righter & Parsons, B500; Headley-Reed Co., E-400-03-04; George P. Hollingbery Co., C100; Joseph Hershey McGillvra, A311-15; Meeker Tv Inc., Robert Meeker Assoc., A500; Edward Petry & Co., Annex G200; Venard, Rintoul & McConnell, B508-10.

MAYFLOWER—Free & Peters; The Katz Agency.

STATLER—John E. Pearson Co.; Paul H. Raymer Co.; Walker Representation Co.; Weed & Co.; H-R Representatives Inc.; H-R Television Inc.; Weed Television; Adam J. Young Jr.

DUPONT PLAZA—Hoag-Blair.

RALEIGH—William G. Rambeau Co.

WOODNER—Forjoe & Co.

SHOREHAM—Gill-Perna.

RADIO SET SALES DRIVE READIED

COOPERATIVE drive to more than double the sales of home radio sets will be launched Wednesday by Radio Advertising Bureau, more than 70 radio stations and six radio set manufacturers. The manufacturers are General Electric, Motorola, Philco, RCA, Stromberg-Carlson and Zenith.

The campaign announcement coincides with the RAB session next Wednesday afternoon at the NARTB convention in Washington (see story, page 30).

RAB reported that nearly all stations in Dallas, Denver, Kansas City, Nashville, Omaha, Pittsburgh, Portland (Ore.), Providence, Seattle, and Washington will participate in the campaign.

Purpose of the campaign is to increase the sale of home radio sets from the current 7-8 million receivers annually to 15 million in 1956. Kevin Sweeney, RAB president, pointed out that in the tests radio will provide the "springboard" from which the manufacturers' brand advertising will "jump."

At the suggestion of RAB, the stations and manufacturers have decided on a series of five test campaigns in 1955, each of which will run in five cities for a four-week period. For a month starting May 25, the first two campaigns will run in the cities where stations are co-operating in the drive. The tests will promote portables, radio as a gift, radio for the bedroom, radio for the kitchen and a trade-in-your-old-set drive.

The bedroom and kitchen campaigns will begin immediately after Labor Day, each in a list of five different cities. The trade-in promotion is scheduled for mid-October in five other cities.

Stations will air general announcements to back the campaign. Additional announcements will be run simultaneously by the stations promoting the individual radio products. The radio time which the manufacturers will buy at the national level through their respective agencies will in most cases be supplemented by coopera-

tive dealer-distributor copy placed at the local level.

The station announcements consist of six transcribed musical jingles plus live announcements, both of which will be provided by RAB.

RAB estimates that 30 million kitchens and 55 million bedrooms remain to be equipped with new radios; that 15 million broken radios can be turned in for new models and that portable and gift markets have a potential of not less than 30 million sets.

QRG Survey of Time Sales Unveiled on Convention Eve

THOUGH network radio business is down, time sales are bigger than ever on the individually-owned radio stations.

These findings, emerging from an extensive survey made by Quality Radio Group among its member stations, was reported yesterday (Sunday) by William B. Ryan, executive vice president of QRG, at a pre-NARTB convention meeting of executives of stockholder member stations at the Shoreham Hotel in Washington. Mr. Ryan quoted several replies from executives of QRG member stations, all of which, he said, "are optimistic about the future of radio with time being sold on a big market, big station basis."

Mr. Ryan reported that Dave Partridge, advertising manager of Westinghouse Broadcasting Co., had replied that local sales on WBZ-WBZA Boston had increased 71.9% during the first two months of 1955 as against the same period of 1954. As to the combined figures for all five Westinghouse radio stations, Mr. Partridge said local sales in 1954 were up 48.3% against 1950 when tv was not so vital a factor as now, and up 22.9% against 1953 when tv had become significant.

Mr. Ryan quoted Wayne Coy, president of KOB-AM-TV Albuquerque, N. M., as saying that 1954 "was the best non-network income year despite the addition of two television stations and one radio station to the market."

WCAU Philadelphia told Mr. Ryan that non-network sales in 1954 accounted for 81.9% of the total as against 76% in 1952.

Other radio stations, according to Mr. Ryan, replied in much the same vein, making the point that while rate cards generally are slightly lower, increased sales have offset the price reductions to a large extent.

47 Public Service Agencies To Pay Tribute to Radio-Tv

FORTY-SEVEN public service agencies, joining in a demonstration of radio-tv voluntary contributions to the nation's welfare, will stage the first major exhibition of this broadcast activity during the NARTB convention. Their display will be shown starting with a preview Monday in the Sheraton-Park Hotel.

The Advertising Council and NARTB are jointly staging the exhibit, which carries the theme, "The Highest Distinction Is Service to Others."

Features include a recording setup by which Radio Free Europe will tape messages for transmission behind the Iron Curtain. American Cancer Society will have two cages of rats and mice that have been treated by chemicals. The animals will be taken back to Georgetown U. every night. The society will show cancer cells in microscope slides. U. S. Forest Service will have a huge "Talking Bear," a stuffed specimen equipped with sound.

Coordinating this special feature project are Robert K. Richards, NARTB consultant, and Gordon Kinney, Ad Council radio-tv director.

THE NARTB CONVENTION IN A NUTSHELL

CONVENTION AGENDA

All events at Shoreham unless indicated by SP (Sheraton Park)

SUNDAY

9:00 a.m. Exhibits open

MONDAY

10:00 a.m. Fm session. West Ballroom

12:00 noon Community Broadcasters Assn., Park Room

12:30 p.m. State Assn. Presidents Luncheon, Blue Room

2:30 p.m. Tv business session. West Ballroom

4:30 p.m. Daytime Broadcasters Assn., Park Room

7:00 p.m. BMI-NARTB Dinner, Woodner Hotel.

TUESDAY

10:00 a.m. Joint Session. SP Sheraton Hall. Keynote award; President Eisenhower

12:30 p.m. Joint Luncheon. SP Sheraton Hall; FCC Chairman George C. McConaughy

2:45 p.m. Joint Session. Main Ballroom; Government, FCC officials

6:30 p.m. Engineering Reception. SP Exhibit Hall

WEDNESDAY (Radio Day)

8:00 a.m. State Association breakfasts

8:00 a.m. Wage-Hour breakfast. Blue Room

9:00 a.m. Engineering Conference. West Ballroom

10:00 a.m. Management Conference. Main Ballroom

12:30 p.m. Joint Luncheon. SP Sheraton Hall; NARTB President Harold E. Fellows

2:30 p.m. Radio Advertising Bureau. Main Ballroom

6:00 p.m. Government reception. SP Exhibit Hall

7:30 p.m. Radio Pioneers Dinner, Terrace Ballroom

THURSDAY (Television Day)

8:00 a.m. Labor Relations breakfast. Blue Room

9:00 a.m. Engineering Conference. West Ballroom

10:00 a.m. Management Conference. Main Ballroom Tv's 10th anniversary

12:30 p.m. Joint Luncheon. SP Sheraton Hall; Dr. Norman Vincent Peale Resolutions

2:30 p.m. Tv Bureau of Advertising, Main Ballroom

6:00 p.m. Reception. SP Exhibit Hall

7:30 p.m. Convention Banquet, SP Sheraton Hall

NON-CONVENTION ACTIVITY

9 a.m.—Broadcasting-Telecasting Golf Tournament, Goose Creek Country Club, Leesburg, Va.

10 a.m.—MBS Affiliates, Hall of Nations, Washington Hotel.

11 a.m.-3 p.m.—Quality Radio Group, Louis Seize Room, Shoreham Hotel.

12 noon-5 p.m.—ABC Affiliates, Park Room

12 noon-3 p.m.—BMI Board, Woodner Hotel.

5 p.m.-6 p.m.—Cocktails—ABC Affiliates, Louis Seize Room, Shoreham Hotel.

7:30 p.m.—Tv Pioneers Dinner, Willard Hotel.

8 p.m.—Uhf Industry Coordinating Committee, Washington Hotel.

MONDAY—MAY 23, 1955

8 a.m.—Louisiana State Broadcasters Breakfast, West Lobby Room, Shoreham Hotel.

8 a.m.-9:30 a.m.—Film Breakfast, Blue Room

9 a.m.-12 noon—Clear Channel Broadcast Service, Green Room, Shoreham Hotel.

11 a.m.-4 p.m.—CBS Affiliates Advisory Committee, Louis Seize Room, Shoreham Hotel.

12 noon-2 p.m.—Community Broadcasters Assn. Luncheon, Park Room, Shoreham Hotel.

12:30 p.m.—State Association Presidents Luncheon, Blue Room, Shoreham Hotel.

12:30 p.m.—Ladies Entertainment Committee Luncheon, West Lobby Room, Shoreham Hotel.

4:30 p.m.-6 p.m.—Daytime Broadcasters Association, Park Room

6 p.m.—Cocktails—BMI, Woodner Hotel.

6 p.m.-8 p.m.—Cocktails—MCA, Terrace

7 p.m.—BMI-NARTB Dinner, Woodner Hotel.

TUESDAY—MAY 24, 1955

7:30 a.m.—Heavy Exhibitors Breakfast, Park Room

8 a.m.-9:30 a.m.—West Virginia State Broadcasters Breakfast, West Room, Shoreham Hotel.

8 a.m.-9:30 a.m.—Tennessee State Broadcasters Breakfast, Louis Seize Room, Shoreham Hotel.

8 a.m.-9:30 a.m.—South Dakota State Broadcasters Breakfast, Green Room, Shoreham Hotel.

8 a.m.-9:30 a.m.—Michigan State Broadcasters Breakfast, West Lobby Room, Shoreham Hotel.

8 a.m.-9:30 a.m.—North Carolina State Broadcasters Breakfast, Blue Room, Shoreham Hotel.

8 a.m.-9:30 a.m.—California Tv Broadcasters Breakfast, Adams-Hamilton Room, Sheraton-Park Hotel.

12:30 p.m.—Ladies Luncheon and Fashion Show—Blue Room, Shoreham Hotel.

WEDNESDAY—MAY 25, 1955

7:30 a.m.—Room Exhibitors Breakfast, Park Room, Shoreham Hotel.

8 a.m.-9:30 a.m.—Wisconsin State Broadcasters Breakfast, House of Representatives dining room.

5 p.m.-8 p.m.—Cocktails—Meredith Publishing Co., Louis Seize Room, Shoreham Hotel.

6:30 p.m.—Cocktails—Radio Pioneers, Green Room, Shoreham Hotel.

7:30 p.m.—Radio Pioneers Dinner, Terrace Ball Room, Shoreham Hotel.

THURSDAY—MAY 26, 1955

8 a.m.-9:30 a.m.—Texas Association State Broadcasters Breakfast, West Lobby Room

Welcome to

BROADCASTING*TELECASTING CONVENTION HEADQUARTERS

HOSPITALITY SUITE

FRANKLIN ROOM*

(lobby floor, right)

SHERATON PARK HOTEL

CONVENTION NEWSROOM — SUITE F 1014 — SHOREHAM HOTEL

EXECUTIVE, EDITORIAL, ADVERTISING & CIRCULATION OFFICES

BROADCASTING*TELECASTING BUILDING

1735 DE SALES ST., N. W., WASHINGTON, D. C.

(across from the Mayflower Hotel)

* (Official NARTB Directory incorrectly listed Hospitality Suite in Shoreham)



FIRST AGAIN . . . by a bigger margin than ever!

The ARB ratings tell the story!

From 7:00 AM until midnight, *seven days a week*, KSTP-TV leads all other Minneapolis-St. Paul television stations in average program ratings* . . . and by a bigger margin than ever! During the important evening hours from 5:00 PM until midnight, KSTP-TV leads its nearest competitor in average weekday ratings by more than *seven* points.

In this rich, Northwest market which includes more than 600,000 television homes and commands

a spendable income of **FOUR BILLION DOLLARS**, KSTP-TV has long been the leader. It is the Northwest's *first* television station, *first* with maximum power, *first* with color TV and, of course, *first* in audience.

The listener-loyalty which KSTP-TV has won through superior entertainment, talent, showmanship and service means *sales for you!* That's why—dollar for dollar—KSTP-TV is your *first* buy and your *best* buy in the great Northwest.

*Weekly average, ARB Metropolitan Area Report, March, 1955.

KSTP-TV

CHANNEL
100,000 WATTS



MINNEAPOLIS • ST. PAUL Basic NBC Affiliate

"The Northwest's Leading Station"

EDWARD PETRY & CO., INC. • NATIONAL REPRESENTATIVES

WHERE TO GO, WHAT TO SEE

A B•T GUIDE TO D.C. HIGH SPOTS FOR NARTB CONVENTIONEERS

GOVERNMENT AT WORK

FEDERAL COMMUNICATIONS COMMISSION, New Post Office Bldg., Pennsylvania Ave. between 12th and 13th Sts., N.W. The fearless few who may want to find out first hand that all lions don't bite, no matter how loudly they may roar, will find FCC offices scattered throughout this building, chiefly on the sixth and seventh floor. Or they can dial EXecutive 3-3620.

Chairman George C. McConaughy may be found on the sixth floor at Room 6107. Other FCC members: Comr. Rosel H. Hyde, Room 7241; Comr. Robert T. Bartley, Room 6207; Comr. Frieda B. Hennock, Room 7111; Comr. John C. Doerfer, Room 7207; Comr. E. M. Webster, Room 6239, and Comr. Robert E. Lee, Room 7235.

Chief of the Broadcast Bureau, Curtis B. Plummer, is at Room 7530, while the director of the Office of Information, George O. Gillingham, is at Room 7232. If it's a technical matter you are interested in, go see Chief Engineer Edward W. Allen Jr. in Room 7515. For Conelrad information, contact Ralph J. Renton, Room 7516.

If you want to check up on the public information that's available on your radio or tv competition, you can look at his license file, pending application or hearing record in the Public Reference Room on the seventh floor at Room 7013. George Simcoe or Joseph Jackson will be glad to help you and if they can't find it, Clara M. Iehl, chief of the License Division, certainly can. For an ownership summary in index card form on all persons in the U. S. having any radio or tv station interest, call on Mildred K. Roberts at Room 7014.

If you have a problem involving the

Commission's Field Engineering & Monitoring Division, you will have to go to 415 22d St. N.W., where the chief of the division, George S. Turner, is located. Amateur operators may want to go see Edwin L. White, chief of the Safety & Special Radio Services Bureau, Room 2069, Temporary T Bldg., 14th and Constitution Ave. N. W.

CAPITOL, on Capitol Hill. Open 9 a.m.-4:30 p.m. (if Congress is in session, open until 30 minutes after adjournment). Guided tours every 15 minutes to 3:55 p.m., 25¢. Be sure to see radio correspondents' galleries of House and Senate.



BUREAU OF ENGRAVING & PRINTING, 14th

& C Sts., S. W. Open 8-11 a.m., 12:30-2 p.m., Mon.-Fri. Conducted tours.

FEDERAL BUREAU OF INVESTIGATION, 9th St. & Pennsylvania Ave., N. W. Open Mon.-Fri., 9:30 a.m.-4 p.m. Tours start every half-hour in Room 5634 and last about an hour.

PENTAGON, headquarters of Dept. of Defense and world's largest office building, but easier to get in and out than stories you've heard would indicate. In Arlington, Va. Open, Mon.-Fri., 7 a.m.-6 p.m.

SUPREME COURT, 1st St. & Maryland Ave., N. E. Open Mon.-Fri., 9 a.m.-4:30 p.m.; Sat., 9 a.m.-12 noon. Conducted tours

every 15 minutes, except when court is in session, to half-hour before closing.

UNITED STATES INFORMATION AGENCY, 1778 Pennsylvania Ave., N. W. USIA activities include operating Voice of America.

FLORA & FAUNA

BOTANIC GARDENS, 1st St. & Maryland Ave., S.W. Open Sun.-Fri., 9 a.m.-4 p.m.; Sat., 9 a.m.-12 noon.

MUSEUM OF NATURAL HISTORY (part of Smithsonian group), 10th St. & Constitution Ave., N. W. Stuffed creatures, etc. Open 9 a.m.-4:30 p.m.

ZOOLOGICAL PARK, 3000 Connecticut Ave. (three blocks northwest of Sheraton-Park, just right for that before-breakfast walk). Grounds open 7 a.m.; buildings, 9 a.m.-5 p.m. (Sun., 9 a.m.-5:30 p.m.).

HISTORY

ALEXANDRIA, where Washington slept, ate, worshipped in buildings still standing. Eight miles south of Washington on Mount Vernon Blvd. A must for antiquers.

ARLINGTON NATIONAL CEMETERY, burial ground of the nation's heroes, just across the Potomac (Arlington Memorial Bridge leads to Memorial Entrance, best known of the cemetery's 10 gates). Grounds open 6 a.m.-7:30 p.m. Here are Tomb of Unknown Soldier (change of guard every hour on the hour), Amphitheatre, Iwo Jima Memorial and Lee Mansion (9:30 a.m.-6 p.m., admission 12¢).

FORD'S THEATRE, 10th St. between E & F, N. W., scene of Lincoln's assassination, now a Lincoln museum, open Mon.-Sat., 9 a.m.-9 p.m., Sun., 12:30-9 p.m., admission 10¢. House where Lincoln died, across street, open 9 a.m.-5:30 p.m. (Sun., 12:30-p.m., admission 12¢).



JEFFERSON MEMORIAL, South Bank of Tidal Basin. Open 9 a.m.-9 p.m.

LINCOLN MEMORIAL, West Potomac



Park at foot of 23rd St. Open 9 a.m.-9 p.m.

MOUNT VERNON, Washington's home at Mount Vernon, Va. Open 9 a.m.-5 p.m. Admission 50¢. A 15-mile drive along Memorial Blvd. S.S. Mount Vernon leaves Pier No. 4, Maine Ave. & N St. S. W., daily at 2 p.m. for Mount Vernon, returning to Pier 4 at 6:40 p.m. Round trip, \$1.60.

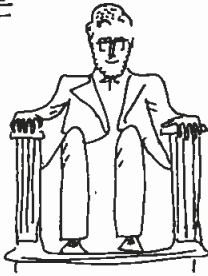

NATIONAL ARCHIVES BLDG., between 7th & 9th St., Pennsylvania & Constitution Aves., where Declaration of Independence, Constitution, Bill of Rights and other Government documents are displayed. Open 9 a.m.-10 p.m. (Sun., 1-10 p.m.).

SMITHSONIAN INSTITUTION, Arts & Industries Bldg., 9th St. & Jefferson Drive, S. W. The original Star Spangled Banner, Lindberg's "Spirit of St. Louis," inaugural gowns of wives of the Presidents and innumerable other U. S. historical memorabilia. Open 9 a.m.-4:30 p.m.

WASHINGTON MONUMENT, on the Mall at 15th St. Open 9 a.m.-5 p.m. Elevator fee, 10¢.

WHITE HOUSE, 1600 Pennsylvania Ave. Open Tuesday-Saturday, 10 a.m.-12 noon. No pass required. (To get in at 9 a.m. ahead



of the crowd, call your Senator or Representative at NAtional 8-3120.)

LEE MANSION, in Arlington Cemetery. Built by George Washington Parke Custis, foster son of the first President, and lived in

by Robert E. Lee, the mansion has been beautifully restored and appropriately furnished. Open 9:30 a.m.-4:30 p.m. Admission, 12¢.

All above open daily unless otherwise noted. Admission free, unless charge stated.

NARTB

NATIONAL ASSN. OF RADIO & TELEVISION BROADCASTERS, 1771 N St., N. W. Gracious old town house, completely remodeled into efficient working quarters. Worth a visit, although you'll probably find many staff members at the convention hotels this week.

PICTURES, STATUES & BOOKS

CORCORAN GALLERY, 17th St. & New York Ave., N. W. Primarily American art. Open 12-noon-4:30 p.m., Mon.; 10 a.m.-4:30 p.m., Tues-Fri.; 9 a.m.-4:30 p.m., Sat.; 2-5 p.m., Sun.

FOLGER SHAKESPEARE LIBRARY, 201 E. Capitol St. Miniature Elizabethan theatre, costumes, etc., and one of world's greatest collections of Shakespearean books and manuscripts. Open 11 a.m.-4:30 p.m., Mon-Sat.

FREER GALLERY, 12th St. & Jefferson Drive, S. W. (one of Smithsonian Group). Paintings by Whistler, Homer, Sargent and other Americans; collection of art from Near East, India and Orient.

NATIONAL GALLERY (Mellon Gallery), 6th St. & Constitution Ave., N. W. Works of many of greatest artists from 13th to 19th century, housed in one of largest marble structures in the world. Green marble rotunda and garden courts, complete with fountains, worth seeing even if you skip the pictures. Open Mon.-Sat., 10 a.m.-5 p.m.; Sun., 2-10 p.m.

PHILLIPS GALLERY, 1600 21st St., N. W. Modern French and American art, housed in former Phillips residence. Open Mon., 11 a.m.-10 p.m.; Tues.-Sat., 11 a.m.-6 p.m.; Sun., 2-7 p.m.

LIBRARY OF CONGRESS, 1st St. between East Capitol & B St., S. E. World's largest library, with a big assist from the 1870 law requiring two copies of every copyrighted work be put here. Main attractions are the Central Stair Hall, which has been called "a vision in polished stone," the main reading room, which must be seen from a gallery unless you really want to read there) and the Gutenberg Bible, but the vestibule with eight statues of Minerva and the second floor murals are also worth a quick look.

SPORTS

BASEBALL. No games in Washington. Senators on road all week.

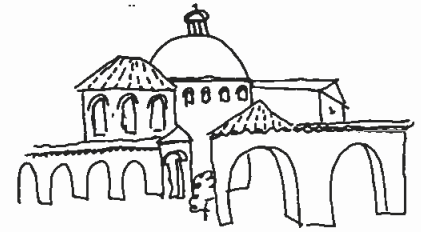

GOLF. Public courses generally crowded and not very sporty. Better find member of one of numerous private clubs and promote a guest card.

PIMLICO RACE TRACK, Baltimore. Post time 2:00 p.m. (Daily double closes 1:50 p.m.). The Preakness will be run on May 28th. Gray Line buses leave from 11:15 a.m. to 12:30 p.m. from 1010 I St., N. W. Round trip, \$2.25 plus tax.

ROSECROFT (Harness Racing), Oxon Hill, Md. (about 8 miles southeast from downtown Washington). Post time 8:30 p.m. (Daily double closes 8:20 p.m.). Good restaurant in clubhouse at reasonable prices. Gray Line buses leave from 5:30 to 7:30 p.m. from 1010 I St., N. W. Round trip, \$1.00 plus tax.

THEATRE

THE MOUSETRAP. Agatha Christie thriller having its American premiere at Washington's semi-pro theatre in the round, Arena Stage, New York Ave. at 9th St., N. W. Curtain nightly (except Monday) at 8:30 p.m.; Sat. matinee, 2:30 p.m. \$2 for all seats. Better phone for reservations (DIstrict 7-8592) or get tickets through your hotel.

FYI

BARS AND RESTAURANTS selling liquor, wine and beer may do so up to 2 a.m., except Saturday night, when drinks will be taken off the table by midnight. Sunday, beer only; midnight closing. Only beer may be served at the bar; all other drinks must be served at tables. You may not drink, or even hold your drink, while standing.

Liquor stores are open, 10 a.m.-9 p.m. Mon-Fri.; 10 a.m.-12 midnight, Sat.; not at all on Sunday, when no liquor may be purchased.

FOOD AND DRINK

MOST of Washington's many restaurants are middle class, middle price, middle quality, the food edible but nothing to write home about. Some exceptions, as found by B•T editors, are listed below.

THE COLONY, 1737 DeSales St. (just west of the B•T Bldg., just east of Connecticut Ave.). French cuisine. Dignified atmosphere. Good bar. Good service. Place to see Washington business and professional leaders, top government officials. Prices on high side, but worth it.

LASALLE DU BOIS, 18th & M Sts., N. W. Same management as Colony, and much like

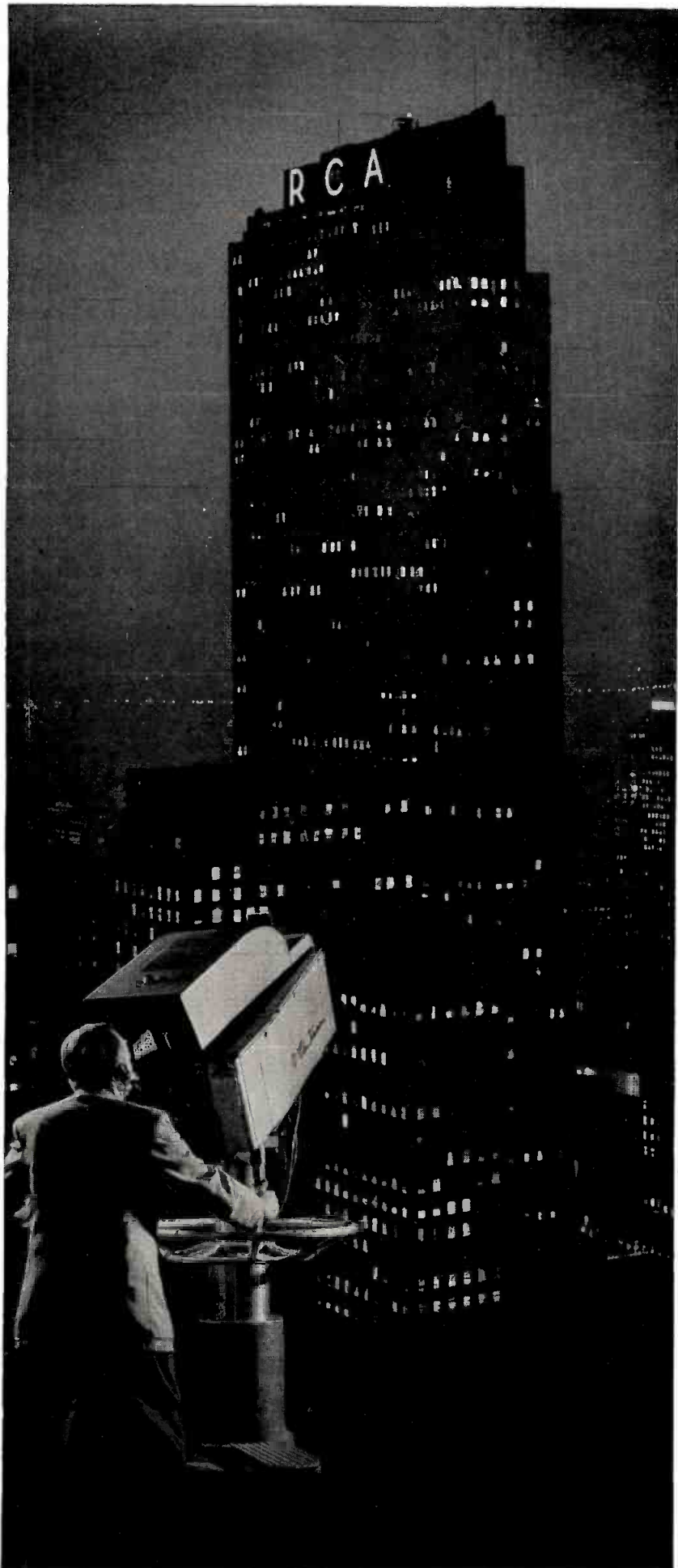

WHY THIS SIGN IS YOUR GUIDE TO FINER TELEVISION

**RCA's 36 years' experience
is yours to share in TV—
black-and-white or color**

When the time comes for you to purchase a TV set and enjoy the most fabulous medium of entertainment ever created for the home, here are facts that will help you make the right decision.

To pioneer and develop television, in color as well as in black-and-white, called for a special combination of practical experience, great resources and research facilities in the fields of communications and electronics.

RCA was well qualified to do the job:

EXPERIENCE: RCA has been the recognized leader in radio communications since its formation thirty-six years ago. Its world-wide wireless circuits, established in 1919, and its development of electron tubes, laid the groundwork for radio broadcasting in 1920 . . . and the first nationwide radio network in 1926.

Radio broadcasting led to television—and in 1939 RCA made history by introducing black-and-white TV as a service to the public.

Dr. V. K. Zworykin of RCA invented the iconoscope, or television camera tube, and he developed the kinescope, now universally used as the picture tube.

RESOURCES: Pioneering and development of color TV has been one of the most challenging and expensive projects ever undertaken by private industry. To date, RCA has spent \$50,000,000 on color TV research and development, in addition to the \$50,000,000 previously spent in getting black-and-white TV "off the ground" and into service.

RESEARCH FACILITIES: RCA has one of the most complete, up-to-date laboratories in the world—the David Sarnoff Research Center at Princeton, N. J. It is the birthplace of compatible color television and many other notable electronic developments.

No wonder that you can turn to RCA to find all of the essentials of quality and dependability born only of experience.

In addition, the RCA Service Company, manned by a corps of trained technicians, operates service branches in all principal television areas. No other organization is so thoroughly equipped to install and service your television set, as well as any other RCA product.

**RADIO CORPORATION
OF AMERICA**

Electronics for Living



it, but slightly less formal, slightly less expensive.

LA FONDA, 1637 R St., N. W., Mexican food (Southwesterners will be critical; others will find it o.k.). Mexican beer. Prices moderate.

MAXIME'S, 1731 Connecticut Ave, N. W. French provincial cooking (wine sauces, but not too fancy). Good bar. Prices moderate. Intimate atmosphere; good place for earnest *tete-a-tete*.

CARRIAGE HOUSE, 1238 Wisconsin Ave., N. W. In Georgetown, but quaintness not



overdone and neither are steaks (around \$4) unless you insist on it. Dry martinis are dry. Moderate prices.

DUKE ZEIBERTS, 1730 L St., N. W. Steaks, chops, etc. Kosher pickles. A meat-and-potatoes place for folks with real appetites. Prices a little above average, but food is more than that.

FAN & BILL'S, 1132 Connecticut Ave., N. W. Large, crowded, noisy. Substantial fare at moderate prices. Watch out for their king-size cocktails.

HARVEY'S, 1107 Connecticut (next door to Mayflower Hotel). Eat seafood at the same table your great grandfather did more than 90 years ago. Prices on the high side, but food is good and traditional decor reassuring that some things go on forever, A-bomb or not.

MICHEL'S, 1020 Vermont Ave., N. W. Candlelight and gypsy music are the chief appeal, but the food is better than that combination may suggest. Prices are in keeping. Recommended for budding romances or second honeymoons.



OCCIDENTAL, 1411 Pennsylvania Ave., N. W. Pictures of statesmen line the walls; their contemporary counterparts, together with leading business and professional men, may be seen at many of the tables; both give visitors a chance to try to guess who's who. Food is substantial, prices reasonable.

O'DONNELL'S, 1221 E St., N. W. Nautical atmosphere sets the stage for the seafood for which O'Donnell's is noted. Try the Shrimp Norfolk. Moderate prices.

OLMSTED, 1336 G St., N. W. Same ownership as Luchow's in New York, meaning good hearty food with a German accent. Rum buns recommended for those who don't have to count calories. Wurzberger beer, May wine. Reasonable prices.

HALL'S, 7th & K Sts., S. W. Lobsters, steak, chops, fowl, substantial portions served in an oldtime gaslight setting. Good bar. Reasonable prices.

HOGATE'S, 9th St. & Maine Ave., S. W. Eat seafood on the waterfront. Large touristy. Good place for family parties. Food plentiful and served piping hot. Prices moderate.

NEAR HEADQUARTERS

ARBAUGH'S, 2606 Connecticut Ave., N. W. Specialty—barbecued spareribs, excellent coleslaw, Good bar. Prices moderate. Informal atmosphere.

NAPOLEON'S, 2649 Connecticut Ave., N. W. As name would indicate, French cooking. Excellent onion soup. Take the family.

SMORGASBORD, 2641 Connecticut Ave., N. W. Eat all you want. Prices reasonable.

TED LEWIS RESTAURANT, 2655 Connecticut Ave., N. W. Nice for large or small groups. Pianist. Steaks, lobsters or even ham 'n' eggs. Fair prices.

CHIN'S RESTAURANT, 2614 Connecticut Ave., N. W. Good Chinese food. Plenty of family style dinners. No atmosphere but food better than average. Prices reasonable.

ROCCO'S RESTAURANT, 2637 Connecticut Ave., N. W. Italian or American food. Take the family. Prices average.

EL MEXICO, 2603 Connecticut Ave., N. W. Enchiladas, tamales, arroz con pollo, tacos, with Mexican beer to wash it down. Reasonable prices.

SHOPPING

FOR WIVES with a shopping bent or husbands with obligations to take home a souvenir gift, F Street is the backbone of Washington's shopping center, running from the bargains of Hecht's at 7th Street to the luxury items of Garfinckel's at 14th. Next door to Garfinckel's, also on 14th, is F.A.O. Schwartz, where bewildered parents can find the latest fashions in toys for all ages.



NIGHT LIFE

WASHINGTON does not excel in this department. Most of the better hotels have supper rooms (like the Paladian Room and the Blue Room in the Shoreham) with music for dancing and discreet entertainment. Louder, but not necessarily better, floor shows may also be found, but for the lusty - busty girly - girly bumps - and - grind routines you'll have to head for Baltimore Street in the city of the same name, some 40 miles north on U. S. 1.



GENERAL INFORMATION

YOUR HOTEL can supply full information regarding guided tours by bus or limousine, where the nearest church of your faith is, what's playing at the movie houses and that sort of information. If they don't know the answer to any question about Washington, try the D. C. Information Center at 1616 K St., N. W., or you can call them at STerling 3-3535.

Washington is a planned city and consequently somewhat harder for a stranger to find his way around in than normal cities which just grew. Streets running north and south are numbered; streets running east and west are lettered; avenues (all named for states) run diagonally. Occasionally north-and-south streets, east-and-west streets and avenues all come together; then it's a circle and if you're trying to cross it and continue on your way you've got to look sharp to leave by the same street you came in on.

Traffic lights at some corners have separate sections, separately timed, to tell the driver whether he should go straight ahead, or turn to the left or right or stay put until the light changes. At other corners, a simple green light gives him the go ahead to proceed straight or turn either way. If you slow down to try to see what kind of a signal it is, the car behind will honk helpfully.

Best bet is to leave your car in the garage and take a taxi to reach any points within the District boundaries. Taxis are plentiful (unless it's raining) and less expensive than in most cities. Fares are figured by zones and are based on the number of passengers, too, and not on a straight mileage basis.

Open House



Edward Petry & Co., Inc.



PRESIDENTS AND THE NARTB

IKE'S 'IN PERSON' APPEARANCE WILL MARK ANOTHER FIRST IN BROADCASTING HISTORY

TUESDAY morning, for the first time in history, a President will stand on the broadcasters' own convention platform to greet delegates and speak on problems of common interest. Dwight D. Eisenhower will be heard at 11:30 a.m., with radio and tv networks carrying the words to the nation and to the world.

It has been 24 years since the broadcasting industry has heard the spoken words of a President of the United States. In 1931 Herbert Hoover addressed the National Assn. of Broadcasters convention in Detroit—by remote control.

In his 1931 talk, President Hoover recalled the chaos of early

broadcasting, and the steps that led to federal regulation. He observed that operation by private enterprise with "no restraint upon programs" had given wider variety of programs and excellent service at no cost to the listener.

President Hoover called radio "an incalculable extension of happiness and contentment." President Eisenhower has set many radio-tv precedents, including telecasts of his news conferences and special programs involving top government officials.

Text of President Hoover's 1931 message to broadcasters follows:

PRESIDENT HOOVER'S MESSAGE TO THE BROADCASTERS

IT gives me great pleasure to greet the ninth annual convention of the National Association of Broadcasters meeting this week in Detroit. As Secretary of Commerce I had the pleasure of wide acquaintance with the purposes of your association in the annual national radio conferences which were called at that time for the development of the national policies in relation to radio.

The decisions reached at that early date have been of unending importance. The determination that radio channels were public property and should be controlled by the government; the determination that we should not have governmental broadcasting supported by a tax upon the listener, but that we should give license to use of these channels under private enterprise where there would be no restraint upon programs, has secured for us far greater variety of programs and excellence of service without cost to the listener. This decision has avoided the pitfalls of political and social conflicts in the use of speech over the radio which would have been involved in government broadcasting. It has preserved free speech to the country.

These principles are now strongly imbedded in our law and in our entire public system. The industry has constantly faced new and complex problems in developing policies and practices abreast of development and need. Your association has contributed greatly to their solution. I am confident that you recognize the responsibility which rests upon you in public interest. It is needless to mention the many-sided importance of radio in modern life. Its dissemination of entertainment, of knowledge, and of public opinion and topics of the public welfare, has become an essential element in the intellectual development of our country. It has brought most of the supposed values which were formerly available exclusively to life in the cities, to every home throughout the land, for the

treasures of music, of entertainment, and of information have been brought to the loneliest farm and the most remote hamlet. It is an incalculable extension of happiness and contentment.

I extend to you my most cordial greetings and good wishes for your meeting, with the confidence that you will develop still further policies of sound management and public service.



FROM FAR AND NEAR... THEY'RE WATCHING CHANNEL 2

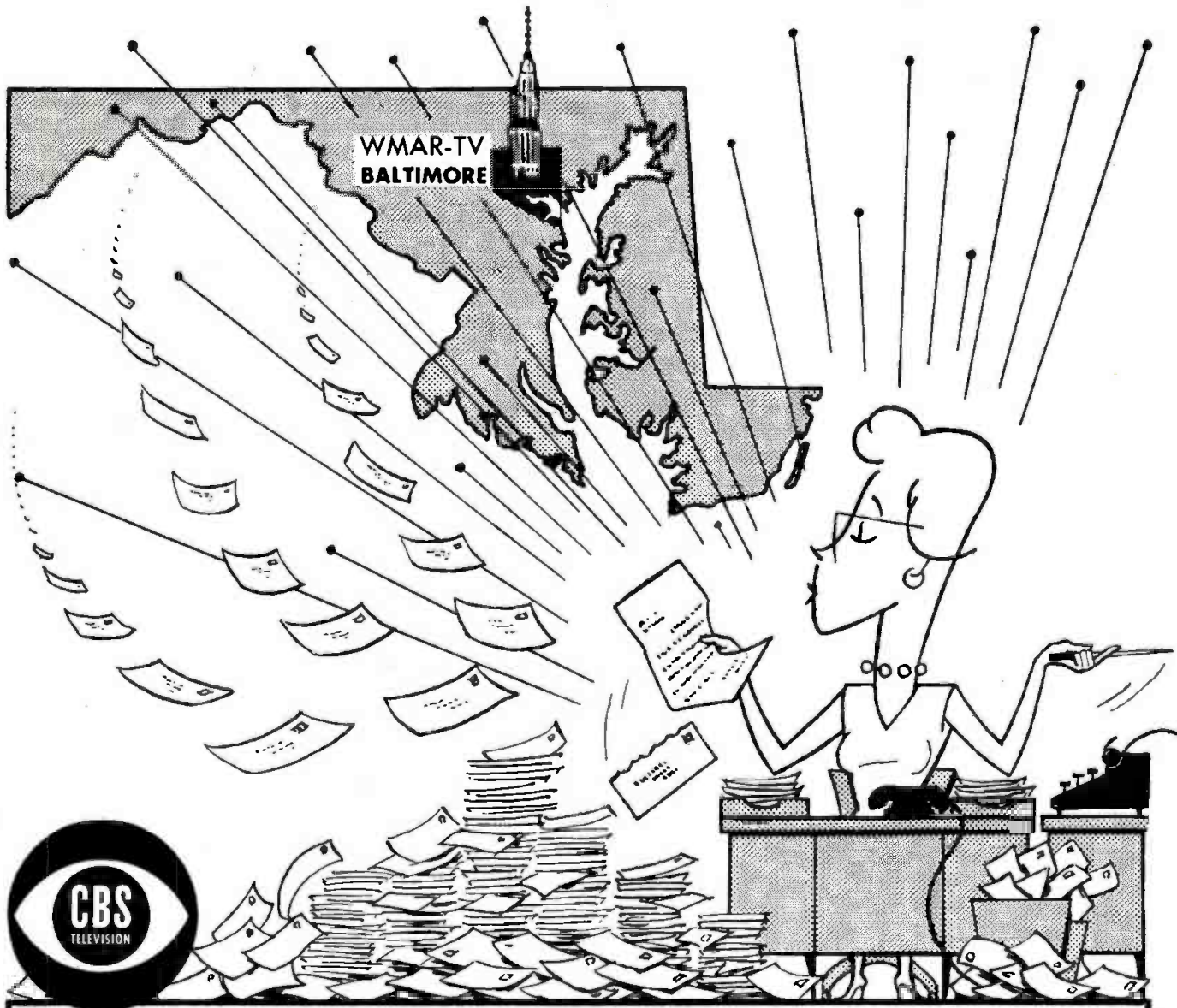

Baltimore is a rich prosperous market, and WMAR-TV covers its 602,840* teleshets like a tent. But sponsors on Sunpapers Television get an extra bonus of coverage in a lush surrounding area that extends from far up into Pennsylvania down into tidewater Virginia—with, of course, the rich Central Maryland and Delaware areas thrown in.

Evidence? CONSISTENT unsolicited mail from 243 postoffices outside of Baltimore City during March and April, 1955.

The bonus of consistent viewing, attested month after month in WMAR-TV's mail-count, reduces cost-per-thousand and increases sales. The nearest Katz office can fill in the details.

*Total, April 1, 1955, from the Baltimore TV Circulation Committee.

On Maximum Power - Televising Color

WMAR-TV

CHANNEL 2 SUNPAPERS TELEVISION BALTIMORE MARYLAND

Telephone MULberry 5-5670 ★ TELEVISION AFFILIATE OF THE COLUMBIA BROADCASTING SYSTEM

Represented by THE KATZ AGENCY, Inc. New York, Detroit, Kansas City, San Francisco, Chicago, Atlanta, Dallas, Los Angeles

N

FABULOUS...

I

A

66

69

40 FABULOUS FEATURE
FILMS FOR THE FINEST TV
ENTERTAINMENT...
ALL FRESH FROM TOP
THEATRE SHOWINGS
WHERE THEY GROSSED
MANY MILLIONS AT
THE BOX OFFICE.

The Captain's Paradise
Breaking the Sound Barrier
The Man Between
Tales of Hoffman
Cry the Beloved Country
The Great Gilbert and Sullivan
Outcast of the Islands
A Letter to Three Husbands
The Magic Box
Pickwick Papers
Blanche Fury
Dead of Night
Man of Evil
Passport to Pimlico
The Adventuress
Captain Boycott
The True and the False
Cage of Gold
Saraband
Highly Dangerous
Bad Lord Byron
The Secret People
Sleeping Car to Trieste
Blackmailed
Woman Hater
The Overlanders
Train of Events
The Blue Lamp
Diamond City
Valley of the Eagles
The Dark Man
Tony Draws a Horse
Johnny-on-the-Spot
Death Tide
Flannelfoot
Johnny in the Clouds
Waterfront
The Hidden Room
Pink String and Sealing Wax
Night Without Stars

40 FABULOUS FEATURE FILMS

REPRESENTING THE FINEST

TALENT IN THE WORLD.

FABULOUS...

... PRODUCED IN THE WORLD'S MOST
FAMOUS STUDIOS ... DIRECTED BY THE WORLD'S
MOST FAMOUS DIRECTORS ... WRITTEN BY
THE WORLD'S MOST FAMOUS WRITERS ...

TO CAPTURE AND
ENTRANCE AUDIENCES
IN EVERY MARKET.

James Mason
Audrey Hepburn
Stewart Granger
Deborah Kerr
Alec Guinness
Yvonne De Carlo
Jean Simmons
Eve Arden
Robert Donat
Laurence Olivier
Dane Clark
Richard Burton
Ralph Richardson
Signe Hasso
Maurice Evans
Maira Shearer
Alastair Sim
Margaret Lockwood
Robert Newton
Ruth Warrick
John Mills
Michael Redgrave
Trevor Howard
Hildegard Neff
Ann Todd
Canada Lee
Robert Morley
Valerie Hobson
Mai Zetterling
Leo Genn
Claire Bloom
Wendy Hiller
Vanessa Brown
Billie Burke
Emlyn Williams



Visit us at the NARTB Convention, Suite F203-205
Hotel Shoreham, Washington, D. C.

National *Television Associates, Inc.*
60 West 55 Street, New York 19, N. Y. PLata 7-2100

THE EIGHT NEW NARTB RADIO DIRECTORS

WILLIAM HOLM
WLPO La Salle, Ill.
District 9

SIX YEARS of radio training in eastern North Carolina provided the background for the Illinois broadcast career of William Holm. He entered radio at WEED Rocky



MR. HOLM

Mount, N. C., and after six years' experience started WENC Whiteville in the same state.

He moved to La Salle in 1947 to put the new WLPO on the air. The station's policy of intensified local newscasting, which he developed, has been widely pub-

lized. Mr. Holm discussed it at 17 BMI clinics, during the 1951-54 period, in the U. S. and Canada.

In World War II he was assigned to Air Force public relations. In 1953 he was elected president of Illinois Broadcasters Assn. His local activities include Kiwanis, Boy Scouts, Chamber of Commerce and Red Cross. He was reared and educated in Huntington, N. Y., where he was born Jan. 11, 1910.

OWEN F. URIDGE
WQAM Miami
District 5

BACK IN 1926 Owen Uridge went to work for the old WAFD Detroit, becoming its general manager. WJR Detroit hired him in 1928 as announcer-salesman but he moved



MR. URIDGE

to WGHP-WXYZ in 1930 as commercial manager. He returned to WJR in 1932 for a four-year term as sales manager and next headed the Detroit office of CBS Radio Sales. Again he returned to WJR, serving as assistant general manager for the 1937-46 period and

vice president-general manager for the next two years.

In 1948 he left after more than a score of years in Detroit radio to become assistant secretary and general manager of WQAM-AM-FM Miami. Industry activities include ABC Affiliates Committee; Broadcast Advertising Bureau, Plans Committee; director, Florida Assn. of Broadcasters; member, NARTB 1954 Convention Committee; Radio Pioneers and Radio-Tv Executives Society. Kiwanis, Masonry and numerous business and civic activities keep him on the move.

CECIL B. HOSKINS
WWNC Asheville, N. C.
Medium Stations

MANY broadcast executives are converted engineers and Cecil Hoskins is one of this group. A native Kentuckian, he moved to Asheville in 1921 and has lived ever since



MR. HOSKINS

in the land of energizing atmosphere and tumbling hills. After graduation from Dodge Radio Institute in 1929, he joined WWNC as an engineer and was appointed chief in 1931.

For 16 years Mr. Hoskins directed the technical operation of WWNC. His administrative

talent was moved to the business side Jan. 1, 1947, when he became general manager.

State association activities have utilized his services for years. After six years on the North Carolina Assn. of Broadcasters board he was elected president in 1953. At present he is executive secretary and treasurer of the association. He is a member of Trinity Episcopal Church in Asheville. Civic activities include the Lions Club, of which he is president-elect for the 1955-56 term.

JOHN M. OUTLER JR.
WSB-AM-TV Atlanta
Large Stations

ANY TIME two or more broadcasters assemble and one of them is John Outler, there's bound to be an anecdote and it will be narrated in his genial, Georgian manner



MR. OUTLER

famed around the industry. Mr. Outler was born in Georgia, attended school there (Emory College, BS) and has spent his business career in the state. Starting with the *Augusta Herald* in 1914, he moved to the *Atlanta Journal* in 1916 and has been

in the organization ever since. After World War I service in France he became *Journal* auto editor, then manager of rotogravure advertising.

Mr. Outler entered radio in 1931 as business manager of WSB, moving up to general manager in 1944. With entry into tv in 1948 he was named general manager for both am and tv operations. At NARTB he has served on Sales Managers and Standards of Practice committees, and presently is a member of the Freedom of Information

Committee. His civic activities include Kiwanis, Druid Hills Golf Club, Atlanta Athletic Club, C. of C. and director of Armed Forces Communication Assn., Atlanta chapter.

JOHN F. PATT
WJR Detroit
Large Stations

THE LIST of commercial and civic activities in which John F. Patt has held official rank occupies a full page, single spaced, and ranges alphabetically from American Red



MR. PATT

Cross to Youth Bureau. Currently Mr. Patt is president of WJR Detroit and licensee of WJRT (TV) Flint, Mich., which is to take the air next September. In addition he is consultant to WGAR Cleveland, which he headed before sale to Peoples Broadcasting Co. in 1954, and

has retained his home in Cleveland.

Other industry posts include Radio Advertising Bureau director and chairman of CBS Radio Affiliates Assn. He is the only nominee for senior vice presidency of Radio Pioneers. If custom is followed, he will assume this office at the Pioneers dinner Wednesday.

One of a family of broadcasting brothers, Mr. Patt entered radio at WDAF Kansas City in 1922 as announcer and assistant radio editor. He joined WJR in 1926 as assistant manager.

ALEX KEESE
WFAA Dallas
District 13

SINCE 1952 Alex Keese has managed WFAA Dallas, a station he joined in 1930 as musical director. Before entering radio he had played violin in several orchestras



MR. KEESE

and had directed pit orchestras in Atlanta, Kansas City, Boston and other large centers. Shortly after he took the musical post at WFAA he decided to shift over to sales. This soon led to the sales manager-ship.

In 1944 Mr. Keese left WFAA to join the Taylor-

Howe-Snowden radio group and set up the organization's sales departments in principal cities. He rejoined WFAA in 1948 and was placed in charge of regional sales, holding the position until his advance to station manager of the radio outlet in 1952.

He is a native of Fort Gaines, Ga. In Dallas he has been active in civic life. He is a member and past director of the Rotary Club and Advertising League; member of Variety Club, Salesmanship and Dallas Sales Executive clubs; Radio-Television Execu-

BUILD WITH GUILD



PAUL COATES' CONFIDENTIAL FILE

Exposes rackets, unmask social problems, reports on unusual personalities that make up America. Tremendous sales impact . . . Los Angeles' highest rated local show. Dynamic, exciting, unique!

5 new
GUILD WINNERS
to build station ratings
and sponsor sales

THE GOLDBERGS

starring GERTRUDE BERG

They've moved to Haverville, U.S.A. and there's a fresh new flavor to America's most beloved family show as it embarks on a heart-warming new series of adventures.



I SPY

starring RAYMOND MASSEY

Distinguished actor, Raymond Massey, recounting the true stories behind history's most famous spies. Sets a new trend for impact in mystery, intrigue and adventure.

BROTHER MARK

starring RICHARD KILEY

Television's great new dramatic discovery starring in a new and different type of high-pitch adventure drama with a bright spiritual quality, and authentic European backgrounds.



The INA RAY HUTTON Show

Television's first all-girl musical extravaganza. Another thrill-packed musical-variety treat from the producers of the famous LIBERACE Show.

check these current GUILD Hits:

- LIBERACE SHOW
- FLORIAN ZABACH SHOW
- FRANKIE LAINE SHOW
- LIFE WITH ELIZABETH
- JOE PALOOKA
- CONRAD NAGEL THEATRE
- IT'S FUN TO REDUCE
- LOONEY TUNES
- MPTV FEATURE FILMS
- JOHNNY MACK BROWN WESTERNS
- WRESTLING FROM HOLLYWOOD

GUILD



FILMS

COMPANY, INC.

460 PARK AVENUE • NEW YORK 22, N.Y. • MUrray Hill 8-5365
IN CANADA: S.W. CALDWELL, Ltd., TORONTO

tive's Society of New York; Radio Pioneers, and Dallas Athletic Club. He is a member of the First Presbyterian Church in Dallas.

EDWARD A. WHEELER
WEAW-AM-FM Evanston, Ill.

Fm Stations

THERE'S never been, and probably never will be, a more enthusiastic booster of fm broadcasting than Ed Wheeler. He thinks so highly of his WEAW-FM signal that he gives

away WEAW-AM time with every fm purchase. During the life of the old Fm Assn. he was a director, and has been on NARTB's Fm Committee for years. On the NARTB board he succeeds Ben Strouse, WWDC-FM Washington, another fm booster.



MR. WHEELER

Mr. Wheeler got his radio start while at California Institute of Technology, announcing without pay on KPPC Pasadena, a church station. His BA degree came from Stanford in 1943. He started WEAW-FM shortly after World War II and has operated multiplex gear as well as storecasting services. He is a sports lover and tinkerer, building everything from radios to racing boats, and goes in for flying as well as competitive sports. Organizations include Evanston Chamber of Commerce (director), Rotary and many others. When NARTB board sessions take up topics affecting fm, Ed Wheeler will be heard.

ROBERT T. MASON
WMRN Marion, Ohio
District 7

THE evolution of trade association policy for broadcasters is a familiar setting for Robert Mason. He's been there before—

1951-53, when he was director for the Ohio-Kentucky district and 1947-48 when he was small stations director. Born in Milwaukee Oct. 3, 1900, he got his bachelor of arts degree at Ohio State U. in 1922. He became president-treasurer of WMRN Marion in 1940.



MR. MASON

His association service includes membership on many committees, including program, music, copyright, legal-legislative and labor. At present he is a member of the Insurance Committee. For four years he was a member of the Advertising Committee of the U. S. Chamber of Commerce, serving in this role until the committee was abolished. He is a past president of the Ohio Assn. of Radio & Tv Broadcasters.

Two political forays—candidacy for the Republican nomination for Congress in his district, 1948 and 1950—were unsuccessful, but he made a good showing.

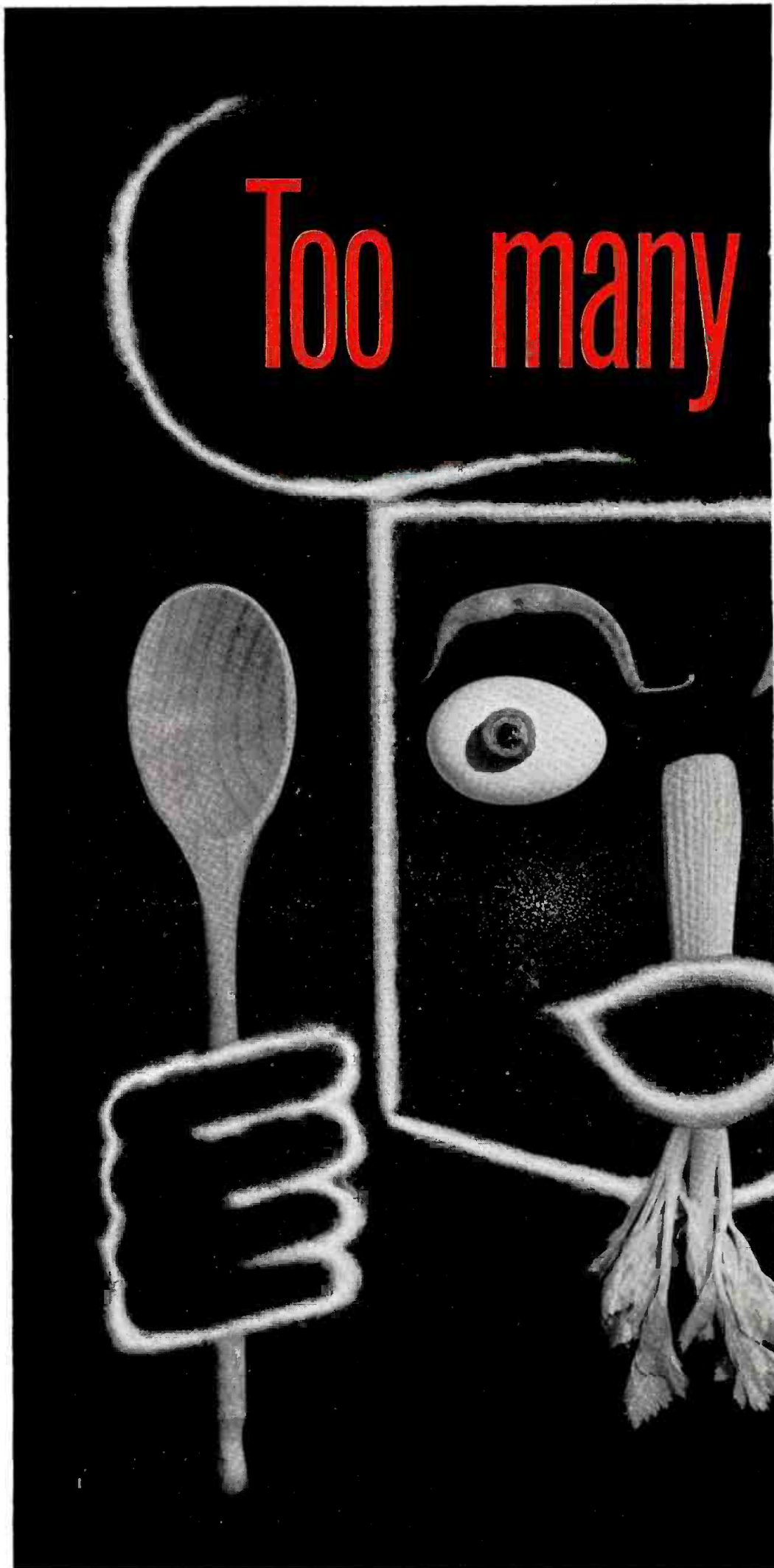

COOKS

(use up the salt!)

WLW seasons your Radio dollar with an extra amount of powerful promotion and merchandising. So you get double your money's worth. Only WLW's Radio two for one plan guarantees you an additional dollar or more in big-time merchandising for every advertising dollar you spend. Nobody else doubles your dollars like WLW.

So how about trying our Radio recipe featuring your product. We'll trade two dollars of ours for every one dollar of yours! You'll like the results when . . .



one equals two on **WLW**
RADIO

a distinguished member of the
CROSLEY GROUP

WLW	Radio
WLW-A	Atlanta
WLW-C	Columbus
WLW-D	Dayton
WLW-T	Cincinnati

Exclusive Sales Offices:
New York, Cincinnati,
Dayton, Columbus, Atlanta,
Chicago, Miami.

WHAT'S WHERE AT THE EXHIBITS

A ONE-PAGE DIRECTORY OF CONVENTION DISPLAYS

Room designations are in Shoreham Hotel with exception of those labeled "SP" or "SP Annex" (Sheraton Park Hotel). Space designations are in the Exhibit Hall, Shoreham Hotel.

Company	Suite or Space
ABC Film Syndication Inc.	C200
Adler Communications Labs.	Space 10
Advertising Age	
M & A Alexander Productions.	E205
Alford Mfg. Co.	Space 17
Altec Lansing Corp.	F100-02-04
American Broadcasting Co.	SP B300
American Research Bureau.	SP 356-58-60
Ampere Electronic Corp.	SP B312-14
Ampex Corp.	E202-04
Andrew Corp.	Space 26
Associated Artists Productions.	F218
Associated Press.	SP Madison Suite
Atlas Television Corp.	F200
Avery-Knodel.	SP 489
Bell System.	F107; SP 689-91; Space 11
Berlant-Concertone	G102
Billboard Magazine.	D201
John Blair & Co.	SP C200
Blair-Tv	SP C200
Blaw-Knox Equipment Div.	G104
Bolling Co.	SP A611-15-07-09
Bonded Tv Film Service.	F407
Branham Co.	SP A211-15
Broadcast Music Inc.	SP 657-661
BROADCASTING*TELECASTING	SP Franklin Suite Newsroom, Shoreham F1014
Camera Equipment Co.	Space 12
Caterpillar Tractor Co.	Space 30
CBS Radio Network.	SP Annex H400-02-04
CBS Television Films Sales.	A200-07
CBS Television Network.	SP Annex H600-02-04
Century Lighting.	Space 21
Cheryl Tv Corp.	F202
Henry I. Christal Co.	SP 656-58-60
Collins Radio Co.	Space 34
Community Club Services.	F217-19
Conrac Inc.	F208
Continental Electronics Mfg. Co.	Space 19
Crouse-Hinds Co.	F213
Dage Television Div.	SP E406-08
Dresser-Ideco Co.	E102-04
Allen B. DuMont Labs.	Space 9; G600
DuMont Television Network	SP B200
Electro-Voice Inc.	F212
Elgin Metalformers Corp.	Space 4
Emsco Mfg. Co.	F220
Flamingo Films.	F207
Fota-Video Labs.	F115
Gates Radio Co.	Space 36
General Communications.	Space 37
General Electric Co.	Space 2; G500
General Precision Lab.	Space 1; F204
General Teleradio, Film Div.	D204, D209; SP 772-74-76
Harry S. Goodman Productions.	D111, D213
Gray Research & Development Co.	F114
Graybar Electric Co.	Spaces 19, 20; F100-02-04
Guild Films Co.	D200, D202, D800, D802

Company	Suite or Space
Harrington, Righter & Parsons.	SP B500
Harwald Co.	C201
Headley-Reed Co.	SP E400-03-04
George P. Hollingbery Co.	SP C100
Hollywood Television Service.	G204, A500-02
C. E. Hooper Inc.	SP 356-58-60
Houston Fearless.	Space 22
Hughey & Phillips.	E105
International News Service.	F209
Kay Lab.	Space 12; SP A111-15
Keystone Broadcasting System.	A711-15
Kliegl Bros.	Space 14
Langlois Filmusic.	E100
Lang-Worth Feature Programs.	E100
MCA-TV Ltd.	B200
Joseph Hershey McGillvra.	SP A311-15
Machlett Labs.	Space 20
Magne-Tronics.	F100-02-04
Meeker Tv Inc; Robert Meeker Assoc.	SP A500
Motorola Com. & Electronics.	Space 5A
Multiplex Services Corp.	F118
Musicolor Inc.	C202
Mutual Broadcasting System.	SP A200
Muzak Corp.	SP B411-15
NBC Film Division.	D212-14; E208
National Broadcasting Co.	SP D200-03-04
National Affiliated Television Stations.	F201
National Citizens Committee for Educational Television.	F110
National Guard.	F120
National Musitime Corp.	E100
National Telefilm Assoc.	F203-05
Nems-Clarke.	Space 5; F206

Company	Suite or Space
A. C. Nielsen Co.	SP 690-92
Northwest Radio & Television School.	SP M290
Official Films.	C203, C205
Edword Petry & Co.	SP Annex G200
Phelps Dodge Copper Products Corp.	F113
Philco Corp.	Space 27
Prodelin Inc.	Space 29; SP Annex H100
Pulse Inc.	SP 291-93
Radio Corp. of America.Spaces 24, 25; F214-16; SP C400-03-11
RCA Recorded Program Services.	G100-01
Radio Advertising Bureau.
Radio-Television Daily.	F-109-11
Roytheon Mfg. Co.	Space 31
Rust Industrial Co.	Space 6
Schafer Custom Engineering.	G201-02
Screen Gems.	D219-21; SP A406-08
SESAC Transcribed Library.	D208-10
Sponsor.	F603-05; F1015
Standard Electronics Corp.	Space 33; F101-03-05
Standard Radio Transcription Services.	E101-03
Standard Rate & Data Service.	SP 684-86-88
Station Film Library.	F221
Sterling Television Co.	C204
Sarkes Tarzian Inc.	Space 35
Telechrome Sales Corp.	Space 32
Teleprompter Corp.	Space 23; D215-17
Television Age	F222
Television Bureau of Advertising.	A500-02
Television Digest.	D615-17
Television Magazine.	D-500-02
Television Programs of America.	B202-04
Tel-Instrument Co.	Space 8
Tower & Equipment Insurance.	E203
Tower Construction Co.	Space 7
Tv Guide.	G400
U. M. & M. Inc.	D203-05-07
United States Air Force.	E106
U. S. Army Recruiting Service.	F106
U. S. Navy Recruiting Service.	E206
U. S. Treasury Dept.	F116
Unity Television Corp.	E107
Vandivere Labs.	Space 36
Venard, Rintoul & McConnell.	SP B508-10
Vitapix Corp.	SP B100
World Broadcasting System.	B201-03
Frederic W. Ziv Co.	A208
Ziv Television Programs Inc.	A209; SP C211-15

THE SHOREHAM EXHIBIT AREA

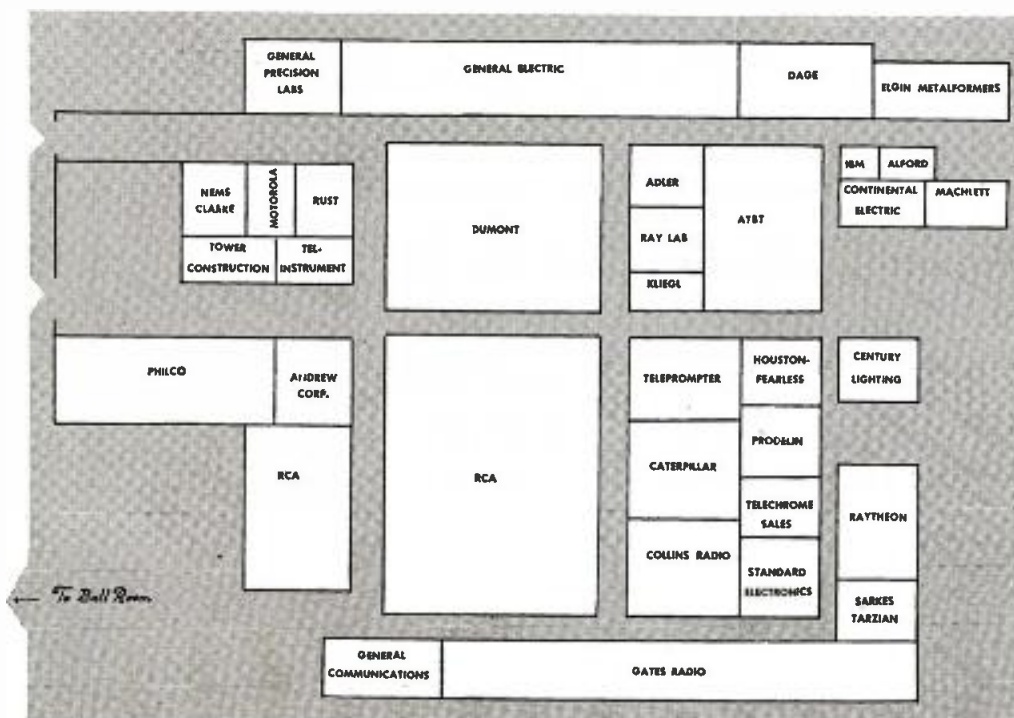

**you HIT the
whole 30-county
Portland, Oregon
target with**

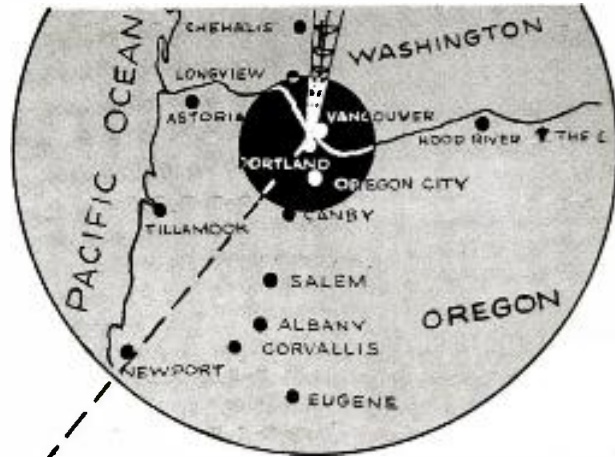

KOIN-TV *Oregon's only
maximum power station...*

**Set your Sales - Sights on these
KOIN-TV Exclusives —**

BIGGEST COVERAGE WITH KOIN-TV

- ☆ Maximum Power.
- ☆ Highest Tower.
- ☆ Full 30-County Portland Market.
- ☆ 35,000 square miles of Sales Prospects.

HIGHEST RATINGS WITH KOIN-TV

- ☆ Absolute Leadership Morning, Afternoon, Night.
- ☆ 49% More Audience Every Week.
- ☆ 12 out of Top 15 Weekly Shows.
- ☆ 8 out of Top 10 Multiweekly Shows.
(February 1955 ARB Metropolitan Portland)

**IN COVERAGE — IN RATINGS — IN TOTAL AUDIENCE
KOIN-TV IS YOUR BEST BUY**

KOIN-TV
CHANNEL 6
PORTLAND 1, OREGON



The Big Mr. 6 in the West

REPRESENTED NATIONALLY BY CBS TELEVISION SPOT SALES

POSITIVE THINKING WORKS FOR RADIO, TOO!

By Oliver Gramling

AP

OLIVER GRAMLING is assistant general manager of The Associated Press, and a fervent booster of radio. He made some remarks on that subject before the Alabama Broadcasters Assn. last month. His speech is excerpted below.

THE OTHER DAY I happened to run across a story about a medical convention. The story quoted a group of researchers as having concluded that being just plain happy about things can cure many ills, fancied or real.

Reading the story reminded me about how all of us these days are going through a period of many changes—and of how those changes have been causing some of us considerable worry. And, the more I thought about it, the more I wondered if two or three years of worry and uncertainty aren't about enough for most of us.

The old habit of worrying, you know, goes back a long way. But the fact is that every generation—every enterprise—goes through revolution and change. That is the penalty—or the reward—for progress.

You know, it took a long time for many to realize it, but radio didn't kill off the newspaper. And now it seems to be taking just about as long for many to be convinced that television is not killing off either the newspaper or radio.

The fact is that newspapers, radio and television all have their place. All are communications media and each complements the other.

There seems no logical reason why all three of these media—after some reasonable period of adjustment, of course—should not live and prosper. There's probably nothing radically wrong with any of them. So, if there is any worry at the moment, I wonder if it isn't at least an even chance that it may be with our reluctance to adapt ourselves and our businesses to change and progress?

Take radio, for example. It's no reflection on either television or the newspaper to say that radio has inherent qualities that neither of the other two can offer—and vice versa.

But specifically, as to radio:

What other medium, minute by minute, can keep millions of isolated people completely abreast of the progress of an oncoming hurricane?

What other medium can be more intimate, can reach the man with a 200-mile drive before him and no distraction other than the long stretch of concrete ahead—the prospective bride and groom on a picnic, dreaming to music from a portable radio and talking about the home they hope to

furnish—the housewife busy with her daily chores?

What other medium can serve the small businessman so effectively and so cheaply—not only for the advertiser but for the broadcaster as well? In radio, you don't have to set your sponsor's message in type and run it through a million dollars worth of presses or tubes. You just say it over your microphone, and it's delivered.

Radio has many other distinctions, just as television and newspapers have their distinctions. Whether we are radio or television broadcasters or both, don't you think we should do a little better job of recognizing those distinctions and promoting them accordingly?

The other afternoon, after one of those usual days, some visiting broadcasters suggested we meet for a drink. They were a



MR. GRAMLING

pretty good cross-section, some radio, some television, some both. Well, we got to talking about business and one of the broadcasters, from an am station in a small market, got on the subject of some of his recent worries. He said:

"You know, until a few months ago, I was in a real stew. I was worried about business dropping off. I was going in every morning with a long face and only a few kind words. Pretty soon, it seemed that everybody around the place also had a long face.

"Then one day I got a new worry. I got to worrying about the morale of my staff. The popular notion about morale," he said, "is that it is something that must be built up from below—from the bottom. That's wrong, and I realized it when I began to realize that my own attitude was wrong. I realized that morale—real morale—must come from above. It's got to trickle down from the top—from positive leadership and confidence. I figured that I wasn't providing it. And so I changed. I started coming in with a smile and some new confidence.

"Now," he said, "everybody on my staff is in a better frame of mind. We are again selling radio for what it is—the best buy in the business. My revenue is up—and I know now that we can keep it that way. I know now *how* to keep it that way."

Another broadcaster, with both am and tv, said he had been in the dumps because his radio was down and his television costs

—plus new competition—were eating him up. But he had been especially worried about radio.

"You know," he said, "for years my radio station rode a national network and we made plenty of money. Then I got immersed in television. Also my radio network business began to fall off, and that meant my revenue took a nose-dive.

"I came to New York several times and worked on the network. I pounded the pavements and cooled my heels in agency offices. But I didn't get very far. And I went back home with just about as long a face as you can imagine.

"Things got so bad," he said, "that I finally decided I just had to stop worrying long enough to start thinking. Here I had been riding a radio network so long that I didn't even have a local salesman on my staff. Now I was trying to recover by cutting off peanuts—\$5 a week here, \$10 a week there—when what I should have been doing was building up a local sales staff and selling advertisers I never had tried to sell before.

"So," he said, "I built up a staff of seven local salesmen. Now we've got business we had never dreamed of. We are serving our area and local advertisers as we never served them before. And we are doing it in a market in which there are seven other radio stations and three tv!"

There was one other little incident that afternoon. You may recall that there's a revolving door over at one side of the men's bar at the Waldorf.

We happened to look up. A big, fine-looking fellow was coming through the door. He not only was big, but he was carrying just about the biggest briefcase I've ever seen. It was obvious that he was a salesman, and it was just as obvious that he had had a tough day.

He struggled toward the bar and on the way he stopped near our table to hang up his hat and coat. He noticed we were watching him. He must have realized that we were kindred souls. Anyway, with a great, almost collapsing shrug, he faced us and said:

"Gentlemen, death of a salesman!"

Then he wandered on over to the bar. He ordered a martini. Then he ordered a second one. Pretty soon he started talking to the fellow next to him. They started buying each other drinks.

An hour later they parted like bosom friends. Our salesman had a new spirit and a spring in his step as he came over our way to get his things.

Then, apparently, he remembered us again. He stopped, drew himself to his full height and delivered his parting line.

"Gentlemen!" he said, "In the words of our founder, let's all get out and sell!"

Don't you agree that the makings for a martini for the broadcasting industry are at our finger tips? Don't you agree that all we have to do is use the right mix for the particular taste of our own community? Don't you agree that, if some change is needed in formula, then we should recognize the need and make the change? Don't you agree that is the *positive, progressive* thing to do—the right thing to do?

And they say, you know, that doing the right thing should always make us happy!

out-selling... out-performing

ALL OTHER COLOR TV SYSTEMS

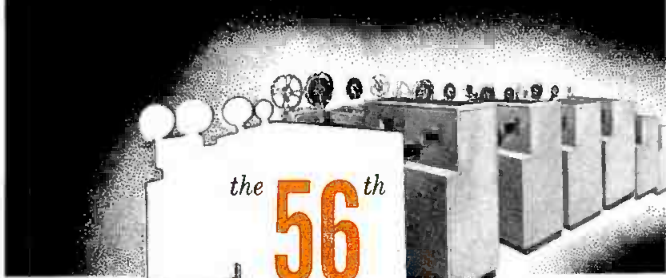

DUMONT multi-scanner
now installed at **WAGA-TV**
Atlanta, Georgia

by
popular
demand...

DUMONT *first with the finest in television*

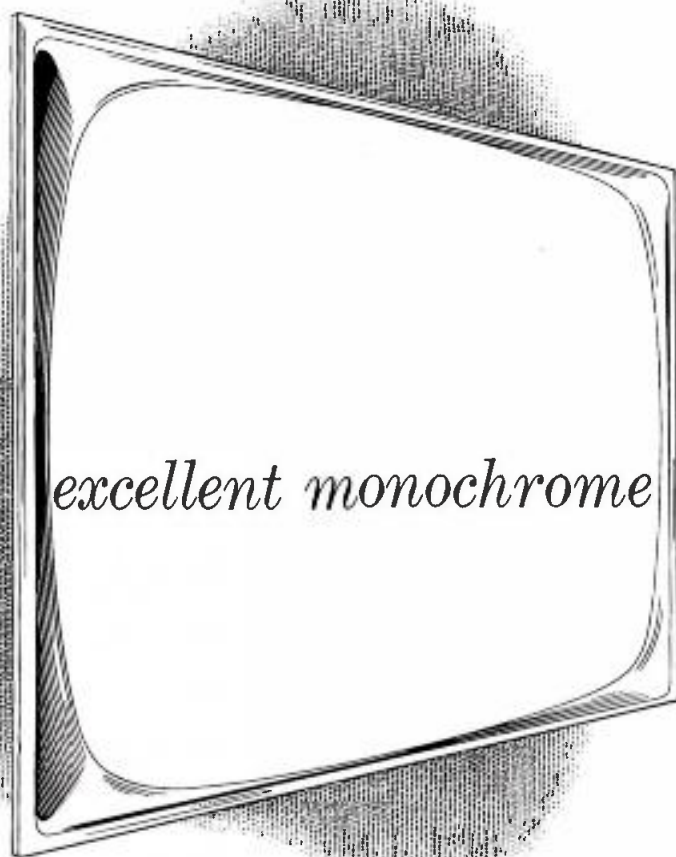

excellent monochrome . . .

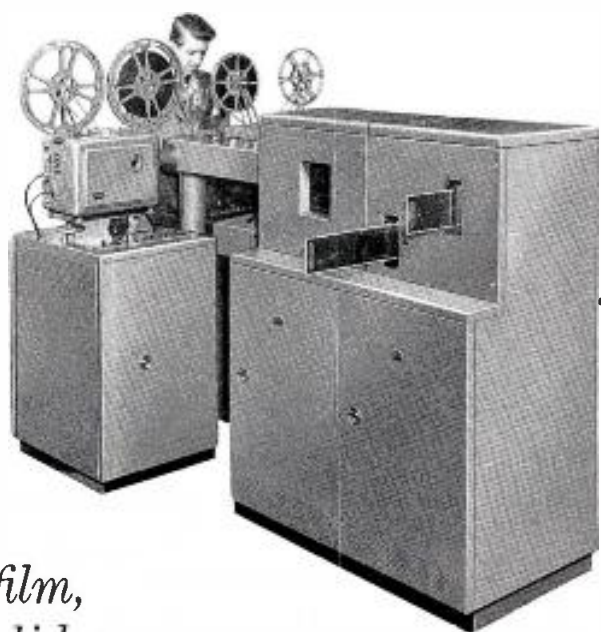

*film,
slides,
opaques...*

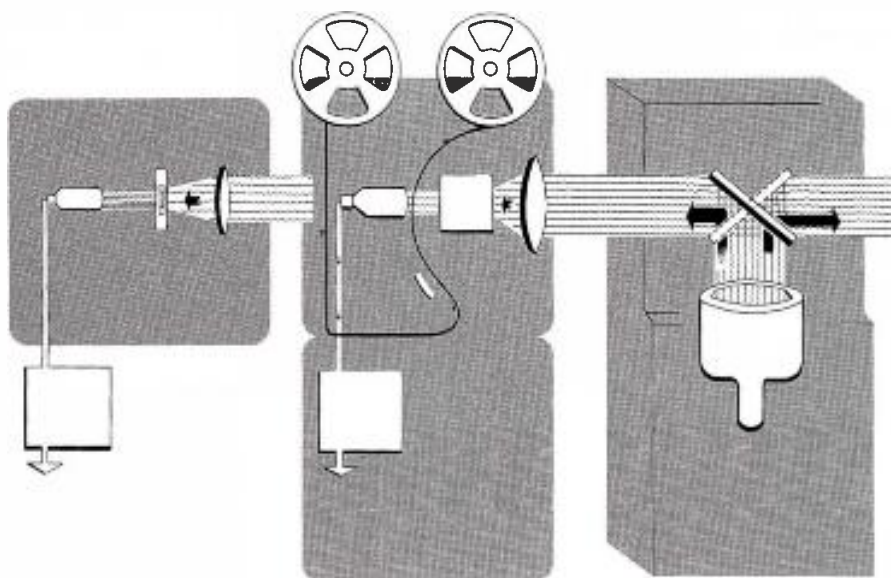

In monochrome operation the Multi-Scanner provides pickup for 16 mm film, transparent slides and glossy or matte opaques. Simplicity of system assures operating economies, dependability and top performance.

The Color Multi-Scanner can be ordered as such, or may be a modification of the Monochrome unit. Principle of operation is identical to monochrome. The pickup assembly consists of three multiplier phototubes and color filters. There are no registration problems with this system.

for
monochrome
film, slides
and opaques...

color
film and
slides...

and now

local

LIVE

COLOR

in a

**single
unit!**

the **DU MONT** multi-scanner

DU MONT first with the finest in low-cost, local live color television!

*simple
addition!*

By means of a simple addition, the Du Mont Color Multi-Scanner can pick up local live color programs. The same light source scans the program subjects in a fully illuminated studio and multiplier phototubes, grouped like studio floods, pick up reflected light to form a picture. System permits specialized lighting effects similar to studio floods and spots.

This is the quick and economical way to achieve local live color programming now, along with color films and slides to provide complete color programming at minimum cost.



.. and now **color!**

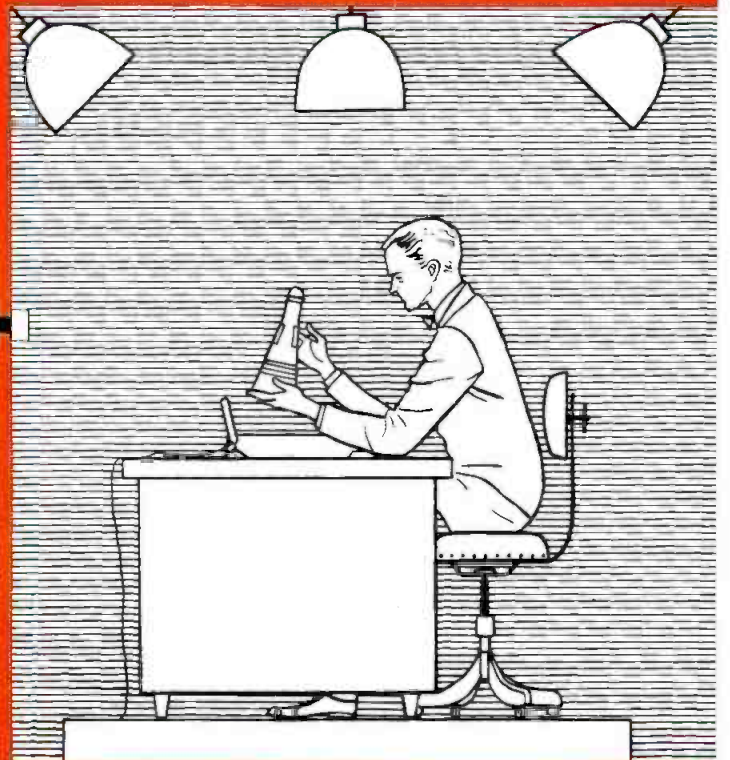
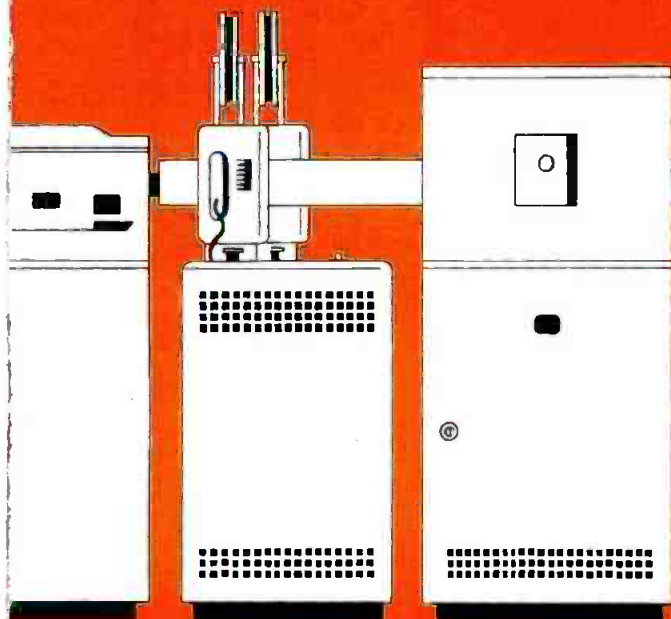

DU MONT first with the finest in *color* television



*simple
conversion!*

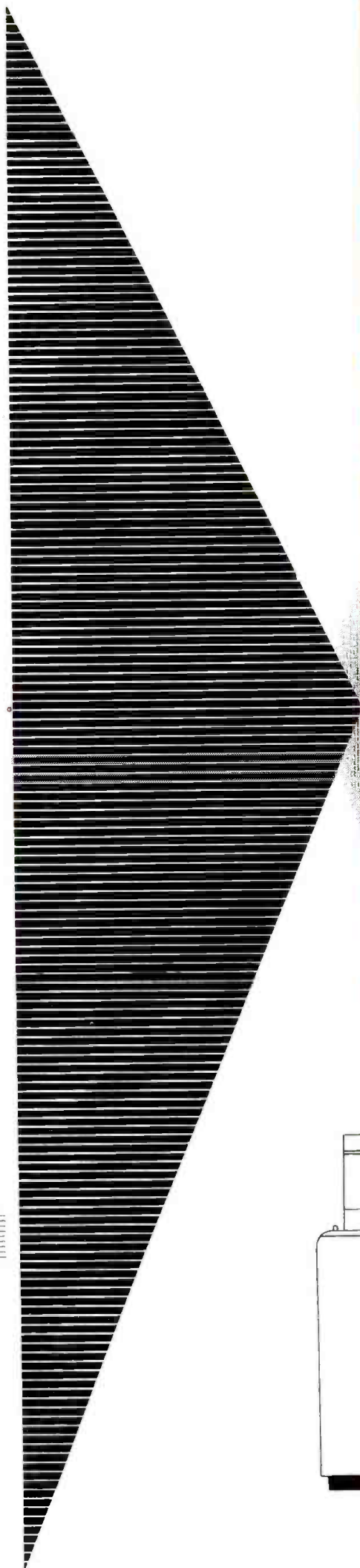
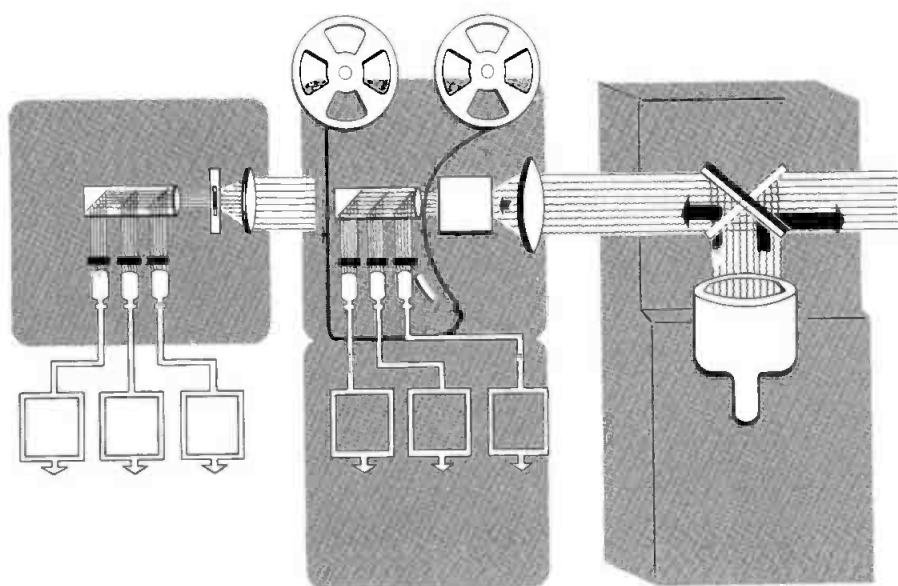

studio
color
equipment *by*

UNENCODED COLOR SWITCHER

For control of color signals from color film equipment or other color pickup sources.

COLOR ENCODER

To form the composite color video signal as transmitted from the TV station.

BROADCAST COLOR PICTURE MONITOR

Used to view a color picture either before or after system encoding.

MULTI-CHANNEL WAVEFORM MONITOR

Four separate signals can be viewed simultaneously on a 4-gun display tube. Unit contains four separate video amplifiers and is designed for either monochrome or color operation.

UNENCODED COLOR PATCH PANELS AND CORDS

Designed for use in color systems requiring patching of red, green, and blue unencoded color signals. One panel permits twelve unencoded color circuits to terminate at the panel.

COLOR STABILIZING AMPLIFIER

Corrects signal deficiencies resulting from network coaxial cable or microwave transmission.

COLOR SYNCHRONIZING GENERATOR

Provides the basic driving signals needed by color signal generating units.

SUB-CARRIER GENERATOR

Provides the necessary signals to adapt most monochrome sync generators to operate at the frequency required for color system pickup equipment.

BURST KEY GENERATOR

Supplies the "burst key" pulse to "key in" the color sub-carrier signal.



DU MONT[®]

COLOR SUB-CARRIER FREQUENCY MONITOR

This equipment checks the accuracy of the color sub-carrier frequency.

CONVERGENCE AND LINEARITY GENERATOR

Supplies a bar or dot signal for linearity and convergence adjustments of color picture monitors.

COLOR BAR GENERATOR

Supplies the color bar pattern used for checking encoders, color monitors and other studio broadcast equipment and for transmission of test patterns facilitating adjustment of home color receivers.

VECTORSCOPE

Used to display and analyze an encoded color bar signal after passing through a television system.

SQUARE WAVE GENERATOR

Provides a square-wave test signal for use in color studio equipment testing.

STEP WAVE GENERATOR

Provides a composite video test signal for television system testing.

LUMI-CHROME FILTER

This unit is a switchable input filter for use with oscillographs in certain color signal analysis work, and is also useful for other color systems measurements where either low or high-pass filtering is required.

POWER SUPPLY AND POWER SUPPLY REGULATOR

Compact unit contains two low voltage supplies capable of delivering total of 500 ma. Single regulator supplies control voltage for any number of stacked power supplies.

TELEVISION TRANSMITTER DEPARTMENT • ALLEN B. DU MONT LABORATORIES, INC. • CLIFTON, NEW JERSEY

Copyright 1955 Allen B. DuMont Laboratories, Inc.

RINSO, PEPSODENT TO SHIFT AGENCIES

Lever Bros. products with accounts totaling \$8 million move to J. Walter Thompson and Foote, Cone & Belding.

LEVER BROS., New York, will shift two of its products—Rinso, with an approximate \$5 million budget, and Pepsodent, with \$3 million—from their present advertising agency affiliations to two other Lever agencies effective July 1.

Rinso, which has been serviced by Ogilvy, Benson & Mather, New York, for the past two years, moves to J. Walter Thompson Co. The latter agency had handled Rinso in the early 20's. Prior to the Ogilvy, Benson & Mather appointment, Ruthrauff & Ryan was the agency for Rinso for many years. JWT also services Lux for Lever Bros.

It was reported that the change in agencies probably would mean that Rinso would return to a fuller radio-tv campaign. Rinso dropped out of Arthur Godfrey radio-tv sponsorship several years ago and put the money into magazines, including 52 pages a year in *Life*.

Pepsodent moves from a four-year stay at McCann-Erickson, New York, back to Foote, Cone & Belding, which with its predecessor, Lord & Thomas, serviced the account for more than 30 years.

Pepsodent currently sponsors half of the

LATEST RATINGS

NIELSEN

TOP 10 TELEVISION PROGRAMS
Two Weeks Ending April 23, 1955
NUMBER OF TV HOMES REACHED

RANK		HOMES (000)
1.	I Love Lucy (P & G) (CBS)	16,429
2.	I Love Lucy (P. Morris) (CBS)	15,947
3.	Toast of the Town (CBS)	15,824
4.	Jackie Gleason Show (CBS)	15,776
5.	Disneyland (ABC)	15,506
6.	You Bet Your Life (NBC)	14,379
7.	Dragnet (NBC)	14,059
8.	Martha Raye Show (NBC)	13,871
9.	George Gobel Show (Armour) (NBC)	13,423
10.	George Gobel Show (Pet Milk) (NBC)	12,828

PER CENT OF TV HOMES REACHED
PROGRAM STATIONS BASIS

RANK		HOMES %
1.	I Love Lucy (P & G) (CBS)	50.8
2.	I Love Lucy (P. Morris) (CBS)	50.4
3.	Jackie Gleason Show (CBS)	50.1
4.	Toast of the Town (CBS)	49.7
5.	Disneyland (ABC)	48.9
6.	You Bet Your Life (NBC)	44.6
7.	Martha Raye Show (NBC)	43.8
8.	Dragnet (NBC)	43.5
9.	George Gobel Show (Armour) (NBC)	41.3
10.	George Gobel Show (Pet Milk) (NBC)	40.0

Copyright 1955 by A. C. Nielsen Company

TRENDEX

Top Ten Tv Shows—May 1-7

1.	I Love Lucy (CBS)	35.6
2.	Toast of the Town (CBS)	29.7
3.	Jack Benny (CBS)	28.7
4.	This Is Your Life (NBC)	27.7
5.	Your Hit Parade (NBC)	26.2
6.	You Bet Your Life (NBC)	25.9
7.	Person to Person (CBS)	25.3
8.	Ford Theatre (NBC)	25.1
9.	December Bride (CBS)	24.2
10.	Truth or Consequences (NBC)	23.9

Jimmy Coons children's show on CBS-TV, alternate-week portions of Arthur Godfrey on CBS radio and television and one commercial on Lever Bros.' *Lux Video Theatre* on NBC-TV.

Pepsodent has a long history as an advertiser on radio and television. The toothpaste firm originally underwrote the *Amos 'n' Andy* show in radio and later was the first advertiser to sponsor comedian Bob Hope.

The move back to FC&B reportedly was because T. E. Hicks, newly-appointed vice president in charge of merchandising, wanted that agency because he had dealt with it when he was with Armour & Co.

Underwood, 4 Others Start Radio Campaigns

UNDERWOOD CORP. (office machines), returning to spot radio for the first time since last Christmas, is joining several other advertisers in accelerated radio spot campaigns, B•T learned last week.

Other advertisers involved in last week's activity included *Life* magazine, Hazel Atlas Glass Co., Coughlin Copper Cleaner and Breakers Beach Club.

Underwood, through Brooke, Smith, French & Dorrance, New York, is preparing a radio spot announcement schedule to break today (Mon.) and run for a short term in approximately 200 markets. The advertiser is buying mostly news adjacencies.

Life magazine and its agency, Young & Rubicam, New York, are meeting to consider *Life's* radio budget and its new pattern for a spot schedule. Specific details are expected to be worked out by next week.

Hazel Atlas Glass Co., through Abbott Kimball Co., is buying a radio spot announcement campaign for a short term in several states including New York and Pennsylvania.

G. N. Coughlin Co., Orange, N. J. (copper cleaner), through Reidle & Freede, Paterson, N. J., is placing radio spot schedules on women's shows as distribution increases.

The Breakers Beach Club, Lido Beach, L. I., through Gibraltar Adv. Agency, has purchased radio participations on seven New York stations, starting immediately.

Three More Take 'Monitor'; Series Now 58% Sold Out

THREE more major advertisers have signed for sponsorship of *Monitor*, NBC Radio's new weekend service scheduled to start June 12, bringing gross billings for the series to \$1 million [B•T, May 16]. The advertisers are Chevrolet Motor Div., General Motors Corp., through Campbell-Ewald Co.; Philip Morris through Biow-Beirn-Toigo Inc., and Gruen Watch Co. through Grey Adv.

Chevrolet's 13-week schedule, which will start June 12, is the largest single order received for *Monitor* to date, the network announced last week. The Philip Morris schedule will commence July 2 for 52 weeks. The 13-week Gruen order will run from June 12 through June 26 and from Oct. 15 through Dec. 18.

With these recent signings, the number of minutes sold for *Monitor* now totals 853. The total number of six-second "billboard" announcements is 325. The new series, the network announced, is now 58% sold out.

Other network sponsors who have purchased participations on the series are Western Union Telegraph Co., RCA, Nash Motors and Carter Products.

'Spots' Offers Stations Rate-Cut Advertising Deal

RATE-SMASHING device offering 75-100 word spot announcements at \$1 each is being submitted to stations by "Spots," 755 Birch St., Denver, Colo. "We are selecting 200 local radio stations in the 20-state area around Denver to induce national 'advertisers' to use local stations to promote the sale of their products," according to a circular letter sent out by J. L. Porter, general manager.

"Announcements can be placed on the air at the stations 'convenience' any time within a four-hour time limit selected by the 'advertiser,'" Mr. Porter writes. He said he had "over 1,000 of these 'advertisers'" interested in the use of spots, with payment to be made in full at \$1 per announcement. He adds, "While this rate may be below your regular charges we have eliminated your sales expense, bookkeeping and continuity cost plus bringing you a new source of revenue outside of your regular clients."



FORD DEALERS of Southern California have signed a 52-week contract for KRCA (TV) Hollywood *Jack Latham and the News*, five times weekly quarter-hour program. Negotiators of the pact (l to r): standing, Thomas C. McCray, KRCA general manager; James Parks, KRCA sales manager; Hamilton Nerney, director, Southern Calif. Ford Dealers Adv. Assn.; Walter Cooper, district sales manager, Ford Motor Co.; Mr. Latham; E. J. Reeser, vice president, J. Walter Thompson Co., Detroit; seated (in a Ford Thunderbird), J. H. Wray, president, Southern Calif. Ford Dealers Adv. Assn.



**On the
line . . .
a million dollars
in the first
three weeks!**

On June 12, NBC will present the special premiere broadcast of MONITOR.

But MONITOR has already arrived. In the three weeks since the rate-card was issued, *America's alertest advertisers and their agencies have rushed to invest more than \$1,000,000 in MONITOR with the first program almost a month away.*

For MONITOR is an unequalled opportunity to reach a huge *cumulative* audience at prices no national advertiser can afford to pass by. Wherever Americans go, MONITOR goes with them—from 8 a.m. each Saturday until midnight Sunday—into living rooms, bedrooms and kitchens; at beaches, ball parks and summer camps; along the highways in 29,000,000 family cars.

Packed with forty hours of the most exciting and entertaining material that the full resources of NBC can provide, MONITOR has everything for everyone—new sounds in music, in news, in everyday living—even new sounds in

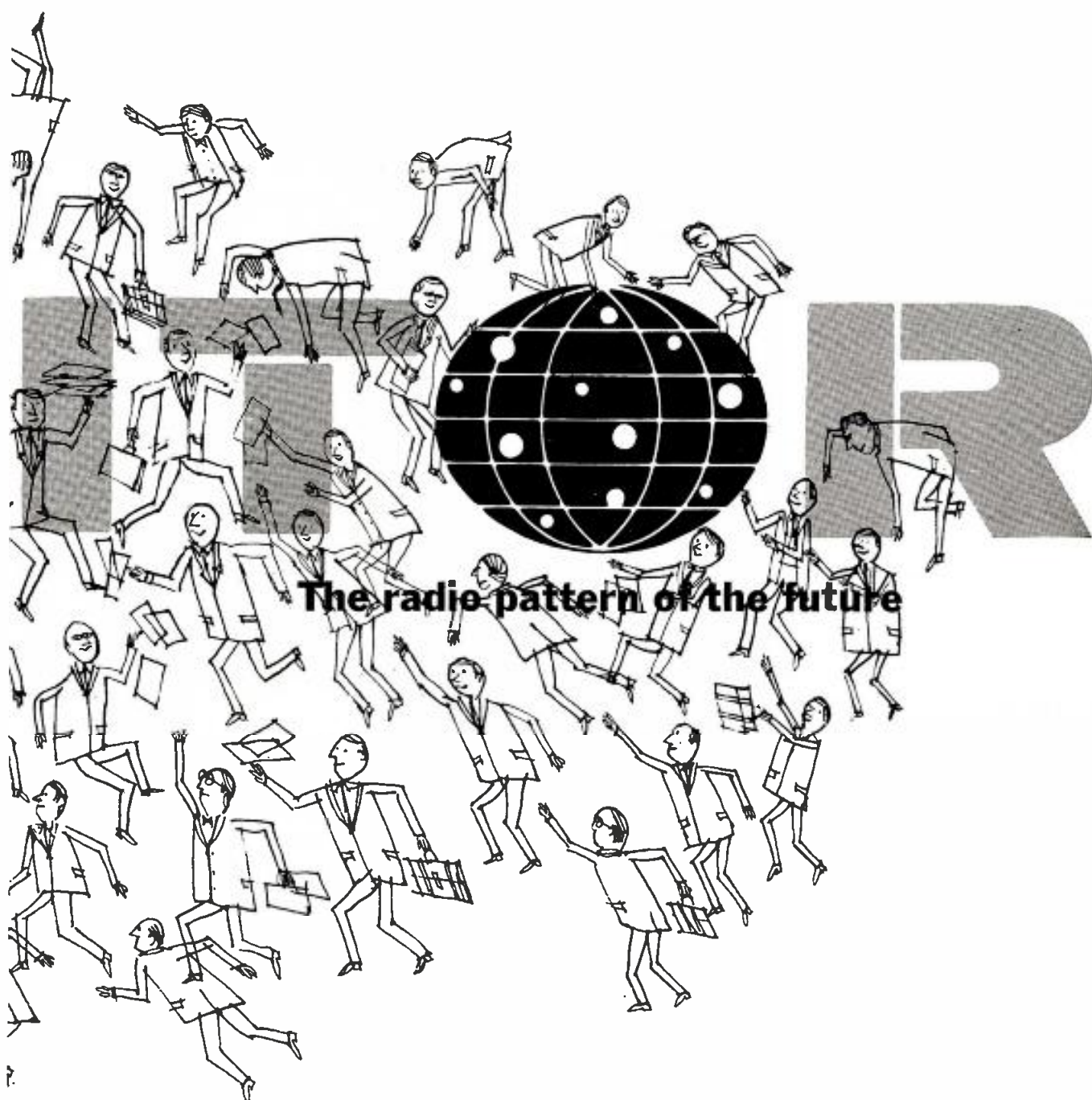

oddities (the nation will hear a worm turn, an oyster laugh). MONITOR will take its listeners to the boulevards of Paris with Art Buchwald . . . an assault on the sound barrier with an Air Force jet pilot . . . the uncontrolled hilarity in a TV studio as the comedian warms up his audience . . . above all, to the raw, pulsing life of the unexpected news-break.

Even now, NBC Radio reaches half the families in the United States each weekend. MONITOR will bring in millions more, and keep their radios near them. And to take your message to these millions, MONITOR offers the most flexible plan in broadcasting history. You can buy one-minute announcements, 30-second announcements and 6-second "bill-boards," and you can buy them as you need them—on the entire network or on any or all of the five NBC-owned stations.

A special Introductory Dividend Plan gives you an extra bonus if you sign up now—value piled on value in the precedent-shattering pattern for radio's future.

These are some of the sponsors who have already put their money in Monitor

- American Motors Nash Division*
- Bendall Pontiac, Inc. Carter Products*
- Douglas Laboratories, Inc.*
- Food Fair Super Markets, Inc. (Washington, D.C.)*
- General Motors Corp., Chevrolet Division*
- Gruen Watch Company*
- Mid-Continent Petroleum Corp.*
- Philip Morris Inc.*
- Radio Corporation of America*
- Seaforth! Shulton, Inc.*
- Thomas J. Lipton, Inc. Western Union*

EXCITING THINGS ARE HAPPENING ON

NBC Radio
 a service of 

Car Dealer Found Guilty Of 'Bait-Switch' Practice

FOUND GUILTY in Los Angeles Municipal Court of violating the California business and professional code—specifically, in advertising used cars on tv for one price and selling them to respondents at a much higher price—a Lynwood, Calif., car dealer and one of his salesmen will be sentenced on May 24.

Conviction of Jack Tankersley, owner of Farmer Jack's used car lot, on two code violations and salesman Gene King on one violation marked completion of the first part of a drive by the Los Angeles Better Business Bureau and police against used car "bait-switch" tv commercial practices [B•T, May 16].

Also on May 24, Cal Worthington Motors, Huntington Park, Calif., will go on trial in Los Angeles Municipal Court on similar charges.

Mr. Tankersley and Mr. King both were convicted of selling a 1953 Chevrolet, advertised on KCOP (TV) Hollywood last Jan. 30 for \$999, to a BBB shopper for \$1,300. Only Mr. Tankersley and Farmer Jack's, as a corporation, were found guilty on the second charge, the sale of a 1951 Plymouth offered on KCOP Feb. 6 for \$699, at a final price of \$1,045.

KCOP subsequently cancelled all Farmer Jack's and Cal Worthington Motors advertising after bait-switch charges were filed against the car dealers by the city attorney's office.

Improvement Noted in N. Y. Decrease of Bait-Switch

"SUBSTANTIAL IMPROVEMENT" in the "quality and character" of many radio and tv commercials formerly subject of criticism in New York for alleged bait advertising connotations were reported last week by the Better Business Bureau there.

The bureau, in its *Monthly Memo*, said the improvement had been noticeable in "recent weeks." According to this report, "some of our tv and radio stations have done a fine job of insisting that their advertisers play fair and square with the listening audience, although two or three of them continue to carry copy which is open to substantial criticism."

Particular attention was paid to WATV (TV) Newark, to which the bureau said, "We doff our hats . . . [WATV] seems to have done an outstanding job of cleaning up baiters and insisting upon full and fair disclosure of what is being offered to its viewers."

At the same time, the bureau noted that some advertising still appears in New York "newspapers and on radio and tv" which indicate a bait-and-switch approach.

Apple Growers Increase Advertising Assessment

APPLE GROWERS in Washington State have voted to assess themselves an additional one cent a box, beginning with shipment of the

1955 crop, to increase the advertising and promotional budget of the Washington Apple Commission. Cole & Weber, Seattle, is the agency, with Floyd O. Flint as account executive.

In a year of average apple production, according to Pacific Northwest fruit-growing experts, the one-cent increase may be expected to yield approximately \$200,000. Television, which has had a substantial share of the budget in the past, is expected to benefit from the raise.

In requesting the increase, the commission pledged that the entire additional amount would be used for advertising and other promotion, rather than for administration or research.

Maybelline to Participate In NBC Spectacular Series

MAYBELLINE Co., Chicago (eye beauty aids), was reported last week to have purchased participations on NBC-TV's projected series of color spectaculars this fall on a 13-time basis. The contract calls for participations in each month's program and was claimed to be the largest yet purchased by a client for the spectaculars.

The pact was negotiated by Roy M. Kirtland, vice president of Gordon Best Co., which handles the Maybelline account, a heavy tv spot advertiser.

Gardner Names Chipperfield

GARDNER Adv. Co., St. Louis, last week announced the appointment of Frank L. Chipperfield as media director, succeeding Warren Kratky, promoted to head the newly-created dept. of marketing. Mr. Chipperfield has been media director of the Joseph Katz Co., Baltimore, and previously was associated with Hewitt, Ogilvy, Benson & Mather Inc., New York; Roy S. Durstine agency, New York, and Gardner Displays Inc., New York.



MR. CHIPPERFIELD

Michigan Brewing Firm Signs For 30 Hours Weekly on WJR

TOTAL of 30 hours weekly will be sponsored on WJR Detroit by E&B Brewing Co., hailed as one of the largest time buys by a Michigan brewery. Under the purchase, effective last Monday, E&B will sponsor five hours nightly, six times a week, between 12 midnight and 5 a.m.

Announcement of the deal was made by LeRoy Payne, E&B president; Leonard Simons, Simons-Michelson Co., agency for E&B, and Worth Kramer, WJR vice president and general manager. The five-hour E&B period will be a varied program of news, music, interviews, weather and road reports, plus a nightly 15-minute man-on-the-street interview segment.

Cabot Elects Edward Chase

ELECTION of Edward F. Chase as executive vice president of Harold Cabot & Co., Boston, was announced last week by Harold Cabot, president. Mr. Chase has been with the agency since 1942 and as vice president since 1945.

two "BEST SELLERS" in the Detroit Area!

CKLW-TV penetrates a population grand total area of 5,295,700 in which 85% of all families own TV sets.

CKLW radio covers a 15,000,000 population area in 5 important states. The lowest cost major station buy in the Detroit area.

Channel 9 325,000 Watts	CKLW	800 kc. Radio 50,000 Watts
National Rep. Adam J. Young, Jr., Inc.		J. E. Campeau, Pres. Guardian Bldg., Detroit

WNEW

Announces the Appointment of

SIMMONS ASSOCIATES

INCORPORATED

NEW YORK • CHICAGO

As National Sales Representative

June 1, 1955

WNEW BROADCASTING COMPANY, INC.

565 Fifth Avenue, New York 17, N. Y.

PLaza 3-3300

SIMMONS ASSOCIATES, INCORPORATED

270 Park Avenue, New York 17, N. Y.

MUrray Hill 8-2821

Flint listens

Ven Marshall is Flint's top news voice on Flint's top-rated morning newscasts over WFDF. His assured, authoritative delivery is backed by WFDF's full-time local news bureau. That means when Ven takes the air he has something to talk about, because Flint's only radio news staff breaks stories hours (even days) ahead of any other news source. Ven's listeners know it's good reporting, and they come back for more, morning after morning. His sponsors know it sells. It can work for you. Phone Katz now.

flint, michigan

REPRESENTED NATIONALLY BY THE
Katz Agency



NBC Affiliate

Associated with: WFBM & WFBM TV Indianapolis—WOOD & WOOD TV Grand Rapids—WTCN & WTCN TV Minneapolis-St. Paul.

when
Ven Marshall
reports
the
local news
on

wfdf

ADVERTISERS & AGENCIES

Major Leagues Seek Data On Effect of Radio, Tv

BASEBALL Comr. Ford Frick announced last week that he has hired an independent research firm to survey the problems of baseball, covering such topics as the effect of radio and tv on attendance and the attitudes of fans toward pay-as-you-see tv.

The assignment given to Stephen Fitzgerald & Co., New York, according to Mr. Frick, is to "get the facts" concerning radio-television, major-minor league relations, feasibility of expansion, failing game attendance, unpopular legislation, relations between front office and players and the front office and press.

"There has been a lot of loose talk regarding what effect radio-tv has had on baseball attendance, both in the majors and minors," Mr. Frick said.

The survey is expected to begin next week and will cover both fans and sports writers in various cities. A spokesman for the Fitzgerald organization said that the number of cities to be surveyed has not yet been determined but that a preliminary report is expected for the mid-season meeting to be held in July by the American and National leagues.

SPOT NEW BUSINESS

Goetz Beer, St. Joseph, Mo., preparing supplemental radio spot campaign in about eight markets for 13 weeks starting today (Mon.).

NETWORK NEW BUSINESS

Polk Miller Products Corp. (Sargeant's Dog Care products), Richmond, Va., makes tv debut with 24 participations on NBC-TV *Home* during 14-week period on summer incentive plan, effective in June. Agency: N. W. Ayer & Son, Phila.

American Medical Assn., Chicago, will sponsor special broadcast covering inauguration ceremonies and address of incoming AMA president June 7 on ABC Radio (8:30-9:15 p.m. EDT). Agency: J. Walter Thompson Co., Chicago.

NETWORK RENEWAL

Gulf Oil Corp., Pittsburgh, renews *The Life of Riley* on NBC-TV (Fri., 8:30-9 p.m. EDT) for 52 weeks, starting Sept. 16. Agency: Young & Rubicam, N. Y.

AGENCY APPOINTMENTS

Lionel Corp., electric train div., N. Y., names Grey Adv., same city.

American Institute of Men's & Boy's Wear, N. Y., has named BBDO, N. Y.

Athena Products Corp. (Nev-R-Spot Surface Protection); Panda Products Corp. (plastic foam processors), and Sherwood Industries (business development), all Buffalo, N. Y., appoint Comstock & Co., same city.

Valley Ford, Rancho Motors (Studebaker-Packard), Stansbury Buick and Snyder-Lynch Motors (Dodge-Plymouth), L. A. area auto dealers, and Citizens Filing Service (land development), Hollywood, name Jimmy Fritz & Assoc., Hollywood. Radio spot announcements will be used in all campaigns.

White Ice Cream & Milk Co., Wilmington, N. C., has named Tucker Wayne & Co, Atlanta.

Anton's Continental Frozen Foods, Miami, has named Bishopric/Green & Assoc., same city. Tv is planned.

Let's Face The Facts!

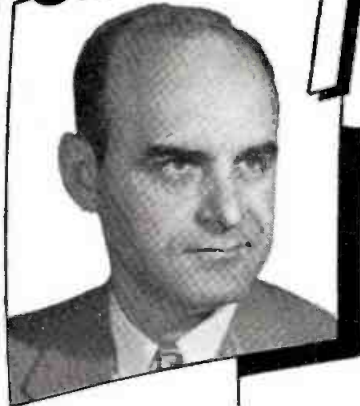

This month, KFAB is proud to "Face the Facts" with Harold L. Coons, Advertising Manager of the Keystone Steel and Wire Company.

Keystone is a great believer in radio advertising and has long association with KFAB in the Omaha market. Big Mike and his staff are proud of the many long-term advertisers of the caliber and reputation of Keystone. The station has sold everything from cake mix to Red Brand fence . . . with a corresponding range in success stories.

When you're considering the multi-billion dollar market that centers in Omaha, you're invited to Face the Facts. A Free & Peters man will be glad to give you the KFAB station and market story. Or, have a visit with General Manager Harry Burke.

Farm livestock income in the KFAB area is over \$1,172,000,000 annually.



Big Mike is the physical trademark of KFAB — Nebraska's most listened-to-station

Foxhaven Frozen Foods Ltd., Chippawa, Ont., has named **Comstock & Co.**, Buffalo, N. Y. All media will be used.

Smart & Final Iris Co. (wholesale grocers), L. A., has appointed **Mogge-Privett Inc.**, same city. **Herb Beaven** is account executive.

Capitol Records Inc., Hollywood, has named **Young & Rubicam Inc.**, L. A. **John Dryer** is account executive.

Dayton Bowling Proprietors Assn., Dayton, Ohio, and **Dayton Speedway Inc.** there have appointed **Bridges-Sharp & Assoc.**, same city. **Philip S. Church Jr.** is account executive on both.

Galla Foods (cooked hams and specialties), Copenhagen, Denmark, has named **Birmingham Castleman & Pierce**, N. Y., effective June 1.

Los Angeles Plumbing Contractors Assn. has named **Frank Bull Adv.**, L. A., for third consecutive year to handle local public relations drive. Radio-tv will be used.

Wonder Products Co. (Wonder Logs and other briquet products), San Fernando, Calif., has named **Jimmy Fritz & Assoc.**, Hollywood. Radio spot campaign planned for summer months.

Charles Antell Inc. (Formula 9, shampoo, hair spray), Baltimore, has named **Joseph Katz Co.**, same city.

Hamilton Watch Co., allied products div., Lancaster, Pa., has named **Arndt, Preston, Chapin, Lamb & Keen**, Phila., with **Norton Bond** as account manager.

Atlanta Baking Co. (Betsy Ross and Holsum bread), Atlanta, Ga., has named **Bearden-Thompson-Frankel**, same city. All major media will be used.

Frontier Foods Co. (E-Z popcorn), L. A., has named **Raymond R. Morgan Co.**, Hollywood. **Paul McKinney** is account executive.

Mohawk Bedding Co., Utica, N. Y., has named **Bozell & Jacobs Inc.**, Omaha.

AGENCY SHORTS

Duane Jones Co., N. Y., moves to larger offices at 122 E. 42d St., at Lexington Ave.; telephone: Murray Hill 7-0270.

A. Martin Rothbardt Inc., Chicago, changes name to **Rothbardt & Haas Adv. Inc.**

Aubrey, Finlay, Marley & Hodgson Inc., Chicago, elected to American Assn. of Adv. Agencies.

A&A PEOPLE

Dr. Joseph Schultz, president, **Lady Esther Co.**, Chicago, and director, parent **Zonite Products Corp.**, New Brunswick, N. J., to **Consolidated Cosmetics Inc.** (Lanolin Plus products), Chicago, as president, effective June 1, succeeding **Karl Kaempfer**; **Charles T. Silloway**, Zonite president, assumes Mr. Schultz' duties.

Cornelius W. Hauck, media director, **Guenther, Brown & Berne Inc.**, Cincinnati, appointed vice president.



MR. HAUCK

Stan Pfarr, account executive, **Bozell & Jacobs**, Seattle, named vice president in charge of creative activities; **Lloyd Stackhouse**, assistant manager, appointed vice president and assistant general manager.

Thomas D. Murray, formerly vice president in charge of advertising and promotion, **Coca-Cola Bottling Co.** of New York, to **Getschal Co.**, N. Y., as vice president and merchandising director.

Nat Kalech, former vice president and sales director, **Tintair Co.**, L. A., to **Anatole Robbins Inc.** (cosmetics), Hollywood, in similar position.

Stuart D. Strand, formerly radio-tv consultant, **Barber & Baar** (public relations), N. Y., to **E. M. Eisfeld Adv. Management**, Miami, as tv-radio dept. director.



MR. STRAND

Robert Lamb, **Henry Stirling**, **Ken Mulbach** and **Mike Hamilton** form **Empire Adv. Corp.**, Hollywood, as president, executive vice president, radio-tv sales director and

publicity director, respectively. Offices at 8303 **Melrose Ave.**; telephone: Webster 8-3894.

Jack Beauvais, **WEEI** Boston, resigns to form own agency, **Beauvais, Zitso & Wenning Inc.**, 1711 Massachusetts Ave., Lexington, Mass.

Dave Titus to **Cole & Weber**, Seattle, as radio-

Turnabout

ALLEN FUNT, whose *Candid Camera* tv program has been sponsored by various advertisers, is about to become a television sponsor himself. Mr. Funt last week reported he has acquired a "substantial interest" in the **Nev-Er-Slip**, a new product designed to make bathtubs and showers slip-proof. He will introduce the product in New York with a spot advertising campaign on the *Claire Mann Show* over **WABD (TV)** New York.

tv director; **Edna Erickson**, formerly with **McCann-Erickson**, Chicago, to **Cole & Weber** as media director; **Niles E. Kelley Jr.** to agency as visual director; **Sherwood Armstrong**, formerly creative and marketing director, **Ryder & Ingram**, Oakland, Calif., to creative staff.

Brooks Elms, formerly with **McCann-Erickson**, N. Y., to **Birmingham, Castleman & Pierce**, same city, as radio-tv director; **Robert Rowell**, **BBDO**, N. Y., to **Birmingham, Castleman & Pierce** as assistant to radio-tv director.

Alfred J. Blake, formerly head of own public relations agency, to public relations dept., **Emil Mogul Co.**, N. Y., as director.

Lloyd Miller, research project director, **Dancer-Fitzgerald-Sample**, N. Y., promoted to research dept. manager.

Ben Gedalecia, **BBDO**, N. Y., appointed research director.

Jack Stanley, copy chief, **Harvey Waldman & Assoc.**, L. A., to **Walter McCreery Inc.**, Beverly Hills, Calif., in same capacity.

William H. Ryan, former promotion, merchandising and publicity manager, **KFMB-AM-TV** San Diego, to **Dick Bradley Adv. Agency**, same city, as account executive and creative supervisor.

Monte J. Curry, Phoenix, Ariz., representative, **Caples Co.**, L. A., to L. A. office as account executive; **Marion Welborn**, account executive, adds duties as L. A. office manager.

John A. Charlesworth, sales promotion manager, **Hoffman Electronics Corp.**, S. F., to **Don Larson Adv.**, Beverly Hills, Calif., as account executive.

Faith Green, formerly assistant fashion editor, *Vogue* magazine, to **Morey, Humm & Johnstone**, N. Y., as assistant account executive.

Ted Huston, commercials producer, **Lennen & Newell Inc.**, N. Y., named head, commercial production dept., Hollywood office.

Donald Riethmiller, formerly with **Ketchum, McLeod & Grove**, Pittsburgh, to **Lang, Fisher & Stashower**, Cleveland, as art director; **Edward T. Noll**, formerly producer-director, **WXEL (TV)** Cleveland, to **Lang, Fisher & Stashower** radio-tv staff.

R. Allan Gardner, **Monsanto Chemical Co.**, St. Louis, appointed household products advertising manager, merchandising div.; **Stanley W. Sullivan**, **Monsanto**, named merchandising div. garden products sales manager, headquartered in Chicago.

C. M. Garnes, sales staff, **Southern Premium Stamp Co.**, Atlanta, appointed east Tennessee sales manager, headquartered in Morristown.

Maidie Alexander to public relations dept., **BBDO**, N. Y.

Alfred N. Steele, president, **Pepsi-Cola Co.**, N. Y., and **Joan Crawford**, motion picture and tv star, were married May 9.

SELLING—THE NATION'S 37TH FOOD MARKET



RONALD B. WOODYARD, PRESIDENT AND GENERAL MANAGER

One of the Nation's Great Independent Stations

980 KC • 5,000 WATTS
PHONE HEADLEY REED CO.

DAYTON, O.
"THE CITY BEAUTIFUL"

NBC, WBC TRADE PROPERTIES IN CLEVELAND, PHILADELPHIA

NBC pays Westinghouse \$3 million cash to boot in unprecedented swap transaction. Neither party gives reasons for the unusual deal, but for NBC Philadelphia is a better television market than Cleveland.

VIING with the NARTB's 33d annual convention in Washington this week for the attention of the nation's broadcasters was the NBC-Westinghouse swap-plus-cash transaction involving Philadelphia and Cleveland, announced last Tuesday after intermittent negotiations.

The unprecedented deal gives Westinghouse the NBC-owned WNBK (TV) and WTAM-AM-FM Cleveland in exchange for the Westinghouse Philadelphia stations, WPTZ (TV) and KYW, plus \$3 million of NBC cash.

NBC and Westinghouse, upon FCC approval of the transaction, would become more firmly entrenched as associates in the basic structure of the network. There had been earlier reports of possible switches in affiliation by several Westinghouse outlets to CBS and also of a possible deal whereby NBC would have traded even-up its Cleveland properties for other Philadelphia outlets.

The FCC informally was notified of the transaction last Tuesday, prior to the public announcement. The announcement was made by NBC President Sylvester L. Weaver and Westinghouse Broadcasting Co. President Chris J. Witting, the latter and Joseph V. Heffernan, NBC financial vice president, having signed the actual agreement.

Since trades are involved, the only dollar figure used was the \$3 million cash which NBC pays Westinghouse. Westinghouse purchased WPTZ (TV) from Philco in May 1953 for \$8.5 million. It has spent about \$200,000 in bringing the ch. 3 outlet up to full power. Figuring the radio properties as even-up (both are 50 kw with WTAM a I-A clear and KYW a I-B) the differential as between the Philadelphia and Cleveland tv stations is \$3 million, which would place an evaluation on WNBK (TV) of \$5.5 million.

Last January, Westinghouse purchased WDTV (TV) (now KDKA-TV) Pittsburgh from DuMont for the record single station figure of \$9,750,000. The previous high had been the \$8.5 million paid by Westinghouse for WPTZ. WPTZ has a one-time class AA rate of \$2,500, while the WNBK class AA rate is \$1,300.

The KYW one-time class A rate is \$450 and the comparable WTAM class AA rate is \$520.

The Philadelphia television station in 1954 had a gross business of approximately \$5.5 million. KYW's gross income was approximately \$1 million. The Cleveland stations had 1954 grosses of approximately \$4.3 million for television and \$900,000 for radio.

While no announcement was made regarding reasons for the exchange, the major networks consistently have contended that they realize no profit from network operations *per se* and that their owned-and-operated stations are the bread winners. As a consequence, the major networks efforts have been to acquire owned-and-operated outlets in the top markets of the country, upgrading existing owned properties wherever possible.

Moreover, the Philadelphia area is of great importance to NBC's parent, RCA, because of its far-flung manufacturing operations in Lancaster, Pa., and Camden and Harrison, N. J., as well as the David Sarnoff Labs in Princeton, N. J.

The promotional value of operation in the area also would be of great importance, since



MR. WEAVER

MR. WITTING

Philadelphia is the headquarters for Philco, one of the important entities in electronics manufacturing and white goods and the founder and former owner of WPTZ.

By last Thursday questions were raised in both official and in broadcasting quarters about the "timing" of the deal in view of the "climate" in Congress and at the FCC. The FCC is about to embark upon an investigation of network-affiliate relations under special mandate from

Congress, being virtually assured of an appropriation of \$80,000 earmarked for that purpose.

Both the Senate and the House Commerce committees, headed by Sen. Warren G. Magnuson (D-Wash.) and Rep. Percy Priest (D-Tenn.) have announced plans for studies of the overall broadcasting regulatory and network structures, with the Senate committee having engaged special majority and minority counsel for this purpose.

Westinghouse now is awaiting final FCC decision on its application for ch. 8 in Portland, Ore., which would give it its fifth vhf station as a companion to its KEX there. There is no assurance, however, that Westinghouse will be the successful applicant among the four applying for the facility.

NBC, with its full quota of vhfs, under the former multiple ownership regulation knocked out recently by the Court of Appeals, is awaiting FCC action on applications to acquire by purchase two uhf outlets—WKNB (TV) New Britain, Conn., and WBUF-TV Buffalo. The FCC has already issued a McFarland letter in the case of the New Britain transfer. In this case, the FCC made one of the issues the question of possible overlap between that station and the NBC-owned WRCA-TV New York (ch. 4), specifying grade B coverage extending roughly 200 miles. NBC, however, views this issue as a "technicality" because of the requirements under FCC regulations for automatic hearing in economic protest cases [Sec. 309 (c)].

Upon FCC approval of the Philadelphia-

Westinghouse: Big Dealer

WESTINGHOUSE has been a principal in the four biggest single station transactions in history.

Last December it bought WDTV (TV) Pittsburgh, now KDKA-TV, from DuMont for \$9,750,000.

In July 1954 it bought KPIX (TV) San Francisco from Wesley I. Dumm and associates for \$6 million in cash and Westinghouse stock. By the time of FCC approval, the stock had risen in value so that the FCC described the total sale as a \$7.5 million package.

In May 1953 Westinghouse bought WPTZ (TV) from Philco for \$8.5 million.

Its swap of WPTZ for NBC's WNBK (TV) last week represented a rock-bottom figure of \$8.5 million, although only \$3 million in money changed hands.

Here are some other sales figures of the past six years:

July 1949: KRSC-TV Seattle (now KING-TV), sold by P. K. Leberman to Mrs. A. Scott Bullitt and associates for \$375,000.

July 1950: WOIC (TV) Washington (now WTOP-TV), sold by Bamberger Broadcasting Co. to WTOP Inc. (then 55% owned by *Washington Post* and 45% owned by CBS) for \$1.4 million.

December 1950: KTSL (TV) Los Angeles (now KNXT [TV]), sold by Thomas S. Lee Enterprise Inc. (General Tire & Rubber Co.) to CBS for \$3.6 million.

August 1951: KFI-TV Los Angeles (now KHJ-TV), sold by Earle C. Anthony Inc. to General Teleradio Inc. for \$2.5 million.

September 1951: WOW-TV Omaha, sold by Francis B. Matthews and associates to Meredith Publishing Co. for \$2.5 million (with WOW).

January 1952: WOR-TV New York, sold

by Bamberger Broadcasting Co. to General Teleradio Inc. for \$4.5 million, plus \$315,000 annual lease and 10% interest in purchasing company, by R. H. Macy Co., majority stockholder of Bamberger (including WOR-AM-FM).

February 1953: WBKB (TV) Chicago (now WBBM-TV), sold by Balaban & Katz Inc. (now part of American Broadcasting-Paramount Theatres Inc.) to CBS for \$6 million.

May 1953: WPTZ (TV) Philadelphia, sold by Philco Corp. to Westinghouse Broadcasting Co. for \$8.5 million.

June 1954: KLZ-TV Denver, sold by Aladdin Radio & Television Inc. to Time Inc. for \$3.5 million (including KLZ-AM-FM).

November 1954: WCCO-TV Minneapolis, 47% interest sold by CBS to Cowles Publishing Co. for \$3.9 million (with WCCO).

December 1954: WTOP-TV Washington, 45% interest sold by CBS to 55% owners *Washington Post & Times Herald* for \$3.5 million.

January 1955: WDEL-TV Wilmington, Del., sold by Steinmans to Paul F. Herron (WIBG Philadelphia) for \$3.7 million.

WTCN-TV Minneapolis, sold by Robert Butler and associates to Consolidated Tv & Radio Bcstrs. Inc. (Bitner) for \$1.9 million.

WMIN-TV St. Paul, sold by N. L. Bentson and associates to Consolidated Tv & Radio Bcstrs. Inc. (Bitner) for \$1.23 million.

WTVW (TV) Milwaukee sold by Milwaukee Telecasters Inc. to Hearst Corp. for \$2 million.

March 1955: WNBC-TV Binghamton, N. Y., sold by Clark Associates Inc. to Triangle Publications Inc. (WFIL Philadelphia) for \$3 million (with WNBC).



"I didn't like to cook very much until I started watching your program..."

"... and now I *like* to cook," says a viewer from Trenton, Tennessee, writing to Carolyn Godman of WMCT.

This is just one excerpt from thousands of letters Mrs. Godman has received since she has conducted the Homemakers Program with Trent Wood, over WMCT, Memphis. Some others:

"I'm sure you're giving great pleasure to many housewives."

"Your recipes are good. I try lots of them and pass them on to others."

"You make cooking look so easy and enjoyable."

She really does — every day, Monday through Friday. Some participations still available.

WMCT

MEMPHIS' FIRST TV STATION

NOW 100,000 WATTS

NATIONAL REPRESENTATIVES
THE BRANHAM CO.

Owned and operated by
THE COMMERCIAL APPEAL



Cleveland station exchange, NBC expects to transfer its top management team in Cleveland to Philadelphia, and WBC will move its key Philadelphia executives to Cleveland. The rest of the NBC and Westinghouse personnel will remain in place under the new ownership.

Lloyd E. Yoder is general manager of WNBK (TV) and WTAM-AM-FM Cleveland. Top WBC executives in Philadelphia are Roland V. Tooke, station manager of WPTZ (TV), and Frank A. Tooke (no relation), station manager of KYW.

Conversations have been held off and on between Messrs. Heffernan and Witting since early last fall, but there had been discussions also between Westinghouse and CBS regarding possible switches in affiliation, dating back to 1953. These, it was learned, had been revived as recently as several weeks ago. CBS, however, was reportedly loath to change its long-established affiliation with WCAU-AM-TV, now owned by the *Philadelphia Bulletin* but established by the Levy brothers, both of whom had served on the CBS board of directors almost from start of the network's operation.

In some quarters it was reported that NBC would make an acquisition in Philadelphia whether or not it was with Westinghouse. Last fall there were reports of conversations regarding a possible shift in affiliations by NBC from Westinghouse to WFIL-AM-TV, owned by the *Philadelphia Inquirer*. Reports of a possible even-up swap of the *Inquirer* properties for NBC's Cleveland properties were never verified.

Last January it had been said that the NBC board had approved the very transaction agreed to last week—exchange of the Cleveland properties for the Philadelphia properties with \$3 million to boot for Westinghouse. At that time it was reported that Westinghouse was reluctant to trade because of the profitability of the Philadelphia operations.

The Westinghouse Electric board, it is understood, last fall authorized the subsidiary WBC to engage in the negotiations. There was one postponement after another until last week.

FCC Notified

Last Tuesday, F. M. Russell, vice president of NBC in Washington, and Joseph E. Baudino, WBC vice president, called on members of the FCC informally to notify them of the transaction. Transfer papers, it was indicated, would be filed within a fortnight.

In the negotiations over the past several months, Messrs. Witting and Heffernan conferred frequently. Mr. Witting also had discussed the transaction several times with Brig. Gen. David Sarnoff, RCA's board chairman, and, as such, the policy head of NBC. Also in the conversations for NBC from time to time were Robert W. Sarnoff, executive vice president of NBC, and Charles R. Denny, vice president in charge of owned-and-operated stations. E. V. Huggins, vice president of corporate affairs of Westinghouse Electric Co., and chairman of WRC, and Mr. Baudino also sat in from time to time for Westinghouse.

Originally NBC had suggested not only the Cleveland-Philadelphia swap, but also a sister transaction involving NBC's Washington properties, WRC-AM-FM-TV, for Westinghouse's Boston properties, WBZ-WBZA and WBZ-TV. Mentioned then was the prospect that Westinghouse could locate WRC-TV (ch. 4) at a point midway between Washington and Baltimore (separated by about 40 miles) to cover both markets. Westinghouse has important factory operations in the Baltimore area but would not consider this proposal, and the conversations settled down to Cleveland for Philadelphia.

Subsequently NBC renewed its regular affilia-

Another thinly disguised WJR success story

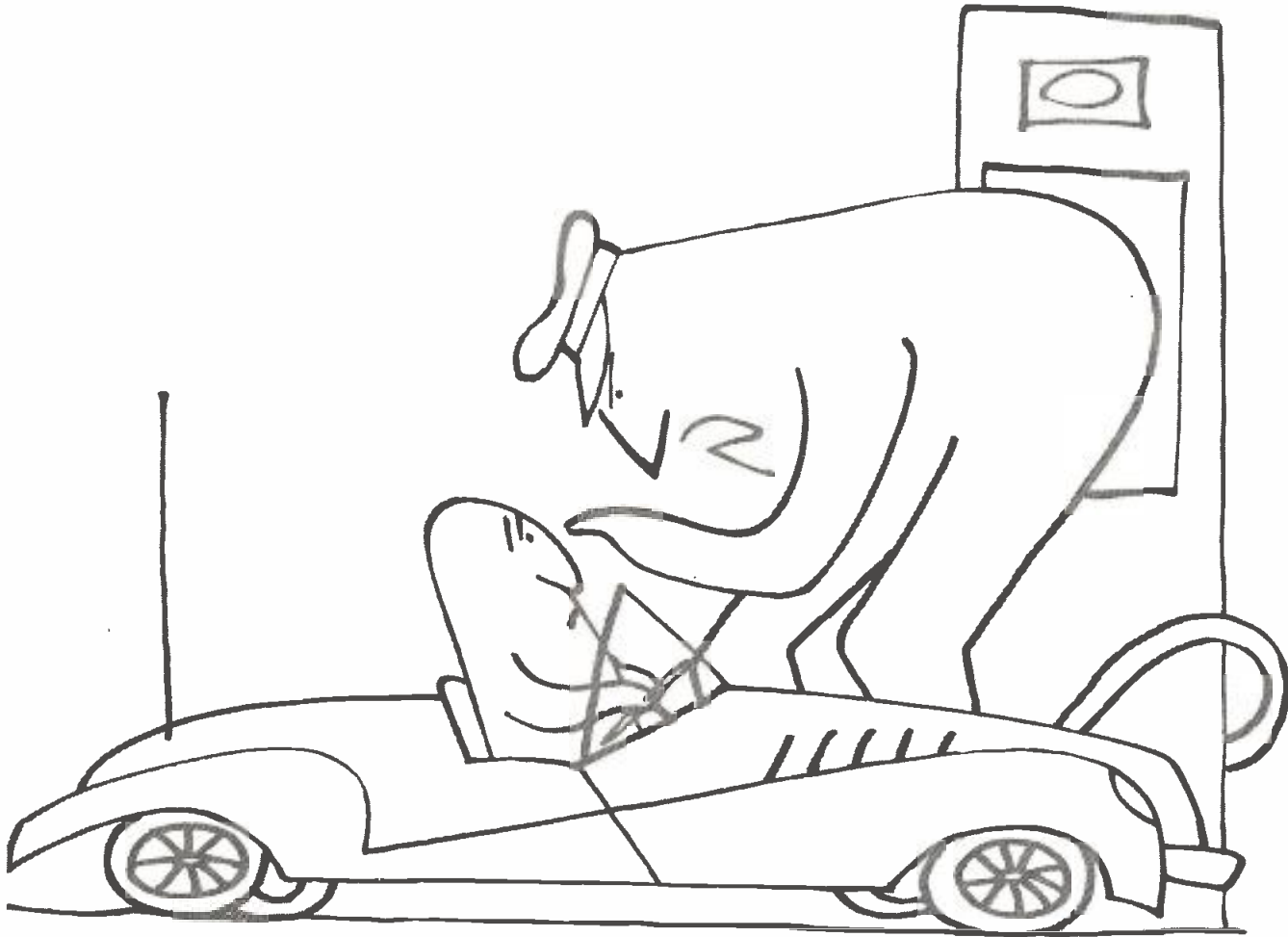

I don't care what WJR says—we haven't got it!

One day an advertiser sent us a commercial announcing a new ingredient in his product.

It went on sale Wednesday. Part of his strategy was that the dealers themselves weren't to know it until Wednesday.

He sponsored an early evening newscast on WJR. Naturally, we put the commercial on his Tuesday show—to give him a headstart on announcement day.

And even we didn't anticipate what would result. Right away, dealers in Cleveland, Toledo, Saginaw, Lansing, Flint and Detroit got on the phone. They barraged the Detroit division manager—even called the New York office. They were

being pestered by people for a product they didn't have.

The Detroit division manager is a charming fellow with great respect and admiration for WJR. (He points to his sales to back him up.) When the home office and his dealers called him, he had a very simple lesson for them.

First, he said, this was proof that the best—and *cheapest*—way to *move goods fast* is to advertise with *spot radio on WJR*.

Because, he warned, when WJR goes to work, your product had better be ready to go—right now.

They believed him. Wednesday sales were out of this world. WJR believes him, too. Your Henry I. Christal man can tell you why.

The Great Voice of the Great Lakes

WJR

Detroit

50,000 Watts CBS Radio Network

WJR's primary coverage area:
16,000,000 people





Advertisement

From where I sit by Joe Marsh

Sales "Picking Up"

Someday when you're waiting on the corner for a bus, don't be surprised if Slim Miller from the Town Used Car Lot pulls up and offers you a ride.

"I hate to see anyone standing in the cold," Slim says. "One day when I picked up a fellow in my own re-conditioned car we got to talking about its smooth-running motor. Next day he came down to buy a used car."

"Now I drive a different car each day, so when I pick someone up I can demonstrate its slick performance. I'm selling more used cars than ever before—making lots of new friends, too!"

From where I sit, Slim's "be nice to your neighbor" campaign is one reason for his being a leading businessman in this town. But it goes further than that because he isn't only nice to potential customers. He's neighborly to everyone—local folks and tourists, Democrats and Republicans, lemonade-fanciers and those who'd rather enjoy a glass of beer. There's nothing "secondhand" about his community spirit."

Joe Marsh

Copyright, 1955, United States Brewers Foundation

STATIONS

tion contract with WBAL-TV, Hearst-owned station in Baltimore.

Last January, B•T published this CLOSED CIRCUIT:

"PHILADELPHIA STORY AGAIN. Although talk of NBC-Westinghouse swap of stations had subsided, reports were current again last week that network would like to get KYW-WPTZ (TV) Philadelphia, in exchange for WTAM-AM-FM and WNBK (TV) Cleveland, throwing in a bundle of cash of several million to make up difference. There was no confirmation out of NBC, and Westinghouse denied current conversations. Westinghouse paid \$8.5 million to Philco for WPTZ (ch. 3) in May, 1953, and presumably isn't in trading mood after its \$9,750,000 purchase of WDTV (to be KDKA-TV) Pittsburgh, closed last week."

Subsequently, consistent inquiries regarding the status of negotiations brought unofficial word from NBC that a deal was imminent but denials from Westinghouse. Ten days ago, on Friday, May 13, reports became current in Cleveland that the transaction had been "closed." Inquiries by B•T of responsible Westinghouse officials brought the response that the situation was *status quo* and that no deal had yet been made. By Monday noon, however, word was received that the contract had been approved by both boards, had been signed and that a simple announcement would be made the following day.

Shouse to Return as Chief Of Crosley Broadcasting Corp.

RETURN of James D. Shouse as head of Crosley Broadcasting Corp. and the election of Chester G. Gifford to the newly-created post of president of the Crosley and Bendix Home Appliances Div. of Avco Mfg. Corp. was announced last week by Victor Emanuel, Avco president and board chairman. Mr. Gifford also was elected a vice president of Avco.

Mr. Emanuel said that following an extended rest Mr. Shouse, vice president of Avco who has been acting general manager of the Crosley and Bendix divisions, will resume his duties as chairman of Crosley Broadcasting, an Avco subsidiary.

Mr. Gifford was president of Schick Inc. until 1954. He had been with that company since 1940 except for a two-year period when he was vice president and director of Swank Inc. During World War II, he served with the U. S. Army Signal Corps in Europe.

B. P. Timothy Resigns Post With Avery-Knodel in Chicago

B. P. (TIM) TIMOTHY has announced his resignation as general sales manager in the Chicago office of Avery-Knodel Inc., national station representative firm, effective June 1. He said he plans to enter the station ownership field in the West or Southwest and also attributed his resignation partly to "family considerations."

Mr. Timothy has been associated with Avery-Knodel since it was founded as the Lewis H. Avery Co. in 1945, and was a director and secretary of the representative firm. Previously he was with Free & Peters, representative firm, for over three years, advertising manager of Griesedieck-Western Brewing Co. for four years and national advertising representative for Oklahoma Pub. Co. Mr. Timothy was Chicago office manager of Avery-Knodel for 13 months until October 1946.

BROADCASTING • TELECASTING



What happened in Amarillo, Texas when KGNC-AM & TV went to bat for the Cancer Fund

(Excerpts from the Amarillo Daily News, April 18, 1955)

Telethon Tops Cancer Crusade Goal

The famed creator of the polio vaccine, Dr. Jonas Salk, was given a 1955 Oldsmobile—and the Cancer Crusade gained \$22,244.29 as the result of the 6½-hour telethon from KGNC-TV and KGNC-Radio yesterday.

In a triple play—from auto dealer to Cancer Crusade to the famed scientist—the big car, with air conditioning to be added, was paid for by the gifts of enthusiastic West Texans.

To the young scientist who will receive no remuneration for his long work on perfecting the vaccine that may eliminate polio from the world, other givers added a gold key, a license plate, in fact, everything including an expense paid trip to Texas to accept the car.

Late last night Dr. Salk had not yet been reached for a statement at his home near the University of Pittsburgh where he is a staff member of the medical department. Although he has steadfastly refused any gifts from individuals, it was thought by some of his co-workers in Pittsburgh that he would take the car since it was purchased with dollars that will go to search for a cure for another dreaded disease—cancer.

Originally KGNC-TV planned to auction off dozens of items contributed from Amarillo merchants (with one big refrigerator from a Happy merchant and the Happy Lions Club). And until around 4 p.m. the auction went off as scheduled with more than \$8,000 raised by the sale of merchandise.

Then a Chevrolet truck was brought on, and a bid came from New Mexico for \$1750 on the valued \$2064.25. Sam Fenberg called in:

"Let's put up the money and buy that truck for Boy's Ranch. I'll give \$300."

The idea caught on. The auction had been going well enough when people were bidding for merchandise for their own use, with the knowledge that all monies would go to the Cancer Crusade. But with the chance to simply give without any hope of having something to show for it, the telephone lines clogged.

Before you could say, jack-rabbit, the value of the truck had been met—and passed. In fact, a Graham-Hoernig plow was being brought up into the background, with a price tag of \$419, and someone yelled "Let's give the plow to the Boy's Ranch, too."

The Oldsmobile had been displayed, as had some other expensive appliances to the televiewers. But no bids had been received on it, yet.

Then came a call. Jim Pearson, 1606 Lipscomb, was making another attempt to give an appreciative gift to Dr. Salk. Earlier he had sent a check for \$5 to the Amarillo Daily News, asking that it be given to Salk. His letter had been used in Letters to the Editor and the check sent back with a suggestion that it be given to the National Foundation for Infantile Paralysis, which had raised the funds that provided the research teams for polio.

"Why don't we give that automobile to Dr. Salk," he said. "Come and get my \$5."

It was like hitting the jackpot. In less than an hour, \$6,538.50 had been donated toward the value of that car—and with every cent of it going into the Cancer Crusade funds!

One of the first donors to the fund was Ken Randall, whose firm of Garner-Randall Motors, Inc., had donated the car in the first place. His was one of many \$100 gifts. (In fact, a few of the contributions came in addressed to the polio fund, but these would be separated and sent to that organization. The team of auctioneers, headed by Johnnie Linn, and formed of Pappy Watson and Bob Izzard, explained carefully what was going on—but on any triple play, the onlookers are apt to be confused!)

The telethon was a runaway by that time. With a dozen fine appliances awaiting homes, the "gift for Dr. Salk" kept eight telephone lines in constant use. It was after 6 p.m. before Johnnie Linn could get the cameras back on the appliances.

Between times the Amarillo Chamber of Commerce had offered to pay Dr. Salk's expenses to Texas to pick up the car. Several individuals had offered to take the car to him without

cost. Mrs. Warren Freeman said she'd buy the license plates, and Hubert Cole, Potter County tax collector, who has worked with the Cancer Crusade for years, said he'd guarantee any license number Dr. Salk wanted. Someone offered a gold key. And the cost of airconditioning the car was added by inspiration of one caller.

Then W. A. Graham called to say he could stand the gift of another plow. "Auction it off so Dr. Salk can have one if he's got a farm," he said. No one knows yet whether Dr. Salk has a farm or not. He's got a plow!

The generosity of the Plains people was truly a Golden Age and yesterday afternoon. Frank Purley of Miami bought a \$500 defense bond for \$501. Even after waiting 10 years to get his \$500, he'll still be short of what he paid for it.

Other items sold at well over retail price as Plainsmen bid to give the Cancer Crusade assistance. Exhorted by Johnnie Linn to remember what research had done toward stamping out polio, the money came a-bouncing.

"We can give our time and our money to defend our country in war times. Why can't we give both to wipe out the shameful death rate of cancer—one of every seven deaths in the U.S.A. was caused by cancer last year," he said. "At least 265,000 Americans will die from cancer this year. Our dollars can help to fight this battle, too."

Not all of the \$22,000 fund raised in the telethon will be credited to the Potter County goal (which already had more than \$3,000 in earlier donations). All of the donations made by residents of other counties will be credited to their counties. The breakdown of contributions will be given Monday by Calvin Handy, head of the accounting department of KGNC, who kept the books on the telethon yesterday.

To try to give full credit to all the people who made the telethon a success was like trying to sweep up the ocean, said Pappy Watson as he scurried from television studio to radio rooms, keeping the simulcast under way for an extra two hours.

First, there was Tom Kritzer, who conceived the idea after

watching a similar auction in Cleveland. Kritzer personally took on the task of interesting merchants in contributing the items to be auctioned.

There were the staff members of the radio and television station who built the show, staff it through the long afternoon. With no lunch and a long delayed dinner hour, they were fed by hamburgers from Stanley's, and fried chicken from Jones. Dell's Ranch House told the tired, hot crew to come out for a steak dinner.

Armstrong Transfer Co. hauled the heavy auction items to the studios. Dub Trotter offered to deliver to the buyers any items purchased.

And of course there were thousands who bought auctioned items, or made contributions—many of them anonymous. For example, there was the lady who paid \$139 for a chair she could buy for \$100, or Sam Fenberg, who after giving \$300 to the truck for Boys Ranch added another \$100 to the Cancer Crusade by contributing \$100 to Dr. Salk's car.

"The Only Bargain Here May Be Your Life!"

That sign dominated the camera picture. No one tried to buy any bargains.

And they gave in gratitude to a young man who had saved their children from polio—and to win the battle against cancer which another young scientist, God willing, will do in some not too far off future.

KGNC
AM & TV
Amarillo,
Texas



NBC and
DuMont
Affiliate
National
Reps:
The Katz
Agency

Wednesday, May 11, 1955

VARIETY

CBS-TV TO 'SPEC

... ..

VARIETY

... ..

RADIO-VIDEO-TV FILMS

27

IT UP, TOO

Wednesday, May 11, 1955

TV Specs for Britain, Too

London, May 10.

tern of commercial tv in London taking shape
associated

EXCITING THINGS ARE HAPPENING ON



TELEVISION

a service of 

WE WELCOME BACK AGAIN THIS FALL THESE SPECTACULAR SPONSORS:

- Ford Motor Company;
- General Motors Corp., Oldsmobile Division;
- Sunbeam Corporation;
- Radio Corporation of America

AND WELCOME TO THESE NEW SPECTACULAR SPONSORS:

- Hallmark Cards, Inc.
- The Maybelline Co.

N E M S - C L A R K E I N C O R P O R A T E D

THE TR-1 TV REBROADCAST RECEIVER

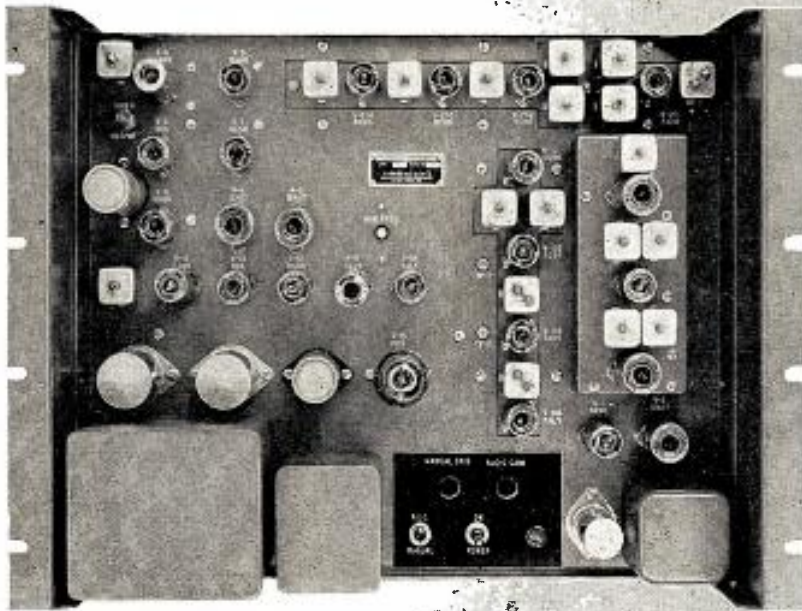

Unattended Operation Keyed AGC

- THREE OUTPUTS - VIDEO, AUDIO AND SYNC • EXCEPTIONALLY CLEAN SIGNAL • MAXIMUM REDUCTION OF IMPULSE NOISE • SPECIAL CIRCUITS IN RECEIVER CORRECT DISTORTION CAUSED BY SIDE-BAND FILTERS
- HIGH DEGREE OF PHASE CORRECTION • SOUND CHANNEL SEPARATE FROM VIDEO CHANNEL TO AVOID LOSS OF SOUND IN CASE OF VIDEO FAILURE • WIDE FREQUENCY RANGE, LOW DISTORTION • BETTER QUALITY SIGNAL THAN THE USUAL INTERCITY CO-AXIAL CONNECTION
- BOTH MANUAL AND AUTOMATIC GAIN CONTROL • 75 OHM CO-AXIAL INPUT • 75 OHM CO-AXIAL OUTPUT ON SYNC • 75 OHM CO-AXIAL OUTPUT ON PICTURE • 600 OHM BALANCED OR UNBALANCED ON AUDIO OUTPUT

These are merely a few of the many reasons why TV station owners with an eye to a bigger share of the listener audience are installing our TR-1 TV Rebroadcast Receiver.

For complete descriptive spec sheet, write or wire Department H at once.

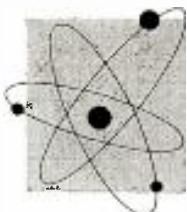

NEMS • CLARKE Incorporated

919 JESUP • BLAIR DRIVE
SILVER SPRING, MARYLAND

STATIONS

Wood, Schreiber Elected To Top WGN Inc. Posts

ELECTION of J. Howard Wood, business manager of the *Chicago Tribune*, as president and Frank Schreiber as vice president of WGN Inc. (WGN-AM-TV Chicago) was announced Monday following the annual board meeting of the Tribune Co.

Mr. Wood also was elected a vice president of the Tribune Co., holding organization for the *Tribune*, *New York Daily News* and 13 subsidiary firms in the U. S. and Canada. He is also a director and trustee of the McCormick estate. Chesser M. Campbell, former director of MBS who earlier was named president of the company, in addition becomes publisher of the *Tribune*.

Mr. Schreiber continues as manager and business manager of WGN Inc. and was re-elected a director. He relinquishes his post of treasurer to J. A. Cotey. Mr. Schreiber, who also is a director of WPIX (TV) New York, MBS and RAB, has been identified with the



MR. WOOD

MR. SCHREIBER

Chicago Tribune radio-tv-newspaper properties for over 30 years. He has been manager and treasurer of WGN Inc. since 1940 and of WGN-TV since 1948.

New directors elected to the board of WGN Inc. include Mr. Wood; W. D. Maxwell, managing editor of the *Tribune* and vice president of the Tribune Co.; Fred Thrower, vice president of WPIX, and C. E. McKittrick, *Tribune* advertising manager. Re-elected as directors were Mr. Campbell; F. M. Flynn, publisher of the *New York News*; Richard W. Clarke, executive editor of the *News*; Mrs. Garvin McCormick Tankersley; Alfred Cowles, and Henry E. Floyd Jr.

J. J. Jameson was named auditor and controller of WGN Inc. and Fred Byington Jr. continues as secretary. Elections and appointments follow in the wake of the death of Col. Robert R. McCormick, editor and publisher of the *Tribune*, on April 1.

New officers of WPIX Inc. (WPIX [TV] New York, which is owned by the News Syndicate Co., subsidiary of the *Chicago Tribune*) are J. J. Lynch, assistant treasurer, and T. E. Mitchell, auditor and controller.

WWTV (TV) Goes to 104 Kw

REPLACEMENT of its 530-ft. tower with a 1,282-ft. model, which reaches 2,985 ft. above sea level and increases power to 104 kw, has been announced by ch. 13 WWTV (TV) Cadillac, Mich. The new signal is projected into 42 Michigan counties with a population of 1,338,525 people, WWTV reports. The tower is triangular, has 11-ft. sides and was constructed by the Truscon Steel Div. of Republic Steel Corp., Youngstown, Ohio.

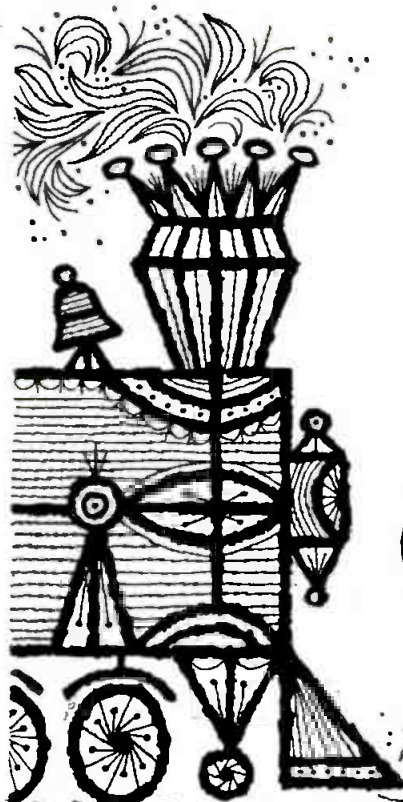

right on time in Chicago...

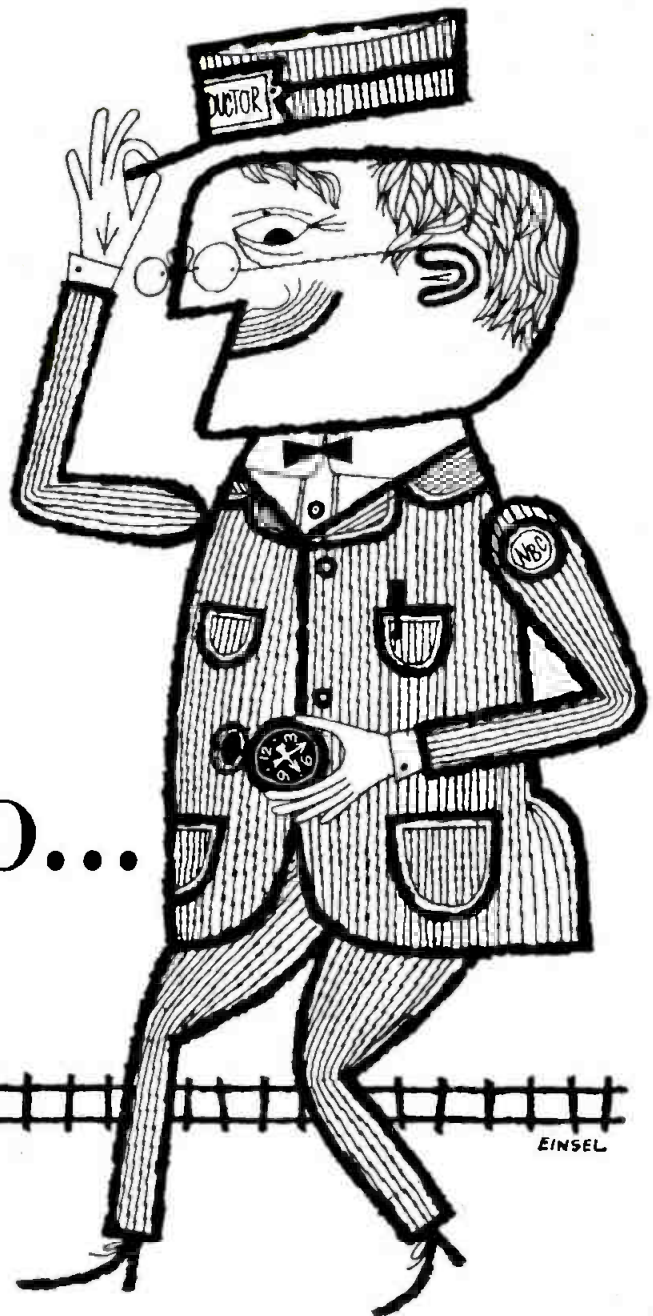

*Time on WMAQ, that is. And it's the
right way to run a railroad!*

Mr. E. E. Gordon, Passenger Traffic Manager of the Chicago & Eastern Illinois Railroad, recently wrote a letter about how right his company's time-buys are on WMAQ:

"We want to convey our appreciation for the *immediate response that we received from advertising our services over your station*. Mr. Henry Cooke on the morning program, as well as Mr. Howard Miller in the evening, along with Mr. Joe Wilson's sport broadcast, made a very effective story from the announcement that described our new train service to Florida, that was *reflected so successfully in inquiry and ultimately in actual sales*. Considerable interest was created as a result of their personal efforts. We are presently contemplating extending the program . . ."

Messrs. Cooke, Miller and Wilson are three of the many home-grown, top-rated WMAQ personalities ready to make sure for advertisers that

THE PAY-OFF IS AT THE POINT OF SALE!

And they're backed to the hilt by WMAQ's strong promotional and merchandising support.

There's a personality and a time that's just right for *your* product or service. All aboard!

WMAQ



RADIO IN CHICAGO

50,000 watts Clear Channel

represented by NBC SPOT SALES

a service of 

to cover the
NEW YORK

Metropolitan area...

*in Spring, an
Advertiser's fancy
turns to...*

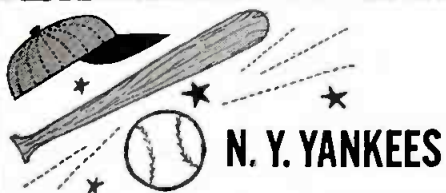

**NEW YORK'S TOP
DISC JOCKEYS:**

*Bob & Ray
Jack Lacy
Alan Freed
Brad Phillips
Peter Roberts
Stan Shaw*

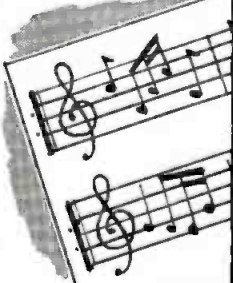

*New York's most
exciting station and
one of America's 2
GREAT independents!*

WINS



*50,000 watts...
...24 hours a day*

SAN FRANCISCO OFFICE:

*Chuck Christianson
Hotel Fairmount
D'Ouglas 2-2536*

CHICAGO OFFICE:

*George Clark
360 N. Michigan Ave.
RAndolph 6-0712*

STATIONS

**19 TV STATIONS
SIGN WITH NATS**

AFFILIATION of 19 tv stations with National Affiliated Television Stations Inc., New York, recently-formed organization which offers member stations management counsel, a sales force, a basic film library and, if necessary, financial assistance [B•T, March 21], was announced last week by Berman Swartz, NATS vice president and secretary-treasurer. The stations are the first to be accepted as NATS affiliates.

They are WROW-TV Albany, N. Y.; KBMT (TV) Beaumont, Tex.; WBLN (TV) Bloomington, Ill.; WCMB-TV Harrisburg, Pa.; WHTN-TV Huntington, W. Va.; WKNY-TV Poughkeepsie, N. Y.; WTOM-TV Lansing, Mich.; WTVE (TV) Longview, Tex.; KEYD-TV Minneapolis; WJMR-TV New Orleans; WVEC-TV Norfolk, Va.; KTVQ (TV) Oklahoma City; WPFA (TV) Pensacola, Fla.; WEEK-TV Peoria, Ill.; KCCC-TV Sacramento; KSAN-TV San Francisco; KTVI (TV) St. Louis; KVVG (TV) Tulare, Calif., and WORA (TV) Mayaguez, P. R.

NATS is backed by General Electric Co. and National Telefilm Assoc. with the intention of helping both uhf and vhf television stations with their management, sales programming and financial problems. Some 700 hours of film from the National Telefilm Assoc. library have been turned over to NATS in addition to other material which includes exclusive footage.

Financial Assistance Offered

Loans to stations may be obtained, where necessary, on a cash basis from GE and deferred film rentals from NTA. At the request of a member station NATS sales personnel will handle promotions and sales campaigns at the local level.

Officers of the NATS organization are Joseph Justman, president of Motion Picture Center Studios, Hollywood, board chairman; Ely A. Landau, president of NTA, executive vice president; Oliver Unger, executive vice president of NTA, vice president, and Mr. Swartz, who is a motion picture producer and attorney.

In announcing the affiliation of the 19 stations with NATS, Mr. Swartz said that of the 19 stations only three had requested financial assistance.

Within the next few days, Mr. Swartz said he expects to announce additional affiliates. He pointed out that a number of station operators have made arrangements to meet with NATS executives at the NARTB convention this week.

**Farm Shows Featured
In WREX-TV Lineup**

WREX-TV Rockford, Ill., is stressing farm shows on its programming schedule and reports a number of contracts signed by rural advertisers.

Among programs now carried by the station are one sponsored by Murphy Products Co., Burlington, Wis., and devoted to national and local news, market quotations and other statistics; *Town and Country Time*, featuring rural music, and *Waterfront*, syndicated film package just renewed for 26 weeks by 16 area John Deere dealers.

Among other advertisers signed by the station are American Cyanide Co. (Lederle Lab Div. for a cow remedy) and Pfizer Corp. (Ter-ranicyn). Les Davis, WREX-TV farm director, handles local programs.

to cover the
SAN FRANCISCO
Bay area...

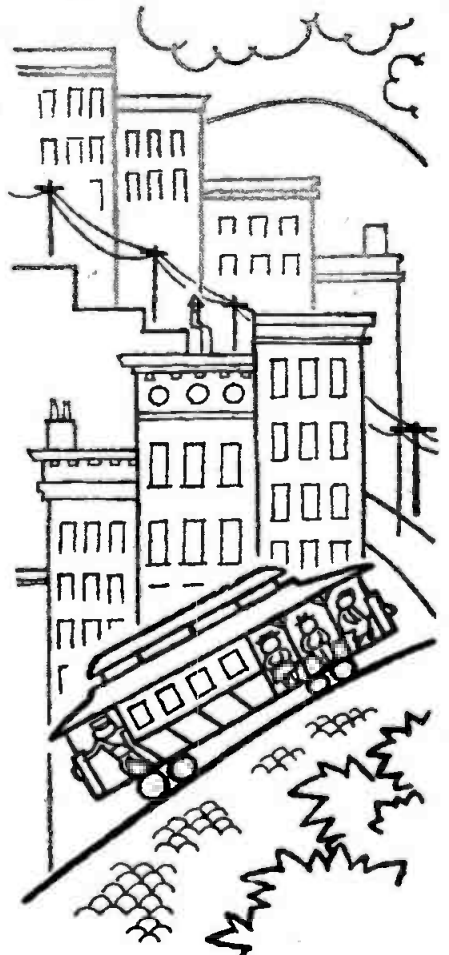

*... use one of
America's 2
GREAT independents!*

KYA

*The Personality Station
... 1260 k. c.*

NEW YORK OFFICE:

*John Barry
28 West 44th St.
BRyant 9-6018-14*

CHICAGO OFFICE:

*George Clark
316 N. Michigan Ave.
RAndolph 6-0712*



each one is different

The staff of life — despite its many origins and types — is a common need around the world. Quality television stations — just as diverse in their personalities and origins — share a common need for individualized representation.

Some of the most outstanding find their answer with Harrington, Righter and Parsons. If your standards are similar to theirs, this is the kind of quality representation worth investigating.

Harrington, Righter and Parsons, Inc.

*New York
Chicago
San Francisco*

<i>WAAM</i>	<i>Baltimore</i>
<i>WBEN-TV</i>	<i>Buffalo</i>
<i>WFMY-TV</i>	<i>Greensboro</i>
<i>WTPA</i>	<i>Harrisburg</i>
<i>WDAF-TV</i>	<i>Kansas City</i>
<i>WHAS-TV</i>	<i>Louisville</i>
<i>WTMJ-TV</i>	<i>Milwaukee</i>
<i>WMTW</i>	<i>Mt. Washington</i>
<i>WSYR-TV</i>	<i>Syracuse</i>

television — the *only* medium we serve

FARRIS, NATS SET KTVQ (TV) REVAMP

U. S. District Court approves plan by E. A. Farris, new controlling owner, and National Affiliated Tv Stations Inc. to reorganize Oklahoma City uhf.

PLAN for financial revitalization of uhf KTVQ (TV) Oklahoma City was approved last week by the station's creditors and confirmed by the federal district court. Major backing for the station's reorganization comes from the combined resources of KTVQ's new controlling owner, E. A. Farris, who was one of the major creditors, and the National Affiliated Television Stations Inc., formed two months ago to give aid to ailing stations, uhf or vhf.

The plan for reorganization was formulated by NATS with Mr. Farris, Oklahoma attorney, oilman and rancher. Mr. Farris cancelled all station debts owed him in exchange for all voting common stock [AT DEADLINE, May 16].

NATS was formed by General Electric Co., National Telefilm Assoc. and Hollywood motion picture people because of concern over the increasing number of financially unstable tv stations in seemingly profitable markets. Its part in the rebuilding of ch. 25 KTVQ will be to furnish financial assistance where required, management counsel, an experienced national and regional sales representation and programming. At the time NATS was first announced it offered affiliates a basic film library of over 1,000 hours, mainly the library of National



MR. FARRIS

MR. LESTER

Telefilm Assoc. plus feature films released for tv.

All present KTVQ stockholders will surrender their voting stock for preferred stock. Mr. Farris then will be issued all the voting common stock, becoming controlling owner, subject to FCC approval.

New personnel and management counsel appointed to put KTVQ back on a financial footing include:

- Richard Doherty, director of NATS management services and president of Radio-Tv Management Corp., Washington, who will work closely with the station in an advisory capacity.

- Robert Purcell, tv consultant and former executive of KTTV (TV) Los Angeles, who at the recommendation of NATS will serve as director of television for 60 to 90 days.

- R. Mack Lester, for the past four years station manager of KTOW Oklahoma City, who will be general manager, assuming complete responsibility for KTVQ when Mr. Purcell's job is done. Mr. Lester has been in broadcasting for nine years, almost all in Oklahoma

City. He was sales manager of KOCY there for three years and also served with KBYE there a year and a half. He is a past director of Oklahoma Broadcasters Assn.

In commenting on the reorganization which was filed last December, Judge Edgar S. Vaught of the U. S. District Court for Western Oklahoma, lauded the plan and said he was glad to see both local and national organizations coming to the aid of KTVQ. He said local creditors have been motivated by a "sense of civic pride," recognizing the benefit the community will receive by "preserving the station."

Added cooperation is being received from ABC-TV, which is expected to increase substantially the number of network programs carried by KTVQ.

Francis J. Brott Dies; KOMO Engineering Chief

FRANCIS J. BROTT, 65, director of engineering for KOMO-AM-TV Seattle, Wash., died May 11 following a four-month illness.

Mr. Brott was a radio pioneer, obtaining his first amateur license in 1916. He built five of the original broadcast station transmitters in the Pacific Northwest, as well as KFIY and KGCL, two early broadcast stations which were owned and operated by him in Seattle.

He was named chief engineer for KOMO when it was organized in 1926 and in 1952 was named director of engineering for radio-tv. During his tenure at KOMO, four complete studio installations have been made, including the present \$1 million six-studio plant which houses the stations.

He was a registered professional engineer, a senior member of the Institute of Radio Engineers and a member of Radio Pioneers.

He is survived by his widow, Florence Reed Brott, and two sons.



MR. BROTT

Stafford Warner Dies

FUNERAL SERVICES have been held for Stafford Warren Warner, founder, general manager and co-owner of KWBR Oakland, Calif. Mr. Warner, 63, died May 8 at Oakland's Peralta Hospital. Services were held May 12.

In 1919 Mr. Warner established one of the first radio stations. A year later his experimental outlet began operating under the call KLS which was changed to KWBR in 1945. Mr. Warner also is a pioneer in radio retailing; he opened his first store in 1920.

He is survived by his mother, a sister and three brothers, one of whom is Eugene, co-owner of KWBR.

KPTV (TV) Plans 1,000 Kw

INCREASE in power to 1,000 kw, maximum allowed for a uhf station, has been slated for June 11 by KPTV (TV) Portland, Ore., the nation's first commercial uhf outlet. Delivery of a new RCA high-power antenna is expected late this month at which time it will be placed atop a new 535-ft. tower, replacing the present 210-ft. structure. Target date for the power increase is set to coincide with Portland's Rose Parade. KPTV operates on ch. 27 and is owned by Storer Broadcasting Co.

SESAC

"the best music in America"



475 FIFTH AVENUE

NEW YORK

ONLY ON



Sound-est investment

Only on WBTV Radio can you associate for your product the massive, traditional selling power of "Grady Cole Time", now in its twenty-sixth year and stronger than ever. Grady gives each of his forty-six current sponsors individualized benefit of his 8.7 average Pulse rating (5:45 to 9 a.m., Monday through Saturday) plus canny commercializing and immense influence with consumers, retailers and wholesalers.

The rarity of availabilities underlines the prudence of regular contacts with your CBS Radio Sales man.

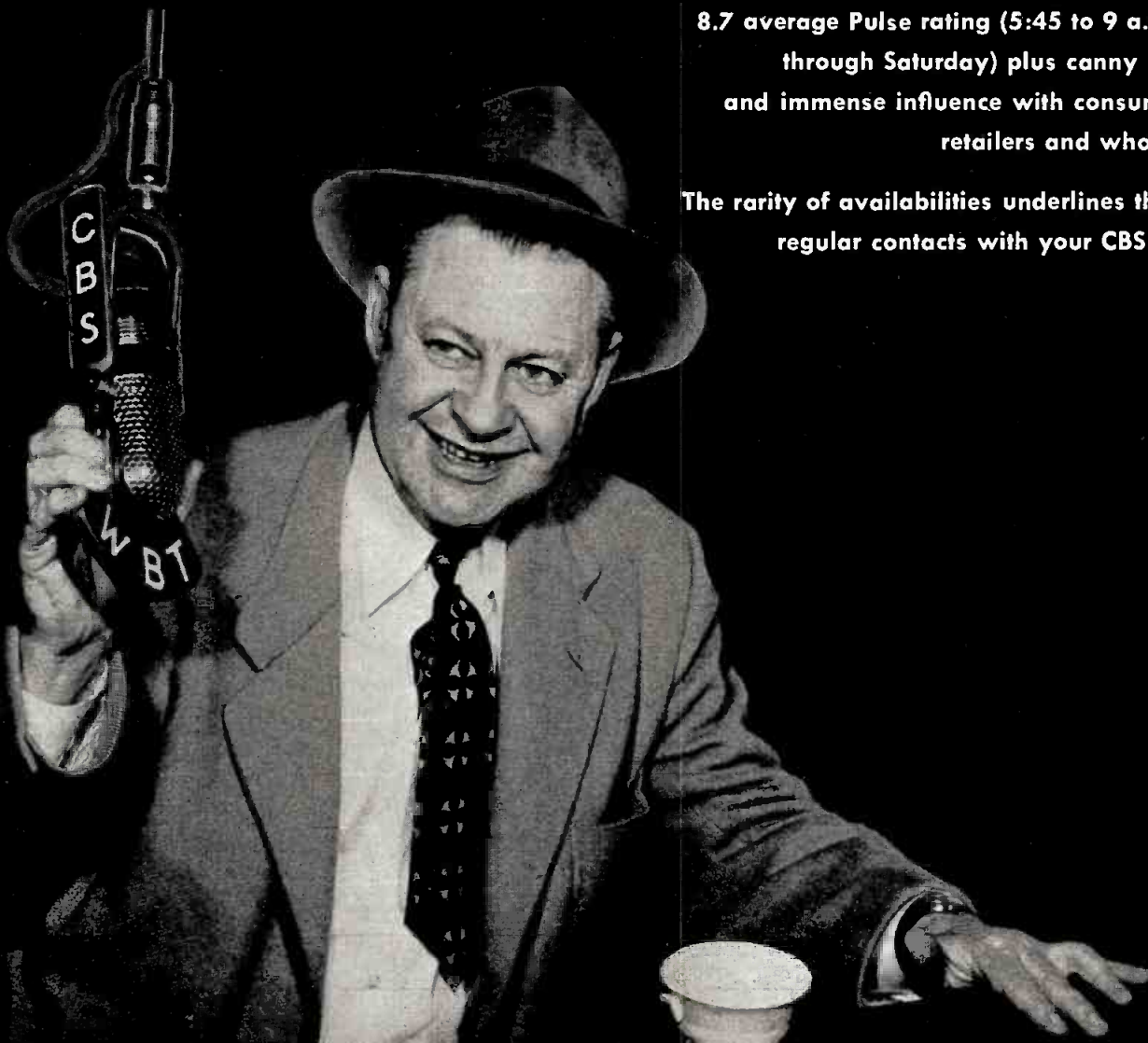

A
Progress
Report
(and sincere thank-you)

to
all
our
ABC
Affiliates

When we're thrashing out our problems (everybody has 'em), it's pleasant to remember we're in the middle of the most exciting year in ABC's history.

It's a year which has seen the success of many major TV properties...like DISNEYLAND, to name an outstanding example. Before it's over, you'll be adding such shows as MICKEY MOUSE CLUB, WARNER BROS. PRESENTS, WYATT EARP, IT'S A GREAT COUNTRY and others to the list.

Since January, ABC Television has signed \$43 million worth of new business and renewals. Already, that's a record, topping our TV revenue for the entire year 1954. And these orders are coming from blue-chip advertisers and agencies.

We are pleased that our radio and television networks are now offering such diversified and interesting programs as the WEDNESDAY NIGHT FIGHTS and the VOICE OF FIRESTONE. This combination of radio and television for the same program makes excellent advertising sense. In the fall, Bishop Sheen's unique LIFE IS WORTH LIVING will be an important new addition to the list of ABC Radio *and* ABC Television programs.

Radio presents knotty problems, but we are proud of our success in this medium, and we continue to make gains. In just the past two years, for example, ABC Radio's morning audience has increased 15%. Another outstanding success: our WEEKEND NEWS saturation package. It has been continually sponsored for two years and earns a gross audience rating bigger than that of any other radio show on the air.

Naturally, these solid achievements don't clear up all our headaches. We are frankly not content with our present progress in such areas as nighttime radio. But you may be sure we are devoting special attention to these items, and developing new plans.

No one can know all the answers in this business of ours. Certainly, *we* don't claim to. But every season we hope to bring solid accomplishments to the industry.

To you, our affiliates, we owe a good share of the credit for all this. Thanks for your loyalty and cooperation.

ABC

Radio

and

Television

Networks

Walbridge Now Exec. V. P., Manager of KTRK (TV)

WILLARD E. WALBRIDGE, general manager of KTRK (TV) Houston, Tex., has been elected executive vice president and general manager, John T. Jones Jr., president, announced last week following a meeting of the board of directors.

Mr. Walbridge is a pioneer tv executive, having served with WWJ-TV Detroit when it went on the air in 1946. He later became station manager. Before joining KTRK (ch. 13), Mr. Walbridge was executive vice president and general manager of WJIM-AM-TV Lansing, Mich.



MR. WALBRIDGE

WAGC Chattanooga Owners Buy 80% of WAPO There

SWITCH in ownership of two Chattanooga, Tenn., am stations was announced last week, pending FCC approval.

Ramon G. Patterson, owner of ABC-affiliated WAPO (1150 kc, with 5 kw day, 1 kw night), has sold an 80% interest to local businessmen Rice T. Russell, Hubert M. Martin, Gordon Gambill and Humphrey B. Heywood. The

transaction involved more than \$225,000. Mr. Patterson will remain as president and general manager of the WAPO operation. WAPO-FM, also involved, operates on 99.1 mc with 60 kw.

Messrs. Russell, Martin, Gambill and Heywood, owners of MBS-affiliated WAGC Chattanooga (1450 kc with 250 w), have sold their stock to Prentiss Furlow, N. O. Waites and Cecil Beaver for more than \$100,000. Messrs. Furlow, Waites and Beaver own WHHM Memphis (1340 kc with 250 w). Messrs. Furlow and Waites are Chattanooga businessmen; Mr. Waites is from Memphis.

Mr. Patterson also is 50% owner of Mountain City Television Co., which holds an initial decision for Chattanooga's ch. 3.

ABC-TV Names Wettersten WBKB (TV) Sales Manager

HAROLD R. WETTERSTEN, account executive in the sales department of WBKB (TV) Chicago, has been promoted to sales manager of the ABC o&o outlet, it has been announced by James W. Beach, new director of ABC-TV Central Div.

Mr. Wettersten fills a position that had been vacant since the resignation of Gerald Vernon from the division's director post. Mr. Vernon resigned May 16 and was succeeded by Mr. Beach, veteran sales executive and former Hearst newspaperman [AT DEADLINE, May 16]. Mr. Wettersten has been with ABC since 1950 and previously worked in sales and announcing capacities in Chicago, Milwaukee and Green Bay, Wis.

WTVJ (TV) Foils a Racket

NEWS FILM by WTVJ (TV) Miami, said to be actual shots of local police officers taking protection money from a "bookie," has precipitated an upheaval in Dade County circles. So far, the film, telecast May 9 by WTVJ, has resulted in the arrest of two Miami policemen and prompted Miami's city commissioners to threaten the city manager with loss of his position, according to the station.

Prelude to WTVJ's dramatic scoop began four weeks ago when Daniel Sullivan, managing director of the Greater Miami Crime Commission, asked for and was promised the assistance of station news director Ralph Renick in obtaining evidence of bookie payoffs to Miami policemen.

The county solicitor placed an undercover agent, posing as a bookie, in a downtown Miami hotel room. WTVJ then mounted a camera in an adjacent room, aimed through the back of a one-way glass that appeared to be a wall mirror in the "bookie's" room. A clock and marked calendar were placed in camera range to establish time.

Shortly after the bookie began soliciting business, two Miami police officers—Sgt. James King and Officer E. J. Carberry—visited the room and arranged for a \$50 weekly "protection" fee, according to WTVJ, which recorded the sight and sound of the conversation.

One week later, an emissary, who identified himself as having been sent by Sgt. King, came to the "bookie's" room and, WTVJ reports, was recorded and filmed as \$50 in marked bills for "protection" was counted out.



IN THE SEQUENCE at left, Miami Detective Sgt. James King (l) is caught by the WTVJ (TV) camera as he allegedly discusses "protection" payments with "bookie" Ben Moscovitz. The sequence at right shows cab driver Porter Monroe receiving payoff money from Mr. Moscovitz.

The two officers involved were then arrested and suspension charges filed against both, according to the station. The WTVJ news film shot by cameraman Jay Weand constituted the main evidence.

In the wake of the tv scoop, city commissioners have asked the Dade County delegation to the Florida legislature to introduce a new law empowering the city manager to discharge the police chief without regard to civil service regulations. Within Miami all precinct captains have been switched to new districts and a new chief of detectives installed.

City officials have commended WTVJ for its public service in helping to maintain an efficient, graft-free police operation.

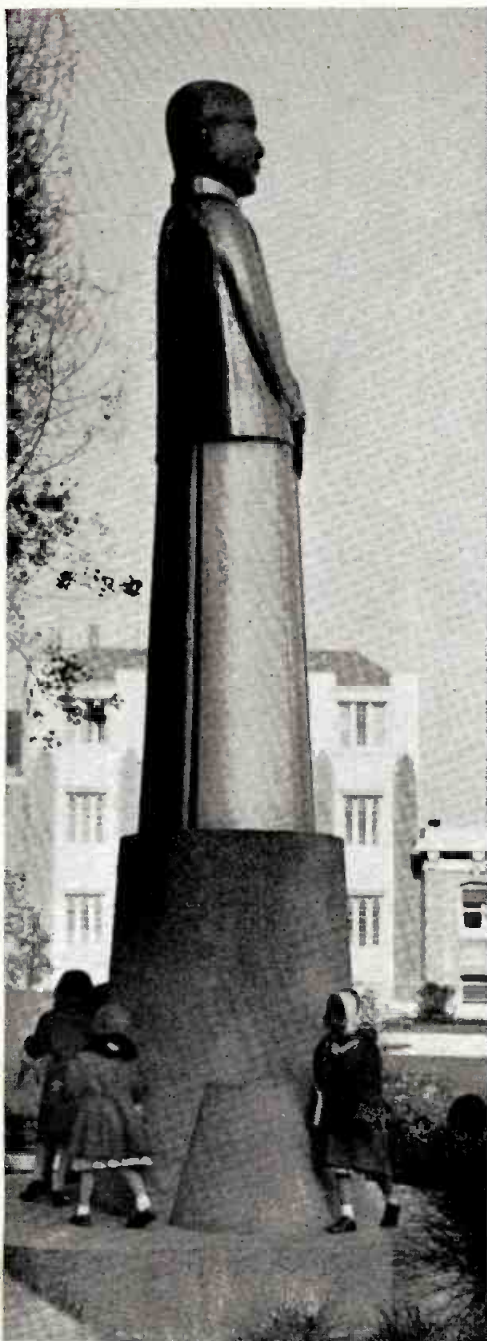

This is San Francisco...

where according to the new Pulse Cumulative Study KCBS reaches 83.4% of the radio families in a week...44.6% in a day. That's more families per week or per day than any other San Francisco radio station!

KCBS

50,000 WATTS

Represented by CBS Radio
Spot Sales



"Ed Murrow's gonna Person-to-Person Gran'pappy this week."

STORER REALIGNS TOP EXECUTIVE DUTIES

George Storer Sr. to serve only at policy level with new duties going to Lee Wailes, Stanton Kettler, George Storer Jr., John E. McCoy and William E. Rine.

REALIGNMENT of functions of the top echelon of Storer Broadcasting Co. was announced last Thursday by George B. Storer Sr., president.

Lee B. Wailes, executive vice president, was given broader executive responsibilities, with Mr. Storer Sr. functioning only at the policy level.

Stanton P. Kettler, heretofore vice president in charge of the southern district, was ele-

vated to vice president in charge of operations of the Storer enterprises, with George B. Storer Jr. succeeding him as southern district vice president. Mr. Storer Jr. formerly served as vice president in charge of finance.

John E. McCoy, secretary of Storer, was elevated to vice president in charge of all non-operating activities of the corporation. He continues as secretary. Mr. McCoy formerly was on the legal staff of the FCC and joined the Storer organization five years ago as staff attorney.

All of these officers headquarter in Miami.

William E. Rine, vice president in charge of the northern district who continues in that post, receives additional responsibility. Mr. Storer noted that as head of the northern dis-

trict where the largest Storer operations are located, Mr. Rine will "by virtue of the geographical separation from the home office in Miami, act in an increased autonomous basis."

Mr. Storer, in making the announcement, said:

"This realignment of executive duties is in line with increased responsibilities resulting from the growth of our company and the nature of our business.

"All of the top executives in the company have come up through the ranks, have been with the company for years and had a large part in its development. Therefore, with day to day operations in their hands, I hope to be able to spend more of my time on overall company problems and planning."

Mr. Wailes joined Storer in March 1946



OH What a BEAUTIFUL MORNING!

SHARE OF RADIO AUDIENCE:

WHEC 50.9

STATION B	18.7
STATION C	14.9
STATION D	7.6
STATION E	4.2
STATION F	3.1*

*Adjusted to compensate for sign-off at local sunset.



MR. WAILES

MR. KETTLER



MR. STORER JR.

MR. MCCOY

...And what a LOVELY AFTERNOON!



SHARE OF RADIO AUDIENCE:

WHEC 34.4

STATION B	25.4
STATION C	4.2
STATION D	18.0
STATION E	11.3
STATION F	5.4*

*Adjusted to compensate for sign-off at local sunset.



ALL DAY LONG ...

MONDAYS THRU FRIDAYS—WHEC GETS THE MOST LISTENERS IN ROCHESTER, N. Y.

All figures taken from Hooper Radio Audience Index, November 1954 through February 1955

BUY WHERE THEY'RE LISTENING ... ROCHESTER'S TOP-RATED STATION

Representatives: EVERETT-MCKINNEY, Inc. New York, Chicago, LEE F. O'CONNELL CO., Los Angeles, San Francisco

after being associated with Westinghouse Broadcasting Co. He was made executive vice president of the company in 1952 and has been an officer and a director since 1948.

Mr. Kettler, with Storer since 1937 when he started as a salesman at WWVA Wheeling, W. Va., progressively advanced as manager of Storer stations to the post of vice president in charge of southern district in 1951. Since 1949 he has been an officer and director.

Also a veteran with the Storer organization, Mr. Rine similarly started at WWVA as a salesman in 1932, subsequently becoming sales manager and managing director. He was appointed to the vice presidency for the northern district Jan. 1, 1953, and has been an officer and director since 1949.

Mr. Storer, Jr. was with the company on a full-time basis beginning in 1948, supervising construction and operation of WAGA-TV Atlanta. In November 1951, he moved to San Antonio to manage KGBS-TV and in April 1954 was shifted to the Miami home office as vice president. He has been an officer and a director since 1951.

WMRI-AM Commences

WMRI-AM Marion, Ind., went on the air on 860 kc May 11, making it now a combined am-fm operation, according to the stations. WMRI-FM has been on the air since October 1953 and has been operating with a staff of four people. The staff has been doubled with the addition of WMRI which operates with 250 w daytime only.

Summer

BRINGS 10,000,000

MORE LISTENERS TO

KYW

10,118,000 out-of-state motorists come into KYW's area June-through-August. Almost 4,000,000 of their cars have radios. What's more, even during summer, KYW's regular listeners rarely leave the signal area. KYW goes along with the vacation crowd, follows them to the mountains, to the shore. Or stays with folks in their own backyards. Yes, KYW entertains a booming summer market. Statistics prove it—

- In the KYW signal area, 91.1% of the families are at home on *any* summer day.
- Of the less than 10% who are on vacation, 54.6% visit vacation spots in Pennsylvania and New Jersey. This means that less than 5% actually go beyond KYW's signal area, even on vacation.

That's IT! Home-bodies, highway-huggers, vacationers alike make up the bonus summer market that gets your message via KYW. More mileage for your advertising money, more push for your product. Get on the bandwagon. See Bob Teter, KYW Sales Manager, or call him at LOcust 4-3700. In New York, it's Eldon Campbell, WBC National Sales Manager at MUrray Hill 7-0808.



KYW
PHILADELPHIA



**WESTINGHOUSE
BROADCASTING COMPANY, INC.**

KYW • WPTZ, Philadelphia; WBZ+WBZA
WBZ-TV, Boston; KDKA • KDKA-TV,
Pittsburgh; WOWO, Fort Wayne;
KEX, Portland; KPIX, San Francisco

KPIX represented by THE KATZ AGENCY,
Inc.; All other WBC Stations represented
by FREE & PETERS, Inc.

EVERYTHING

**for news
for the air!**

For whatever news they need, radio and television turn first to United Press.

Because United Press has everything for news for the air — newswire, newspaper pictures, newsfilm.

And because every one of these is the best of its kind.

Take the newswire. U.P. was the first to provide one for broadcasting, 20 years ago. And ever since U.P.'s been making it better and better, improving the form and widening the scope of its shows. In value it's still the pioneer.

In newspaper pictures too U.P. blazed the trail, coming out with facsimiles that an established network could carry — from any point on it to any other point — without relay or recopying — finished, ready-to-use pictures that do away with the need of a darkroom.

United Press Movietone News again showed the way by delivering newsfilm clip by clip, like dispatches to newspapers, and by keeping them as up to date as the tick of a watch with a day-long script wire — still an exclusive feature.

In consequence United Press from the start has run far ahead in all three forms of news.

Many more stations — over 1600 in all — take the U.P. newswire than any other.

U.P. Movietone News holds a corresponding lead.

U.P. newspaper pictures is the fastest-growing service of its kind in the world: Unifax clients are five times as many as a year ago.

On the page to the right are some specifications of the services that are earning this triple supremacy.

United Press

THE WORLD'S BEST COVERAGE OF THE WORLD'S BIGGEST NEWS



newswire

Around-the-clock world-news report, ready to broadcast as received. The same news shows that more than 1600 stations and more than 200 kinds of sponsors buy. Comprises over 50 news programs and news features daily. In the course of every week it presents: 196 basic news programs running from one to 15 minutes, plus 60 on sports, one to 15 minutes; 16 five-minute features for women; 34 of general human interest, one to five minutes; 17 five-minute farm programs; 20 of commentary and review, five minutes; eight on business and science, five minutes . . . plus a one-hour Sunday Show. Scores more of extra shows of seasonal or special topical interest throughout the year.



newspictures

By wire: Unifax* pictures on continuous roll—or Telephotos—from some 160 sending points in the U. S., Canada, Mexico, South America, Europe, the Orient. Full service averages from 60 to 70 seven-by-nines a day, with 24 top shots duplicated in three-by-four-inch size. Bulletin service available on big news breaks . . . by airmail, messenger, courier: 10 or more selected matte Telephotos daily, in standard, balop or telap sizes, or 35mm transparencies, individually or in strips . . . Supplementary shows: Weather—facts-at-a-glance maps, cartoons, scripts. Baseball Scoreboard—500 cartoons, action shots, scoreboard charts making lively visual program of results. Sports Show—day's top sports photos.

*REG. U. S. PAT. OFF.



newsfilm

United Press Movietone News, produced jointly by U.P. and 20th Century-Fox. 400 to 900 feet of film daily, 16mm, sound-on-film and silent, ample for building as many as three 15-minute shows five days a week. Processed in New York, Washington, Los Angeles, Paris. Delivered by plane and motorcycle courier, story by story, like news to newspapers. Eight-hour leased wire carries scripts keyed and timed to fit film-clips, keep them abreast of latest developments. Service includes 24-hour, 60,000-word daily world-news report. Hold-for-release film clips present scheduled events as they happen. Clients may use clips for own news library; special background footage serviced from Movietone's 50-million-foot library. Special coverage anywhere in the world on assignment.



Don Potter

Star of

"Matinee in Birmingham"

5:00 to 6:30 p.m., Monday-Friday

"Songs in the Night"

10:30 to Midnight, Monday-Friday

**Stars Sell on
Alabama's
greatest radio station**

WAPI

Don is a newcomer to WAPI but is a veteran radio man, having 8½ years experience with leading radio stations in the Midwest. Although he has been in Alabama for only a few weeks, listeners agree that Don's smooth, relaxing music is just what they want to hear on afternoon and late-night disc-jockey shows.

**You can SELL
Your Products
to Alabama folks
If you TELL
them on programs
they enjoy hearing**

**Represented by
John Blair & Co.**

**Southeastern Representative:
Harry Cummings**



BACK on the air after a 44-hour layoff, caused by a \$100,000 fire which destroyed all the equipment of WHIS Bluefield, W. Va., Chief Engineer John Byers (with earphones) operates the transmitter from his seat on cinder blocks as workmen proceed with reconstruction.

WHIS Back on Air After \$100,000 Fire

RADIO was dead in Bluefield, W. Va., but the mourning period was only 44 hours, according to a report from WHIS there. On Sunday, May 8, a disastrous fire, which caused \$100,000 damage, burned down the transmitter building of WHIS and consumed the adjoining domicile of Pat Flanagan, manager of the station. Although damage to the transmitter building was total, alert neighbors and townspeople managed to salvage all of the furniture from Mr. Flanagan's home.

A passing engineer from WELC Welch, W. Va., offered to lend WHIS a transmitter for temporary use and by the following afternoon it was hooked up. With John Byers, WHIS chief engineer, supervising operations, a frequency test was made early Tuesday morning and the transmitter was found to be only three cycles off. With permission from the FCC, WHIS was able to get back on the air just 44 hours after the fire. The station reports that during the blackout many calls were received from concerned citizens, who hoped that the station soon would return to the air.

DuMont Program Division On WABD (TV) Announced

AS AFTERMATH of move in which the DuMont programming department has been divided largely into the Electronicam unit and programming department of WABD (TV) New York, David Lowe, station program director, May 13 announced the make-up of his WABD staff.

It includes Lewis E. Arnold Jr., production supervisor; Hank Humphrey, manager of film department; Walter Wulff, assistant manager of film department; Don Russell, chief announcer; Elizabeth Mears and Joan Thompson, continuity and public service; Wes Kenney, Arnee Nocks, Richard Sanwick, Pat Fay and Barry Shear, directors; Merle Bredwell, Al Kassel, Steve Otis, Jim Saunders and Joel Weisman, associate directors; Frank Cronican and Frank Maguire, program assistants; Dominick Celenano, supervisor of music clearance and library, and Frank Savage and William Kobin, news editors and writers.

WAGE-TV Names Munkhof To Supervise Construction

SOREN H. MUNKHOF, tv consultant and former general manager of WTVW (TV) Milwaukee, has been appointed consultant to handle construction and start of operation of WAGE-TV Marquette, Mich. In making the announcement Jerome Sill, president of licensee Peninsula Television Inc., noted that Mr. Munkhof will turn the management of WAGE-TV (ch. 6) over to Harry Peck after an interim operation period.

Mr. Peck is a one-time business rival of Mr. Munkhof, having served as general manager of WISN Milwaukee when the latter was with WTVW. Previously they were on competing radio stations in Omaha. In addition to his duties as president of WAGE-TV, Mr. Sill is general manager of WMIL Milwaukee.

Clark, Annenberg Complete Purchase of WNBFA-AM-TV

PURCHASE of WNBFA-AM-TV Binghamton, N. Y., by Walter H. Annenberg's Triangle Publications Inc. for \$3 million cash from John C. Clark Sr. and family was completed in Philadelphia Thursday. FCC approval to the sale was announced a fortnight ago [B*T, May 9].

The Binghamton properties, according to Mr. Annenberg, were taken over by Triangle's Radio-Television Div., which operates WFIL-AM-FM-TV Philadelphia and holds 50% interest in WHGB Harrisburg, Pa. Triangle also publishes the Philadelphia *Inquirer*, *Seventeen*, *Tv Guide* and other national publications.

Mr. Annenberg said the WNBFA outlets will continue to be "hometown" stations geared to the needs of the area they serve.

Roger W. Clipp, general manager of Triangle's Radio-Television Div., said George R. Dunham would continue as general manager of WNBFA-AM-TV. WNBFA-AM is a CBS affiliate while WNBFA-TV, only video outlet in that market, carries all four tv networks. Mr. Clipp said a headquarters staff would be named soon to service the Triangle stations in Binghamton, Harrisburg and Philadelphia.

WHBQ-TV Names Lawhead As Sales Service Director

PROMOTION of Gorden Lawhead from program director to sales service director of WHBQ-TV Memphis, Tenn., has been announced by William H. Grumbles, WHBQ-TV operations manager.



MR. LAWHEAD

Mr. Lawhead, who in his new post will serve as liaison between WHBQ-TV and its national representative, Blair-Tv, and the networks, will be succeeded as program director by Wilson Northcross, former production director, who joined WHBQ in 1940 and has been in tv the past seven years.

Succeeding Mr. Northcross is Mark Forrester, former traffic director and creator of WHBQ-TV's *Mars Patrol* program who at one time worked for Disney Studios in Hollywood.



YOU MIGHT THROW A BASEBALL 443 FEET*—

**BUT . . . YOU NEED WJEF RADIO
TO PLAY BALL
IN GRAND RAPIDS!**

GRAND RAPIDS HOOPERS November, 1954—January, 1955					
MONDAY THRU FRIDAY	WJEF	B	C	D	E
7 a.m.—12 noon	26.2	21.7	17.5	15.3	11.3
12 noon—6 p.m.	28.1	17.6	16.4	24.7	10.6
SUNDAY THRU SATURDAY					
6 p.m.—11 p.m.	41.7	27.2	17.6		

WJEF gets the biggest share of the Metropolitan Grand Rapids radio audience, *morning, afternoon and night*. Latest Hoopers show that of the area's 116,870 radio homes, WJEF delivers:

20.7% more morning listeners than the next station—

13.8% more afternoon listeners—

53.3% more evening listeners!

What's more, WJEF costs less. On a 52-time basis, you can buy a daytime quarter-hour for less than 25¢ per thousand radio homes!



The Feltzer Stations

WKZO — KALAMAZOO
 WKZO-TV — GRAND RAPIDS-KALAMAZOO
 WJEF — GRAND RAPIDS
 WJEF-FM — GRAND RAPIDS-KALAMAZOO
 KOLN — LINCOLN, NEBRASKA
 KOLN-TV — LINCOLN, NEBRASKA
 Associated with
 WMHD — PEORIA, ILLINOIS

WJEF

CBS RADIO FOR GRAND RAPIDS AND KENT COUNTY
 Avery-Knodel, Inc., Exclusive National Representatives

* Don Grate, an outfielder for Chattanooga in the Southern Association, set this record on August 23, 1953.



Whose Beak Holds More Than His Belly Can . . .

That's an old Cajun saying round South Louisiana . . . interpret it any way you wish! However, we want to reassure you that there's more people than pelicans in the South Louisiana area that WAFB-TV covers—some 600,000 people.

WAFB-TV has 200,000 watts to beam out your sales message not only to the 9 parishes in the Baton Rouge trade area with an annual buying income of \$450,000,000—but also to many outlying South Louisiana cities, including Opelousas, New Iberia and Lafayette.

PROGRAMS?

Top rated shows from ABC, CBS and DuMont along with our own impressive local shows keep folks in this rich market area watching from sign-on to sign-off!

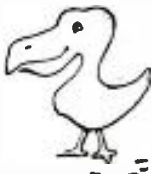

POWER?

200,000 watts. Enough to prompt one of our viewers 150 miles away to write us, and we quote: "...reception couldn't be clearer if we were sitting right on top of WAFB-TV!"

To put your sales message across to the non-pelican population of South Louisiana, get the facts you need from:

ADAM J. YOUNG, JR., INC.
National Representative

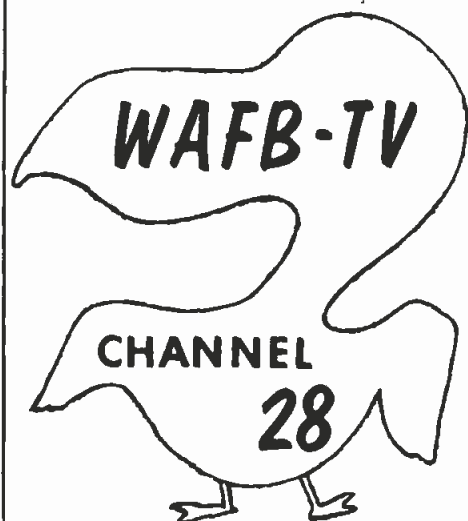

BATON ROUGE, LA.

Tom E. Gibbens, Vice President & Gen. Mgr.

KHAS-TV Hastings, Neb., Sets Fall Target Date

DEBUT of KHAS-TV Hastings, Neb., is expected by early fall, Fred A. Seaton, president of the Seaton Publishing Co., has announced.

Personnel appointed to key posts are Duane L. Watts, who will be general manager of KHAS-AM-TV, and Duane B. Allison, named chief engineer for both am and tv. Mr. Watts was with KHAS from 1940 to October 1953 when he left to become station manager of KHOL-TV Kearney, Neb. Mr. Allison joined KHAS in 1941 and later was named chief engineer.

KHAS-TV (ch. 5) will operate at full 100 kw from a 767-ft. tower and 12-bay antenna. A one-story building, 58 by 120 ft., will be constructed to house studios, equipment and business offices. Bids for construction will be called within the next few weeks. KHAS-TV will be affiliated with NBC-TV.

Malloy Offers \$1,000 Reward For Arrest of KVSM Vandals

LES MALLOY, owner-operator of KVSM San Mateo, Calif., last week offered a \$1,000 reward for the arrest or information leading to the arrest of vandals who have twice put the 1 kw (day) station off the air.

On May 8 KVSM was off the air nearly two hours because somebody cut through a protective fence around the station's antenna, removed the antenna tuner and threw it into nearby San Francisco Bay.

A week later vandals entered the transmitter building, an automatic operation, and removed the crystals, thus putting the station off the air again for more than five hours.

San Mateo police, investigating the two acts, said that the person responsible either had access to one of the three keys to the transmitter building, or has been able to have a duplicate made.

Independent KTTV (TV) Profits Near Quarter Million

KTTV (TV) Hollywood made a profit of \$225,833 during 1954, according to the annual stockholders' report issued by Norman Chandler, president of the Times-Mirror Co., licensee. The 1954 gross revenue of \$5,640,555 is 40% higher than the station's 1953 gross revenue of \$4,011,981. Loss during 1953 was \$607,699 as compared with the loss during 1952 of \$896,940.

Station currently has 243 employes, having added 26 during the past year. Capital expenditures were over \$400,000 including items such as new transmitter equipment, and increase in signal power and building alterations, the report continued.

Petry Radio Sales Names Two

APPOINTMENTS of Edwin F. England and Edward A. V. Smith as sales executives of Edward Petry & Co.'s New York staff, both effective May 31, have been announced by William B. Maillefert, radio sales manager.

Mr. England was with ABC in spot and local sales before joining Petry. From 1949-1952, he was a salesman in NBC's spot division and before that, associate director of NBC's research department. Mr. Smith, for two years an account executive with WIP Philadelphia, also has been in sales with WCAU Philadelphia and WIKK Erie, Pa.

Animated 'Bow Ties'

APPARENTLY not affected by any vhf competition, WKBN-TV Youngstown, Ohio, is distributing a promotion piece which asks: "Vhf? What's That?" The brochure, which is being sent to 1,000 local businessmen and 1,600 agency and advertising executives, points out that over 151,000 "bow ties," [uhf antennas] are "marching, marching, marching" in Youngstown with "hardly a ripple of excitement over vhf." WKBN-TV, the brochure says, is running away with "the lion's share" of the uhf conscious audience. Charts and graphs of the "32d U. S. market" show that WKBN-TV leads all other stations there in terms of share of audience for all time periods, with 26 of the top 30 programs being carried by the ch. 27 outlet. WKBN-TV, affiliated with ABC, CBS and DuMont and represented nationally by Paul H. Raymer Co., urges advertisers who wish to cover the Youngstown market to remember that "the big potential is with uhf" and particularly with WKBN-TV.

Simmons Names Blocki V.P.

APPOINTMENT of Gale Blocki Jr., formerly midwestern representative of RAB, as vice president of Simmons Assoc., radio station representatives, is being announced today (Monday) by David N. Simmons, president. The firm recently was formed as an organization representing radio exclusively [B•T, May 16].

Mr. Blocki, who also will serve as Chicago manager of Simmons Assoc., will assume his new post on June 15. He has been with RAB for three years and previously served for several years with John Blair & Co. in Chicago, rising to the post of vice president.

WNEW First Simmons Client

APPOINTMENT of Simmons Assoc., New York, newly-formed station representative firm, by WNEW New York, was announced last Thursday. It is the first station to be represented by Simmons, which will handle radio outlets exclusively [B•T, May 16]. The appointment is effective June 1.

WMBV-TV Goes to 234 Kw

MORE THAN two-fold increase in power along with addition to its tower and opening of new studios has been announced by Joseph D. Mackin, general manager of WMBV-TV Marinette, Wis. The ch. 11 station simultaneously boosted its power from 110 kw to 234 kw and opened studios in Green Bay, offering Packerland improved reception of NBC-TV and local shows. In addition WMBV-TV has added to its 500-ft. tower, which now measures 825 ft. including an 80-ft. antenna.

Baldwin to CBS Radio Spot

APPOINTMENT of Keith Baldwin, sales manager of WAKR Akron, Ohio, to the Sales Development Dept., of CBS Radio Spot Sales was announced last week by Newell T. Schwin, manager of sales development. Mr. Baldwin will service advertisers in Michigan, Ohio, West Virginia and Western Pennsylvania. He will have headquarters in the Fisher Bldg., Detroit.

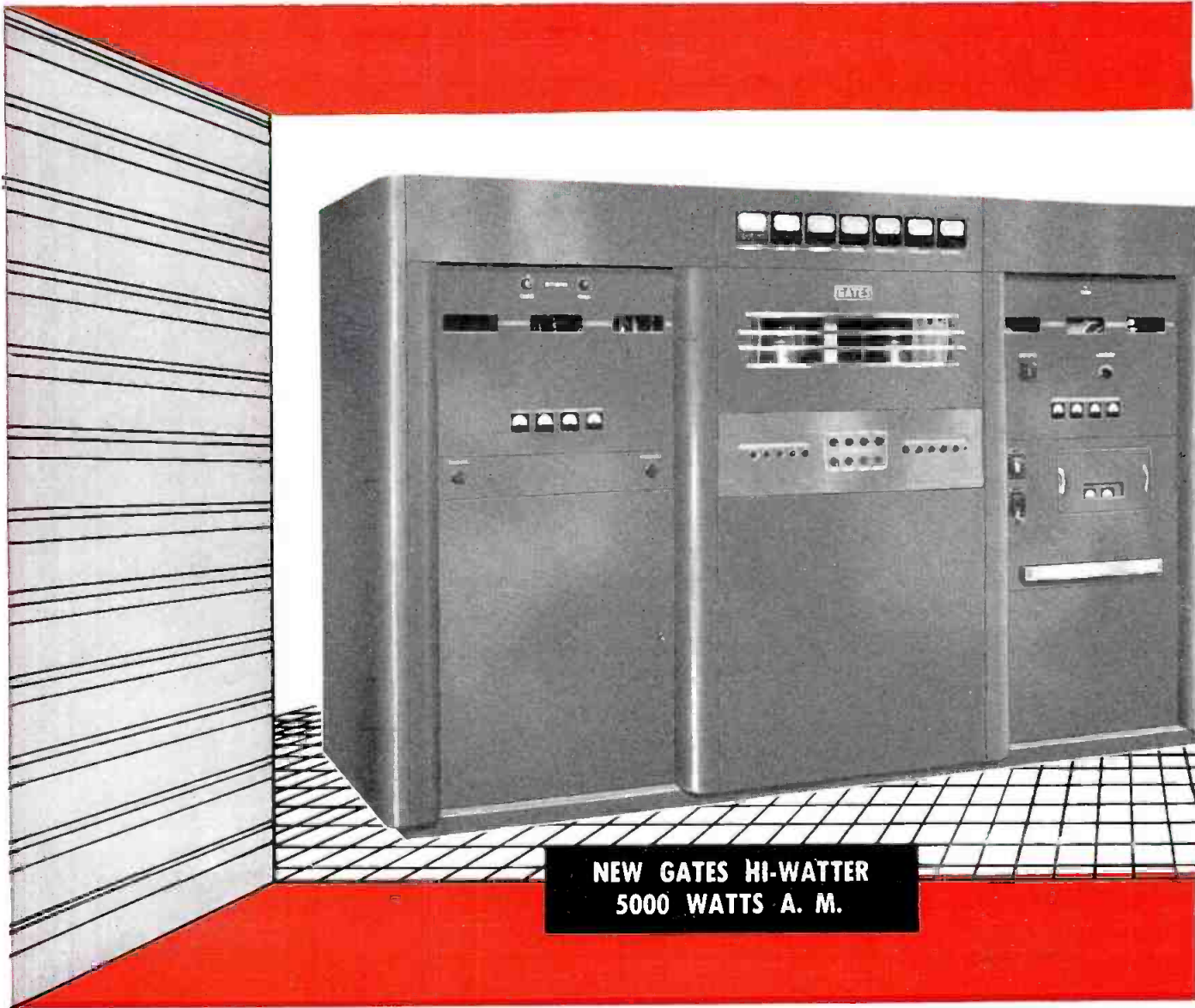

NEW GATES HI-WATTER
5000 WATTS A. M.

GATES LEADERSHIP IN AM BROADCAST EQUIPMENT IS EXEMPLIFIED IN THIS NEWEST 5000 WATT TRANSMITTING PLANT. — SETTING THE PACE IN QUALITY, PERFORMANCE AND SERVICEABILITY IS A GATES TRADITION — THE LOWER SELLING PRICE IS A GATES EXCLUSIVE!



ON DISPLAY
AT N. A. R. T. B.

— OUR 33rd YEAR —

QUINCY, ILL. — NEW YORK — WASHINGTON — ATLANTA — HOUSTON — LOS ANGELES

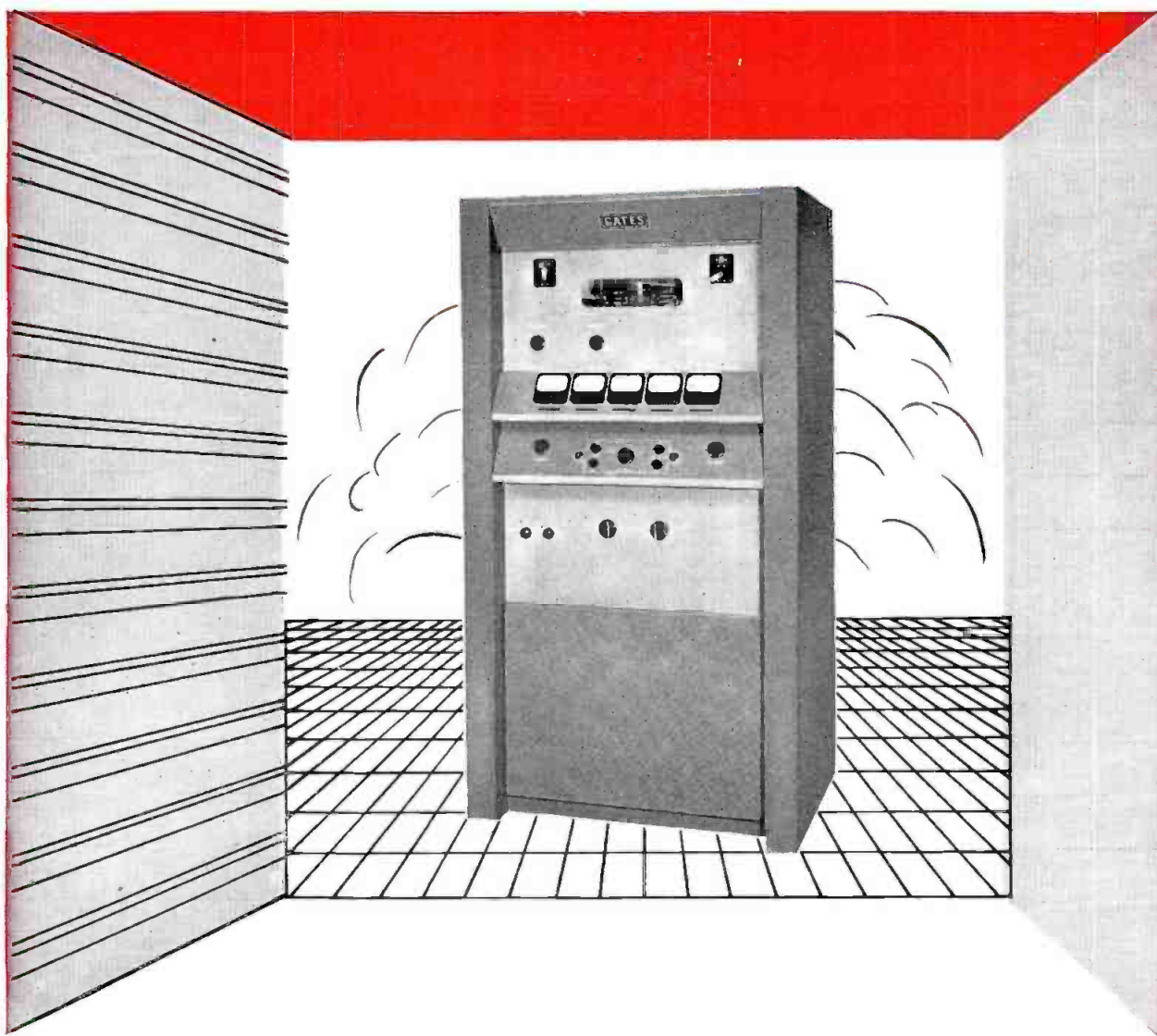

GATES NEW 1 KW AM "HI-WATTER" — "HI-WATTER" MEANS MORE WATTS PER DOLLAR INVESTED. THIS NEW PACE SETTING 1 KW GATES "HI-WATTER" IS WAY AHEAD. FIRST TO PROVIDE COMPLETE INBUILT 540-1600 Kc! FIRST WITH INBUILT CONELRAD. FIRST IN DASHBOARD LEVEL METERING. FIRST WITH "TWIN DRIVE" AUDIO. FIRST TO HAVE ALL TERMINATIONS FOR REMOTE CONTROL. FIRST IN A WAY LOWER SELLING PRICE THAT SAYS, "GATES REALLY DID SOMETHING".
—LEADERSHIP!



ON DISPLAY
AT N. A. R. T. B.

— OUR 33rd YEAR —

OFFICES AND FACTORIES IN QUINCY, ILL., U. S. A.

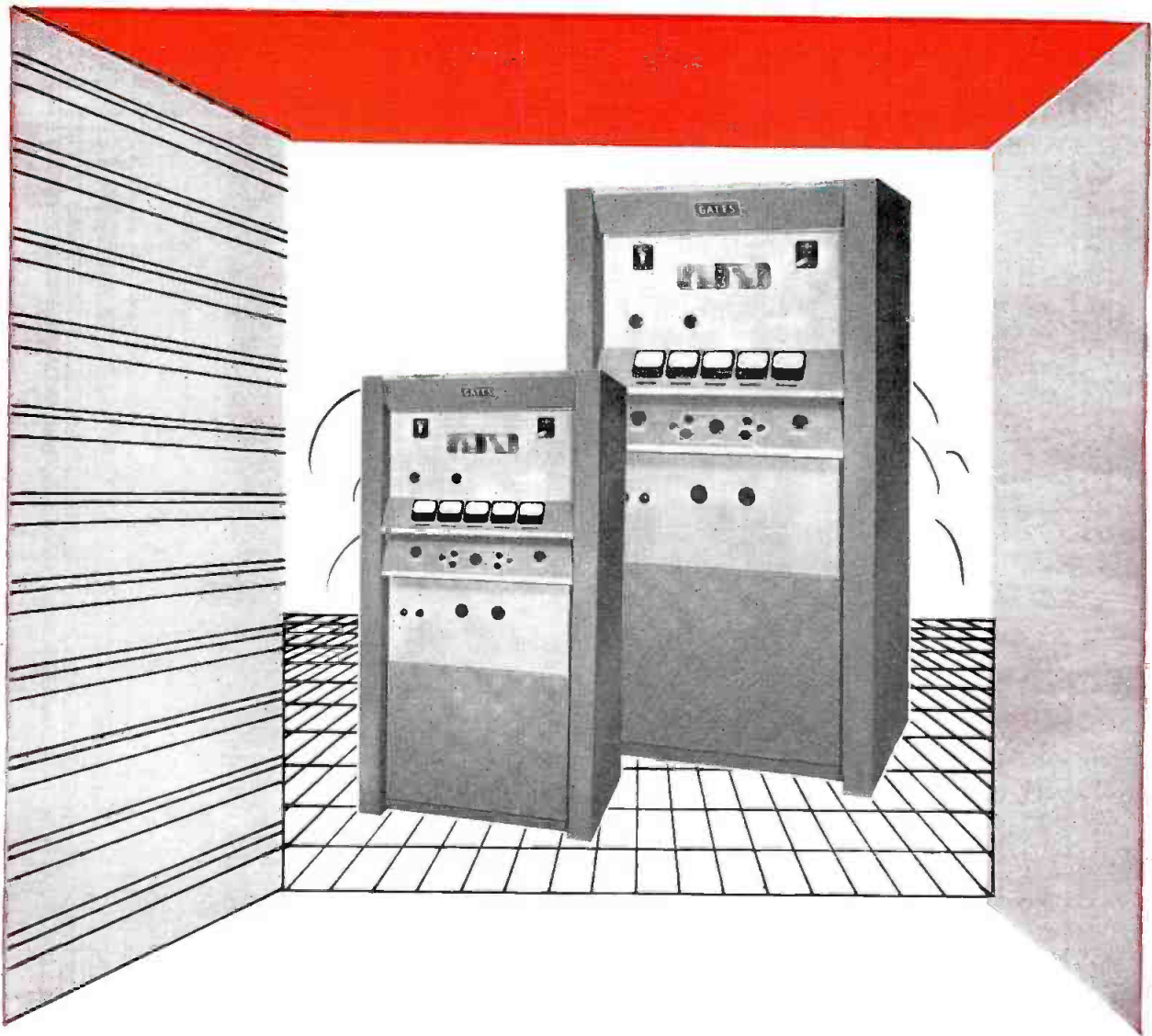

STEP UP WITH GATES—250 WATTS NOW AND 1 KW LATER. —
BROADCASTERS ASKED FOR THIS AND IT'S HERE! — THE NEW
GATES 250 WATTER THAT MAY BE STEPPED UP TO 1000 WATTS
WITHOUT ONE PENNY PREMIUM. BUY 250 WATTS NOW—GO
TO 1 KW LATER. THE CONVERSION CAN BE MADE IN 2 HOURS
WITHOUT DRILLING AN EXTRA HOLE OR ADDING AN EXTRA
WIRE. — THIS PACE SETTING "HI-WATTER" IS A 1 KW TRANS-
MITTER MODIFIED FOR 250 WATTS, YET THE COST IS NO MORE
THAN ORDINARY 250 WATT TRANSMITTERS. — LEADERSHIP!

ON DISPLAY
AT N. A. R. T. B.

— OUR 33rd YEAR —

BRANCHES IN NEW YORK, WASHINGTON, ATLANTA, HOUSTON AND LOS ANGELES

GATES

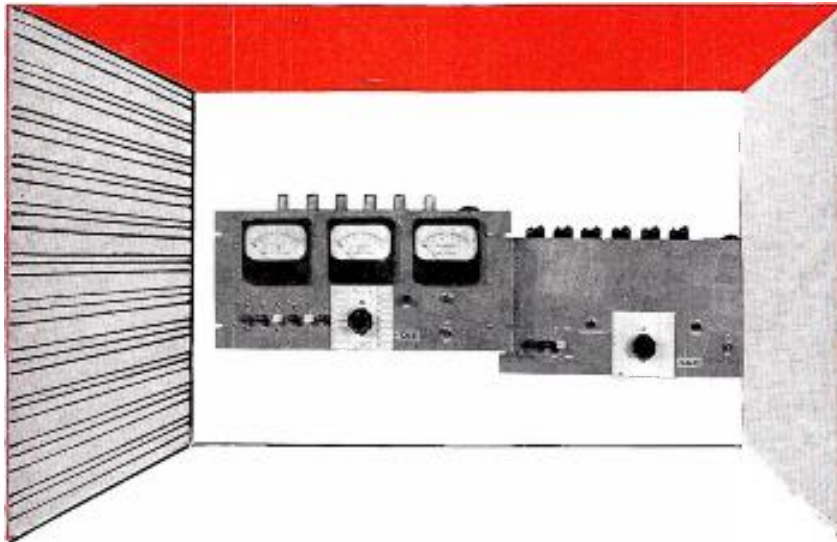

ON DISPLAY
AT N. A. R. T. B.

For unattended operation, Gates has developed a completely new remote control unit with facilities that have an eye on the future. — Pace setting all the way, the price is as attractive as the host of exclusive features.

Your letters have often said, "What broadcasting needs is a good low priced 2-channel remote amplifier." The Gates "Biamote" is the modern approach to this need. — With performance and quality superb, the very low price is the natural result of leadership!

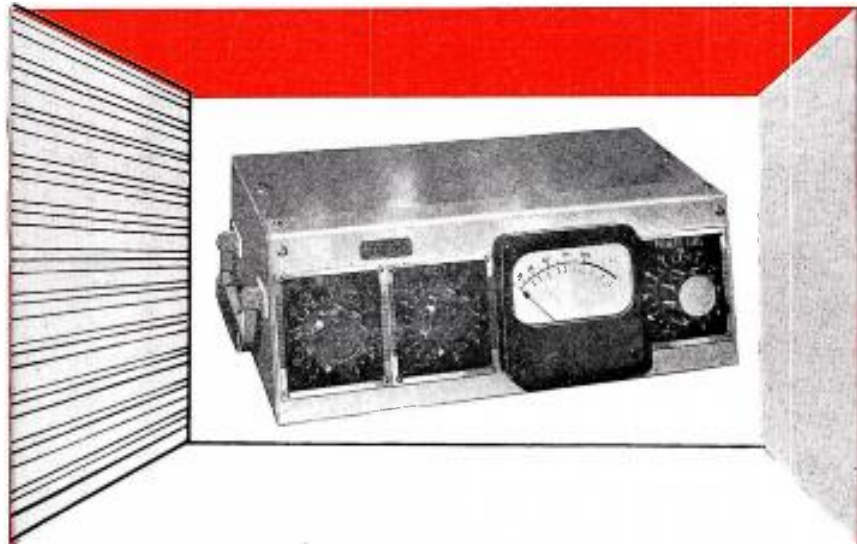

GATES

— OUR 33rd YEAR —

GATES RADIO COMPANY, QUINCY, ILL., U. S. A.

Manufacturing Engineers Since 1922

STATION PEOPLE

Arthur D. Stamler, news director, WHIL Medford, Mass., transfers to affiliated WGUY Bangor, Me., as general manager.

Tom E. Gibbens, vice president and general manager, Modern Broadcasting Co. (WAFB-AM-FM-TV Baton Rouge, La.), elected president; **Homer Griffith**, former operator of own radio representative firm, appointed WAFB-AM-FM manager.



MR. GIBBENS

MR. GRIFFITH

Marvin H. Hult, assistant manager of WMBD Peoria, Ill., appointed manager; **Robert O. Runnerstrom**, formerly associated in executive capacity with WLOK-AM-TV Lima, Ohio, to WMBD in executive position [AT DEADLINE, May 16].



MR. HULT

MR. RUNNERSTROM

Amos Baron, local sales manager, KCOP (TV) Hollywood, named sales manager, succeeding **Dave Lundy**, resigned.

John Melton, account executive, Moloney, Regan & Schmitt (newspaper representative), L. A., to KHJ-TV Hollywood as national advertising manager, succeeding **Robert Bowman**, who has been named account executive.



MR. HENNESSY

MR. LEVIS

Edward J. Hennessy appointed general sales manager, WEAT-TV West Palm Beach, Fla.; **C. C. Levis** named local sales manager.

Dave R. Wilson named publicity-promotion director, WCPO-TV Cincinnati, succeeding **Morrie Wattenberg**, who moves to WTAM-WNBK (TV) Cleveland as manager, advertising and promotion departments.

George W. DeBlieux, formerly chief engineer, WTAP-TV Parkersburg, W. Va., named chief engineer, WJNO-TV West Palm Beach, Fla.

W. Edwin Harris to WDBS Durham, N. C., as station manager; **Pete Taylor** to WDBS as production manager; **George C. Beacham Jr.** to station as business manager; **Jonnie Adams** to WDBS as public relations manager.

W. Randall Davidson, general manager, WAKN Aiken, S. C., elected secretary and director, licensee Aiken Electronics Adv. Corp.

Dean Craig, executive director, KRCA (TV) Hollywood, promoted to program director.

Herbert Graham appointed chief engineer, WAIT Chicago.

Meg Kingbay, announcer, WCCO Minneapolis-St. Paul, appointed women's service director.

Milton F. Komito, production manager, WAKR-TV Akron, Ohio, appointed general manager, WTAP-TV Parkersburg, W. Va.



MR. KOMITO

Harry Smith, disc m.c., WSUN-TV St. Petersburg, Fla. named sales representative.

Jim Dugan, former account executive, KOOL Phoenix, Ariz., to KVOO-TV Tulsa, Okla., as account executive.

William S. Oliver, formerly account executive, Curt Freiburger Adv. Agency, Denver, to KIMN there in same capacity.

Willard L. Dougherty, former general manager, WDOK Cleveland, to WJW Cleveland as account executive.

Rod MacLeish, formerly Washington correspondent, Vic Diehm stations, named news director, WBZ-WBZ A Boston-Springfield, Mass.



MR. MacLEISH

Michael J. Lutomski, formerly salesman, W C A R Pontiac, Mich., to sales staff, WWJ-AM-FM Detroit; **John S. Logan** to WWJ-TV sales staff.

Frank Lokey, formerly with WRDW-AM-TV Augusta, Ga., to WLWA (TV) Atlanta, Ga., as announcer-program personality; **Frank Ennis**, formerly with WCPO-AM-TV Cincinnati, to WLWA as sales coordinator.

Eddie Herbert, newswriter, CBS-TV Washington, to WCAU-AM-FM-TV Philadelphia in same capacity, effective today (Mon.).

John P. Frankenfield, production manager, WBAL-TV Baltimore, father of boy, Richard Burgess, May 5.

Milton D. Friedland, general manager, WICS (TV) Springfield, Ill., father of boy, Stuart Marvin, May 2.

Del Hostetler, director, WPTZ (TV) Philadelphia, father of girl, Lauren Ruth, April 28.

Dick Luetters, merchandising representative, WEEL Boston, father of boy, April 27; **Tom Young**, sales executive, father of boy.

JOE FLOYD'S IN WASHINGTON
On Behalf of His
Constituents!

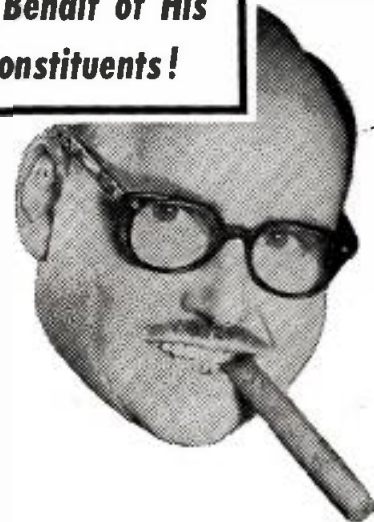

Joe's 78% of the population (see map below) needs shoes, toothpaste, two-toned cars and everything that rolls off your assembly line. The folks back there have the money to spend and want good things to spend it on. They look to Joe's interconnected K E L O - t v and KDLO-tv to tell them what to buy next. Better grab Floyd while he's in Washington and get him to stump for your products too!

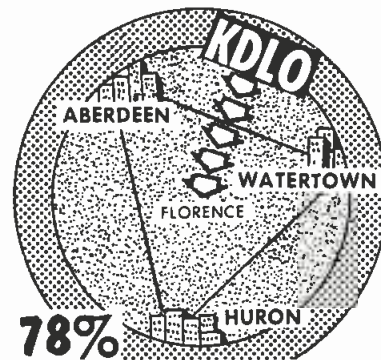

78%
Coverage of South Dakota
— Plus Minnesota and Iowa

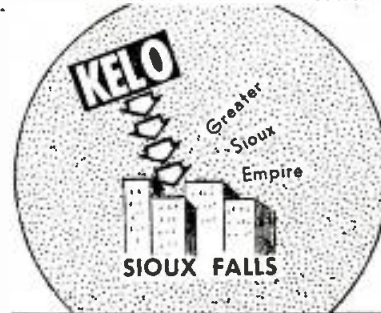

KELO

JOE FLOYD, President.

NBC (TV) PRIMARY
CBS • ABC • DuMONT

**TWO SMASH SERIES FROM
FIRST-RUN IN OVER 100 MARKETS!**

**DATELINE
EUROPE**

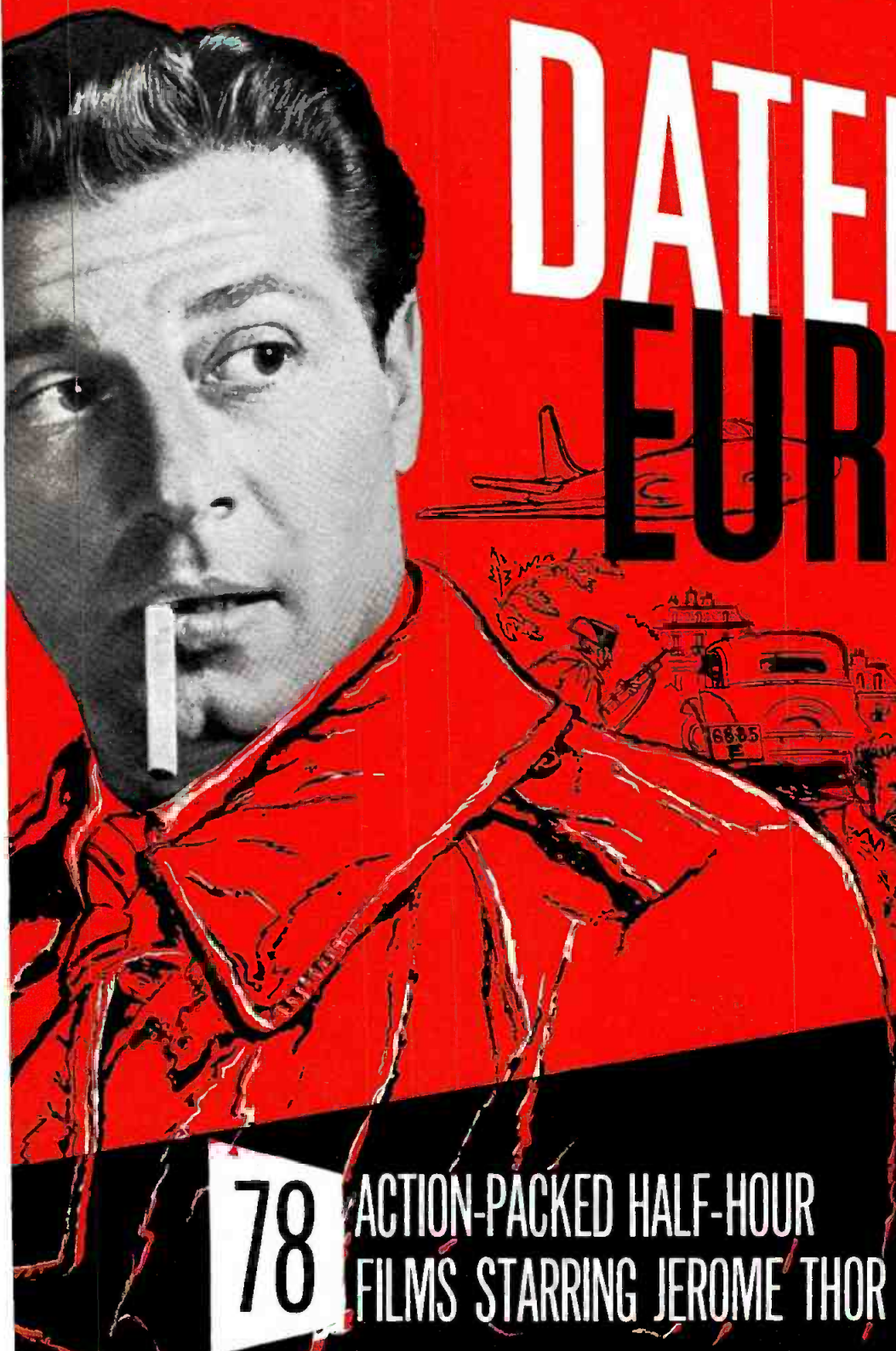

***"FOREIGN**

78

**ACTION-PACKED HALF-HOUR
FILMS STARRING JEROME THOR**

TV'S GREAT SUCCESS!*

OVERSEAS ADVENTURE

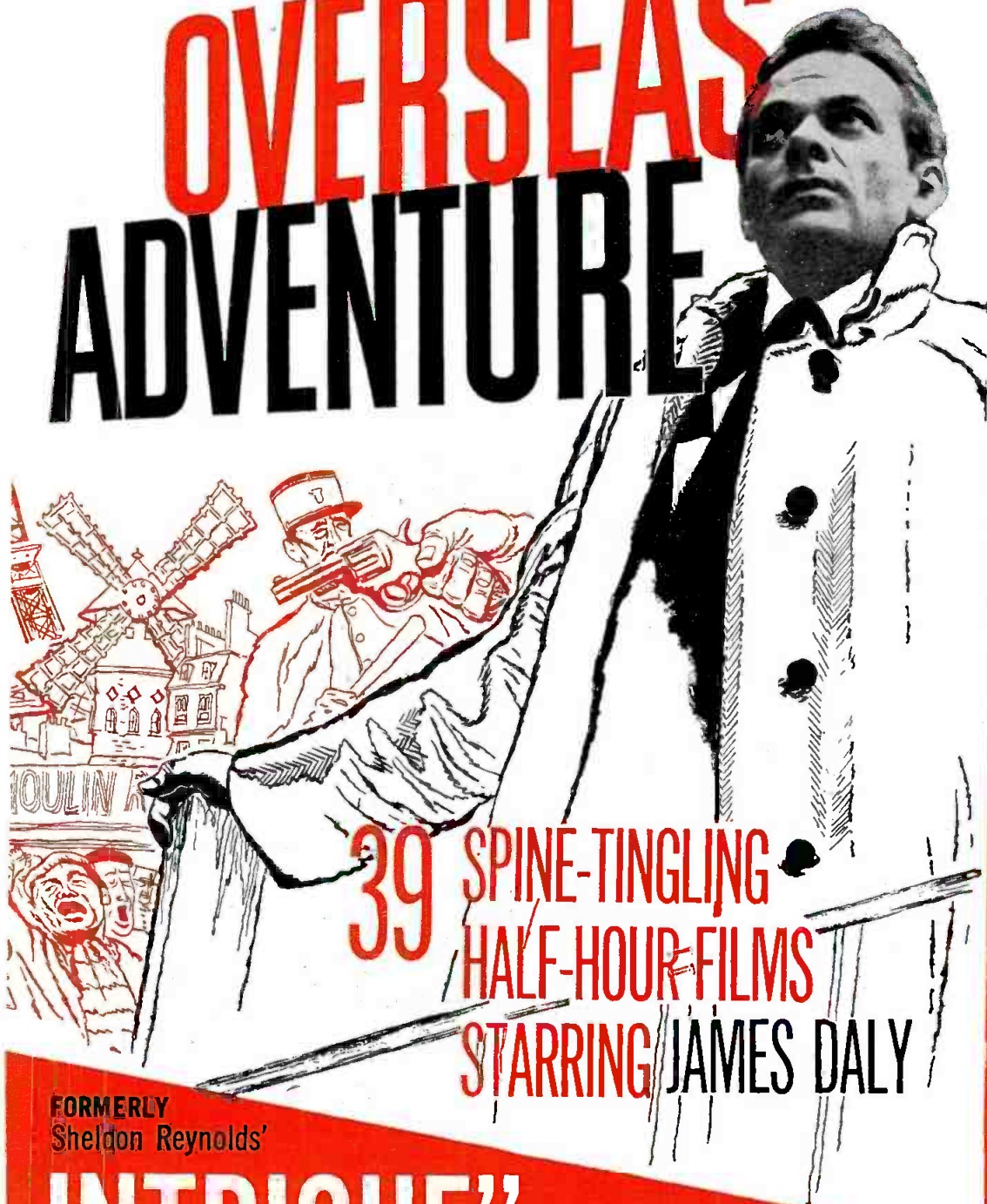

39 SPINE-TINGLING
HALF-HOUR FILMS
STARRING JAMES DALY

FORMERLY
Sheldon Reynolds'

INTRIGUE"

- THE TOPS IN
- ★ COMEDY
 - ★ DRAMA
 - ★ MYSTERY
 - ★ VARIETY

They're Here!

- ★ "THE STAR AND THE STORY"
- ★ "MY HERO"
- ★ "THIS IS YOUR MUSIC"
- ★ "SECRET FILE, U.S.A."
- ★ "COLONEL MARCH OF SCOTLAND YARD"
- ★ "TERRY AND THE PIRATES"

OFFICIAL FILMS, INC.

25 WEST 45th ST., NEW YORK 36, N. Y. PL 7-0100

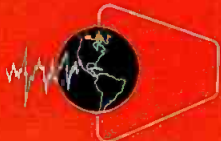

Beverly Hills—121 S. Lapeer Drive
St. Louis—415 North 12th Blvd.
Philadelphia—1420 Walnut St.
Chicago—360 No. Michigan Ave.
Boston—419 Boylston Street
Atlanta—333 Candler Bldg.

Dallas—Second Unit Santa Fe Bldg.
Baltimore—2301 No. Charles St.
Denver—1535 Hudson St.
Minneapolis—Calhoun Beach Hotel,
2925 Dean Blvd.
Cleveland—2459 Fenwick Road

The Only
TV STATION
with
Grade A
COVERAGE
in . . .
Shreveport
BOSSIER CITY

AND A
PROVEN
TV AUDIENCE OF

88% DAYTIME
(12:00-6:00 p.m.)

87% NIGHTTIME
(6:00 p.m.-Midnight)

Shreveport Telepulse
Jan. 23-29, 1955

THERE'S MONEY IN MOTION in Shreveport and Bossier City, Louisiana . . . over \$70,000,000 in new construction underway in 1955, for instance . . . and a consumer spendable income 10.6% above the national average.

And, once again Pulse proves that the only SURE way of reaching the responsive Metropolitan Shreveport TV audience is by using the only station that gives it Grade A coverage . . . KSLA.

Your Raymer Man has the complete, convincing details. Why not see him soon and start letting KSLA put money into motion moving your products?

KSLA
Channel 12

Shreveport, Louisiana

PAUL H. RAYMER CO., INC.
National Representatives

FILM

KATZ DISCONTINUES
STATION FILMS INC.

PLANS for the Katz Agency, representation firm, to discontinue the operation of its subsidiary Station Films Inc. were disclosed last week coincident with the announcement that Robert H. Salk, general manager of SFI, had been named director of sales of Screen Gems Inc.



MR. SALK

Mr. Salk will take over the newly-created post at Screen Gems, tv subsidiary of Columbia Pictures Corp., on Aug. 1. He will report to John H. Mitchell, vice president in charge of sales, and will further develop and integrate all Screen Gems sales operations, officials said.

Station Films was formed in 1953 and has operated as a film-buying organization, essentially for stations represented by Katz. Explaining discontinuance of the operation, officials said that SFI was formed to help stations at a time when film distribution generally was in a "chaotic" state, but that the field has now become stabilized with the result that the original need for SFI no longer exists.

Mr. Salk has been general manager of Station Films since its formation. His association with the Katz Agency dates to 1945, when he joined the company as director of research. He served later as head of Katz' Tv Sales Dept. in Chicago then returned to New York and was put in charge of the Tv Sales Development Dept. In 1948 he created a presentation, "Tv Facts For Advertising," which won wide acclaim.

In 1950 Mr. Salk moved to the CBS Network Sales Dept., returning to Katz the following year as tv program and sales development manager. In this post he worked with stations buying film for spot use until the creation of Station Films as a separate entity.

ABC Film Syndication, president of ABC Film Syndication, is announcing today (Monday) that the company has acquired distribution rights to the *Ray Bolger Show*, series of 60 half-hour musical comedy films starring comedian-dancer Ray Bolger. The series started on ABC-TV in October 1953 under sponsorship of Pall Mall cigarettes and Sherwin-Williams Co. The current season, which ends June 10, has been sponsored by Lehn & Fink and Dorothy Gray Products.

ABC Film Syndication
Acquires 'Bolger' Rights

With the addition of the Bolger series, six programs are now being distributed by ABC Film Syndication. The others are: *Passport to Danger*, *Racket Squad*, *Douglas Fairbanks Jr. Presents*, *The Playhouse* and *John Kieran's Kaleidoscope*. Another, *Sheena, Queen of the Jungle*, will be placed on sale some time in June, Mr. Shupert said.

THE *Range Rider* film series distributed by CBS-TV Film Sales ranked first in Boston in American Research Bureau's April ratings. The film, which had an ARB rating of 35.9, was inadvertently omitted from the ARB list published in B•T on May 9, and the list was labeled March instead of April.

'Rider' First in Boston

Among speakers were J. L. Van Volkenburg, CBS-TV president; Merle S. Jones, CBS vice president in charge of owned stations and general services; Sig Mickelson, CBS vice president in charge of news and public affairs; George Abrams, vice president and advertising manager of Block Drug Co., and Richard Pack, national program manager of Westinghouse Broadcasting Co.



PRESENT at a meeting when Official Films acquired exclusive distribution rights to *My Little Margie* and *The Stu Erwin Show* are (l to r): E. H. Goldstein, vice president of Hal Roach Studios; Hal Roach Jr., president of Hal Roach Studios, and Herman Rush, vice president of Official Films.

'Margie,' 'Erwin' Rights
Acquired by Official Films

DISTRIBUTION rights to 126 half-hour films of *My Little Margie* and 130 episodes of *The Stu Erwin Show* have been acquired by Official Films, New York. The announcement was made last week by Harold Hackett, Official Films president; Hal Roach Jr., president of Hal Roach Studios, and Roland Reed, president of Roland Reed Productions.

The two series represent approximately \$8 million worth of film footage. *My Little Margie* was sponsored on CBS-TV by Philip Morris & Co. Ltd. and Scott Paper Co. L & M Cigarettes and General Mills previously sponsored *The Stu Erwin Show* on ABC-TV.

CBS-TV Film Sales
To Syndicate Four More

ACQUISITION of four tv film properties to be syndicated by CBS-TV Film Sales was announced at its national sales meeting last week by Leslie Harris, vice president and general manager. The three-day meeting in New York ended Wednesday.

New programs are *San Francisco Beat*, half-hour films (re-runs of *The Lineup* carried on CBS-TV); *Life with Father*, half-hour series (re-runs of the CBS-TV program); *Eye on the World*, new half-hour dramatic news program; *March or Die*, half-hour adult adventures series starring Errol Flynn.

The meeting, which briefed personnel from nine offices on plans in all areas of the operation, including advertising, merchandising, sales policy and new programming, was presided over by Mr. Harris, with various sessions directed by Fred J. Mahlstedt, director of operations and production, and Wilbur S. Edwards, general sales manager.

Among speakers were J. L. Van Volkenburg, CBS-TV president; Merle S. Jones, CBS vice president in charge of owned stations and general services; Sig Mickelson, CBS vice president in charge of news and public affairs; George Abrams, vice president and advertising manager of Block Drug Co., and Richard Pack, national program manager of Westinghouse Broadcasting Co.

Leon Bernard Joins TPA

LEON BERNARD, formerly with Ziv Television Programs Inc., has joined Television Programs of America Inc. (TPA) as its midwest manager, Michael M. Sillerman, TPA executive vice president, announced Friday. Mr.



"Dig this CRAZY Ladder!"

"Man, this ain't no ladder . . . it's a list of the Top Ten TV shows in the Central Arkansas Market according to the March 1955 ARB survey!"

"It's a ladder, son . . . and every rung is a step nearer the top for every KATV advertiser!"

"Sing on, Dad . . . this ladder is beginning to interest me!"

"It should interest you, boy . . . and it should interest any advertiser who wants to climb to the top in Arkansas!"

"Should? Man, it does!!! Not only does KATV have ALL TEN of the Top Ten . . . but this page just isn't long enough to include all of their top programs. Why, Dad, we could go on-and-on-and-on . . ."

"A real cool advertiser's dream-come-true! Complete details on climbing the ladder to success in Arkansas is available from those Hep Reps . . . Avery-Knodel, Inc."



1. I Love Lucy 68.6

2. Amos & Andy 58.1

3. Burns & Allen 56.2

4. December Bride 55.8

5. Toast of the Town 54.5

6. Badge 714 53.0

7. Mr. District Attorney 51.7

8. Studio One 50.6

9. G. E. Theatre 49.6

10. Private Secretary 46.6

To climb to the top in Arkansas see:
Bruce B. Compton
National Sales Manager

To climb to the top in Arkansas see:
Avery-Knodel, Inc.
National Reps

Studios in Pine Bluff & Little Rock

KATV

Channel 7



John H. Fugate, Manager
620 Beech Street
LITTLE ROCK, ARKANSAS





KBIG RADIO IS THE STURDY FOUNDATION OF STURDY SALES

In 1954 the Sturdy Dog Food Company of Burbank, California, changed from multiple media to the one medium which matched its Southern California - wide distribution - RADIO. Through the Mogge-Privett Agency, the Sturdy Co. selected a mid-morning KBIG News Broadcast by Alan Lisser, the Catalina Station's Program Director and award-winning newscaster, as their Advertising Foundation. This gave blanket coverage at low cost. It was supplemented by spot announcement campaigns.

One year later Craig Sandford, Sturdy President, writes KBIG: "We showed a 17½% gain in sales for the year. The last six months and the first two months of this year show a 22¼% increase. Our KBIG newscast was the only advertising we ran consistently throughout 1954."

Sturdy contract renewal on KBIG for 1955 is the most eloquent testimonial possible. Whether it's dog food or cement, men's clothes or groceries, floor wax or real estate, your KBIG account executive or Robert Meeker contact can show you case histories which may be helpful in your Southern California advertising problems.



JOHN POOLE BROADCASTING CO.
6540 Sunset Blvd., Hollywood 28, California
Telephone: HOLLYWOOD 3-3205
Nat. Rep. Robert Meeker & Assoc. Inc.

Bernard's association with TPA was effective immediately. He started his duties at the NARTB convention now underway in Washington. His headquarters will be in Pittsburgh.

Before his four-year Ziv Tv relationship, Mr. Bernard held a number of radio station managerships including that of WKNY Kingston, N. Y.

TPA Plans N. Y. Clinic

A SALES CLINIC will be held by Television Programs of America in New York May 30 through June 3 for the film firm's field account executives. The meeting will be conducted by Mickey Sillerman, executive vice president of TPA.

FILM DISTRIBUTION

Sportsvision Inc., S. F., will handle sales in midwestern and western markets of *Jimmy Demaret*, tv film show of Award Television Corp., N. Y.

Tom J. Corradine & Assoc., Hollywood, has acquired *The Ruggles*, syndicated package of 91 half-hour episodes, for national distribution.

RANDOM SHOTS

Bemiller Productions (tv film commercials), Hollywood, has moved to 2350 Hyperion Ave.; telephone remains Normandy 5-5137.

Atlas Television Corp., N. Y., has appointed Tom Corradine & Assoc., L. A., as west coast sales representative for all properties in 12 western states.

FILM PEOPLE

Don M. Alexander, executive vice president, Alexander Film Co., Colorado Springs, Colo., assumes management of firm, succeeding J. Don Alexander, brother, who died May 6 [B•T, May 16].



MR. ALEXANDER

Edward H. Feldman, radio-tv director, Biow - Beirn - Toigo, Beverly Hills, Calif., to Desilu Productions Inc., Hollywood, as vice president in charge of commercial division.

Norton Locke, radio-tv producer, Hollywood, to Camera Vision Productions Inc. there in executive capacity.

Earl Klein, president, Storyboard Inc. (tv film commercials), Hollywood, resigns to form Animation Inc. (tv film commercials), Hollywood, with offices at 843 N. LaCienega Blvd.; telephone: Crestview 5-4925.

Tony Capps, producer-m.c. KCOP (TV) Hollywood *Latin Holiday*, forms Tony Capps Productions, Hollywood, to film that program for future tv syndication. Offices at 8718 W. 3d St.; telephone: Crestview 5-9629.

Bill McLaren, former operations director and program manager, KCEB-TV Tulsa, Okla., to Guild Films Co., Hollywood, working on *Ina Ray Hutton Show*.

Peter Frank, agency producer, BBDO, Hollywood, to Robert Maxwell Productions, same city, as assistant producer.

FOR-RADIO CAMPAIGN DETAILED BY WORLD

A FOR-RADIO merchandising and promotion campaign, including local, regional and national contests run by stations serviced by World Broadcasting System, was announced in New York last week by Pierre Weis, general manager of World. Full release of details is being made at the NARTB convention in Washington [B•T, May 16].

Purpose is to generate "new excitement" for radio by the users who have come to take the medium for granted, Mr. Weis asserted. Involved is use of a new sales caricature to carry the theme of radio's power as a medium. The little, strong man's name is "Radio's Big Little Man."

World, through its radio affiliates, will cooperate in the campaign with local, regional and national advertisers. World estimated it will spend at least \$250,000 for merchandising-promotion with stations expected to spend between \$500,000 and \$750,000 in time, direct mailing, newspaper advertising and card display. Another \$500,000 is expected to be spent by the advertisers.

Mr. Weis acknowledged at a news conference Monday that World anticipates the campaign will pay off dividends primarily in giving stations identification with the campaign as those outlets doing an "alert, merchandising job" and only incidentally perhaps adding new stations to World's affiliate list.

In the national contest, from which local winners will participate, prizes include vacation trips to Paris, the Virgin Isles and Bermuda. Stations also are in line for prizes. Through the promotion, run with cooperation of a local advertiser or group of advertisers, people will be invited to tell why they like to listen to their favorite radio station.

The baby-faced, strong-physique "Little Strong Man" will be reproduced in posters, window streamers, car and truck stickers, mailing pieces, bumper strips, newspaper ads and in other ways both in and out of stores and window displays. Linked will be the station's call letters.

Tv Screen Testing Firm Formed by Raymond Pheelan

PEOPLE who deal with tv talent, selling or buying their services, now have a new service available to them for "screen testing." A firm called Screen Tests to Order Inc., New York, has been formed under the managing directorship of Raymond Pheelan.

Mr. Pheelan also heads the parent company, Stock Shots to Order Inc., New York, which films background scenes and inserts for commercials and programs. The new service will be a division of Stock Shots.

According to Mr. Pheelan, the new division, with the facilities including 16 and 35 mm sound cameras, was formed at the suggestion of agency casting directors who found that auditioning and casting of talent from film clips showing the performer in action are efficient. Mr. Pheelan said that agencies "have begun making inquiries for testing in color and on location." He noted, too, that Screen Tests to Order expects "long-distance" testing assignments from Hollywood, principally to fill available roles in west coast tv film productions from the roster of New York's legitimate stage performers.

Television: Pair of French Cave Men

again, Jourdan Act C. B. S. Premiere

By F. P. SHANLEY

It is not as if "Montez and Thelma" the first of the new Sunday evening series called "Apartment 13" is an original approach. The drama seen over the luncheon broadcasting system, dealt with a group of men who were plotting to take over the city. They looked at though they were in a "Cave Men" situation. The drama, which is the first of a series of three, is a comedy. The projected main character, a man named "Montez," is played by Claude Rains. The other two men, "Thelma" and "Jourdan," are played by Louis Jourdan and Louis Jourdan. There was a story to the plot, too. She was portrayed by Miss Powers.

As the story unfolded, it became known that the "Cave Men" were a group of men who were plotting to take over the city. They looked at though they were in a "Cave Men" situation. The drama, which is the first of a series of three, is a comedy. The projected main character, a man named "Montez," is played by Claude Rains. The other two men, "Thelma" and "Jourdan," are played by Louis Jourdan and Louis Jourdan. There was a story to the plot, too. She was portrayed by Miss Powers.

They Go Spunking With Mala Powers

They go spunking with Mala Powers. The drama, which is the first of a series of three, is a comedy. The projected main character, a man named "Montez," is played by Claude Rains. The other two men, "Thelma" and "Jourdan," are played by Louis Jourdan and Louis Jourdan. There was a story to the plot, too. She was portrayed by Miss Powers.

They Go Spunking With Mala Powers

They go spunking with Mala Powers. The drama, which is the first of a series of three, is a comedy. The projected main character, a man named "Montez," is played by Claude Rains. The other two men, "Thelma" and "Jourdan," are played by Louis Jourdan and Louis Jourdan. There was a story to the plot, too. She was portrayed by Miss Powers.

Because of the unusual interest this ad aroused when it first appeared in THE NEW YORK TIMES we are reprinting it for the benefit of many NARTB members who did not have the opportunity to see it.

ON RADIO

STATION	PROGRAM	TIME
WABC	11:30-12:00	11:30-12:00
WABC	12:00-12:30	12:00-12:30
WABC	12:30-1:00	12:30-1:00
WABC	1:00-1:30	1:00-1:30
WABC	1:30-2:00	1:30-2:00
WABC	2:00-2:30	2:00-2:30
WABC	2:30-3:00	2:30-3:00
WABC	3:00-3:30	3:00-3:30
WABC	3:30-4:00	3:30-4:00
WABC	4:00-4:30	4:00-4:30
WABC	4:30-5:00	4:30-5:00
WABC	5:00-5:30	5:00-5:30
WABC	5:30-6:00	5:30-6:00
WABC	6:00-6:30	6:00-6:30
WABC	6:30-7:00	6:30-7:00
WABC	7:00-7:30	7:00-7:30
WABC	7:30-8:00	7:30-8:00
WABC	8:00-8:30	8:00-8:30
WABC	8:30-9:00	8:30-9:00
WABC	9:00-9:30	9:00-9:30
WABC	9:30-10:00	9:30-10:00
WABC	10:00-10:30	10:00-10:30
WABC	10:30-11:00	10:30-11:00
WABC	11:00-11:30	11:00-11:30
WABC	11:30-12:00	11:30-12:00



MILLION TV VIEWERS*
see these four sponsored first-run tv network programs produced by Screen Gems, Inc., television subsidiary of Columbia Pictures Corp.,

EACH WEEK

Program	Sponsored by
Ford Theater	Ford Motor Co. J. Walter Thompson
Adventures of Rin Tin Tin	National Biscuit Co. Kenyon & Eckhardt
Captain Midnight	Wander Co. & General Mills Tatham-Laird
Father Knows Best	P. Lorillard Co. Young & Rubicam

More Millions
will soon be added to this total by
Damon Runyon Theater (spring '55 premiere)
Celebrity Playhouse (fall '55 premiere)

Still More Millions
will be added when we premiere
Jungle Jim and You Can't Take It With You

And Even More Millions
are part of the weekly audience for our current syndication offerings

Big Playback (15-minute sports show)	All-Star Theater (originally seen as Ford Theater)
Jet Jackson (Captain Midnight alternate)	Top Plays of 1955 (this season's Fireside Theater)

This same inventive talent and production know-how is creating television commercials which are selling products for many of the country's largest advertisers.

SCREEN GEMS Inc.
TELEVISION SUBSIDIARY OF COLUMBIA PICTURES CORPORATION, 233 WEST 45th STREET, NEW YORK 19, N.Y. • Circle 5-5048

NARTB Members: Visit us at the Shoreham Hotel, Rooms D219-221.

EVEN MOHAWK WATCHES

W·H·E·N

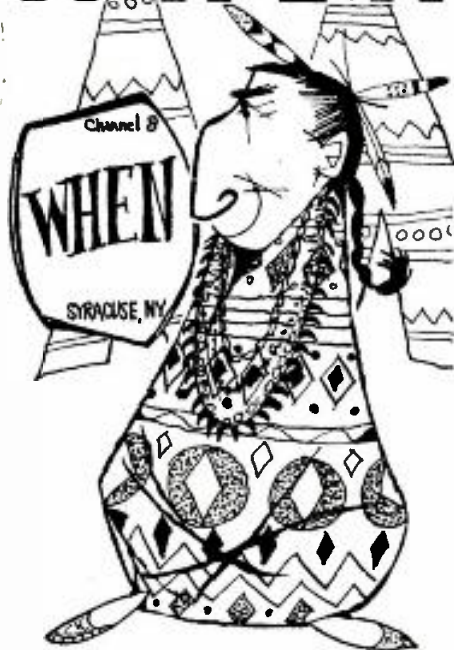

No smoke signals from Mohawk any more — folks are too busy watching WHEN to build a fire!



And Mohawk, N. Y., is only one of more than 250 communities covered exclusively by WHEN. Over 2¼ million people in 26 counties look to WHEN for shopping information (and 2¼ million people have a lot of shopping dollars). Don't you be low man on the totem pole in upstate New York — GET COMPLETE COVERAGE OF THIS IMPORTANT MARKET WITH WHEN.

SEE YOUR NEAREST
KATZ AGENCY

Everybody WATCHES
W·H·E·N
CHANNEL 8
SYRACUSE, N.Y.

CBS
ABC
DUMONT
A
MEREDITH
STATION

TRADE ASSNS.

WEBB TO SUCCEED FLANAGAN AT SRA

LAWRENCE WEBB, former national sales manager of WLOK-AM-TV Lima, Ohio (now WIMA-AM-TV), will succeed Thomas F. Flanagan as managing director of Station Representatives Assn. on June 1, Adam J. Young Jr., president of SRA, is announcing today (Monday).



MR. WEBB

Mr. Flanagan, who is retiring from the managing directorship, will continue to work with SRA on a long-term, active consulting basis with offices at SRA's New York headquarters [B•T, May 16]. He will carry out special assignments for the association.

Mr. Webb was associated with WLOK for two years, headquartering in New York where he worked with agencies and clients, selling spot radio and spot tv. He similarly aided in obtaining tv network programming for the station. He joined WLOK in April 1953, helping in the establishment of the tv station which made its debut that month.

Film Distributors Group Has Meeting, Plans Another

MEETING of the organization committee of the proposed trade association among tv film distributors [AT DEADLINE, May 16] was held in New York last week under the direction of Dave Savage of Guild Films, committee chairman. No details of the closed-session affair were revealed, but another meeting is scheduled after this week's NARTB convention to develop plans on forming the trade organization.



MR. SAVAGE

The organization committee, in addition to Mr. Savage, consists of Dwight Martin, General Teleradio Film Div.; Ralph Cohn, Screen Gems; Frank Reel, Ziv-Tv, and Herbert Gelbspan, Hal Roach Studios.

RTES to Honor Hagerty

JAMES C. HAGERTY, White House news secretary, will be given the annual achievement award for 1954 by the Radio & Television Executives Society, at the White House this morning (Monday).

The award to Mr. Hagerty is for "distinguished service to the radio and television broadcasting industry in your accomplishment of coordinating the efforts of President Dwight D. Eisenhower and the broadcasters, thereby resulting in enlightenment to listeners and viewers throughout the entire world."

Roger Pryor, vice president in charge of radio and television, Foote, Cone & Belding, retiring president of RTES; Elliott Sanger, executive vice president and general manager of WQXR New York, and Merle S. Jones, vice president in charge of CBS-owned television stations and general services, will present the plaque to Mr. Hagerty.

'Sale of Month' First Prize Goes to KNKS' Offenbach

RADIO ADVERTISING Bureau's first prize in its March contest of "Best Sale of the Month" went to Mel Offenbach, sales manager, KNKS Hanford, Calif., Kevin Sweeney, RAB president, announced Tuesday.

Mr. Offenbach's sale involved 55 five-minute newscasts per week to Sears, Roebuck & Co. in Hanford, which prior to this time had limited its radio advertising to one short saturation campaign supporting store-wide sales events.



MR. OFFENBACH

In the contest, C. J. Thornquist, account executive, WONE Dayton, placed second, and Jack de Mello, sales manager, KROW Oakland, Calif., placed third and became the first radio salesman to repeat in the monthly nationwide sales competition conducted by RAB (Mr. de Mello won first place last October).

TvB Names Griffin, Murphy

APPOINTMENT of Lloyd Griffin, vice president in charge of tv for Free & Peters Inc., New York, as chairman of the membership committee for the northeast for Television Bureau of Advertisers, New York, was announced last week by L. H. (Bud) Rogers, vice president and general manager of WSAZ-AM-TV Huntington, W. Va., national membership committee chairman.

A midwest territory for the membership committee has also been created, Mr. Rogers said. It will be headed by John T. Murphy, Crosley vice president in charge of WLWA (TV) Atlanta, WLWC (TV) Columbus, Ohio, WLWD (TV) Dayton, and WLWT (TV) Cincinnati. Mr. Griffin will supervise membership activities in New York, Maine, New Hampshire, Vermont, Pennsylvania, Delaware, Maryland, Connecticut, New Jersey, Massachusetts, and Rhode Island. Mr. Murphy will oversee Ohio, Indiana, Kentucky, West Virginia, Illinois, Wisconsin and the cities of Minneapolis-St. Paul and St. Louis.

Brett Named to TvB Board

ELECTION of George W. Brett, vice president and director of sales policy, the Katz Agency, New York, to the board of directors of Television Bureau of Advertising, New York, is being announced today (Monday). Mr. Brett was elected by the six station representation firm members of TvB. Representative firms recently received full voting membership. TvB's station representation firm members are Blair-Tv, Meeker-Tv Inc., Hoag-Blair Co., Free & Peters Inc., the Katz Agency and Edward Petry & Co.

NARTB Meeting Shifted

CHANGE of date for NARTB Region 3 meeting next September has been announced. Region 3 sessions will be held Sept. 28-30 at St. Charles Hotel, New Orleans, instead of Sept. 26-28 at Jung Hotel. The change was made because of a religious holiday. Region 3: Fla., Ga., Ala., Miss., La., Ark., Tenn., P. R.

LOOKING?

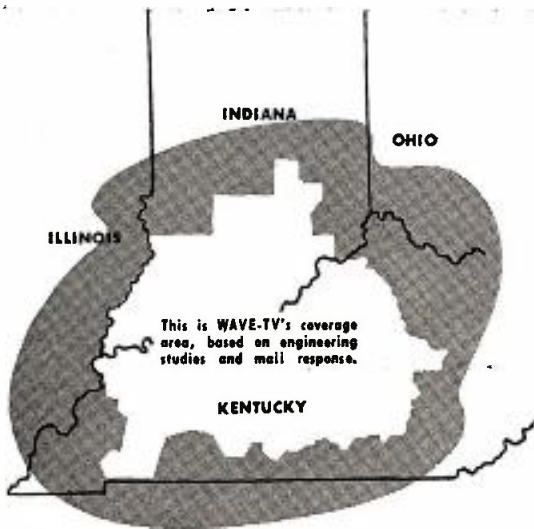

If you're looking for the key to the biggest TV audience in Kentucky and Southern Indiana

CALL YOUR REGIONAL DISTRIBUTORS!

Ask each, "What Louisville TV station do you and your friends prefer?"

Try it. You'll open the door to a clear picture of viewing habits in this area.

WAVE-TV

CHANNEL **3** LOUISVILLE

FIRST IN KENTUCKY

Affiliated with NBC, ABC, DUMONT



SPOT SALES

Exclusive National Representatives

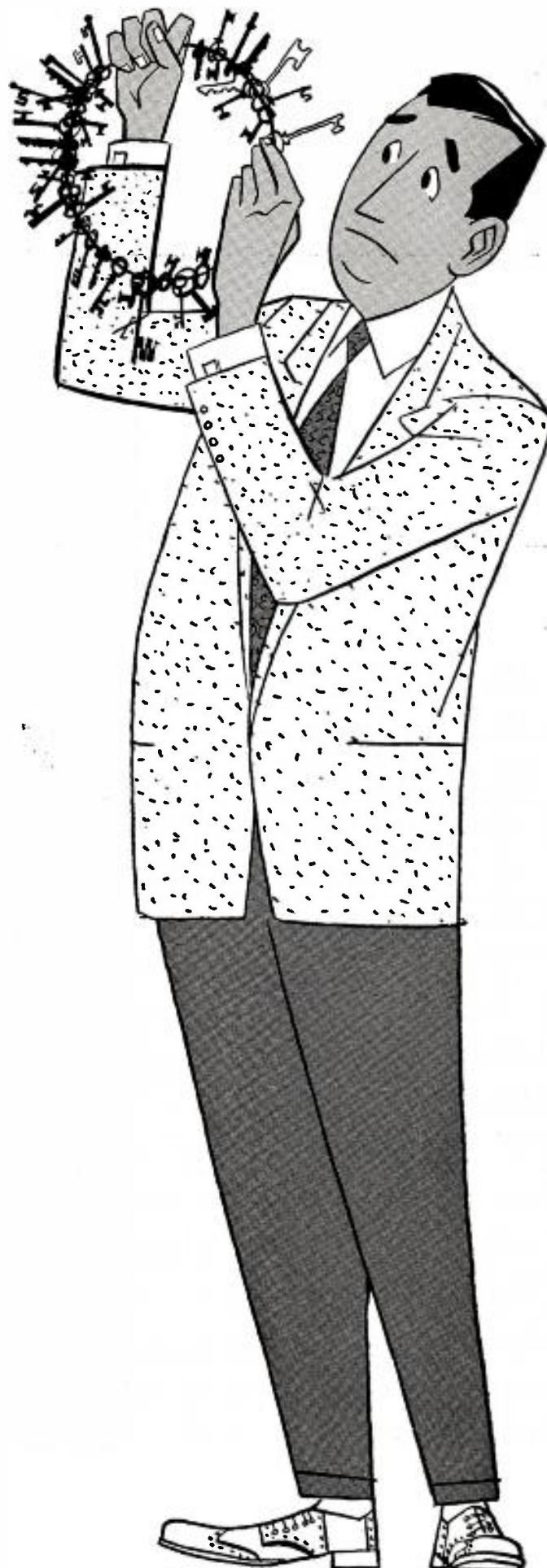

STAKE YOUR CLAIM

IN NEW

RCA *Thesaurus*



Platinum Anniversary money-yielding features



THE GRANTLAND RICE STORY—from *The Tumult and The Shouting*... 15 minute, once a week broadcast with famous sportscaster Jimmy Powers and big name "sports world" guests such as Bobby Jones, Walter Hagen, Ty Cobb and Gene Tunney. Fully recorded.

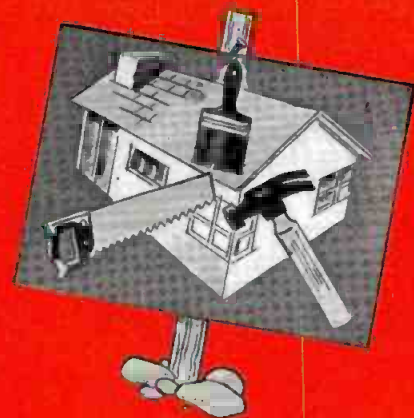

DO-IT-YOURSELF... Cash in on your local share of the 6 billion dollar do-it-yourself business with this new Thesaurus "Do-it-Yourself" 15 minute show. Three times per week.



**RECORDED
PROGRAM
SERVICES**

630 Fifth Avenue, New York 20, N. Y.—JUdson 2-5011
1016 N. Sycamore Ave., Hollywood 38, Cal.—HOLlywood 4-5171
522 Forsyth Building, Atlanta 3, Ga.—LAmAr 7703
445 N. Lake Shore Drive, Chicago 11, Ill.—WHitehall 4-3530
1907 McKinney Avenue, Dallas 1, Tex.—Rlverside 1371

TMKS.®

©RCA

RADIO CORPORATION OF AMERICA • RCA VICTOR RECORD DIVISION

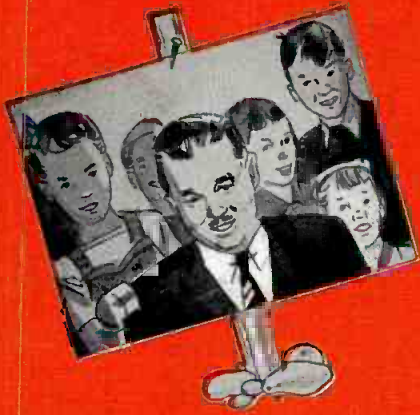

THE FRANK LUTHER FUN SHOW . . . Frank Luther, nationally popular entertainer, brings enjoyment to children from 6 to 96 . . . fully recorded with songs—many created specially for this show, plus jokes, limericks, "mail-pulling" ideas and guest stars.



GREAT DAYS WE HONOR . . . 15 minute, fully recorded show for 39 important holidays during the year. 10 Catholic holidays, 10 Jewish, 10 Protestant and 9 Patriotic holidays. Ideal for institutional type advertisers. Ray Middleton, Henry Hull, other well known personalities.

It's our Platinum Anniversary . . . we're 20 years old, and to celebrate we're adding 8 new sponsor-selling, platinum-studded features to our service.

For the past 20 years our Library Service has been growing bigger, better, and more profitable for our subscribers. The broad range of 25 different shows, complete continuity service, sponsor-selling recorded sell-effects, voice tracks, sales clinching brochures, new big local time selling merchandising plan, other selling aids, and 52 new releases each and every month . . . all this gives RCA Thesaurus subscribers the most profitable program service in the industry. For example, due to tremendous success of two of our shows, we are increasing the popular Freddy Martin and Sammy Kaye programs from 3 broadcasts a week to 5. Stake your claim to the lion's share of your local advertisers' dollars by using the one Library Service that's king of them all! Write, wire or call, today your nearest Recorded Program Services office.

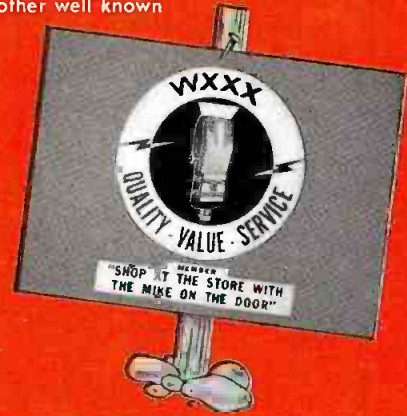

SHOP AT THE STORE WITH THE MIKE ON THE DOOR . . . a great new local radio time selling merchandising plan. Builds sales and listeners.



PRESENTING THE STATESMEN QUARTET . . . A popular, talented group brings favorite gospel type singing to your listeners. ½ hour, once a week.

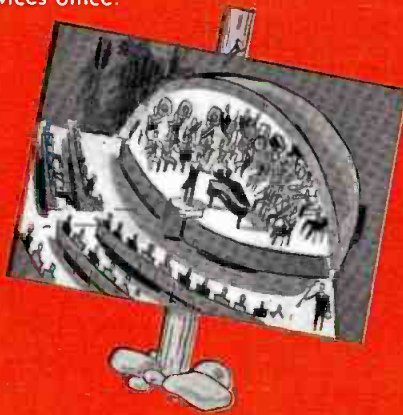

CONCERT ON THE MALL . . . This rich, lush sounding band plays everything . . . from "South Pacific" medleys and traditional marches to symphonic and popular types of music. ½ hour, once a week.



WEEKEND SHOPPERS' SPECIAL . . . This new show was designed to give stations a program with strong appeal to sponsors who want to sell to weekend shoppers. Ideal for participations. Once a week, 30 minutes.



Be sure to see us at the NARTB Convention
Washington, D. C. May 22-26
Shoreham Hotel, Suite G-100
(1 floor above the lobby)

THE DE-INTERMIXTURE COMMENTS ARE IN

Opposition and supporting comments on proposals to de-intermix Evansville, Hartford Madison and Peoria filed with FCC at Tuesday deadline.

OPPOSITIONS to the proposals to de-intermix Evansville, Ind.; Hartford, Conn.; Madison, Wis., and Peoria, Ill. [B*T, April 3], were filed with FCC at its deadline last Tuesday.

Also filed were supporting comments by the original petitioners for the move.

The objectors generally argued that the changes proposed were against the public interest and in the interest only of uhf broadcasters. The adherents of the changes argued that the proposals would serve the public interest and aid in establishing uhf broadcasting as part of the national television system.

In all four instances, the Commission's proposal called for the switch of the educational reservation from a uhf channel to the single vhf frequency allocated to the communities. This would make all four cities all-uhf commercially. In each instance, the vhf channel is the subject of a competitive hearing. In three cities, an initial decision has already been issued.

In Evansville, it was suggested moving the educational reservation to ch. 7 and deleting ch. 9 from Hatfield, Ind., replacing it by ch. 14 from Henderson, Ky.

Opposing this were Evansville Tv Inc. and WGBF Evansville. Evansville Tv Inc. holds an initial decision for ch. 7 there. Also opposing were WVJS and WOMI Owensboro, Ky., both of which have gone through a hearing for Hatfield's ch. 9. Rep. Winfield K. Denton (D-Ind.) also wrote in opposition to the move. In favor of the moves were WFIE (TV) Evansville, WEHT (TV) Henderson, Ky., and WKLO-TV Louisville, Ky.

In Hartford, the only oppositions to the proposal to switch ch. 3 to the educators or to assign it to Westerly, R. I., or Norwich or New London, Conn., came from WTIC Hartford and Hartford Telecasting Co., both applicants for that channel which have completed the hearing. Original group of uhf Connecticut River Valley stations—WGTH-TV Hartford, WKNB-TV New Britain, WHYN-TV and WWLP (TV) Springfield, Mass.—supported the proposal. Asking that ch. 3 be assigned to

Norwich, Conn., was WICH there; to New London, Conn., WNLC-TV there, and to Westerly, R. I. (about 35 miles from Providence), was WNET (TV) Providence. Also opposing the Hartford shift was WELI-TV New Haven, which would have to move from ch. 59 to ch. 75.

In Madison, the proposal to move the educational reservation from uhf to ch. 3 there or move it to Beloit, Wis., brought objections from Badger Tv Co. and WISC, the former holding an initial decision for that frequency. Also opposing was WREX-TV Rockford, Ill., ch. 13. One of the proposals would substitute a uhf channel for Rockford's ch. 13. In favor were WKOW-TV and WMTV (TV), both Madison uhf stations, and WTVO (TV) Rockford.

Opposing the Peoria proposal to move the educational reservation from the uhf wavelength to ch. 8 were WIRL Peoria, holding an initial decision for the channel, and WMBD Peoria, the other ch. 8 contestant. Favoring the move were WEEK-TV and WTVH-TV, both uhf stations in Peoria.

MAYOR LAWRENCE SUPPORTS LAMB

MAYOR David L. Lawrence of Pittsburgh testified before FCC Examiner Herbert Sharfman last week about Edward Lamb's anti-communist stand during organization of the steel workers in 1937.

Also Democratic National Committeeman from Pennsylvania, Mayor Lawrence said that when the FCC's Lamb story "broke," he called Mr. Lamb voluntarily and offered to testify in the license renewal hearing ordered for Mr. Lamb's WICU (TV) Erie, Pa. He did this, he said, "because I knew from my own personal knowledge his attitude on these matters and I felt there was a great injustice being done him."

The WICU case, underway since last September to learn whether Mr. Lamb misrepresented alleged communist ties, was expected to be concluded on Friday as Mr. Lamb returned to the stand for completion of questioning by FCC counsel Joseph M. Kittner.

Appearing on Wednesday, Mayor Lawrence told Examiner Sharfman that Mr. Lamb in 1937 was counsel for the Steel Workers Organizing Committee and was in "entire agreement" with Philip Murray, John L. Lewis and Sidney Hillman in fighting communist efforts to infiltrate the labor movement.

J. Howard McGrath, ex-U. S. Attorney General and now counsel for Mr. Lamb and executive vice president of Lamb Enterprises, testified that he and co-counsel Russell Morton Brown took full responsibility for the averment contained in Mr. Lamb's pleading in U. S. District Court last summer which charged FCC representatives with causing at least one bribe to be offered to secure false testimony against Mr. Lamb.

He said Mr. Lamb acted fully on the advice of counsel in allowing the charge to be included in the court petition seeking to enjoin the FCC from holding the WICU renewal hearing. The court turned down the plea and an appeal now pends in a higher court. FCC subsequently made the bribe charge an issue in the WICU renewal case.

Mr. McGrath testified that he decided the averment should be made after a visit from Emmett Wheaton, who he said related a bribe attempt by William Garfield Cummings, FCC's first witness in the WICU case and part-time



WITNESS in behalf of Edward Lamb, Mayor David L. Lawrence of Pittsburgh (r) listens to Lamb counsel J. Howard McGrath explain status of the license renewal hearing now in final stage before FCC examiner.

paid consultant to the FCC. Mr. McGrath said Mr. Wheaton told him that Mr. Cummings took him (Wheaton) to see three FCC investigators in Toledo and later offered him \$1,000 if he would "remember" that Mr. Lamb had been speaker at the dedication of Lincoln House in Toledo in 1944. Mr. Cummings identified Lincoln House as headquarters of the local Communist Party.

Mr. McGrath said Mr. Wheaton told him he couldn't recall the Lincoln House dedication and had so informed the FCC representatives. The former Attorney General said Mr. Wheaton then dictated and signed an affidavit concerning the bribe attempt. Mr. McGrath said he still believes the affidavit is true, although Mr. Brown told Examiner Sharfman that the truth of the story was not in issue. Mr. Brown said the explanation was given in order to prove Mr. Lamb's good faith in allowing the averment to be made in the court brief.

Sunne Miller, manager of WTOP Toledo, another Lamb station, testified she was told by Eugene Stoll, before he appeared as FCC witness, that Commission "investigators" told him (Stoll) they were "out to get Lamb" and take his tv station "worth \$10 million" away from him. Mrs. Miller said she was present in the hearing room when Mr. Stoll denied that FCC investigators said this to him.

Mr. Brown at one point claimed, "There was a constant stream of reports reaching us about highly improper and irregular conduct on the part of the government's representatives from a wide variety of sources." He said, however, that they "didn't go into them all."

NATVIG GUILTY ON PERJURY COUNTS

TURNABOUT witness Mrs. Marie Natvig was found guilty by a Federal District Court jury last Monday on three counts of perjury involving her testimony before FCC Examiner Herbert Sharfman in the license renewal hearing on Edward Lamb's WICU (TV) Erie, Pa.

The jury, deliberating about 20 minutes, held that Mrs. Natvig testified falsely when she said she did not tell FBI and FCC officials last

\$10,000 Last Straw

BADGER Tv Inc., favored in an initial decision for Madison's ch. 3, filed three typewritten pages as its response to the proposal to de-intermix the Wisconsin capital. It said it refused to incur any more expense in connection with its application, which was originally filed in 1948. It said it had already spent \$75,000 in prosecuting its application, laid out \$10,000 as a deposit for equipment, and estimated that it would cost \$10,000 more to compile, assemble and present the data called for by the FCC.

Most of the other respondents to the de-intermixture proposals involving not only Madison, but also Evansville, Ind.; Hartford, Conn., and Peoria, Ill., filed voluminous documents, complete with detailed analysis of their arguments pro and con.

PORTRAITS OF WGY-LAND



SCHENECTADY, N. Y.



Hello. I'm Martha Brooks—hostess on the Martha Brooks Show (WGY Monday thru Friday—9:15—10:00 a.m.) Today I'd like to tell you something about the WGY market area.

Schenectady, N. Y. is the second largest city in the New York Capital District market which ranks 32 in national retail sales. (Albany, N. Y. is the first city) Schenectady has a population of more than 98,000. It is the center of heavy industry for eastern New York. Schenectady is the western gateway to the rich farm country of the Mohawk Valley.

Schenectady is just one of 22 cities in WGY-land

with a population more than 10,000. The entire WGY market includes 1,004,750 radio homes in 53 counties of New York and New England.

I can help you reach this market during prime morning hours on the Martha Brooks Show.

Just one thing more. Only one radio station can reach this huge market for You.

WGY

A GENERAL ELECTRIC STATION

ALBANY—TROY—SCHENECTADY—plus—53 counties in New York and New England
Represented nationally by Henry I. Christal Co., Inc. New York ★ Boston ★ Detroit ★ San Francisco



HATS OFF TO

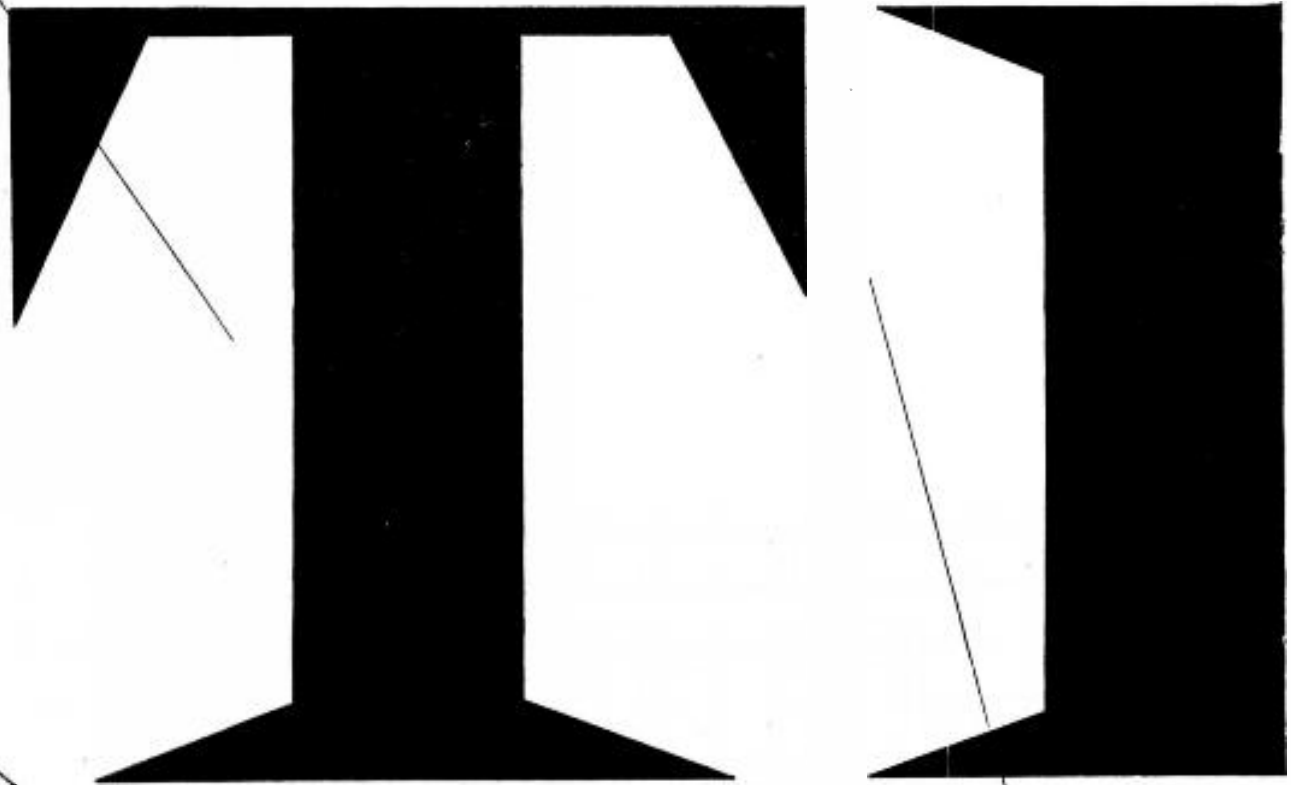

WINNERS!



Ramar

Ellery Queen

Lassie

Your Star Showcase

Halls of Ivy

Captain Gallant

Edward Small Features

Science In Action



at the NARTB Convention

Television Programs of America, Inc.

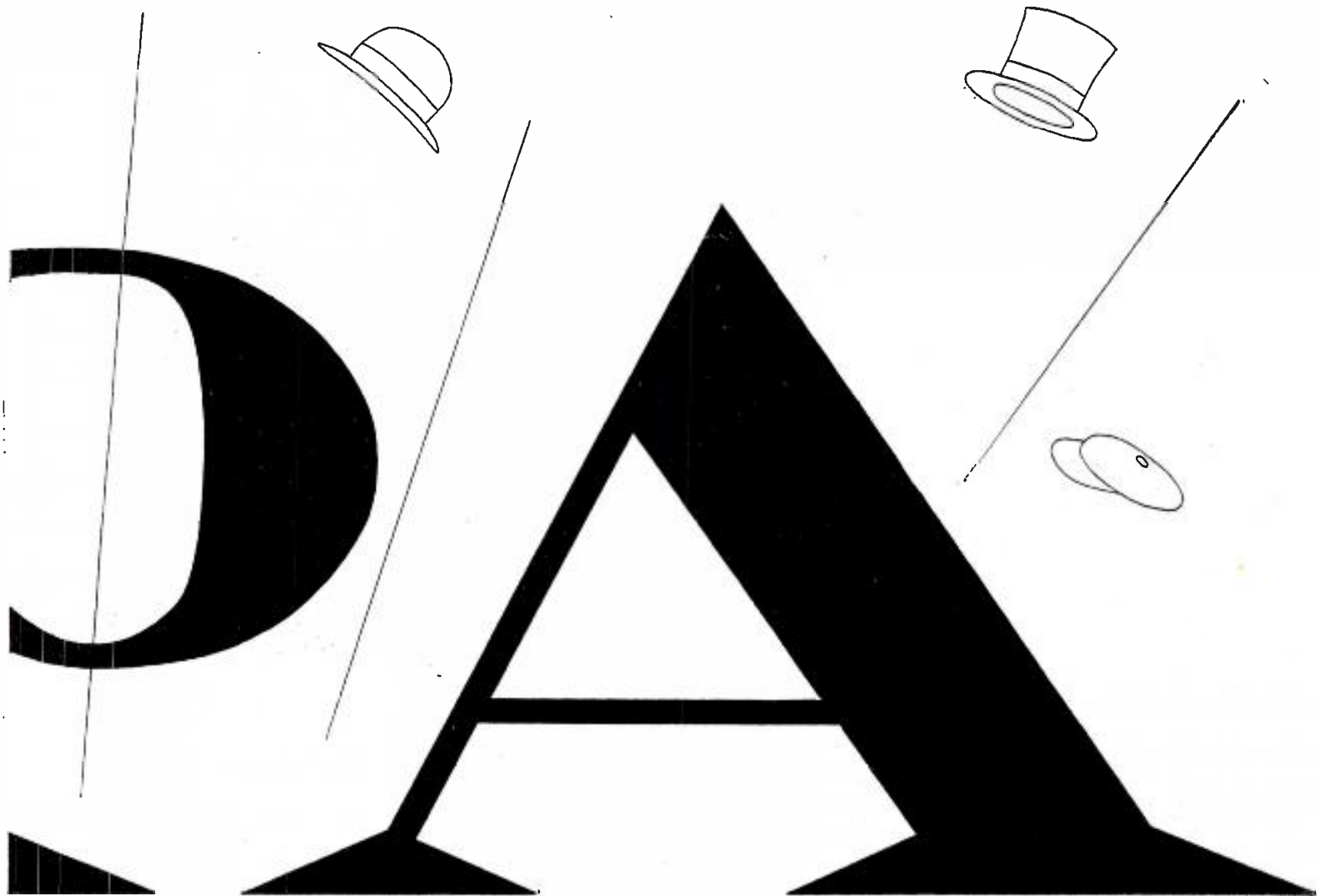

Win Yourself a Brand New Stetson!

It's as easy as this: Just drop in at

Suite B202 and drop your hat check in TPA's "lucky hat."

Three drawings daily! Three Stetson winners daily!

Free Hats For Everybody!

Here's how to use your head: Come up to Suite B202.

Bring your wife . . . bring your secretary . . . bring your mother-in-law.

Get your free souvenir hats. Everybody comes out a winner.

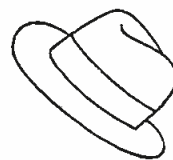

• *Suite B202-204 Shoreham Hotel, Washington.*



It's

"BIG MIKE"

Houston's ONLY
Radio Station on Wheels

FIRST WITH NEWS
LIVE... DIRECT!

HERE'S AN ACTUAL
COVERAGE REPORT:

FEB. 1, 9:30 A.M.
Window washer falls
10 stories to death.

FEB. 4, 11:45 A.M.
Runaway steer ties up
Freeway traffic. Cap-
tured.

FEB. 7, 1:30 P.M.
Auto-pedestrian fa-
tality.

FEB. 11, 10:22 A.M.
Heights State Bank
Robbed.

FEB. 14, 8:15 P.M.
Truck overturns on San
Jacinto Bridge. Driver
pinned in cab.

All Houston is talking
about "BIG MIKE", Hous-
ton's only Completely Re-
mote Radio Equipped
Truck. Let him sell for
YOU.

Nat'l Rep. Forjoe & Co.
In Houston call: Dave
Morris, KE-2581.

K-NUZ
RADIO RANCH

K-NUZ Carries
Houston's Top
Local Accounts

fall that she once was a member of the Communist Party and knew Mr. Lamb in that connection. The truth of her statement about Mr. Lamb was not at issue in the trial, held before Judge Alexander Holtzoff. In dismissing the jury, Judge Holtzoff said he agreed with its verdict.

Mrs. Natvig is free on \$2,500 bail pending completion of a report to the court by the probation officer, at which time a date for sentencing will be set. Maximum penalty involved is \$6,000 fine and 15 years in jail. John and Jean Dwyer, defense counsel for Mrs. Natvig, said they may appeal the case.

The original indictment listed nine counts of perjury, but two were dismissed by the court before the trial began and four more were dropped during the proceeding, including the government's principal charge that Mrs. Natvig lied when she said she had been coerced in her original testimony by ex-FCC counsel Walter R. Powell Jr. [B•T, May 16]. The government abandoned this count because Mr. Powell, recovering from a heart attack, was excused from testifying. Other FCC witnesses, however, told the court Mrs. Natvig was not coerced by Mr. Powell.

FCC STAFF CONSULTATION URGED BY McCONNAUGHEY

Chairman says Commission
should be permitted to have
advice of FCC 'experts' work-
ing on a case.

STRONG PLEA for the FCC to be permitted to consult with its staff was made last week by FCC Chairman George C. McConnaughey in a speech to the Federal Communications Bar Assn. at a luncheon meeting.

Mr. McConnaughey said that the Commission would ask Congress to revise Sections 5(c) and 409(c) of the Communications Act to permit commissioners to have the "expert" advice of the general counsel, chief engineer, chief accountant and the review staff.

The present provisions, which prohibit commissioners from consulting with any staff member who has anything to do with a case, were added to the Communications Act by the 1952 McFarland amendments.

The FCC chairman said he had made a study of the reasons for the separation of commission and staff and that he could find no "Svengali" from whom the commissioners must be protected.

Mr. McConnaughey also referred to the requested revision of Sec. 309(c)—the protest rule—to permit the Commission more leeway in handling such protests. He said that the present provisions—also added to the Communications Act by the McFarland Act—resulted in delay, competitive advantage and an undue amount of FCC time. He said that the protest provision has become an instrument of "blackmail" in some instances.

The Commission has asked that the protest rule be amended to permit discretion on whether a grant made without a hearing on which a protest is filed must be automatically stayed. It also has asked that it be permitted to dismiss the protest if in its judgment the allegations even if proven do not justify a reversal of the grant. The Commission also has asked for the right to draw the issues for a protest hearing.

The Commission's proposals have won the support of the FCBA executive committee and Communications Law Section, Administrative Law Division of the American Bar Assn. [B•T, May 16]. Both, however, have qualified their support in various instances.

COURT RULES NETWORKS CAN BE SUED ANYWHERE

U. S. judge in Alabama says
CBS and Westinghouse can be
sued there. If ruling stands it
would overturn precedent.

NETWORK attorneys last week were pondering a ruling of a federal court in Alabama that a network may be sued in that state.

The implication of that ruling—handed down by U. S. District Judge C. B. Kennamer May 9 in a libel action against CBS and Westinghouse for a 1954 *Studio One* program—is that any network may be sued in any state of the Union.

Heretofore the networks have insisted, and the courts have upheld, that suit could only be brought in the state in which networks are incorporated, or in the District of Columbia.

The ruling followed a CBS motion to dismiss the suit or quash the "service" on the ground that it did not "do business" in that state.

The Montgomery, Ala., court held that CBS does "do business" in Alabama. It cited the fact that the "airlines over Alabama are filled day and night with broadcasts from CBS." It also stated that CBS has contracts with radio and tv affiliates in four Alabama cities, to which it paid in 1954 the sum of \$656,189.19. (The court also said that CBS collected from advertisers the sum of \$1.6 million for having its programs carried by its Alabama affiliates.) The court said CBS had originated programs from Alabama, citing the 1954 Senior Bowl football game from Mobile. The court also pointed to CBS' leasing of AT&T lines to carry its programs to Alabama affiliates.

It is understood that CBS is considering appealing this decision.

The \$1 million libel suit was brought last year against CBS and Westinghouse Electric Corp., sponsor of *Studio One*, by Hugh Bentley, former head of the Russell County (Ala.) Betterment Assn. He contended that a *Studio One* program broadcast early in December 1954 implied he was the slayer of A. L. Patterson, Phenix City, Ala., crime figure. On the following week's *Studio One* broadcast, CBS specifically denied that the finger of suspicion had been pointed at Mr. Bentley.

Court Rules Station Is Asset From Time Permit Is Granted

TAX RULING involving the question of whether a station becomes an asset at the time of the FCC's issuance of a construction permit, or later when the station is built and operating was made in favor of the first interpretation by the District of Columbia Tax Court last week.

Case involved the 1950 sale of WOIC (TV) Washington, ch. 9, then owned by General Teleradio Inc. (Bamberger-Macy interests) to WTOP Inc. (then owned 55% by the *Washington Post* and *Times Herald* and 45% by CBS) for \$1.4 million. Suit was for a refund of \$37,257 in taxes paid under protest under D. C. law which holds that the gain from selling assets held less than two years comes under an income and franchise tax.

Judge J. V. Morgan ruled that the station's principal asset, the right to broadcast, dated from 1946 when a construction permit for the station was issued by the FCC. This asset was valued at more than \$750,000. The D. C. government had claimed that this asset dated from 1949 when the station was built.



Demonstrate the Product, We Always Say

And who can make a better pitch for U. S. Keds than the pooch that delights a half a million kids on Seattle's most popular afternoon TV strip, KING's CLUBHOUSE with STAN BORESON. The hound's name is "No-Moshun"...as any youngster in Western Washington will tell you. She helps Stan pull down an average 22.3 ARB rating in the 4:30-5:00 P.M. period. Together, they swamp the competition (79% share of audience).

But the KING-TV story doesn't stop with superior ratings. We not only encourage talent tie-ins with client products—we *insist* on it. KING-TV personalities believe in selling. They like to sell

and they spend time at the job. Besides, they've had a five-year headstart on the competition. That's why most local advertisers count on KING-TV's *personal plus*, when advertising must pay off.

So, whether you are selling tennis shoes or toothpaste, the place to go is KING-TV. In the Pacific Northwest, that's where your sales begin.

Channel 5—ABC
100,000 Watts
BLAIR TV

FIRST IN SEATTLE

KING-TV



**FAIRBANKS
HITS 48%
SHARE-OF-
AUDIENCE
IN NEW
YORK**

Throughout last year, "Douglas Fairbanks Jr. Presents" topped all syndicated shows in the nation's top market: New York. Its average rating was 18.5, share-of-audience over 40%. This year, it's doing even better. In January, almost every other viewing home in New York was watching this show! (ARB)

**"DOUGLAS
FAIRBANKS JR.
PRESENTS"**

CONVENTION HQRS.
SUITE C-200
SHOREHAM HOTEL

**ABC FILM
SYNDICATION, INC.**
7 West 66th St., N. Y.

CHICAGO • ATLANTA • HOLLYWOOD • DALLAS

**APPEALS COURT GETS
DIVERSIFICATION ISSUE**

THE question of the FCC's right to favor an applicant for a tv station because it does not own newspapers or radio stations over a competitor which does was squarely up to the U. S. Court of Appeals in Washington last week, after a two-hour argument.

At issue is the FCC's 1954 decision granting Sacramento's ch. 10 to Sacramento Telecasters Inc. and denying McClatchy Broadcasting Co. This overturned an examiner's initial decision favoring McClatchy.

The Commission said that the grant to Sacramento Telecasters favored diversification of the media of communications.

Sacramento Telecasters is owned by a group including John H. Schacht, former half-owner of KMOD Modesto, Calif. McClatchy owns KFBK-AM-FM Sacramento. KMJ-AM-FM-TV Fresno, KBEE (FM) Modesto, KERN-AM-FM Bakersfield, all Calif., and KOH Reno, Nev. It also publishes the *Sacramento Bee*, *Fresno Bee* and *Modesto Bee*. McClatchy's purchase of KBOX Modesto for \$75,000 has been set for hearing on the question of overlap.

McClatchy's appeal—in which it was joined by the American Newspaper Publishers Assn. as *amicus curiae*—was on the ground that the Commission discriminated against it solely because of its newspaper ownership. This is illegal, McClatchy held. It claimed it was clearly superior in most respects.

The FCC held that it was in the public interest to diversify control of media in the Central Valley of California. It denied that newspaper ownership was an automatic bar to broadcast licenses. The Commission argued that actually Sacramento Telecasters was superior to McClatchy in several significant factors—local ownership, integration of ownership and management, among others.

Each party held that the appellate court's 1951 Scripps-Howard decision bolstered its case. McClatchy held that in the Sacramento decision the Commission had gone beyond the terms of that decision. FCC held the Sacramento ruling was exactly in line with that decision.

The Scripps-Howard decision was that the Commission could weigh newspaper ownership as a factor in a comparative hearing.

**Senator Johnson Praises
Sarnoff Plan at Dinner**

THE SARNOFF Plan "points the way to a solution of the greatest problem before our people," Senate Majority Leader Lyndon B. Johnson (D-Tex.) said in New York May 15.

Sen Johnson spoke at a dinner honoring Brig. Gen. David Sarnoff, RCA-NBC board chairman, at the Waldorf-Astoria where he was presented the 1955 gold medal achievement award of the Williamsburg Settlement, a social agency serving the Williamsburg section of Brooklyn. The award was presented by Herbert Bayard Swope. Other dignitaries included Bernard M. Baruch and Dr. Ralph Bunche.

Gen. Sarnoff's plan, as presented to the White House [B•T, May 16], calls for a stepped-up "political offensive" as a means of winning the Cold War. Sen. Johnson said the plan may yet prove to be the general's "greatest effort." He noted that the "basic elements" of the Sarnoff blueprint have been endorsed by the President. The senator recommended that the creation of a political strategy board be the first step in carrying through the Sarnoff plan. A board, with a cabinet-level official at its head, was one of the suggestions made by Gen. Sarnoff.

**KVOA-AM-TV Sale
Submitted to FCC**

APPLICATION for FCC approval to the sale of KVOA-AM-TV Tucson, Ariz., for a total consideration of \$513,904 was filed last week.

Purchasing groups is headed by Clinton D. McKinnon (20%), 75% owner of *North Shores* (San Diego) *Sentinel*, 51% owner of the *Coronado* (Calif.) *Journal* and former editor-publisher-majority stockholder of the defunct *Los Angeles Daily News*. Mr. McKinnon is a former Congressman from California. Others in the group are Vice President Bernard Weinberg (20%), Milton Weinberg Advertising Co.; Vice President Frank J. Oxarart, commercial manager, KFWB Hollywood, and radio-tv production; Secretary Arthur A. Desser (20%), attorney and real estate development, and Treasurer Harold B. Garfield (20%), drugstore owner and associated with Mr. Desser in a business and property management firm.

Purchasing price includes \$288,904 for the stock of the Tucson stations and purchase of obligations totaling \$225,000. Majority (76.9%) selling stockholder of KVOA-AM-TV is KTAR Broadcasting Co., operator of KVAR (TV) Mesa and KTAR Phoenix, both in Arizona. KTAR Broadcasting is controlled by John J. Louis, who also controls KYUM Yuma and KYCA Prescott, both in Arizona. Mr. Louis is also president of Needham, Louis & Brorby Inc., Chicago advertising agency and is a principal stockholder of S. C. Johnson & Sons Inc. (wax and polishes).

**Recall Hearing on FCC Budget
Rescheduled for Wednesday**

RECALL hearing on the FCC's budget for fiscal 1956, which had been scheduled for last Thursday by a Senate Appropriations Subcommittee headed by Sen. Warren G. Magnuson (D-Wash.), last week was postponed to 2 p.m. this Wednesday.

The Senate group has held initial hearings on the FCC's proposed 1956 budget of \$6,870,000—which includes \$170,000 added by the House above Budget Bureau recommendations—but senators want to ask FCC members more about the agency's proposed study of the broadcasting industry and about other FCC policy matters.

In its \$170,000 boost for the FCC in the appropriations bill (HR 5240), the House earmarked \$80,000 for the proposed FCC study, but FCC Chairman George C. McConaughy has told the Senate appropriations group that this amount will only initiate the investigation [B•T, May 9]. The FCC also feels the total 1956 budget should be raised to \$7,240,930—the amount FCC originally requested.

**FCC Approves Merger
Of Jackson, Miss., Tvs**

FCC last week approved the consolidation of WSLI-AM-TV and WJTV (TV), both of Jackson, Miss.

Under terms of the agreement, Standard Life Insurance Co. relinquishes control of the WSLI stations through sale of 40% interest for \$176,000 to Mississippi Publishers Corp. In turn, Standard Life will pay Mississippi Publishers \$175,000 for ch. 25 WJTV equipment and facilities. WSLI-TV operates on ch. 12. The FCC approval is subject to the condition that the permit for ch. 25 WJTV be disposed.

Mississippi Publishers Corp. owns the *Jackson Clarion-Ledger* and *News*. Standard Life will retain a 32.4% interest in WSLI-AM-TV.

The **DIFFERENCE**

between

A PROGRAM SCHEDULE

and

A PROGRAM SERVICE



Represented
Nationally
by

**THE
HENRY I. CRISTAL
COMPANY**



A howling blizzard last March 27-28 dropped 20 to 30 inches of snow over the 20-county area served by WSYR. Highways were blocked. Schools closed. It was one of those times when Central New Yorkers realized how much they depend upon radio . . . how surely they rely on WSYR.

WSYR's local programs poured forth a steady stream of information about conditions in every city, village and hamlet in the area. The voices were those of familiar personalities who have become, over the years, the trusted daily companions of a great share of the 428,000 radio families in WSYR's coverage area. . . .

. . . Folks like Farm Editor Deacon Doubleday . . . Time-keeper Elliott Gove . . . Newsmen Fred Hillegas, Bob Nelson, Rod Swift and Carl Zimmerman . . . Jim Deline and His Gang . . . Women's Editor Jennie-Belle Armstrong.

WSYR's superior local program service, performed by people who know — and are known by — the communities they serve, is a powerful reason for WSYR's commanding leadership in a market with \$2 billion buying power.

NBC in Central New York

WSYR

5 KW • SYRACUSE • 570 KC

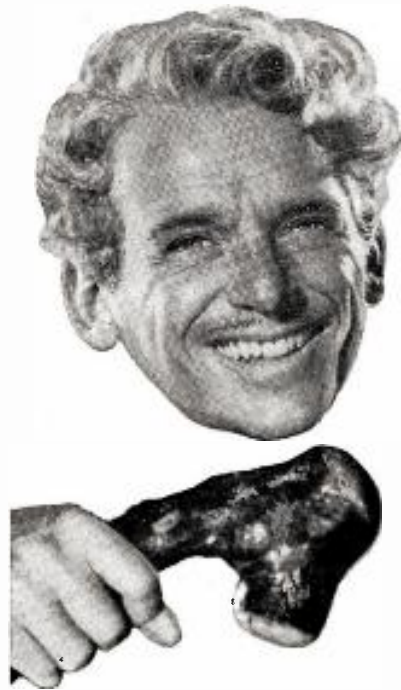

**RHEINGOLD
SPONSORS
"FAIRBANKS"
AGAIN...
3rd YEAR
IN A ROW!**

In January, almost every other viewing home in New York was watching "Douglas Fairbanks Jr. Presents", (ARB, January '55)! Rheingold Beer is so impressed, they're sponsoring Fairbanks regionally for the 3rd consecutive year. Many markets available for first run. 'Nuff said!

**"DOUGLAS
FAIRBANKS JR.
PRESENTS"**

CONVENTION HDQRS.
SUITE C-200
SHOREHAM HOTEL

**ABC FILM
SYNDICATION, INC.**

7 West 66th St., N. Y.

CHICAGO · ATLANTA · HOLLYWOOD · DALLAS

One Fm, Four Am Outlets Granted by Commission

FOUR new daytime standard stations at Harlan, Ky., Plymouth, Mass., Clarksdale, Miss., and Spruce Pine, N. C., and an fm station at Providence, R. I., were granted by the FCC last week.

A new 1 kw daytime am station on 1410 kc at Harlan, Ky., was granted to Ky-Va Broadcasting Corp., operator of WTCW Whitesburg, Ky. President and 97.5% stockholder is Kenneth J. Crosthwait.

At Plymouth, Mass., a new 500 w standard daytime station on 1390 kc was granted to Plymouth Rock Broadcasting Co., composed of President-General Manager Joseph M. Corcoran (51%), salesman; Treasurer Robert G. Clark Jr. (39%), attorney, and Eleanor Corcoran (10%), school teacher.

A new 1 kw daytime standard station on 1600 kc at Clarksdale, Miss., was granted to Coahoma Broadcasting Co., a general partnership composed of Anne P. McLendon (60%), retail furniture; Harding Corley (20%), accountant, and Harvey T. Ross (20%), attorney.

The new 1 kw daytime am station at Spruce Pine, N. C., was granted to Toe River Valley Broadcasting Co., headed by Tom N. Cooper, drive-in theatre owner.

The new class B fm station at Providence, R. I., was granted to General Broadcasting Corp. The new station will operate on ch. 268 (101.5 mc) with effective radiated power of 20 kw and antenna height of 500 ft. above average terrain.

Initial Decision Favors WCEM Increase to 250 W

INITIAL decision proposing to grant the application of WCEM Cambridge, Md., to increase power from 100 w to 250 w on 1240 kc fulltime, was issued by FCC Examiner Hugh B. Hutchison last week.

WCEM's application was designated for hearing to determine whether the proposed operation would involve objectionable interference with WSNJ Bridgeton, N. J. The examiner concluded that a grant of the WCEM proposal would be in the public interest in view of the fact that it would provide a first local nighttime primary service and a medium of local self-expression to a portion of the population in the immediate Cambridge area.

Biscayne Tv Takes Issue With Storer De-Intermix Bid

STORER Broadcasting Co.'s proposal to de-intermix Miami by removing chs. 7 and 10 from that Florida city drew the fire of Biscayne Television Corp. last week.

Biscayne, which holds an initial decision for Miami's ch. 7, opposed the de-intermixture proposal on the grounds (1) that it would reduce competition from five stations to two stations; (2) that its original proposal would have left one uhf channel for the competitors seeking chs. 7 and 10; (3) that the rights and interests of the parties in the chs. 7 and 10 hearings had been lost sight of; (4) that Storer contradicted itself by filing an application for Miami's ch. 10; (5) that it amended its Miami de-intermixture petition when its Toledo, Ohio, vhf station (WSPD-TV) was threatened by a de-intermixture petition for that city; (6) that it would cost the Miami public about \$8 million to convert their receivers to uhf. Biscayne comprises the Cox and Knight news-

paper-radio interests in Miami and Niles Trammell, former NBC president.

In answer to the protest of WKAT Miami Beach to Storer's filing of its application for ch. 10 there [B•T, May 16], Storer averred that WKAT was wrong in stating it does not have the right to file. Even though its appeal was on the multiple ownership rule, the FCC's denial of its then proffered ch. 10 application was a part of that appeal, Storer said. WKAT has the initial decision for Miami's ch. 10.

FCC Orders KOAT Back To 1240 Kc From 860 Kc

FCC last week ordered KOAT Albuquerque, N. M., to cease operation on 860 kc as of May 31 and to resume operation on its regularly licensed facility of 1240 kc with 250 w fulltime on or after June 1.

The Commission's action last week postponed the effective date of its Feb. 4, 1954, grant to KOAT to change from its regular facility to 860 kc, 5 kw day, 1 kw directional night and scheduled a hearing on the grant.

KOA Denver, operating clear channel on 850 kc, had objected to KOAT's move to 860 kc on ground it obliterated its signal from part of New Mexico. The FCC denied the protest and the U. S. Court of Appeals in Washington remanded the case to the Commission for a hearing on the ground that KOA had shown it was likely to be financially injured and thus had standing as a protestant [B•T, April 18].

Kilgore Monopoly Probe Scheduled to Begin June 1

"FULL-SCALE investigation into every significant phase of antitrust and monopoly problems" is promised by Chairman Harley M. Kilgore (D-W.Va.) of the Senate Antimonopoly Subcommittee, which opens two weeks of hearings at 10 a.m. June 1. FTC and Justice Dept. officials are among those scheduled to testify.

— PROFESSIONAL SERVICES —

Kessler Leaves Cohn & Marks, Will Open Own Law Practice

SYLVIA D. KESSLER, former chief of the FCC's Office of Opinions & Reviews, has resigned from the Washington law firm of Cohn & Marks to open her own office. She joined Cohn & Marks in August 1953.



MISS KESSLER

Miss Kessler was born in the District of Columbia and received her law degree in 1936 from Southeastern U. there. After private practice, she joined the FCC in 1943 as legal assistant to the late Comr. Ray C. Wakefield. In February 1952, Miss Kessler became chief of the Office of Opinions & Reviews, the office which writes decisions for the Commission.

Blackburn-Hamilton in S. F.

NEW OFFICE opened in San Francisco by Blackburn-Hamilton Co., media brokers, is located at 111 Sutter St., Suite 340. William T. Stubblefield is in charge of the office. The address is not 235 Montgomery St., as was reported in B•T May 9.

**WELCOME — NATIONAL ASSOCIATION
OF RADIO AND TELEVISION BROADCASTERS**
The Sheraton-Park Hotel is at your service

NOW—HOLD SIMULTANEOUS SALES MEETINGS COAST TO COAST



Sheraton Hotels Closed Circuit TV Network

Now — management can talk "face to face" with the entire sales force . . . introduce a new product simultaneously to dealers in all territories . . . get reactions and answer questions from plant personnel scattered all over the country. What's more — all this can be done without pulling a single key man from his district and without paying costly travel expenses!

These are a few of the advantages you gain by using the new Sheraton Closed Circuit Television Network with a two-way audio pick-up — in any Sheraton Hotels in cities from Massachusetts to California (or independent hotels in non-Sheraton cities).

An experienced staff handles production details, assists in all planning, including budgeting and analysis.

LEARN MORE about this newest and most modern way to communicate "in person" at less cost. Write to SHERATON CLOSED CIRCUIT TV, 470 Atlantic Avenue, Boston 10, Mass.

SHERATON
The Proudest Name in
HOTELS

IN THE U. S. A.

AKRON
ALBANY
BALTIMORE
BOSTON
BROOKLINE, Mass.
BUFFALO
CHICAGO
CINCINNATI
DETROIT
INDIANAPOLIS
LOS ANGELES
NEW YORK
PASADENA
PROVIDENCE
ROCHESTER
SAN FRANCISCO
SPRINGFIELD, Mass.
ST. LOUIS
WASHINGTON

IN CANADA

MONTREAL—Sheraton-Mt. Royal
—The Laurentien
TORONTO—King Edward Sheraton
NIAGARA FALLS—Sheraton-Brock
HAMILTON—Royal Connaught

(Non-Sheraton cities may also be included
in the Sheraton TV Network.)

CBS RADIO CHARTS ONE RATE, MAINTAINS IT'S NOT A CUT

Plan would replace and reportedly equal present rates that have complicated discount arrangements. It would not result in lowered charges, affiliates are assured.

A SINGLE rate for all time periods on CBS Radio—week days, week nights and weekends—is being considered by network officials to simplify the current structure which produces virtually the same result for the advertiser via elaborate discount arrangements, it was reported last week.

Members of the executive committee of the CBS Radio Affiliates Assn.'s board of directors, meeting with network officials in New York last Monday and Tuesday in preparation for a meeting of the association's full board in Washington today (Monday), said they had long been assured by top CBS and CBS Radio authorities that such a simplification would not involve lowered charges to advertisers.

On the other hand, they said, a single rate for all time periods would mean a slight increase for Saturday and Sunday time, which currently is priced somewhat lower than Monday-through-Friday segments. At present, Monday-Friday evening periods carry a higher rate than daytime segments, but the actual cost is equalized through discounts.

If CBS Radio proposes to reduce affiliates' compensation for carrying network programs, affiliates said, the effort will be resisted. They said they knew of no such proposal, however. Both adoption of a single rate and any change in station compensation, should any be made, presumably would be subject to renegotiation of affiliation contracts between the network and the affiliates individually.

Rates are slated to be one of several subjects up for discussion at today's affiliates board meeting, to start this morning with a session of the board alone and followed by a luncheon and perhaps afternoon meeting with top network officials.

Plans for the annual convention of all CBS Radio affiliates, scheduled Sept. 12-13 in Detroit, are expected to rank high on today's board agenda.

Other discussions are expected to range across such subjects as co-op programs, including the charges and arrangements therefor; Daylight Saving Time and its effects and the matter of charges for taping programs for non-DST stations; station clearances, and research activities.

Executive committee members at last week's meeting, held with new President Arthur Hull Hayes and other key officials of the network, included John F. Patt, WJR Detroit, chairman of the affiliates board as well as of the executive committee; Victor A. Sholis, WHAS Louisville; George B. Storer, Storer Broadcasting Co.; Saul Haas, KIRO Seattle, and Kenyon Brown, KWFT Wichita Falls, Tex.

Other members of the affiliates board are Arnold Schoen, WPRO Providence, R. I., secretary-treasurer; George Coleman, WGBI Scranton, Pa.; C. T. Lucy, WRVA Richmond, Va.; John Rivers, WCSC Columbia, S. C.; F. C. Sowell, WLAC Nashville, Tenn.; C. C. Caley, WMBD Peoria, Ill., and Hugh Terry, KLZ Denver.

Three of the nine districts will hold elections this summer. In District 1, Joseph K. Close of WKNE Keene, N. H., and J. Maxim Ryder of WBRY Waterbury, Conn., are running for the board seat now held by Mr. Schoen. In

District 2, Mr. Coleman of WGBI, C. Grover DeLaney of WHEC Rochester, N. Y., and Keith W. Horton of WELM Elmira are seeking the seat now held by Mr. Coleman (who is eligible for the contest only because he has not served a full term, having been named to fill out the term of I. E. Lounsberry), and in District 3, John S. Hayes of WTOP Washington and Donald Thornburgh of WCAU Philadelphia are running for the seat now held by Mr. Lucy.

The directors from the nine districts elect three directors-at-large to round out the board membership. These three—who are eligible for re-election but serve only one-year terms as against three-year terms for district directors—currently are chairman Patt and Messrs. Storer and Sholis.

The affiliates association now numbers approximately 175 members, a gain of 10 over the total a year ago. Officials hope to bring the number to around 200 by the time of the Detroit convention. CBS Radio currently has 221 affiliates.

CBS-TV GETS PCC, BIG TEN FOOTBALL

PLANS for telecasting top football games of the Big Ten and the Pacific Coast conferences on a regional basis this fall were revealed to CBS-TV affiliates meeting in New York last week. (See other stories, page 116.)

A joint announcement was made in New York Thursday by Sig Mickelson, CBS vice president in charge of news and public affairs, and K. L. (Tug) Wilson, commissioner of the Big Ten, revealing some of the details of the Big Ten pact.

Included in the Big Ten arrangement is an agreement to telecast for the second straight year CBS-TV's coverage of the conference's basketball games in December.

No details of sponsorship nor price of the games were disclosed, although Mr. Mickelson said that a national sponsor, picking up the tab for the whole Big Ten football package, would be preferred over a game-by-game sale to different advertisers.

Under the agreement, CBS-TV has the right to select the games to be telecast as the season progresses. On an estimate basis, these are the dates and games available for regional telecast:

Sept. 24—Washington vs. Minnesota at Minneapolis; Oct. 8—Wisconsin vs. Purdue at Lafayette, Ind.; Oct. 22—Michigan vs. Minnesota at Minneapolis; Nov. 5—Wisconsin vs. Northwestern at Evanston, Ill., and Nov. 12—Iowa vs. Ohio State at Columbus.

Mr. Mickelson said CBS-TV also expected within "a short time" similar regional agreements with eastern colleges, principally in the New England and middle Atlantic regions.

As of Thursday, CBS-TV had this tentative schedule for Pacific Coast games: Sept. 24—California vs. Illinois and (at Stanford only) Oregon vs. San Francisco; Oct. 8—Washington vs. U. of So. Calif.; Oct. 22—Washington vs. Stanford; Nov. 5—Washington State vs.



**YOUR STAR...
YOUR HOST...
YOUR
SALESMAN:
DOUGLAS
FAIRBANKS JR.**

To all moviegoers in the country (and that's just about everybody) "Fairbanks" is a magic name. It promises action... danger... excitement. And "Fairbanks" lives up to that promise as producer-host of every show, star of one out of four in the sponsor-proven TV film series:

**"DOUGLAS
FAIRBANKS JR.
PRESENTS"**

CONVENTION HDQRS.
SUITE C-200
SHOREHAM HOTEL

**ABC FILM
SYNDICATION, INC.**
7 West 66th St., N. Y.

CHICAGO • ATLANTA • HOLLYWOOD • DALLAS

Oregon, and Nov. 12—Oregon State vs. California.

Although announcers have not yet been designated, Mr. Mickelson said sportscaster Tom Harmon probably would be assigned to do the west coast telecasts.

It was explained that the decision to telecast conference games was premised on the belief that national games do not hold the strength of interest enjoyed in football-minded areas such as the states supporting the Big Ten.

Mr. Mickelson said the agreements were entered into by CBS-TV because of the network's belief that the game telecasts would "build intensive viewer interest" and bring to the tv screens those games "closest to the viewers."

Mr. Wilson was asked if the Big Ten, on the basis of the experience with the basketball schedule that was telecast, could expect an increase or decline in actual football attendance next season. He said the Big Ten did not know at this time what effect tv had on basketball or what it would have on football but that advance "football ticket sales have exceeded anything we have had to date. We are happy to bring the games back to the people who pay the bills."

Asked to what extent the gate was "hurt" during the last basketball season as compared to previous attendance, Mr. Wilson answered that it was "very small." Proceeds from sale of the games, Mr. Wilson said, would be divided among the member Big Ten schools—and "of course will mean more money for them."

Another sports event to be on CBS-TV nationally, Mr. Mickelson said, is the National Collegiate Athletic Assn.'s track and field meet, to be held in Los Angeles on June 18.

CBS-TV PLANS TEN 90-MINUTE SHOWS, 17 NEW NIGHTTIME SERIES FOR FALL

Network's affiliates meeting in New York hear Network Program Vice President Hubbell Robinson Jr. tell of revamped schedule to meet competition from other tv networks. Color plans and coverage of sporting events were also agenda items.

THE PROGRAM schedule which CBS-TV plans to pit against the lineups of rival networks this fall—including ten 90-minute Saturday night specials, with Noel Coward starring in three and Bing Crosby in two—was outlined to CBS-TV affiliates last Thursday by Network Programs Vice President Hubbell Robinson Jr.

The program plans, which also include 17 new half-hour nighttime series, shared honors at the first general conference of CBS-TV affiliates, held Thursday and Friday at the Waldorf-Astoria in New York, with such diverse agenda subjects as subscription television (see story, page 27) and CBS-TV policy statement opposing pay-tv, (on page 28), plans for color, arrangements for regional telecasts of Big Ten and Pacific Coast Conference collegiate football and other sports events (opposite page), and election of the first permanent CBS-TV Affiliates Advisory Board (page 116).

An estimated 300-plus officials of CBS-TV affiliated stations were on hand for the two-day meeting. First-day speakers included Dr. Frank Stanton, president of CBS Inc.; CBS-TV President J. L. Van Volkenburg; Programs Vice President Robinson, and Sig Mickelson, CBS vice president in charge of news and public

affairs. The Friday agenda included an informal luncheon address by FCC Chairman George C. McConaughy and business session speeches by a number of CBS-TV department heads including William B. Lodge, vice president in charge of engineering; John P. Cowden, operations director, advertising and sales promotion department, and Charles Oppenheim, public relations director.

President Van Volkenburg said color tv plans for fall encompass at least two weekly programs on a regular basis, a "majority" of the ten-hour-and-a-half specials, all of some *Omnibus* programs and segments of others, plus the Chrysler Corp.'s hour-long *Shower of Stars* presentations, which also were carried in color during the past season.

Jack Benny will be starred in six of the *Shower of Stars* programs in addition to his alternate-Sunday series. Three of the six will be written especially for him; the first, now in preparation, is by F. Hugh Herbert, author of "The Moon Is Blue" while the two others will be musicals, one featuring a full symphony orchestra.

Mr. Robinson said that among the Saturday night 90-minute specials—which will run from 9:30 to 11 p.m. EST, every four weeks—the first of Noel Coward's three shows will co-star

ZOOMING

THE LITTLE RASCALS

TO INSTANT TOP RATING IN EVERY MARKET!

CONVENTION SPECIAL

THE AMAZING RASCALS COMBINE SOLID ENTERTAINMENT WITH FULL FAMILY ACCEPTANCE!

The big talk at the convention is about the big pull of 'THE LITTLE RASCALS.' They grab the big audience instantly, spectacularly! Yes, everybody, everywhere, loves 'THE LITTLE RASCALS' — the youngsters, the adults, and especially the man whose business it is to sell merchandise!

Interstate
TELEVISION Corporation

NEW YORK • HOLLYWOOD • CHICAGO

1560 BROADWAY
PLAZA 7-3070

4376 SUNSET DRIVE
NORMANDY 2-9131

1250 S. WABASH
WABASH 2-7937

Mary Martin with the British actor-author and the two others will be Mr. Coward's own "Blithe Spirit" and "Peace In Our Time."

The two Bing Crosby specials will be plays with music, identified by Mr. Robinson as Thornton Wilder's "Our Town" and Maxwell Anderson's "High Tor." Of the five remaining specials, three will be produced by Paul Gregory, who conceived, produced and staged "Don Juan in Hell" and "John Brown's Body" and whose "Three for Tonight" is currently playing on Broadway. The first Gregory special for CBS-TV will be "The Big Banjo," story of American minstrelsy, with a name cast.

Night by night, here are highlights of the fall schedule reported by Mr. Robinson:

The 7:30-8 p.m. block Monday through Friday will be programmed with "wholesome, family entertainment of high quality, with the accent on action and adventure." On Monday night Johnson & Johnson will sponsor *Adventures of Robin Hood* in this spot; Tuesdays, Whitehall Pharmaceutical Co. will sponsor *Name that Tune*; Wednesday nights will see *Brave Eagle* in that period; Thursday, Quaker Oats will sponsor *Sergeant Preston of the Yukon* and on Friday will have *My Friend Flicka*. The Monday night schedule from 8 p.m. onward will be unchanged.

Tuesday night, however, will be "re-programmed almost in its entirety." The *Phil Silvers Show* will start off at 8 p.m. followed by the new Marie Wilson series, *Miss Pepperdine*, at 8:30. *Joe and Mabel*, described by Mr. Robinson as expected to be "one of the season's big sleepers," will go in at 9 p.m. and the revamped *Red Skelton Show* will resume at 9:30. *The \$64,000 Question*, which looks as though it should be the blockbuster of all giveaway programs, goes into the 10 p.m. segment, and Ed Murrow's *See It Now* is slated to continue at 10:30.

Wednesday night's main change will bring two new occupants into the 10-11 hour: *United States Steel Hour* alternating with General Electric Co.'s *20th Century-Fox* series. Mr. Robinson told the affiliates that in its new time spot *Steel Hour* "should have the chance to reach the rating heights it was unable to achieve before," and that the *20th Century-Fox* series "is being planned to consist of top picture names in top picture properties. They will have the budget and the creative resources to make it outstanding television entertainment."

Approximately 50% of Thursday night's schedule will be new. A new documentary called *Wanted*, with each half-hour dealing factually with people and events leading to the crime for which a criminal is wanted, is slated at 8-8:30. Chrysler's *Climax (Shower of Stars one week in four)* will be back from 8:30-9:30, and *Four Star Playhouse* will resume at 9:30. The new *Johnny Carson Show* is slated from 10-10:30 and Mr. Robinson said "we are so confident" about the young comic that "we are currently formulating plans and discussing with advertisers the extension of this show into a full-hour revue."

The Friday night schedule will remain unchanged following the introduction of *My Friend Flicka* at 7:30-8 p.m.

The regular Saturday night lineup will start with *Stage Show*, followed by Jackie Gleason's *The Honeyymooners*. Then at 9:30 will come a new comedy, *The Four of Us*, starring Janis Paige, with *Gunsmoke* next at 10 p.m.

On Sunday nights, Ed Sullivan's *Toast of the Town* will continue in the 8-9 period. *General Electric Theatre* will remain at 9-9:30. The new *Alfred Hitchcock Series* goes into the 9:30-10 segment, to be followed by another new show on which "we are working with agency and client now."

ABC'S GOLDENSON SEES BRIGHT FUTURE

Stockholders meeting hears AB-PT president speak out on his confidence in radio and tv. First and second quarter profits for 1955 are ahead of those for the same periods last year.

BRIGHT FUTURE for the ABC Div. of AB-PT during the remainder of 1955 was pictured by Leonard H. Goldenson, president of AB-PT, at the annual stockholders meeting last Tuesday in New York.

Mr. Goldenson reported that the first quarter for ABC "was profitable and substantially ahead of last year," and that earnings in the second quarter are "running well ahead" of the same period of 1954. He enumerated in some detail ABC-TV's fall programming plans, including *Mickey Mouse Club*, *Warner Bros. Presents* and the new Bishop Sheen program, and added:

"Figures do not tell the entire story but tv network time sales for program renewals and new programs beginning this summer and this coming fall, sold since early February of this year, exceed the total network time sales for the entire year of 1954. We feel that ABC's growth in television will continue."

ABC Radio, Mr. Goldenson said, has been operating at "a profitable level, and we feel that radio will continue to be a profitable and vital medium." He told stockholders that radio listening habits have changed because of television, and that consequently ABC Radio has revamped its programming to place emphasis on drama shows for housewives during the daytime and short news programs in the evening.

In reply to a question, Mr. Goldenson said that consideration is being given to diversifying operations by expanding into the electronics and the phonograph record fields. He said that if AB-PT takes positive action, it may acquire an established electronics firm but it would prefer to establish its own record company.

Since AB-PT's activity is substantially in motion picture exhibition, Mr. Goldenson dwelt at length on the value of using tv to encourage attendance at motion picture theatres by promoting motion pictures on television. He cited the *Disneyland* program as an example, pointing out that after the motion picture *20,000 Leagues Under the Sea* was exposed on that program, theatre attendance was very high. He added that the new Warner Bros. tv program also is expected to accomplish the purpose of promoting motion pictures at the theatres.

Mr. Goldenson told stockholders that the company's theatre operating subsidiaries largely are opposed to subscription tv, and said the ABC Div. will take a stand against pay-see tv in proceedings before the FCC. (See subscription-tv story, page 27.)

Most of the questions and comments from stockholders centered around the resignation of ABC commentator Walter Winchell [B•T, March 14]. Mr. Goldenson replied that it had been the decision of the board of directors to accept the proffered resignation of Mr. Winchell, effective the end of this year. Several stockholders suggested that the board ask Mr. Winchell to reconsider, but others expressed approval of the board's action.

Re-elected to the board of directors of AB-PT for a one-year term were Earl E. Anderson, vice president of ABC; John Balaban, president of Balaban & Katz Corp.; A. H. Blank,

president of Tri-States Theatre Corp.; John A. Coleman, senior partner, Adler Coleman & Co.; Charles T. Fisher Jr., president of National Bank of Detroit; E. Chester Gersten, president of the Public National Bank & Trust Co. of New York; Walter W. Gross, vice president and general counsel of the corporation; Robert H. Hinckley, vice president of ABC; Robert L. Huffines Jr., president of Textron American Inc.; William T. Kilborn, president of Flannery Mfg. Co.; Robert E. Kintner, president of ABC; Walter P. Marshall, president of Western Union Telegraph Co.; Edward J. Noble, chairman of the board of directors of Life Savers Corp. and chairman of the finance committee of AB-PT; Robert H. O'Brien, financial vice president of the corporation; Robert B. Wilby, president of Alabama Theatres Inc. and North Carolina Theatres Inc.; Owen D. Young, retired, and Mr. Goldenson. Sidney M. Markley, vice president of AB-PT, was elected a director to fill the vacancy caused by the death of Herbert J. Schwartz.

CBS-TV Affiliates Elect Permanent Advisory Board

THE FIRST permanent CBS-TV Affiliates Advisory Board, an 11-man group representing nine regional districts and two Extended Market Plan divisions, was elected Thursday at the first general conference of CBS-TV affiliates in New York.

Named for two-year terms, the board members are:

District 1, Paul Adanti, WHEN-TV Syracuse; District 2, Richard Borel, WBNS-TV Columbus, Ohio; District 3, Glenn Marshall Jr., WMBR-TV Jacksonville; District 4, T. B. Lanford, WJTV (TV) Jackson, Miss.; District 5, Bruce McConnell, WISH-TV Indianapolis; District 6, William B. Quarton, WMT-TV Cedar Rapids, Iowa; District 7, Clyde Rembert, KRLD-TV Dallas; District 8, James Russell, KKTU (TV) Colorado Springs; District 9, Howard Lane, KOIN-TV Portland, Ore.; EMP for the West, Rex Howell, KFXJ-TV Grand Junction, Colo., and EMP for the East, Frank E. Busby, WTVY (TV) Dothan, Ala.

A group, consisting of Mr. Marshall as chairman, Mr. Rembert, E. K. Jett, WMAR-TV Baltimore, and Philip G. Lasky, KPIX (TV) San Francisco, has been functioning as an interim advisory committee for several years. The four members were given a vote of thanks and presented desk cigarette cases by CBS-TV President J. L. Van Volkenburg in appreciation of their services.

Facts Forum Withdraws From 'State of Nation'

HARDY BURT Productions, New York, announced last week that effective June 16, the *State of the Nation* radio program will be presented by Mutual in cooperation with the Hardy Burt organization. On that date, Facts Forum, non-profit public service organization in Dallas, headed by H. L. Hunt, millionaire Texas oilman, will withdraw its support of the program.

Facts Forum has paid production costs for *State of the Nation*, which is carried on 400 Mutual radio stations, as well as for various other radio-tv programs which are made available free of charge to stations. It could not be ascertained from a spokesman for Hardy Burt whether Facts Forum plans to curtail its other radio-tv activities.

A big step toward a Modern Transportation Policy

On April 18, the White House released the report of the Presidential Advisory Committee on Transport Policy and Organization calling for a revised national transportation policy. The railroad industry endorses this report as an important contribution toward working out to the best interest of the public the changes in transportation policy which are made necessary by changed competitive conditions.

In its report, the Advisory Committee finds...

- That the public interest requires the maintenance of a sound and vigorous common carrier transportation system, adequate for an expanding economy in peace and for the national security in war.
- That, in many respects, present government policy prevents — or severely limits — the most economical use of the nation's transportation plant and imposes large and needless costs upon common carriers and so upon travelers, shippers and the consuming public.
- That common carriers should be permitted greater freedom to utilize their economic capabilities in the competitive pricing of their services, so long as their prices do not exceed reasonable maximum rates or are not less than reasonable minimum rates fixed by the Interstate Commerce Commission.
- That the cornerstone of a modernized regulatory program under a system of dynamic competition is increased reliance on competitive forces in rate making, to enable each form of transport to reflect its abilities by aggressive experimentation in rates and service in order to demonstrate to the full its possibilities for service to the shipping and traveling public.

The report of the Presidential Advisory Committee contains other sound recommendations intended to establish and maintain the "progressive and financially strong system of common carrier transportation" which the committee feels is of "paramount importance to the public interest."

That's why the railroads regard the report of the Presidential Advisory Committee as a distinct step toward greater equality in transportation, with improved service and economy to the public.

Association of American Railroads
WASHINGTON, D. C.

in Virginia use these Selling Personalities

★ Mondays thru Fridays
No Premium Rates



ALDEN AAROE 6 to 7 A.M.

Gets out with the farmers and talks their language.



GARL STUTZ 9 to 10 A.M.

Knows his music. Co-author "Little Things Mean a Lot."



SUNSHINE SUE

5:30 to 5:45 P.M. Sweet talking mistress of ceremonies and selling.



50,000 Watts
Richmond, Va.

For 29 years a Virginia institution

REPRESENTED BY
CBS RADIO SPOT SALES

WRVA

SESAC

your best

transcription

buy . . .



475 FIFTH AVENUE

NEW YORK

FILM NETWORKING NEAR AT DUMONT

Trend accented as current sponsors put shows on Electronicam film as experiment.

FIRST DuMont moves—audible above a rumbling—toward "film networking" were detected last week with disclosure that all of the network's current sponsors are filming their programs with the Electronicam system on an experimental basis.

DuMont, it was learned, expects the first commercial program filmed by Electronicam (live-film camera) to be on the airwaves "within a few weeks."

As of this week, commercial network time programmed by DuMont has been trimmed to some four hours as compared to the five hours programmed at the time of Electronicam's demonstration in New York [B•T, May 16].

Meanwhile, Ted Bergmann, managing director of the network, said last week that station executives at the NARTB convention this week will "see for themselves the superiority" of Electronicam-filmed programs.

Frequent showings of the system with "typical Electronicam program excerpts" are being held at the network suite, B-200, at the Sheraton-Park Hotel.

Referring to the New York demonstration, Mr. Bergmann said that station managers who saw "what we will shortly be putting on the air are amazed at the quality and agree that the day of the kinescope has ended." He said station executives agree with those concerned with agencies, film producers and program packagers that DuMont has "found a way to offer every station in the country, interconnected or not, programs indistinguishable in quality or effectiveness from the live show as it leaves the studio."

The Electronicam system's use of filming programs at present in New York is in the process of "shakedown," it was said. Although most advertisers reportedly are "in favor" of having their current programs so filmed on the DuMont Network, the majority also are adopting a "wait and see" policy.

DuMont Network officials report they are confident that some advertisers will seek extended station lineups with Electronicam-filmed programs because of the preference for these over kinescope.

Attending the suite will be Mr. Bergmann; John H. Bachem, network general manager; James L. Caddigan, newly-named head of the Electronicam production unit; Rodney D. Chipp, director of engineering; Robert L. Coe, director of station relations, and Edwin G. Koehler, station relations.

Hearst's WISN Milwaukee Joins ABC Radio Network

AFFILIATION of WISN Milwaukee with ABC Radio, effective immediately, was announced Friday by Charles T. Ayres, ABC vice president in charge of the radio network, and D. L. (Tony) Provost, vice president and general manager of the radio and television division of the Hearst Corp., operator of WISN. Station operates with 5 kw on 1150 kc.

Mr. Ayres, noting that ABC was "proud and happy to welcome WISN as the newest member of the ABC family," described the station as one of the oldest in the U. S. and at its debut "a pioneer in an infant industry." He said WISN, a "key station in a key market," would be a strong addition to the ABC Radio lineup.

ANNOUNCING **NEW** ADVANCED DESIGNS IN **REMOTE CONTROL SYSTEMS**

**RUST'S TWO NEW MODELS OUTMODE
ALL OTHERS ON THE MARKET TODAY!**

Inside new modern chassis, lie the most advanced remote control units ever devised. Rust Industrial, pioneers in the field, now announces two new systems that offer performance and dependability never before achieved!

Already proven in actual operation in both full time directional and non-directional stations, where continuous operation is paramount, these systems are custom-engineered to each stations requirements . . . and complete

in every respect. Such features as *simplified design . . . drop-down panel construction . . . no tubes . . . the very finest components*, virtually assure years of trouble-free operation. And Rust facilitates proper installation with complete *interconnecting diagrams* and expert *engineering consulting service*.

Write about these new systems today. Start saving thousands of dollars tomorrow!



Rust
industrial co., inc.

130 SILVER STREET
MANCHESTER, N.H.

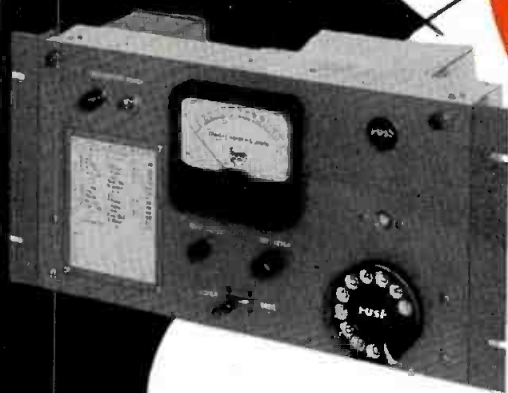

NEW!

24 FUNCTION SYSTEM

Recommended for use in directional and multi-transmitter installations where up to 24 control and metering functions are required.



NEW!

10 FUNCTION SYSTEM

Recommended for use in non-directional installations where no more than 10 control and metering functions are required.



See our display at Booth #6, NARTB Show, Washington, D. C. — May 22-27

CALL, WIRE OR WRITE TODAY FOR NEW CATALOGUE

PULSE * PROVES

SAGINAW

Wnem-TV
HAS

70% AVERAGE
SHARE OF
AUDIENCE

BAY CITY

MIDLAND

* All Figures From Pulse Report
of Saginaw-Bay-Midland Area
January 16, 1955.

100% YARDSTICK SHARE OF AUDIENCE			
	10 A.M.	1:34 P.M.	6-12 P.M.
STATION WNDM-TV	77	72	58
STATION B	20	15	13
STATION C	2	11	25

FLINT

312,555 Sets

- \$1,986,419,000 SPENDABLE INCOME
- \$1,484,325,000 RETAIL SALES
- 1,312,422 POPULATION

For Complete Details . . .
Call Headley Reed,
New York, Chicago
Mich. Spot Sales-Detroit

FULL POWER-NETWORK COLOR
Wnem-TV
NBC - DUMONT

Affiliated With
Gerity Broadcasting Co.
WABJ, ADRIAN WPON, PONTIAC



JAMES GERITY, JR., President HARRY E. TRAVIS, Gen. Mgr.



*KTVH BEAMS PRINCIPAL CITY SIGNAL OVER WICHITA

Both the Wichita ARB and the KTVH area PULSE show at least 7 out of 10 leading film and network shows on KTVH. Programming and strength of signal offer you a profitable combination. *Take advantage of it, now!*

*Recent report from the FCC states that KTVH has a principal city signal over Wichita.

KTVH

HUTCHINSON

VHF
240,000
WATTS

CBS BASIC-DUMONT

CHANNEL
12

Represented Nationally by H-R Representatives, Inc.

KTVH, pioneer station in rich Central Kansas, serves more than 14 important communities besides Wichita. Main office and studios in Hutchinson; office and studio in Wichita (Hotel Lassen). Howard O. Peterson, General Manager.

NETWORKS

NBC Radio Teenager Show Planned for Friday Nights

FRIDAY NIGHT will be the only night in the week so far as recording stars' fans are concerned if NBC Radio scores with a new 90-minute show (8:30-10 p.m. EDT) it is starting June 17. Idea of the show, according to John Cleary, director of programs for NBC Radio, is to supply entertainment for youngsters "in keeping with America's Friday night 'party' frame of mind.

Thus, NBC plans for fan clubs of all recording stars to register in a "National Radio Fan Club" to promote the individual star's recordings and to receive certain benefits from club membership, including special discount record purchases and a subscription to a magazine.

A live audience will dance to recordings played on the program in the studio at Radio City, New York. Each half-hour of the program will feature an outstanding record artist who will appear on the program and will speak directly with fans in various parts of the country through special facilities set up with NBC affiliates.

Danzig to Program Post With NBC O&O Stations

APPOINTMENT of Jerry A. Danzig as general executive for programming for NBC o&o stations was announced last Monday by Charles R. Denny, vice president of NBC owned stations and NBC Spot Sales. Mr. Danzig formerly was with CBS-TV, where he served as associate director of network programs, member of program plans board, supervisor of color programs and network



MR. DANZIG

producer.

WROW Joins CBS in Fall

AFFILIATION of WROW Albany, N. Y., with CBS Radio, effective Nov. 15, was announced last week by William A. Schudt Jr., vice president in charge of station relations, CBS Radio. The Albany outlet will replace WTRY Troy as the CBS affiliate in the Albany-Schenectady-Troy area.

WROW is owned and operated by the Hudson Valley Bcstg. Co., Albany. General manager of the station is Thomas S. Murphy. CBS Radio affiliates now total 221, Mr. Schudt said.

Hoffer Joins ABC

APPOINTMENT of Jay Hoffer to the promotion and publicity department of ABC as head of advertising and promotion for WABC-AM-TV New York and ABC o&o stations was announced last week by Gene Accas, ABC director of promotion and publicity. Mr. Hoffer was with WJAR-AM-TV Providence as promotion manager.

Martin Heads CBS-TV Talent

PROMOTION of Robert Dale Martin from assistant director to director of CBS-TV's Talent and Casting Dept. was announced last week by Hubbell Robinson Jr., CBS-TV vice president in charge of network programs.



WJRT (TV) Flint, Mich., will affiliate with CBS-TV effective Sept. 1. The contract is approved by (l to r): seated, John F. Patt, president of WJR, The Good Will Station Inc., Detroit; Worth Kramer, vice president-general manager, WJRT; standing, Robert Wood, assistant director, and Ed Shurick, national director, CBS-TV station relations.

NBC Names Bishop

APPOINTMENT of Don Bishop, manager of program publicity in the press department of NBC, as director of publicity for the network's o & o stations, NBC Spot Sales Div. and WRCA-AM-TV New York was announced last week by Charles R. Denny, vice president in charge of NBC o & o stations and NBC Spot Sales, and Hamilton Shea, vice president in charge of WRCA-AM-TV.

Mr. Bishop succeeds Robert F. Blake, who resigned to join CBS-TV [B•T, April 25].

Greaves to New NBC Post

GEORGE GREAVES, general manager of KNBC San Francisco, has been named staff assistant to Thomas C. McCray, general manager, NBC Radio, Pacific Div., and of KRCA (TV) Hollywood. Mr. Greaves will assist Mr. McCray in both radio and tv fields in the newly-created position.

W. K. McDaniels, KNBC sales manager, succeeds Mr. Greaves.

Broadway Show on CBS-TV

A BROADWAY SHOW entitled "Three for Tonight," due to close June 18, will be telecast by CBS-TV June 22, 10-11 p.m. EDT. The musical stars Marge and Gower Champion and Harry Belafonte. The telecast, as yet unsponsored, will originate from Hollywood.

Two Wednesday 10-11 p.m. time periods are open alternating with General Electric Co.'s *Front Row Center*, on CBS-TV before the *United States Steel Hour* moves from ABC-TV to CBS-TV on July 6. One period will be filled by "Three for Tonight." Plans for the June 8 time slot have not been set, a CBS spokesman said.

NETWORK PEOPLE

Ray D. Williams, licensee and general manager, WHIT New Bern, N. C., elected secretary-treasurer, Tobacco Network, succeeding Lester Gould, WJNC Jacksonville, N. C. TN is composed of nine eastern N. C. radio stations with offices in Raleigh.

Lloyd Sloop, manager, mimeograph dept., ABC Radio Hollywood, to ABC continuity acceptance dept. there as editor; Bernie Fullmer, mimeograph dept. assistant manager, succeeds Mr. Sloop.



ASCAP MUSIC

...salesman of the airways!

In 1920 when Station KDKA first startled listeners with the strains of "Avalon" rendered through a carbon mike, ASCAP was six years old with only a handful of members.

Today the broadcasting industry has expanded from a single commercial station to more than 3,000, and the advent of television has revolutionized the airways.

The ASCAP membership has grown to more than 3,000 writers and nearly 800 publishers, and its repertory today is truly "the music of America".

Music is the basic program material used on the airways.

We the creators of music – and you the broadcasters and telecasters – are mutually dedicated to provide the American Public with the best in entertainment.

In the future, as in the past, broadcasters and telecasters will find ASCAP music the best salesman of the airways – with the strongest listener and sponsor appeal.



THE AMERICAN SOCIETY OF COMPOSERS, AUTHORS AND PUBLISHERS
575 MADISON AVENUE, NEW YORK 22, N. Y.

DUMONT SHOWS 'VITASCAN' COLOR PLAN

The new system uses the flying-spot scanner technique. It will permit local color originations quickly and at little cost.

A NEW color tv development in station equipment is being shown for the first time today (Monday) at the NARTB convention in Washington.

The system being announced today by Allen B. DuMont Labs is for originating live color without use of color tv cameras. The novel system, according to DuMont, will permit the small tv station to originate its own color and get it on the air quickly and at little cost. There is no registration problem involved as in the conventional method of originating live programs with the color camera.

A private showing of the system nearly two weeks before the NARTB convention at a DuMont plant in New Jersey demonstrated that pictures were in good registration and color satisfactory.

Adjunct of Multi-Scanner

The system is called a "Vitascan" color studio scanner and is an adjunct to the DuMont color Multi-Scanner which has been marketed for some time. Normal delivery of from 30 to 60 days is offered. This is how the color "pickup" works:

A beam of light from a cathode-ray tube "scans" persons or objects being televised—the flying-spot scanner technique. The scanned

light that is thus reflected is picked up by multiplier phototubes. These tubes convert the light into an electrical signal that is passed on to a regular standard color transmitter for broadcast.

DuMont points out that the new system will produce live color tv pictures of "highest quality" without the expense of color tv cameras, large studio crews and highly-trained



SKETCH shows how either mobile or stationary light sources can be used with the "Vitascan" system. The barrel-shaped objects, resembling flood lights, actually are clusters of photo-tubes which pick up the red, green and blue light components used in the color system. These flash on and off 60 times a second to light the studio during the "blinking" intervals when the scanning light is not working. This "fully-lighted dark room" method allows the studio to be lit but prevents the studio lighting from interfering with the scanning light.

color engineers and without usual problems of color registration.

For the national and local advertiser, DuMont anticipates use of the system to allow quick staging of live commercials of high color quality. It's also designed as "an easy, inexpensive method for producing live closed-circuit commercial telecasts in color.

An advantage of the new system is that it can be installed at a station which already has Multi-Scanner equipment, thus placing the

STANDARD is the
BUY-WORD
at the Convention

the only Services you can
BUY and OWN FOREVER!

The Complete Standard Program Library

- over 5000 musical selections
- over 400 commercial aids

The Partial Standard Program Library

- your choice of any 100 discs

The "Shorty-Tunes" Monthly Release

- 20 bright brief instrumental hits

The Super Sound Effects Library

- over 1000 subjects
- the biggest and best catalog in the world
- special starter package of 25 "BEST" records

Visit
us in
Room
E103
Shoreham
Hotel

STANDARD
RADIO TRANSCRIPTION SERVICES, INC.
360 N. Michigan Avenue, Chicago 1, Illinois



conversion at a very low cost, it is pointed out by DuMont, which estimates it has shipped more than 60 Multi-Scanning units to stations.

It also is estimated that the cost of a color camera is \$60-85,000. The DuMont equipment, however, is much lower, it is pointed out, and not only permits "live" color programming but color films and slides as well.

According to DuMont's price listings, stations which already have a monochrome Multi-Scanner can be equipped for live monochrome for \$9,207. Stations which already have a color Multi-Scanner can be equipped for live color for \$15,692.

Stations which are not equipped with a monochrome Multi-Scanner can be equipped for live monochrome (stationary or mobile) for \$18,415. Stations not equipped with a color Multi-Scanner can be equipped for live color (stationary or mobile) for \$32,570.

DuMont's monochrome Multi-Scanner provides pickup for 16mm film, transparent slides and glossy or matte opaques. The color Multi-Scanner provides, in general, the same uses. The "Vitascan" unit actually is an addition to permit pick up of local live color. The same light source is used for the scanning process. The studio is illuminated with strobe lighting as compared to floodlighting and the multiplier phototubes (grouped like studio floods) make the pickup.

Thus, in general terms, the "Vitascan" principle could be described as a conventional tv pickup system in reverse. The phototubes are placed in the studio about where the usual floodlights would be in a conventional studio.

According to DuMont, "all that is needed is a light source, a light-tight room, and the necessary clusters of pickup tubes and strobe lights" to operate with the "Vitascan" system.

No "warm up" or "fire up" of color equipment is necessary. The time used to turn on the system corresponds to about the time it takes to turn on a home tv receiver. Only one

New!

ONE Watt



Raytheon KTR-1000A TV Microwave Link

A new addition to the proven KTR series[†]



The ultimate in simplicity and portability. Only 4 compact units per system.

- Uses stable, dependable one watt Klystron
 - Reliable, low cost, powerful operation
 - Frequency range—6875-7125 mc
 - For STL, Remote, Intercity, Network interconnection
 - Monochrome or Compatible Color with Audio Channel
- Model KTR-1000E available soon for common carrier band.

[†] In use by leading TV stations throughout the U.S.A. — names on request.



RAYTHEON MANUFACTURING COMPANY

Equipment Marketing Division, Waltham 54, Mass.

Excellence in Electronics

See Raytheon's exhibit at booth 31, NARTB show, May 22-27, Shoreham Hotel, Washington, D. C.

TV BROADCAST ANTENNA SYSTEMS?

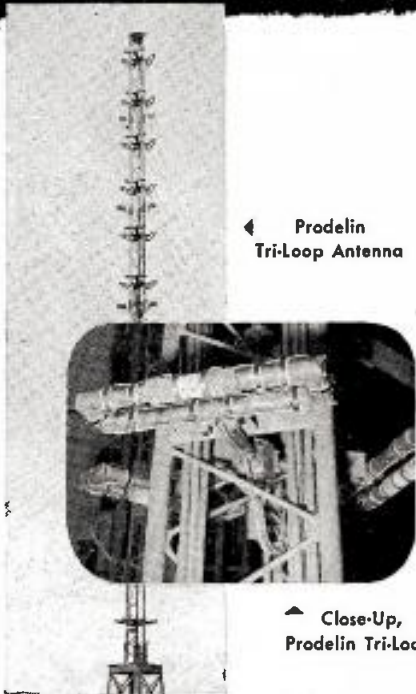

Prodelin

"Job Packaging"
is the **COMPLETE ANSWER**

Supply Prodelin with only your specifications, and Prodelin will deliver a complete antenna system—*systematized* to your particular job, with *matched components* and *installation-ready* at your site, when you need it!

ANTENNA SYSTEMS:

- ANTENNAS — VHF TRI-LOOP

ANTENNA ACCESSORIES:

- DE-ICING KITS

TRANSMISSION LINE AND ACCESSORIES:

- COAXIAL CABLE (AM-FM and TV)
- WAVEGUIDE
- COUPLINGS
- BENDS
- FITTINGS
- DEHYDRATING EQUIPMENT
- ELBOWS
- TRANSITIONS
- HANGERS

RF FILTERS:

- TELEPLEXER
- NOTCH DIPLEXER
- GHOST ELIMINATOR

See us at the NARTB Show. Booth 29

WRITE FOR SPECIFIC INFORMATION

Prodelin Inc

307 Bergen Ave.

Kearny, N. J.

man is needed to turn on the system and then operate it.

According to DuMont, it takes hours to warm up regular color cameras before each broadcast and "even then, their operating techniques change and drift, and demand frequent readjustment."

In its present form, the use of "Vitascan" is limited. The system cannot be used where the light source cannot be controlled. Thus, there is no intention for the system to be utilized in daylight or in studios which are lighted from sources other than stroboscopic. DuMont also has mobile "Vitascan" equipment which permits studio dollying and other movement.

Programming adaptable to the system, according to DuMont, would include news commentaries, debates, panel discussions, speeches, commercial showings of products and other programs not requiring extensive movement of studio apparatus.

RCA Reveals Equipment To Color B-&W Commercials

PRODUCTION of special color-effects equipment that will enable broadcasters to originate tv commercials, program titles and station identification in color from black-and-white slides and artwork was announced last week by A. R. Hopkins, manager of broadcast equipment marketing, Engineering Products Div., RCA.

The new equipment, to be exhibited at the NARTB convention, enables stations without live or film color cameras to obviate a return to monochrome during station breaks in network color programs by originating spot commercials and station IDs in color, it was explained.

Mr. Hopkins said the equipment permits electronic addition of up to 24 different pre-selected colors to the black and to the white portions of a monochrome picture. All the units are standard for colorcasting and can be used by the station when it converts its facilities for origination of local tv programs.

An RCA colorplexer which produces the various color combinations is the essential color-adding element of the color effects equipment. Both the blanking and the signal from the monochrome camera which views the black-and-white slide or artwork are fed into the blue-green-red color channels of the colorplexer. The color combinations produced vary according to the combination of channels into which the blanking and black-and-white signal are fed.

Electronic Components Shown to Distributors

MILLIONS of dollars of component equipment, including newest developments in tape and high fidelity products, were exhibited at the Electronic Parts Distributors Show in Chicago last week.

The show drew over 9,000 distributors from the U. S. and 23 foreign countries to the Conrad Hilton Hotel as parts-makers displayed 15 different major types of wares.

Winston Electronics Inc. showed a new tv test instrument (a circuit analyzer) for color or monochrome application, designed to troubleshoot horizontal and vertical deflection circuits.

New "Irish brand long playing tape" promising 50% more playing time over standard tapes on the same reel was exhibited by ORRadio Inc. The tape provides up to six hours more time at 1 1/2 inches per second speed. Officials felt it would expand the market for pre-recorded tapes, broadcast station application, background music in business and industry and the home recorder field.

BONFIG TO HEAD CBS-COLUMBIA

H. C. BONFIG, vice president and director of sales of Zenith Radio Corp., last week was named president of CBS-Columbia, tv and radio receiver manufacturing division of CBS Inc. He



MR. BONFIG

succeeds Seymour Mintz, resigned.

Appointment of Leonard C. Truesdell to succeed Mr. Bonfig effective immediately also was announced last week by E. F. McDonald Jr., Zenith president.

The resignation of Mr. Mintz and appointment of Mr. Bonfig were announced by CBS President Frank

Stanton. Mr. Mintz' future plans were not disclosed. A former vice president of Admiral Corp., he had headed CBS-Columbia since March 1, 1954.

Mr. Bonfig has been a vice president of Zenith for 11 years and formerly was commercial vice president of RCA. His home is at Winnetka, Ill. CBS-Columbia's main offices and plant are in Long Island City, N. Y.

Mr. Truesdell has been vice president in charge of radio-tv sales at Zenith since April 1950. He joined the firm a year earlier as sales manager for home instruments.

First Quarter Tv Shipments Up 300,000 Over '54 Figure

TELEVISION set shipments to dealers during the first quarter of 1955 totaled 1,968,347, over 300,000 more than the 1954 figure, according to Radio-Electronics-Tv Mfrs. Assn. March shipments totaled 690,097 compared to 640,771 in February and 582,839 shipped in March 1954.

Following are tv set shipments to dealers by states for the first quarter of 1955:

State	Total	State	Total
Alabama	35,180	New Jersey	60,216
Arizona	10,941	New Mexico	6,320
Arkansas	24,124	New York	187,003
California	144,335	North Carolina	51,752
Colorado	14,339	North Dakota	7,729
Connecticut	26,981	Ohio	100,647
Delaware	3,855	Oklahoma	29,675
District of Columbia	19,628	Oregon	25,787
Florida	61,153	Pennsylvania	125,252
Georgia	40,268	Rhode Island	9,416
Idaho	9,380	South Carolina	29,607
Illinois	108,071	South Dakota	6,211
Indiana	52,994	Tennessee	43,755
Iowa	32,215	Texas	114,675
Kansas	29,057	Utah	7,812
Kentucky	37,014	Vermont	7,729
Louisiana	39,687	Virginia	37,479
Maine	15,502	Washington	34,009
Maryland	26,388	West Virginia	22,025
Massachusetts	55,860	Wisconsin	43,883
Michigan	78,431	Wyoming	1,970
Minnesota	36,326		
Mississippi	18,526	U. S. TOTAL	1,962,726
Missouri	54,829	Alaska	2,360
Montana	6,468	Hawaii	3,261
Nebraska	18,670		
Nevada	2,332	GRAND TOTAL	1,968,347
New Hampshire	7,271		

GE Names Harry Thorson

HARRY L. THORSON, manager of the television camera tube project of General Electric Co., has been appointed manager of transmitting tube product engineering, it was announced last week by Charles M. Young, engineering manager.

In his new post, Mr. Thorson is responsible for all product design of gaseous discharge power control tubes, vacuum rectifiers and power tubes and camera and storage tubes.

ZENITH INVITES MEMBERS AND GUESTS OF THE NARTB

TO A DEMONSTRATION OF

PHONEVISION

ZENITH'S TESTED AND PROVED SYSTEM OF

SUBSCRIPTION TV

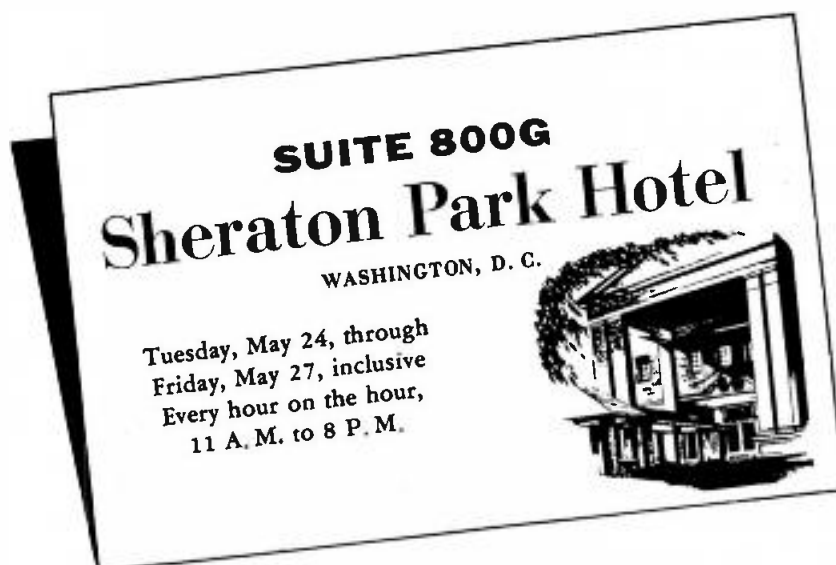

SEE the first industry demonstration of the Phonevision Aircode system and its associated equipment.

SEE a demonstration which duplicates the entire Phonevision operation as it would be established in a community. You will see transmitting equipment, computers, and receiving apparatus installed on many television sets of different brands and models.

Discuss with Zenith officials all operational details of Phonevision, such as revenue and profit potential, business relationships, programming, etc.

BE OUR GUESTS THIS WEEK AT THE SHERATON PARK HOTEL, SUITE 800G.

ZENITH RADIO CORPORATION, CHICAGO 39, ILLINOIS



© 36 years of experience in radionics exclusively—
25 years of development in subscription television

THANKS

For the very Pleasant Association we have enjoyed working with the Advertising Agencies of the Great Pacific Northwest . . . Which find it Profitable for their Clients to Use Our List of Radio and Television Stations !!!

MOORE and LUND, Inc.

519 Jones Building, Seattle
617 Cascade Building, Portland

SESAC

*the Library
that's lowest in cost
for a complete program service*



475 FIFTH AVENUE

NEW YORK

Color Will Increase Tv Sales To Over \$2 Billion Annually

TELEVISION, now a billion dollar industry, with color "will top two billion annually" in gross sales of receivers, according to Robert A. Seidel, executive vice president of RCA's consumer products. Mr. Seidel spoke to members of the National Appliance & Radio-Television Dealers Assn. in Milwaukee Wednesday.

Mr. Seidel said that while factors are lining up to bring more of color tv to the American public, black-and-white tv continues at a good pace, offering unprecedented values and service. He cited the decision of some manufacturers, including RCA, to offer compatible color receivers (RCA's suggested list price is \$795 and \$895), which, he said, "in no way changes the great future of black-and-white television." He said retail merchandisers—the dealers—have a greater opportunity "for progress and profit than at any time since the early kick-off days of television."

RCA's color set line, two new 21-inch receivers, will be available in limited quantities beginning in early June, he said.

Tv, Radio Receiver Sales Run Ahead of Last Year

RETAIL sales of tv and radio sets increased during the first quarter compared to 1954, according to Radio-Electronics-Tv Mfrs. Assn. Tv sales totaled 669,794 sets in March compared to 626,613 in February and 505,493 in March 1954. First-quarter tv sales totaled 1,943,992 units compared to 1,773,427 year ago.

Radio set sales (not including auto sets which are sold to factories) totaled 451,049 in March compared to 320,042 in February and 486,034 in March 1954. First-quarter radio sales in retail stores totaled 1,246,038 compared to 1,059,336 in the same 1954 period. Production of auto receivers in the first quarter totaled 1,945,604 sets. March was a five-week reporting period.

Sylvania Expands at Waltham

SYLVANIA ELECTRIC Products Inc. announced last week it is increasing by 50% the size of its new electronics laboratory nearing completion in Waltham, Mass. Henry Lehne, general manager of Sylvania's Electronic System Div., said that because of the company's "continuous expansion" in the electronics industry, the size of the new facility is being enlarged from 80,000 to 120,000 sq. ft.

DuMont Promotes Zusi

APPOINTMENT of Fred C. Zusi as sales engineer for industrial electronics for Allen B. DuMont Labs, Clifton, N. J., was announced last week by Emil G. Nichols, technical sales manager. Mr. Zusi, who has been with DuMont since 1952, has most recently been in charge of applications engineering for the company's technical sales department.

DuMont Sales Realignment

MOVE to strengthen DuMont tv receiver sales at distributor and dealer levels has been made by William C. Scales, division manager, in announcing appointment of four new field sales managers. They are: Richard F. O'Brien, national field sales manager; Robert Cheshire, New England-Mid-Atlantic manager; A. G. Evans, New York State manager; C. J. Molthop, Midwest manager.

Only STEEL can do so many jobs so well



Steel Diet for Golf Shoes. If you play 18 holes of golf on a normal course, you take about 12,000 steps, so a light shoe is very important. The world's largest golf shoe manufacturer found a way to reduce weight by 1/3 - by adding steel construction. The spikes screw into an inner sole plate made from USS Stainless Steel. The resulting shoe is feather-light, flexible as your foot, and you never feel the spikes.



Wheat Suffocation. Stored wheat needs lots of air, or it will mildew and rot. Giant-sized USS American Quality Springs are covered with Cyclone Insect Screening to form tunnels through the wheat piles. Air is pumped through under pressure to ventilate the wheat, and keep it sweet and dry.

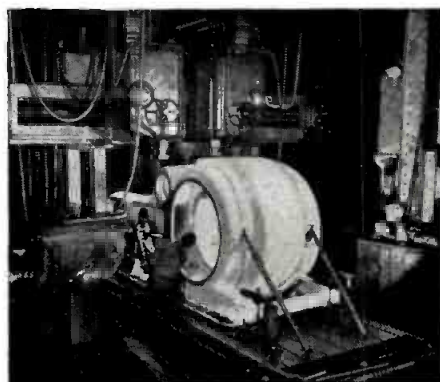

Thousands of Horses ... Coming Up! It takes gasoline to get the horsepower out of your automobile, but first it takes horsepower to get the gasoline out of the ground. Shown here is the power frame for a gigantic "Oil-well" slush pump that utilizes nearly 1,000 input horsepower to force mud down into an oil well while it is being drilled. United States Steel makes a complete line of oil drilling, production, pipe line and refining equipment.

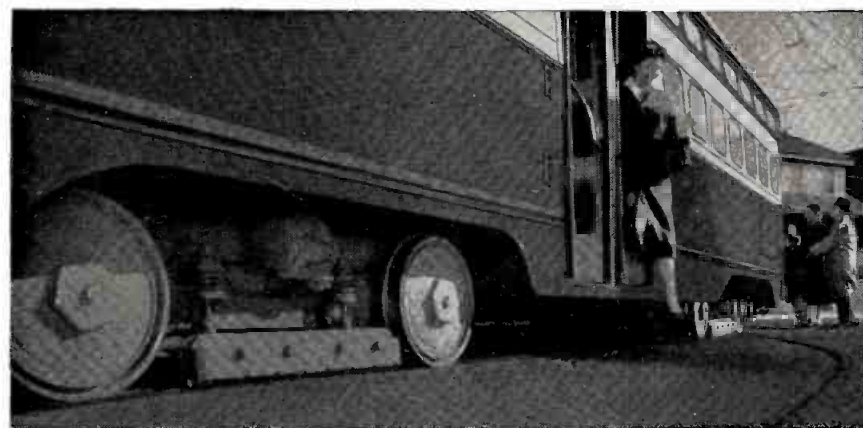

Hard as Steel, Soft as Rubber. The wheels of most trolley cars have a hard steel rim, but they are fastened to the hub with a band of tough rubber. These Resilient Steel Wheels, supplied by United States Steel, last longer and ride easier than solid steel wheels.



This trade-mark is your guide to quality steel

UNITED STATES STEEL

For further information on any product mentioned in this advertisement, write United States Steel, 525 William Penn Place, Pittsburgh, Pa.

AMERICAN BRIDGE . . AMERICAN STEEL & WIRE and CYCLONE FENCE . . COLUMBIA-GENEVA STEEL . . CONSOLIDATED WESTERN STEEL . . GERRARD STEEL STRAPPING . . NATIONAL TUBE OIL WELL SUPPLY . . TENNESSEE COAL & IRON . . UNITED STATES STEEL PRODUCTS . . UNITED STATES STEEL SUPPLY . . Divisions of UNITED STATES STEEL CORPORATION, PITTSBURGH
UNITED STATES STEEL HOMES, INC. • UNION SUPPLY COMPANY • UNITED STATES STEEL EXPORT COMPANY • UNIVERSAL ATLAS CEMENT COMPANY

SEE THE UNITED STATES STEEL HOUR. It's a full-hour TV program presented every other week by United States Steel. Consult your local newspaper for time and station.



Philco 16MM CineScanner



"State of the Union"



"Dragnet"

PHILCO

FEATURES

- Provides preview—exclusive with Philco.
- Available in 16MM and 35MM models.
- Quiet, continuous film motion—no intermittent mechanism to cause film wear and damage.
- Cold light source—no burning or discoloring of film.
- Instantaneous run-up with provision for quick starts, stop and reversal.
- Highest quality reproduction in monochrome and color.

PHILCO REGIONAL OFFICES

Chicago 11, Illinois
666 Lake Shore Drive

San Francisco 4, Calif.
650 Russ Building

Los Angeles 25, Calif.
10589 Santa Monica Boulevard

Dallas 1, Texas
201 Southland Life Bldg.

Washington 6, D.C.
744 Jackson Place, N. W.

Dayton 2, Ohio
Talbot Bldg., 1st & Ludlow Sts.



"Lady in the Dark"

"Babes in Toyland"

CineScanner

... film "star" of network color shows!

Over and over, the Philco CineScanner continues to prove itself the star performer on top-notch network shows: Transforming scenes-on-film to bright, crisp, steady pictures in rich full color... with unequalled simplicity and dependability!

CineScanner employs the simplest film telecasting technique known. There are no problems of shading or color registration. In fact, color registration insurance is actually built in!

Here's how CineScanner works:

A dependable cathode ray tube projects bright "cold" light through the film on to low cost, non-synchronous pickup tubes. Simultaneously, these tubes generate signals for the red, green and blue images—all from a single scanning tube! Operation is simple and direct. Costly camera tubes are eliminated. Perfect registration is assured.

CineScanner has other exclusive advantages. A continuous-motion film transport mechanism designed by Philco and built by the Mitchell Camera Company eliminates mechanical shutters and noisy film-damaging intermittents. The film can be started, stopped—run forward and backward—instantaneously!

Install the Philco CineScanner and enjoy this simple, practical way of film telecasting. You can start today in monochrome... convert tomorrow to color with a simple conversion kit.

For complete information write Dept. BT

PHILCO CORPORATION

GOVERNMENT AND INDUSTRIAL DIVISION

PHILADELPHIA 44 PENNSYLVANIA



*A Fact
You Ought
to Know...*

UNDULICATED

Coverage

ON

kang-tv

AND HERE'S WHY...



kang-tv

First... in Waco, Texas

Nationally Represented by PAUL H. RAYMER CO., INC.
CBS ★ ABC TV NETWORKS

Best wishes from

W S R S

CLEVELAND

to NARTB and Members

Meeting here

is a "Capital" idea

S. R. SAGUE

PRESIDENT

W S R S

CLEVELAND



JOHN WENTWORTH (l), RCA manager of tv terminal equipment engineering, was one of the principal speakers at the State U. of Iowa Color Tv Conference, held last month at Iowa City. Listening as Mr. Wentworth details a new tube are (l to r): John Beeston and Ray Stauffer, WHO-TV Des Moines, and E. B. Kurtz, who is in charge of the university's electrical engineering department.

HALPIN TO SALES POST WITH WESTINGHOUSE

Former DuMont executive appointed assistant general manager in WBC tv-radio division.

DAN D. HALPIN, general sales manager, DuMont television receiver sales division, has been appointed assistant general manager of marketing and general sales of Westinghouse Corp.'s television-radio division, Metuchen, N. J., succeeding Richard L. Sandefur, who has resigned.

Mr. Halpin also has been associated with RCA Victor Division and the Dictograph Products Co.

He is also chairman of the sale managers committee of the Radio-Electronics-Television Mfrs. Assn.

IRE Electron Devices Meet Set for Oct. 24-25 in D. C.

FIRST annual meeting of the professional group on electron devices of the Institute of Radio Engineers will be held Oct. 24-25 at the Shoreham Hotel, Washington, George A. Espersen, Philips Labs Inc. and chairman of the group, has announced. Mr. Espersen said the sessions will "provide an exclusive medium for exchange of engineering information" in the field of electron devices.

Chairman of the Washington meeting will be George D. O'Neill, Sylvania Electric Products Inc. Approximately 1,000 engineers from government and industry are expected to attend the meeting for an exchange of information on advanced developments and applications of both electron tubes and transistors in radio, television, business machines and equipment for the military.

The program will include papers read by scientists and engineers representing various organizations in the United States and foreign countries.

1 + 1 + 1 = 3 Colors

LEE BERRYHILL, chief engineer, KRON-TV San Francisco, and his staff used a little "sleight of camera" to produce color station identifications during a color network show without using color cameras.

They made three color separation title cards and focused a black-and-white camera on each one. Then they fed the signal from each camera into one of the color inputs of the encoder which combined it all into a composite color signal.

GE Portable Tv Line Styled as 'Second Set'

THREE 32-pound portable tv sets, with suggested list prices starting at \$99.95, have been added to the General Electric line, it was announced last week by Paul H. Leslie, monochrome tv sales manager for the company's radio and television department in Syracuse, N. Y. Mr. Leslie felt the sets will be GE's answer to a growing demand for a second tv set in the home. The sets have 14-inch picture tubes.

Distribution of the portable is expected to be nationwide by July, Mr. Leslie said. He predicted the new portable will be useful in hotels, for invalids, for children, in game rooms, kitchens, bedrooms, porches or outdoor living areas.

Admiral Sales, Earnings Dip

DROP in sales of 11% and net earnings of 18% for the first quarter of 1955 has been reported for Admiral Corp. by John B. Huarisa, executive vice president and treasurer.

Sales were tabbed at \$50,034,396 as against \$55,977,563 for the same period last year, with the decrease attributed to "sharply lower sales to the nation's armed forces." Net earnings fell off from \$1,504,044 the first three months of 1954 to \$1,238,176 this past quarter. Earnings before taxes were roughly \$1.8 million compared to \$3.8 million last year.



General Traffic Manager Douglas Dawson of Norton Company tells

“How Norton makes the sparks fly!”

“When a plant's grinding operations break down, their production lines may grind to a halt, too. *We* have to make the sparks fly!” says Doug Dawson.

“The abrasive that can meet specifications — and *gets there first* — gets the order.

“We win those races time after time from our one big plant in Worcester, Mass.

“How? With on-the-ball engineering — and Air Express!

To us, Air Express is like a full warehouse in every community; we can deliver anywhere in the U.S. in a few hours.

“Yet, we actually save money when we use Air Express instead of other air carriers. A typical 25-lb. shipment from Worcester to Chicago, for example, costs \$8.85. That's \$3.55 cheaper than any other direct air service!

“Those savings add up when you ship as much as 1,000 pounds a day by Air Express, as we do!”



Air Express



GETS THERE FIRST via U.S. Scheduled Airlines

CALL AIR EXPRESS . . . division of RAILWAY EXPRESS AGENCY

WTVD
DURHAM - RALEIGH

now
has

232,020

TV SETS (source: Television Magazine)
More Sets than
JACKSONVILLE, Florida
OR
RICHMOND,
Virginia

WTVD
DURHAM - RALEIGH

CHANNEL 11
NBC - ABC
Call HEADLEY-REED

Electronics Faces Two Years Of Great Expansion—Folsom

THE ELECTRONICS industry is on "the threshold of its greatest period of expansion" and sales will increase at least 35% in the next two years, RCA President Frank M. Folsom predicted in Chicago last Monday.

Mr. Folsom spoke before 500 RCA employees at the opening of its new distribution center on Chicago's south side. He said that industry sales will approach \$14 billion by 1957, having passed the \$10 billion mark already.

Mr. Folsom stated:

"Knowing of the new products now in our laboratories and the rate at which additional ones are being developed, it is safe to say that by 1962, regardless of the size of the radio, television and electronics industry, more than half of the volume will be in products and services that do not exist today."

MANUFACTURING SHORTS

Bell Sound Systems Inc., Columbus, Ohio, has announced new portable battery-powered dual track tape recorder, Cub-Corder, designed as fully portable, high quality recording device to aid reporters and others in places where it is impossible to use standard recorders. Utilizing rechargeable non-spill wet battery and 67½ volt B battery, unit will record for one hour at 3¾ ips or 30 minutes at 7½ ips on single 5-in. 600-ft. tape reel. Housed in carrying case approximately size of average brief case, Cub-Corder weighs 12¾ lbs. and may be carried by handle or shoulder strap. Complete details obtainable from firm at 555 Marion Rd., Columbus 7.

Electromec Inc., Burbank, Calif., announces

Diddler's Delight

RECALLING the havoc created with its color tv demonstrations at the 1954 convention by technicians who tinkered with cameras and controls, RCA Engineering Products Div. has added special "Diddler's Delight" gear to its demonstration. With a complete live color studio and a film studio operating, RCA has labeled cameras and controls which visitors will be encouraged to operate—without affecting the transmitted color pictures on receivers designed to show performance at its best. "Last year we took the rap for fouled-up transmissions," said John P. Taylor, manager of advertising and sales promotion. "This year the diddlers can operate gear without hurting the pictures that visitors see."

large screen precision oscilloscopes are now available in console type cabinets. Console oscilloscope utilizes 17-in. rectangular tube and is useful for production test set-ups where work can be placed in front of operator during test. Further information available at console oscilloscope dept., Electromec Inc., 3200 N. San Fernando Blvd., Burbank.

RCA Tube Div., Harrison, N. J., has announced production of new 90° deflecting yoke for replacement use in tv receivers using picture tubes up to 27 inches. Yoke, RCA-237D1, supercedes RCA-219D1 and is smaller, lighter and cheaper.

Raytheon Mfg. Co., Waltham, Mass., announces new portable transistor radio with front and back speaker grilles providing full-

The best way to sell the **KANSAS FARM MARKET**

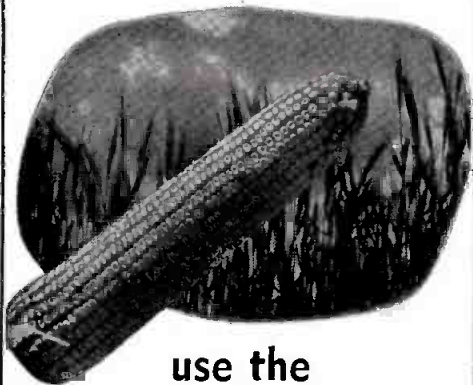

use the **KANSAS FARM STATION**

WIBW

CBS RADIO in Topeka

Ben Ludy, Gen. Mgr., WIBW, WIBW-TV, KCKN
Rep. Capper Publications, Inc.



R. J. McELROY (seated), general manager of KWWL-TV Waterloo, Iowa, contracts for RCA equipment, including a 50 kw transmitter which will boost the station to maximum 316 kw power by Aug. 1. L to r (standing): W. G. Eberhart, RCA representative; Don E. Inman, KWWL radio and tv sales director; Robert Buckmaster, legal counsel, and T. W. Kirksey, KWWL radio and tv director of engineering. In addition to going to full power, the ch. 7 station will have a 1,055-ft. above-average-terrain tower and expects to increase its coverage to 328,078 tv homes

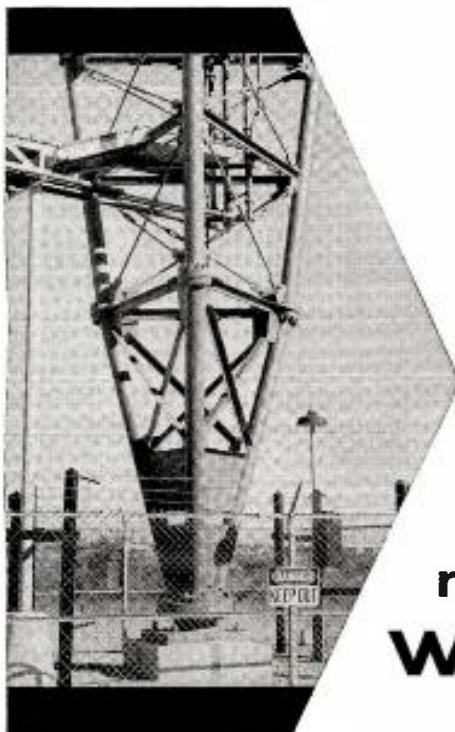

**Another
Truscon
Thousand-
Footer . . .**

**now serving
WBAP-TV,
FT. WORTH**

Everything's big in Texas. No exception is this giant Truscon Guyed Tower which climbs 1030 feet into the air. The tower mounts an 83-foot antenna. Tower and antenna together total 1113 feet. And that's tall . . . even for Texas.

Taller towers such as this are a job for experts only.

Truscon knows towers, can offer you the top talent in towers. With Truscon handling your assignment, you are assured of the skill and experience responsible for the design and construction of many hundreds of towers now standing strong and tall in all types of topography . . . in all kinds of wind and weather.

As a matter of fact, to the best of our knowledge, not one Truscon Guyed Tower has ever failed in any kind of storm.

Truscon builds them for you tall or small . . . guyed or self-supporting . . . tapered or uniform in cross-section . . . for AM, FM, TV, and Microwave transmission.

Turn your tower problems over to experts. Your phone call or letter to any Truscon District Office—or to "tower headquarters" in Youngstown—will get your program started without delay.

TRUSCON®



**TRUSCON STEEL DIVISION
REPUBLIC STEEL**



1074 ALBERT STREET • YOUNGSTOWN 1, OHIO
EXPORT DEPT.: CHRYSLER BLDG., NEW YORK 17, N. Y.

A NAME YOU CAN BUILD ON

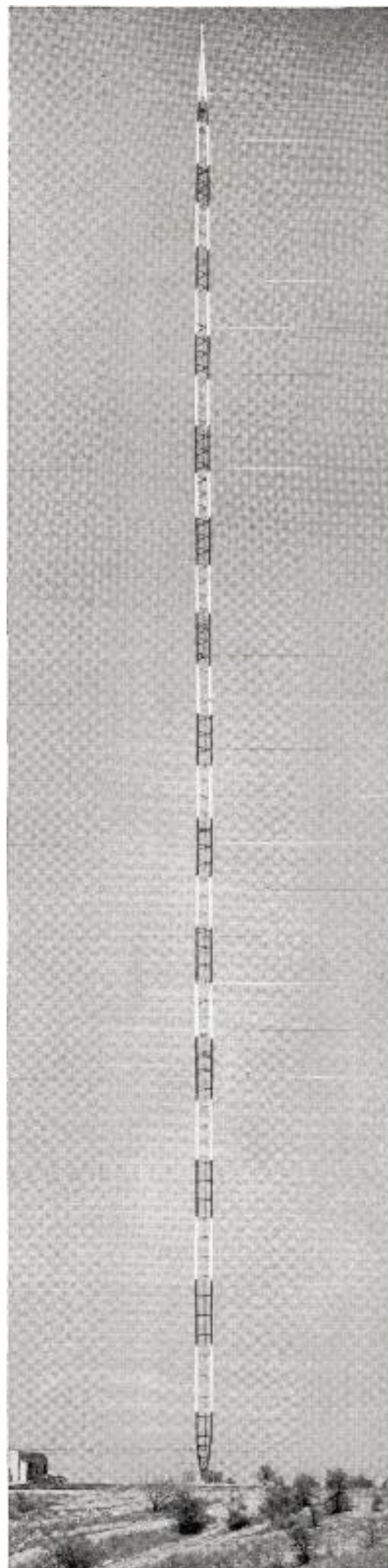

NEW **BOLEX** ZOOMING LENS GIVES

**through-the-lens viewing •
four-to-one ratio •
finer optical quality •**

Two completely new zooming lenses by Som Berthiot: Pan Cinor-70 and Pan Cinor-100. These 14-element lenses offer crystal-clear, corner-to-corner sharp images. Both have through-the-lens viewing, giving sharp, brilliant field of view — regardless of aperture!

Ideal for news shots, grab shots of any subject, and for sports filming. Both lenses are optically sharp at F:2.4.

No parallax problems; focusing is from 7' to infinity; from 32" using close-up attachments.

Pan Cinor-70 zooms from 17.5 mm to 70 mm — wide angle to telephoto. Pan Cinor-100 zooms from 25 mm to 100 mm — standard to extreme telephoto. Price including leather case is \$449.50. For full details, write address below or see your Bolex dealer.

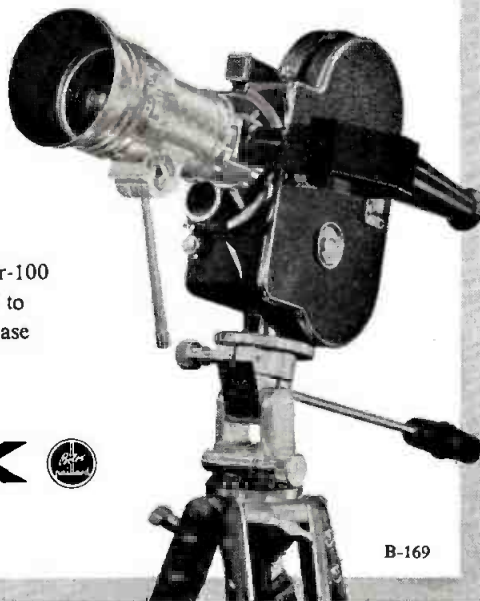

BOLEX 

PAILLARD PRODUCTS, INC., Dept. BT-5
100 Sixth Avenue, New York 13, N. Y.
Fine Swiss mechanisms since 1814

B-169



PURCHASE of a 50 kw transmitter, antenna and complete terminal facilities from Allen B. DuMont Labs is agreed to by WDBJ-TV Roanoke, Va., ch. 7 station slated to go on the air next fall. L to r: seated, Lewis Radford, DuMont; M. W. Armstead III, president of the Times-World Corp., owner of WDBJ-AM-TV; standing, Ray Jordan, general manager of WDBJ, and Edward J. Newman, WDBJ chief engineer.

directional sound, claiming development is first of its kind in industry.

Gotham Audio Development Corp., N. Y., has announced development of new 150 w power amplifier specifically designed for disc recording, accommodating every cutterhead made for disc recording, including BBC Grampian feedback cutterhead for which feedback circuit connections have been provided, according to company. Firm claims four-position equalizer switch provides correct RIAA recording characteristics as well as level changes for 33 1/3, 45 and 78 rpm records from 30-15,000 cycles.

THE BUFFALO EVENING NEWS STATION



WBEN-TV LEADS THE WAY

1st on the air . . . 1st in know how . . . 1st in experience. WBEN-TV, Buffalo's favorite station, is also 1st in Niagara Falls, Olean, Jamestown, Lockport and other Western New York communities. WBEN-TV has high penetration in Toronto and Southern Ontario. Trained and experienced personnel of Buffalo's 1st station are equipped to interpret and handle your advertising needs. . . .

Get the WBEN-TV Story from HARRINGTON, RIGHTER & PARSONS, INC.

MANUFACTURING PEOPLE

Leonard F. Cramer, formerly vice president, Avco Mfg. Corp., N. Y., and general manager, Crosley radio-tv div. of Avco, appointed vice president and general manager, tv-radio-phonograph div., Magnavox Co., Ft. Wayne, Ind.

Arthur H. Bolt, sales director, Bell & Howell (motion picture equipment), Chicago, appointed assistant to vice president of western operations, headquartering in Hollywood.

Richard P. Axten, public relations director, Alexander Smith Inc. (soft surface floor coverings), N. Y., appointed public relations director, Raytheon Mfg. Co., Waltham, Mass., effective June 1.

Robert E. Steele appointed New York area public relations manager, General Dynamics Corp., N. Y.

Bernard B. Cohen to General Transistor Corp., N. Y., as works manager.

Sam F. Arn Jr., engineering sales manager, Packard-Bell Co. (radio-tv-electronics), L. A., named sales manager, civilian and military technical electronic products.

Ray McCadam, General Electric Co., Syracuse, N. Y., appointed western region district sales manager, equipment sales organization, tube dept., headquartering in Los Angeles.

Fred C. Zusi, in charge of applications engineering, technical sales dept., Allen B. DuMont Labs, Clifton, N. J., appointed industrial electronics sales engineer.

How do Boeing methods help achieve "More Air Force per dollar"?

Living in the atomic age, we find that each year makes certain facts stand out in sharper relief.

The first such fact, now grasped by all thinking Americans, is that the power to inflict terrible destruction on an enemy is no longer ours alone. We know that nuclear weapons have been produced by the Soviets. We know, too, that the U. S. S. R. has aircraft capable of delivering them. Therefore, the major deterrent to war is now, and must continue to be, the superiority of our own air arm.

At the same time it is clear that a free nation cannot afford to cripple its economy by *wasting* any of the billions of dollars being spent to maintain air superiority.

A double responsibility

The Boeing Airplane Company, as a principal supplier of Strategic Air Command planes, has a double responsibility to the public.

Our first duty is to build the world's most potent bombers and refueling tankers. In doing so we are making weapons for the defense of our country. The consequences of producing aircraft that would place second in the event of international conflict would be unthinkable.

That is why the Boeing tradition of achieving the utmost in quality is more important today than ever before. Not only our management but all of our nearly 65,000 employees are imbued with the idea of building the best that can be built. Research, design and engineering all contribute to that objective.

The company's second and equally vital responsibility is to deliver its product to the Air Force at the lowest possible cost.

"More Air Force per dollar"

That meaningful phrase is a slogan of the Air Materiel Command. And helping to make it a fact is one of Boeing's permanent objectives.

Efficient production is as deeply ingrained in this organization as the urge to build well. It was demonstrated during World War II, in the steadily lowered costs of the B-17 Flying Fortress and the B-29 Superfortress.

More recently, the constant drive for efficiency has broken records in reducing the number of man-hours needed to produce the B-47 Stratojet bomber and the KC-97 tanker. As a result, many millions of dollars have been returned to the U. S. Treasury.

Saving dollars for the taxpayer starts with the design of the aircraft itself. It follows through the planning and setting up of tools and jigs for fast, smooth-flowing production. It is inherent in Boeing's constant emphasis on manufacturing efficiency throughout the production life of the airplane. It is supplemented by workers' suggestions for process improvement—for which scores of cash awards are made each month. Finally, it is highlighted by an extreme cost consciousness throughout the ranks of Boeing management.

Management training pays off

Primary among Boeing's policies is the building of an ever-stronger management team. In an industry producing mechanisms of growing complexity, the manager's role of channeling skills for maximum effectiveness takes on more and more importance. For that reason, thorough training is a must for every man at the management level. Boeing has established programs ranging from a forty-hour course for supervisors to six-week university courses for men in higher positions.

These training programs, along with Boeing's continuing emphasis on efficiency and effective long-range planning, are paying off every day. They are playing a large part in giving America more and better airplanes at lower cost—helping to reach the goal of "More Air Force per dollar."

BOEING AIRPLANE COMPANY

SEATTLE, WASHINGTON; WICHITA, KANSAS

IN EVANSVILLE INDIANA

WISE
BUYERS
CHOOSE



THIRTY
FIFTY

SALES WITH SHOWMANSHIP

Nancy Thompson
Homemaker Supreme

Every survey for 18 months shows WEHT's NANCY THOMPSON "tops" as the Evansville, Indiana Tri-State's NUMBER 1 Homemaker.

PARTICIPATIONS AVAILABLE

Represented by MEEKER TV and
ADAM YOUNG—St. Louis



WEHT



CHANNEL 50

WLS

gives you

All 3

Market...

Coverage...

Programming

Contact us
or call your
John Blair man
TODAY!



850 KILOCYCLES • 50,000 WATTS • ARC NETWORK

IN PUBLIC INTEREST

McCray Elected '55-56 Head Of R-T-R-A Charities Inc.

THOMAS C. McCRAY, general manager of KRCA (TV) Hollywood, has been elected 1955-56 president of Radio-Television-Recording-Advertising Charities Inc. Other officers are M. J. Rockford, vice president, Music Corp. of America, vice president; James V. Melick, director of production administration, CBS-TV, vice president; Robert P. Myers, attorney, re-elected secretary, and Liz Gould, executive secretary, Radio-Tv Directors Guild, treasurer.

Elected to the board of directors, in addition to the five officers, were C. Burt Oliver, vice president and general manager, Hollywood office, Foote, Cone & Belding Inc.; Ben Alexander, co-star of NBC-AM-TV *Dragnet*; Harold R. Maag, vice president and western div. manager, Radio Corp. of America; Hildred Sanders, vice president in charge of radio-tv, Dan B. Miner Co.; Robert L. Redd, vice president in charge of radio-tv, Erwin, Wasey & Co.; Richard A. Moore, vice president and general manager, KTTV (TV) Hollywood, and Walter Tibbals, vice president in charge of west coast production, BBDO.

Fire Film

TEN-MINUTE film depicting its activities was presented to St. Louis Fire Dept. Training School by KWK-TV there and shown publicly in connection with the school's graduation exercises. A film clip was shown on KWK-TV.

KFSD-AM-TV Hits MS

OVER \$50,000 in cash and pledged donations to the San Diego Multiple Sclerosis Society was reported after a two-day simulcast on KFSD-AM-TV San Diego. Jack Rourke emceed and produced the program.

'Life in a Radio Station'

CFBC St. John, N.B., used a minstrel show theme for its "Life in a Radio Station" which played four nights in the local YMCA. The show played before 1,100 spectators per performance with funds going to the aid of the YMCA. Publicity for the program was all on CFBC. The production was also put on in nearby Moncton.

Home, Safe Home

A SPECIAL half-minute tv spot has been produced by Lucille Ball and Desi Arnaz, stars of *I Love Lucy*, for use by the National Safety Council. The spot depicts the hazards which have made falls the nation's No. 2 accidental killer. Theme of the campaign is "Don't let home be where the hurt is."

\$500 for Education

WDRS Hartford, Conn., has participated in a campaign which netted \$500 for two scholarships to be donated by the alumni association of a local high school. The scholarship drive is an annual affair.

\$30,000 CP Telethon

CONTRIBUTIONS from the 1955 Cerebral Palsy Telethon conducted by WICS (TV) Springfield, Ill., are expected to exceed \$30,000—\$10,000 more than the amount received last year. It was the second annual telethon staged by the station and attracted a grand total of about 18,000 people to a local hotel ballroom for the 1 1/2-hour telecast which featured 47 acts, 11 bands and nine emcees.

Modern Medicine Highlighted

WOAI-TV San Antonio, Tex., is presenting a series on modern medical practice, in cooperation with the Bexar County Medical Society. Two Bexar County physicians appear on the weekly programs to discuss diagnosis and treatment of disease and explain the proper use of new medical discoveries.

Tv Outlines Cancer Cures

WNBK (TV) Cleveland has presented an hour-long special feature dramatizing the possibilities for cure of cancer by means of radioactive isotope treatment. The program was coordinated with the local drive for funds to support the cancer crusade.

Interstate Conclave

A SPECIAL 14 station network carried the initial broadcast of a once-a-month series in which the governors of Pennsylvania, New Jersey and Delaware discussed problems of common interest. The series is originated by WFIL-AM-TV Philadelphia for the tri-state network.

UCP Material Available

UNITED CEREBRAL PALSY has announced that it has color tv slides available for use by stations equipped with color transmitting facilities. The public service organization also has black-and-white slides, telops and semi-animated cartoons for tv stations and has prepared transcriptions, starring name Hollywood actors, for radio use.

Welfare Agencies Given Aid

WTVJ (TV) Miami, Fla., held a "Television Workshop" for representatives of greater Miami's welfare agencies so that the groups could better utilize their public service time in presenting their stories to the viewing public.

Telecast Saves Life

NEW SURGICAL techniques used in treating certain heart conditions were being demonstrated on a WEWS (TV) Cleveland public service program when a viewer recognized the symptoms described by the surgeon as those experienced by his sister. Because of the telecast the operation was performed and the girl can look forward to a normal life instead of the prospect of death in less than two years as had been previously predicted by medical authorities.

'No Second Chance'

A PROGRAM prepared and produced by WJR Detroit to explain the meaning and operation of Conelrad is being distributed to all radio stations in the U. S. and territories by the Federal Civil Defense Administration.

No Second Chance was originally broadcast as a public service over WJR every day for two weeks during different time segments so as to reach all the station's different listening audiences.

WJR produced the show after civil defense surveys and a B•T editorial (Nov. 29, 1954) indicated an urgent need for further public education on Conelrad. The program simulates a Conelrad alert and an enemy air raid complete with sound effects.

Initial program expenses were defrayed by WJR. FCDA is pressing the 3,000 records necessary for distribution.



PROTECTING YOU IN MORE WAYS THAN YOU KNOW



This ad is appearing nationally. To encourage supplementary home town advertising, the National Board, through State insurance agents' associations, provides mats and suggested copy for local insurance boards. These, with other artwork and suggested copy, radio and TV spots, are available to your advertising department.

Putting a new roof over your head... fast

DISASTERS OCCUR ALL TOO FREQUENTLY—without warning—from fire, explosion or windstorm. No one knows where or when they will strike. The next one may hit your home. Then you will need help—fast. The capital stock fire insurance companies are ready for just these emergencies. Adjusters are rushed to the disaster to speed up claim payments. Through this "Catastrophe Plan," your capital stock fire insurance company gives you immediate aid so you can quickly re-

build your home, start up business anew and be back on your feet—fast.

Protecting you is our business. Don't take chances—make sure you're protected against loss by fire, explosion and windstorm. You safeguard your health by seeing your doctor and dentist. You can be equally sure you're adequately protected against fire and other disasters by seeing another specialist regularly—your insurance agent or broker. This protection, too, is necessary for your sense of security.

Capital Stock Fire Insurance Companies are represented by independent local agents or brokers. It's the insurance service that gives you the personal advice of a man right in your own neighborhood. And he protects you in more ways than you know; he's the man who can take care of ALL your insurance needs!



NATIONAL BOARD OF FIRE UNDERWRITERS
85 John Street New York 38, N. Y.
222 West Adams Street, Chicago 6, Illinois
465 California Street, San Francisco 4, Cal.

**Now it costs less
to sell**

**MINNEAPOLIS
ST. PAUL**

Maximum power at minimum cost.
Ask your H-R representative
about choice availabilities.

ASK H-R 316,000
watts on
Channel 9



HOWARD E. STARK
BROKERS and FINANCIAL CONSULTANTS
RADIO and TELEVISION STATIONS

50 EAST 58th STREET EL 5-0405
NEW YORK 22, N. Y.

All Inquiries Confidential

**1st in Power
and Coverage
1,000,000
WATTS**

WILK-TV
Wilkes-Barre
Scranton
Call Avery-Knodel, Inc.

WBAW Aids Salk Inoculations

WBAW Barnwell, S. C., staged a spot campaign to have local parents give consent for their children to be inoculated with Salk anti-polio vaccine. When the announcements started, about 40% of the eligible children had the necessary consent, but after the campaign had been underway for a few days the percentage was near the 100% mark.

Fund Benefits From Store's Loss

CANCER CRUSADERS, during a telethon staged by KGNC-TV Amarillo, Tex., not only auctioned off a load of merchandise intended for fund raising purposes, but got carried away and sold to the highest bidders a 10-foot freezer, a 17-inch tv set and an air conditioner which were part of a commercial of a local furniture and appliance store.

KFAB Starts Ordinance Probe

KFAB Omaha, Neb., claims credit for throwing the spotlight on a "breakdown" in record-keeping at the understaffed city clerk's office there which has resulted in the journal record of general city ordinances falling some five years behind. After KFAB reporter Glenn Desmond probed the logjam, the station aired a broadcast calling attention to the situation.

Funeral Expenses Defrayed

OVER \$600 was raised by WAIN Columbia, Ky., to help a destitute local family pay the funeral bills contracted when the family's six-year-old girl drowned in a creek.

WPTR Kicks Off Drive

WPTR Albany, N. Y., was selected by the local committee of the Arthritis & Rheumatism Fund to open its drive for contributions. The station, airing an hour-long broadcast from one of Albany's busiest streets, featured entertainment personalities, an orchestra and a fur fashion show.

Thirty-five Second Record

KVEN Ventura, Calif., aired a missing person bulletin which produced results in record time, the station reports. Thirty-five seconds after the report was broadcast that the whereabouts of a nine-year-old girl were unknown, a KVEN listener called the station and said the girl was seen sleeping in a parked car.

GOC Gains 2,300

CENTRAL IOWA's Ground Observer Corps increased by 2,300 volunteers during the three-week period that WOI-TV Ames, Iowa, conducted a drive in behalf of the group. A special half-hour program, spot announcements, and a running tabulation of new volunteers highlighted the campaign.

WPEN Aids Cancer Fund

WPEN Philadelphia personalities "Pancho" and Larry Brown, co-m.c.'s of the *Mambo Dancing Party*, raised funds for the fight against cancer by getting donations from members of the show's studio audience who had their pictures taken with the stars during the show.

Child Problems Analyzed

KRNT Des Moines, Iowa, has aired a special panel program on "Why Children Blow Off Steam." The program, put on with the cooperation of the local Parent-Teachers Assn. and Drake U., was listened to by 80 individual parent-teacher groups which held discussions on the matter after the radio panel was closed.

WFMY-TV Aids Blood Drive

WFMY-TV Greensboro, N. C., studios and offices were turned into a blood donor center when the North Carolina bloodmobile made its visit in that area. Fifty pints more than the quota were collected.

\$260,000 Donation

TIME WORTH \$260,000 was donated for public service programming on WHLI Hempstead, N. Y., during 1954, George Ball, station's director of public affairs, has announced. During the year, the station aired 1,174 public service programs and 11,202 public service announcements.

'You and the Law'

WERE Cleveland is presenting a 13-week series of programs, *You and the Law*, which is designed to familiarize the public with common legal problems and methods. The broadcasts are being produced in cooperation with the Cleveland Bar Assn.

City Budgets Discussed

WKNE Keene, N. H., has aired a series of panel programs dealing with the city's budget. It has met with such success, the station feels, that a series on the school budget is planned. The station also is using a saturation campaign of spot announcements urging greater participation in civic affairs on the part of its listeners.

\$50,000 for UCP

KGEO-TV Enid, Okla., enriched the United Cerebral Palsy Assn. by \$50,000 by broadcasting a 17-hour telethon on its behalf. National and local personalities contributed to the show's success. The station estimated that approximately 17,000 people filed through KGEO-TV studios during the course of the program.

WSTC Urges Fire Caution

WSTC Stamford, Conn., is airing forest fire warnings on all its daily weather reports.

4-H Club Week Marked

DEMONSTRATIONS and explanations of 4-H Club projects were telecast by WICS (TV) Springfield, Ill., during observance of National 4-H Club Week. Besides the daily series WICS also set aside time for several other programs featuring club members and their activities.

WFMY-TV Studies Education

WFMY-TV Greensboro, N. C., is presenting a series, *Your Child at School*, in which various facets of public education are being discussed. The 15-minute-a-week 18-week series is being aired with the cooperation of the North Carolina Education Assn.

Safety Patrols Honored

WGN-TV Chicago honored the nation's school safety patrols and the Chicago Motor Club, which conceived of the patrol idea 32 years ago, by airing a special program in which club, municipal and school officials were presented.

Health Facilities Described

A 13-WEEK series, *Public Health is People*, describing the work being done by the Minnesota Dept. of Public Health to safeguard the health of Minnesotans, is being presented by KSTP-TV Minneapolis-St. Paul. The show, produced by the department, will present both physicians and municipal executives during the programs.

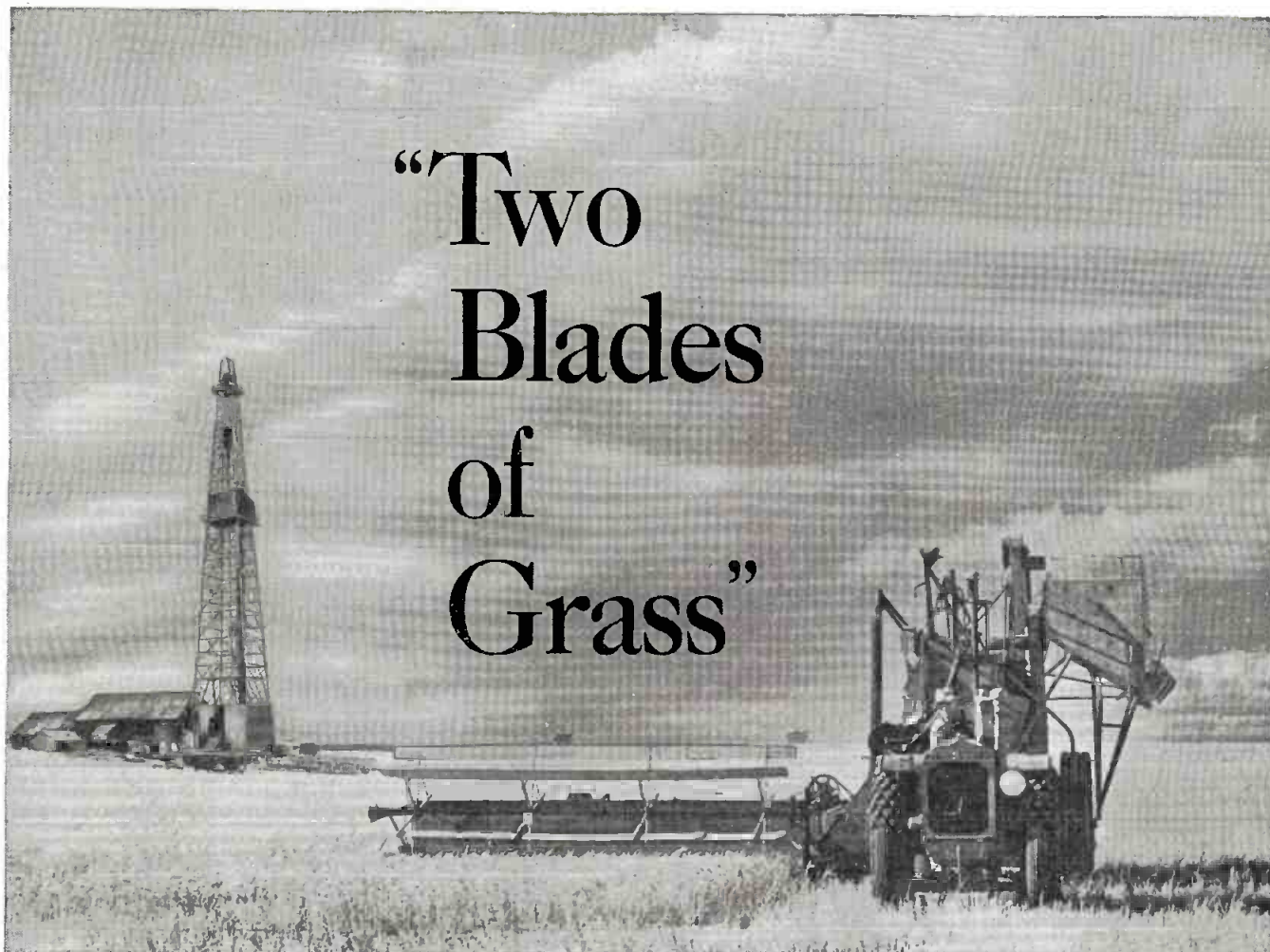

“Two Blades of Grass”

TWO CENTURIES ago Voltaire said, “He who makes two blades of grass grow in place of one renders a service to the State.” The job of Standard Oil Company (New Jersey) and its affiliates is something like that – to produce oil where none was produced before and, by so doing, to create wealth for everybody.

How well have we been doing this job? Our Annual Report for 1954, which has just been sent to the 300,000 shareholders who own Jersey Standard, tells about it.

It tells how wealth was created by extending known oil fields . . . And by discovery of new ones . . . By converting crude oil, itself of little value, into hundreds of useful products . . . By moving petroleum products from where they were made to where they were needed.

All these things helped the people and strengthened the nations where we do business.

Some highlights of these activities, drawn from the Annual Report, are set forth here as a matter of public information.

1. During 1954, the free world used more oil than ever before. And oil is energy, which is basic to the world's progress.

2. To meet these needs, our affiliates produced and refined more oil than ever before in the Company's history. But additions to oil reserves were greater than the oil used.

3. We had vigorous competition everywhere. There is nothing like competition to bring you better products and service.

4. 1954 was our top year in sales, earnings, and dividends paid to owners.

5. During the year, we spent 764 million dollars for new equipment and for exploration. Since World War II, we have spent 5 billion dollars for the means to meet your future oil needs.

6. Research was productive. Our research affiliate obtained more patents on products and processes than any other oil company. In Linden, N. J., the first atomic laboratory in the oil industry is being built to study the uses of radiation in oil refining.

7. Current developments in atomic energy will mean greater availability of electric power: increased mechanization, expanded industry, and greater use of petroleum products. The oil business will gain, and you will have the benefits of both kinds of energy.

8. We played an important part in arranging to return Iran's oil to world markets.

9. A world's safety record for major refineries was set by Esso employees at Baton Rouge, La. . . . 7,911,769 man-hours with no disabling injury. This passed the previous record by more than a million man-hours.

10. We have long supported education through our taxes. We have also felt an obligation to aid privately supported colleges and universities, which are an important source of new employees and of informed citizens. During 1954, we contributed about a million dollars to such institutions.

If you wish a copy of the full Report for 1954, write to Standard Oil Company (New Jersey), Room 1626, 30 Rockefeller Plaza, New York 20, N. Y.

STANDARD OIL COMPANY (NEW JERSEY)
AND AFFILIATED COMPANIES





can forewarn you of

**LIBEL • SLANDER
PIRACY
COPYRIGHT VIOLATION**

**BUT our specialized
INSURANCE
covers these daily hazards
ADEQUATELY • INEXPENSIVELY
DON'T RISK**

possible embarrassing loss while
protection is readily available—but
DO RISK 5 minutes and 3c
to write for details and a
rate built for you.

WRITE FOR DETAILS AND RATES

*Employers
Reinsurance
Corporation*

INSURANCE EXCHANGE
KANSAS CITY, MISSOURI



CONSTANT SERVICE

OF **HIGHEST TYPE**

WILL **NET SPONSORS**

INCREASED **SALES IN**

HALIFAX • NOVA SCOTIA

Joseph Weed & Company
579 Fifth Ave., New York
Representative

5000 WATTS

A GOOD SPOT

WEAV

PLATTSBURG, N. Y.

Ask **GILL-PERNA Inc.**

IN PUBLIC INTEREST

CKCO-TV Silent Promotion

CKCO-TV Kitchener, Ont., had all its announcers who appeared on camera wear Red Cross buttons on their lapels during the local drive for funds by the public service organization. No verbal attention was called to the pins, but their presence was eye-catching and self-explanatory, the station reports.

'Louisville: Target 21'

WAVE Louisville, Ky., has presented a three-week series (six 15-minute shows), *Louisville: Target 21*, detailing the civilian defense measures necessary to prevent chaos in case of an enemy attack. Purpose of the series is to acquaint the public with the dangers of such an attack and to recruit personnel for the armed forces and for Civil Defense work.

Delinquency Problems Detailed

WTAG Worcester, Mass., has aired a five-broadcast panel series *Juvenile D*, in which the psychological and social factors underlying delinquency were analyzed. The series was put on with the cooperation of the Worcester Area Mental Health Assn. and the local PTA.

Jazz Aids Blind

JAZZ and variety concert was staged May 6 at Carnegie Hall by WCBS New York to help celebrate the 50th anniversary of the Lighthouse, supported by the New York Assn. for the Blind. Leading stars from radio, television and the recording industry participated in the show. Part of the proceeds are to be used to expand the facilities of the Lighthouse Music School, which now has 235 blind students.

Orchestra Fund Aided

WWLP (TV) Springfield, Mass., presented executives and a performer of the local Springfield Orchestra Assn. during the organization's drive for funds to sustain its musical programs.

Public Service Time Tallied

WNHC-TV New Haven, Conn., provided free air time for 49 different campaigns with a total of 611 public service spot announcements during March, the station has reported. During that month the station donated 34 hours of tv program time to public service organizations, including religious groups, industrial groups, service organizations, Red Cross and educational institutions.

WFBC-TV Aids UCP

PLEDGES to United Cerebral Palsy amounting to \$69,057 were received through a telethon on WFBC-TV Greenville, N. C. Of the total amount pledged, \$32,518 was in cash donated at the auditorium where the telethon originated. A major portion of the funds will be used to assist palsy victims in Greenville and Spartanburg counties.

UCP Trailer

DANNY THOMAS, star of ABC-TV's *Make Room for Daddy*, has made a three-minute trailer for the sixth annual United Cerebral Palsy campaign. Lou Edelman and Sheldon Leonard, producer and director, respectively, of *Make Room for Daddy*, acted in like capacities for the trailer, with Earl J. Hudson, vice president of the ABC western division and the UCP fund, supervising production for UCP.

AWARDS

SLOAN SAFETY AWARDS PRESENTED

Winners include WCPO-TV, NBC Radio, WOWL, KOY and WUOT. Four radio-tv advertisers also get awards. Rural Radio Network receives honorable mention.

ONE TV station, three radio stations and one radio network were among the recipients of the Alfred P. Sloan radio-tv awards for outstanding public service in traffic safety.

Plaques were presented last Tuesday in New York by Alfred P. Sloan Jr., board chairman of General Motors Corp. and president of the Sloan Foundation, to WCPO-TV Cincinnati, NBC Radio, three radio outlets—WOWL Florence, Ala., KOY Phoenix and WUOT Knoxville (non-commercial, educational station)—and four advertisers. Rural Radio Network, Ithaca, N. Y., was given an honorable mention.

Presentations were made at the annual awards dinner in the Waldorf-Astoria Hotel, drawing over 200 business and industry executives, government officials and civic leaders. Mr. Sloan lauded broadcasters for their role in helping the nation to achieve its lowest motor vehicle death rate last year. Harold E. Fellows, NARTB president, also spoke briefly.

Expresses Industry's Thanks

Mr. Fellows expressed the gratitude of the broadcasting industry to the Sloan Foundation for making the awards possible. He said stations and advertisers considered it "a privilege" to participate in the campaign, and paid tribute to the personnel of stations for contributing to the project.

WCPO-TV was cited "for resourceful programming of safety features for young people of all school levels." NBC Radio won in the national or regional network sustaining category "for highlighting traffic safety on many excellent programs" and for "repeated emphasis by spot announcements and mentions through all seasons."

WOWL emerged victorious in the 1 kw or less sustaining category, KOY in the 1 kw or over group and WUOT in the educational station field. Advertisers cited were DeSoto-Plymouth Dealers of America (national or regional radio network commercial category), Esso Standard Oil (tv network commercial), Twin City Federal Savings & Loan Assn. (over 1 kw radio station commercial group) and Plymouth Dealers of Greater Detroit (tv station commercial category).

Rural Radio Network won honorable mention for "its contribution to highway safety in rural areas . . . through its helpful daily road reports over 13 fm stations."

Citations follow:

NBC Radio Network (winner in the national or regional network sustaining category).

For highlighting traffic safety, particularly *Road Show* and *Heart of the News*, and for repeated emphasis by spot announcements and mentions through all seasons. . . . A stand-out feature [of *Road Show*] was the awarding of prizes to Drivers of the Day selected in various parts of the U. S. in cooperation with local representatives of the American Automobile Assn.

WOWL Florence, Ala. (winner in the 1 kw or less sustaining category).

For its strong promotion of safe driving

among teenagers. . . . Through a highly successful contest for young drivers, intensively publicized on the air, WOWL was able to unite the support of influential community groups, both civic and official, in a common effort.

KOY Phoenix, Ariz. (winner in the over 1 kw radio station sustaining category).

For its balanced and consistent coverage of traffic safety throughout the year. KOY did a notable job in integrating accident prevention into several types of programs, including its disc jockey shows, newscasts and other features. Its additional activities ranged from recorded messages from the Governor's Highway Safety Committee, safety roundtables, regular road condition bulletins and safety tips to special campaigns on back-to-school safety and Safe-Driving Day observance.

WUOT Knoxville, Tenn. (winner in the non-commercial educational radio station category).

For its comprehensive schedule of traffic safety broadcasts, as well as for the enterprise shown in spreading the safety gospel among other stations in its region. Tapes of 130 15-minute programs aired by WUOT were made available to 15 other Tennessee outlets, one in Kentucky and one in Virginia. The fine effort of this U. of Tennessee educational station earned it two previous Sloan Awards.

WCPO-TV Cincinnati, Ohio (winner in the television station sustaining category).

For resourceful programming of safety features for young people of all school levels. Convinced that instilling a "do-it-yourself" attitude is the first step in developing a real sense of personal responsibility in traffic, WCPO-TV has created a series of popular and distinctive participation programs for the various age groups. Typical are *Fun 'n Facts*, conducted for teenage drivers in conjunction with the Cincinnati Junior Safety Council; *Big Wheels*, a program for the bicycle set, and *Play It Safe*, a quiz-type program for elementary school children.

Marx Show Listed

De Soto-Plymouth Dealers of America (winner in the national or regional radio network commercial category).

For potent support of highway safety on the high-rated Groucho Marx *You Bet Your Life* show, with safety reminders on 44 weekly programs over 207 NBC Radio network stations. . . . The De Soto-Plymouth dealer program, a three-time winner of the Sloan Award, regularly reached nearly 80% of all radio and television homes in the U. S.

Esso Standard Oil Co. (winner in the television network commercial category).

For effective, year-round safety promotion on *Your Esso Reporter* over 18 television stations. The flexible schedule of *Your Esso Reporter* made it possible to time special messages in advance of and during holiday weekends and other critical traffic periods. . . . Esso's unswerving dedication to highway safety is exemplified in this, its third, Sloan Award.

Twin City Federal Savings & Loan Assn., Minneapolis, Minn. (winner in the over 1 kw radio station commercial category).

For its series of 75 half-hour shows entitled *As We Journey, Let Us Live*, devoted to varied traffic safety appeals and services to motorists, interlaced with top musical selections. . . . The program boasts the most complete road condition report in the Twin City area, with local truck firms relaying special information on hazardous locations.

Plymouth Dealers of Greater Detroit (winner in the television station commercial category).

For their instructive and provocative traffic series, *The Plymouth Safety Eye*, beamed on

36 half-hour programs over WJBK-TV [Detroit]. Incidents involving both motorists and pedestrians were photographed in candid-camera fashion, providing a basis for commentary emphasizing proper driving and walking practices. Related educational topics included development of expressways, weekend driving problems, traffic ordinances and school safety patrols.

Rural Radio Network, Ithaca, N. Y. (honorable mention).

For its contribution to highway safety in rural areas, specifically in New York State and northern Pennsylvania, through its helpful daily road reports over 13 fm stations.

There was no award in the 1 kw or less radio station commercial category.

Holmes Awards Luncheon Set

NINTH ANNUAL Frances Holmes Awards Competition, open to all women in advertising or allied fields in the 11 western states and British Columbia, will hold its "Lulu" presentation luncheon June 5 at the Ambassador Hotel, Los Angeles. Classifications are copy, layout, advertising illustration, research project, direct mail, radio commercial, tv commercial, commercial film, publicity, public relations and sale promotion-merchandising. Deadline was yesterday (Sunday).

AWARD SHORTS

Beverly Brown, Beverly Brown Productions, New Orleans, and director, *Hilites*, WNOE New Orleans, and writer-producer, *Teene-Towne*, WSMB there, presented fourth annual New Orleans Community Theatre award for contributions to New Orleans theatre through years of developing young talent.

WMAL-AM-TV Washington presented certificate of merit from Washington Board of Trade's architectural awards committee for erection of workshop building on American U. there as one of eight outstanding structures built in Washington area during past two years. Structure is gift from stations to school to house radio-tv course classes.

Judith Waller, education and public affairs director, NBC Central Div., Chicago, cited by Chicago Council on Foreign Relations with "Pioneer World Understanding" Award [B•T, May 16].

Jack Bailey, host-m.c., Mutual-Don Lee and KHJ-TV Hollywood *Queen for a Day*, received special award from United Cerebral Palsy Foundation for wishing-well project, in which wells are installed across country to keynote annual UCP fund drive.

Dr. Herman Harvey, host-lecturer, KNXT (TV) Hollywood *Child Psychology on Tv*, and associate psychology professor, U. of Southern California, received special award from national women's committee of Brandeis U., Waltham, Mass., at Beverly Hills, Calif., luncheon meeting, for "special contribution to American culture and education through . . . his college credit courses presented on KNXT."

WIS-TV Columbia, S. C., presented special certificate from Veterans of Foreign Wars, South Carolina dept., for "promotion and perpetuation of the true spirit of Americanism."

WSB-TV Atlanta, Ga., *News of the World* program, sponsored by Atlanta Gas Light Co., winner of first award for tv shows in 1955 Better Copy Contest of Public Utilities Adv. Assn.

Audio Productions, N. Y., "Before They Happen," film, produced for National Bureau of Fire Underwriters, awarded bronze plaque

from national committee on films for safety. Documentary film, describing work of municipal fire prevention bureau, is available to tv stations for black-and-white showings.

Wilson R. Thornley, creative writing instructor, Ogden (Utah) High School, presented engraved plaque from KLO Ogden in appreciation of contributions to Utah's life and letters by fostering his students to win nine awards in annual *Scholastic* magazine and Sheaffer Pen Co. high school literary competition.

KIMA-AM-TV Yakima, Wash., and satellite **KEPR-TV** Pasco, Wash., presented Junior Activities Service Award from Veterans of Foreign Wars, Washington dept., for time and facilities donated to VFW.

Burke Ormsby, production director, KTNT-TV Tacoma, Wash., presented state flag of Washington from Veterans of Foreign Wars for aiding VFW in search for outstanding high school and college musical talent through *Talent Contest* program.

Maynard Speece, farm service director, WCCO Minneapolis-St. Paul, named honorary state farmer by Minnesota Assn. of Future Farmers of America in recognition of outstanding service to FFA and agriculture.

KVWO Cheyenne, Wyo., presented award from White King Soap Co., L. A., for promotion of Big Boy Barbeque Contest on MBS *Queen for a Day* program in western states; **KCAP** Helena, Mont., and **KIFI** Idaho Falls, Idaho, presented plaques for best merchandising and promotion jobs among 250 w and 1 kw and above stations.

WPEN Philadelphia presented silver mike award from Better Business Bureau of Philadelphia for "20 years of consistent cooperation in presenting *Look . . . Before You Weep*" program.

Russ Graeff, host, *Platter Party*, WGLV (TV) Easton, Pa., presented award from Easton Area Junior Chamber of Commerce for service to teenagers of Lehigh Valley and fight against juvenile delinquency.

WTRF-TV Wheeling, W. Va., presented 21-in. RCA color tv set as winner of "Lux Video Theatre's Festival of Academy Award Winners" contest to promote program, conducted by Lever Bros. Co., N. Y.

Ampex Corp. (magnetic tape recording equipment), Redwood City, Calif., presented certificate of outstanding achievement in industrial accident prevention from Argonaut Insurance Group, S. F., for record of one million man hours of labor in 1954 without lost time from accidents due to industrial causes.

John Scott, disc m.c., WEEL Boston, cited by *Musician's Guide* as "one of the top disc jockeys in the U. S." and appointed to its editorial advisory board.

Claude M. Bolser, coordinator, cooperative training program of advertising, Baruch School Chapter, Alpha Delta Sigma, presented distinguished service key from fraternity.

Ed Sullivan, host, CBS-TV *Toast of the Town*, presented annual American of the Year award from U. of Detroit students for "outstanding devotion to his country and his fellow citizens . . ."

Eric Sevareid, chief Washington correspondent, CBS, presented first Edgar J. Kassan Award last Tuesday in recognition of role "in public enlightenment through his responsible coverage of the news of the day." Award will be made annually by Edgar J. Kassan Memorial Fund, set up in honor of late Mr. Kassan, vice president, Joseph Katz Co., Baltimore, who died last year.

WTIC Hartford, Conn., cited by Hartford Court of Common Council for aid in polio fight.

Robert R. Tincher, general manager, WMAX Yankton, S. D., and vice president, Cowles Broadcasting Co., presented 1955 distinguished award from school of business, U. of South Dakota.

Normaglen Field and George J. Fox, Indiana U. radio-tv dept. postgraduates, and Marvin Goodman, undergraduate, presented annual scholarships of Sarkes and Mary Tarzian, who own and operate WTTT-TV (TV) Bloomington, Ind.

Robert F. Browning, newsman, WKNY-AM-TV Kingston, N. Y., presented annual citizenship

award of Veterans of Foreign Wars' Joyce-Schirick Post.

CBS-TV *Mama* presented citation from American Mothers Committee in recognition of "inspiration given to families throughout six years of continuous presentation" on tv.

Helen Thomas, vice president and radio time-buyer, Street & Finney, N. Y., presented top award of \$100 for winning estimate in WDSM Duluth, Minn., contest to guess day and time first freighter would break through Lake Superior ice and enter Duluth harbor this season.

Jack Benny, CBS Radio and CBS-TV comedian, presented citation at May 4 brotherhood dinner of Massachusetts Committee of Catholics, Protestants & Jews.

DUNTON CITES CBC LONG-TERM EXPENSE

Chairman of CBC board of governors tells Parliamentary Broadcasting Committee that CBC will continue to need more money from the government to complete its program.

THE EXPECTATION that capital expenses of the Canadian Broadcasting Corp. "will be extensive for many years" was voiced May 13 to the Canadian Parliamentary Broadcasting Committee at Ottawa by A. D. Dunton, chairman of the board of governors of the CBC. Mr. Dunton said that it would take CBC four or five years to complete its capital program which includes new studios at Vancouver, new quarters at Toronto to centralize operations now in a number of buildings, and construction of new stations.

Mr. Dunton told the committee that at present, CBC is confined to six major city areas for its tv operations, but ultimately the CBC planned to service rural areas which would not be serviced by independent tv stations. CBC would continue to need more money from the government because the yield from excise taxes on radio and tv sets, now earmarked for the CBC, would decline.

CBC has two sources of revenue, Mr. Dunton said, commercial and public. The latter included an annual grant of \$6,250,000 and the 15% excise tax on tv and radio sets and components. He estimated that in the current fiscal year there would be an operating deficit of \$560,000 for sound broadcasting, and a surplus of \$3,500,000 for tv. Net commercial revenue last year was \$3,800,000, he reported.

Mr. Dunton told the committee he did not expect any color tv or pay-as-you-see tv in Canada as operations of the CBC, the former as being too expensive at present, and the latter as being impractical for the CBC.

He told committee member Tom Goode, Liberal member for Burnaby-Richmond (a Vancouver area) that decision to have more than one tv station in any one market was up to government policy, but CBC felt that the effect would be to weaken the economy of the CBC. Competitive tv stations would weaken commercial support for Canadian programs. Mr. Goode had pointed out that U. S. stations near Vancouver were obtaining a large volume of Canadian advertising directed at Vancouver audiences from advertisers who could not get time on CBC station CBUT (TV) Vancouver. Mr. Dunton said CBC could operate at a profit without assistance from the government if CBC would import programs and drop the development of Canadian talent.

He pointed out that CBC planned more tv programs like the recent two-hour showing of *Hamlet* with all-Canadian talent, which cost \$30,000 to produce. Several such shows are planned for next year and sponsors have been approached on using these cultural programs.

Tv Gets First Political Use In June 9 Canadian Election

THE FIRST provincial election in Canada since the advent of television takes place in Ontario on June 9. Under Canadian broadcasting regulations time is made available to candidates on a free as well as paid basis, with free time allotted on a basis of party standing. All elec-

RADIO & TV STATIONS!



Up to \$20,000 in Revenue...

A Large Percentage of Which is Paid to You Before Any Service is Rendered on Your Part!

1. PICK A WINNER contest secures local merchants who act as co-sponsors — creates many new accounts.
2. PICK A WINNER contest gives you up to \$3,000 in prize merchandise.
3. PICK A WINNER contest provides publicity for your station. Each co-sponsor receives a display and entry blank that carries your call letters and kilocycles.



Pick a Winner

ATTENTION CONVENTIONEERS

See Richard Duglin at the Statler Hotel or Telephone EXecutive 3-5037

ALL YOU DO:

Provide each co-sponsor with a sixty (60) word weekly announcement at a time left to your discretion, and aid in the distribution of your entry blanks by announcing daily where they may be obtained.



UPRE

ADVERTISERS LTD.

270 Park Avenue, New York 17, N.Y.

The Song Hit **BOX SCORE**

BMI presents a four month accounting of the outstanding current song hits in the BMI repertoire as determined by two of the music trade barometers.

The "HIT PARADE"

	January					February				March				April				
	1	8	15	22	29	5	12	19	26	5	12	19	26	2	9	16	23	30
LET ME GO LOVER (Rumbalero)	2	1	3	2	1	2	3	4										
HEARTS OF STONE (Granite-Regent)				6	5	6	6	2	2	4	5							
THAT'S ALL I WANT FROM YOU (Weiss & Barry)						7	7	7	3	5	6	6	7	7	7			
SINCERELY (Arc)							4	5	6	2	3	4	2	5	4	6	5	
TWEEDLEE DEE (Progressive)								6	7	3	4	1	4	2	2	4	4	4
KO KO MO (Meridian)									5	7	2	5	6	6	5			
OPEN UP YOUR HEART (Hamblen)										7								
BALLAD OF DAVY CROCKETT (Wonderland)												3	3	1	1	1	1	1
DANCE WITH ME, HENRY (Modern)																	6	7

The "HONOR ROLL OF HITS"

	January					February				March				April				
	1	8	15	22	29	5	12	19	26	5	12	19	26	2	9	16	23	30
LET ME GO LOVER (Rumbalero)	2	2	1	1	1	1	2	4	5	8								
THIS OLE HOUSE (Hamblen)	7	8	8	9														
HEARTS OF STONE (Granite-Regent)	8	6	4	4	3	4	3	2	3	3	5	7	8	10				
THAT'S ALL I WANT FROM YOU (Weiss & Barry)					9	7	7	8	9	7	9	9	10	9	9			
NO MORE (Maple Leaf)				10		10			10									
SINCERELY (Arc)				6		6	5	3	2	2	2	2	2	3	3	3	4	8
EARTH ANGEL (Dootsie Williams)							9	6	6	5	6	6	7	8	10			
OPEN UP YOUR HEART (Hamblen)											10	10	9	7	7	8	9	9
TWEEDLEE DEE (Progressive)								10	8	6	4	4	4	4	4	4	3	7
KO KO MO (Meridian)							8	7	4	4	3	5	5	6	6	10		
BALLAD OF DAVY CROCKETT (Wonderland)											7	3	3	1	1	1	1	1
DANCE WITH ME, HENRY (Modern)																7	7	5

The numbers in the above tabulation indicate the week-to-week positions of BMI-licensed song hits among the seven on the "Hit Parade" and the top ten selections of the Billboard "Honor Roll of Hits."

These songs have achieved success because the writers, composers, publishers and performers have pleased the public taste. BMI salutes their joint achievements.

If You Attend
the NARTB Convention
Visit BMI's Exhibit
"The Music of the Presidents"
Suite 557-661
Sheraton-Park Hotel

BROADCAST MUSIC, INC. 589 FIFTH AVENUE
NEW YORK 17, N.Y.
NEW YORK • CHICAGO • HOLLYWOOD • TORONTO • MONTREAL



tion broadcasts come under the Canadian Broadcasting Corp., even those on independent stations.

The three major Ontario parties, Progressive-Conservative, Liberal and Cooperative Commonwealth Federation, will share without charge four and one-fourth hours on 11 Ontario tv stations and five hours on radio stations. The tv time consists of three half-hour, three 15-minute and three 10-minute periods, with three local 15-minute periods on CBC stations CBOT Ottawa and CBLT Toronto. Free-time telecasts will be on eight tv stations on microwave network from May 19 to June 6, with kinescope on three stations not yet connected with the network.

On radio, 15 Ontario stations will be on the network in 18 quarter-hour periods and three 10-minute periods from May 12 to June 6.

Rehearsal time up to three hours for a half-hour free-time political telecast is provided, and programs can take the form of a straight talk, discussion involving two or more speakers or question-and-answer presentation, with only bona fide party representatives participating.

CBS Newsfilm to Cover For England's New ITN

CBS NEWSFILM will supply filmed news coverage of North and South America and the Far East to Independent Television News Ltd. of England under a contract signed in New York last week.

The agreement was signed by Aidan Crawley, editor of ITN, and Sig Mickelson, CBS vice president in charge of news and public affairs. Also present at the negotiations were Philip Dorte, director of operations of ITN, and Howard Kany, CBS Newsfilm manager.

ITN is the news programming company set up by the new Independent Television Authority that was created upon authorization of commercial tv in Great Britain.

Under the contract, ITN will receive full syndicated film coverage of the news by more than 250 Newsfilm cameramen, soundmen and correspondents located in world capitals and news centers in more than 50 countries. CBS Newsfilm also draws upon a library of more than 5 million feet of film of past news events and color and background material. Commentaries and news shows are distributed in addition to "spot" news coverage.

The ITN contract adds Great Britain to the list of Newsfilm customers which, in addition to stations in U. S., include tv stations in Japan, Italy, Sweden, Denmark, Mexico, Cuba, Puerto Rico, Venezuela, Alaska and Hawaii.

To the Salt Mines

A NEW "voice of America" may have been heard behind the Russian Iron Curtain and it may have been the first of its kind not sponsored by the U. S. Information Agency's Voice of America program. On April 22, KBYR Anchorage, Alaska, directed a message to Siberia at the start of its regular noon newscast. It was broadcast by Jack Wandell, KBYR news editor, after he was advised that the KBYR music and news programs were being received in the Bering Sea and Nunivak. The station believes it was the first time a privately-owned longwave radio station has attempted to reach people behind the "Iron Curtain." Mr. Wandell, in his message, described the freedom that the American press and radio stations enjoy and he told those people who were receiving KBYR's programs: "Keep listening and you will hear the truth."

Canada's April Radio Poll

TOP eight evening programs reported for April by the Radio Panel of International Surveys Ltd., Montreal, were (in percentage of homes reached): *Our Miss Brooks* 15%, *CBC News* (Canadian) 14, *Lux Radio Theatre* 13, *Take a Chance* (Canadian) 6, *CBC News Roundup* (Canadian) 6, *Toronto Symphony Concert* (Canadian) 4, *Championship Fights* 4 and *Byng's Choice* (Canadian) 3.

Daytime leading programs reported by the Radio Panel of Canada were *Ma Perkins* 32, *Pepper Young's Family* 29, *Right to Happiness* 29, *Guiding Light* 28 and *The Happy Gang* (Canadian) 25.

CARTB to Urge Control Shift

CANADIAN INDEPENDENT broadcasters are slated to appear before the Parliamentary Broadcasting Committee at Ottawa on May 24 when the full board of the Canadian Assn. of Radio & Television Broadcasters is expected to present further reasons for the appointment of an independent regulatory body to control both independent and Canadian Broadcasting Corp. stations. The CARTB also is expected to urge the committee to recommend a change in government policy in regard to licensing second tv stations in cities.

Elliott-Haynes Releases Radio Ratings for April

APRIL national ratings of Elliott-Haynes Ltd., Toronto, list six Canadian evening radio network shows, led by *Our Miss Brooks* with a rating of 15.2, and *Wayne & Shuster* (Canadian) 9.9, *Army Show* (Canadian) 9.8, *Singing Stars of Tomorrow* (Canadian) 9, *Championship Fights* 8.6 and *Toronto Symphony Concert* (Canadian) 5.5.

National ratings on transcribed evening shows placed these four on top: *People Are Funny* 16.5, *Denny Vaughan Show* (Canadian) 11.8, *Fun Parade* (Canadian) 10.3 and *Take a Chance* (Canadian) 8.7.

Daytime network shows numbered 12, with leading five being *Ma Perkins* 14.4, *Guiding Light* 13.6, *Pepper Young's Family* 13, *Right to Happiness* 12.5 and *Road of Life* 11.7.

Leading five French-language evening network shows were *Un Homme et Son Peche* 37.3, *Le Survenant* 27.6, *La Famille Plouffe* 26.9, *La Voix du CARC* 18.9 and *Tambour Battant* 16.5.

Leading French-language daytime network programs were *Vies de Femmes* 31.5, *Je Vous ai Tant Aime* 28.2, *Jeunesse Doree* 27.2, *Rue Principale* 27 and *Les Joyeux Troubadours* 26.9.

Canada Considers Troop Tvs

TV STATIONS with limited range for use in entertaining troops at defense bases in Canada, used by both U. S. and Canadian troops, are now under consideration by the Canadian government. The Canadian Army is understood to have negotiated for establishment of a non-commercial tv station at Churchill, Man., on the west shore of Hudson Bay, along the lines of the army radio station CHFC Churchill. Funds for the tv station would come from the regimental institutes. United States forces have also requested tv stations at bases they are using in northern Canada.

Two Canada Tvs Set Debut

CKVR-TV Barrie, Ont. (ch. 3), expects to be on the air by Sept. 15, according to owner Ralph Snelgrove, who also owns CKBB Barrie.

CKNX-TV Wingham, Ont., plans to be on the air early in October, in time for the World Series baseball games. The ch. 8 station was recently recommended for a tv license by the board of governors of the Canadian Broadcasting Corp.

Three Ams Merge for Tv

THREE British Columbia radio stations—CKOK Penticton, CKOV Kelowna and CJIB Vernon—have formed Okanagan Valley Television Co. and plan to apply for a tv station license, with transmitter to be located at Westbank, near Kelowna. Jim Brown, CKOV, is president of the company, which expects to invest \$500,000 in the tv station.

1,376,101 Tv Sets in Canada

CANADA had 1,376,101 television receivers in use at the end of March, according to tabulations of the Canadian Radio & Television Manufacturers Assn. and All-Canada Television, Toronto. Of these, 724,103 were in the province of Ontario, 401,794 in the province of Quebec, 104,403 sets in the three prairie provinces, 100,339 in British Columbia, and 45,462 in the four Atlantic Coast provinces.

THE LATEST
WCKY
STORY

What in Radio Can You Buy for 6¢?

Here's What!

1,000 Listening Homes

Here's Where!

823,500 Homes in 10 Southern States*

Here's How!

WCKY Open 1 minute rate \$50.00

823 | 50.00 | .06.

* WCKY Audience, according to Nielsen Coverage Service.



Where in Radio Can You Buy More for 6¢?

NOW! the new

**Eliminates extra
manpower
requirements**

*Gray
Telop III*

opaque and transparency projector



**REMOTE OR LOCAL CONTROL
CHECK THESE NEW FEATURES**

- Completely automatic . . . utilizing features contained in the now famous Telop and Telojector . . . Slides change by push button control.
- Sequence of up to 50 slides can be handled at one loading . . . additional pre-loaded slide holders easily inserted in unit.
- Remote control of lap dissolves . . . superposition of two slides . . . and slide changes.
- Shutter type dimming permits fades without variation of color temperature . . . opaque copy cooled by heat filters and adequate blowers . . . assembly movable on base which permits easy focus of image.

**SCREEN OUT HIGH PRODUCTION
COSTS FOR LOCAL SPONSORS**

Telop III by the elimination of extra manpower assures the production and projection of low-cost commercials that local sponsors can afford. It can be used with any TV camera including the new Vidicon camera. Telop III projects on single optical axis opaque cards, photographs, art work, transparent 3 1/4" x 4" glass slides, strip material, and 2" x 2" transparencies when Telojector is used with optical channel provided. Telop III eliminates costly film strips and expensive live talent.

WRITE FOR: Illustrated bulletin describing Telop III specifications. Your request will receive prompt response.

YOU ARE CORDIALLY INVITED . . . to see Gray's complete line of TV-Broadcasting Equipment at the NARTB Exposition . . . May 22-26 . . . Room F-114, Shoreham Hotel, Wash., D.C.



Telop III . . . interior view of automatic slide holder which accommodates 4" x 5" opaque slides . . . One lens . . . no registration problem . . . no keystoneing.

GRAY RESEARCH

AND DEVELOPMENT CO., Inc., Hilliard St., Manchester, Conn.
Division of the GRAY MANUFACTURING COMPANY
Originators of the Gray Telephone Pay Station and the
Gray Audograph and PhonAudograph.

29 of the Best Independent Radio Stations!

**ALWAYS BEST
in the MARKET -
the AIMS station!**

Boston	WCOP	New Orleans	WTIX
Cleveland	WDOQ	New York	WINS
Dallas	KLIF	Omaha	KOWH
Denver	KMYR	Portland, Ore.	KXL
Des Moines	KCBC	San Antonio	KITE
Evanston, Ill.	WNMP	San Francisco	KYA
Evansville, Ind.	WIKY	Seattle	KOL
Houston	KNUZ	Springfield, Mass.	WTXL
Indianapolis	WXLW	Stockton, Cal.	KSTN
Jackson, Miss.	WJXN	Syracuse	WOLF
Kansas City	WHB	Tulsa	KFMJ
Huntington, L.I.	WGSM	Wichita, Kan.	KWBB
Louisville	WKYW	Worcester, Mass.	WNEB
Milwaukee	WMIL		

Canada

Calgary, Alberta, Canada
New Westminster, B.C.

CKXL
CKNW

Only one
in each
market



Membership
by invitation
only

RADIO GROUP



"Since KRIZ Phoenix has been advertising Dydee Service, business has soared."

TAPE DUPLICATION

Unrivalled capacity, fast complete service—
Multiple destination mailings. Experienced en-
gineers—Ampeg installations assure quality.

RECORDED PUBLICATIONS LABS.

1558-70 Pierce Avenue Camden, N.J.
Cam.: WO 3-3000 • Phila.: WA 2-4649

Economic Development Aided By Advertising, Gamble Says

ADVERTISING on an international scale can hasten the economic development of the world's nations, Frederic R. Gamble, president of the American Assn. of Advertising Agencies, told the 15th Congress of the International Chamber of Commerce meeting Wednesday in Tokyo.

Briefly, these are the main benefits that a nation's economy and its people can derive from advertising, according to Mr. Gamble:

1. Successful advertising enables sellers to find customers for their goods and services and thus to succeed in business.
2. Advertising, which stimulates new wants and desires (for cultural services as well as commodities), is one of the most powerful agents in raising the standard of living.
3. It also raises the living standard by selling new models, new designs and improved features, thus permitting older models to spread throughout the population.
4. Advertising supports mass media, helps to keep a nation informed and entertained and brings a national way of living to the country.

Ziv's Stern Off to Europe

EDWARD STERN, head of international activities, Ziv Television Programs Inc., left May 13 for a six-week European trip to meet with tv executives and producers in Germany, France, Holland and England. Mr. Stern will demonstrate the first German language version of *Favorite Story*, starring Adolph Menjou, and the French language version of *Mr. District Attorney*, starring David Brian.

Mr. Stern recently returned from Havana, Cuba, where he completed arrangements for CMBF-TV Havana to acquire a Ziv package of six tv shows: *Boston Blackie*, *Cisco Kid*, *The Unexpected*, *Mr. District Attorney*, *I Led Three Lives* and *Science Fiction Theatre*.

INTERNATIONAL SHORTS

A. C. Nielsen S. A., Alpenstrasse 1, Lucerne, Switzerland, established by A. C. Nielsen Co., Chicago, as affiliated marketing research company, is eighth Nielsen associate company to be organized out of the U. S. Dr. Rudi Zingg, with experience in Nielsen operations in U. S., Great Britain and Netherlands, will head organization.

CFPL-TV London, Ont., has published rate card 3, effective July 1, with new class A time rates starting at \$370 per hour and one minute spot announcements class A time at \$85.

CHSJ-TV St. John, N. B., has ordered 35 kw amplifier from Canadian General Electric Ltd., Toronto, to increase power to 100 kw video.

INTERNATIONAL PEOPLE

Louis Jose Arreaza Almenar, owner of eight Venezuelan radio stations and of Eastern Venezuelan Radio Network and part owner of Caracas tv interest, visiting U. S. to study possibilities of introducing tv into eastern Venezuela.

Phil MacKellar, disc jockey, CKLW Windsor, Ont., to CKFH Toronto in similar capacity.

John Boates, promotion dept., CKWX Vancouver, B. C., to promotion staff, CJAT Trail, B. C.

WLWT (TV) Joins Campaign To Aid Distressed WCET (TV)

FACILITIES and talent of Crosley Broadcasting Corp.'s WLWT (TV) Cincinnati have been contributed in the campaign to raise a needed \$150,000 to keep on the air WCET (TV), the educational outlet there. Ch. 48 WCET needs the money to continue its operations for the remainder of 1955.

On May 6, WLWT conducted a special one-hour show featuring nearly 30 staff members. Additionally the station is making numerous air promotions explaining the importance and value of WCET, and asking viewers to support the educational station during its critical period.

According to WLWT, proposed legislation promises relief in 1956 for WCET. Under a new bill passed by the Ohio General Assembly (Substitute Senate Bill 42), the Cincinnati and Hamilton County schools, through a tax evaluation contribution, will provide the funds necessary for operation of the educational station.

U. of Chicago's Redfield Heads New BFA Officer Slate

OFFICERS of the recently established Broadcasting Foundation of America were elected at an organizational meeting in New York last week. The Foundation has been set up to provide world exchange of educational radio and television programs.

Officers elected are Robert Redfield, head of the anthropology department of the U. of Chicago, chairman of the board of trustees; Frank N. Freeman, *emeritus* chairman of the Dept. of Education, U. of California, president; Seymour N. Siegel, director of radio communications for the City of New York (WNYC-AM-FM New York), executive vice president and treasurer.

The group headquarters in New York at 165 Broadway.

CBS Increases Grants For Educational Use

THE NUMBER of key CBS employees included this year in educational grants to universities and colleges from which the executives graduated has been increased from 16 to 20, CBS Foundation Inc., the agency that makes charitable and educational grants for CBS Inc. and its divisions, has announced.

The Foundation instituted the plan last year as a method of assisting privately supported colleges and universities through unrestricted grants. Aggregate of the foundation's grants was increased this year to \$40,000 from the \$32,000 announced last year. Each grant was set at \$2,000 as it had been last year.

Dr. Frank Stanton, CBS Inc. president and member of the Foundation's board, noted that last year's grants were so well received both in educational and industrial quarters that the board decided upon an expansion this year.

"The principle which CBS Foundation has adopted in this plan is one which affirms the obligation of our business and professional life to the institutions in all parts of the country which depend on private support," Dr. Stanton observed.

Institutions receiving grants were named under a formula that automatically selects both junior and senior executives. The formula includes minimum service of 30 months on a continuous basis, and promotion to or beyond a specified level of responsibility, as well as graduation from an accredited privately-supported educational institution.

The list of universities and alumni in this

year's grants follows: Augustana College (Sioux Falls, S. D.)—Sig Mickelson, vice president, CBS Inc., in charge of news and public affairs; Brown U.—Don I. Ball, director of editing, CBS Radio; Columbia U.—Jules Dundes, general manager, KCBS San Francisco; Benjamin F. Feiner, executive producer, CBS-TV Hollywood; Cornell College (Mt. Vernon, Iowa)—Earl H. Gammons, vice president, CBS Inc., Washington office; Cornell U.—Julius F. Brauner, general attorney and secretary, CBS Inc.; Charles J. Oppenheim, director of information services, CBS-TV; Creighton U. (Omaha, Neb.)—William Dozier, director of network programs, CBS-TV, Hollywood; Dartmouth College—Robert E. Kalaidjian, director of personnel relations, CBS Inc.; Harvard U.—Sidney S. Alexander, economic adviser, CBS Inc., and John J. Karol, vice president, CBS Radio, in charge of network sales.

Also: Edward L. Saxe, vice president and assistant to the president, CBS-TV; Massachusetts Institute of Technology—William B. Lodge, vice president, CBS Television, in charge of general engineering; Stanford U.—Richard W. Jencks, resident attorney, CBS-TV Hollywood, and assistant secretary, CBS Inc.; U. of Chattanooga—Eugene B. Wilkey, general manager, KMOX St. Louis; U. of Detroit—Arthur Hull Hayes, president, CBS Radio; U. of Pennsylvania—Guy G. Della Cioppa, vice president, CBS Radio, Hollywood, in charge of network programs; U. of Southern California—Henry R. Flynn, general sales manager, CBS Radio Spot Sales; Wesleyan U.—Edward G. Reeve, sales and promotion research manager, CBS Radio; Yale U.—William H. Hylan, vice president in charge of network sales, CBS-TV.

Award-Winner Hugh Terry Addresses Journalism School

THE "virtually unlimited" opportunities in radio and television bring with them a "siamese twin-responsibility," Hugh B. Terry, president and general manager of KLZ-AM-TV Denver, emphasized in an address to the Missouri U. School of Journalism May 5. Mr. Terry participated in the university's annual Journalism Week during which he received its 26th annual Honor Award for Distinguished Service in Journalism [B•T, May 2].

Mr. Terry traced the history of the electronic media up to the present, pointing out that they are "big, healthy and growing," and "begging for new ideas, fresh, different techniques." But he cautioned the students that as no method of communication reaches as many people as fast and as frequently as radio-tv, the responsibility is great, and "those who utilize these tools of journalism should be well educated, thoroughly trained, mature of thought and action, and willing and able to accept responsibility."

"We in electronic journalism," he said, "must all fight to be accepted for what we are—a vital part of freedom of the press." "It will be one of your responsibilities," he stressed, "to guard against arbitrary curtains of silence whenever and wherever they may threaten these new and modern tools of journalism."

Six-Course Program Set For NBC Summer Institute

PROGRAM of six courses has been set up for the fifth annual Summer Institute of Radio & Television, which will be presented June 27-Aug. 5 by Barnard College and NBC from the NBC studios in New York.

The schedule of courses and teachers are:

"An Introduction to Television Production and Direction," by NBC-TV producer-director Caroline Burke (special session on color tv to be given by Barry Wood, NBC color coordinator and director of special events); "Technical Operations Orientation," by Paul L. Gerhart, assistant to the president of RCA Institutes; "Techniques of Announcing on Radio & Television," by Steve White, program manager of WRCA-AM-TV New York; "Your Television Career," by Michael Dann, director of program sales for NBC-TV; "Film Production for Television," by Stanton Osgood, manager of film production and theatre television for NBC, and "Writing," by Ross Donaldson, director of NBC's writing services.

The institute is open to 40 men and women college graduates and non-degree holders who have paid experience in radio and tv. Students successfully completing the course will receive a certificate from Barnard College and NBC. Application should be made before June 1 on forms obtainable from Dorothy Kemble, 112 Millbank Hall, Barnard College, New York 27.

\$25,000 for Educ. Tv Granted to META

GRANT of \$25,000 from the New York Foundation has been received by the Metropolitan Educational Television Assn., it was announced last Wednesday by Arthur Hungerford Jr., executive director of the association, which plans to establish a non-commercial television station to serve New York City and Westchester and Nassau counties.

David M. Heyman, president of the foundation, said the grant was made to "aid in the work of developing educational television in the New York City area." The association was chartered last year by the New York State Board of Regents.

EDUCATION SHORTS

RCA Institutes, N. Y., awarded three \$1,600 scholarships to high school seniors selected from 41 contestants representing metropolitan N. Y. area schools. Winners, who will study advanced radio-tv technology course at school, are Mary Anne Fitzmaurice, Jackson Heights, N. Y.; Frank Heinrich, N. Y., and John C. Sanford, Gaylordsville, Conn.

Pennsylvania State U., University Park, Pa., establishes School of Journalism, effective July 1, replacing journalism dept. and composed of news and editorial journalism dept., headed by Dr. James W. Markham, and advertising dept., headed by Donald W. Davis. George J. Palmer, telegraph desk editor, *New York Daily News*, will head overall school.

National Academy of Broadcasting, Washington, held commencement exercises May 13.

EDUCATION PEOPLE

Stephen F. Temmer signed by School of Dramatic Arts, Columbia U., N. Y., to conduct 15-week course, "Motion Pictures," covering recording for films, tv, radio and phonograph, beginning in fall.

D. Brandon Bernstein, Beverly Hills, Calif., attorney, appointed western regional counsel, National Audience Board.

STREAMLINED low-windage
SLOTTED-RING
TV-Transmitting
ANTENNA

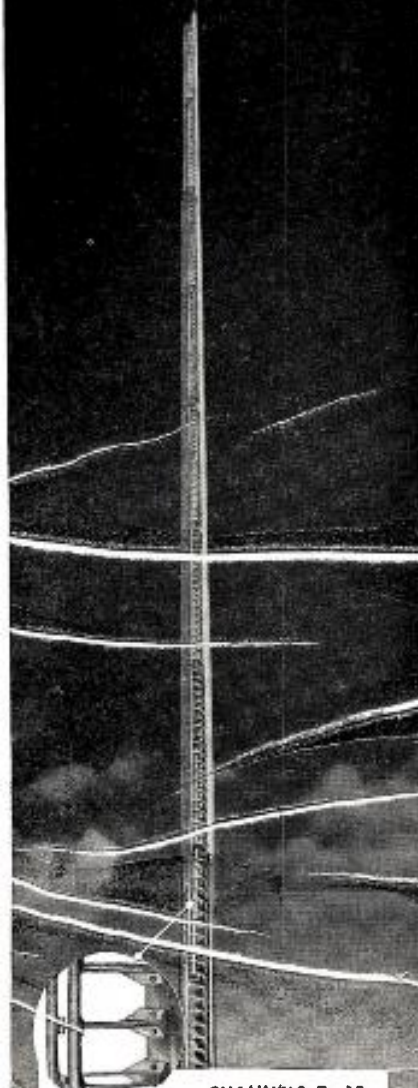

CHANNELS 7-13

The new AMCI Type 1046 antenna is a streamlined version of the Type 1040, resulting in substantially lower windage. This new design allows many existing towers to support a four-bay array with a gain of 16, often enabling one to achieve an ERP of 316 kw with a 25 kw transmitter, instead of the usual 40 or 50 kw. Ask for Bulletin B-555

ANTENNA SYSTEMS—COMPONENTS
 AIR NAVIGATION AIDS—INSTRUMENTS



NBC COVERING BRITISH VOTE

NBC NEWS is staging radio-tv shows May 21-27 as coverage of the British elections, scheduled to be held May 26. Foreign correspondents Romney Wheeler, Ed Newman and Frank Bourgholtzer are covering the event for the network. Camera work is being handled by Guy Blanchard and Alan Blowey. During this week, special election programs are being carried and election news is featured on regularly scheduled NBC radio and television news shows.

MBS ADDS MARKET SERIES

AS A REFLECTION of current interest in stock market investment, Mutual last Friday launched a 15-minute weekly program of business analysis, called *Forbes Reports* (Fri., 10:15-10:30 p.m. EDT). The program is being presented in cooperation with *Forbes* magazine. Three months ago Mutual started a spot news program of business and finance, *America's Business* (Mon.-Fri., 5:45-5:50 p.m. EDT).

'TOWN MEETING' CAVALCADE

SPECIAL anniversary program, "Town Meeting: A 20-Year Cavalcade," highlighting programs of 20-year history of *America's Town Meeting of the Air*, will be on ABC Radio May 29 (8-9 p.m. EDT). John Daly will narrate the program, which will feature recorded excerpts of prominent people of past and present. The first *Town Hall* broadcast was May 30, 1935.

NOTRE DAME GAME LISTED

GAME between Notre Dame and Southern Methodist Sept. 24 at South Bend will be one of five football contests to be covered by NBC-TV on a regional basis as part of its NCAA football coverage next fall, the network has announced. The game will be seen only on stations in NCAA District 4: Ohio, Mich., Ind., Wis., Minn., Ill., Iowa. Regional telecasts are in addition to eight games which will be carried nationally by NBC-TV.

DAVY CROCKETT ON NBC

NEW five-minute strip entitled *Stories of Davy Crockett* will start on NBC Radio May 30 as five-day-a-week program, 5:55-6 p.m. EDT. New verse to now-popular Crockett theme song will be introduced each evening. Plans for the series were announced by John Cleary, director of NBC Radio network programs.

COLORCASTING

**Advance Schedule
Of Network Color Shows**

CBS-TV

June 9 (8:30-9:30 p.m.): *Shower of Stars*, "Musical Review," Chrysler Corp. through McCann-Erickson.

NBC-TV

May 30 (8-9:30 p.m.): *Producers' Showcase*, "Petrified Forest," Ford Motor Co. through Kenyon & Eckhardt, and RCA through Kenyon & Eckhardt, Al Paul Lefton and Grey Adv. Agency.

June 4 (9-10:30 p.m.): *Max Liebman Presents*, "Chocolate Soldier," Oldsmobile Div. of General Motors through D. P. Brother & Co.

June 27 (8-9:30 p.m.): *Producers' Showcase*, Ford Motor Co. through Kenyon & Eckhardt, and RCA through Kenyon & Eckhardt, Al Paul Lefton and Grey Adv. Agency.

[Note: This schedule will be corrected to press time of each issue of B.T.]

WABD (TV) AIRS AT THE PARK

SPECIAL advertising, promotion and merchandising tie-up has been arranged between WABD (TV) New York and the Rockaways' Playland amusement park on Long Island, whereby the station will be able to reach through a public address system and other means persons who visit the park. Under the plan, the station's programs and commercial announcements will be broadcast over the public address system; station personalities will make personal appearances; WABD and the park will cooperate in staging a series of contests and Playland will share time on the station's giant "spectacular" sign in Times Square.

WHOD-'COURIER' TIE-UP

AGREEMENT has been signed between two competitive media, WHOD Pittsburgh and the *Pittsburgh Courier*, and is "without precedent in the Negro radio field." The *Courier* is claimed to be the largest Negro paper in the world, with circulation in all 48 states and WHOD is claimed to be one of the first radio stations in the country to program to the Negro audience. WHOD will feature the paper's writers in its news and homemaking programs and the two media will combine facilities for promotion and merchandising.

PRESIDENTS ON THE AIR

FEATURE ARTICLE in the May 21 *Saturday Evening Post* describes how networks have stage-managed Presidents on the air, from President Harding's broadcasts on primitive facilities to the classy tv show of President Eisenhower. Woodrow Wilson, the article said, would have been the first chief executive to broadcast had not his physician declared it was "beneath the dignity of a President" to speak into a mike. President Roosevelt made extensive use of radio with his "fireside chats." Now the value of tv is so realized that performer Robert Montgomery holds "kitchen-cabinet" status on the White House staff.

WOR-TV GETS 11 FEATURE FILMS

IN A transaction said to involve more than \$102,000, WOR-TV New York last week acquired from National Telefilm Assoc., New York, the television rights in the metropolitan area to 11 feature films. The pictures will be used on the station's *Million Dollar Movie* series starting in the fall. Seven of the films are Alexander Korda Productions which were released in theatres in 1952, 1953, and 1954.

KIERNAN TO JOIN 'MONITOR'

WALTER KIERNAN, radio-tv personality, last week was selected to preside over a four-hour block of entertainment and information segment of NBC Radio's *Monitor* weekend service. Program will be launched with a one-hour simulcast on June 12 (4-5 p.m. EDT) and thereafter will be heard each weekend from 8 a.m. Saturday until Sunday midnight EDT on NBC Radio.



A NEW children's quiz show, *Watch the Birdie*, produced by Richard H. Ullman Inc., is purchased by KPIX (TV) San Francisco for 52 weeks. William Dempsey (seated r), KPIX general manager, signs the sales agreement with Richard B. Ullman, Ullman Inc. account executive. Standing (l to r): Sandy Spillman, KPIX, and Peter Abenheim, KPIX's Captain Fortune, whose program *Watch the Birdie* will be incorporated into the Ullman production.



**DEFENSE ALERTS
YOU DON'T HAVE MAXIMUM
PROTECTION FOR A DEFENSE
ALERT UNLESS YOU HAVE A
"WARE" CONELRAD SYSTEM**

Designed to be triggered by carrier break of key station.
Clock stops to indicate time of break, bull's eye pilot light glows, and alarm sounds if desired when carrier goes off. Push button to reset.
Adjustable time delay to prevent false indication. Will operate reliably on less than 1 volt A.V.C. from ordinary receiver. Ready for rack mounting. F.O.B. Ware \$85.00

Other items available from
Ware Electronics:

- Remote Control Unit (Custom Built—For Directionals, too)
- Automatic Transmitter Restart
- Radio Frequency Amplifier for Modulation and Frequency Monitors
- Audautrol (Automatic Audio Gain Control and Limiter)

Write for further particulars

WARE ELECTRONICS

Ware Coupling & Nipple Co.—Ware, Mass.

D. W. HOWE, JR.—ENGINEER

MAURICE EVANS PROGRAM

CURTAIN raiser on the new series, *Maurice Evans Presents the Hallmark Hall of Fame*, starting Oct. 23 on NBC-TV, will be "Alice in Wonderland." The announcement was made last week by Mr. Evans who has just returned from a six-week trip to England where he lined up dramatic material and screened acting talent to star in some of the telecasts. The version to be televised was prepared by Florida Friebus and Eva Le Gallienne. Miss Le Gallienne will appear in the show. The new programs will be hour-and-a-half dramatic presentations. Mr. Evans will produce and be host on all the shows, also starring in two during the season.

'KATHY GODFREY SHOW'

RADIO program stressing the good news of the day will start on CBS Radio May 29 with Kathy Godfrey, sister of Arthur Godfrey, as its star. *The Kathy Godfrey Show*, scheduled for Sundays, 2:05-2:30 pm. EDT, will be produced and directed by Ira Ashley. Miss Godfrey will interview people from the entertainment world and others who make good news, the network announced. The show also will feature the music of Norman Leyden and his orchestra.

FOURTH 'VICTORY' RERUN

OVER 10,000 requests from station viewers resulted in KTTV (TV) Hollywood renewing the 26-week syndicated film *Victory at Sea* series for a fourth run in the Los Angeles market. At the conclusion of the third run May 9, the station had the program announcer suggest that viewers call or write if they wished to see the series again. With the resultant response, the award-winning film history of World War II naval operations, originally produced by NBC-TV and since syndicated, started its fourth run the following week. Bill Murphy Buick, Los Angeles car dealer, renewed sponsorship.

FOR ASPIRING DISC M.C.'S

ASPIRANTS to platter spinning on radio will serve as disc jockeys at WVNJ Newark every Monday morning as part of the course at Broadcasting Coaching Assoc., New York, according to Fred Darwin, staff announcer at WPAT Paterson, N. J., and director of the school. Students will work in teams, introducing new records and interviewing personalities.

MURROW-OPPENHEIMER FILM

FUND for the Republic Inc., New York, has announced that approximately 400 showings of the tv film interview between J. Robert Oppenheimer, scientist, and Edward R. Murrow, CBS news commentator, have taken place since February, when the organization began distribution of the film. A steady circulation of 78 prints with a total audience through March of 36,297 people also was reported. An additional 25 prints, owned by universities and foundations have accounted for another 400 showings in addition to those reported by the fund. The films are available only to non-profit groups. Most showings have been sponsored by colleges, high schools, scientific groups and civic organizations.

1,000 BASEBALL GAMES

ADVERTISING and agency executives turned out in numbers May 11 for a special luncheon hosted by WGN-TV Chicago in connection with the station's celebration of the 1,000th play-by-play baseball telecast in that city, with sportscaster Jack Brickhouse the honored guest. In addition, team executives from the Chicago Cubs and sportswriters were represented. The *Chicago Tribune* station exclusively has covered

100 Horseless Carriages Commemorate WOOD's 30 Years

APPROXIMATELY 100 antique automobiles were assembled last Saturday in the parking lot of WOOD-AM-TV Grand Rapids, Mich., to participate in the first annual WOODland Tour, a 90-mile excursion commemorating WOOD's 30 years of broadcasting. The trip was staged in conjunction with the Grand Rapids chapter of the Veteran Motor Car Club of America. Col. Alexis de Sakhnoffsky, internationally known automotive stylist, was a guest of honor. He aided Bob Runyon, WOOD-TV news director, in providing radio-tv coverage of the event.

With the drivers and guests attired in goggle and duster outfits of the touring car era, the procession got underway with a live tv show from the parking lot. Then, complete with police escort, the caravan traveled to Holland, Mich., and Poll's Antique Car Museum where they were guests of Henry Poll for lunch and a tour of his museum. The group continued on to Grand Haven, Mich. WOOD-AM-TV held a dinner-dance for the motorists at the Bil-Mar Hotel there, where the group spent the night. Sunday morning the procession traveled back to Grand Rapids and arrived at WOOD-TV studios for an hour-long show.

On the program drivers were interviewed



WOOD-AM-TV General Manager Wilard Schroeder (r) discusses this 1921 Dodge with Bob Maurer (l), president, Grand Rapids chapter of the Veteran Motor Car Club of America, and Bob Ethridge, chapter member.

and a 21-inch Westinghouse tv set was awarded to the one with the most popular car. Other prizes were given for the auto traveling the longest distance, the oldest car on the tour, the best costumes and the driver who ran into the most hard luck.

Two radio remotes were staged en route, one from the Poll Museum and the other from the Bil-Mar.

every daytime home game of the Cubs and the Chicago White Sox since April 20, 1948. WGN-TV claims Mr. Brickhouse is the nation's only sportscaster to handle the tv games of two major league clubs.

WNAC-TV AIRS HORSE RACE

WNAC-TV Boston featured the 19th running of the \$10,000 Commonwealth Handicap, for three-year-olds and up, directly from the Suffolk Downs grass course May 21. Turfcaster Babe Rubenstein called the race and Les Smith aired color commentary for the sports event, sponsored by Carling Brewing Co. The race is run over a mile and one-sixteenth course.

KMPC BREAKFAST

"SELL the salesmen and you can sell the customer" was the theme behind a breakfast which KMPC Los Angeles hosted to the entire sales staff of the Felix Chevrolet Co. of that city

which co-sponsors the Los Angeles Angels baseball broadcasts on the station. The program for the breakfast was arranged by Ed Stodel Adv., agency for Felix Chevrolet, and consisted of pep talks by Felix and KMPC executives, entertainment by KMPC disc jockeys and a simulated baseball re-creation by Bob Kelley, station sports director. "We wanted the 40 salesmen of the Felix Chevrolet Co. to realize what their management . . . is doing to bring customers into their showrooms," Loyd Sigmon, KMPC vice president and assistant general manager, said. "We think of KMPC as part of the sales staff of every advertiser represented on the station."

WKNB-AM-TV OPEN HOUSE

WKNB-AM-TV West Hartford, Conn., threw open its doors to visitors for nine hours during its show-and-sales open house. Thirteen merchants bought participations in two hour-long

BROADCASTING TELECASTING

THE NEWSWEEKLY OF RADIO AND TELEVISION
1735 De Sales Street, N. W., Washington 6, D. C.

PLEASE START MY SUBSCRIPTION WITH THE NEXT ISSUE.
I've checked service desired.

- | | |
|--|--------|
| <input type="checkbox"/> 52 weekly issues of BROADCASTING • TELECASTING | \$7.00 |
| <input type="checkbox"/> 52 weekly issues and BROADCASTING Yearbook-Marketbook | 9.00 |
| <input type="checkbox"/> 52 weekly issues and TELECASTING Yearbook-Marketbook | 9.00 |
| <input type="checkbox"/> 52 weekly issues and both Yearbook-Marketbooks | 11.00 |

Enclosed Bill

name	title/position
company name	
address	
city	zone state

Agency Personnel See and Hear the Story of the Quint-City Area



MANAGEMENT of WOC-AM-TV Davenport, Iowa, feted timebuyers from the Chicago offices of major advertising agencies to a tour of the "Quint-City" area to give them an on-the-spot story of the rapidly growing market of Davenport and Bettendorf, Iowa, and Rock Island, Moline and East Moline, Ill.

Agency people were taken on a bus tour of the five cities, with nearly 250,000 population, and a special boat trip gave the visitors a view of the area from the Mississippi River. A highlight of the tour was a conducted tour of the U. S. Rock Island Arsenal, located on an island between Davenport and Rock Island. Market data and the programming stories of WOC-AM-TV rounded out the session.

Present on the tour were (l to r):

Ralph Evans, executive vice president, Tri-City (WOC) and Central Broadcasting (WOC-TV) companies; Mark Wodlinger, sales manager, WOC-AM-TV; W. F. Helms, WOC-TV sales department; Beverly Hicks, MacFarland, Aveyard & Co.; Pat Kral, Weiss & Geller Co. (rear); Ed Kasser, Ruthrauff & Ryan Inc.; Jack Severson, Mathisson Advertising Co.; Bud Trude, MacFarland, Aveyard & Co.; Gwen Dargell, Foote, Cone & Belding Inc.; Charles Fairall, WOC sales department; Virginia

Russett, Russel M. Seeds Co.; Art Bagge, radio sales manager, Free & Peters Inc.; William Tynan, television sales manager, Free & Peters Inc.; Marilyn Bielefeldt, Earle Ludgin & Co.; John Cole, McCann-Erickson Inc.; Marian Reuter, Young & Rubicam Inc.; Bob Frank, WOC-AM-TV news director; Ruth Babick, Earle Ludgin & Co.; Esther Anderson, McCann-Erickson Inc.; Don Grass, Tatham-Laird Inc. (rear); Betty Armstrong, Grant, Schwenck & Baker; Helen Davis, Clinton E. Frank Inc.; Janice Wardman, WOC-AM-TV traffic manager; Roy Kirtland, Gordon Best Co.; Helen Stanley, Leo Burnett Co.; David S. Williams, Geoffrey Wade Adv. (rear); Paul Schlesinger, Tatham-Laird Inc. (rear); Ruth Leach, Young & Rubicam Inc.; Jack Ragel, Tatham-Laird Inc.; Bill Kennedy, J. Walter Thompson Co. (rear); Nic Wolf, Leo Burnett Co.; Tee Watson, J. Walter Thompson Co.; Fred Norman, Grant Advertising Inc.; Paul Arvidson, WOC-AM-TV technical director; Ernest C. Sanders, WOC-AM-TV resident manager; Irene Hess, Ruthrauff & Ryan Inc.; Wayne Blick, WOC-AM-TV comptroller; Kay Knight, Gordon Best Co.; Fred Reed, WOC-AM-TV assistant manager; Ray Guth, WOC-TV program director; Paul Ives, WOC-AM-TV promotion director, and Walter Fry, Rogers & Smith Co.

programs presented during the event and received booth space in the studios as well. The event, promoted only by the stations, drew 12,000 persons, they report.

EIGHT-WEEK NEWSCAST

AN EIGHT-week-long newscast was staged by Don Greene, news director of WSVS Crewe, Va., when he began reading the text of the Yalta Papers on March 21 and concluded May 13. Mr. Greene read a portion of the text as written in the *New York Times* each day on a 15-minute program. The purpose of the airings was to inform the public about the papers' content because so many people were giving their own version as to what was contained. The programs received nationwide publicity, according to WSVS, with Mr. Greene receiving mail from 31 states. Mr. Greene was afraid many persons would find the material dry, the station says, but that this wasn't the case. Not one adverse comment was received.

WPTZ (TV) PREVIEWS ELECTION

TV NEWSCAST on WPTZ (TV) Philadelphia served as the first sounding board for the local mayoralty race, with newspapers assigning reporters for complete coverage. Particular interest in the election is focused on Republican candidate Thacher Longstreth, vice president of Geare-Marston Inc., who is the first advertising agency executive to run for the office. At 1 a.m. last Thursday Mr. Longstreth met with his Democratic number, Richardson Dilworth,

on WPTZ. The session was given full treatment along with pictures of the telecast by two of the city's dailies. Mr. Longstreth made his first victory statement as Republican candidate over Taylor Grant's news show at 11 p.m. the night before. Mr. Grant at that time set up the early morning meeting, inviting Mr. Dilworth and local newspapers.

MAN OF THE WORLD

COMMENTATOR with a cloak-and-dagger background is now airing news for KDKA Pittsburgh. He is Col. Jaroslav Sustar, former Czechoslovakian career soldier, diplomat and resistance leader, whose analyses of world events, based on personal knowledge of the people and leaders of many countries, are featured on the daily, 15-minute *The News in Depth* program. Born in the old Austro-Hungarian Empire, Col. Sustar served in the Czech Army until the German invasion in 1939 when he joined the underground. Arrested by the Nazis in 1940, he escaped to Yugoslavia and later went to Palestine and organized part of the Czech forces in exile. In 1941 he was in England working with Czech government leaders where his work included BBC broadcasts to the Czech underground. He also organized a paratrooper group which carried out sabotage and intelligence behind German lines in Czechoslovakia. This phase included the assassination of SS Reichsprotektor Reinhard Heydrich, "The Hangman," whose death brought

the Nazi execution of the Colonel's entire family. Col. Sustar subsequently went to China as military attache to Chiang Kai-shek, where he met Chou-En-Lai. In 1946 he was sent to Berlin as military representative of the Czech government on the Allied Control Commission but when the Reds took over his country later he "walked off the job" and eventually came to the U. S. with his wife and child. Since then he has worked for WTVU (TV) and WARM-TV Scranton, Pa.

'VITAPIX AND GUILD'

BROCHURE, *Vitapix and Guild*, "a new idea in television," has been released by the two associated companies. The booklet answers such questions as "What does Vitapix Corp. do?", "What does Guild Films Co. do?", "What are the Guild Films programs?" and "What is this new idea in television?" A gallery of the executives of both firms is contained, as is a list of the subscribing stations. A section describing how to join the group is included.

CPRN AT THE RACES

HOLLYWOOD Park Saturday feature races during the present 11-week season is being offered by Columbia Pacific Radio Network from the Inglewood, Calif., racetrack, starting May 14. Announcer Hal Moore calls the actual

Station Authorizations, Applications

(As Compiled by B • T)

May 12 through May 18

Includes data on new stations, changes in existing stations, ownership changes, hearing cases, rules & standards changes and routine roundup.

Abbreviations:

CP—construction permit. DA—directional antenna. ERP—effective radiated power. STL—studio-transmitter link, synch. amp.—synchronous amplifier. vhf—very high frequency. uhf—ultra high frequency. ant.—antenna. aur.—aural. vis.—visual. kw—kilowatts. w—watts. mc—

megacycles. D—day. N—night. LS—local sun-set. mod.—modification. trans.—transmitter. unl.—unlimited hours. kc—kilocycles. SSA—special service authorization. STA—special temporary authorization. (FCC file and hearing docket numbers given in parentheses.)

running, while sportscaster Tom Hanlon handles before-and-after race color features. Gene Webster directs.

'EDUCATIONAL INSTITUTE'

NEW YORK-owned WNYC presented its second annual "Educational Institute" last week, with more than 25 hours of special programming devoted to such topics as teacher shortage, overcrowded classrooms and desegregation. A feature dealing with mass media was presented Friday and consisted of a panel discussion by Judith Waller, director of public affairs for NBC's Central Div.; Charles F. Murphy, administrator of the Code Authority of the Comic Magazine Assn. of America; Paul C. Smith, president of Crowell-Collier Pub. Co.; Josette Frank, Child Study Assn. of America, and Theodore Waller, vice president of the Grolier Society and Encyclopedia Americana.

WHITE KING CONTEST

A 1,650 sq.-ft. four-bedroom home already constructed in Costa Mesa, Calif., and fully equipped with various appliances, is the first prize in a contest started by White King Soap Co., Los Angeles, on two Don Lee-Intermountain Network radio programs. Additionally, White King will give away 120 Rheem-Wedge-wood gas ranges and clothes dryers during the six-week contest. Listeners to *Queen for a Day* and *Frank Hemingway and the News*, both sponsored by White King, are required to name the house and tell in a maximum of 20 words the reason for their choice.

L. A. CHURCH PROGRAMS

SOME 90 radio and television programs will be presented over Los Angeles area stations under the auspices of the Presbyterian Church in the U. S. A. during the period of its 167th General Assembly in Los Angeles May 15-29. The schedule was arranged by the Los Angeles Broadcasting Committee, under the chairmanship of the Rev. Clifton E. Moore, in cooperation with Clayton T. Griswold, executive director of the radio and tv department of the Presbyterian Church in the U. S. A.

REP. BOLTON OFFERS TAPE

A TAPED "handout" of a talk she made on WHK Cleveland about juvenile delinquency has been furnished to Capitol Hill radio correspondents by Rep. Frances P. Bolton (R-Ohio). With the tape, Rep. Bolton sent a letter saying radio stations "might find some use for the program in whole or in part."

Tv for Builder

IN its first use of television on a regular program basis, Levitt & Sons Inc., builders, inaugurated sponsorship of a 13-week, 15-minute tv series, *The Miracle City*, over WFIL-TV Philadelphia. The series consists of a 9½-minute color film about Levittown, Pa., the housing development built by Levitt, plus live interviews with company officials and community leaders. A spokesman for Al Paul Lefton Co., agency for Levitt, said the company has taken the step "in order to find out how effective tv is as an advertising medium for its particular product—housing." He added that the sponsorship may have far-reaching implications for tv, pointing out that the building industry, with an annual volume of more than \$10 billion, ranks behind only the automobile and steel industries.

FCC Commercial Station Authorizations As of April 30, 1955 *

	AM	FM	TV
Licensed (all on air)	2,704	522	134
CPs on air	13	17	†319
CPs not on air	98	13	121
Total on air	2,717	539	453
Total authorized	2,815	552	574
Applications in hearing	127	3	180
New station requests	201	8	18
New station bids in hearing	69	0	127
Facilities change requests	142	9	38
Total applications pending	823	80	196
Licenses deleted in April	0	1	0
CPs deleted in April	1	0	4

* Does not include noncommercial educational fm and tv stations.

† Authorized to operate commercially, but station may not yet be on air.

Am and Fm Summary through May 18

	On Air	Licensed	CPs	Appls. Pending	In Hearing
Am	2,725	2,704	118	214	67
Fm	539	522	30	3	0

Television Station Grants and Applications Since April 14, 1952

Grants since July 11, 1952:

	vhf	uhf	Total
Commercial	281	322	603 ²
Noncom. Educational	17	18	35

Total Operating Stations in U. S.:

	vhf	uhf	Total
Commercial on air	310	106	416
Noncom. Educ. on Air	9	3	12

Applications filed since April 14, 1952:

	New	Amend.	vhf	uhf	Total
Commercial	963	337	743	539	1,283 ²
Noncom. Educ.	58		30	28	58 ²

Total 1,020 337 773 567 1,341⁴

¹ One hundred-forty-one CPs (29 vhf, 112 uhf) have been deleted.

² One applicant did not specify channel.

³ Includes 35 already granted.

⁴ Includes 638 already granted.

ACTIONS BY FCC

New Tv Stations . . .

APPLICATION

Owensboro, Ky.—Alrcast Inc., uhf ch. 14 (470-476 mc); ERP 20.9 kw visual, 11.3 kw aural; antenna height above average terrain 275 ft., above ground 303 ft. Estimated construction cost \$77,450, first year operating cost \$84,000, revenue \$96,000. Post office address 3015 Radiance Rd., Louisville, Ky. Studio and transmitter location 214 Frederica St., Owensboro. Geographic coordinates 37° 46' 27" N. Lat., 87° 06' 49" W. Long. Transmitter and antenna RCA. Consulting engineer Fred O. Grimwood & Co., St. Louis. Principals include Pres. Stephen P. Bellinger (30%), 25% owner of WVMC Mt. Carmel, Ill., 22.5% owner of WIZZ Streator, Ill., and 25% owner of WINL-FM Lebanon, Ind.; Vice Pres. Ben H.

Townsend (20%), 18.7% owner of WVMC, 6.2% owner of WINL-FM and 6% owner of WIZZ; Sec. Joel W. Townsend (20%), 18.7% owner of WVMC, 6.2% owner of WINL-FM and 6% owner of WIZZ, and Treas. Morris E. Kemper (30%), 37.5% owner of WVMC, 12.5% owner of WINL-FM and 11.5% owner of WIZZ. Filed May 13.

Existing Tv Stations . . .

ACTIONS BY FCC

KFMB-TV San Diego, Calif.—Wrather-Alvarez Bcstg. Inc. granted mod. of CP for ch. 8 to change ERP to 240 kw visual, 120 kw aural; change antenna system from nondirectional to directional; antenna height above average terrain 760 ft. Granted May 12; announced May 17.

KTIV (TV) Sioux City, Iowa—KTIV Tv Co. granted mod. of CP for ch. 4 to change ERP to

ALLEN KANDER

Negotiator

FOR THE PURCHASE AND SALE
OF RADIO AND TELEVISION
STATIONS

NARTB CONVENTION HEADQUARTERS
Suite 303-F
SHOREHAM HOTEL

1701 K St., N. W. • Washington 6, D. C., NA. 8-3233

Lincoln Building • New York 17, N. Y., MU. 7-4242

100 kw visual and 50 kw aural. Granted May 12; announced May 17.

CALL LETTERS ASSIGNED

WPFR (TV) Wilmington, Del.—WDEL Inc., ch. 12. Changed from WDEL-TV.
WOKA (TV) Macon, Ga.—Macon Television Co., ch. 47. Changed from WNEK-TV.
KWGB-TV Goodland, Kan.—Goodland Bcstg. Co., ch. 10.
KTVR (TV) Hastings, Neb.—The Seaton Publishing Co., ch. 5.
KRSM (TV) Yakima, Wash.—Chinook Television Co., ch. 23.
WFOX-TV Milwaukee, Wis.—Business Management Inc., ch. 31.

New Am Stations . . .

APPLICATIONS

Hobbs, N. M.—Permian Basin Radio Corp., 1050 kc, 250 w daytime. Post office address % Charles R. Scott, Box 914, Hobbs. Estimated construction cost \$12,673, first year operating cost \$36,000, revenue \$45,000. Principals include Pres. Charles R. Scott (20%), employe of KHOB Hobbs; Vice Pres. Helen F. Orr (20%), employe of KHOB; Sec.-Treas. Quenton K. Crandall (30%), and Earl Stafford (20%), bank cashier. Filed May 5.
Kingston, N. Y.—McGillvra Bcstg. Corp., 1300 kc, 1 kw daytime. Post office address % Agnes McGillvra, Spring Valley Rd., Ossining, N. Y. Estimated construction cost \$22,543, first year operating cost \$50,000, revenue \$65,000. Sole owner is Agnes McGillvra, wife of Joseph H. McGillvra, station representative. Mrs. McGillvra owns minority interest in WOKO Albany, N. Y., and KXL Spokane, Wash. Filed May 9.
Milton, Pa.—Williamsport Radio Bcstg. Associates Inc. (WMPA Williamsport, Pa.), 1380 kc, 1 kw daytime. Post office address 330 Government Place, Williamsport. Estimated construction cost \$21,655, first year operating cost \$46,500, revenue \$52,000. Principals include Pres. Harry J. W. Kiessling (32%); Vice Pres.-Treas. William P. Wilson (25.4%); Vice Pres. George R. Lamade (10.7%); Sec. Woodrow Ott (8%), and 5 others. Filed May 5.
Fairfax, Va.—Arthur Kellar & George E. Oleson d/b as O. K. Bcstg. Co., 1310 kc, 500 w daytime. Post office address 984 Radcliffe Drive, Alexandria, Va. Estimated construction cost \$12,660, first year operating cost \$32,000, revenue \$48,000. Principals include George E. Oleson (50%), general manager WEAM Arlington, Va., and Arthur Kellar (50%), sales manager and assistant manager WPIK Alexandria, Va. Filed May 9.

Existing Am Stations . . .

ACTION BY FCC

WAYE Dundalk, Md.—Erway Bcstg. Corp. granted mod. of CP to change transmitter location to along bank of NE Creek and Edgewater Ave., near Dundalk; specify studio location as 230 Dunkirk Bldg., Shipping Place, Dundalk. Granted May 11; announced May 17.

Existing Fm Stations . . .

ACTIONS BY FCC

KIND-FM Independence, Kan.—Central Bcstg.

Inc. granted mod. of CP to change studio and transmitter locations to 1513 W. Maple; ERP to 720 w; antenna height above average terrain 165 ft. Granted May 11; announced May 17.

WTJS-FM Jackson, Tenn.—The Sun Pub. Co. granted CP to change to ch. 281 (104.1 mc). Granted May 13; announced May 17.

STATION DELETED

WKBZ-FM Muskegon, Mich.—Ashbacker Radio Corp. FCC granted request to cancel license for fm station on ch. 226 (98.9 mc). Deleted May 10; announced May 17.

Ownership Changes . . .

ACTIONS BY FCC

KROY Sacramento, Calif.—KROY Inc. granted voluntary transfer of control to Robert W. Dumm through purchase of 80% interest for \$97,500 which includes \$40,000 obligations owed selling stockholders. Mr. Dumm is vice president of Sacramento Bcstrs. Inc., operator of KXOA Sacramento. Granted May 18.
KSON-FM San Diego, Calif.—KSON Bcstrs. granted assignment to Music Unlimited. No consideration involved. Granted May 10; announced May 17.
WSWN Belle Glade, Fla.—Seminole Bcstg. Co. granted voluntary transfer of control to E. D. Rivers Jr. through sale of all stock for \$60,000. Mr. Rivers is owner WEAS Decatur, WJIV Savannah, WGOV-AM-TV Valdosta, all in Georgia, and KWEM Memphis, Tenn. Granted May 18.
WKTG Thomasville, Ga.—Southern Bcstg. System Inc. granted assignment to John H. Phipps for \$62,000. Mr. Phipps is owner of WTAL Tallahassee, WTYS Marianna, Fla., and WCTV (TV) Thomasville, Ga. Granted May 11.
WCTV (TV) Thomasville, Ga.—E. D. Rivers Sr. granted voluntary assignment of CP to John H. Phipps for \$887,000 for tv expenses and equipment, and \$331,464 for GE equipment obligations. Mr. Phipps also pays \$38,000 for Mr. Rivers' contract to purchase WKTG there for \$62,000. Mr. Phipps is owner of WTAL Tallahassee, WTYS Marianna, Fla., and WKTG Thomasville, Ga. Granted May 11.
WLBK-AM-FM Bowling Green, Ky.—The Bowling Green Bcstg. Co. granted involuntary transfer of control to Mrs. Mary Tapp Jenkins, executrix of the estate of L. B. Jenkins (57.3%), deceased. Granted May 13; announced May 17.
WFTG London, Ky.—States Bcstg. System Inc. granted voluntary assignment of CP to London Bcstg. Co. for \$4,500. Principals include Pres. Elmo Mills (50%), 16.2% owner WWKO Ashland, Ky.; Sec.-Treas. John P. Mills (40%), purchasing agent for coal company; Betty O. Mills (5%), 7% owner WWKO, and Frances S. Mills (5%). Granted May 18.
WHIR Danville, Ky.—Commonwealth Bcstg. Corp. seeks voluntary transfer of control to W. T. Isaac and David B. Highbaugh through purchase by corporation of 38.2% interest of James D. Russell for \$15,340. Granted May 13; announced May 17.
WMIS Natchez, Miss.—Natchez Bcstg. Co. granted involuntary transfer of control (91%) to Mrs. P. K. Ewing, executrix of the estate of P. K. Ewing, deceased. Mrs. Ewing will now own 94%. Granted May 10; announced May 17.
WSLI-AM-TV Jackson, Miss.—Standard Life Bcstg. Co. granted voluntary relinquishment of control by Standard Life Insurance Co. through sale of 40% interest to Miss. Publishers Corp., owner of WJTV (TV) Jackson and publisher of Jackson Clarion Ledger and News. Miss. Publish-

ers pays \$176,000 for its interest and Standard Life Bcstg. will pay Miss. Publishers \$175,000 for WJTV equipment and facilities. Standard Life Ins. Co., former owners of 52.8% interest, will now own 32.4%. Permit for WJTV will be surrendered. Granted May 18.

KDRO-AM-TV Sedalia, Mo.—Milton J. Hinlein granted voluntary assignment of license to corporation KDRO-TV and Radio Inc. Mr. Hinlein will then sell 1/2 interest. Granted May 10; announced May 17.

KOLN Lincoln, Neb.—Cornhusker Radio & TV Corp. granted assignment to Frudeger Bcstg. Co. for \$120,000. Sole owner is Robert W. Frudeger, vice pres.-general manager WGIL Galesburg, Ill., and executive advertising director of Daily Register-Mail, Galesburg. Granted May 18.

WNBF-AM-TV Binghamton, N. Y.—Clark Associates Inc. granted voluntary assignment to parent corporation Triangle Publications Inc. (Radio & TV). Granted May 10; announced May 17.

WDXB Chattanooga, Tenn.—WDXB Inc. granted voluntary transfer of control from Joseph Bloom and David Cohen to Joseph Bloom and David Cohen as trustees. Granted May 13; announced May 17.

WOAI-AM-TV San Antonio, Tex.—Southland Industries Inc. granted transfer of control from executor of the estate of G. A. C. Half, deceased, to Hugh A. L. Half, individually and as trustee for Hugh A. L. Half Jr. and others. Granted May 12; announced May 17.

WDBJ-AM-FM-TV Roanoke, Va.—Times-World Corp. granted transfer of control from J. B. Fishburn, deceased, to The First National Exchange Bank of Roanoke, executor. Granted May 12; announced May 17.

WLSD Big Stone Gap, Va.—William H. Wren Sr., William H. Wren Jr., and Jean B. Wren d/b as Gap Bcstg. Co. granted involuntary assignment to W. H. Wren Jr., Jean B. Wren and Bradley G. Wren & L. McCarthy Downs, executors of the estate of William H. Wren Sr. (20%), deceased. Granted May 12; announced May 17.

WTKM Hartford, Wis.—The Kettle-Moraine Bcstg. Co. granted voluntary acquisition of control by Walter G. Zastrow through purchase by corporation of 22 1/2% interest of Leo M. Durnil for \$1,000. Mr. Zastrow, former 45% owner, will now own 58%. Granted May 13, announced May 17.

APPLICATIONS

KRLW Walnut Ridge, Ark.—Southern Baptist College seeks voluntary assignment to Lawrence County Bcstg. Co., composed of Dr. R. O. Norris (25%), physician; Nora M. Norris (25%); William H. Cate (25%), manager KRLW, and Carma N. Cate (25%). Filed May 10.

KSON San Diego, Calif.—C. Frederick Rabell and Dorothy H. Rabell seek voluntary assignment to Rabell Enterprises. No consideration involved as principals retain identical interests. Filed May 12.

KKTV (TV) Colorado Springs, Colo.—Tv Colorado Inc. seeks transfer of control from Voice of the Rockies Inc. to James D. and Betty Russell. No consideration involved. Filed May 10.

KVOR Colorado Springs, Colo.—Voice of the Rockies Inc. seeks voluntary transfer of control to Riggs & Green Inc. through sale of all stock for \$110,000 plus amount equal to net quick assets. Principals include F. Robert Greene (50%), vice pres.-1/2 owner WAIR-AM-FM Winston-Salem, N. C., and John S. Riggs (50%), pres.-26.6% owner WELM Elmira, N. Y., and pres.-1/2 owner WAIR. Filed May 10.

WRUS Russellville, Ky.—Roth E. Hook seeks voluntary assignment to Roth E. Hook and Woodrow Sosh d/b as South Ky. Bcstrs. Mr. Sosh, manager of local department store, purchases 1/4 interest for \$11,250. Mr. Hook retains 3/4 interest. Filed May 11.

KREH Oakdale, La.—Cyril W. Reddoch, individually and as executor of estate of Klien Evans, deceased, d/b as Louisiana Bcstg. Service seek voluntary assignment to Cyril W. Reddoch and Ralph L. Hooks d/b as Louisiana Bcstg. Service. Mr. Hooks, 1/2 owner of WFPK Hammond, La., purchases 1/2 interest in station for \$4,815. Mr. Reddoch will now own 3/5 interest. Filed May 11.

WCSH-AM-TV Portland, Me.—Congress Square Hotel seeks voluntary assignment to wholly owned company Maine Radio & Tv Co. Filed May 12.

Killeen, Tex.—W. A. Lee, A. W. Stewart & Franklin T. Wilson d/b as Highlite Bcstg. Co. seeks voluntary assignment of CP to corporation Highlite Bcstg. Co. Mr. Lee sells his 1/2 interest for \$300. One-third interest will now be held by Ladelle M. Drake. Filed May 10.

KACT Andrews, Tex.—Joseph E. Young and Archie W. Holman d/b as Andrews Bcstrs. seek voluntary assignment to Joseph E. Young through purchase of 50% interest from Mr. Holman for \$9,000. Filed May 9.

WARL-AM-FM Arlington, Va.—Northern Va. Bcstrs. Inc. seeks voluntary transfer of control to Cy Blumenthal. Consideration is exchange of Mr. Blumenthal's 1/2 interest in WCAN-TV Mil-

(Continued on page 153)

Radio Station and Newspaper Appraisals

Tax, estate and many other personal problems create the need for an independent appraisal. Extensive experience and a national organization enable Blackburn-Hamilton Company to make accurate, authoritative appraisals in minimum time.

Appraisals • Negotiations • Financing

BLACKBURN - HAMILTON COMPANY

RADIO-TV-NEWSPAPER BROKERS

WASHINGTON, D. C.
 James W. Blackburn
 Clifford Marshall
 Washington Bldg.
 Sterling 3-4341-2

CHICAGO
 Ray V. Hamilton
 Phil Jackson
 Tribune Tower
 Delaware 7-2755-6

SAN FRANCISCO
 William T. Stubblefield
 111 Sutter St.
 Exbrook 2-5671-2

PROFESSIONAL CARDS

JANSKY & BAILEY INC.
Executive Offices
1735 De Sales St., N. W. ME. 8-5411
Offices and Laboratories
1339 Wisconsin Ave., N. W.
Washington, D. C. ADams 4-2414
Member AFCCE *

JAMES C. McNARY
Consulting Engineer
National Press Bldg., Wash. 4, D. C.
Telephone District 7-1205
Member AFCCE *

—Established 1926—
PAUL GODLEY CO.
Upper Montclair, N. J. MO. 3-3000
Laboratories Great Natch, N. J.
Member AFCCE *

GEORGE C. DAVIS
501-514 Munsey Bldg. Sterling 3-0111
Washington 4, D. C.
Member AFCCE *

Commercial Radio Equip. Co.
Everett L. Dillard, Gen. Mgr.
INTERNATIONAL BLDG. DI. 7-1319
WASHINGTON, D. C.
P. O. BOX 7037 JACKSON 5302
KANSAS CITY, MO.
Member AFCCE *

A. D. RING & ASSOCIATES
30 Years' Experience in Radio
Engineering
Pennsylvania Bldg. Republic 7-2347
WASHINGTON 4, D. C.
Member AFCCE *

GAUTNEY & JONES
CONSULTING RADIO ENGINEERS
1052 Warner Bldg. National 8-7757
Washington 4, D. C.
Member AFCCE *

Craven, Lohnes & Culver
MUNSEY BUILDING DISTRICT 7-8215
WASHINGTON 4, D. C.
Member AFCCE *

Frank H. McIntosh & Assocs.
CONSULTING RADIO ENGINEERS
1216 WYATT BLDG.
WASHINGTON, D. C.
Metropolitan 8-4477
Member AFCCE *

RUSSELL P. MAY
711 14th St., N. W. Sheraton Bldg.
Washington 5, D. C. Republic 7-3984
Member AFCCE *

WELDON & CARR
Consulting
Radio & Television
Engineers
Washington 6, D. C. Dallas, Texas
1001 Conn. Ave. 4212 S. Buckner Blvd.
Member AFCCE *

**PAGE, CREUTZ,
GARRISON & WALDSCHMITT**
CONSULTING ENGINEERS
710 14th St., N. W. Executive 3-5670
Washington 5, D. C.
Member AFCCE *

KEAR & KENNEDY
1302 18th St., N. W. Hudson 3-9000
WASHINGTON 6, D. C.
Member AFCCE *

A. EARL CULLUM, JR.
CONSULTING RADIO ENGINEERS
HIGHLAND PARK VILLAGE
DALLAS 5, TEXAS
JUSTIN 6108
Member AFCCE *

GUY C. HUTCHESON
P. O. Box 32 AR. 4-8721
1100 W. Abram
ARLINGTON, TEXAS

ROBERT M. SILLIMAN
John A. Moffet—Associate
1405 G St., N. W.
Republic 7-6646
Washington 5, D. C.
Member AFCCE *

LYNNE C. SMEBY
"Registered Professional Engineer"
1311 G St., N. W. EX 3-8073
WASHINGTON 5, D. C.

GEO. P. ADAIR ENG. CO.
Consulting Engineers
Radio-Television
Communications-Electronics
1610 Eye St., N.W., Washington 6, D. C.
Executive 3-1230 Executive 3-5851

WALTER F. KEAN
AM-TV BROADCAST ALLOCATION
FCC & FIELD ENGINEERING
1 Riverside Road—Riverside 7-2153
Riverside, Ill.
(A Chicago suburb)

WILLIAM E. BENNS, JR.
Consulting Radio Engineer
3738 Kanawha St., N. W., Wash., D. C.
Phone EMerson 2-8071
Box 2468, Birmingham, Ala.
Phone 6-2924
Member AFCCE *

ROBERT L. HAMMETT
CONSULTING RADIO ENGINEER
821 MARKET STREET
SAN FRANCISCO 3, CALIFORNIA
SUTTER 1-7545

JOHN B. HEFFELFINGER
815 E. 83rd St. Hiland 7010
KANSAS CITY, MISSOURI

**Vandivere,
Cohen & Wearn**
Consulting Electronic Engineers
612 Evans Bldg. NA. 8-2698
1420 New York Ave., N. W.
Washington 5, D. C.

CARL E. SMITH
CONSULTING RADIO ENGINEERS
4900 Euclid Avenue
Cleveland 3, Ohio
HENDERSON 2-3177
Member AFCCE *

J. G. ROUNTREE, JR.
4515 Prentice Street
EMerson 3266
Dallas 6, Texas

VIR N. JAMES
SPECIALTY
Directional Antenna Proofs
Mountain and Plain Terrain
3955 S. Broadway Sunset 9-9182
Denver, Colorado

JOHN H. BATTISON
CONSULTING RADIO & TELEVISION
ENGINEER
technical advisory service for TV film and
production problems.
4515 Saul Rd., Kensington, Md.
Olympic 7-9593

Member AFCCE *

SERVICE DIRECTORY

**COMMERCIAL RADIO
MONITORING COMPANY**
MOBILE FREQUENCY MEASUREMENT
SERVICE FOR FM & TV
Engineer on duty all night every night
JACKSON 5302
P. O. Box 7037 Kansas City, Mo.

**CAPITOL RADIO
ENGINEERING INSTITUTE**
Accredited Technical Institute Curricula
3224 16th St., N.W., Wash. 10, D. C.
Practical Broadcast, TV, Electronics en-
gineering home study and residence
courses. Write For Free Catalog, specify
course.

COLLECTORS-ADJUSTORS
For the Industry
Collections Coast to Coast
TV—Radio—Film and Media
Accounts Receivable
No Collection—No Commissions
STANDARD ACTUARIAL WARRANTY CO.
220 West 42nd St., N. Y. 36, N. Y.
LO 5-3990

**TO ADVERTISE IN THE
SERVICE DIRECTORY**
Contact
BROADCASTING • TELECASTING
1735 DESALES ST., N.W., WASH. 6, D. C.

CLASSIFIED ADVERTISEMENTS

Payable in advance. Checks and money orders only.

Deadline: Undisplayed—Monday preceding publication date. Display—Tuesday preceding publication date.

Situations Wanted 20¢ per word—\$2.00 minimum • Help Wanted 25¢ per word—\$2.00 minimum.

All other classifications 30¢ per word—\$4.00 minimum • Display ads \$15.00 per inch

No charge for blind box number. Send box replies to

BROADCASTING • TELECASTING, 1735 DeSales St. N. W., Washington 6, D. C.

APPLICANTS: If transcriptions or bulk packages submitted, \$1.00 charge for mailing (Forward remittance separately, please). All transcriptions, photos, etc., sent to box numbers are sent at owner's risk. BROADCASTING • TELECASTING expressly repudiates any liability or responsibility for their custody or return.

RADIO

Help Wanted

Managerial

Sales manager: This 50 kw clear channel, major network affiliate wants an aggressive young sales manager. Major market experience desirable. Salary plus override. All replies confidential. Excellent future with group-owned stations. Send complete details; salary requirements and complete resume to Box 515A, B•T.

Successful sales manager. Excellent opportunity. National company. Salary, commission and travel expenses. Box 520A, B•T.

Sales manager, New Mexico. Need imagination, versatility and aggressiveness. Future station manager. Good salary. All details first letter. Box 540A, B•T.

Eastern Shore—new well equipped daytime station with excellent coverage needs manager by June 15. Good salary and commission. Must be progressive, energetic, versatile, and civic minded with emphasis on sales ability. Prefer family man with experience in small markets. Box 570A, B•T.

Salesmen

Wanted: Man or woman salesman. \$50 a week, plus 25% commission. Box 176A, B•T.

Major market southeast network top power and Hooper rated station seeks a salesman or local sales manager of proven quality, ability and experience. I'll substantiate with bonafide figures an income potential of \$15,000 a year upward if you substantiate your high calibre and experience rating to deserve consideration for this amazing opportunity. It's a once in a life time opening. Contact me through Box 423A, Broadcasting • Telecasting headquarters, Shoreham Hotel, during the NARTB convention. I'll then contact you and we'll exchange mutual confidences.

Proven salesman. Excellent opportunity. Nationwide organization. Salary, commission and travel expenses. Box 521A, B•T.

Radio salesman—for a man who wants a future, here it is—major market—salary plus highest commission deal. We're particular. Write all. Box 527A, B•T.

Immediate opening radio time salesman with or without first phone ticket. Guarantee \$380.00 monthly and commission. Send experience and photo. KCHJ, P. O. Box 262, Delano, California.

IN AMARILLO . . .

Just like many, many other areas, wise TV broadcasters, interested in well-screened and highly trained personnel, have turned to Northwest Radio & TV School graduates. Why don't YOU start using our FREE Radio-TV personnel service? Save TIME and MONEY! Our graduates are well qualified and professionally trained in our studios using standard commercial equipment. We screen them . . . train them . . . refer them to you with complete details, as they fit your specific needs. Let us help you with your personnel needs. We assure you of prompt, personal attention. Write or call COLLECT, John Birrel, Placement Director . . .

NORTHWEST RADIO & TELEVISION SCHOOL

1221 N. W. 21st Ave., Portland 9, Oregon

with schools in

HOLLYWOOD • CHICAGO • WASHINGTON, D. C. • PORTLAND

RADIO

Help Wanted—(Cont'd)

Combo-man, first phone, must be capable maintenance man and have experience announcing. Progressive daytime station, nice community, favorable working conditions. Contact WAAG, Adel, Georgia.

WUSJ, Lockport, N. Y., has immediate opening for first ticket engineer. Transmitter, console, no announcing. \$55 start with overtime. Contact Joseph Pinna, Manager.

Production-Programming, Others

Learn news—assistant to news director wanted. Make calls, rewrite, staff. Qualifications: Good voice; command of English; confidence you could learn to edit and write. Midwest. \$60 to start. Box 990G, B•T.

Reporter-newscaster—send complete information. KVOR, Colorado Springs.

Top-flight newsman for Cleveland. Must be thoroughly experienced. Send tape, resume, and photograph to WSRS, Cleveland 18, Ohio.

Situations Wanted

Managerial

Producer-director with 9 years major N. Y. networks experience, desires management production position with tv station located western U. S. Available July 1st. Box 529A, B•T.

General manager—radio or tv—26 years experience every phase radio. Last five years managing consultant. Know agency business. Wish to settle where there is a good potential. Best references. Box 539A, B•T.

Manager—sales manager—radio and/or tv. Over 20 years experience radio-tv, including sales-management—ownership. Presently vhf-tv. 48, young family, church and civic leader. Welcome close investigation. Consider all, prefer south. Offer must be sound with future. Box 556A, B•T.

Manager-salesman available on two-week notice. Thoroughly experienced, can build sales and operate economically. Best record, references, clean habits, family. Prefer good commission arrangement to straight salary. Prefer Virginia, Tennessee, Carolinas, consider other states. Now employed. Box 569A, B•T.

Sales manager—available June 15—twenty-two years experience—will assume complete responsibility for local, regional and national sales. Large and small market experience. Last eighteen years with major network stations in one of the nation's first thirteen markets. Advanced from salesman to local, national and general sales manager. Well acquainted with national agencies, accounts and reps. Excellent references. Box 574A, B•T.

Manager or sales manager with 10 years experience, seeks position with progressive station. Young family man with fine sales record and top industry references. Active state association, community leader. Present station has been sold. Will be available at NARTB Convention. Write Box 576A, B•T.

General manager—family man—32—strong, programming-sales-personnel. Presently successful sales manager medium midwest market. Past general manager experience. Want general management medium to large market. Prefer midwest-east-southeast-Florida. Box 578A, B•T.

Salesmen

Commercial manager—assistant manager: Ten years sales-programming. Medium market preferred. Box 531A, B•T.

Announcers

Can do an excellent job for a radio station in broadcasting and public relations. 12 years experience as woman commentator in radio and television. Also worked as free-lance fashionist conducting fashion shows and lectures. Transcriptions and references upon request. Box 243A, B•T.

Superior, experienced announcer available. Good salary, working conditions required. Family. Box 326A, B•T.

Excellent announcer . . . nine years experience. First phone . . . employed. Wants Florida. Box 376A, B•T.

RADIO

Help Wanted—(Cont'd)

Salesman competent, experienced sell radio in highly competitive market. Compensation based on guarantee plus commission depending upon ability. Pleasant college town, 5 kw CBS affiliate. Picture, complete business and personal history first letter to Manager, WCAX, Burlington, Vermont.

Managers—salesmen. Our men earn from \$6,000 to \$12,000 yearly selling special features for radio and tv station from coast-to-coast since 1931. We prefer married couples (wives can earn \$60-\$80 weekly) who can travel continuously. Write Merle V. Watson, Inc., First National Bank Bldg., Peoria, Ill.

Announcers

3 experienced announcers, network station in large city near New Orleans. Permanent to right persons. Box 475A, B•T.

2 experienced announcers with first phone. Must be good. Network station, large city, south Louisiana. Box 476A, B•T.

Experienced announcer. Must have above average delivery, voice and intelligence. West Pennsylvania indie. \$75 up. Send tape, photo and resume. Box 526A, B•T.

One of America's great independent stations will hire top-flight disc jockey. Don't answer unless you are capable of hard sell and strong in audience building. This is a major job in a major market. Box 555A, B•T.

Eastern Shore—need versatile dependable announcers for new well equipped completely air-conditioned daytime station. Box 571A, B•T.

Top-flight DJ needed immediately for major metropolitan market. \$200 per week. Send qualifying letter only with photo and background. No tapes until notified. Box 577A, B•T.

Combo—first ticket for Long Island independent. Contact Program Director, WALK Patchogue, New York.

WCRB needs combination announcer-engineer with first class ticket. Familiarity with concert music desirable. Experience secondary to ability. Contact Program Director, Waltham 5-7080, Waltham, Mass.

Experienced announcer, first ticket desirable, not essential. North Florida independent. Contact Fred Temple, Manager, WDSR, Lake City.

Attention—hillbilly morning men! Need immediately. Character hillybilly DJ that can capture early morning audience and sell commercial! Write: Rex Osborne, Manager, Radio Station WPRT, Prestonburg, Ky.

Need man to gather local news, but capable all phases mike work. Give experience with top references. Bob Bradbury, Box 30, Lamesa, Texas.

Technical

Wanted: Engineer with first class license; 1 kw network affiliate, New York State. Box 443A, B•T.

Individuals have experimented with multiplex equipment for fm broadcast band and obtained patents, contact Box 535A, B•T.

Radio operator for control board, some maintenance. Midwest's most modern am and tv station. Chance to break into tv. Box 549A, B•T.

Combo man. Excellent equipment and working conditions. Must have passable voice and be good on equipment. New station in small town on Atlantic seaboard. Box 572A, B•T.

Engineer-announcer for southern California independent; must have good voice but emphasis on technical. Ours is a pleasant community, centrally situated, one hour's drive from beaches, mountains, desert, metropolis (Los Angeles). Station is well equipped, stable, affiliated with daily newspaper. Write of experience, availability, salary requirements, Robert Walker, KOCs, P. O. Box 593, Ontario, California.

RADIO

Situations Wanted—(Cont'd)

Announcers

Deejay, go anywhere, aim to please, coached by top New York announcers, Sober, dependable, tape and resume on request. Box 516A, B•T.

Announcer—7 years experience. Prefer Georgia or Florida. Consider all. Must offer incentive benefits. Box 518A, B•T.

Experienced Tarheel announcer in Jersey wants to return to southeast. Box 522A, B•T.

Some guys read commercials—news like they were all lies. I read them like they were the Gospel. Skeptical? Penny for your thoughts—via postcard—you'll be convinced via my tape. No screwball. Just weary of conventional ads. Box 525A, B•T.

Announcer, disc jockey, veteran, 25, single. Versatile, earnest worker, seeking experience, radio-tv training, broad musical knowledge, pleasing personality, photo, tape, resume. Box 528A, B•T.

Young announcer—DJ, vet, single, board operator. 3rd ticket. Available immediately. Tape-resume on request. Box 530A, B•T.

Announcer—four years experience in all phases of small town radio. Would like larger market within three or four hours traveling time to New York. Thank you for your interest. Box 538A, B•T.

DJ—one of top men in S.E. desires relocate immediately with aggressive station in professional market. Teen following, vet, grad, tv experience. \$200 weekly minimum. Box 542A, B•T.

Married, 30, disabled vet, college graduate, B.A. degree, broadcasting major, desire start in broadcasting. Tape and picture available upon request. Personal interview desired. Available mid-June. Box 545A, B•T.

Married announcer seeks permanent position as PD, DJ or sports announcer. Box 553A, B•T.

Announcer—DJ, strong news, excellent commercials, college graduate, veteran—tape and resume. Box 554A, B•A.

Experienced announcer available. Gospel and pop, classical, hillbilly. Fine delivery. Third phone. Tape upon request. Box 557A, B•T.

Ambitious young DJ with fine voice, excellent recommendation but limited experience. Will work hard. Hours or salary no object. Will consider parttime or summer replacement. Box 558A, B•T.

Married vet, 25, 5 years radio and 1 year on camera news, desires move to larger market. Can do news, sports, and special events, prefer news on camera. Presently employed. Details on request. Box 559A, B•T.

Young staff announcer who does good job on play-by-play. Light professional experience but good recommendations. Box 562A, B•T.

Negro disc jockey, rhythm and blues, with commercial, Good spiritual. Box 563A, B•T.

Staff, sports, good commercial, married, reliable, draft exempt. Box 564A, B•T.

Hardworking all around staff announcer. Can handle any type DJ. 1 year experience. Box 565A, B•T.

Staff, singer. Strong on news, commercials. Write copy, do DJ, 3rd class ticket. Married, will travel. Box 566A, B•T.

Loaded (with ability) staff announcer, fine DJ, light experience, but man you're looking for. 23, tape, travel. Box 567A, B•T.

Announcer. Third phone. Sharp on news, DJ, ad-lib. Will travel. Box 580A, B•T.

June-Sept. Experienced; versatile; fine voice. Bill Brand. 246 E. Tremont Ave., Bronx 57, N. Y.

Radio-television staff announcer. 8 years radio, 20 months tv. No floater—last station 7 years. Seek new opportunity in larger market. Single, veteran, 31, car. Available immediately. Write Ken Bryant, Box 132, RR 3, Mound, Minnesota, or call Mound, Minnesota, 905-J.

Announcer: Negro DJ. Good rhythm and blues man. Funny. Good selling voice, 5 years experience. No hot shot, dependable. Go anywhere. Tape available. Contact Mr. "B," 3207 Ellis St., Berkeley, California.

All around staff and sports announcer, including play-by-play. Strong on news, commercials, friendly DJ style, third class ticket, tapes available, married, will travel. Raymond Damgen, 111 North Walnut Street., East Orange, New Jersey. Orange 6-8872—call after 6 p.m.

RADIO

Situations Wanted—(Cont'd)

DJ, live voice, versatile, sports, play-by-play, 28, married, vet, two years experience, reliable. Pete Franklin, 73 Propp Avenue, Franklin Square, L. I., New York. Floral Park 2-6268.

Experienced announcer with 3rd class license. Tops in music and news. Prefer California or midwest. Contact Robert Goss, KPFC, Pasadena.

Announcer—staff, news, DJ. Sincere, friendly delivery. 2½ years all-around experience in college fm station. Degree, married, 23. Available June 8th. Tape on request. David Harold, 1635-C Division Street, Evansville, Indiana.

Announcer: Recent radio school graduate. Strong on news and commercials. Married, college, vet. Michael Lepre, 760 William Street, Harrison, New Jersey.

Reliable, qualified announcer, light experience, strong news, pleasing personality, college, sales background, seek permanent staff. Relocate short notice. Tape, resume, references. William Pappas, 565 West 192nd Street, New York, N. Y.

Announcer, recent graduate, extensive course, all phases, light experience, strong news, excellent commercials, good deejay. 21, single, draft deferred, willing to travel, tape, resume. Robert Rower, 42-15 Layton Street, Elmhurst 3, New York.

Staff announcer. Superior, friendly, mature voice. Strong news, commercials. Some copywrite. Recent grad. Reliable family man. New England to midwest. Matt Watson, 24 Wappanocca Avenue, Rye, New York.

Technical

First phone, 4 years am, 27, single, car, prefer midwest. Will consider interim summer employment. Box 442A, B•T.

Chief engineer—salesman, 7 years experience, good billing, family man, desire change, prefer midwest remote control. Box 517A, B•T.

New England—N. Y. First phone, am-tv experience, car, available immediately. Box 532A, B•T.

Chief engineer-program director. First class ticket. Thoroughly experienced both. Can do sports and copy. Southern stations only. Box 546A, B•T.

First phone, radio-tv service experience, two years experience, control board operator. Diploma from two radio schools. Attended Port Arthur College. Amateur, married, one child. Transportation. Non-drinker, some experience hillbilly record shows. Remotes, very best personal financial references. Seeking permanent position, will invest in good (am) station, Missouri or Arkansas. Box 550A, B•T.

Engineer wants permanent position south, southeast, no announcing. 8 years experience, ham, 25 years. Capable of chief. Box 551A, B•T.

Engineer-announcer now employed as chief, desire change. Three years experience. Prefer Texas, Tennessee, Kentucky. Will consider all. Box 579A, B•T.

College engineering student desires summer employment. Experienced. Vet. First phone, anywhere. Will combo. Bernard Budenbender, 1020 Poyntz, Manhattan, Kansas.

1st phone, no experience, radio-tv school grad, vet, 31, can travel—Peter Cap, 233 Cook Ave., Yonkers, N. Y.

RADIO

Situations Wanted—(Cont'd)

Engineer, 33 1st phone and radar, available now, will relocate, anxious for start. Langlois, RFD 1, Pascoag, R. I.

Chief—39—married, two children—8 years experience—some announcing. Want to settle. Available immediately. Box M, Double Springs, Alabama.

Production-Programming, Others

Program director—accustomed to delivering audience-building programs on limited budget. Seven years experience, all phases radio. West Coast. Box 449A, B•T.

First class news specialist. Top grade copywriter, heavy sales, theatrical, writing, college background. All commercials—special delivery. Tape, photo available. Box 524A, B•T.

Production manager. Desires hard work to advance future. Experienced. Family. Young. Employed. Box 544A, B•T.

SRT graduate seeking first break—vet—single—will travel. Sincere and willing to work. Box 552A, B•T.

TELEVISION

Help Wanted

Salesmen

Sales—outstanding opportunity for salesmen and sales manager KSN-TV, growing station, ideal market, San Francisco. Send complete experience and qualifications first letter to Norwood J. Patterson.

Announcers

Need young men with or without radio experience. Send complete information to Smullin tv, Box 1189, Medford, Oregon or Box 1021, Eureka, California.

Technical

Wanted: A man who is now doing a good job in tv maintenance who would like to advance to management as assistant chief engineer of a midwest tv station. Station will be at maximum power soon and is affiliated with NBC. Write Box 537A, B•T, giving previous training and experience and salary expected.

Top tv engineer—thoroughly experienced man capable of taking charge and assuming full responsibility for technical operation of full power vhf station with GE equipment. Write in full, stating salary requirements to Walter M. Windsor, General Manager, KCMC-TV, Texarkana, Texas, or contact at NARTB Convention in Washington May 22-26.

Tv engineer with strong maintenance and operating background on studio, kinescope and/or transmitter gear. Reply Chief Engineer, WTTW, 38 S. Dearborn St., Chicago, Illinois.

(Continued on next page)

RADIO STATION IN THE OZARK WONDERLAND

Nationally famous market. Fishing, outdoor sports. Heavy retail. Detailed study of city and market invited.

RADIO STATION FULLTIME-TEXAS-COUNTY SEAT

Single-Station market. Thriving agricultural, retail center. City population 12,500 plus large rural market.

Details to qualified principals

RALPH J. ERWIN

Box 811

Broker

Tulsa

TELEVISION

Help Wanted—(Cont'd)

Programming-Production, Others

Outstanding vhf station in southeast needs a smart promotion director. Must have experience in broadcast field, writing ability, knowledge of research, merchandising, preparation of newspaper ads. This job entails sales, market and program promotion. Write giving full details on training and experience and send small photo. Box 412A, B.T.

Experienced film cutter for large metropolitan station, east. Top pay for top man to fill in as summer replacement. Send references, salary requirements and experience to Box 575A, B.T.

Outstanding opportunity for experienced director both station and sports, strong emphasis on baseball. KSAN-TV, San Francisco, California.

WABI-TV, Bangor, Maine, wants for expanding production department, tv commercial copywriter. Must be currently working in profession or will consider trained college graduate. Send complete resume and sample copy to Dick Bronson, Production Manager.

WLWD-TV, Dayton, requires traffic manager.

Situations Wanted

Managerial

Experienced general manager or sales manager available immediately. Strong in sales, budgeting and management. Now situated in middle west. Will submit resume, photo, excellent network, national and local references. Box 494A, B.T.

Sales manager: offer three-dimensional experience as sales manager major tv station; radio-tv timebuyer major N. Y. agencies and station representative. This background built impressive sales record at tv station. It can work for you in general or sales management position. Experienced in creating and giving station sales presentations to large groups. Youthful family man will relocate for opportunity to inspire and direct your sales department. Top industry references. Box 560A, B.T.

Announcers

Highly professional DJ, news, special events announcer available to quality operation. Tape, picture on assurance of proper handling and return—\$150 per week minimum guarantee. Professional; family man for professional operation only. Box 192A, B.T.

Announcer—presently employed with almost two years radio experience. News-commercials—DJ-man in the street. Desires opportunity in television. Single, vet, 24. Capable-confident-sincere. Box 573A, B.T.

Production-Programming, Others

Experienced program director—economy-minded executive with proven record in competitive tv market. 12-year background radio, tv. Efficient, practical, respected individual who knows tv from long experience. Available immediately. Prefer midwest. Box 468A, B.T.

Producer-director, 3 years major market experience. Excellent references. Prefer east. Box 503A, B.T.

Tv producer-director with network experience desires change. Presently employed by a leading net-originating station. Radio and N. Y. ad agency background. Box 519A, B.T.

News editor, tv-radio. Emphasizing local, regional coverage w/film, stills; highest ratings, references. Box 523A, B.T.

Program director—television degree, chief director, production manager, university teacher of tv, strong on local live programming. Vet, married, 28. Box 533A, B.T.

Experienced film man. Can purchase, edit, make film and slides. Will organize film department. References. Box 534A, B.T.

Cameraman—2 years experience, all studio operations, excellent references, relocate. Box 561A, B.T.

Tv-radio promotion director, photographer, former newspaper editor-publisher with sales promotion background available. Wally Blake, 221 South Main, Charles City, Iowa.

FOR SALE

Stations

Mid-south single station markets: Half interest in profitable daytimer, \$23,500 (includes work opportunity); 100% stock with steady earnings \$55,000—\$15,000 down, balance over 10 years; full-time local break-even, \$40,000, half cash. Paul H. Chapman, 84 Peachtree, Atlanta.

Southwestern city over 25,000 population. Close inspection of market and property invited. Principals only. Ralph Erwin, Broker, Box 811, Tulsa.

Arkansas. Established station. Good market. Combination operation optional. Available to qualified principals only. Ralph Erwin, Broker, Box 811, Tulsa.

Vhf, \$800,000 CBS exclusive area. Uhf \$190,000 cash; financing available. No conversion problem, ABC. Exclusive listings. Write Hugh R. Norman, Davenport, Iowa.

Free list of good radio and tv station buys now ready. Jack L. Stoll & Associates, 4958 Melrose, Los Angeles 29, California.

Radio and television stations bought and sold. Theatre Exchange. Licensed Brokers. Portland 22, Oregon.

Equipment

Western Electric coils 154C—\$15; 119C—\$8.00. New—23A—\$10.00; 26A—\$7.00; Jack Panels—\$17.00; 12 volt relay supply—\$18.00. Box 497A, B.T.

For sale: DuMont series 8000, 5 kw high-band transmitter; color corrected, GE TF-4-A 20 kw amplifier; 500 foot Stainless tower; tower lighting and photoelectric control; 1,000' 3 1/2" Andrew steatite transmission line; transmission line hangers for 500' dual run; RCA TF 6A1, antenna, modified to handle 19 kw input; sleet melting equipment, and 5 kw RCA diplexer. All equipment now operating on channel 7. Bids on all or part of equipment considered. Write Box 536A, B.T.

For sale: One Blaw-Knox CFN 275-foot self-supporting tower, now standing. Contact Roy Giles, Box 702, Roanoke, Virginia.

For sale: one flexible completely airconditioned coach, excellent condition driven 44,000 miles priced at bargain. Albany Hardware Company, Albany Georgia.

WANTED TO BUY

Stations

Miss.—Ark.—La.—W. Tenn.—Stations or CPs—Towns 5000 plus or cities. Box 947G, B.T.

Radio. Texas, Oklahoma, Arkansas, Missouri, Kansas. Professionally licensed service. Ralph Erwin, Broker, Box 811, Tulsa.

Wanted to buy RCA-76-B audio console or equivalent. Please state price, condition and availability. KSBW-TV, P. O. Box 1651, Salinas, California.

Wanted: Good condition fm used antenna for side mounting. Four-bay Andrews multi-V, or Collins. Also 1 1/2 in. 451 Andrews cable or equivalent. WMVA, Martinsville, Virginia.

Limiting amplifier, GE type BA-5-A, in good working condition. Also consider RCA, Raytheon, Collins. Barry Trading Company, Lebanon, Tennessee.

Instruction

Get your FCC first phone license in 8 weeks. Intensive, personalized instruction in residence or by correspondence. For details, write Grant-Ham School, Dept. 1-K. Address either 6064 Hollywood Blvd., Hollywood, Calif., or 737 11th Street N.W., Washington, D. C.

Your FCC first phone license in a hurry. Nation's largest professional school offers brand new, streamlined course. Guaranteed coaching—nationwide placement. Full information rushed to you free (no salesmen will call). Get the best— it costs no more! Northwest Radio & Television School, 1221 N. W. 21st Avenue, Portland 9, Oregon.

RADIO

Help Wanted

TOP-FLIGHT DISC JOCKEY NEEDED IMMEDIATELY

For Major Metropolitan Market. \$200 Per Week. Send Qualifying Letter Only With Photo And Background. No Tapes Until Notified. Box 577A, B.T.

Programming-Production, Others

TOP-FLIGHT NEWSMAN for CLEVELAND

Must be thoroughly experienced. Send tape, resume, and photograph to WSRS, Cleveland 18, Ohio.

Situations Wanted

Managerial

MANAGEMENT—PRODUCTION EXECUTIVE

Recently completed 2 1/2 years as Mgr., Radio-Recording-Transcriptions for top TV, Radio & Recording Musical Personality.

Account Executive 3 1/2 years with leading NYC Recording Company. Desires position, preferably away from Metropolitan Areas, where enthusiasm and new ideas are welcomed and will be used.

Available after June 1st.

Box 547A, B.T

Manager or Sales Manager

With 10 years experience seeks position with progressive station. Young family man with fine sales record and top industry references. Active state association and community leader. Present station has been sold. Will be available at NARTB Convention. Write

Box 576A, B.T.

TELEVISION

HELP WANTED

Salesman

TV SALESMAN WANTED

KCRG-TV, Channel 9, Cedar Rapids, Iowa, has excellent opportunity for experienced salesman. Station owned by newspaper. Full power, 1,085 foot tower gives station greatest TV coverage in state. Guarantee plus commission. Contact Manager Pat Patterson with full particulars or Joseph F. Hladky at Willard Hotel during NARTB Convention. Application confidential.

New and expanding VHF TV station and affiliated Radio station located in medium market in lower Midwest making staff additions. Want experienced permanent people in the following categories:

Announcer strong on News and "On Camera selling"
Continuity Writer TV Copy Production
Traffic Manager
Salesman
Operating Engineer

Want people who are interested in permanent Community living. Send full information first letter including your present salary scale.

Box 543A, B•T

Situations Wanted

Programming-Production, Others

DO YOU NEED A VHF OPERATIONS MANAGER OR PROGRAM MANAGER?

8 yrs. experience in all phases of VHF-TV operations
Current Program Manager but must relocate due to Corporation merge.
Top industry references. Available June 5th.

Box 541A, B•T

FOR SALE

Stations

STATIONS

Outstanding Carolinas network—fulltime, grossing above \$100,000 annually—nets one-third. Priced realistically at \$120,000—Good financing. Also Carolinas small market. Excellent operation fulltime exclusive. Good annual net—\$47,500 with \$15,000 down. Qualified clients only.

J. T. Snowden, Jr.
Box 129, Augusta, Georgia
Hotel Statler—Convention Week

Equipment, Etc.

TOWERS

RADIO—TELEVISION

Antennas—Coaxial Cable
Tower Sales & Erecting Co.
6100 N. E. Columbia Blvd.,
Portland 11, Oregon

FOR SALE—(Cont'd)

Equipment

FOR SALE TV PLANT

GE-5KW TRANSMITTER, CHs 7-13 INC,
DIPLEXER, FILTERS & DUMMY LOAD
GE—BAY ANTENNA
GE-FREQUENCY MONITORS, SPARES
PRICED RIGHT
KFMB-TV SAN DIEGO, CALIF.

NEW RCA SURPLUS
TV CAMERA
only \$197.50!



A spare camera for a fraction of the usual price! Excellent for closed circuit, factories, swim pools, prisons, medicine, etc. 1846 Iconoscope, 6-stage video amplifier and clipper.

Write for complete technical data.

FREE CATALOGUE ON REQUEST

SURPLUS EMPORIUM, Dept. B•T
503 N. Victory Blvd. Burbank, Calif.

WANTED TO BUY

Stations

RADIO STATION WANTED

Experienced manager-owner wishes to lease or manage station with option to purchase. Medium or large market. Will be at convention. Box 502A, B•T.

Box 502A, B•T

RADIO STATION WANTED
MINNESOTA-WISCONSIN-
IOWA
OR SURROUNDING AREA
ADEQUATE FINANCING
AVAILABLE
FOR ANY OFFER
BOX 436A, B•T

INSTRUCTION

NATIONAL ACADEMY of BROADCASTING



3338 16th St., N.W.
Washington, D. C.

Job Getting Courses in
Announcing, Writing, Producing
for Radio & TV

Call Decatur 2-5580
New Term Starts June 2

FOR THE RECORD

(Continued from page 148)

waukee, for Lou Poller's 56.6% interest in WURL. Mr. Blumenthal is sole owner of WCMS and now will be sole owner of WURL. Filed May 10.

Hearing Cases . . .

FINAL DECISION

Latrobe, Pa.—New am, 1480 kc. FCC by order made effective immediately an initial decision and granted application of Latrobe Bcstrs. for new am station in Latrobe, Pa., on 1480 kc, 500 w, daytime only, conditioned upon applicant filing, within 60 days, an application for mod. of CP specifying a transmitter site and antenna system conforming to Commission rules and standards. Action May 11.

INITIAL DECISION

WCEM Cambridge, Md.—FCC Hearing Examiner Hugh B. Hutchison issued initial decision looking toward grant of the application of The Shore Bcstg. Co. for CP to increase power of WCEM Cambridge, Md., from 100 w to 250 w, operating unlimited time on 1240 kc. Action May 17.

OTHER ACTIONS

Miami, Fla.—Ch. 7 proceeding. FCC announced its decision which concludes that public interest, convenience and necessity will be served by permitting Storer Bcstg. Co. to operate a tv station on ch. 23 in Miami, Fla. Comr. Hennock dissented. Grant without hearing on Dec. 16 last of assignment of license of WMIE-TV (now WGBS-TV) from WMIE-TV Inc., to Storer Bcstg. Co., followed by mod. of CP and STA, were protested by Hollywood Bcstg. Co. (WINZ), Miami-Hollywood, and Miami-Biscayne Television Corp. (WMFL [TV], ch. 33), Miami, and oral argument was held on Feb. 28. Action May 11.

Evansville, Ind.—Ch. 7 proceeding. FCC scheduled oral argument on June 6 in ch. 7 proceeding involving Evansville Tv Inc. and WEOA and WGBF, both Evansville. Action May 11.

KHTV (TV) Hibbing, Minn.—FCC by order on petition filed Dec. 13, 1954, by North Star Television Co., granted without hearing latter's application for 6-month extension of time to complete construction of station KHTV (TV) (ch. 10), Hibbing, Minn. Comrs. Webster and Bartley dissented. Action May 11.

Albany, N. Y.—FCC by order denied petition filed March 31 by Van Curler Bcstg. Corp., WTRI (TV), ch. 35, Albany, N. Y., for review of an examiner's ruling of March 29 and clarification of issues involved in protest proceedings instituted by Van Curler as a result of Commission grant on Nov. 3, 1954, of transfer of control of Hudson Valley Bcstg. Co., WROW-AM-TV (ch. 41), Albany, N. Y., to Lowell J. Thomas, et al. Comr. Hennock dissented. Action May 11.

Bay Shore, N. Y.—FCC scheduled oral argu-

INSTRUCTION

FCC 1st PHONE LICENSE
IN 5 to 6 WEEKS

THE ORIGINAL INTENSIVE
'DOOR OPENING COURSE'
RADIO-TELEVISION
OUR INTEGRITY PROVEN

Check the school that
others try to copy.

WILLIAM B. OGDEN
1150 W. Olive Avenue
Burbank, California

BE TAUGHT—NOT TOLD
UNDERSTAND—NOT MEMORIZE
Over 1600 successful
students in NINE years

ment on June 6 in case involving bid by Key Bcstg. System Inc. for new am station on 1300 kc and WAVZ New Haven, Conn., requesting change of facilities from 1250 kc. Action May 11.

WWBZ Vineland, N. J.—FCC scheduled oral argument on June 6 involving application for renewal of license. Action May 11.

Hermiston, Ore.—FCC Examiner William G. Butts granted petition of Carl F. and Sarah Knierim to amend bid for new am station to specify 1570 kc instead of 800 kc and amended bid was removed from hearing docket. Action May 11.

Bridgeport, Wash.—FCC by order denied a request of April 21 by C. J. Community Services Inc., operator of an unlicensed booster tv station in Bridgeport, Wash., for a copy of field reports pertaining to illegal booster operations in current proceedings. Action May 11.

Routine Roundup . . .

May 18 Decisions

BROADCAST ACTIONS

By the Commission en banc
STA

WMAL-TV Washington, D. C., The Evening Star Bcstg. Co.—Granted STA for experimental operation (ch. 7) between 8 a.m. and 12:30 p.m. during period May 25 to June 24 to transmit nonstandard tv signals in order to demonstrate coding and decoding apparatus of Zenith Radio Corp. "phonevision" system to persons attending NARTB convention at Sheraton Park Hotel, Washington, and to members of Congress and FCC on special receivers for the purpose. The signals can not be received on regular receivers. These tests (before WMAL-TV's regular program hours) shall avoid any action which may create public impression that FCC has or will approve any system of subscription tv. Comr. Webster dissented.

Renewal of License

The following stations were granted renewal of licenses for the regular period: WHTB-FM Talladega, Ala.; WAKU Latrobe, Pa.; WOZK Ozark, Ala.; WJBF (TV) Augusta, Ga.; WBHB Fitzgerald, Ga.; KDBS Alexandria, La.; KREH Oakdale, La.; KRLW Walnut Ridge, Ark.; KRMD-AM-FM Shreveport, La.; KRUS Ruston, La.; KSGI Crowley, La.; KSLO Opelousas, La.; KSYL Alexandria, La.; KTBS-AM-FM Shreveport, La.; KTHS Little Rock, Ark.; KTLO Mountain Home, Ark.; KUOA-AM-FM Siloam Springs, Ark.; KVOK Honolulu; KVOL-AM-FM Lafayette, La.; KVOM Morrilton, Ark.; KVPI Ville Platte, La.; KWAK Stuttgart, Ark.; KWCB Searcy, Ark.; KWKC Natchitoches, La.; KWHN Ft. Smith, Ark.; KWKH-AM-FM Shreveport, La.; KXAR Hope, Ark.; KXJK Forrest City, Ark.; WBKH Hattiesburg, Miss.

May 18 Applications

ACCEPTED FOR FILING

Remote Control

WSGN Birmingham, Ala., Jemison Bcstg. Co.—(BRC-725).
WHEP Foley, Ala., Alabama-Gulf Radio Inc.—(BRC-724).

Renewal of License

WHTS Murfreesboro, Tenn., Murfreesboro Bcstg. Co.—(BR-2890).
WBBS (FM) Crawfordsville, Ind., First Baptist Church—(BRH-749).
WKY-FM Evansville, Ind., South Central Bcstg. Corp.—(BRH-251).
WRSW-FM Warsaw, Ind., Reub Williams & Sons Inc.—(BRH-404).
WSON-FM Henderson, Ky., Henderson Bcstg. Co.—(BRH-212).

WFMW-FM Madisonville, Ky., Messenger Bcstg. Co.—(BRH-475).

WJHL-FM Johnson City, Tenn., WJHL Inc.—(BRH-770).

WKPT-FM Kingsport, Tenn., Kingsport Bcstg. Co.—(BRH-149).

WLAF-FM Lexington, Ky., American Bcstg. Corp.—(BRH-597).

Applications Returned

WCNB-FM Connorsville, Ind., News-Examiner Co.—Renewal of license. Incorrectly signed.

License for CP

KXJK Forrest City, Ark., Forrest City Bcstg. Co.—License to cover CP (BP-9516) which authorized installation of new antenna and transmitter at National Bank Bldg., 109 North Washington Street, Forrest City, to be operated on 950 kc, 250 w, for auxiliary purposes only. Amended to change name to W. W. Campbell, W. M. Campbell, Jack Bridgeforth, William B. Fogg and E. J. Butler, d/b as Forrest City Bcstg. Co. (BL-5692).

KBAB El Cajon, Calif., Babcock Bcstg. Corp.—License to cover CP (BP-9321) which authorized new standard broadcast station (BL-5721).

KPTL Carson City, Nev., Edwin L. Bullis and Alma F. Bullis—License to cover CP (BP-9384) which authorized new standard broadcast station (BL-5722).

Modification of CP

WRBV Boonville, N. Y., Black River Radio Inc.—Mod. of CP (BP-8985) which authorized new standard broadcast station for extension of completion date (BMP-6843).

License for CP

WNBT Wellsboro, Pa., Farm and Home Bcstg. Co.—License to cover CP (BP-9230) as mod. which authorized new standard broadcast station (BL-5720).

KAMQ Amarillo, Tex., Top of Texas Bcstg. Co.—License to cover CP (BP-9139) as mod. which authorized increase daytime power; install new transmitter and change from employing directional antenna night only to DA both day and night (DA-2) (BL-5719).

Renewal of License

WTRC Elkhart, Ind., The Truth Pub. Co.—(BR-495).

WJCD Seymour, Ind., Dr. Azra C. Baker—(BR-2368).

WAEW Crossville, Tenn., WAEW Inc.—(BR-2799).

WLIL Lenoir City, Tenn., WLIL Inc.—(BR-2473).

Remote Control

WSAC Radcliff, Ky., Fort Knox Bcstg. Co.—(BRC-726).

Renewal of License Returned

KVMA Magnolia, Ark., Magnolia Bcstg. Co.

WVLK Lexington, Ky., Bluegrass Bcstg. Co.

Applications Returned

Holbrook, Ariz., Donald Edward Jacobs Sr. and Irene N. Tabor d/b as Northeastern Ariz. Bcstrs. (PO Box 31, & Irene N. Tabor)—CP for new standard station on 1270 kc, 1 kw, daytime hours only. (VA & VG; Exhibits 8 & 9 dated after Section I.)

May 17 Decisions

BROADCAST ACTIONS

By the Broadcast Bureau

Actions of May 13

STA

KAYE Puyallup, Wash., Puyallup Valley Bcstg. Co.—Granted permission to operate the following schedule during June, July and August: 6:30 a.m. to 6:30 p.m. (with additional hours as required to cover special events); 12 a.m. to 2 a.m. (optional as conditions may warrant).

Remote Control

The following stations were granted authority to operate transmitters by remote control: WDEC Americus, Ga.; WTX New Orleans; WMK Mid-diesboro, Ky.; WSTV Steubenville, Ohio.

Actions of May 12

Modification of CP

The following were granted mod. of CPs for extension of completion dates as shown: KGNC-TV Amarillo, Tex., to 12-8-55; KYTV (TV) Springfield, Mo., to 11-15-55; WAGE-TV Marquette, Mich., to 12-7-55; KTLA (TV) Los Angeles, to 12-2-55; WGR-TV Buffalo, N. Y., to 11-7-55.

Actions of May 9

Modification of License

WRAP Norfolk, Va., Cavalier Bcstg. Corp.—Granted mod. of license to change name to Rollins Bcstg. of Virginia Inc.; condition (BML-1626).

Modification of CP

KRWC Forest Grove, Ore., Irving V. Schmidtke—Granted extension of completion date to 9-1-55 (BMP-6831).

WIMA-TV Lima, Ohio, WLOK Inc.—Granted mod. of CP for extension of completion date to 12-6-55 (BMPCT-3088).

ACTIONS ON MOTIONS

The Commission, on petition of RETMA, extended from May 20 to July 21 the time for filing comments in re Docket 11331, and reply comments thereto 20 days thereafter, in the matter re operation of co-channel amplifying transmitters in conjunction with the main transmitter of tv stations (Action May 13).

On petition of The Jacksonville Journal Co., the Commission extended from May 13 to May 27 the time for filing comments in re Docket 11361 the matter of assigning Channel 10 to Bunnell, Fla., with replies thereto 10 days thereafter (Action May 12).

By Comr. Robert E. Lee on May 13

Broadcast Bureau—Granted petition for an extension of time to and including May 23, in which to file exceptions to initial decision in re applications of City of Jacksonville, et al. for ch. 12 in Jacksonville, Fla. (Dockets 10833 et al).

Broadcast Bureau—Granted petition for an extension of time to and including May 30 in which to file exceptions to initial decision in re applications of Queen City Bcstg. Co., et al. for ch. 7 in Seattle, Wash. (Dockets 9030 et al).

Chief Broadcast Bureau—Granted petition for an extension of time to and including May 18 within which to file exceptions to initial decision in re applications of KFAB Bcstg. Co., and Herald Corp. for ch. 7 in Omaha, Neb. Dockets 9009, 10909).

Chief Broadcast Bureau—Granted petition for an extension of time to and including May 18 in which to file exceptions to initial decision in re applications of Dorsey Eugene Newman, Hartsell, Ala. et al (Dockets 10638 et al).

By Examiner Annie Neal Hunting

Issued a Third Statement concerning pre-hearing conferences and order in re application of Theodore Feinstein for new am station in Newburyport, Mass. (Docket 11141) (Action of 5/16).

WAPF McComb, Miss., Southwestern Bcstg. Co. of Miss.—Granted motion for a ten-day extension of time for filing proposed findings in re its am application (Docket 11251). (Action of 5/11).

By Examiner Elizabeth C. Smith on May 13

On joint request by counsel for protestant and for assignor and assignee for KPLN Camden, Ark., ordered that the subpoenas directed to D. Randolph James, Sr., are amended with respect to time and place for his appearance and production of documents, and said D. Randolph James, Sr. is released from appearance on May 16; in other respects the subpoenas shall remain in full force and effect until subsequent order. (Docket 11363).

By Examiner Basil P. Cooper on May 13

Indianapolis, Ind., WIBC Inc.; Indianapolis Bcstg. Inc.—Granted motions for certain specified corrections to be made in the transcript in re applications for ch. 13 (Dockets 8906 et al).

By Examiner Hugh B. Hutchinson on May 10

Broadcast Bureau—Granted petition for an extension of time to and including May 18 within which to file its proposed findings in re application of KSWS-TV Roswell, N. M. (Docket 11303). Also announced that no requests by any of the parties to this proceeding for additional time in which to file proposed findings beyond May 18 will be accorded favorable consideration.

May 17 Applications

ACCEPTED FOR FILING

License for CP

WPCT Putnam, Conn., The Israel Putnam Bcstg. Co.—License to cover CP (BP-9652) which

BROADCASTING • TELECASTING



**UHF CONSULTANT
FOR
PROFITABLE OPERATION**

LAMBERT B. BEEUWKES

LITTLE BLDG. BOSTON, MASS.

At NARTB CONVENTION

HOTEL STATLER EX 3-1000

22 years' experience in network, large- and small-market management, sales, programming, promotion, merchandising

authorized increase in power (BL-5713).

Modification of CP

WABJ Adrian, Mich., Gerity Bcstg. Co.—Mod. of CP (BP-6251) as modified, which authorized change frequency, change hours of operation; transmitter equipment and type transmitter for extension of completion date (BMP-6838).

Remote Control

WMIK Middlesboro, Ky., Cumberland Gap Bcstg. Co.—(BRC-721). WSTV Steubenville, Ohio, WSTV Inc.—(BRC-720). KXA Seattle, Wash., KXA Inc.—(BRC-719).

Renewal of License

KENA Mena, Ark., R. B. Bell—(BR-2495). WHBU Anderson, Ind., Anderson Bcstg. Corp.—(BR-342). WCBL Benton, Ky., Purchase Bcstg. Co.—(BR-3058). WAIN Columbia, Ky., Tri-County Radio Bcstg. Corp.—(BR-2635). WMTK Lawson, Ky., The Kentucky Mountain Hollness Assn.—(BR-2090). WMIK Middlesboro, Ky., Cumberland Gap Bcstg. Co.—(BR-2293). WLAR Athens, Tenn., Athens Bcstg Co.—(BR-1250). WDKN Dickson, Tenn., Dickson County Bcstg. Co.—(BR-3068). WDSG Dyersburg, Tenn., State Gazette Bcstg. Co.—(BR-1272). WCRK Morristown, Tenn., Cherokee Bcstg. Corp.—(BR-1651). WSM Nashville, Tenn., WSM Inc.—(BR-483). WOWO Fort Wayne, Ind., Westinghouse Bcstg. Co.—(BR-492). WJPS Evansville, Ind., WJPS Inc.—(BR-2150). WTCJ Tell City, Ind., Tell City Bcstg Co.—(BR-1890). WIEL Elizabethtown, Ky., Elizabethtown Bcstg. Co.—(BR-2520). WFKY Frankfort, Ky., Frankfort Bcstg. Co.—(BR-1249). WHLN Harlan, Ky., Blanfox Radio Co.—(BR-1129). WKOA Hopkinsville, Ky., Pennyrile Bcstg. Co.—(BR-2985). WLBN Lebanon, Ky., Lebanon-Springfield Bcstg. Co.—(BR-2900). WGRG Louisville, Ky., Northside Bcstg. Corp.—(BR-900). WSIP Paintsville, Ky., Big Sandy Bcstg. Co.—(BR-2437). WPRT Prestonsburg, Ky., Kentucky Mountain Bcstg. Co.—(BR-2759). WGRM Greenwood, Miss., Mrs. P. K. Ewing, executrix of the estate of P. K. Ewing, deceased —(BR-847). WMIS Natchez, Miss., Natchez Bcstg. Co.—(BR-1127). WNAT Natchez, Miss., Old South Bcstg. Co.—(BR-2387). WHIN Gallatin, Tenn., Sumner County Bcstg. Co.—(BR-2157). WIRJ Humboldt, Tenn., Gibson County Bcstg. Co.—(BR-2380). WHDM McKenzie, Tenn., The Tri-County Bcstg. Co.—(BR-2925). WMMT McMinnville, Tenn., McMinnville Bcstg. Co.—(BR-1713). WDBL Springfield, Tenn., Springfield Bcstg. Co.—(BR-2494).

Renewal of Lincese Returned

WTCO Campbellsville, Ky., South Central Kentucky Bcstg. Co.

License for CP

WKBJ Milan, Tenn., West Tenn. Bcstg. Co.—License to cover CP (BP-9211) as modified which authorized new standard broadcast station (BL-5714).

Applications Returned

Golden State Broadcasters Nr. Auburn, California (PO % Charles E. Halstead, Jr. P. O. Box 992, Auburn, Calif.)—CP for new standard station on 770 kc 1 kw daytime hours only (incomplete and incorrect). David M. Segal, Clarksdale, Miss., (PO 1012 Baltimore Bldg.; Kansas City, Mo.)—CP for new standard station on 900 kc 250 w daytime hours of operation (Request of attorney). Macomb, Illinois, Western Illinois State College —CP incorrectly filled out.

Renewal Application Returned

KWGS (FM) Tulsa, Okla., U. of Tulsa—CP to make changes in licensed station. Filed on wrong form.

Renewal of License

WETB Johnson City, Tenn., Press Inc.—(Name incorrect application incomplete). WITZ-FM Jasper, Ind., Jasper on the Air Inc.—(BRH-773). WCTW (FM) New Castle, Ind., Courier-Times Inc.—Improperly signed. WFBM-TV Indianapolis, Ind., WFBM Inc.—(BRCT-86). WAVE-TV Louisville, Ky., WAVE Inc.—(BRCT-74). WMCT (TV) Memphis, Tenn., Memphis Pub. Co.—(BRCT-24). WSM-TV Nashville, Tenn., WSM Inc.—(BRCT-84).

UPCOMING

MAY

May 22-26: NARTB Convention, Shoreham and Sheraton-Park hotels, Washington. May 23: Community Broadcasters Assn., Shoreham Hotel, Washington. May 25: Senate Appropriations Subcommittee recall hearing on FCC budget for fiscal 1956, G-16, Capitol Bldg., 2 p.m. May 31: Deadline, Fund for the Republic Television Awards (script contest), New York. May 31: RAB Clinic, St. Louis.

JUNE

June 1: Deadline, Nominations for Outstanding Young Advertising Man, Assn. of Adv. Men & Women of New York. June 1: RAB Clinic, Wichita, Kan. June 2: RAB Clinic, Denver. June 3: RAB Clinic, Salt Lake City. June 5-8: Adv. Federation of America golden anniversary convention, Palmer House, Chicago. June 5-8: Alpha Delta Sigma convention (adv. fraternity), Palmer House, Chicago. June 6-8: National Community Tv Assn. convention, Park Sheraton Hotel, New York. June 12-14: Iowa Broadcasters Assn., Crescent Beach Lodge, Lake Okaboji. June 13: BMI Clinic, Turf Club, Twin Falls, Idaho. June 13: RAB Clinic, New York. June 14: BMI Clinic, Rainbow Hotel, Great Falls, Mont. June 14: RAB Clinic, Hartford, Conn. June 15: BMI Clinic, Hotel Utah, Salt Lake City. June 15: RAB Clinic, Boston. June 16: RAB Clinic, Manchester, N. H. June 16-18: Maryland-D. C. Radio & Television Broadcasters, Stephen Decatur Hotel, Ocean City, Md. June 17: BMI Clinic, Hotel Denver, Glenwood Springs, Colo. June 17: BMI Clinic, Edgewater Beach Hotel, Detroit Lakes, Minn. June 17: RAB Clinic, Bangor, Me. June 17-18: Colorado Broadcasters Assn. meeting, Denver Hotel, Glenwood Spring. June 19-22: National Assn. of Television-Radio Farm Directors, Washington. June 20-July 1: WSM-Peabody College Radio-Tv Workshop, Nashville, Tenn. June 21: Television News Institute, Northwestern U., Evanston, Ill. June 23-25: NARTB combined boards of directors, The Homestead, Hot Springs, Va. June 24-25: Virginia Assn. of Broadcasters, Engle-side Hotel, Staunton. June 26-29: Adv. Assn. of the West convention, Portland, Ore. June 27-30: Western Assn. of Broadcasters (Canadian) convention, Jasper Park Lodge, Jasper, Alberta. June 28: Presentation, Outstanding Young Advertising Man, Assn. of Adv. Men & Women of New York.

JULY

July 1: RAB Clinic, Cedar Rapids, Iowa. July 11-31: Institute in Live & Filmed Tv, U. of Miami, Coral Gables, Fla.

July 18-29: WSM-Peabody Tv Workshop, Peabody College, Nashville, Tenn.

AUGUST

Aug. 1-9: Educational Television Workshop, Michigan State College, East Lansing. Aug. 8: RAB Clinic, Atlanta. Aug. 9: RAB Clinic, Charleston, S. C. Aug. 10: RAB Clinic, Winston-Salem, N. C. Aug. 11: RAB Clinic, Norfolk, Va. Aug. 12: RAB Clinic, Philadelphia. Aug. 14-Sept. 3: National Assn. of Educational Broadcasters television production workshop, State U. of Iowa, Iowa City. Aug. 22: RAB Clinic, Tampa, Fla. Aug. 23: RAB Clinic, Birmingham, Ala. Aug. 24: RAB Clinic, Baton Rouge, La. Aug. 25: RAB Clinic, Ft. Worth, Tex. Aug. 26: RAB Clinic, San Antonio, Tex.

SEPTEMBER

Sept. 6: RAB Clinic, Los Angeles. Sept. 7: RAB Clinic, Bakersfield, Calif. Sept. 8: RAB Clinic, San Francisco. Sept. 9: RAB Clinic, Ogden, Utah. Sept. 12-14: CBS Radio Affiliates meeting, Detroit. Sept. 12-16: National Assn. of Educational Broadcasters engineering workshop, Michigan State College, East Lansing. Sept. 19: RAB Clinic, Seattle, Wash. Sept. 20: RAB Clinic, Portland, Ore. Sept. 21: RAB Clinic, Colorado Springs, Colo. Sept. 22: RAB Clinic, Cheyenne, Wyo. Sept. 23: RAB Clinic, Albuquerque, N. M.

OCTOBER

Oct. 3: RAB Clinic, Washington. Oct. 3-5: National Electronics Conference, Sherman Hotel, Chicago. Oct. 4: RAB Clinic, Pittsburgh. Oct. 5: RAB Clinic, Rochester, N. Y. Oct. 6: RAB Clinic, Burlington, Vt. Oct. 7: RAB Clinic, Boston. Oct. 8: Alabama Broadcasters Assn., U. of Alabama, Tuscaloosa. Oct. 17: RAB Clinic, Milwaukee. Oct. 18: RAB Clinic, Chicago. Oct. 19: RAB Clinic, Detroit. Oct. 20: RAB Clinic, Cleveland. Oct. 21: RAB Clinic, New York. Oct. 24-25: Electron devices group of IRE, Shoreham Hotel, Washington. Oct. 31: RAB Clinic, Indianapolis.

NOVEMBER

Nov. 1: RAB Clinic, Louisville, Ky. Nov. 2: RAB Clinic, St. Louis. Nov. 3: RAB Clinic, Memphis, Tenn. Nov. 4: RAB Clinic, Knoxville, Tenn. Nov. 14: RAB Clinic, Minneapolis. Nov. 15: RAB Clinic, Omaha, Neb. Nov. 16: RAB Clinic, Des Moines, Iowa. Nov. 17: RAB Clinic, Kansas City. Nov. 18: RAB Clinic, Wichita, Kan.

TRANSIT RADIO, INC.

(R. C. CRISLER & CO.)

CONVENTION HEADQUARTERS

THE SHOREHAM

(Suite F-707)

Where we shall be happy to see our friends.

RICHARD C. CRISLER

LINTON WELLS

Presidential Precedent

TOMORROW (Tuesday) President Eisenhower addresses the opening session of the NARTB Convention in Washington. It is programmed as an "informal" talk. It is our guess that it will be something more than that, because the President speaks only when he has something to say.

The President talks well off-the-cuff. He has demonstrated this at his news conferences, now thrown open to broadcast coverage. He knows broadcasting not only as the chief of state. He knew how broadcasting was used by the sinister Hitler police state during his tenure as Supreme Allied Commander. He knows about domestic broadcasting through his younger brother, Dr. Milton S. Eisenhower, who has been a student of radio since his days as information director of the Dept. of Agriculture in the 20's.

Tomorrow a precedent will be set. It will mark the first personal appearance by a President of the United States before a broadcasters' convention in the 33 years of organized broadcasting. Every future convention, it is to be hoped, will be addressed by the nation's chief executive, just as the President each year addresses a meeting of one of the national newspaper conventions.

A Word to the Wise

THE spectacular success of a number of the larger entities in broadcasting whose capital stock is available for public subscription has attracted the attention of security underwriters to the point where trouble may be in the offing. The magic of television and the popularity of radio make an attractive package for the average investor, with the result that virtually all of the offerings thus far made have been snapped up and oversubscribed.

Some stock brokers see in this a chance for free-wheeling sales to smaller investors. They are encouraging station licensees (usually with both radio and tv) to package a minority of their holdings, offer it for public subscription, and still retain legal control and management. They argue that such public participation actually strengthens the lot of the broadcaster individually and of the field as a whole, by broadening the investment base. For the investor they point to earnings and expansion prospects.

On the surface, it would appear that the brokers are right on all counts. Certainly most of the companies whose stock is available are successful. RCA (NBC), CBS, Westinghouse, Storer, Meredith, to mention a few, have excellent earning and expansion records. All, however, are long-established and are diversified, in that they are either in other non-licensed pursuits, or have a multiplicity of markets in which they operate stations.

The danger lies in overselling the public, without adequate explanation of the vagaries of licensed operation in the broadcast field. A company having a television station in an existing single or dual-station market may have a most attractive current earning statement. But entry of another station in the market, or loss of a major network affiliation, could swiftly alter that financial picture.

The ordinary stock-selling prospectus would not divulge these negative possibilities. Nor could one expect the Securities & Exchange Commission to be familiar with them. The FCC presumably has no present responsibility in such situations, but members of the Commission are not unaware of the danger, fearing that the zeal to make a profit and pay a dividend might result in a deterioration of station service.

FCC Comr. Robert T. Bartley has repeatedly warned stations, both in his dissenting opinions and in his speeches, that broadcasting "is not a strictly business proposition." He has said its basic asset "does not belong to it. Without the frequency on which it operates, it is a rag, a bone and a hank of hair; a breathless and lifeless thing."

A couple of weeks ago Mr. Bartley dissented from an FCC transfer action involving a public offering by a company operating an am-tv combination in a single market. He wanted a hearing "lest the rights of unknown minority stockholders interfere with the prime responsibility of the licensee to render a public service, as contrasted with the officers' responsibility to public stockholders unfamiliar with the obligations of a broadcast licensee."

Without reference to what goes on in broadcasting, J. Sinclair Armstrong, newly-designated chairman of the SEC, the other day cautioned that neither government regulation nor industry self-



Drawn for BROADCASTING • TELECASTING by Sid Hix

"When Chester doesn't like a show, he insists on getting his money back!"

regulation in securities advertising is proving adequate to protect investors. He warned that prompt steps would have to be taken.

Sale of stock in broadcast enterprises is perfectly legal and proper. The important point, at this stage when owners are being solicited, is to make certain that the stock prospectus clearly sets forth the true and full facts, so that the public will know precisely what it is being offered. Otherwise, all broadcasting could be stigmatized, once unsuspecting speculative investors find themselves losers. Because stations are licensed, any serious public complaint could bring legislative restrictions that could impede the broadcasters' future freedom of action.

Squirrels and Grease Paint

SEN. Richard L. Neuberger (D-Ore.) has been in the Senate a relatively short time, but already he has taken two firm stands on the side of the oppressed.

First, it will be recalled, he took up a defense of squirrels that were being heartlessly evicted from their ancestral homes on the White House putting green.

Second, and more recently, he has come out on behalf of the gullible television audience which he says is being duped by theatrical devices which forgetful and unattractive politicians use to enhance their memories and appearances before the tv camera. Sen. Neuberger has introduced a proposed amendment to the Communications Act to require it to be announced when a politician uses a TelePrompTer or makeup. That way, he believes, the viewer will find it easier to spot the ornamented phonies.

We are certainly in sympathy with anyone who sympathizes with the put-upon, whether squirrels or voters with television sets. But we suspect the senator has a greater cause in his first effort. Squirrels really cannot defend themselves effectively. A nut hurled by even the most powerful squirrel is not apt to create extensive damage.

But the voter—well, he's got a vote, the weapon most feared by the politician. He also has sense enough to spot a phony through the greasepaint, without having to be told that Max Factor may have been among the advisors of a candidate.

The 'American Plan' Prevails

NEXT September an international paradox evaporates. Commercial television debuts in Great Britain. The significance of the event extends much farther than that tight little island.

From the beginning of broadcasting on an international basis in the 1920s, it has always been "The British Plan" of tax-supported operation, versus the "American Plan" of free competitive enterprise. Initially, all of Europe followed the British Plan, because Britannia then ruled Europe's air waves, too.

Today the story is different. In almost every nation, except those under the heel of the Communists, there either is commercial broadcasting in some form, or plans to embark upon it. Thus, the "American Plan" has prevailed in all democratic nations.

Henceforth, the lexicon will change. It will be the "American Plan" versus the "Totalitarian Plan" until the latter collapses.



... COMPLETE NEWS COVERAGE ... BY FULLTIME NEWSCASTERS ... COMPLETE NEWS ...

What makes a great radio newscast? WWJ has the answer: matchless newsgathering facilities, complete coverage, and real "pros" behind the mike.

That's why Detroit's number one news station is *The Detroit News* station. That's why WWJ's popular 15-minute newscasts offer so much extra value to advertising agencies and their clients.

Before you buy any radio in Detroit, check into WWJ's newscasts. Hollingbery will gladly give you a complete rundown on newscasters, ratings, and availabilities.

WWJ **AM**
FM

Associate Television Station WWJ-TV
Basic NBC Affiliate

AM—950 KILOCYCLES—5000 WATTS
FM—CHANNEL 246—97.1 MEGACYCLES

WORLD'S FIRST RADIO STATION • Owned and Operated by THE DETROIT NEWS • National Representatives: THE GEORGE P. HOLLINGBERY CO.

Here's how Lee Little of
KTUC in Tucson adds to his station's
revenue with *Muzak**

I thought you would be interested in learning how very pleased we are with the way our new Muzak franchise is working out.

You will recall that when you and I initially went over the projection of the development possibilities of Muzak in Tucson, I estimated that it would take us from 9 months to a year to reach the "break even point".

I am delighted to tell you that after only 4 months of operation we have been able to sign up a sufficient number of Muzak subscribers to get our franchise operation into the clear.

One of the contributing reasons for our success has been the facility with which we have been able to combine our radio and Muzak business. Our salesmen who sell radio time also sell Muzak. Our transmitter and studio engineers do double duty, they have complete charge of the tapes and do what little maintenance is necessary on the tape machines, and our KTUC bookkeeping department also handles billing on our Muzak accounts.

We have found a ready acceptance for Muzak in Tucson due to the general reputation of Muzak and your national advertising campaign.

If you should ever want to use my name as a reference to any broadcaster potentially interested in a Muzak franchise as a strong source of supplemental income, please feel perfectly free to do so.

Best regards.

Most sincerely,

Lee Little



As a convenience to broadcasters interested in finding out more about MUZAK affiliations, MUZAK has arranged for Hospitality Suite B411-415 at the Sheraton-Park Hotel during the N.A.R.T.B. Convention in Washington. We'd be pleased to see you there. An advance appointment is suggested.

As Lee Little's letter points out, MUZAK affords a most unusual opportunity to profitably supplement your station income.

There are many MUZAK functional background music prospects in your station's coverage area—prospects like offices, banks, factories, restaurants, hotels, super markets, department stores and specialty shops—just to mention a few with whom your salesmen probably are already acquainted and are now calling on.

Of course, there is only one MUZAK—and only one exclusive MUZAK franchise available for each market. We'd be pleased to furnish you further details and discuss the availability of a MUZAK franchise in your city.

*MUZAK—Reg. U. S. Pat. Off.