

MICROSCALE EMISSIONS MODELING SYSTEM

96-316

JEFFREY BRIAN GERFEN

CALIFORNIA POLYTECHNIC STATE UNIVERSITY FOUNDATION

JANUARY 28, 2002

**PREPARED FOR THE CALIFORNIA AIR RESOURCES BOARD AND THE
CALIFORNIA ENVIRONMENTAL PROTECTION AGENCY.**

This Report, "Microscale Emissions Modeling System", was submitted in fulfillment of ARB contract # 96-316 by California Polytechnic State University Foundation under the sponsorship of the California Air Resources Board. Work was completed as of January 25, 2002.

DISCLAIMER

The statements and conclusions in this Report are those of the contractor and not necessarily those of the California Air Resources Board. The mention of commercial products, their source, or their use in connection with material reported herein is not to be construed as actual or implied endorsement of such products.

ACKNOWLEDGEMENTS

Jim Alves
Pulnix Corporation
Provided technical support for Hughes LPR used in this project.

Bill Klyczic
Econlite Corporation
Provided technical support for Econolite Autoscope used in this project.

TABLE OF CONTENTS

Abstract.....	vi
Executive Summary	vii
1. Introduction.....	1
2. Materials and Methods	2
2.1 Phases.....	2
2.2 Quality Assurance and Limitations.....	3
2.3 Theoretical Approach.....	3
2.4 System Overview.....	3
2.5 Electronic and Instrumentation Systems.....	5
2.6 Control Software Description	7
2.6 Electrical and Mechanical Equipment.....	11
3. Results.....	14
3.1 Electronic and Instrumentation Systems.....	14
3.2 Control Software	15
3.3 Electrical and Mechanical Equipment.....	16
4. Discussion.....	17
4.1 Rangefinder Interference	17
4.2 Speed and Acceleration Estimation.....	23
5. Summary and Conclusions	25
6. Recommendations	26
7. References	27
APPENDIX.....	28

LIST OF FIGURES

Figure 1. Overview of system software, including rangefinder control system, integration system, LPR system, and the database system.	4
Figure 2. Rangefinder and Integration computers; a Rangefinder mounted on a pan-tilt unit.....	5
Figure 3. License plate reader (top on left) and LPR camera as installed in the Microscale Emissions Modeling System.....	6
Figure 4. Autoscope Supervisor PC (bottom on left) and the Autoscope camera as installed.	7
Figure 5. Video surveillance system as installed in the operator console.	7
Figure 6. Rangefinder target utilized in referencing the rangefinders to the side of the roadway.	9
Figure 7. Rangefinder scanning target.....	9
Figure 8. Mast controls; air-compressor	11
Figure 9. Mast top complete with rangefinders; view of mast inside van	11
Figure 10. Various views of the roof rack	12
Figure 11. Operator console in Microscale Emissions Modeling System. VCRs and video controls are in the left-hand equipment rack and the PC computer monitor is in the right. AC electrical power system controls and the environmental thermostat are on the far right.	12
Figure 12. Generator and the generator fuel reserve.....	13
Figure 13. One leveling system jack and the leveling system controls	13
Figure 14. Graph showing rangefinder return data with no interference. Note the three successive waveforms that represent the profile of the vehicle traced by each rangefinder.	18
Figure 15. Graph showing rangefinder data with interference.....	19
Figure 16. Magnification of interference problem.....	20

ABSTRACT

The Microscale Emissions Modeling System is a mobile roadside utility that estimates vehicle emissions for a section of roadway. The system utilizes three laser rangefinders to estimate vehicle speed and acceleration and trigger a license plate reader (LPR) for vehicles passing through a selected lane of traffic. A record of speed, acceleration and license plate number is created for each vehicle that passes during a data collection session. The Microscale Emissions Modeling System post-processes the vehicle records to estimate the emissions of each vehicle. The emissions estimates are based on empirically derived lookup tables provided by the ARB Planning and Technical Support Division. These tables relate vehicle emissions to speed, acceleration, and vehicle technology type.

The Microscale Emissions Modeling System was developed inside a full-size passenger van that is capable of self-contained operation on the side of the roadway. The complete system includes mast-mounted laser rangefinders, on-board processing and database computers, and a commercial license plate reader. Roadside testing has indicated that this rangefinder-based system is a viable approach. The installed rangefinders suffer from cross interference, making speed and acceleration measurement unreliable, and hence emissions estimates inaccurate. Upgrading the laser rangefinders to units that do not suffer from interference will solve this problem and give reliable system operation.

EXECUTIVE SUMMARY

Background

Satisfactory mathematical models for determining micro-scale emissions in terms of fleet vehicle age, technology type, and activity do not exist. The California Air Resources Board has significant empirically derived fleet emissions data that can be related to vehicle technology type, speed, and acceleration. The Microscale Emissions Modeling System seeks to marry advanced vehicle sensing technologies with available fleet emissions data to better model roadway emissions based on vehicle speed, acceleration, and vehicle technology type.

The ARB provided Cal Poly with a full-size passenger van, an Econolite Autoscope system, and a Hughes License Plate Reader (LPR). The Autoscope is an off-the-shelf system that utilizes a camera, an image processor, and software to monitor traffic and calculate vehicle speeds. These systems and the van were provided to Cal Poly as a starting point for the Microscale Emissions Modeling System.

Methods

Cal Poly evaluated the performance of the LPR and the Autoscope to determine the feasibility of including them in the to be developed Microscale Emissions Modeling System. The LPR equipment evaluation led Cal Poly to conceptualize a laser rangefinder-based LPR triggering system that is capable of detecting the exact point in time when the rear bumper of a vehicle crosses a precise location. A laser rangefinder is a device that uses bursts of laser light and proven “time-of-flight” technology to determine a target’s distance. This LPR triggering concept was extended to utilize three laser rangefinders to mark the time points at which a vehicle crosses three sequential locations in the roadway, providing enough information to calculate two successive velocities and hence yield an acceleration estimate.

The system design was undertaken with the goal of using an array of three precisely aimed laser rangefinders to perform the tasks of triggering the LPR and estimating the speed and acceleration of passing vehicles. The Microscale Emissions Modeling System design also included: computer systems; a video surveillance, recording, and display system; the AC power generation and distribution system; a pneumatic mast; a vehicle leveling system; a roof rack with walkways and safety railings; an operator console with swivel seat and workspace; and an auxiliary heating and air conditioning system.

Results

The system elements described above were installed and integrated. Subsystem and system testing was completed, with all electrical, mechanical, electronic, computer, and database systems extensively tested. The Hughes LPR is installed and operates properly, allowing the Microscale Emissions Modeling System to record vehicle license plates from departing vehicles in a lane of traffic. The laser rangefinder aiming and control system works as designed, allowing the array of three laser rangefinders to be accurately pointed at three successive points on the roadway. The laser rangefinder control computer and software reliably acquires 2,000 ranges per second from each rangefinder, and provides the appropriate state machine functionality for detection of passing

vehicles. This software also performs speed and acceleration calculations when the rangefinders present valid range data. The emissions calculation and inventory software components are implemented and require final integration and testing once upgraded rangefinders are installed.

Conclusions

The Microscale Emissions Modeling System is nearly complete, and most of the integrated technologies operate as specified. The rangefinder-based speed and acceleration measurement subsystem is the only system not working as designed. The laser rangefinders interfere with each other when aimed at successive points on the roadway, causing inaccurate range readings and hence unreliable speed and acceleration estimation. Cal Poly has performed extensive roadway testing to determine if the rangefinder interference can be eliminated. This testing, along with consultation with the laser rangefinder manufacturer, has indicated that the existing rangefinders will not operate as desired for this application. Replacing the existing rangefinders with units that are designed to not interfere with each other is the only viable path for successful system operation. A new set of laser rangefinders, designed to operate in close proximity without interference, will enable the Microscale Emissions Modeling System to meet its goal of marrying advanced vehicle sensing technologies with available fleet emissions data to better model vehicle emissions.

1. INTRODUCTION

Satisfactory methods for estimating emissions from vehicles on California roadways at a microscale level do not exist. Current models view the fleet on a macroscale level. The California Air Resources Board has significant empirically derived fleet emissions data that can be related to vehicle technology type, speed, and acceleration. The Microscale Emissions Modeling System seeks to marry advanced vehicle sensing technologies with available fleet emissions data to better model roadway emissions based on vehicle speed, acceleration, and vehicle technology type.

The Microscale Emissions Modeling System is a stand-alone mobile tool used to monitor a lane of traffic and estimate vehicle emissions based on vehicle type and activity. The Microscale Emissions Modeling System was implemented as a single system, not intended for production, and is to be used by Air Resources Board (ARB) staff for data collection and emissions estimation. The Microscale Emissions Modeling System output is intended to give users a much more detailed look at emissions activity than is typically available through macro-level emissions models. This output will provide per-vehicle and aggregate emissions estimates for vehicles in a lane of traffic.

ARB provided an Econolite Autoscope vehicle detection system, a Hughes license plate reader (LPR), and a full-size passenger van as baseline equipment for this project. An empirically derived database of emissions data for the fleet of registered California vehicles was also provided by ARB. This database made it possible to link a license plate number to a vehicle type, and more importantly, to expected emissions performance when coupled with vehicle speed and acceleration. This close linkage of vehicle type, activity, and emissions performance intends to model vehicle emissions on a microscale level.

Development of the Microscale Emissions Modeling System assumed that the ARB-provided Autoscope Vehicle Detection System would have sufficient accuracy for estimating vehicle speed and acceleration. This development also assumed that the ARB-provided LPR and emissions database of California vehicles were suitable for integration into the system.

2. MATERIALS AND METHODS

2.1 Phases

The Microscale Emissions Modeling System project consisted of evaluation, design, development and integration, and experimentation and system testing phases. Although these phases sometimes overlapped or required revisiting, project work was largely completed in this order.

Evaluation

The Hughes LPR and the Econolite Autoscope were tested to determine if they were sufficiently capable for inclusion in the system design. Operating characteristics of these devices were observed for later use in the system design. The design phase used knowledge gained from the evaluation phase to design the Microscale Emissions Modeling System. Detailed results from this evaluation are provided in the appendix.

Design, Development, and Integration

The mechanical, electrical, software, instrumentation, and database systems were designed. A system design, which included software prototypes and a cardboard and foam mockup of the to-be-installed operator console, was presented to ARB for approval. System components and development commenced upon receiving this approval.

System components were procured and miscellaneous components fabricated on an as-needed basis. All mechanical, electrical, computer, and instrumentation systems were then integrated. With all hardware integrated, software tools were developed to mechanically control various instrumentation components. The software functionality was tested as it was written. This approach made debugging easier because each piece of functionality was written and tested prior to inclusion in the final system, which simplified troubleshooting.

Experimentation and System Testing

Once all mechanical components were in place and all software controls verified, the real time aspects of the system were tested. The Microscale Emissions Modeling System was moved outdoors and tested on a single lane road on the Cal Poly campus in San Luis Obispo. Vehicle speeds on this road were typically less than 55 Km/Hr (35 mph). The Microscale Emissions Modeling System was positioned about 100 meters upstream from a stop sign, and the detection points started 70 meters upstream from the stop sign. The road was essentially flat, with a very slight upward slope. Real-time testing took place during the summer of 2001. The weather was generally clear and sunny. It was common to have a steady wind ranging from 8-24 Km/Hr (5-15 mph). Wind conditions are relevant as wind has the potential to move the mast and hence add error to measurements.

Specific setup data such as detection point coordinates, rangefinder thresholds for vehicle detection, and rangefinder pan and tilt values were recorded for each data run so that, if need be, the data run could be precisely repeated. As testing proceeded, it became apparent that the exact rangefinder range data used for internal calculations needed to be recorded so system performance could be analyzed using external means such as graphs and spreadsheets. Data recording and presentation

functionality was added to the system, helping to pinpoint and fix subtle system errors and anomalies.

2.2 Quality Assurance and Limitations

System reliability was enhanced through the use of commercial off-the-shelf products whenever possible. The pneumatic mast, generator, heating and air conditioning unit, leveling system and the roof-rack were all obtained off-the-shelf. The rangefinder control software was designed using established software engineering techniques. Comprehensive system testing was also performed to ensure quality.

The LPR requires careful setup. Additionally, the LPR is an early generation model and therefore may be less accurate than later models. The LPR can not provide license plate reads interactively due to its vintage, requiring that read license plate data be transferred to the integration computer via floppy disk. It is necessary to transfer license plate data to the integration computer so that vehicle records can incorporate license plate numbers.

The aggregation of tolerances in rangefinder aiming may affect the accuracy of speed and acceleration measurements. It is anticipated that once a rangefinder array can be reliably utilized, rangefinder-based speed measurement will be accurate to within 5%.

2.3 Theoretical Approach

The Microscale Emissions Modeling System is a mobile roadside utility used to estimate the amount of vehicle emissions given off over a specific section of road. Using an array of laser rangefinders that can check for the presence of a vehicle 2000 times a second, the system measures the activity of vehicles through a designated area of a single lane. As vehicles exit this area, the vehicle's license plate is read and its speed and acceleration are estimated. This information is later passed through a mathematical model to determine emissions information for the roadway. The model utilizes ARB-supplied formulas and also utilizes existing emissions information regarding vehicle type and vehicle history. This emissions data is then presented to the user in a per-vehicle and an aggregate format.

2.4 System Overview

Figure 1 below shows a high-level diagram of the Microscale Emissions Modeling System, subdivided into four elements. A brief description of the primary functions of each of these system elements follows.

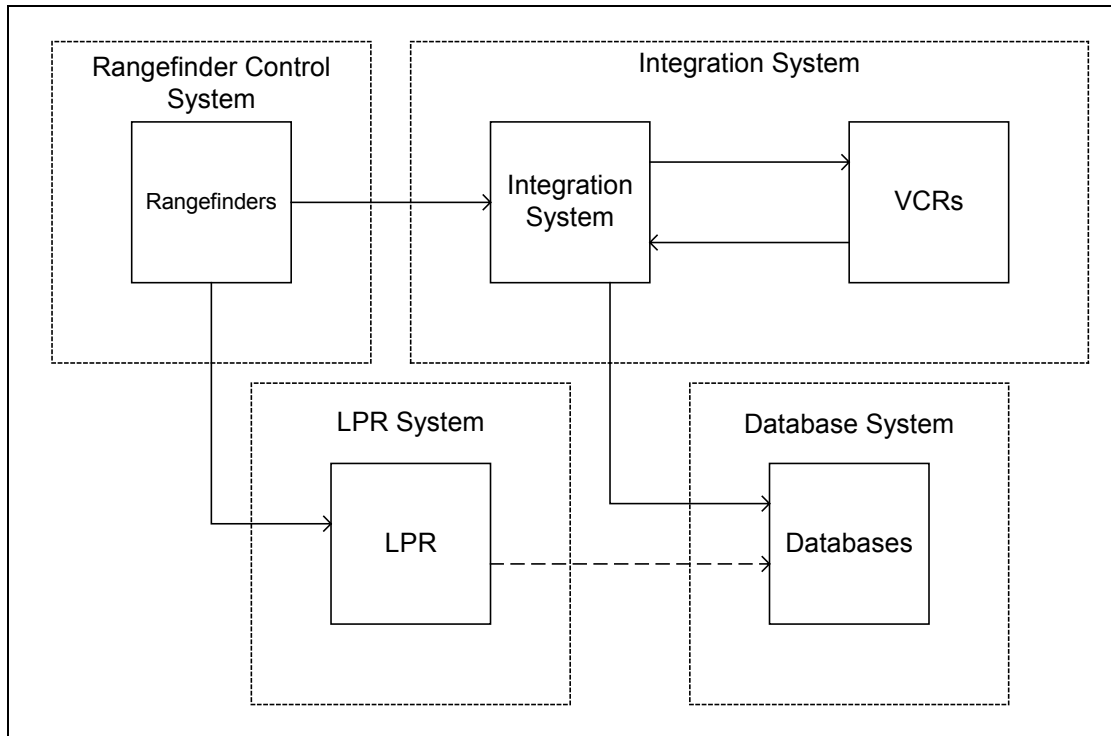

Figure 1. Overview of system software, including rangefinder control system, integration system, LPR system, and the database system.

Rangefinder system. The rangefinder system utilizes a computer to provide command, control, and data acquisition functions, allowing an array of three laser rangefinders to estimate vehicle activity for a lane of traffic. Specifically, this system estimates vehicle speed and acceleration. It also provides an electronic trigger to both the LPR when vehicle events occur.

Integration system. The integration system records information during data collection, receiving vehicle speed and acceleration records from the rangefinder system in real time and querying the VCRs for time stamps for each vehicle event. The integration system also performs all emissions calculations and inventory operations after data collection.

License plate reader system. The LPR system reads license plates for passing vehicles from the LPR camera and writes the read license plate number and a TIFF image of the license plate to a file. The LPR system operates stand-alone, with its only connection to the rest of the systems being an electronic trigger it receives from the rangefinder system. Information gathered about license plates is transferred to the integration computer via floppy disk during data processing.

Database system. The Microscale Emissions Modeling System utilizes two databases. The first is a small active vehicle event database used to collect and archive vehicle events and their associated estimated emissions during data collection and processing. The second database is a large, static database of over 20 million California vehicles. This vehicle database was provided by the Air Resources Board and must be accessed with an ARB-provided software utility.

2.5 Electronic and Instrumentation Systems

The Microscale Emissions Modeling System utilizes several different pieces of system hardware that are either controlled or monitored by software systems. System hardware includes laser rangefinders and their pan-tilt units, the LPR system and its cameras, the Autoscope and its camera.

Laser Rangefinders.

The Microscale Emissions Modeling System uses three Riegl laser rangefinders, model number LD90-3100VHS, to detect vehicle presence. The laser rangefinders use a “time of flight” technique to measure distance to the target. During operation, each rangefinder emits a collimated burst of light for a very short period of time, approximately 10 nanoseconds. This burst of light travels forward until it reflects off of an object. Upon reflection, the laser light is scattered in all directions. This means that the reflected light energy in any one direction is very low. Some of this low-level reflected energy will travel directly back to the rangefinder. The reflected laser light will be distinguishable by the rangefinder’s receiver lens from the other light that it receives because laser light is a denser, more directed form of light. Even a low-level version of this laser light will be detectable over sunlight reflected from other objects.

The rangefinder control computer is a Pentium II, 350 MHz PC with 64 megabytes of RAM and runs MS-DOS 6.22. A Dolphin ISA four port serial expansion card is installed on the rangefinder control computer, allowing use of more than the two standard serial ports, which is required to control the three laser rangefinders and communicate with the integration computer. Figure 2 shows the rangefinder and integration computers, as well as one of the three rangefinders mounted on its pan-tilt unit. The small camera mounted to the left of the laser rangefinder is used as a sighting camera during rangefinder aiming, helping to verify the location rangefinder is aimed at.

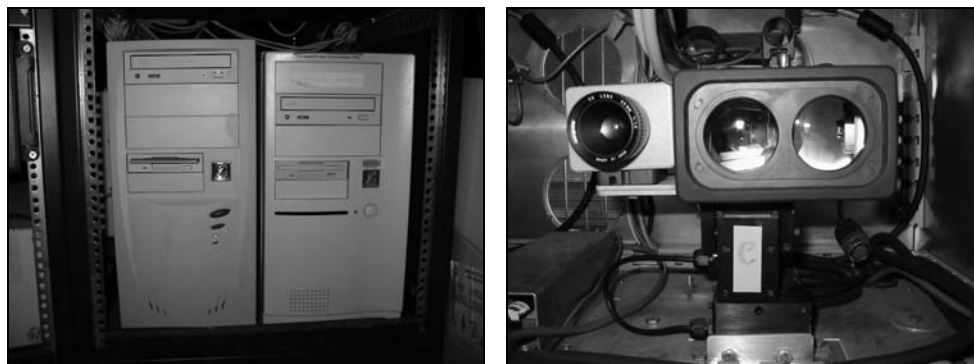

Figure 2. Rangefinder and Integration computers; a Rangefinder mounted on a pan-tilt unit

Each rangefinder reports 2000 range readings per second to the rangefinder control computer via a 115.2 KB/s RS-232 serial connection. Each rangefinder is mounted with its sighting camera on a pan-tilt unit. Each pan-tilt unit is connected to a pan-tilt controller. The array of controllers are connected to the integration computer via a single RS-232 connection. The integration and rangefinder computers are also connected to each other through a serial connection.

License Plate Reader System.

The Microscale Emissions Modeling System utilizes a Hughes LPR to electronically read license

plates as vehicles pass through the observed lane of traffic. The LPR camera must be calibrated through the LPR's software for accurate license plate reading. The LPR system utilizes an advanced camera with a high-speed light sensor to mitigate shifting light levels due to changing environmental conditions, such as clouds passing overhead or the sun moving in the sky.

The computer running the LPR software is a 486-level PC with 8 megabytes of RAM. The PC runs MS-DOS 6.00. All license plate data read with this system must be transferred to the integration computer via floppy disk. Figure 3 shows the LPR processing unit and the LPR camera.



Figure 3. License plate reader (top on left) and LPR camera as installed in the Microscale Emissions Modeling System.

Econolite Autoscope.

The Econolite Autoscope utilizes a non-zoomable monochrome surveillance camera and an image processing unit to measure vehicle activity. The Autoscope serves two functions in the Microscale Emissions Modeling System. First, the Autoscope video is captured on VCR to document traffic conditions during data collection. This VCR is frame controllable, providing the ability to later access video at specific time points. Second, the Autoscope acts as a secondary, independent data collector of vehicle activity in the lanes surrounding the monitored lane. The Autoscope will record and document general traffic conditions from these surrounding lanes in the form of average speed, lane occupancy, and count for each lane. Even though the Autoscope is not being utilized in its planned role of measuring vehicle speed and acceleration for emissions estimation, it still provides useful traffic information that can help put collected estimated emissions data in context with local traffic flow.

The Autoscope Supervisor PC is a 486-level PC with 8 megabytes of RAM. It runs Microsoft Windows 3.1. Figure 4 shows the Autoscope and Autoscope camera.



Figure 4. Autoscope Supervisor PC (bottom on left) and the Autoscope camera as installed.

Video Surveillance System

The video surveillance system consists of two RS-232 frame-controlled Super VHS VCRs, two color monitors, video switches, and system video cameras. These cameras are the LPR camera, the Autoscope camera, and the three rangefinder sighting cameras. The video surveillance system provides the following functionality:

- View video from any camera on the video monitors
- Record camera video with the VCRs
- Pan and tilt the LPR and Autoscope cameras
- Zoom and focus the LPR camera



Figure 5. Video surveillance system as installed in the operator console.

2.6 Control Software Description

Rangefinder Control and Data Acquisition

The rangefinder computer communicates with the three rangefinders, the LPR, and the integration computer. High-speed packets sent out by each of the three rangefinders are read and interpreted at a 2 KHz rate by the rangefinder computer. The system can discriminate the rangefinder packets into abnormal readings, various errors, bad packets, lack of vehicle, and vehicle presence.

Each rangefinder traces a vehicle's profile as it passes through the rangefinder's beam at freeway speeds. The rangefinder system tracks vehicles as they pass through the three rangefinder beams,

noting the time points when the vehicle exits each rangefinder's beam. The system uses these time points that the vehicle departs each rangefinder beam and knowledge of the distance between the beams to determine speed and acceleration. Speed and acceleration information are then transferred to the integration computer via serial communications port as they occur. The rangefinder computer also generates an electronic trigger for the LPR for every vehicle event.

Real-time system operation data such as current rangefinder distance, vehicle presence, etc. can optionally be displayed to the user to aid in troubleshooting system errors. The rangefinder system also provides the capability to record rangefinder output traces for later analysis. This feature was used to generate the rangefinder data presented in the discussion section of this report.

Integration System

The integration computer communicates with the rangefinder computer, the VCRs, and the pan-tilt controllers to support data collection and analysis. Data from the LPR computer is merged with data on the integration computer after it is transferred via floppy disk. The following subsections describe integration system software operations from a functional perspective.

Target scanning. The integration computer is capable of controlling rangefinder pan-tilt unit movement in any direction. Movement resolution can be set from 0.01285 degrees to 12.85 degrees per move. The system utilizes a known size target, which is placed at a known location to the side of the lanes where the system will be operated. This referencing to the roadway allows the rangefinders to then be aimed at desired detection points on the roadway. Target scanning is accomplished by placing the reference target directly in front of the van at a distance of about 40 meters. Each rangefinder is manually aimed at the target using the pan-tilt controls built into the integration computer's graphical user interface. The rangefinder sighting cameras are used during this process to aid in manual camera aiming. Figure 6 shows how the target is placed to the side of the roadway for target scanning. Note the detection points that the rangefinder will be later aimed at. Figure 7 shows the actual target that is placed on the side of the roadway.

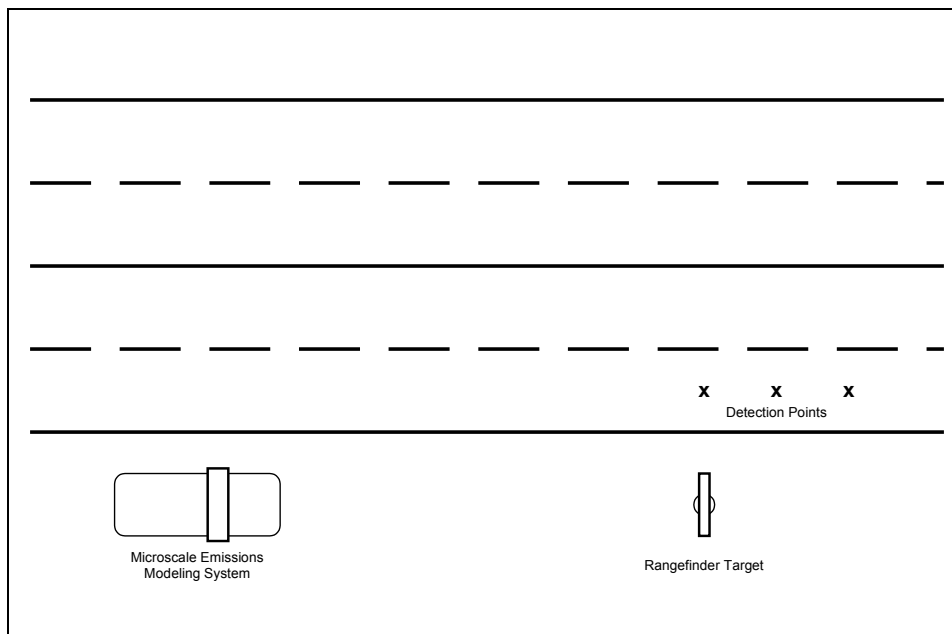

Figure 6. Rangefinder target utilized in referencing the rangefinders to the side of the roadway.



Figure 7. Rangefinder scanning target.

Automatic target scanning is initiated once the target is manually acquired. The integration computer causes the rangefinder to slowly move from side-to-side and up and down on the target, searching for range value increases that indicate where the edges of the target are. Once the edges have been determined, the center of the target is estimated. Knowledge of the center of the target is known via physical measurements on the ground and pan-tilt settings determined during automatic target scanning, effectively referencing the rangefinder to a known point on the roadway. This target scanning process is performed for each rangefinder and allows the each rangefinder to be later pointed at desired detection points in the roadway.

Detection points. The integration system performs geometry calculations that translate desired detection point locations on the roadway to pan-tilt angles for the rangefinders. These calculations take the reference information for each rangefinder pan-tilt unit that is generated during the target scanning process. Detection points are specified in downlane and crosslane distances from the location of the mast on the vehicle. The process aiming the rangefinders allows detection points to be individually locked in once they are set. Rangefinder aiming at detection points is automated by the rangefinder control computer, only requiring the operation to specify points, observe the rangefinder moving by watching the video image from its sighting camera, and then accepting the detection point by pressing a button on the graphical user interface.

Event collection during roadway data collection. The integration computer receives vehicle events containing speed and acceleration from the rangefinder computer via serial port for every valid vehicle detected. Upon receiving these events, the integration computer queries the Autoscope and LPR VCRs to get their time stamp for the current event. The Integration computer then creates a record in the event database containing:

- speed
- acceleration
- Autoscope video VCR timestamp
- LPR video VCR timestamp

This database is capable of holding records from multiple roadway data collection sessions, allowing

data to be later retrieved based on session start and end times.

Data merging. License plate data must be merged with vehicle event data after roadway data collection efforts because the LPR is incapable of providing license plate data electronically in real-time. The integration computer has graphical user interface controls that guide the operator through the following steps:

1. inserting a floppy disk drive in the LPR
2. loading it with the LPR output text file and the license plate TIFF image files from the license plates read during the session
3. inserting the floppy in the integration computer so the LPR output data can be merged with vehicle event database

Data merging then automatically parses the LPR output file from the floppy drive and associates each read license plate number with the appropriate vehicle record from the roadway data collection session. Each LPR TIFF image file on the floppy is also associated with a vehicle event. The end result of this operation is that the vehicle event database contains the following information for each vehicle observed.

- speed
- acceleration
- license plate number
- the TIFF image of the license plate from the LPR
- Autoscope video VCR timestamp
- LPR video VCR timestamp
- time of day the event occurred

Post-processing for license plate verification. The integration system provides an semi-automated system for post-processing vehicle events to correct and verify read license plate numbers. Integration system post-processing utilizes the time-stamps from the VCRs to access camera images from vehicle events. Post-processing steps the operator through each vehicle event, allowing them to observe the following:

- the TIFF image of the license plate read
- the license plate number generated by the LPR
- the video image from the LPR VCR from the vehicle event
- the video image from the Autoscope VCR from the vehicle event

Post-processing controls allow the operator to manually change license plate numbers read if they determine by looking at the presented image video and TIFF images that the LPR's estimation of the license plate number is incorrect.

Emissions estimation and inventory. The integration system performs the task of emissions estimation and inventory based on the data contained in the vehicle event database. Emissions estimation is comprised of feeding read license plate numbers to the ARB-supplied VIN decoder, which returns a VIN number for each license plate. The VIN number is then associated with the other vehicle data in the vehicle event database, creating vehicle records that now include VIN

number. The VIN number is then used to access vehicle technology types from the ARB-supplied database. Once technology type is known, vehicle emissions are then estimated through the use of ARB-supplied emissions equations. These equations require vehicle speed, acceleration, and vehicle technology type as inputs. These equations may be easily modified at a later date to incorporate changes or additional emissions models

2.6 Electrical and Mechanical Equipment

The Microscale Emissions Modeling System's electrical and mechanical equipment includes the pneumatic mast, the operator console, the roof rack, the vehicle leveling system, the electrical power system, and the auxiliary heating and air conditioning system.

Pneumatic mast system

A Will-Burt 6-27 pneumatic mast is used to elevate the instrumentation platform to approximately 9.5 meters above the roadway surface. The mast is secured to the floor of the vehicle and protrudes through the roof via a weatherproof sleeve. The mast system utilizes an air compressor and a set of valves and air lines to raise and lower the mast for operation. Controls for the air compressor are located on the roof of the van to help prevent accidental raising. A very noticeable warning system is located on the dash of the van to make the driver aware of when the mast is raised and the engine is on. Figure 9 shows the mast valve controls as well as the vehicle's air compressor. Figure 10 shows views of the pneumatic mast.



Figure 8. Mast controls; air-compressor



Figure 9. Mast top complete with rangefinders; view of mast inside van

Roof Rack

The vehicle roof rack provides mounting locations and access for the generator and its fuel tank and battery, the mast controls, and the mast-top instrumentation that includes cameras and rangefinders. The roof rack has a walkway and a safety railing, with access provided via ladder on the rear of the van. Figure 10 shows the roof rack with the large protective enclosure that holds the the mast-top instrumentation beam for storage and transport.



Figure 10. Various views of the roof rack

Operator Console

The operator console utilizes two commercially manufactured equipment racks as the supports for the operator's worktable and other equipment mounting and control panels. The operator console seats one person in a swivel-seat with seat belt and provides access to all computer and instrumentation systems, the video surveillance and recording system, the electrical power system, and the auxiliary heating and air conditioning system. Figure 11 shows the operator console.



Figure 11. Operator console in Microscale Emissions Modeling System. VCRs and video controls are in the left-hand equipment rack and the PC computer monitor is in the right. AC electrical power system controls and the environmental thermostat are on the far right.

AC Electrical Power System

The AC power system provides power at 120 VAC to operate all on-board instrumentation and computer systems, the heating and air conditioning system, and the air compressor for the

pneumatic mast. The AC system consists of a 5500 watt Onan gasoline generator mounted in a protective enclosure on the roof rack, a automatic transfer switch allowing operation from either shore power or generator power, main circuit breakers, AC power distribution switches that allow systems to be turned on and off individually, two uninterruptible power supplies, and a shore-power cable that allows the van to be plugged into utility power. Figure 12 shows the Onan generator with its battery and fuel tank.

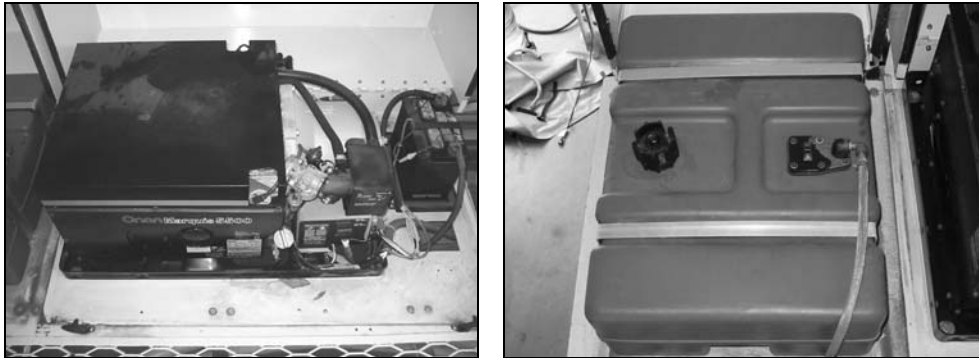

Figure 12. Generator and the generator fuel reserve

Vehicle Leveling System

The vehicle leveling system allows the van to be leveled when parked. This system has the added benefit of stabilizing the vehicle to reduce mast-movement due to people moving around in the van. The controls for the system are located in a protective enclosure located under the operator console. Figure 13 shows one of the four electric-hydraulic jacks and the leveling system controls. The leveling system is fully controlled from inside the van and is powered from the vehicle's DC battery system.



Figure 13. One leveling system jack and the leveling system controls

3. RESULTS

3.1 Electronic and Instrumentation Systems

Laser Rangefinders

- The three laser rangefinders are installed with their sighting cameras on robotic pan-tilt units in a protective enclosure on top of the mast-top beam and can successfully generate 2000 reliable range readings per second when operated individually.
- The laser rangefinder pan-tilt units are networked via a two-wire control network and can be set to pan-tilt positions with .00127 degree resolution via serial communications commands.
- The laser rangefinders and pan-tilt unit power and signals are wired from in-vehicle systems to the top of the mast via a set of well labeled and documented terminal blocks at each end of the connection.

License Plate Reader System

- The Hughes image processing unit is installed in the operator console equipment rack.
- Two LPR camera mounting locations with associated cabling are installed, giving two LPR camera operation options.
- The LPR dynamic light level sensor is installed on the roof rack.
- The LPR system is operational with the camera installed in either of the provided mounting locations.

Econolite Autoscope

- The Autoscope Supervisor PC and Machine Vision Processor are installed in the operator console equipment rack.
- The Autoscope camera in its weatherproof housing is installed on a pan-tilt unit on top of the mast-top equipment beam and cabled to the Autoscope equipment inside the van.
- The Autoscope system is operational and generates roadway data for multiple lanes of traffic.

Video Surveillance System

- Video surveillance and recording equipment, which includes video switches, Super VHS VCRs, pan, tilt, and zoom controls, and monitors are installed in the operator console.
- The video surveillance system is operational, allowing all camera outputs to be observed and recorded.
- Both the Autoscope and the LPR cameras can be panned and tilted from the operator console. The LPR camera can also be zoomed and focused.

3.2 Control Software

Rangefinder System Software

- The rangefinders can be commanded to operate in either single range mode or in 2000 range per second streaming mode.
- 2000 range readings per second can be received and processed concurrently from the three rangefinders on a continuous basis.
- Vehicles can be tracked as they move downlane through the three consecutive rangefinder detection points.
- Vehicle events are detected and speed and acceleration calculated when a vehicle passes successively through the three detection points and when no rangefinder interference is present.
- Successful vehicle events cause a data packet containing speed and acceleration to be transmitted to the integration computer via serial communications port.
- Successful vehicle events cause the LPR system to be triggered and the vehicle's license plate to be read.

Integration System Software

- The rangefinders can be panned and tilted to any position within their range of motion via manual and automatic software controls in the integration system software.
- The roadside reference target can be automatically scanned, referencing rangefinder aiming to the roadway and hence automatically removing errors resulting from rangefinder movement in their mounts or drift in the zero reference of the rangefinder's pan-tilt unit.
- Rangefinders can be automatically pointed to any (x,y,z) coordinate on the roadway a once they have been referenced to the roadway via target scanning.
- Vehicle detection events received from the rangefinder control software via serial communications port are stored in the vehicle event database upon reception.
- The vehicle event database can store vehicle events from multiple data collection sessions, allowing any vehicle event to be recalled if the data and time of the event are known.
- Vehicle events result in the querying and reception of timestamps from each of the VCRs.
- Automatic data merging of the vehicle event database cause LPR output data to be associated with each vehicle event from a data collection session.
- Semi-automated vehicle event post processing allows the read license plate number to be visually verified against VCR images and the LPR-generated TIFF image of the license plate if desired.
- Emissions data for each vehicle can be obtained from the ARB-supplied database of California vehicle emissions using the verified license plate values and the ARB-supplied database query utilities.

3.3 Electrical and Mechanical Equipment

- The pneumatic mast is installed and can be raised and lowered via rooftop controls.
- The AC electrical generation and distribution system is installed and provides conditioned power that can be switched on and off on a per system basis.
- The operator console and roof racks are installed and perform as desired, providing a safe and comfortable work environment.
- The vehicle leveling system allows the Microscale Emissions Modeling System to be leveled and stabilized once parked on site.
- The auxiliary heating and air conditioning system provides a comfortable work environment.

4. DISCUSSION

Development of the Microscale Emissions Modeling System has required stepping back to solve problems on more than one occasion. These problem-solving efforts included both switching the operating system on the rangefinder computer from Windows NT to DOS to make it capable of receiving and processing 2000 ranges per second for three rangefinders and making the decision to use laser rangefinders to measure vehicle speed and acceleration rather than the Autoscope that was specified in the contract. Two problems were significant enough in nature to warrant further discussion here. They are rangefinder interference, which has made the system inoperable, and the calculation of speed and acceleration in real-time as range samples are received.

4.1 Rangefinder Interference

The most costly problem in terms of time and resources was interference between the laser rangefinders. The better part of the summer of 2001 was spent investigating and attempting to remedy this problem.

Problem description.

The interference problem occurs during rangefinder operation when laser light from one rangefinder is reflected off the target back to a different rangefinder, causing that second rangefinder to do one of two things. The rangefinder may see the reflection from the first rangefinder and believe that that is its own reflection, causing the second rangefinder to read an incorrect range. Or, the rangefinder could see both reflections at near enough the same instant that they wash each other out, causing the rangefinder to not make a reading.

Manifestation of interference.

Below are two figures that give a fair indication of how the interference causes incorrect operation within the Microscale Emissions Modeling System. In order to understand how “interference” looks, it is important to understand how “no interference”, or proper operation, appears.

Figure 14 represents laser rangefinder data without interference for a passing vehicle. The graph shows three straight lines, each consecutively interrupted by an awkward dip. The three lines each represent the values returned by each rangefinder (y-axis) as time progresses (x-axis). Each line corresponds to one of the three rangefinders used in the speedtrap. The speedtrap consisted of three rangefinders watching the center of a single lane of traffic. The rangefinders’ three beams were placed between three and four meters apart. The rangefinders returned range readings as they watched this point on the road. As vehicles pass through the beams, the range readings decrease corresponding to the height of the vehicle in the rangefinder beam.

The bottom trace of Figure 14 (at about the 25,000 mm range) represents the ranges returned by the first rangefinder in the speedtrap setup; the upper line (at about the 32,000 mm range) represents the ranges returned by the last rangefinder in the speedtrap setup. The straightness of each line shows the nominal range value of the roadway for that rangefinder. The dip shows where the vehicle passed through the rangefinder’s beam. Lower range values signify that a higher point, such as the hood, roof, or trunk of the vehicle is being seen by the rangefinder.

Figure 14 is a good example of what each rangefinder should see. The dips are very similar in shape and length. This means that each rangefinder traced the same points on the vehicle and that the vehicle was traveling at about the same speed through the speedtrap. Additionally, the difference in time between the vehicle passing through each successive rangefinder beam (at $x \approx 1800$, $x \approx 2400$, and $x \approx 2900$) remains steady. This confirms that the vehicle was traveling a near constant speed through the speedtrap.

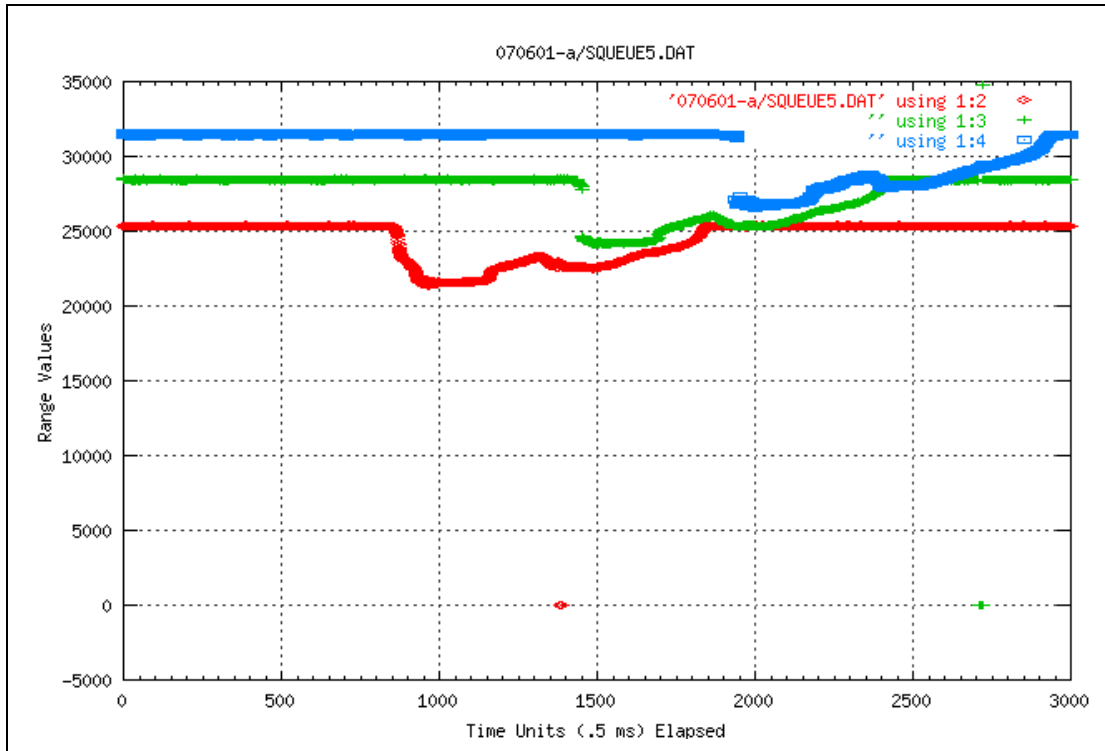

Figure 14. Graph showing rangefinder return data with no interference. Note the three successive waveforms that represent the profile of the vehicle traced by each rangefinder.

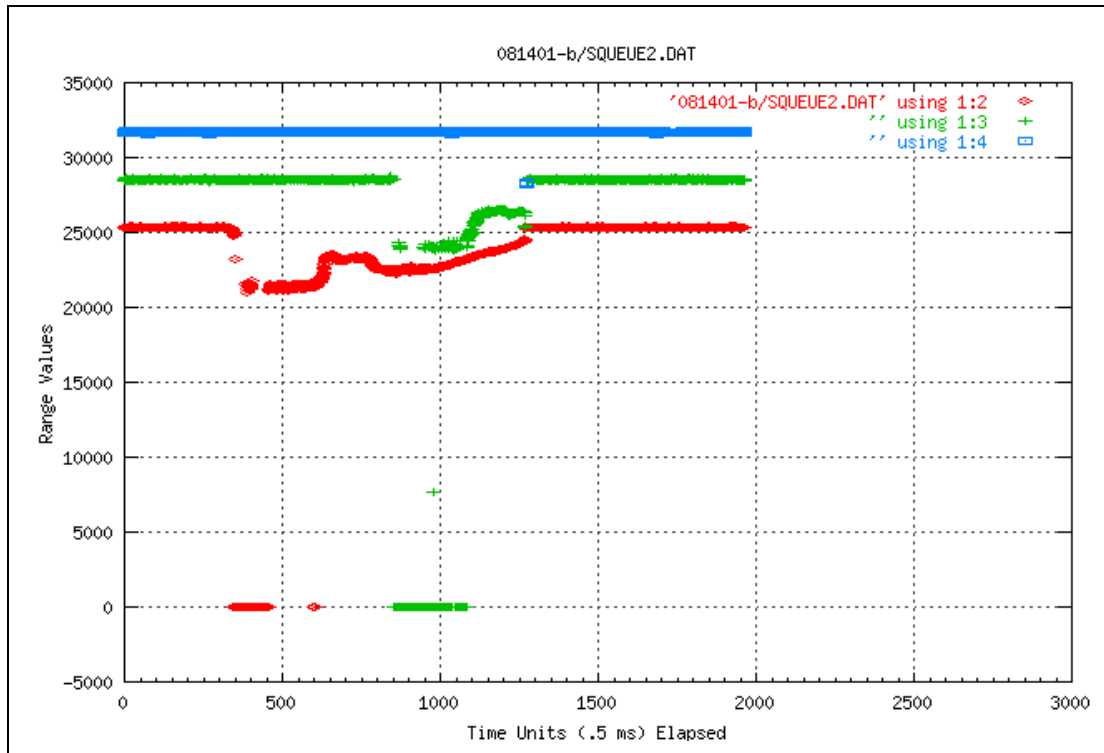

Figure 15. Graph showing rangefinder data with interference.

Figure 15 provides a stark contrast to Figure 14. Where Figure 14 was symmetrical and sequential, Figure 15 is abrupt and jagged. The graph in Figure 15 begins very normally. At about $x=860$, the vehicle becomes present in both the first and second rangefinders' beams. From about $x=860$ to $x=1240$, there is no evidence of interference. This can be told from the fact that the graph of the second rangefinder's values is pretty symmetrical to the first rangefinder's values from $x=280$ to $x=680$. At $x=1280$, however, the vehicle abruptly leaves the speedtrap altogether.

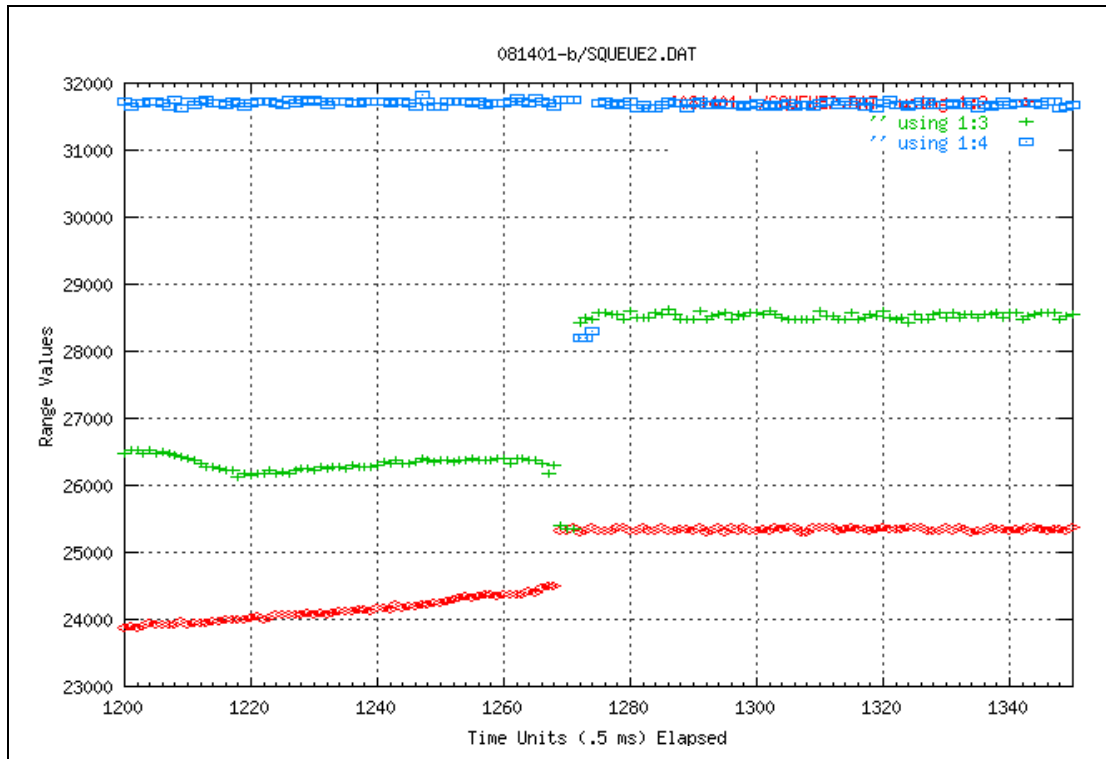

Figure 16. Magnification of interference problem

It is fair to say that the vehicle exited the beam of the first rangefinder at this point in time. The second rangefinder should continue to see it. This is apparent in Figure 16, which shows that the vehicle was seen by the second rangefinder for about 600 time units (about 300 microseconds) after it had exited the first rangefinder (from $x=1850$ to $x=2450$). Knowledge of the speedtrap setup and the vehicle's progress through at a constant velocity makes it impossible to believe that the graph shows valid information. When this data was taken, the distance on the road between the first and second rangefinder beams was about twelve feet. A vehicle cannot, at one instant, be present over two points four meters apart and then, one half a millisecond later, have passed over both of them. In order to do this, a vehicle would have to be traveling over 26000 KM/hr.

To further show the interference problems in Figure 15, Figure 16 zooms in to the points between $x=1200$ and $x=1350$. In Figure 16, $x=1268$ is when the vehicle leaves the detection point. It is at this point that the ranges for detection point A jump from about 24500 to about 25400. Immediately following this point in time, the vehicle also exits the second detection point. This is shown by jump in range values from about 26200 to 28500 on the line composed of plus signs ('+'). It is also at this point in time where detection point C both detects and loses the vehicle. This can be seen by the presence of three boxes near the point (1272, 28300). The three boxes represent range values reported from detection point C and account for detection point C's detection of the vehicle.

Throughout data collection, many graphs were collected that show very similar interference problems as Figure 16. Every graph of this kind would end very suddenly at or near the point the vehicle is shown to have left the first rangefinder's beam. Because this is such a consistent property, it cannot be mere coincidence. Somehow, the rangefinders must be interfering with each other's range readings.

An attempted solution using aperture reduction.

Upon discovery of the interference problem, Riegl USA (the rangefinder manufacturer) was contacted for comments and suggestions. One of their first suggestions was to mount pipes in front of the receiver lenses of the three rangefinders. These pipes were to act as an aperture that would limit the field of view of a rangefinder, effectively blocking reflections from other rangefinders. This solution is akin to looking through a paper towel tube, and having your field of vision reduced.

The logic behind this is simple. The receiver lens is the eyeball of the rangefinder. With the receiver lens being at the front edge of the rangefinder, light from all angles – including a very wide peripheral angle – can get into the lens. By putting an aperture reducing pipe on the receiver lens, the rangefinder is essentially being given tunnel vision. There is no longer a wide peripheral view. Instead, the lens can only receive light from a small cone of perception. The idea behind doing this to the rangefinders was that, if that cone of perception could be made *just* small enough, then it would be impossible for the reflected light of one rangefinder to make it into the view of another rangefinder.

The aperture reducers were constructed from polyvinyl chloride (PVC) pipes. A faceplate designed to match the rangefinder's layout was securely fastened to the rangefinders. Various length pieces of PVC pipe were attached and detached from this faceplate to act as the actual aperture reducer. Each reducer was covered by a piece of copper foil. A small hole was cut into the center of this foil cover to act as the aperture.

Initial tests did not fully take into account the effect of road slope on the cone of perception. It was discovered that road slope caused the aperture reducer's cone of perception to have elongated ends running down the slope of the road. Once the elliptical properties of the cone of perception became apparent, a change in aperture shape was attempted. The biggest concern with this modification was that the apertures would be cutting off too much light from the rangefinders, and negatively affect the system.

An aperture in the shape of a bow-tie was tried next. It was decided that, in order to defeat the extended ends of the ellipses and still let light in, an aperture that blocked out light coming from the top and bottom of the pipe, but not the sides or the center, could be beneficial. When this failed to provide adequate correction, an investigation of the test procedures was done. It was decided to attempt to eliminate – or, at the least, limit – the human and environment error involved in these tests. Possible human and environment error included not centering the aperture over the lens, attaching the pipe at an off-center angle, or slightly knocking the pipe off center through wind or a jostle.

The long pipe with a large aperture was eliminated. Attached to the aperture faceplates was a small piece of PVC pipe. This was used by the longer PVC attachments as a means of attaching to the faceplate. This shorter section of pipe was used as the new aperture reducer. Since it was permanently attached to the faceplate, misalignment was a much smaller worry than with a long pipe.

A 5 cm long pipe with a 4 mm circular aperture was tried. This is congruent with the longer pipes that had been tested. The rangefinders received very few signals back with this arrangement. The

aperture was widened, and more success was recorded. However, by widening the aperture, the theory of reducing the aperture was weakened because the established congruency was being eroded. In the end, it was decided that the rangefinders rely too much on the amount of light received for this solution to work. At such great distances, the aperture would have to be so small for the system to block out neighboring signals that not enough light would be let in for the rangefinder to operate properly. Riegl engineers agreed with this assessment.

A second attempted solution using a polarizing filter.

Riegl also suggested that a polarizing filter placed in front of each receiving lens would attenuate the signal enough to be able to distinguish the rangefinder's own signal from the interfering signals. An infrared polarizing filter with a bandwidth of 780-1000nm was recommended. The polarizing filter, if adjusted correctly over the lens, would be able to filter everything entering the lens except the laser light. The rangefinder would still be seeing interfering signals from neighboring rangefinders, but, since there wouldn't be any other light to get in the way, the rangefinder would be able to distinguish the more powerful laser light (its own light) from the weaker laser light (the interfering light).

Interference testing indicated that two things were happening to cause bad values. First, the laser light from one rangefinder would reflect itself into a neighboring rangefinder; that rangefinder would then interpret that interfering laser light as its own and give an incorrect range reading based on that. Second, an interfering signal would enter a rangefinder at or near the same time as the rangefinder's valid signal. This interfering signal would be strong enough, or even opportune enough, to inhibit the rangefinder's ability to distinguish the valid signal from everything else. This means that interfering signals can be strong enough to be indecipherable from valid signals, making this an unreliable solution.

More importantly, the filters are a bad idea because of their lack of robustness for long-term system operation. Instructions from Riegl described a very precise process to find the point to which the polarizing filters should be screwed in. If this location is not found, the effectiveness of the filters dwindles. The precision of location necessary for these filters makes it a very illogical choice. Assuming the best location is found for the filter, there is no method of ensuring that the filter will stay in that spot. Movement of the van, the mast, or the rangefinders could all cause the filter to move. If this were to happen, it could be very difficult for the user to know this, and system performance diminished.

Other ideas.

A few more suggestions were investigated. Riegl suggested changing the lasers' wavelengths so that each rangefinder was operating on a different wavelength. Riegl later said that that idea was not feasible because it would require expensive modifications to the rangefinders.

Another idea dealt with the rangefinders' ability to be turned on and off through its serial communications port. The purpose of these commands is to be able to turn the rangefinder off when it is to be unused for a long period of time. The idea that was investigated was to use those commands to run the rangefinders in succession, so that only one rangefinder is on at a time. The code would turn off all rangefinders. When it is time to get a range, it would turn the first rangefinder on. When that range was gathered, it would turn that off, and the next one on. This

would continue until all three ranges were collected, and the code would continue as it is. The hardware limited this option, though. The rangefinders need time to turn on and off before a range can be collected. The collective delays from this setup could cause ranges to be read once every second, instead of the current 2000 times a second. Also, the rangefinders claim to take up to 15 minutes before consistently valid and accurate values are returned. Riegl also stated that constant power cycling could greatly reduce rangefinder life.

Replacement Solution.

The most reliable and complete solution Riegl offered was replacing the current rangefinders with newer models. According to Riegl, the new model rangefinders can be externally triggered to request a range value. The trigger doesn't actually turn the laser off. Instead, it inhibits light output except during the trigger period. Riegl states that a triggering board could be built that would trigger each rangefinder in succession, allowing three valid range values to be acquired every 500 microseconds, or 2000 times per second.

This solution would eliminate rangefinder interference, which is caused by rangefinders emitting light simultaneously and not being able to discriminate their signal from that of others. With this trigger board, the rangefinders will never be operating at the same time. The first rangefinder will emit a beam, receive its range, and turn off. There will be a small space in time here (possibly <100 microseconds), and then the second rangefinder will emit a beam. These gaps in time will ensure that the rangefinders are never operating when light is being reflected from another laser.

The drawbacks of all other solutions would be erased here. The rangefinders will never interfere with each other, so all ranges will be valid ranges. The rangefinders would also operate with sufficient speed so that time resolution would be lost.

4.2 Speed and Acceleration Estimation

Another difficult problem dealt with the timing of taking ranges. In order for the system to consistently return valid information, it was necessary to demand that the processing of rangefinder readings be completed in a small finite period of time, so that the requirement of receiving and processing one reading from each rangefinder 2000 times per second would not be violated.

Description of Problem.

Velocity is calculated by dividing distance traveled by the amount of time to cover the distance. In order for the speedtrap computer to calculate velocity, it must therefore know how long a vehicle was in the speedtrap. The small size of the speedtrap combined with the rapid speed of vehicles moving at freeway speeds necessitates a timebase accurate to within 1 millisecond.

The rangefinders return a range value once every 500 microseconds. Because this is such a constant, it is the best time metric the speedtrap computer can use. To use this as a pacemaker, the speedtrap code must be ready and waiting for the rangefinder value when it shows up; the speedtrap software must run in well under 500 microseconds without fail.

Solution.

Tests that were performed to determine the length of time the software required to acquire and

process range values. As stated above, the software needs to be acquire and process a range reading from each rangefinder within the 500 microsecond window, so that it will be ready to repeat the operation for the next set of range readings. If the time measured is greater than 500 microseconds, then the software is taking too long and the goal of acquiring three range readings every 2000 microseconds will not be met. This measurement was accomplished by connecting a logic analyzer to the computer's parallel port. A signal would be set high for a short period of time when the range was acquired, and then set back low. The logic analyzer would be able to show the difference in time between these spikes, indicating how long the software took to acquire and process a range reading.

The first case of mismanaged code timing encountered had to do with the graphical user interface designed for the MS-DOS environment (DOS GUI) on the rangefinder computer. The DOS GUI was placed into the rangefinder code so that real-time system debugging could take place. It essentially displays all information pertaining to the rangefinders – current range value, current state, number of errors, etc – as they change. The first time the timing test was run with the DOS GUI on, it was discovered that the DOS GUI was taking 3.5 ms to refresh the screen every time a set of three range readings were acquired. This means that instead of getting a range every 0.5 ms, a range was being acquired every 4 ms. The DOS GUI is a very useful tool, and it would be very inappropriate to remove it from the system. Instead, it was decided that the DOS GUI should be able to be switched on and off, allowing it be utilized during system troubleshooting. This allows the code to run in its allotted timeframe, unless the user wants to see the DOS GUI. When the DOS GUI is drawn, it will still take its 3.5 ms, but the user will have discretion as to when that 3.5 ms should be sacrificed. The DOS GUI would typically be used observe the actual range readings on the fly during system troubleshooting.

Another major timing mistake that was made involved sending messages over the serial port. The code for sending a multiple byte packet initially sent the packet one byte at a time. However, between these single bytes, the code was delayed by 5 milliseconds. For the packet being sent, this caused a 45 milliseconds delay, which is 90 times slower than the code should be. The reason for the delay was to ensure the serial buffer wouldn't overflow. This situation was remedied by taking advantage of the code's ability to run in 500 microseconds under normal circumstances. Instead of sending the large, multi-byte packet at once, the code sends the packet one byte at a time. To keep the buffer from overflowing, the code waits for three loops through the code before sending the next byte out. This process separates the bytes by a comfortable 1.5 milliseconds without causing any delay to the rest of the code.

5. SUMMARY AND CONCLUSIONS

The Microscale Emissions Modeling System is a mobile roadside utility that estimates vehicle emissions for a section of roadway. This system is desired because current modeling techniques do not provide the ability to determine emissions in terms of fleet vehicle age, technology type, and activity at a microscale level. This project, which included integration and testing of laser rangefinder sensing technologies, a license plate reader, an Autoscope vehicle detection system, development of control and integration software, and use of ARB supplied databases, has led Cal Poly to the following conclusions:

- A reliable LPR trigger can be obtained by processing the output of a single laser rangefinder aimed down at traffic from above and behind as described in the appendix.
- An array of three laser rangefinders can be utilized to estimate vehicle speed and hence acceleration if the rangefinders are prevented from interfering with each other.
- The Econolite Autoscope vehicle detection system does not provide sufficient speed measurement accuracy for this project, as is described in the appendix. However, the Autoscope is suitable for quantifying vehicle activity in the lanes surrounding the specific lane being monitored for emissions estimation.
- Robotic pan-tilt units provide a suitable aiming device for laser rangefinders, creating the ability to direct a laser rangefinder to a desired location on the roadway.
- For real-time computer processing operations with hard timing requirements, DOS offers significant advantages over the more sophisticated Windows NT operating system. DOS provides direct access to the computer's hardware and does not utilize computer system resources for non-critical operations such as providing a graphical user interface.
- The Hughes LPR utilized in this project is capable of providing accurate license plate reading if set up and calibrated properly, as is described in the appendix.
- The electrical and mechanical systems on-board the Microscale Emissions Modeling System have proven themselves to be stable and reliable, hence making the vehicle a suitable platform for roadside data collection and experimentation.

6. RECOMMENDATIONS

The comprehensive rangefinder interference analysis along with the completed state of all other systems indicates that the Microscale Emissions Modeling System is viable if the rangefinders are replaced. Cal Poly recommends that the ARB purchase three new non-interfering rangefinders for installation and integration into the Microscale Emissions Modeling System, making it operational.

7. REFERENCES

- 1) Stallings, William. Data and Computer Communications, Third Edition, Macmillan Publishing Company, 1991
- 2) Black, Uyles. Physical Level Interfaces and Protocols, Institute of Electrical and Electronics Engineers, 1988
- 3) Thomas, Robert M., DOS 5 Instant Reference, Sybex, 1991
- 4) Hogan, Thom. The Programmers PC Sourcebook, Microsoft Press, 1988
- 5) Harrington, Jan L. SQL Clearly Explained, Morgan Kaufmann, 1998
- 6) Johnson and Kalin. Object Oriented Programming in C++, Prentice Hall, 1995
- 7) Bar-David, Tsvi. Object Oriented Design for C++, Prentice Hall, 1993
- 8) Ulrich and Eppinger, Product Design and Development, McGraw Hill, 1995
- 9) Brooks, Frederick P. The Mythical Man Month – Essays on Software Engineering, Addison-Wesley, 1974
- 10) Econolite Corporation, Autoscope 2004 Users Manual
- 11) Hughes Corporation, LPR 3000 Users Guide

APPENDIX

MICROSCALE EMISSIONS MODELING

EQUIPMENT EVALUATION

MAY 1998

MICROSCALE EMISSIONS MODELING

EQUIPMENT EVALUATION

May 1998

California Polytechnic State University

San Luis Obispo

TABLE OF CONTENTS

1. INTRODUCTION	3
2. KEY ISSUES	4
2.1 VEHICLE SPEED AND ACCELERATION MEASUREMENT	4
2.2 LICENSE PLATE READER TRIGGERING.....	4
2.3 LICENSE PLATE READING	4
3. EQUIPMENT ANALYSIS	5
3.1 ECONOLITE AUTOSCOPE 2003	5
3.1.1 <i>Autoscope Performance Objectives</i>	5
3.1.2 <i>Autoscope Speed Measurement</i>	5
3.1.3 <i>Autoscope Vehicle Detection, Classification, and Lane Occupancy</i>	5
3.1.4 <i>Autoscope Acceleration Measurement</i>	6
3.1.5 <i>Factors Affecting Operation</i>	6
3.2 HUGHES LICENSE PLATE READER	6
3.2.1 <i>License Plate Reader Performance Objectives</i>	7
3.2.2 <i>License Plate Reader Testing</i>	7
3.2.3 <i>Factors Affecting Operation</i>	12
3.3 LPR TRIGGER GENERATION	14
3.3.1 <i>LPR Trigger Requirements</i>	14
3.3.2 <i>Tested LPR Trigger Methods</i>	15
3.3.3 <i>LPR Trigger Test Data</i>	16
3.3.4 <i>Operational Notes</i>	16
4. SOLUTIONS AND OPTIONS	18
4.1 ROADWAY CONFIGURATIONS	18
4.2 SUBSYSTEM SOLUTIONS.....	18
5. SUMMARY	22

1. INTRODUCTION

This document provides an overview of the equipment analysis performed by Cal Poly to determine the viability of the Microscale Emissions Modeling System. Key issues are described in section 2. Section 3 provides an analysis of existing equipment including the Econolite Autoscope, the Hughes license plate reader (LPR), and LPR triggering. Section 4 provides solutions and options for implementing the Microscale Emissions Modeling System.

2. KEY ISSUES

The Microscale Emissions Modeling System must estimate vehicle speed and acceleration, trigger a License Plate Reader (LPR), and successfully read the associated license plates. The system must perform these tasks on freeway on and off-ramps, main-line freeway lanes, two lane highways, and surface streets.

2.1 Vehicle Speed and Acceleration Measurement

The system must measure vehicle speeds ranging from 5 to 75 mph with an accuracy of 5 mph. Vehicle accelerations and decelerations of up to 10 mph/sec must be determined to within 1 mph/sec.

2.2 License Plate Reader Triggering

The LPR uses an external trigger to acquire an image of a vehicle's rear license plate. A sensor monitors the roadway and generates a trigger signal when the back of the vehicle is in the LPR camera's field of view. The existing Hughes LPR allows a two-foot window along the roadway in which a license plate will be in the frame and focused. If the trigger signal is too early or late, the vehicle's license plate will either not have reached this window, or will have already passed through it. The LPR trigger, therefore, must be accurate in time, enabling the LPR camera to capture an image of the vehicle license plate.

2.3 License Plate Reading

The LPR must successfully read the license plates for passing vehicles. The accuracy and trigger tolerance of the ARB Hughes LPR are both reduced by moving its camera away from the side of the road or up into the air. The rectangular shape of a license plate becomes trapezoidal as the camera is moved away from a direct rear-view, causing a reduction in accuracy.

3. EQUIPMENT ANALYSIS

3.1 Econolite Autoscope 2003

The Autoscope 2003 was tested at Cal Poly to ensure its operability. Prior research completed by Cal Poly was utilized to characterize the accuracy of the device for measurement of speed and acceleration.

3.1.1 Autoscope Performance Objectives

The following performance objectives were established for the Autoscope:

speed measurement	classify speeds of 5 to 75 mph to within 5 mph
vehicle classification & count	classify vehicles and provide vehicle counts
acceleration measurement	classify accelerations and decelerations of 1 to 10 mph/sec to within 1 mph/sec

3.1.2 Autoscope Speed Measurement

Autoscope Testing at Cal Poly The Autoscope 2003 was tested on highway 227, south of San Luis Obispo. The Autoscope was found to be malfunctioning. Econolite repaired the Autoscope and further testing showed the device to be operational.

Previous Autoscope Testing by Cal Poly Under work on a previous project (*Video Image Processing Systems Applications In Transportation - Cal Poly/Caltrans 1994*), the Econolite Autoscope 2003 was shown to provide average absolute speed measurement accuracy within 4 percent. These tests were conducted under similar conditions to those in which the Autoscope is expected to be utilized on this project. This comprehensive testing utilized frame-by-frame video analysis to characterize the accuracy of the Autoscope 2003.

3.1.3 Autoscope Vehicle Detection, Classification, and Lane Occupancy

Vehicle Detection The Autoscope provides vehicle detection in the form of a real-time electronic signal that indicates when a vehicle is present over a specific area of the roadway. This detection signal can possibly be used to qualify other signals such as the LPR trigger.

Vehicle Classification and Count The Autoscope is able to classify vehicles as either automobiles, single-unit trucks, or semi-tractor trailers, and provides a vehicle count of all vehicles traveling through a lane. Vehicle classification and count data may be useful for extrapolating emissions estimates for missed vehicles from measured vehicles (those with valid license plate reads), to account for the entire set of vehicles that passed through the lane during the measurement period. For example, if the LPR is able to read 80% of passing vehicles, and the distribution of vehicles by class is known for all vehicles, then total emissions may be estimated. This estimation is based

on knowing the emissions for the measured 80% of vehicles and distributing average emissions values by vehicle class for the other 20% based on the total distribution of vehicles by class.

Lane Occupancy The Autoscope provides lane occupancy data, which is the percent of lane space taken up by vehicles. Lane occupancy and speed data may be useful for estimating the relatively small accelerations/decelerations occurring on freeway lanes through the use of freeway acceleration models.

3.1.4 Autoscope Acceleration Measurement

The Autoscope can measure acceleration in some cases, such as freeway on and off ramps and intersection departures, where accelerations are large enough to detect. Other acceleration measurements -- such as within freeway mainline lanes -- are more difficult due to the small accelerations/decelerations to be measured. Measurable instances have not been confirmed/quantified/tested for accuracy. Small accelerations may be modeled using vehicle speed and lane density data.

3.1.5 Factors Affecting Operation

Light Levels Prior research indicates that the Autoscope works best in daylight or complete darkness. Performance degrades during daytime/nighttime transitions. No testing has been completed to verify this fact since it is anticipated that the Microscale Emissions Modeling system will be used during daylight hours.

Occlusion The Autoscope camera must be mounted high enough to allow it to see over the top of vehicles in between the camera and the lane being observed.

Weather Econolite technical staff have indicated that the Autoscope will work in inclement weather, but with reduced accuracy. This expected accuracy reduction has not been quantified through testing or specifications provided by Econolite. It is anticipated that the Microscale Emissions Modeling System will not be used in inclement weather.

3.2 Hughes License Plate Reader

The Hughes license plate reader (LPR) was tested to further understand its operational limits and capabilities. This testing resulted in a better understanding of the instrument's configuration procedures, the video camera's operation and interaction with the LPR, and environmental factors that affect both the instrument and camera. Lessons learned and quantitative test results will be expanded later in this document, along with suggestions for future operation and use.

LPR testing required several iterations to understand how to correctly configure the device. Once correct configuration of the LPR was understood, correct reads on the order of 60 to 80 percent of all passing vehicles were possible with post-processing.

3.2.1 License Plate Reader Performance Objectives

When considering LPR performance, it is necessary to understand the different types of errors that can occur. All vehicle license plates can either be classified as either readable or non-readable. A plate is readable if it is installed on the back of the vehicle, is of standard configuration (i.e. a standard issue California plate), and is not illegible or obscured. For readable plates, the LPR will produce one of four outcomes:

- read correctly
- read incorrectly with one or more errors
- plate located and captured but not read
- plate not located

The accuracy of license plate reads can be increased through the use of semi-automated post processing, which allows a human operator to review suspect plate reads and make corrections. The human operator will be able to successfully read plates unreadable by the LPR due to factors such as large license plate frames, trailer hitch balls obstructing the plate, and plates being commemorative, government, or from out of state. Because the Hughes LPR is designed to operate in the near-ideal conditions of a toll plaza (camera mounted 6 feet off the ground, directly to the rear of the vehicle), it is important to understand how the system will operate when its camera is moved to different viewing positions. Specifically, it is important to understand how LPR performance is affected by moving the camera position away from the center of the observed lane and elevating it above the standard mounting height of 5 feet. The effect of these camera position variations will determine if the LPR is suitable for use viewing interior freeway lanes.

The following measures of LPR performance were established to guide LPR testing efforts:

- percent of all passing vehicles read correctly
- percent of all passing vehicles read correctly with help of post-processing
- effect of camera distance from center of lane on plate reading performance
- effect of camera elevation on plate reading performance

3.2.2 License Plate Reader Testing

The LPR was tested under a variety of conditions in order to understand the effects of camera placement and light conditions on accuracy. Camera placement was adjusted as much as practical to simulate LPR use on lanes adjacent to the edge of the roadway and interior freeway lanes.

The LPR was tested in three locations: along the side of the southbound on-ramp to highway 101 at Grand Avenue, southbound Highway 227 south of San Luis Obispo, northbound Highway 227 south of San Luis Obispo. The LPR was installed in the Cal Poly test van, with its camera located outside on a tripod. The triggering device was placed downlane from the test van and LPR camera so that the LPR captured the rear license plates of vehicles after they drove past the test van.

Physical Geometry Referring to Figure 3.1 below, several distances and geometric relationships must be clarified to understand Tables 3.1 and 3.2 at a glance. Points A and C are imaginary locations within the center of the roadway lane of interest. Point B is the location of the video camera. The line segment BC is the hypotenuse of right triangle ABC; its length is found by the equation: $(BC)^2 = (AC)^2 + (AB)^2$

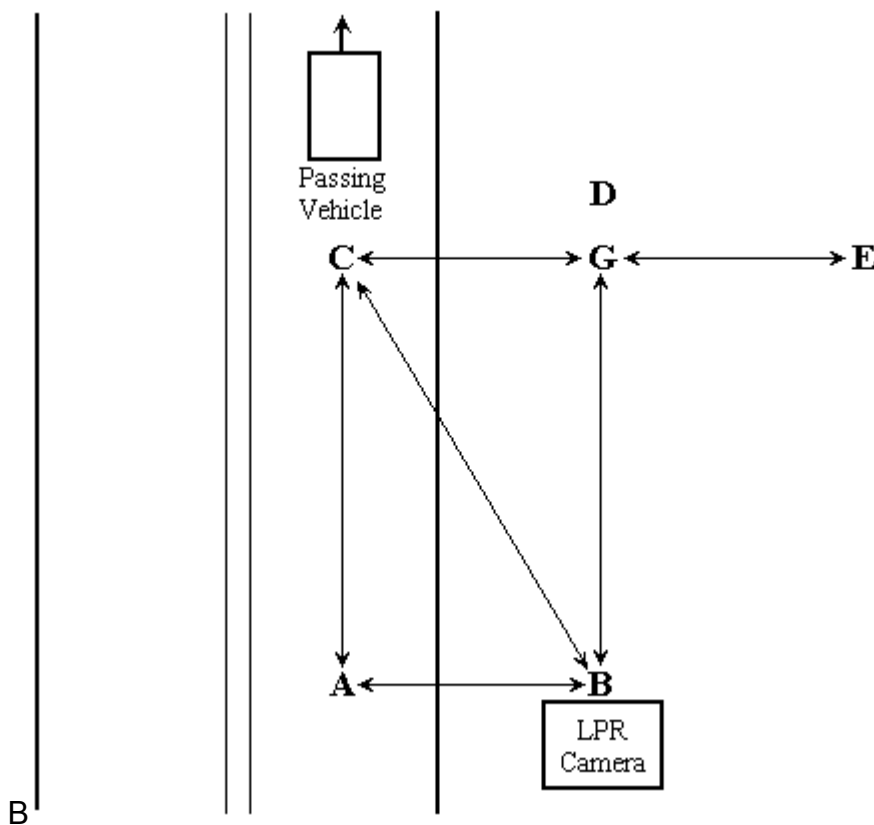

Figure 3.1 LPR setup geometry on roadway

While calibrating the LPR camera, a mock-up license plate must be at the same distance from the camera as the real plates to be read. Placing the mock-up at point D accomplishes this provided that line segments BC and BD are equivalent, and segments BD and AB are perpendicular. At point D the apparent size of the license plate is nearly the same as plates read from the roadway. It is preferable, however, to make the plate's angle of incidence the same as well. This is possible by placing a mock-up plate at point E, such that line segments CG and GE are equivalent and perpendicular to segment GB, and angles CBG and GBE are equal.

If the camera is to be raised above its normal height for viewing interior lanes, define point F (not shown on this two-dimensional diagram) as the distance above the normal tripod height. In this case, a mock-up plate at point E may be used to calibrate the LPR and the video camera without changes. Point D may be used to calibrate the LPR and the video camera if the following equation is used (solid geometry instead of plane geometry):

$$BC^2 = AB^2 + AC^2 + BF^2$$

Table 3.1 below shows the roadside geometries for each of the datasets tested.

DATASET	MEASURED						CALCULATED		
	AB	CG	BG	BD	GE	BF	BC	BE	∠ACB
120297A	10'	10'	50'	50'	n/a	n/a	51'	n/a	11.3 ☐
120297B	22'	22'	50'	54'	n/a	n/a	54.6'	n/a	23.7 ☐
120397A	20'	20'	50'	53'	n/a	n/a	53.9'	n/a	21.9 ☐
120397B	20'	20'	50'	53'	n/a	n/a	53.9'	n/a	21.9 ☐
120397C	11'	11'	50'	51'	n/a	n/a	51.2'	n/a	12.4 ☐
120497A	15.5'	15.5'	50'	n/a	15.5'	n/a	52.3'	52.3'	17.1 ☐
120497B	15.5'	15.5'	50'	n/a	15.5'	n/a	52.3'	52.3'	17.1 ☐
120497C	27.5'	28'	87.5'	n/a	22'	n/a	91.9'	90.2'	17.8 ☐
120497D	27.5'	28'	87.5'	n/a	22'	7'	92.1'	90.5'	17.8 ☐
052798A	20'	20'	75'	n/a	20'	n/a	79.1'	79.1'	14.9 ☐
052798B	20'	20'	75'	n/a	20'	n/a	79.1'	79.1'	14.9 ☐
052798C	20'	20'	75'	n/a	20'	n/a	79.1'	79.1'	14.9 ☐
052798D	20'	20'	75'	n/a	20'	n/a	79.1'	79.1'	14.9 ☐
052798E	20'	20'	75'	n/a	20'	n/a	79.1'	79.1'	14.9 ☐

Table 3.1 Roadside geometry dimensions for LPR testing.

Trigger Two different trigger systems were used for these tests, a laser trigger and the laser rangefinder. The cross-road laser trigger was used for all tests up to dataset 120497D. In the absence of roadway activity, the laser detector maintains an unbroken beam across traffic with the aid of a stationary reflector to return the laser light to the detector. Traffic moving away from the camera breaks the laser beam and a trigger signal is produced by the detector when the departing vehicle clears the beam. This laser trigger beam crossed both directions of Highway 227, creating false and

corrupted triggers. These bad triggers were discounted during post-processing data analysis.

The laser rangefinder trigger was used for all datasets after 120498D. This rangefinder trigger was used in both cross-road and overhead modes and provided a trigger which was not susceptible to interference by traffic outside of the lane of interest.

Test Results Tables 3.2 and 3.3 below summarizes the collected LPR data. All data was hand validated by comparing LPR output with the captured LPR image for each vehicle observed.

Dataset	total # vehicles observed	# read correctly by LPR	# vehicles read incorrectly	# vehicles not read	# reads corrected	total % correct plates read	camera distance to center of lane	Notes
120297A	35	22	2	10	8	86 %	10'	On-ramp. Sunny and bright conditions.
120297B	70	14	5	51	17	44 %	22'	On-ramp. Setting sun directly into camera lens caused significant glare. Near dark conditions.
120397A	n/a	n/a	n/a	n/a	n/a	n/a	20'	On-Ramp. Test suspended due to changing light conditions.
120397B	21	7	7	7	11	86 %	20'	On-ramp. Bright light caused contrast problems and suspension of data collection.
120397C	195	128	4	63	42	87 %	11'	Highway 227 southbound. High clouds, diffused light.
120497A	89	39	2	48	18	64 %	15.5'	Highway 227 northbound. High clouds, diffused light. Noticed camera view of plates was tilted due to crown in road.

Table 3.2 LPR test results using cross-road laser trigger.

Dataset	total # vehicles observed	# read correctly by LPR	# vehicles read incorrectly	# vehicles not read	# reads corrected	total % correct plates read	camera distance to center of lane	Notes
120497B	77	37	6	34	23	78 %	15.5'	Highway 227 northbound. High clouds, diffused light. Removed tilting plates by rolling camera to compensate - found that accuracy improved.
120497C	122	56	3	63	26	67 %	27.5'	Highway 227 northbound. High clouds, diffused light.
120497D	144	54	15	75	49	72 %	27.5'	Highway 227 northbound. High clouds, diffused light. Getting dark. Camera 12.5' above ground.

Table 3.2 continued. LPR test results using cross-road laser trigger.

The results from data sets 120297B and 120397A are suspect due to poor light conditions. Data set 120497A is suspect due to uncompensated roadway crown causing tilting license plate images. Jim Alvs of Hughes verified that roadway crown will reduce system performance if not properly compensated for. All data except for data set 120497D were taken with the camera 5 feet off the ground, the recommended camera height. Data set 120497D was taken with the camera 12.5 feet off the ground to simulate an elevated camera used to view interior freeway lanes.

Table 3.3 shows LPR test results which were taken using the laser rangefinder trigger. The first three datasets, 052798A, B, and C were taken with the laser rangefinder operating in cross-road mode. Datasets 052798D and E were taken with the laser rangefinder in overhead mode.

It is important to note that LPR testing involved a learning process and some data sets, which seem to indicate poor LPR performance, are a result of trying new approaches to configuring the LPR system. The last two datasets, 052798D and E, which show good performance, had the benefit of all prior learning in addition to the overhead laser rangefinder triggering and increasing the field of view by zooming further out. These last two datasets, with post-processed accuracy in the range of 85%, are indicative of how the LPR should be able to work as part of the Microscale Emissions Modeling System.

Dataset	total # vehicles observed	# read correctly by LPR	# vehicles read incorrectly	# vehicles not read	# reads corrected	total % correct plates read	camera distance to center of lane	Notes
052798A	99	45	9	45	15	61%	20'	Highway 227 northbound. Bright sunlight - plates had half shadows. Cross-road laser rangefinder trigger
052798B	139	55	18	66	49	75%	20'	Highway 227 northbound. Bright sunlight - plates had half shadows. Cross-road laser rangefinder trigger
052798C	103	55	10	38	24	77%	20'	Highway 227 northbound. Bright sunlight. Increased field of view. Cross-road laser rangefinder trigger
052798D	138	80	17	41	36	84%	20'	Highway 227 northbound. High clouds - diffused sunlight. Increased field of view. Overhead laser rangefinder trigger. Rangefinder 25' from center of observed lane.
052798E	112	69	9	40	27	85%	20'	Highway 227 northbound. High clouds - diffused sunlight. Increased field of view. Overhead laser rangefinder trigger. Rangefinder 39' from center of observed lane.

Table 3.3 LPR test results using cross-road and overhead laser rangefinder trigger.

3.2.3 Factors Affecting Operation

During LPR testing, the following factors were observed to have a negative effect on data system accuracy.

Light Levels - Glare, Darkness, etc. The LPR is designed for operation during daylight hours and works best under consistent light conditions, whether they be bright or cloud diffused sunlight. Operation under changing light conditions, such as the sun

moving in and out of clouds, is possible if a camera with automatic gain and iris controls were used, as per Jim Alvs of Hughes. The current LPR camera, provided by Hughes, uses manually controlled iris and gain, requiring that the camera be setup for a single light condition. If lighting changes, system performance will degrade. The LPR system will be outfitted with an automatic gain control system controlled by a light meter when installed in the Microscale Emissions Modeling System. Hughes currently sells their LPR systems with this gain control feature.

The LPR has poor performance when the sun shines into the camera lens, creating glare and poor contrast. Also, the LPR will not work in the dark.

Vehicle Speed and Position in Lane Vehicle speeds during data collection ranged from 20 to 40 mph for the data sets taken on the on-ramp (first four data sets) and from 40 to 75 mph for all data sets taken on Highway 227 (the last ten data sets). Vehicle speed appears to have no effect on LPR accuracy.

LPR testing was performed with the camera at different distances from the center of the monitored lane, ranging from 10 to 27.5 feet (distance AB in Table 3.1). These distances simulated using the LPR to measure lanes other than the one closest to the edge of the roadway. Total LPR read performance appears constant across the range of 10 to 22 feet, and drops by about 10% for a distance of 27 feet. These are rough observations and significantly more data would be required to accurately quantify the relationship between distance AB and LPR accuracy. Also, due to the manual setup requirements (hand adjustment of gain potentiometer during setup) of the LPR camera, it was not feasible to test the LPR with the camera higher than 12.5 feet, a height which was obtained by placing a tripod on top of the ARB Dodge van.

Roadway Crown Roadway crown appears to have a negative effect on LPR performance and needs to be compensated for by rolling the camera a few degrees in the direction of the roadway slope. Jim Alvs of Hughes verified this observation.

Inclement Weather The LPR was not tested in inclement weather. Test efforts centered on trying to make the LPR work under good weather conditions.

Field of View The LPR field of view can be increased by zooming the camera lens out from the field of view recommended by Hughes. Three datasets (052798C, D, & E) were taken under this condition with no apparent reduction in accuracy. Further data would need to be taken to verify this.

Occlusion The LPR camera must be mounted high enough to be able to view an interior freeway lane without the view being impeded by vehicles in lanes closer to the shoulder.

Proper Equipment Setup Set-up and configuration of the LPR as well as the video camera calibration, are vital to the accuracy of the LPR's image-capture and optical character recognition functions. Improper setup will lead to significantly degraded LPR accuracy.

3.3 LPR Trigger Generation

Different LPR triggering methods were tested with the LPR. This testing resulted in better understanding of both triggering techniques and LPR operation. LPR trigger requirements are presented in this section, along with trigger methods tested, and LPR triggering test results.

3.3.1 LPR Trigger Requirements

The ideal trigger point is a vertical plane crossing the roadway as shown in Figure 3.2, such that a vehicle's rear license plate is in the center of the camera's field of view as the vehicle crosses this plane. The Hughes LPR requires that the license plate be within plus or minus one foot of that plane. Moving the LPR camera away from the side of the roadway or up in the air reduces this tolerance to less than one foot due to viewing the backs of vehicles from an angle.

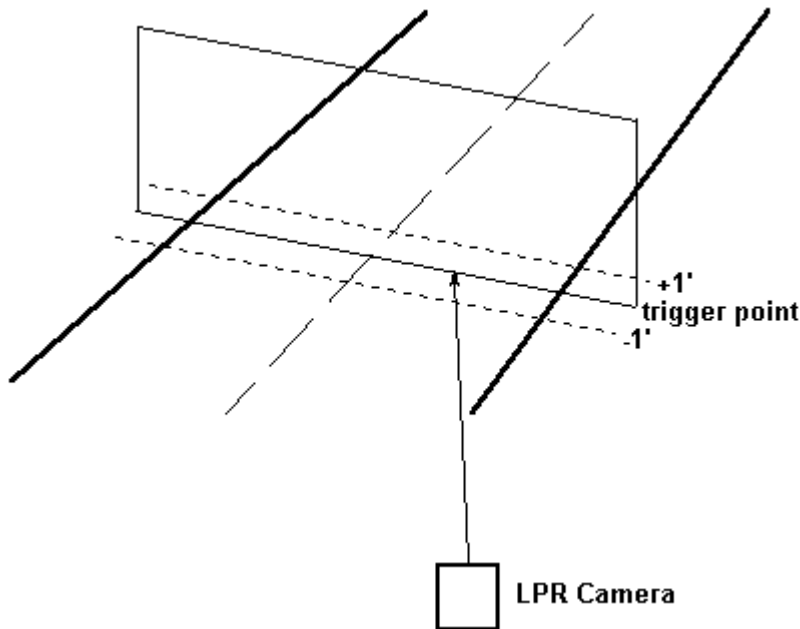

Figure 3.2 LPR trigger plane.

If the trigger signal is too early or late, the vehicle's license plate will either not have reached this window, or will have already passed through it. Therefore, the LPR trigger must be accurate in time to capture an image of the vehicle's license plate. For example, a vehicle traveling at 110 feet per second (75 mph) will travel one foot in about 9.1 ms. The trigger signal for this vehicle must be within plus or minus 9.1 ms of the vehicle crossing the trigger plane in order for the vehicle's license plate to be captured within the plus or minus 1 foot triggering window.

LPR trigger requirements are as follows:

time accuracy	the LPR trigger must occur when the vehicle is within plus or minus 1 foot of the trigger plane.
reliability	the LPR trigger should trigger on all vehicles within the lane of interest and should not generate false triggers.

3.3.2 Tested LPR Trigger Methods

Two different sensors in a total of three configurations were tested as potential LPR triggers. An infrared laser sensor was tested in a cross-road road configuration and a laser rangefinder was tested in cross-road and overhead configurations. The infrared laser sensor, which is simple to operate and provides excellent time resolution (<1 millisecond), was used as a time reference to benchmark the laser rangefinder trigger output.

Cross-road Infrared Beam This LPR trigger method utilized an infrared laser sensor that was directed at a reflector across the roadway to detect vehicle presence. A trigger signal is generated when the back end of the vehicle passes through the infrared beam.

Laser Rangefinder in Cross-road Mode The laser Rangefinder generates range information 234 times per second by reflecting an infrared laser beam off of objects. Aimed across the roadway, it is possible to detect the presence of a vehicle in a specified lane by monitoring range readings with a computer.

To test the suitability of the laser rangefinder as an LPR trigger source, it was set up at the same location as the cross-road infrared beam so that the passing test vehicle would cause LPR triggers to be generated from each system. The two triggers were recorded using a logic analyzer. The laser rangefinder trigger was compared to the cross-road infrared beam-generated trigger to determine if it met the time accuracy requirements described above. This data is presented in section 3.3.3 below.

Laser Rangefinder in Overhead Mode The laser rangefinder was configured for overhead operation by attaching it to a camera pan-tilt unit mounted atop the Cal Poly test van's pneumatic mast. A sighting camera was installed with the rangefinder to aid

in aiming. To generate LPR triggers, the rangefinder was aimed at the desired LPR trigger location down the lane. The rangefinder effectively observes the silhouette of vehicles from above as they pass through the trigger zone. An LPR trigger is generated when the rear bumper of the test vehicle is observed to pass through the detection zone.

The suitability of the laser rangefinder operating in overhead mode was tested in a similar fashion to the rangefinder operating in cross-road mode. The overhead rangefinder was pointed at the desired LPR detection zone where the infrared beam cross-road detector was operating. The two generated trigger signals were recorded in time and later analyzed for time differences. Test data is presented in section 3.3.3 below.

3.3.3 LPR Trigger Test Data

The laser rangefinder-generated LPR triggers were compared to the cross-road infrared beam-generated triggers to determine their time accuracy. Table 3.4 below shows a summary of LPR trigger test data. Standard deviation in inches represents how close the laser rangefinder trigger was in time to the cross-road infrared beam trigger at a given vehicle speed. All data was taken on the test track at vehicle speeds ranging from 20 to 60 mph.

TEST MODE	Number of Samples	AVERAGE STD DEV (inches)
Cross-Road	24	1.9
Overhead	117	3.6

Table 3.4 Summary of laser rangefinder trigger test data.

This test data indicates that the laser rangefinder is capable of providing LPR triggers within the required plus or minus one foot trigger window.

3.3.4 Operational Notes

The infrared laser sensor and Rangefinder each has its own operating requirements and capabilities. The laser Rangefinder’s versatility allows it to be used in several configurations. These two devices and their various operating modes can generate accurate triggers in diverse roadside conditions.

Cross-road Infrared beam The infrared laser trigger proved to be extremely time-accurate during testing. It has the additional advantage of being simple to align during setup, as the infrared beam can be visually aimed at the reflector across the roadway. This device is well suited for single lane applications such as freeway on and off-ramps. The cross-road infrared beam as an LPR trigger has drawbacks on multi-lane roads. It requires a reflector and does not distinguish between lanes; any car in any lane that breaks the beam will generate a trigger. The infrared laser trigger can potentially provide the highest time resolution.

Laser Rangefinder in Cross-Road Mode Since the rangefinder does not require a reflector across the roadway, it serves as a good substitute for the laser sensor in situations where placing a reflector is difficult or impossible. Although the rangefinder does not have the time accuracy of the infrared beam detector, its accuracy is within the tolerance required by the LPR.

In addition, the rangefinder system is capable of ignoring cars in lanes other than the desired one. The computer interpreting the real-time data can tell which lane is occupied by the actual range value it receives from the Rangefinder. So, it has no trouble generating triggers on cars in the rightmost lane of even the widest freeway. It may even be able to pick out a percentage of triggers from interior lanes.

Laser Rangefinder in Overhead Mode This is perhaps the most versatile trigger mode as it can be used on interior lanes. The overhead approach also has advantages inherent in looking down from above, which include making it easier to accurately distinguish the trailing edge of large trucks. It is difficult to detect the back of a truck using the cross-road configurations due to false triggers created by irregular undercarriage components.

4. SOLUTIONS AND OPTIONS

4.1 Roadway Configurations

The Microscale Emissions Modeling System will be used to estimate emissions on the following roadway configurations: freeway lanes (both interior and right hand lane), on and off-ramps, two lane highways, and surface streets. Table 4.1 outlines these roadway configurations and provides some insight regarding their specific requirements.

ROADWAY CONFIGURATIONS	DESCRIPTION
Interior Freeway Lanes	Requires viewing license plates from an angle at the side of the road. Some plates will be missed due to occlusion and must be statistically accounted for. Triggering may be done from above, via a mast mounted device or from the side of the road. If triggering is done from the side of the road, some additional vehicles will be missed due to occlusion of the triggering device. These additional missed vehicles must also be accounted for statistically.
Right Hand Freeway Lanes	License plates may be optimally viewed from a camera mounted either roadside or on a tripod or on top of the van. Triggering may be done via a mast mounted device or from the side of the road. No vehicle samples should be lost due to occlusion of either the LPR camera or its trigger.
On and Off-Ramps	License plates may be optimally viewed from a camera mounted roadside on a tripod or on a mount on top of the van. Triggering may be done via a mast mounted device or from the side of the road. No vehicle samples should be lost due to occlusion of either the LPR camera or its trigger for single lane ramps.
Surface Streets and Two-Lane Highways	Similar to freeway lanes. License plates must be viewed from above if interior lanes are being measured.

Table 4.1 Microscale Emissions Modeling System roadway configurations.

4.2 Subsystem Solutions

The Microscale Emissions Modeling System requires the following subsystems to collect vehicle classification and activity data:

- LPR triggering
- license plate reading
- vehicle speed measurement
- vehicle acceleration estimation

Each of these subsystems can potentially be implemented with more than one solution. Table 4.2 provides a summary of possible subsystem solutions.

SUBSYSTEM SOLUTIONS		DESCRIPTION
LPR Triggering	Single IR Beam	A single IR beam directed perpendicular to the flow of traffic at a reflector across the roadway. Passing vehicles break the beam and cause a trigger signal to be generated. False triggers will occur when vehicles in other lanes break the beam. Time resolution to within 1 ms. May have difficulty detecting large trucks due to different wheel/undercarriage configurations.
	Laser Rangefinder (cross-road)	A laser rangefinder is directed across the roadway perpendicular to the flow of traffic. The rangefinder provides range estimates approximately 235 times per second, allowing the leading and trailing edges of passing vehicles to be detected. This trigger method is capable of triggering on vehicles in any lane from the side of the road. Some vehicles in interior lanes may be missed due to occlusion. Some difficulty detecting the trailing edge of large trucks due to different wheel/undercarriage configurations. The laser rangefinder provides time resolution to within 5 milliseconds.
	Laser Rangefinder (overhead)	A laser rangefinder would be placed on the pneumatic mast and directed downlane, pointing down at vehicles as they pass through the desired trigger point on the roadway. The rangefinder would trace the silhouette of each passing vehicle from above and generate an LPR trigger signal upon the back of the vehicle passing through the rangefinder's target zone. As in crossroad operation, the rangefinder provides time resolution to within 5 milliseconds.
	SEO Autosense	Schwartz Electro-Optics, Inc. produces active infrared vehicle sensors for cross-road or overhead use. These sensors require no reflector and provide an accurate LPR trigger and are essentially a specialized laser rangefinder adapted for vehicle detection.
License Plate Reading	Hughes LPR	The Hughes License plate reader will be used for all license plate reading. The LPR camera will operated from the top of the vehicle's mast when interior roadway lanes are being measured and from a mount on the roof of the van for all other roadway configurations.
Speed Measurement	Econolite Autoscope	The Econolite Autoscope 2003 provides speed estimates accurate to within 5 percent. The Autoscope camera would be mounted on a pan-tilt unit on top of the pneumatic mast.
	Two IR Beams	Two Infrared sensors would be used to detect vehicles as they cross pre-determined points in the roadway. These sensors can only be used in single-lane cross-road configurations such as some on and off-ramps due to their need for a reflector. Accuracy better than plus or minus one mph is feasible. As with previously described cross-road detection methods, difficulty may be encountered measuring large trucks.
	Two Laser Rangefinders	Two laser rangefinders would be used to time vehicles as they pass between two predetermined points in the roadway. This method could work in either cross-road or mast mounted configuration, allowing use on all of the different roadway configurations. Accuracy of plus or minus one mph is feasible. May have difficulty measuring large trucks in cross-road configuration.
	SEO Autosense	The SEO Autosense vehicle sensors measure speed as well as providing LPR triggers. These sensors are accurate to within plus or minus one mile per hour and can be used in either overhead or cross-road configuration.
Acceleration Estimation	Econolite Autoscope	The Econolite Autoscope would be set up with two speed detection zones that each vehicle would drive through. Acceleration would be calculated from these speed values.
	Multiple IR Beams	Multiple IR sensors would be set up to provide two or more speed detection zones across the road. Vehicle acceleration would be calculated from the measured vehicle speeds. As was the case for speed measurement, these sensors are only applicable for single lane use. As with previously described cross-road detection methods, difficulty may be encountered measuring large trucks.
	Multiple Laser Rangefinders	Three laser rangefinders would be set up to create two speed measurement zones from which acceleration would be calculated. These rangefinders could be used in cross-road or overhead configuration. May have difficulty measuring large trucks in cross-road configuration.
	SEO Autosense	An Autosense unit would be custom configured by SEO Schwartz to provide acceleration estimation.

Table 4.2. Summary of possible subsystem solutions.

Table 4.3 provides a summary of subsystem solutions which are applicable to each of the specific roadway configurations.

		Roadway Configuration				
		Freeway (right hand lane)	Freeway (interior lane)	On/Off Ramp	Two Lane Road	Surface Street
LPR Triggering	Single IR Beam			* ***		
	Laser Rangefinder (cross-road)	***	** ***	** ***	* ***	** ***
	Laser Rangefinder (overhead)	*	*	*	*	*
	SEO Autosense	*	*	*	*	*
License Plate Reading	Hughes LPR	*	*	*	*	*
Speed Measurement	Multiple IR Beams			***		
	Multiple Laser Rangefinders	*	*	*	*	*
	Autoscope	*	*	*	*	*
	SEO Autosense	*	*	*	*	*
Acceleration Estimation	Econolite Autoscope			*		
	Multiple IR Beams			***		
	Multiple Laser Rangefinders	*	*	*	*	*
	SEO Autosense	*	*	*	*	*

*** = applicable solution**

**** = will work but will miss some vehicles due to occlusion**

****** = other more optimal solution exists***

Table 4.3 Matrix of subsystem solutions and roadway configurations

5. SUMMARY

Essential instrumentation components and concepts for the Microscale Emissions Modeling System have been evaluated to determine the feasibility of the system as a whole. This investigation has resulted in better understanding of the license plate reader (LPR), LPR triggering methods, and vehicle speed and acceleration measuring methods applicable to this effort. Key findings of this investigation include:

- The existing Hughes LPR has been demonstrated to provide 80 to 85 percent successful plate reads with the help of semi-automated post processing.
- Various methods for triggering the LPR have been tested and a mast mounted laser rangefinder looking down on passing vehicles is the most promising approach; it provides a versatile and reliable trigger that has been tested successfully with the Hughes LPR.
- The Econolite Autoscope 2003 has been demonstrated to be operational and is suitable for speed measurements and vehicle classification/counting; it does not appear that the Autoscope is suitable for acceleration measurement on roadways other than on and off-ramps.
- An array of mast-mounted laser rangefinders will provide a suitable means for measuring speed and acceleration of individual vehicles. Speed measurements have the potential for being more accurate than those provided by the Autoscope.

Successful deployment of the Microscale Emissions Modeling System is feasible and the project should move forward.