







MXP Optics Technical Guide

The MXP ports on Arista leaf and spine switches can run as standards based 10Gb, 40Gb or 100Gb Ethernet, and simply require the correct fiber cables to enable multi-vendor interoperability. This technical guide is intended to provide accurate information for cabling triple-speed MXP ports with MTP and MPO cables for use with the Arista 7500E and 7280E (10GbE, 40GbE and 100GbE ports) and Arista 7050X (10GbE and 40GbE ports). MTP and MPO cables are widely available and this guide provides the information needed to specify cables to connect to the MXP interface. Arista customers should provide this document to their cabling vendors to get cables for their specific needs.

Arista Portfolio With MXP Ports

Arista offers a portfolio of leaf and spine switches with MXP ports for high-density applications. Arista platforms with MXP ports range from the flagship 7500E spine switch series to ultra deep buffer top of rack 7280E and the high performance 7050X top of rack switches. The MXP ports offer flexibility to customers with investment protection when migrating from 10G to 40G and 100G speeds while maintaining low cost/bit and high reliability.

Switch Family	Part Number	# of MXPs	Supported Speeds	
7500E	7500E-12CM	12	10/40/100G	
	7500E-72S	2	10/40/100G	
7280E	7280SE-72	2	10/40/100G	
7050X	7050SX-72	2	10/40G	
	7050SX-96	4	10/40G	
	7050TX-72	2	10/40G	
	7050TX-96	4	10/40G	

Arista 7500E

The Arista 7500E Series deliver line rate non-blocking switching that enables faster and simpler network designs. The 7500E Series offers two choices for the datacenter a 4-slot 7504 and the 8-slot 7508. The 7500E Series supports a range of interface speeds from 100Mbps up to 100Gbps Ethernet in a single system, ensuring broad choices without limiting system performance when scaling from 10Gb to 100Gb Ethernet.

The 7508E is a 11RU chassis with a 30Tbps fabric that supports up to 8 line cards and provides 1,152 – 10Gb ports, 288 – 40Gb ports, or 96 – 100Gb Ethernet ports in a single system - unparalleled density and performance in the industry.

The Arista 7504E provides room for 4 line cards in a compact 7RU chassis that delivers 15Tbps of bandwidth allowing up to 576 - 10Gb ports, 144 – 40Gb ports, and a massive 48 – 100Gb Ethernet ports.

A choice of high-density wire-speed 10GbE, 40GbE and 100GbE line cards is fully supported with the ability to mix and match any combination of modules. The 40GbE and 100GbE modules enable up to 144x10G ports per line card. Each 40G interface can be used as either a single 40G port or quad 10G Ethernet ports. The 100G MXP interfaces can be a single port of 100Gb, three ports of 40Gb or 12 ports of 10Gb Ethernet.



Figure 1: 7504E and 7508E with up to 1,152 10G ports

Arista 7280E

The Arista 7280E Series are purpose-built 10/40/100GbE ultra deep buffer fixed configuration systems built for the highest performance environments, where wire speed L2 and L3 forwarding are combined with advanced features for network virtualization, open monitoring and network analysis, resiliency and architectural flexibility.

The 7280E Series are available in three models each with 48 SFP+ ports for 1/10GbE and choice of 40GbE and 100GbE uplinks. The 7280SE-72 has two 100GbE uplinks through the use of Arista MXP interfaces and embedded optics. Each MXP port enables twelve 10GbE, three 40GbE or one 100GbE for a wide choice of cost effective connections. The 7280SE-64 has four QSFP+ uplink ports that allow a choice of four 40GbE or up to 16 additional 10GbE ports with a range of transceivers or cables. The 7280SE-68 has two 100GbE QSFP uplinks that allow the use of both 100GbE and 40GbE optics for the widest range of both short and long reach connection optics.

Arista 7050X

The Arista 7050X Series are purpose-built 10/40GbE switches with wire speed layer 2/3/4 performance combined with low latency and advanced features for software defined cloud networking.

- The 7050SX-72 and 7050SX-96 provide a 1RU system with 48 10GbE SFP+ ports and 2 or 4 MXP ports that each support 3x40GbE or 12x10GbE.
- The 7050TX-72 and 7050TX-96 provide a 1RU system with 48 10GBASE-T ports and 2 or 4 MXP ports that each support 3x40GbE or 12x10GbE.

Deploying an Optical Cabling Infrastructure in the Data Center for 40G and 100G

Recommended cabling infrastructure deployments in the data center are based upon guidance found in TIA-942, "Telecommunications Infrastructure Standard for Data Centers." Utilizing a distributed star topology in a structured cabling implementation provides the most flexible and manageable infrastructure. Many data center deployments today utilize the reduced topology described in TIA-942, where the Horizontal Distribution Areas (HDAs) shown are collapsed to the Main Distribution Area (MDA). In this collapsed architecture, the cabling is installed between the MDA and the Equipment Distribution Areas (Figure 2).

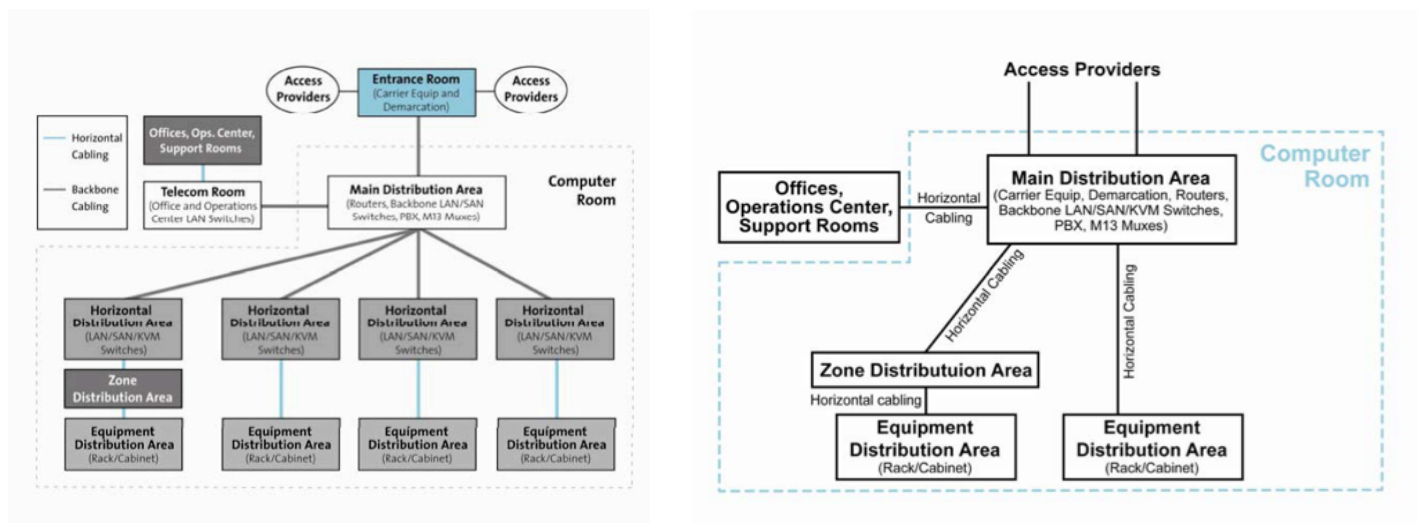

Figure 2: TIA 942 Architecture

For optimized performance in meeting data center requirements, the topology of the cabling infrastructure should not be selected alone; infrastructure topology and product solutions must be considered in unison.

Cabling deployed in the data center today to support 10GbE must be selected to support data rate applications of the future, such as 40Gb and 100Gb Ethernet. To do this, OM3 or OM4 multi-mode fiber is a must as the legacy OM1 and OM2 specifications do not support either 40GbE or 100GbE. In addition to being the only multimode fibers included in the 40G and 100G Ethernet standard, OM3 and OM4 fibers provide the highest performance as well as the extended reach often required for structured cabling installations in the data center.

In addition to the performance requirements the choice in physical connectivity is also important. Because parallel optics technology requires data transmission across multiple fibers simultaneously, a multi-fiber (or array) connector is required. Utilizing MPO-based connectivity in today's installations for either 10G or 40G Ethernet provides the means to migrate to this multi-fiber parallel optic interface when needed.

Factory-terminated MPO solutions allow connectivity to be achieved through a simple plug-and-play system. To meet the needs of today's serial Ethernet applications, MPO-terminated backbone/horizontal cabling is simply installed into pre-terminated modules, panels or harnesses (Figure 3).

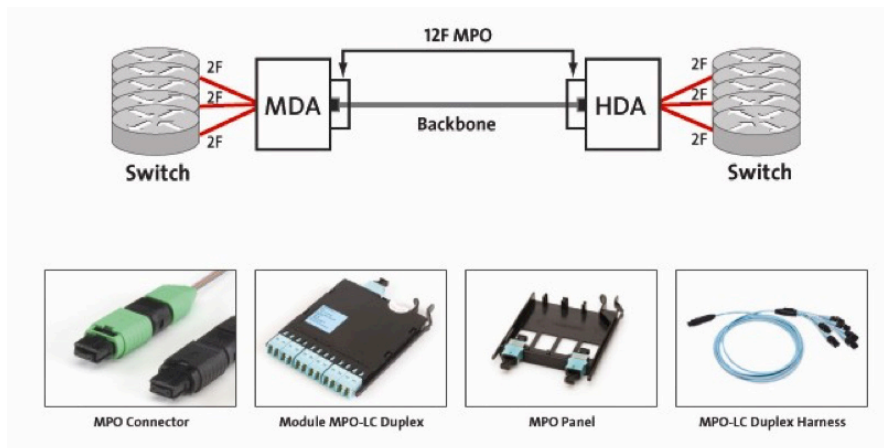

Figure 3: Pre-terminated Solutions (courtesy of Corning Cable Systems)

Cabling Arista MXP Ports with MTP Cables

Traditional optical-based Ethernet physical media (for speeds below 10Gb) required a duplex fiber scheme and required only two fibers for transmit and receive. The IEEE "SR" specifications for 40Gbps and higher multimode cabling uses parallel optics. By combining multiple channels, each running at 10Gbps or 25Gbps the higher data rates are achieved. This parallel transmission approach requires the use of parallel fiber cables for both structured and non-structured systems. Structured cabling systems use MTP-12 and MTP-24 as standard cabling options. The 40GBASE-SR4 and 100GBASE-SR4 specifications require 4 pairs (8 fibers) in a 12-fiber cable, and the 100GBASE-SR10 standard requires 10 pairs (20 fibers) in a 24-fiber cable.



Figure 4: MTP-12 and MTP-24 Connectors (courtesy of Complete Connect)

As the 40GbE SR4 specification only uses 8 of the 12 pins in the MTP-12 connector 4 are left unused (or not present). This need for just 8 fibers out of 12 allows an MTP-24 to be used to transport three 40GbE links each utilizing 8 fibers. This is used in structured cabling systems to optimize the trunk utilization between cabling distribution points.

Each 40GbE connection is presented to the active equipment as an MTP-12 connector but with only 8f present, which maximizes the channel capacity.

The Arista MXP ports provide an MTP-24 port, which can be operated in one of many modes: 1 port of 100GbE, 3 ports of 40GbE or 12 ports of 10GbE and combinations of 10GbE and 40GbE. Each mode uses the same MTP-24 port, and a series of breakout cables is used to adapt this to the correct number of terminations.

For example, a 24 fiber MTP to 3x 8-fiber MTP-12 can be used to provide 3 40GbE ports. Figure 5 below shows an example of the cable.



Figure 5: 24-fiber MTP to 3x 8-fiber MTP (image courtesy of Leviton Network Solutions)

MXP in 100GbE Mode - MTP-24 to MTP-24

Both the 7500E and 7280E support 100GbE mode with Arista MXP. Operating the MXP port in 100GbE mode requires an MTP-24 to MTP-24 cable (for a point to point or cross-over connection). The cables use 20 of the 24 fibers to carry 100GbE across 10 send and 10 receive channels. When connecting two 100GbE MXP ports, the TX lanes must be crossed with the RX lanes, as shown in the table below.

Table 2: MXP to MXP crossover cable

MTP-24 Fiber Number	MTP-24 Fiber Number
2-11 TX	14-23 RX
14-23 RX	2-11 TX

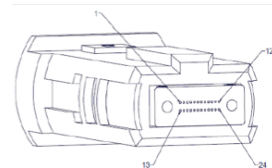

Figure 6: MTP-24 pin-out

MXP in 40GbE Mode - MTP-24 to 3x MTP-12

All Arista MXP ports support a 40GbE mode. Operating the MXP port in 40GbE mode requires an MTP breakout cable that provides a split into three individual MTP-12 ends. The cable is used to adapt the MXP port into three 40GbE interfaces as shown in figure 7. This breaks out the MXP port into three MTP-12 ends each compatible with standards based 40GBASE-SR4 ports over OM3 or OM4 fiber up to 100m or 150m.

Table 3 below shows the pin-outs required. Following these pin-outs will guarantee standards based compatibility with existing 40G SR4 optics. In point to point scenarios all plugs should be unpinned for connecting to the active ports.

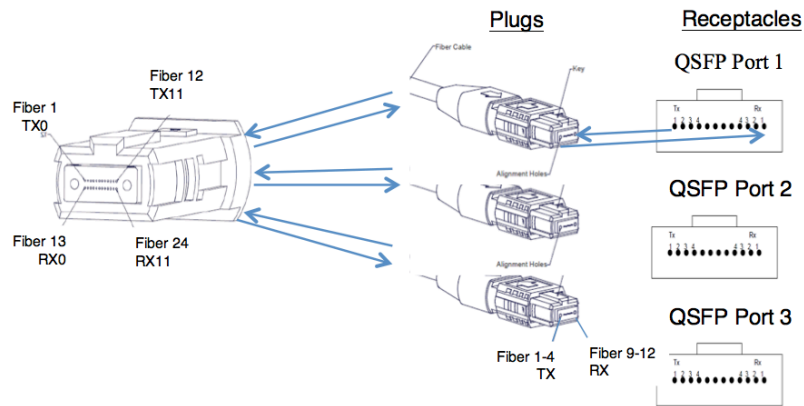

Figure 7: MTP-24 to 3x MTP-12 array cable

Table 3: MTP-24 to MTP-12 point-to-point (crossover) cable			
MTP-24 Fiber Number	MTP-12-Port 1	MTP-12-Port 2	MTP-12-Port 3
1-4 TX	9-12 RX1-RX4		
13-16 RX	1-4 TX1-TX4		
5-8 TX		9-12 RX1-RX4	
17-20 RX		1-4 TX1-TX4	
9-12 TX			9-12 RX1-RX4
21-24 RX			1-4 TX1-TX4

MXP in 10GbE Mode - MTP-24 to 12X LC

All the Arista switches with embedded MXP support operation in 10GbE mode. To operate as 12x 10GbE a different breakout cable is used to adapt the MTP-24 port to 12x pairs of LC connectors. An MTP-24 to 12xLC cable is used as shown below in figure 8. This cable presents the Arista MXP port as 12 ports of standard LC connectors for using with 10GBASE-SR or 10GBASE-SRL optics over multimode OM3/OM4 cable. The MTP-24 end should be unpinned to connect to the Arista switch MXP ports.

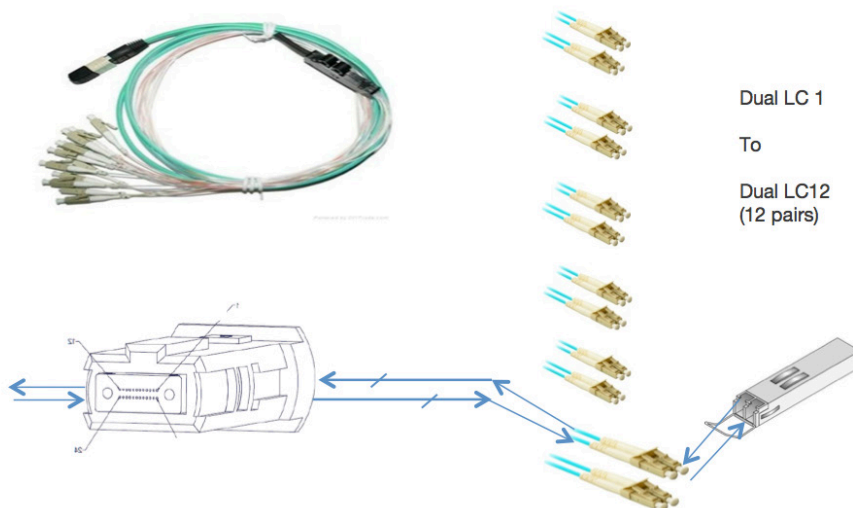

Figure 8: MTP-24 to 12x LC break out cable

Table 4: MTP-24 to 12 LC Point to Point (Cross-over) cable

MTP Position #	LC Leg / Side	MTP Position #	LC Leg / Side
1 TX	1/B	13 RX	1/A
2 TX	2/B	14 RX	2/A
3 TX	3/B	15 RX	3/A
4 TX	4/B	16 RX	4/A
5 TX	5/B	17 RX	5/A
6 TX	6/B	18 RX	6/A
7 TX	7/B	19 RX	7/A
8 TX	8/B	20 RX	8/A
9 TX	9/B	21 RX	9/A
10 TX	10/B	22 RX	10/A
11 TX	11/B	23 RX	11/A
12 TX	12/B	24 RX	12/A

Summary

MXP ports enable high density and flexible connectivity options. Each of the MXP modes requires the use of the correct breakout cable to adapt the MTP-24 interface to either 100GbE, 40GbE or 10GbE presentation. The cable specifications shown in this document provide the information on how to identify the correct cable types. In addition cables that are pre-defined for usage with Arista MXP in each of the modes described are available directly from Arista Networks in both 3m and 5m lengths.

Santa Clara—Corporate Headquarters

5453 Great America Parkway,
Santa Clara, CA 95054

Phone: +1-408-547-5500

Fax: +1-408-538-8920

Email: info@arista.com

Ireland—International Headquarters

3130 Atlantic Avenue
Westpark Business Campus
Shannon, Co. Clare
Ireland

Vancouver—R&D Office
9200 Glenlyon Pkwy, Unit 300
Burnaby, British Columbia
Canada V5J 5J8

San Francisco—R&D and Sales Office
1390 Market Street, Suite 800
San Francisco, CA 94102

India—R&D Office

Global Tech Park, Tower A & B, 11th Floor
Marathahalli Outer Ring Road
Devarabeesanahalli Village, Varthur Hobli
Bangalore, India 560103

Singapore—APAC Administrative Office
9 Temasek Boulevard
#29-01, Suntec Tower Two
Singapore 038989

Nashua—R&D Office

10 Tara Boulevard
Nashua, NH 03062



Copyright © 2016 Arista Networks, Inc. All rights reserved. CloudVision, and EOS are registered trademarks and Arista Networks is a trademark of Arista Networks, Inc. All other company names are trademarks of their respective holders. Information in this document is subject to change without notice. Certain features may not yet be available. Arista Networks, Inc. assumes no responsibility for any errors that may appear in this document. MM/YY