

Network Rail A Guide to Overhead Electrification

132787-ALB-GUN-EOH-000001

February 2015 Rev 10



Alan Baxter

Network Rail A Guide to Overhead Electrification

132787-ALB-GUN-EOH-000001

February 2015 Rev 10

Contents

1.0	Introduction.....	1
2.0	Definitions.....	2
3.0	Why electrify?.....	4
4.0	A brief history of rail electrification in the UK.....	5
5.0	The principles of electrically powered trains	6
6.0	Overhead lines vs. third rail systems	7
7.0	Power supply to power use: the four stages of powering trains by OLE	8
8.0	The OLE system	10
9.0	The components of OLE equipment.....	12
10.0	How OLE equipment is arranged along the track	17
11.0	Loading gauges and bridge clearances.....	24
12.0	The safety of passengers and staff	28
13.0	Installing OLE on different types of structure.....	32
14.0	Conclusion	48



Network Rail's nationwide electrification programme, and the route of HS2

1.0 Introduction

Overhead Line Equipment – or OLE – is the name railway engineers give to the assembly of masts, gantries and wires found along electrified railways.

All this steel and cable has only one purpose – to supply power to make electric trains move.

Operationally, environmentally and from the perspective of passenger service and comfort, OLE is now the preferred means of powering trains throughout the world. For example, when the High Speed line from St Pancras to Paris was built, there was only one choice for the engineers: OLE.

But there is no doubt that it can be visually intrusive, and installing it on existing lines can require alterations to bridges, stations and other structures.

OLE is also undeniably complex and frankly baffling to the lay person.

The purpose of this guide, therefore, is to help all those with an interest in the current Network Rail electrification projects – whatever that interest may be – to understand why the line is being electrified, and why some changes to existing structures are required. It has been produced by Alan Baxter & Associates on behalf of Network Rail with information supplied by, and with the assistance of, a number of the company's engineers. Its contents have been reviewed and signed-off by Network Rail.

The document has been written for the non-specialist, not the expert, and explains with the aid of diagrams how OLE works and why it has to look the way it does.

Most importantly, it explains in ways we can all understand what is and what is not technically and legally possible – from attaching OLE to listed stations and putting up masts on prominent viaducts, to getting wires under historic bridges and through famous tunnels .

We hope you find this useful. You may even find it interesting!

2.0 Definitions

The intention of this guide is to explain OLE to a non-technical audience. To that end, we have tried wherever possible to describe electrification in non-professional terms. However, it is impossible to discuss OLE without using some technical language. This glossary explains what these terms mean. The diagram on the following page illustrates many of them:

<i>Alternating Current (AC)</i>	Electrical current that changes direction 50 times per second.
<i>Autotransformer Feeder System (ATF)</i>	System to be used for supplying power to the OLE. Incorporates ATF cables, generally one per track, attached to OLE masts and connected to autotransformer stations at intervals alongside the track.
<i>Cantilever</i>	OLE structure comprising horizontal or near horizontal members supporting the <i>catenary</i> projecting from a single mast on one side of the track (see diagram on opposite page).
<i>Catenary</i>	The longitudinal wire that supports the <i>contact wire</i> .
<i>Conductor</i>	Any insulated wire, cable or bar that carries electric current.
<i>Contact wire</i>	Carries the electricity which is supplied to the train by its <i>pantograph</i> .
<i>Contact & catenary wire tensioning</i>	In order to keep the wires taut, they are in lengths of no more than c.1500m, and tensioned at each end.
<i>Direct Current (DC)</i>	Electrical current that flows in one direction, like that from a battery.
<i>Dropper</i>	Wires suspended vertically from the <i>catenary</i> at regular intervals to support the <i>contact wire</i> .
<i>Feeder station</i>	A facility next to National Grid electricity transmission lines that extracts 25,000V and transmits it to the railway. The spacing of these stations depends on the electrification system used.
<i>Insulators</i>	Components that separate electrically live parts of the OLE from other structural elements and the earth. Traditionally ceramic, today they are often synthetic materials.
<i>Kinematic envelope</i>	The space that defines the train and all its allowable movements - rocking, swaying, bouncing, for example.
<i>Loading gauge (vehicle gauge)</i>	The dimensions – height and width – to which trains must conform in order to avoid colliding with line-side structures such as bridges and platforms.
<i>Mast</i>	Trackside column, normally steel, that supports the OLE.
<i>Mid point anchor</i>	At the midpoint of the standard length of OLE wires, the wires are fixed in position to keep the <i>contact wire</i> stable.

<i>Neutral section</i>	A length of electrically isolated or non-conducting material incorporated into the <i>contact wire</i> to completely separate electrical sections of OLE. It may take the form of a short insertion in the <i>contact wire</i> or that of an extended <i>overlap</i> .
<i>OLE</i>	Overhead line electrification equipment, which supplies electric power to the trains.
<i>Overlap</i>	Each length of the <i>contact wire</i> overlaps with the next so that the <i>pantograph</i> slides smoothly from one to the other.
<i>Pantograph</i>	The device on top of the train that collects electric current from the <i>contact wire</i> to power the train.
<i>Structure gauge</i>	The defined space into which a structure must not intrude, to avoid trains colliding with it. This is larger than the <i>kinematic envelope</i> and <i>loading gauge</i> .
<i>Third rail system</i>	Railway electrification system using a third rail located alongside the track to supply DC power to the trains. No longer permitted for new installations on national railways.

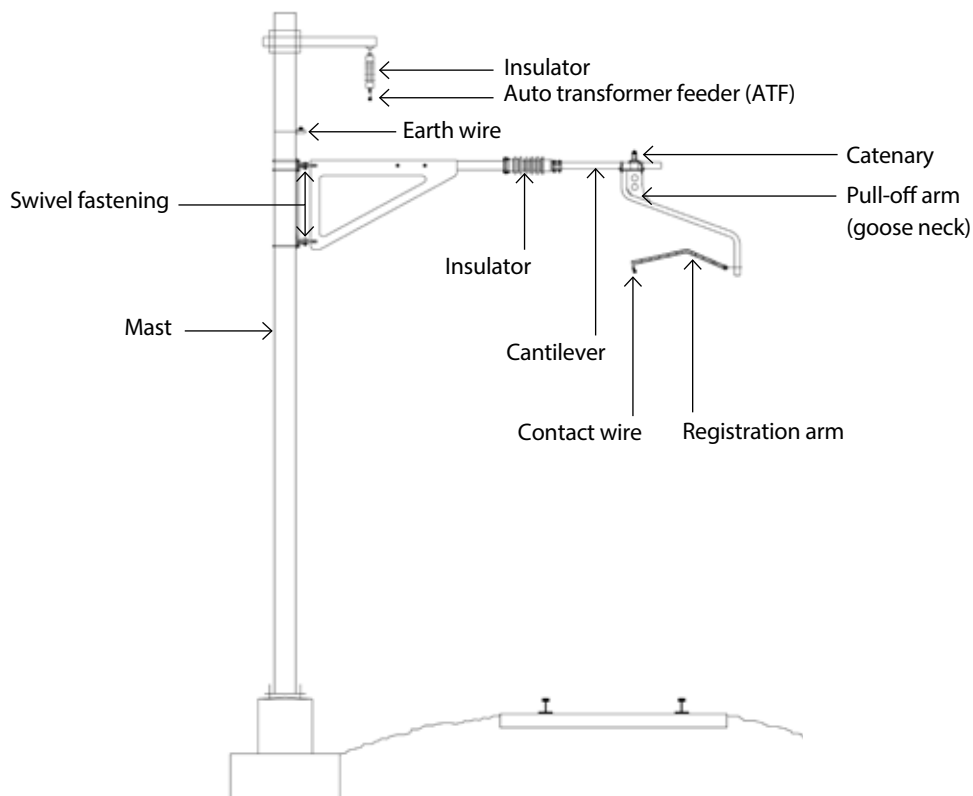

An example of an OLE mast, cantilever and associated equipment (in this case, 'Series 1')

3.0

Why electrify?

An efficient railway system that provides sufficient capacity for the future growth of both passenger and freight traffic is fundamental to creating the robust national infrastructure necessary for a successful, competitive and sustainable economy. In the last fifteen years passenger journeys have increased by nearly 100% and freight by 60%. They continue to grow. We need to provide extra capacity for this now if we are not to hinder economic growth in the future.

At the moment, all trains on un-electrified routes are powered by diesel engines, similar in concept if not size to those under the bonnets of many lorries. However, electrification is preferred for major railway lines because electric trains are lighter, cleaner, cheaper, quieter and faster to accelerate. They allow more trains to be run more efficiently and more quickly.

Electric trains are cheaper than diesel trains because:

- they are cheaper to build and 20% cheaper to lease
- maintenance costs are typically 33% lower
- fuel costs are typically 45% lower because electric trains are lighter and more efficient and electricity from the National Grid is cheaper than diesel fuel
- electric trains are lighter and therefore cause on average 13% less wear to the tracks
- track maintenance costs are therefore lower

Electric trains are environmentally superior because:

- they do not pollute the air during operation
- power stations generating the electricity are more efficient and have more sophisticated and effective emissions controls
- they therefore emit on 20-30% less carbon per passenger mile than diesel
- they are quieter

Electric trains are more comfortable because:

- they are quieter and vibrate less due to the absence of diesel engines

Electric trains provide a better service because:

- they have a higher power-to-weight ratio, which means that they are generally faster than diesel trains
- they accelerate more quickly, which reduces the journey times

For all these reasons, the Government has made completing the electrification of the most heavily used main lines in England some of its most important infrastructure projects, and has committed to running the first electric trains from London to Bristol by the end of 2016, from London to Nottingham and Sheffield by 2020 and between Leeds and Manchester by 2018.

4.0 A brief history of rail electrification in the UK

From the birth of the railways in the early 19th century until the 1950s, steam locomotives were the dominant form of motive power on Britain's railways. They were finally phased out by 1968.

Diesel power – pioneered in America – started to become widespread in the 1950s. On the Great Western and Midland Main Lines this is still how long-distance services are powered – either in the form of locomotives at both ends of the train, like High Speed Trains, or where a number of smaller diesel engines are distributed underneath carriages, as found on many other trains (see drawing below).

Electrically powered trains have a much longer history in the UK, beginning with the London Underground in 1890. This was - and still is - powered by a direct current system.

The first OLE systems appeared before the First World War in south London and Lancashire (using 6,600V DC), and others followed in East London and on Merseyside in the 1920s and 30s. But the first major network was created by the Southern Railway from the 1920s. This is the 750V DC third rail system that still powers trains throughout the South East.

Long-distance mainline 25,000V AC OLE systems are more recent. They are a product of the Modernisation Plan that swept steam away from the 1960s. First, the West Coast Main Line from Euston to the North West, in the 1960s and '70s, followed by the East Anglian Main Line in the 1980s, and then the East Coast Main Line, completed in 1990.

OLE was introduced to the eastern end of the Great Western Main Line in the late 1990s to power the Heathrow Express, and is being extended as far as Maidenhead for the trans-London Crossrail service. The Great Western Main Line electrification project will extend this to Newbury, Oxford, Bristol and Cardiff by 2017.

On the Midland Main Line, electrification from London to Bedford was installed in the 1980s. The Midland Main Line electrification project will extend this to Nottingham and Sheffield by 2020.

In the Lancashire-Yorkshire corridor, electrification between Liverpool and Manchester is under construction at the time of writing and is due for completion in 2015. The Northern Trans-Pennine electrification project will continue this to Leeds and York by the end of the decade.

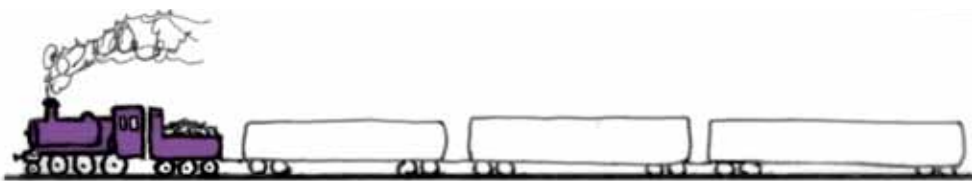

Steam Locomotive



Diesel Locomotive



Diesel with under-slung engines (DMU - Diesel Multiple Unit)

↑
Under-slung engines under each coach



Electric Train (EMU - Electric Multiple Unit)

↑
Electric motors on some or all coaches

5.0 The principles of electrically powered trains

In its simplest terms, the electric train power system consists of a power supply wired to an electric motor in the train that drives the train's wheels.

To complete the circuit and thereby allow the current to flow, the track is used to make the return connection.

As part of this circuit, the single purpose of OLE is to supply electricity to the moving trains.

This power supply must be something that trains can access at all times. The key objective of OLE designers is thus to ensure uninterrupted uniform, reliable and safe supply of power to trains.

5.0 The principles of electrically powered trains

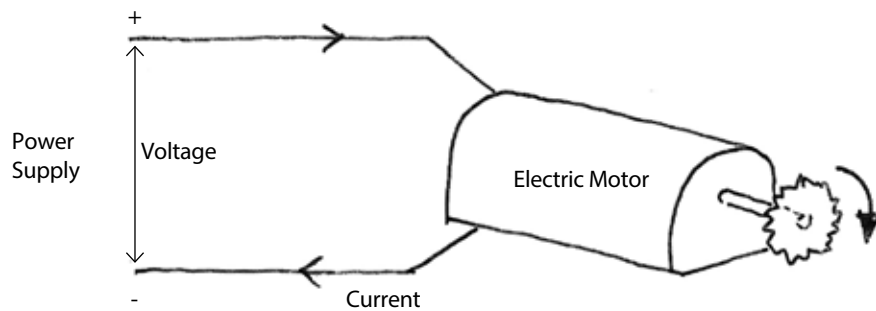

Principle

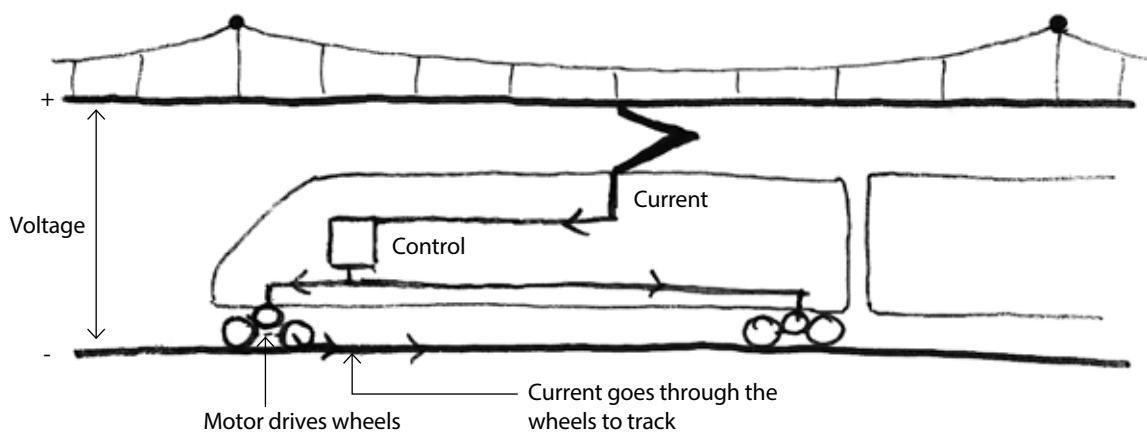

The principle applied via OLE

6.0

Overhead lines vs. third rail systems

OLE can undoubtedly be visually intrusive and may require alterations to existing bridges and stations. For this reason, the third rail system has sometimes been suggested as an alternative for sensitive landscapes or historic areas.

In railway terms, however, the third rail system is now obsolete, and there is a long term objective to replace it with OLE systems. Legislation governing the ability to operate international trains across the European networks only permits the installation of further OLE systems, not third rail ones.

Other reasons for not using third rail electrification include:

- it is not possible to run trains faster than 110mph (160kph)
- it requires 20% more electricity to power trains compared with OLE
- it requires substations at closer intervals (every 8km) than for OLE (every 40-60km)
- it is much more susceptible to service disruption caused by rain, snow, ice or leaf fall
- its long-term maintenance and renewal costs are greater than OLE
- the public, trespassers and track workers are at ten times more risk of being electrocuted on third rail lines than by OLE systems



Overhead line electrification (photograph: ©Bill Welsh)



Third rail electrification (photograph: ©Malcolm McDonald)

7.0 Power supply to power use: the four stages of powering trains by OLE

7.1 The Four Stages

The supply of electricity to power trains is divided into 4 stages:

1. power generation
2. power transmission
3. power feeding
4. power collection

Power is generated at an electricity generating source – normally a **power station** - and then transmitted via transformers into overhead **transmission lines** at high voltage (approximately 400,000V) - the National Grid.

The supply is alternating current (AC). AC is more economical and practical to transmit over long distances than direct current because it suffers from smaller losses. High voltages means smaller wires: to transmit the same power at low voltage needs high currents and therefore large conductors (wires).

Power is taken from the National Grid at **feeder substations** located next to the transmission lines, which reduce the voltage to 25,000V and transmit the power to the OLE. Although it is more economical to transmit electricity at higher voltages as the voltage grows the required clearances increase as does the cost of the equipment. Therefore, it has been found that 25,000V is the optimum voltage for main line trains.

Masts and gantries support the overhead wire carrying the power - the **contact wire**. The power is transmitted from the contact wire to the train by a sprung '**pantograph**', which is attached to the roof of the moving train. In the train, the current is used to drive the motors with the aid of on-board controllers.

7.0 Power supply to power use

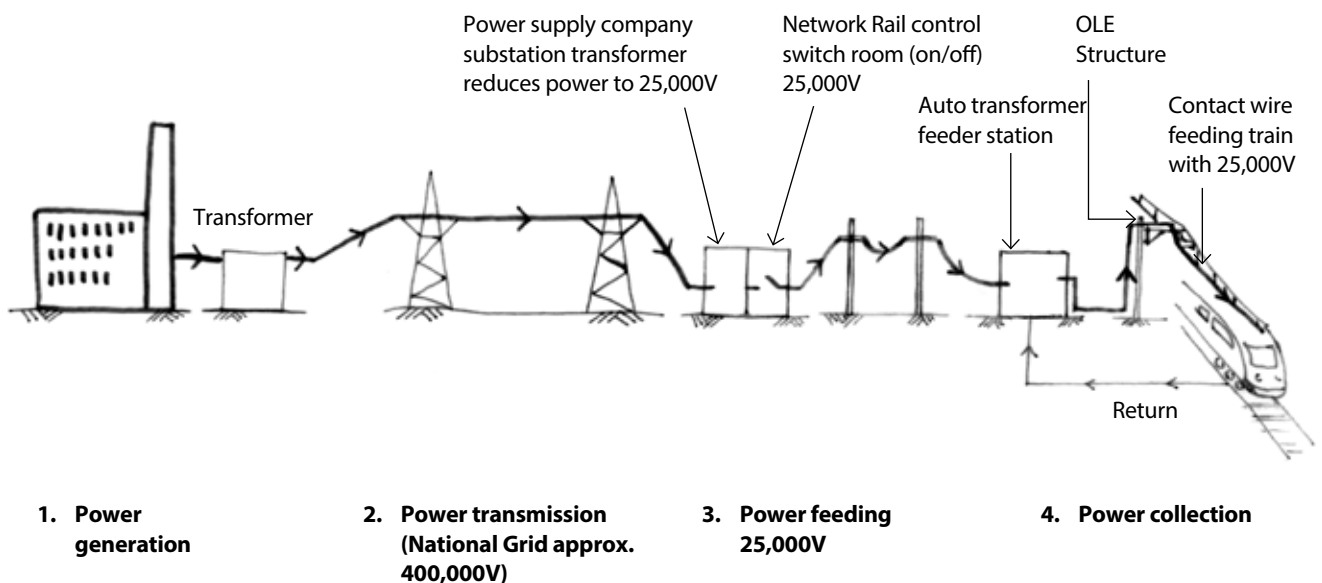

Four stages of power generation and supply

7.2 Completing the circuit

There has to be a closed electrical circuit in order for the current to flow and the train to move. The circuit can be completed through the train wheels to the rails and then by connecting the rails back to the feeder substation. However, significant complications arise from power loss over long distances and safety-critical interference with signalling and telecommunication. Section 8.1 explains how power loss is tackled.

7.3 AC and DC current

The power supply can be either direct current (DC) or alternating current (AC). AC changes direction 50 times per second while DC always flows in the same direction.

The National Grid transmits at AC because it is more economical and practical to transmit high voltages long distances. OLE in the UK uses AC too, but the older third rail system used extensively in the South East supplies DC. Because OLE is elevated it can transmit higher voltages more safely and efficiently. The standard used in the UK and most of Europe is 25,000V AC.

8.0 The OLE system

8.1 New technology

New systems of OLE are being adopted on Britain's railways. To the general public these will not look appreciably different to the structures that we are used to, but this new equipment - known as Series 1, Series 2 and Master Series - is intended to be adopted throughout the network for future electrification projects.

These new systems are designed to meet European standards for the interoperability of trains across the continent, and also incorporates a number of technological advances. The wire tensioning system is improved to reduce the likelihood of wires coming down in severe weather, which is a cause of significant disruption on the East Coast Main Line, for example. The systems also require fewer wires.

But perhaps the most significant development in the context of this document is what is known as the Autotransformer System. This is the way that power is supplied from the National Grid via feeder substations to the line. The existing system requires booster transformers positioned on the masts every 3-8 km along the line; a significant intrusion in the landscape. An Autotransformer System removes the need for these booster transformers as well as substantially reducing the overall number of feeder substations required.

8.0 The OLE system

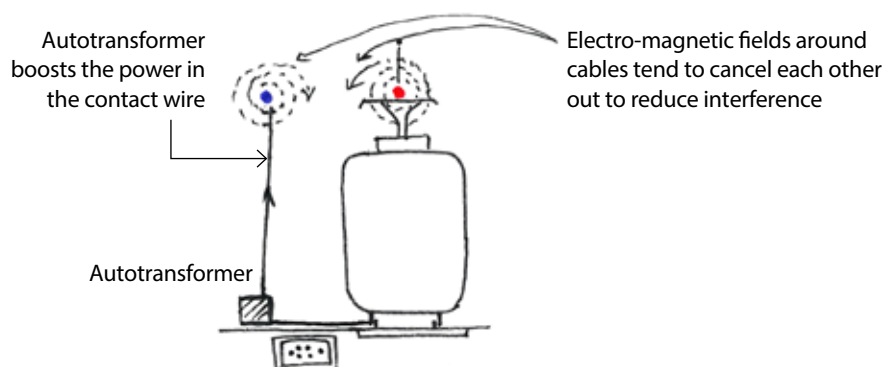
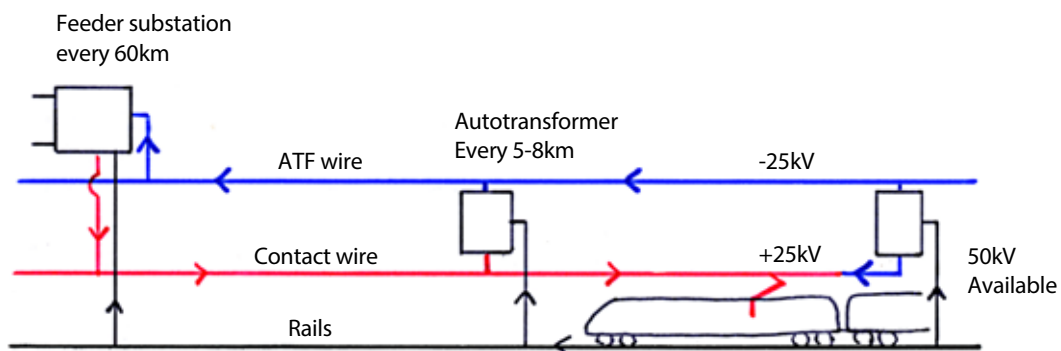

The Autotransformer System

8.2 Feeder stations

Because of the extra voltage, using the Autotransformer System dramatically reduces the number of feeder stations required. For example, electricity to the Great Western Main Line will be fed from only four feeder stations: at Kensal Green in London, and Didcot, Melksham and Cardiff. Reducing the number of feeder stations in this way reduces the impact of electrification on the landscape because fewer components, buildings and wires are required.

Each feeder station generally feeds two separate electrical sections of the route as shown in the diagram. Neutral sections are provided in order to separate different circuits.

The location of feeder stations on the Midland Main Line and the Transpennine route are currently being finalised.

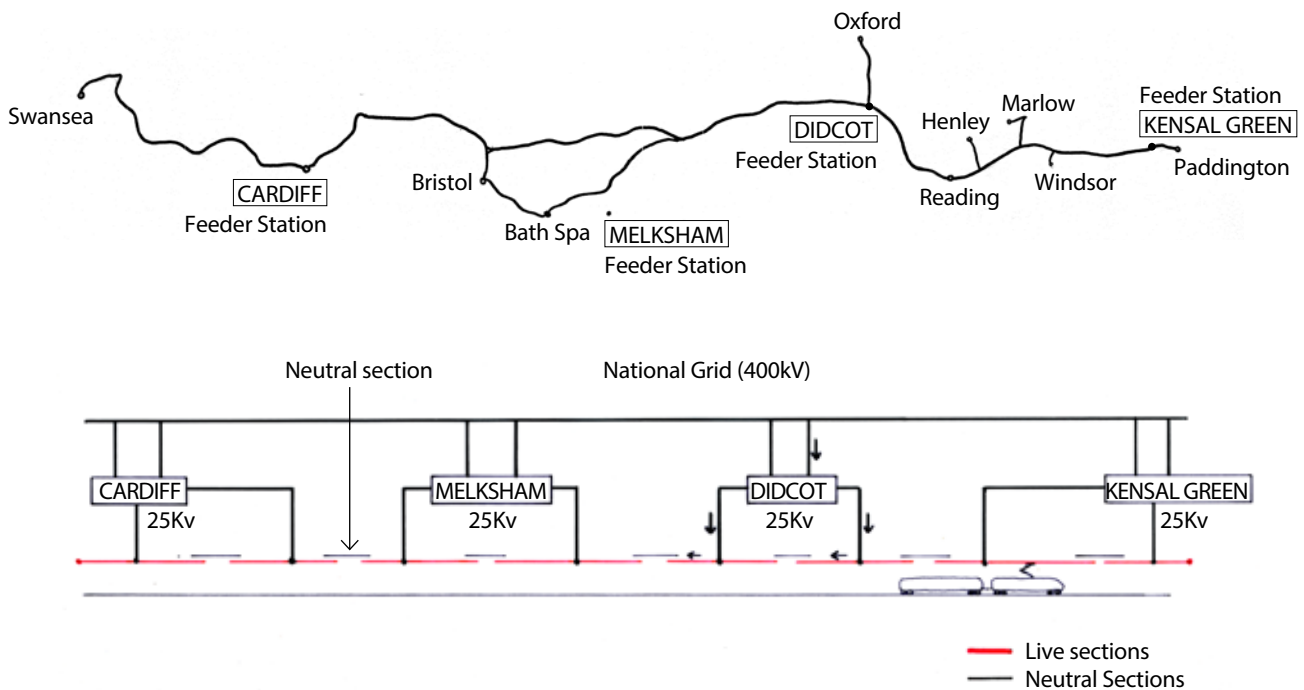

Location of feeder stations for the Great Western Main Line electrification project

9.0 The components of OLE equipment

9.1 OLE components and their purpose

Overhead line equipment comprises a large number of standardised components.

Most of them are there to achieve the principal aims of OLE designers: keeping the **contact wire** as stationary as possible so that power can flow uninterrupted to the train; and minimising wear of the system.

To achieve this, the contact wire is tensioned between support structures in such a way that it can withstand deflection by high winds and extreme temperatures. This ensures that the current passes to the train in all weather, even at high speed.

The contact wire is suspended from vertical cables called **droppers** that are supported by a longitudinal cable called the **catenary**. The catenary and contact wire span between support structures – either **masts** or **frames** – which are normally spaced approximately 50m apart (although there is some flexibility in spacing).

The wires themselves are normally about 1500m long and **tensioned** at either end. To ensure no loss of power to the pantograph, adjoining sections of wire **overlap** for about 180m.

In designing the supporting structures, the most important engineering consideration is the effect of high winds, both along and across the tracks. The supports are made sufficiently stiff so that they do not deflect enough to impair current collection.

9.0 The components of OLE equipment

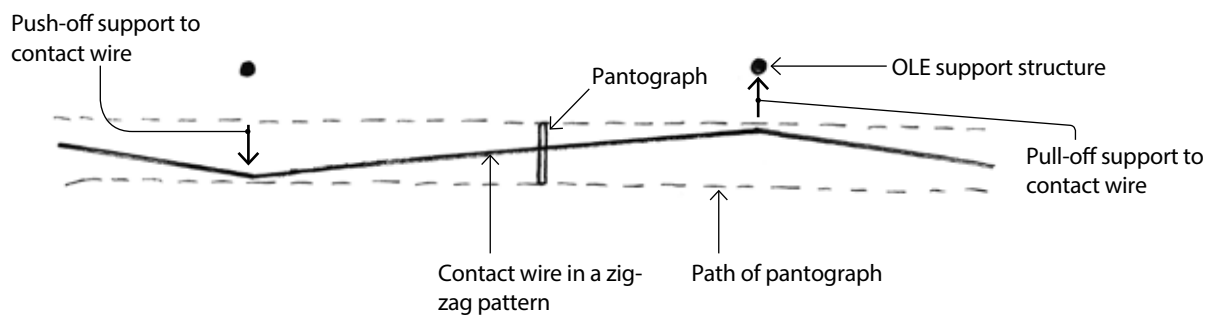

OLE in plan

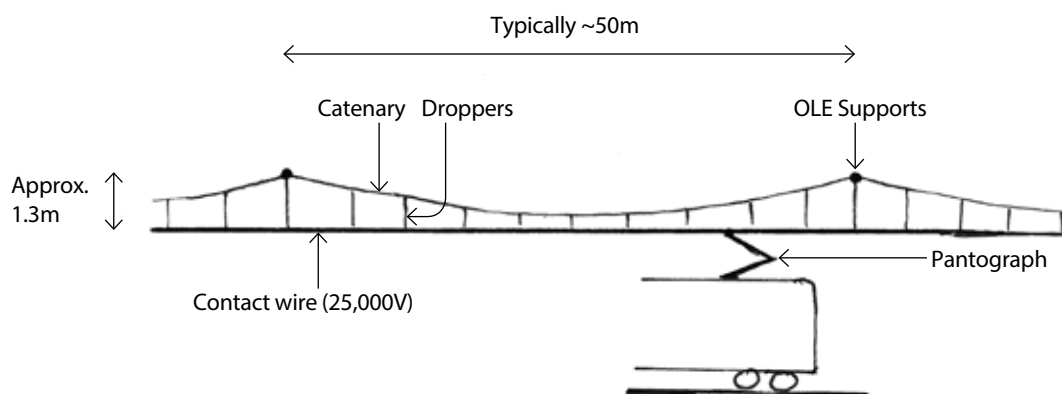

OLE in elevation

The contact wire also runs in a zig-zag path above the track to avoid wearing a groove in the pantograph. The zig-zag - known as the '**stagger**' - is generally achieved by the use of '**pull-off**' arms attached to the support structures.

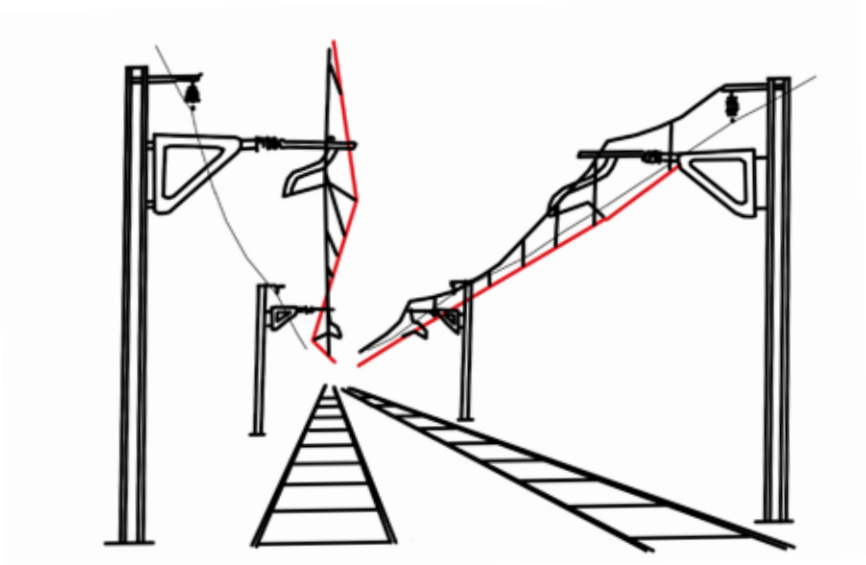

Stagger



Stagger of contact wire and catenary. Note also the pantograph on top of the train (photograph ©Graeme Bickerdike/Four by Three)

9.2 Cantilever masts

Where there are only one or two tracks, OLE is normally supported from lineside **masts** - typically made of H-section steel - using cantilevers. The **catenary** cable and the **pull/push-off arms** supporting the **contact wire** are attached to the ends of the **cantilever**. Where the masts and cantilevers meet, **insulators** are required to separate the electrically live elements. The **earth wire** is normally attached to the **mast**.

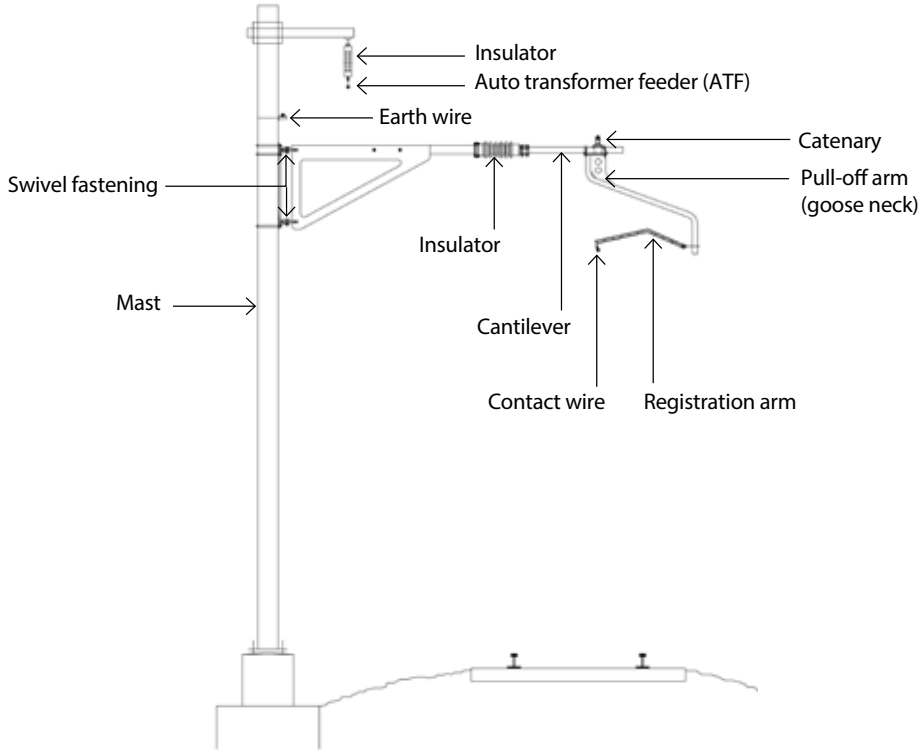

OLE mast, cantilever and associated equipment (in this case Series One)



Newly installed Series Two OLE cantilever masts on the North West Electrification Project (photograph: ©Mark Barber)

9.3 Portal frames

Where there are more than two tracks, cantilever masts are not always feasible. Instead, a steel **frame** may be adopted, spanning the tracks. This is generally referred to as a portal frame.

The frame consists of masts joined by a horizontal **boom**, which might be H section or lattice steel as shown on the diagram below.

On frames, the cantilevers supporting the wires are attached to the boom by vertical members called **drop tubes**.

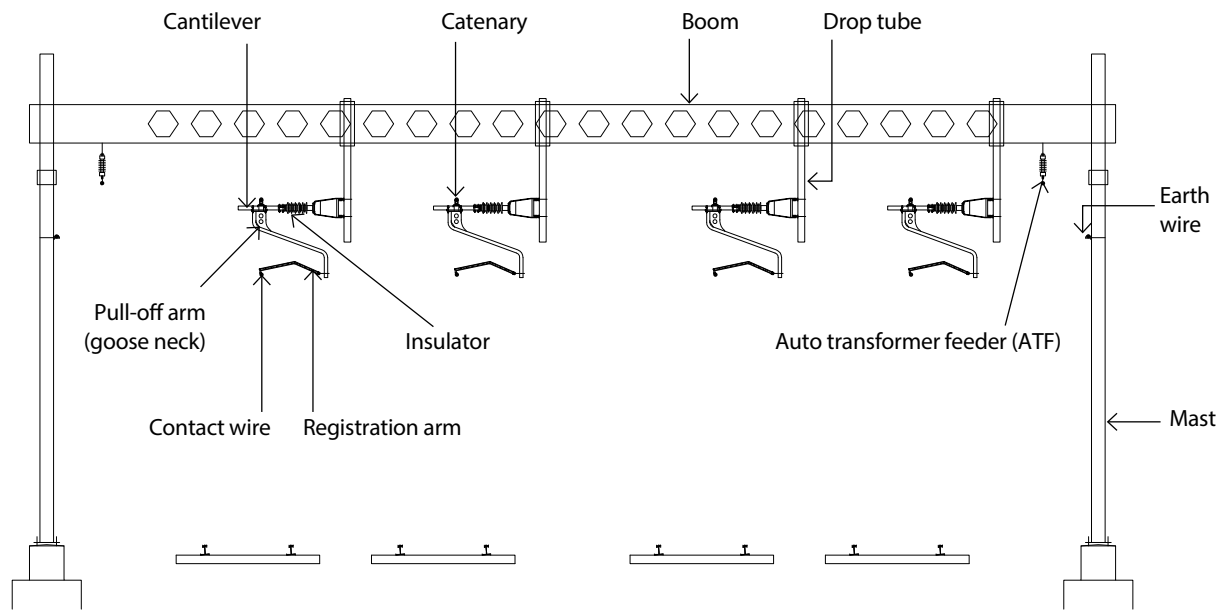

Portal frame OLE support structure



A typical portal frame made of H-section steel members (photograph: ©Network Rail)

9.4 Headspans

Earlier overhead electrification projects have frequently used a system of wires spanning between masts either side of the tracks to support the OLE catenary and contact wires. These are known as 'headspans'. There have been difficulties with this system in practice, in particular because there is a much greater risk that damage to the OLE will affect all tracks, resulting in much greater disruption than with other systems. As a consequence, headspans are now avoided, except in historic train sheds where slow train speeds reduce the risk of damage. Headspans are still favoured in these circumstances because they are much less visually obtrusive than other support methods (see section 13.6).



Headspans at Hanwell Station, on the Great Western Main Line. These supports are no longer favoured except where trains move very slowly, such as depots or terminus stations (see section 13.6) [photograph: ©Alan Baxter & Associates]

10.0 How OLE equipment is arranged along the track

10.1 Tensioning

The catenary and contact wires are installed in lengths that are tensioned at either end in order to keep the contact wire as still as possible. This is so that a good contact is maintained with the pantograph at all times and in all conditions. The tensioned wires will generally be up to 1500m long. An overlap between the length of wires of up to 195m is needed in order to provide a continuous supply of electricity to the trains.

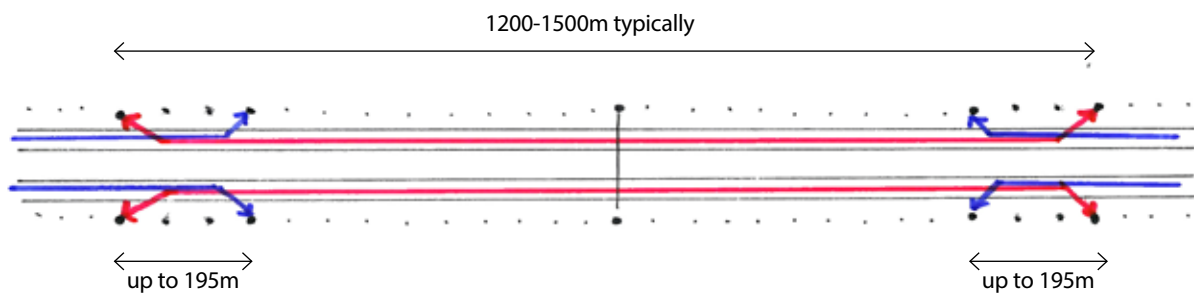

Plan

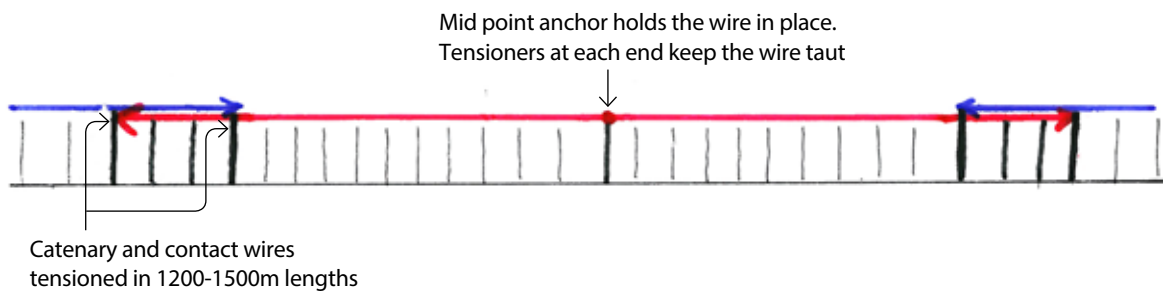

Section

Tensioning

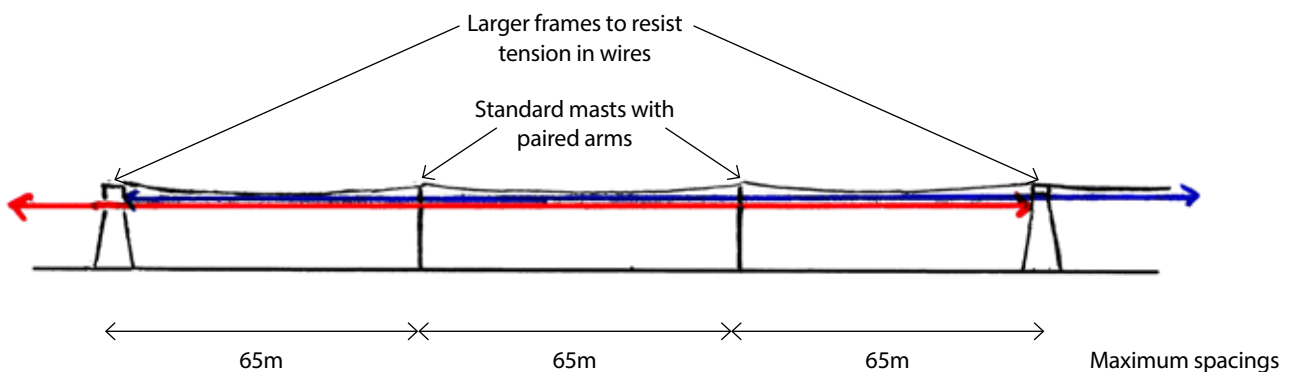

Overlapping

10.0 How OLE equipment is arranged along the track

The conventional tensioning mechanism consists of a braced mast and iron weights, as shown below. However, this system is susceptible to mechanical problems and to vandalism that can cause service disruptions. Therefore new systems use a spring tensioning mechanism, as shown here. Each wire needs two springs at each end (one for the catenary and one for the contact wire) and these are attached above the track to frames spanning the line. These supporting frames are larger than typical OLE structures because of the greater forces at work.

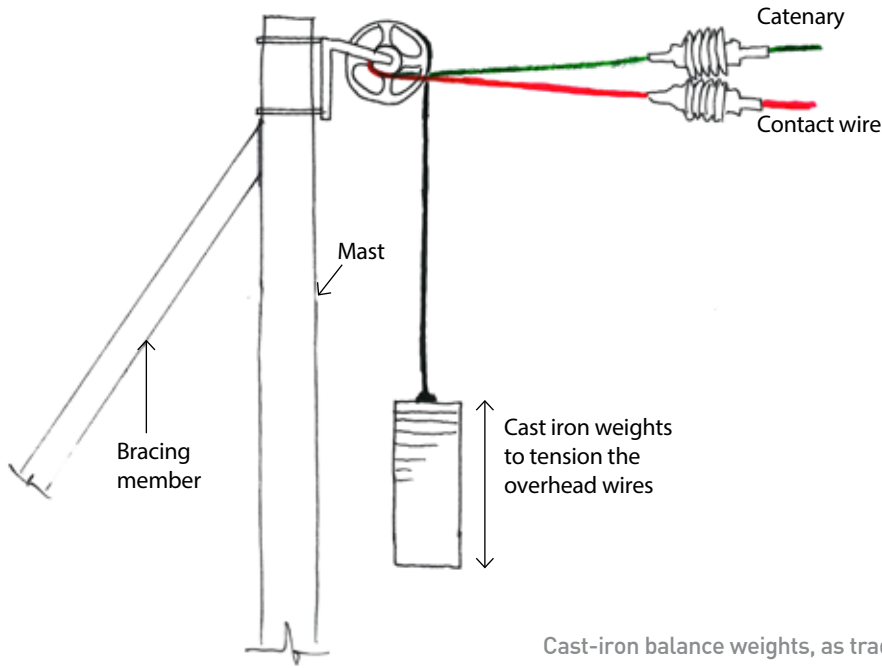

Cast-iron balance weights, as traditionally used on UK railways

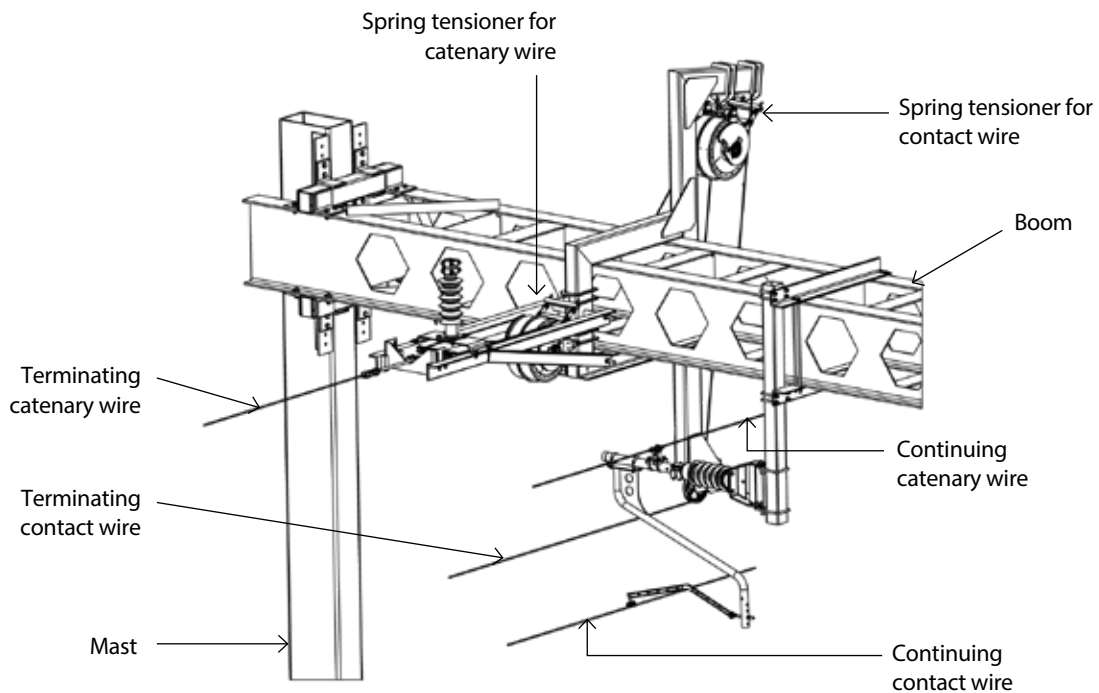

Spring tension device, as proposed for new electrification projects

10.2 Mid-point anchor

At the midpoint along a tensioned length, the wires are fixed in place. This is called the midpoint anchor and its purpose is to resist the effect of the friction caused by the passing pantograph trying to drag the contact wire forward. Midpoint anchor structures are likely to be portal frames that are slightly bigger than typical OLE structures.

10.3 At cross-overs (points)

To ensure a continuous supply of power when a train switches from one track to another across points, or cross-overs, additional wires are provided. These are normally installed between four sets of supports, as shown below. They are fixed in position at one end and tensioned at the other using springs. Two of the supports are needed at the beginning and the end of the cross-over in order to direct the additional wires over the points.

This means that wherever there are points there have to be more and larger supporting structures and wires. This is exemplified by the approaches to major stations such as Euston or Paddington, where there is a profusion of gantry supporting the OLE.

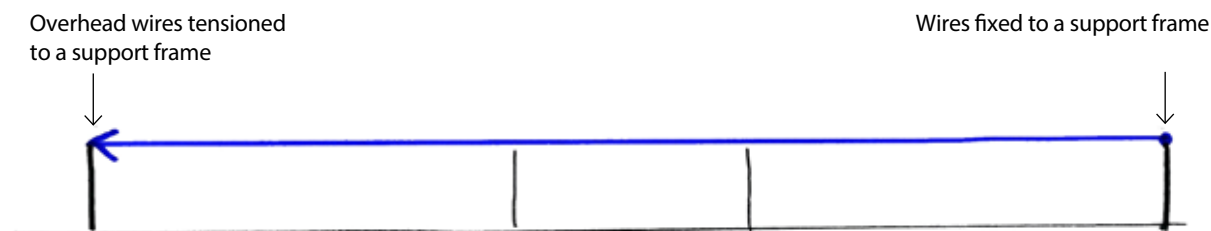
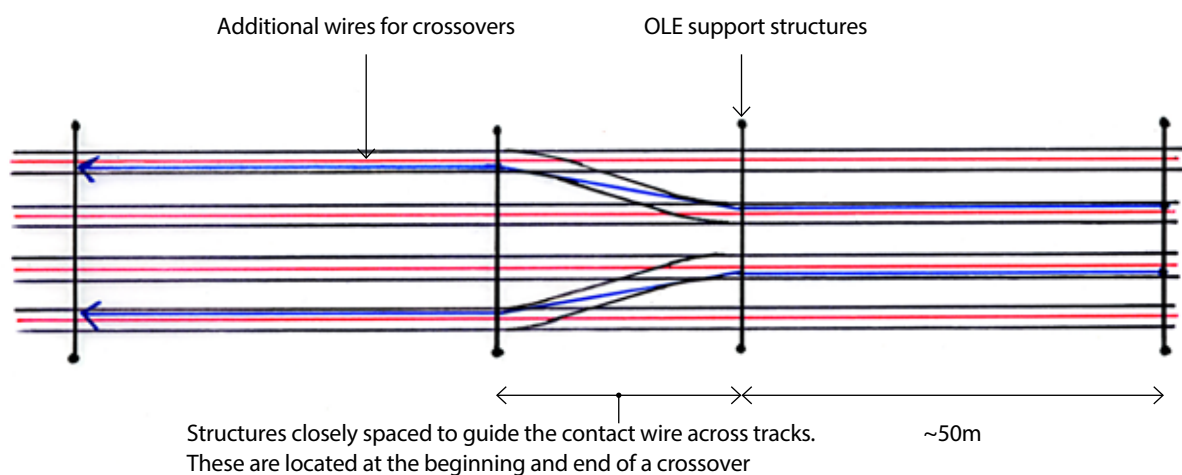

OLE at cross-overs (points)

10.4 Around bends and changes in gradient

OLE support structures are generally spaced 50–60m apart. Where the line goes around a bend, however, they may need to be more closely spaced so that the contact wire is kept in the right position for the pantograph.

A similar principle applies to vertical curves where track changes gradient, i.e. at the tops and bottoms of slopes.

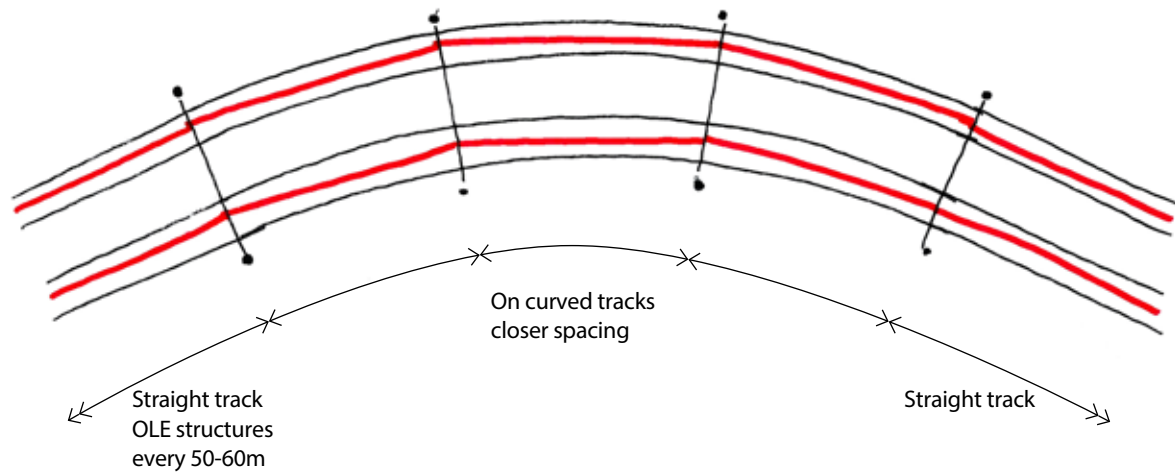

OLE around bends

10.0 How OLE equipment is arranged along the track

10.5 Neutral sections

Neutral sections are electrical “gaps” in the OLE wiring, used to isolate sections of wiring for maintenance purposes and to separate lengths of line supplied with power from different feeder stations (see 8.2). This is necessary to avoid power from one feeder inadvertently passing via the OLE to another and thus bypassing National Grid’s switching systems.

Neutral sections are formed by inserting short electrically-isolated or non-conducting elements between lengths of live contact wire, and fitting the catenary wire with insulators.

There are two basic types of neutral section, which are illustrated on the following page. The first is a full, “switched” neutral section. This consists of separate insulated lengths of contact wire in the overlap between two normal sections. The insulated neutral sections are connected to the normal contact wires by switches which are operated automatically by passing trains, thereby maintaining an unbroken electrical supply.

The second type of neutral section is a short length of non-conducting material spliced into the contact wire to enable local lengths of wire to be isolated, e.g. for maintenance work.

Neutral sections need to be sited away from junctions, signals or stations because any train that stops when its pantograph is on an isolated or insulated section will not have any power and will be unable to restart.

A full switched neutral section consists of an extended set of overlaps, together with an adjacent portakabin-sized switchgear cabinet; a short neutral section is attached to a standard single track cantilever mast and is less obtrusive. In sensitive landscapes or historic townscapes it is preferable for neutral sections to be sited in unobtrusive or screened locations because of their visual impact.

10.6 Neutral sections and low bridges

To run OLE under some low bridges, extended versions of the short neutral section have been employed, using an insulated rod or cable instead of the copper contact wire below the bridge. This can be combined with automatic switches to isolate the train’s pantograph so that it can coast beneath the bridge. The clearance between the insulated wire and the bridge deck or arch can then be reduced, in some cases by up to 200mm. This system only works for slowly moving trains and at locations where there is minimal risk of the train stopping near or under the bridge (see 10.5 above).

In addition, the system needs portal type OLE supports immediately either side of the bridge. These supports may need to anchor the contact wires and also carry power cables to maintain the electrical connection between the OLE on either side. All this equipment can harm the setting of historic bridges.

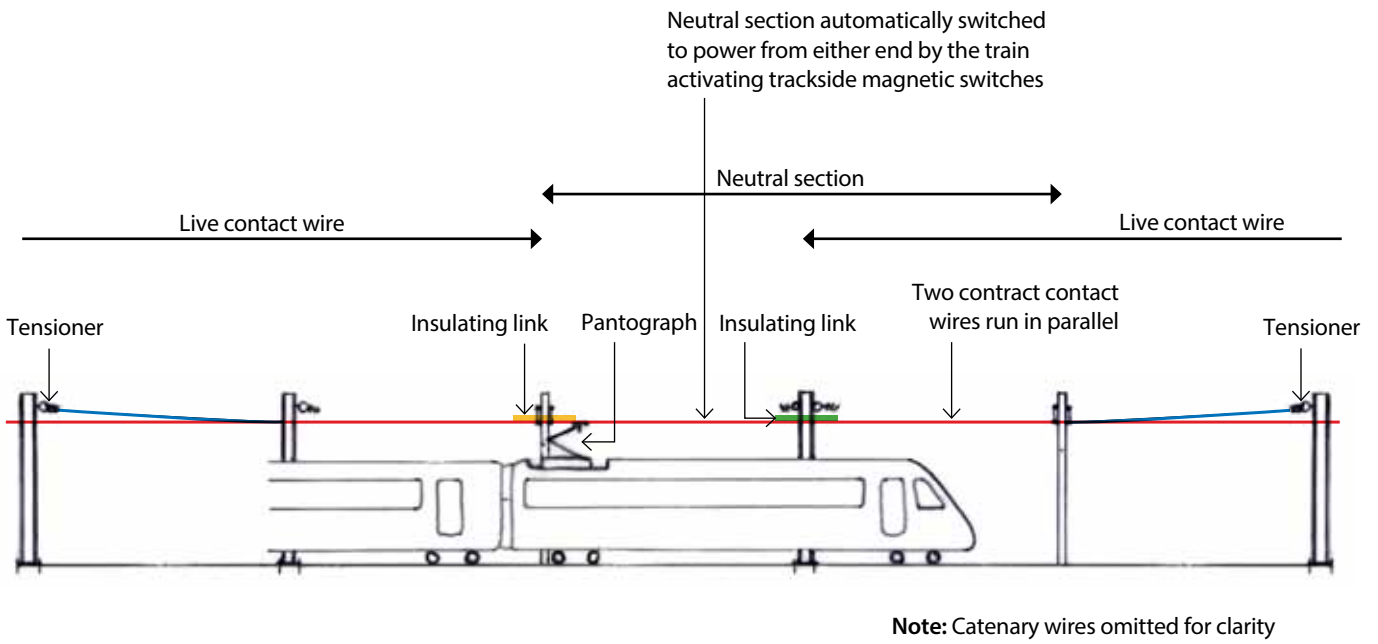

Full switched neutral section

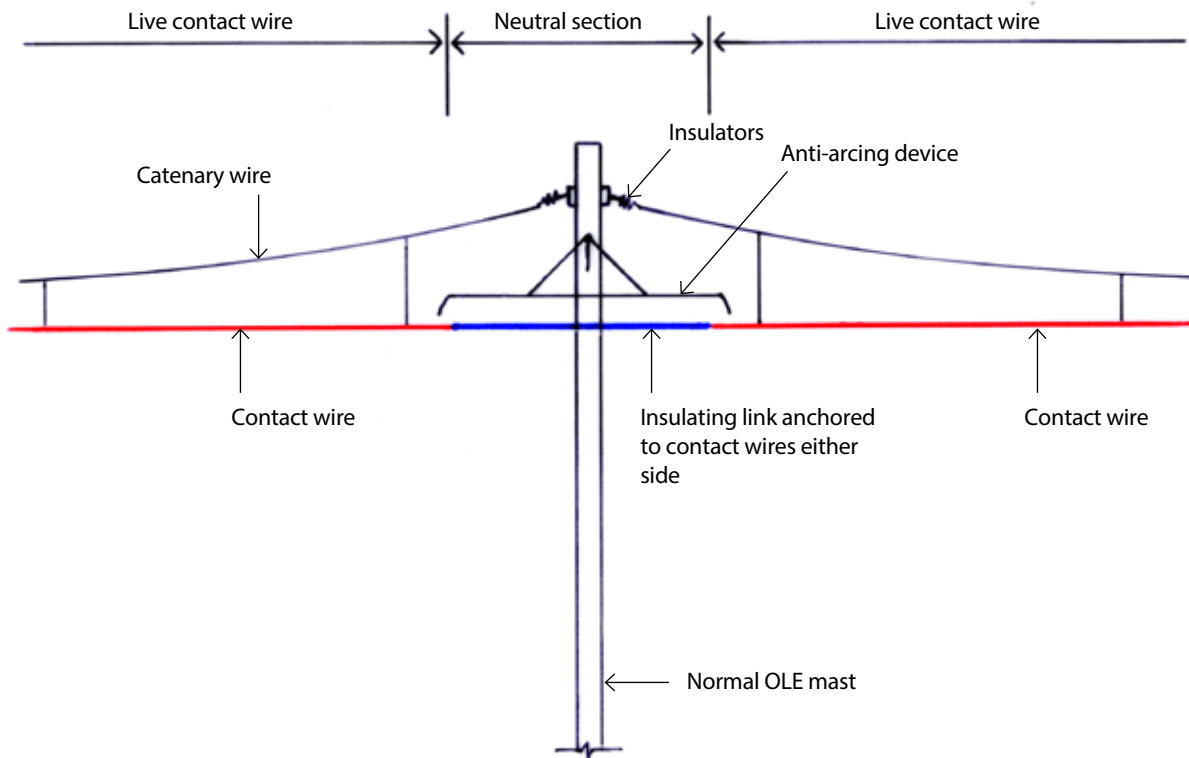

Short neutral section

10.7 Mitigating the impact of OLE on sensitive landscapes

The sketch below illustrates how intelligent use of standard components can minimise the impact of OLE on the landscape through which it passes. The railway is likely to be more prominent after OLE is installed because it is necessary to remove vegetation within 5 m of electrified tracks to avoid the risk of trees and shrubs interfering with or falling on the OLE, and reduce the risk of lineside fires caused by sparks.

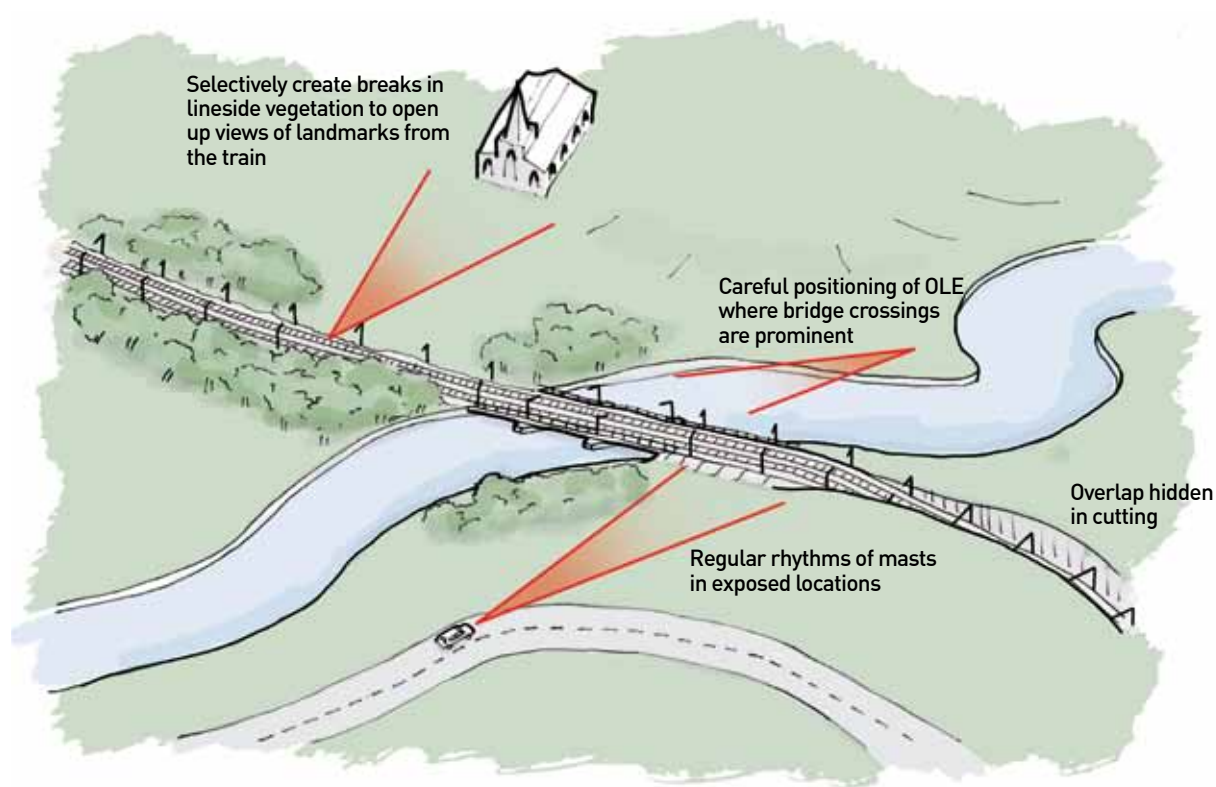

OLE in the landscape

10.0 How OLE equipment is arranged along the track

11.0 Loading gauges and bridge clearances

11.1 Overview

The greatest engineering challenge to installing OLE on existing lines is getting it under bridges and through tunnels that were almost all constructed in the 19th or early 20th centuries with no thought of electrification in mind.

11.2 Historical background

Passenger carriages were originally derived from stage coach superstructures set on railway wagon undercarriages. These, together with the height of steam locomotive chimneys, set the height and width needed to allow trains to pass safely through bridges and tunnels. Succeeding generations of locomotive and trains have been designed to fit these original profiles, known as 'loading gauges'. This is why UK trains are smaller than on the continent where railways were built later and for large trains.

11.0 Loading gauges and bridge clearances

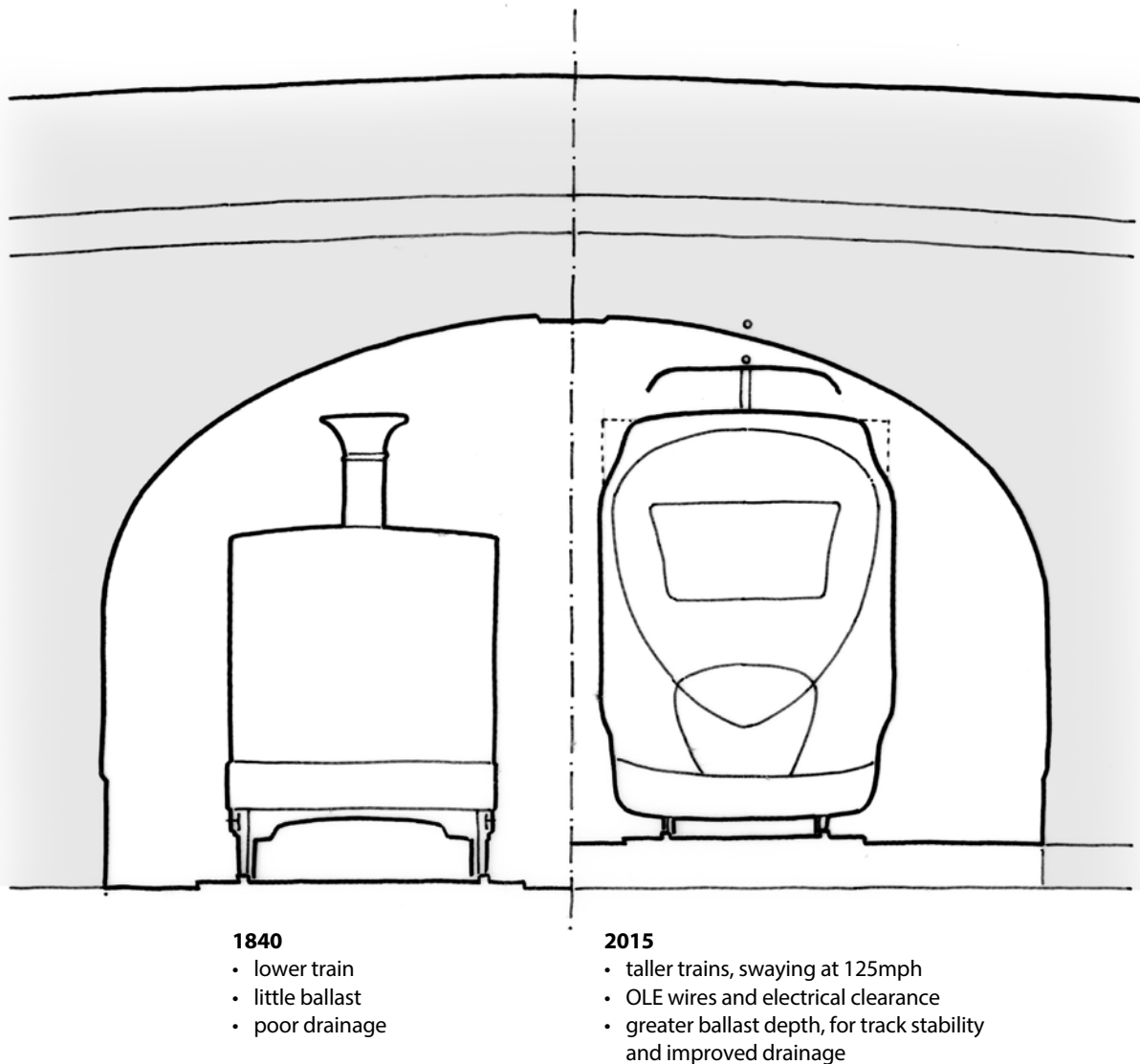

Gauge clearance: then and now

11.3 Requirements for OLE

Electrification of the railway brings significant changes. The trains have pantographs on their roofs and, above this, there must be space for the wires themselves. New electric trains cannot be made lower in order that the wires can be fitted into the existing space because existing trains need to be able to run as well. So greater height is needed at bridges and tunnels, particularly those with arched profiles.

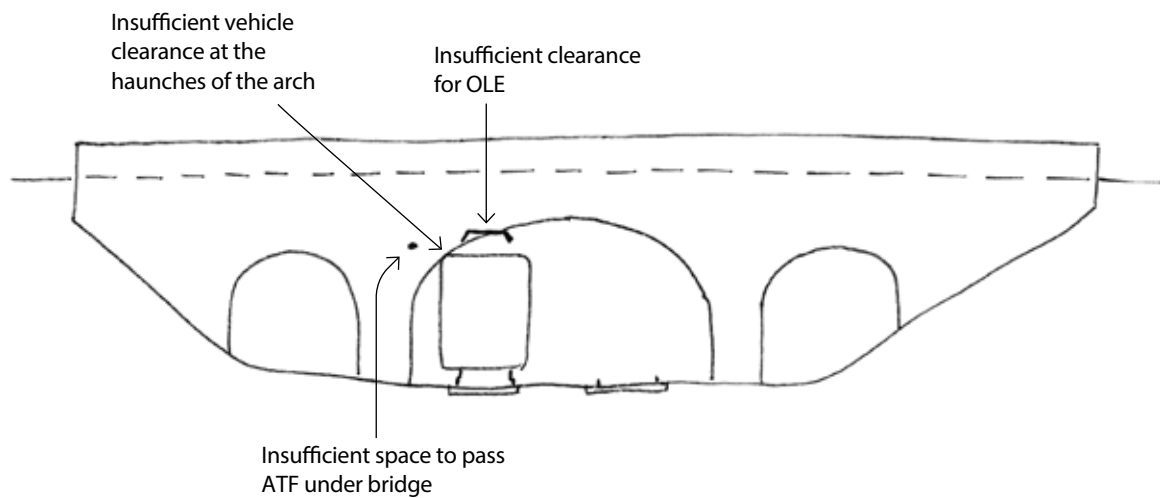

Typical constraints for the installation of OLE wires under an existing bridge

11.4 Requirements for improved freight trains

At the same time as the track and structures are being modified to accommodate electrification, the opportunity is also being taken to allow for larger freight trains. International shipping containers come in two standard sizes, 2.6m high x 2.44m wide and 2.9m high x 2.5m wide. These are too large to be carried on most UK railway lines without specialist wagons. Therefore, a larger profile, known as W12 gauge, is being adopted as part of the electrification works, to facilitate the more efficient transport of containers by rail.

Arched structures tend to conflict with the top corners of the container profile.

- Existing train envelope - passenger & freight
- Electric train requirements
- W12 freight train profile

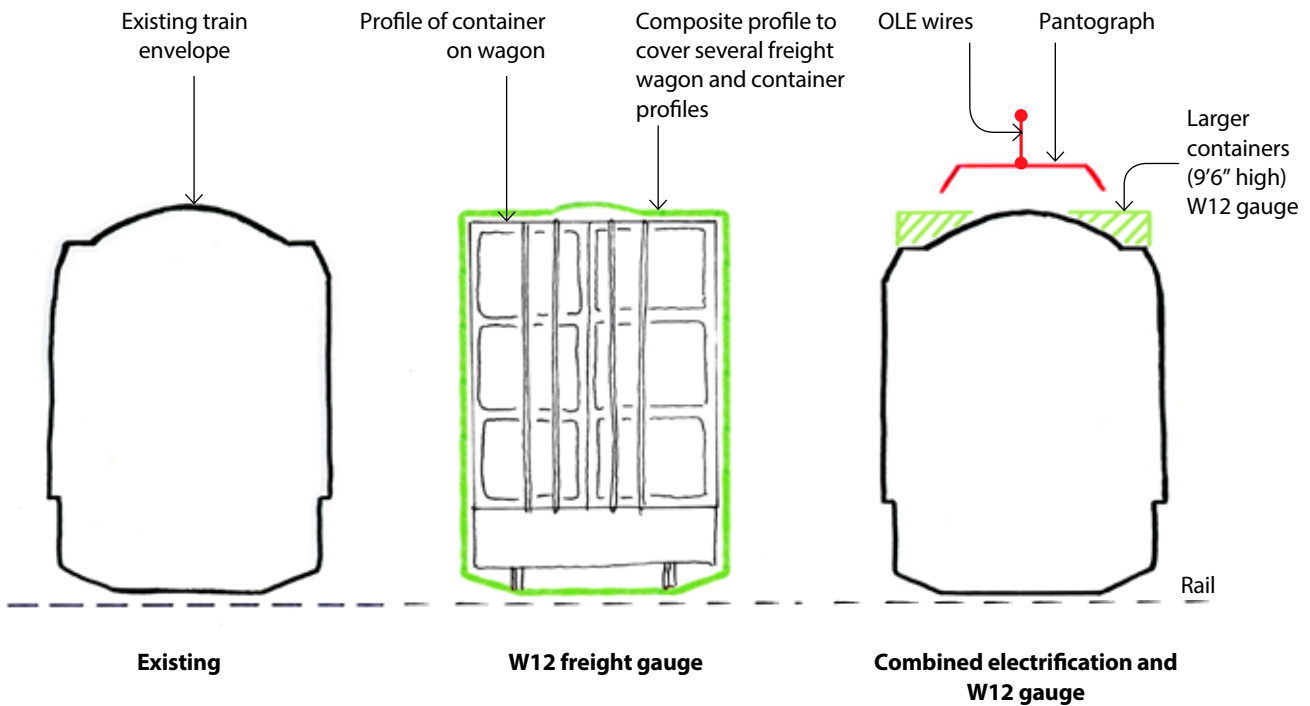

Gauge profile requirements

11.5 Different clearances

The amount of clearance (safety space) needed between the train, OLE and bridge or tunnel can depend on the nature and condition of the track and the trackbed, the amount the train can sway and bounce, the accuracy within which the positions of the track and OLE wires are maintained and the risks of accidental short-circuiting. There are a number of categories of clearance, including Desired, Normal, Reduced and Special Reduced, in order of decreasing height:

- Normal Clearance with free running OLE allows OLE wires to pass under bridges without any attachment.
- Normal Clearance with fitted OLE needs the wires to be held in position by attaching them to the underside of the bridge.
- Reduced and Special Reduced clearances have tight tolerances that require the track and OLE wiring to be monitored and adjusted much more frequently in order to keep close control over their positions. This is expensive, disruptive and precludes the use of standard maintenance machinery and practices. Therefore, it is only practical to adopt Reduced or Special Reduced clearances at major stations, where trains always travel very slowly and so disturb the track and OLE much less.

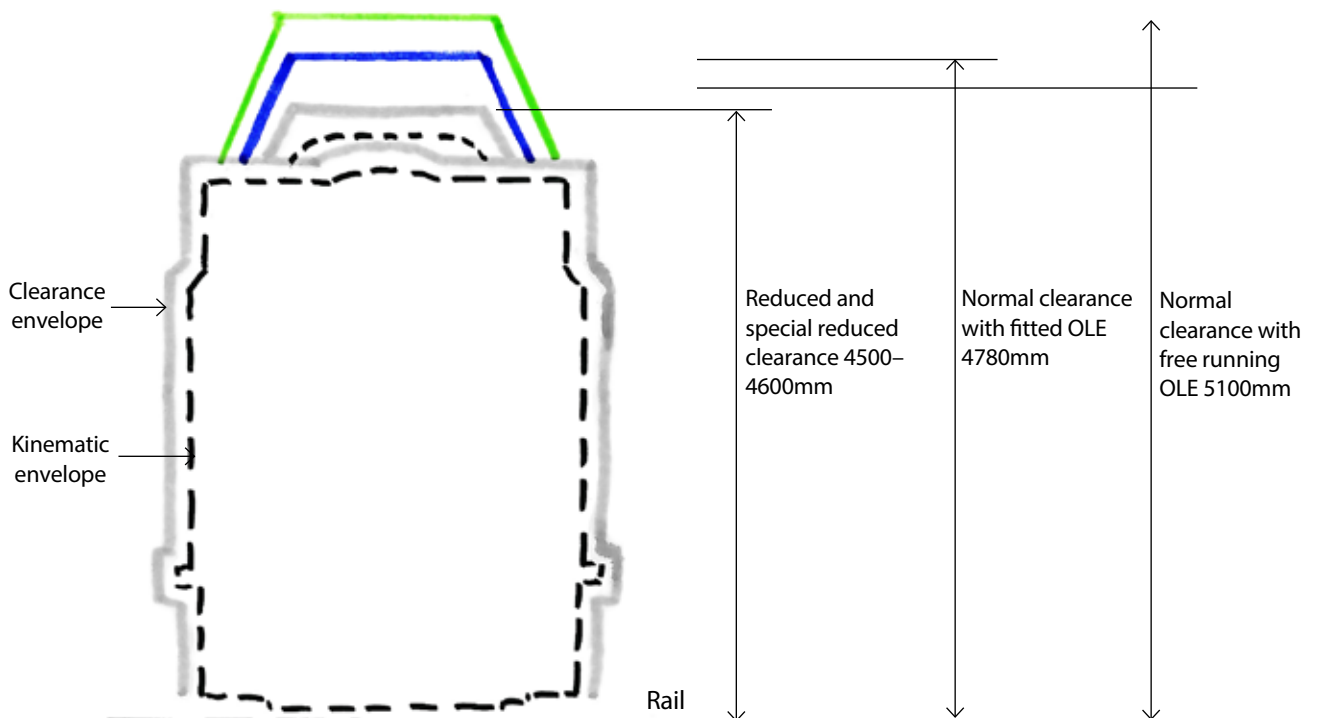

Different electrical clearances

12.0 The safety of passengers and staff

12.1 Clearance to live electrical equipment

Section 11 established the required clearances for trains. This section looks at the clearances required to reduce the risk of people coming into contact with the 25,000V in OLE. The diagram below shows requirements for minimum clearances in public areas. These clearances are measured from the closest standing surface to the closest live electrical parts of the OLE. If these dimensions are not met, barriers are needed.

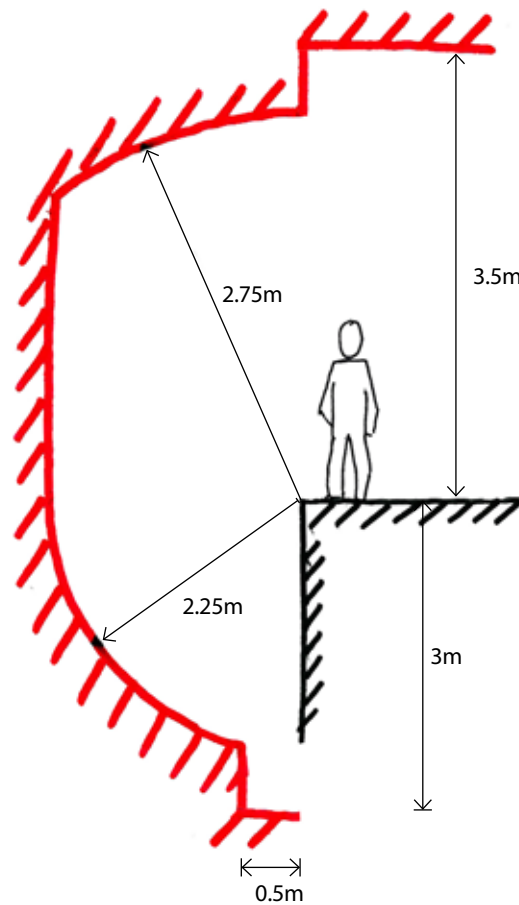

Public safety: clearances in public areas

12.2 Bridge and wall parapets

Network Rail has a legal obligation to take reasonable steps to prevent people from accidentally or otherwise falling onto OLE:

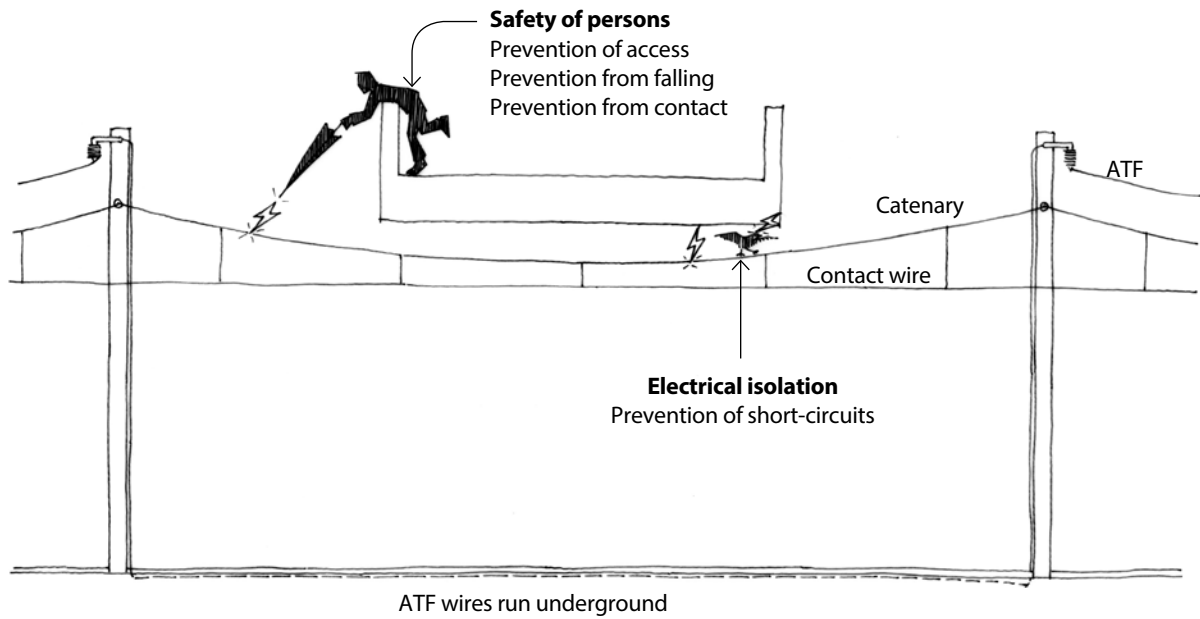

Public safety: bridges over OLE

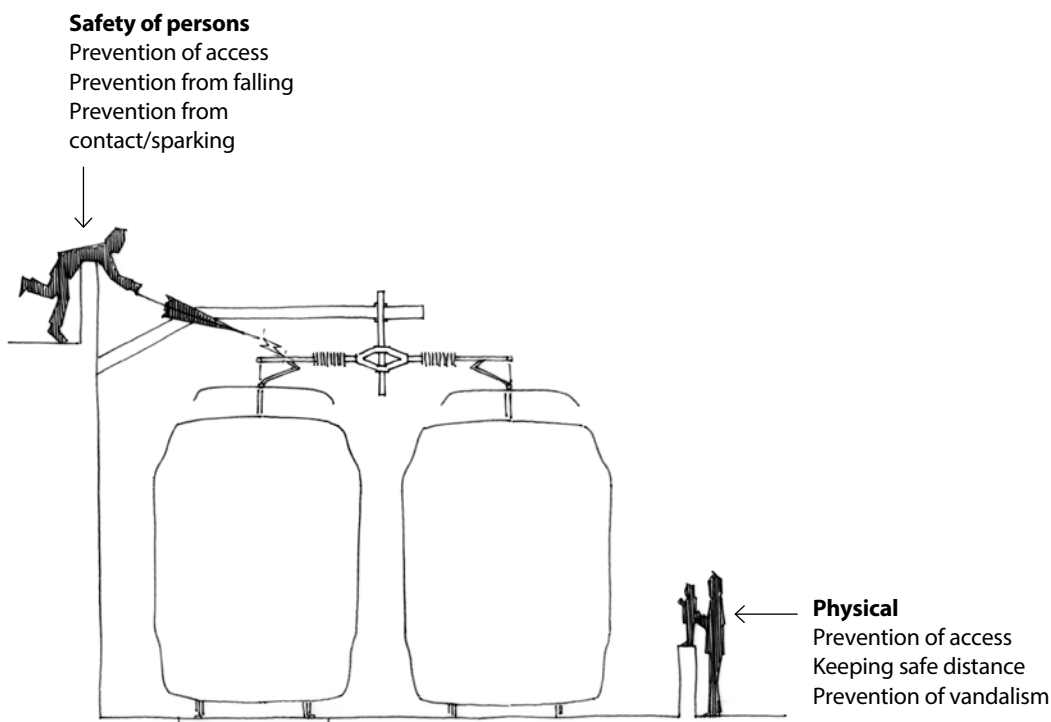

Public safety: lineside

12.2.1 Bridges

For existing bridges over lines that are to be electrified, Network Rail requirements are that parapets must be imperforate, climb-resistant and at least 1.5m high, and have an anti-climb (that is, pointed) coping on top. In addition they must further protection in the form of either:

- A increased height to 1.8m, or
- B a 300mm high mesh screen, to reach a total height of 1.8m, or
- C a hood projecting over the OLE.

These three options are illustrated here:

Option A

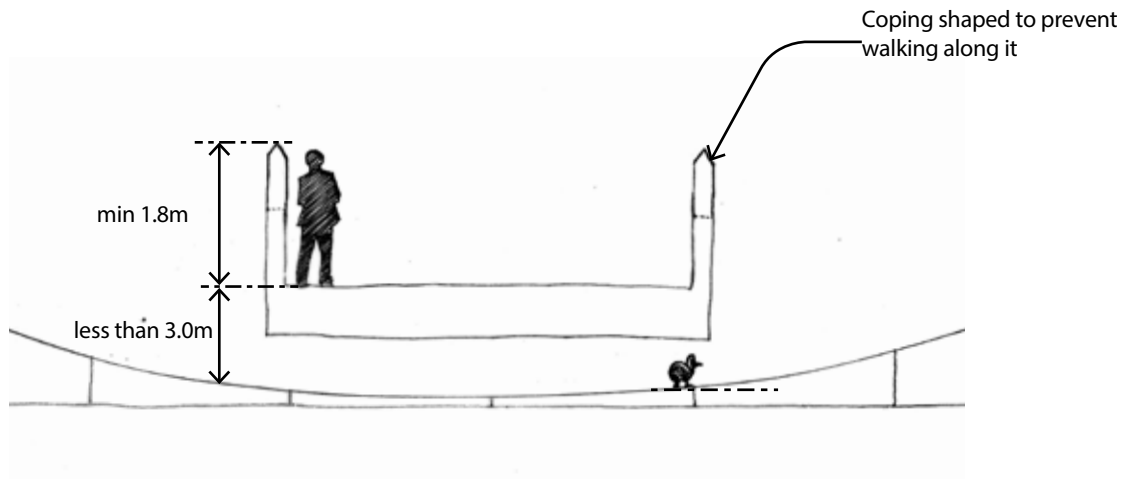

Option B

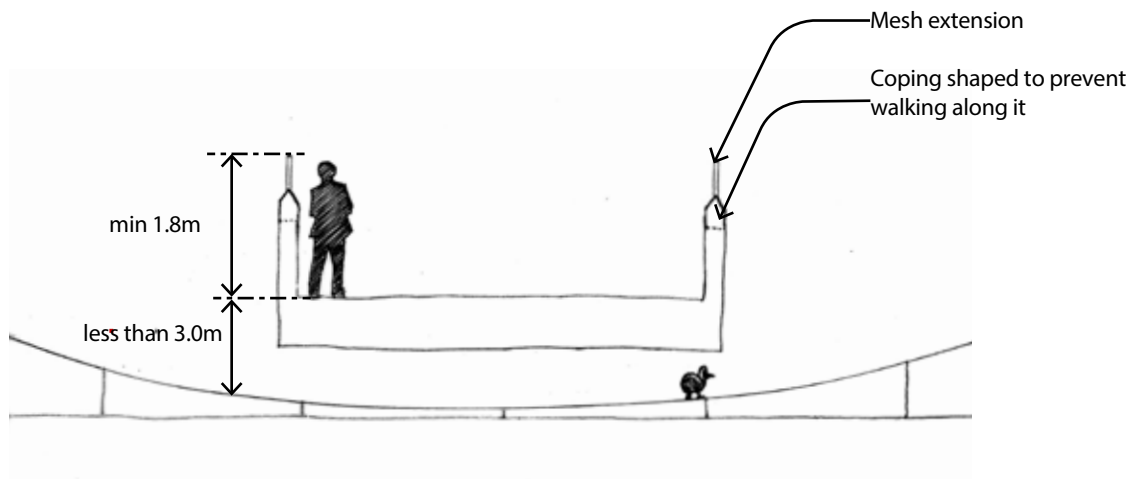

13.0 Installing OLE on different types of structure

13.1 Overbridges

The biggest engineering challenge to installing OLE on historic railway lines is fitting it under the existing bridges over the line. The key issues are:

- insufficient clearance at the top corners of the loading gauge
- insufficient clearance for OLE wires
- insufficient space for ATFs
- insufficient parapet heights

These two diagrams show, first, the general requirements that must be met, and, second, typical issues with historic bridges:

13.0 Installing OLE on different types of structure

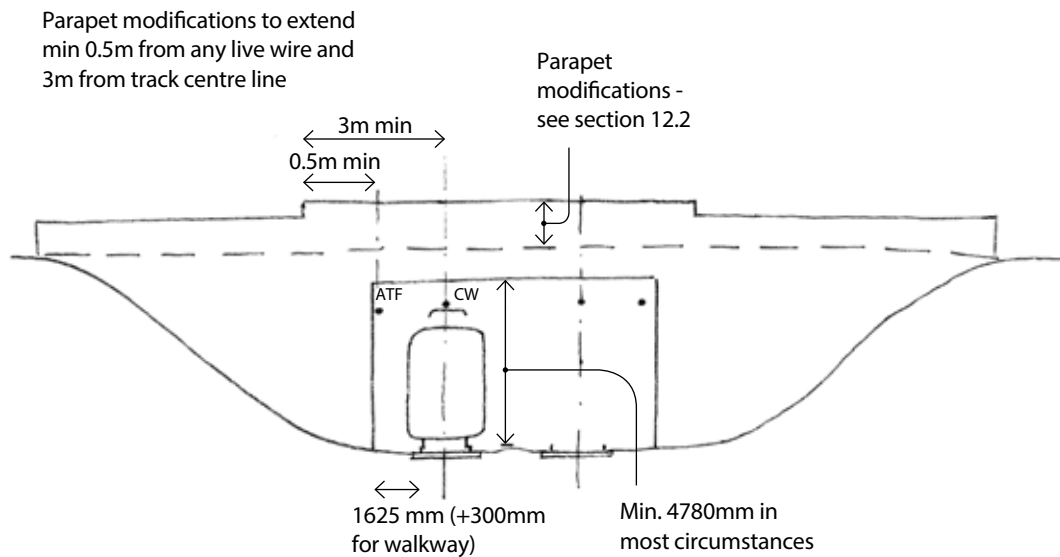

Requirements

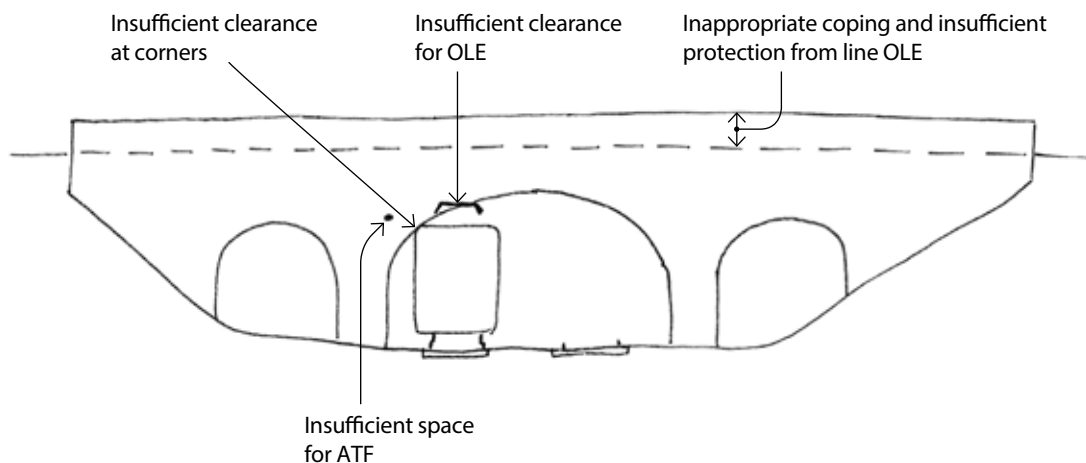

Typical constraints

13.2 Solutions for problematic overbridges

If an existing overbridge has insufficient clearance for OLE and/or loading gauge clearance, a number of options are available to the engineer.

13.2.1 Track lowering and slewing

The first option is to lower the track, or 'slew' it sideways, or both. The principle of track lowering is shown here:

Sequence

1. Lift track
2. Lower ballast and trackbed
3. Relay track to new lowered level

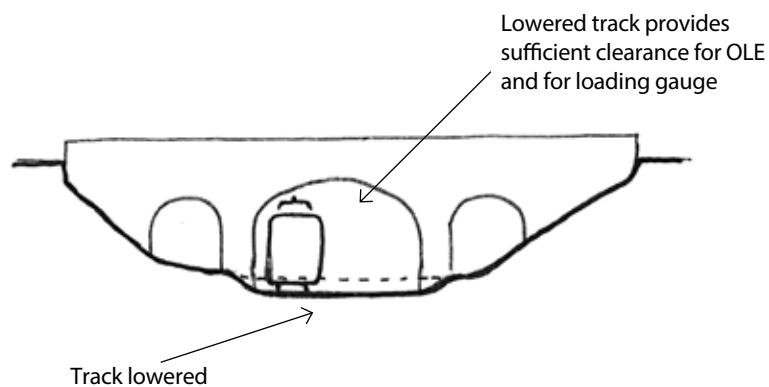

Elevation of bridge

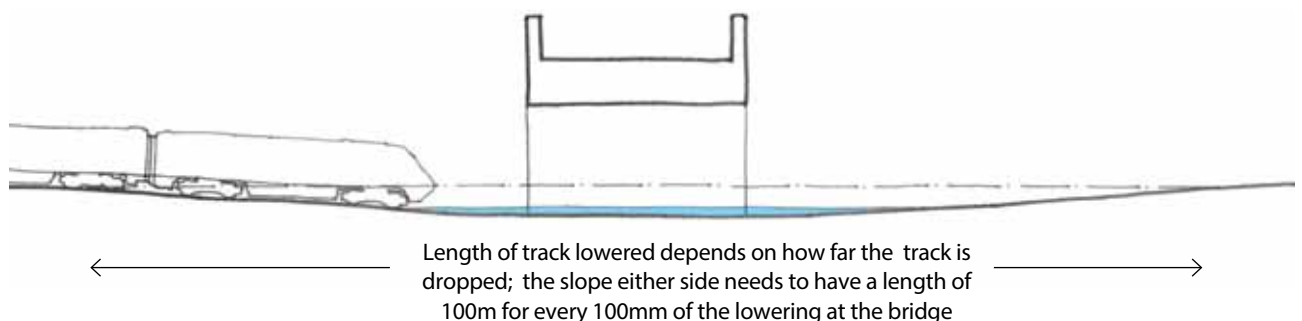

Section through bridge

Lowering track under a bridge

When considering **track lowering**, a number of factors must be taken into account:

- The lowered track needs to slope down under the bridge and back up again. The slopes need to be sufficiently gentle that passengers do not notice them and track wear is not significantly increased. Slopes may be as shallow as 1 in 1000, which means that many metres of track may have to be re-laid, which is expensive, time consuming and can cause disruption.
- It may be possible to lower the track by up to approximately 150mm without the need to take up and replace the track, using special equipment. However, if the track has to be lowered by more than c. 150mm or if the track bed is in poor condition, the existing track needs to be lifted, the underlying ballast and track bed re-profiled to the new level, and then the track re-laid. This is much more expensive and disruptive.
- If nearby stations, junctions or points are affected, the costs are greater still. For example, platforms may have to be lowered to match the new track level, which can be extremely expensive.
- Track lowering can give rise to significant problems with drainage, for example in the bottom of a cutting. Improved gravity drainage of the track bed may be needed and the pipes may have to run some considerable distance to a suitable discharge point. Installation of pumped drainage may appear to be a potential solution, but the pumps would be used infrequently and are therefore highly likely to fail when needed. Some lengths of track are already particularly prone to flooding causing disruption to train services. In such cases, track lowering would increase the risk of flooding and disruption and is therefore unacceptable.

The use of track slab, where the rails are supported on a continuous concrete base instead of sleepers and ballast, can allow the rails to be lowered by 50–100mm, due to its thinner construction and its more accurate control of the track position. However, the concrete slab needs to be broken up and re-made if in the future the alignment or level of the track needs to be adjusted. This is much more expensive than minor adjustments to ballasted track, so the use of track slab is normally avoided.



Water collecting at low points on the track causes many thousands of 'delay minutes' each year (photograph: ©Network Rail)

Track slewing means moving the track sideways in order to create greater clearances, as shown below. Many of the drawbacks of track lowering also apply to slewing. The extent of slewing is limited by the need to maintain passing clearances to adjacent structures and trains.

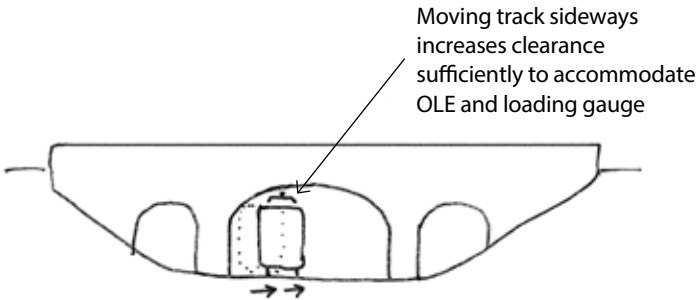
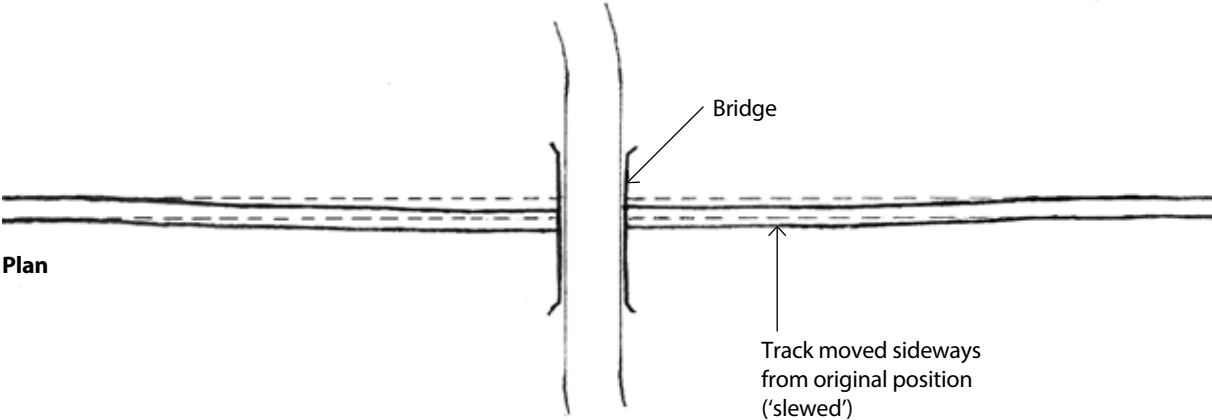

Elevation of bridge

Track Slewing

13.2.2 Bridge jacking

An alternative approach is to jack the bridge. This is a relatively commonplace undertaking on the railways with bridges which have a level steel or concrete deck, as shown in the diagram below. Even so, there are significant implications:

- reprofiling approach roads and possibly junctions to suit the new level
- impact on services and public utilities, such as telecoms, buried in the bridge. These are surprisingly numerous and most road bridges contain several. Altering and possibly temporarily severing these can be expensive.

Most historic railway bridges are brick or stone arched structures. The jacking of such a structure over a working railway is an operation that has never yet been tried, and is considered much too risky for it to be attempted.

Such an operation would require inserting jacks into the brick piers and abutments and involve a considerable loss of historic fabric. Other repairs and masonry replacement once the jacking was completed would be necessary. The result would alter the appearance of the bridge. It could also significantly affect the integrity and safety of a masonry arch bridge.

The whole complex process would also require closing the railway, either wholly or in part, for a considerable time.

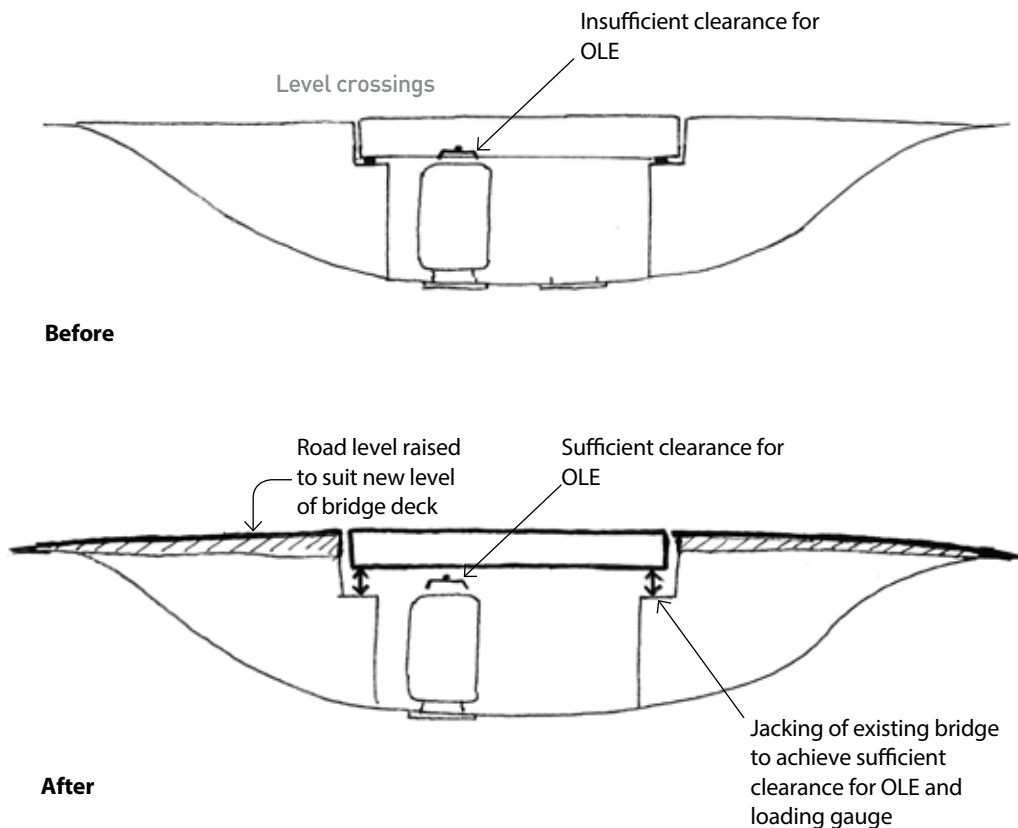

Jacking a bridge

13.2.3 Bridge reconstruction

Depending on the architectural and historical significance of the bridge under consideration, reconstruction might be an option. Reconstruction could either involve complete replacement of the bridge or reconstruction of just the span over the tracks, supported on the existing abutments.

Depending on the layout of the bridge, the design of the replacement deck may provide this desired clearance without re-profiling road approaches, though the impact on buried services remains.



Typical reconstruction of a non-heritage bridge (photograph: ©Network Rail)

Some arched bridges have slender piers. Removing the main arch could destabilise these piers. In some of these cases some additional buttressing might be needed within the approach arches, as shown here:

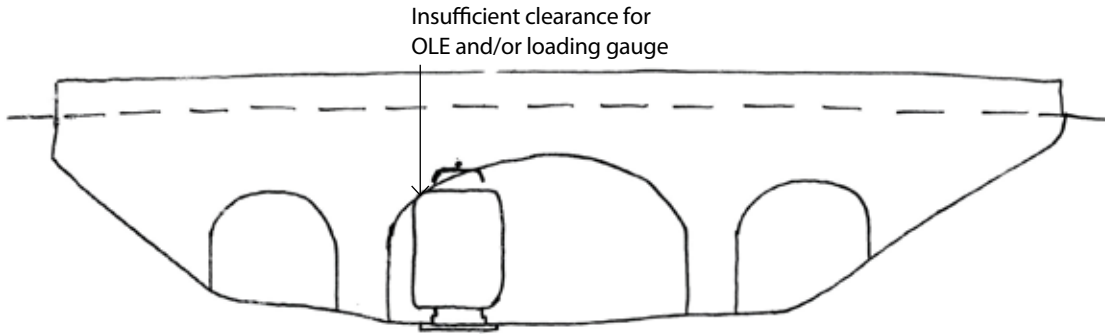

Bridge before reconstruction

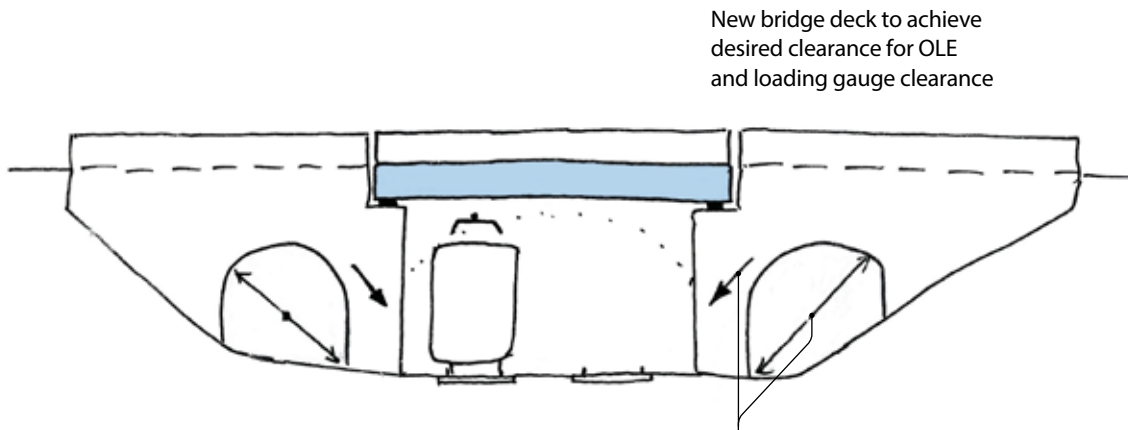

New bridge deck to achieve desired clearance for OLE and loading gauge clearance

Existing piers may not be stable when central arch is removed. Therefore, some additional buttressing might be needed within approach arches

Bridge following insertion of new deck

13.2.4 Reducing the clearance under a bridge to the OLE wires

The clearance between the OLE wires and the underneath of the bridge may be reduced by inserting an insulated rod or cable into the wires below the bridge. This is described further in 10.6 above. This solution can only be applied where trains move slowly and where there is a very low risk of the train coming to a halt below the bridge.

13.3 Level crossings

OLE wires rise to their highest point at level crossings, to provide sufficient headroom for lorries to use them. If the road is a designated high load route, a larger clearance is needed.

The normal height of the contact wire is 4.7m above rail level, and the minimum is 4.165m to get under a bridge. The normal height of the wire at a level crossing is 5.6m, so the contact wire may need to climb approx. 1.4m between an overbridge and a level crossing. This could be a problem when these are located near together because the contact wire can only climb at a certain gradient if adequate and safe contact is to be maintained with the pantograph. This raises a significant issue for the design of OLE in general, which is that existing structures cannot always be thought of in isolation: works proposed to address the problems in one location can have consequences for other structures along the line, because of the distances involved in OLE engineering.

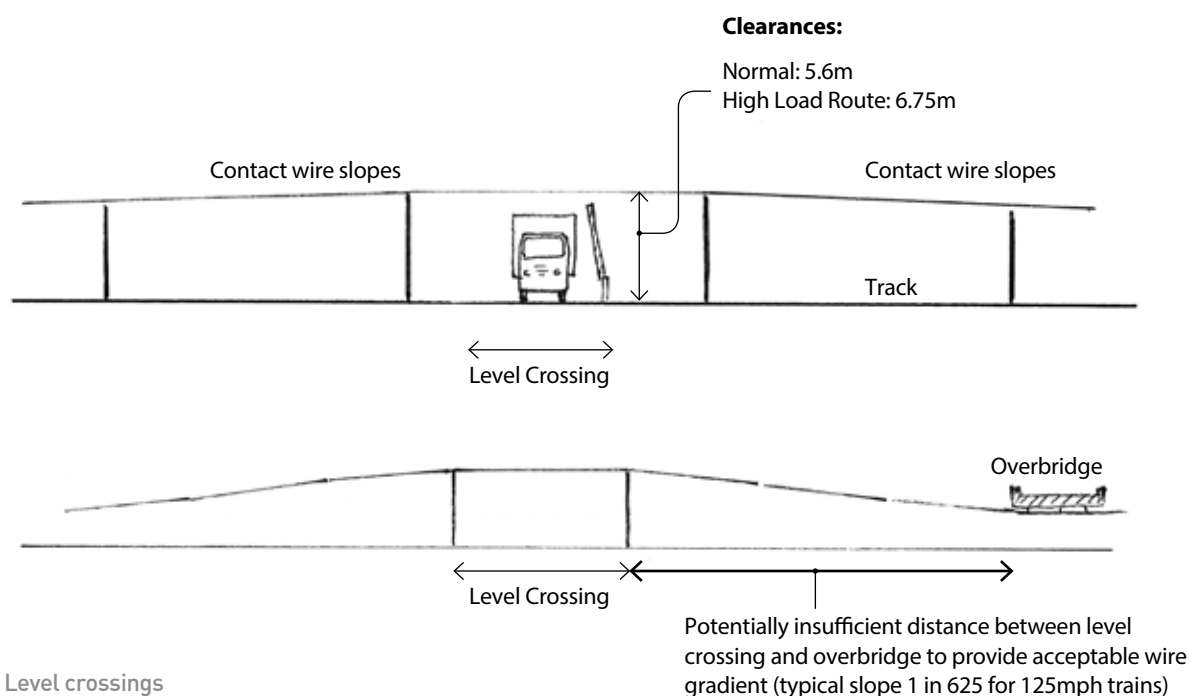

Level crossings



Level crossings - note how the pantograph on the train is extended to reach the raised contact wire [photograph: ©Philip Hilbert]

13.4 Underbridges and viaducts

There are unlikely to be problems providing sufficient clearance to install OLE over underbridges and viaducts unless other objects such as electricity transmission wires interfere.

The majority of underbridges are short structures of one, two or three spans. Because the distance between OLE supports is approximately 50-60 metres, it should be possible for the OLE to span these bridges without positioning masts or frames on them or adjacent to them, in most cases. This might be important where the setting of the bridge is sensitive because it is historically or architecturally significant, or it forms part of an attractive townscape or landscape scene.

Any bridge or viaduct longer than about 60 metres will need to have supports erected on it. If the viaduct is of architectural or historical interest, for example if it is listed, it may be appropriate to erect bespoke designs that respond to the particular character of the structure and its setting. This has been done before, for example on Stephenson's Royal Border Bridge at Berwick, and is also proposed for Brunel's Maidenhead Railway Bridge by Crossrail (see illustrations on the following pages).

There are two issues to consider in such circumstances. First, the spacing of the masts or frames should respond to the structural and architectural rhythm of the viaduct, even if this means positioning them more closely than technically necessary, as shown below. Second, the distance between the tracks and parapets will determine if it is possible to install masts on the bridge deck, as shown in the diagram on the following page. This is the simplest and least intrusive solution; an example is Crossrail's proposal for Maidenhead Railway Bridge. Where there is insufficient clearance between parapet and track and where parapets are sufficiently wide, supports can be embedded within the parapet, as shown on p.43. The Grade I listed Wharnccliffe Viaduct is an example of where this has been achieved, by locally rebuilding the parapets around the masts. Where neither of these solutions are possible because the viaduct has both a narrow deck and thin or no parapet walls, masts should be fixed to the elevations of the viaduct, as shown on p.44. The Royal Border Bridge is an example of where this necessity has been handled with some elegance.

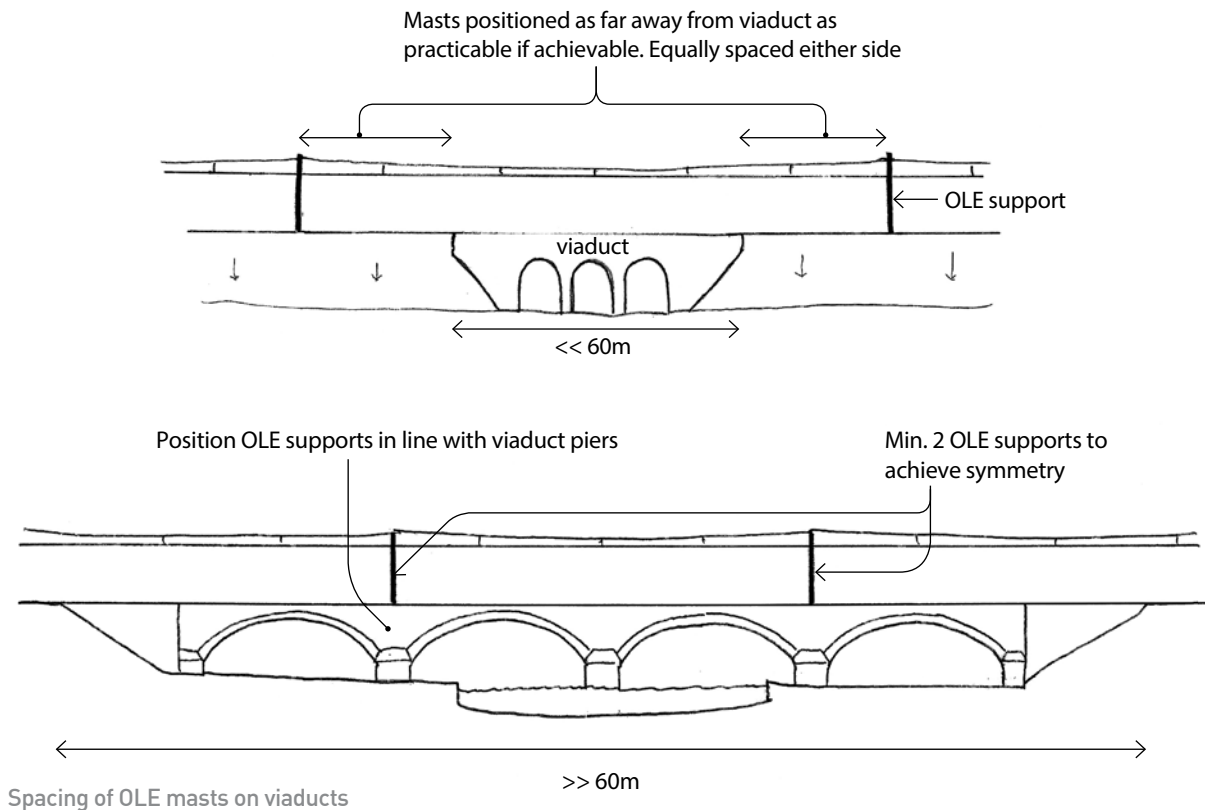

Masts on viaducts: on the deck, in board of the parapets

Sufficient clearance to accommodate masts — increased clearances may be needed where track is curved

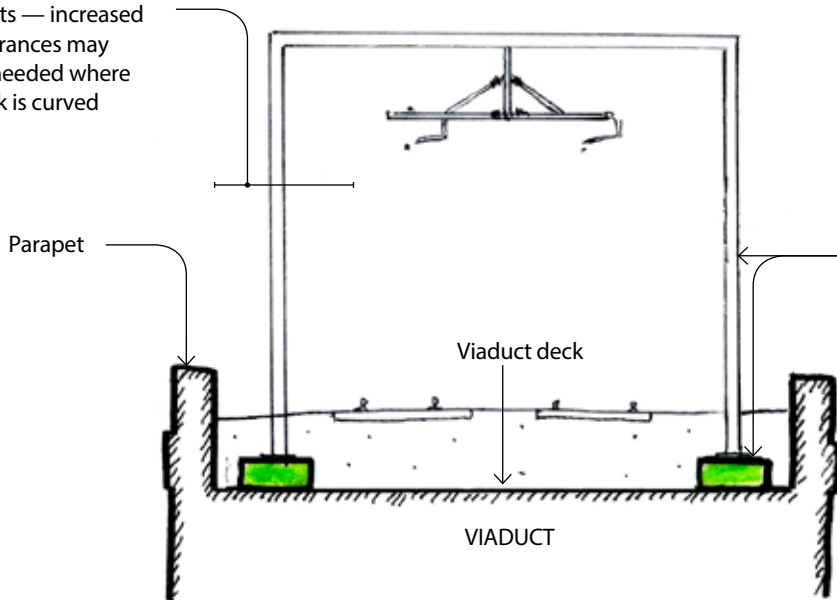

OLE masts installed on the deck of the viaduct if there is sufficient clearance between the tracks and the parapet



Maidenhead Railway Bridge, Great Western Main Line (Grade I). Proposed OLE supports (photograph: ©Network Rail)

Masts on viaducts: embedded within the parapets

Sufficient clearance to accommodate masts

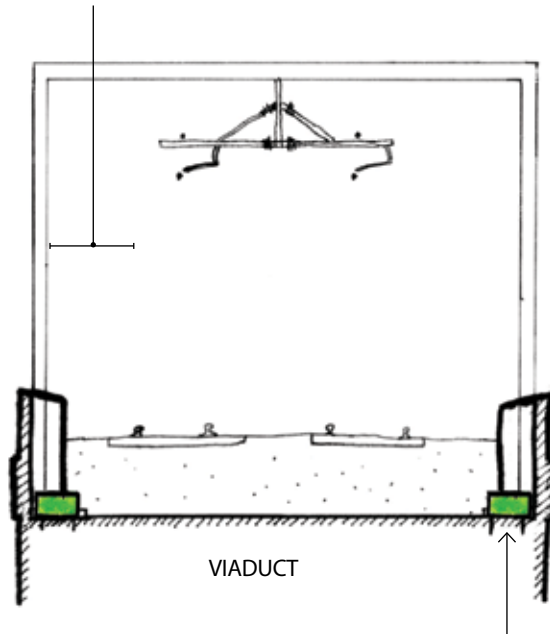

OLE masts supported on viaduct deck within the width of the parapet if there is sufficient clearance between the track and the inner edge of the parapet



Wharncliffe Viaduct, Great Western Main Line (Grade I). OLE installed c.1998 (photograph: ©Alan Baxter & Associates)

Masts on viaducts: attached to the face of the piers

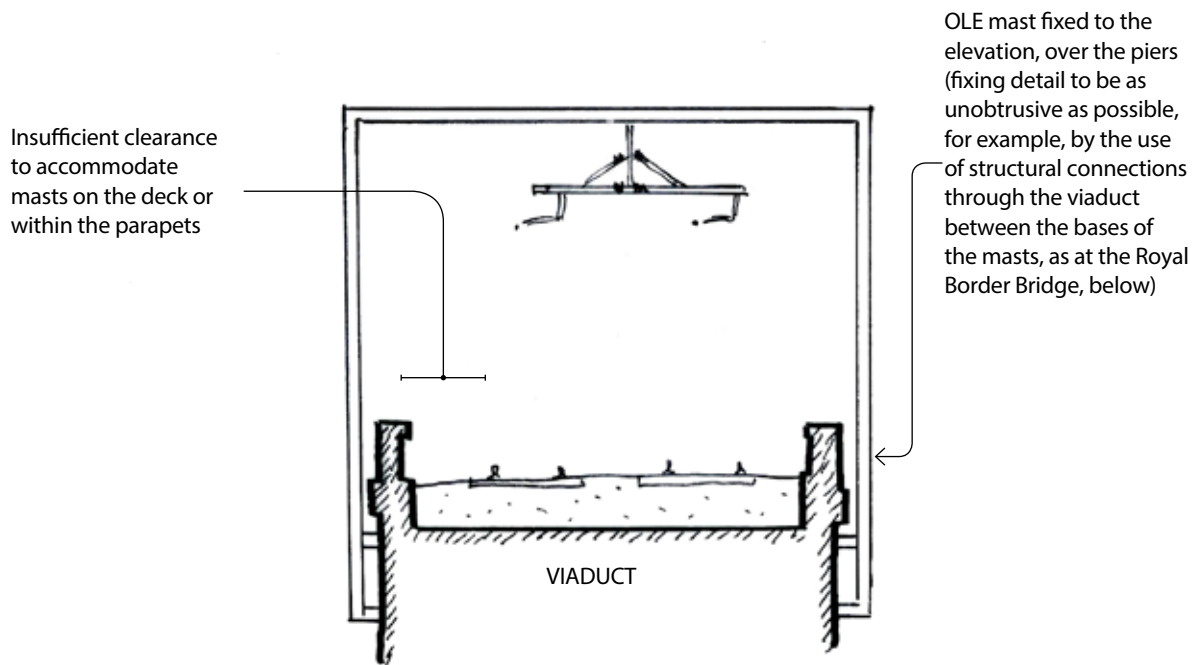

Royal Border Bridge, Berwick-upon-Tweed (Grade II*). OLE installed c. 1989 (photograph: ©flickr.com/photos/forest_pines)

13.5 Tunnels

The principles and issues for inserting OLE into tunnels are similar to those for overbridges. Therefore, track lowering and slewing are potential options if there is insufficient clearance within the bore of a tunnel. The main concern, however, is to avoid fixing OLE to the face of tunnel portals if these are of architectural or historical interest, which many are. In most instances this can be achieved by using fixings just inside the tunnel mouth, hidden in shadow. Normally, the nearest mast to the portal can be positioned 25 metres away.

The route of ATF cables may present a particular problem. In normal circumstances, a metal plate is attached to the face of the tunnel to which the ATF is attached and then diverted around and through the tunnel mouth. This has a significant visual impact which might not be acceptable if the portal is a formal architectural composition. As an alternative, ATF cables can be run through troughs at track level on the approach to the tunnel portals.

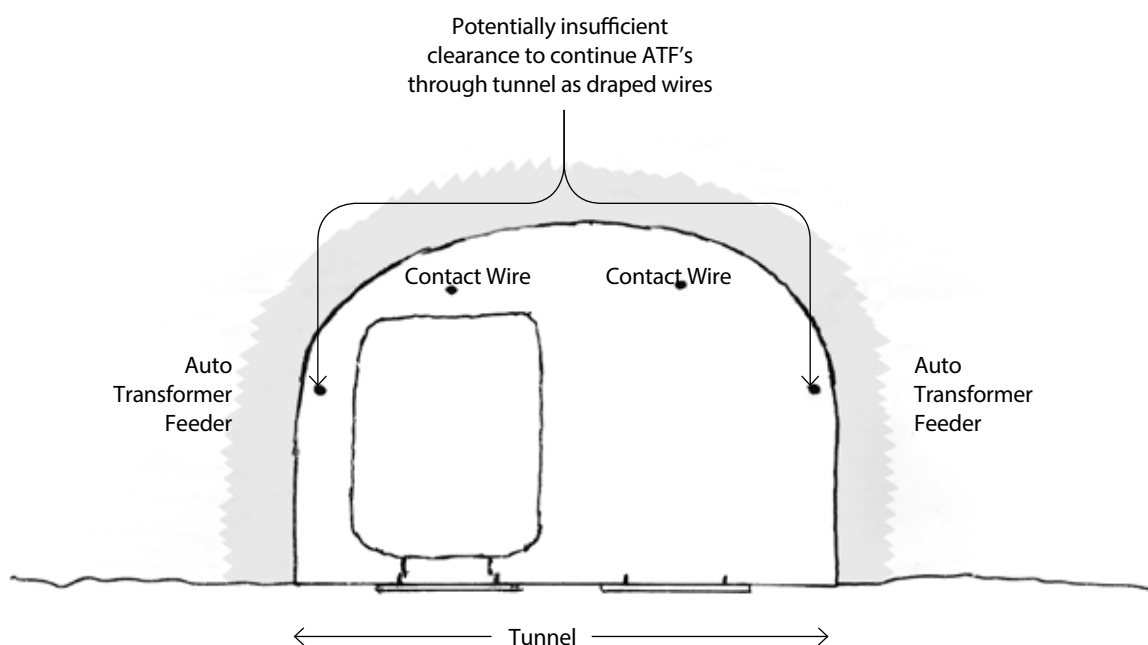

Running wires and cables through tunnels



Box Tunnel West Portal, Great Western Main Line (Brunel, Grade I): seen from public viewing area (photograph: ©Alan Baxter & Associates)

When tunnels are shorter than the length of tensioned wire, tensioning of the catenary and contact wire is undertaken in the normal manner outside the tunnel at either end. Care should be taken to position overlaps as far as practicable from listed portals.

If a tunnel is longer than about 1200m, the tensioning of the wires needs to be done within the tunnel, which can be quite complex because of the physical restrictions and environmental conditions.

Note: Overlaps kept well clear of tunnel portal or fixed inside tunnel

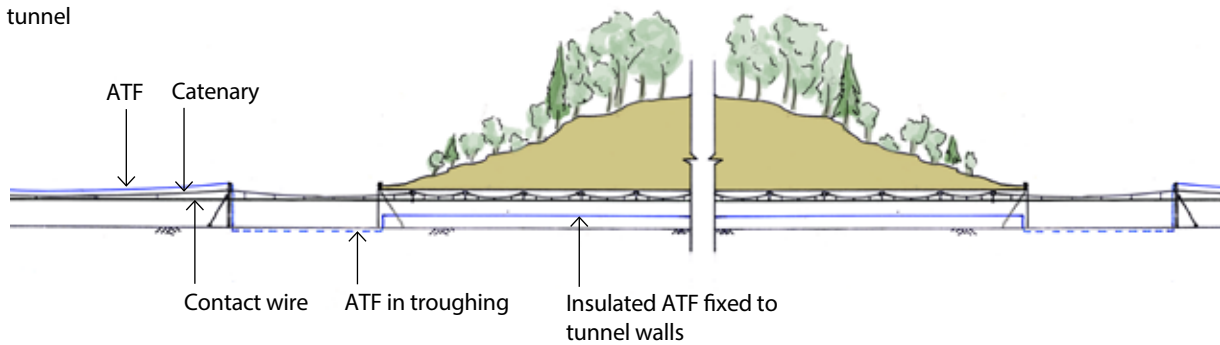

Running OLE wires through tunnels



Tunnels: poor practice! Kilsby Tunnel, West Coast Main Line (Grade II*) (photograph: ©Ian Robinson)

13.6 Stations

The principal matters that designers must consider when installing OLE at stations come under three headings:

OLE and platform canopies

Historic canopies usually extend out beyond the platform edge (to overlap with carriages) and therefore may need to be cut back to satisfy required clearances to the train, OLE and live electrical equipment (such as at Hanwell Station in West London, illustrated below). It may not be possible to fulfil 'restricted access clearances' to canopy roofs, meaning that lines would have to be closed to undertake maintenance work to the canopies.

OLE masts might need to be positioned on platforms if there is not sufficient space between tracks for them, and they may have to be punched through canopies if the canopies are longer than the maximum possible spacing between OLE supports. In such cases, to the person standing beneath a canopy, the visual intrusion of OLE is surprisingly limited because their upward view is constrained by the canopy, whilst masts inserted through the canopy are lost amidst the clutter of the average platform, with its columns, downpipes and other paraphernalia.

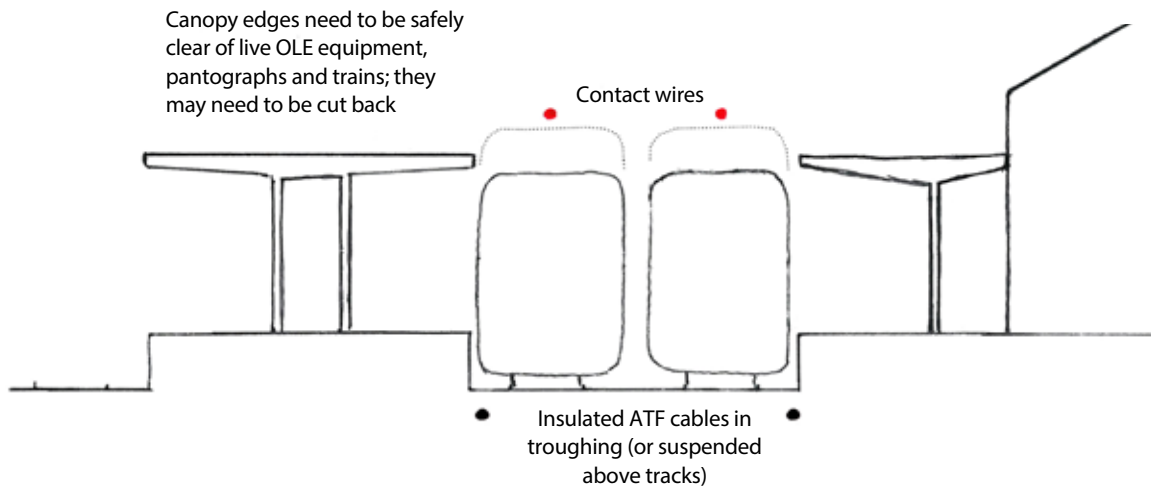

Required clearances on station platforms



OLE at Hanwell Station on the Great Western Main Line (Grade II). The canopies have been cut back sympathetically (photograph: ©Alan Baxter & Associates)

OLE in train sheds

For stations with train sheds, it may be desirable to attach the OLE to the roof structures using headspans, as at Paddington, Kings Cross, Newcastle and St Pancras (all listed Grade I). This avoids the need for masts. The architectural consequences may not be as one would imagine; a visit to any of the above stations reveals that fixing OLE to a Victorian train shed has remarkably little impact on its the architecture, or appreciation of it, because the wires are lost amongst the ironwork of the roof.

OLE and station approaches

Whilst OLE can be sympathetically integrated into stations, the complex and extensive trackwork and pointwork on the approaches to major stations can require equally complex and extensive OLE supports at the end of the platforms and beyond. Because of the requirements set out in section 10, this is unavoidable.

In other instances, platforms may have to be altered or rebuilt as a consequence of track lowering or slewing associated with overcoming clearance issues at nearby bridges.



OLE inside Kings' Cross Station, 'camouflaged' by the backdrop of the trainsheds (photograph: ©Alan Baxter & Associates)

14.0

Conclusion

This Guide began by saying that, though the principle of overhead line electrification equipment is simple, the reality is complex. Yet an understanding of at least some of this engineering is helpful to all those who have an interest in the current electrification projects.

We hope that this document has been a useful introduction to these engineering issues, and you finish it with a better understanding of why electrification equipment must look the way it does, and why alterations will have to be made to structures on the railway.

Alan Baxter

Prepared by Fredrik Nyberg and Richard Pollard

Reviewed by John Mason and Robert Thorne

Revised by John Mason, Richard Pollard and André Siwek

Reviewed by Fredrik Nyberg and Reider Payne

GWML Draft issued 16 November 2011

Final GWML Version issued 23 November 2011

All-lines Rev 2 Version issued 16 October 2013

All-lines Rev 3 Version issued 04 November 2013

All-lines Rev 4 Version issued 17 December 2013

All-lines Rev 5 Version issued 17 January 2014

All-lines Rev 6 Version issued 03 February 2014

All-lines Rev 7 Version issued 17 July 2014

All-lines Rev 8 Version issued 27 November 2014

All-lines Rev 9 Version issued 27 January 2015

All-lines Rev 10 Version issued 17 February 2015

L:\RAILWAYS\A Guide to Overhead Electrification Equipment\OHLE Report.indd

Note on photograph credits: in all cases effort has been made to contact the authors for permission. Where this has not been successful we welcome future contact from those authors regarding this matter.

This document is for the sole use of the person or organisation for whom it has been prepared under the terms of an invitation or appointment by such person or organisation. Unless and to the extent allowed for under the terms of such invitation or appointment this document should not be copied or used or relied upon in whole or in part by third parties for any purpose whatsoever. If this document has been issued as a report under the terms of an appointment by such person or organisation, it is valid only at the time of its production. Alan Baxter & Associates LLP does not accept liability for any loss or damage arising from unauthorised use of this report.

If this document has been issued as a 'draft', it is issued solely for the purpose of client and/or team comment and must not be used for any other purpose without the written permission of Alan Baxter & Associates LLP.

Alan Baxter & Associates LLP is a limited liability partnership registered in England, number OC328839. Registered office: 75 Cowcross Street, London, EC1M 6EL.

© **Copyright** subsists in this document.

