

**Geoguide 2**

# **Guide to Site Investigation**

**Geotechnical Engineering Office  
Civil Engineering and Development Department  
The Government of the Hong Kong  
Special Administrative Region**

**Geoguide 2**

# **Guide to Site Investigation**

**Geotechnical Engineering Office  
Civil Engineering and Development Department  
The Government of the Hong Kong  
Special Administrative Region**

© The Government of the Hong Kong Special Administrative Region

First published, September 1987

Reprinted, December 1990

Reprinted, December 1993

Reprinted, September 1996

Reprinted, October 2000

Continuously updated e-version, 18 December 2017

Prepared by:

Geotechnical Engineering Office,  
Civil Engineering and Development Department,  
Civil Engineering Building,  
101 Princess Margaret Road,  
Homantin, Kowloon,  
Hong Kong.

This Geoguide is a continuously updated version incorporating amendments issued since the Geoguide was last published. The continuously updated version is released in e-format only on the CEDD website. This Geoguide is to be cited as “GEO (2017). Guide to Site Investigation (Geoguide 2) (Continuously Updated E-Version released on 18 December 2017). Geotechnical Engineering Office, Civil Engineering and Development Department, HKSAR Government, 349 p.”

## Foreword

This Geoguide presents a recommended standard of good practice for site investigation in Hong Kong, the need for which was formally recognized as early as July 1983 by the Subcommittee of the Building Authority Working Party on Geotechnical Regulations. In its format and content, the Geoguide follows closely the British Standard BS 5930 : 1981, Code of Practice for Site Investigations, but the recommendations in the British Standard have been adapted to suit local conditions and practices. It should be used in conjunction with the companion document, Guide to Rock and Soil Descriptions (Geoguide 3). These Geoguides expand upon, and largely replace, Chapter 2 of the Geotechnical Manual for Slopes.

This Geoguide covers Sections 1 to 7 of BS 5930, while Section 8 is dealt with in Geoguide 3. It has been prepared in such a way that the organization and format of the British Standard have generally been preserved. Where portions of BS 5930 have been adopted in the text without significant amendment, this is clearly denoted by the use of an *italic* typeface.

It should be noted that this Geoguide gives guidance on good site investigation practice and, as such, its recommendations are not mandatory. It is recognized that the practitioner will often need to use alternative methods. There will also be improvements in site investigation practice during the life of the document which will supersede some of its recommendations.

The Geoguide was prepared in the Geotechnical Control Office (GCO) under the general direction of Mr J.B. Massey. The main contributors to the document were Dr A. Cipullo, Mr K.S. Smith and Mr D.R. Greenway, with significant contributions during the final stages of preparation from Dr P.L.R. Pang and Dr R.P. Martin. Many other members of the GCO made valuable suggestions and contributions.

To ensure that the Geoguide would be considered a consensus document of the civil engineering profession in Hong Kong, a draft version was circulated widely for comment in early 1987 to contractors, consulting engineers and Government Departments. Many organizations and individuals made useful and constructive comments, which have been taken into account in finalizing the Geoguide, and their contributions are gratefully acknowledged.

Practitioners are encouraged to comment at any time to the Geotechnical Control Office on the contents of this Geoguide, so that improvements can be made to future editions.



E.W. Brand  
Principal Government Geotechnical Engineer  
September 1987

## Contents

	Page No.
Title Page	1
Foreword	3
Contents	4
Part I : Introduction	17
1. Scope	18
2. Terminology	20
Part II : General Considerations	21
3. Primary Objectives of Site Investigation	22
4. General Procedures	23
4.1 Extent and Sequence of Investigation	23
4.1.1 General	23
4.1.2 Adjacent Property	23
4.2 Desk Study	24
4.3 Site Reconnaissance	25
4.4 Detailed Examination and Special Studies	25
4.5 Construction and Performance Appraisal	25
4.6 Site Investigation for Tunnel Works	26
5. Earlier Uses of the Site	28
5.1 General	28
5.2 Tunnels	28
5.3 Mines and Quarries	28
5.4 Waste Tips	28
5.5 Other Earlier Uses	28
5.6 Ancient Monuments	29
6. Aerial Photographs	30
6.1 General	30
6.2 Topographic Maps and Aerial Photographic Imagery	30

	Page No.	
6.2.1	Map and Plan Scales	30
6.2.2	Aerial Photographic Imagery	30
6.2.3	Orthophoto Maps and Plans	31
6.3	Aerial Photograph Interpretation	31
6.3.1	Identification and Interpretation of Ground Features	31
6.3.2	Examples of API in Hong Kong	32
 Part III : Planning the Ground Investigation		 33
7.	Introduction to Ground Investigation	34
7.1	Objectives	34
7.2	Planning and Control	35
8.	Types of Ground Investigation	37
8.1	Sites for New Works	37
8.2	Defects or Failures of Existing Features or Works	37
8.3	Safety of Existing Features and Works	38
8.3.1	Effect of New Works upon Existing Features and Works	38
8.3.2	Types of Effects	38
8.3.3	Procedure	39
8.4	Materials for Construction Purposes	39
9.	Geological Mapping for Ground Investigation	41
10.	Extent of the Ground Investigation	42
10.1	General	42
10.2	Character and Variability of the Ground	42
10.3	Nature of the Project	43
10.3.1	General	43
10.3.2	Slope and Retaining Wall Construction	43
10.3.3	Foundations for Structures	43
10.4	Preliminary Investigation	43
10.5	Location	44

	Page No.	
10.6	Spacing	44
10.7	Depth of Exploration	45
	10.7.1 General	45
	10.7.2 Foundations for Structures	45
	10.7.3 Embankments	47
	10.7.4 Cut Slopes	47
	10.7.5 Pavements	47
	10.7.6 Pipelines	47
	10.7.7 Marine Works	48
10.8	Specific Guidance for Silt- and Clay-rich Layers of Rock Cut Slopes	48
10.9	Specific Guidance for Tunnel Works	50
	10.9.1 Preliminary Design Stage	50
	10.9.2 Detailed Design Stage	51
11.	Selection of Ground Investigation Methods	53
	11.1 General	53
	11.2 Site Considerations	53
12.	Effect of Ground Conditions on Investigation Methods	55
	12.1 General	55
	12.2 Granular Soils Containing Boulders, Cobbles or Gravel	55
	12.3 Granular Soils	56
	12.4 Intermediate Soils	57
	12.5 Very Soft to Soft Cohesive Soils	57
	12.6 Firm to Stiff Cohesive Soils	57
	12.7 Cohesive Soils Containing Boulders, Cobbles or Gravel	58
	12.8 Fill	58
	12.9 Rock	59
	12.10 Soils Derived from Insitu Rock Weathering	59
	12.11 Discontinuities	60
	12.12 Cavities	61

	Page No.
13. Aggressive Ground and Groundwater	62
13.1 General	62
13.2 Investigation of Potential Deterioration of Concrete	62
13.3 Investigation of Potential Corrosion of Steel	62
13.4 Investigation of Fill Containing Industrial Wastes	63
14. Ground Investigations over Water	64
14.1 General	64
14.2 Stages and Platforms	65
14.3 Floating Craft	65
14.4 Working between Tide Levels	66
14.5 Locating Borehole Positions	66
14.6 Determination of Reduced Levels	66
14.7 Drilling, Sampling and Testing	67
15. Personnel for Ground Investigation	68
15.1 General	68
15.2 Planning and Direction	68
15.3 Supervision in the Field	68
15.4 Logging and Description of Ground Conditions	69
15.5 Laboratory Testing	70
15.6 Specialist Advice	70
15.7 Interpretation	70
15.8 Operatives	70
16. Review during Construction	72
16.1 General	72
16.2 Purpose	72
16.3 Information Required	73
16.3.1 Soil and Rock	73
16.3.2 Water	73
16.4 Instrumentation	73
16.5 Tunnel Works	73



	Page No.
Part IV : Ground Investigation Methods	75
17. Introduction to Ground Investigation Methods	76
18. Excavations and Boreholes	77
18.1 Shallow Trial Pits and Slope Surface Stripping	77
18.2 Deep Trial Pits and Caissons	78
18.3 Headings or Adits	78
18.4 Hand Auger Boring	78
18.5 Light Cable Percussion Boring	79
18.6 Mechanical Augers	79
18.7 Rotary Open Hole Drilling and Rotary Core Drilling	79
18.7.1 General	79
18.7.2 Flushing Medium	80
18.7.3 Inclined Drilling	81
18.8 Wash Boring and Other Methods	82
18.8.1 Wash Boring	82
18.8.2 Other Methods of Boring	82
18.9 Backfilling Excavations and Boreholes	83
19. Sampling the Ground	84
19.1 General	84
19.2 Sample Quality	85
19.3 Disturbed Samples from Boring Tools or Excavating Equipment	85
19.4 Open-tube Samplers	86
19.4.1 Principles of Design	86
19.4.2 Sampling Procedure	87
19.4.3 Thin-walled Samplers	88
19.4.4 General Purpose 100 mm Diameter Open-tube Sampler	88
19.4.5 Split Barrel Standard Penetration Test Sampler	89
19.5 Thin-walled Stationary Piston Sampler	89
19.6 Continuous Soil Sampling	89

	Page No.	
19.6.1	General	89
19.6.2	The Delft Continuous Sampler	90
19.7	Sand Samplers	90
19.8	Rotary Core Samples	90
19.9	Block Samples	92
19.10	Handling and Labelling of Samples	92
19.10.1	General	92
19.10.2	Labelling	93
19.10.3	Disturbed Samples of Soil and Hand Specimens of Rock	93
19.10.4	Samples Taken with a Tube Sampler	94
19.10.5	Rotary Core Extrusion and Preservation	95
19.10.6	Block Samples	96
20.	Groundwater	97
20.1	General	97
20.2	Methods of Determining Groundwater Pressures	98
20.2.1	Response Time	98
20.2.2	Observations in Boreholes and Excavations	98
20.2.3	Standpipe Piezometers	99
20.2.4	Hydraulic Piezometers	99
20.2.5	Electrical Piezometers	100
20.2.6	Pneumatic Piezometers	100
20.2.7	Installation of Piezometers	101
20.2.8	Varying Groundwater Pressures	102
20.2.9	Soil Suction	103
20.3	Groundwater Samples	103
21.	Tests in Boreholes	105
21.1	General	105
21.2	Standard Penetration Tests	105
21.2.1	General Principles	105
21.2.2	Preparation for Testing	105

	Page No.
21.2.3 Advantages and Limitations	106
21.2.4 Results and Interpretation	106
21.3 Vane Tests	107
21.3.1 General Principles	107
21.3.2 Advantages and Limitations	107
21.4 Permeability Tests	108
21.4.1 General Principles	108
21.4.2 Preparations for the Test	108
21.4.3 Variable-head Test	109
21.4.4 Constant-head Test	109
21.4.5 Analysis of Results	110
21.4.6 Formulae for Borehole Permeability Tests	110
21.4.7 Advantages and Limitations	111
21.5 Packer (Water Absorption) Tests	113
21.5.1 General Principles	113
21.5.2 Packers	114
21.5.3 Application and Measurement of Pressure	114
21.5.4 Measurement of Flow	115
21.5.5 Execution of Test	115
21.5.6 Results and Interpretation	116
21.6 Plate Tests	116
21.6.1 General	116
21.6.2 Limitations	117
21.6.3 Preparation	117
21.6.4 Bedding of the Plate	117
21.6.5 Application and Measurement of Load	118
21.6.6 Measurement of Deflection	118
21.6.7 Execution of Test	118
21.6.8 Uses of the Test	118
21.6.9 Supplementary Test	118
21.6.10 Horizontal Plate Tests	119

	Page No.	
21.7	Pressuremeter Tests	119
21.7.1	Test Description	119
21.7.2	Equipment Calibration	119
21.7.3	Forming the Test Pocket	120
21.7.4	Results and Interpretation	120
21.7.5	Tests in Rock	120
21.8	Borehole Discontinuity Surveys	121
21.8.1	Impression Packer Survey	121
21.8.2	Core Orientators	122
22.	Frequency of Sampling and Testing in Boreholes	123
22.1	General Principles	123
22.2	Determination of the Ground Profile	123
22.3	Routine Determination of Soil and Rock Properties	124
22.4	Double-hole Sampling	124
22.5	Special Techniques	124
23.	Probing and Penetration Testing	126
23.1	General	126
23.2	Dynamic Probing	126
23.3	Static Probing or Cone Penetration Testing	127
23.3.1	General Description	127
23.3.2	Mechanical Cone Penetrometers	127
23.3.3	Electrical Cone Penetrometers	128
23.3.4	General Recommendations	128
23.3.5	Uses and Limitations of the Test	129
23.3.6	Presentation of Results	129
23.4	Static-dynamic Probing	129
Part V : Field and Laboratory Tests		130
24.	Field Tests	131
24.1	General	131

	Page No.	
24.2	Rock Strength Index Tests	132
	24.2.1 Point Load Strength	132
	24.2.2 Schmidt Hammer Rebound Value	133
24.3	Infiltration Tests	133
25.	Pumping Tests	135
	25.1 General Principles	135
	25.2 Groundwater Conditions	136
	25.3 Test Site	136
	25.4 Pumped Wells	136
	25.5 Observation Wells	138
	25.6 Test Procedures	138
	25.7 Analysis of Results	139
26.	Discontinuity Surveys	140
	26.1 General	140
	26.2 Discontinuity Surveys for Rock Cut Slopes	140
	26.3 Discontinuity Roughness Surveys	140
27.	Field Density Tests	142
	27.1 General Principles	142
	27.2 Sand Replacement Method	142
	27.3 Core Cutter Method	143
	27.4 Immersion in Water Method	143
	27.5 Water Displacement Method	143
	27.6 Rubber Balloon Method	143
	27.7 Nuclear Methods	144
	27.8 Water Replacement Method for Rock Fill	144
28.	Insitu Stress Measurements	146
	28.1 General	146
	28.2 Stress Measurements in Rock	146
	28.3 Stress Measurements in Soils	147

	Page No.
29. Bearing Tests	149
29.1 Vertical Loading Tests	149
29.1.1 General Principles	149
29.1.2 Limitations of the Test	149
29.1.3 Site Preparation	150
29.1.4 Test Arrangement	150
29.1.5 Measurements	151
29.1.6 Test Methods	151
29.1.7 Analysis of Results	152
29.1.8 Interpretation of Results	153
29.2 Horizontal and Inclined Loading Tests	154
29.3 Pressurized Chamber Tests	154
29.4 Insitu California Bearing Ratio (CBR) Tests	155
29.4.1 General	155
29.4.2 Test Method	155
29.4.3 Limitations and Use of Test	155
30. Insitu Direct Shear Tests	157
30.1 General Principles	157
30.2 Sample Preparation	157
30.3 Test Arrangement	158
30.4 Measurements	159
30.5 Test Methods	159
30.6 Analysis of Results	159
31. Large-scale Field Trials	160
31.1 General	160
31.2 Methods of Instrumentation	160
31.3 Trial Embankments and Excavations	161
31.4 Construction Trials	162
32. Back Analysis	163
32.1 General	163

	Page No.
32.2 Failures and Design of Slope Preventive or Remedial Works	163
32.3 Other Cases	164
33. Geophysical Surveying	166
33.1 General	166
33.2 Land Geophysics	167
33.2.1 Resistivity	167
33.2.2 Gravimetric	167
33.2.3 Magnetic	167
33.2.4 Seismic	168
33.2.5 The Gamma Density Method	168
33.2.6 The Spectral Gamma Ray Method	169
33.2.7 The Neutron Porosity Method	170
33.3 Marine Geophysics	170
33.3.1 General	170
33.3.2 Echo-sounding	170
33.3.3 Continuous Seismic Reflection Profiling	170
33.3.4 Side Scan Sonar	170
33.4 Borehole Logging	170
33.5 Corrosion Testing	172
33.6 Identification of Weak Layers in the Ground	172
34. Principles of Laboratory Testing	173
35. Sample Storage and Inspection Facilities	174
35.1 Handling and Labelling	174
35.2 Storage of Samples	174
35.3 Inspection Facilities	174
36. Visual Examination	176
36.1 General	176
36.2 Soil	176
36.3 Rock	176

	Page No.
36.4 Photographic Records	176
37. Tests on Soil	178
37.1 General	178
37.2 Sample Quality	178
37.3 Sample Size	178
37.4 Test Conditions	178
37.5 Relevance of Test Results	179
38. Tests on Rock	180
Part VI : Reports and Interpretation	181
39. Field Reports	182
40. Site Investigation Report	183
40.1 General	183
40.2 Descriptive Report	183
40.2.1 Report as Record	183
40.2.2 Introduction	183
40.2.3 Description of Site	183
40.2.4 Geology	184
40.2.5 Field Work	184
40.2.6 Borehole Logs	184
40.2.7 Incidence and Behaviour of Groundwater	187
40.2.8 Location of Boreholes	187
40.2.9 Laboratory Test Results and Sample Descriptions	188
40.3 Engineering Interpretation	188
40.3.1 Matters to be Covered	188
40.3.2 Data on which Interpretation is Based	188
40.3.3 Presentation of Borehole Data	189
40.3.4 Design	190
40.3.5 Construction Expedients	191
40.3.6 Sources of Materials	192



	Page No.
40.3.7 Failures	192
40.3.8 Calculations	193
40.3.9 References	193
40.4 Documentation for Site Investigation of Tunnel Works	193
References	194
Tables	215
List of Tables	216
Tables	217
Figures	233
List of Figures	234
Figures	237
Plates	284
List of Plates	285
Plates	286
Appendices	298
Appendix A: Information Required for Desk Study	399
Appendix B: Sources of Information	307
Appendix C: Notes on Site Reconnaissance	331
Appendix D: Information Required for Design and Construction	336
Appendix E: Safety Precautions	341

Part I

Introduction

## 1. Scope

This Geoguide deals with the investigation of sites in Hong Kong for the purposes of assessing their suitability for civil engineering and building works, and of acquiring knowledge of site characteristics that affect the design and construction of such works and the security of adjacent properties. It is essentially BS 5930 : 1981, Code of Practice for Site Investigations (BSI, 1981a), modified as considered desirable for use in Hong Kong.

While the basic structure and philosophy of BSI (1981a) has been maintained in this Geoguide, topics of particular importance in Hong Kong have been supplemented or rewritten in the light of local conditions and experience. Other sections of BSI (1981a) have been repeated herein without significant amendment, and this has been denoted by an *italic* script. Less relevant or rarely-used portions of BSI (1981a) have been incorporated only by reference, or have been specifically deleted.

In this Geoguide the expression "site investigation" has been used in its wider sense. It is often used elsewhere in a narrow sense to describe what has been termed herein "ground investigation". The use of soil and rock as construction materials is treated only briefly; further information on this is given in BSI (2009). [Amd GG2/01/2017]

*From Part II onwards, this Geoguide is divided as follows :*

***Part II.*** *Part II deals with those matters of a technical, legal or environmental character that should be taken into account in selecting the site (or in determining whether a proposed site is suitable) and in preparing the design of the works.*

***Part III.*** *Part III discusses general aspects and planning of ground investigation, including the influence of general conditions and ground conditions on the selection of methods of investigation.*

***Parts IV and V.*** *Parts IV and V discuss methods of ground investigation, sub-divided as follows : Part IV deals with excavation, boring, sampling, probing and tests in boreholes; Part V deals with field tests and laboratory tests on samples.*

***Part VI.*** *Part VI deals with the preparation of field reports and borehole logs, the interpretation of the data obtained from the investigation and the preparation of the final site investigation report.*

The last section of BSI (1981a), which deals with the description of soils and rocks, is not covered in this Geoguide. A companion document, Geoguide 3 : Guide to Rock and Soil Descriptions (GCO, 1988), has been devoted entirely to this topic, and the reader should refer to it for guidance on the description and classification of Hong Kong rocks and soils.

It may be noted that there are some imbalances in treatment of the various topics, with, in some cases, more comprehensive coverage given to methods that are less frequently used. Because it would not be possible to include full coverage of all available site investigation techniques, methods that are well documented elsewhere in the literature receive abbreviated coverage in this Geoguide.

This Geoguide represents a standard of good practice and therefore takes the form of recommendations. Compliance with it does not confer immunity from relevant statutory and legal requirements. The recommendations given are intended only as guidance and should not be taken as mandatory. In this respect, it should be realized that improvements to many of the methods will continue to evolve.

## 2. Terminology

A few commonly-used descriptive terms for geological materials and types of ground investigation are often interpreted in different ways and therefore require definition. In this Geoguide, the terminology given in the following paragraphs has been adopted.

"Rock" refers to all solid material of natural geological origin that cannot be broken down by hand. "Soil" refers to any naturally-formed earth material or fill that can be broken down by hand and includes rock which has weathered insitu to the condition of an engineering soil. Further guidance on the use of these terms is given in Geoguide 3 (GCO, 1988).

Excluding any boulders or cobbles, a "fine-grained soil" or a "fine soil" is one that contains about 35% or more of fine material (silt and clay size particles). A "coarse-grained soil" or a "coarse soil" contains less than 35% of fine material and more than 65% of coarse material (gravel and sand size particles). Further guidance is given in Geoguide 3.

A "cohesive soil" is one which, usually by virtue of its fines content, will form a coherent mass. Conversely a "granular soil" or a "cohesionless soil" will not form a coherent mass. These simple terms are useful in the classification of materials during ground investigation for the purpose of choosing a suitable method for sampling the ground. A fine soil is generally cohesive.

The "matrix" of a composite soil refers to the fine-grained material enclosing, or filling the spaces between, the larger grains or particles in the soil.

"Boring" is a method of advancing a cased or uncased hole (viz a "borehole") in the ground and includes auger boring, percussion boring and rotary drilling, in which a drill bit is rotated into the ground for the purpose of forming the hole. Although the term "drillhole" is commonly used in Hong Kong because of the popular use of the rotary core drilling method in ground investigations, the general term "borehole" is used throughout this Geoguide for simplicity, whether the hole is bored, augured or drilled.

## Part II

### General Considerations

### 3. Primary Objectives of Site Investigation

*Investigation of the site is an essential preliminary to the construction of all civil engineering and building works, and the objectives in making such investigations are as follows :*

- (a) Suitability. To assess the general suitability of the site and environs for the proposed works.*
- (b) Design. To enable an adequate and economic design to be prepared, including the design of temporary works.*
- (c) Construction. To plan the best method of construction; to foresee and provide against difficulties and delays that may arise during construction due to ground and other local conditions; in appropriate cases, to explore sources of indigenous materials for use in construction (see Section 8.4); and to select sites for the disposal of waste or surplus materials.*
- (d) Effect of Changes. To determine the changes that may arise in the ground and environmental conditions, either naturally or as a result of the works, and the effect of such changes on the works, on adjacent works, and on the environment in general.*
- (e) Choice of Site. Where alternatives exist, to advise on the relative suitability of different sites, or different parts of the same site.*

*In addition, site investigations may be necessary in reporting upon the safety of existing features and works (see Section 8.3), for the design of extensions, vertical or horizontal, to existing works, and for investigating cases where failure has occurred (see Section 8.2).*

## 4. General Procedures

### 4.1 Extent and Sequence of Investigation

#### 4.1.1 General

*The extent of the investigation depends primarily upon the magnitude and nature of the proposed works and the nature of the site.*

*A site investigation will normally proceed in stages, as follows : desk study; site reconnaissance; detailed examination for design, including ground investigation, topographic and hydrographic survey and special studies; follow-up investigations during construction (Figure 1). This may be followed by appraisal of performance. Some of the stages may overlap, or be taken out of sequence; for example, the site reconnaissance may well take place before completion of the desk study.*

*The costs of a site investigation are low in relation to the overall cost of a project and may be further reduced by intelligent forward planning. Discussion at an early stage with a specialist contractor will help to formulate an efficient and economic plan. The technical requirements of the investigation should be the overriding factor in the selection of investigatory methods, rather than their cost.*

*As far as possible, assembly of the desk study information should be complete, at least in respect of those aspects related to ground conditions, before ground investigation begins. A preliminary ground investigation may be desirable to determine the extent and nature of the main ground investigation. The extent of the ground investigation is discussed in Chapter 10.*

For regional studies or site investigation of projects covering large areas, e.g. road, tunnel or transmission line routes, techniques such as engineering geological and geomorphological mapping, terrain classification and hazard analysis may be useful to delineate critical areas so that detailed investigations can be concentrated in areas where they are most required (Brand et al, 1982; Griffiths & Marsh, 1984; Hansen, 1982).

#### 4.1.2 Adjacent Property

Because of the dense urban development in Hong Kong, construction activities can often affect adjacent property. It is therefore essential that investigations should cover all factors that may affect adjacent property, including features such as slopes and retaining walls (see Chapter 7 and Section 8.3). Where possible, records of ground levels, groundwater levels and relevant particulars of adjacent properties should be made before, during and after construction. Where damage to existing structures is a possibility, adequate photographic records should be obtained.

Adjacent buildings, structures and buried services, including pipes conveying water, gas or sewage, should be specifically considered, as they may be affected by vibrations, ground settlement or movement, or changes in groundwater levels during and after construction activities on the site. Hospitals and other buildings containing sensitive instruments or apparatus should be given special consideration.



Special permission or approval must be obtained when the site is above or near the Mass Transit Railway Corporation's tunnels or structures, or is within the Mid-levels Scheduled Area (see Appendices A and B; see also Chapter 7). The approximate locations of these two features are shown in Figure 2.

## 4.2 Desk Study

As a first stage in a site investigation, a desk study is necessary and Appendix A indicates the types of information that may be required. Much information about a site may already be available in existing records. A summary of the important sources of information is given in Appendix B. Readers are advised to take note of any warning messages on the data, check with the relevant data owners on the reliability, accuracy and completeness of the data they require where necessary, taking into account the needs of their project. Readers are also invited to provide feedback to the GEO should the need to update this Geoguide 2 be identified.

[Amd GG2/01/2017]

A new geological survey is currently underway in Hong Kong to replace the existing 1:50 000 scale geological maps and memoir (Allen & Stephens, 1971); new 1:20 000 scale geological maps will become available between 1986 and 1991 (Figure 3). The new geological survey uses different nomenclature for certain major rock divisions and rock types (Addison, 1986; GCO, 1988; Strange & Shaw, 1986); this should be used wherever possible.

An important source of basic geotechnical information is the Geotechnical Area Study Programme (GASP) publications available from the Government Publications Centre. Systematic terrain evaluation has been undertaken at a scale of 1:20 000 covering the entire Territory (Brand et al, 1982). These publications generally contain Engineering Geology, Terrain Classification, Erosion, Landform and Physical Constraint Maps. Selected areas of the Territory have also been evaluated at the 'district' scale of 1:2 500, but these have not been published. The GASP programme and the areas covered by the GASP publications are shown in Figure 4, and examples of some of the 1:20 000 maps are given in Figure 5.

The Geotechnical Information Unit also contains numerous records of boreholes from throughout the Territory, as well as useful records of landslides, rainfall and piezometric data, and laboratory test results on soil and rock samples. Relevant data can be easily accessed by geographical location of the site. Further details of the Geotechnical Information Unit are given in Appendix B.

A useful bibliography on the geology and geotechnical engineering of Hong Kong is also available (Brand, 1992). Local maps and plans are easily obtained (Table 1), and as-built records of private developments are retained by the Buildings Ordinance Office or the Public Records Office (see Appendix B). Valuable information may often be obtained from aerial photographs, as discussed in Chapter 6.

### 4.3 Site Reconnaissance

At an early stage, a thorough visual examination should be made of the site. The extent to which ground adjacent to the site should also be examined is, in general, a matter of judgement (see Section 4.1.2). In the intensely-developed urban areas of Hong Kong, it will usually be necessary to inspect existing slopes and retaining walls within and surrounding the site and adjacent properties during the site reconnaissance stage. Appendix C gives a summary of the procedure for site reconnaissance and the main points to be considered but should not be regarded as necessarily covering all requirements.

*Nearby cut slopes can reveal soil and rock types and their stability characteristics, as can old excavations and quarries. Similarly, in the vicinity there may be embankments or buildings and other structures having a settlement history because of the presence of compressible or unstable soils. Other important evidence that might be obtained from an inspection is the presence of underground excavations, such as basements and tunnels. The behaviour of structures similar to those intended should also provide useful information, and the absence of such structures may be significant, as may be also the presence of a vacant site in the midst of otherwise intensive development.*

*Examples of earlier uses of the site that may affect the new construction works are given in Chapter 5.*

### 4.4 Detailed Examination and Special Studies

*For most projects, the design and planning of construction will require a detailed examination of the site and its surroundings (see also Appendix D). Such requirements may necessitate a detailed land survey (see Appendix D.2), or an investigation of liability to flooding. The investigation of ground conditions is dealt with in Parts III and IV. Other requirements may entail studies of special subjects such as hydrography (see Appendix D.3); micrometeorology (see Appendix D.4); sources of materials (see Appendix D.5); disposal of waste materials (see Appendix D.6); or other environmental considerations.*

*The possibility of disused tunnels affecting the site should also be considered (see Section 5.2).*

In areas where underground cavities are suspected (Culshaw & Waltham, 1987), it may be necessary to carry out a special study to assess the suitability of the site for development (see Section 7.1).

### 4.5 Construction and Performance Appraisal

*Construction and performance appraisal are discussed in Chapter 16.*

#### 4.6 Site Investigation for Tunnel Works

[Amd GG2/01/2017]

Pre-tender site investigation should be as comprehensive as possible to provide adequate information for the design of tunnel works and contract preparation. In addition to the geological and hydrogeological conditions, the site investigation should identify utilities and buried installations to ascertain whether they will interfere with or be affected by the tunnel works (see ETWB TC(W) No. 17/2004 for government projects).

[Amd GG2/01/2017]

There are inherent uncertainties in the subsurface geology and hydrogeology, regardless of the extent of site investigation. Also, physical constraints, e.g. existing buildings and subsurface installations could limit the pre-tender site investigation for particular sections of tunnel works. Therefore, it is essential to make provision for additional ground investigation in the works contract to check and monitor continuously the actual conditions against those assumed, and to take measures to deal with conditions not anticipated but having significant impact on the design, construction, or on life and property.

[Amd GG2/01/2017]

The US Army Corps of Engineers Manual (USACE, 1997) includes a practical guide to the relative cost of site investigation as a proportion of the estimated construction cost. Based on this guide, the typical cost of site investigation for a deep tunnel located in difficult ground conditions and in a dense urban area is about 3-4% of the estimated construction cost. Notwithstanding, the cost of site investigation for a particular project depends greatly on the quality, suitability and adequacy of available information, and the data needed for the design and risk management of the types of tunnel works involved. The client should include adequate funding for site investigation in the project cost estimate.

[Amd GG2/01/2017]

Site investigation for projects involving tunnel works should be phased. This approach is necessary as different phases of the project have different requirements. Also, the tunnel alignment and design requirements can change during route planning or design.

[Amd GG2/01/2017]

Using the data obtained at each phase, the impact of the proposed excavation method on the sensitive receivers identified and the geotechnical risks at each tunnel section should be assessed. The risk assessment should be reviewed when the tunnel alignment is fixed and as more information becomes available.

[Amd GG2/01/2017]

Some simple guidelines on site investigation for tunnelling are given in ITA (2009). An outline of the engineering considerations and site investigation techniques for rock tunnels, based on IMMM (2003), is given in Table 13. Supplementary information on ground investigation techniques is given in Appendix F.

[Amd GG2/01/2017]

For sources of information and expertise, reference should be made to Appendix B of this Geoguide and GEO (2016) for general guidance on, and sources of information for SI and tunnels in Hong Kong. Reference should also be made to Geoguide 4 (GEO, 1992), which contains guidance on site investigation for cavern schemes, much of which is also applicable to tunnels and shaft construction.

[Amd GG2/01/2017]

Information on the pre-Quaternary geology of Hong Kong is given in Sewell et al (2000).

The Hong Kong Geological Survey (HKGS) section of GEO/CEDD has the most detailed information on the geology of Hong Kong and offers an advisory service. HKGS should be consulted, especially at the planning stage of new projects involving tunnel works, in the formulation of geological models, anticipation of difficult areas, and the verification of significant geological features (faults, dykes, contact zones between geological units, etc.). This consultation process in actual projects also allows feedback of important geological information from the project to existing geological archives maintained by HKGS.

[Amd GG2/01/2017]

## **5. Earlier Uses of the Site**

### **5.1 General**

*If a site has been used for other purposes in the past, this can have a significant effect on the present intended use. A careful visual inspection of a site and the vegetation it sustains may reveal clues suggesting interference with the natural subsoil conditions at some time in the past. Examples are given in Sections 5.2 to 5.6.*

Due to the relatively short history of development in Hong Kong, many instances of previous use of a site can be discovered by an inspection of early maps, aerial photographs and other historical records (see Appendices A and B).

### **5.2 Tunnels**

The presence of nearby tunnels may have a profound effect on the intended use of the site, and should be fully considered. In addition to tunnels in active use for water supply, sewage conveyance, roads and railways, underground shelters and disused tunnels (of average dimensions 2 m high and 3 m wide) exist in places throughout the Territory as a result of previous wartime activities.

### **5.3 Mines and Quarries**

A relatively minor amount of either opencast or underground mining has been undertaken in Hong Kong, but quarrying for rock products has been extensive at some locations, as have borrow area operations. Where this has occurred, detailed consideration must be given to its influence on affected sites.

### **5.4 Waste Tips**

Waste tips, used for the disposal of domestic refuse, industrial waste and other refuse, may be found in places throughout the Territory. The location of past or present 'controlled tips' operated by Government are documented, but other tips may also exist. Harmful industrial wastes may also be encountered. The use of waste tip sites for other purposes must consider fully the effects of combustible gas, toxic leachate and ground settlement. Furthermore, sites in the proximity of waste tips may also be subject to the effects of laterally migrating combustible gas and leachate.

### **5.5 Other Earlier Uses**

Much of the low-lying land of Hong Kong has been extended by successive stages of reclamation in the past 80 to 90 years. Former seawalls and other obstructions may therefore be encountered beneath these areas. The fill materials used have been variable, often containing large boulders and building debris. The fill is often underlain by soft compressible

marine sediments.

Natural slopes and boulders, and older cut and fill slopes and retaining walls, are often prone to landslides and other forms of instability. It is of paramount importance that all slope features on or adjacent to the site should be examined for areas of past, current or potential instability at an early stage in the site investigation.

## **5.6 Ancient Monuments**

A list of gazetted historical sites is maintained by the Antiquities and Monuments Office of the Government Secretariat, and a permit is required before commencement of any work within a gazetted historical site. It is advisable to consult the Antiquities and Monuments Office before entering any historical site, even ungazetted sites. During site investigation, any discovery of antiquities or supposed antiquities should be reported to the Antiquities and Monuments Office (see Appendices A and B).

## 6. Aerial Photographs

### 6.1 General

Aerial photographs can be used in the preparation and revision of maps and plans, and they can assist in the identification and general assessment of natural and man-made features, including geology, geomorphology, hydrology and vegetation, on or in relation to a site. They are particularly useful in the assessment of site history (i.e. changes in form, materials and land use) and can provide valuable information for the assessment of slope stability (Geological Society, 1982).

Black and white aerial photograph coverage of Hong Kong is extensive. Although partial coverage of the Territory is available from 1924, the first complete coverage was obtained in 1963, as summarised in Table 2. For almost any site in the Territory, repeated aerial photograph coverage records the land use and development changes that have occurred, as well as any history of recent instability. The small scale black and white photographs obtained at flying heights of over 6 000 m are more suitable for obtaining an overall view of the Territory. A small number of true colour, (false) colour infrared and black and white infrared photographs are also available. Advice on how to obtain the aerial photographs is given in Appendix B.3.3.

[Amd GG2/01/2017]

### 6.2 Topographic Maps and Aerial Photographic Imagery

#### 6.2.1 Map and Plan Scales

Accurate topographic maps and plans can be produced from aerial photographs. A partial catalogue of maps and plans available from the Lands Department is given in Table 1 (see also Appendix B.3.1). Large scale plans (scales 1:500 to 1:1 000) are usually most appropriate for site investigations of small areas, whereas plans with scales of 1:5 000 to 1:20 000 are more appropriate for district or regional studies.

[Amd GG2/01/2017]

#### 6.2.2 Aerial Photographic Imagery

The scale of an image on an aerial photograph is proportional to the distance between the camera and the subject. For an aerial photograph taken vertically, tall objects (tops of hills and buildings), and objects near the centre of the photograph, create images at slightly larger scales than low terrain or similar objects near the edge of the photograph. Radial distortion about the optical axis of the camera displaces the true vertical away from centre of the photograph, an effect which becomes more pronounced near the edges of a photograph. This may create dramatic effects on large-scale photographs with considerable changes in elevation from one portion to another.

Despite these sources of distortion, for sites which can be identified within the central third of a vertical aerial photograph and which contain terrain of broadly similar elevation, reasonably accurate scaled images can be obtained by proportioning the distances between objects identifiable on a map (or plan) and a contact print of an aerial photograph, and by using this proportion ratio as an enlargement factor. Most aerial photography has been obtained

using cameras with large format negatives. Prior to 1963, the sizes of the contact prints vary, but are usually 162 mm by 175 mm. With few exceptions, the negatives obtained from 1963 to the present are 228 mm by 228 mm. The image produced on contact prints is extremely sharp, and clear images can be obtained either by viewing the contact prints with a magnifying lens or stereoscope, or by enlarging all or part of the negative. Enlarged prints can be used even for studies of small areas of the size of an individual building site.

### **6.2.3 Orthophoto Maps and Plans**

Orthophoto maps and plans, which consist of rectified (true to scale) photographs overprinted with contours or grids can be made (overseas only) for both vertical and oblique aerial photography. Rectification of the image can be performed optically or digitally; the accuracy is determined by the number of control points supplied, the degree of rectification desired and the scale of the original photography.

## **6.3 Aerial Photograph Interpretation**

### **6.3.1 Identification and Interpretation of Ground Features**

Aerial photographs can be interpreted at a range of scales and levels of detail to provide information valuable to both the design of site investigations and to the interpretation of the results. The design of site investigations for large projects such as route corridors (e.g. roads, railways, pipelines or transmission lines) can benefit enormously from a preliminary aerial photograph interpretation (API) survey. This can highlight the natural and man-induced characteristics of the terrain, noting in particular hazards and resources that may have a significant effect on the feasibility or design of the project. Even when performed for smaller sites, an API study can often provide useful information on the distribution and thickness of natural and fill materials, and may reveal potential problems originating from adjacent land. Sequences of aerial photographs taken at different dates can be compared to determine the location, extent and approximate time of filling and reclamation, and the sequence of development of an area.

Aerial photographs, particularly when examined stereoscopically, can often be used to identify and delineate specific ground features such as the distribution of soil types (e.g. colluvial and alluvial deposits), soil thickness, bedrock type, depth to bedrock, fracture patterns and spacings, as well as local relief. API is of particular value in the mapping of "photolineaments". This term refers to straight or gently-curving features on aerial photographs which are usually the surface expression of variations in the structure or materials of the underlying bedrock. Photolineaments are usually marked by topographic highs or lows in the terrain but sometimes they may be more subtle features, which can only be identified by different vegetation growth, reflecting underlying changes in soil type, soil thickness or moisture content. Well-defined linear depressions usually indicate the location of less resistant bedrock or of discontinuities in the bedrock structure such as faults, fracture zones or major joints. Local linear topographic highs or lines of boulders or rock outcrops may indicate the presence of a rock unit that is more resistant to weathering.

All the features mentioned above may be important for the interpretation of site



conditions. Early identification by API of major changes in soil and rock types and features that are likely to have a significant influence on the local groundwater regime can be of great assistance in the design of the ground investigation and in establishing a geological model for the site.

Reviews of API and related mapping techniques are contained in Geological Society (1982). Some good examples of the use of API techniques are provided by Ho et al. (2006), Lueder (1959), Van Zuidam & Van Zuidam-Cancelado (1979), Verstappen & Van Zuidam (1968) and Way (1978).

[Amd GG2/01/2017]

### **6.3.2 Examples of API in Hong Kong**

In Hong Kong, API techniques have been successfully applied to both specific problems and regional appraisals. Examples of the former are given in Brimicombe (1982), Bryant (1982) and Koirala et al (1986). Systematic regional API studies have been undertaken within the Geotechnical Area Studies Programme (GASP) to provide information for planning, resource appraisal and engineering feasibility studies (see Section 4.2). The first of the regional GASP reports was available in 1987 (GCO, 1987) and a further eleven reports in the series were published between 1987 and 1989. All GASP maps are available for inspection in the Geotechnical Information Unit (see Appendix B).

Figure 6 shows an example of a vertical black and white aerial photograph of part of Hong Kong Island and includes the corresponding portion of the 1:20 000 scale geological map (GCO, 1986). Some features of the bedrock structure can be interpreted from the aerial photograph. For example, the location of the fault line shown on the geological map can be clearly seen as a straight, deep valley in the centre-east part of the photograph. Near the north eastern corner of the photograph, the photolineaments indicated on the map can be seen to correspond to less clearly-defined valleys.

Part III

Planning the Ground Investigation

## 7. Introduction to Ground Investigation

### 7.1 Objectives

For new works, the objectives of ground investigation are to obtain reliable information to produce an economic and safe design and to meet tender and construction requirements. The investigation should be designed to verify and expand information previously collected. In Hong Kong, because of intense urban development, it is often necessary to investigate the effects of new works on the safety of existing features and works; in particular, the effects on the stability of existing slopes and retaining structures (see Sections 4.1.2 and 8.3).

*The objective of ground investigation related to defects or failures of existing features or works (see Section 8.2), or to safety of existing features and works (see Section 8.3), will be directly related to the particular problems involved. The requirements for investigation of materials for construction purposes are discussed in Section 8.4.*

*An understanding of the geology of the site is a fundamental requirement in the planning and interpretation of the ground investigation. In some cases where the geology is relatively straightforward and the engineering problems are not complex, sufficient geological information may have been provided by the desk study, subject to confirmation by trial pits or boreholes or both. In other cases, it may be necessary to undertake geological mapping, which is discussed in Chapter 9.*

*Of primary importance will be the establishment of the soil profile or soil and rock profile, and the groundwater conditions. The profile should be obtained by close visual inspection and systematic description of the ground using the methods and terminology given in Geoguide 3 (GCO, 1988), or a suitable alternative system. In many cases, this, supplemented by limited insitu or laboratory testing, will suffice. In others, it will be necessary to determine in detail the engineering properties of the soils and rocks. The extent of the ground investigation is discussed in Chapter 10. Where appropriate, the geometry and nature of discontinuities should be established (see Section 12.11).*

In many cases, especially in slope design, it will be very important to determine the variations in the groundwater regime in response to rainfall.

*The investigation should embrace all ground in which temporary or permanent changes may occur as a result of the works. These changes include : changes in stress and associated strain, changes in moisture content and associated volume changes, changes in groundwater level and flow pattern, and changes in soil properties such as strength and compressibility. Materials placed in the ground may deteriorate. It is therefore necessary to provide information from which an estimate of the corrosivity of the ground can be made (see Chapter 13).*

Special measures may be required to locate disused tunnels or underground cavities, which may collapse, resulting in damage to structures (see Sections 8.3.2, 10.3.3 and 10.7.2). Other hazards may arise from earlier uses of the site (see Chapter 5).

## 7.2 Planning and Control

*Before commencing ground investigation, all relevant information collected from the sources discussed in Part II should be considered together to obtain a preliminary conception of the ground conditions and the engineering problems that may be involved. This will assist in planning the amount and types of ground investigation required.*

*Planning of the ground investigation should be flexible so that the work can be varied as necessary in the light of fresh information. On occasions, especially on large or extended sites, a preliminary investigation may be necessary in order that the main investigation may be planned to best advantage (see Sections 4.1.1 and 10.4).*

The ground investigation should be largely completed before the works are finally designed. It is therefore important that sufficient time for ground investigation (including dealing with all legal, environmental, contractual and administrative matters, reporting and interpretation) is allowed in the overall programme for any scheme. For example, in slope design, piezometers should be installed well in advance to obtain sufficient groundwater data for the design. Should changes in the project occur after completion of the main investigation, additional ground investigation may be required. If so, the programme should be adjusted to allow for the additional time required.

*Sometimes, conditions necessitate additional investigation after the works commence. In tunnelling, for example, probing ahead of the face may be required to give warning of hazards or changes in ground conditions. The properties of the ground and also the groundwater levels may vary with the seasons. In planning the investigation, consideration should be given to predicting the ground conditions at other times of the year.*

*The imposition of limitations on the amount of ground investigation to be undertaken, on the grounds of cost and time, may result in insufficient information being obtained to enable the works to be designed, tendered for and constructed adequately, economically and on time. Additional investigations carried out at a later stage may prove more costly and result in delays.*

As ground investigations in Hong Kong must often be undertaken in urban areas (Plate 1A), it is often necessary to obtain road excavation permits, temporary licences or way leaves before commencing the ground investigation. For some sites it will be necessary to coordinate the works with the requirements of the traffic police and other authorities (Plate 1B). Proper identification and maintenance of utilities encountered by the works is essential; high voltage power cables, gas distribution lines and other utilities often present significant safety hazards.

Since backfilled pits and boreholes might interfere with subsequent construction, they should be sited and backfilled with care. It is essential that the precise location of every excavation, borehole or probing is properly referenced to the 1980 Hong Kong Metric Grid and recorded during the execution of the fieldwork. It is also essential to establish and record the ground levels of these locations. The records should be such that the locations and levels can be readily incorporated into the report on the investigations (see Sections 10.5 and 40.2.8).

Investigations for new works and all other building works within the Mid-levels

Scheduled Area (Figure 2) must comply with the provisions of the Buildings Ordinance (Government of Hong Kong, 1985), including the submission of the ground investigation plan to the Buildings Ordinance Office for approval and consent to commence the work.

Where the proposed investigation is in the vicinity of the Mass Transit Railway, or within the limits of the railway 'protection boundary', details and locations of the proposed works, including the depths of any proposed boreholes, should be forwarded to the Mass Transit Railway Corporation for agreement prior to commencement of the work.

Should it appear during the course of the investigation that items of archaeological or historical significance have been encountered, the Antiquities and Monuments Office should be notified (see Section 5.6).

*To obtain the greatest benefit from a ground investigation, it is essential that there is adequate direction and supervision of the work by competent personnel who have appropriate knowledge and experience and the authority to decide on variations to the ground investigation when required (see Chapter 15).*

In planning ground investigations, particular attention should be paid to the safety of personnel. Certain methods present special safety problems, and recommendations are given in the relevant sections. Other methods involve normal safety precautions appropriate to site or laboratory work. A list of statutory regulations which may apply to ground investigations is given in Appendix E; this list is not necessarily complete, and if there is doubt over safety precautions, further advice should be obtained.

In the project planning stage for tunnel works, alternative tunnel routes and potential shaft locations are typically considered. It is sufficient to have only a general picture of the subsurface geology and hydrogeology, to define the preferred route corridor and to estimate the order of project cost. The site investigation should largely comprise desk studies and site reconnaissance, and include only limited ground investigation, if any is needed. Reference should be made to information available from nearby tunnel projects (see, for example, the references given in GEO (2016)).

[Amd GG2/01/2017]

Appendix A summarises the types of information that may be required in planning a ground investigation.

## 8. Types of Ground Investigation

### 8.1 Sites for New Works

*Investigations for new works differ from the other types of investigation mentioned in Chapter 7, in that they are usually wider in scope because they are required to yield information to assist in selecting the most suitable location for the works, and the design and construction of the works. For example, when slope excavation has to be carried out, a knowledge of the subsurface materials and groundwater conditions should indicate :*

- (a) whether removal of the material will be difficult,
- (b) whether the sides of the excavation will be stable if unsupported or will require support,
- (c) whether groundwater conditions will necessitate special measures such as groundwater drainage or other geotechnical processes,
- (d) whether the nature of the ground will change as a result of excavation, e.g. opening of relict joints in the soil mass,
- (e) what form of surface protection is required.

*On the design side, it is necessary to assess such considerations as bearing capacity and settlement of foundations, stability of slopes in embankments and cuttings, earth pressures on supporting structures, and the effect of any chemically aggressive ground conditions. For the design of new works, it is important that the range of conditions, including least favourable conditions, should be known. This entails not only a study of the degree of variability in the soil and rock profiles over the area of the site, but also an appreciation of the possible injurious effects of groundwater variations and weather conditions on the properties of the various subsurface materials. Where works require excavations into or within rock, including weathered rock, the orientation and nature of discontinuities in the rock may be the most important factors.*

Often, a preliminary design of the proposed works is of great assistance in the identification of parameters that are required to be obtained from the ground investigation.

Investigations should assess whether the proposed works may induce ground movements which could affect adjacent land, services and structures, and whether the hydrogeological regime may be adversely affected (see Sections 4.1.2 and 8.3).

### 8.2 Defects or Failures of Existing Features or Works

*The investigation of a site where a failure has occurred is often necessary to establish the cause of the failure and to obtain the information required for the design of remedial measures.*

Observations and measurements of the feature or structure to determine the mode or mechanism of failure are first needed, and these will often suggest the origin of the trouble, or at least indicate whether the ground conditions were partly or wholly responsible. If this is the case, an investigation will be required to ascertain the ground and groundwater conditions relevant to three phases of the site history, i.e. before the works were constructed, at the time of failure and as they exist at present (see also Chapter 32). Each problem will need to be considered on its merits. Indications of the probable cause of a failure will often result in detailed attention being directed to a particular aspect or to a particular geological feature.

*In the case of slope failure, or where such failure is considered imminent, it is common practice to monitor movements both of the surface and underground. The former is conducted by conventional survey methods and the latter by means of slip indicators or inclinometer measurements. These techniques are fully described in the Geotechnical Manual for Slopes (GCO, 1984). It is also usually necessary to monitor groundwater pressures within the various underlying zones (see Chapter 20).* [Amd GG2/01/2017]

*Therefore, an investigation to determine the causes of a failure may be much more detailed in a particular respect than would normally be the case in an investigation of new works.*

### **8.3 Safety of Existing Features and Works**

#### **8.3.1 Effect of New Works upon Existing Features and Works**

Because of the dense urban development in parts of Hong Kong, it is often necessary to investigate existing features and works in the immediate vicinity or even remote from the site of the proposed new works, to decide whether the existing works are likely to be affected by changes in the ground and groundwater conditions brought about by the new works.

#### **8.3.2 Types of Effects**

Existing slopes and structures may be affected by changed conditions such as the following :

- (a) Impeded drainage, which may result in a rise in the groundwater level. This can cause softening of cohesive materials and reduction of shear strength of permeable materials, and give rise to increased pore pressures affecting the stability of slopes and retaining walls; swelling may result in ground heave.
- (b) Excavations or demolitions in the immediate vicinity, which may cause a reduction in support to the slope or structure, either by general ground deformation or by slope instability.
- (c) Stresses that the new structure may impose on existing slopes or structures, or on the foundation materials below adjacent

structures, which can cause slope instability or distress to existing structures.

- (d) Vibrations and ground movement resulting from traffic, vibratory compaction, piling or blasting in the immediate vicinity, or from other construction activities.
- (e) *Lowering the groundwater level by pumping from wells or dewatering of excavations or tunnels will cause an increase in the effective stress in the subsoil affected, which can lead to excessive settlement of adjacent structures. Also, if pumps do not have an adequate filter, the leaching of fines from the subsoil can easily result in excessive settlement of structures at considerable distance from the pump.*

In areas where natural underground cavities can occur, e.g. karst features in the Yuen Long basin, increase in effective stress or downward ravelling of soil due to heavy pumping may lead to subsidence or the formation of sinkholes (Siu & Wong, 1984).

- (f) *Tunnelling operations in the neighbourhood, which may cause deformations and subsidence; the effect of tension and compression on drainage should not be overlooked.*
- (g) *Alteration in stream flow of a waterway, which may cause undercutting of banks or scouring of foundations of walls, bridges and piers, and may be due to works carried out some distance away.*
- (h) *Siltation of the approaches of harbour works or the changing of navigation channel alignments.*

### **8.3.3 Procedure**

*In the investigation of the safety of existing features or works, the first requirement is an appreciation of the changes to the ground that are likely to occur. The ground investigation will need to provide knowledge of the subsurface materials, together with the examination and testing of samples to assess the effect that the changed conditions are likely to have on these materials. In some cases, it may be necessary to carry out a detailed analysis to estimate the effect of the changed conditions on the safety of the existing features and works.*

## **8.4 Materials for Construction Purposes**

*Investigations of sites are sometimes required :*



- (a) to assess the suitability, and quantities, for construction work of materials that become available from excavations or dredging, e.g. whether spoil from cuts in road and railway works will be suitable for fills in other places,*
- (b) to find suitable materials for specific purposes, e.g. to locate borrow pits or areas for earthworks (a common problem in Hong Kong where intense urban development demands a constant search for suitable fill materials); to assess the suitability of materials in waste tips that may need to be removed for environmental reasons,*
- (c) to locate suitable disposal sites for waste and dredged materials.*

## 9. Geological Mapping for Ground Investigation

The object of geological mapping is to assess the character, distribution and structure of the soils and rocks underlying the area. Interpretation of the geological conditions at the site may not be possible without mapping a larger area. An understanding of geological features is a pre-requisite to interpreting the geological conditions at the site, and a suitably trained specialist should normally undertake this task.

As a base map or reference, the new 1:20 000 scale geological maps are most useful. These maps will become available between 1986 and 1991 (Figure 3). Two existing 1:50 000 geological maps (which cover the entire Territory) are also available (Allen & Stephens, 1971). Methods used for geological mapping at the regional scale are equally suitable for site specific mapping for ground investigations (Geological Society, 1982; Strange, 1986) and may be supplemented by interpretation of aerial photographs (see Chapter 6) and geophysical investigations (see Chapter 33).

*Natural exposures and artificial exposures, such as cut slopes and quarries, beyond the site may provide data on the material and mass characteristics of soils and rocks, including, for example, the orientation, frequency and character of bedding and jointing discontinuities, weathering profiles, and the nature of the junction between superficial and solid formations. Such information should be used as a guide only to conditions likely to be present at the site. Caution is needed in extrapolating data; geological deposits may vary laterally, and very important geological structures, such as faults and other major discontinuities, may have only a restricted extent.*

*It may be expedient to investigate local conditions at an early stage of the mapping, using mechanically excavated shallow pits and trenches. The walls of excavations and, where appropriate, the floor should be mapped at a suitably large scale and sampled before backfilling takes place.*

Slope surface stripping is also commonly used in Hong Kong for the purpose of geological mapping (see Section 18.1).

*Recording of geological information should be undertaken at all stages of the works.*

General principles and key considerations relating to the development of engineering geological models are given in Section 3 of the Engineering Geological Practice in Hong Kong (GEO, 2007).

[Amd GG2/01/2017]

Further information and examples of engineering geological mapping are given elsewhere (Burnett & Styles, 1982; Geological Society, 1972; IAEG, 1981; ICE, 1976; UNESCO, 1976).

## 10. Extent of the Ground Investigation

### 10.1 General

*The extent of the ground investigation is determined by the character and variability of the ground and groundwater, the type of project, and the amount of existing information. It is important that the general character and variability of the ground should be established before deciding on the basic principles of the design of the works.*

In Hong Kong, soils derived from insitu rock weathering generally exhibit great variability even within relatively short distances. Granitic and volcanic rocks, which together form the major portion of the solid geology of the Territory, may be weathered to soils typically to depths of 30 m and 10 m respectively. Under certain geological conditions, granitic rocks may be weathered to over 100 m deep. Examples can be found in the Mid-levels area, Ma On Shan and Yuen Long. It is important to recognize that ground conditions may not always improve with depth; on occasions, hard rock at the ground surface may be underlain by thick zones of weaker material. Similarly, fill materials within reclamations may vary considerably. Hong Kong soils and rocks are further discussed in Geoguide 3 (GCO, 1988).

*Investigations include a range of "methods", e.g. excavations, boreholes, probing, see Chapters 17 to 23. The factors determining the selection of a particular method are discussed in Chapters 11, 12 and 17 to 23. In general, the recommendations in Sections 10.2 to 10.7 apply irrespective of the method adopted, and the term "exploration point" is used to describe a position where the ground is to be explored by any particular method.*

*Each combination of project and site is likely to be unique, and the following general points should therefore be considered as guidance in planning the ground investigation and not as a set of rules to be applied rigidly in every case.*

### 10.2 Character and Variability of the Ground

*The greater the natural variability of the ground, the greater will be the extent of the ground investigation required to obtain an indication of the character of the ground. The depth of exploration is generally determined by the nature of the works projected, but it may be necessary to explore to greater depths at a limited number of points to establish the overall geological conditions. The technical development of the project should be kept under continuous review, since decisions on the design will influence the extent of the investigation.*

*It is important to realize that the detailed geology of a site can be no more than inferred from aerial photography, surface outcrops and subsurface information at the positions of the exploration points. The possibility remains that significant undetected variations or discontinuities can exist, including lateral or vertical variations within a given layer. The uncertainties can be reduced but, except by complete excavation, can never be wholly eliminated by a more intensive investigation. The use of angled boreholes can in certain cases greatly assist interpreting variations between vertical boreholes (see also Section 10.7.8). In some circumstances, additional information between investigation points can be obtained by geophysical methods (see Chapter 33).*

## **10.3 Nature of the Project**

### **10.3.1 General**

*The investigation should yield sufficient data on which to base an adequate and economical design of the project. It should in addition be sufficient to cover possible methods of construction and, where appropriate, to indicate sources of construction materials. The lateral and vertical extent of the investigation should cover all ground that may be significantly affected by the new works or their construction. Two typical examples are the zone of stressed ground beneath the bottom of a group of piles; and an adjacent slope, the stability of which may be reduced by the works.*

### **10.3.2 Slope and Retaining Wall Construction**

Due to the extensive construction of slopes and retaining walls in Hong Kong, detailed guidance on the nature and content of site investigation for these features is given in Tables 3 and 4. Further discussion of the design and construction of slopes and retaining walls is given in the Geotechnical Manual for Slopes (GCO, 1984) and in Geoguide 1 : Guide to Retaining Wall Design (GEO, 1993).

### **10.3.3 Foundations for Structures**

Most structures in Hong Kong are founded on piles. Hand-dug caissons, driven piles, machine-bored piles and barrettes are commonly used. A general approach to planning a ground investigation suitable for pile design purposes is given in ICE (1978). The investigation should make a full appraisal of the site and the ground conditions should be investigated at depths well below the proposed pile toe level to allow for variations in the pile design. Knowledge of the groundwater conditions is also required. Further advice on ground investigation for foundations is given in Section 10.7.2, BSI (1986) and Weltman & Head (1983).

In areas where major structural defects in rock may occur (e.g. karst features in the Yuen Long basin, or major shear or fault zones), more intensive investigation and greater exploration depths than normally recommended may be required. Consideration may need to be given to locating underground cavities within the zone of influence of the loaded area, and to identifying other possible significant features such as steeply-dipping rockhead, fractures and alternating soil and rock layers.

Recommendations on the depth of exploration for foundations for structures, including shallow foundations, are given in Section 10.7.2.

## **10.4 Preliminary Investigation**

Before deciding on a full investigation programme, it may be advisable to excavate trial pits or to strip the surface cover from slopes for a preliminary assessment of ground conditions.

These should be carefully examined, logged and sampled (see Section 18.1).

For large projects requiring staged ground investigations, it will often be useful during the first stage to carry out a geophysical survey in addition to some widely-spaced boreholes to identify those areas which require more detailed investigation.

## 10.5 Location

*The points of exploration, (e.g. boreholes, soundings, pits) should be located so that a general geological view of the whole site can be obtained, together with adequate details of the engineering properties of the soils and rocks and of groundwater conditions. More detailed information should be obtained at positions of important structures and earthworks, at points of special engineering difficulty or importance, and where ground conditions are complicated, e.g. suspected buried valleys, old slipped areas and underground cavities. Rigid, preconceived patterns of pits, boreholes or soundings should be avoided. In some cases, it will not be possible to locate subsurface features until much of the ground investigation data has been obtained. In such cases, the programme of investigations should be modified accordingly.*

The locations of boreholes and other exploration points should only be planned after the desk study, site reconnaissance and geological mapping are completed. It is often useful to locate boreholes at the intended positions of large deep foundations. For slopes, boreholes should generally be located along anticipated critical slope sections, as well as uphill and downhill for area and regional stability studies.

*For tunnels and inclined shafts, boreholes should be offset so as not to interfere with subsequent construction. For other structures, the need to offset boreholes and trial excavations from critical points should be considered. In most cases, boreholes should be carefully backfilled, concreted or grouted up. Trial excavations should be located outside proposed foundation areas.*

*It is essential that accurate locations and ground levels for all exploration points should be established, if necessary by survey (see Section 7.2).*

## 10.6 Spacing

*Although no hard and fast rules can be laid down, a relatively close spacing between points of exploration, e.g. 10 to 30 m, will often be appropriate for structures. For structures small in plan area, exploration should be made at a minimum of three points if possible. Where a structure consists of a number of adjacent units, one exploration point per unit may suffice. Certain engineering works, such as dams, tunnels and major excavations, are particularly sensitive to geological conditions, and the spacing and location of exploration points should be more closely related to the detailed geology of the area than is usual for other works.*

In the case of a proposed cut slope extending from soil into rock, the level of bedrock

along the face of the cutting is important. Consideration should be given to obtaining the subsurface profile by additional drilling and geophysical means. In the case of reclamation, very closely spaced boreholes may be required to locate and delineate buried obstructions such as remnants of an old seawall.

## 10.7 Depth of Exploration

### 10.7.1 General

The depth of exploration is governed by the depth to which the new project will affect the ground and groundwater or be affected by them. Normally, exploration should be taken below all deposits that may be unsuitable for foundation purposes, e.g. fill and weak compressible soils, including any weak materials overlain by a stronger layer. The exploration should be taken through compressible soils likely to contribute significantly to the settlement of the proposed works, generally to a depth where stress increases cease to be significant, or deeper.

In Hong Kong, it is common practice to drill into rock for a depth of at least 5 m to establish whether corestone, boulder or bedrock has been encountered. However, the final depth of drilling will depend on the need to prove bedrock. In some cases, it will be necessary to drill deeper than 5 m to establish conclusively the presence of bedrock, for example, in investigations for end bearing piles (see Section 10.7.2). In other instances, it may not be necessary to terminate drilling in rock (see Section 10.7.4).

*More specifically, the recommendations given in Sections 10.7.2 to 10.7.8 may be considered for certain types of work. It is not always necessary that every exploration should be taken to depths recommended in Sections 10.7.2 to 10.7.8. In many instances, it will be adequate if one or more boreholes are taken to those depths in the early stages of the field work to establish the general subsurface profile, and then the remainder sunk to some lesser depths to explore more thoroughly the zone near the surface which the initial exploration had shown to be most relevant to the problem in hand.*

### 10.7.2 Foundations for Structures

*In the case of foundations for structures, the depth of exploration should be at least one and a half times the width of the loaded area. Commonsense will indicate exceptions to this guideline; for example, it would not usually be necessary to continue drilling for long distances in strong rock. For foundations near the surface, the loaded area is considered as either :*

- (a) the area of an individual footing, or*
- (b) the plan area of the structure, where the spacing of foundation footings is less than about three times the breadth, or where the floor loading is significant, or*
- (c) the area of a foundation raft.*

*In each case, the depth should be measured below the base of the footing or raft.*

*Where piled foundations are considered to be a possibility, the length of pile usually cannot be decided until an advanced stage of the project. No explicit rules can be given for the depth of exploration, but the following offer some guidance :*

- (a) Fill and weak compressible soils seldom contribute to the shaft resistance of a pile and may add down drag to the load on it. The whole pile load, possibly with the addition of down drag, will have to be borne by the stronger materials lying below the weak materials, either in end bearing or through shaft resistance.
- (b) The length of driven piles is often determined initially by the driving resistance, and subsequently checked by load tests. Hence, in such cases, the length of the pile is not accurately known until the piling contract begins, but it may be possible to gain an early indication from standard penetration test (SPT) blow counts.
- (c) In the case of end bearing piles in strong rock, boreholes should be of sufficient depth to establish conclusively the presence of bedrock. The rock should then be further explored, usually by means of rotary drilling, to such a depth that the engineer directing the investigation (see Section 15.2) is satisfied that there is no possibility of weaker materials occurring lower down that could affect the performance of the piles. This will usually require penetrating at least 5 m, or two and a half times the diameter of the pile, whichever is larger, below the proposed founding level of the pile. For boreholes carried out during construction to prove satisfactory pile founding levels, the depth of penetration may have to be increased where large corestones or boulders are suspected or have been identified nearby.
- (d) In weathered rocks, it may not always be feasible to locate underlying fresh rock. Foundations in this case must often be founded in the weathered rock, and proving the strength and continuity of the material below the intended founding level and the location, nature and orientation of discontinuities may then suffice.
- (e) Pile-supported rafts on clay may be used solely to reduce settlement. In these cases, the depth of exploration is governed by the need to examine all subsurface materials that could contribute significantly to the settlement. Similarly, for pile groups on clay, it will be necessary to ensure that the depth of exploration is sufficient to prove the adequacy of the

founding material below the toe of the piles.

*Based on the information of the probable subsurface profile obtained from the desk study, the general guidance given in (a) to (e) above, and an assessment of the types of pile likely to be considered, the engineer directing the investigation should determine the depth of exploration and be ready during the course of the field work to modify this depth as appears to be necessary. In any event, exploration should at same points be taken below the depth to which it is considered likely that the longest piles will penetrate.*

It should be noted that if any structure is likely to be affected by subsidence due to collapse of underground cavities (e.g. karst features in the Yuen Long basin) or any other causes, greater exploration depths than those recommended in this Section may be required.

### **10.7.3 Embankments**

*For embankments on alluvial and marine soils, the depth of the exploration should be sufficient to check possible shear failure through the foundation materials and to assess the likely amount of any settlement due to compressible materials. In the case of water-retaining embankments, investigation should explore all materials through which piping could be initiated or significant seepage occur.*

### **10.7.4 Cut Slopes**

The depth of exploration for cut slopes should be sufficient to permit full assessment of the stability of the slope. This may necessitate proving the full depth of any relatively weak or impermeable materials such as decomposed dykes (Au, 1986). In general, exploration for slopes should extend a minimum of 5 m below the toe of the slope or 5 m into bedrock, whichever is shallower. However, one or more exploration points should in all cases extend below the toe of the slope or excavation, irrespective of bedrock level. Groundwater conditions, including the possibility of perched or multiple water tables, should also be determined.

### **10.7.5 Pavements**

For pavements, the depth of exploration should be sufficient to determine the strength and drainage conditions of possible sub-grades. Exploration to a depth of 2 to 3 m below the proposed formation level will probably be sufficient in most cases.

### **10.7.6 Pipelines**

For shallow small pipelines, it will frequently be sufficient to take the depth of exploration to 1 m below the invert level. For deeper pipelines the depth of exploration should be sufficient to enable any likely difficulties in excavating trenches and supporting the pipelines to be discovered; a depth at least 1 to 2 m below the invert level may be advisable. Large



pipelines, especially those in ground of low bearing capacity, require special consideration.

### 10.7.7 Marine Works

*For marine works, the effects described in Sections 10.7.2 and 10.7.3 may apply and, in addition, consideration should be given to the effects of tidal variations.*

In many cases of reclamation, it may be sufficient to terminate drilling shortly below the base of any soft deposits that are present.

[Amd GG2/01/2017]

### 10.8 Specific Guidance for Silt- and Clay-rich Layers of Rock Cut Slopes

[Amd GG2/01/2017]

In assessing the stability of a cut slope in volcanic or granitic rock, attention should be given to establishing whether any of the following geological features are present, and if so, whether they may adversely affect slope stability:

[Amd GG2/01/2017]

- (i) laterally persistent (e.g. > 4 m) weak silt- and clay-rich layers (which predominantly comprise white to buff kaolin, but may contain other materials, most notably dark brown manganiferous and iron oxides), within the rock mass, regardless of thickness,

[Amd GG2/01/2017]

- (ii) completely and highly decomposed rock (Grades V and IV) forming planar layers that sit on slightly and moderately decomposed rock (Grades II and III), and which dip directly, or obliquely outwards from slope faces (At the Fei Tsui Road landslide site, the rock type was a eutaxitic fine-ash crystal tuff. The investigation of the Fei Tsui Road landslide (GEO, 1996a) highlighted various geological features in this rock type that influence the stability of cut slopes. The recognition of these geological features during site investigation at other cut slopes in similar rock types should raise awareness of the potential for a slope failure in similar circumstances to those pertaining at the Fei Tsui Road site.), and

[Amd GG2/01/2017]

- (iii) persistent (e.g. > 4 m), planar, steep joint sets and other geological contacts (e.g. dykes, faults etc.) that could form release surfaces.

[Amd GG2/01/2017]

The following additional ground conditions are often indicative of the presence of

geological features listed in previous paragraph and should also be checked: [Amd GG2/01/2017]

- (i) stratification dipping out of the slope (e.g. as indicated by eutaxitic foliation in some fine ash tuffs), [Amd GG2/01/2017]
- (ii) zones of continuous seepage, and [Amd GG2/01/2017]
- (iii) clusters of previous slope failures. [Amd GG2/01/2017]

In site investigation, the following items are recommended to facilitate the identification of geological features that may be adverse to slope stability: [Amd GG2/01/2017]

- (i) The desk study should establish the history of any past failures (including the mechanism and type of failure) and continuous seepage, and, where site formation photographs are available, the presence of significant geological features. [Amd GG2/01/2017]
- (ii) The engineering geological mapping should establish whether the orientation of bedding, bedding-parallel fabrics (e.g. eutaxitic foliation, which could provide an indication of the orientation of potential bedding plane structures in volcanic rocks.) or laterally continuous discontinuities (e.g. sheeting joints) are adversely oriented, and identify any weak silt- and clay-rich layers, especially within adversely-oriented persistent discontinuities or along the weathering front (i.e. the boundary below which rock predominates in a partially weathered rock mass profile). Such adversely oriented weak layers may also occur in local depressions in the weathering front, caused for example by zones of faulting, discontinuities with close spacing, and subvertical eutaxitic foliation. Evidence of previous movement, especially that associated with any weak layers, should be noted, and could include: [Amd GG2/01/2017]
  - (a) slickensiding, particularly within silt and clay-rich layers, [Amd GG2/01/2017]
  - (b) brecciation and shear deformation of silt and clay-rich layers, and [Amd GG2/01/2017]
  - (c) tension cracks and infilled tension cracks, possibly controlled by subvertical joints and particularly where associated with adversely oriented weak layers. [Amd GG2/01/2017]

Zones of continuous seepage, especially where associated with

silt- and clay-rich layers, should also be mapped.

[Amd GG2/01/2017]

- (iii) During the initial phase of ground investigation, emphasis should be directed to developing a representative geological and hydrogeological model rather than testing. The ground investigation should focus on examining and logging the saprolite profile in detail, with emphasis placed on identifying the presence of adversely-oriented, weak silt- and clay-rich layers, especially in the vicinity of the weathering front, regardless or not whether these layers daylight in the slope under investigation. The ground investigation should also identify any such features within the rock mass where they may influence slope stability.

[Amd GG2/01/2017]

Suitable techniques for detailed examination of the saprolite profile should include:

[Amd GG2/01/2017]

- (a) full-face mapping and logging of cut slopes, after stripping of surface cover, and adjacent exposures, [Amd GG2/01/2017]
- (b) excavation and logging of trial pits, and [Amd GG2/01/2017]
- (c) logging of drillholes. [Amd GG2/01/2017]

Suitable techniques for detailed examination of the saprolite profile may also include:

[Amd GG2/01/2017]

- (d) excavation of trenches or adits, [Amd GG2/01/2017]
- (e) continuous sampling in drillholes using triple tube core barrels with air-foam as the flushing medium, and [Amd GG2/01/2017]
- (f) downhole geophysical logging and other downhole techniques, including borehole televiewer and impression packer. (Technical guidelines on the use of downhole geophysical investigation techniques in the identification of weak layers are given in Section 33).

[Amd GG2/01/2017]

## 10.9 Specific Guidance for Tunnel Works

[Amd GG2/01/2017]

### 10.9.1 Preliminary Design Stage

[Amd GG2/01/2017]

In the preliminary design stage, recommendations are made on a preferred tunnel

alignment and the scope of works, including risk mitigation measures based on assumed methods of excavation. Ground investigation with a geophysical survey could be undertaken to refine the geological model, to gain additional information on significant geological features, identify sensitive receivers and to establish baseline conditions.

[Amd GG2/01/2017]

Boreholes should extend well below the anticipated depth of the tunnel and shafts to allow for any subsequent changes in the vertical alignment of the tunnel in the detailed design stage, *and because the zone of influence of the tunnel may be extended by the nature of the ground at a greater depth.*

[Amd GG2/01/2017]

Long horizontal boreholes parallel to the proposed tunnel alignment are extremely useful, particularly where the location of the proposed tunnel is overlain by thick layers of deeply weathered rock (McFeat-Smith, 1987).

[Amd GG2/01/2017]

Soil permeability tests and Lugeon tests at close spacings should be undertaken in the boreholes to assess the soil mass and rock mass permeability, respectively. It is important not to overlook areas of apparently strong bedrock, as the mass permeability of these areas may be high and may affect significantly construction of the tunnel works. The test results should be used for development of the hydrogeological model, defining the hydraulic boundary conditions for the design and for assessing the need to control groundwater inflow/drawdown during construction.

[Amd GG2/01/2017]

### 10.9.2 Detailed Design Stage

[Amd GG2/01/2017]

In the detailed design stage, when the tunnel alignment has been fixed, the main aim of the ground investigation should be to obtain information for the reference design or detailed design of the tunnel works and the associated temporary works. The ground investigation should also identify conditions at likely problematic areas along the chosen alignment. The ground investigation data should be adequate for preparing the design of the ground support, ground treatment, groundwater control works and the risk mitigation measures. It should also be adequate for planning the inspection, testing and monitoring works during construction.

[Amd GG2/01/2017]

Where existing boreholes are found close to or intercepting the tunnel, the risk of these boreholes not properly grouted should be assessed and mitigation measures, where necessary, should be carried out to ensure that these boreholes would not form preferential flow paths that could jeopardize the tunnel construction.

[Amd GG2/01/2017]

New boreholes along the chosen tunnel alignment and shaft locations should generally extend to a sufficient depth below the invert of the tunnel/shafts to obtain information for the assessment of possible failure mechanisms/limit states, and/or construction of the tunnel/shafts. For tunnels in rock, this should be a least 2.5 times the tunnel diameter (or the crown to invert dimension) below the invert.

[Amd GG2/01/2017]

Directional coring along the tunnel alignment should be considered. If this is to be carried out, it should preferably be done immediately on commencement of the detailed design

stage, in order to yield early data to maximise its benefit for the design. Despite the cost, the directional coring together with pumped down packer tests could provide useful information on the geology and hydrogeology along the tunnel alignment which could not be obtained from vertical or inclined boreholes. The information along the tunnel alignment would help to enhance the management of ground risks in tunnel excavation. [Amd GG2/01/2017]

For ground investigation to support the design of shafts, particular attention should be given to identifying poor ground conditions, which could lead to collapse, excessive ground deformation/vibration or excessive groundwater inflow/drawdown. For deep shafts with a significant length in rock, the ground investigation should assess the hydrogeology and inflow into the unlined sections of the rock mass, and the need for ground treatment and groundwater control works to prevent excessive drawdown of piezometric pressures in the rock and the soil overburden. [Amd GG2/01/2017]

For significant temporary works to be designed by the contractor, e.g. major ground treatment, groundwater control and ground support works, the pre-tender site investigation should provide sufficient geological and hydrogeological data for the pre-tender reference designs of such works, which should be carried out to adequately define the scope of the works required to meet the safety standards and the performance criteria specified. [Amd GG2/01/2017]

## 11. Selection of Ground Investigation Methods

### 11.1 General

*Although the character of the ground and the technical requirements are the most important aspects in the selection of methods of ground investigation, selection may also be influenced by the character of the site, the availability of equipment and personnel, and the cost of the methods.*

The specialist nature of ground investigation work should at all times be considered. In most cases it will be necessary to employ a contractor who is experienced in the type of investigation work which is being proposed, and who has proper equipment and experienced personnel to carry out the works.

### 11.2 Site Considerations

*The topography, nature of the ground surface, surface water, the existence of buildings or other structures and land 'ownership' may cause problems of access to the locations for boreholes, or interfere with geophysical methods. For example, on very steeply sloping open sites, it may be necessary to construct an access road or lower the equipment down the slope or haul it up. Where the working position is on steeply sloping ground, it will be necessary to form a horizontal working area by excavation or the use of staging (Plate 2A). On sites that are obstructed by buildings and other structures, it may be necessary to demolish walls to gain access. Alternatively, it may be possible to lift the equipment over obstructions using a crane or to use special equipment that can be dismantled and man-handled through the building and used in a confined space. Gaining access to sites covered by water presents special problems (see Chapter 14). If the ground surface is soft, it can be traversed only by very light equipment. Where this would not be effective, access roads for heavier equipment will be required. Alternatively, the use of helicopters or hovercraft may be appropriate.*

For ground investigation within or requiring access through privately-owned land, including properties of the utilities companies and armed forces, permission should first be obtained from the owners. For Government land, approval should be sought from the relevant District Lands Office. For sites under the control of Government, approval must be obtained from the relevant Department concerned. Such sites include reservoirs, service reservoirs, roads, highways, country parks, Urban Council parks, etc. Permission to enter a site for purposes of ground investigation may place further restrictions on the methods used. For example, it may be necessary to control or eliminate the return of flushing media from boreholes that affect adjacent slopes, fish ponds, cultivated fields, or highways (see Section 18.7.1). Also, the presence of foundations and services often restrict the use of inclined drilling through existing retaining walls into adjacent properties.

Access for drilling rigs should be assessed in the field with the assistance of plans, maps and aerial photographs. Timber scaffolding is often used in Hong Kong to provide access over rugged terrain and to construct drilling platforms in very steep terrain (Plate 2B). As such scaffolding can account for a large portion of the total cost of the investigation, care should be taken to locate boreholes for ease of access where possible.

Most methods of boring and field testing require a supply of water. On a site where water is not available, it will be necessary to arrange for a temporary supply to be provided. In the urban area, water can often be obtained from fire hydrants upon application to the Water Supplies Department for the hire of a metered adaptor. In rural areas water may be obtainable from wells, rivers or streams. On sites where the provision of water presents a major problem, it may be necessary to transport the water in bowsers, or to use alternative methods of investigation; for example, with rotary drilling an air foam flush could be used instead of water flush (see Section 18.7). Where water is used as the flushing medium, adequate measures should be provided to prevent silt and other debris in the flushing return from entering the permanent drainage system, thereby causing siltation and other problems. Such measures may include settling basins and sand/silt traps.

Other site considerations which may restrict the methods used are as follows :

- (a) Trees on Government land are protected, and should be preserved as far as possible in gaining site access or in choosing investigation points. Permission to lop or cut down any trees will not be granted unless good cause is shown.
- (b) 'Fung Shui' aspects of some sites are of great social and religious significance, and local advice should be sought in planning the investigation.
- (c) Buried utilities and services are very common and must be accounted for, as must subways and other tunnels (e.g. Mass Transit Railway tunnels) that may pass beneath the site.
- (d) Seismic surveys employing explosives may be restricted or prohibited in built-up areas.
- (e) Noise restrictions may prohibit the use of certain methods of investigation.
- (f) The difficulty in storage of spoil may restrict the use of trial pits on some sites.

Further advice on planning a ground investigation and relevant sources of information can be found in Appendices A and B (see also Sections 4.1.2 and 7.2).

## 12. Effect of Ground Conditions on Investigation Methods

### 12.1 General

This chapter considers the factors involved in the choice of the most suitable procedures for boring, drilling, sampling, probing and field tests, as determined by the character of the ground. Specific reference is made to the ground conditions commonly encountered in Hong Kong; these are further described elsewhere (Brand & Phillipson, 1984; Endicott, 1984; GCO, 1988; Phillipson & Brand, 1985). The following sections should be read in conjunction with Table 8, which summarises typical sampling procedures for different types of materials (see Section 19.1). Frequent reference is made to classes of sample quality, which are defined in Table 9 (see Section 19.2).

*The determination of the groundwater conditions is a most important part of a ground investigation. It involves the installation of piezometers and borehole or field testing (see Chapters 20, 21 and 25), and is not, in general, a major consideration in the choice of a procedure for drilling and sampling. Geophysical methods are often a useful means of interpolating between boreholes in a variety of ground conditions (see Chapter 33).*

### 12.2 Granular Soils Containing Boulders, Cobbles or Gravel

Some types of colluvium and alluvium may fall into this category, as may some fill and soils derived from insitu rock weathering, although the latter two types are considered more fully in Sections 12.8 and 12.10.

Within the limits of cost, the best method for investigating this type of ground is by means of a dry excavation (see Sections 18.1 and 18.2). The excavation permits the structure of the ground to be inspected, samples to be obtained, and field tests to be used to measure insitu density, strength and deformation characteristics (see Chapters 27, 29 and 30).

If it is necessary to investigate the ground below the groundwater table, dewatering may be required to obtain a dry excavation. The possible effects on adjacent ground of any dewatering should first be assessed, however, and it may be necessary in some cases to adopt alternative methods of investigation below the groundwater table.

Rotary water flush drilling may be employed (see Section 18.7), using a triple-tube core-barrel with retractor shoe for matrix material and a diamond drill bit for boulders. It may also be possible to use a U100 sampler (see Section 19.4.4) in matrix material to obtain class 3 or 4 samples. The use of air foam as a flushing medium may enhance core recovery and sample quality.

During boring, there may be difficulty in advancing the boreholes and, consequently, in obtaining samples of adequate quality. Boring may be undertaken with the light cable percussion method using the shell (see Section 18.5), and employing the chisel when rock fragments too large to enter the shell are encountered. The sides of the borehole must be supported with casing. Disturbed samples taken from the shell are usually only class 5 (grading incomplete) because the fine fraction may have been washed out and the coarse



fragments may have been broken up by use of the chisel.

*Borehole tests can be used to obtain an indication of the properties of the ground. The standard penetration test (see Section 21.2) will give some indication of relative density. Occasional high values that are unrepresentative of the true relative density will be obtained when the penetrometer encounters coarse gravel. In ground containing cobbles or boulders, the standard penetration test gives an increasing proportion of unrealistically high results. The borehole permeability test (see Section 21.4), may give a reasonable indication of permeability, and the results can also be used to give a guide to the proportion of fine particles in the soil. A more reliable assessment of permeability will be obtained from a pumping test (see Chapter 25). The cone penetration test (see Section 23.3), has limitations where there is a significant content of boulders or cobbles. It is also limited because of the inability of the cone to penetrate dense gravel. The "static-dynamic" test (see Section 23.4), is useful for this purpose, although its results will also be affected where cobbles or boulders are encountered. The pressuremeter is useful in coarse granular soils when held within a slotted casing (see Section 21.7).*

### **12.3 Granular Soils**

These soils include sands, silty sands and sandy silts, and are fairly common in alluvial or marine deposits. Boreholes in these materials may be sunk by the light cable percussion method using the shell, or by rotary drilling. Disturbed samples taken with the shell are likely to be deficient in fines, and therefore of class 5 only. Samples suitable for a particle size distribution test, class 4, may be obtained using the split barrel standard penetration test sampler. Larger class 4 samples can sometimes be obtained using U100 sampling equipment with a core-catcher.

*The action of forcing a sampler into granular soils tends to cause a change in volume, even if the area ratio is small (see Section 19.4.1(2)), and hence the density of the sample may not be representative of the layer. In some cases, a piston sampler will be effective (see Section 19.5); this should produce class 2 samples or, where the soil is loose or very dense, class 3 samples. However, in both cases the moisture content of the samples may be unrepresentative of the insitu ground. With clean sand, normal sampling equipment may fail to recover a sample, and it will then be necessary to use the compressed air sand sampler (see Section 19.7); sample classes will be similar to those obtained with a piston sampler.*

*In shallow investigations above the water table, excavations or hand augering (see Section 18.4), may be used.*

*A guide to the relative density of granular soils is obtained by the standard penetration test. However, the results can easily be invalidated by loosening of the soil below the water table. Where it is important that the relative density should not be underestimated, for example when a driven pile project is being investigated, the relative density should be assessed by the cone penetration test.*

*Approximate values of the strength and compressibility parameters can be estimated on an empirical basis from the results of the standard penetration test or, preferably, from the*

*results of the cone penetration test. Pressuremeter tests are also useful. A more direct determination requires the use of plate tests carried out in a dry excavation (see Section 21.6 and Chapter 29).*

*Permeability may be assessed from borehole permeability tests (see Section 21.3), or by pumping tests (see Chapter 25).*

#### **12.4 Intermediate Soils**

These include clayey sands, clayey silts and silts, and may be encountered in alluvial and marine deposits. The selection of methods of ground investigation will depend on whether the material behaves as a granular soil or a cohesive soil.

#### **12.5 Very Soft to Soft Cohesive Soils**

These include sandy clays, silty clays or clays. They are commonly encountered in marine and alluvial deposits. The normally consolidated and lightly overconsolidated marine clays may be sensitive, while the alluvial silty clays are generally insensitive.

Rotary drilling or the light cable percussion method may be used to advance holes in soft cohesive soil. Considerable care is required with rotary drilling to avoid change of water content and disturbance by the drilling fluid. Class 1 samples can be obtained by using a piston sampler. Class 2 or 3 samples can sometimes be obtained with an open-tube sampler. Continuous samples, usually class 3, can be obtained with a Delft sampler (see Section 19.6). Disturbed samples from the clay cutter of the light cable percussion method are generally class 4. Where the borehole contains water, it may be necessary to use the shell, in which case class 4 samples can be obtained provided that lumps of intact soil can be recovered.

The insitu vane test is by far the most satisfactory means of measuring the undrained shear strength of soft clays, but the penetration vane test apparatus is much to be preferred to equipment which is used in boreholes (see Section 21.3). Vane tests are particularly effective if combined with static cone penetration tests (see Section 23.3). For laboratory test purposes (particularly oedometer tests) large diameter samples (greater than 150 mm) should be obtained wherever possible. The compressibility values obtained from Rowe cell tests on large diameter samples (see Chapter 37 and Table 12) may be used in conjunction with insitu constant head permeability measurements to give a reasonable estimate of rate of consolidation settlement.

#### **12.6 Firm to Stiff Cohesive Soils**

These materials may be encountered as layers within marine or alluvial deposits.

Rotary drilling can be used, but considerable care is required to avoid change of water content and disturbance by the drilling fluid. The retractable triple-tube core-barrel can be used in rotary drilling to obtain class 2 and sometimes class 1 samples. The 100 mm open-

tube sampler can be used to obtain class 2 to 3 samples. Alternatively, the light cable percussion method with clay cutter can be used, which will result in class 5 samples.

## 12.7 Cohesive Soils Containing Boulders, Cobbles or Gravel

Most colluvium and some types of alluvium fall into this category, as may some fill and soils derived from insitu rock weathering, although the latter two types are considered more fully in Sections 12.8 and 12.10.

*Within the limits of cost, the best method of investigating cohesive soils containing boulders, cobbles or gravel is by a dry excavation. The excavation will enable the structure of the ground to be inspected, samples to be obtained, and field tests for the determination of the insitu density, strength and undrained deformation characteristics to be carried out.*

When using borehole methods of investigation, this type of ground presents difficulties in both advancing the hole and recovering samples of adequate quality. Rotary drilling is often employed, using triple-tube core-barrels equipped with a retractor shoe for the matrix materials and diamond-impregnated drill bits for rock fragments and boulders. Class 1 samples can be obtained by employing air foam flush with the large diameter triple-tube core-barrel. Class 1 to 2 samples may be obtained with retractable triple-tube core-barrels and water flush. The use of U100 samplers can yield class 2 or 3 samples of the matrix material, while the split barrel standard penetration test sampler can be used to obtain class 3 to 4 samples. The standard penetration test is sometimes used to obtain a rough indication of strength, but it may give misleading results if boulders and cobbles are present.

## 12.8 Fill

*Fill can consist of replaced natural ground, or waste materials of various origins. The uniformity of fill will depend on the degree of control which has been imposed, on the quality of the incoming material and on the method of placing and compaction. In older fill, there may have been little or no control of the filling operation, and the major problem in planning the ground investigation will be to assess the variation in character and quality across the site. Often, the variation will be random.*

*Conventional methods of boring, sampling and insitu testing, as appropriate to the character of the ground, can give information on the thickness and properties of the fill at the particular locations of the boreholes or insitu tests. It is essential to ensure that the borehole is always fully cased through fill to avoid contamination of the natural ground from falling material. Pits and trenches are particularly useful for investigating the nature and variability of fill (see Chapter 18).*

*In combustible fills, temperature measurements may be necessary. It should be noted that on waste tips, burning materials below ground may give rise to toxic or flammable fumes from the borehole. Tip fires may also create voids, which may collapse under the weight of an investigation rig. Lagoons within waste tips may be areas of very soft ground.*

## 12.9 Rock

Rotary diamond bit core drilling with water flush is normally used in rock. Soils derived from insitu rock weathering are further considered in Section 12.10. Double-tube or triple-tube core-barrels may be employed, with triple-tube core-barrels giving better core recovery and causing less disturbance, especially in highly fractured or jointed rock. The use of larger-sized equipment producing cores of about 100 mm diameter or more will also help to improve core recovery.

*Soft infilling of rock discontinuities can sometimes be lost due to erosion by the flush water, and air or air foam flush drilling may be desirable. In general rotary core drilling with a diamond drill bit will produce samples which may allow an assessment of the character and engineering properties of the intact rock material. Such samples may also give some indication of the frequency and dip angle of the discontinuities but not their dip direction, unless special techniques are used. The use of borehole periscopes, impression packers, cameras, and television cameras may be useful in this connection (see Section 21.8). In many cases, rotary core samples give no indication of the character of any infilling of the discontinuities.*

*In a ground investigation using light cable percussion boring or rotary core drilling, an indication of the properties of the rock mass can be obtained from tests in boreholes. For certain of such tests, however, it will be necessary to take into account the probable effects of disturbance of the ground by the drilling process. The standard penetration test (see Section 21.2), can give a rough indication of the variation of strength and compressibility in weak rock. The permeability test (see Section 21.4), or the packer or Lugeon test (see Section 21.5), may give a measure of the mass permeability, which in turn can give an indication of the presence of open joints and other water-bearing discontinuities. Where applicable, the plate test (see Section 21.5), and dilatometers such as the pressuremeter (see Section 21.7), can be used to investigate deformation properties and possibly also the strength.*

*The best method for determining the properties of a rock mass, including the orientation of discontinuities, is visual inspection, and field tests carried out in excavations, caissons or headings (see Chapter 18).*

## 12.10 Soils Derived from Insitu Rock Weathering

Weathered rock that can be regarded and treated essentially as soil from an engineering viewpoint occurs extensively throughout Hong Kong. These materials are derived primarily from the chemical decomposition of the parent bedrock, and their character depends on the parent rock type. Soils derived from granite are typically silty or clayey sands, while those derived from tuff and other volcanic rocks are often sandy or clayey silts. These soils very often contain corestones of less decomposed rock within a more decomposed matrix, and it is not uncommon to encounter granite corestones as large as 3 m or more. The depth over which decomposed material changes to fresh rock is extremely variable and is related to the rock type, joint pattern, the spacing of the joints, faulting, alteration, and the position of the water table (GCO, 1988).

Where these soils occur at shallow depth, pits are probably the most effective means of

investigation; class 1 block samples of the matrix material can usually be obtained for laboratory testing and the exposure can be fully described and logged.

Rotary drilling can be used to advance boreholes in these materials provided considerable care is taken to limit disturbance by the drilling fluid. Retractable triple-tube core-barrels can generally be used to obtain class 2 and sometimes class 1 samples. Class 1 samples can be obtained using a large diameter triple-tube core-barrel with air foam flush. Open-tube samplers generally provide class 2 to class 4 samples. The split barrel standard penetration test sampler can be used to obtain small class 3 or 4 samples.

Borehole tests can be used to obtain an indication of the properties of the ground. The standard penetration test will give some indication of density and degree of weathering, although the presence of corestones may give unrealistically high results. The standard penetration test can generally provide useful information for the initial assessment of likely pile founding depths. The borehole permeability test may give a reasonable indication of permeability. The pressuremeter may be useful for measuring ground stiffness.

### **12.11 Discontinuities**

*In most rocks, the mass properties depend largely on the geometry and nature of the discontinuities. This can require the engineering properties to be measured in the plane of the discontinuities along specific orientations determined by the anticipated directions of the stresses to be applied. The control by discontinuities over the strength and deformation characteristics of a ground mass is less obvious in soils derived from insitu weathering than in moderately weathered to fresh rock, but may be equally important.*

*There are no satisfactory drilling or boring techniques available for ensuring that the core recovered can be orientated over the full depth penetrated, but borehole discontinuity surveys can be conducted (see Section 21.8). In soils, the discontinuities are often destroyed by the drilling and therefore overlooked. Where discontinuities are important to the engineering problems involved, insitu exposures of discontinuities are necessary to obtain data on their orientation and nature. After initial investigations using interpretation of aerial photographs, surface outcrop logging and the drilling of vertical and inclined orientated holes, it may be necessary to form full surface exposures, large diameter boreholes, trenches, pits or adits to allow visual inspection around and within the undisturbed ground mass, and measurement of the relevant discontinuity data (see Chapter 26). In some projects, suitable exposures may be provided in excavations necessitated by the permanent works. The extraction or insitu preparation of orientated test samples can be carried out in these excavations, together with orientated large scale tests. The orientation of the excavations controls their intersection with the discontinuities and, consequently, the discontinuity data that can be obtained. Generally, three orthogonal exposures are required to define fully the spatial distribution of the discontinuities. The extent of the excavations is governed by the spacing between discontinuities and the size of the works.*

## 12.12 Cavities

Ground containing natural or man-made cavities can be found in Hong Kong (e.g. caverns in karst, disused tunnels and old mineshafts) and the cavities may be vacant or infilled (Culshaw & Waltham, 1987). Difficulties may be experienced in advancing a borehole through such ground. A variety of drilling techniques may need to be tried, and precautions should be taken to prevent dropping of the drill string, and to maintain verticality of the hole. Care may also be required to avoid ground subsidence during investigation (see Section 8.3.2). Close supervision is essential for such investigations.

## **13. Aggressive Ground and Groundwater**

### **13.1 General**

In some areas, soil, rock and groundwater may contain certain constituents in amounts sufficient to cause damage to Portland cement concrete or steel. While insitu weathered rocks and their associated soils in Hong Kong are generally not aggressive, this should be confirmed by ground investigation and laboratory testing whenever the use of ground anchors, reinforced fill structures or other susceptible structures are contemplated. Investigations for aggressive ground and groundwater should be considered for all sites where transported soils are encountered, and for all marine sites.

The principal constituents causing damage to concrete are sulphates, which are most common in clay soils and acidic waters. Total sulphate contents of more than 0.2% by weight in soil and 300 parts per million in groundwater are potentially aggressive (BRE, 1981).

Corrosion of metal is caused by electrolytic or other chemical or biological actions. In industrial areas, corrosive action may arise from individual waste products that have been dumped on the site. In river and marine works, the possible corrosive action of water, sea water and other saline waters, and trade effluents may also require investigation. In a marine environment, the most severe corrosion is found in the 'splash zone' (i.e. the zone that is only wetted occasionally). The saline concentration in groundwater near the sea may approach that of seawater, particularly in the case of reclaimed land. In estuarine situations, there may be an adverse condition because of alternation of water of different salinities.

### **13.2 Investigation of Potential Deterioration of Concrete**

Laboratory tests to assess the aggressiveness of the ground and groundwater against Portland cement concrete include determination of pH value and sulphate content (GEO, 2017a). Reference should be made to BRE (1981) regarding the determination of water-soluble sulphate concentrations. The pH value may be altered if there is a delay between sampling and testing, so field determinations should be made if possible.

[Amd GG2/01/2017]

Water sampled from boreholes may be altered by the flushing water used in drilling, or by other flushing media employed. Therefore sulphate and acidity tests carried out on samples from boreholes may not be representative unless special precautions are taken (see Section 20.3).

### **13.3 Investigation of Potential Corrosion of Steel**

The likelihood of corrosion of steel can be assessed from tests of resistivity, redox potential, pH, chloride ion content, total sulphate content, sulphate ion content, and total sulphide content. Details of these tests, and relevant limits for a relatively non-aggressive environment for steel, are given in Geoguide 6 (GEO, 2017b). Chemical tests should be done on undisturbed specimens which have been placed in clean airsealed containers immediately after sampling. If bacteriological attack is expected, undisturbed specimens should be placed

in sterilized containers and tested in accordance with BSI (1990) (see also Section 13.2 and Table 12).

[Amd GG2/01/2017]

#### ***13.4 Investigation of Fill Containing Industrial Wastes***

*Industrial waste products can contain a wide range of chemicals, depending on the industrial processes from which the waste products are derived. Some chemicals are highly aggressive to concrete or steel in underground structures, and some can be highly obnoxious or even poisonous. The last two characteristics can present major construction problems, e.g. the disturbance or disposal of contaminated ground, or the disposal of contaminated groundwater. Local enquiries may give some indication of the origins of the waste materials, and the pH value and sulphate content for the fill and the groundwater will generally give some indication of the magnitude of the contamination. It may then be necessary to carry out a detailed chemical study of the ground conditions.*

Further guidance is given by Naylor et al (1978).



## 14. Ground Investigations over Water

### 14.1 General

*Sinking boreholes below water presents special difficulties in comparison with working on dry land. A reasonably stable working platform may be provided, such as a staging, barge or ship, and the borehole sunk through a conductor pipe spanning between the working platform and the water bottom. Increasing use is being made of a variety of penetration testing techniques (Blacker & Seaman, 1985). In some cases, it may be feasible to lower specially designed boring, drilling or penetration testing equipment to the water bottom to be operated by remote control or a diver. With remote control, operation is restricted to a single continuous process. Penetration depths vary from less than 5 m for some devices, to 20 m or more for others. Geophysical techniques are also used to augment the information obtained from boreholes, or as a preliminary investigation before putting down boreholes (see Chapter 33).*

As in land investigations the choice of suitable equipment for marine investigations depends primarily on the expected ground conditions and the purpose of the investigation. Additional factors that must be considered in marine investigations include the water depth, heave of the craft caused by wave action, tidal fluctuations, and water currents (Blacker & Seaman, 1985). Also, the required working area for a drilling vessel must include a safe margin for anchor lines beyond the dimensions of the craft itself. A typical spread of anchors would be up to 50 m on either side of the craft.

*The scope of the work, including the methods of drilling, sampling and insitu testing, requires careful consideration depending on the particular difficulties of the site. When working over water it is essential that due consideration is given to safety requirements, navigational warnings, and the regulations of Government Departments and other authorities.*

To avoid interference with marine traffic, the Marine Department must be notified of investigations so that a Notice to Mariners can be issued. Special consideration must be given to sites where the investigation or associated craft could present a hazard. For example, craft working close to the runway of Kai Tak Airport must not pose a hazard to aircraft; permission for any such work must first be obtained from the Civil Aviation Department. Similarly, permission must be obtained from the Mass Transit Railway Corporation, the Cross Harbour Tunnel Co. Ltd, the Water Supplies Department, or the various public utility companies if work is to be carried out near submerged tunnels, pipelines or major utilities (see Appendices A and B).

*Ground investigations conducted from above water are often more expensive and time consuming than comparable investigations conducted on dry land, and there may be a temptation to economize by reducing the scope of the investigation. The extent of the requirement for ground investigations should be realistically assessed, since economies in this direction can turn out to be false.*

Tropical cyclones may lead to disruption of investigations, especially in the summer months. It is a usual insurance requirement that vessels proceed to a typhoon shelter when the strong wind warning signal number 3 or above has been issued (or is forecasted) by the Royal

Observatory.

## **14.2 Stages and Platforms**

*Where stable working platforms are available or can be provided, such as oil drilling platforms and jetties or purpose-built scaffold stages and drilling towers, it is generally possible to use conventional dry-land ground investigation drilling equipment and conventional methods of sampling and insitu testing. When working from existing structures, it may be necessary to construct a cantilevered platform over the water on which to mount the drilling rig. When drilling close to the shore in relatively shallow water, it may be more convenient to construct a scaffold staging from land to the borehole location. Alternatively, it may be more economical to construct a scaffold or other tower at the borehole location, in which case some means of transporting the drilling equipment to the tower will need to be provided. Some towers are constructed such that they can be moved from one borehole location to another without having to be dismantled.*

*Jack-up platforms, and special craft fitted with spud legs, can be floated into position and then jacked out of the water to stand on their legs. They can combine manoeuvrability with fulfilment of the requirement for a fixed working platform.*

Jack-up and other fixed platforms effectively overcome the problem of heave and allow a high standard of drilling, testing and sampling to be achieved. Jack-up platforms currently available in Hong Kong are capable of operation in water depths not exceeding about 12 m (Plate 3A).

*The design of all staging, towers and platforms should take into account the nature of the seabed, fluctuating water levels due to tides, waves and swell conditions. It is essential that such constructions should be sufficiently strong for the boring operations to resist waves, tidal flow and other currents and floating debris.*

## **14.3 Floating Craft**

*The type of floating craft suitable as a drilling vessel depends on a number of factors such as whether the water is sheltered or open, the anchor holding properties of the seabed, whether accommodation for the personnel is required on board, the likely weather conditions, the depth of water and the strength of currents. In inland water, a small anchored barge may suffice, but in less sheltered waters a barge should be of substantial size, and anchors will require to be correspondingly heavy. In offshore conditions, a ship is often employed, and it may then be possible to accommodate the personnel on board, with a saving in auxiliary supply vessels.*

*An auxiliary vessel will be required to handle the moorings if a barge is used for the work, but in certain cases a ship may be able to lay and pick up its own moorings. Generally, four or six point moorings will be required, and anchors should have the best holding capacity feasible. In water deeper than 80 m, conventional moorings become difficult, and the use of vessels maintained in position by computer-controlled thrusting devices should be considered.*

Special techniques are required to deal with fluctuating water levels due to tides, waves and swell conditions (Plate 3B), particularly with rotary drilling where a constant pressure between the drill bit and the bottom of the borehole is required (Smyth & McSweeney, 1985). When the heave is anticipated to exceed about 300 mm, it is necessary to employ a heave compensator system if high quality samples are to be obtained. Heave compensator systems allow the drill string and sampling equipment to be isolated from the vertical movements of the craft (Blacker & Seaman, 1985).

Pontoons and barges should be anchored at the corners using anchor lines at least five times the depth of water. In exposed waters, motorized mooring winches are necessary.

#### **14.4 Working between Tide Levels**

Sinking boreholes between high and low tide levels may be achieved using scaffold stagings, platforms (see Section 14.2) or flat-bottomed pontoons, or by moving drilling rigs to the location during periods permitted by the tides.

When it is intended to conduct drilling operations from flat-bottomed craft resting on the seabed at low tide, the profile and condition of the seabed should be assessed in advance.

#### **14.5 Locating Borehole Positions**

Close to shore, borehole positions and other investigation points can be set-out by radiation from known shore stations with distances measured by Electronic Distance Measuring (EDM) equipment. Further offshore, or when visibility is bad, electronic position fixing techniques can be used.

Setting-out by radiation usually involves the initial placement of a marker buoy within 5 m of the specified position. The marker buoy should be fitted with a line of sufficient length to allow for tidal variations and wave heaving. An auxiliary float on a 5 m line can also be tied to the marker buoy to indicate the direction of the current. This will help in manoeuvring the drilling craft into position. Once the drilling craft has been anchored over the sinker of the marker buoy, further measurements from the known shore stations can be taken. The position of the drilling craft can be adjusted by means of anchor winches until the borehole is positioned within 1 m of the required position. All borehole positions should be related to the 1980 Hong Kong Metric Grid, or if a site grid is used, the site grid should be related to the 1980 Hong Kong Metric Grid such that standard co-ordinates can be obtained.

#### **14.6 Determination of Reduced Levels**

*Reduced levels are generally transferred to a drilling vessel from shore by setting up a tide gauge close to the shore. The gauge is read at frequent intervals throughout the tidal cycles at the same time as readings of water depth are taken on the drilling vessel. Corrections may be necessary to allow for tidal variations when the distance between the tide gauge and the vessel is significant.*

Reading of the tide gauge can be facilitated by noting both the crest and trough levels of at least six consecutive waves. An average of the mean crest level and mean trough level can be adopted as the tide level at that instant. The tide gauge should be referenced to Hong Kong's Chart Datum (which is 0.146 m below Principal Datum), so that the reading can be used to obtain the reduced levels of the seabed and subsurface geological boundaries.

### **14.7 Drilling, Sampling and Testing**

Marine investigations commonly encounter interbedded marine and alluvial deposits underlain by weathered bedrock. Each stratigraphic horizon may contain distinctly different materials and may require different investigatory techniques (Beggs, 1983; see also Chapter 12).

For marine investigations, the rotary open hole method of advancing a hole is preferred to the rotary wash boring method (see Section 18.7.1). Drilling mud should be used as a flushing medium and to stabilize the hole when casing is not required. Cable tool boring techniques may be used to advantage in some situations, for example the identification of suitable marine borrow areas. Rotary drilling with a retractable triple-tube core-barrel (see Section 19.8) is often employed in soils derived from insitu rock weathering, as for land-based investigations.

If a fixed platform is not used during sampling, particular care must be taken to prevent sample disturbance due to heave. Continuous sampling of soft soils can be undertaken with a Delft or Swedish foil sampler, but these are particularly sensitive to heave and should only be attempted from a fixed platform. With the Delft samplers, care should be taken to prevent necking of the nylon jacket due to unbalanced fluid pressures, and ripping of the jacket due to shells in marine deposits.

A range of field tests in boreholes is useful in marine investigations, including standard penetration tests, vane shear tests and permeability tests. Static cone penetration testing and geophysical testing are also of value. In the case of vane shear tests, it is preferable to provide a stable support for the equipment on top of a soft marine mud seabed (Fung et al, 1984).

A special category of marine investigations involving only shallow-depth seabed materials is often required for pipeline foundations, pollution monitoring and similar projects. Disturbed, shallow-depth seabed samples may be obtained for these purposes with a grab sampler, gravity corer or vibrocorer. The grab sampler is the simplest of these devices, but it can only obtain samples from the uppermost 0.5 m of the seabed. The gravity corer normally consists of an open barrel 3 m in length that is allowed to fall and penetrate the seabed under its own weight. The vibrocorer is driven by a motorized vibrator and can penetrate 3 to 6 m depending on the nature of the seabed materials. The samples recovered using these methods are generally of poor quality but nevertheless should be suitable for classification testing. The principal advantage of these methods is the speed with which samples may be recovered over a considerable area (Blacker & Seaman, 1985).

## **15. Personnel for Ground Investigation**

### **15.1 General**

In view of the importance of ground investigation as a fundamental component of the proper design and efficient and economical construction of all civil engineering and building works, it is recommended that personnel involved in the investigation should be familiar with the purpose of the work, and should have appropriate specialized knowledge and experience.

### **15.2 Planning and Direction**

The person planning and directing the ground investigation should be a suitably qualified and experienced engineer or engineering geologist. This person should have a university degree in civil engineering or geology, or an equivalent professional qualification, and at least four years post-qualification engineering experience, some of which should be local experience on projects of a similar nature to the one being contemplated. If the ground conditions at the site are anticipated to be complex and the safety and economy of the project are significantly influenced by the ground conditions, the person planning and directing the ground investigation should possess, in addition, specialized qualifications or experience in geotechnical engineering, and specialized knowledge in site investigation practice in Hong Kong.

The person planning and directing the ground investigation should be thoroughly familiar with the project requirements and capable of liaising effectively with the project designer or client throughout all phases of the investigation (Figure 1). This person should determine the content and extent of the investigation, direct the investigation in the field and laboratory, and assess the results in relation to the project requirements. Part of these duties may be delegated to geotechnical specialists or suitably trained and experienced subordinates.

### **15.3 Supervision in the Field**

Ground investigation works should generally be carried out under the supervision of a suitably qualified and experienced engineer or geologist, assisted by trained and experienced technical personnel. The supervising engineer or geologist should have a university degree in civil engineering or geology, or an equivalent professional qualification, and at least four years post-qualification engineering experience, some of which should have been in ground investigations. Technical personnel should possess a certificate in civil engineering from a polytechnic and at least one year of specialized training and experience in ground investigations, including training in the proper logging and description of ground conditions.

The supervising engineer or geologist should be full time or part time on site, depending on such factors as the :

- (a) size of the investigation,
- (b) nature of the project,

- (c) complexity of the anticipated ground conditions,
- (d) complexity of the sampling and field testing schedule,
- (e) reliability of the contractor's personnel undertaking the ground investigation works.

Increasing size and complexity of the project, as well as increasing complexity of ground conditions and investigation techniques, or decreasing reliability of the contractor's personnel, should all lead to heavier time commitments for the supervising engineer or geologist. The supervisor will normally be required full-time on site whenever it is planned to carry out works which are critically dependent on a high standard of workmanship for their success or safety. Only when minor ground investigation works are undertaken for confirmatory purposes, and where the works involve simple investigation techniques, should full delegation of the supervision of the works to technical personnel be contemplated.

Technical personnel will normally be required full-time on site. Several technical staff may be required on site if a number of drilling rigs are operating simultaneously, if several field tests or instrument installations are being undertaken simultaneously, or if the works are widely scattered.

The supervising engineer or geologist should be aware of the type of information required from the investigation, and should always maintain close liaison with the engineer or engineering geologist directing the ground investigation (see Section 15.2), or with the project designer, to ensure that the project requirements are satisfied. In most cases, it is worthwhile for the project designer to spend some time on site during the ground investigation works in order to appreciate fully the actual ground conditions. Wherever possible, the supervising engineer or geologist should be independent of the contractor undertaking the ground investigation works. If this is not the case, the engineer or engineering geologist planning and directing the ground investigation should take steps to ensure that there is an adequate level of site supervision and that reliable information is obtained from the works.

#### **15.4 Logging and Description of Ground Conditions**

The supervising technical personnel (see Section 15.3) should be responsible for recording the information obtained from boreholes or other investigations as it arises. This information should include a measured record of the subsurface profile with rock and soil descriptions, and a record of the drilling and sampling techniques used. In complex ground conditions, or when the information is particularly important, the supervising engineer or geologist should record this information as it arises. In some cases, it may be necessary to obtain specialist advice on the logging and description of ground conditions (see Section 15.6).

Detailed descriptions of the ground conditions encountered and of all rock and soil samples obtained should be made in accordance with Geoguide 3 (GCO, 1988), or a suitable alternative system. All personnel undertaking logging and description of ground conditions should be thoroughly familiar with the system to be used and suitably experienced in its application.

## 15.5 Laboratory Testing

The testing of soil and rock samples should be carried out in a laboratory approved by the directing engineer or engineering geologist referred to in Section 15.2. The laboratory testing should be done under the control of a suitably qualified and experienced supervisor, and all laboratory technicians should be skilled and experienced in the type of test they are conducting. The laboratory testing schedule should be finalised only after selected samples have been examined by the person directing the investigation or by the supervising engineer or geologist. The latter should supervise the more complex tests.

## 15.6 Specialist Advice

Depending on the complexity of the ground conditions and the nature of the project, specialist advice on particular aspects of the ground investigation may be needed. For example, the advice of an experienced engineering geologist may be required on such aspects as :

- (a) full detailed geological descriptions of soils and rocks,
- (b) differentiating fill from insitu materials, or boulders/corestones from bedrock,
- (c) identifying and classifying colluvial deposits,
- (d) rock mass classifications,
- (e) geological and groundwater models of ground conditions at the site.

Similarly, the advice of an experienced instrumentation specialist will be invaluable for the planning, calibration, installation, commissioning and data interpretation of the more complex geotechnical instruments.

## 15.7 Interpretation

The interpretation of the ground investigation should be directed by the engineer or engineering geologist referred to in Section 15.2, incorporating any specialist advice obtained (see Section 15.6).

## 15.8 Operatives

The driller in charge of an individual drilling rig should be skilled and experienced in the practice of ground investigation by means of boreholes and simple sampling and testing techniques. Operators of other equipment used in ground investigations should have appropriate skills and experience. Any timbering, shoring or other support required in

excavations or caissons should be installed only by suitably skilled workmen. All operatives should be familiar with and observant of safety precautions (see Appendix E).



## 16. Review during Construction

### 16.1 General

*There is an inherent difficulty in forecasting ground conditions from ground investigations carried out before the works are started since, however intensive the investigation and whatever methods are used, only a small proportion of the ground is examined.*

### 16.2 Purpose

*The primary purpose of the review during construction is to determine to what extent, if any, in the light of the conditions newly revealed, conclusions drawn from the ground investigation are required to be revised.*

*In some cases, additional information is found which may necessitate amendment of the design or the construction procedures. In certain cases, it may therefore be appropriate to initiate a site procedure in the early stages of the contract, so that correct and agreed records are kept during the duration of the contract by both the engineer and the contractor. The purposes of these records are :*

- (a) to assist in checking the adequacy of the design,*
- (b) to assist in checking the safety of the works during construction and to assess the adequacy of temporary works,*
- (c) to check the findings of the ground investigation and to provide a feed-back so that these findings may be reassessed,*
- (d) to check initial assumptions about ground conditions, including groundwater, related to construction methods,*
- (e) to provide agreed information about ground conditions in the event of dispute,*
- (f) to assist in checking the suitability of proposed instrument installations,*
- (g) to assist in deciding the best use to be made of excavated materials,*
- (h) to assist in the reassessment of the initial choice of construction plant and equipment.*

### **16.3 Information Required**

#### **16.3.1 Soil and Rock**

*Accurate descriptions of all material encountered below ground level should be made in accordance with Geoguide 3 (GCO, 1988), or a suitable alternative system. The subsurface profile revealed on site should be recorded and compared with that anticipated from the ground investigation. The descriptions should be made by an engineer or geologist (see Section 15.4). It may be advantageous to arrange for the site to be inspected by the organization that carried out the site investigations, particularly if ground conditions appear to differ significantly from those described in the ground investigation.*

#### **16.3.2 Water**

*It is most important to record accurately all information about the groundwater obtained during construction, for comparison with information recorded during the investigation. The information should cover the flow and static conditions in all excavations, seepage from slopes, seasonal variations, tidal variations in excavations or tunnels near the sea or estuaries, suspect or known artesian conditions, the effect of weather conditions on groundwater, and any unforeseen seepage under or from water-retaining structures. The effect of groundwater lowering should also be recorded in observation holes to determine the extent of the cone of depression.*

Groundwater rises due to the damming effects of new construction or temporary works should likewise be recorded.

### **16.4 Instrumentation**

*On many types of structures, such as earth dams, embankments on soft ground, some large buildings with underground construction, excavations and tunnels, it is prudent to consider regular observations by means of instrumentation in order to check that construction works can proceed safely (Bureau of Reclamation, 1987; DiBiagio & Myrvoll, 1982). Such observations may include measurement of pore pressure, seepage, earth pressure, settlement and lateral movements (see also Sections 8.2, 28.3 and 31.2). The instrumentation may be usefully continued after construction in order to observe the performance of the project. This is particularly necessary in the case of earth dams for maintaining a safe structure under varying conditions, and in other cases for gaining valuable data for future design.*

For projects involving slopes, it is common practice in Hong Kong to monitor groundwater levels and pore pressures, and their response to rainfall. Methods of measuring pore water pressures are given in Chapter 20. In many situations, it will also be essential to monitor movements and the condition of nearby buildings and structures.

### **16.5 Tunnel Works**

[Amd GG2/01/2017]

In the construction stage, further site investigation should be undertaken to obtain

information to support the design review of the tunnels, caverns and shafts, in order to ensure that there is adequate safety margin and performance. [Amd GG2/01/2017]

For the exposed faces in tunnel works, the site investigation should include geological and engineering geological mapping, and an assessment of the tunnel sections/shafts using a soil/rock mass classification scheme on which the design may be based. A proforma for recording the rock mass mapping and classification data in rock tunnels is available from the Hong Kong Slope Safety Website under the downloading area at <http://hkss.cedd.gov.hk>. [Amd GG2/01/2017]

Depending on the tunnel excavation method and the risk assessment, probing ahead of the tunnel excavation may be carried out. The penetration rate, the quantity of water inflows, and the colour and nature of cuttings and flushing water returns should be recorded. This information should be used to assess the ground conditions ahead, in particular the soil/rock interfaces and sections with potentially high water inflow, and the need for implementation of robust mitigation measures before further tunnel excavation. In addition to probing, use of non-invasive techniques and coring during construction may be considered where cost effectiveness can be demonstrated. For TBM works, further ground investigation may be necessary prior to or during the TBM drive to confirm the locations of permeable soils and soil/rock interfaces and the variations in groundwater pressures for design. [Amd GG2/01/2017]

Sufficient time should be allowed in the construction programme for the results of additional ground investigation and site inspection and monitoring to be fed back into the design and risk management processes, in order that modifications to the design can be implemented or other contingency measures undertaken in a timely manner. [Amd GG2/01/2017]

Part IV

Ground Investigation Methods

## 17. Introduction to Ground Investigation Methods

There is a considerable variety of methods of ground investigation, and normally a combination of methods is employed to cover the technical requirements and the range of ground conditions that are encountered. The factors involved in the selection of methods are discussed in Chapters 7 to 16. Particular attention should be paid to the safety of existing features, structures and services in the course of ground investigation. Advice on planning and control is given in Section 7.2 (see also Appendix A). The selection of methods may be influenced by the character of the site (see Section 11.2), and particular ground conditions often dictate which specific investigation technique should be used (see Chapter 12). Attention should also be given to the safety of personnel (see Appendix E).

*In situ tests that are carried out in boreholes as part of a borehole investigation are described in Chapter 21. Other in situ tests, for which a borehole either is unnecessary or is only an incidental part of the test procedure, are described in Chapters 24 to 33. Laboratory tests on soil and rock are discussed in Chapters 34 to 38. The collection and recording of data is discussed in Chapters 39 and 40.*

## 18. Excavations and Boreholes

### 18.1 Shallow Trial Pits and Slope Surface Stripping

Shallow trial pits are usually dug by hand using a pick and shovel, and commonly extend to a depth of about 3 m. It is essential that the pit sides are guarded against sudden collapse in order to protect personnel working in the pit. For this purpose, timber shoring is usually provided when excavation is deeper than 1.2 m. The spacing of the shoring should be sufficiently wide to allow inspection of the pit sides. Shallow trial pits may also be dug by machine; a hydraulic back-hoe excavator is the most commonly used.

Shallow trial pits permit the insitu condition of the ground to be examined in detail both laterally and vertically, and allow mass properties to be assessed. They also provide access for taking good quality (block) samples and for carrying out insitu tests. Trial pits are particularly useful for investigating and sampling soils derived from insitu rock weathering and colluvium, both of which often exhibit a high degree of variability. Pits may also be used to investigate the dimensions and construction details of old retaining walls, and to ascertain the exact position of buried utilities and services.

The field record of a shallow trial pit should include a plan giving the location and orientation of the pit, and a dimensioned section showing the sides and floor. Ground conditions should be fully described in accordance with Geoguide 3 (GCO, 1988) or a suitable alternative system, and samples taken should be fully documented. Two examples of trial pit logs are given in Figures 7 and 8. Logs should always be supplemented with colour photographs of each face and of the base of the pit. The positions and results of any field testing should also be recorded, such as insitu density tests or Schmidt hammer, hand penetrometer and hand shear vane index tests.

Material excavated from trial pits should be stockpiled in such a manner that it does not fall back into the pit or cause instability of the pit excavation, e.g. by surcharging the adjacent ground. Wooden hoardings anchored by steel bars driven into the ground are often used on steep slopes to retain spoil from falling back into the pit. The spoil should be placed and covered so as not to be washed downhill during rainstorms or allowed to enter surface drainage systems.

It is advisable to backfill pits as soon as possible after logging, sampling and testing have been completed, since open pits can be a hazard. Recommendations on backfilling are given in Section 18.9. Pits that must be left open temporarily should be covered and sealed so that rain water cannot enter; they should also be securely fenced off if readily accessible by the public.

Trial pits can be extended readily into trenches or slope surface stripping. The latter is used extensively in Hong Kong to investigate both natural and man-made slopes, and generally consists of a 0.5 m wide strip, extending from the crest to the toe of the slope, in which the ground has been laid bare of vegetation, chunam plaster or other coverings. Bamboo scaffolding or access ladders are provided for inspection, logging and reinstatement.

An example of a log sheet for slope surface stripping is given in Figure 9. Colour

photographs of salient geological features revealed by the stripping should always be obtained. Fill is sometimes used to smooth the surface of a cut slope before application of the chunam plaster; if this is encountered in slope stripping the depth of excavation should be increased if possible to reveal the true nature of ground beneath.

## 18.2 Deep Trial Pits and Caissons

Deep trial pits, shafts and caissons are normally constructed by hand excavation using various methods for supporting the sides. Temporary or permanent liners are necessary for the protection of personnel working in these excavations, but it is also necessary to consider the need to expose the ground for inspection and logging; considerable judgement and experience is often required to establish suitable procedures for such excavations.

Hand-dug caissons 1 m in diameter and larger are commonly used in Hong Kong for foundation construction to depths of 30 m or more. Typically, cast-insitu concrete liners are used in soil, while the caisson is left unlined in rock. These caissons may be particularly useful for the investigation of rock at or near the founding level of large foundations (Irfan & Powell, 1985). An example of a caisson log is given in Figure 10. It is recommended that the guidance notes on the technical and safety aspects of hand-dug caissons issued by the Hong Kong Institution of Engineers (HKIE, 1981) should be followed.

*Working in deep shafts will be dangerous unless the appropriate safety precautions are strictly followed. Attention should be given to the possible occurrence of injurious or combustible gases or of oxygen deficiencies. Correct methods of inspection should be followed and appropriate precautions should be taken (see Section 7.2 and Appendix E). Oxygen-consuming engines that emit toxic exhaust fumes, such as petrol-driven pump motors, should not be employed in shafts.*

## 18.3 Headings or Adits

Headings are driven from the bottom of shafts or laterally into sloping ground, and can be used for the insitu examination of the ground or existing foundation structures, and for carrying out special sampling or insitu testing. Further considerations are given in BSI (2010).

[Amd GG2/01/2017]

## 18.4 Hand Auger Boring

*The hand auger boring method uses light hand-operated equipment. The auger and drill rods are usually lifted out of the borehole without the aid of a tripod, and no borehole casing is used. Boreholes up to 200 mm diameter may be made in suitable ground conditions to a depth of about 5 m. The method can be used in self-supporting ground without hard obstructions or gravel-sized to boulder-sized particles. Hand auger boreholes can be used for groundwater observations and to obtain disturbed samples and small open-tube samples.*

## 18.5 Light Cable Percussion Boring

Light cable percussion boring is an adaptation of common well-boring methods, employing a clay cutter for dry cohesive soils, a shell (or bailer) for granular soils, and a chisel for breaking up rock and other hard layers. The drill tools are worked on a wire rope using the clutch of the winch for percussive action. The shell can only be used when there is sufficient water in the borehole to cover the lower part of the shell.

Light cable percussion boring cannot be used for boring into or proving rock, and it is severely restricted in bouldery ground where the frequent use of a heavy chisel is required. The widespread occurrence in Hong Kong of bouldery colluvium and corestone-bearing soils derived from insitu rock weathering has therefore curtailed the use of light cable percussion boring, as has the widespread need to core into and prove rock. However, the method can be used to investigate the finer-grained marine sediments and alluvium found in the flat coastal areas.

## 18.6 Mechanical Augers

Mechanical augers, comprising a continuous-flight auger and a hollow stem, are suitable for augering soft cohesive soils and may be suitable for firm cohesive soils. They are of limited use in soils with boulders or corestones and are therefore seldom used in Hong Kong. Further considerations are given in BSI (2010). [Amd GG2/01/2017]

## 18.7 Rotary Open Hole Drilling and Rotary Core Drilling

### 18.7.1 General

Rotary drilling, in which the drill bit or casing shoe is rotated on the bottom of the borehole, is the most common method of subsurface exploration used in Hong Kong (Chan & Lau, 1986). The drilling fluid, which is pumped down to the bit through hollow drill rods, lubricates the bit and flushes the drill debris up the borehole. The drilling fluid is commonly water, but drilling mud or air foam are often used with advantage (see Section 18.7.2).

There are two basic types of rotary drilling: open hole (or full hole) drilling, in which the drill bit cuts all the material within the diameter of the borehole; and core drilling, in which an annular bit fixed to the outer rotating tube of a core-barrel cuts a core that is returned within the inner stationary tube of the core-barrel and brought to the surface for examination and testing. Drill casing is normally used to support unstable ground or to seal off open fissures which cause a loss of drilling fluid. Alternatively, drilling mud or cement grout can be used to seal open fissures.

In ground investigations, rotary core drilling has the important advantage over rotary open hole drilling of providing a core sample while the hole is being advanced, and it is recommended for most situations. In rotary open hole drilling, drill cuttings brought to the surface in the flushing medium can only provide an indication of the ground conditions being encountered. However, rotary open hole drilling is useful for rapid advancement of a borehole required for field testing or instrument installation, and samples may be obtained between drill



runs even when the open hole technique is used.

Water used as a flushing medium in rotary drilling may have a deleterious effect on both the stability of the surrounding ground and on the samples obtained, and its use must be carefully considered (see Section 18.7.2). A crude adaptation of the rotary open hole method, often termed rotary wash boring, may be particularly detrimental in this regard. This method involves advancing the hole by casing alone, with the inside of the casing cleaned out by surging and flushing. Water pressures sufficient to flush the casing are often high and may lead to increased pore pressures (or reduced pore suctions) in the surrounding ground. When drilling on a slope or behind an old masonry retaining wall, for example, this may be detrimental to stability and may actually trigger rapid collapse. Also, in soils containing gravel-sized fragments, it is impossible to flush out all the coarse fragments, irrespective of the water pressure employed, and they will accumulate in the base of the hole. These fragments will affect the representativeness of further sampling and testing done in the borehole. In soft or loose ground, the flushing water may not only carry the cuttings up through the casing, but also up around the outside of the casing, thus creating a large zone of disturbed material which can extend for some distance below the bottom of the hole. As a result, samples obtained from rotary wash boring may be disturbed, at least over a portion of their length. In marine investigations, the standard rotary open hole method should therefore be used in preference to rotary wash boring (see Section 14.7).

Rotary drilling rigs are available in a wide range of weights and power ratings in Hong Kong. Rigs are normally skid mounted, with a typical configuration as shown in Figure 11. They are commonly available with a power rating in the range of 10 to 50 horsepower and capable of stable drill string rotation up to 1 500 or 2 000 rpm. Drilling rigs should be mounted on a stable platform such that a force of 12 to 15 kN can be applied to the drill bit without movement of the rig. In choosing a rig, consideration must be given to the expected depth and diameter of the hole to be drilled, the possible casing requirements, and site access. Rigs should generally have a minimum ram stroke length of 600 mm, and be able to operate with a minimum of vibration. The sizes of commonly-used core-barrels, casings and drill rods are shown in Table 5.

Smaller scale rotary drilling rigs are also available and can sometimes be used to great advantage in special situations. Hand-portable rotary core drills may often be useful for coring through existing concrete or masonry retaining walls; horizontal boreholes often enable the wall thickness and backfill materials to be determined.

*Drilling is in part an art, and its success is dependent upon good practice and the skill of the operator; particularly when coring weathered, weak, partially cemented and fractured rocks, where considerable expertise is necessary to obtain full recovery of core of satisfactory quality. This is greatly influenced by the choice of core-barrel and cutting bit type (see Section 19.8) and by the method of extruding, handling and preservation of the core (see Section 19.10.5).*

### **18.7.2 Flushing Medium**

Careful selection of a flushing medium which is compatible with the equipment

employed and suitable for the ground to be drilled is very important. Water is the simplest flushing medium. Other fluids used as flushing media are drilling muds (which consist of water with clay or bentonite), water with an additive such as sodium chloride, air foams and polymer mixtures. The main advantage of these other flushing media is that drill cuttings may be removed at a lower flushing velocity and with less disturbance to the ground. The use of drilling mud can also minimise the need for casing of the hole, as it helps to stabilise the sides and bottom of the hole in caving soils. Another advantage of drilling mud is that it can reduce soil disturbance and hence improve sample quality. However, drilling mud is not recommended if permeability tests are to be carried out in the borehole, or if piezometers are to be installed. Further guidance on the use of drilling mud is given by Clayton et al (1982).

The use of air foam as a flushing medium has enabled increased core recovery and quality to be achieved in colluvium and soils derived from insitu rock weathering (Phillipson & Chipp, 1981; 1982). This technique involves the injection of foaming concentrate and water into the air stream produced by a low volume, high pressure air compressor, as shown diagrammatically in Figure 12. A polymer stabiliser is added when drilling below the water table. The foam is forced down the drill rods in the conventional manner, and a slow-moving column of foam with the consistency of aerosol shaving cream carries the suspended cuttings to the surface. Compared with water, the air foam has a greater ability to maintain the cuttings in suspension, and the low uphole velocity and low volume of water utilized serve to reduce disturbance of the core and surrounding ground. The air foam also resists percolation into open fissures, and it stabilises the borehole walls. The polymer stabiliser, however, has the disadvantage of coating the walls of the hole such that insitu permeability testing may not be representative.

When investigating potentially unstable slopes, or when drilling into failed slopes to obtain samples from the slip zone, the use of water as the flushing medium may not be advisable (see Section 18.7.1). Air foam flushing, or in some instances, air flushing should be considered to reduce the risk of slope movement in such cases.

### **18.7.3 Inclined Drilling**

Inclined boreholes can often be used to great advantage in ground investigations (McFeat-Smith, 1987; McFeat-Smith et al, 1986). While they are generally more costly than similar vertical holes, they often allow additional geological data to be obtained.

Inclined holes may be found to deviate in both dip and direction from the intended orientation (Craig & Gray, 1985). This is particularly common in the vertical plane due to the weight of the drill rods. Some of the factors which contribute to deviation are :

- (a) worn and undersized drill rods, rods much smaller than the borehole, and overly flexible rods,
- (b) drilling rig rotation and vibration, which tends to produce spiraling in the hole, and
- (c) difficult ground conditions, such as bouldery soils or soils

containing corestones.

In situations where deviation is detrimental, it can be minimised by the use of securely-anchored drilling rigs and platforms, a very stiff drill string and core-barrels at least 3 m long coupled to drill rods of the same diameter as the core-barrel or to rods fitted with centralizers. Directional control may also be achieved by careful adjustments to rotational speeds, thrust pressures, and the location of centralizers placed on the drill rods. In some difficult ground conditions, such as colluvium containing very hard boulders within a loose soil matrix, it may be very difficult to control the deviation of inclined holes.

Several instruments are available for measuring borehole orientation or deviation, such as the Eastman-Whipstock single-shot or multi-shot photographic survey tools, the Pajari mechanical single-shot surveying instrument and the ABEM Fotobor multi-shot photographic probe. The function of the Eastman and Pajari tools is to record the orientation of a gimbaled magnetic sphere, by photographic and mechanical means respectively. This precludes the use of these instruments within steel casings or attached to steel rods, or in areas where other magnetic disturbances may be anticipated. The ABEM Fotobor records cumulative deflection measurements photographically within the borehole and it can be used within steel casings. Multi-shot tools such as the ABEM Fotobor, or the multi-shot version of the Eastman-Whipstock tool, are useful for undertaking complete borehole surveys, but may be cumbersome for taking repeated deviation checks during drilling, in which case single-shot tools may be preferable.

## **18.8 Wash Boring and Other Methods**

### **18.8.1 Wash Boring**

Wash boring utilizes the percussive action of a chisel bit to break up material that is flushed to the surface by water pumped down the hollow drill rods. In ground which is liable to collapse, casing may be driven down to support the sides of the borehole, or drilling mud may be used. The fragments of soil brought to the surface by the wash water are not representative of the character and consistency of the materials being penetrated, and the flushing water may disturb the surrounding ground in the same manner as the rotary wash boring method discussed in Section 18.7. For these reasons, wash boring is seldom used in Hong Kong.

### **18.8.2 Other Methods of Boring**

*There are many other methods of boring, which have been developed generally to obtain maximum penetration speed, e.g. rotary percussive drilling for blast holes and grouting. When such boreholes are sunk for purposes other than ground investigation, limited information about ground conditions may be obtained, provided that the boreholes are drilled under controlled conditions, with measurement of rate of penetration, observation of drilling characteristics, and sampling of the drilling flushings (Horner & Sherrell, 1977).*

One such rotary percussive method is the Overburden Drilling Eccentric method, or ODEX (Plate 4A), which is based on the principle of under-reaming. During drilling in soil,

an eccentric reamer bit swings out and drills a hole larger than the outer diameter of the casing, which is inserted at the same time as the hole is being advanced. The percussive action may be provided by either a top hammer or a down-the-hole hammer. When the desired depth has been reached, the drill rods are rotated in a reverse direction to allow the reamer to be folded in and the bit to be retracted through the casing, which remains in the hole. Drilling may then be further extended into rock by replacing the ODEX bit with a normal rock drill bit. This method is not commonly used in ground investigations as no intact samples are obtained, but it has been used in Hong Kong to install long horizontal drains in colluvium (Craig & Gray, 1985) and for drilling through bouldery fill to prove the bedrock profile. It may also be a useful technique for the location of cavities in karst terrain (Horner & Sherrell, 1977).

### **18.9 Backfilling Excavations and Boreholes**

*Poorly-compacted backfill will cause settlement at the ground surface and can act as a path for groundwater. The latter effect can cause very serious inconvenience if the backfilled excavations or boreholes are on the site of future deep excavations, tunnels or water-retaining structures. It could also lead to the future pollution of an aquifer. For boreholes in dry ground, it is possible to use compacted soil as a backfill, although the procedure is often unsuccessful in preventing the flow of water. The best procedure is to refill the borehole with a cement-based grout introduced at the lowest point by means of a tremie pipe. Cement alone will not necessarily seal a borehole, on account of shrinkage, and it is often preferable to use a cement-bentonite grout, e.g. mix proportions about four to one, with no more water added than is necessary to permit the grout to flow or to be pumped. The addition of an expanding agent may be necessary. It is possible to compact the backfill of excavations by means of the excavator bucket or other mechanical means. In some cases, weak concrete may be used, e.g. to fill a small hole on a steeply sloping face.*

## 19. Sampling the Ground

### 19.1 General

The main purposes of sampling are to establish the subsurface geological profile in detail, and to supply both disturbed and undisturbed materials for laboratory testing. The selection of a sampling technique depends on the quality of the sample that is required and the character of the ground, particularly with regard to the extent to which disturbance occurs before, during or after sampling. The principal causes of soil disturbance are listed in Table 6 (Clayton et al, 1982) and are further discussed by Clayton (1984).

It should be borne in mind that the overall behaviour of the ground is often dictated by planes or zones of weakness which may be present (e.g. discontinuities). Therefore, it is possible to obtain a good sample of material that may not be representative of the mass. Because of this, and the frequent need to modify the sampling technique to suit the ground conditions, very close supervision of sampling is warranted (see Chapter 15). In choosing a sampling method, it should be made clear whether mass properties or intact material properties are to be determined (see Section 12.11). The distinction between mass and material properties is discussed further in Geoguide 3 (GCO, 1988).

*There are four main techniques for obtaining samples (Hvorslev, 1948) :*

- (a) taking disturbed samples from the drill tools or from excavating equipment in the course of boring or excavation (see Section 19.3),*
- (b) drive sampling, in which a tube or split tube sampler having a sharp cutting edge at its lower end is forced into the ground either by a static thrust or by dynamic impact (see Sections 19.4 to 19.7),*
- (c) rotary sampling, in which a tube with a cutter at its lower end is rotated into the ground, thereby producing a core sample (see Section 19.8),*
- (d) taking block samples specially cut by hand from a trial pit, shaft or heading (see Section 19.9).*

*Samples obtained by techniques (b), (c) and (d) will often be sufficiently intact to enable the ground structure within the sample to be examined. The quality of such samples can vary considerably, depending on the technique and the ground conditions, and most will exhibit some degree of disturbance. A method for classifying the quality of the sample is given in Section 19.2. Sections 19.3 to 19.9 describe the various sampling techniques and give an indication of the sample qualities that can be expected. Intact samples obtained by techniques (b), (c) and (d) are usually taken in a vertical direction, but specially orientated samples may be required to investigate particular features.*

The mass of sample required for various purposes is determined by the character of the

ground and the tests that are to be undertaken. Guidance on the mass of soil sample required for different laboratory tests is given in Table 7.

A summary of the typical sampling procedures for materials commonly encountered in Hong Kong is given in Table 8, which should be read in conjunction with Sections 19.3 to 19.9.

## **19.2 Sample Quality**

*The sampling procedure should be selected on the basis of the quality of the sample that is required, and is assessed largely by the suitability of the sample for appropriate laboratory tests. A classification for soil samples developed in Germany (Idel et al, 1969) provides a useful basis for classifying samples in terms of quality (Table 9).*

*In some cases, whatever sampling methods are used, it will only be possible to obtain samples with some degree of disturbance, i.e. class 2 at best. The results of any strength or compressibility tests carried out on such samples should be treated with caution. Samples of classes 3, 4 and 5 are commonly regarded as 'disturbed samples'.*

*A further consideration in the selection of procedures for taking class 1 samples is the size of the sample. This is determined largely by the geological structure of the ground, which, for soil, is often referred to as 'the fabric' (Rowe, 1972). Where the ground contains discontinuities of random orientation, the sample diameter, or width, should be as large as possible in relation to the spacing of discontinuities. Alternatively, where the ground contains strongly orientated discontinuities, e.g. in jointed rock, it may be necessary to take samples which have been specially orientated. For fine soils that are homogeneous and isotropic, samples as small as 35 mm in diameter may be used. However, for general use, samples 100 mm in diameter are preferred since the results of laboratory tests may then be more representative of the mass properties of the ground. In special cases, samples 150 mm and 250 mm in diameter are used (Rowe, 1972).*

*GEO (2017a) and BSI (1990) give precise details of the mass of soil sample required for each type of test. Where the approximate number of tests is known, it is a simple matter to estimate the total amount of soil that has to be obtained. If the programme of laboratory tests is uncertain, Table 7 gives some guidance on the amount of soil that should be obtained for each series of tests. Where materials for mineral aggregates, sands and filters are being considered, details of the size of sample required are given in CS3:2013 (2016).*

[Amd GG2/01/2017]

## **19.3 Disturbed Samples from Boring Tools or Excavating Equipment**

*The quality of the sample depends on the technique used for sinking the borehole or excavation and on whether the ground is dry or wet. When disturbed samples are taken from below water in a borehole or excavation, there is a danger that the samples obtained may not be truly representative of the ground. This is particularly the case with granular soils containing fines, which tend to be washed out of the tool. This can be partly overcome by placing the whole contents of the tool into a tank and allowing the fines to settle before*

*decanting the water.*

*The following classes of sample can generally be expected from the various methods of boring and sampling :*

- (a) Class 3. Disturbed samples from dry excavations and from dry boreholes sunk either by a clay cutter using cable percussion equipment or by an auger.*
- (b) Class 4. Disturbed samples obtained in cohesive soil from excavations, or from boreholes sunk either by a clay cutter using cable percussion equipment, or by an auger, in conditions where water is present.*
- (c) Class 5. Disturbed samples in granular soil from wet excavations or from any borehole sunk by a shell using cable percussion equipment or from any borehole sunk by a method in which the drill debris is flushed out of the borehole, e.g. rotary open hole drilling, wash boring.*

*Care should be taken to ensure that the sample is representative of the zone or layer from which it is removed, and has not been contaminated by other materials.*

## **19.4 Open-tube Samplers**

### **19.4.1 Principles of Design**

*(1) **General.** Open-tube samplers consist essentially of a tube that is open at one end and fitted at the other end with means for attachment to the drill rods. A non-return valve permits the escape of air or water as the sample enters the tube, and assists in retaining the sample when the tool is withdrawn from the ground. Figure 13 shows the basic details of a sampler suitable for general use having a single sample tube and simple cutting shoe. The use of sockets and core-catcher is discussed in Section 19.4.4. An alternative sampler incorporates a detachable inner liner.*

*The fundamental requirement of a sampling tool is that it should cause as little remoulding and disturbance as possible on being forced into the ground. The degree of disturbance is controlled by three features of the design : the cutting shoe, the inside wall friction and the non-return valve.*

*(2) **The cutting shoe.** The cutting shoe should normally be of a design similar to that shown in Figure 13 and it should embody the following features :*

- (a) Inside clearance. The internal diameter of the cutting shoe,  $D_c$ , should be slightly less than that of the sample tube,  $D_s$ , to give inside clearance, typically about 1% of the diameter. This allows for slight elastic expansion of the sample as it enters the tube, reduces frictional drag from the inside wall*

*of the tube and helps to retain the sample. A large inside clearance should be avoided since it would permit the sample to expand, thereby increasing the disturbance.*

- (b) Outside clearance. The outside diameter of the cutting shoe,  $D_w$ , should be slightly greater than the outside diameter of the tube,  $D_T$ , to give outside clearance and facilitate the withdrawal of the sampler from the ground. The outside clearance should not be much greater than the inside clearance.*
- (c) Area ratio. The area ratio represents the volume of soil displaced by the sampler in proportion to the volume of the sample (Figure 13). It should be kept as small as possible consistent with the strength requirements of the sample tube. The area ratio is about 30% for the general purpose 100 mm diameter sampler, and about 10% for a thin-walled sampler. Some special samplers have a large outside diameter  $D_T$ , relative to the internal diameter  $D_c$ , e.g. in order to accommodate a loose inner liner. The sampling disturbance is reduced by using a cutting shoe that has a long outside taper, and is considerably less than that which would be expected from the calculated area ratio.*

*(3) Wall friction. This can be reduced by a suitable inside clearance, and by a clean, smooth finish to the inside of the tube.*

*(4) Non-return valve. The non-return valve should have a large orifice to allow air and water to escape quickly and easily when driving the sampler, and to assist in retention of the sample when removing the sampler from the borehole.*

*Typical designs of open-tube samplers which are used for various purposes are described in Sections 19.4.3 to 19.4.5.*

### **19.4.2 Sampling Procedure**

*Before a sample is taken, the bottom of the borehole or surface of the excavation or heading should be cleared of loose or disturbed material as far as possible. Some or all of any such loose or disturbed material that is left will normally pass into the 'overdrive' space.*

*Below the water table, certain types of laminated soils occurring below the bottom of the borehole or excavation may be disturbed if the natural water pressure in the laminations exceeds the pressure imposed by the water within the borehole or excavation. To prevent this effect, it is necessary to keep the level of the borehole water above the groundwater level appropriate to the location of the sample.*

*The sampler can be driven into the ground by dynamic means, using a drop weight or*



*sliding hammer, or by a continuous static thrust, using a hydraulic jack or pulley block and tackle. There is little published evidence to indicate whether dynamic or static driving produces less sample disturbance, and for most ground conditions it is probable that there is no significant difference. The driving effort for each sample may be recorded as an indication of the consistency of the ground.*

*The distance that the tool is driven should be checked and recorded as, if driven too far, the soil will be compressed in the sampler. A sampling head with an 'overdrive' space (Figure 13 will allow the sample tube to be completely filled without risk of damaging the sample. After driving, the sampler is steadily withdrawn. The length of sample that is recovered should be recorded, compared with the distance that the tool was driven, and any discrepancy investigated. For example, if the length of the sample is less than the distance driven, the sample may have experienced some compression or, alternatively, the sample tool may have permitted the sample to slip out as the tool was being withdrawn.*

### **19.4.3 Thin-walled Samplers**

*Thin-walled samplers are used for soils that are particularly sensitive to sampling disturbance, and consist of a thin-walled steel tube whose lower end is shaped to form a cutting edge with a small inside clearance. The area ratio is about 10%. These samplers are suitable only for fine soils up to a firm consistency, and free from large particles. They generally give class 1 samples in all fine cohesive soils, including sensitive clays, provided that the soil has not been disturbed by sinking the borehole. Samples between 75 mm and 100 mm in diameter are normally obtained; samples up to 250 mm in diameter are often obtained for special purposes. It should be noted that disturbance at the base of a borehole in weak soil will occur below a certain depth because of stress relief. Piston samples penetrating well below the base of the borehole are therefore preferable (see Section 19.5). A typical thin-walled sampler is illustrated in Figure 14.*

### **19.4.4 General Purpose 100 mm Diameter Open-tube Sampler**

The 100 mm diameter open-tube sampler, often termed the U100 sampler (Plate 4B), is a fairly robust sampler that can be used for many Hong Kong soils, but the driving action during sampling is likely to introduce some disturbance. The highest sample quality that can be obtained is class 2 at best (Whyte, 1984).

*The details of the sampler is illustrated in Figure 13 and consists of a sample barrel, about 450 mm in length, with a screw-on cutting shoe and drive head. The area ratio is about 30%. Sample barrels can be coupled together with screw sockets to form a longer sampler. Two standard barrels, forming a sampler about 1.0 m in length, are often used for sampling soft clays (Serota & Jennings, 1958), although the increased length of the sample tube may lead to some disturbance. In soils of low cohesion, such as silt and silty fine sand, the sample may fall out when the tool is withdrawn from the ground. Sample recovery can be improved by inserting a core-catcher between the cutting edge and the sample barrel. When using a core-catcher, the sample quality is unlikely to be better than class 3.*

*Smaller samplers of about 50 mm or 75 mm diameter can be used if use of the 100 mm sampler is precluded by the borehole size. The smaller samplers are of similar design, except that the cutting edge may not be detachable.*

#### **19.4.5 Split Barrel Standard Penetration Test Sampler**

*The split barrel sampler is used in the standard penetration test and is described in BSI (2011b). It takes samples 35 mm in diameter and has an area ratio of about 100%. It is used to recover small samples, particularly under conditions which prevent the use of the general purpose 100 mm sampler, and gives class 3 or class 4 samples (see Section 21.2 and Figure 25).*

[Amd GG2/01/2017]

#### **19.5 Thin-walled Stationary Piston Sampler**

*The thin-walled stationary piston sampler (Plate 4C) consists of a thin-walled sample tube containing a close-fitting sliding piston, which is slightly coned at its lower face. The sample tube is fitted to the drive head, which is connected to hollow drill rods. The piston is fixed to separate rods which pass through a sliding joint in the drive head and up inside the hollow rods. Clamping devices, operated at ground surface, enable the piston and sample tube to be locked together or the piston to be held stationary while the sample tube is driven down. Figure 15 shows the basic details of a stationary piston sampler. The sample diameter is normally 75 mm or 100 mm, but samplers up to 250 mm diameter are used for special soil conditions.*

*Initially, the piston is locked to the lower end of the sample tube to prevent water or slurry from entering the sampler. In soft clay, with the piston in this position, the sampler can be pushed below the bottom of the borehole. When the sample depth is reached, the piston is held stationary and the sample tube is driven down by a static thrust until the drive head encounters the upper face of the piston. An automatic clamp in the drive head prevents the piston from dropping down and extruding the sample while the sampler is withdrawn.*

*The sampler is normally used in low strength fine soils and gives class 1 samples in silt and clay, including sensitive clay. Its ability to take samples below the disturbed zone and to hold them during recovery gives an advantage over the thin-walled sampler described in Section 19.4.3. Although normally used in soft clays, special piston samplers have been designed for use in stiff clays (Rowe, 1972).*

### **19.6 Continuous Soil Sampling**

#### **19.6.1 General**

*Continuous soil sampling can produce samples up to 30 m in length in soils such as recent fine alluvial deposits. This is of particular value for identifying the soil 'fabric' (Rowe, 1972) and gives results superior to those which can be obtained by consecutive drive sampling. The Swedish system (Kjellman et al, 1950) takes samples 68 mm in diameter using steel foils to eliminate inside friction between the sample and the tube wall. The Delft system, which uses*

lighter equipment and offers two sizes of sample, is described more fully in Section 19.6.2.

### **19.6.2 The Delft Continuous Sampler**

*The Delft continuous sampler, developed by the Laboratorium voor Grondmechanica of Delft, Holland, is available in two sizes to take continuous samples 29 mm and 66 mm in diameter (Delft Soil Mechanics Laboratory, 1977). The 66 mm sampler is pushed into the ground with a conventional Dutch deep sounding machine having a thrust of 200 kN. The sampler is advanced by pushing on the steel outer tubes, and the sample is fed automatically into a nylon stockinette sleeve which has been treated to make it impervious. The sample within the sleeve is fed into a thin-walled plastic inner tube filled to the appropriate level with a bentonite-barytes supporting fluid of similar density to the surrounding ground. The upper end of the nylon sleeve is fixed to the top cap of the sample, which is connected through a tension cable to a fixed point at the ground surface. Extension tubes 1 m in length are added as the sampler is pushed into the ground. The sampler normally has a maximum penetration of 18 m, but in suitable ground, with a modified magazine and increased thrust, samples up to 30 m in length can be obtained. The 29 mm sampler is of similar design and requires less thrust to effect penetration. Class 2 to class 3 samples can be obtained with these samplers.*

*The samples are cut into 1 m lengths and placed in purpose-made cases, samples taken with a 66 mm sampler being retained in the plastic tubes. The 66 mm samples are suitable for a range of laboratory tests. The 29 mm samples are used for visual examination and the determination of bulk density and index properties. After specimens have been removed for testing, the samples are split and are then described and photographed in a semi-dried state when the soil fabric can be more readily identified. For 29 mm samples, only one half of the split material is used for testing, thus preserving a continuous record of the ground.*

### **19.7 Sand Samplers**

*The recovery of tube samples of sand from below the water table presents special problems because the sample tends to fall out of the sample tube. A compressed air sampler (Bishop, 1948) enables the sample to be removed from the ground into an air chamber and then lifted to the surface without contact with the water in the borehole. The sampler is generally constructed to take samples 60 mm in diameter. If the sampler is driven by dynamic means, the change in volume of the sand caused by the driving gives a sample quality not better than class 3. However, if static thrust is used, generally class 2 and sometimes class 1 samples can be recovered. An alternative design (Serota & Jennings, 1958) introduces a bubble of air at the base of the sampler before it is withdrawn from the ground.*

### **19.8 Rotary Core Samples**

*Samples are obtained by the rotary core drilling procedures described in Section 18.7. The quality of sample may vary considerably depending on the character of the ground and the type of coring equipment used.*

Core-barrel sizes commonly used in Hong Kong are given in Table 5, together with the core sizes produced. Single-tube core-barrels are seldom used, as the core-barrel rotates directly against the core and core recovery is usually unsatisfactory. Double-tube and triple-tube barrels are used, with applicability and limitations as follows :

- (a) Double-tube core-barrels, with an inner tube mounted on bearings which does not rotate against the core, can normally be used in fresh to moderately decomposed rocks. However, these barrels do not protect the core from the drilling fluid unless the equipment is modified. In addition, the core is often removed by hanging the barrel in a near vertical position and tapping on the sides of the barrel. In highly fractured rocks this can result in a jumble of rock fragments in the core box and may make logging and measurement of fracture state indices difficult. The use of a core extruder is recommended in such situations. An example of a double-tube core-barrel is shown in Figure 16 (see also Plate 4D).
- (b) Triple-tube core-barrels, containing detachable liners within the inner barrel that protect the core from drilling fluid and damage during extrusion, are suitable for use in fresh to moderately decomposed rock and some of the stronger highly decomposed materials. They are particularly useful in coring highly fractured and jointed rock as the split liners facilitate the retention of core with the joint system relatively undisturbed. An example of a non-retractable triple-tube core-barrel (with split liners) is shown in Figure 17 (see also Plate 4E).

When coring soils derived from insitu rock weathering, triple-tube core-barrels fitted with a retractable shoe are normally used (Table 5). The cutting shoe and connected inner barrel projects ahead of the bit when drilling in soft material and retracts when the drilling pressure increases in harder materials. This greatly reduces the possibility of drilling fluid coming into contact with the core at or just above the point of cutting. These cutting shoes can be added to the same triple-tube core-barrel used for coring fresh to moderately decomposed rock. Alternatively, and far more commonly in Hong Kong, a Mazier core-barrel (Figure 18 and Plate 4F) is used. However, it should be noted that the Mazier has a tungsten carbide tipped cutting shoe and is therefore not suitable for coring fresh to moderately decomposed rock. When rock or corestones are encountered, a core-barrel with a diamond-impregnated drill bit has to be used to advance the hole (e.g. the double-tube Craelius T2-101 barrel as shown in Figure 16). The Mazier core-barrel has an inner plastic liner which protects the

sample during transportation to the laboratory. The 74 mm diameter core obtained with the Mazier is compatible with the commonly-used laboratory triaxial testing apparatus.

High quality (class 1) core samples of soils derived from insitu rock weathering and colluvium can be obtained using the large diameter triple-tube core-barrels in conjunction with air foam as the flushing medium (see Section 18.7.2). Samples of class 1 to class 2 can also be obtained using the Mazier sampler in conjunction with air foam or water as the flushing medium.

Another type of triple-tube barrel is the wireline core-barrel. This non-retractable barrel incorporates a line mechanism for withdrawing the inner barrel up through the drill rods without withdrawing the outer barrel or rods from the hole. This core-barrel may be used in fresh to moderately decomposed rock, and in very deep vertical or inclined holes to achieve more rapid drilling progress.

Further discussions of core-barrels, drilling techniques and their suitability to materials found in Hong Kong can be found in Brand & Phillipson (1984), Brenner & Phillipson (1979) and Forth & Platt-Higgins (1981).

## **19.9 Block Samples**

Block samples are cut by hand from material exposed in trial pits and excavations. They are normally taken in fill, soils derived from insitu rock weathering and colluvium in order to obtain samples with the least possible disturbance. The procedure is also used to obtain specially orientated samples, e.g. to measure the shear strength on specific discontinuities. The location and orientation of a block sample should always be recorded before the sample is separated from the ground. Block samples should be taken and handled as described in Section 19.10.6. More detailed recommendations for block sampling are given in USBR (1974).

### ***19.10 Handling and Labelling of Samples***

#### ***19.10.1 General***

*Samples may have cost a considerable sum of money to obtain and should be treated with great care. The usefulness of the results of the laboratory tests depends on the quality of the samples at the time they are tested. It is therefore important to establish a satisfactory procedure for handling and labelling the samples, and also for their storage and transport so that they do not deteriorate, and can readily be identified and drawn from the sample store when required.*

*The samples should be protected from excessive heat and temperature variation, which may lead to deterioration in the sealing of the sample containers and subsequent damage to the samples. The temperature of the sample store will be influenced by the climate, but it is recommended that the samples should be stored at the lowest temperature practicable within the range 2°C to 45°C. The daily temperature variation within the store should not exceed 20°C.*

### 19.10.2 Labelling

*All samples should be labelled immediately after being taken from a borehole or excavation. If they are to be preserved at their natural moisture content, they will at the same time have to be sealed in an airtight container or coated in wax. The label should show all necessary information about the sample, and an additional copy should be kept separately from the sample; this latter is normally recorded on the daily field report. The label should be marked with indelible ink and be sufficiently robust to withstand the effect of its environment and of the transport of the sample. The sample itself should carry more than one label or other means of identification so that the sample can still be identified if one label is damaged.*

The sample label should give the following information, where relevant :

- (a) name of contract,
- (b) name or reference numbers of the site,
- (c) reference number, location and angle of hole,
- (d) reference number of sample,
- (e) date of sampling,
- (f) brief description of the sample,
- (g) depth of top and bottom of the sample below ground level,  
and
- (h) location and orientation of the sample where appropriate (e.g.  
a sample from a trial pit).

### 19.10.3 Disturbed Samples of Soil and Hand Specimens of Rock

*Where samples are required for testing, or where it is desirable to keep them in good condition over long periods, they should be treated as described below.*

*Immediately after being taken from a borehole or excavation, the sample should be placed in a non-corrodible and durable container of at least 0.5 kg capacity, which the sample should fill with the minimum of air space. The container should have an airtight cover or seal so that the natural moisture content of the sample can be maintained until tested in the laboratory. For rock samples, an alternative procedure is to coat the sample in a layer of paraffin wax. A microcrystalline wax is preferred because it is less likely to shrink or crack. Large disturbed samples that are required for certain laboratory tests may be packed in robust containers or plastic sacks.*

*The sample containers should be numbered, and the tear-off slip or a label, as described in Section 19.10.2, should be placed in the container immediately under the cover. An*

*identical label should also be securely fixed to the outside of the container under a waterproof seal (wax or plastics). The containers should be carefully crated to prevent damage during transit. During the intervals while the samples are on site or in transit to the sample store, they should be protected from excessive heat.*

*For hand samples of rock, the reference number should be recorded by painting directly on the surface of the sample or by attaching a label. Samples should then be wrapped in several thickness of paper and packed in a wooden box. It is advisable to include in the wrapping a label of the type described in Section 19.10.2.*

#### **19.10.4 Samples Taken with a Tube Sampler**

*The following recommendations are applicable to all samples taken with tube samplers, except those taken with thick-walled samplers (see Section 19.4.5). The precautions for handling and protection of samples are to be regarded as a minimum requirement for samples taken by the usual methods. In special cases, it may be necessary to take more elaborate precautions. For samples that are retained in a tube or liner, procedure (a) should be followed; for other samples, procedure (b) should be followed.*

- (a) *Immediately after the sample has been taken from the borehole or excavation, the ends of the sample should be removed to a depth of about 25 mm and any obviously disturbed soil in the top of the sampler should also be removed. Several layers of molten wax, preferably microcrystalline wax, should then be applied to each end to give a plug about 25 mm in thickness. The molten wax should be as cool as possible. It is essential that the sides of the tube be clean and free from adhering soil. If the sample is very porous, a layer of waxed paper or aluminum foil should be placed over the end of the sample before applying the wax.*

*Any remaining space between the end of the tube or liner and the wax should be tightly packed with a material that is less compressible than the sample and not capable of extracting water from it, and a close-fitting lid or screw-cap should then be placed on each end of the tube or liner. The lids should, if necessary, be held in position with adhesive tape.*

- (b) *Samples that are not retained in a tube should be wholly covered with several layers of molten paraffin wax, preferably microcrystalline wax, immediately after being removed from the sampling tool, and then should be tightly packed with suitable material into a metal or plastic container. The lid of the container should be held in position with adhesive tape. If the sample is very porous, it may be necessary to cover it with waxed paper or aluminium*

*foil before applying the molten wax.*

*A label bearing the number of the sample should be placed inside the container just under the lid. The label should be placed at the top of the sample. In addition, the number of the sample should be painted on the outside of the container; and the top or bottom of the sample should be indicated. The liners or containers should be packed in a way that will minimize damage by vibration and shock during transit.*

For soft marine soil samples, the tube or liner should be held vertically, keeping the sample in the same direction as it left the ground, and extreme care should be taken during all stages of handling and transportation.

### **19.10.5 Rotary Core Extrusion and Preservation**

*After recovery of the core-barrel to the surface, every effort should be made in subsequent handling to ensure that, as far as possible, the quality of the core is maintained in its natural state until it is finally stored.*

*Except in relatively strong and massive rocks, core is almost inevitably disturbed if it is removed from the barrel held in a vertical position and then placed into the core box. The barrel should be held in a horizontal position, and the core extruded into a tray in such a manner that it is continuously supported. Rain-water guttering or other conveniently available rigid split tube can be used for this purpose. When it is required to preserve the core such that it does not dry out, a convenient method is to extrude it from the core-barrel into sleeving formed of thin-gauge polyethylene, again supporting the core with rigid split tube. Where selected lengths of core are to be preserved at their natural moisture content for laboratory testing, any drilling mud contamination and softened material should first be removed; the sample should then be wrapped in foil, coated with successive layers of waxed cheese cloth and labelled as described in Section 19.10.2.*

*In the extrusion process, the core should preferably be extruded in the same direction as it entered the barrel. Extruders should be of the piston type, preferably mechanically activated, since water-pressure type extruders can lead to water contact with the core, and to damage by impulsive stressing of the core. It should be noted that in weak, weathered or fractured rocks, extrusion can lead to core disturbance, however carefully it is done. The use of a low-friction transparent plastic liner in the inner tube of a modified conventional double-tube swivel core-barrel overcomes the majority of the problems encountered in core extrusion, and facilitates preservation of the core in the condition in which it is recovered. The general practice is to tape the outside of the sleeved core every 200 mm, and lengthwise along the overlap in the plastic sheet, and then, with the aid of plastic guttering for extra support, the core can be boxed without too much disturbance to the fabric. However, the presence of abrasive and fractured rocks may preclude the use of such liners.*

*The difficulties of extrusion and preservation can be overcome by the use of triple-tube core-barrels with low-friction liners (see Section 19.8). Split liner tubes are an ideal method of examining the recovered core without further damage after the drilling process. On the other hand, seamless metal liners and plastic liners are particularly useful where core is to be*



*removed from site for logging or where confined, undisturbed samples are required for sample preservation and subsequent laboratory testing.*

*It is usual to preserve all core obtained from the borehole for the period of the main works contract to which the core drilling relates. This is conveniently achieved with wooden or plastic core boxes, usually between 1 m and 1.5 m in length and divided longitudinally to hold a number of rows of core. The box should be of such depth and the compartments of such width that there is minimal movement of the cores when the box is closed (Geological Society, 1970). The box should be fitted with a hinged lid and strong fastener, and should be designed so as not to be too heavy for two persons to lift when the box is full of core.*

*In removing the core from the barrel and placing it in the box, great care should be taken to ensure that the core is not turned end for end, but lies in its correct natural sequence. Depths below ground surface should be indicated by an indelible marker on small spacers of core diameter size that are inserted in the core box between cores from successive runs. Where there is failure to recover core, or where specimens of recovered core are removed from the box for other purposes, this should be indicated by spacing-blocks of appropriate length. Both the lid and the box should be marked to show the site location, borehole number and range of depth of the core within the box, in addition to the number of the box in relation to the total sequence of boxes for that borehole. Core box marking should be done so as to facilitate subsequent photography which, if required, should be carried out as soon as is practicable after recovery of the core, and before description, sampling and testing.*

#### **19.10.6 Block Samples**

Sample cutting should be carried out as quickly as possible to prevent excessive moisture loss, and the sample should be protected from rain and direct sunlight. The sample should be trimmed to size in plan while still connected at its base (Plate 5A). The sides should be protected with aluminium foil or grease-proof paper, and then coated with a succession of layers of microcrystalline wax, reinforced with layers of porous fabric (e.g. muslin), if required. A close-fitting box with the top and bottom lids removed should then be slid down over the sample (Plate 5B). The top of the sample should be trimmed flat, marked with location and orientation, coated as described above, and the top lid attached to the box, ensuring a close fit. The sample may then be cut along its base, and turned over slowly and carefully for trimming and coating of the bottom prior to attachment of the bottom lid. A strong, rigid, close-fitting box is required to minimize sample disturbance during transport and to prevent discontinuities from opening.

## 20. Groundwater

### 20.1 General

*The determination of groundwater pressures is of the utmost importance since they have a profound influence on the behaviour of the ground during and after the construction of engineering works. There is always the possibility that various zones, particularly those separated by relatively impermeable layers, will have different groundwater pressures, some of which may be artesian. The location of highly permeable zones in the ground and the measurement of water pressure in each is particularly important where deep excavation or tunnelling is required, since special measures may be necessary to deal with the groundwater. For accurate measurement of groundwater pressures, it is generally necessary to install piezometers. The groundwater pressure may vary with time owing to rainfall, tidal, or other causes, and it may be necessary to take measurements over an extended period of time in order that such variations may be investigated. When designing drainage works, it is normally desirable to determine the contours of the water table or piezometric surface to ascertain the direction of the natural drainage, the seasonal variation and the influence of other hydrological factors.*

The monitoring of groundwater levels and pore pressures, and their response to rainfall, is carried out routinely in Hong Kong, as this information is vital to the design and construction of slopes, excavations in hillsides, and site formation works. The choice of piezometer type depends on the predicted water pressures, access for reading, service life and response time required. Open-hydraulic (Casagrande) piezometers are often used in soils derived from insitu rock weathering and colluvium, which are generally relatively permeable. Other piezometer types may be used for specific projects; the available types are described in Sections 20.2.3 to 20.2.6, and their advantages and disadvantages are summarized in Table 10.

Slope failures in Hong Kong are normally triggered by rainstorms. The response of the groundwater regime to rainfall varies widely from site to site, ranging from virtually no response to a large immediate response. The measurement of transient response is therefore very important (see Section 20.2.8). In order to provide design data, groundwater monitoring should extend over at least one wet season; this wet season should ideally contain a storm that has a return period of greater than ten years. For site formation works which involve substantial modifications to the hydrogeological characteristics of the site, the period of monitoring may need to be extended to beyond the end of the site formation works. Ground conditions in Hong Kong may produce perched or multiple water tables which must also be considered when installing and monitoring piezometers (Anderson et al, 1983).

It may also be necessary to measure negative pore water pressures, or soil suction (see Section 20.2.9). In many cases, existing groundwater data in the vicinity of the site will be available in the Geotechnical Information Unit (see Section 4.2), and may be useful in planning an appropriate groundwater monitoring scheme.

An additional consideration in urban areas is the contribution of leakage from water-bearing services to the overall groundwater regime. This contribution can be significant at some sites. Hydrochemical analysis of groundwater may aid the identification of the leak, e.g. the presence of fluoride attributable to leakage from fresh water mains. Advice on chemical

analysis of groundwater and related interpretation techniques such as trilinear plotting of cation and anion contents are given in ICE (1976).

*Borehole permeability tests are described in Section 21.4, packer, or Lugeon, tests are described in Section 21.5 and large-scale pumping tests are described in Chapter 25.*

## **20.2 Methods of Determining Groundwater Pressures**

### **20.2.1 Response Time**

*All the methods described in Section 20.2 require some flow of water into or out of the measuring device before the recorded pressure can reach equilibrium with the actual groundwater pressure. For an excavation or a borehole, a large volume of water may flow before the water level reaches equilibrium with the groundwater pressure. On the other hand, some types of piezometer require only a very small change in volume of water in order that the groundwater pressure may be read. The rate at which water flows through the soil depends on the permeability. The time required for a measuring device to indicate the true groundwater pressure is known as the response time and depends on the quantity of water required to operate the device ('volume factor'), the 'shape factor' of the piezometer (Brand & Premchitt, 1980), the permeability of the porous element, and the permeability of the ground. The selection of a suitable method for measuring the groundwater pressure will largely be determined by the response time (Penman, 1986).*

### **20.2.2 Observations in Boreholes and Excavations**

The crudest method of determining the groundwater level is by observation in an open borehole or excavation. This method may involve a long response time unless the ground is very permeable, and observations should be made at regular time intervals until it is established that the water level has reached equilibrium. The readings will be misleading if rain or surface water is allowed to enter the open hole. Readings taken in a borehole shortly after completion of drilling should be treated with caution, as it is unlikely that equilibrium will have been re-established.

The reliability of water level observations in boreholes or excavations can be somewhat improved by the installation of a standpipe, as shown in Figure 19. A standpipe (not to be confused with the standpipe piezometer described in Section 20.2.3) consists of an open-ended tube of hard plastic of approximately 19 mm internal diameter which has been perforated either over its entire length or just the lowest 1 to 2 m. The perforated section, with openings over at least 5% of its surface area, should be wrapped in a suitable filter fabric. The space between the tube and the wall of the borehole or excavation is normally backfilled with medium to coarse sand and fine gravel to act as a filter. The top 0.5 m around the standpipe should be sealed to prevent the ingress of surface water. While readings taken in a standpipe are more controlled than in an open borehole, standpipe response time is still slow, and if zones of different permeabilities have been penetrated, flow between zones may occur. Standpipe readings may therefore not be representative of actual groundwater levels. These drawbacks can largely be overcome by the installation of open-hydraulic or other piezometers.

### 20.2.3 Standpipe Piezometers

The standpipe piezometer, perhaps better termed the open-hydraulic piezometer, consists of a tube with a porous filter element on the end that can be sealed into the ground at the appropriate level (Figure 19). Two types of filter elements, viz the high air entry filter and the low air entry filter, are generally used. Depending on the size and uniformity of the pores, the filter can sustain a pressure difference between air and water on its surface due to the effect of surface tension. The maximum pressure difference that can be sustained is known as the air entry value of the filter. The smaller the size of the pores, the higher will be the filter's air entry value, but the lower will be the filter's permeability, and this can give rise to a long response time. A high air entry filter can be used to measure matric soil suction, as air can be kept out of the measuring fluid system, which is then allowed to come into equilibrium with the surrounding negative pore water pressure (see Section 20.2.9). The filter cannot, however, prevent the entry of air by diffusion, hence the need to flush air bubbles out of the measuring system from time to time. A low air entry filter has large pores and therefore does not impede the passage of air. Low air entry filters are therefore not suitable for measuring pore water pressures in unsaturated ground.

The Casagrande-type device is the most frequently installed standpipe piezometer (Plate 6A). It has a cylindrical (low air entry) porous element protected by a perforated rigid sheath about 35 mm in diameter and 300 mm long. This element is connected to a 19 mm or 25 mm internal diameter pipe. The response time of this type of piezometer is comparatively slow, but it generally does not become a significant factor until the soil permeability is less than about  $10^{-7}$  m/sec (Hvorslev, 1951). At this permeability, the response time should not be more than a few hours when the piezometer is installed within a 150 mm diameter by 400 mm long sand pocket.

Open-hydraulic piezometers are normally installed in boreholes. Access to the top of the piezometer is generally required in order to measure the water level with a diameter (see Section 20.2.8) or similar device, although the water level can be read remotely using an air-bubbling system (see Section 20.2.8). The piezometer top should be well protected, but it must remain vented to the atmosphere.

If the pore pressure temporarily drops below atmospheric, the open-hydraulic piezometer will cease functioning, but being self de-airing, it will resume satisfactory operation without maintenance. The piezometer tube should generally not be smaller than 12 mm internal diameter or the self de-airing function may be impaired (Vaughan, 1974).

The main advantages of an open-hydraulic piezometer are its simplicity and reliability. Also, water can be pumped down the pipe to flush out blockages. Moreover, it can be used to determine the permeability of the ground in which the tip is embedded (see Section 21.4). Its main disadvantage is slow response time in soils of low permeability.

### 20.2.4 Hydraulic Piezometers

In hydraulic piezometers, also termed closed-hydraulic piezometers, the groundwater pressure is detected in a small piezometer tip with porous walls and conducted through small

diameter plastic tubes to a remote point, where the pressure is measured, usually with a mercury manometer, Bourdon gauge or pressure transducer. Air in the tubes will cause erroneous readings, and because of this the tubes must be kept full of water and routinely de-aired.

Various types of hydraulic piezometers are available, the most common being the twin-tube types shown in Figure 20. In these piezometers, the tip is connected to the measuring point by two tubes, so that water can be circulated to flush out any air bubbles. This should be done in such a way that the pressure in the tip is left approximately at working pressure.

In order to avoid cavitation, the measuring point and connecting tubes should not be more than 7 m above the piezometric level being measured (Penman, 1978). Hydraulic piezometers are not self de-airing and regular maintenance is required for satisfactory performance. The hydraulic leads facilitate remote reading, and the measuring point can be separated laterally from the piezometer tip by fairly long distances.

*A closed-hydraulic piezometer has a small response time and can be used for measuring rapid changes in pore water pressure due to rainfall infiltration, pressure changes due to tidal variation or to changes of stress induced by superimposed loads or excavations. It can also be used for insitu measurements of permeability. In zones of high permeability, care should be taken to see that the limiting permeability of the porous tip is considered.*

#### **20.2.5 Electrical Piezometers**

*Electrical piezometers have a pressure transducer located close to the porous element. Very rapid response times can be achieved provided the tip is de-aired. Where long term stability is required, or the signal is to be transmitted over a long distance, the transducer is usually of the vibrating wire type. The main disadvantage of the electrical piezometer is that it requires calibration, which cannot be checked easily after installation. It should be noted that some transducers have temperature-sensitive elements, so that check calibrations should be carried out at groundwater temperature. Moreover, it is not always easy to check that the instrument is behaving reliably. De-airing is not possible after installation, and misleading results can be obtained, particularly in unsaturated soils or soils containing gas, e.g. methane in organic soils. The electrical piezometer cannot be used for insitu permeability measurements (Penman, 1960).*

Electrical piezometers have not been widely used in Hong Kong.

#### **20.2.6 Pneumatic Piezometers**

*Pneumatic systems comprise two air-filled tubes connecting the measuring point to a valve located close to the porous element. When the air pressure in the input line equals the water pressure in the porous element, the valve operates, thereby holding constant the pressure either in the return line or in the supply line. The operation of the valve requires a small volume change in the porous element, and in impermeable clays this can lead to difficulties. Also, dirt entering the lines can prevent valve operation. The pneumatic piezometer is cheap and easy to install and has a rapid response. It cannot be used for insitu permeability*

*measurements (Marland, 1973). Pneumatic piezometers have the same limitations as electrical piezometers in that they cannot be checked and the porous tips cannot be de-aired after installation.*

The use of pneumatic piezometers in Hong Kong is described by Handfelt et al (1987).

### **20.2.7 Installation of Piezometers**

*The success of pore water pressure measurement depends upon the care taken during installation and sealing of the piezometer or standpipe. The porous element should be fully saturated and filled with de-aired water before installation.*

*In soft ground, the porous element can often be pushed or driven into position. It is, however, necessary to avoid clogging the porous element if it is pushed through soft clays. This can be achieved by using a drive-piezometer which has a removable sleeve that covers the element during driving (Parry, 1971). In clay, a pushed or driven piezometer shears and remoulds the clay, destroys the fabric in the clay adjacent to the porous element, and can lead to erroneous measurements of insitu permeability. It should also be noted that the action of pushing or driving may set up high excess pore-pressures, which in soils of low permeability may take a long time to dissipate. In harder ground, the instrument is installed in a borehole with the porous element surrounded by well-graded sand. Above the sand, the borehole should be sealed off, preferably with grout.*

The typical method of installation of a piezometer in a borehole is illustrated in Figure 21. The tip should be placed within a sand pocket in the specific zone for which pore pressures are to be measured, referred to as the response zone. The length of the response zone should be at least four hole diameters, preferably not less than 400 mm. Washed sand with particle sizes in the range 0.2 mm to 1.2 mm is recommended for the response zone in most soils derived from insitu rock weathering. For coarse transported soils (e.g. alluvial and marine sands and gravels), filters should be specifically designed to match the surrounding material (GCO, 1984).

Bentonite should be used to provide a seal above the sand pocket, and if the piezometer has not been installed near the base of the borehole, a bentonite seal should also be placed beneath the sand pocket. The length of bentonite seals is typically 0.5 m, although longer seals may be preferable, especially on the upper side of the piezometer. Bentonite balls approximately 25 mm in diameter, formed from powdered bentonite and water, may be used to form the seals. An alternative is to use compressed bentonite pellets, in which case sufficient time should be allowed for the swelling action of the pellets to occur before grout is placed on top of the seal.

The remaining sections of the borehole, both above the upper seal and beneath the lower seal (if applicable), should be filled with a cement-bentonite grout of the same or lower permeability than the surrounding soil. A tremie pipe should be used to place the grout. The volume of grout used should be compared with the volume of the hole to be grouted.

*The composition of the grout mix will depend on a variety of factors, such as the availability of materials, the required permeability, the type and make of bentonite, the*

*condition of the borehole and the groundwater levels. The grout should be easily pumped, of the required permeability, and flexible. The constituents should not segregate while the grout is still liquid. A typical mix might be four parts of bentonite mixed thoroughly with eight to twelve parts of water, to which is added one part of ordinary Portland cement. Special mixes and chemical additives may be necessary if the grout is to be used in sea water or very acid water.*

Poor sealing of the piezometer will permit the migration of water from one level to another, and may render the readings meaningless. The installation of more than one piezometer in a single borehole is not generally recommended. If two piezometers are placed in a single hole, great care must be taken to achieve proper seals.

A well-drained, lockable surface box should be provided for every piezometer installation (Figure 21).

After installation, a response test should be conducted on each piezometer where possible, to check the adequacy of the installation. The response test may be of the falling head type, with the results presented on falling head permeability test result sheets. Unexpected results in a response test may indicate that the piezometer is defective. Similar response tests carried out at intervals during the life of the piezometer are also recommended to ensure that readings remain valid. In soft cohesive soils, care should be exercised to ensure that the head used in response tests does not cause hydraulic fracture in the soil.

### **20.2.8 Varying Groundwater Pressures**

*In addition to varying response to rainfall, water pressures may show seasonal variation, response to tidal changes or may be affected by abstraction from neighbouring wells or by other causes. Where it is important to take account of these effects, adequate periods of observation should be adopted.*

Groundwater levels in open-hydraulic piezometers or standpipes are commonly measured with battery-operated electrical diameters (McNicholl & Cho, 1985). This technique relies on the conductivity of the groundwater to complete a circuit. In some instances the diameter may fail to function until the conductivity of the water has been increased, for example by the addition of a few crystals of common salt (sodium chloride).

Groundwater levels or pressures should be recorded and plotted systematically. A typical record sheet is shown in Figure 22, where the readings have been plotted on a time base for ease of interpretation, together with corresponding rainfall data.

The observation of peak groundwater response in open-hydraulic piezometers or standpipes can be measured using a string of piezometer 'buckets' (Figure 23 and Plate 6B). The buckets are filled progressively as water rises in the piezometer and will retain their water even if the piezometric pressure subsequently falls. By using a series of closely-spaced piezometer buckets, the peak transient response during or after a rainstorm can be recorded at a convenient time later on. The buckets are tied to a weighted nylon string at selected depth intervals above the normal base water level and can be pulled to the surface for readings. They

might typically be placed at 0.5 m intervals within the range of 2 m both above and below the critical groundwater level assumed in the design. A typical data sheet is shown in Figure 24. Care should be taken when handling the string to ensure that it does not drop into the borehole (thus rendering the piezometer useless), or that it does not tangle and reduce the spacing between the buckets.

Another method for recording transient water levels in open-hydraulic piezometers or standpipes is the automatic bubbling recorder, or 'bubbler' system. In this system, a small diameter air line is installed down to the piezometer tip with a small air flow sufficient to produce several bubbles per minute. The air pressure required to release bubbles can be equated to the water pressure produced by the height of water in the standpipe.

An electronic pressure transducer and "Scanivalve" have been used for automatic recording of a number of piezometers (Pope et al, 1982). Functioning of the system may be controlled by a microprocessor, allowing variation in the number of piezometers read, the dwell time on each piezometer, and the interval time between readings.

### **20.2.9 Soil Suction**

Measurement of matric soil suction, or negative pore water pressure, in the range 0 to -80 kPa can be undertaken in the field with tensiometers. A high air entry pressure ceramic tip allows equilibrium to be achieved between soil moisture and a confined reservoir of water within the tensiometer. A vacuum gauge is located at the top of the tensiometer. At suctions greater than -80 kPa, water inside the tensiometer cavitates and is lost through the ceramic tip. An example of a tensiometer is shown in Plate 6C.

The pressure exerted by the column of water within the tensiometer must also be considered; for example, if the tip were located 1.5 m vertically beneath the gauge, the maximum soil suction that could be measured would be reduced to -65 kPa. When suction measurements are required at greater depths, a caisson may be excavated and tensiometers installed through the sides of the caisson (Sweeney, 1982). The reliability of a tensiometer depends on a good contact between the soil and the ceramic tip, and a good seal between the tensiometer tube and the soil.

For measurement of soil suctions beyond the range of tensiometers, psychrometers may be used (Richards, 1971), although their accuracy is doubtful. The measurement of soil suction in Hong Kong slopes has been reviewed by Anderson (1984).

### **20.3 Groundwater Samples**

*Care should be taken to ensure that samples are representative of the water-bearing zone from which they have been taken and that they have not been contaminated or diluted by surface water or water used for boring. Water samples should be taken as soon as possible after the water-bearing zone has been met in the borehole. If other water-bearing zones occur at higher levels, these should be sealed off by the borehole casing. As far as is possible, all the water in the borehole should be removed by pumping or baling, and the sample taken from water*



*which collects by seepage. About one litre should be collected in a clean glass or inert plastic bottle, rinsing the bottle three times with the water being sampled before filling. More stringent requirements may apply in certain cases, e.g. use of sterilized containers (see Chapter 13). Even when precautions are taken, water samples from boreholes may be unrepresentative. Better results can be obtained if samples can be taken from a standpipe piezometer sealed within the relevant zone. Water samples may deteriorate rapidly and should therefore be tested as soon as possible after sampling.*

## 21. Tests in Boreholes

### 21.1 General

This chapter describes various tests that may be conducted as supplementary to a ground investigation carried out by boreholes. The tests described are generally undertaken as an integral part of the drilling operation. Additional field tests are described in Chapters 24 to 33, and include some tests which can also be conducted in boreholes. The division of the subject matter has been somewhat arbitrary; therefore, where coverage of a particular test is not given in this chapter, it should be sought in later chapters.

### 21.2 Standard Penetration Tests

#### 21.2.1 General Principles

The standard penetration test is a frequently used dynamic penetration test and is described in BSI (2011b). A small disturbed soil sample (quality class 3) is normally obtained when the split barrel sampler is used (Figure 25 and Plate 7A). The test results have been related empirically to soil parameters and foundation conditions, especially in sands and gravels.

[Amd GG2/01/2017]

Minor variations from the specified equipment and procedures can seriously affect the results of the test (De Mello, 1971; Ireland et al, 1970; Nixon, 1982; Skempton, 1986). It is important that the test is carried out precisely as described in BSI (2011b), except that the following modifications should be incorporated :

[Amd GG2/01/2017]

- (a) The diameter of the borehole should be between 60 mm and 200 mm.
- (b) Drill rods with a stiffness equal to or greater than type BW rods should be used to reduce energy dissipation.
- (c) The results of standard penetration tests should be included in borehole records without the application of corrections.

[Amd GG2/01/2017]

[Amd GG2/01/2017]

[Amd GG2/01/2017]

[Amd GG2/01/2017]

#### 21.2.2 Preparation for Testing

*It is necessary to clean out the bottom of the borehole. When the test is carried out below the groundwater level, certain types of soil may be loosened below the base of the borehole by the action of the boring tools and by pressure differences between the groundwater and water in the borehole. This effect can be particularly severe in sands. The effect can be reduced by keeping the borehole topped up with water and by very careful operation of the boring tools but often these expedients will not be completely successful.*

The drill casing should not be advanced ahead of the borehole where a standard penetration test is to be performed.

### 21.2.3 Advantages and Limitations

*The great merit of the test, and the main reason for its widespread use, is that it is simple and inexpensive. The soil strength parameters which can be inferred are very approximate, but give a useful guide in ground conditions where it may not be possible to obtain borehole samples of adequate quality, e.g. gravels, sands, silts, clay containing sand or gravel and weak rock. In conditions where the quality of the 'undisturbed' sample is suspect, e.g. very silty or very sandy clays, or hard clays, it is often advantageous to alternate the sampling with standard penetration tests, thereby obtaining a check on the strength. If the samples are found to be unacceptably disturbed, it may be necessary to use a different method for measuring strength, e.g. the plate test described in Sections 21.6 and 29.1.*

*When the test is carried out in granular soils below groundwater level, the soil may become loosened, even when the test is carried out in strict accordance with BSI (2011b) and the borehole has been properly prepared. In certain circumstances, it can be useful to continue driving the sampler beyond the distance specified, adding further drill rods as necessary. Although this is not a standard penetration test, and should not be regarded as such, it may, at least, give an indication as to whether the deposit is really as loose as the standard test may indicate. When there is good reason to believe that unrealistically low values are being recorded, consideration should be given to the use of some other test which can be performed independently of a borehole, e.g. the cone penetration test described in Section 23.3.*

[Amd GG2/01/2017]

When the test is carried out in soils derived from insitu rock weathering in Hong Kong, it is commonly extended to high blow counts, sometimes in excess of 200. However, it is recommended that the test should be discontinued when the blow count reaches 100 or if the hammer bounces and insignificant penetration is achieved, as is frequently the case when corestones are encountered. If the test is curtailed due to hard driving, the number of blows used to achieve the actual penetration should be measured and recorded (e.g. Blow/Penetration = 100/80 mm), and this may be used to estimate the blow counts for 300 mm penetration.

*In the construction of bored piles, the test is sometimes carried out in boreholes considerably larger in diameter than those used for ground investigation work. The result of the standard penetration test is dependent upon the diameter of the borehole, and these tests should not be regarded as standard penetration tests. They may, however, provide useful information to a piling contractor, particularly if he has considerable experience in their use.*

### 21.2.4 Results and Interpretation

The resulting N value is defined as the number of blows required to drive the standard split spoon sampler a distance of 300 mm. The sampler is initially driven 150 mm to penetrate through any disturbed material at the bottom of the borehole before the test is carried out. The number of blows required for each 75 mm advance in the initial seating drive should be recorded;

the test may then proceed, with recording of the number of blows required for each 75 mm incremental advance of the test drive.

When the test is used in soils derived from insitu rock weathering, it should be noted that the empirical relationships developed for transported soils between N value and foundation design parameters, relative density and shear strength may not be valid. Corestones, for example, can be responsible for misleadingly high values that are unrepresentative of the mass. In view of this, the test should only be used to give a rough indication of relative strength in these soils, or to develop site-specific correlations.

## 21.3 Vane Tests

### 21.3.1 General Principles

A cruciform vane on the end of a solid rod is forced into the soil and then rotated (Figure 26). The torque required to rotate the vane can be related to the shear strength of the soil. The method of carrying out the test is described in BSI (1990). Vanes can take the form of borehole vanes or penetration vanes, the latter being much more reliable. The test can be extended to measure the remoulded strength of the soil. This is done by turning the vane through ten complete rotations. A pause of not more than one minute is permitted to elapse and the vane test is then repeated in the normal way. The degree of disturbance caused by rotating the vane differs from that obtained by remoulding a sample of clay in the laboratory, and the numerical value of the sensitivity of the clay determined by these procedures is not strictly comparable with the results obtained from laboratory triaxial tests.

[Amd GG2/01/2017]

The test is normally restricted to fairly uniform, cohesive, fully-saturated soils, and is used mainly for clay having an undrained shear strength of up to about 75 kPa. The results are questionable in stronger clays, or if the soil tends to dilate on shearing or is fissured.

In Hong Kong, the vane test is invaluable in the marine sediments (Fung et al, 1984; Handfelt et al, 1987). However, some strata are sandy or contain shells, in which case vane shear results should be interpreted with caution. Marine muds are generally very soft, and it is often necessary to provide a separate support frame on top of the seabed to carry out the vane test (see Section 14.7).

*It should be noted that the undrained shear strength determined by an insitu vane test is, in general, not equal to the average value calculated at failure in the field, e.g. in the failure of an embankment on soft clay. The discrepancy between field and vane shear strengths generally increases as the clay becomes more plastic (Bjerrum, 1973).*

### 21.3.2 Advantages and Limitations

*The main advantage is that the test itself causes little disturbance of the ground. This is particularly apparent in sensitive clays, where the vane test tends to give higher shear strengths than those derived from laboratory tests on samples obtained with the general purpose sampler described in Section 19.4.4. In these conditions, the vane test results are*

*generally considered to be much more reliable. If the test is carried out in soil that is not uniform and contains even thin layers of laminations of sand or dense silt, the torque may be misleadingly high. The presence of rootlets in organic soils, and also of coarse particles, may lead to erroneous results.*

With the penetration vane test apparatus (vane borer) described in BSI (1990), the vane and a protective casing (Plate 8) are forced into the ground by jacking. At the required depth, the vane is advanced a short distance ahead of the protective casing, the test is conducted, and the casing and vane are then subsequently advanced to the next required depth. However, with this type of test it is not always possible to penetrate to the desired layer without the assistance of pre-boring.

[Amd GG2/01/2017]

Small hand-operated vane test instruments are available for use in the sides or bottom of an excavation. These devices can also be used on samples, with tests done either in the field or in the laboratory. The results thus obtained are generally adequate for the purpose of classifying the consistency of cohesive soils (GCO, 1988). Comparative hand vane tests carried out in both the field and laboratory may provide an indication of possible disturbance during handling and transportation of the sample.

## **21.4 Permeability Tests**

### **21.4.1 General Principles**

*The determination of insitu permeability by tests in boreholes involves the application of an hydraulic pressure in the borehole different from that in the ground, and the measurement of the flow due to this difference. The pressure in the borehole may be increased by introducing water into it, which is commonly called a falling-head or inflow test, or it may be decreased by pumping water out of it in a rising-head or outflow test. The pressure may be held constant during a test (a constant-head test) or it may be allowed to equalize to its original value (a variable-head test). The technique is strictly applicable only to the measurement of permeability of soils below groundwater level, although an approximate assessment may be made above this level (Schmid, 1966). However, this approximate value will reflect the infiltration capacity of the subsurface material rather than its permeability (see also Section 24.3). A great variety of tests are included under this heading, varying from the very crude, where simple problems can be solved by simple means, to the sophisticated when the nature of the problem demands more refined data.*

### **21.4.2 Preparations for the Test**

*In the simplest form of test, preparation consists of cleaning out the bottom of the borehole. The test is then conducted by measuring the rate of flow of water out of the borehole into the soil, or vice versa, through the open end of the casing. The borehole may be extended beyond the bottom of the casing, thus increasing the surface through which water can flow. If necessary, the uncased part of the borehole is supported by a suitable filter material. Water leaking through the casing joints has at times been found to cause misleading results and the problem has been overcome by the use of fibre rings.*

Misleading results can also arise if any return flow occurs up the outside of the casing.

*For more accurate measurements, a perforated tube or a suitable piezometer tip is installed, which is then surrounded by a granular filter to prevent erosion of the ground, and the casing withdrawn. It is essential that the filter material used has a permeability much greater than that of the soil being tested. Recommendations for sealing the borehole above the granular filter are given in Section 20.2.7. In order to avoid errors in flow measurement due to compression and solution of trapped air in the leads, ceramic piezometer tips should be saturated with de-aired water before installation.*

Permeability tests can be carried out at various depths in the borehole as drilling progresses. Figure 27 shows a suitable test arrangement.

*Before a permeability test is conducted, it is essential to determine the level of the natural groundwater table by one of the methods described in Chapter 20.*

Measurements of water level taken soon after cessation of drilling usually do not represent equilibrium values, and a series of measurements may be necessary. If a piezometer is finally installed in the borehole, the piezometric data obtained from monitoring may provide a check on the measurements taken at the time of the test.

*The period required for constant-head tests is decreased and the interpretation simplified if short lengths of borehole are used for the test. Pore pressures should be in equilibrium before the test is performed, and with clays of low permeability it can take several months for the pore pressures set up by the drilling of the borehole to equalize. For soils derived from insitu rock weathering and colluvium, equalization typically occurs very much faster.*

#### **21.4.3 Variable-head Test**

*The first operation is either to fill the piezometer tube with water (falling-head test) or to force the water level down by a foot-pump or bicycle pump (rising-head test). The head in the borehole is then allowed to equalize with that in the ground, the actual head being measured at intervals of time from the commencement of the test. The depth of the borehole should be checked to determine whether any sediment has come out of suspension or whether the bottom of the borehole has heaved during the test period.*

#### **21.4.4 Constant-head Test**

*A constant-head test is normally conducted as an inflow test in which arrangements are made for water to flow into the ground under a sensibly constant head. It is essential to use clean water. It will not be possible to achieve a constant head if the groundwater level is not constant or the head lost by friction in the pipes is significant. Where a high flow rate is anticipated and where the installation comprises a piezometer tip surrounded by a filter material, two standpipes should be installed, one to supply the water and the other to measure the head in the filter material surrounding the piezometer tip. The rate of flow of water is*

*adjusted until a constant head is achieved and, in the simplest form of test, flow is allowed to continue until a steady rate of flow is achieved. In some ground, this may take a long period of time, and, in such cases the method suggested by Gibson (1963) may be used, in which the actual rate of flow is measured and recorded at intervals from the commencement of the test.*

**21.4.5 Analysis of Results**

*There are numerous published formulae for calculating permeability from these tests, many of them partly empirical. Those given by Hvorslev (1951), which are reproduced in outline in Section 21.4.6, are much used and cover a large number of conditions. They are based on the assumption that the effect of soil compressibility is negligible. The method given in Gibson (1963) for the constant-head test is also indicated. This gives a more accurate result with compressible soils.*

It must be emphasized that the formulae given in Section 21.4.6 are steady-state equations suitable for calculation of permeability when the test is carried out below the water table. In Hong Kong, it is often necessary to measure permeability above the water table. In this case, the steady-state equations can only be used if the time over which the test is conducted becomes very long. Under these circumstances, permeability should be assessed using the constant-head test interpreted according to Method 2 in Section 21.4.6(2), with  $H_c$  measured from the centre of the response zone in the test.

**21.4.6 Formulae for Borehole Permeability Tests**

*(1) Method 1 (after Hvorslev, 1951).*

*For Constant-head test,*

$$k = \frac{q}{FH_c} \text{ (Time lag analysis) .....(1)}$$

*and for variable-head test,*

$$k = \frac{A}{FT} \text{ ..... (2)}$$

*or*

$$k = \frac{A}{F(t_2 - t_1)} \log_e \frac{H_1}{H_2} \text{ (General approach) ..... (3)}$$

*where*  $k$  *is the permeability of soil,*  
 $q$  *is the rate of flow,*  
 $F$  *is the intake factor (Figures 28 and 29),*  
 $H_c$  *is the constant head,*

$H_1$  is the variable head measured at time  $t_1$  after commencement of test,  
 $H_2$  is the variable head measured at time  $t_2$  after commencement of test,  
 $A$  is the cross-sectional area of borehole casing or standpipe as appropriate,  
 $T$  is the basic time factor (Figure 30).

It should be noted the above formulae assume that the natural groundwater level remains constant throughout the test. For the case where the natural groundwater varies, see Hvorslev (1951).

**(2) Method 2 (Constant-head Test, after Gibson, 1963).**

$$k = \frac{q_\infty}{FH_c} \dots\dots\dots (4)$$

$$C = \frac{q_\infty^2 r^2}{\pi n^2} \dots\dots\dots (5)$$

where  $k$  is the permeability of soil,  
 $C$  is the coefficient of consolidation or swelling,  
 $q_\infty$  is the steady state of flow (read off the  $q, 1/\sqrt{t}$  graph at  $1/\sqrt{t} = 0$ ),  
 $F$  is the intake factor (Figures 28 and 29),  
 $H_c$  is the constant head,  
 $r$  is the radius of a sphere equal in surface area to that of the cylindrical tip,  
 $n$  is the slope of the  $q, 1/\sqrt{t}$  graph.

The following points regarding this method should be noted :

- (a) Heads are referred to natural groundwater level before the test.
- (b) The method makes allowance for the compressibility of the soil and also permits the coefficient of consolidation or swelling to be calculated.
- (c) The flow,  $q$ , has, in theory, a linear relationship with  $1/\sqrt{t}$ . In practice, it may take some hours for the plot to come on a straight line. The line can then be extrapolated to give  $q_\infty$  and  $n$ , where the test would otherwise take too long.

**21.4.7 Advantages and Limitations**

For most types of ground, field permeability tests yield more reliable data than those carried out in the laboratory, because a larger volume of material is tested, and because the ground is tested insitu, thereby avoiding the disturbance associated with sampling. The appropriate choice of drilling method and careful drilling technique are necessary to avoid disturbing the ground to be tested. In granular soils, the ground may be loosened below the



*bottom of the borehole; in layered deposits of varying permeability, a skin of remoulded mixed material may be formed on the walls of the borehole, thus blocking the more permeable layers; in jointed rock, the joints may be blocked by the drilling debris.*

In very soft marine clays, it is very difficult to carry out a successful permeability test because of the low permeability of the soil, its compressibility, and the possibility of hydraulic fracture arising from the relatively large head required for a falling-head or constant-head test.

*Constant-head tests are likely to give more accurate results than variable-head tests, but, on the other hand, variable-head tests are simpler to perform. The water pressure used in the test should be less than that which will disrupt the ground by hydraulic fracturing. It has been shown that serious errors may be introduced if excessive water pressures are used (Bjerrum et al, 1972). In general, it is recommended that the total increase in water pressure should not exceed one half the effective overburden pressure. With soils of high permeability, greater than about  $10^{-3}$  m/s, flow rates are likely to be large and head losses at entry or exit and in the borehole may be high. In this case, field pumping tests, where the pressure distribution can be measured by piezometers on radial lines away from the borehole, will probably yield more accurate results; these are described in Chapter 25. When the test is carried out within a borehole using the drill casing, the lower limit of permeability that can be measured reliably is determined by the watertightness of the casing joints and by the success achieved in sealing the casing into the ground. In soil, the reliable lower limit is about  $10^{-8}$  m/s. In lower permeability soils and unweathered rock, it is advisable to carry out the test using a standpipe or piezometer which is sealed within the test length using grout. In ground of low permeability, the flow rate may be very small, and measurements may be subject to error owing to changes in temperature of the measuring apparatus.*

The permeability of a compressible soil is influenced by the effective stress at which it is measured, and there may be significant differences between the results of inflow tests, in which effective stress is reduced, and the results of outflow tests, in which it is increased. The test to be used should model the field conditions as closely as possible, e.g. where the conditions indicate increasing effective stress, such as in embankment construction, a rising-head test should be used; for the case of decreasing effective stress, such as when assessing the quantity of inflow into an excavation, a falling-head test would be appropriate. The permeability of soil around the borehole may also be influenced by changes in its stress history owing to installation of the borehole and any previous permeability tests performed on it.

*The compressibility is influenced in a similar way, and this may affect the results achieved. The accuracy with which the coefficient of permeability may be deduced from variable-head tests decreases with the coefficient of consolidation of the soil being tested. In principle, the coefficient of consolidation or swelling may be deduced from the results of both constant-head and variable-head tests. In practice, results of only limited accuracy can be obtained, owing to difficulties in interpretation and the extent to which the stress history of the soil adjacent to the borehole is modified by the installation of the borehole.*

*Execution of the borehole permeability test requires much expertise, and small faults in technique lead to errors of up to one hundred times the actual value. Even with considerable care, an individual test result is often accurate to one significant figure only. Accuracy will usually be improved by analysing the results of a series of tests. However, in many types of*

*ground, particularly stratified soil or jointed rock, there may be a very wide variation in permeability, and the permeability of the mass of ground may be determined by a relatively thin layer of high permeability or a major joint. Very considerable care is needed in interpreting the test data. In cases where a reliable result is required, the programme of borehole permeability tests is generally followed by a full-scale pumping test (see Chapter 25).*

## **21.5 Packer (Water Absorption) Tests**

### **21.5.1 General Principles**

*The packer or Lugeon test gives a measure of the acceptance by insitu rock of water under pressure. The test was originally introduced by Lugeon (1933) to provide an acceptable standard for testing the permeability of dam foundations. In essence, it comprises the measurement of the volume of water that can escape from an uncased section of borehole in a given time under a given pressure. Flow is confined between known depths by means of packers, hence the more general name of the test. The flow is confined between two packers in the double packer test, or between the packer and the bottom of the borehole in the single packer test. The test is used to assess the amount of grout that the rock will accept, to check the effectiveness of grouting, to obtain a measure of the amount of fracturing of the rock (Snow, 1968), or to give an approximate value of the permeability of the rock mass adjacent to the borehole.*

*The results of the test are usually expressed in terms of Lugeon units. A rock is said to have a permeability of 1 Lugeon if, under a head above groundwater level of 100 m, a 1 m length of borehole accepts 1 litre of water per minute. Lugeon did not specify the diameter of the borehole, which is usually assumed to be 76 mm (N size), but the test is not very sensitive to change in borehole diameter unless the length of borehole under test is small.*

When the packer test is carried out at shallow depths, as is frequently the case in Hong Kong, the applied water pressure must be limited to a value that will not cause hydraulic fracturing of the ground (see Section 21.5.3). This often leads to the test being conducted at pressures of 50 to 500 kPa, and extrapolation is then necessary to obtain the Lugeon value equivalent to a 100 m water head (approximately 1 MPa pressure).

If the rock discontinuity spacing is sufficiently close for the test section to be representative of the rock mass, a mass permeability can be calculated as described in Section 21.5.6. A simple rule that is sometimes used to convert Lugeon values into mass permeability is to take one Lugeon as equal to a permeability of  $10^{-7}$  m/s.

As the packer test is used to assess the potential for water to penetrate rock discontinuities, clean water should be used as the drilling fluid when forming the borehole, rather than drilling mud. If drilling mud has been used, the hole should be thoroughly flushed out prior to packer testing; appropriate explanatory notes should also be given with the test data. In situations where only salt water is available to conduct the test, this should also be clearly indicated on the test results.

### 21.5.2 Packers

Several types of packer are in use, such as the mechanical tail pipe, the manual mechanical-expanding packer and the hydraulic self-expanding packer, but by far the most commonly used is the pneumatic packer.

This comprises a rubber canvas duct tube which can be inflated against the sides of the borehole by means of pressurized gas (Figure 31). Bottled nitrogen or oxygen is fed down the borehole through a small diameter nylon tube. The inflation pressure has to be sufficient to expand the packer against the head of water in the borehole, but not sufficient to cause heaving of the ground surface or fracturing of the rock. A useful rule of thumb is that the pressure, in kPa, should lie between 12 times and 17 times the depth, in metres, of the borehole. The difference between the diameter of the uninflated packer and the diameter of the borehole should be such that the packer can be easily inserted. At the same time, the inflated diameter of the packer should be sufficient to provide an efficient seal. A double packer is two packers connected by a length of pipe of the same length as the test section. The test water is introduced between the packers.

### 21.5.3 Application and Measurement of Pressure

Water pressure is applied by a flush pump as used for diamond bit core drilling. The maximum water pressure which should be applied should not be sufficient to cause uplift of the ground or to break the seal of the packers in deep holes in weak rock. The standard head of 100 m above groundwater level may not be attainable in these conditions.

The applied pressure should not exceed overburden pressure at the test depth, and it may be necessary to keep the pressure well below the overburden pressure, as under some circumstances vertical cracks can develop in weak rocks at pressures much lower than this value. Excessive pressure may be detectable by careful analysis of the test data, e.g. an abrupt change of slope in a graph plot of applied water pressure versus flow rate may indicate possible hydraulic fracture during the test.

The pressure to be determined for use in the calculation of permeability is that causing flow into the rock itself. This is sometimes measured directly, but it is more usual to measure it at ground level by means of a Bourdon gauge, with the readings adjusted in accordance with the following expression :

$$h = P + (H - H_g) - H_f \dots\dots\dots (6)$$

where  $h$  is the pressure head causing flow into the rock (m),  
 $P$  is the Bourdon gauge reading converted to head (m),  
 $H$  is the height of Bourdon gauge above the mid-point of test section (m),  
 $H_g$  is the height of natural groundwater level above the mid-point of test section (m),  
 $H_f$  is the friction head loss in the pipes (m).

*The pressure gauge should be positioned so that it will give a true reading without interference from local pressure variations induced by flow through the pipe work. The natural groundwater level should be measured before the test begins. This is not always easy, especially when the rocks are of low permeability, and water has been used for flushing purposes during drilling. If necessary, separate observation wells should be installed, and the groundwater levels should be measured over a period to establish the general groundwater level. Friction head loss in the pipes is best established by means of a calibration test, with the pipe work laid out on the ground.*

Calibration must be carried out for each test arrangement (pump, packer, valves and bypass, pressure gauge and flowmeter) with various lengths of drill rods and varying flow rates. All pressure gauges and flow meters used in the test should be calibrated regularly.

#### **21.5.4 Measurement of Flow**

*The rate of flow of water may be measured either by a flowmeter or by direct measurement of flow out of a tank of known dimensions by means of a dipstick or depth gauge. Where a flowmeter is used, it should be installed upstream of the pressure gauge, well away from bends or fittings in the pipework, and in accordance with the manufacturer's instructions. The accuracy of the meter should be checked before the test begins, and periodically afterwards, by measuring the time taken to fill a container of known volume at different rates of flow. Where the flow out of a tank is to be measured, the use of one large tank can lead to inaccuracies where the plan area is large and the fall in level correspondingly small. A better arrangement is to use a number of small containers.*

Flowmeters are prone to inaccuracies, especially at low flow rates, and calibrations should therefore be carefully checked on site. Industrial water meters commonly available in Hong Kong are not sufficiently accurate for use in the packer test. For very low flows, a rotameter board with a series of graduated tubes can provide an accurate measurement of flow rate, as can an orifice plate meter.

#### **21.5.5 Execution of Test**

*The test may be carried out either as a single or as a double packer test. The single packer test is generally to be preferred because any leakage past the packer can be detected, whereas leakage past the lower packer in the double packer test cannot. However, the single packer test normally has to be done periodically during the drilling of the hole, which makes it more costly. An important point is to ensure that the packer is properly seated in the borehole. Where a complete core has been recovered from the borehole, or where appropriate logging or television inspection has been carried out, a careful examination may reveal suitable places to seat the packer. Where the seating proves unsatisfactory, the length of the test section should be altered or test sections overlapped, so as to seat the packer at a different depth in the borehole.*

While the number of packer tests carried out in a borehole depends on the requirements of the project, it is usual to test the whole length of the borehole that is in rock. However, the

upper limit of testing may be constrained by the highest level at which a packer can be sealed satisfactorily. Typically, overlapping tests are used, each having a test section length of 3 to 6 m. In any case, the test section length should not be less than ten borehole diameters so as to minimise end effects.

It is customary to run a staged test at each location, using different pressures. A five-stage test is desirable, with the maximum pressure applied in three equal increments and then reduced with decrements of the same amount (Figure 32). The data obtained from these measurements are particularly useful in assisting in the interpretation of the behaviour of the rock under test.

The water level in the borehole above the packer should be observed during each test, as a rising level may indicate that leakage is occurring around the upper packer.

### 21.5.6 Results and Interpretation

The varying values of pressure and flow recorded during the test may be plotted as shown in Figure 33. The interpreted Lugeon value,  $L$ , is given by the formula :

$$L = (100/l) (q/h) \dots\dots\dots (7)$$

where      100 is the standard head of water (m),  
                $l$  is the length of test section (m),  
                $q$  is the flow rate (litres/minute),  
                $h$  is the pressure head causing flow into the rock (m) (see Section 21.5.3.),  
                $q/h$  is the slope of graph as shown in Figure 33.

Where a test has been conducted at pressure heads considerably less than the standard 100 m head, the Lugeon value may be somewhat over-estimated by the above formula, due to possible differences in energy loss between laminar flow (at low head) and turbulent flow (at high head). Further considerations on test interpretation are given by Houlsby (1976).

## 21.6 Plate Tests

### 21.6.1 General

*The plate test is one particular application of the vertical loading test, and the general procedures for the test are described in Section 29.1. Only the specific problems which arise from carrying out the test in the bottom of a borehole are discussed in this Section. Wherever practicable, the test should be conducted in a borehole which is of sufficient diameter for a technician to enter, clean out the bottom, and bed the plate evenly on undisturbed ground. Careful attention should be directed towards safety for operators working below ground (see Section 18.2 and Appendix E). Where, for reasons of economy, the test is conducted in a small diameter borehole, the cleaning of the bottom and the bedding of the plate has to be done from the surface, so that it is very difficult to be certain that the plate is not resting on disturbed material. This would, of course, limit the value of the results.*

*The techniques used for tests in large and small diameter boreholes differ in some respects and, where differences occur, the methods are described separately in Chapter 29. The diameter of the plate used should, so far as practicable, be equal to that of the borehole, provided that care is taken to eliminate cohesion or friction on the side of the plate. Except in strong materials, the plate should have a skirt as shown in Figure 43 (see Section 29.1.4). Where the diameter of the plate is significantly less than that of the borehole, the results of the test become difficult to interpret. At a hole-diameter to plate-diameter ratio greater than about 3:2, the parameters being measured are those pertaining to a load at a free surface and not at depth under confined conditions, which are usually the conditions of interest.*

### **21.6.2 Limitations**

*The general limitations of the vertical load test are discussed in Section 29.1.2 and they apply similarly to the borehole test. Additionally, in the bottom of a borehole it is more difficult to achieve a satisfactory bedding of the loading plate on the test surface, and hence values obtained for the deformation parameters may be of limited significance.*

### **21.6.3 Preparation**

*Where, necessary, casing should be used to support the sides of the borehole and to seal off water seepages from materials that are above the test elevation. When the test is to be carried out below the prevailing water table, dewatering by pumping or baling from within the borehole may cause seepages which disturb the ground and have an adverse effect on its deformation characteristics. It would then be necessary to resort to external dewatering (see Section 29.1.2). If the test is undertaken only for measuring the strength parameters, disturbance due to groundwater seepage may be a less significant factor and the borehole may be emptied, if this is possible, while the plate is being installed. The water should be allowed to return to its normal rest level before the test is commenced. Alternatively, the plate can be installed under water, although it may not then be possible to set the plate sufficiently accurately for the deformation characteristics to be measured.*

### **21.6.4 Bedding of the Plate**

*(1) **Large Diameter Boreholes.** Subject to safety requirements (see Appendix E), a technician should be lowered to the bottom of the borehole to remove all loose soil manually, after which the plate is bedded as described in Section 29.1.3.*

*(2) **Small Diameter Boreholes.** The cleaning is carried out by means of a suitable auger or hinged bucket operated at the end of a drill rod assembly. A layer of neat cement mortar is then placed at the bottom of the borehole by means of a tremie or bottom opening bucket, and the plate lowered down the hole and lightly pressed on to the surface of the mortar. Plaster and resins can also be used for bedding.*

### **21.6.5 Application and Measurement of Load**

*The plate is usually loaded through a column formed by a steel tube, with the load applied to the column by means of an hydraulic jack operating against the resistance of kentledge, tension piles or ground anchors, as described in Section 29.1.4.*

### **21.6.6 Measurement of Deflection**

*The movement of the plate under load is generally transmitted to dial gauges at the surface by means of a settlement measurement rod that is located within the steel tube by which the load is applied. The rod is restrained from lateral movement by rod guides fixed within the tube. Methods of supporting the dial gauges are given in Section 29.1.4.*

### **21.6.7 Execution of Test**

*The method of carrying out the test is given in Section 29.1.6.*

### **21.6.8 Uses of the Test**

*(1) **Large Diameter Boreholes.** The main use of the test is to determine the strength and deformation characteristics of the ground. It is sometimes used to establish the working load of piles (Sweeney & Ho, 1982).*

*(2) **Small Diameter Boreholes.** The deformation characteristics obtained are of very dubious value owing to doubts about the elimination of ground disturbance and errors resulting from unsatisfactory bedding of the plate. The main use of the test is for measuring the strength characteristics of those cohesive soils in which undisturbed samples cannot be obtained, e.g. some gravelly clays and very weak rocks. The plate diameter should be large in relation to the structure of the ground.*

### **21.6.9 Supplementary Test**

*Although not strictly a plate test, a test is sometimes made by insitu methods to determine the coefficient of friction between the ground and concrete as an aid to the assessment of shaft friction for pile design. At the bottom of a borehole is placed either a layer of compressible material or a suitably-designed collapsible container. The shaft above this level is then filled with concrete while the casing is withdrawn. When the concrete has sufficiently matured, the load is applied, and the deflection measured in a manner similar to that described in Section 21.6.6. Where the shaft friction of only part of the ground profile is required, as in a rock socket, the concrete is first brought up to the level of the top of the ground layer concerned, and the shaft is continued in smaller diameter.*

### 21.6.10 Horizontal Plate Tests

The plate test may also be conducted horizontally within a large diameter borehole or caisson (Whiteside, 1986). In this case, either two tests can be conducted simultaneously on opposite sides of the caisson, or the caisson wall opposite the test can simply be used to provide the necessary reaction force. Casing or lining of the caisson must of course be kept well away from the test location. Guidance on interpretation of test results is given in Section 29.2.

## 21.7 Pressuremeter Tests

### 21.7.1 Test Description

*In a pressuremeter test, a probe is inserted into a pocket below the bottom of a borehole or directly into the appropriate size of borehole and expanded laterally by compressed air or gas. The applied pressures and resulting deformations are measured and enable the strength and deformation characteristics of the ground to be investigated.*

*The earliest instrument, and that in most general use, is the Ménard pressuremeter (Ménard, 1965). With this instrument, the lateral load is applied by a probe consisting of a water-filled central measuring cell flanked by two guard cells, either gas-filled or water-filled, depending on the type of instrument.*

*Readings are taken at the ground surface on pressure and volume gauges which are connected to the central cell by means of a back-pressured annular plastic tube. The pressure tube and probe must be calibrated on site. The function of the guard cells is to ensure a condition of plane strain in the ground in contact with the central cell. The probes are manufactured in four sizes up to 75 mm diameter, and can be operated at considerable depths. The Ménard pressuremeter can be used in soil or weak rock, but is not suitable for stronger rock, since the instrument is limited by its sensitivity to the tube calibration. It can be used in granular soils where special means are used to insert it.*

*Another pressuremeter that has been developed has an 150 mm diameter gas-expanded probe in which the deformation is measured directly by potentiometers located in the centre of the probe (McKinlay & Anderson, 1975). It can be used to determine the deformation characteristics of the more deformable weathered rocks.*

A wireline-operated push-in pressuremeter exists and has been in use in an offshore environment (Fyffe et al, 1986). Self-boring pressuremeters, which can be inserted into some soil types with minimal disturbance, have also been developed (Baguelin et al, 1978; Windle & Wroth, 1977). Pressuremeter testing in rock is described in Section 21.7.5.

### 21.7.2 Equipment Calibration

The probe and tubing of the pressuremeter require calibration on site, as follows :

- (a) Pressure calibration. This is to account for pressure losses which occur because of stiffness of the rubber membrane and



slotted steel sheath of the probe.

- (b) Volume calibration. This is to account for volume losses which occur because of expansion of the connecting tubes.

Pressure and volume calibrations should be carried out at the beginning and end of a testing programme, or whenever lengths of connecting tubes are changed, new sheaths or membranes are installed, any water line subjected to vacuum or pressure has been suddenly released, or any other factor affecting the calibration has changed. In addition, the hydrostatic pressure due to fluid in the test equipment below the pressure gauge should be determined prior to each test.

### **21.7.3 Forming the Test Pocket**

The formation of a suitable test pocket is a crucial step in pressuremeter testing, as the test data are obtained by radial expansion of the probe of only a few millimetres and even a thin disturbed zone around the pocket will affect the results. The test pocket must therefore be formed with minimal disturbance of the sidewalls, and with the proper diameter for the instrument to be used. The water flush rotary open hole drilling technique with open-ended casing (rotary wash boring, see Section 18.7.1) should not be used to form the test pocket. Briaud & Gambin (1984) have outlined procedures for preparation of an acceptable test pocket of the required diameter, as well as methods of placing the probe and conducting the test.

### **21.7.4 Results and Interpretation**

The test is normally conducted by increasing the pressure in equal increments and taking volumetric readings at time intervals after application of each pressure increment. Values of the soil deformation modulus are then interpreted from these data. Winter (1982) has discussed the presentation and interpretation of results for both granular and cohesive soils. A discussion of the application of the pressuremeter to foundation design in Hong Kong is given by Chiang & Ho (1980).

### **21.7.5 Tests in Rock**

*In strong rocks, it is necessary to use instruments of high sensitivity in which the deformation of the rocks is measured over small strain ranges by electronic transducers located within the probe. There are two types of instrument available : a flexible type, 73 mm in diameter, operated hydraulically by oil to a pressure of about 14 MPa (Rocha et al, 1966); and a rigid type, consisting of a steel cylinder split vertically into two halves and called the Goodman jack (Goodman et al, 1968). The rigid type is also operated hydraulically by oil, but with a considerably higher pressure than the flexible type, and is therefore particularly suitable for rocks in the higher modulus range.*

The Goodman jack is capable of exerting pressures in excess of 60 MPa within a normal NX size borehole. A method of estimating the insitu modulus of deformation from tests with

this device is presented by Heuze (1984).

## **21.8 Borehole Discontinuity Surveys**

### **21.8.1 Impression Packer Survey**

An impression packer survey provides an assessment of the orientation and aperture of discontinuities in a borehole in rock by means of an inflatable rubber membrane which presses an impressionable thermoplastic film against the borehole wall (Figure 34 and Plate 9). The impression packer can be used to provide data for the design of rock slopes, excavations or tunnels (Brand et al, 1983; Gamon, 1984a; Starr & Finn, 1979), and it can be used in conjunction with the packer (water absorption) test to define the location, orientation and opening of discontinuities where high water losses have occurred.

The impression packer device is commonly available in sizes to fit N and H size boreholes. A borehole length of about 1.5 m can be surveyed with each test, after which the device must be withdrawn from the hole and the thermoplastic film changed. Tests can be conducted as drilling progresses, but more commonly a series of overlapping tests are run after drilling has been completed in order to obtain a full survey of the borehole. Use of the device is usually restricted to vertical or slightly inclined boreholes.

Care must be taken when lowering the device into the borehole so that the thermoplastic film is not scuffed or damaged. The packer may be inflated by either air pressure or water pressure applied through a central perforated tube. Two metal leaves, curved to match the borehole wall, thereby force the impressionable thermoplastic film against the borehole wall, causing a permanent impression to be registered on the film. The device must be fully deflated before removal, or the film may be damaged.

The device may be orientated in the borehole in two ways, depending on the accuracy required :

- (a) By positioning the two metal leaves in a known direction at the surface, and subsequently marking this direction on each drill rod as the device is lowered into the borehole. This method, suitable only in shallow holes and when drill rods are utilized, is usually only accurate to about  $\pm 5^\circ$  in orientation at best.
- (b) By the use of an orientation instrument attached to the bottom end of the device. The orientation of a floating compass is set within a fixative solution at the time the packer is inflated, providing a record of orientation that can later be transferred onto the thermoplastic film. Somewhat better accuracy may be achievable with this technique.

It is recommended that test sections should be overlapped to the extent that at least one discontinuity common to adjacent sections is recorded. This will provide data for checking the north direction between successive impressions. Data from such surveys should also be

checked against relevant data from surface exposures whenever possible.

An example of an impression packer survey is given in Figure 35.

### **21.8.2 Core Orientators**

Several devices are available for determining the orientation of drill core, of which the Craelius core orientator has been widely used (Hoek & Bray, 1981). This mechanical device is usually installed in a fixed orientation in a core-barrel, and it initially protrudes ahead of the barrel in order to sense and record the contour of the rock surface. The core orientator then proceeds up the core-barrel and core drilling commences. Upon retrieval of the core sample, the uppermost core segment can again be matched against the core orientator and its relative orientation can be determined. The remainder of the core run may then be oriented with respect to the uppermost core segment.

The Craelius core orientator can operate in steeply inclined or horizontal boreholes as well as vertical holes, but it does not provide information on the aperture or infilling of discontinuities, nor does it provide a permanent record of discontinuities. In addition, the orientation of the core must be determined relative to the uppermost core segment, and this may prove difficult where core recovery is poor or where the core contains sub-horizontal joints (Gamon, 1984a).

## 22. Frequency of Sampling and Testing in Boreholes

### 22.1 General Principles

*The frequency of sampling and testing in a borehole depends on the information that is already available about the ground conditions and the technical objectives of the investigation. In general, the field work will cover three aspects, each of which may require a different sampling and testing programme and may also require phasing of operations. These aspects are as follows :*

- (a) the determination of the character and geological structure of the ground,
- (b) the determination of the properties of the various zones or materials whose locations have been determined in (a), using routine techniques for sampling and testing,
- (c) the use of special techniques of sampling and testing in ground for which routine techniques may give unsatisfactory results.

### 22.2 Determination of the Ground Profile

In areas where suitable information about the ground profile is available from previous investigations, it may be possible to reduce the need for this aspect. Otherwise, it is necessary to determine as far as possible the location, character and structure of each zone in the soil or rock mass. Some zones may be quite thin, and continuous sampling of the entire borehole may be required in order to obtain the necessary information.

In soils derived from insitu rock weathering, colluvium and some fill materials, the ground profile can be defined by taking samples using a triple-tube core-barrel. Samples should be taken continuously or at close intervals supplemented by standard penetration tests. Continuous rotary coring should be undertaken in fresh to moderately decomposed rock. Where a run with the rotary core-barrel results in poor core recovery, it may be useful to try to recover a small drive sample using the split barrel SPT sampler. However, this does not obviate the need to adjust the rotary coring equipment and techniques in order to obtain the best core recovery possible.

*In fine cohesive soil, and some silty sand, consecutive drive samples can be obtained using the 100 mm diameter sampler, or similar. In soft clay or sand, the barrels of the sampler can be coupled together to form a sampler 1 m in length and, if necessary, the core-catcher can be used to help retain the samples. In soft clays, it is generally good practice to obtain at least one complete profile for the site using the continuous piston sampling technique. Special sampling equipment is available for taking long continuous samples in soft clay, loose silt and loose silty sand (see Section 19.6).*

*In coarse granular soil, such as gravel, it is advisable to take disturbed samples from*

*the drill tools (see Section 19.3), together with split barrel standard penetration test samples (see Section 19.4.5) at about 1 m intervals.*

*Some of the soil samples obtained by drive sampling or rotary coring, if not required for 'undisturbed' tests, should be split along their longitudinal axis and carefully examined and described in their fresh condition. This exercise should be repeated later when soil is in a semi-dried state and the fabric may be more readily identified. Where highly variable ground conditions are expected, it may be advantageous to sink one or more boreholes first, either by rotary core sampling or by cable tool boring with continuous tube sampling. The cores or tube samples can then be examined to give guidance for sampling at selected depths in other boreholes which are sunk subsequently close to the initial boreholes (see Section 22.4).*

### **22.3 Routine Determination of Soil and Rock Properties**

Once the zones or materials whose properties are likely to be relevant to the technical objectives of the investigation have been identified, these properties may be assessed using routine or special techniques (the latter are discussed in Section 22.5). The programme of sampling and testing should be varied to suit the particular requirements of the investigation and the equipment that is in use.

The following programme is an example of a reasonable sampling and testing frequency where a borehole is being sunk through colluvium or weathered rock into fresh rock by means of rotary coring :

- (a) Colluvium and soils derived from insitu rock weathering. At the top of each zone or layer in the ground, and thereafter at 1.5 to 3 m intervals, an 'undisturbed' sample, i.e. class 1 or class 2 sample (see Section 19.2), followed by a standard penetration test should be taken. A disturbed sample should be recovered from the SPT sampler whenever possible.
- (b) Moderately decomposed to fresh rock. Continuous rotary core sampling should be undertaken.

### **22.4 Double-hole Sampling**

In this method, a borehole is first sunk to ascertain the ground profile. A second borehole is then sunk adjacent to the first, but at a sufficient distance away from it to avoid the disturbed zone, and samples are taken at predetermined levels. This method may be used where high variability in ground conditions is expected, e.g. in variable sedimentary deposits, or for the location and sampling of the shear zone material in a failed slope.

### **22.5 Special Techniques**

Special techniques of sampling and testing include the following :

- (a) Sampling techniques. These include the use of sand samplers, piston samplers and continuous soil samplers.
- (b) Testing techniques. These include vane tests, cone penetration tests, plate tests, pressuremeter tests, packer tests and discontinuity surveys.

*Some of the equipment used in these techniques is fragile, and easily damaged if used in unsuitable ground. It should preferably be used only where it is known that ground conditions are suitable.*

*Using a special sampling technique, the frequency of sampling in sand and in soft sensitive clay will in general be determined by similar considerations to those given in Section 22.3. However, if the material requiring the use of a special sampling technique is of limited thickness, it may be advisable to take samples at smaller than usual depth intervals so as to obtain a sufficient quantity of that material.*

*In the borehole vane test, only the small volume of clay that is rotated by the vane is tested, and individual results often show a considerable scatter. For this reason, vane tests should be carried out as frequently as possible. The vertical interval will be determined by the depth at which the test is carried out below the bottom of the borehole; this interval is usually 500 mm. Closer spacing can be obtained using the penetration vane apparatus.*

The cone penetration, pressuremeter and packer tests, as well as discontinuity surveys, are generally taken continuously, or such that complete coverage of the borehole is provided.

*Where a series of plate tests is required at increasing depths, the minimum spacing is determined by the depth to which the soil has been stressed by the test. A vertical interval of about four times the borehole diameter is usually adequate.*

## 23. Probing and Penetration Testing

### 23.1 General

*Probing from the surface probably represents the oldest method of investigating the depth to a hard layer where the overlying material is weak and not unduly thick. The simplest probe is a sharpened steel rod which is pushed or driven into the soil until it meets resistance. The method is still of use where other means of site investigation have disclosed relatively thin layers of very soft soils overlying much harder soils. In such cases, the thickness of the soft layer may be determined over a wide area very quickly and economically. The method has many limitations, and a variety of more sophisticated apparatus has been developed, both in an attempt to overcome these drawbacks and to extend the use beyond that of detecting a hard layer, e.g. to give some measure of the allowable bearing capacity of the soils present. Two distinct types of probe have been developed : one where the probe is driven into the soil by means of some form of hammer blow; the other where the probe is forced into the soil by a static load.*

### 23.2 Dynamic Probing

The apparatus for dynamic probing comprises a sectional rod fitted at the end with a cone whose base is of greater diameter than the rod. It is driven into the ground by a constant mass falling through a fixed distance. A device commonly used in Hong Kong is the GCO Probe (Figure 36 and Plate 10A), which is essentially a larger and heavier version of the Mackintosh Boring and Prospecting Tool. Probe results are very useful for assessing the depth and degree of compaction of buried fill, making comparative qualitative assessments of ground characteristics, and in supplementing the information obtained from trial pits and boreholes. Probing has also been carried out in the base of hand-dug caissons (Evans et al, 1982). Probe results are normally reported as the number of blows per 100 mm penetration, as shown in Figure 37.

As additional rods are added for probing at depth, the driving energy provided to the tip is attenuated by the additional mass of the rods. Correction of the probe values is sometimes made to allow for this effect. The correction is negligible at the shallow depths at which many probings terminate, and it is unnecessary to apply a correction if only qualitative comparisons between probe results at similar depth are being undertaken.

The fact that the rod and couplers are somewhat smaller in diameter than the base of the cone prevents, to some extent, shaft friction from influencing the results; however, at depth in certain soils, this factor should also be considered.

The primary use of dynamic probing is to interpolate data between trial pits or boreholes rapidly and cheaply. Therefore, probing should first be carried out adjacent to a trial pit or borehole where ground conditions are known, and then extended to other areas of the site. As with other types of penetrometers, probing may sometimes be unsuccessful in soils containing corestones, cobbles or boulders. In fill or completely decomposed rock, the maximum depth to which a GCO probe can be driven is about 15 m. In order to minimise damage to the equipment, probing should terminate when the blow count reaches 100, or when the hammer

bounces and insignificant penetration is achieved.

### **23.3 Static Probing or Cone Penetration Testing**

#### **23.3.1 General Description**

Several types of static probing equipment have been developed and are in use throughout the world (De Ruiter, 1982; Sanglerat, 1972). The basic principles of all systems are similar, in that a rod is pushed into the ground and the resistance on the tip (cone resistance) is measured by a mechanical, electrical or hydraulic system. The resistance on a segment of the rod shaft (friction sleeve resistance) may also be measured. Static probing, or cone penetration testing, is also known by a number of other descriptive terms, depending on the manufacturer or operator of the particular device being used.

There is no British Standard for cone penetration testing, but suitable recommendations are given by the ISSMFE (1977) and the ASTM (1985k). Both of these test standards recognize a number of traditional types of penetrometers, and it is imperative that the actual type of instrument used is fully documented, as the interpretation of the results depends on the equipment used. Two common types of penetrometers, mechanical and electrical, are described further in Sections 23.3.2 and 23.3.3 respectively.

The reaction required to achieve penetration of the cone may be obtained by screw anchors, the weight of the thrusting machine, kentledge, or a combination of these. When cone penetration testing is done in shallow water, the thrusting machine may be secured to a jack-up platform (see Section 14.7).

#### **23.3.2 Mechanical Cone Penetrometers**

Two common mechanical cones, the Dutch mantle cone and the Dutch friction sleeve cone, are shown in Figure 38 (see also Plate 10B). These cones were developed mostly at the Delft Soil Mechanics Laboratory in the 1930's. With either type, the cone is pushed into the ground by a series of hollow push rods. With the mantle cone, the force on the cone is then measured as the cone is pushed downward by means of inner rods inside the push rods. This force is generally measured at the ground surface by a hydraulic load cell. With the friction sleeve cone, the same initial measurement is made, and then a second measurement is taken while the cone and friction sleeve are together pushed downward a further increment. The friction is calculated by deducting the former reading from the latter. This procedure is normally repeated at regular depth intervals of 0.2 or 0.25 m.

An alternative quick continuous method of penetration is sometimes used with the mantle cone. In this method, the cone and push rods are pushed into the ground with the cone permanently extended and connected to the load cell. Accuracy is reduced in this operation, however, and the free movement of the cone should be checked at frequent intervals.

*For accurate work, the weight of the inner rods should be taken into account in calculations. In very soft soils when soundings are carried to a significant depth, the weight of the inner rods may exceed the force on the cone or cone plus jacket; in these circumstances,*



*it is impossible to obtain readings. This effect can be reduced by the use of aluminium inner rods. The inner rods should be free to slide inside the push rods, and the cone, and friction jacket where used, should be checked for free sliding both at the start and at the end of each penetration test. All push rods and inner rods should be straight, clean and well-oiled internally. The accuracy of the load and pressure gauges should be checked periodically by calibration.*

### **23.3.3 Electrical Cone Penetrometers**

*A number of types of electrically-operated cone are in use, and these generally incorporate vibrating wire or impedance strain gauges for measuring the force on the cone and friction jacket. In use, the cone is advanced at a uniform rate of penetration by pressure on the top of the push rods, and signals from the load-measuring devices are carried to the surface by cable threaded through the push rods. Forces on the cone, and friction jacket, can either be displayed on a readout at the surface or recorded automatically on a chart recorder, punched tape or magnetic tape. Exclusive recording on punched tape or magnetic tape which does not allow direct access to the data during or immediately after sounding is not recommended. Provision should be made for calibration of the force-measuring system at regular intervals, preferably on site. An inclinometer built into the cone is available with some equipment.*

*The cones are generally parallel-sided, and the friction jacket, where fitted, is immediately behind the point, as shown in Figure 39a (see also Plate 10B). However, parallel-sided electrical cones do not give exactly the same results as those obtained with the mechanical cone penetrometer, although the difference is usually of little importance. Electrical cones with a profile modified to give better agreement with the mechanical cone are also available (Figure 39b and c).*

One particular type of electrical cone penetrometer is the "Brecone", which has a combined 5 kN and 50 kN force measurement range (Rigden et al, 1982). It has the advantage of being able to measure cone resistances in clays containing dense sand layers without suffering damage to the more sensitive load cell.

The recently developed "piezocone", which incorporates a pore pressure transducer within an electrical cone, has also found application in some Hong Kong marine investigations (Blacker & Seaman, 1985; Fung et al, 1984; Koutsoftas et al, 1987).

### **23.3.4 General Recommendations**

The following general recommendations apply to cone penetration testing, whether undertaken with mechanical or electrical cone penetrometers :

(a) *The cone cross-sectional area should be 1 000 mm<sup>2</sup>, and the cone apex angle should be 60°.*

(b) *The friction sleeve, if present, should have a surface area of 15 000 mm<sup>2</sup>.*

- (c) *The rate of penetration should be  $20 \pm 5$  mm/s.*
- (d) *Force measurements should be accurate to within  $\pm 5\%$  of the maximum force reached in the test.*

### 23.3.5 Uses and Limitations of the Test

*The cone penetrometer test is relatively quick to carry out, and inexpensive in comparison with boring, sampling and laboratory testing. It has traditionally been used to predict driving resistance, skin friction, and the end bearing capacity of driven piles in granular soils. In recent years, the cone penetrometer test has also been used to give an indication of the continuous soil profile by interpretation of the ratio of friction sleeve and cone resistances. In addition, there is substantial published information relating cone resistance value with other soil parameters.*

*The cone penetrometer test is also the preferred substitute for the standard penetration test in soil conditions where results of the latter test are suspect, and where hard driving is not anticipated. The test is also commonly used as a rapid and economical means of interpolating between boreholes. Although it may be possible to estimate the type of soil through which the cone is passing as described above, it is preferable to carry out the test in conjunction with some other means of determining the nature of the soil present.*

Cone penetration is limited by both the safe load that can be carried by the cone, and the thrust available for pushing it into the ground. It is also limited by the compressive strength of the inner rods; some machines are capable of crushing the inner rods before the rated capacity of the machine is reached. Because of limited cone capacity, penetration normally has to be terminated where dense sand or gravel, highly to moderately decomposed rock, or cobbles are encountered. For this reason, cone penetration testing in Hong Kong has been limited to the Recent alluvial and marine sediments.

### 23.3.6 Presentation of Results

*Results are normally presented graphically with cone resistance (and local skin friction where a friction jacket cone is used) plotted against depth. The friction ratio, defined as (friction resistance/cone resistance)  $\times 100$ , may also be plotted against depth. This ratio is used to assist in interpreting the soil type penetrated. Suitable scales for plotting the results are given in ISSMFE (1977).*

## 23.4 Static-dynamic Probing

The standard penetration test is rather insensitive in loose materials and is not truly relevant to cohesive soils. On the other hand, the cone penetrometer is of limited use when dense or stiff layers are encountered. The static-dynamic test combines the two methods (Sherwood & Child, 1974).

Part V

Field and Laboratory Tests

## 24. Field Tests

### 24.1 General

*Field tests are generally desirable where it is considered that the mass characteristics of the ground would differ appreciably from the material characteristics determined by laboratory testing. These differences generally arise from several factors, the most important of which are the extent to which the laboratory samples are representative of the mass, and the quality of the sample that can be obtained for laboratory testing. Factors affecting sample quality are dealt with in Chapter 12 and attention is drawn to factors affecting the representative nature of a laboratory sample. These factors are partly related to the insitu conditions of stress, pore pressure and degree of saturation, and can be altered from an unknown insitu state by the sampling processes. Consequently, their influence cannot be accounted for in laboratory testing.*

*The material tested insitu by a field test is analogous to a laboratory sample, and can be considered as a 'field sample'. The insitu conditions of a field sample may be affected by the process of gaining access to the test position (e.g. digging a trial pit) but, generally, the effect is very much less than for a laboratory sample.*

*More obvious, however, are the controlled effects of the nature, orientation, persistence and spacing of discontinuities (Geological Society, 1972), the nature of any infilling, and the size of sample required for it to be representative. To ensure that they are representative, the selection and preparation of samples in the field is subjected to the same requirements as for laboratory samples. Considerable attention should be given in the field to these aspects, because, generally, fewer field tests can be carried out than laboratory tests.*

*The size of sample tested in a field test will depend on the nature of the ground and type of test, and may vary from a fraction of a metre, such as in the insitu triaxial state of stress measurements, to several metres for field trials, to one or two kilometres in the pumping test.*

*Field tests may therefore be necessary where the preparation of representative laboratory samples is complicated by one or more of the following conditions :*

- (a) The spacing of the discontinuities in the mass being considered is such that a sample representing the mass, including the discontinuities, would be too large for laboratory test equipment. The discontinuities are assumed to govern the geomechanical response of the mass relative to the scale of the engineering structure concerned.*
- (b) There is difficulty in obtaining samples of adequate quality owing to the lack of cohesion or irreversible changes in mechanical properties, resulting from changes in pore pressure, degree of saturation and stress environments during sampling and from physical disturbance resulting from the sampling procedure.*

- (c) *There is difficulty in determining the insitu conditions such as those of pore pressure, degree of saturation, and stress environments for reproduction in the laboratory testing.*
- (d) *Sample disturbance due to delays and transportation from remote sites is excessive.*

The locations and levels of all field tests should be fully recorded during the execution of the work. The records should be such that the locations and levels can be readily incorporated into the report on the investigation (see Sections 10.5 and 40.2.8).

Some field tests are relatively inexpensive and are undertaken on a routine basis (e.g. field density tests described in Chapter 27, the various borehole and penetration tests previously described in Chapters 21 and 23, and the index tests described in Section 24.2). Other field tests are expensive and must be designed specifically to account for both the nature of the works and the character of the ground mass. These latter tests should not be undertaken before a comprehensive understanding of the geology and nature of the ground has been obtained.

## **24.2 Rock Strength Index Tests**

### **24.2.1 Point Load Strength**

The point load strength index test measures the strength of rock material by means of a concentrated load applied to specimens of rock core or irregular lumps of rock (Figure 40). The test gives an indirect measure of the tensile strength of the rock, which has been correlated with the uniaxial compressive strength (Bieniawski, 1975; Broch & Franklin, 1972; Norbury, 1984). The test results are a useful aid to rock description and classification (GCO, 1988). The point load strengths of some Hong Kong rocks are discussed by Gamon (1984b), Irfan & Powell (1985) and Lumb (1983).

A standard test procedure has been recommended by the ISRM (1985). Specimens of rock core can be tested in either an axial or diametral mode, as can irregular lumps of rock, provided specified shape criteria are met. The test results are dependent on the size of the specimen tested, and a 50 mm standard reference diameter has been selected for the reporting of results.

The test is intended to measure primarily the intact strength of the rock material, and specimens for testing should therefore be selected to meet the necessary shape criteria without incorporating discontinuities. Similarly, the failure surface from each test should be examined, and if the failure passes along a discontinuity, the test result should be discarded.

The main advantages of the point load test are that a large number of tests can be completed rapidly, with minimal sample preparation. The test equipment is easily portable, and by testing samples of the same material in various orientations, indications of strength anisotropy and tensile (splitting) strength of discontinuities can be obtained.

Point load tests can be carried out in the field or in the laboratory. In either case, the visual examination and logging of samples described in Section 36.3 should be undertaken prior

to testing, as the test is destructive.

### 24.2.2 Schmidt Hammer Rebound Value

The Schmidt impact hammer can be used to measure the hardness of rock. This device, originally developed to measure the hardness of concrete, measures the rebound of a spring-loaded piston from a metal anvil resting on the surface to be tested. The height of the piston rebound is taken as an empirical measure of rock hardness, and this value has been correlated with rock and weathered rock properties (Hencher & Martin, 1982; Hucka, 1965; Irfan & Powell, 1985).

The Schmidt hammer is a portable, hand-operated device and is available in two models, i.e. the L type (impact energy of 0.735 N-m) and the N type (impact energy of 2.207 N-m). The N Schmidt hammer is more robust, and generally to be preferred for field testing of rock exposures. Brown (1981) recommends a standard test method for the type L hammer, but the recommendations are equally applicable to type N hammers.

Although the Schmidt hammer is quick and easy to use, great care should be taken when testing weak rocks, or any rock surface which is rough, cracked or fissured. In such cases, it is recommended that a number of seating blows are taken initially, to ensure a good contact between the rock surface and the hammer head. Poole & Farmer (1980) concluded that reliable values could be obtained by ignoring artificially low readings and selecting peak rebound values from a minimum of five consecutive impacts at a point. The Schmidt hammer is relatively insensitive on very weak rocks which yield rebound values below 10, and it cannot be used on rock core unless the core is held in a heavy vice or a steel cradle.

The Schmidt hammer test provides a rapid quantitative assessment of rock hardness and is suitable for use in trial pits or caisson excavations, or on surface exposures. Use of the test results is discussed further in Geoguide 3 (GCO, 1988).

## 24.3 Infiltration Tests

The limiting infiltration rate for water entering the soil can be determined with a double ring infiltration test (Figure 41). The test is commonly carried out at the bottom of a trial pit or caisson. Water is fed from graduated bottles to the exposed soil surface in the inner ring, and to the annular space between the rings. The amount of water flowing out of the bottle is measured with time. The flow under steady-state conditions is used to determine the limiting infiltration rate (Figure 42). Because of the percolating water from the outer ring (the 'buffer zone'), water within the inner ring is constrained to infiltrate vertically into the ground, resulting in a flow with approximately unit hydraulic gradient. Therefore, the limiting infiltration rate is roughly equal to the 'saturated' field permeability of the soil. In practice, complete saturation of the ground may not occur due to entrapped air in the soil voids, in which case the test result will only give a lower bound value for the saturated permeability (Schmid, 1966). The test can be performed at successive depths to give a complete permeability profile.

It is also possible to perform simpler single ring infiltration tests and crude soakaway

tests (i.e. timing a known water head loss in a steel tube, hole or trial pit of standard dimensions). However, it must be appreciated that no buffer zone is provided in such tests to encourage vertical infiltration. The results may be useful in a comparative sense but should not be regarded as an indication of the true permeability of the soil.

## 25. Pumping Tests

### 25.1 General Principles

*In principle, a pumping test involves pumping at a steady known flow from a well and observing the drawdown effect on groundwater levels at some distance away from the pumped well. In response to pumping, phreatic and piezometric levels around the pumping well will fall, creating a 'cone of depression'. The permeability of the ground is obtained by a study of the shape of the cone of depression, which is indicated by the water levels in the surrounding observation wells. The shape of the cone of depression depends on the pumping rate, the duration of pumping, the nature of the ground, the existence, or otherwise, of intermediate or other boundaries, the shape of the groundwater table, and the nature of recharge.*

*From the data obtained from the test, the coefficients of permeability, transmissivity and storage can be determined for a greater mass of ground than by the use of the borehole tests described in Chapter 21. The results can be used in the evaluation of dewatering requirements and groundwater resources, as well as in the design of positive groundwater cut-offs. It should be noted that a given coefficient of transmissivity can result from many different distributions of permeability with depth. If the test is intended for the evaluation of permeability in the design of dams and other similar projects where seepage is an important consideration, the use of down-the-hole velocity profiling at constant outflow can provide a permeability profile of the ground.*

*Pumping tests can be expensive, requiring adequately screened and developed pumping and observation wells, suitable pumping and support equipment, and personnel. Care should be taken therefore to design a suitable test programme. Before attempting to carry out a pumping test, reliable data should be obtained on the ground profile, if necessary by means of boreholes sunk especially for the purpose. The geological units encountered may then be grouped into hydrological units on the basis of permeability (Leach & Herbert, 1982).*

*The natural groundwater conditions should be determined by careful monitoring over a sufficient period before the pumping test. Ideally, the conditions should be stable during the test; if they are not, the fluctuations have to be recorded.*

Fluctuations can be caused by rainwater infiltration, tides, groundwater extraction from wells, and nearby construction activities. This is particularly important in highly permeable ground subject to rapid recharge.

*The interpretation of the data from a pumping test can be complicated and is much affected by the inferred ground conditions and by the influence of any boundaries. Where necessary, expert advice should be sought.*

In Hong Kong, pumping tests have been used occasionally to determine hydrogeological parameters (as described above) but are more often carried out for the purpose of estimating the yield of water wells. They are also conducted occasionally to provide data for the design of major dewatering schemes associated with the construction of deep basements. The possible effects on adjacent ground and structures, e.g. settlements and inducement of negative skin-friction on piles, should be carefully considered before conducting a pumping test (see



Section 8.3.2(e)). Pumping test proposals for private developments must be submitted to the Buildings Ordinance Office for approval and consent prior to the commencement of works (see Appendix A.8).

## 25.2 Groundwater Conditions

*There are two main types of groundwater conditions, confined and unconfined, and these should be recognized for analytical and design purposes.*

- (a) Confined. If the ground under investigation is fully saturated and the water is confined under pressure between two impermeable layers, then confined conditions are said to exist.*
- (b) Unconfined. If the original phreatic level is everywhere below the upper surface of the aquifer, then unconfined conditions are said to exist.*

*Intermediate between the above two groundwater conditions is a third called the semi-confined condition. In this case, fully saturated ground is overlain by material of significant but lower permeability, and significant leakage takes place across the boundary in response to pumping. Analysis of data from semi-confined conditions is possible, but the condition is less commonly encountered than the other two types.*

The three types of groundwater conditions may be recognized by the test response (BSI, 2010).

[Amd GG2/01/2017]

## 25.3 Test Site

*Although the choice of test site may be dictated by practical considerations, such as access and availability of existing boreholes, the site should be representative of the area of interest. The hydrological conditions should not change appreciably over the site. It is essential that discharged water is not able to return to the ground under test.*

## 25.4 Pumped Wells

*Pumped wells should be of sufficient diameter to permit the insertion of a rising main and pump of a suitable type and capacity, together with a standpipe and velocity meter, if required. They should be provided with an adequate well screen, and filter pack where necessary, to prevent the withdrawal of fine particles from the surrounding soil. The minimum borehole diameter which will achieve this purpose is often 300 mm. It is desirable that they penetrate the full depth, of the water-bearing zone being tested. Where the ground is composed of two or more independent horizons, each should be tested separately. Where fully penetrating conditions do not exist, the data have to be corrected before analysis. In all cases, the screen intake area should be such as to ensure that the maximum velocity of water entering*

*the well is not greater than about 30 mm/s to ensure that hydraulic well losses are of an acceptable level.*

*If, during the test, changes in the shape of the cone of depression that are due to extraneous causes are a significant fraction of those due to pumping, then the resulting estimate of permeability may become unacceptable. Such influences can be corrected by monitoring (Walton, 1962), both before and during testing. Where possible, and within the limitations set by the permeability, the pumping rate should be chosen so that resulting changes in water levels are much greater than those due to extraneous causes, thus minimizing the effects of the latter on the results.*

*Suction pumps can be used where the groundwater does not have to be depressed by more than about 5 m below the intake chamber of the pump, and drawdown can be increased by setting the pump in a pit. For greater depths, submersible pumps are preferable. The more permeable the ground, the greater the pump capacity required to produce measurable drawdowns in the observation wells.*

*It is essential that the discharge is kept constant for the duration of the test and that all the water level observations are related to a time-scale referred to the onset of pumping.*

*It is particularly important to maintain a constant pumping rate when vertical flow velocities in the pumping well are being measured for the purpose of determining the relative permeabilities of specific horizons in the ground under test. The pumping rate may be controlled by a gate valve in the discharge line or by varying the speed of the pump, or both. The rate of flow from the pump may be measured by a flow or orifice meter, or by a notch tank with automatic recording.*

*It is important that pumping wells should be adequately developed. Development of a well is the process by which particles surrounding the screen are rearranged, with coarsening grade and better uniformity towards the screen; it can be achieved in a number of ways (Johnson, 1982). Maximum development is indicated when the ratio of pumping rate to fall in water level in the pumping well reaches a maximum. Fine particles from the ground are removed during development, resulting in a stable, porous and permeable medium surrounding the well.*

Successful well development results in reduced hydraulic head losses as the water enters the pumping well but, in any case, these losses (well losses) should be accounted for in the analyses of test results.

In Hong Kong, pumping tests are sometimes carried out in large diameter hand-dug caissons. This has several disadvantages, as the caisson may only partly penetrate the aquifer being tested, and the well storage is large. Also, high well losses are often incurred, and for this reason observation wells should always be used in conjunction with pumping tests in caissons.

## 25.5 Observation Wells

Observation wells should have an internal diameter large enough to permit insertion of a diameter or other water-level measuring device, but if the diameter is too large this may cause a time lag in drawdown. Standpipes with an internal diameter of 19 mm are often used. Observation wells should penetrate the same ground as the pumping well and should permit entry of water from the full depth of ground being tested. If there is any risk that fine soil particles may clog the observation wells, they should be surrounded by a suitably graded filter material.

*Although the permeability of the ground may be estimated from the pumping well drawdown data alone, more reliable values are obtained using data from one or more observation wells. The recommended minimum number of observation wells required to yield reasonably representative results is four, arranged in two rows at right angles to each other. Their distances from the pumping well should approximate to a geometrical series. It may be necessary to add more wells if the initial ones yield anomalous data. If linear boundary conditions are associated with the site (e.g. river, canal or an impermeable subsurface bedrock scarp, fault or dyke), the two rows of observation wells are best arranged parallel and normal to the boundary.*

*The minimum distance between observation wells and the pumping well should be ten times the pumping well radius, and at least one of the observation wells in each row should be at a radial distance greater than twice the thickness of the ground being tested. However, unless the pumping rate is very high, and the duration of pumping long, particularly in low permeability ground under unconfined conditions, falls in water levels may be small at such distances. Preliminary calculations using assumed permeabilities estimated from borehole data will help to indicate the likely response in observation wells to pumping. Hence the appropriate distance of the observation wells from the pumping well and the timing of observations can be assessed.*

*In addition to the observation wells described above, it is desirable to have an additional standpipe inside the pumping well in order to obtain a reliable record of the drawdown of the well itself.*

*Depths to water levels should be measured to within  $\pm 5$  mm. This usually means that measurement devices have to be checked at regular intervals against, for example, a graduated steel tape.*

The water levels can be monitored with either an electrical dipmeter or an automatic well level recording system.

## 25.6 Test Procedures

*Once the character of fluctuations and other extraneous influences has been established, the test programme designed and the wells developed, pumping of the ground at a constant rate should commence. Water levels in all wells are then measured with respect to time since commencement of the pumping. Typically the frequency of measurement might be at 1 min*

*intervals for the first 15 min and at regular logarithmic intervals thereafter. Sometimes, shorter intervals may be required initially. Therefore each well may have to be monitored by independent observers for the first 100 min, and then by one or more observers thereafter. In distant observation wells where head changes are small, automatic recorders can be used, although these generally require observation wells of 100 mm diameter or greater.*

The measurements should be plotted during the course of pumping to evaluate the quality of the data, the nature of the response, and the required duration of pumping. Johnson (1982) and Kruseman & DeRidder (1980) have discussed the time requirements for both steady and non-steady state pumping tests carried out on confined, semi-confined and unconfined aquifers.

*In all cases, water levels should continue to be monitored with respect to time from cessation of pumping until recovery of levels to the original values is complete. As in the drawdown phase, recovery data should be taken at 1 min intervals for 15 min following cessation of pumping and thereafter at regular intervals on a logarithmic scale.*

## **25.7 Analysis of Results**

There are two forms of analysis of pumping test data :

- (a) **Steady state.** If pumping continues long enough, water levels cease to fall, and the hydraulic condition of the ground is said to be in a steady state with respect to time.
- (b) **Non-steady state.** Before equilibrium is reached, water levels fall at a changing rate with respect to time and the hydraulic condition of the ground is said to be in a non-steady state.

The simpler form of analysis is the steady state type, but the necessary duration of pumping can be significantly longer than that necessary for non-steady state analysis. The analysis technique is also dependent on aquifer response, i.e. whether confined or unconfined conditions are present. A summary of some of the available analysis techniques is given in BSI (2012c), and these are further discussed by Johnson (1982) and Kruseman & DeRidder (1980).

[Amd GG2/01/2017]

A number of simplifying assumptions regarding ground conditions are required in whatever method of analysis is used, and it is therefore common that the actual drawdown data collected in the field may lead to ambiguities in the analysis. This may be caused by inhomogeneity and anisotropy in the aquifer, or the presence of unknown barriers to groundwater flow. In some cases, high flow velocities around the well may invalidate the use of Darcy's law, upon which most methods of analysis are based.

## 26. Discontinuity Surveys

### 26.1 General

Discontinuities such as joints usually control the mechanical behaviour of a rock mass. Where surface exposures or outcrops of the rocks exist, a joint survey may be carried out to assess the risk of joint-controlled instability, e.g. in cut slopes and excavations.

The methods and equipment used to carry out a joint survey are described in ISRM (1978), and techniques for analysing the results are given by Hoek & Bray (1981). Further guidance on joint surveys and description can be found in Geoguide 3 (GCO, 1988).

During analysis, care must be taken that rare but critical joints are not overlooked by the usual statistical methods of data sorting (Beattie & Lam, 1977; Brand et al, 1983). An experienced supervising engineer or geologist (see Section 15.3) should visit the site to examine in detail the nature of those discontinuities that have been identified as critical. The slope or exposure should be examined again during construction for the presence of unfavourable joint sets not identified in the survey. The need to carry out a joint survey for cut slopes formed in soils derived from insitu rock weathering should also be considered; unfavourably orientated relict joints may cause slope failures.

### 26.2 Discontinuity Surveys for Rock Cut Slopes

[Amd GG2/01/2017]

In the mapping of discontinuities, special emphasis should be given to identifying adverse geological features and dilated rock joints or open joints with infill or sediment, which could indicate progressive slope deterioration and/or adverse groundwater conditions. The key characteristics of these adverse geological features should be adequately mapped. In addition, care must be taken to ensure that apparently minor, but kinematically significant joint sets or individual joints are not overlooked (Evans & Irfan, 1991). However, sample of joint measurements should be representative of the overall picture, in order to avoid collection of large quantities of measurements that may have little relevance to stability assessment.

[Amd GG2/01/2017]

Large-scale rock slope failures have occurred involving laterally persistent discontinuities such as sheeting joints. The waviness of a sheeting joint could involve local steepening of the joint dip angle behind the slope face, which can be difficult to detect in practice (HCL, 2001).

[Amd GG2/01/2017]

Site-specific laboratory tests may be carried out to characterise the operational joint shear strength where considered necessary, with consideration given to the roughness and persistence of the joint, influence of any weak infill, etc. (Hencher, 1981).

[Amd GG2/01/2017]

### 26.3 Discontinuity Roughness Surveys

[Amd GG2/01/2017]

It is often not possible to account fully for discontinuity roughness in an insitu or laboratory shear test, due to limitations on the length of the joint plane which can be tested in

standard equipment, and on the selection of representative sampling points. Therefore, discontinuity roughness surveys are often undertaken to supplement such tests.

Procedures for undertaking and interpreting field roughness surveys are described in detail by the ISRM (1978). The most commonly-used method is to employ a set of thin circular plates of various diameters. These are taken into the field and a series of discontinuity dip directions and dip angles are measured in turn for each plate when placed on the discontinuity surface. The accuracy of these measurements is improved by taking a large number (e.g. 50 or more) readings for each plate and by ensuring that the discontinuity surface is relatively large and reasonably representative of a particular joint set. The results are often presented as contoured polar diagrams on an equal-area stereographic projection. The smallest base plate will give the largest scatter of readings and the largest roughness angles (and vice versa). A graphical plot of maximum roughness angles versus plate diameter is often used to assess the sensitivity of the relationship between roughness angle and length of potential shear displacement along the discontinuity plane.

The main engineering use of a field roughness survey is for the assessment of design values of discontinuity shear strength (Hoek & Bray, 1981). This is achieved by combining the survey results with data from direct shear tests or assumed basic friction angles. Methods for interpreting the contribution of roughness to discontinuity shear strength in Hong Kong granite are discussed by Hencher & Richards (1982); the application of a roughness survey at an engineering site in North Point, Hong Kong is described by Richards & Cowland (1982).

## 27. Field Density Tests

### 27.1 General Principles

Field testing of soil bulk density is a common and useful procedure. When coupled with moisture content determinations, the test results can be used to obtain the dry density of the soil. A major use of such testing is for the control of compaction of embankments, where it forms the 'field' portion of a relative compaction test (the other portion of the test being carried out in the laboratory). Field density testing may also be used in evaluation of insitu materials and old fills, where it provides a direct determination of density that is independent of the sampling disturbance normally present in laboratory tests.

In essence, most of the available methods of field density testing depend on the removal of a representative sample of soil, followed by determinations of the mass of the sample and the volume it occupied prior to removal. However, the nuclear methods discussed in Section 27.7 are an exception to this general rule. Mass determinations are relatively straightforward but accurate measurements of sample volume are more difficult and may lead to significant variations in test results, depending on the technique used, which is in turn dependent on the nature of the soil being tested.

All the test methods described below require physical access to the soil insitu. Therefore, they are normally restricted to soil within 2 to 3 m of the surface, although they can also be used equally well within caissons or shafts. Use of the nuclear probe technique is an exception to this depth limitation.

The methods described generally measure bulk density, and representative moisture contents are required if the dry density is to be calculated. Ideally, the weight of the moisture content sample should be determined on site, then the sample should be transported to the laboratory for oven drying in accordance with GEO (2017a). Otherwise, the entire sample has to be preserved in an airtight container until it can be weighed. Alternatively, a rapid determination of moisture content can be made using a microwave oven, the 'Speedy' moisture tester, or one of the rapid methods described in BSI (1990). However, all such rapid determinations should be thoroughly correlated with the standard oven-drying technique for the particular soil type being tested. In any case, moisture content samples should be as representative and as large as practical, or several determinations should be made in order to obtain a reliable mean value. [Amd GG2/01/2017]

With the exception of the water replacement method for rock fill (see Section 27.8), the methods outlined below are described further in Geospec 3 (GEO, 2017a) and BSI (1990) or the ASTM standards quoted. [Amd GG2/01/2017]

### 27.2 Sand Replacement Method

GEO (2001) describes two variations on the sand replacement method. *The first, employing a small pouring cylinder, is used for fine and medium grained soils. The second, using a large pouring cylinder, is suitable for fine, medium and coarse grained soils.*

[Amd GG2/01/2017]

*These methods are unsuited to soils containing a high proportion of very coarse gravel or larger particles because the apparatus is not large enough to cope with a hole of sufficient size to obtain a representative sample; also the sand will tend to run into the interstices of the material, thus leading to inaccurate results. The method cannot be used in soils where the volume of the hole cannot be maintained constant. It also loses accuracy in soils where it is difficult to excavate a smooth hole because the sand cannot easily occupy the full volume.*

The test should not be carried out when compaction plant is operating nearby, or when ground vibrations are present.

The calibration of the sand is sensitive to humidity and should be checked daily. The sand should be oven-dried and stored for about a week for the moisture content to reach equilibrium with atmospheric humidity. After each test, the sand should be dried and sieved to remove any extraneous material before further use.

### **27.3 Core Cutter Method**

*The core cutter method is described in BSI (1990). The method depends upon being able to drive a cylindrical cutter into the soil without significant change of density and to retain the sample inside it so that the known internal volume of the cylinder is completely filled. It is therefore restricted to fine soils that are sufficiently cohesive for the sample not to fall out, and to completely decomposed rock free of large fragments. The method is generally less accurate than the sand replacement method because driving the sampler tends to alter the density of the soil.*

[Amd GG2/01/2017]

### **27.4 Immersion in Water Method**

[Amd GG2/01/2017]

*The immersion in water method is described in BSI (1990). It is applicable to any soil where representative samples occur in discrete lumps that will not disintegrate during handling and submersion in water. In practice the method is restricted mainly to cohesive soils.*

[Amd GG2/01/2017]

### **27.5 Water Displacement Method**

*The water displacement method is described in BSI (1990). It is an alternative to the immersion in water method and has the same limitations.*

[Amd GG2/01/2017]

### **27.6 Rubber Balloon Method**

*A description of the rubber balloon, or densometer, method can be found in ASTM (1985b). In essence it is a water replacement test with a rubber membrane retaining the water. It is an alternative to the sand replacement method with the limitation that it is not suitable for very soft soil which will deform under slight pressure, or in which the volume of the hole cannot be maintained constant. The ASTM standard does not describe the apparatus in precise terms*



*and hence the method could be used for coarser soils than the sand replacement method if a sufficiently large apparatus were constructed.*

The densometer allows a simpler and more rapid determination of density than the sand replacement method, but the apparatus is somewhat cumbersome and may be prone to leakage (GCO, 1984).

## **27.7 Nuclear Methods**

Nuclear methods of density measurement at shallow depth are described in ASTM (1985e). They do not measure density directly, and calibration curves have to be confirmed for each soil type, which involves measuring the densities of representative samples of the soils concerned by one of the direct methods discussed in Sections 27.2 to 27.6. However, once this has been done, and provided there are no significant changes in soil, the method is very much faster than the others. It is therefore most suited to situations where there is a continuous need for many density determinations over a period of time, and where the soils do not vary to any significant extent. It should be noted that the density determined by nuclear methods is not necessarily the average density within the volume involved in the measurement.

The measurement of moisture content at shallow depth by the nuclear technique is described in ASTM (1985h). In many modern nuclear instruments, measurements of both density and moisture content are made simultaneously. As the moisture content determination is indirect, it is essential that nuclear determinations (which often overestimate moisture content of local soils obtained by the oven-drying method) are correlated with conventional oven-drying moisture determinations for the particular soil being investigated.

Nuclear measurements of density and moisture content can be made at depth by employing a nuclear probe within a borehole (Brown, 1981; Meigh & Skipp, 1960). This technique may be particularly useful when undisturbed samples cannot be obtained readily, such as in some fine granular soils. As only indirect measurements are obtained, the limitations mentioned above for shallow nuclear techniques apply equally well to the nuclear probe.

All nuclear techniques utilize radioactive materials, and appropriate safety precautions must be followed. The use and handling of nuclear instruments should be fully in accordance with the manufacturer's recommendations and applicable regulations (see Appendix E).

## **27.8 Water Replacement Method for Rock Fill**

*The methods quoted in Sections 27.2 to 27.7 can rarely be used in materials containing a substantial fraction larger than coarse gravel, and the water replacement method, which is described below, has been devised for such soils. Although it is not covered by any standard specification, some experience in its use has been gained. In principle, it consists of excavating a hole large enough to obtain a representative sample, lining the hole with flexible polyethylene or similar sheeting and then determining the volume of water required to fill the hole. A 'density ring' is used as a template for the size of hole and also as a datum from which*

to measure water levels. This is made up from structural steel plate, and for rock fill may be 2 m in diameter, 200 m in height and provided with a mark on the inside.

The procedure is to place the ring on a levelled surface, packing sand under it where it is not in contact with the soil, and weighing it down with sandbags. Polyethylene sheeting is placed over the ring, pressed into it and smoothed out as far as possible so as to line completely the cylindrical cavity so formed. A measured supply of water is then run into it and the volume required to fill it up to the mark on the density ring is noted.

The polyethylene sheeting is then removed, the hole excavated, and the spoil loaded into skips for subsequent weighing and grading, if required. Care is needed in the excavation to ensure that the density ring is not disturbed and, to this end, the edge of the excavation should be kept at least 150 mm away from the inner edge of the ring. The sides of the hole should be trimmed to minimize projecting stones.

Polyethylene sheeting is then placed over the ring and hole and partially secured with sandbags. Water is then run in from a measured source and, at the same time, the polyethylene lining is fed into the hole, helping it into crevices and minimizing folds. This continues until the water level is again up to the mark on the inside of the density ring. The difference in the two volumes is then a measure of the volume of the hole. It is customary to allow the water to remain in the hole for a period of time to see whether there is any fall of water level, which would indicate leaks in the polyethylene lining.

The accuracy of the results of this test can be enhanced by attention to the following details :

- (a) The hole should be made as large as possible.
- (b) The sides of the hole should be made as smooth as possible.
- (c) As thin a gauge of polyethylene as possible should be used, consistent with it not fracturing too easily. Two sheets of 0.1 mm polyethylene laid together have been found to be satisfactory. It is not quite so flexible as one sheet of the same thickness, but is less prone to punctures.

Accounts of the practical use of this method can be found elsewhere (Frost, 1973; Stephenson, 1973).

## 28. Insitu Stress Measurements

### 28.1 General

*The stresses existing in a ground mass before changes caused by the application of loads or the formation of a cavity within the mass are referred to as the initial insitu state of stress. These stresses are the resultant of gravitational stress and residual stresses related to the geological history of the mass.*

*Data on the initial insitu state of stress in rock and soil masses before the execution of works are increasingly important in design, more particularly when using finite element analysis. The most favourable orientation, shape, execution sequence and support of large and complex underground cavities and the prediction of the final state of stress existing around the completed works are dependent on knowing the initial insitu state of stress. Measurements of insitu stress have shown that in many areas the horizontal stresses exceed the vertical stress, which in turn often exceeds that calculated assuming that only gravity is acting on the ground mass.*

*Measurement of insitu stress in soils may be made, although the equipment used generally provides an estimate of horizontal stress only. In order that both total and effective stresses can be estimated, it is usual to measure the pore water pressure in addition to the total stress.*

*The interpretation of insitu stress measurements requires specialist experience.*

### 28.2 Stress Measurements in Rock

The methods available are generally based on induced stress changes, achieved in some cases by over-coring or slotting an instrumented test area.

*Over-coring is used for measurement within the rock mass, whereas slotting is used for surface stress measurements. Measurements taken have to be adjusted to take account of the redistribution of stresses as a result of formation of the borehole or slot, and, in the case of underground works, when the measurement is made in the zone of influence of the main access, such as an adit. The accuracy of most methods of measurement of insitu stress in rock limits their use to locations where the rock cover is at least 75 m. Stress measurements may also be determined from the measurement of displacements of the walls of a tunnel, or of an exploratory adit, close to the working face.*

*With the exception of the static equilibrium method (Morgan & Panek, 1963), the available techniques generally require that the material in which the measurements are made behaves in a near elastic, homogeneous and isotropic manner, and that it is not excessively fractured or prone to swelling as a result of the effects of drilling water. For the over-coring methods, the elastic behaviour is assumed to be reversible, the elastic constants being obtained from laboratory tests.*

*Stress measurements may be made using electrical strain gauges, photo-elastic discs,*

*solid inclusions and systems for measuring the diametral change of a borehole. Some equipment is designed to measure stress change with time, or stress change due to an advancing excavation, whereas other equipment is designed to obtain an instantaneous measurement of stress. The technique selected has to be chosen in relation to the rock material and mass quality. Strain gauges cannot be glued reliably to highly porous or wet rock.*

Special methods for measuring and interpreting the uniaxial, biaxial or triaxial state of stress in a rock mass are described in BSI (2010). [Amd GG2/01/2017]

*The report on the results of insitu stress measurement should include information on the following :*

- (a) Location of test and direction and depth of the boreholes, method of drilling and diameters of cores.*
- (b) Depth below ground level of the point of measurement.*
- (c) Geological description of the rock material and rock mass.*
- (d) Type and sizes of strain gauges, and strain readings to the nearest 10 micro-strain.*
- (e) Temperature and humidity at the test location, and temperature of the flush water if applicable.*
- (f) The modulus of elasticity,  $E$ , and Poisson's ratio,  $\nu$ , of the rock sampled from each stress measurement area, as determined from static laboratory testing of core (preserved at insitu moisture content) over the appropriate stress path.*
- (g) The six components of stress ( $\sigma_x$ ,  $\sigma_y$ ,  $\sigma_z$ ,  $\tau_{xy}$ ,  $\tau_{yz}$ ,  $\tau_{zx}$ ) at each point to the nearest 100 kPa.*
- (h) The three principal stresses and their directions (to the nearest degree), related to both a borehole or adit axis system and a global axis system.*
- (i) Colour photographs of the cores or test location.*
- (j) Date of measurement and date at which the excavation passes the point of measurement.*

### **28.3 Stress Measurements in Soils**

*The analysis of the response of soil masses to applied loads requires reliable data on their strength and deformation characteristics, and, as these are stress dependent, a knowledge of the insitu state of stress assists in their evaluation by laboratory testing.*

*Direct insitu measurements of the initial state of stress in soils is difficult because the disturbance created by gaining access to the ground mass is generally non-reversible, and several times that produced by a stress-relieving technique. The accuracy of most instruments that have been developed suffers because of the disturbance created in the ground on insertion.*

*It is usual to measure only horizontal stress, and to make assumptions concerning the level of vertical stress based on the overburden depth. Only total stress may be measured; therefore, to determine the effective stress conditions, the pore water pressure at the test level has to be measured or assumed. Methods of determining pore water pressure in the field are discussed in Section 20.2.*

In soft clays, hydraulic pressure cells have been carefully jacked into the ground, or installed in a pre-bored hole (Kenney, 1967). The "Camkometer", a self boring pressuremeter, reduces disturbance to a minimum by fully supporting the ground it penetrates (Windle & Wroth, 1977). The total horizontal insitu stress may then be obtained by measuring the contact pressure. Facilities to measure pore pressure are available in the same instrument. Hydraulic fracturing has also been used to estimate minimum horizontal stresses in soft clay (Bjerrum & Anderson, 1972).

In large excavations, pressure cells are sometimes used to measure the contact pressure between the soil and a retaining structure. The type and position of a cell should be chosen with great care, because the introduction of the cell into the soil causes a redistribution of the stresses around it, and the errors depend on the geometry of the instrument. Details of the types of cells available and the problems that may be encountered when using them are given by Brown (1981) and Hanna (1985). Some of the factors that affect the accuracy of contact pressure cells are discussed by Pang (1986).

## 29. Bearing Tests

### 29.1 Vertical Loading Tests

#### 29.1.1 General Principles

*In situ vertical loading tests involve measuring the applied load and penetration of a plate being pushed into a soil or rock mass. The test can be carried out in shallow pits or trenches, or at depth in the bottom of a borehole, pit or adit (see Section 21.6). In soils, the test is carried out to determine the shear strength and deformation characteristics of the material beneath the loaded plate. The ultimate load is often not attainable in rocks, where the test is more frequently used to determine the deformation characteristics.*

*The test is usually carried out either under a series of maintained loads or at a constant rate of penetration. In the former, the ground is allowed to consolidate under such a load before a further increment is applied; this will yield the drained deformation characteristics and also strength characteristics if the test is continued to failure. In the latter, the rate of penetration is generally such that little or no drainage occurs, and the test gives the corresponding undrained deformation and strength characteristics.*

*It should be emphasized that the results of a single loading test apply only to the ground which is significantly stressed by the plate; this is typically a depth of about one and a half times the diameter or width of the plate. The depth of ground stressed by a structural foundation will, in general, be much greater than that stressed by the loading test. For this reason, the results of loading tests carried out at a single elevation do not normally give a direct indication of the allowable bearing capacity and settlement characteristics of the full-scale structural foundation. In order to determine the variation of ground properties with depth, it will generally be necessary to carry out a series of plate tests at different depths. These should be carried out such that each test subjects the ground to the same effective stress level it would receive at working load.*

*Where tests are carried out in rock, blasting for rock excavation may seriously affect the rock to be tested. This effect can be minimized by using small charges, and by finishing the excavation by hand methods.*

#### 29.1.2 Limitations of the Test

*The main limitation of the test lies in the possibility of ground disturbance during the excavation needed to gain access to the test position.*

*Excavation causes an unavoidable change in the ground stresses and may result in irreversible changes to the properties which the test is intended to study. In spite of this effect, the moduli determined from plate tests are more reliable and often many times higher than those obtained from standard laboratory tests. In a project which involves a large excavation, e.g. a building with a deep and extensive basement, the excavation may cause disturbance to the ground beneath, with a consequent effect on the deformation characteristics. In such a case, it will be necessary to allow for this unavoidable disturbance when interpreting the results of loading tests.*

*When carrying out the test below the prevailing groundwater table, the seepage forces associated with dewatering may affect the properties to be measured. This effect is most severe for tests carried out at significant depths below the water table in soils and weak rocks. It may therefore be necessary to lower the water table by a system of wells set outside and below the test position.*

### **29.1.3 Site Preparation**

*It is necessary to ensure that any material loosened or softened by the excavation is removed and that the plate will lie in direct planar contact with the sample surface. It is essential that this surface is undisturbed, planar and free from any crumbs or fine loose debris. Where access is possible the surface is best prepared by hand; elsewhere, special tools are required to trim and prepare the surface from a remote point. As the sample preparation involves stress relief and exposure to different temperature and humidity conditions, the delay between setting up and testing should be minimized and the time lag should be reported with the results.*

*The even transference of load onto the test surface can best be achieved by setting the plate on a suitable bedding material, which usually consists of cement mortar or plaster of paris. Where the test is being performed to measure the deformation characteristics of a relatively stiff material, considerable care is required in setting the plate, and a series of bedding layers may be needed (Ward et al, 1968). Changes in water content of the ground being tested should be kept to a minimum.*

### **29.1.4 Test Arrangement**

*The test is subject to scale effects. Several plate sizes and shapes are used, the most common being circular plates ranging from 300 mm to 1 000 mm in diameter. The choice depends on the problem being studied. In rocks, plates larger than 1 000 mm diameter may be used, depending on the jointing frequency. The test arrangement used by the U.K. Building Research Establishment is shown in Figure 43 and is fully described elsewhere (Marsland, 1971; 1972; Ward et al, 1968).*

*The need sometimes arises to measure displacements in the ground below the plate (Marsland & Eason, 1973; Moore, 1974). The plate has to be rigid and the direction of the resultant applied load has to be vertical and without eccentricity. The loading may be applied directly by kentledge or jacking against a reaction system provided by means of kentledge, tension piles or ground anchors. Where kentledge is used, it should be supported on a properly designed frame or gantry such that there is no possibility of the load tilting or collapsing. The foundations of this frame or gantry should be sufficiently far away from the sample not to affect its behaviour to any significant extent. Where tension piles or ground anchors are used, they should be sited sufficiently far away from the sample so as to have no significant influence on its behaviour. The normal practice is to maintain a minimum distance of three times the plate diameter from the centre of the plate to the centre of the pile. The amount of kentledge or jacking resistance that needs to be provided is governed by the purpose for which the tests are carried out and also, to some extent, by economic considerations.*

*In general, the nearer the soil or rock under the plate approaches the point of shear failure, the more worthwhile are the data derived from the tests. The test is sometimes conducted in a similar fashion to the constant rate of penetration (CRP) test for piles (ICE, 1978).*

*The penetration or deflection of the plate should generally be measured at the centre and the edge of the plate. In order to minimize the effect of poor bedding and sample disturbance, the displacement of the material at some depth beneath the prepared test surface can be determined by inserting reference datum rods anchored at various depths (Wallace et al, 1969). Such measurements are intended to provide more realistic data on the mass behaviour of the ground; they are usually taken through a central hole in the loaded plate.*

*The displacement of the plate is related to a fixed datum. This often consists of a reference beam supported by two foundations positioned outside the zones of influence of either the loaded area or the reaction area. The deflection-measuring equipment has to be set up in such a way that any tilting of the plate will not cause errors in the measurements. Dial gauges are often used, and the rods transmitting the displacements of the plate should incorporate a ball joint or other similar device to eliminate the effects of bending. The reference beam and measuring devices should be protected from the direct rays of the sun and from wind by means of tarpaulins or other forms of shelter; errors of measurement can easily arise from these causes.*

A comparable arrangement for performing the test in an adit is given in BSI (2010).

[Amd GG2/01/2017]

### **29.1.5 Measurements**

*(1) **Applied Forces.** The load on the plate is best measured by means of a load cell, which should be capable of reading to an accuracy of 1% of the maximum load. It is advisable to have the cell calibrated over the anticipated range of loading before and after the test programme.*

*(2) **Displacements.** Displacements in the direction of load application may be measured by dial gauges or electrical transducers and the readings can be taken continuously if required. Displacements should be measured to an accuracy of 0.1 mm.*

*(3) **Time.** Records of time for the various stages of setting-up and testing are required, particularly where cyclic loading and creep tests are being carried out.*

*(4) **Temperature.** The measurement of temperature will be required in the event that corrections to the settlement or load readings are considered necessary.*

### **29.1.6 Test Methods**

*(1) **General.** The test is most frequently used to measure the ultimate bearing capacity. In cases where settlements and elastic deformation characteristics of the ground need to be determined, as in rock foundations, care should be exercised to work at stresses that are relevant.*



*The observation of deformation, particularly at low stress levels, requires the utmost care in sample preparation and setting-up if meaningful results are to be achieved. The errors that can be introduced by sample disturbance and inaccuracies of measurement can often be similar in size or greater than the data sought.*

*The effect of sample disturbance can be reduced, to some extent, by carrying out preliminary cycles of loading and unloading. The maximum load in these cycles should not exceed the intended load. The rate of loading should be sufficiently rapid to prevent any significant consolidation or creep. After two or three cycles, the stress/settlement graph will generally tend to become repeatable, and the test can then be extended to the main testing programme. The data from the preliminary load-cycles give an indication of the effect of the sampling disturbance. The undrained deformation moduli, as measured after preliminary load-cycling, generally give a more reliable indication of the true properties of the undisturbed ground.*

*(2) **Maintained Load.** The load is usually applied in equal increments, with each increment being maintained until all movement of the plate has ceased, or an acceptably low rate of increase has been reached. The increments are continued up to some multiple of the proposed working load, to failure or to the full available load. When the test is carried out to investigate the deformation characteristics of the ground, it is preferable to carry out preliminary load cycling. Cycles of unloading and reloading may also be carried out at various stages in the main test to gain some indication of the relative amounts of reversible (i.e. 'elastic') and irreversible deformation that have occurred. If the rate of unloading and reloading is sufficiently rapid, the slope of the load/deformation curve may be used to determine the undrained deformation modulus, or an approximation to it. However, in relatively permeable ground this may not apply.*

*(3) **Constant Rate of Penetration.** Constant rate of penetration tests are more suitable for soils. Such tests are described by Marsland (1971) for plates ranging from 38 mm to 868 mm diameter, using a penetration rate of 2.5 mm/min. Where the maximum bearing capacity is not clearly defined, the value of the bearing pressure at a settlement of 15 per cent of the plate diameter is used. If the undrained deformation modulus is required, the plate diameter should be greater than 750 mm, but it is preferable to carry out a separate test with the load applied incrementally at a rapid rate.*

*(4) **Creep.** The measurement of creep under sustained loads is sometimes carried out in connection with the design of foundations which are highly stressed or where the structures concerned are particularly sensitive to settlement (Meigh et al, 1973). If the structure is to be subjected to fluctuating loads, the test programme will probably include cyclic loading.*

### **29.1.7 Analysis of Results**

*The assumptions made for the analysis are that the material is homogeneous, elastic, isotropic and that the classic equation for the penetration of a rigid circular plate on a semi-infinite plane surface applies :*

$$S = \frac{\pi q}{4} B \frac{(1 - \nu^2)}{E} \dots\dots\dots (8)$$

where *E* is the elastic modulus,  
*q* is the pressure applied to the plate,  
*S* is the average settlement of the plate,  
*B* is the diameter of the plate,  
*ν* is Poisson's ratio.

This equation can be used when the test is carried out either at the ground surface or in a pit whose plan dimensions are at least five times those of the plate (Ireland et al, 1970). If the test is carried out at the end of a borehole, the expression becomes :

$$S = \frac{\pi q}{4} B \frac{(1 - \nu^2)}{E} I_d \dots\dots\dots (9)$$

where *I<sub>d</sub>* is a depth correction factor (Burland, 1969). When the test is carried out in an adit, other modifications to this equation will be required depending on the extent and planarity of the tested surface (Carter & Booker, 1984). Finite element analysis can sometimes be applied to problems where rigorous solutions are not available, although the problem of choosing representative soil parameters to put into the analysis still remains. An equation for calculating the modulus at any depth beneath the centre line of the loaded plate is given elsewhere (Benson et al, 1970; Wallace et al, 1970). For jointed rock, Poisson's ratio can be assumed to be between 0.10 and 0.25 for practical purposes.

For cohesive soils, an estimate of the undrained shear strength, *C<sub>u</sub>*, can be obtained from the plate test carried out in a borehole by using the following equation :

$$C_u = \frac{q_u - \gamma H}{N_c} \dots\dots\dots (10)$$

where *q<sub>u</sub>* is the ultimate bearing capacity of the soil under the plate. When this is not clearly defined the bearing pressure at a penetration of 15% of the diameter is used,  
*γ* is the bulk density of the soil,  
*H* is the height of soil above test level,  
*N<sub>c</sub>* is the bearing capacity factor. For a rigid circular plate at the base of a deep shaft of the same diameter as the plate, *N<sub>c</sub>* is assumed to have a value of 9.25. However, if the plate has a significantly smaller diameter than the shaft, or if the depth is less than four times the plate diameter, the value of *N<sub>c</sub>* may be smaller and approaches 6.15 for a circular surface load. Some allowance should be made for side shear on the plate where this is appropriate.

**29.1.8 Interpretation of Results**

The correct interpretation of the behaviour of the mass of ground under investigation

*requires a careful examination of the results, not only of the loading tests, but also of other data concerning the ground (Sweeney & Ho, 1982). Depending on the objectives of the investigation, such data might include the geological structure, the nature and distribution of discontinuities, and the variability of the ground.*

*Several deformation moduli can be obtained from these tests, depending on the method used and the application (Brown, 1981). The results obtained will reflect the effects of the width and frequency of the discontinuities and will give an indication of the mass behaviour under loading. The stress level at which these parameters should be examined will depend on the working stress levels. In the case of tests on rock in adits, it may be necessary to consider the insitu stresses in the test sample.*

*The moduli to be used for design purposes should be those which relate to the ground at the time of construction and after it has been affected by the construction procedures; for example, a deep excavation might affect the deformation moduli of a soil, and blasting may affect the properties of a rock. Sometimes, the effect of a construction procedure may be sufficiently severe to justify the examination of alternative methods of construction.*

*On completion of the test, full identification of the material beneath the loaded area should be carried out by sampling and testing in the laboratory. Results obtained from these tests will in many cases assist in extrapolating the test results to other areas on the site.*

## **29.2 Horizontal and Inclined Loading Tests**

*Basically, horizontal and inclined loading tests are the same as vertical loading tests, and are carried out and analysed in a comparable way (see Section 21.6.10). Loading tests at a preferred orientation are carried out to investigate particular characteristics of the ground. They are frequently carried out in rock for investigations concerning tunnels and underground excavations (Brown, 1981; Carter & Booker, 1984). A simple lateral loading test, carried out between the opposite sides of a trial pit or caisson using an hydraulic jack, forms a very convenient means of measuring the insitu modulus and shear strength of soils. Interpretation of the elastic modulus of soil from lateral loading tests should follow the advice given by Carter & Booker (1984). Care should be taken to support the weight of the jack and other loading equipment so as to prevent the application of shearing forces to the test area.*

## **29.3 Pressurized Chamber Tests**

*The test is carried out in an underground excavation or length of tunnel and consists of charging the chamber with water under various pressures and measuring the deformation moduli of the surrounding ground. The test is generally carried out for projects involving tunnels carrying water under pressure.*

*The test site should preferably form part of the actual excavation, or be of the same size and parallel to the axis in representative ground. The length of a test section should be at least five times the excavated diameter; unless allowance can be made for the end effects. The method of excavation used should be capable of producing a formed surface of similar quality*

to the actual excavation. In order to ascertain whether the modulus determined is drained, partially drained or undrained, it is necessary to know the drainage conditions which applied during the test.

## **29.4 Insitu California Bearing Ratio (CBR) Tests**

### **29.4.1 General**

The CBR method of flexible pavement design is essentially an empirical method in which design curves are used to estimate a pavement thickness appropriate to the CBR of the soil. There is no unique CBR of a soil, and in any CBR test the value obtained depends very much on the manner in which the test is conducted. The design curves are usually based on one carefully specified method of measuring the CBR, and this is usually a laboratory method. The parameter required for the design of flexible pavements is the CBR attained by the soil at formation level after all necessary compaction has been carried out, the pavement has been laid and sufficient time has elapsed for equilibrium moisture content to become established. Before embarking on insitu CBR tests, it is therefore necessary to consider carefully how relevant they will be to the proposed design method, and whether the condition of equilibrium moisture content is likely to pertain.

### **29.4.2 Test Method**

The test is carried out by the method described in BSI (1990). The load is generally applied through a screw jack using the weight of a vehicle as jacking resistance, and deflections are measured by dial gauges carried on a bridge with independent foundations resting on the ground well clear of the test area. [Amd GG2/01/2017]

### **29.4.3 Limitations and Use of Test**

The test is unsuitable for any soil containing particles of longest dimension greater than 20 mm because the seating of the plunger on a large stone may lead to an unrepresentative result. The test is of dubious value with sands because it tends to give results much lower than the laboratory tests on which the design charts are based. This is because of the confining effect of the mould in the laboratory tests. The test is most suited to clay soils, subject always to the soil under test being at equilibrium moisture content. The moisture content at a depth of 1 to 2 m below ground surface, where the soil is normally unaffected by seasonal moisture content changes, often gives a good indication of the equilibrium moisture content, provided that there is no significant change of soil type. An alternative is to carry out the test directly beneath an existing pavement having identical subsoil conditions to those of the proposed construction; this method has been used with some success for the design of airfield pavements.

Insitu CBR tests have sometimes been carried out in conjunction with insitu density and moisture content tests and then linked with laboratory compaction tests. A careful study of all the resulting data may allow a reasonable design parameter to be chosen for suitable soils. Attempts have sometimes been made to use the test as a means of controlling the compaction of fill or natural formations, but they have not usually been successful and the procedure cannot

*be recommended.*

## 30. Insitu Direct Shear Tests

### 30.1 General Principles

In this test, a sample of soil or rock is prepared and subjected to direct shearing insitu. The applied stresses and boundary conditions are similar to those in the laboratory direct shear test. The test is generally designed to measure the peak shear strength of the intact material, or of a discontinuity (including a relict joint in soil), as a function of the normal stress acting on the shear plane. More than one test is generally required to obtain representative design parameters.

*The measurement of residual shear strength can present major practical problems in arranging for a sufficiently large length of travel of the shear box, but a useful indication of residual strength may be obtained by continuing the test to the limits of travel of the apparatus. In certain applications, the test may be designed to establish the strength of the interface between concrete and rock or soil.*

Insitu shear tests on soil may be carried out either within boreholes (Bauer & Demartinecourt, 1982; Handy & Fox, 1967) or near the ground surface (Brand et al, 1983b). Equipment for testing close to the ground surface in trial pits may be adopted to enable testing to be carried out within deep excavations, large diameter shafts or caissons. Insitu shear tests on specific discontinuities in rock may also be conducted using similar equipment; the results may be used to confirm the strength of discontinuities derived from laboratory tests and field roughness surveys (see Section 26.2).

### 30.2 Sample Preparation

*Samples are generally prepared at the bottom of pits or trenches in soil. Adits are more common for rock testing. The excavations permit access to the material at the zone of interest, and in many cases provide a suitable means of setting-up the reaction for the applied forces.*

The orientation of the sample and the forces applied to it are generally governed by the direction of the forces which will become effective during and on completion of the works, but modified to take account of the orientation of significant discontinuities. In many cases, however, to facilitate the setting-up of the test, the sample is prepared with the shear plane horizontal. The normal and shearing stresses are generally imposed as forces applied normally and along the shear plane. However, an inclined shear force passing through the centre of the shear plane may be preferred as this tends to produce a more uniform distribution of stress on the shear surface (Brown, 1981).

*As a rough guide, the sample dimension should be at least ten times that of the largest particle; in rock, the sample size should reflect the roughness of the rock discontinuity being tested. For stronger rocks, the sample can be rendered with suitably strong cement and reinforced concrete to ensure adequate load distribution. The equipment should be of robust construction. Samples between 300 mm and 1 500 mm square have been used for testing soil and weak rocks. Larger samples may be required in ground containing boulders or in coarse fill material.*

*Great care has to be exercised in preserving the environmental conditions when forming the excavation. Excavation techniques which would affect the discontinuities in the sample test area should be avoided, e.g. those which give rise to crumbling, fracturing or excessive dynamic shock loading. Hand sawing, cutting and diamond drilling should be used to prepare and trim the sample. Adequate protection from the elements should be provided. Final exposure and trimming of the sample to fit the loading frame and the testing itself should all be completed with minimum delay to avoid possible significant changes in the moisture and stress conditions of the sample. If tests are carried out below the water table, precautions should be taken to avoid the effects of water pressure and seepage (see Section 29.1.2).*

*Where it is intended to test one discontinuity only, care has to be taken to avoid disturbance to the surface of the discontinuity, and to prepare the sample so that the forces are applied correctly in the plane of the discontinuity. The spatial orientation of the discontinuity should be defined by dip direction and dip measurements.*

*Where drained conditions are required, suitable drainage layers can be inserted around the sample and on the loaded upper surface.*

With the borehole shear device, there is no sample preparation as such, but care is required during the formation of the borehole so as to limit disturbance of the surrounding soil (Bauer & Demartinecourt, 1985).

### **30.3 Test Arrangement**

*The equipment for applying the normal load can consist of weights, kentledge, hydraulic rams, flat jacks acting against the excavation roof, or an anchor system. The reaction system should ensure the uniform transfer of the normal loads to the test sample and minimum resistance to the shear displacement, e.g. by the use of low-friction devices such as ball seatings or rollers (Brown, 1981). A porous piston or other suitable medium can be used to distribute the load where drained conditions are required. The alignment of the force needs to be maintained during the test.*

*The shearing force application system should ensure that the load is applied uniformly over the plane of shearing, and that the load and geometrical centroids are matched to eliminate movement. Where an inclined shear force is required, the resultant of the shear force should pass through the centre of the base of the shearing plane (Brown, 1981). If a constant normal load is required for this type of test, suitable reduction has to be made to the applied normal load during testing to compensate for the increase in vertical component with increasing shear force. The shear force application can be developed by similar means to the normal loading. In both cases, care has to be taken to ensure that the ground reaction does not extend to the sample. The reaction system can frequently be provided by the excavation sidewalls. In certain cases, it may be necessary to provide the shear force by traction on a system anchored by piles or cables. Sufficient travel in the shear force application system should be provided so that the complete test can be run without interruption.*

### 30.4 Measurements

*Provision should be made for the following :*

- (a) The applied forces should be capable of being measured with an accuracy of  $\pm 2\%$  of the maximum forces reached in the test.*
- (b) Shear, normal and lateral displacements should be measured. Sufficient travel should be provided to run the complete test without the need to reset the gauges. The anchorage datum of each gauge needs to be rigid and set up at a point sufficiently remote that it is not affected by the forces applied during testing.*
- (c) Steps should be taken to guard against the effects of changes in temperature. Alternatively, temperatures should be measured and any sensitive equipment should be calibrated.*

### 30.5 Test Methods

The stresses applied in the testing programme should be within the range of the relevant working stresses at the site, including those applied by the final structure, if appropriate. Where drained test conditions are required, a consolidation stage is necessary to allow the pore water pressures to dissipate under each increment of normal load. The rate of consolidation should be monitored, as this is useful for determining the rate of shearing (Brown, 1981). For drained tests, the rate of shearing has to be sufficiently slow to ensure that induced pore pressure changes are a very small proportion of the shear stress. At best, the appropriate shear rate can only be estimated prior to the test, and experience gained in similar soil or rock conditions and with similar test configurations is beneficial.

On completion of the test, full identification of the material sheared should be carried out by visual examination, sampling and laboratory testing. Photographs of the shear surface form a useful record of the test conditions and may assist in the interpretation of results.

### 30.6 Analysis of Results

Graphs of consolidation behaviour (if applicable) and shear force (or stress) plotted against both normal and shear displacements are prepared in the analysis. The peak shear stress and corresponding shear and normal displacements may then be obtained and related to the applied normal stress. When failure occurs in a plane dipping at an angle to the applied shearing force, this should be accounted for in the analysis (Bishop & Little, 1967).

For tests on discontinuities in rock, the results from individual tests should not be extrapolated to the rock mass without confirmation that the surface tested is representative of the overall roughness of the discontinuity (see Section 26.2).



## 31. Large-scale Field Trials

### 31.1 General

*Large-scale field trials are carried out in such a manner that the ground is tested on a scale and under conditions comparable with those prevailing in the project under investigation. However, such trials are likely to be costly in terms of instrumentation, the requirements for purpose-made equipment and technical support. The methods and types of instrumentation available for monitoring field tests are given in brief outline in the following sections, together with some of the more common large-scale field trials used to obtain geotechnical data for design and construction.*

*Large-scale field trials involve the principles of site investigation embodied in this document, and would usually include the use of ground investigation techniques already described. Large-scale field trials are not standard tests, and should be designed to suit the individual requirements of the proposed works and the particular ground on which or within which they are to be performed. On large projects, field trials can provide the necessary design parameters, as well as valuable construction data on excavation, handling and placing, resulting in considerable savings and enhanced safety. Such methods and trials can be usefully extended into the construction stage, and also to the monitoring of the interrelated response of the ground and structure after completion under the working conditions.*

### 31.2 Methods of Instrumentation

Several techniques can be used in ground investigation to monitor displacements and strains associated with known or suspected ground movements resulting from slope failures, foundation displacement, subsidence and ground response in large-scale field trials (BGS, 1973; Brown, 1981; BSI, 2009; GCO, 1984; Hanna, 1985). A review of instruments commonly used in Hong Kong is given by Coleman (1984). Handfelt et al (1987) have described the performance of the instrumentation used in an offshore test fill (see also Foott et al, 1987).

[Amd GG2/01/2017]

*Ground movements are generally associated with stress redistribution and pore pressure changes which are characteristic of the particular ground. Total stress can be monitored using total pressure cells (see Chapter 28), while normal and shear stresses can be measured by special transducers (Arthur & Roscoe, 1961). The techniques for the measurement of pore pressure response are covered in Sections 20.2.3 to 20.2.6.*

*Ground movements are generally measured in terms of the displacement of points which can be positioned on the surface of the ground or within the ground mass. The absolute movement of a point has to be referred to a stable datum, and sufficient measurements should be taken to define movement in three dimensions if this is required. Some of the commonly-used techniques permit the movement or relative displacement of points to be referenced to arbitrary horizontal and vertical planes. This relative movement can be used to obtain strain.*

Surface observations of ground movements can be made by an accurate survey (Cole & Burland, 1972). An accuracy of  $\pm 0.5$  mm can be achieved in levelling (Froome & Bradsell,

1966) and  $\pm(5 \text{ mm} + 5 \text{ ppm})$  for distance measurement using electro-optical instruments (Mayes, 1985). Care has to be taken to position datum points away from the effects of movements due to load and water changes.

*Vertical movements can be observed by means of settlement gauges with an accuracy of  $\pm 0.1 \text{ mm}$  (Bjerrum et al, 1965); more details are given by Dunnicliff (1971). Multipoint displacement measurements can also be employed (Burland et al, 1972). The use of vertical tubes gives an accuracy of about  $\pm 3 \text{ mm}$  (Penman, 1969). A full profile-measuring technique which uses a torpedo traversing a flexible tube is described by Penman & Michell (1970). Telescopic tubes, inclinometers and tensioned wires anchored in boreholes at stable points can also be used for measuring strains or displacements.*

*Lateral movements can be measured by offsets and triangulation. Rods, telescopic tubes and tensioned wires can also be employed. Where a torpedo is used, access from both ends of the tubing is preferable.*

Photogrammetric techniques can be used to survey inaccessible sites such as steep slopes and ravines (Borehers, 1968). The accuracy of measurements taken by a photogrammetric method is about  $\pm 1/10000$  of the camera to object distance under normal working conditions (Cheffins & Chisholm, 1980).

### **31.3 Trial Embankments and Excavations**

*The construction of trial embankments may serve three purposes. First, the quality and compaction characteristics of available borrow materials can be determined at the field scale and compared with laboratory test results; second, the characteristics and performance of placing and compacting equipment can be investigated; third, the strength, and settlement characteristics of the ground on which the embankment is placed can be examined. Failure of a trial embankment will usually not be of major consequence, and therefore a trial bank may be constructed so as to induce failure deliberately, either in the embankment alone or in the embankment and the foundations. However, any installed instrumentation may be destroyed. Such failures sometimes occur in an unexpected manner, and the engineer should take precautions to ensure that no injury to persons or unexpected damage is caused. The value of such a failure is that back analysis (see Chapter 32), can be used to check strength parameters. Bishop & Green (1973) have described the development and use of trial embankments.*

*Compaction trials can include experiments with variable borrow materials, layer thicknesses, amounts of watering and amounts of work performed in compaction. Measurements should be made of insitu density and water content; the results should be compared with those from laboratory compaction tests, to obtain a specification standard, and with insitu borrow pit densities, so that the degree of bulking or volume reduction can be estimated for given quantities (BSI, 2009). Trials of equipment can also be undertaken. Care should be taken not to vary too many factors at the same time, otherwise the effects of variation of an individual factor cannot be estimated.*

[Amd GG2/01/2017]

*Trial excavations yield information on the material excavated and the performance of excavating equipment; they also permit more detailed examination of the ground than is*

*possible from borehole samples. Excavations can be constructed such that failures are caused deliberately; hence they can sometimes be used to test the short-term stability of excavated slopes. However, failures in deep excavations are correspondingly more dangerous than failures of fills, and increased vigilance is needed.*

*If the maximum information is to be gained, adequate instrumentation of trial embankments or excavations is essential, together with continuous observation (see Section 31.2). The scale of trial embankments or excavations needs careful consideration. Clearly, the more closely the size of the trial approaches that of the prototype, the more directly applicable will be the results obtained from the trial.*

### **31.4 Construction Trials**

*In many projects, considerable value can be derived from trials carried out before the commencement of the permanent works. Such trials permit the evaluation of the procedures to be adopted and the effectiveness of the various expedients. As with all large scale testing, a prior knowledge of the characteristics of the ground is essential. The results of the trial will often permit an assessment of the properties of the ground and hence enable a correlation to be made with other results obtained from routine ground investigation methods.*

*A wide range of construction methods is commonly tested in trials, e.g. pile tests, ground anchor tests, compaction tests for earthworks, experimental shafts and adits for tunnels, grouting, trial blasts for explosives and dewatering.*

## 32. Back Analysis

### 32.1 General

*Natural or man-made conditions on a site sometimes create phenomena which may be used to assess parameters that are otherwise difficult to assess or which may be used as a check on laboratory measurements. Examples of such phenomena are slope failures and settlement of structures. It may then be possible, starting from the observed phenomena, to perform a back analysis, for example, in the case of a slope failure, to arrive at shear strength parameters which fit the observed facts. Back analysis of settlements is also possible, but care is required in assessing actual loadings and the times for which they have acted.*

All applications of back analysis should be accompanied by rigorous geological and geotechnical investigations, which should include a thorough review of the history of the problem and examination of relevant climatic and groundwater records. Back analysis should only be used if it is applicable to the problem in hand and the ground conditions encountered. All parameters that can have a significant effect on the analysis should be carefully considered. Since it is very rare for a unique analytical solution to be obtained, sensitivity studies are normally carried out to assess the effect of parameters that cannot be obtained by direct means. The pitfalls of back analysis are discussed further by Leroueil & Tavenas (1981).

### 32.2 Failures and Design of Slope Preventive or Remedial Works

[Amd GG2/01/2017]

In Hong Kong, numerous landslides are caused by intense rainfall every year, and back analysis is sometimes carried out to derive shear strength parameters as part of the design procedure for slope remedial or preventive works. However, a note of caution is necessary regarding the interpretation and use of the results. Although the failure itself can be studied in great detail after the event, it is extremely rare to have accurate information on the specific ground conditions at the time of failure, particularly with regard to pore water pressures (Hencher et al, 1984). For this reason, back analysis may be just as useful in permitting a rational, qualitative assessment of the failure mechanism as in deriving information specifically on shear strength parameters for use in design (Hencher & Martin, 1984).

Whilst the back analysis approach serves as a useful yardstick for assessing the mass shear strength, this approach should not be used in isolation. The application of the back analysis approach for the design of slope preventive or remedial works should be accompanied by rigorous geotechnical investigation, including ground investigation, laboratory testing and engineering geological mapping in order to provide a more reasonable basis for making judgement on suitable mass shear strength parameters.

[Amd GG2/01/2017]

Extreme care must be taken to avoid the adoption of unduly high shear strength parameters derived from back analysis which may have incorporated the effect of suction. Where the ground mass is relatively homogeneous with no corestones or boulders, binding effect of tree roots, three-dimensional effects of the slope geometry, etc., back-analysed shear strength parameters which are higher than those determined from laboratory tests on saturated specimens should not be used.

[Amd GG2/01/2017]

The notion that the continued stability of an existing slope may be proven by past rainstorms should be treated with caution. Factors such as deterioration of the slope condition, progressive slope deformation and possible changes in environmental conditions (e.g. enhanced infiltration through a dilapidated hard surface cover, leakage from water-carrying services, etc.) should be carefully considered before one can confidently count on past performance in the use of the back analysis approach. In particular, the use of the back analysis approach to derive mass shear strength parameters for designing upgrading works should be done with extreme caution where the proposed works involve the replacement of a hard surface cover with a vegetated cover. [Amd GG2/01/2017]

When back analysis is used, it should be for deriving the possible range of strength parameters. If more than one predominant soil type (e.g. fill and CDG) is involved, the back analysis approach, if used, should be applied to assess the strength parameters for the particular soil type with greater uncertainty (e.g. high spatial variability, difficulty in retrieving representative samples for laboratory testing, etc.), whilst the strength parameters for the other soil type(s) should be determined by other means such as conventional laboratory tests. [Amd GG2/01/2017]

The back-analysed shear strength parameters for a certain slope section should not be applied to other sections of the slope in the case of a sizeable slope with highly varied characteristics (e.g. in terms of slope geometry, geology, catchment characteristics, etc.) along its length. Different sets of strength parameters may need to be obtained by back-analysing suitably selected sections. [Amd GG2/01/2017]

Back analysis of a landslide or a slope with signs of distress can be useful where there is sufficient and reliable information on the ground conditions and the geometry of the rupture surface. This can assist in the diagnosis of failure mechanisms and examination of the likely combinations of soil shear strength and groundwater conditions at the time of failure. For the design of remedial works, however, the back-analysed groundwater conditions prevailing at the time of the landslide should not necessarily be taken as the design groundwater conditions. This is because the groundwater response for rainstorms with differing characteristics in terms of intensity, duration and return period may be different, and because the hydrogeological setting of the failed slope may be altered by the landslide and/or the proposed remedial works. [Amd GG2/01/2017]

The above guidance on the use of the back analysis approach is also generally applicable to the design of preventive or remedial works for retaining walls. [Amd GG2/01/2017]

### 32.3 Other Cases

Although back analysis is carried out typically when slope failures or significant ground movements have occurred, it can be useful in other cases where conventional predictive methods may not lead to realistic design solutions. An example of this application in Hong Kong is in the design of preventive works for existing steep slopes formed in soils derived from insitu rock weathering. In such cases, conventional slope stability analysis will often yield factors of safety less than unity even when a slope has stood safely without signs of distress for many years. Shear strength parameters obtained from back analysis of hypothetical failure

surfaces through the existing slope often allow a more realistic form of stability improvement to be made than would be possible from conventional analysis. However, it is very important to check that the assumptions made in the back analysis are valid; for example, the failure surfaces selected should be realistic and the proposed works should not result in any substantial change to the form of or loadings on the slope. Similarly, in the prediction of settlements in variable ground, or in ground from which it is impossible to retrieve representative samples, back analysis of settlement data from an adjacent site in similar materials may be the only satisfactory means of producing sensible predictions.

### 33. Geophysical Surveying

#### 33.1 General

*Geophysics is a specialized method of ground investigation. Where a geophysical investigation is required, the engineer directing the ground investigation (see Section 15.2) would normally entrust it to an organization specializing in this work. This organization will usually advise on the details of the method to be used and will interpret the results once they have been obtained into a form that can be used directly by the directing engineer. There is advantage in maintaining a close liaison between the directing engineer and the geophysicist since difficult ground conditions may give rise to problems of interpretation and hence a need for further investigation. Engineering applications of geophysics have sometimes been disappointing, and it is important that the type of information supplied by the investigation is suitable for the project (Griffiths & King, 1983; Ridley Thomas, 1982). The intention of the following sections is to list the various geophysical methods which are currently available, to give some indication of the problems they may help to solve and to indicate the limitation of each method. The applicability of the various geophysical methods is summarized in Table 11.*

*Adequate borehole control is essential for the interpretation of geophysical observations, which are best included in a ground investigation employing more conventional methods.*

*The aim of most geophysical methods of ground investigation is to locate some form of subsurface anomaly where the materials on either side have markedly different physical properties. These anomalies may take, for example, the form of a boundary between two rock types, a fault, underground services, or a cavity. In the initial stages it will almost always be necessary to check the true nature of these anomalies by physical means, normally by boreholes. Once a correlation between the geophysical test results and the underground phenomena has been established, the geophysical investigation may then yield useful results rapidly and economically. It follows that, where there is no distinct change in physical properties across the anomaly, the geophysical investigation may not detect a boundary. Geophysical methods can also be used to deduce soil and rock parameters; when this is done, the results obtained should always be confirmed by directly measured parameters.*

*Geophysical survey techniques are based on determining variations in a physical property, such as electrical conductivity (resistivity), variations in density (gravimetric), magnetic susceptibility (magnetic) or velocity of sonic waves (seismic). Anomalies such as near surface disturbance (often known as 'noise') are common in the urban environment and may limit the usefulness of geophysics in these areas. Moreover, a geophysical anomaly does not always match an engineering or geological boundary, and often there is a transition zone at a boundary. This may lead to a margin of uncertainty, for example, in determining the depth of sound rock that has a weathered boundary or overlying boulders.*

*Good results in geophysical techniques are obtained when the geological conditions are relatively simple, with large clear-cut contrasts in the relevant physical properties between the formations. However, less favourable ground conditions may still warrant consideration of geophysics, particularly at an early stage in an investigation, because of the relatively low cost and high speed of the methods, e.g. to assist in eliminating alternative explanations of the geology. It may at times be necessary to use two or more methods on a trial and error basis*

*to ascertain which yields the most reliable results.*

*Geophysical surveying is generally used in a ground investigation to make a preliminary and rapid assessment of the ground conditions. In favourable conditions, a geophysical technique may indicate variations and anomalies which can be correlated with geological or man-made features. The results of geophysical survey can then be used to interpolate the ground conditions between boreholes, and to indicate locations where further boreholes are needed so that the significance of a geophysical anomaly can be investigated.*

## **33.2 Land Geophysics**

### **33.2.1 Resistivity**

*This technique is used for investigating the simpler geological problems. A current is usually passed into the ground through two metal electrodes, and the potential difference is measured between two similar electrodes (BSI, 1990). With suitable deployment of the electrodes, the system may be used to provide information on the variation of geo-electrical properties with depth (depth probes), lateral changes in resistivity (constant separation traversing) or local anomalous areas (equipotential survey), e.g. karst features, disused tunnels or shafts. The unsuspected presence of electrical conductors, e.g. pipes or cables, under the site will, of course, render the results unreliable. The interpretation of the results obtained by this method does not always provide a definite solution, particularly as the number of subsurface layers increases, because it involves a curve matching technique which requires the assumption of idealised conditions.*

[Amd GG2/01/2017]

### **33.2.2 Gravimetric**

*In ground investigation, the gravity survey is normally limited to locating large cavities or faults. Precision levelling and positioning of the instrument at each station is essential. With the more accurate instruments now available, it is possible that the gravity survey method will become a useful tool in locating hidden shafts and smaller cavities.*

### **33.2.3 Magnetic**

*Local changes in the earth's magnetic field are associated with changes in rock types. In suitable circumstances, the technique may locate boundaries (e.g. faults or dykes) between rocks which display magnetic contrasts. However, its main use in the civil engineering field is the location of buried metalliferous man-made objects, such as cables or pipelines. It can sometimes be used for locating old mine shafts and areas of fill. In using this method to detect the location of faults or dykes, it is, of course, essential to eliminate the possibility that the anomaly detected is in truth buried metal.*



### 33.2.4 Seismic

*The seismic technique, either reflection or refraction, may be used to locate subsurface boundaries which separate materials having different values of sonic wave velocities. In carrying out geophysical surveys on land, the refraction method is the one most frequently used. It involves producing seismic waves, either from a small explosive charge or from a mechanical source (e.g. a hammer), and measuring accurately the time taken for them to travel from the point of origin to vibration detectors (geophones) at varying distances away.*

*The greatest use of this technique is in the determination of bedrock level (McFeat-Smith et al, 1986). Therefore, it is commonly used in the estimation of quantities of soft materials available from a borrow area site. One limitation of seismic refraction, however, is that when the velocity of transmission in the upper layer is greater than that below (e.g. if very compact gravel overlies a clay), then the intervening boundary cannot be detected and false layers may appear to be present. Another use of this technique is to provide wave velocity data for the assessment of insitu dynamic modulus values of rock masses (Meigh, 1977). Only rarely will the dynamic and static modulus values be the same. Environmental considerations sometimes limit the application of this test. For example, explosives cannot be used in urban areas, and where the site lies near to the source of vibrations, such as a busy road, the induced vibration may not be detectable.*

*By traversing a seismic refraction survey configuration, the resulting variation of velocity along the traverse can be used to indicate areas of different rock types or fracture zones. This information is useful in deciding the type of equipment to be used for rock excavation.*

Direct seismic measurements can also be taken between two boreholes, or from surface to borehole or borehole to surface. These techniques may be useful for assessing the properties of the intervening rock mass, and in detecting geological features such as cavities. Cross hole surveys, i.e. between boreholes, may provide the best geophysical means for detecting cavities at depth (McCann et al, 1987), but results can only be confirmed by subsequent drilling.

### 33.2.5 The Gamma Density Method

[Amd GG2/01/2017]

The principle of the Gamma Density method is to irradiate the target material with medium-high energy collimated gamma rays and to measure their attenuation between the tool source and the detectors. The attenuation is a function of the electron density of the target material, which in turn is closely related to its mass density.

[Amd GG2/01/2017]

Based on the relative density contrast between target materials, the technique can be used, within a drillhole, to identify weak layers in the ground at a practical logging speed of 1 m/min. Such weak layers include clay-rich layers, weathered seams and disturbed zones that are of comparatively lower mass density. The resolution of the method increases with the increase in relative density contrast between the target and the adjacent materials. The resolution decreases if casing is used and as the dip angle of the weak layer becomes aligned with the drillhole axis (i.e. sub-vertical in a vertical drillhole).

[Amd GG2/01/2017]

Two examples are shown in Figures 45 and 46. Figure 45 shows strong signatures for the weak clay-rich layers at locations A to D where the density contrast is high between the weak layers and the adjacent materials. In this case the method was able to identify weak layers as thin as in the centimeter range. The clay-rich layers at E to I as a whole give a strong signature in the log, but the individual layers cannot be clearly distinguished. Figure 46 shows poor correlation for those weak clay-rich layers at locations A to H where the density contrast between the weak layers and the adjacent materials is low. [Amd GG2/01/2017]

The method is most suitable for use in uncased or plastic-cased drillholes and where the relative density contrast between the target (weak layers) and adjacent materials is high. However, caution needs to be exercised in interpreting the data as the absence of a strong signature does not necessarily confirm the absence of weak layers in the ground. [Amd GG2/01/2017]

### 33.2.6 The Spectral Gamma Ray Method [Amd GG2/01/2017]

The Spectral Gamma Ray method is based on the principle that decomposition of potassium-bearing minerals leads to a progressive loss of potassium ions (K). Naturally occurring potassium contains radiogenic K. Thus the amount of radiogenic K present in the material is related to the degree of decomposition of potassium-bearing minerals in the parent rock and hence the degree of weathering of the rock mass. The Spectral Gamma Ray method produces a log of the potassium count rate along the drillhole. [Amd GG2/01/2017]

The location along the drillhole where the count rate shows a significant reduction compared to the adjacent materials can be interpreted as a more weathered, weak layer. However, interpretation of the data is dependent on the origin of the target material, which may significantly affect the potassium count rate. For instance, where a clay layer does not originate directly from the decomposition of the adjacent materials, the potassium count rate of the layer may not necessarily be lower than those of the adjacent materials. Also, if thin layers are to be identified, a slow logging speed will be required, e.g. 0.05 m/min for a resolution of 50 mm. [Amd GG2/01/2017]

This method does not require the use of any radioactive source and it can be used in drillholes lined with different types of casing. Also it is much cheaper than the Gamma Density method (about half the price based on term contract rates in 1999/2000). The Spectral Gamma Ray method, when applied to materials of the same origin and preferably backed up by site-specific calibration, can give an indication of the degree of weathering. Although the method is not as good as the Gamma Density method in identifying thin weak clay-rich layers, there is potential for it to be used in verifying ground conditions, especially in the case of a large number of drillholes without the need for sampling, e.g. drillholes for installing soil nails, raking drains, observation wells and piezometers, etc. [Amd GG2/01/2017]

The example in Figure 45 shows that the potassium count rate log gives signatures for the weak clay-rich layers at locations A, B and C. The potassium count rate log in Figure 46 is unable to identify any of the weak layers (A to H). However, the trend of increasing potassium count rate in less weathered material is evident. [Amd GG2/01/2017]

### 33.2.7 The Neutron Porosity Method

[Amd GG2/01/2017]

The principle of the Neutron Porosity method is to irradiate the target materials with fast neutrons. The neutrons collide with particles having similar mass as the neutrons in the target material, reducing their speed and becoming thermal neutrons. Within the ground, those particles that would normally have similar mass as the neutrons are mainly hydrogen nuclei. If the ground is saturated, the hydrogen content equates with water content and that in turn is related to porosity. So the neutron porosity log gives an indication of porosity if the target material is saturated.

[Amd GG2/01/2017]

Based on the relative moisture content contrast between the target materials, the technique can be used in open and steel-cased drillholes to identify weak layers in saturated ground at a practical logging speed of 1 m/min. However, in unsaturated ground, the relative moisture content between target materials does not truly reflect the porosity and misleading results will be given by the method.

[Amd GG2/01/2017]

The method does not work where plastic casing is used because the hydrogen molecules in the plastic absorb the neutrons and affect the results.

[Amd GG2/01/2017]

## 33.3 Marine Geophysics

### 33.3.1 General

*With suitable modifications of equipment, the land survey techniques, such as seismic refraction, magnetic and gravimetric techniques, may be extended to the marine environment. Of greater use, however, are the techniques that have been developed specifically for offshore work; these are described in the following three sections. It is necessary to apply tidal corrections to the data obtained, reducing them to an appropriate datum level for proper interpretation. It is also important to establish precise survey control if the capacity for detailed structural identification is to be exploited fully. Where appropriate, electronic navigation systems should be employed.*

In Hong Kong, the presence of sewage-rich seabed layers and certain naturally gassy marine mud deposits results in 'masked zones', which can severely limit the effectiveness of a geophysical survey.

### 33.3.2 Echo-sounding

*A continuous water depth profile along the track of a survey vessel is obtained by using an instrument that measures the time taken for a short pulse of a high frequency sound wave to travel from a transducer attached to the survey vessel down to the seabed and back again. Such profiles are combined to produce a bathymetric chart. However, additional control may be required to ascertain whether the sounding is reproducing reflections from soft surface sediments or higher density material underneath, and dual frequency sounders may be useful for this.*

### **33.3.3 Continuous Seismic Reflection Profiling**

*The use of continuous seismic reflection profiling should always be considered as a complementary aid to exploratory boreholes in major offshore investigations. An extension of the echo-sounding principle is used to provide information on sub-seabed acoustic reflectors which usually correspond to changes in material types. The instrumentation required, especially the types of acoustic source, depends on the local ground conditions and its choice should therefore be left to a geophysicist who has suitable experience. As a guide, the higher frequency sources such as 'pingers' and 'high resolution boomers' are generally suitable for resolving near surface layering, whereas 'standard boomers' and 'sparkers' are more suited for coarser and thicker layers. Typically, high resolution boomers have a resolution of about 0.5 m and a depth penetration of about 80 m.*

*The results may give a visual representation of geological features, but quantitative data on depths to interfaces can only be determined if velocities of transmission are known.*

*There are two main limitations to the technique. Firstly, it cannot usually delineate the boundary between two different materials that have similar geophysical characteristics; secondly, in water depths of less than about 2 m, near-seabed reflectors may be obscured by multiple reflections originating from the seabed. Other problems are described in Table 11.*

### **33.3.4 Side Scan Sonar**

*This is an underwater acoustic technique analogous to oblique aerial photography, enabling discontinuities and profiles offset from the line of traverse to be recorded for subsequent bathymetric charting by echo-sounding or other techniques. It is based on the reflection of high frequency pulses of sound by the seabed. The results provide a quantitative guide to the position and shape of seabed features and a qualitative guide to the type of seabed material. The system is particularly useful in searches for rock outcrops, pipelines, trenches and seabed obstructions, such as wrecks.*

### **33.4 Borehole Logging**

*With suitable instrumentation, certain geophysical techniques may be adapted to provide logs of boreholes that are analogous to conventional geological logs. These borehole logs may be used for geological correlation purposes across a site. Additionally, analysis of the data can assist in the assessment of insitu values of parameters such as dynamic moduli and density. The normal techniques consist of seismic (structural data), electrical (stratigraphical data), gamma gamma (density data), natural gamma (stratigraphical data) and caliper (borehole diameter data); all these techniques are discussed by Brown (1981). Experience in the use of these methods is at present relatively limited and the data obtained should always be correlated against the examination and testing of borehole samples and against the results of other insitu tests.*

### **33.5 Corrosion Testing**

*Electrical resistivity may be used to assess the corrosivity of soils towards ferrous materials. Conventional traverses with fixed intervals between electrodes enable rapid coverage of the ground and the location of areas of low resistivity. The spacing between electrodes should be appropriate to the depth of burial of the ferrous material. The conventional 'expansion' technique using "depth probes" (see Section 33.2.1) may also be used to determine the variation in soil resistivity with depth. Generally, the likelihood of severe corrosion decreases as the resistivity rises (see Chapter 13 and Table 12).*

### **33.6 Identification of Weak Layers in the Ground**

[Amd GG2/01/2017]

The Gamma Density and Spectral Gamma Ray methods (see Sections 33.2.5 and 33.2.6 for further elaboration) are recommended for use as supplementary ground investigation techniques to help to identify weak layers in the ground. These methods have been included in CEDD's ground investigation term contracts to facilitate their use in government projects.

[Amd GG2/01/2017]

Useful results may be obtained from the Neutron Porosity method (see Section 33.2.7) in identifying weak layers in ground that is saturated with water. However, in unsaturated ground, the method can give misleading results.

[Amd GG2/01/2017]

The Self Potential method, Acoustic Borehole Televiwer method, 4-arm Dipmeter method, 3-arm Caliper method and Electrical Cylinder method did not give consistent and reliable results in the identification of weak layers.

[Amd GG2/01/2017]

### 34. Principles of Laboratory Testing

*The aims of laboratory testing of samples of soil and rock may be summarized as follows :*

- (a) to identify and classify the samples with a view to making use of past experience with materials of similar geological age, origin and condition, and*
- (b) to obtain soil and rock parameters relevant to the technical objectives of the investigation.*

A thorough discussion of laboratory testing is beyond the scope of this Geoguide. However, some basic aspects are briefly reviewed in Chapters 35 to 38 as laboratory testing is considered to be a part of the ground investigation, and the overall site investigation would normally not be complete without it. Further guidance on laboratory testing of rocks and soils is given in Brown (1981) and BSI (1990) and GEO (2017a) respectively. The Geotechnical Manual for Slopes (GCO, 1984) discusses the testing of Hong Kong rocks and soils in particular. Guidance on the description and classification of Hong Kong rocks and soils is given in Geoguide 3 (GCO, 1988). [Amd GG2/01/2017]

A general understanding of the ground conditions at a site is essential before embarking on a programme of soil and rock testing. It is also necessary to consider carefully how the data obtained from the tests are to be used, and whether the information can assist in the solution of the engineering problems concerned. As general guidance, the test method to be used should have direct relevance to the engineering problem at hand and should simulate the field conditions as closely as possible.

## **35. Sample Storage and Inspection Facilities**

### **35.1 Handling and Labelling**

*The general procedures for handling and labelling of samples in the field are given in Section 19.10. Samples should be treated with equal care on arrival at the core store or at the laboratory.*

### **35.2 Storage of Samples**

*An orderly procedure should be established so that each sample is registered on arrival and is then stored away in such a manner that it can be located readily when required for examination or testing. Disturbed samples should be stored on shelves, and, where jars are used, they should be placed in purpose-made carriers. General purpose 100 mm diameter samples should be stored on their sides in purpose-made racks, while thin-walled or piston samples containing soft clays should be stored vertically with the same orientation as in the field prior to sampling. The sample storage area should be of sufficient size to cater for the number of samples being handled, without overcrowding (see also Section 19.10.1).*

### **35.3 Inspection Facilities**

*An important feature is a sufficient area for the temporary stacking of the samples, and an adequate amount of bench space for the actual inspection. The following equipment should be provided :*

- (a) an extruder for removing general purpose 100 mm diameter samples from the sampler tubes,*
- (b) an adequate number of trays to enable disturbed samples of granular soils to be tipped out for inspection, and some means of returning them quickly to their containers afterwards,*
- (c) spatulas and knives for splitting general purpose 100 mm diameter samples,*
- (d) dilute hydrochloric acid for the identification of soils and rocks,*
- (e) a water supply and appropriate sieves for washing the fines out of samples of soils to facilitate description of the coarser particles, and for cleaning rock cores and block samples,*
- (f) a balance suitable for checking that the weight of bulk samples is adequate for testing,*

- (g) a sufficient number of dustbins, or other means of disposal, to contain samples not required after inspection,*
- (h) means of resealing samples required for further use,*
- (i) washing facilities for the person inspecting the samples, so that notes can be kept as tidy as possible,*
- (j) hand lens, geological hammer, penknife, metre scale and protractor for logging cores,*
- (k) simple stereo-microscope with magnification to x30, where necessary,*
- (l) adequate photographic facilities (see Section 36.4).*



## **36. Visual Examination**

### **36.1 General**

*The examination and description of samples of soil and rock is one of the most important aspects of ground investigation. The results of a ground investigation may need to be used long after the disposal of the samples, in which case the descriptions are, in many cases, the only remaining evidence of what was discovered.*

Detailed guidance for the description of soils and rocks is given in Geoguide 3 (GCO, 1988).

### **36.2 Soil**

*All disturbed soil samples, both jar and bulk, should be examined individually and described by means of a permanent record made either on site or shortly after the samples arrive in the laboratory. It is customary during sample description to examine the ends of undisturbed samples or to examine the jar sample obtained from the cutting shoe where it has been used, or both. However, all undisturbed samples should be re-examined each time a specimen is taken for testing as colour changes or drying of the sample may have taken place. When it is known that no further soil testing is likely to be required, the remaining undisturbed samples should be extruded and split down the middle for examination, description and photographing.*

### **36.3 Rock**

*A complete rock description should cover both the rock material and rock mass characteristics. The latter cannot be determined from individual samples, but may be deduced to some extent from many sample descriptions and other data. Where the material characteristics are not obvious, thin sections are a valuable aid to first assessments made with a hand lens.*

In the examination and description of large rock samples and rock cores, particular attention should be paid to the location and nature of discontinuities. The reduced level of shear zones and other major discontinuities should be deduced and recorded. Other details such as orientation, roughness and infilling should also be noted. If the discontinuities contain infilling material, both this and the adjacent materials should be described. Where possible, an undisturbed sample of both the infill and its surrounding material should be extracted for testing purposes. For projects where the nature of discontinuities is particularly important, a separate detailed discontinuity log should be prepared (Figure 35).

### **36.4 Photographic Records**

*Photographic records, particularly if they are in colour, are a most valuable supplementary record, although they cannot replace visual description completely. Where the*

*purpose of the photographs is to provide a continuous record, the same scale should be used throughout. The photographs should be free from distortion normal to the surface and should contain a clear scale.*

A standard colour chart should be included in all colour photographs. When photographing rock core, the best effect can often be obtained by wetting the surface of the core first. Soil samples should be photographed at natural moisture content wherever possible, particularly if testing is to be undertaken on the samples. In some instances, allowing a soil sample to dry out partially may make differences in composition or structure clearer (see Section 22.2).

## 37. Tests on Soil

### 37.1 General

Laboratory tests on soil are undertaken on a routine basis to determine classification, strength, deformation, permeability, compaction and pavement design parameters. Dispersion, collapse potential, chemical and corrosivity tests may also be carried out. Table 12 lists the range of laboratory tests on soil and groundwater, together with references and remarks on their use. Some of these tests are reviewed in more detail in the Geotechnical Manual for Slopes (GCO, 1984). It is important to ensure that tests are carried out on samples that are truly representative of the materials at the site. For this purpose, a full and accurate description of all samples tested should always be recorded. When laboratory tests are not likely to be representative of the mass behaviour of the ground at the site, the laboratory tests should be supplemented or replaced by appropriate field tests.

*In many cases, a field test will give more realistic results than a laboratory test because of reduced problems of sample disturbance. However, there is a large body of practical experience behind some of the common laboratory tests, and when the data derived from them are used with skill, reliable predictions can be obtained. The general considerations set out in the following four sections should be borne in mind.*

### 37.2 Sample Quality

*Quality classes are defined in Section 19.2. It is essential that the sample used is of sufficiently high quality for the test in question. Handling of samples in the field is described in Section 19.10. When samples arrive in the laboratory, all necessary steps should be taken to ensure that they are preserved and stored at their natural moisture content and suffer the minimum amount of shock and disturbance. Very often tests are carried out on 'undisturbed' samples which are far from undisturbed. In addition, the sampling process itself will have released the initial state of stress in the sample.*

*In preparing the laboratory test specimen, there is further disturbance and unavoidable change in the stress conditions, and hence the test is not generally carried out under the same stress conditions as those which exist in the natural ground (see Section 37.4).*

### 37.3 Sample Size

*For disturbed samples, the amount of soil required for any particular test is given in Table 7. As the behaviour of the ground is greatly affected by discontinuities, 'undisturbed' samples should ideally be sufficiently large to include a representative pattern of these discontinuities. This can often be achieved by the use of large 'undisturbed' samples.*

### 37.4 Test Conditions

*Where the test can be carried out under several different sets of conditions, e.g. in the*

*determination of soil strength, the particular test selected should be the one in which the conditions correspond most closely to those that will exist in the field at the particular time which is being considered in the design.*

### **37.5 Relevance of Test Results**

*Some laboratory tests are suitable only for particular types of soil. In cases, where a test has been carried out and it is found later that the test was not relevant to the actual sample used, the result should be discarded.*

### 38. Tests on Rock

*The behaviour of rock masses is often controlled by the nature of the discontinuities present and their orientation to the stresses created by the works or during their construction. In most cases, the scale of discontinuities is such that tests on laboratory specimens may yield results which cannot be applied directly to the behaviour of the rock mass. In considering laboratory tests on rock, a clear distinction needs to be made between tests which relate to the behaviour of the rock mass as affected by the proposed construction and tests which are relevant only to the rock material.*

Laboratory tests on rock material are undertaken to determine classification, strength and deformation parameters. Tests to determine the basic shear strength of specific discontinuities may also be undertaken. Table 13 lists the range of common laboratory tests on rock, together with references and remarks on their use. Some of these tests are reviewed in the Geotechnical Manual for Slopes (GCO, 1984) and BSI (2010). The significance of the size and quality of the sample, the test conditions and the relevance of the results, as discussed in Chapter 37 for soils, also apply in general to tests on rock.

[Amd GG2/01/2017]

Part VI

Reports and Interpretation

### 39. Field Reports

The essential requirement of a field report is that it should contain all the data necessary for the subsequent interpretation and use of the borehole or field test. Field report forms should be easy to fill in and well laid out so as to encourage the operator or field supervisor to record all necessary data. Such forms can in many cases be based upon the illustrative logs contained in this Geoguide, but these need not be regarded as standard as other forms may also be satisfactory. Examples of other field report forms can be found in BSI (1990a) and the appropriate Parts of BSI (2011a, 2011b, 2012a, 2012b, 2012c, 2012d, 2012e, 2012f).

[Amd GG2/01/2017]

The existing ground level, the location of any boreholes, and the location and level of any points of sampling or testing, should always be recorded. Where possible, the locations should take the form of reference coordinates based on the Hong Kong Metric Grid and levels should be referenced to the Hong Kong Principal Datum.

Daily reports form the basis of good field reports on rotary drilling. It is not uncommon for drillers to keep their records on odd scraps of paper while drilling is in progress and to make up their daily report forms from these notes at the end of the day. This practice should be strongly discouraged and the driller should be provided with a standard notebook which can, if necessary, be checked against the daily report at a later date.

## **40. Site Investigation Report**

### **40.1 General**

*Interpretation is a continuous process which should begin in the preliminary stages of data collection and should proceed as information from the ground investigation becomes available. By using this information it is often possible to detect and resolve anomalies as field and laboratory work progresses. Engineering problems should be considered as the data becomes available so that the engineer in charge of the investigation can decide what additional exploration and testing needs to be carried out or conversely, where appropriate, what reductions in his original programme are possible.*

*When an engineering interpretation and recommendations are required, the report is best prepared in two distinct and separate parts, one a descriptive report covering the procedures employed and the data obtained, and the other the analysis, conclusions and recommendations. A general account of the style and format of a report is given elsewhere (Palmer, 1957).*

### **40.2 Descriptive Report**

#### **40.2.1 Report as Record**

*In preparing a report, it should always be remembered that a few months after it is written, when all the samples have been destroyed or rendered unrepresentative, the report will be the only record of what was found. Generally, the results will be presented in an appropriate format in a formal report, which should be bound and issued in a number of copies. This formal report will contain a description of the site and the procedures used, together with tables and diagrams giving the results. In addition, there will be the field and laboratory report forms and data sheets, which provide a detailed record of the data that were obtained. These forms are sometimes not included in the formal report, but should in any case be preserved for a sufficiently long period so that they can be made available for reference when necessary at a later date.*

A copy of all descriptive reports should normally be lodged in the data bank of the Geotechnical Information Unit (see Appendix B).

#### **40.2.2 Introduction**

*The report should have an introduction stating for whom the work was done, the nature of the investigation and its general location, the purpose for which the investigation was made and the period of time over which the work was carried out.*

#### **40.2.3 Description of Site**

The report should contain an unambiguous description of the geographical location of the site, so that the area covered by the investigation can be located readily at a later date. This



should include street names together with Hong Kong Metric Grid references and a location map at an appropriate scale. The description should also include general statements on site conditions at the time of investigation.

#### **40.2.4 Geology**

*An account should be given of the geology of the site, and the sources from which the information was obtained should be stated (see Section 4.2). The amount of the data included will depend upon the nature of the work being planned and also upon the amount of data available. The soil and rock types identified and described in the report should be linked with the known geology of the site, see Geoguide 3 (GCO, 1988).*

#### **40.2.5 Field Work**

*An account should be given of the methods of investigation and testing used. It should include a description of all equipment used, e.g. types of drilling rigs and tools. A note should be made of any difficulties experienced, e.g. problems in recovering samples. The dates when the exploratory work was done should also be recorded, together with a note about the weather conditions where appropriate. The report should contain a drawing indicating the positions of all pits, boreholes, field tests, etc. It should contain sufficient topographical information so that these positions can be located at a later date.*

#### **40.2.6 Borehole Logs**

*(1) General. The final borehole logs should be based on the visual examination and description of the samples, the laboratory test results where appropriate, the driller's daily report forms and what is known of the geology of the site. Being an interpretation of ground data which may at times be conflicting, the logs should be finalised only when the appropriate field and laboratory work has been completed. It is important that all relevant data collected by the driller, once checked and amended where necessary, should be recorded.*

*The method of presentation of the data is a subject on which there can be no hard and fast rules. In principle, the borehole logs should give a picture in diagrams and words of the ground profile at the particular point where the borehole was formed. The extent to which minor variations in soil and rock types should be recorded, together with any discontinuities and anomalies, will depend on the various purposes for which the information will be used.*

*Most organizations carrying out site investigation have standard forms for borehole logs. It is seldom practicable in these to make allowance for all data which may possibly need to be recorded. It is therefore important that an adequate space for remarks is available to allow a record to be made of items that are not specifically covered. An expedient which makes a standard form rather more flexible is to leave one or more columns without headings so that they can be used according to the data to be recorded.*

*All borehole logs are a compromise between what it is desirable to record and what can*

be accommodated. What is actually presented will need to be considered individually for each investigation. Where the data are copious, it may be preferable to record part of them elsewhere in the report, with a cross-reference on the logs. The subsections which follow indicate the data which a well-prepared borehole log may contain.

(2) **General Data Common to All Logs.** The following should be recorded on all logs :

- (a) title of investigation,
- (b) job number or report number,
- (c) location detailed by grid references,
- (d) date of exploration,
- (e) borehole number and sheet number, e.g. sheet 2 of 2,
- (f) method of forming borehole, e.g. cable percussion or rotary,
- (g) make and model of plant used,
- (h) ground level related to the Hong Kong Principal Datum,
- (i) diameter of borehole,
- (j) diameter of casing and depth to which the casing was taken,
- (k) a depth scale such that the depth of sampling, tests and change in ground conditions can be readily determined,
- (l) depth of termination of borehole,
- (m) depths of observation wells or piezometers, where these have been installed, together with details of the installation, preferably in the form of a diagram,
- (n) groundwater levels measured subsequent to the completion of piezometers, unless recorded separately.

(3) **Legend and Symbols.** The ground profiles should be illustrated by means of a legend using the symbols illustrated on figures in this document, and more fully presented in Geoguide 3 (GCO, 1988). The legend is most commonly placed near the centre of the sheet, which enables reduced levels, depths, thicknesses and sampling data to be arranged conveniently on either side. An alternative is to have it as the extreme right hand column, which enables the logs of adjacent and nearby boreholes to be readily compared without folding or cutting the sheets.

Apart from the symbols referred to above, no recommendations are given for the many

*other symbols required for the preparation of borehole logs. Many different types are in use, and provided an adequate key is given with every set of borehole logs, there should be no difficulty in interpreting them. The symbols may be given on a separate sheet or on each sheet. Both methods have advantages and corresponding disadvantages. The first saves space on the actual logs, thus enabling a greater depth to be logged on each sheet or a larger 'remarks' space to be provided. It does have the disadvantage that the reader may need constantly to refer back to the key.*

**(4) Light Cable Percussion Boring.** *For light cable percussion boring, in addition to the items referred to in Sections 40.2.6(2) and 40.2.6(3), the following information should be recorded in the log :*

- (a) A description of each zone or material type together with its thickness.*
- (b) The depth and level of each change of zone or material type.*
- (c) The depth of the top and bottom of each tube sample, or bulk sample and its type (see Chapter 19); the depth of each small disturbed sample.*
- (d) The depth at the top and bottom of each borehole test, and the nature of the test.*
- (e) For standard penetration tests, it should always be noted if the sampler has not been driven the full 450 mm required for the test (see Section 21.2.3).*
- (f) The date when each section was bored.*
- (g) A record of water levels, including rate of rise of water level, depth of water in the borehole at the start and finish of a shift, and the depth of casing when each observation was made.*
- (h) A record of any water added to facilitate boring.*

**(5) Rotary Drilling.** *For rotary drilling, in addition to the items referred to in Sections 40.2.6(2) and 40.2.6(3), the following information should be recorded in the log :*

- (a) A description of all ground conditions encountered.*
- (b) The depth and level of each change in ground conditions.*
- (c) The depth of the start and finish of each core run.*
- (d) The core recovery for each run, usually expressed as percentage total core recovery (GCO, 1988).*

- (e) *For rock, the fracture state, expressed in terms of one or more of the following : rock quality designation (RQD), solid core recovery or fracture index (GCO, 1988).*
- (f) *The date when each section of the core was drilled.*
- (g) *An indication of the drilling water recovery for each core run, with a note on any change in colour.*
- (h) *A record of the depth of water in the hole at the start and finish of a shift and the depth of the casing, where used, at the time the observations were made.*
- (i) *A record of tests carried out, such as permeability and packer tests.*
- (j) *The orientation of the boreholes.*

(6) **Summary or Condensed Log.** Where an investigation contains a large number of deep boreholes, the full logs can add up to a substantial weight of paper, and to include all of these in each copy of the report may be unnecessary. An alternative is to include only summarized or condensed logs in the report itself, provided these are sufficiently comprehensive and significant details are not omitted.

An example of a borehole log is given in Figure 44.

#### **40.2.7 Incidence and Behaviour of Groundwater**

*In order to obtain a clear understanding of the incidence and behaviour of groundwater, it is essential that all data collected on the groundwater should be included and that, where no groundwater was encountered, this too should be recorded. Where the information derived from boreholes is not too voluminous, it is best included in the logs. When this is not possible, the data should be given elsewhere in the report and cross-referenced in the borehole logs. Where the position of the borehole casing at the time of an observation is relevant, its position should be stated. All other data, including those from separate observation wells or piezometers, should be given separately. Where drilling with water or air flush has been used, this should be recorded and its effect on groundwater levels should be assessed.*

#### **40.2.8 Location of Boreholes**

*The report should contain a plan showing the precise location and top level of each borehole (see Chapter 39).*

### **40.2.9 Laboratory Test Results and Sample Descriptions**

*Where test procedures are covered by recognized standards, the reporting of the results should be in accordance with those standards; where they are not so covered, relevant data should be given. For example, in a triaxial compression test the actual numerical result on each specimen should be given and not only the interpreted parameters. Where an extensive programme of testing has been undertaken, a summary should be provided in addition to the detailed results. The precise test carried out should also be stated without ambiguity. Where the test is reasonably standard, for instance "consolidated drained triaxial compression test on 100 mm diameter samples", the name alone will suffice, but where the test is not standard, a full description should be given.*

*The visual descriptions of all samples tested should appear in the report. The precise method of recording them will depend upon circumstances. It may be convenient to show them on the same sheets as the results of the laboratory tests, or a separate table may be preferable.*

In any event, the descriptions should all appear in one place. At times, the results of the laboratory tests, and in particular the identification tests, will indicate a soil different from that indicated by the visual description. The original description should not be discarded on that account but should be preserved as a record of the observer's opinion. If soil descriptions have been modified in the light of laboratory test data, this should be indicated clearly in the report, see Geoguide 3 (GCO, 1988). The laboratory report forms and data sheets should be filed for possible future reference (see Section 40.2.1).

## **40.3 Engineering Interpretation**

### **40.3.1 Matters to be Covered**

*Methods of analysing ground data and applying them to the solution of engineering problems are not covered in this Geoguide. Guidance on analysis and application of ground data may be found in various British Standards (e.g. BSI, 1974; 1986; 1991; 2004; 2007; 2009) and local guidance documents (e.g. Geotechnical Manual for Slopes and Geoguide 1). Sections 40.3.2 to 40.3.9 deal with the form of the report, and list the most common topics on which advice and recommendations are required. These sections also contain some guidance on what should be included. The topics are listed briefly under the general headings : design, construction expedients, sources of materials, and failure. It is likely that in many cases the client commissioning the investigation will indicate those aspects of the project on which he requires advice and recommendations; the topics listed below are intended as a guide where this may not have been done.*

[Amd GG2/01/2017]

### **40.3.2 Data on which Interpretation is Based**

*The data on which the analysis and recommendations are based should be clearly indicated. The information generally comes under two separate headings :*

- (a) Information related to the project (which is usually supplied*

by the designer). For example, for buildings and other structures this should include full details on the loading (including dead and live loads), column spacing (where appropriate), depth and extent of basements and details of neighbouring structures. For earthworks, the height of embankments, the materials to be used and the depths of cut slopes are relevant to the interpretation.

- (b) *Ground parameters (which are usually selected from the descriptive report by the engineer who performs the analysis and prepares the recommendations). There is no universally accepted method of selecting these parameters, but the following approach may help to arrive at reliable values :*
- (i) *compare both laboratory and insitu test results with ground descriptions,*
  - (ii) *cross-check, where possible, laboratory and insitu results in the same ground,*
  - (iii) *collect individually acceptable results for each ground unit, and decide representative values appropriate to the number of results,*
  - (iv) *where possible, compare the representative values with published data for similar geological formations or ground units.*

### **40.3.3 Presentation of Borehole Data**

*For the purpose of analysis, it is frequently necessary to make simplifying assumptions about the ground profile at the site. These are best conveyed in a report by a series of cross sections illustrating the ground profile, simplified as required, and showing the groundwater levels. The sections should preferably be plotted to a natural scale. If it is necessary to exaggerate the vertical scale, the multiplying factor should be limited to avoid conveying a misleading impression. Where the ground information is either very variable or too sparse to enable cross sections to be prepared, individual borehole logs plotted diagrammatically are an acceptable alternative. If it is particularly important to prepare cross sections, sparse and variable information can sometimes be supplemented by means of information from soundings and geophysical investigations on areas between boreholes. It can be helpful to indicate relevant soil parameters on cross sections, for example, results of standard penetration tests, triaxial tests and representative parameters from consolidation tests.*

In certain engineering problems, it may be useful to construct contours of the bedrock and groundwater surfaces from borehole data. In marine investigations, contours of the seabed, and contours and isopachs of the various stratigraphic units below the seabed, may be

constructed.

#### 40.3.4 Design

*The following list, which is by no means exhaustive, indicates the topics on which advice and recommendations are often required, and also what should be included in the report.*

- (a) Slope stability: geological model; shear strength parameters; water pressures for the design condition; assessment of risk to life and economic risk; recommended slope angle. Comment should be made on surface drainage and protection measures, and on any subsurface drainage required. For rock slopes, an assessment of potential failures due to unfavourably orientated discontinuities should be made. Possible methods of stabilizing local areas of instability and surface protection measures should be recommended. Advice on monitoring of potentially unstable slopes should also be given (GCO, 1984).
- (b) Retaining walls: earth and water pressures; passive and frictional resistance; foundation bearing capacity, see Geoguide 1 (GEO, 1993).
- (c) *Embankments: stability of embankment foundations; assessment of amount and rate of settlement and the possibility of hastening it by such means as vertical drains; recommendations for side slopes (see (a) above); choice of construction materials and methods.*
- (d) *Drainage: possible drainage methods during construction for works above and below ground; general permanent land drainage schemes for extensive areas.*
- (e) Basements: earth and water pressures on basement walls and floor; comment on the possibility of flotation. An estimate of the rise of the basement floor during construction should be made, where appropriate.
- (f) *Piles: types of piles suited to the ground profile and environment; estimated safe working loads, or data from which they can be assessed; estimated settlements of structures.*
- (g) *Ground anchors: bearing ground layer and estimated safe loads, or data from which they may be calculated, e.g. suitability tests (Brian-Boys & Howells, 1984).*

- (h) *Pavement design: design California Bearing Ratios; type and thickness of pavement; possibility of using soil stabilization for forming pavement bases or sub-bases; recommendations, where appropriate, for sub-grade drainage.*
- (i) *Tunnels and underground works: methods and sequence of excavation; whether excavation is likely to be stable without support; suggested methods of lining in unstable excavations; possible use of rock bolting; possibility of encountering groundwater; and recommendations for dealing with it; special features for pressure tunnels.*
- (j) *Safety of neighbouring structures: likely amount of movement caused by adjacent excavations and groundwater lowering, compressed air working, grouting and ground freezing or other geotechnical processes. The possibility of movement due to increased loading on adjacent ground may also need to be considered.*
- (k) *Monitoring of movements: need for measuring the amount of movement taking place in structures and slopes, together with recommendations on the method to be used (see Section 16.4); recommendations for taking photographs before the commencement of works (see Section 4.1.2).*
- (l) *Chemical attack: protection of buried steel or concrete against attack from aggressive soils and groundwater.*

#### **40.3.5 Construction Expedients**

*Comments and recommendations are often required on the points listed below. Safety aspects should be included where appropriate.*

- (a) *Open excavations: method and sequence of excavation; what support is needed; how to avoid 'boiling' and bottom heave; estimated upward movement of floor of excavation; relative merits of sheet piling and diaphragm or contiguous bored pile walls where appropriate.*
- (b) *Underground excavations: method and sequence of excavation and the need for temporary roof and side support.*
- (c) *Groundwater: likely flow, head and quantity and how to deal with it.*
- (d) *Driven piles, bored piles and ground anchors: methods of*



*driving or construction suited to the ground profile, environment and neighbouring buildings.*

- (e) Grouting: types of grouts likely to be successful in the ground and recommended method of injection.*
- (f) Mechanical improvement of soil below ground level: suitability of techniques for the consolidation of loose soils.*

#### **40.3.6 Source of Materials**

*The following are suggested :*

- (a) Fill: possibility of using excavated material for filling with an assessment of the proportions of usable material; methods and standards of compaction; possible off-site sources of fill; bulking factor.*
- (b) Filter materials, concrete aggregates, road base and surfacing materials: possible sources and the suitability of the materials from these sources.*

#### **40.3.7 Failures**

*Where site investigation has been undertaken in an attempt to identify the cause of failures the undermentioned points may be relevant.*

- (a) Foundations: nature and dimensions of the foundations; identification of the cause of failure and, where appropriate, an estimate of the amount of settlement which has already occurred, together with an assessment of how much more is likely to occur and its probable effect on the structure; cause of excessive vibrations of machine foundations; recommendations for remedial measures.*
- (b) Landslides: classification of the type of movement and location of the failure planes; recommendations for immediate stabilizing expedients and long term measures.*
- (c) Embankments: identification of whether the seat of failure lies within the embankment itself or the underlying foundation, the probable cause and suggested method of repair and strengthening.*
- (d) Retaining walls: cause of failure or excessive deflection; forecast of future behaviour of wall and recommendations*

*where appropriate for strengthening it.*

- (e) Pavements: determination of whether the failure is within the pavement itself or the sub-grade and recommendations for repairs or strengthening or both.*

#### **40.3.8 Calculations**

*Where calculations have been made, they should be included as an appendix, or a clear indication of the methods used should be given.*

#### **40.3.9 References**

*All published works referred to in the report should be listed.*

### **40.4 Documentation for Site Investigation of Tunnel Works**

[Amd GG2/01/2017]

Factual engineering geological and hydrogeological data relating to the tunnel project should be fully documented including any field data obtained from the excavation faces or inferred from the equipment/processes adopted for the tunnel works. [Amd GG2/01/2017]

Survey and monitoring reports should include factual data, details of the survey and monitoring methods, and equipment/system calibration. [Amd GG2/01/2017]

Interpretative engineering geological and inspection and monitoring reports should be prepared using the data obtained during the various phases of the site investigation and from construction records. These reports should update any previous relevant interpretative reports and be presented in a form that will meet the needs of the professional users. They should incorporate information on the cavern/tunnel/shaft excavation method and working sequence, trends of key performance indicators and records of actual impacts observed during construction. [Amd GG2/01/2017]

## References

- Addison, R. (1986). *Geology of Sha Tin, 1:20 000 Sheet 7*. Hong Kong Geological Survey Memoir No. 1, Geotechnical Control Office, Hong Kong, 85 p.
- Akroyd, T.N.W. (1969). *Laboratory Testing in Soil Engineering*. Soil Mechanics Ltd, London, 249 p.
- Allen, P.M. & Stephens, E.A. (1971). *Report on the Geological Survey of Hong Kong, 1967-1969*. Hong Kong Government Press, 116 p, plus 2 maps.
- American Public Health Association (1985). *Standard Methods for the Examination of Water and Wastewater. (Sixteenth edition). Part 427-Sulfide*. American Public Health Association, Washington D.C., pp 470-478.
- Anderson, M.G. (1984). *Prediction of Soil Suction for Slopes in Hong Kong*. GCO Publication No. 1/84, Geotechnical Control Office, Hong Kong, 242 p.
- Anderson, M.G., McNicholl, D.P. & Shen, J.M. (1983). On the effect of topography in controlling soil water conditions, with specific regard to cut slope piezometric levels. *Hong Kong Engineer*, vol. 11, no. 11, pp 35-41.
- Arthur, J.R.F. & Roscoe, K.H. (1961). An earth pressure cell for the measurement of normal and shear stresses. *Civil Engineering and Public Works Review*, vol. 56, pp 765-776.
- ASTM (1985a). Standard test method for penetration test and split-barrel sampling of soil. Test Designation D1586-67. *1985 Annual Book of ASTM Standards, American Society for Testing and Materials*, Philadelphia, vol. 04.08, pp 298-303.
- ASTM (1985b). Standard test method for density and unit weight of soil in-place by the rubber balloon method. Test Designation D2167-84. *1985 Annual Book of ASTM Standards, American Society for Testing and Materials*, Philadelphia, vol. 04.08, pp 342-347.
- ASTM (1985c). Standard test method for triaxial compressive strength of undrained rock core specimens without pore pressure measurements. Test Designation D2664-80. *1985 Annual Book of ASTM Standards, American Society for Testing and Materials*, Philadelphia, vol. 04.08, pp 429-434.
- ASTM (1985d). Standard test method for laboratory determination of pulse velocities and ultrasonic elastic constants of rock. Test Designation D2845-83. *1985 Annual Book of ASTM Standards, American Society for Testing and Materials*, Philadelphia, vol. 04.08, pp 445-452.

- ASTM (1985e). Standard test methods for density of soil and soil aggregate in place by nuclear method (shallow depth). Test Designation D2922-81. *1985 Annual Book of ASTM Standards, American Society for Testing and Materials*, Philadelphia, vol. 04.08, pp 463-472.
- ASTM (1985f). Standard test methods for direct tensile strength of intact rock core specimens. Test Designation D2936-84. *1985 Annual Book of ASTM Standards, American Society for Testing and Materials*, Philadelphia, vol. 04.08, pp 473-477.
- ASTM (1985g). Standard test method for unconfined compressive strength of intact rock core specimens. Test Designation D2938-79. *1985 Annual Book of ASTM Standards, American Society for Testing and Materials*, Philadelphia, vol. 04.08, pp 484-487.
- ASTM (1985h). Standard test methods for moisture content of soil and soil aggregate in place by nuclear methods (shallow depth). Test Designation D3017-78. *1985 Annual Book of ASTM Standards, American Society for Testing and Materials*, Philadelphia, vol. 04.08, pp 508-513.
- ASTM (1985i). Standard test method for direct shear test of soils under consolidated drained conditions. Test Designation D3080-72 (Reapproved 1979). *1985 Annual Book of ASTM Standards, American Society for Testing and Materials*, Philadelphia, vol. 04.08, pp 514-518.
- ASTM (1985j). Standard test method for elastic moduli of intact rock core specimens in uniaxial compression. Test Designation D3148-80. *1985 Annual Book of ASTM Standards, American Society for Testing and Materials*, Philadelphia, vol. 04.08, pp 519-525.
- ASTM (1985k). Standard test method for deep, quasi-static, cone and friction cone penetration tests of soil. Test Designation D3441-79. *1985 Annual Book of ASTM Standards, American Society for Testing and Materials*, Philadelphia, vol. 04.08, pp 550-557.
- Au, S.W.C. (1986). Decomposed dolerite dykes as a cause of slope failure. *Hong Kong Engineer*, vol. 14, no. 2, pp 33-36 (Corrigendum, vol. 14, no. 9, p 24). (Discussion, vol. 14, no. 5, p 13, and no. 8, p 43).
- Baguelin, F., Jezequel, J.F. & Shields, D.H. (1978). *The Pressuremeter and Foundation Engineering*. Trans Tech Publications, Clausthal, Germany, 617 p.
- Bauer, G.E. & Demartinecourt, J.P. (1982). The modified borehole shear device. *Geotechnical Testing Journal*, vol. 6, pp 24-29.
- Bauer, G.E. & Demartinecourt, J.P. (1985). The application of the modified borehole shear device to a sensitive clay. *Geotechnical Engineering*, vol. 16, pp 167-189.
- Beattie, A.A. & Lam, C.L. (1977). Rock slope failures - their prediction and prevention. *Hong Kong Engineer*, vol. 5, no. 7, pp 27-40 (Discussion, vol. 5, no. 9, pp 27-29).

- Beggs, C.J. (1983). A review of investigation and sampling methods in the recent sediments in Hong Kong. *Proceedings of the Meeting on the Geology of Surficial Deposits in Hong Kong*, Hong Kong, pp 11-18. (Published as *Geological Society of Hong Kong, Bulletin* no. 1, edited by W.W.S. Yim, 1984).
- Benson, R.P., Murphy, D.K. & McCreath, D.R. (1970). Modulus testing of rock at the Churchill Falls Underground Powerhouse, Labrador. *Proceedings of the Symposium on Determination of the In Situ Modulus of Deformation of Rock*. American Society for Testing and Materials Special Technical Publication, no. 477, pp 89-116.
- BGS (1974). *Field Instrumentation in Geotechnical Engineering (Proceedings of the British Geotechnical Society Symposium, London, 1973)*. Butterworths, London, 726 p.
- Bieniawski, Z.T. (1975). The point load test in geotechnical practice. *Engineering Geology*, vol. 9, pp 1-11.
- Bishop, A.W. (1948). A new sampling tool for use in cohesionless sands below groundwater level. *Géotechnique*, vol. 1, pp 125-131.
- Bishop, A.W. & Green, P.A. (1973). The development and use of trial embankments. *Proceedings of the Symposium on Field Instrumentation in Geotechnical Engineering*, London, pp 13-37.
- Bishop, A.W. & Henkel, D.J. (1976). *The Measurement of Soil Properties in the Triaxial Test*. Edward Arnold, London, 227 p.
- Bishop, A.W. & Little, A.L. (1967). The influence of the size and orientation of the sample on the apparent strength of the London Clay at Maldon, Essex. *Proceedings of the Geotechnical Conference on the Shear Strength of Natural Soils and Rocks*, Oslo, vol. 1, pp 89-96.
- Bjerrum, L. (1973). Problems of soil mechanics and construction on soft clays and structurally unstable soils (collapsible, expansive and others). *Proceedings of the Eighth International Conference on Soil Mechanics and Foundation Engineering*, Moscow, vol. 2.3, pp 111-159. (Reprinted in *Norwegian Geotechnical Institute, Publication* no. 100, 1974, 53 p).
- Bjerrum, L. & Anderson, K.H. (1972). Insitu measurement of lateral pressures in clay. *Proceedings of the Fifth European Conference on Soil Mechanics and Foundation Engineering*, Madrid, vol. 1, pp 11-20. (Reprinted in *Norwegian Geotechnical Institute, Publication* no. 91, 1972, pp 11-20).
- Bjerrum, L., Kenney, T.C. & Kjaernsli, B. (1965). Measuring instrumentation for strutted excavations. *Journal of the Soil Mechanics and Foundations Division, American Society of Civil Engineers*, vol. 91, no. SMI, pp 111-114. (Reprinted in *Norwegian Geotechnical Institute, Publication* no. 64, 1965, pp 1-17).

- Bjerrum, L., Nash, J.K.T.L., Kennard, R.M. & Gibson, R.E. (1972). Hydraulic fracturing in field permeability testing. *Géotechnique*, vol. 22, pp 319-332. (Reprinted in *Norwegian Geotechnical Institute, Publication no. 94, 1972, pp 1-12*).
- Blacker, P. & Seaman, J.W. (1985). A review of current nearshore and offshore site investigation practice in waters around Hong Kong. *Proceedings of the Conference on Geological Aspects of Site Investigation*, Hong Kong, pp 41-58. (Published as *Geological Society of Hong Kong, Bulletin no. 2*, edited by I. McFeat-Smith, 1985).
- Borchers, P.E. (1968). Photogrammetric measurement of structural movement. *Journal of the Surveying and Mapping Division, American Society of Civil Engineers*, vol. 94, no. SU1, pp 67-81.
- Brand, E.W. (1994). *Bibliography on the Geology and Geotechnical Engineering of Hong Kong to May 1994 (GEO Report No. 39)*. Geotechnical Engineering Office, Hong Kong, 202 p.
- Brand, E.W., Burnett, A.D. & Styles, K.A. (1982). The Geotechnical Area Studies Programme in Hong Kong. *Proceedings of the Seventh Southeast Asian Geotechnical Conference*, Hong Kong, vol. 1, pp 107-123.
- Brand, E.W., Hencher, S.R. & Youdan, D.G. (1983a). Rock slope engineering in Hong Kong. *Proceedings of the Fifth International Rock Mechanics Congress*, Melbourne, vol. 1, pp C17-C24.
- Brand, E.W. & Phillipson, H.B. (1984). Site investigation and geotechnical engineering practice in Hong Kong. *Geotechnical Engineering*, vol. 15, no. 2, pp 97-153.
- Brand, E.W., Phillipson, H.B., Borrie, G.W. & Clover, A.W. (1983b). Insitu direct shear tests on Hong Kong residual soils. *Proceedings of the International Symposium on Soil and Rock Investigation by Insitu Testing*, Paris, vol. 2, pp 13-17. (Discussion, vol. 3, pp 55-56).
- Brand, E.W. & Premchitt, J. (1980). Shape factors of cylindrical piezometers. *Geotechnique*, vol. 30, pp 369-384.
- BRE (1981). Concrete in sulphate-bearing clays and groundwaters. *Building Research Establishment*, UK, Digest no. 250, 4 p.
- Brenner, R.P. & Phillipson, H.B. (1979). Sampling of residual soils in Hong Kong. *Proceedings of the International Symposium on Soil Sampling*, Singapore, pp 109-120.
- Brian-Boys, K.C. & Howells, D.J. (1984). *Model Specification for Prestressed Ground Anchors*. GCO Publication No. 3/84, Geotechnical Control Office, Hong Kong, 127 p.

- Briaud, J.L. & Gambin, M. (1984). Suggested practice for drilling boreholes for pressuremeter testing. *Geotechnical Testing Journal*, vol. 7, pp 36-40.
- Brimicombe, A.J. (1982). Engineering site evaluation from aerial photographs. *Proceedings of the Seventh Southeast Asian Geotechnical Conference*, Hong Kong, vol. 2, pp 139-148.
- Broch, E. & Franklin, J.A. (1972). The point load strength test. *International Journal of Rock Mechanics and Mining Sciences*, vol. 9, pp 667-697.
- Brown, E.T. (Editor) (1981). *Rock Characterization Testing and Monitoring: ISRM Suggested Methods*, Pergamon Press, Oxford, 211 p.
- Bryant, J.M. (1982). Engineering geological applications of aerial photograph interpretation in Hong Kong. *Proceedings of the Fourth International Congress of the International Association of Engineering Geology*, New Delhi, vol. 1, pp 155-166.
- [Amd GG2/01/2017]
- BSI (1974). *Code of Practice for Foundations for Machinery (CP 2012:1974). Part 1 - Foundations for Reciprocating Machines*. British Standards Institution, London, 36 p.
- BSI (1986). *British Standard Code of Practice for Foundations (BS 8004:1986)*. British Standards Institution, London, 150 p.
- BSI (1990). *Methods of Test for Soils for Civil Engineering Purposes - Parts 1 to 9: (BS 1377, Parts 1 to 9:1990)*. British Standards Institution, London, 406 p.
- [Amd GG2/01/2017]
- BSI (1991). *Cathodic Protection - Part 1: Code of Practice for Land and Marine Applications - (formerly CP 1021) (BS 7361-1:1991)*. British Standards Institution, London, 122 p.
- [Amd GG2/01/2017]
- BSI (2004). *Eurocode 7: Geotechnical Design - Part 1: General Rules (BS EN 1997-1:2004)*. British Standards Institution, London, 174 p.
- [Amd GG2/01/2017]
- BSI (2006). *Geotechnical Investigation and Testing - Sampling Methods and Groundwater Measurements - Part 1: Technical Principles for Execution (BS EN ISO 22475-1:2006)*. British Standards Institution, London, 134 p.
- [Amd GG2/01/2017]
- BSI (2007). *Eurocode 7 - Geotechnical Design - Part 2: Ground Investigation and Testing (BS EN 1997-2:2007)*. British Standards Institution, London, 202 p. [Amd GG2/01/2017]
- BSI (2008). *Safety Precautions and Procedures for the Construction and Descent of Machine-bored Shafts for Piling and Other Purposes (BS 8008:1996+A1:2008)*. British Standards Institution, London, 20 p.
- [Amd GG2/01/2017]

- BSI (2009). *Code of Practice for Earthworks (BS 6031:2009)*. British Standards Institution, London, 128 p. [Amd GG2/01/2017]
- BSI (2010). *Code of Practice for Site Investigations (BS 5930:1999+A2:2010)*. British Standards Institution, London, 206 p. [Amd GG2/01/2017]
- BSI (2011a). *Geotechnical Investigation and Testing - Field Testing - Part 2: Dynamic Probing (BS EN ISO 22476-2:2005+A1:2011)*. British Standards Institution, London, 40 p. [Amd GG2/01/2017]
- BSI (2011b). *Geotechnical Investigation and Testing - Field Testing - Part 3: Standard Penetration Test (BS EN ISO 22476-3:2005+A1:2011)*. British Standards Institution, London, 26 p. [Amd GG2/01/2017]
- BSI (2012a). *Geotechnical Investigation and Testing - Geohydraulic Testing - Part 2: Water Permeability Tests in a Borehole using Open Systems (BS EN ISO 22282-2:2012)*. British Standards Institution, London, 36 p. [Amd GG2/01/2017]
- BSI (2012b). *Geotechnical Investigation and Testing - Geohydraulic Testing - Part 3: Water Pressure Tests in Rock (BS EN ISO 22282-3:2012)*. British Standards Institution, London, 36 p. [Amd GG2/01/2017]
- BSI (2012c). *Geotechnical Investigation and Testing - Geohydraulic Testing - Part 4: Pumping Tests (BS EN ISO 22282-4:2012)*. British Standards Institution, London, 34 p. [Amd GG2/01/2017]
- BSI (2012d). *Geotechnical Investigation and Testing - Geohydraulic Testing - Part 5: Infiltration Tests (BS EN ISO 22282-5:2012)*. British Standards Institution, London, 30 p. [Amd GG2/01/2017]
- BSI (2012e). *Geotechnical Investigation and Testing - Geohydraulic Testing - Part 6: Water Permeability Tests in a Borehole using Closed Systems (BS EN ISO 22282-6:2012)*. British Standards Institution, London, 24 p. [Amd GG2/01/2017]
- BSI (2012f). *Geotechnical Investigation and Testing - Field Testing, Part 1: Electrical Cone and Piezocone Penetration Test (BS EN ISO 22476-1:2012)*. British Standards Institution, London, 46 p. [Amd GG2/01/2017]
- Bureau of Reclamation (1987). *Embankment Dam Instrumentation Manual*. Bureau of Reclamation, US Department of the Interior, Washington DC, 265 p.
- Burland, J.B., Moore, J.F.A. & Smith, P.D.K. (1972). A simple and precise borehole extensometer. *Géotechnique*, vol. 22, pp 174-177.
- Burnett, A.D. & Styles, K.A. (1982). An approach to urban engineering geological mapping as used in Hong Kong. *Proceedings of the Fourth International Congress of the International Association of Engineering Geology*, New Delhi, vol. 1, pp 167-176.



- Carter, J.P. & Booker, J.R. (1984). Determination of the deformation modulus of rock from tunnel and borehole loading tests. *Proceedings of the Fourth Australia-New Zealand Conference on Geomechanics*, Perth, vol. 1, pp 509-513.
- Chan, M.P. & Lau, S.H. (1986). Drilling in Hong Kong. *Contractor* (Hong Kong), May 1986, pp 11-14.
- Cheffins, D.W. & Chisholm, N.W.T. (1980). Engineering and industrial photogrammetry. *Developments in Close Range Photogrammetry - 1*, edited by K.B. Atkinson, pp 149-180. Applied Science Publishers Ltd, London.
- Chiang, Y.C. & Ho, Y.M. (1980). Pressuremeter method for foundation design in Hong Kong. *Proceedings of the Sixth Southeast Asian Conference on Soil Engineering*, Taipei, vol. 1, pp 31-42.
- Cipullo, A. & Irfan, T.Y. (1984). Discussion on "The determination of the uniaxial compressive strength of rock material - a review of current practice in Hong Kong" by T.I. Gamon & P.L. Szeto. *Proceedings of the Conference on Geological Aspects of Site Investigation*, Hong Kong, pp 69-71. (Discussion, pp 71-72). (Published as *Geological Society of Hong Kong, Bulletin* no. 2, edited by I. McFeat-Smith, 1985).
- Clayton, C.R.I. (1984). Sample disturbance and BS 5930. *Proceedings of the 20th Regional Meeting of the Engineering Group of the Geological Society*, Guildford, UK, pp 31-41. (Published as *Site Investigation Practice : Assessing BS 5930*, edited by A.B. Hawkins, *Geological Society, Engineering Geology Special Publication* no. 2, 1986) (Also published in preprint vol. 2, pp 61-75).
- Clayton, C.R.I., Simons, N.E. & Mathews, M.C. (1982). *Site Investigation, A Handbook for Engineers*. Grenada, London, 424 p.
- Cole, K.W. & Burland, J.B. (1972). Observations of retaining wall movements associated with a large excavation. *Proceedings of the Fifth European Conference on Soil Mechanics and Foundation Engineering*, Madrid, vol. 1, pp 445-453.
- Coleman, M. (1984). Experience with geotechnical instruments in Hong Kong. *Contractor* (Hong Kong), January, pp 23-27.
- Craig, D.J. & Gray, I. (1985). *Groundwater Lowering by Horizontal Drains*. GCO Publication No. 2/85, Geotechnical Control Office, Hong Kong, 123 p.
- CS3:2013 (2016). *Aggregates for Concrete (Construction Standard CS3:2013)*. Civil Engineering and Development Department, Hong Kong, 140 p. [Amd GG2/01/2017]
- Culshaw, M.G. & Waltham, A.C. (1987). Natural and artificial cavities as ground engineering hazards. *Quarterly Journal of Engineering Geology*, vol. 20, pp 139-150.

- Dearman, W.R. & Irfan, T.Y. (1978). Assessment of the degree of weathering in granite using petrographic and physical index tests. *UNESCO International Symposium on Deterioration and Protection of Stone Monuments*, Paris, paper 2.3, 35 p.
- Decker, R.S. & Dunnigan, L.P. (1977). Development and use of the Soil Conservation Service Dispersion Test. *Dispersive Clays, Related Piping, and Erosion in Geotechnical Projects*. American Society for Testing and Materials, Special Technical Publication no. 623, pp 94-109.
- Deere, D.W. & Miller, R.P. (1966). *Engineering Classification and Index Properties for Intact Rock*. Report AWFL-TR-65-116, Air Force Weapons Laboratory (WLDC), Kirtland Air Force Base, New Mexico, 273 p.
- Delft Soil Mechanics Laboratory (1977). *Site Investigations*. Delft Soil Mechanics Laboratory, Delft, the Netherlands, 144 p.
- De Mello, V.F.B. (1971). The standard penetration test. *Proceedings of the Fourth Panamerican Conference on Soil Mechanics and Foundation Engineering*, San Juan, Puerto Rico, vol. 1, pp 1-86.
- Department of Transport (1976). *Department of Transport Specification for Road and Bridge Works*, Clause 2722. Her Majesty's Stationery Office, London, pp 174-175.
- DeRuiter, J. (1982). The static cone penetration test, state of the art report. *Proceedings of the Second European Symposium on Penetration Testing*, Amsterdam, vol. 2, pp 389-405.
- DiBiagio, E. & Myrvoll, F. (1982). Field instrumentation for soft clay. *Soft Clay Engineering*, edited by E.W. Brand & R.P. Brenner, pp 697-736. Elsevier Scientific Publishing Company, Amsterdam.
- Dunnicliff, C.J. (1971). Equipment for field deformation measurements. *Proceedings of the Fourth Panamerican Conference on Soil Mechanics and Foundation Engineering*, San Juan, Puerto Rico, vol. 2, pp 319-332.
- Endicott, L.J. (1984). Site investigations for roads and tunnels in weathered rock. *Proceedings of the Symposium on Geotechnical Aspects of Mass and Material Transportation*, Bangkok, pp 133-151.
- ETWB (2004). *Impossibility/Unforeseen Ground Conditions/Utility Interference (Environment, Transport and Works Bureau Technical Circular (Works) No. 17/2004)*. Environment, Transport and Works Bureau, Government Secretariat, Hong Kong.  
[Amd GG2/01/2017]
- Evans, N.C. & Irfan, T.Y. (1991). *Landslide Studies 1991 : Blast-induced Rock Slide at Shau Kei Wan, November 1991*. Special Project Report No. SPR 6/91, Geotechnical Engineering Office, Hong Kong, 115 p.  
[Amd GG2/01/2017]

- Evans, G.L., McNicholl, D.P. & Leung, K.W. (1982). Testing in hand dug caissons. *Proceedings of the Seventh Southeast Asian Geotechnical Conference*, Hong Kong, vol. 1, pp 317-332.
- Flanagan, C.P. & Holmgren, G.G.S. (1977). Field methods for determination of soluble salts and percent sodium from extract for identifying dispersive clay soils. *Dispersive Clays, Related Piping, and Erosion in Geotechnical Projects*. American Society for Testing and Materials, Special Technical Publication no. 623, pp 121-134.
- Foott, R., Koutsoftas, D.C. & Handfelt, L.D. (1987). Test fill at Chek Lap Kok, Hong Kong. *Journal of Geotechnical Engineering, American Society of Civil Engineers*, vol. 113, pp 106-126.
- Forth, R.A. & Platt-Higgins, P.M. (1981). Methods of investigation of weathered rocks in Hong Kong. *Proceedings of the International Symposium on Weak Rock*, Tokyo, vol. 2, pp 159-166. (Discussion, vol. 3, p 1387).
- Franklin, J.A. (1985). A direct shear machine for testing rock joints. *Geotechnical Testing Journal*, vol. 8, pp 25-29.
- Franklin, J.A., Broch, E. & Walton, G. (1971). Logging the mechanical character of rock. *Transactions of the Institution of Mining and Metallurgy*, vol. 80, pp A1-A9.
- Franklin, J.A. & Hoek, E. (1970). Developments in triaxial testing equipment. *Rock Mechanics*, vol. 2, pp 223-228.
- Froome, K.D. & Bradsell, R.H. (1966). A new method for measurement of distances up to 5 000 ft by means of a modulated light beam. *Journal of Scientific Instruments*, vol. 43, pp 129-133.
- Frost, R.J. (1973). Some testing experience and characteristic of boulder - gravel fill in earth dams. *Evaluation of Relative Density and Its Role in Geotechnical Projects Involving Cohesionless Soils*. American Society for Testing and Materials, Special Technical Publication no. 523, pp 207-233.
- Fung, A.K.L., Foott, R., Cheung, R.K.H. & Koutsoftas, D.C. (1984). Practical conclusions from the geotechnical studies on offshore reclamation for the proposed Chek Lap Kok Airport. *Hong Kong Engineer*, vol. 12, no. 6, pp 17-26. (Discussion, vol. 6, no. 10, p. 53 and vol. 7, no. 2, pp 7-8).
- Fyffe, S., Reid, W.M. & Summers, J.B. (1986). The push-in pressuremeter: 5 years offshore experience. *The Pressuremeter and Its Marine Applications*. American Society for Testing and Materials, Special Technical Publication no. 950.
- Gamon, T.I. (1984a). A comparison between the core orienter and the borehole impression device. *Proceedings of the 20th Regional Meeting of the Engineering Group of the Geological Society*, Guildford, UK, pp 247-251. (Published as *Site Investigation Practice : Assessing BS 5930*, edited by A.B. Hawkins, Geological Society, Engineering

- Geology Special Publication* no. 2, 1986) (Also published in preprint vol. 1, pp 228-231). (Discussion, p 72).
- Gamon, T.I. (1984b). The use of the point load test for the determination of strength of weathered rocks in Hong Kong. *Geological Society of Hong Kong Newsletter*, vol. 2, no. 4, pp 9-16.
- Gamon, T.I. & Szeto, P.L. (1984). The determination of the uniaxial compressive strength of rock material - a review of current practice in Hong Kong. *Proceedings of the Conference on Geological Aspects of Site Investigation*, Hong Kong, pp 9-19. (Published as *Geological Society of Hong Kong, Bulletin* no. 2, edited by I. McFeat-Smith, 1985).
- GCO (1984). *Geotechnical Manual for Slopes. (Second edition)*. Geotechnical Control Office, Hong Kong, 295 p.
- GCO (1986). *Hong Kong and Kowloon, Solid and Superficial Geology (1:20 000 map)*. Hong Kong Geological Survey Map Series HGM20, Sheet 11. Geotechnical Control Office, Hong Kong, 1 map.
- GCO (1987). *Geotechnical Area Studies Programme : Hong Kong and Kowloon*. GASP Report No. 1, Geotechnical Control Office, Hong Kong, 172 p.
- GCO (1988). *Guide to Rock and Soil Descriptions (Geoguide 3)*. Geotechnical Control Office, Hong Kong, 189 p.
- GEO (1992). *Guide to Cavern Engineering, Geoguide 4*. Geotechnical Engineering Office, Hong Kong, 156 p. [Amd GG2/01/2017]
- GEO (1993). *Guide to Retaining Wall Design (Geoguide 1). (Second edition)*. Geotechnical Engineering Office, Hong Kong, 267 p.
- GEO (2007). *Engineering Geological Practice in Hong Kong*. Geotechnical Engineering Office, Hong Kong, 278 p. [Amd GG2/01/2017]
- GEO (2016). *Catalogue of Hong Kong Tunnels (up to February 2016)*. Geotechnical Engineering Office, Hong Kong.  
(<http://www.cedd.gov.hk/eng/publications/reference/doc/HK%20Tunnel%20Cat.pdf>) [Amd GG2/01/2017]
- GEO (2017a). *Model Specification for Soil Testing (Geospec 3)*. Geotechnical Engineering Office, Hong Kong, 340 p. [Amd GG2/01/2017]
- GEO (2017b). *Guide to Reinforced Fill Structure and Slope Design (Geoguide 6)*. Geotechnical Engineering Office, Hong Kong, 236 p. [Amd GG2/01/2017]

- Geological Society (1970). The logging of rock cores for engineering purposes. Geological Society Engineering Group Working Party Report, *Quarterly Journal of Engineering Geology*, vol. 15, pp 265-316.
- Geological Society (1972). The preparation of maps and plans in terms of engineering geology. Geological Society Engineering Group Working Party Report, *Quarterly Journal of Engineering Geology*, vol. 5, pp 295-381.
- Geological Society (1982). Land surface evaluation for engineering purposes. Geological Society Engineering Group Working Party Report, *Quarterly Journal of Engineering Geology*, vol. 15, pp 265-316.
- Gibson, R.E. (1963). An analysis of system flexibility and its effect on timelag in pore-water pressure measurements. *Géotechnique*, vol. 13, pp 1-11.
- Goodman, R.E., Van, T.K. & Heuze, F.E. (1970). Measurement of rock deformability in boreholes. *Proceedings of the Tenth United States Symposium on Rock Mechanics*, Austin, Texas, pp 523-555.
- Government of Hong Kong (1985). *Buildings Ordinance (and Building Regulations). Laws of Hong Kong, Chapter 123, revised edition 1985*. Hong Kong Government Printer, 387 p. (Amended from time to time).
- Griffiths, D.H. & King, R.F. (1983). *Applied Geophysics for Geologists and Engineers : The Element of Geophysical Prospecting*. Pergamon Press, 230 p.
- Griffiths, J.S. & Marsh, A.H. (1984). BS 5930 : The role of geomorphological and geological techniques in a preliminary site investigation. *Proceedings of the 20th Regional Meeting of the Engineering Group of the Geological Society*, Guildford, UK, pp 261-267. (Published as *Site Investigation Practice: Assessing BS 5930*, edited by A.B. Hawkins, *Geological Society, Engineering Geology Special Publication no. 2*, 1986). (Also published in preprint vol. 1, pp 249-259).
- Gyenge, M. & Herget, G. (1977). *Pit Slope Manual, Supplement 3-2 - Laboratory Tests for Design Parameters*. CANMET (Canada Centre for Mineral and Energy Technology), CANMET Report 77-26, 74 p.
- Haas, C.J. (1983). Proposed new standard test method for dimensional and shape tolerances of rock core specimens. *Geotechnical Testing Journal*, vol. 6, pp 226-229.
- HCL (2001). *Detailed Study of Selected Landslides on Slope No. 11NE-D/C45, Hiu Ming Street, Kwun Tong*. Landslide Study Report No. LSR 7/2001, Geotechnical Engineering Office, Hong Kong, 96 p. [Amd GG2/01/2017]
- Handfelt, L.D., Koutsoftas, D.C. & Foott, R. (1987). Instrumentation for test fill in Hong Kong. *Journal of Geotechnical Engineering, American Society of Civil Engineers*, vol. 113, pp 147-160.

- Handy, R.L. & Fox, N.S. (1967). A soil borehole direct-shear test device. *Highway Research News*, USA, no. 27, pp 42-52.
- Hanna, T.H. (1985). *Field Instrumentation in Geotechnical Engineering*. Trans Tech Publications, Clausthal, Germany, 843 p.
- Hansen, A. (1982). Landslide hazard analysis. *Slope Instability*, edited by D. Brunsten & D.B. Prior, John Wiley & Sons Ltd, Chichester, pp 523-602.
- Hawkes, I. & Mellor, M. (1970). Uniaxial testing in rock mechanics laboratories. *Engineering Geology*, vol. 4, pp 177-285.
- Head, K.H. (1986). *Manual of Soil Laboratory Testing*, Volume 3, Effective Stress Tests. Halsted Press, New York, pp 743-1238.
- Hencher, S.R. (1981). *Report on Slope Failure at Yip Kan Street (11SW-D/C86) Aberdeen on 12th July 1981*. Geotechnical Control Office Report No. GCO 16/81, Geotechnical Control Office, Hong Kong, 26 p. [Amd GG2/01/2017]
- Hencher, S.R. & Martin, R.P. (1982). The description and classification of weathered rocks in Hong Kong for engineering purposes. *Proceedings of the Seventh Southeast Asian Geotechnical Conference*, Hong Kong, vol. 1, pp 125-142. (Discussion, vol. 2, pp 167-168).
- Hencher, S.R. & Martin, R.P. (1984). The failure of a cut slope on the Tuen Mun Road in Hong Kong. *Proceedings of the International Conference on Case Histories in Geotechnical Engineering*, St Louis, Missouri, vol. 2, pp 683-688.
- Hencher, S.R., Massey, J.B. & Brand, E.W. (1984). Application of back analysis to some Hong Kong landslides. *Proceedings of the Fourth International Symposium on Landslides*, Toronto, vol. 1, pp 631-638.
- Hencher, S.R. & Richards, L.R. (1982). The basic frictional resistance of sheeting joints in Hong Kong granite. *Hong Kong Engineer*, vol. 11, no. 2, pp 21-25.
- Heuze, F.E. (1984). Suggested method for estimating the insitu modulus of deformation of rock using the NX borehole jack. *Geotechnical Testing Journal*, vol. 7, pp 205-210.
- Hilf, J.W. (1975). Compacted fill. *Foundation Engineering Handbook*, edited by H.F. Winterkorn & H.Y. Fang, Van Nostrand Reinhold Company, New York, pp 244-311.
- HKIE (1981). *Guidance Notes on Hand-dug Caissons*. Hong Kong Institution of Engineers, 15 p.
- HKSARG (2013). *Construction Standard, Aggregates for Concrete (CS3:2013)*. The Government of the Hong Kong Special Administrative Region, Hong Kong, 140 p. [Amd GG2/01/2017]

- Ho, H.Y., King, J.P. & Wallace, M.I. (2006). *A Basic Guide to Air Photo Interpretation in Hong Kong*. Applied Geoscience Centre, Department of Earth Sciences, University of Hong Kong, 115 p. [Amd GG2/01/2017]
- Hoek, E. & Bray, W.J. (1981). *Rock Slope Engineering. (Third edition)*. Institution of Mining and Metallurgy, London, 358 p.
- Hoek, E. & Franklin, J.A. (1968). A simple triaxial cell for field and laboratory testing of rock. *Transactions of the Institution of Mining and Metallurgy, Section A*, vol. 77, pp 22-26.
- Holtz, W.G. (1948). The determination of limits for the control of placement moisture in high rolled earth dams. *Proceedings of the American Society for the Testing of Materials*, Philadelphia, pp 1240-1248.
- Horner, P.C. & Sherrell, F.W. (1977). The application of air-flush rotary-percussion techniques in site investigation. *Quarterly Journal of Engineering Geology*, vol. 10, pp 207-221.
- Houlsby, A.C. (1976). Routine interpretation of the Lugeon water test. *Quarterly Journal of Engineering Geology*, vol. 9, pp 303-313.
- Hucka, V. (1965). A rapid method of determining the strength of rocks insitu. *International Journal of Rock Mechanics and Mining Sciences*, vol. 2, pp 127-134.
- Hudson, J.A. & Ryley, M.D. (1978). Measuring horizontal ground movements. *Tunnels and Tunnelling*, vol. 10, no. 2, pp 55-58.
- Hvorslev, M.J. (1948). *Subsurface Exploration and Sampling of Soils for Civil Engineering Purposes*. US Army Waterways Experiment Station, Vicksburg, Mississippi, 521 p.
- Hvorslev, M.J. (1951). Time lag and permeability in groundwater observations. *US Army Waterways Experiment Station, Bulletin* no. 36, 50 p.
- IAEG (1981). Report of the commission on site investigations. *Bulletin of the International Association of Engineering Geology*, no. 24, pp 185-226.
- ICE (1976). *Manual of Applied Geology for Engineers*. Institution of Civil Engineers, London, 375 p.
- ICE (1978). *Piling : Model Procedures and Specifications*. Institution of Civil Engineers, London, 161 p.
- Idel, K.H., Muhs, H. & Von Soos, P. (1969). Proposal for "quality classes" in soil sampling and the importance of boring methods and sampling equipment. *Proceedings of the Specialty Session on Site Investigation, Seventh International Conference on Soil Mechanics and Foundation Engineering*, Mexico City, pp 56-61.

- IMMM (2003). *Ground Investigation Working Party - Final Report*. Institute of Materials, Minerals and Mining, Hong Kong Branch, 46 p. [Amd GG2/01/2017]
- Ireland, H.O., Moretto, C. & Vargas, M. (1970). The dynamic penetration test : a standard that is not standardized. *Géotechnique*, vol. 20, pp 185-192. (Discussion, pp 452-456).
- Irfan, T.Y. & Powell, G.E. (1985). Engineering geological investigations for pile foundations on a deeply weathered granitic rock in Hong Kong. *Bulletin of the International Association of Engineering Geology*, no. 32, pp 67- 80.
- ISRM (1978). Suggested methods for the quantitative description of discontinuities in rock masses. *International Journal of Rock Mechanics and Mining Sciences & Geomechanics Abstracts*, vol. 15, pp 319-368.
- ISRM (1985). Suggested method for determining point load strength. *International Journal of Rock Mechanics and Mining Sciences & Geomechanics Abstracts*, vol. 22, no. 2, pp 51-60.
- ISSMFE (1977). Report of the subcommittee on standardization of penetration testing in Europe, Appendix 5. *Proceedings of the Ninth International Conference on Soil Mechanics and Foundation Engineering*, Tokyo, vol. 3, pp 95-117.
- ITA (2009). *General Report on Conventional Tunnelling Method*. International Tunnelling and Underground Space Association. (<http://www.ita-aites.org/cms/ita-aites-home/latest-news-detail/datum/2009/05/13/ita-report-online-copie-1.html>) [Amd GG2/01/2017]
- Johnson, E.E. (1982). *Groundwater and Wells*. Johnson Division, Universal Oil Products Company, St Paul, Minnesota, 440 p.
- Kenney, T.C. (1967). Field measurements of insitu stresses in quick clays. *Proceedings of the Geotechnical Conference on the Shear Strength of Natural Soils and Rocks*, Oslo, vol. 1, pp 49-55. (Reprinted in *Norwegian Geotechnical Institute, Publication no. 76*, 1968, pp 19-25).
- King, R.A. (1977). A review of soil corrosiveness with particular reference to reinforced earth. *Transport and Road Research Laboratory, Supplementary Report no. 316*, Crowthorne, Berkshire, 27 p.
- Kjellman, W., Kallstenius, T. & Wager, O. (1950). Soil sampler with metal foils : device for taking undisturbed samples of very great length. *Proceedings of the Royal Swedish Geotechnical Institute*, no. 1, pp 1-75.
- Koirala, N.P., Hee, A. & Burnett, A.D. (1986). Geotechnical input to land use planning in Hong Kong. *Proceedings of the Conference on Planning and Engineering Geology (22nd Regional Conference of the Engineering Group of the Geological Society)*, Plymouth, UK, preprint vol., pp 729-739.



- Koutsoftas, D.C., Foott, R. & Handfelt, L.D. (1987). Geotechnical investigations offshore Hong Kong. *Journal of Geotechnical Engineering, American Society of Civil Engineers*, vol. 113, pp 87-105.
- Kruseman, G.P. & DeRidder, N.A. (1980). Analysis and evaluation of pumping test data. *International Institution for Land Reclamation and Improvement, Wageningen, The Netherlands, Bulletin* no. 11, 200 p.
- Lambe, T.W. (1951). *Soil Testing for Engineers*. John Wiley & Sons, Inc., New York, 165 p.
- Leach, B. & Herbert, R. (1982). The genesis of a numerical model for the study of the hydrogeology of a steep hillside in Hong Kong. *Quarterly Journal of Engineering Geology*, vol. 15, pp 243-259.
- Leroueil, S. & Tavenas, F. (1981). Pitfalls of back analyses. *Proceedings of the Tenth International Conference on Soil Mechanics and Foundation Engineering*, Stockholm, vol. 1, pp 185-190.
- Lueder, D.R. (1959). *Aerial Photographic Interpretation Principles and Applications*, McGraw-Hill, New York, 462 p.
- Lugeon, M. (1933). *Barrages et Géologie*. Dunod, Paris.
- Lumb, P. (1983). Engineering properties of fresh and decomposed igneous rocks from Hong Kong. *Engineering Geology*, vol. 19, pp 81-94.
- Marsland, A. (1971). Large insitu tests to measure the properties of stiff fissured clays. *Proceedings of the First Australia - New Zealand Conference on Geomechanics*, Melbourne, vol. 1, pp 180-189.
- Marsland, A. (1972). Clays subjected to insitu plate tests. *Ground Engineering*, vol. 5, no. 6, pp 24-31.
- Marsland, A. (1973). Instrumentation of flood defense banks along the River Thames. *Proceedings of the Symposium on Field Instrumentation in Geotechnical Engineering*, London, pp 287-303.
- Marsland, A. & Eason, B.J. (1973). Measurement of displacements in the ground below loaded plates in deep boreholes. *Proceedings of the Symposium on Field Instrumentation in Geotechnical Engineering*, London, pp 304-317.
- Mayes, M. (1985). Which EDM? *Land and Mineral Surveying*, vol. 3, no. 11, pp 594-595.
- McCann, D.M., Jackson, P.D. & Culshaw, M.G. (1987). The use of geophysical surveying methods in the detection of natural cavities and mineshafts. *Quarterly Journal of Engineering Geology*, vol. 20, pp 59-73.

- McFeat-Smith, I. (1987). Drilling long horizontal boreholes for site investigation purposes. *Contractor* (Hong Kong), June 1987, pp 7-12.
- McFeat-Smith, I., Nieuwenhuijs, G.K. & Lai, W.C. (1986). Application of seismic surveying, orientated drilling and rock classification for site investigation of rock tunnels. *Proceedings of the Conference on Rock Engineering and Excavation in an Urban Environment*, Hong Kong, pp 249-261.
- McKinlay, D.G. & Anderson, W.F. (1975). Determination of the modulus of deformation of a till using a pressuremeter. *Ground Engineering*, vol. 8, no. 6, pp 51-54.
- McNicholl, D.P. & Cho, G.W.F. (1985). Surveillance of pore water conditions in large urban slopes. *Proceedings of the 21st Annual Conference of the Engineering Group of the Geological Society*, Sheffield, pp 403-415. (Published as *Groundwater in Engineering Geology*, edited by J.C. Cripps et al, *Geological Society, Engineering Geology Special Publication* no. 3, 1986) (Also published in preprint volume, pp 445-467).
- Meigh, A.C. (1977). Techniques of exploration, sampling and testing, including field tests, in structurally complex formations. (General Report). *Proceedings of the International Symposium on the Geotechnics of Structurally Complex Formations*, Capri, Italy, vol. 2, pp 238-254.
- Meigh, A.C. & Skipp, B.O. (1960). Gamma-ray and neutron methods of measuring soil density and moisture. *Géotechnique*, vol. 10, pp 110-126.
- Meigh, A.C., Skipp, B.O. & Hobbs, N.B. (1973). Field and laboratory creep tests on weak rocks. *Proceedings of the Eighth International Conference on Soil Mechanics and Foundation Engineering*, Moscow, vol. 1.2, pp 265-271.
- Ménard, L. (1965). Regles pour le calcul de la force portante et du tassement des fondations en fonction des resultats pressiometriques. (Rules for the calculation of bearing capacity and foundation settlement based on pressuremeter tests). *Proceedings of the Sixth International Conference on Soil Mechanics and Foundations Engineering*, Montreal, vol. 2, pp 295-299.
- Moore, J.F.A. (1974). A long-term plate test on Bunter Sandstone. *Proceedings of the Third Congress of the International Society for Rock Mechanics*, Denver, vol. 2B, pp 724-732.
- Morgan, T.A. & Panek, L.A. (1963). *A Method for Determining Stresses in Rock*. Report of Investigations No. 6312, Bureau of Mines, U.S. Department of the Interior.
- Naylor, J.A., Rowland, C.D., Young, C.P. & Barber, C. (1978). The investigation of landfill sites. *Water Research Centre, UK, Technical Report TR91*, 68 p.
- Nixon, I.K. (1982). Standard penetration test : state-of-the-art report. *Proceedings of the Second European Symposium on Penetration Testing*, Amsterdam, vol. 1, pp 3-24.

- Norbury, D.R. (1984). The point load test. *Proceedings of the 20th Regional Meeting of the Engineering Group of the Geological Society*, Guildford, UK, pp 325-329. (Published as *Site Investigation Practice: Assessing BS 5930*, edited by A.B. Hawkins, Geological Society. *Engineering Geology Special Publication* no. 2, 1986). (Also published in preprint vol. 1, pp 344-352).
- Palmer, D.J. (1957). *Writing Reports*. Soil Mechanics Ltd, London, 24 p.
- Pang, P.L.R. (1986). A new boundary stress transducer for small soil models in the centrifuge. *Geotechnical Testing Journal*, vol. 9, pp 72-79.
- Parry, R.G.H. (1971). A simple driven piezometer. *Géotechnique*, vol. 21, pp 163-167.
- Penman, A.D.M. (1960). A study of the response times of various types of piezometers. *Proceedings of the Conference on Pore Pressures and Suction in Soils*, London, pp 53-58.
- Penman, A.D.M. (1969). Instrumentation for earth and rockfill dams. *BNCOLD News and Views*, May 1969, pp 7-10. (Reprinted in *Building Research Establishment, UK, Current Paper* no. 35/69, 6 p).
- Penman, A.D.M. (1978). Pore pressure and movement in embankment dams. *Water Power and Dam Construction*, vol. 30, no. 4.
- Penman, A.D.M. (1986). Field measurement of pore pressures. *Proceedings of the Fourth International Geotechnical Seminar on Field Instrumentation and In-Situ Measurements*, Singapore, pp 163-173.
- Penman, A.D.M. & Mitchell, P.B. (1970). Initial behaviour of Scammonden Dam. *Proceedings of the Tenth Conference of the International Commission on Large Dams*, Montreal, pp 723-747. (Reprinted in *Building Research Establishment, UK, Current Paper* no. 20/70, 19 p).
- Phillipson, H.B. & Brand, E.W. (1985). Sampling and testing of residual soils in Hong Kong. *Sampling and Testing of Residual Soils : A Review of International Practice*, edited by E.W. Brand & H.B. Phillipson, Scorpion Press, Hong Kong, pp 75-82.
- Phillipson, H.B. & Chipp, P.N. (1981). High quality core sampling - recent developments in Hong Kong. *Hong Kong Engineer*, vol. 9, no. 4, pp 9-15.
- Phillipson, H.B. & Chipp, P.N. (1982). Air foam sampling of residual soils in Hong Kong. *Proceedings of the Specialty Conference on Engineering and Construction in Tropical and Residual Soils*, Honolulu, pp 339-356.
- Poole, R.W. & Farmer, I.W. (1980). Consistency and repeatability of Schmidt hammer rebound data during field testing. *International Journal of Rock Mechanics and Mining Sciences & Geomechanics Abstracts*, vol. 17, pp 167-171.

- Pope, R.G., Weeks, R.C. & Chipp, P.N. (1982). Automatic recording of standpipe piezometers. *Proceedings of the Seventh Southeast Asian Geotechnical Conference*, Hong Kong, vol. 1, pp 77-89.
- Richards, B.G. (1971). Psychometric techniques for field measurements of negative pore pressure in soils. *Proceedings of the First Australia - New Zealand Conference on Geomechanics*, Melbourne, vol. 1, pp 387-394.
- Richards, L.R. & Cowland, J.W. (1982). The effect of surface roughness on the field shear strength of sheeting joints in Hong Kong granite. *Hong Kong Engineer*, vol. 10, no. 10, pp 39-43.
- Ridley Thomas, W.N. (1982). The application of engineering geophysical techniques to site investigations in Hong Kong. *Proceedings of the Seventh Southeast Asian Geotechnical Conference*, Hong Kong, vol. 1, pp 205-226.
- Rigden, W.J., Thorburn, S., Marsland, A. & Quartermain, A. (1982). A dual load range cone penetrometer. *Proceedings of the Second European Symposium on Penetration Testing*, Amsterdam, pp 787-796.
- Road Research Laboratory (1952). *Soil Mechanics for Road Engineers*. Her Majesty's Stationery Office, London, 565 p.
- Rocha, M., Silveira, A. da., Grossmann, N. & Oliveira, E. de. (1966). Determination of the deformability of rock masses along boreholes. *Proceedings of the First Congress of the International Society for Rock Mechanics*, Lisbon, vol. 1, pp 697-704.
- Ross-Brown, D.M. & Walton, G. (1975). A portable shear box for testing rock joints. *Rock Mechanics*, vol. 7, pp 129-153.
- Rowe, P.W. (1972). The relevance of soil fabric to site investigation practice. *Géotechnique*, vol. 27, pp 195-300.
- Rowe, P.W. & Barden, L. (1966). A new consolidation cell. *Géotechnique*, vol. 16, pp 162-170.
- Sanglerat, G. (1972). *The Penetrometer and Soil Exploration*. Elsevier Publishing Co., Amsterdam, 464 p.
- Schmid, W.E. (1966). Field determination of permeability by the infiltration test. *Permeability and Capillarity of Soils, American Society for Testing and Materials, Special Technical Publication no. 417*, pp 142-159.
- Serota, S. & Jennings, R.A. (1958). Undisturbed sampling techniques for sands and very soft clays. *Proceedings of the Fourth International Conference on Soil Mechanics and Foundation Engineering*, London, vol. 1, pp 245-248.

- Sewell, R.J., Campbell, S.D.G., Fletcher, C.J.N., Lai, K.W. & Kirk, P.A. (2000). *The Pre-Quaternary Geology of Hong Kong*. Geotechnical Engineering Office, Hong Kong, 181 p. [Amd GG2/01/2017]
- Sherwood, D.E. & Child, G.H. (1974). A static dynamic sounding technique. *Proceedings of the European Symposium on Penetration Testing*, Stockholm, vol. 2.2, pp 361-366.
- Sherard, J.L., Dunnigan, L.P., Decker, R.S. & Steele, E.F. (1976). Pinhole test for identifying dispersive soils. *Journal of the Geotechnical Engineering Division, American Society of Civil Engineers*, vol. 102, pp 69-85.
- Siu, K.L. & Wong, K.M. (1984). Concealed marble features at Yuen Long. *Proceedings of the Conference on Geological Aspects of Site Investigation*, Hong Kong, pp 75-88. (Published as *Geological Society of Hong Kong, Bulletin* no. 2, edited by I. McFeat-Smith, 1985).
- Skempton, A.W. (1986). Standard penetration test procedures and the effects in sands of overburden pressure, relative density, particle size, ageing and overconsolidation. *Géotechnique*, vol. 36, pp 425-447.
- Smyth, D.V. & McSweeney, T.V. (1985). Power swivel improves offshore drilling quality. *Contractor* (Hong Kong), June 1985, pp 13-15.
- Snow, D.T. (1968). Rock fracture spacings, openings, and porosities. *Journal of the Soil Mechanics and Foundations Division, American Society of Civil Engineers*, vol. 94, no. SMI, pp 73-91.
- Standards Association of Australia (1980). Determination of the Emerson Class Number of a soil. *Australian Standard Methods of Testing Soils for Engineering Purposes*, no. AS 1289, C8.1-1980. Standards Association of Australia, Sydney, 3 p.
- Starr, D.C. & Finn, P.S. (1979). Practical aspects of rock slope stability assessment in Hong Kong. *Hong Kong Engineer*, vol. 7, no. 10, pp 49-56.
- Stephenson, R.J. (1973). Relative density tests on rockfill at Carters Dam. *Evaluation of Relative Density and Its Role in Geotechnical Projects Involving Cohesionless Soils. American Society for Testing and Materials, Special Technical Publication* no. 523, pp 234-247.
- Strange, P.J. (1986). Urban geological mapping - techniques used in Kowloon and Hong Kong. *Proceedings of the Symposium on the Role of Geology in Urban Development in Southeast Asia, (Landplan III)*, Hong Kong, pp 181-189. (Published as *Geological Society of Hong Kong, Bulletin* no. 3, edited by P.G.D. Whiteside, 1987). (Abstract in *Geological Society of Hong Kong Abstracts*, no. 4, 1986, pp 14)
- Strange, P.J. & Shaw, R. (1986). *Geology of Hong Kong Island and Kowloon, 1:20 000 Sheets 11 and 15*. Hong Kong Geological Survey Memoir No. 2, Geotechnical Control Office, Hong Kong, 136 p.

- Sweeney, D.J. (1982). Some insitu soil suction measurements in Hong Kong's residual soil slopes. *Proceedings of the Seventh Southeast Asian Geotechnical Conference*, Hong Kong, vol. 1, pp 91-106. (Discussion, vol. 2, pp 93-96).
- Sweeney, D.J. & Ho, C.S. (1982). Deep foundation design using plate load tests. *Proceedings of the Seventh Southeast Asian Geotechnical Conference*, Hong Kong, vol. 1, pp 439-452.
- UNESCO (1976). *Engineering Geological Maps, A Guide to Their Preparation*. The UNESCO Press, Paris, 79 p.
- USACE (1997). *Engineer Manual 1110-2-2901 Engineering and Design - Tunnels and Shafts in Rock*. US Army Corps of Engineers.  
(<http://140.194.76.129/publications/eng-manuals/em1110-2-2901/toc.htm>)  
[Amd GG2/01/2017]
- USBR (1974). *Earth Manual. (Second edition)*. United States Bureau of Reclamation, US Government Printer, Washington D.C., 810 p.
- Van Zuidam, R.A. & Van Zuidam-Cancelado, F.I. (1979). Terrain analysis and classification using aerial photographs : A geomorphological approach. *ITC Textbook of Photo-Interpretation Volume VII - Use of Aerial Detection in Geomorphology and Geographical Landscape Analysis*, International Institute of Aerial Survey and Earth Sciences (ITC), Enschede, The Netherlands, 333 p.
- Vaughan, P.R. (1974). The measurement of pore pressure with piezometers. *Proceedings of the Symposium on Field Instrumentation in Geotechnical Engineering*, London, pp 411-422.
- Verstappen, H.T. & Van Zuidam, R.A. (1968). *ITC Textbook of Photo-interpretation*. ITC, Delft. The Netherlands. 7 vols.
- Wallace, G.B. Slebir, E.J. & Anderson, F.J. (1970). Insitu methods for determining deformation modulus used by the Bureau of Reclamation. *Determination of the In Situ Modulus of Deformation of Rock, American Society for Testing and Materials, Special Technical Publication no. 477*, pp 3-26.
- Walton, W.C. (1962). Selected analytical methods for well and aquifer evaluation. *Illinois State Water Survey, Urbana, Illinois, Bulletin no. 49*, 81 p.
- Ward, W.H., Burland, J.B. & Gallois, R.W. (1968). Geotechnical assessment of a site at Munford, Norfolk, for a large proton accelerator. *Géotechnique*, vol. 18, pp 399-431.
- Way, D.S. (1978). *Terrain Analysis - A Guide to Site Selection Using Aerial Photographic Interpretation. (Second edition)*. McGraw Hill, New York, 438 p.

- Weltman, A.J. & Head, J.M. (1983). Site investigation manual. *Construction Industry Research & Information Association Special Publication no. 25 / PSA Civil Engineering Technical Guide no. 35*, 144 p.
- Whiteside, P.G.D. (1986). Horizontal plate loading tests in completely decomposed granite. *Hong Kong Engineer*, vol. 14, no. 10, pp 7-14. (Discussion, vol. 14, no. 10, p. 14 and vol. 15, no. 2, pp 37-39, 48).
- Whyte, I.L. (1984). The quality of U100 sampling. *Proceedings of the 20th Regional Meeting of the Engineering Group of the Geological Society*, Guildford, UK, pp 419-423. (Published as *Site Investigation Practice : Assessing BS 5930*, edited by A.B. Hawkins, *Geological Society, Engineering Geology Special Publication no. 2*, 1986). (Also published in preprint vol. 1, pp 485-494).
- Wilson, N.E. (1963). Laboratory vane shear tests and the influence of pore water stresses. *Laboratory Shear Testing of Soils. American Society of Testing and Materials, Special Technical Publication no. 361*, pp 377-385.
- Windle, D. & Wroth, C.P. (1977). The use of a self-boring pressuremeter to determine the undrained properties of clays. *Ground Engineering*, vol. 10, no. 6, pp 37-46.
- Winter, E. (1982). Suggested practice for pressuremeter testing in soils. *Geotechnical Testing Journal*, vol. 5, no. 3/4, pp 85-88.

Tables



**List of Tables**

Table No.		Page No.
1	Selected Maps, Plans and Aerial Photographs Available from the Lands Department	217
2	Aerial Photographs Available from the Lands Department (two sheets)	218
3	Guidance on Site Investigation for Slopes and Retaining Walls in Hong Kong	220
4	Content of Site Investigation for Slopes Retaining Walls in Hong Kong	221
5	Sizes of Commonly-used Core-barrels, Casing and Drill Rods Used in Hong Kong	222
6	Principal Causes of Soil Disturbance	223
7	Mass of Soil Required for Various Laboratory Tests	223
8	Expected Sample Quality from Different Sampling Procedures for Hong Kong Materials	224
9	Soil Sample Quality Classification	225
10	Evaluation of Piezometer Types	226
11	Field Geophysical Techniques Used in Ground Investigations	227
12	Tests on Soils and Groundwater (four sheets)	228
13	Outline of Engineering Consideration and SI Techniques for Rock (based on IMMM, 2003)	232

**Table 1 - Selected Maps, Plans and Aerial Photographs Available from the Lands Department**

Map / Plan	Coverage	Number of Sheets	Size (mm)	Series No.	Price per Copy (1987 HK\$)
Large - scale plans					
1:1 000	Full	1967	750 x 850	HP1C	10.00
1:1 200	NT & Islands	580	762 x 1 016	-	10.00
Medium - scale plans					
1:2 500	Urban	73	750 x 850	HP2.5C	10.00
1:5 000	Urban & NT	122	750 x 850	HP5C	10.00
1:7 500 Street maps	Urban & NT Townships	22	650 x 800	SM7D	10.00
1:10 000 Street maps	Urban, Shatin, Tsuen Wan & Tsing Yi	9	750 x 850	SM10D	10.00
1:15 000	Kowloon	1	755 x 1 115	SM15D	10.00
	Hong Kong	1	765 x 1 090		
Topographic maps					
1:20 000	Full	16	780 x 850	HM20C	15.00
1:50 000	Full	2	1 020 x 755	HM50CL	12.50
				HM50CP	10.00
1:100 000	Full	1	625 x 785	HM100CL	10.00
1:200 000	Full	1	235 x 343	HM200CL	2.50
Geological maps					
1:50 000 (1971)	Full	2	1 020 x 755	-	8.00
1:20 000 (1986)#	Map Sheet 7 & 11	2	780 x 850	HGM20	20.00
Aerial photographs	Full*	-	250 x 250	-	20.00
Approved town plans	-	-	-	-	10.00 / 20.00
Legend:					
#	See Figure 3 for full programme of the new geological survey				
*	See Table 2 for further details				

**Table 2 - Aerial Photographs Available from the Lands Department  
(Sheet 1 of 2, low altitude photographs)**

[Amd GG2/01/2017]

Year	Scale(s)	Approximate Coverage (%)			Remarks
		HKI	K	NT	
1924	Approx. 1:14 000	60	10	30	Medium to low resolution, single frames with incidental stereo overlap.
1945	1:12 000	95	60	95	Medium to good resolution. Almost all areas except east-west strip from Tuen Mun to Sai Kung.
1949	1:4 800 1:11 600	100	95	30	Good resolution. Excellent coverage of north-west New Territories. Good coverage of lowland areas.
1956 1959	1:10 000 1:13 300	10	50	5	Good resolution; some stereo overlap.
1961-1962	1:10 000	100	100	10	Good resolution; small relief exaggeration.
1963	NT = 1:7 800 HKI + K = 1:5 400	100	100	95	Excellent resolution, full stereo coverage. Coverage of all areas except Mai Po to Sha Tau Kok.
1964	1:3 600	5	5	10	Coverage of trunk roads.
1967	1:7 800 - 1:12 500	90	90	20	Coverage of main Urban Area only.
1968-1970	1:5 000 - 1:10 000	40	100	20	Coverage of Urban Areas.
1972	1:6 000 - 1:13 000	40	80	20	Coverage of trunk road.
1973	1:3 000 1:10 000 - 1:12 000	70 70	100 100	5 90	Urban Areas only. Most of HKSAR.
1974	1:5 000	10	70	30	Coverage of north-west and west New Territories.
1975	1:4 600 - 1:10 000	5	40	30	Coverage of north-west and west New Territories.
1976	1:2 000 - 1:8000	100	100	40	Coverage of Urban Areas and New Towns.
1977	1:2 800 - 1:8 000	100	100	50	Detailed coverage of north-west and north New Territories plus New Towns.
1978-1987	1:4 000 - 1:8 000	100	100	60	Annual coverage of Urban Areas including New Towns and lowland areas.
1988 to present	1:2 000 - 1:12 000	100	100	45-90	Annual coverage of New Territories varies from year to year.
Note: Colour aerial photographs have also been taken routinely since 1993.					

**Table 2 - Aerial Photographs Available from the Lands Department  
(Sheet 2 of 2, high altitude photographs)**

[Amd GG2/01/2017]

Year	Scale(s)	Approximate Coverage (%)			Remarks
		HKI	K	NT	
1954	1:60 000	2	80	90	Good resolution.
1964	1:25 000	100	100	100	Excellent resolution. Mosaic of aerial photographs available. East to west flight lines, 4 to 5 km apart.
1973	1:25 000	100	100	90	Good resolution. East to west flight lines, 3 to 5 km apart.
1974-1976	1:25 000	100	100	100	Good resolution. Annual coverage. East to west flight lines, 1 to 4 km apart.
1977	1:25 000	20		20	Obliques only of Urban Area. Coverage of Lantau, west New Territories and Sha Tin.
1978	1:25 000	100	100	100	Complete coverage.
1979	1:20 000	100	100	100	Complete coverage.
1980	1:20 000	100	80	20	Southern half of HKSAR only.
1981	1:20 000 1:50 000	100 80	100 80	100 10	Complete coverage. Urban Area and Lantau only.
1982	1:20 000	100	100	100	Complete coverage
1983	1:20 000 1:40 000	100 100	100 100	100 95	Complete coverage. Almost complete coverage.
1984	1:20 000	30	40	15	Coverage of Urban Area, Clearwater Bay and Sai Kung Peninsula.
1985	1:20000 1:30 000	100	100	100	Complete coverage
1986	1:20 000	100	100	100	Complete coverage.
1987	1:40 000	100	100	100	Complete coverage.
1988 – 1997*	1:20 000 - 1:40 000	100	100	100	Complete coverage.
1998 to present	1:16 000 - 1:40000	100	100	100	Complete coverage.
Note: Colour aerial photographs have also been taken routinely since 1993. *Year 1996: only 1:20 000 available					

**Table 3 - Guidance on Site Investigation for Slopes and Retaining Walls in Hong Kong**

S.I. Class Boundaries for Different Features	
Cut Slopes	Other Features
<p><b>Soil</b></p>	<p><b>Fill Slope</b></p>
<p><b>Rock</b></p>	<p><b>Retaining Wall</b></p>
<p><b>Legend :</b></p> <p>H Height of feature  <math>\theta</math> Angle of feature  <math>\alpha</math> Angle of natural hillside (Table 4)</p>	
<p><b>Notes:</b></p> <p>(1) This Table is intended to provide general guidance only. It should be read in conjunction with Table 4. Each situation must be assessed on its own merits to decide on the appropriate scope of the S.I. More or less intensive S.I. than that recommended may be required, depending on the particular site conditions.</p> <p>(2) Irrespective of the above S.I. class boundaries, the least stringent S.I. class for different risk categories should be Class 1 for 'High' risk, Class 2 for 'Low' risk and Class 3 for 'Negligible' risk. The risk categories are those given in the Geotechnical Manual for Slopes (GCO, 1984) and should be assessed with reference to both the present use and the development potential of the site.</p>	

**Table 4 - Content of Site Investigation for Slopes and Retaining Walls in Hong Kong**

S.I. Class	Angle of Natural Hillside in the Vicinity of the Site, $\alpha$		
	0° to 20°	20° to 40°	Greater than 40°
1	<p>A C1 D E1 G1 B2 C2 E2 F2 G2 E3 G3</p> <p>Detailed topographical and geological survey of the site and its surroundings. Stability analysis of features within the site, using strength and groundwater parameters obtained from the investigation.</p>	<p>A B1 C1 D E1 F1 G1 B2 C2 E2 F2 G2 E3 G3</p> <p>As for 0° to 20°. Survey of boulders and hydrological features affecting the site. Extend investigation locally outside limits of site to permit stability analysis of features above and below the site.</p>	<p>A B1 C1 D E1 F1 G1 B2 C2 E2 F2 G2 E3 G3</p> <p>As for 20° to 40°. Extend investigation more widely outside limits of site to permit stability analysis of features above and below the site.</p>
2	<p>A C1 D E1 G1 B2 C2 E2 F2 G2 E3 G3</p> <p>Topographical and geological survey of the site and its surroundings. Stability analysis of features within the site. For fill slopes steeper than 1 on 3, remoulded strength tests on fill should be carried out.</p>	<p>A B1 C1 D E1 F1 G1 B2 C2 E2 F2 G2 E3 G3</p> <p>As for 0° to 20°. Survey of boulders and hydrological features affecting the site.</p>	<p>A B1 C1 D E1 F1 G1 B2 C2 E2 F2 G2 E3 G3</p> <p>As for 20° to 40°. Extend investigation outside limits of site to permit stability analysis of features above and below the site.</p>
3	<p>B2 D E3 G3</p> <p>Assessment of surrounding topography and geology for indication of stability. Visual examination of geological materials.</p>	<p>B1 D B2 C2 E3 G2 G3</p> <p>As for 0° to 20°, with survey of topography and geology, including survey of boulders and hydrological features affecting the site.</p>	<p>A B1 C1 D B2 C2 E2 F2 G2 E3 G3</p> <p>As for 20° to 40°. Area outside the site boundary should also be examined for potential instability.</p>
<p>A. Examination of terrestrial photographs, aerial photos and geological maps</p> <p>B. Survey of</p> <ol style="list-style-type: none"> <li>1. boulders and hydrological features</li> <li>2. topographical, geological and surface drainage features</li> </ol> <p>C. Mapping of</p> <ol style="list-style-type: none"> <li>1. geological structures</li> <li>2. surface features</li> </ol> <p>D. Ground investigation, such as trial pits, boreholes, coring, probing and piezometer installations, as appropriate</p> <p>E. Sampling</p> <ol style="list-style-type: none"> <li>1. quality class 1 or 2</li> <li>2. quality class 3</li> <li>3. quality class 4</li> </ol> <p>F. Field measurements of</p> <ol style="list-style-type: none"> <li>1. permeability</li> <li>2. pore pressures</li> </ol> <p>G. Laboratory tests</p> <ol style="list-style-type: none"> <li>1. intact strength tests for soils and rock joints, remoulded strength tests for fill</li> <li>2. density tests for fill materials</li> <li>3. classification/index tests</li> </ol>			
<p>Notes: (1) This table is intended to provide general guidance only. It should be read in conjunction with Table 3.</p> <p>(2) Installation of instruments for long term monitoring of ground displacements and pore pressures should be considered during the site investigation stage.</p>			



**Table 6 - Principal Causes of Soil Disturbance**

Before Sampling	During Sampling	After Sampling
Stress relief	Stress relief	Stress relief
Swelling	Remoulding	Migration of water within the sample
Compaction	Displacement	Loss of moisture
Displacement	Shattering	Overheating
Base heave	Stones at the cutting shoe	Vibration
Piping	Mixing or segregation	Chemical changes
Caving	Failure to recover	Disturbance during extrusion
Note: Table adapted from Clayton et al (1982).		

**Table 7 - Mass of Soil Required for Various Laboratory Tests**

Purpose of Sample	Soil Type	Mass of Sample Required
Soil identification. including Atterberg limits, sieve analysis, moisture content and sulphate content tests	Clay, silt, sand	1 kg
	Fine and medium gravel	5 kg
	Coarse gravel	30 kg
Compaction tests	All	25 kg to 60 kg
Comprehensive examination of construction materials, including soil stabilization	Clay, silt, sand	100 kg
	Fine and medium gravel	130 kg
	Coarse gravel	160 kg
Note: Table taken from BS 5930 (BSI, 2010).		[Amd GG2/01/2017]



**Table 8 - Expected Sample Quality from Different Sampling Procedures for Hong Kong Materials**

Material Type	Typical Composition of Materials	Sampling Procedure	Expected Quality Class
Soils derived from insitu rock weathering	Composition of soils varies depending on the nature of parent rock material. Soils derived from granitic rock are usually silty and clayey sands; soils derived from volcanic rock are usually sandy and clayey silts.	Block sample from dry excavation	1
		Large diameter triple-tube core-barrel (102 mm diameter cores) with retractor shoe, air-foam flush	1
		Triple-tube core-barrel ( $\geq 74$ mm diameter cores) with retractor shoe	1/2
		U100 sampler	2/4
		SPT split barrel sampler with or without liner	3/4
		Bulk samples and jar samples from dry open excavation	3/4
		Light percussion shell and chisel for boulders	5
Colluvium	Fresh or variably decomposed rock fragments (boulders, cobbles and gravels) within a matrix of varying proportions of sand, silt and clay	The sampling procedures for soils derived from insitu rock weathering apply.	
Alluvial and marine deposits	(a) Granular soils (sands, silty sands or sandy silts)	Piston sampler or compressed air sand sampler	2/3
		U100 sampler (with core-catcher)	4
		SPT split barrel sampler	4
		Light percussion shell	5
	(b) Very soft to soft cohesive soils (sandy clays, silty clays or clays)	Piston sampler	1
		Thin-walled sampler	1/2
		U100 sampler	2/3
		Delft continuous sampler	2/3
	(c) Firm to very stiff cohesive soils	Light percussion clay cutter (dry boreholes) or shell (wet boreholes)	4/5
		Triple-tube core-barrel with retractor shoe	1/2
		U100 sampler	2/3
	(d) Cohesive and granular soils containing boulders, cobbles or gravel	Light percussion clay cutter	5
		The sampling procedures for soils derived from insitu rock weathering apply.	
Fill	Variable material, which can include compacted or uncompacted soil, rock fragments and building debris mixtures	See sampling procedures for relevant soil type and composition under 'Alluvial and Marine Deposits' above.	
Rock	All rock types found in Hong Kong, including boulders in colluvium	Diamond core drilling with double or triple-tube core-barrel. The latter generally causes less disturbance and gives better core recovery, especially in highly fractured or jointed rocks.	N/A
Notes:	(1) The typical composition of materials should only be taken as a general guide. (2) The quality classes are defined in Table 9. (3) The expected quality classes given should only be taken as a guide, as sample quality is highly dependent on workmanship and on the compactness (or consistency) and grading of the soil.		

**Table 9 - Soil Sample Quality Classification**

Sample Quality	Soil Properties that Can Be Reliably Determined
Class 1	Classification, moisture content, density, strength, deformation and consolidation characteristics
Class 2	Classification, moisture content, density
Class 3	Classification, moisture content
Class 4	Classification
Class 5	None (approximate sequence of materials only)
<p>Notes:</p> <ul style="list-style-type: none"> <li>(1) Large diameter class 1 and class 2 samples are often sufficient to allow the 'fabric' of the soil to be examined. Sometimes this may also be done using class 3 and class 4 samples.</li> <li>(2) Remoulded properties can be obtained using class 1 to class 4 samples.</li> <li>(3) Table adapted from BS EN 1997-2:2007 (BSI, 2007). <span style="color: red;">[Amd GG2/01/2017]</span></li> </ul>	

**Table 10 - Evaluation of Piezometer Types**

Gauge Pressure	Piezometer Type	Pressure Range	Response Time	De-airing Capability	Remote Reading Capability	Long-term Reliability	Other		Recommendations
							Advantages	Disadvantages	
Positive	Open-hydraulic (Casagrande)	Atmospheric to top of standpipe level	Slow	Self de-airing	Not normally, but possible with bubbler system	Very good	Cheap, simple to read & maintain; insitu permeability measurement possible.	Vandal damage often irreparable.	First choice for measurement within positive pressure range unless rapid response or remote reading required; response peaks can be detected by use of Halcrow buckets system.
	Closed-hydraulic (Low air entry pressure)	Any positive pressure	Moderate	Can be de-aired	Yes	Depends on pressure measuring system 1) Mercury manometer - very good 2) Bourdon gauge - poor in humid atmosphere 3) Pressure transducer - moderate but easily replaced	Fairly cheap; insitu permeability measurement possible; can be made vandal proof if required.	Gauge house usually required; regular de-airing necessary; uncovered tubing liable to rodent attack or damage if left exposed.	Useful when remote reading, and for artesian pressures.
	Closed-hydraulic (High air entry pressure)	-1 atmosphere to any positive pressure	Moderate	Can be de-aired	Yes	As above	Fairly cheap; insitu permeability measurements in low permeability soil are possible.	As above; very regular de-airing required when measuring suctions.	Useful for measuring small suctions.
	Pneumatic	Any positive pressure	Rapid	Cannot be de-aired; only partially self de-airing	Yes, some head loss over long distance	Moderate to poor, but very little long term experience available	Fairly cheap; no gauge house required.	No method of checking if pore water or pore air pressure is measured.	Only suitable when tip almost always below groundwater level and no large suctions occur.
	Electric vibrating wire type	Any positive pressure	Rapid	As above	Yes, but special cable required	Signal quality degenerates with time; instrument life about ten years, but reliability of instrument that cannot be checked is always suspect	-	As above; expensive; zero reading liable to drift and cannot be checked.	Not generally recommended.
	Electric resistance type	Any positive pressure	Rapid	As above	Yes, but with care because of transmission losses	poor	-	As above	Not recommended.
Negative (Suction)	Tensiometer	-1 atmosphere to positive pressure	Moderate to rapid	Can be de-aired	Yes	Good	Cheap, simple to read and maintain.	Vandal damage often irreparable; regular de-airing required.	First choice for measuring pore suction.
	Psychrometer	Below -1 atmosphere	Variable	Not relevant	Short distances only	Instrument life one to two years; little long term experience available	-	Not accurate between 0 and -1 atmosphere.	Research stage at the moment.

**Table 11 - Field Geophysical Techniques Used in Ground Investigations**

	Technique	Application	Remarks
Land Investigations	Seismic refraction	Mapping of subsurface material interfaces (including groundwater table). Determination of compression wave velocities. Location of geological features (e.g. faults and caverns).	A hammer impulse may be used for shallow investigations, but explosive charges are needed for deep investigations (> 30 m). Excessive background 'noise' may preclude surveys at some sites. May be unreliable unless velocities increase with depth and bedrock surface is regular. Variable weathering patterns often complicate interpretation. Data are indirect and represent averages.
	Seismic direct methods	Determination of material properties of the ground (sonic wave velocities, dynamic moduli and rock-mass quality). Location of geological features.	Uphole, downhole and crosshole surveys are carried out. Data are indirect and represent averages, and may be affected by other mass characteristics.
	Electrical resistivity	Mapping of subsurface material interfaces (including saltwater boundaries). Estimation of soil resistivity (hence corrosivity). Location of geological features and underground cavities, e.g. disused tunnels.	Variable weathering patterns often complicate interpretation. Water table location often limits the depth for practical study as conductivity rises sharply in saturated materials & makes differentiation between horizons impossible.
	Gravimetric	Location of geological features.	Normally used only to locate cavities, e.g. in karst terrain.
	Magnetic	Location of buried metalliferous man-made objects (e.g. cables and pipelines) and geological features.	Large scale surveys are generally carried out from an aircraft.
Marine Investigations	Seismic reflection	Mapping of the seabed and material interfaces below the seabed.	Long continuous traces can be obtained. Background 'noise', solid waste on the seabed, gas bubbles trapped within sediments, and variable weathering patterns often complicate interpretation. Does not provide sound velocities. Computation of depths to interfaces requires velocity data obtained by other means, e.g. borehole correlation, laboratory tests (Table 13).
	Side scan sonar	Mapping of the seabed (surface only). Location of rock outcrops, gravel deposits, pipelines, wrecks, etc.	The technique does not give accurate distances or depths to an object, and is generally used as a search tool only.
	Magnetic	Location of metalliferous man-made objects on or below the seabed (including sunken vessels).	Sunken objects on the seabed can render the location of specific objects difficult.
	Echo sounding	Bathymetric mapping to determine water depths.	Suspended sediments created by dredging the seabed can render the dredged levels obtained by this method unreliable. The trace obtained by the echo sounder should be checked against depths obtained by conventional methods, e.g. by the use of a gravity corer.

**Table 12 - Tests on Soils and Groundwater (Sheet 1 of 4)**

Category of Test	Name of Test	Recommended References	Remarks
Soil Classification Tests	Moisture content	Geospec 3 (GEO, 2017a) Clause 5; Geotechnical Manual for Slopes (GCO, 1984), Section 3.2.2 [Amd GG2/01/2017]	Frequently used in the determination of soil properties, e.g. dry density, degree of saturation. Soils containing halloysitic clays, gypsum or calcite can lose water of crystallisation when heated, and should be dried at various temperatures to assess the effect on determination of moisture content.
	Liquid and plastic limits (Atterberg limits)	Geospec 3 (GEO, 2017a) Clause 6; Geotechnical Manual for Slopes, Section 3.2.3[Amd GG2/01/2017]	Used to classify fine-grained soils and as an aid in classifying the fine fraction of mixed soils. Soils containing halloysitic clays must be tested at natural moisture content.
	Linear shrinkage	BS 1377-2 (BSI, 1990a) Clause 6.5 [Amd GG2/01/2017]	Used to detect the presence of expansive clay minerals. Limited application in Hong Kong.
	Specific gravity	Geospec 3 (GEO, 2017a) Clause 7; Geotechnical Manual for Slopes, Section 3.2.4; Lambe (1951) Chapter 2 [Amd GG2/01/2017]	Frequently used in the determination of other properties, e.g. void ratio, particle size distribution by sedimentation.
	Particle size distribution: (a) Sieving	(a) Geospec 3 (GEO, 2017a) Clause 8; Geotechnical Manual for Slopes, Section 4.6; Brian-Boys et al (1986) Clause 5.1 [Amd GG2/01/2017]	Wide application in Hong Kong in the classification of soils.  (a) Sieving gives the grading of soil coarser than silt. Care is required with soils derived from insitu rock weathering, to avoid crushing of soil grains during disaggregation. Dispersant should be excluded when determining particle size distribution for certain applications, e.g. for designing filters, and in selecting fill for reinforced fill structures. [Amd GG2/01/2017]
	(b) Sedimentation	(b) Geospec 3 (GEO, 2017a) Clause 8; Geotechnical Manual for Slopes, Section 3.2.5 [Amd GG2/01/2017]	(b) The proportion of the soil passing the finest sieve (63 µm) represents the combined silt and clay fraction. The relative proportions of silt and clay can only be determined by sedimentation.
Laboratory vane shear	Wilson (1963)	A useful test for classifying silts and clays in term of consistency. See also Geoguide 3 (GCO, 1988).	

**Table 12 - Tests on Soils and Groundwater (Sheet 2 of 4)**

Category of Test	Name of Test	Recommended References	Remarks
Chemical and Corrosivity Tests and Groundwater	Organic matter content	Geospec 3 (GEO, 2017a) Clause 9.1 [Amd GG2/01/2017]	Detects the presence of organic matter, which can: (i) interfere with the hydration of Portland cement in soil - cement pastes, (ii) influence shear strength, bearing capacity and compressibility, (iii) influence the magnitude of the correction factor require when using nuclear methods to estimate the insitu moisture content of soils (ASTM, 1985h), (iv) promote microbiological corrosion of buried steel.
	Sulphate content : (a) Total sulphate content of soil	(a) Geospec 3 (GEO, 2017a) Clause 9.3 [Amd GG2/01/2017]	These tests assess the aggressiveness of soil and groundwater to buried concrete and steel. Local experience indicates that sulphate content of Hong Kong soils is generally low. Therefore Geospec 3 (GEO, 2001) Clause 9.3 is normally adequate. [Amd GG2/01/2017]
	(b) Sulphate ion content of groundwater and aqueous soil extracts	(b) Geospec 3 (GEO, 2017a) Clause 9.3 [Amd GG2/01/2017]	
	Total sulphide content of groundwater and aqueous soil extracts	American Public Health Association (1985) Part 427	Assesses the aggressiveness of soil and groundwater to buried steel.
	pH value	Geospec 3 (GEO, 2017a) Clause 9.5 [Amd GG2/01/2017]	Assesses the aggressiveness of soil and groundwater to buried concrete and steel.
	Chloride ion content	Department of Transport (1976) Clause 2722	Assesses: (i) the aggressiveness of soil to buried concrete and steel; (ii) the suitability of fine aggregate for use in concrete.
	Carbonate content	Road Research Laboratory (1952)	The reference describes the method using the Collins calcimeter.
	Resistivity	BS 1377-9 (BSI, 1990) Section 5.1 [Amd GG2/01/2017]	Assesses the potential for electrochemical corrosion of buried steel. The quoted reference gives a test method for compacted fill, as opposed to field measurement using the four electrode method (see Section 33.2.1). Corrosion of steel in soils is discussed in BS 8004 (BSI, 1986) and King (1977).
Redox potential	BS 1377-9 (BSI, 1990) Section 5.2 [Amd GG2/01/2017]	Assesses the likelihood of sulphate reducing bacteria being present, which promote microbiological corrosion of buried steel. The quoted reference gives a test method for compacted fill, as opposed to field measurement, which is described in BS 1377-9 (BSI, 1990). [Amd GG2/01/2017]	

**Table 12 - Tests on Soils and Groundwater (Sheet 3 of 4)**

Category of Test	Name of Test	Recommended References	Remarks
Soil Strength Tests	Triaxial compression tests: (a) Quick undrained (b) Consolidated drained (c) Consolidated undrained with measurement of pore water pressure	(a) Geospec 3 (GEO, 2017a) Clause 15 [Amd GG2/01/2017] (b) Bishop & Henkel (1976) (c) Geotechnical Manual for Slopes, Sections 3.7 and 3.8; Head (1986)	The quick undrained test gives undrained shear strength in terms of total stresses, and has application to short-term stability and bearing capacity analyses. Effective stress analysis is relevant to most soils and engineering applications in Hong Kong; consequently the consolidated drained test or consolidated undrained test with measurement of pore water pressure should generally be used. Tests should be carried out in the stress range appropriate to the analysis. For saturated clays with undrained shear strength less than about 75 kPa, the insitu penetration vane test (see Section 21.3), used in conjunction with the cone penetration test (see Section 23.3), will normally be the best method for measuring undrained shear strength. A number of other triaxial tests are possible, e.g. failure by increasing pore pressure, decreasing $\sigma_3$ etc. Triaxial tests can also be used to find $K_0$ .
	Direct shear test	Akroyd (1969); ASTM (1985i); Geotechnical Manual for Slopes, Sections 3.7 and 3.9; Head (1986)	A useful and practical alternative to the consolidated drained triaxial test for shear strength measurements on fill, colluvium and soils derived from weathering of rock insitu. The test specimen can be oriented to measure shear strength on a pre-determined plane. The major limitation of the test is the specimen thickness, which governs the maximum particle size that can be tested. Common specimen sizes are 60 mm and 100 mm square by 20 mm thick. The less common 60 mm diameter by 20 mm thick and 300 mm square by 160 mm thick direct shear boxes have also been used in Hong Kong
Soil Deformation Tests	Consolidation: (a) One-dimensional consolidation (oedometer test) (b) Triaxial consolidation (c) Rowe cell	(a) Geospec 3 (GEO, 2017a) Clause 14 [Amd GG2/01/2017] (b) Bishop & Henkel (1976) (c) Rowe & Barden (1966); Head (1986)	These tests yield soil parameters from which the amount and time scale of settlements can be calculated. The simple oedometer test is the one in general use. Although reasonable assessment of settlement can be made from the results of the test, estimates of the time scale have been found to be extremely inaccurate for some soils. This is particularly true for clay soils containing layers and partings of silt and sand, where the horizontal permeability is much greater than the vertical. In these cases, more reliable data may be obtained from tests in the Rowe cell, which is available in sizes up to 250 mm diameter and where a larger and potentially more representative sample of soil can be tested (see Section 12.5). Another alternative is to obtain values of permeability, $k$ from insitu permeability tests, and combine them with coefficients of volume decrease, $m_v$ obtained from the simple oedometer test.
	Modulus of deformation	Head (1986)	Values of the modulus of deformation of soil can be obtained from the stress-strain curves from triaxial compression tests, where the test specimens have been consolidated under effective stresses corresponding to those in the field. However, values obtained in this way frequently do not correlate well with insitu observations. It is now generally considered that the plate test (see Section 21.6), the pressuremeter (see Section 21.7) and back analysis of existing structures yield more reliable results.

**Table 12 - Tests on Soils and Groundwater (Sheet 4 of 4)**

Category of Test	Name of Test	Recommended References	Remarks
Soil Permeability Tests	Permeability: (a) Constant head permeability test (b) Falling head permeability test (c) Triaxial permeability test (d) Rowe cell	(a) Akroyd (1969) (b) Akroyd (1969) (c) Bishop & Henkel (1976); Head (1986) (d) Head (1986); Rowe & Barden (1966)	The constant head test is suited only to soils of permeability roughly within the range $10^{-4}$ m/s to $10^{-2}$ m/s. For soils of lower permeability the falling head test is applicable. For various reasons, principally sample size and ground variability, laboratory permeability tests often yield results of limited value, and insitu tests should generally yield more representative data (see Section 21.4). The Rowe cell allows the direct measurement of permeability by a constant head, with a back pressure and confining pressures more closely consistent with the field state, and by both vertical and radial flow.
Soil Compaction Tests	Dry density / moisture content relationship	Geospec 3 (GEO, 2017a) Clause 10 [Amd GG2/01/2017]	Indicates the degree of compaction that can be achieved at different moisture contents and with different compactive effort. It is carried out in conjunction with determinations of insitu dry density (ASTM, 1985b; ASTM, 1985e; ASTM, 1985h; Geospec 3 (GEO, 2017a) Clause 11; see also Chapter 27). [Amd GG2/01/2017]
Pavement Design Tests	California bearing ratio (CBR)	Akroyd (1969); GEO (2017a) Clause 12 [Amd GG2/01/2017]	This is an empirical test used in the design of flexible pavements. The test can also be carried out insitu (see Section 29.4), but the results may be substantially different from the laboratory test due to the difference in the confining condition, especially for sands.
Soil Collapse Potential Tests	Double oedometer test	Hilf (1975); Holtz (1948)	Assesses the potential for soils to collapse on wetting.
Soil Dispersion Tests	Double hydrometer test (dispersion test) Exchangeable sodium percentage test Emerson crumb test (turbidity test) Pinhole test	Decker & Dunnigan (1977) Flanagan & Holmgren (1977) Standards Association of Australia (1980) Sherard et al (1976)	Used to identify dispersive soils, in order to assess the potential for dispersive piping and internal erosion to occur in slopes and earth structures. The different tests may not give consistent indications of dispersion, consequently it is advisable to use more than one test method.



**Table 13 - Outline of Engineering Consideration and SI Techniques for Rock Tunnels (based on IMMM, 2003)**

[Amd GG2/01/2017]

Major Engineering Considerations	Key Points for SI	Approach to Investigation	Testing	Survey / Monitoring	
		Investigation Methods	Insitu Testing	Instrument Types	
<p>Blasting design</p> <p>Machinability (suitability for TBM)</p> <p>Soil and rock mass excavation and support design (possibility of presence of mixed face conditions, fractured ground, and weak, compressible and/or permeable zones)</p> <p>Water pressures acting on lining /retaining structures for their design</p> <p>Potential water inflow into the shafts and along the tunnels.</p> <p>Assessment of tunnels/shafts drainage and pumping requirements</p> <p>Effects of the tunnel works on land stability, e.g. ground collapse/landslide due to inadequate support, hydraulic failure, blow-out failure, etc.</p> <p>Ground settlement, heave and lateral movement and distortion of sensitive receivers as a result of construction-induced ground loss, ground deformation/vibration and groundwater inflow/drawdown</p> <p>Design of tunnel portal slopes</p> <p>Lining/retaining structure durability design</p> <p>Effects of blasting on surface/subsurface facilities and slopes</p>	<p>Nature of soil and/or rock at tunnel level (invert and crown) and around the tunnels, and around/within the shafts</p> <p>Rock mass weathering (including presence of corestones and mixed ground) and strength</p> <p>Distribution, orientation and characteristics of discontinuities</p> <p>Rock mass permeability</p> <p>Insitu stress</p> <p>Presence of fault zones, dykes, contact zones between geological units, etc.</p> <p>Hydrogeology, including permanent groundwater table, perched water tables, permeable zones feeding water to the tunnels, etc.</p> <p>Potential recharge in response to rainfall and the sea, and hydraulic boundary conditions</p> <p>Dewatering effects of the tunnels, and the tunnel works damming subsurface groundwater flow</p> <p>Nature of surface materials, in particular, strength, permeability, compressibility and consolidation and creep characteristics</p> <p>As-built records and site history, in particular, effects of past and on-going construction activities that could affect the tunnels/shafts and the sensitive receivers</p> <p>Ground and groundwater chemistry</p>	<p>Geological mapping of surface rock exposures</p> <p>Aerial photograph interpretation to identify photolineaments</p> <p>Geophysical surveys to identify anomalies and low seismic velocity zones</p> <p>Boreholes – vertical holes needed for sampling and downhole tests. Unless surface materials need to be characterised for assessment of effects of the tunnel works, boreholes can be wash-bored down to the zone of interest</p> <p>Sub-horizontal/inclined holes from the tunnel portal and/or shaft locations to examine variations of ground conditions along the tunnel drive</p> <p>Inclined holes to intercept faults, dykes and contact zones at tunnel level</p> <p>Probing ahead during tunnelling operation</p> <p>Directional coring (for deep tunnels)</p>	<p>Impression packer test, televiwer</p> <p>Packer permeability test and possibly pumping test</p> <p>Insitu stress measurement (e.g. by hydrofracturing)</p> <p>Soil permeability test and response test in piezometer</p>	<p>Piezometers for monitoring pore water pressures at various hydrogeological response zones</p> <p>Settlement gauges</p>	
			<b>Sampling</b>	<p><b>Laboratory Testing/Analysis</b></p> <p>Unconfined Compressive Strength</p> <p>Young's Modulus</p> <p>Poisson's Ratio</p> <p>Point Load Strength</p> <p>Rock joint characteristics</p> <p>Abrasivity</p> <p>Hardness</p> <p>Geological thin sections</p> <p>Classification and consolidation creep tests for settlement-susceptible near-surface materials</p> <p>Salinity testing to assess the effects of groundwater on tunnelling equipment and lining</p>	<p><b>Survey / Monitoring</b></p> <p>Location survey of physical constraints and sensitive receivers</p> <p>Complete annual cycle needs to be monitored to indicate groundwater pressure response to rainfall and seasonal fluctuation, and to recharge from the sea</p> <p>Baseline ground movement and vibration survey and condition survey of sensitive receivers (e.g. cracks on existing structures) over a sufficiently long period to establish trends</p>
					<p>Rock coring through proposed tunnel levels (including all alternative alignments) and covering sufficient ground above crown and below invert</p> <p>Undisturbed soil samples for near-surface materials, potentially affected by the tunnel and shaft construction</p>

NB: Reference should also be made to the ground investigation guidelines for deep excavations and rock tunnels produced by AGS (HK) (2004a & b; 2005).

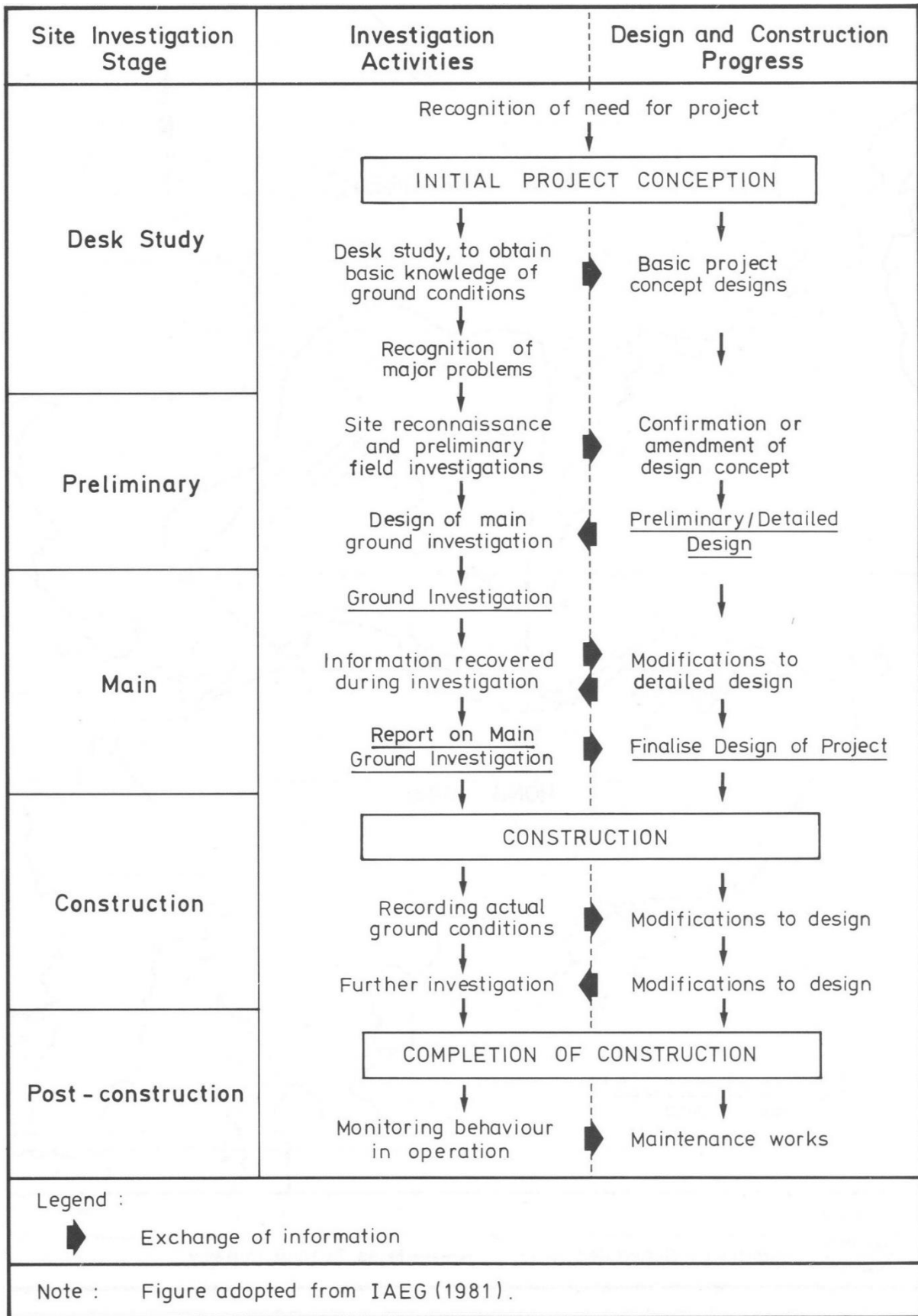
Figures

## List of Figures

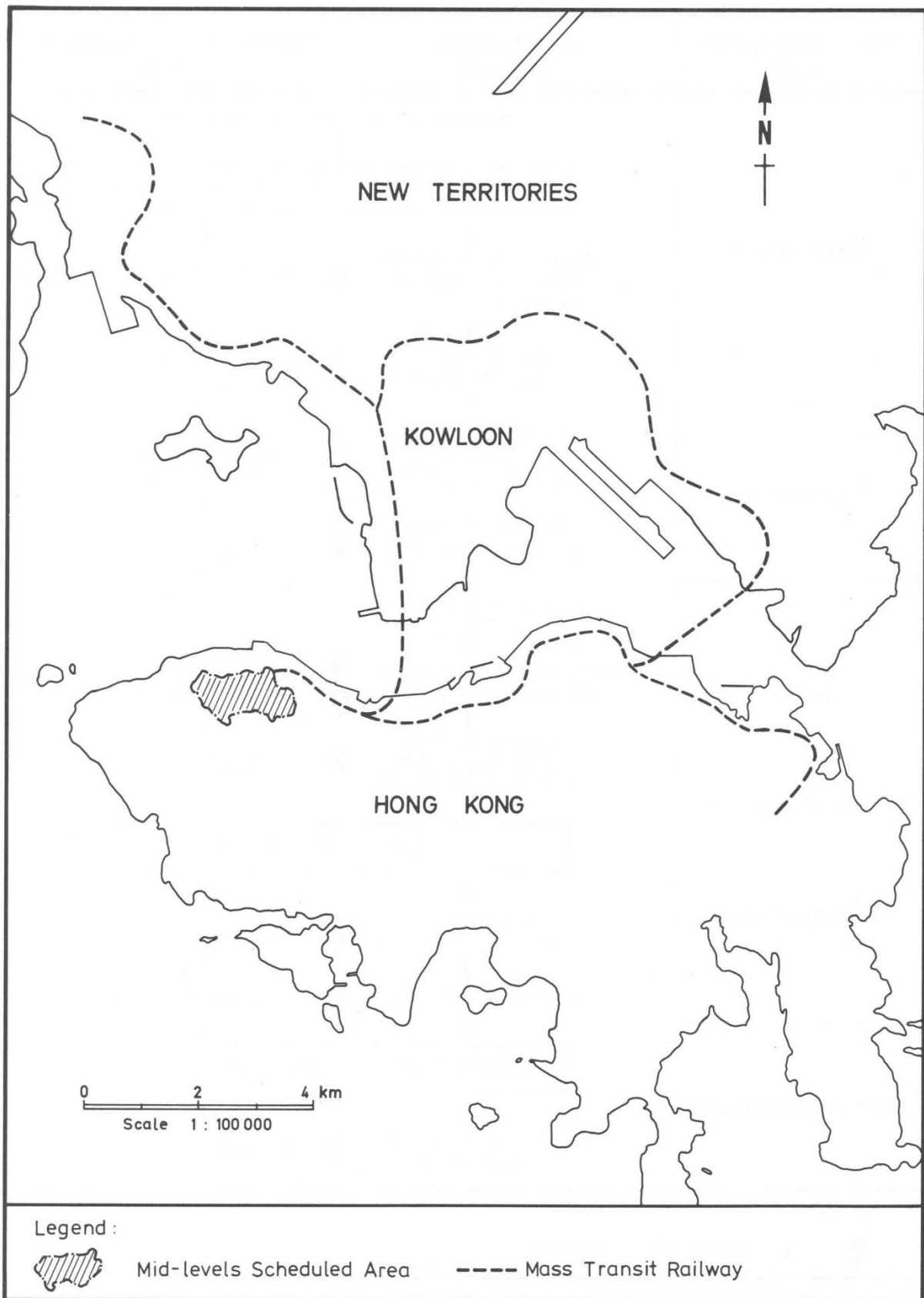
Figure No.		Page No.
1	Stages of a Site Investigation	237
2	Locations of the Mid-levels Scheduled Area and Mass Transit Railway	238
3	Programme of the New Geological Survey	239
4	The Geotechnical Area Studies Programme	240
5	Examples of Maps Available in the Geotechnical Area Studies Programme	241
6	Comparison of Geological Map and Aerial Photograph for Identifying Major Structural and Lithological Features	242
7	Trial Pit Log ( Example 1)	243
8	Trial Pit Log ( Example 2)	244
9	Example of a Log Sheet for Slope Surface Stripping	245
10	Example of a Caisson Log	246
11	Typical Configuration of a Rotary Drilling Rig	247
12	Typical Arrangement of Air Foam Mixing and Flushing System	248
13	General Purpose Open-tube Sampler	249
14	Thin-walled Sampler	250
15	Thin-walled Stationary Piston Sampler	251
16	Example of a Double-tube Core-barrel (Craelius T2-101)	252
17	Example of a Non-retractable Triple-tube Core-barrel (Triefus HMLC)	253
18	Example of a Retractable Triple-tube Core-barrel (Mazier)	254
19	Typical Standpipe and Open-hydraulic Piezometers	255

Figure No.		Page No.
20	Typical Twin-tube Closed-hydraulic Piezometer Tips	256
21	Typical Installation Details of a Piezometer in a Borehole	257
22	Example of Piezometer Record	258
23	Piezometer Buckets (British Patent No. 1538487)	259
24	Example of Piezometer Bucket Data	260
25	Split Barrel Sampler for Standard Penetration Test	261
26	Vane Shear Devices	262
27	Typical Arrangement for Field Permeability Test	263
28	Intake Factors, $F$ , in Borehole Permeability Tests	264
29	Relationship between Dimensionless Intake Factor and Length to Diameter Ratio of Piezometer	265
30	Example of Results from Falling-head Permeability Test	266
31	Typical Arrangement for Packer (Water Absorption) Test	267
32	Example of Packer (Water Absorption) Test Data	268
33	Example of Packer (Water Absorption) Test Calculations	269
34	Impression Packer Device	270
35	Impression Packer Survey and Discontinuity Log	271
36	GCO Probe	272
37	GCO Probe Record	273
38	Mechanical Cone Penetrometers	274
39	Electrical Cone Penetrometers	275
40	Point Load Tester and Example Data	276

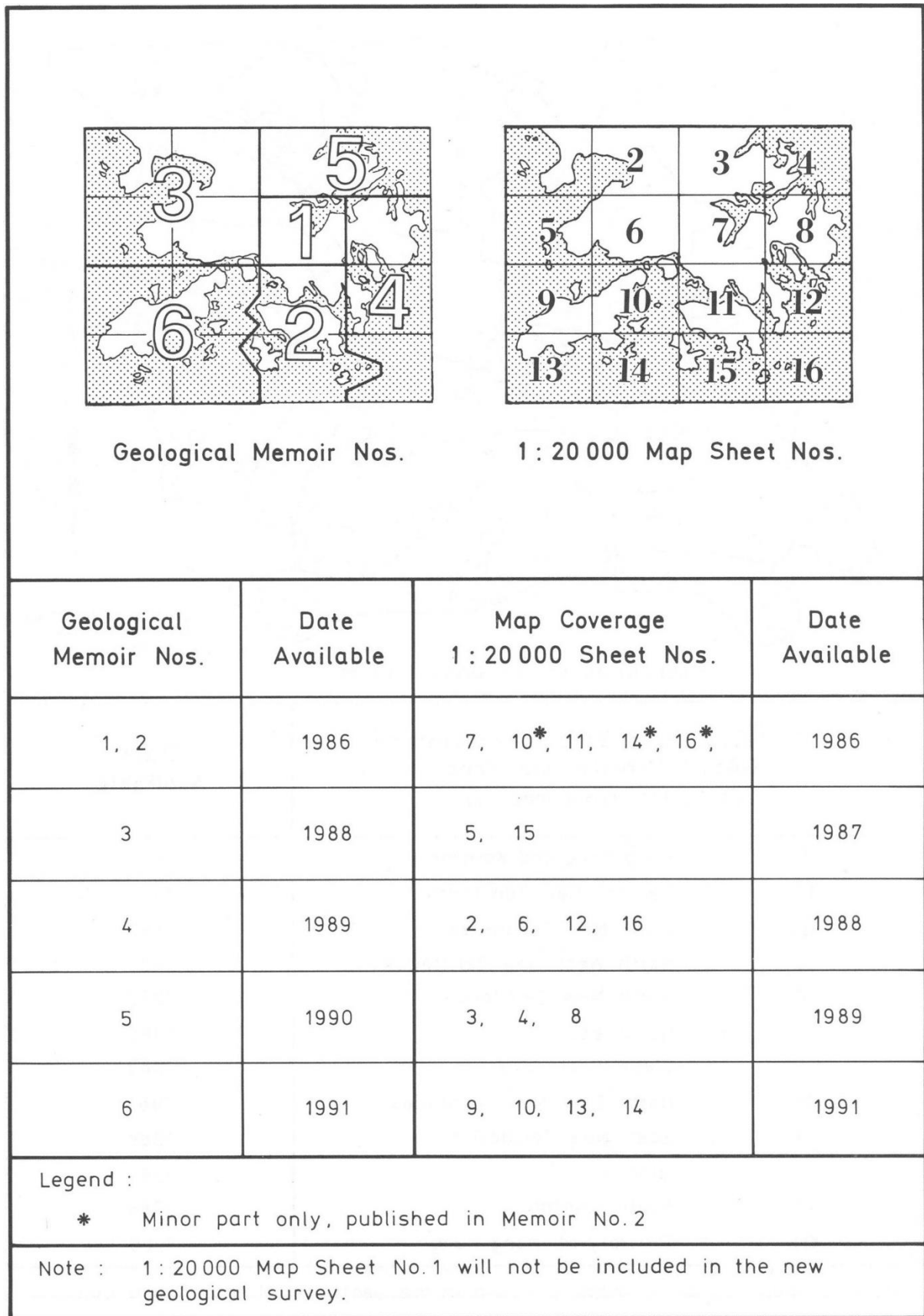
Figure No.		Page No.
41	Typical Arrangement for Double-ring Constant-head Field Infiltration Test	277
42	Example of Results from Field Infiltration Test	278
43	Typical Arrangement for Plate Load Test	279
44	Example of a Borehole Log (two sheets)	280
45	Geophysical Logs – Siu Sai Wan – BH2A	282
46	Geophysical Logs – Shum Wan – BH1A	283



**Figure 1 - Stages of a Site Investigation**

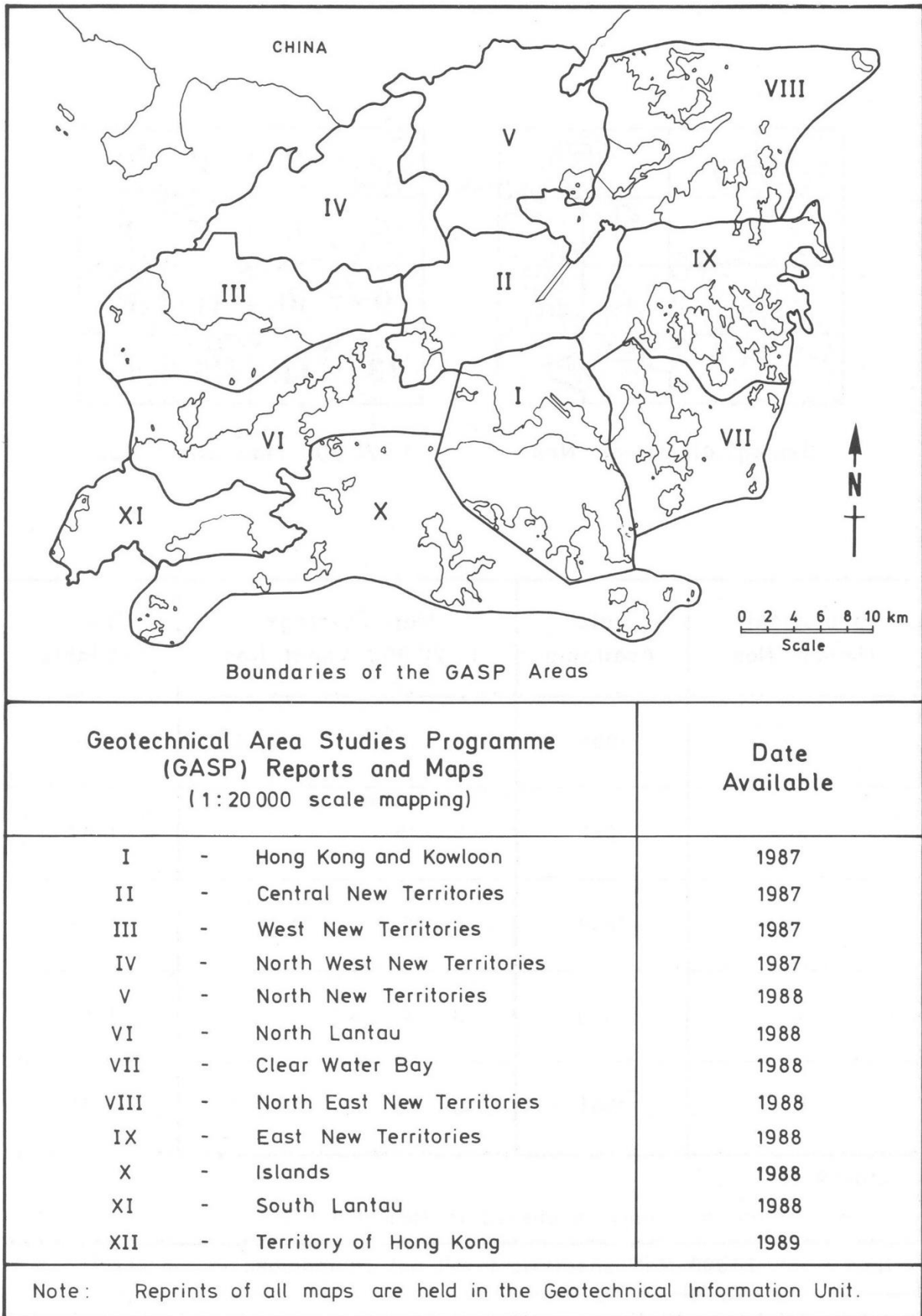


**Figure 2 - Locations of the Mid-levels Scheduled Area and Mass Transit Railway**

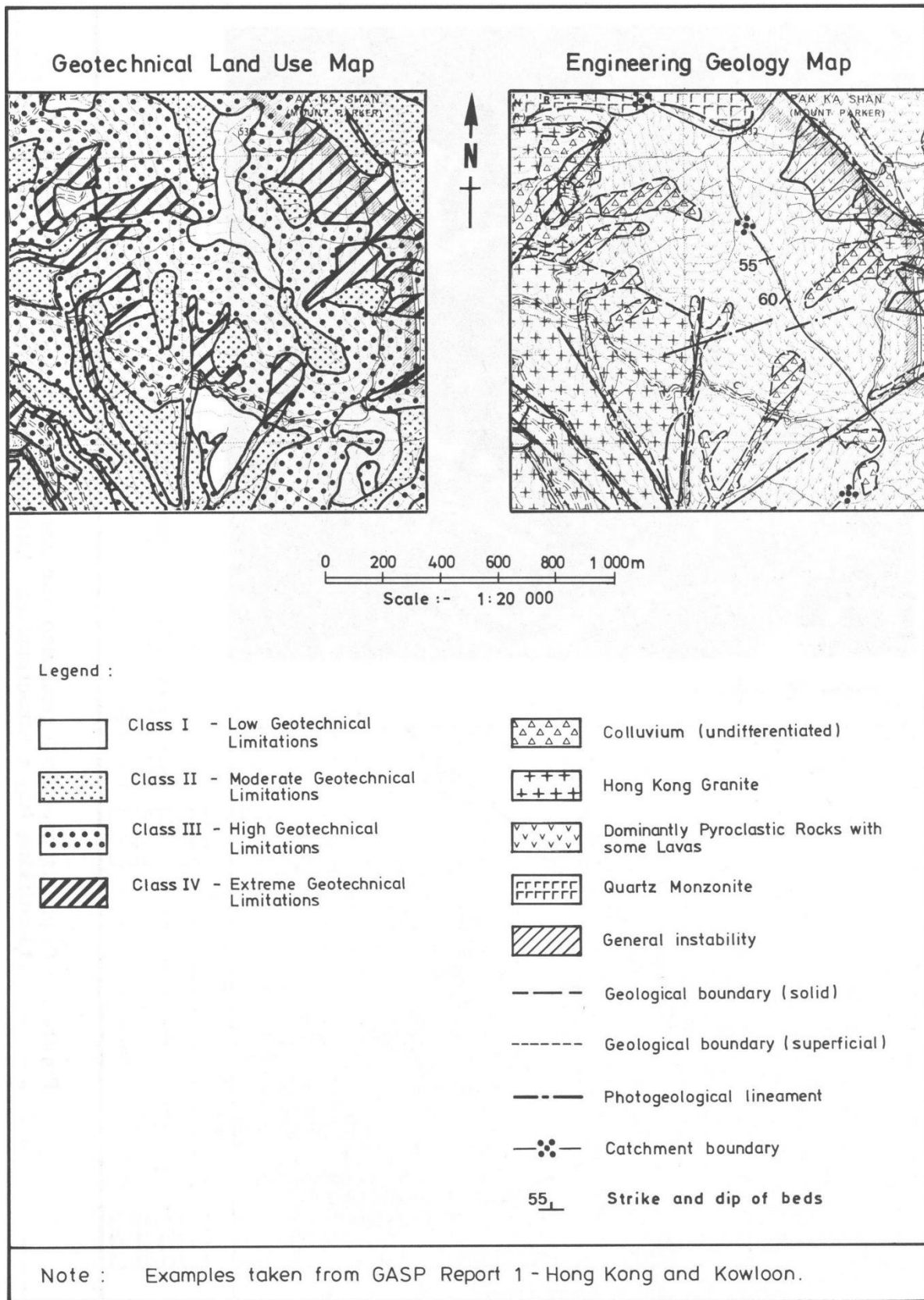


**Figure 3 - Programme of the New Geological Survey**

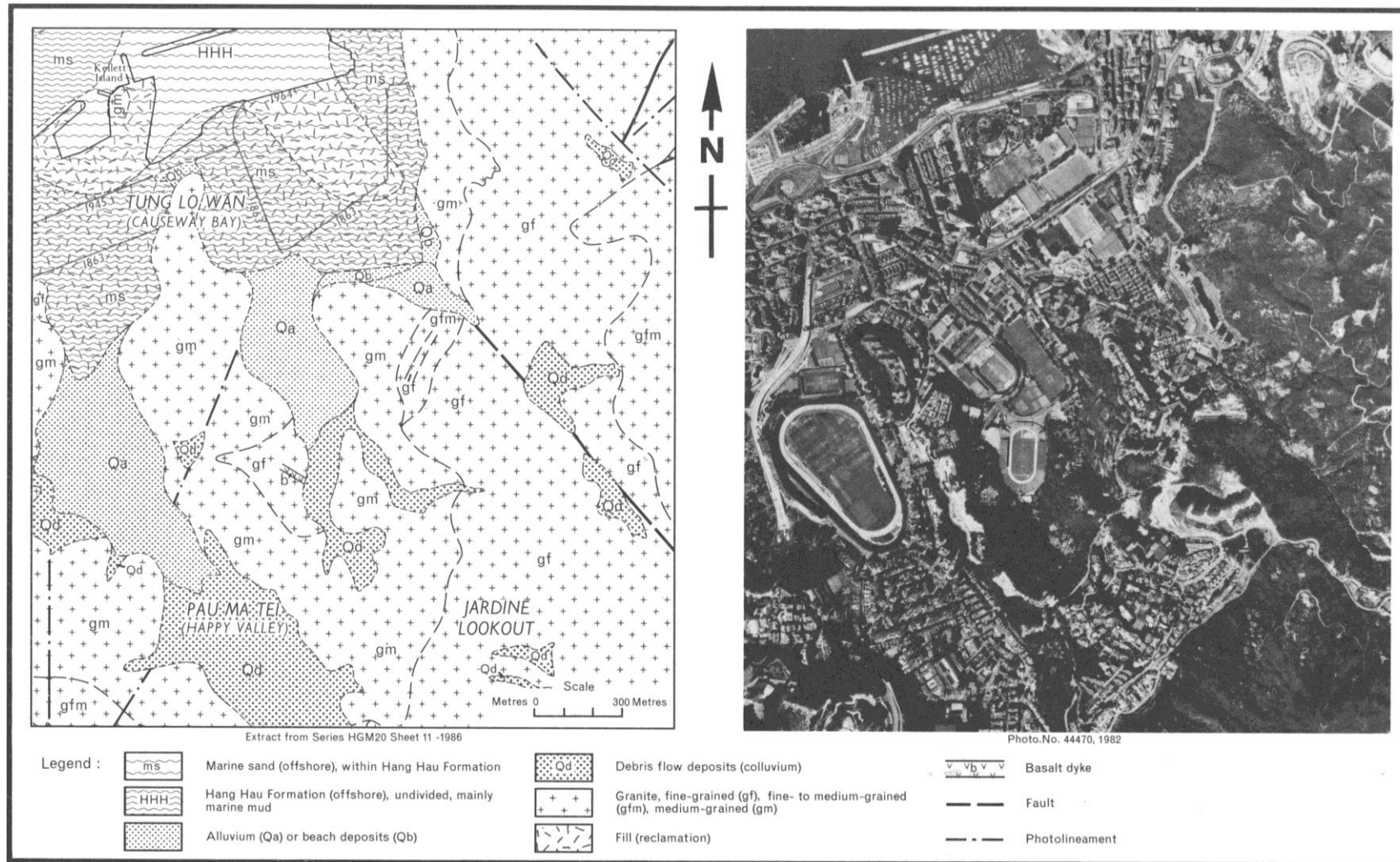




**Figure 4 - The Geotechnical Area Studies Programme**



**Figure 5 - Examples of Maps Available in the Geotechnical Areas Studies Programme**



**Figure 6 - Comparison of Geological Map and Aerial Photograph for Identifying Major Structural and Lithological Features**

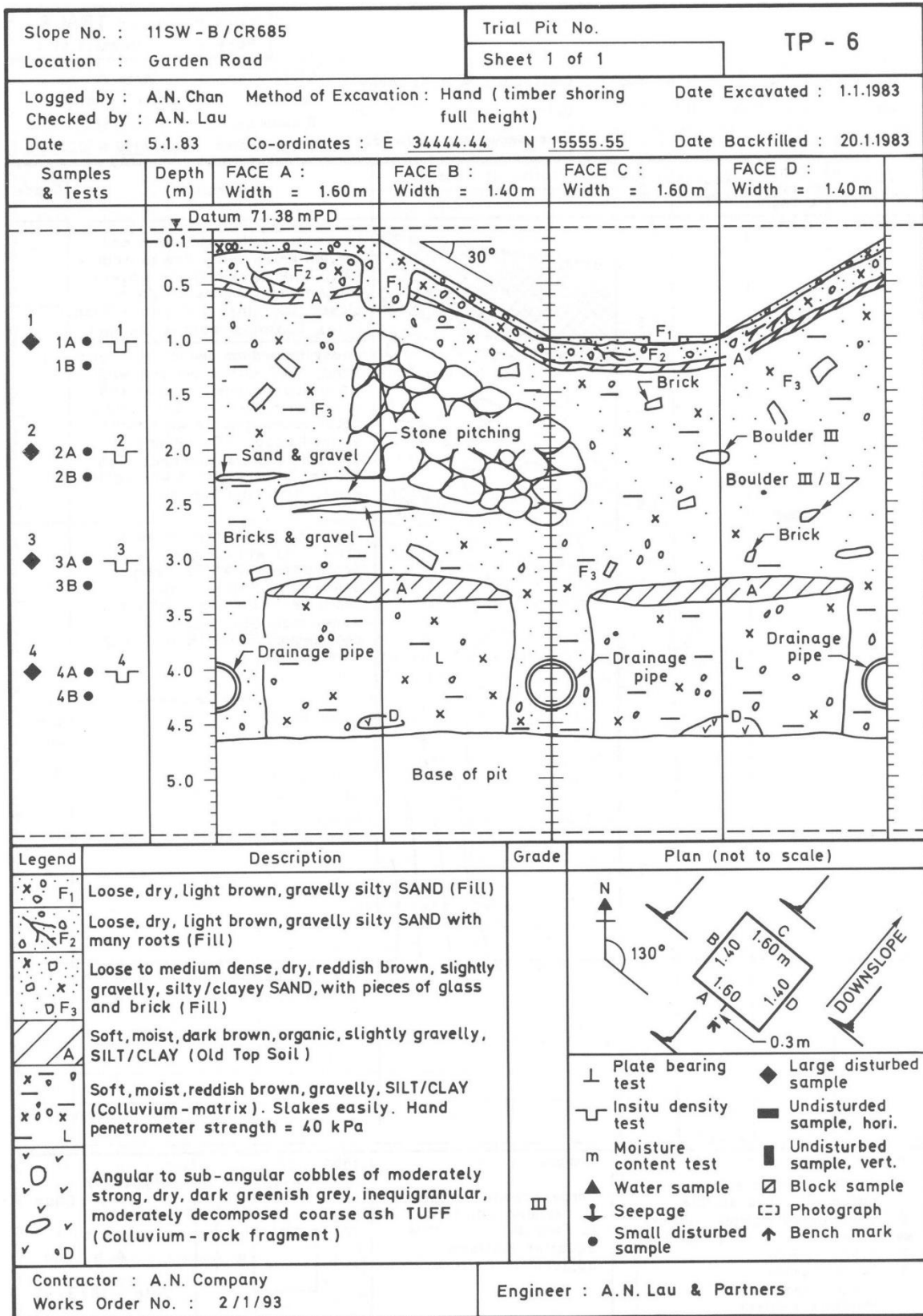


Figure 7 - Trial Pit Log (Example 1)

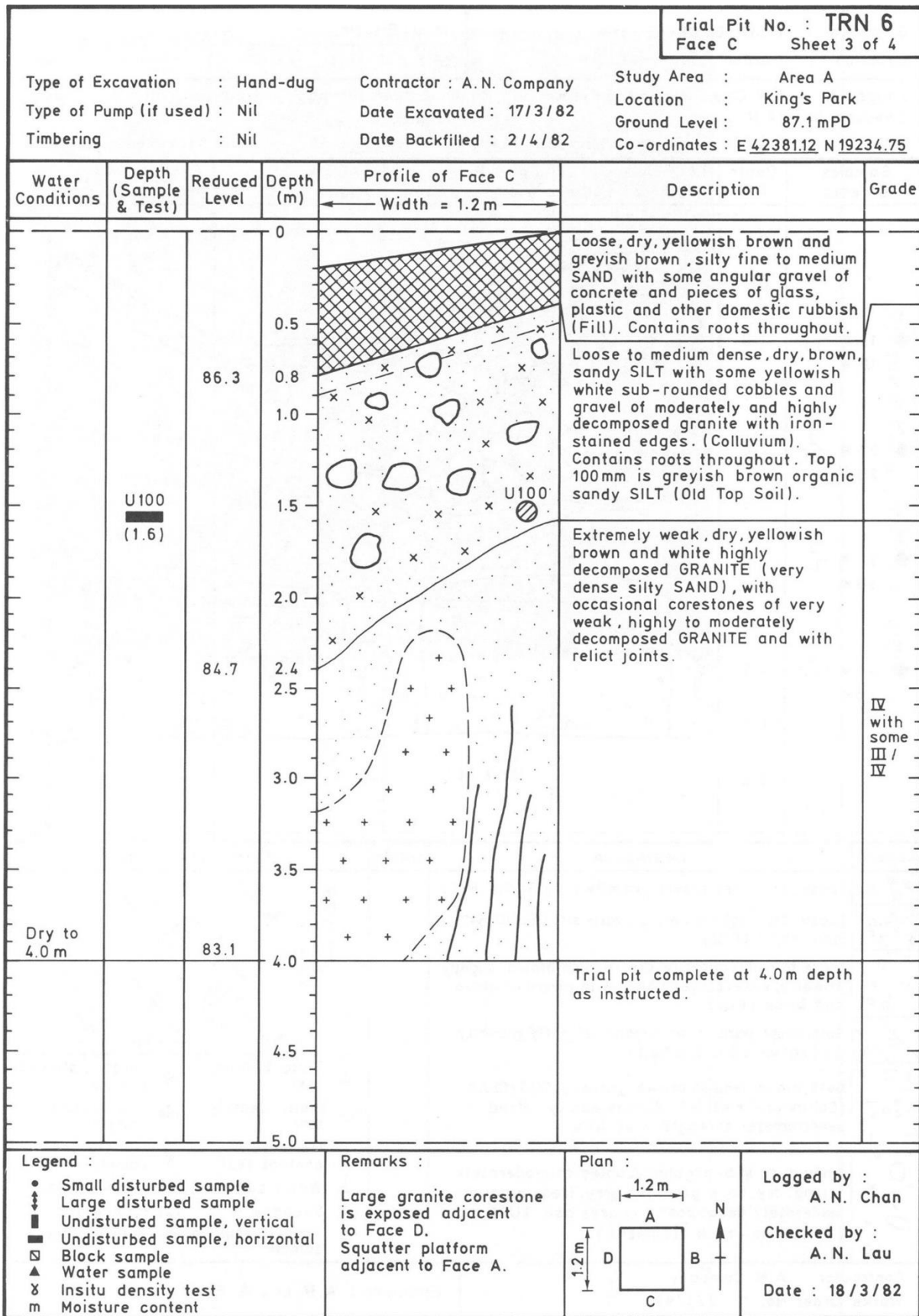


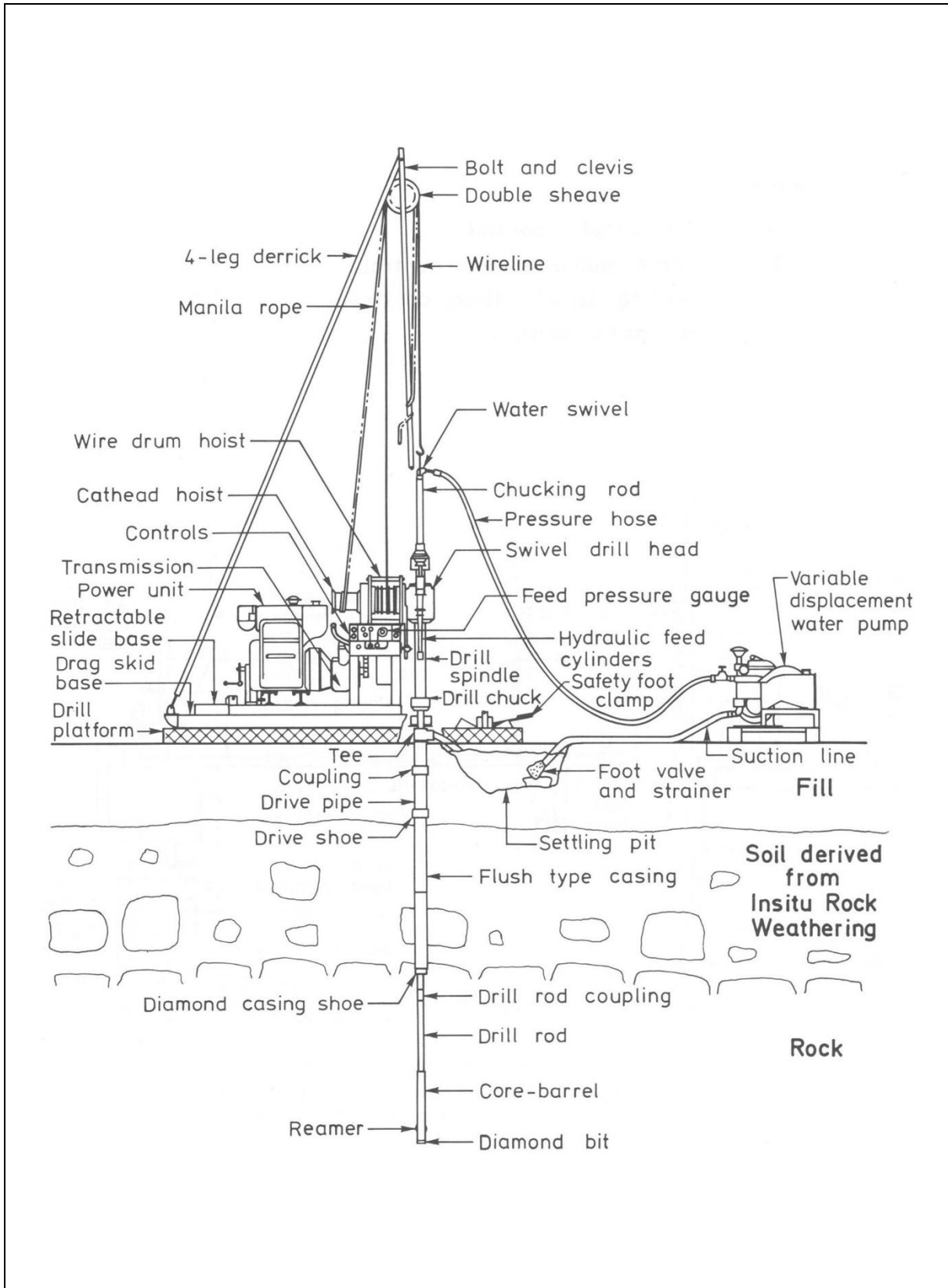
Figure 8 - Trial Pit Log (Example 2)

Project : Slope Remedial Works		Datum (toe) Co-ordinates :		Datum (crest) Co-ordinates :		Strip No. : <b>S4</b>	
Location : Ap Lei Chau		E <u>33 320.12</u> N <u>11 302.43</u>		E <u>33 331.23</u> N <u>11 302.11</u>		Slope No. : Slope at Ch. 4+95	
Contractor : A.N. Company		Level : 6.0 mPD		Level : 18.0 mPD		Sheet 1 of 1	
Date Started : 12.12.83		Date Completed : 19.12.83		Date Reinstated : 26.12.83		Logged by : A.N. Chan	
						Checked by : A.N. Lau	
Distance from Datum (m)	Slope Angle	Reduced Level (mPD)	Description and Sample Data	Legend	Discontinuities		
					Dip Direction / Dip	Nature of Infilling	
14	30°	18.0	Drainage channel (300 x 250mm)				
13			Natural slope covered with small trees and grass with colluvium below.				
12			Boulder of strong to very strong, dry, dark greenish grey, slightly decomposed fine ash TUFF, 600 mm in diameter.	SDV			
11							
10	55°	14.6	Top of chunamed cut slope				
9			Loose, dry, light yellowish brown, silty SAND with some sub-rounded boulders of highly to moderately decomposed fine ash TUFF (Colluvium). The boulders are up to 300mm in diameter and their proportion decreases in an upward direction on the slope.				
8							
7	62°	12.4	Extremely weak, dry, light yellowish brown, highly decomposed fine ash TUFF (very dense, slightly gravelly sandy SILT/CLAY).				
6							
5			11.3	Moderately strong, dry, dark yellowish brown, moderately decomposed fine ash TUFF with very closely-spaced, persistent (over 15m), rough and planar, tight and dry joints dipping 10° - 20°. Very weak highly decomposed material exists adjacent to some joints.			Grade IV
4		10.0					
3							
2			Very strong, dry, dark greenish grey, slightly decomposed fine ash TUFF. Joints are medium-spaced, persistent, rough and planar, tight and dry, with yellowish brown surface staining.		234/71, 215/67, 230/56, 302/15, 235/72	Surface staining	
1							
0		6.0	Base of the slope				
			Roadway				
Remarks :							
Legend :			Sketch Plan :		Sketch Section :		
<ul style="list-style-type: none"> <li>● Small disturbed sample</li> <li>◆ Large disturbed sample</li> <li>▣ Block sample</li> <li>┌─ Insitu density test</li> <li>m Moisture content test</li> <li>▲ Water sample</li> <li>↓ Seepage</li> <li>☐ Photograph</li> </ul>							

Figure 9 - Example of a Log Sheet for Slope Surface Stripping

Project: New Territories Trunk Road Location: North Tai Po to Lam Kam Road				Caisson No: 1 of Bridge 18 Diameter: 1.25 m					
Method of Excavation: Hand-dug 0.0 to 29.5m				Co-ordinates: E <u>33 791</u> N <u>34 902</u> Ground Level: 49.03 mPD		Sheet 2 of 2			
Weathered Mass Zone	Depth (m)	Caisson Log				Reduced Level (mPD)	Discontinuities	Finish	Tests
		1	2	3	4				
Completely weathered granodiorite	16					31.03	The joints are medium-spaced, rough and planar and dry. Some joints contain quartz veins, 2-3mm thick. A sub-vertical fault of less than 100 mm thick containing soft cohesive soil is present.	CONCRETE RINGS	H
	18.0								
Highly weathered granodiorite	20					Ground water level 26.53	The joints are closely to medium-spaced, rough and planar and dry. Some joints contain quartz veins, 1-3 mm thick.	CONCRETE RINGS	H
	24.5								
Moderately weathered granodiorite	26					24.53	The joints are closely to medium-spaced, rough and planar, very narrow and dry, and contain extremely weak highly decomposed rock. FI = 4.	CONCRETE RINGS	H
	28.4								
Slightly weathered granodiorite	28					22.83	The joints are dominantly vertical or sub-vertical, medium-spaced, rough and planar, extremely narrow and dry with brown-stains. Occasional joints contain extremely weak highly decomposed rock, 2-5mm thick. Some horizontal joints are widely-spaced. FI = 3.	TOE-IN UNLINED	AD
	29.5								
	30	Base of Caisson				19.53	The joints are medium to widely-spaced, rough and planar, tight and dry with brown-stains. Occasional joints contain extremely weak highly decomposed rock, 2-5 mm thick. FI = 2.	TOE-IN UNLINED	AD
Legend:						Notes:		Logged by:	
Material grades						(1) Mixtures of Grades IV and V materials present are shown using overlapping symbols.		A. N. Chan	
	V	Completely decomposed	— Joint			(2) Discontinuity data are given separately.		Checked by:	
	IV	Highly decomposed	q-m Mineralized quartz vein					A. N. Lau	
	III	Moderately decomposed	FI Fracture index					Date:	
	II or I	Slightly decomposed or Fresh	H Schmidt hammer test at 0.9m c/c					29-6-84	
	-- f --	Fault	AD Air drill test						
Contractor: A.N. Company						Date Finished: 26-6-84			
Date Started: 4-6-84									

Figure 10 - Example of a Caisson Log



Note : Figure adopted from Acker Drill Co. Inc. data.

**Figure 11 - Typical Configuration of a Rotary Drilling Rig**



Valves :

- A Air supply control
- B Foam pump speed control
- C Drilling supply fluid control
- D By-pass control

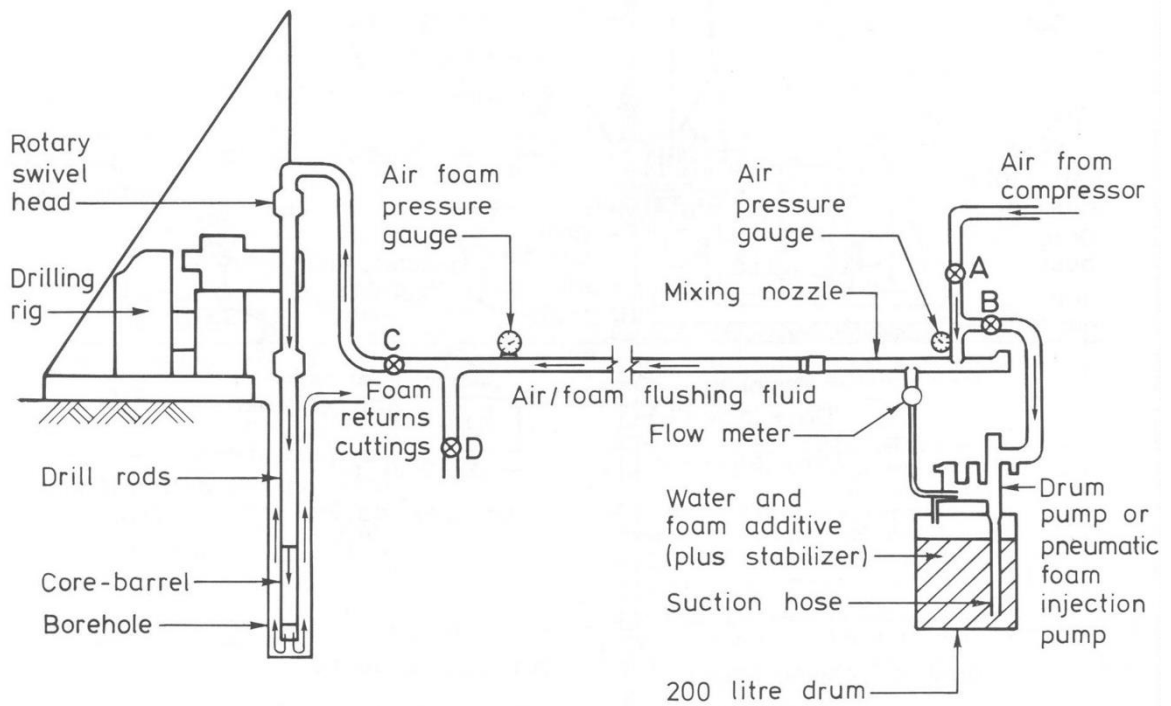
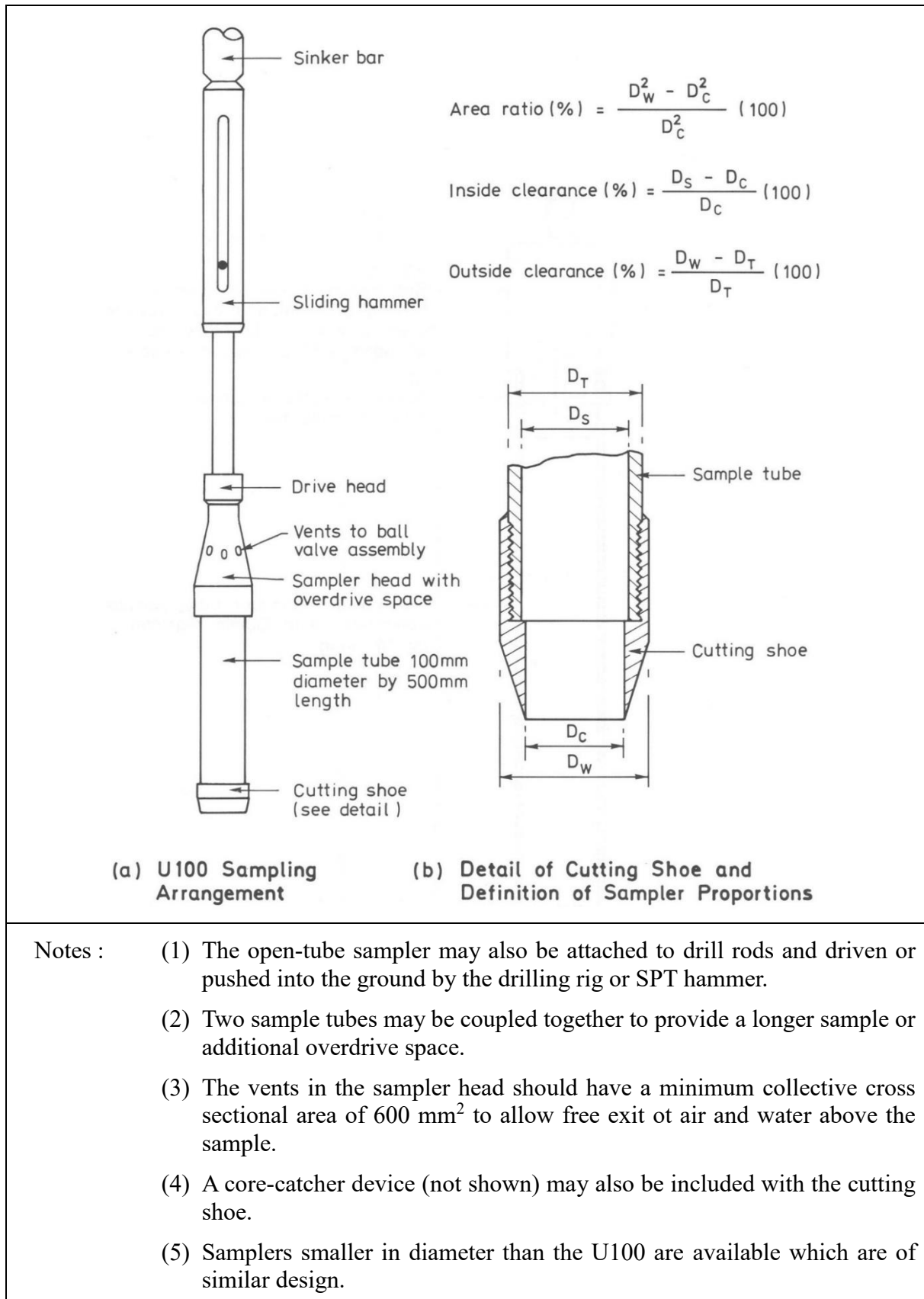
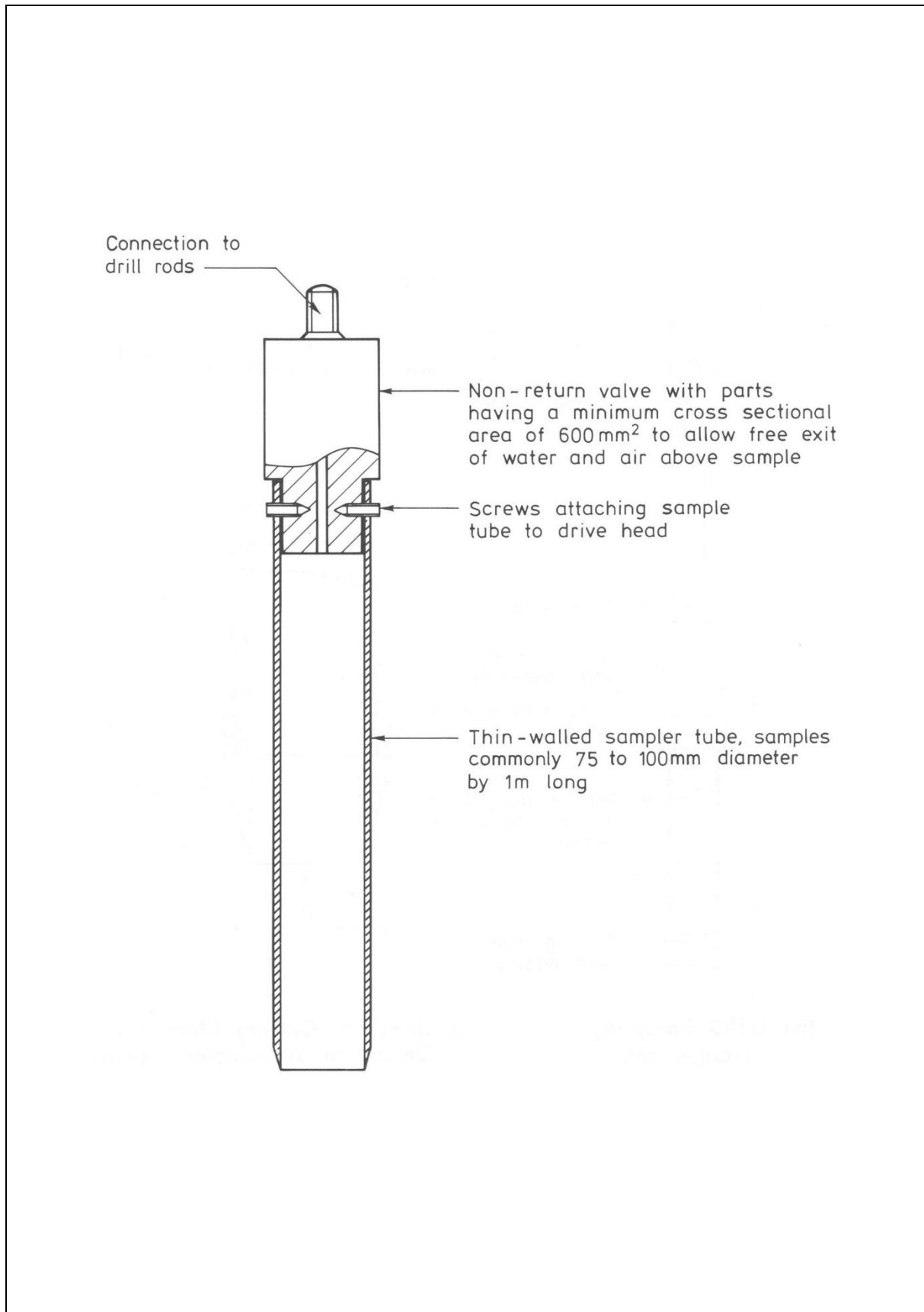


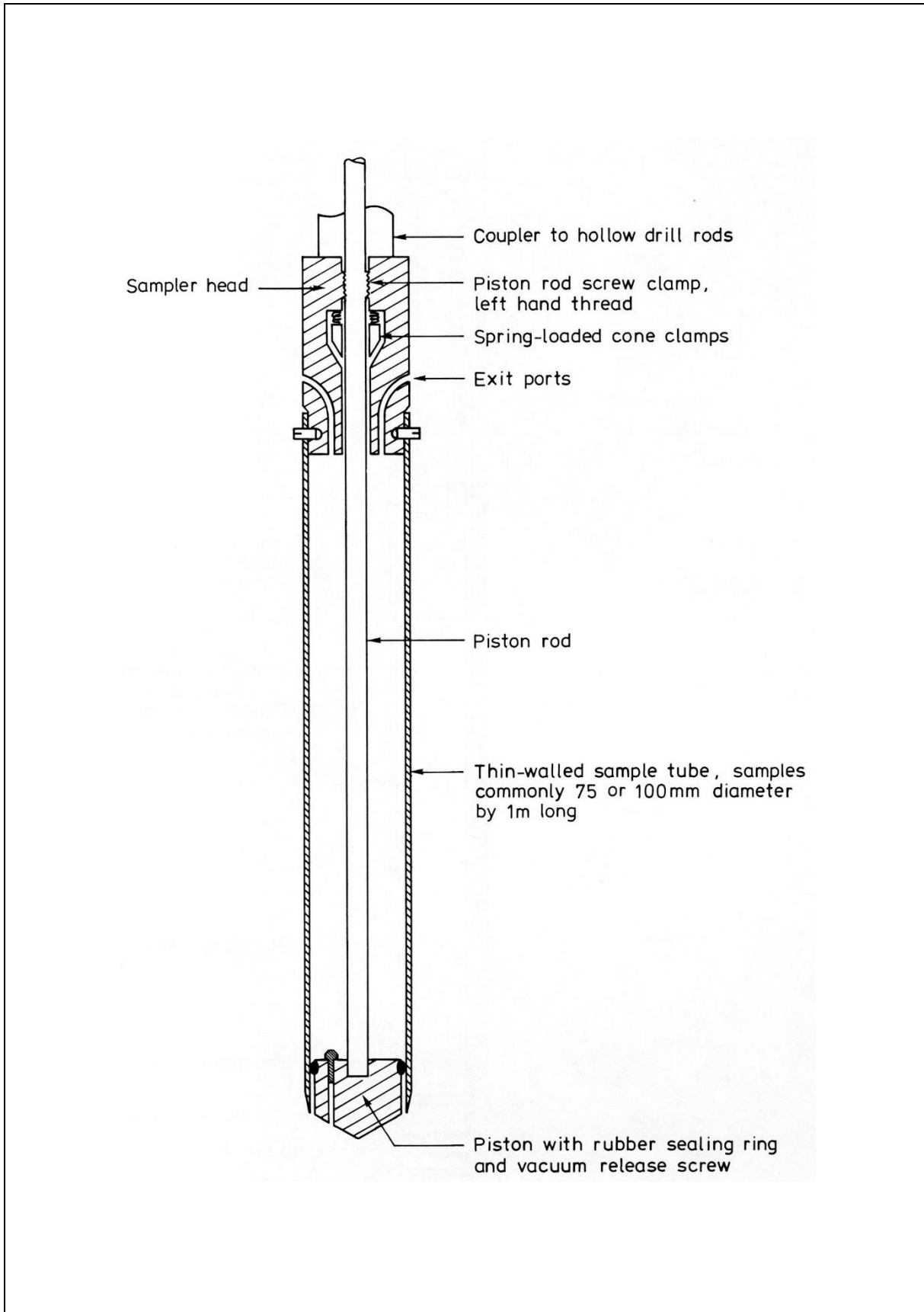
Figure 12 - Typical Arrangement of Air Foam Mixing and Flushing System



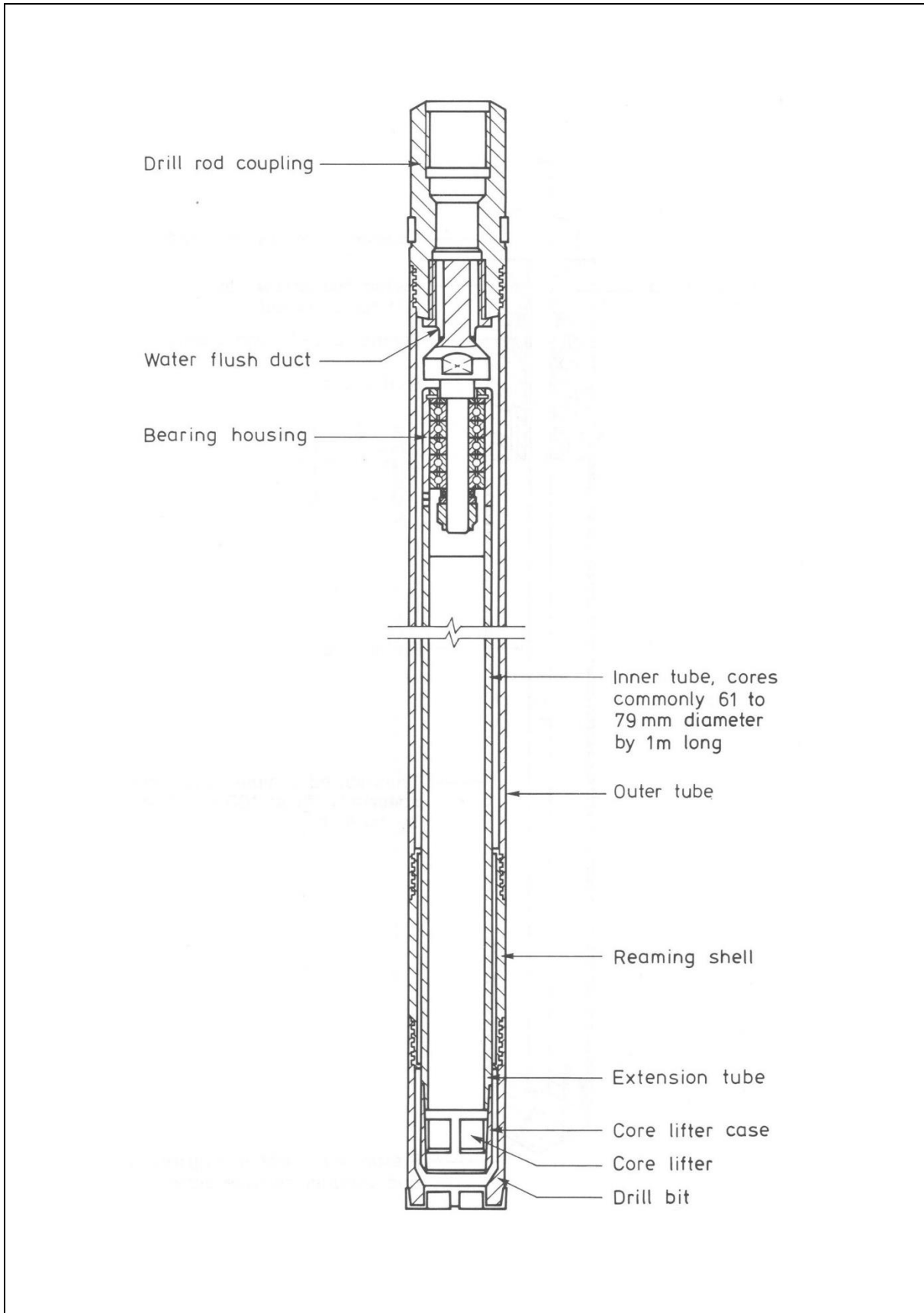
**Figure 13 - General Purpose Open-tube Sampler**



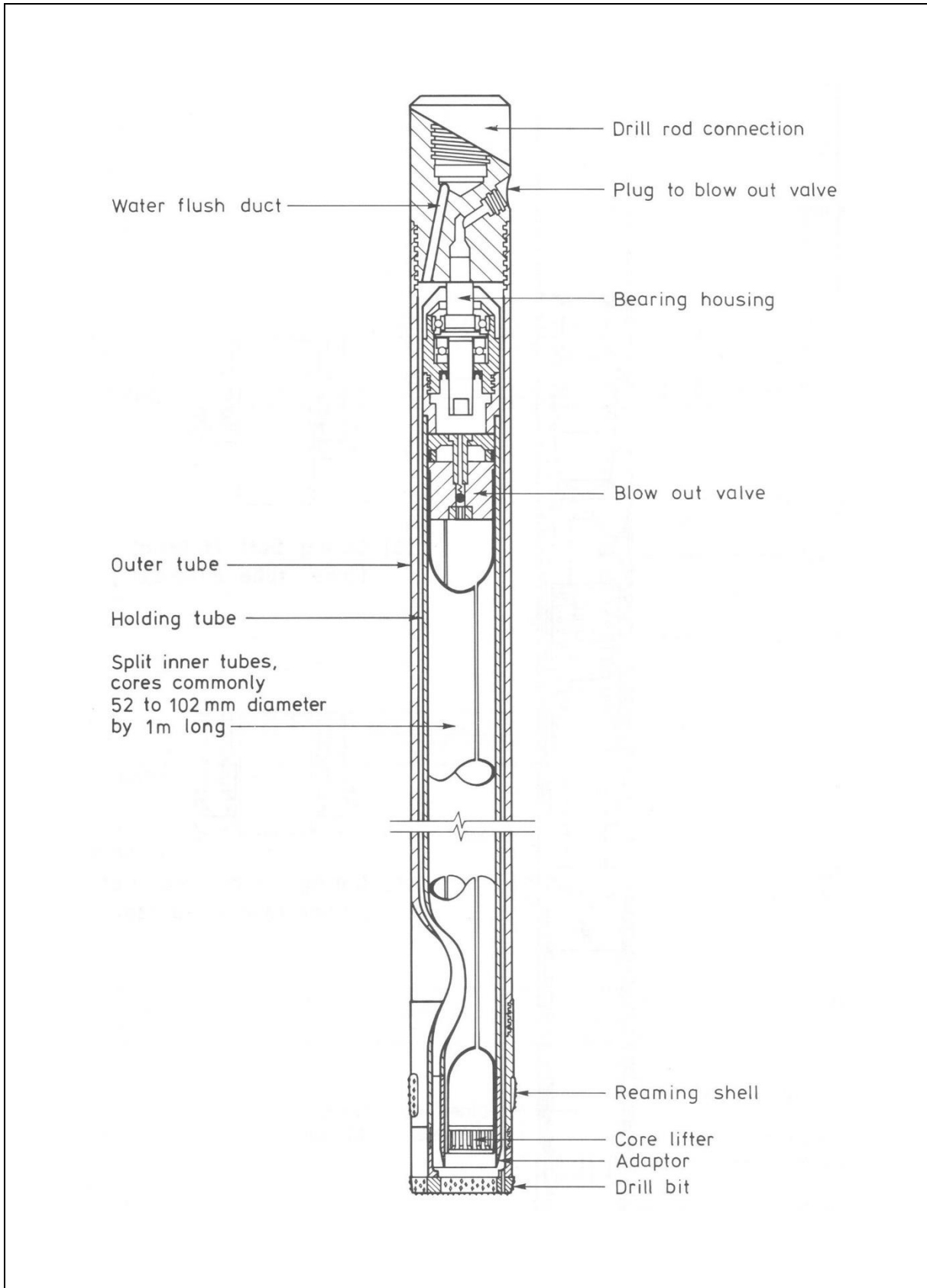
**Figure 14 - Thin-walled Sampler**



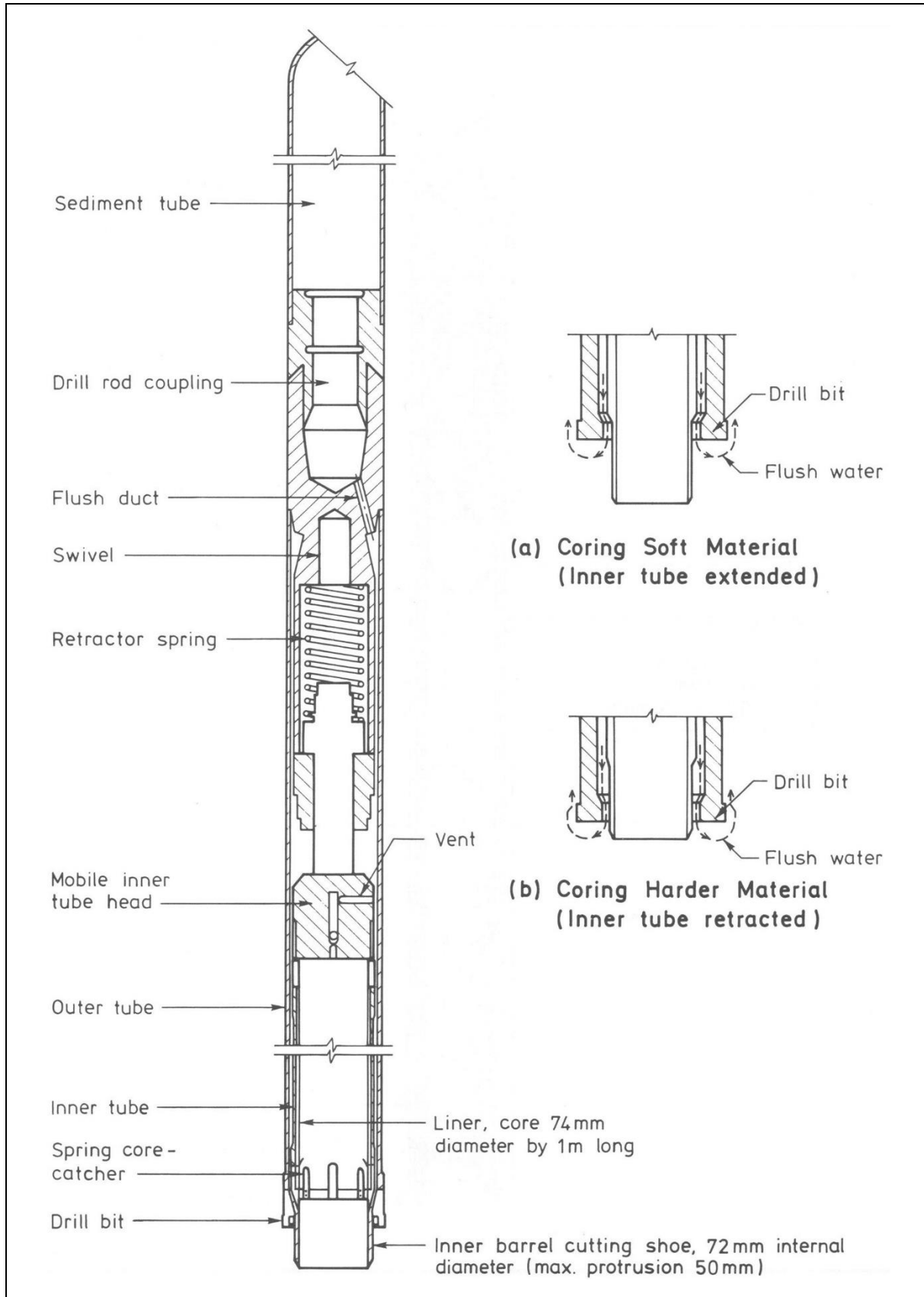
**Figure 15 - Thin-walled Stationary Piston Sampler**



**Figure 16 - Example of a Double-tube Core-barrel (Craelius T2-101)**



**Figure 17 - Example of a Non-retractable Triple-tube Core-barrel (Triefus HMLC)**



**Figure 18 - Example of a Retractable Triple-tube Core-barrel (Mazier)**

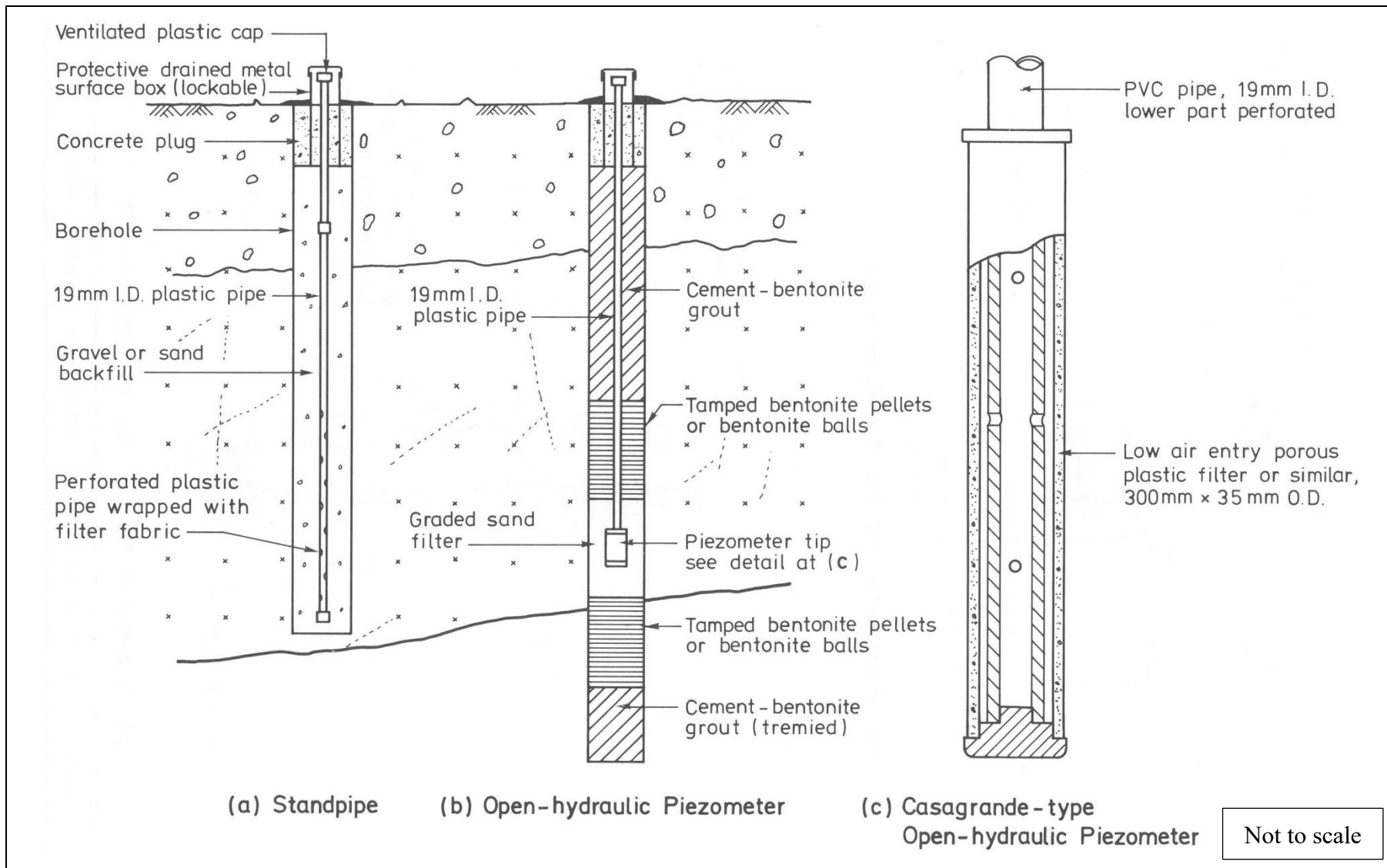
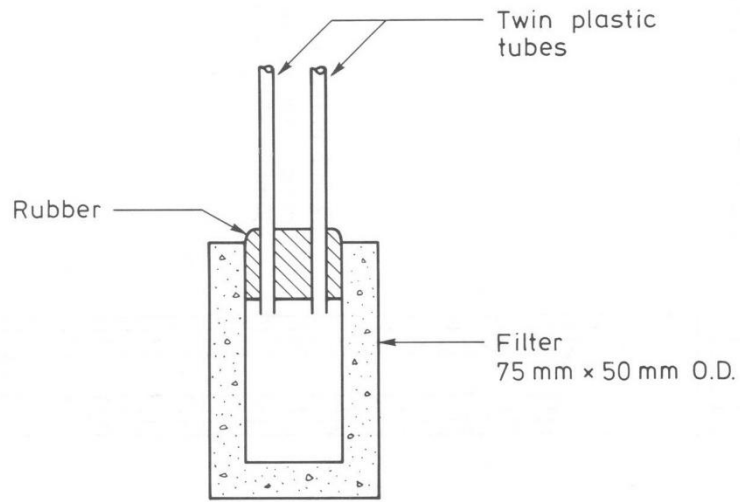
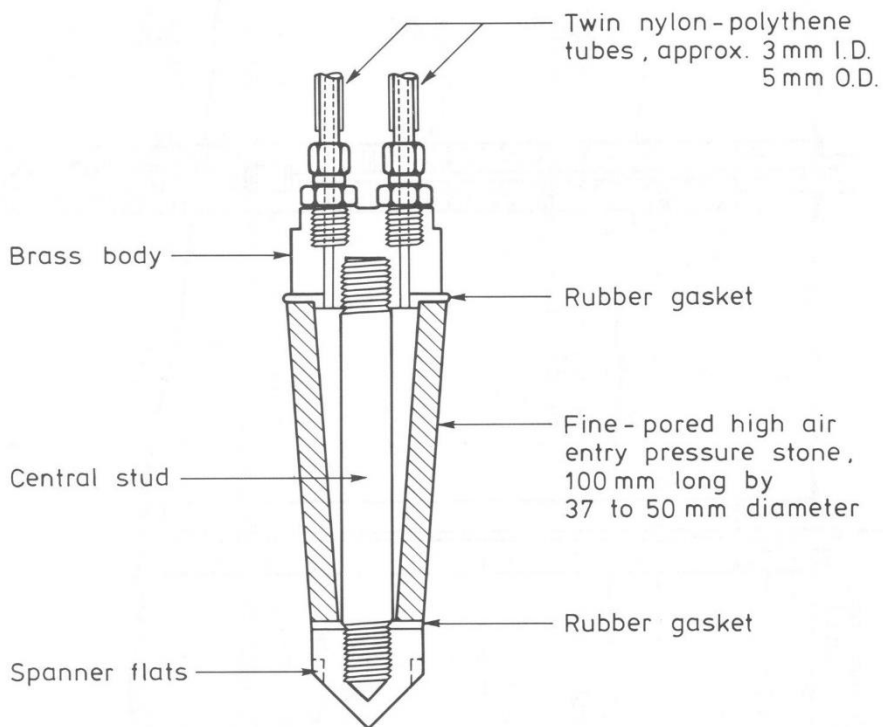


Figure 19 - Typical Standpipe and Open-hydraulic Piezometers





(a) Piezometer Tip for Use in Borehole



(b) Piezometer Tip for Use in Embankment

Note : Figures based on BS 5930 (BSI, 2010) and Penman (1986). [Amd GG2/01/2017]

**Figure 20 - Typical Twin-tube Closed-hydraulic Piezometer Tips**

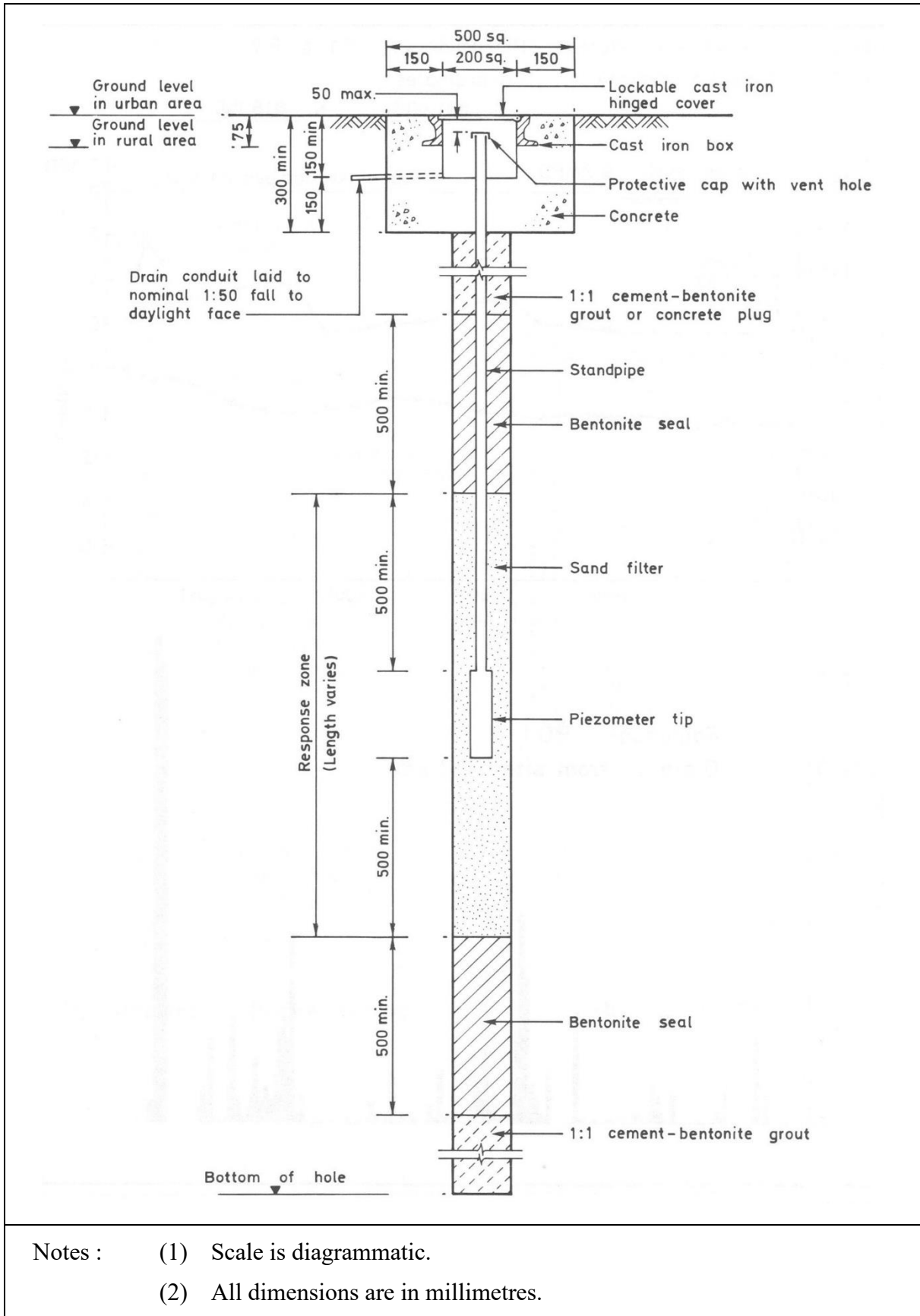


Figure 21 - Typical Installation Details of a Piezometer in a Borehole

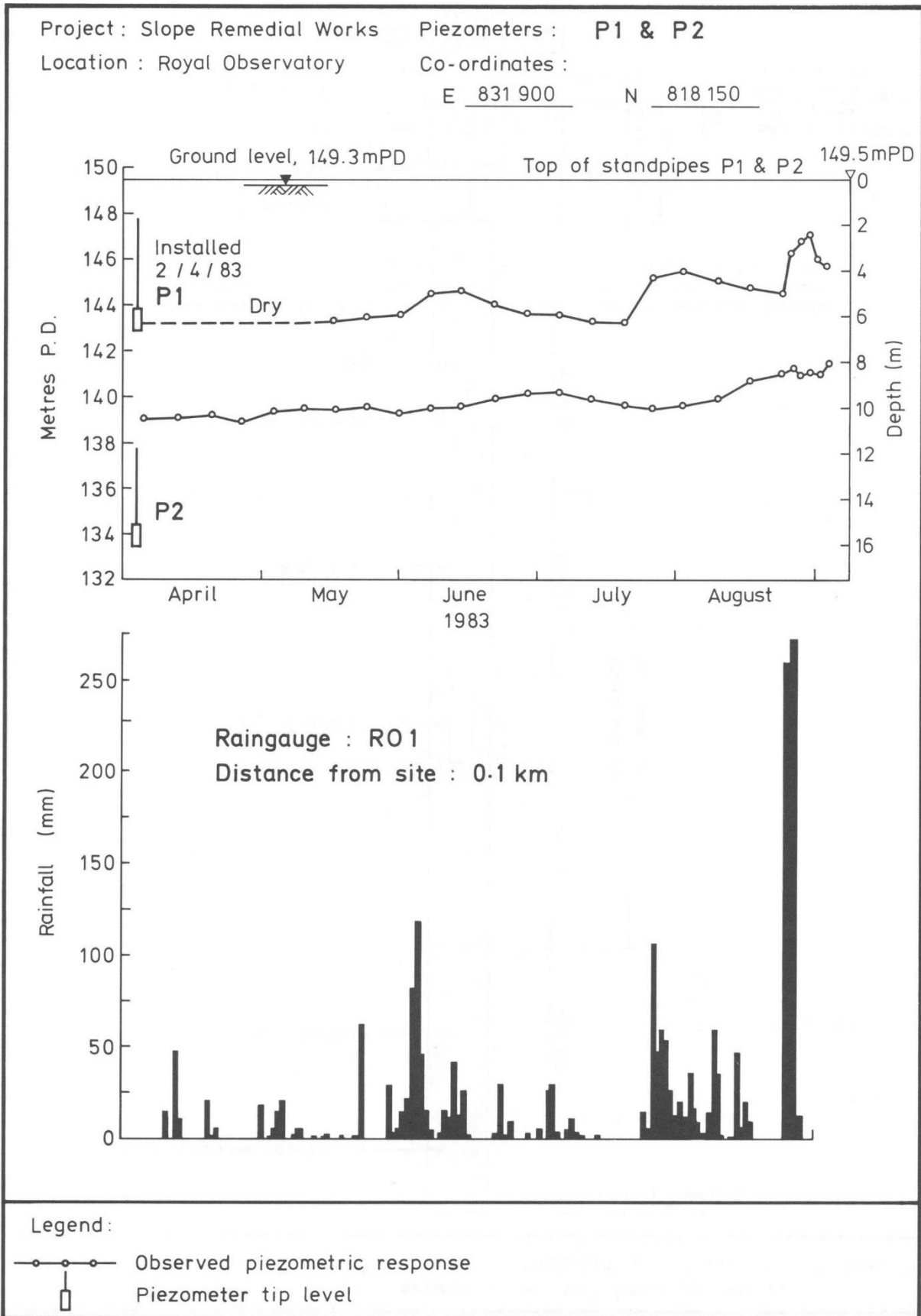
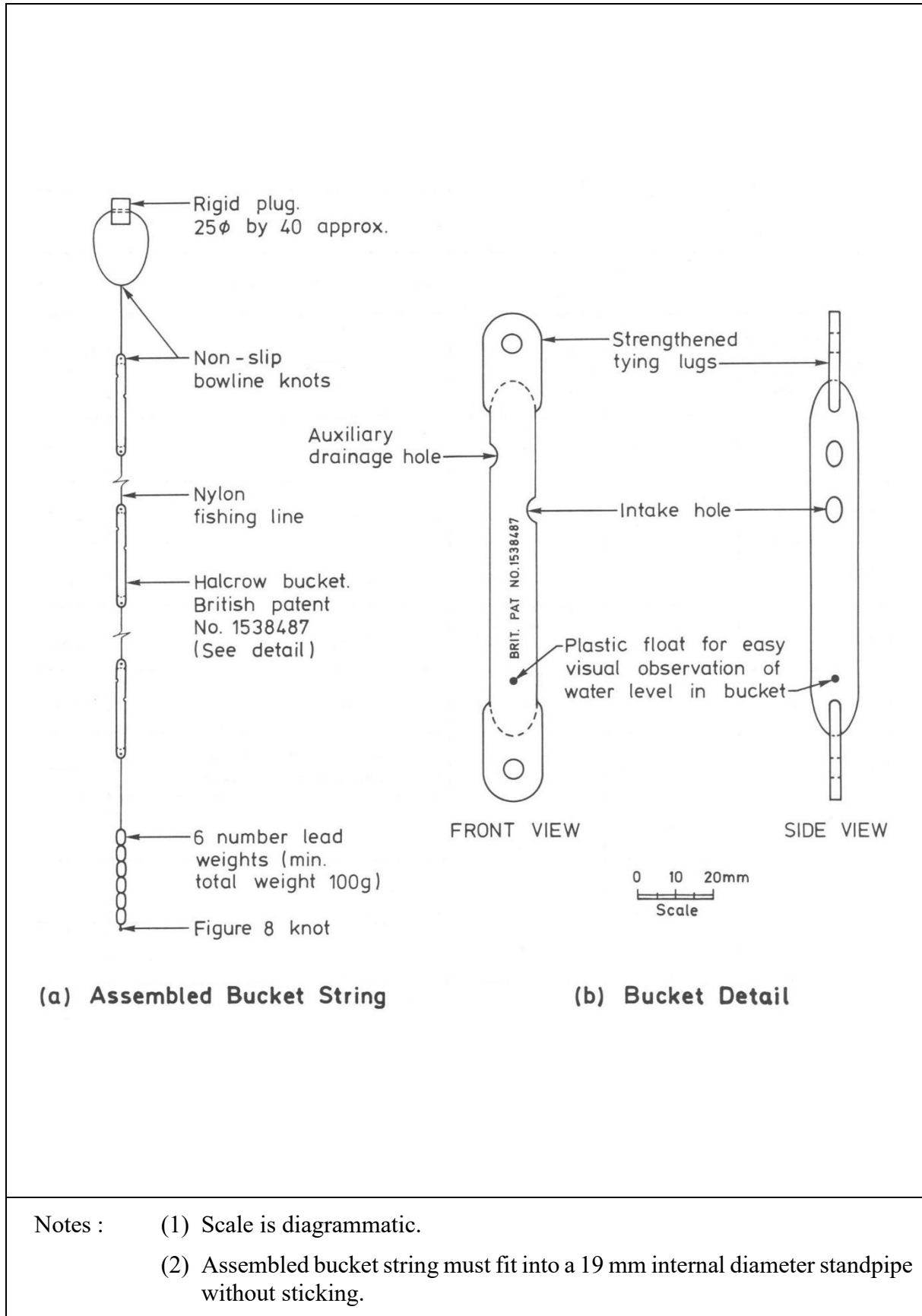


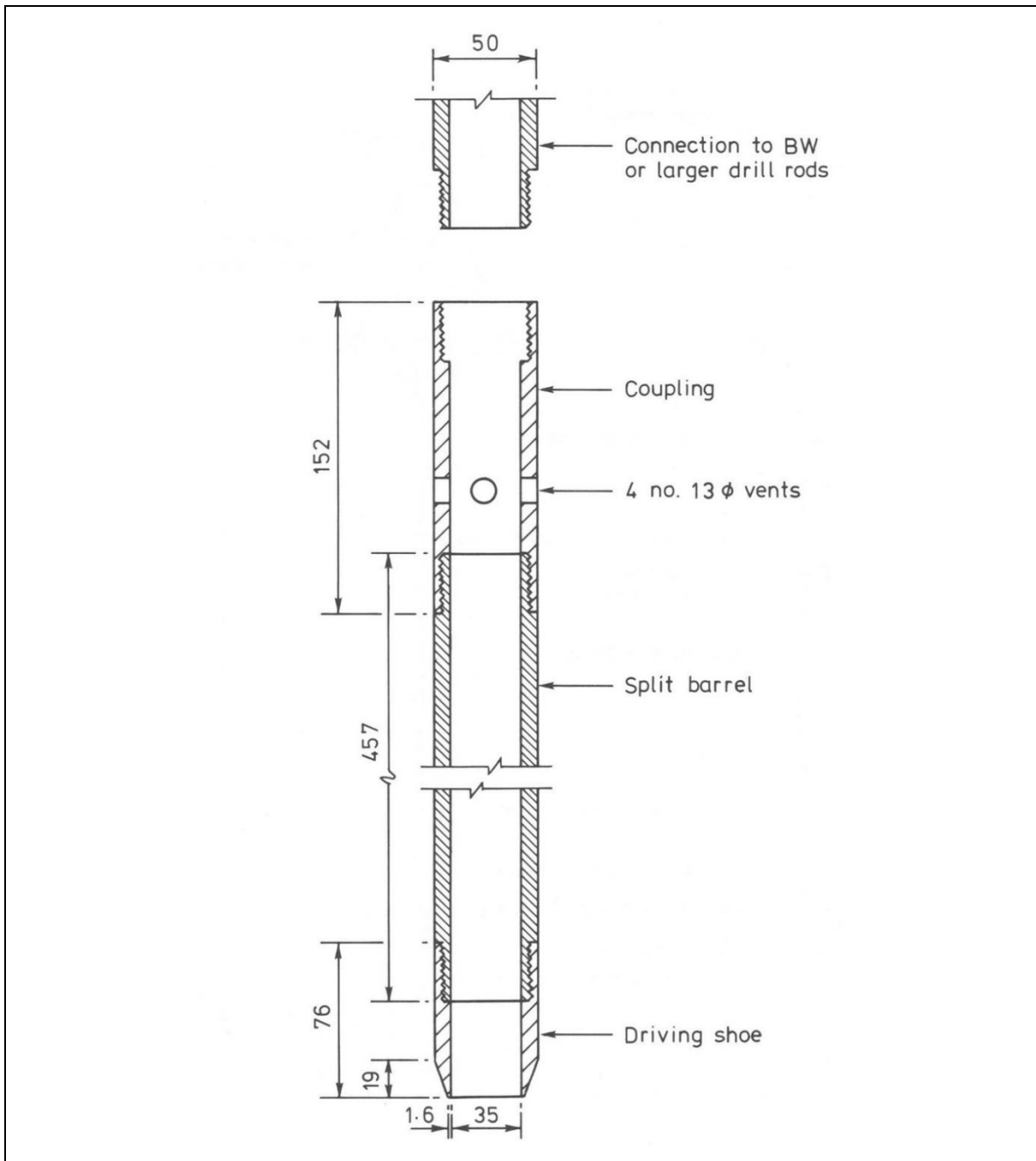
Figure 22 - Example of Piezometer Record



**Figure 23 - Piezometer Buckets (British Patent No. 1538487)**

Piezometer Buckets Record											
Piezometer No. : P1					Design (Critical) Water Level :			Depth of Critical Water Level below Top of Standpipe :			
Location : Royal Observatory					145.5 mPD			4.0 m			
Buckets : Number : 5 Depth : 2.5 m - 5.5 m Spacing : 0.75 m Date Installed : 2/4/83					Level of Top of Standpipe : 149.5 mPD						
Tip Level : 143.1mPD			Ground Level : 149.3mPD			Depth of Tip below Top of Standpipe : 6.4 m					
Date	Measured G.W.L. Depth* (m)	Buckets Found to Contain Water					G.W.L. Depth* Indicated by Buckets (m)	Comments / Weather	Recorded by		
		1	2	3	4	5					
12.5.83	Dry						> 5.5	Sunny	HYC		
20.6.83	5.9					√	4.8 - 5.5	Fine	WPF		
11.7.83	6.2						> 5.5	Sunny	HYC		
2.8.83	5.5			√	√	√	3.3 - 4.0	Cloudy	HYC		
14.8.83	4.6				√	√	4.0 - 4.8	Cloudy	CKC		
30.8.83	3.8	√	√	√	√	√	< 2.5	After storm / fine today Exceeds critical depth	HYC		
Legend :					Bucket No. :		1	2	3	4	5
* Depth measured from top of standpipe					Depth* (m)		2.50	3.25	4.00	4.75	5.50

Figure 24 - Example of Piezometer Bucket Data



- Notes :
- (1) Figure based on BS EN ISO 22476-3 (BSI, 2011b). [Amd GG2/01/2017]
  - (2) A slightly enlarged inner diameter of the split barrel is permitted, provided removable liners are always used which have an inside diameter of 35 mm.
  - (3) A ball valve in the base of the coupling as shown in ASTM (1985a) is also permitted.
  - (4) All dimensions are in millimetres.

**Figure 25 - Split Barrel Sampler for Standard Penetration Test**

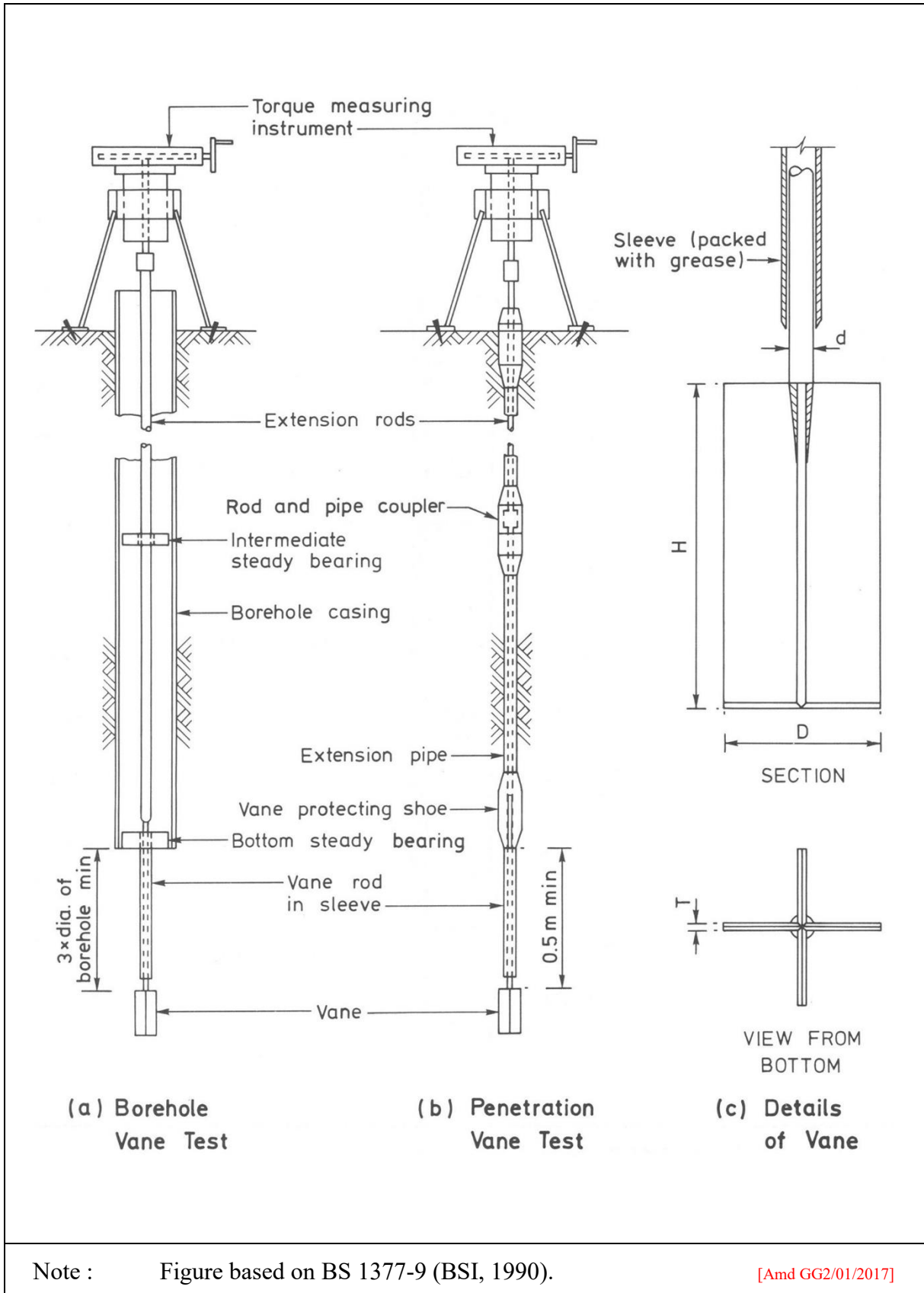
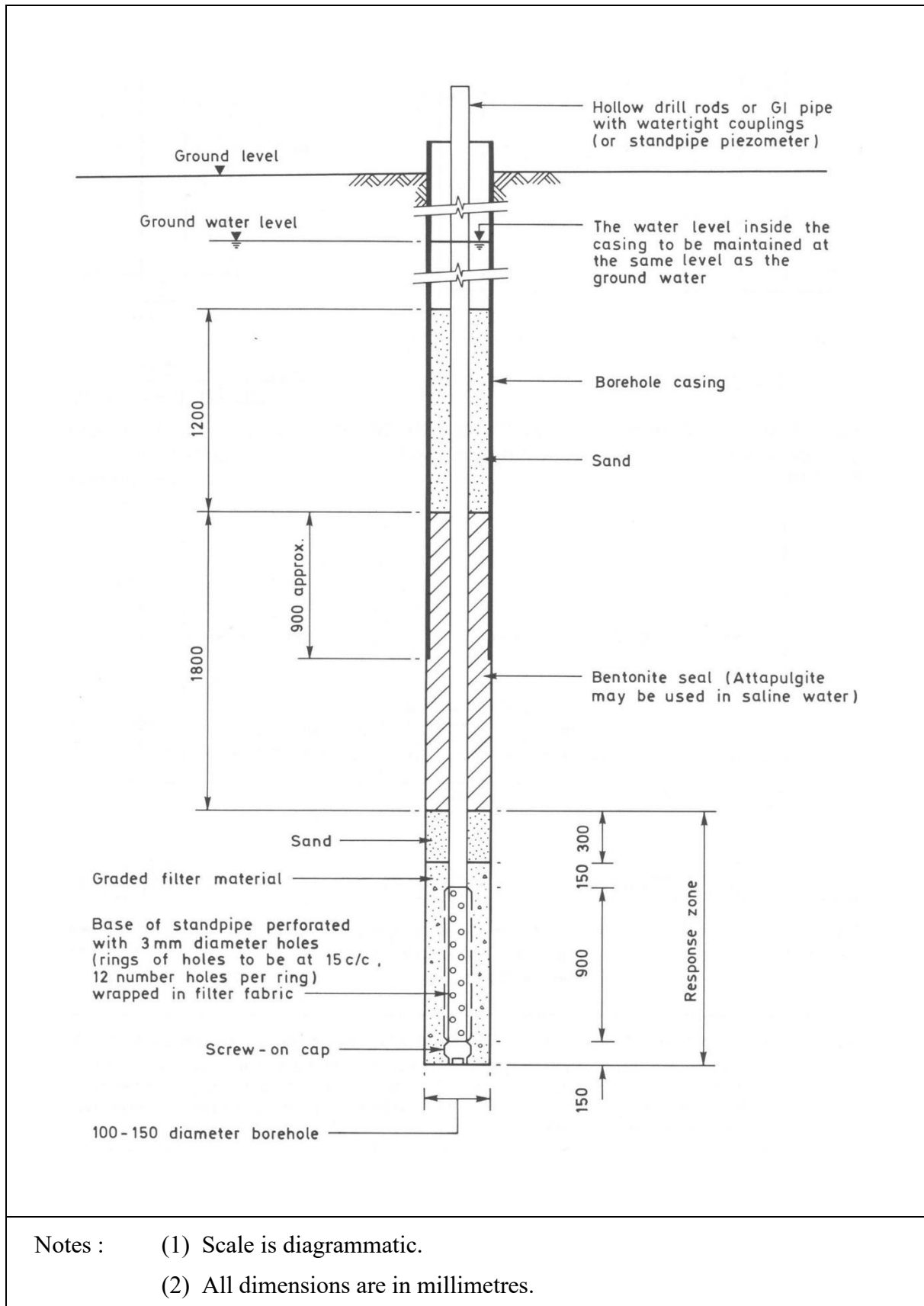
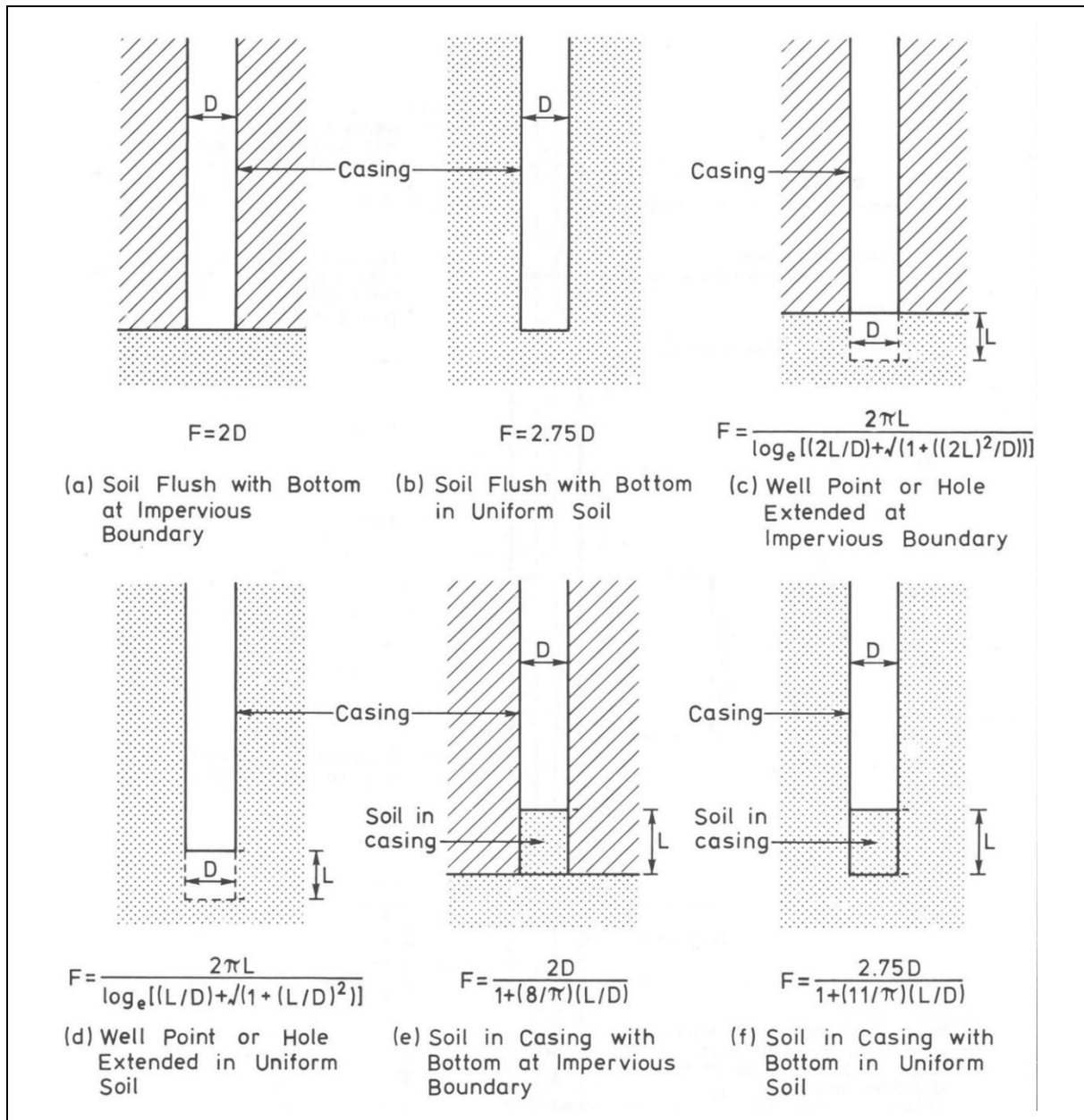


Figure 26 - Vane Shear Devices



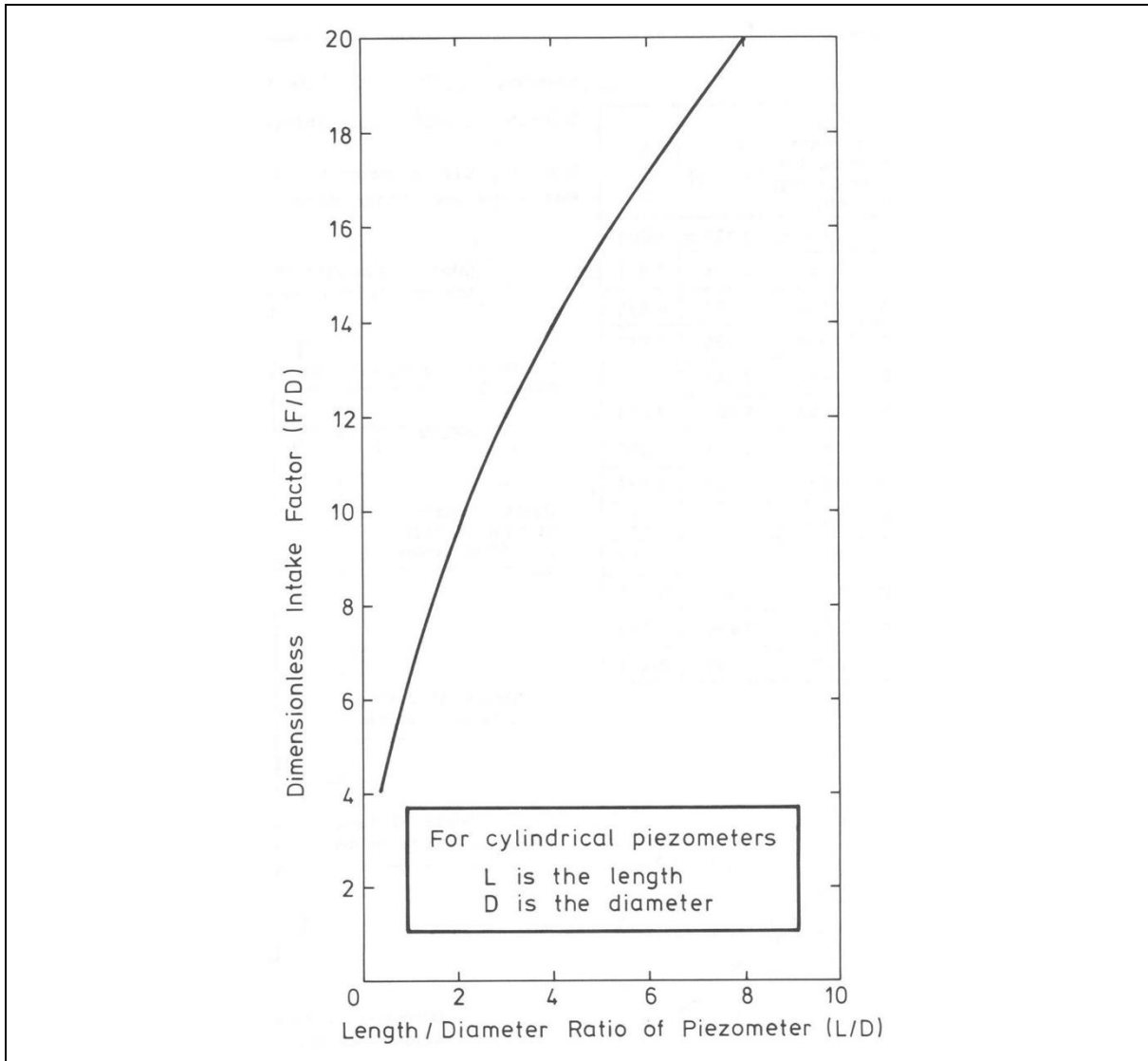
**Figure 27 - Typical Arrangement for Field Permeability Test**





- Notes :
- (1) Expressions come from Hvorslev (1951); figure based on BS 5930 (BSI, 2010).  
[Amd GG2/01/2017]
  - (2) Values are primarily for tests carried out through the open ends of boreholes. Case (d) may be used for tests carried out using piezometer tips, but more accurate results will be obtained by using Figure 29 especially for values of  $L/D > 2$ .
  - (3) Cases (e) and (f) assume the permeability of the soil in the casing to be the same as that below it. Where this is not so, see Hvorslev (1951).
  - (4) Cases (a) and (b) tend to measure the mean permeability of the soil; (c) and (d) the vertical permeability; (e) and (f) the horizontal permeability. Where the horizontal permeability is much greater than the vertical permeability, all tests will tend to measure the former.

**Figure 28 - Intake Factors (F), in Borehole Permeability Tests**



- Notes :
- (1) Graph comes from Brand & Premchitt (1980).
  - (2) Where a piezometer tip is surrounded by a granular filter material, it is the dimensions of this filter which should be used to derive values of F.
  - (3) Where L is large compared with D, the test will tend to measure the horizontal permeability of the soil.
  - (4) Where the horizontal permeability of the soil is much greater than the vertical, the test will measure the former, whatever the relation between L and D.
  - (5) The intake factor may also be calculated from the expression (Brand & Premchitt, 1980) :

$$F = \frac{2.4\pi L}{\log_e \left[ 1.2L/D + \sqrt{1 + [1.2L/D]^2} \right]}$$

**Figure 29 - Relationship between Dimensionless Intake Factor and Length to Diameter Ratio of Piezometers**

### Falling-head Permeability Test

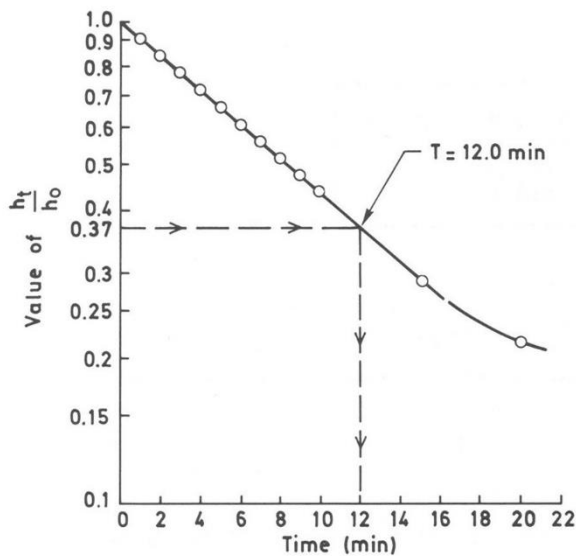
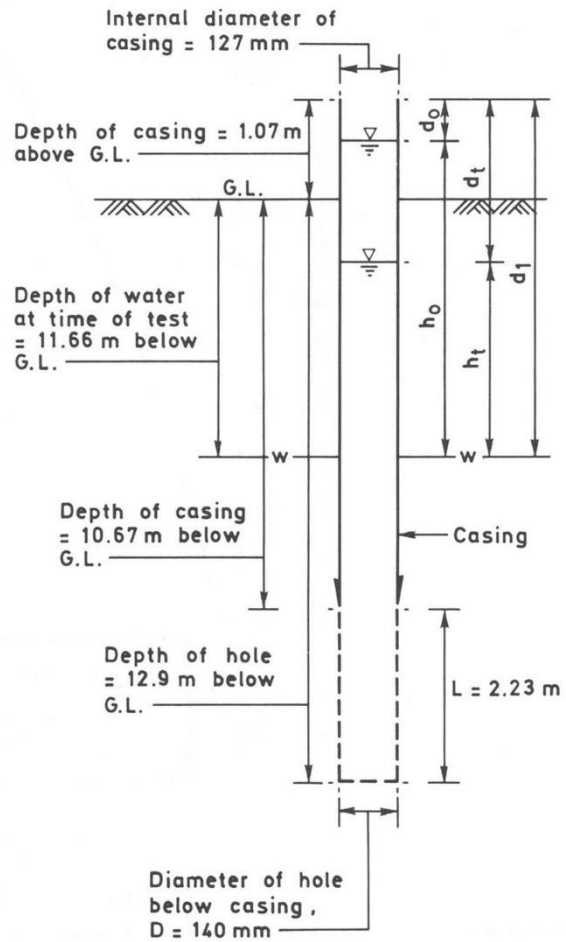
FIELD DATA :

Time on Clock	Time Elapsed min sec	Depth of Water below Top of Casing = $d_t$	$h_t = (d_1 - d_t)$	$\frac{h_t}{h_0}$
	0	9.601 m	3.129 m	1.000
1	0	9.854	2.876	0.919
2	0	10.109	2.621	0.838
3	0	10.300	2.430	0.777
4	0	10.484	2.246	0.718
5	0	10.668	2.062	0.659
6	0	10.826	1.904	0.608
7	0	10.985	1.745	0.558
8	0	11.100	1.630	0.521
9	0	11.227	1.503	0.480
10	0	11.366	1.364	0.435
15	0	11.824	0.906	0.290
20	0	12.065	0.665	0.212

Borehole BH1 Date 18.12.86

Drillhole D7 Observer A.N. Chan

Use only CLEAN water for test.  
Has water been added during boring? Yes/No



CALCULATIONS :

$$K = \frac{A}{FT}$$

where :  $A = \frac{0.140^2 \pi}{4} = 0.01539 \text{ m}^2$   
 $F = 2.5$  (based on case (d) in Figure 28 )  
 $T = 12 \text{ min} \times 60 = 720 \text{ sec}$   
 therefore :  $K = \frac{A}{FT} = \frac{0.01539}{2.5 \times 720} = 8.5 \times 10^{-6} \text{ m/s}$

Figure 30 - Example of Results from Falling-head Permeability Test

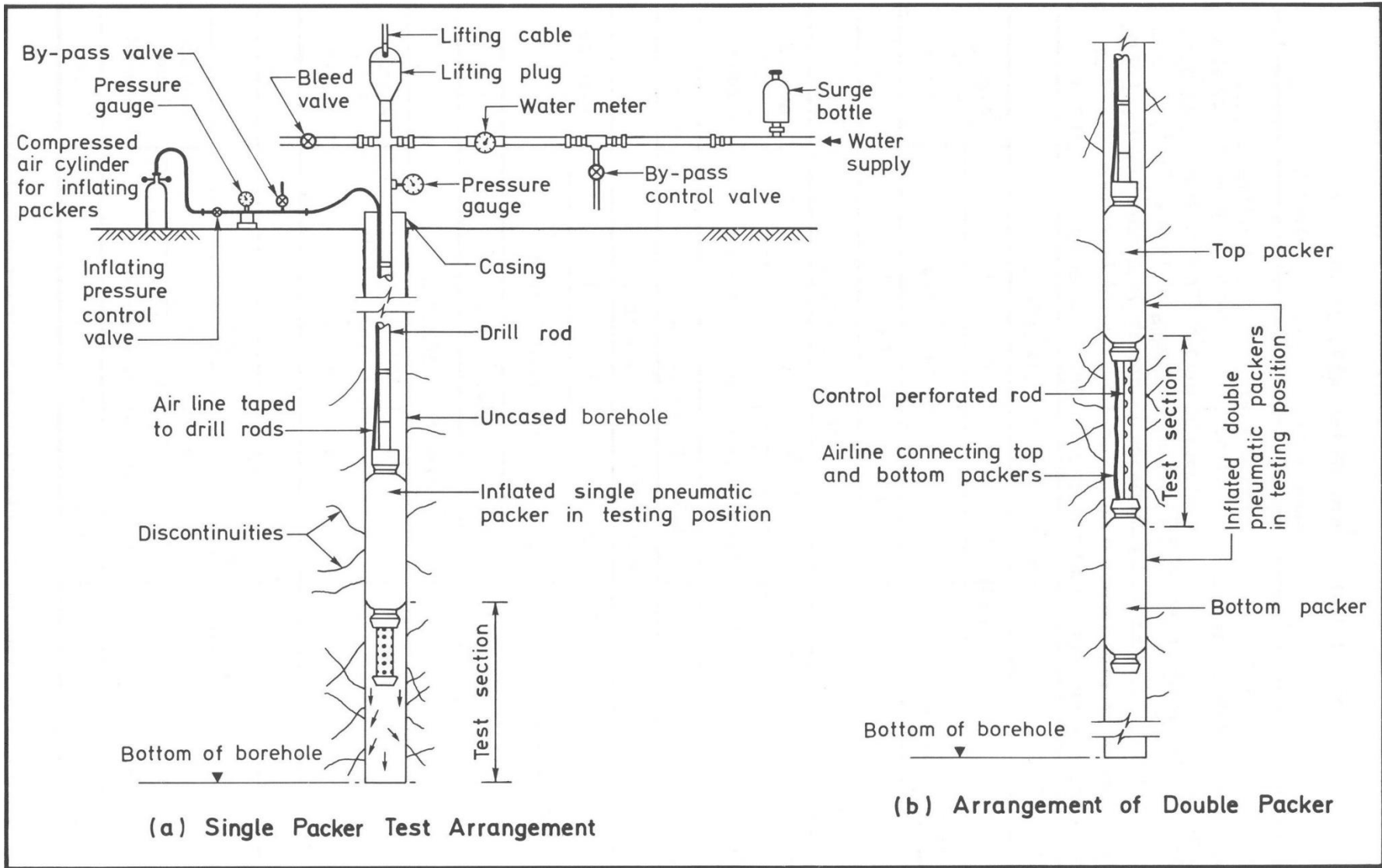
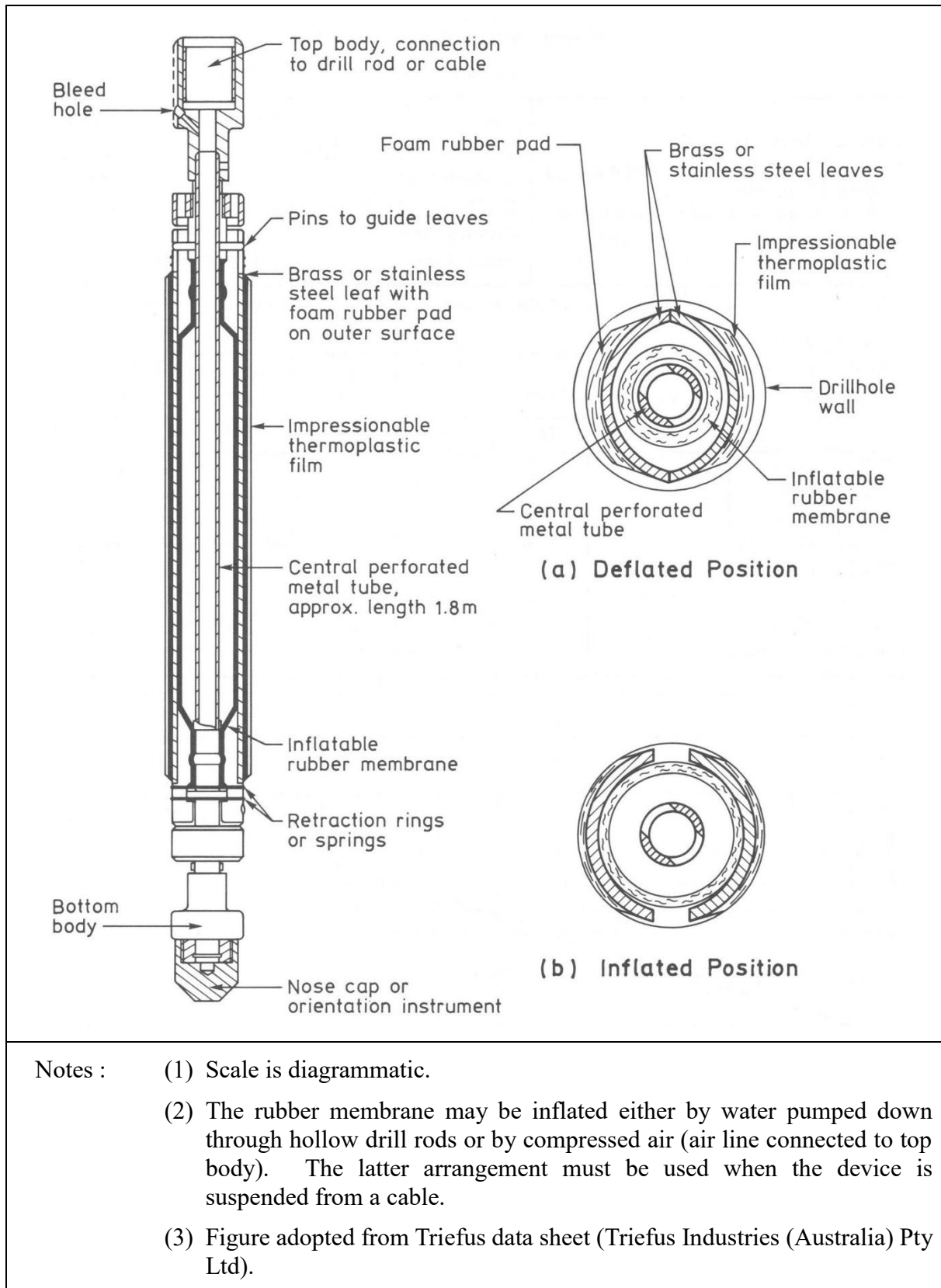


Figure 31 - Typical Arrangement for Packer (Water Absorption) Test

Field Data from Water Absorption Test							
Borehole No. <u>T3</u> Test No. <u>4</u>							
Date of test <u>24.11.75</u>				Tested by <u>A.N. Chan</u>			
Packer type (delete as necessary) <del>Single/ Double</del> Pneumatic / Hydraulic / Mechanical				Tested Section from <u>19.81 m</u> to <u>22.86 m</u>			
Packer pressure <u>276 kPa</u>				Depth of Hole at Time of Test <u>33.84 m</u>			
Depth to Centre of Test Section (measured down line of borehole) <u>21.34 m</u>				Details of Casing at Time of Test <u>-</u>			
Depth to Groundwater Level (measured down line of borehole) <u>21.34 m</u>				Gauge Height above Ground Level <u>1.32 m</u>			
FIRST PERIOD Gauge pressure <u>124 kPa</u>							
Time (minutes)	0	5	10	15			Average Flow (l/min)
Flowmeter <del>Dipstick</del> reading ( l )	218.6	229.3	239.9	250.7			
Water take ( l )	10.7	10.6	10.8				2.14
SECOND PERIOD Gauge pressure <u>248 kPa</u>							
Time (minutes)	0	5	10	15			Average Flow (l/min)
Flowmeter <del>Dipstick</del> reading ( l )	281.8	296.4	311.2	326.3			
Water take ( l )	14.6	14.8	15.1				2.96
THIRD PERIOD Gauge pressure <u>372 kPa</u>							
Time (minutes)	0	5	10	15			Average Flow (l/min)
Flowmeter <del>Dipstick</del> reading ( l )	255.9	276.6	297.5	318.5			
Water take ( l )	20.7	20.9	21.0				4.17
FOURTH PERIOD Gauge pressure <u>248 kPa</u>							
Time (minutes)	0	5	10	15			Average Flow (l/min)
Flowmeter <del>Dipstick</del> reading ( l )	54.5	69.9	85.4	101.1			
Water take ( l )	15.4	15.5	15.7				3.10
FIFTH PERIOD Gauge pressure <u>124 kPa</u>							
Time (minutes)	0	5	10	15			Average Flow (l/min)
Flowmeter <del>Dipstick</del> reading ( l )	377.3	388.6	400.0	411.5			
Water take ( l )	11.3	11.4	11.5				2.28

Figure 32 - Example of Packer (Water Absorption) Test Data





**Figure 34 - Impression Packer Device**

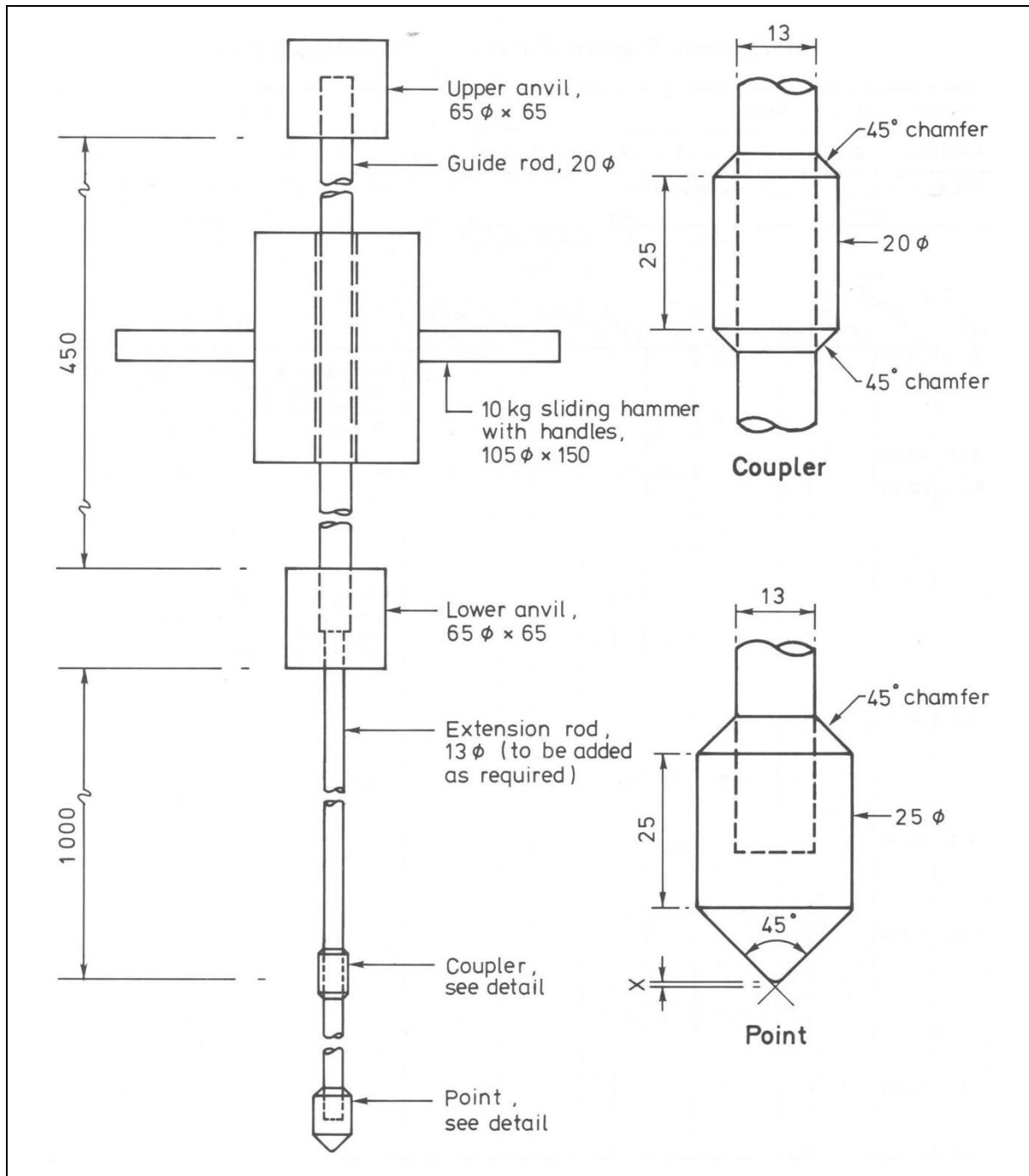
Impression Packer Survey - Discontinuity Log										
Project : Stage 2 Studies							Sheet 1 of 3			
Location : Slope no. 11SW-C/C207, Mt. Davis Road					Logged by : A.N. Chan		Checked by : A.N. Lau			
Drillhole No. : SBH1		Orientation : Vertical			Co-ordinates : E <u>830 610</u> N <u>814 942</u> Ground Level : +127.65 mPD					
Depth (m)	Level (mPD)	Legend	Nature and orientation of discontinuities							Description
			Type	Dip direction	Dip	Aperture	Infilling	Consistency	Unevenness	
6.00	121.65	x								Extremely weak, dry, light brownish red, inequigranular, completely decomposed coarse ash TUFF (Dense, sandy clayey SILT)
6.17	121.48	x								
6.23	121.42	v	2	240	52	4	1	-	7	
		v								Strong to very strong, dry, dark greenish grey mottled with black, inequigranular, slightly decomposed coarse ash TUFF
		v								
		v								
6.6	121.05	v	2	195	66	5	1	-	7	Joint
		v								
6.8	120.85	v								
		v								
6.95	120.70	v	2	250	78	5	1	-	7	Joint
		v								
		v								
7.2	122.85	v								

Type	Dip direction, Dip	Aperture	Nature of Infilling	Consistency of Infilling	Unevenness
0. Fault zone	Dip	1. Wide (>200mm)	0. Clean	Soil strength	Rock strength
1. Fault	Expressed in degrees	2. Mod. wide (60-200mm)	1. Surface staining	1. Very soft	6. Extremely weak
2. Joint		3. Mod. narrow (20-60mm)	2. Decomposed / disintegrated rock	2. Soft	7. Very weak
3. Cleavage		4. Narrow (6-20mm)		3. Firm	8. Weak
4. Schistosity		5. Very narrow (2-6mm)	3. Granular soil	4. Stiff	9. Moderately weak
5. Shear plane		6. Ext. narrow (>0-2mm)	4. Cohesive soil	5. Very stiff	10. Moderately strong
6. Fissure		7. Tight (zero)	5. Quartz	or hard	11. Strong
7. Tension crack			6. Calcite		12. Very strong
8. Foliation			7. Manganese		13. Extremely strong
9. Bedding			8. Kaolin		
			9. Other-specify		

Figure 35 - Impression Packer Survey and Discontinuity Log





- Notes :
- (1) All dimensions are in millimetres.
  - (2) The hammer should be provided with a 22 mm diameter central hole. The hammer should be drilled out as necessary so that its weight (including handles) is  $10.0 \pm 0.1$  kg.
  - (3) The point should be sufficiently sharp that  $x \leq 1.5$  mm.
  - (4) Only straight extension rods should be utilised; rods deviating 5 mm or more from a straight line at any point should not be used.

**Figure 36 - GCO Probe**

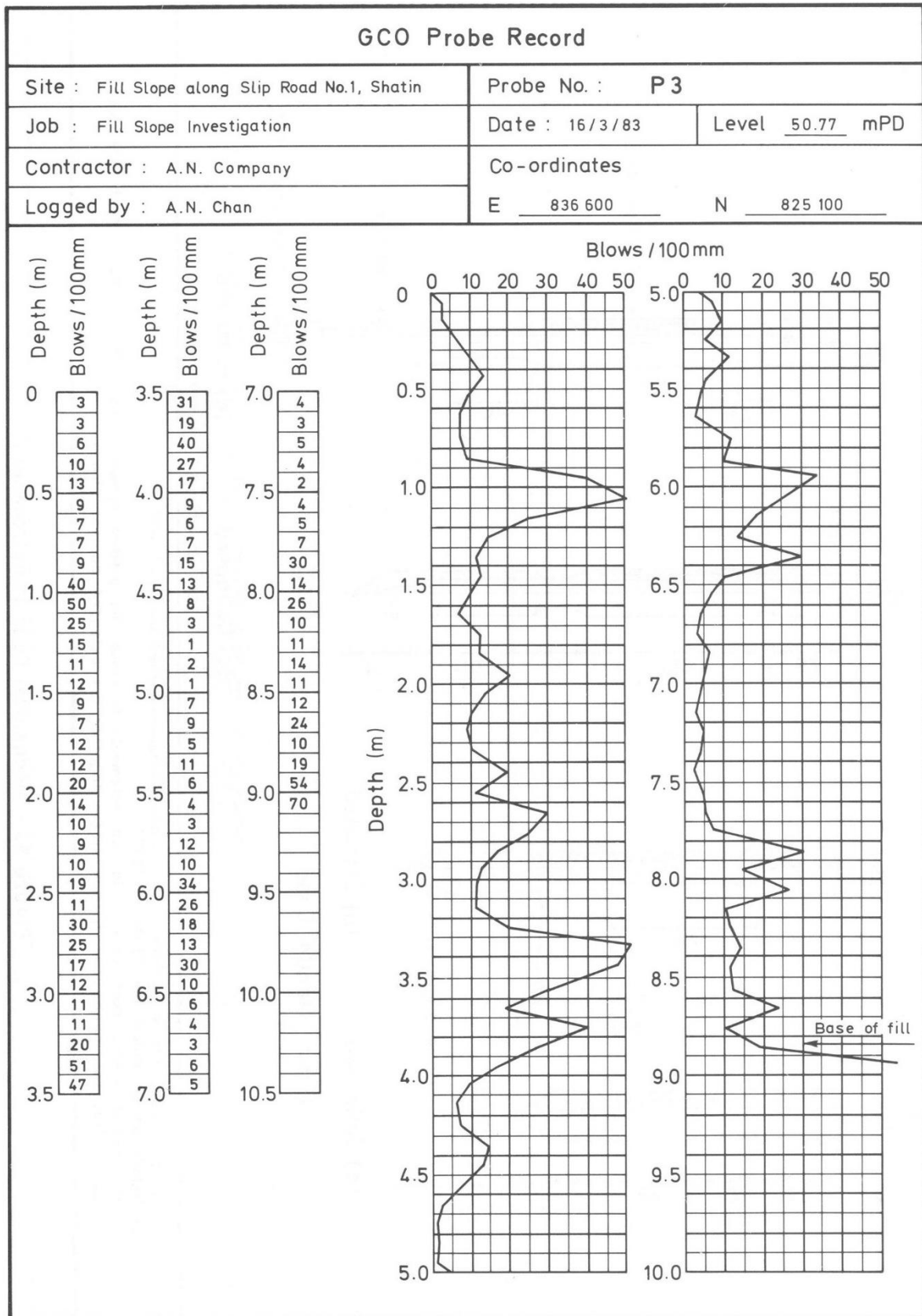
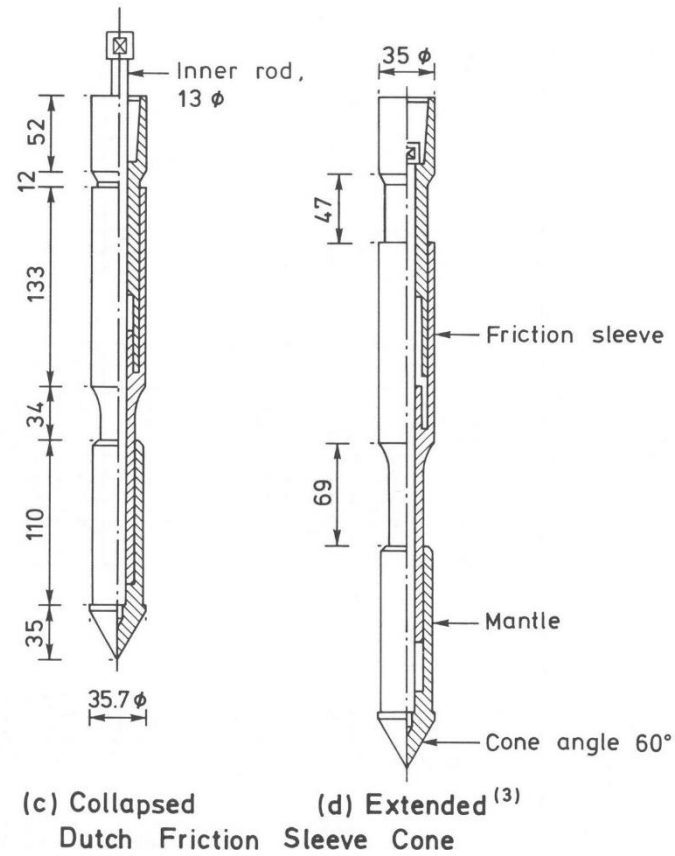
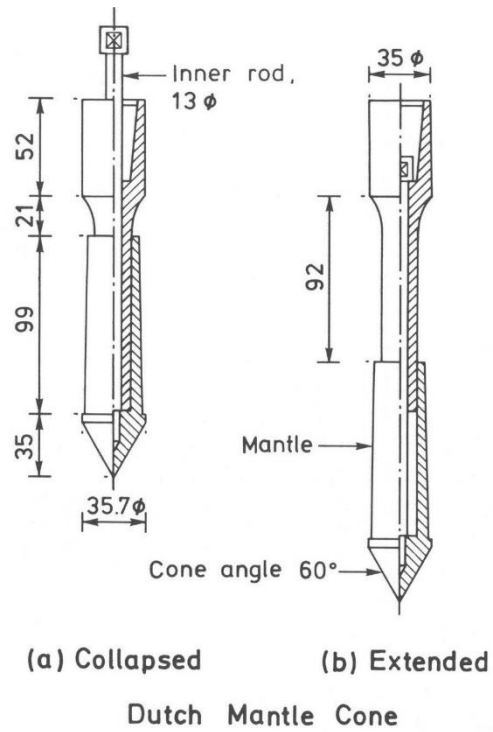


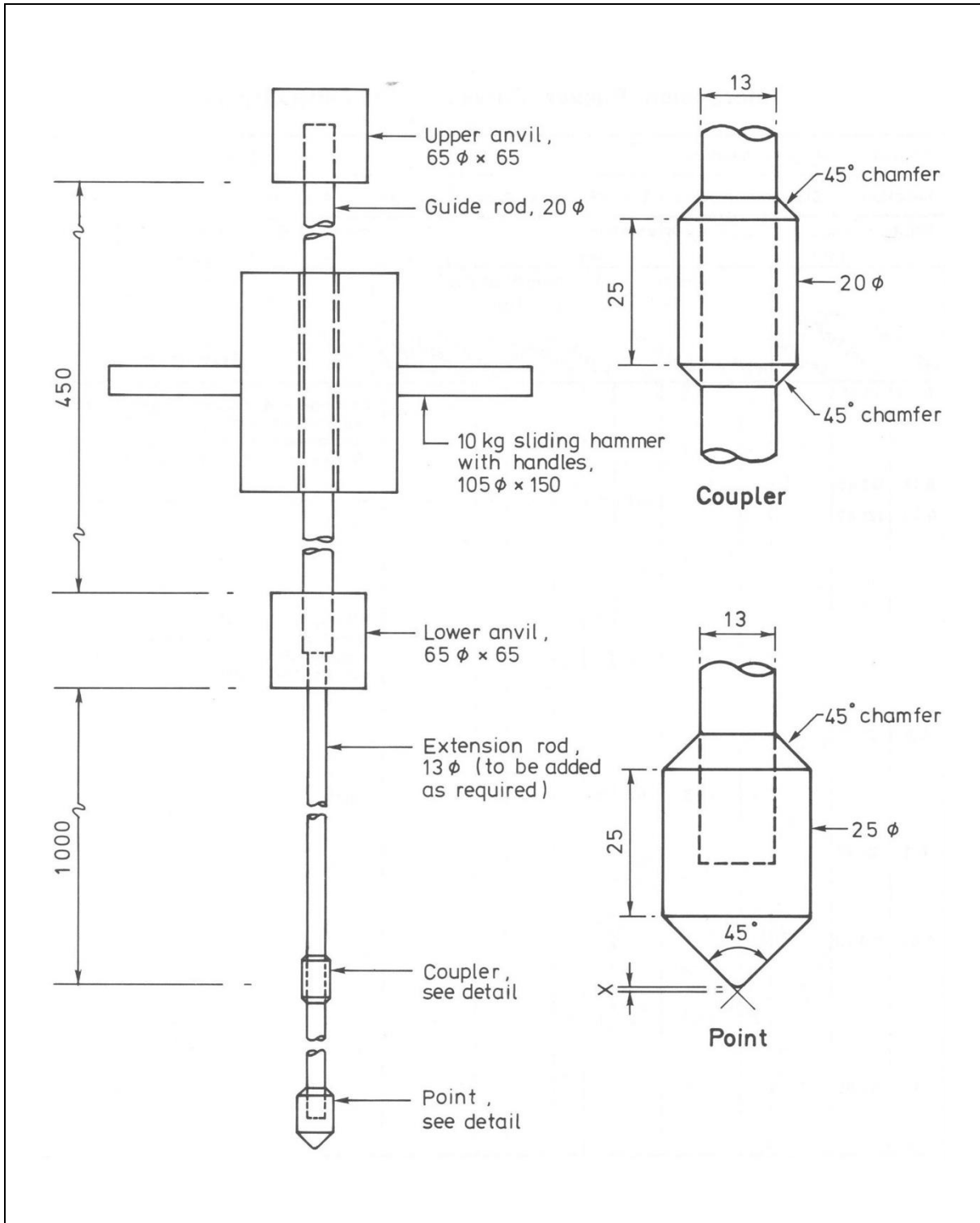
Figure 37 - GCO Probe Record



Notes :

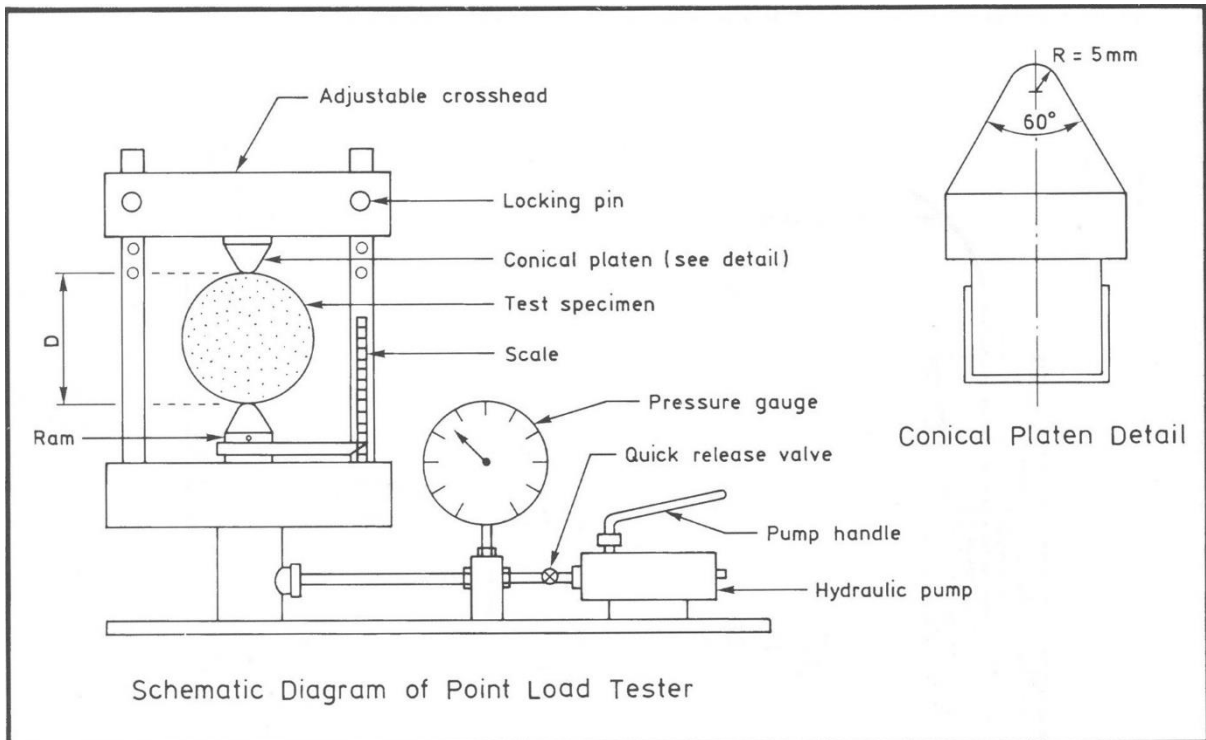
- (1) All dimensions are in millimetres.
- (2) Details shown follow the ISSMFE (1977).
- (3) The friction sleeve cone extends in two increments to reach the position shown in (d). The mantle is first extended 35 mm, then the mantle and friction sleeve together are extended another 35 mm.

**Figure 38 - Mechanical Cone Penetrometers**



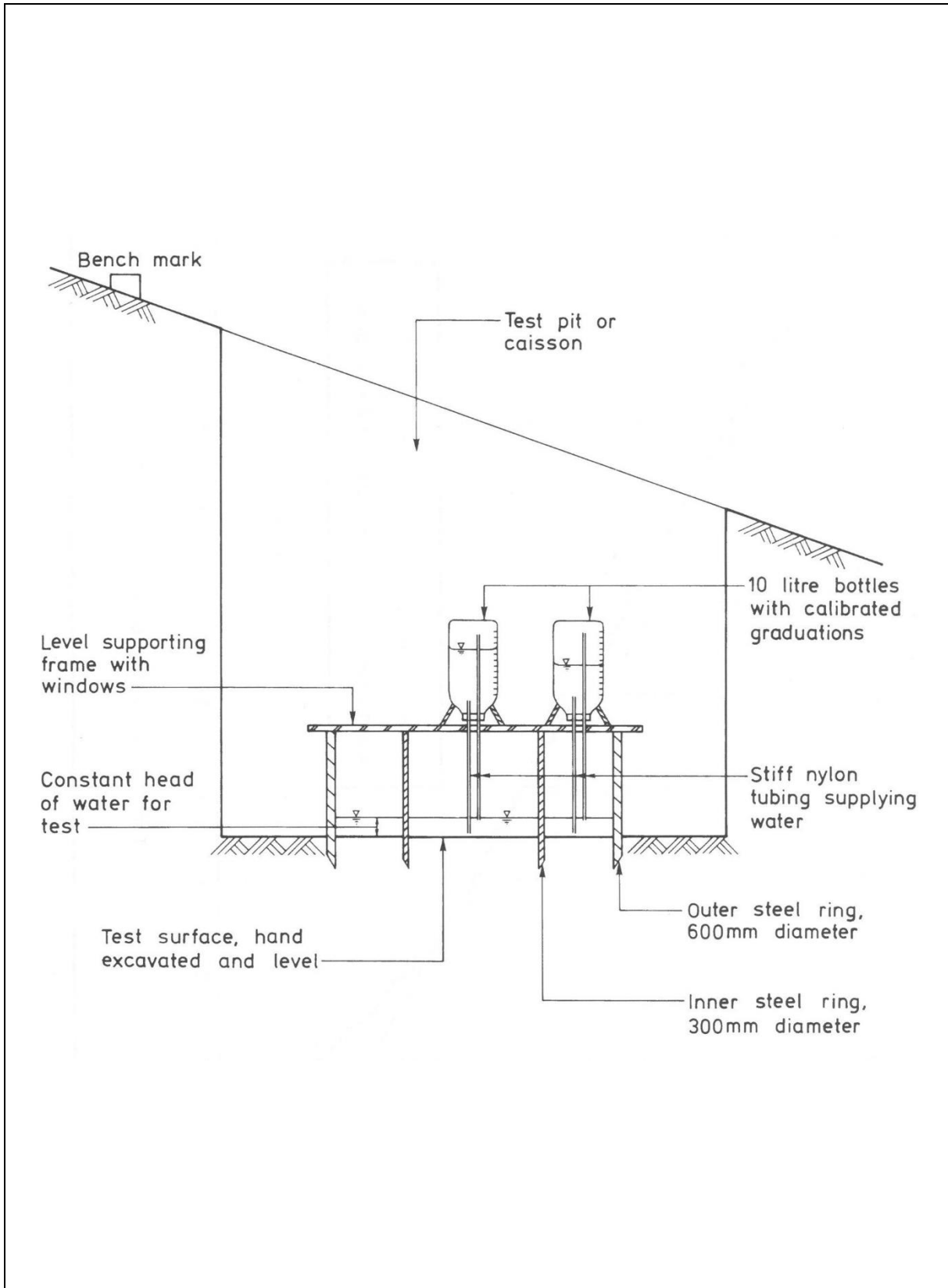
- Notes :
- (1) (a) after BS EN ISO 22476-1 (BSI, 2012f), (b) & (c) after Delft Soil Mechanics Laboratory (1977). [Amd GG2/01/2017]
  - (2) Scale is diagrammatic.
  - (3) All cones shown are 35.6 mm diameter with 60° cone angle.

**Figure 39 - Electrical Cone Penetrometers**

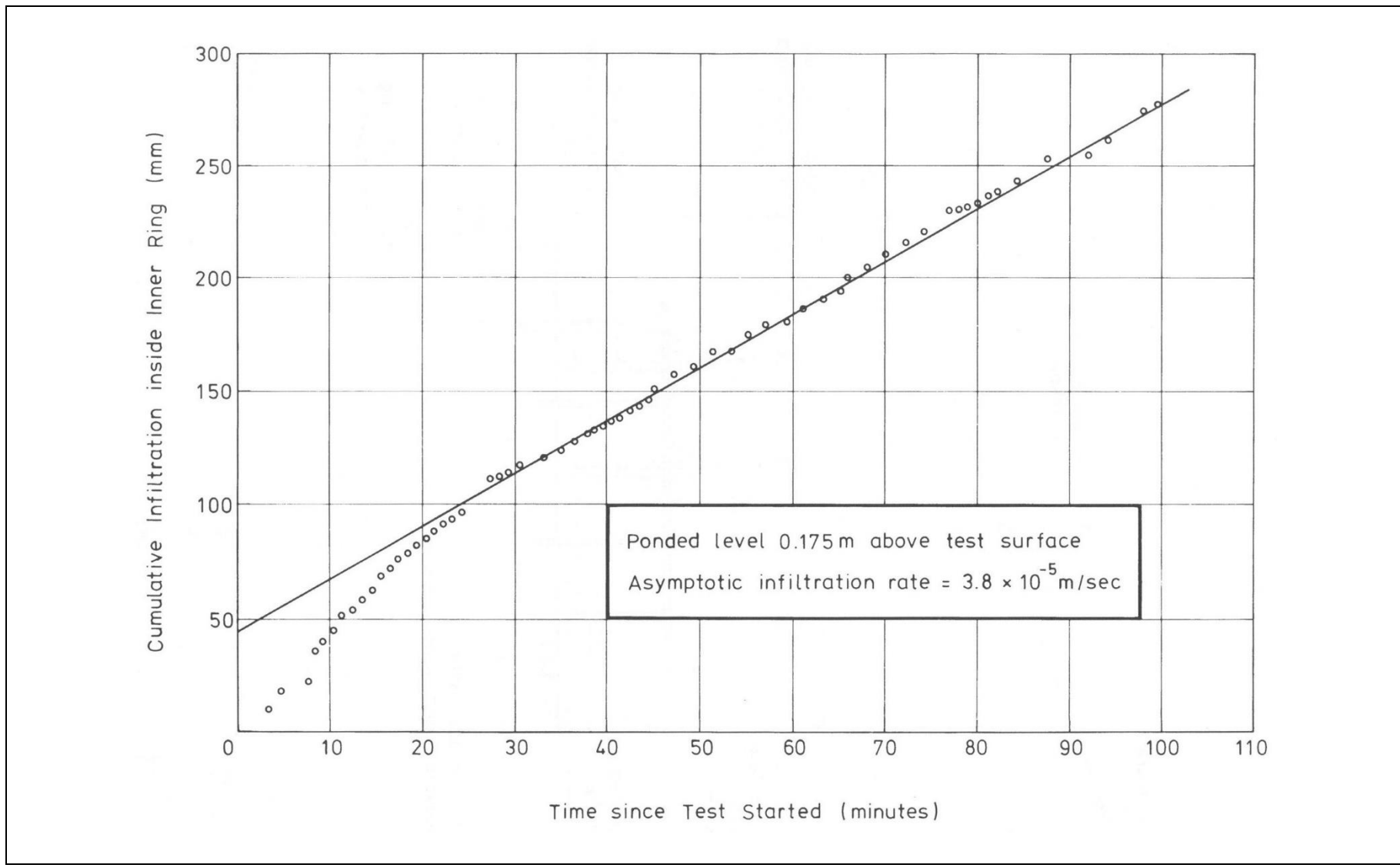


Point Load Test				Borehole No. S4											
Project : New Territories Trunk Road Contract 529/80				Test Machine : ELE PLT3				Date Tested : 7/8/83							
Location : North Tai Po to Lam Kam Road				Ram Area : —				Tested by : KYC							
No. or Depth (m)	Rock Type and Description	Moisture Condition	Test Type and Direction	Sample Width, W (mm)	Platen Separation, D (mm)	Gauge Pressure at Failure (MPa)	Failure Load, P (kN)	Equivalent Diameter, De (mm)	P/De <sup>2</sup> (MPa)	Correction Factor, F	Point Load Index, Is(50) (MPa)				
P10	Very strong, dry greenish grey to grey, inequigranular, slightly decomposed, medium to coarse-grained GRANODIORITE, with reddish brown stains from original joint surfaces around the edges.	d	d //	—	83	—	22.6	83	3.3	1.26	4.1				
			d //	—	83	—	23.6	83	3.4	1.26	4.3				
			a ⊥	83	79	—	42.6	91.37	5.1	1.31	6.7				
(1) Moisture Condition d - air dry s - saturated n - natural moisture  (2) Test Type and Direction d - diametral a - axial L - irregular lump // - parallel to planes of weakness ⊥ - perpendicular to planes of weakness r - random or unknown orientation				Diametral 		$L > 0.5D$ $De^2 = D^2$		Mean Is(50)							
								$De^2 = D^2$		Mean Is(50) ⊥		6.7			
										$De^2 = 4WD/\pi$		Mean Is(50) //		4.2	
										$De^2 = 4WD/\pi$		Ia(50)		1.6	
										$De^2 = 4WD/\pi$		$F = (De/50)^{0.45}$ $Ia = \frac{Is(50) \perp}{Is(50) //}$			

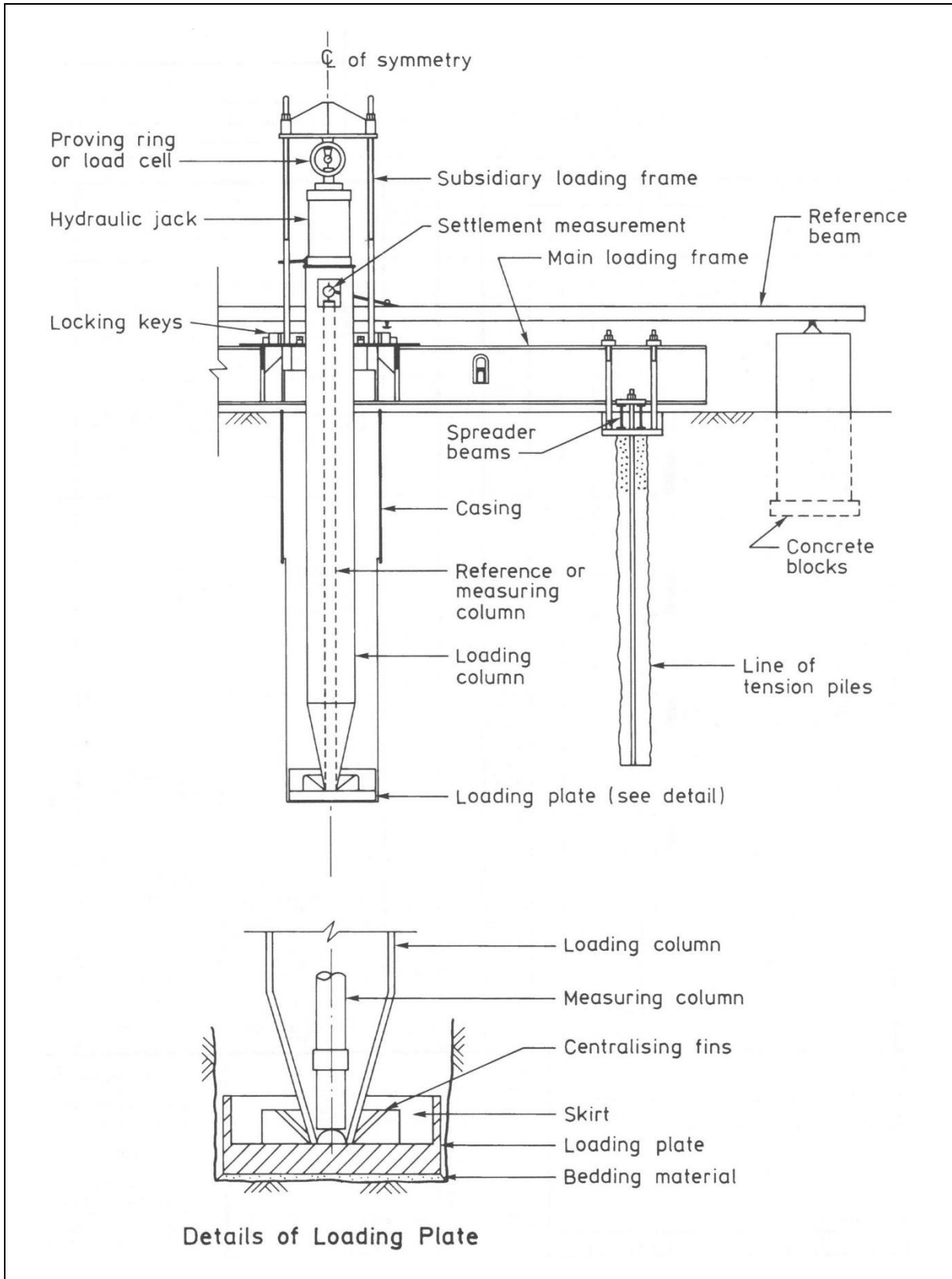
Figure 40 - Point Load Tester and Example Data



**Figure 41 - Typical Arrangement for Double-ring Constant-head Field Infiltration Test**



**Figure 42 - Example of Results from Field Infiltration Test**



Note : Figure adopted from Brown (1981) and BS 5930 (BSI, 2010). [Amd GG2/01/2017]

**Figure 43 - Typical Arrangement for Plate Load Test**



Project : Project A		Job No. : LT / DL / 11		Borehole No. : A11	
Location : Lam Tin		Co-ordinates : E 42497.74 N 19259.55		Sheet No. : 1 of 2	
Contractor : A. N. Company		Orientation : Vertical		Ground Level : 91.6 mPD	
				Logged by : A.N. Chan	
				Checked by : A.N. Lau	
Date of works : 22/2/86 to 24/2/86					

Daily Progress	Flush Return (%)	Core-barrel	Depth of Casing (Size) m (mm)	Sample			Legend	Depth (m)	Reduced Level (mPD)	Description of Materials	Grade
				Field Tests, Samples and Instrumentation	Rec (%)	RQD (%)					
22/2			(140)	Inspection pit excavated to 1.5 m depth.	0	50				Concrete slab, 100mm thick.	
		Mazier						1.0		Loose, pinkish grey, angular COBBLES of medium to coarse-grained slightly decomposed granite with much coarse gravel.	
		Rotary wash boring						1.5	90.1	(Fill)	
		Mazier						2.0		Loose, reddish brown, silty/clayey, sandy GRAVEL with occasional angular cobbles and some rootlets.	
		Rotary wash boring						3.0	88.6	(Fill)	
		Mazier						4.0		Medium dense, yellowish brown, silty SAND with occasional sub-angular gravel and cobbles of moderately to highly decomposed coarse-grained granite.	
		Rotary wash boring						5.0		(Colluvium)	
		Mazier						5.5	86.1		
		Rotary wash boring						6.0		Extremely weak, light reddish brown, completely decomposed coarse-grained GRANITE (Medium dense to dense, sandy SILT / CLAY).	V
		Mazier						7.0			
		Rotary wash boring						8.0		Moderately weak, yellowish brown inequigranular, moderately decomposed, coarse to medium-grained GRANITE with sub-horizontal, closely-spaced, smooth and planar, tight, black-stained joints.	
22/2		Mazier	8.2					8.2	83.4		III
23/2			(101)	Piezometer A11a							
	80	T2 - 101								Strong, pinkish grey, inequigranular, slightly decomposed coarse to medium-grained GRANITE with generally widely-spaced joints. Smooth and planar, tight, black-stained joint dipping at 70° at 9.1-9.3m. Sub-horizontal, smooth and planar, tight, brown-stained joints at 9.6, 10.2 and 10.5m ( see Sheet 2 ).	II
	100										

Remarks : From site formation drawing no. A/30794, original ground level before construction of fill platform and playground was approx. 88mPD.							Legend : ● Small disturbed sample ◆ Large disturbed sample U76, 100 Undisturbed drive samples of 76 mm or 100 mm dia. ( blow count, depth) □ Mazier sample ■ SPT liner sample ↓ Standard penetration test N value; ( blow count / penetration) ⊕ Permeability test			Plant used : Longyear L34 Type of boring /drilling : Rotary drilling Flushing medium : Water Diameter of boring/drilling : 0.00 - 8.20m 140 mm 8.20 - 11.50m 101 mm 11.50 - 12.10m 89 mm 12.10 - 18.10m 76 mm Casing tubes : 0.00 - 8.20m PW 8.20 - 12.10m NW		
Morning/evening water level :												
Date	22/2	22/2	23/2	23/2	24/2	24/2						
BH depth	-	8.2	8.2	13.2	13.2	18.1						
Casing	-	8.2	8.2	12.1	12.1	12.1						
Water	-	3.0	2.9	3.5	7.8	7.6						

Figure 44 - Example of a Borehole Log (Sheet 1 of 2)

Project : Project A Job No. : LT / DL / 11										Borehole No. : A11		
Location : Lam Tin Co-ordinates : E 42497.74 N 19259.55										Sheet No. : 2 of 2		
Contractor : A. N. Company Orientation : Vertical										Ground Level : 91.6 mPD	Logged by : A.N. Chan	Checked by : A.N. Lau
										Date of works : 22/2/86 to 24/2/86		
Daily Progress	Flush Return (%)	Core-barrel	Depth of Casing (Size) m (mm)	Field Tests, Samples and Instrumentation	Sample			Legend	Depth (m)	Reduced Level (mPD)	Description of Materials	Grade
					Rec (%)	RQD (%)	FI					
	50	T2 - 101			0 50 100	100	2.9	+++ ++	10.7 11.0	80.9	Slightly decomposed GRANITE (see Sheet 1 for details).	II
		Rotary wash boring	11.5 (89)	Blow/Penetration = 100 / 150 mm ↓ 10	67	0	10	+++ + x x x x x x x x x	11.5 11.8 12.0		Weak, yellowish brown, inequigranular, highly decomposed coarse-grained GRANITE from 10.7 - 11.0 m. Nil recovery from 11.0 - 11.5 m. Small disturbed sample No. 10 contains dense, pinkish brown, sandy SILT with some relict granite texture (Highly to completely decomposed GRANITE?).	IV/V
		TNW	12.1 Nil		82	55	-	++ +++	12.1 12.5	79.5 79.1	Strong, light pinkish grey, inequigranular, slightly decomposed, medium to coarse-grained GRANITE with sub-horizontal, closely-spaced, rough and planar, tight, brown-stained joints. Moderately to highly decomposed rock recovered as angular gravel at 12.5 - 12.8 m.	II III/IV
23/2 24/2	80				100	70	1.3	+++ ++	12.8 13.0	78.8		II
	90				100	100	1	+++ ++	13.2 14.0	78.4	Very strong, light pinkish grey, inequigranular, fresh, medium to coarse-grained GRANITE with generally widely-spaced joints. Smooth and planar, tight, brown-stained joints dipping at 40° at 13.3 m and 14.8 m.	
	100				100	85	5	+++ ++	15.0 15.5	76.1	Closely-spaced, smooth and planar, tight, brown-stained joints dipping at 40° at 15.0 - 15.5 m.	
	100				100	100	0	+++ ++	16.0 17.0		Nil joints at 15.5 - 17.1 m.	I
	100				100	75	4	+++ ++	17.1 18.0	74.5	Sub-vertical, medium-spaced, smooth and undulating, dark green joints with 1 - 2 mm thick chlorite infill at 17.1 - 17.6 m. Sub-horizontal, smooth and planar, tight, white-stained joint coated with kaolin at 18.0 m.	
24/2								+++ ++	18.1	73.5	Borehole complete at 18.1 m depth.	
Remarks :				Legend :				Plant used : Longyear L34				
Piezometer A11b installed at 17.3 m depth below ground surface with sand filter from 18.1 m to 12.1 m, bentonite seal from 12.1 m to 8.2 m; piezometer A11a installed at 7.55 m depth below ground surface with sand filter from 8.2 m to 6.9 m, bentonite seal from 6.9 m to 4.5 m and cement-bentonite grout from 4.5 m to ground surface.				<ul style="list-style-type: none"> <li>● Small disturbed sample</li> <li>⬇ Large disturbed sample</li> <li>U76, 100 Undisturbed drive samples of 76 mm or 100 mm dia. (blow count, depth)</li> <li>□ Mazier sample</li> <li>■ SPT liner sample</li> <li>↓ Standard penetration test N value; (blow count / penetration)</li> <li>⊗ Permeability test</li> </ul>				Type of boring / drilling : Rotary drilling Flushing medium : Water Diameter of boring / drilling : 0.00 - 8.20 m 140 mm 8.20 - 11.50 m 101 mm 11.50 - 12.10 m 89 mm 12.10 - 18.10 m 76 mm Casing tubes : 0.00 - 8.20 m PW 8.20 - 12.10 m NW				
Morning / evening water level :												
Date				See Sheet 1								
BH depth												
Casing												
Water												

Figure 44 - Example of a Borehole Log (Sheet 2 of 2)

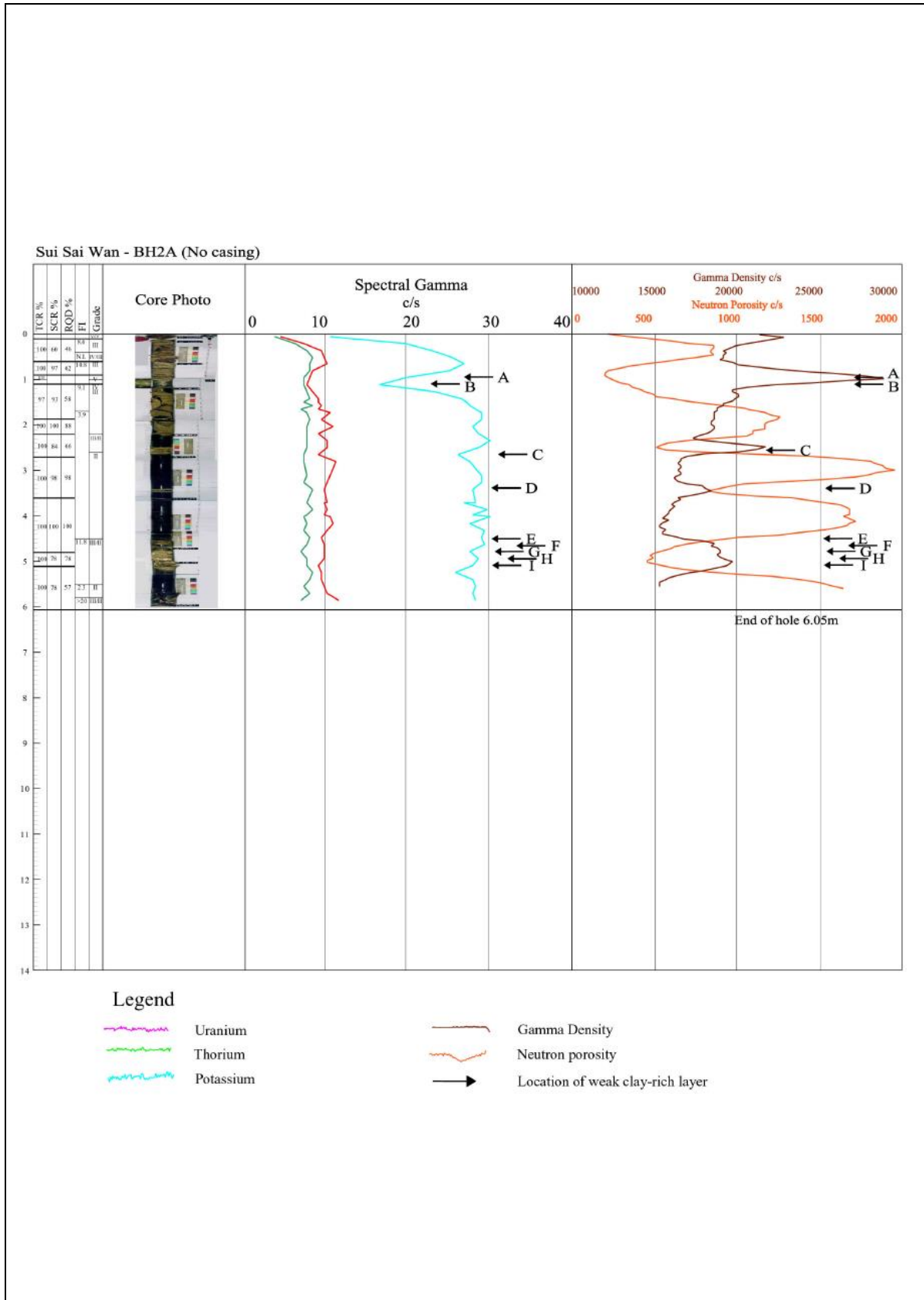
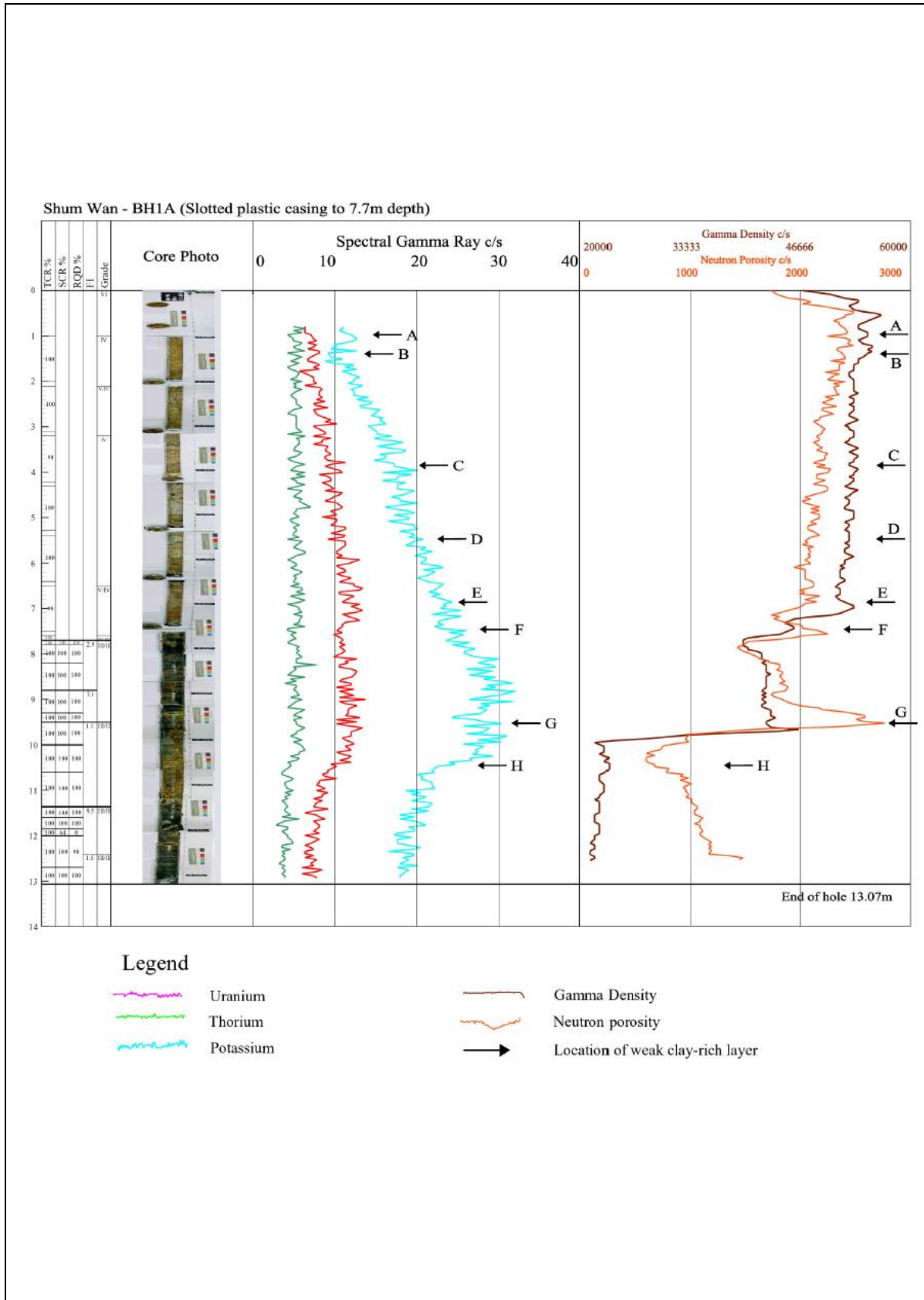


Figure 45 - Geophysical Logs – Siu Sai Wan – BH2A

[Amd GG2/01/2017]



**Figure 46 - Geophysical Logs – Shum Wan – BH1A**

[Amd GG2/01/2017]

Plates

**List of Plates**

Plate No.		Page No.
1	Drilling in Urban Areas of Hong Kong	286
2	Drilling in Steeply Sloping Ground	287
3	Ground Investigations over Water	288
4	Drilling and Sampling Equipment (three sheets)	289
5	Block Sampling	292
6	Groundwater Pressure Measuring Equipment	293
7	Standard Penetration Test Equipment	294
8	Penetration Vane Test Apparatus (Geonor A/S)	295
9	Impression Packer Survey Equipment	296
10	Probing and Penetration Test Equipment	297

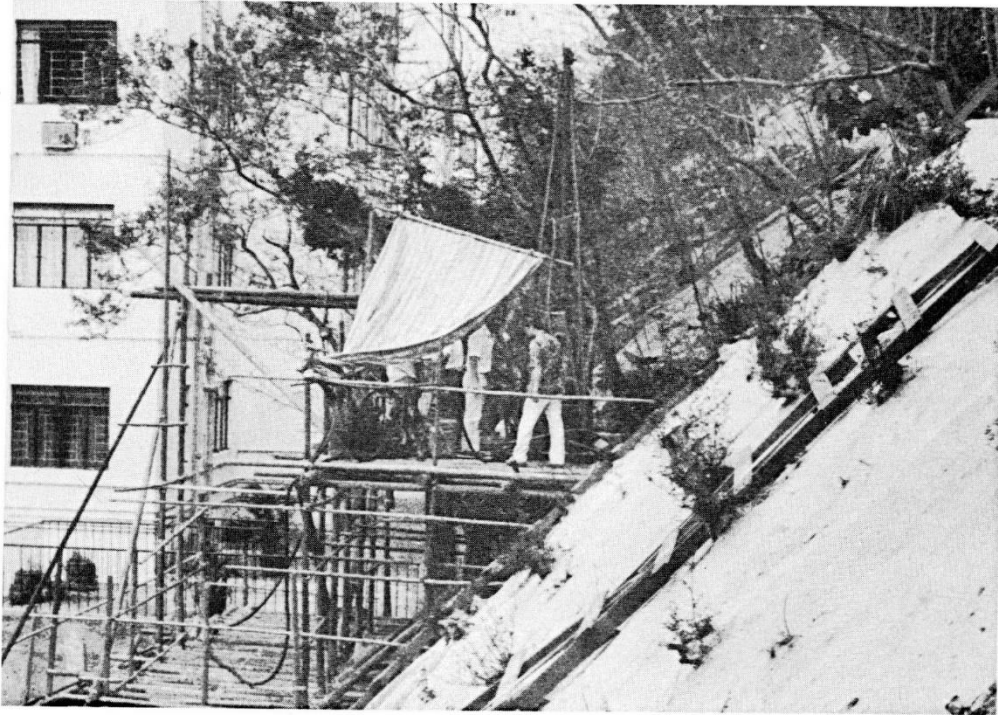


A : Drilling in a Densely - developed Urban Area

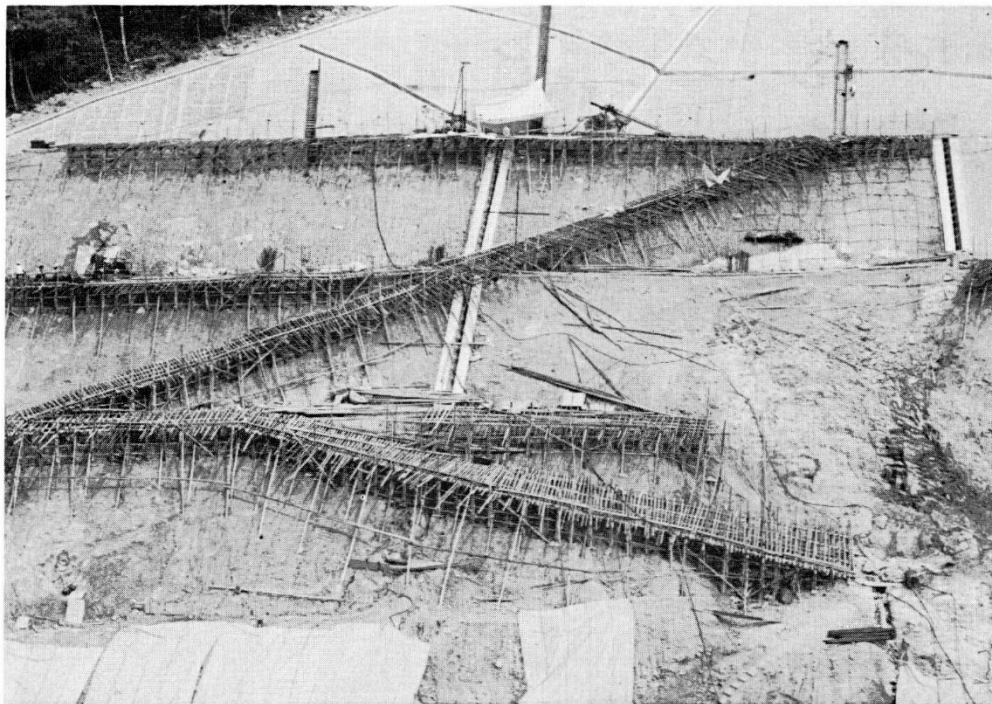


B : Drilling in the Middle of a Busy Road

Plate 1 - Drilling in Urban Areas of Hong Kong

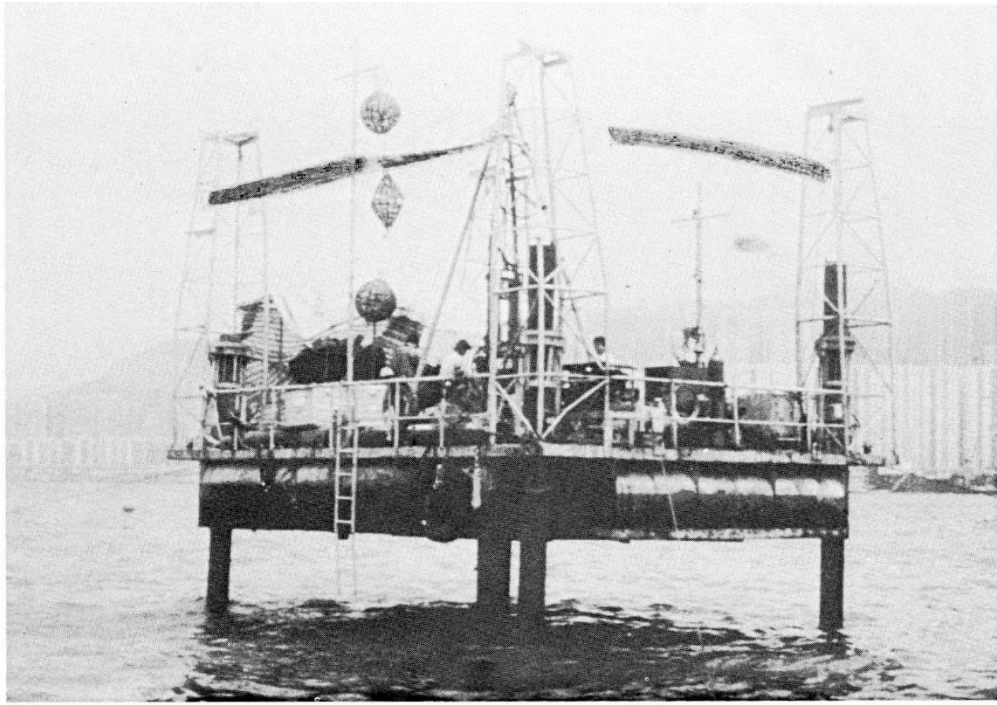


A : Working Platform for Drilling on a Slope

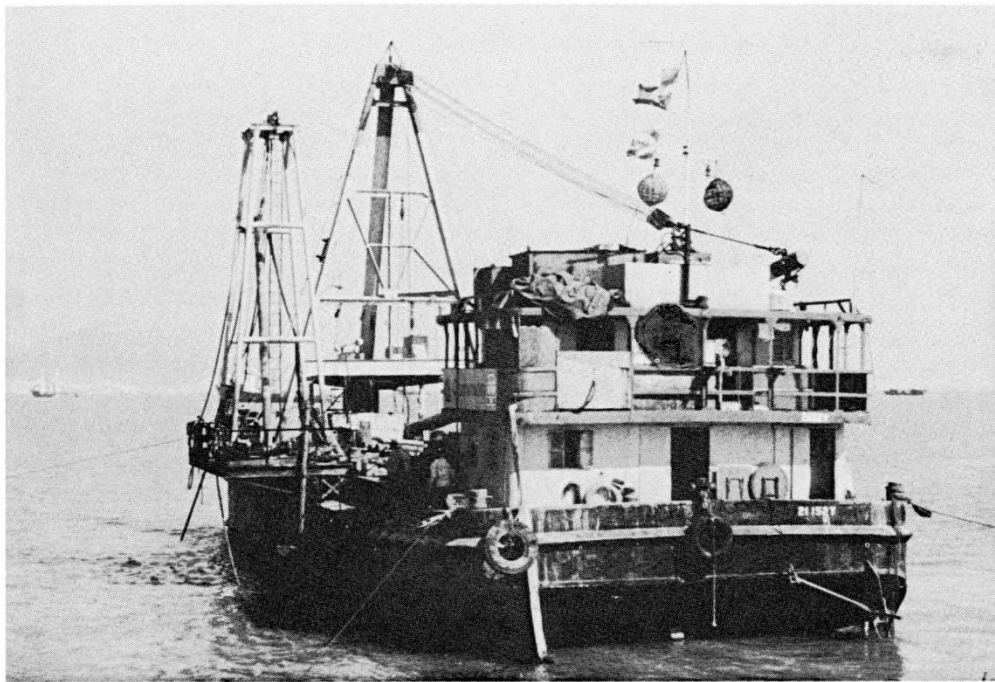


B : Timber Scaffolding for Access

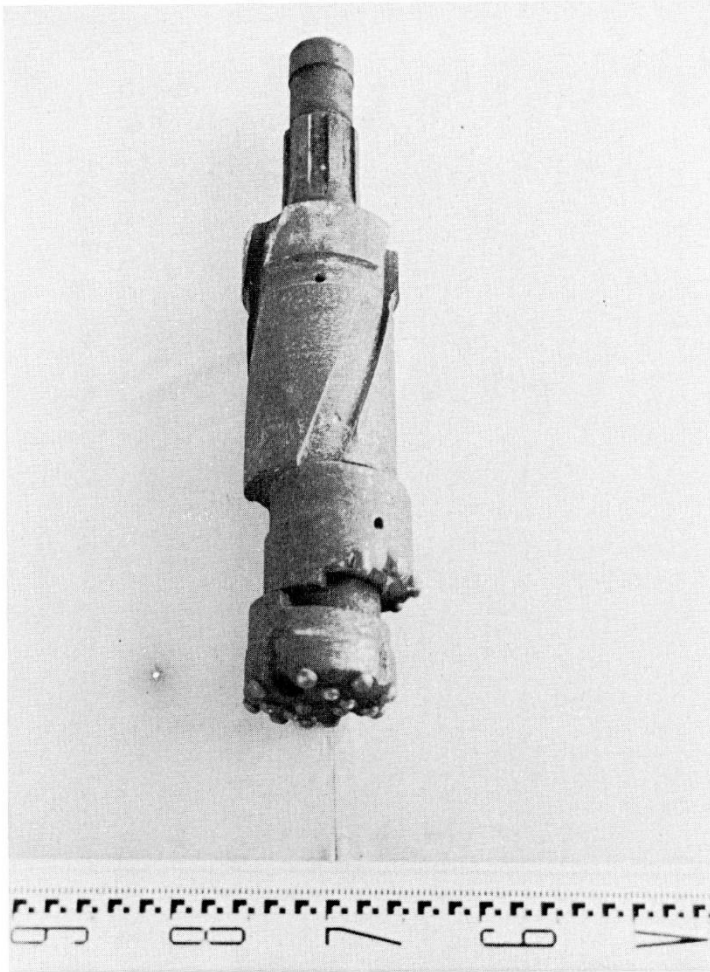




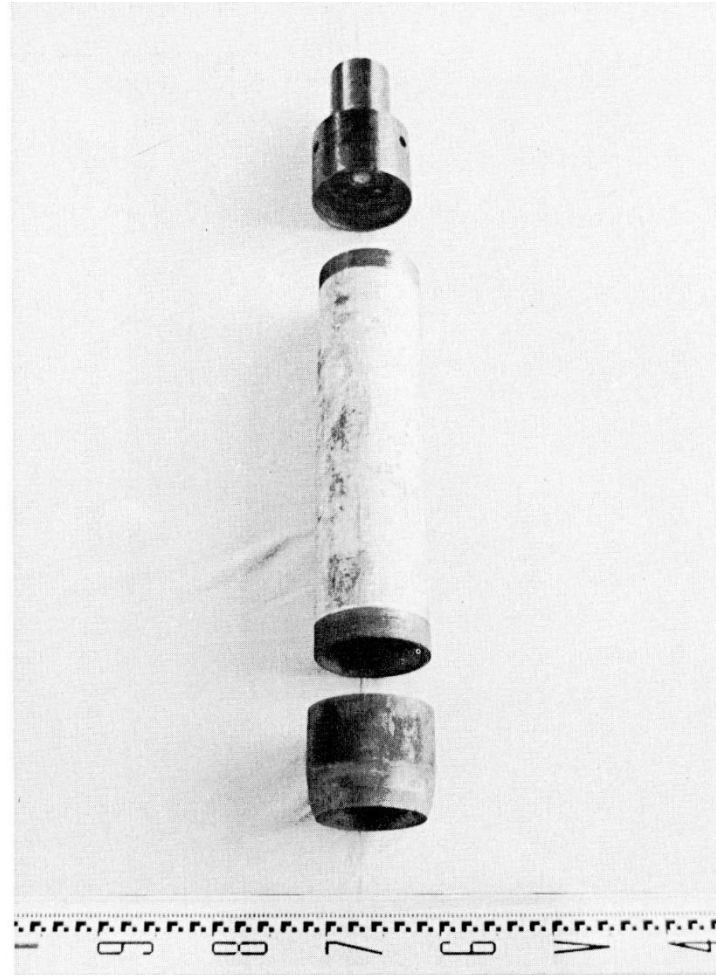
A : Jack - up Platform



B : Power Swivel Drilling System Mounted on a Barge

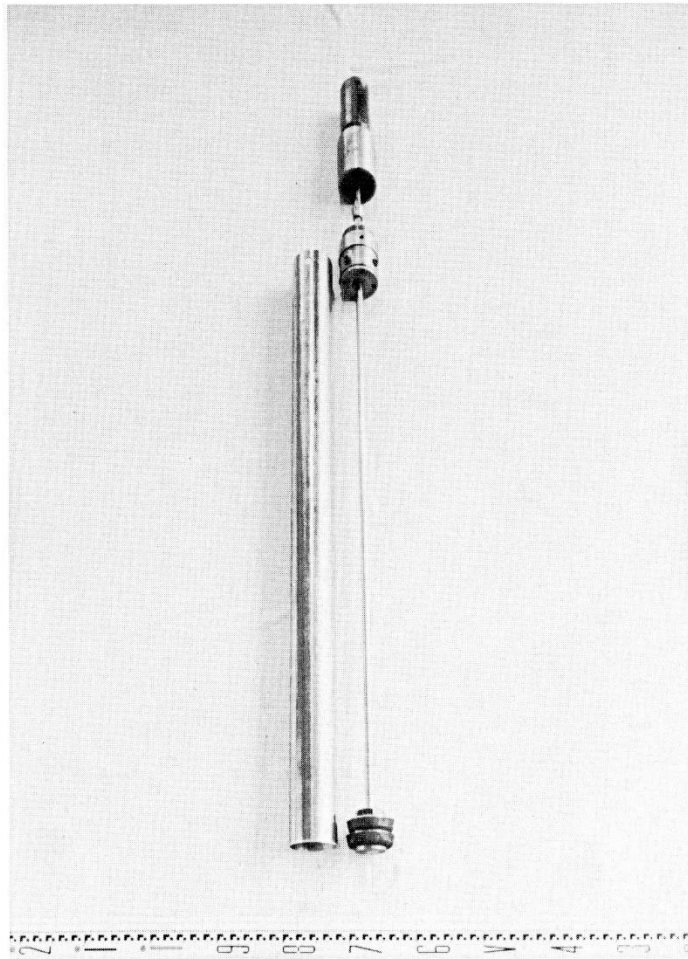


A : The ODEX Drill Bit

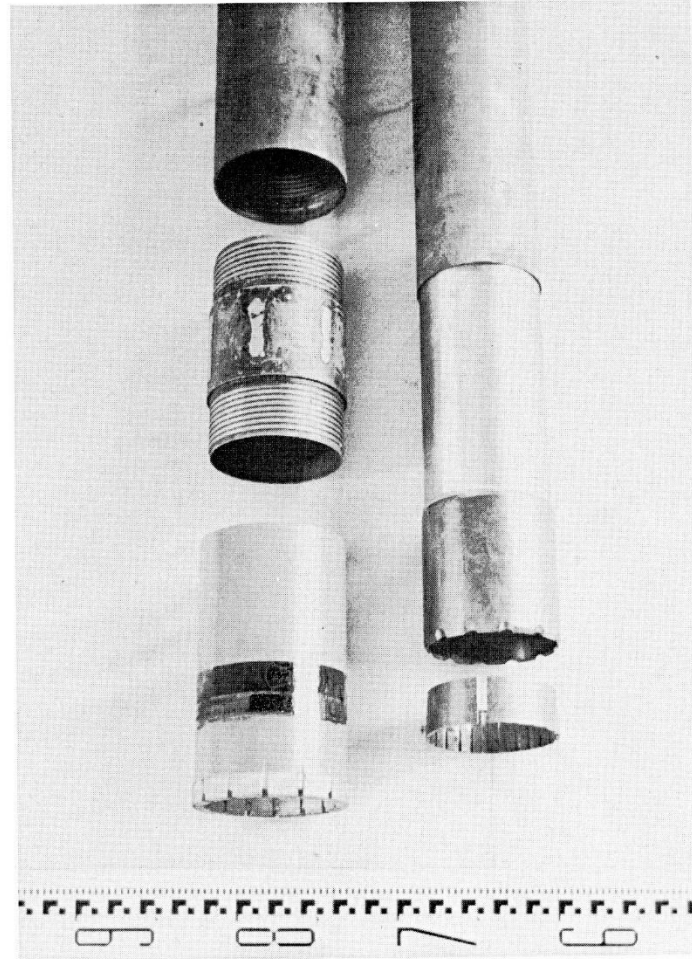


B : The U100 Sampler

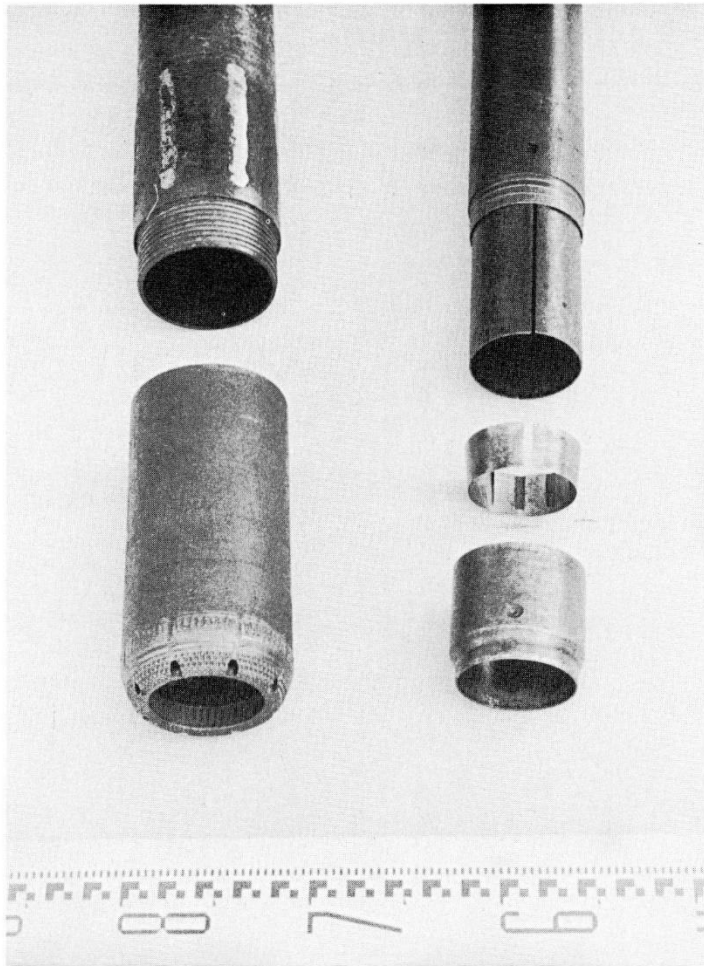
Plate 4 - Drilling and Sampling Equipment (sheet 1 of 3)



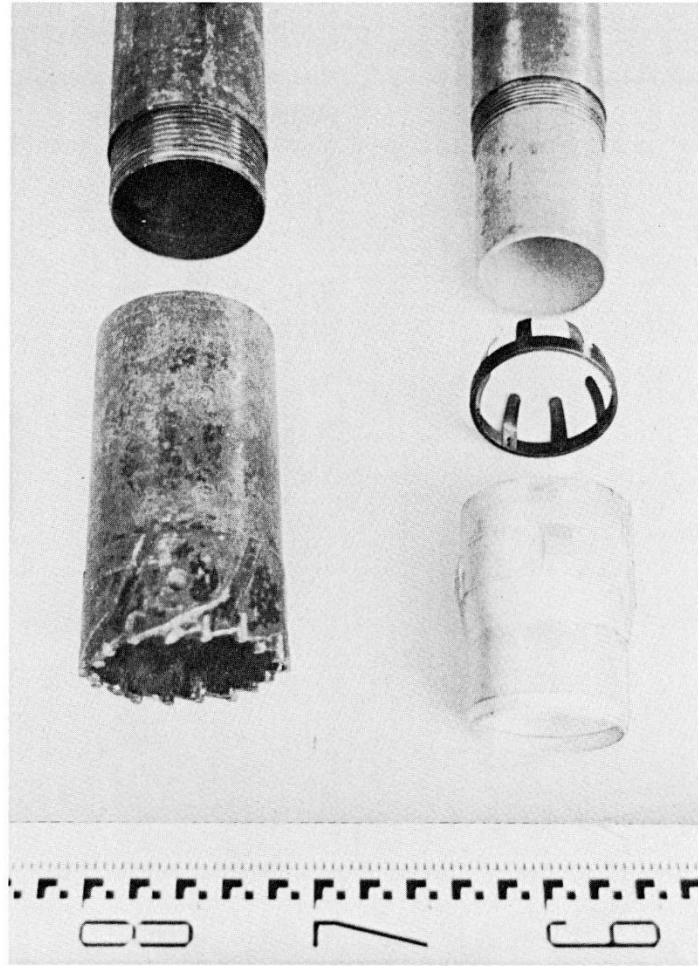
C : Thin-walled Stationary Piston Sampler



D : Components of a Double-tube Core-barrel (Craelius T2-101)

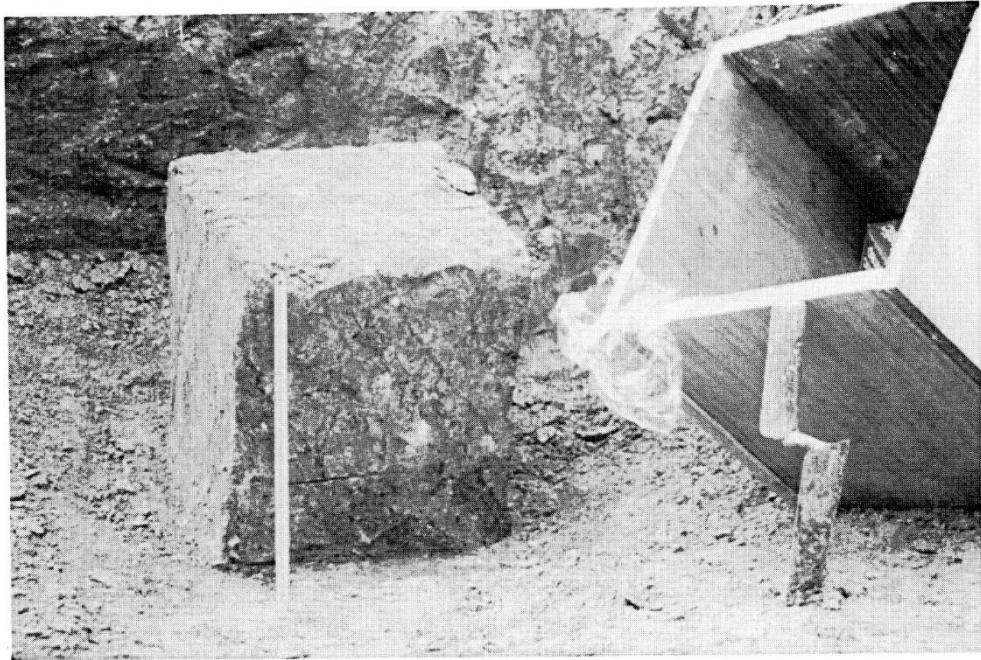


E : Components of a Non-retractable Triple-tube Core-barrel (Triefus HMLC)



F : Components of a Retractable Triple-tube Core-barrel (Mazier)

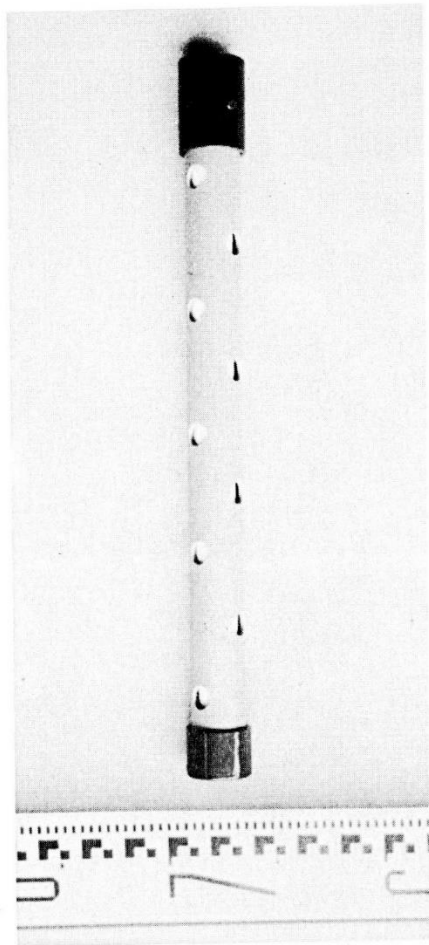
Plate 4 - Drilling and Sampling Equipment (sheet 3 of 3)



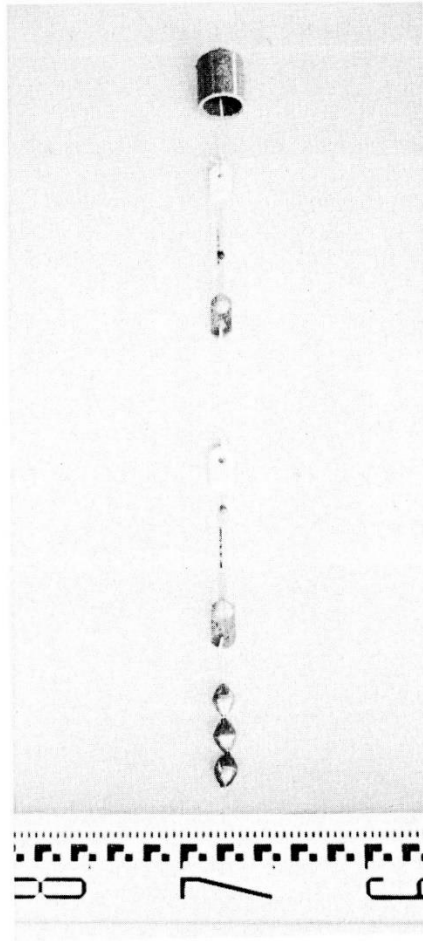
A : Trimmed Block Sample



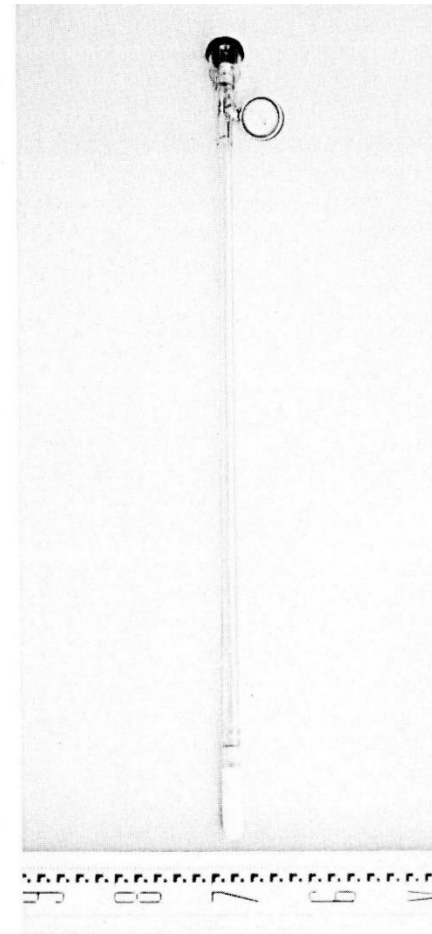
B : Protection of Block Sample



A : Casagrande  
Piezometer Tip

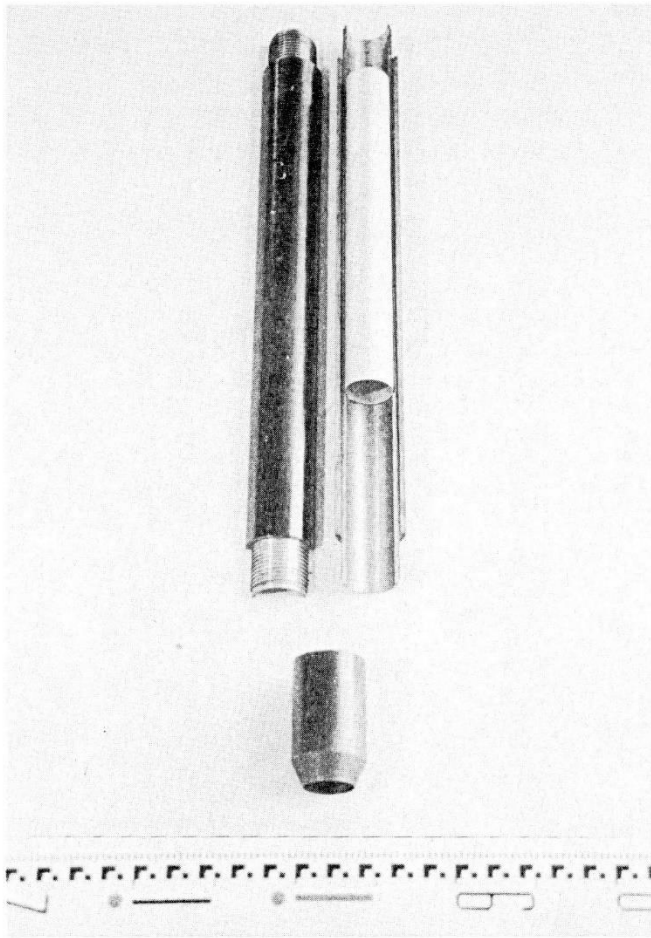


B : String of Piezometer  
Buckets (British  
Patent No. 1538487)



C : Tensiometer (Jetfill)

Plate 6 - Groundwater Pressure Measuring Equipment

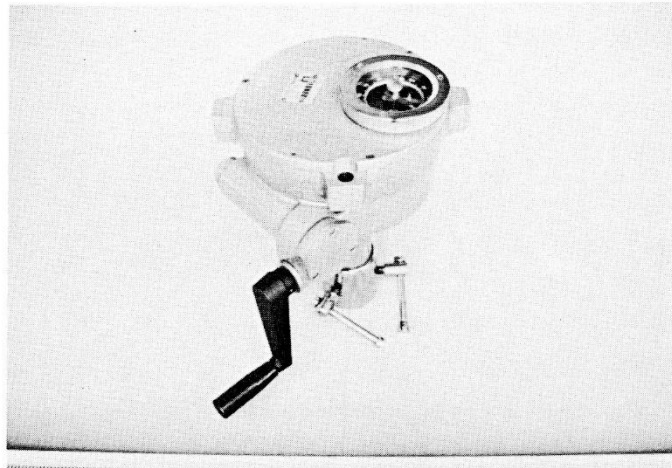


A : Split Barrel SPT Sampler with Sample Liner

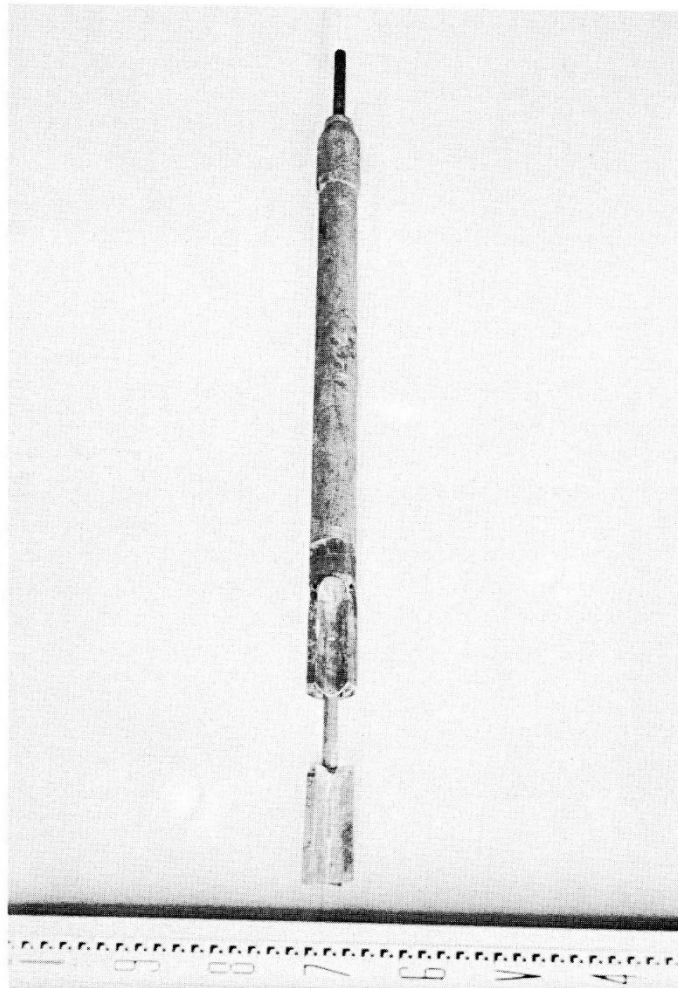


B : Automatic Release Trip Hammer and Drill Rods

Plate 7 - Standard Penetration Test Equipment

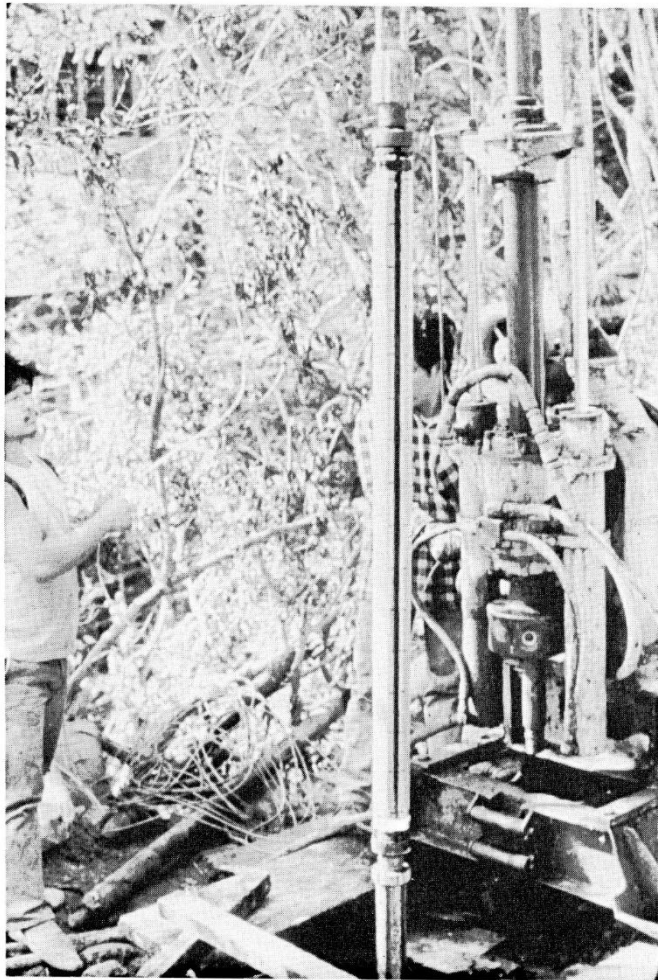


A : Torque Measuring Device

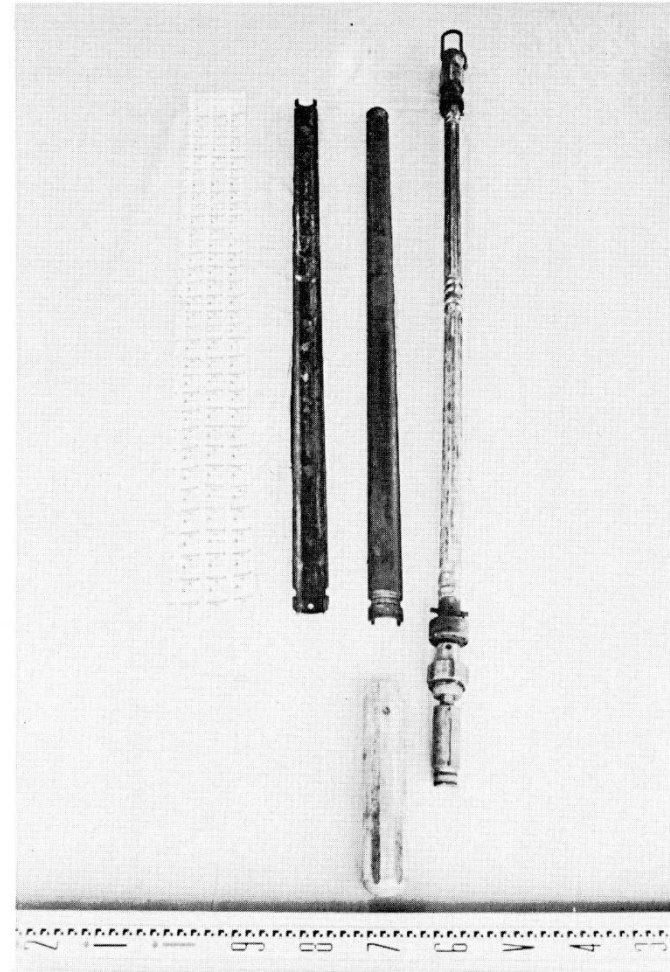


B : Vane Body



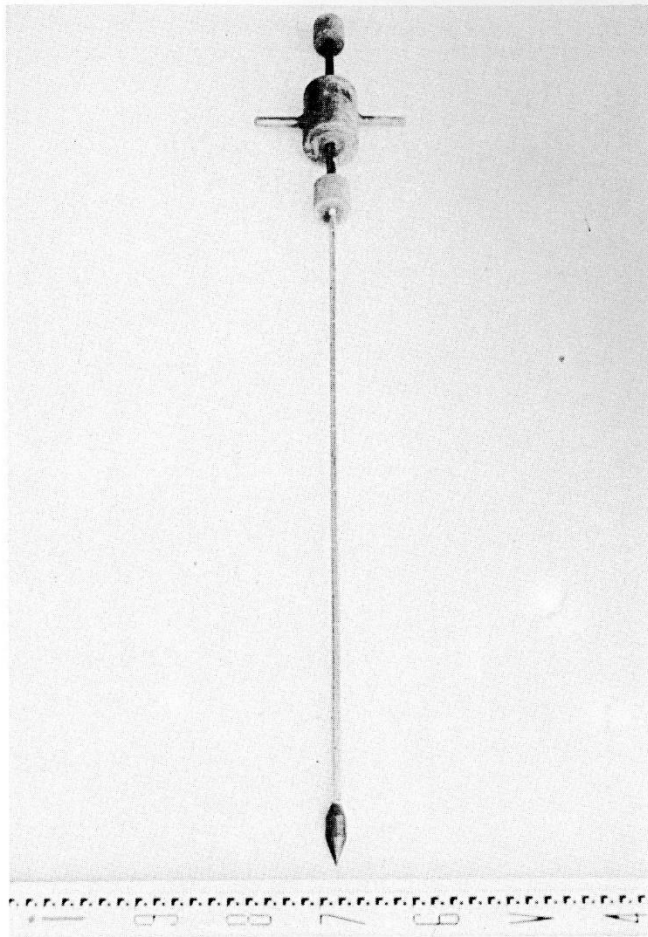


A : Assembled Impression Packer

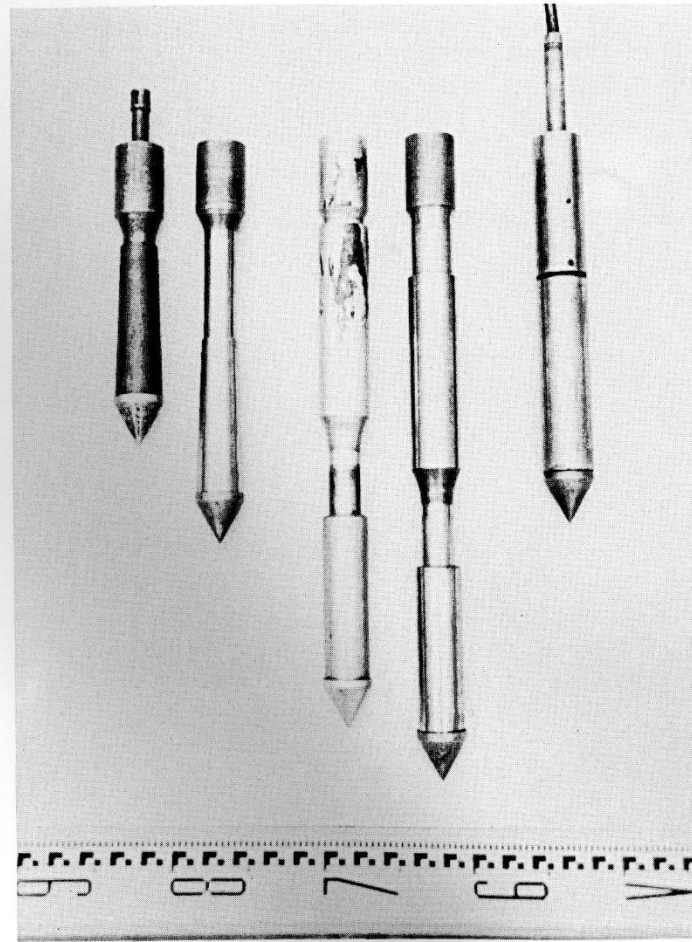


B : Dismantled Equipment

Plate 9 - Impression Packer Survey Equipment



A : GCO Probe



B : Cone Penetrometers

Plate 10 - Probing and Penetration Test Equipment

## Appendices

Appendix A  
Information Required for Desk Study

**Contents**

	Page No.
Title Page	299
Contents	300
A.1 General	301
A.2 Maps, Plans and Charts	301
A.3 Ground Conditions	301
A.4 Meteorological and Hydrological Information	302
A.5 Past Records	302
A.6 Services and Utilities	302
A.7 Lease and Engineering Conditions	303
A.8 Planning a Ground Investigation	304
A.9 References	306

## **A.1 General**

A desk study involves the collection and review of information required for the planning of the project and of the site investigation.

Sources of information are given in Appendix B.

## **A.2 Maps, Plans and Charts**

Topographic maps and plans are useful for studying the general features of the site, and for identifying ground features of engineering significance, e.g. slopes, retaining structures, streams, tunnels, burial grounds and obstructions such as transmission lines and towers. They are also useful for the assessment of the effect of the proposed works on adjacent properties and structures, and for the identification of works areas, storage areas and access, including temporary access for construction purposes.

For works to be carried out in a marine environment (e.g. seawalls and piers), Admiralty charts and tide tables should also be referred to.

In some cases, old maps may be useful, e.g. to check the location and extent of an old seawall or a buried stream course. Archaeological maps may also be required to establish the boundaries of an archaeological site.

## **A.3 Ground Conditions**

The following information should be referred to for a preliminary study of the ground conditions :

- (a) Aerial photographs. These are particularly useful for studying the site history, past instability of the ground, erosion, surface hydrology, vegetation, photolineaments and other surface geological features, and for identifying the presence of colluvium, alluvium, fill and boulders (see Chapter 6).
- (b) Geological maps and memoirs. These provide detailed information on the geology of the district, and are useful as a basis for evaluating the likely influence of the local geology on the proposed works and in the selection of the ground investigation methods.
- (c) Past site investigation records. These should be studied and useful information extracted. Availability of good site investigation records in the vicinity of the site will greatly assist the planning of the ground investigation, and may reduce the scope and extent of the investigation required.

#### **A.4 Meteorological and Hydrological Information**

Local rainfall records should be collected where the proposed works require slope and drainage design. Hydrological information, where available, is useful in drainage studies, including the assessment of flooding risk and the influence of the proposed works on the local and downstream drainage regimes.

In the design of temperature-sensitive structures, or where the performance of the construction materials can be affected by temperature, data on ambient temperatures (including air and ground temperatures) and solar radiation should be referred to.

#### **A.5 Past Records**

Past construction records, for both the site and for adjacent properties, should be obtained where appropriate, to provide information on the following :

- (a) Site formation works such as construction of slopes, retaining structures and basements.
- (b) Foundation works such as piling.
- (c) Details of preventive or remedial works and of any continuing monitoring of, for example, ground anchor installations, horizontal drain installations, building settlements, and slope and retaining wall movements.
- (d) Tunnels and disused tunnels, including details of linings and ground support.

Records of past failure, flooding and settlement of ground and structures should also be noted and studied where necessary.

#### **A.6 Services and Utilities**

Details and locations of existing services and utilities, including stormwater drains, sewers, fresh and salt water mains, fire fighting mains, electrical cables, gas mains and telephone ducts, should be referred to for the following purposes :

- (a) Assessment of the effect of the proposed works (including ground investigation works) on the existing services and utilities, e.g. the effect of dewatering settlement on an old water main or gas main.
- (b) Provision of services and utilities for the project, e.g. provision of cooling water for the air-conditioning system.

- (c) Provision of temporary electricity and water supplies for the ground investigation.

### **A.7 Lease and Engineering Conditions**

Except where an investigation is being planned for a site that has not been allocated to the project (e.g. an investigation that is for the purpose of selecting sites or establishing the suitability of a site), there should be available a set of lease conditions or engineering conditions, depending on whether the proposed project is to be undertaken privately or by Government. It is essential that these conditions are studied thoroughly during the desk study or as soon as they become available.

Engineering conditions are issued by the appropriate District Lands Office of the Lands Department, and lease conditions are normally issued by the Registrar General/Land Officer. These conditions govern the use of the site. They also set down the requirements and restrictions on development, and define the responsibilities of the related parties and authorities. The following items are normally covered :

- (a) Requirements. These normally include:
  - (i) formation and landscaping,
  - (ii) layout of the site,
  - (iii) access,
  - (iv) possession of the site.
  
- (b) Restrictions. Examples of common items covered are :
  - (i) non-building areas,
  - (ii) height of structures,
  - (iii) removal of trees,
  - (iv) dumping on Government land and public roads,
  - (v) drainage reserves,
  - (vi) pile driving,
  - (vii) blasting,
  - (viii) use of water supply,
  - (ix) establishment of rock crushing plants.
  
- (c) Responsibilities. The conditions normally cover responsibilities for :
  - (i) maintaining both the stability of the land and its surface condition, within, and where appropriate, adjacent to the site,
  - (ii) interference with or damage to roads, services, drains, channels, etc.,
  - (iii) water supply,
  - (iv) connections to sewers and stormwater drains,



- (v) drainage.

The following local statutes may be mentioned in the lease conditions :

- (a) The Buildings Ordinance and its subsidiary Regulations (Government of Hong Kong, 1985), governing the safety and the design and construction standards of buildings to be erected, and the planning and administrative procedures to be followed. This Ordinance also governs site investigation work within the Mid-levels Scheduled Area.
- (b) The Fire Services Ordinance (Government of Hong Kong, 1981a), governing the provision of fire services, installations and equipment, and the provision of access for fire services, appliances and personnel.
- (c) The Waterworks Ordinance (Government of Hong Kong, 1974), governing the supply of fresh water and salt water, and the standards of plumbing, installations and equipment.
- (d) The Dangerous Goods Ordinance (Government of Hong Kong, 1983), governing the storage, transportation and use of dangerous goods.

In some cases, special clauses may also be present in the lease conditions. For example, a geotechnical clause may be used to indicate that a site is considered to be geotechnically difficult to develop, hence forewarning a developer that a high degree of skilled geotechnical engineering input will be required.

## **A.8 Planning a Ground Investigation**

In planning a ground investigation, the effect of the proposed works on the ground, on adjacent properties and structures and on existing services and utilities, should be thoroughly examined. For example, the effect of flushing water from drilling on existing slopes and retaining walls should be considered.

Requirements and restrictions imposed by local statutes should be studied and observed in the planning and execution of the investigation. For example, the Summary Offences Ordinance (Government of Hong Kong, 1981b) restricts the use of powered mechanical equipment between 7 p.m. and 7 a.m., and on any public holiday, including Sundays. This Ordinance also controls the general level of noise at night, i.e. from 11 p.m. to 6 a.m., even if powered mechanical equipment is not being used. Statutes governing safety, health and welfare of workmen are given in Appendix E.

Land matters should be dealt with well in advance of the required date of commencement of investigations. For this purpose, the appropriate District Lands Office of the Lands Department, and, where appropriate, the relevant District Office, should be consulted, so as to

arrange for unhindered access for transporting equipment to site, and to enable work to be carried out on site. The land matters should include :

- (a) confirmation of land ownership and lot boundaries,
- (b) permission to enter into and to transport equipment through adjacent land,
- (c) permission to carry out ground investigation work outside the site boundaries,
- (d) allocation of any necessary works areas and storage areas.

It is important that the exact locations of site boundaries of private and Government land, and of allocated works areas and storage areas, should be ascertained from the appropriate District Lands Office. The appropriate District Survey Office of the same Department may also have to be consulted for information on delineation of the ground, especially in the New Territories where land demarcation has not been carried out to a high standard in the past.

The District Lands Office should also be consulted on matters relating to 'fung shui' and burial grounds.

Where trees need to be felled or removed, prior permission should be obtained from the appropriate District Lands Office, who will consult the Agriculture & Fisheries Department, Urban Services Department or Regional Services Department, as appropriate. Whenever possible, permission should be sought twelve months in advance, so that the root system of any tree suitable for transplanting may be prepared for the move.

The approval of the Buildings Ordinance Office, must be obtained for site investigation work that falls within the Mid-levels Scheduled Area. Plans showing the boundary of the Mid-levels Scheduled Area may be viewed in the Buildings Ordinance Office and the Geotechnical Engineering Office. Pumping test proposals for private developments must also be submitted to the Buildings Ordinance Office for approval.

Information on the as-built alignment of the Mass Transit Railway and its "protection boundary" may be obtained from the Mass Transit Railway Corporation, whose advice must be sought where the proposed ground investigation work falls within the protection boundary.

If it is necessary to excavate public roads, road excavation permits must be obtained from the Utilities Section of the Highways Department. Where the proposed ground investigation work may disrupt the use of public footpaths, streets or roads, including high speed roads, the Highways Department should be consulted.

In cases where it is necessary to discharge effluents into public drains or sewers, permission must first be obtained from the Drainage Services Department. The Environmental Protection Department must also be consulted where toxic effluents are involved.

If it is intended to use explosives, for example in a seismic survey, the prior permission of the Commissioner of Mines at the Civil Engineering Department must be obtained.

In the case of marine investigations, the Marine Department must be notified of the details of the proposals, so that notices to mariners can be issued. Special restrictions may be imposed by Director of Marine where works is to be carried out in close proximity to fairways, channels, typhoon shelter entrances, terminals and piers. There may be circumstances where contractors vessels will need to provide mooring arrangements outside typhoon shelters for their vessels during the passage of typhoons. Where investigations are proposed close to the runway of Kai Tak Airport, permission must first be obtained from the Civil Aviation Department. Similarly, permission must be obtained from the Mass Transit Railway Corporation, the Cross Harbour Tunnel Co. Ltd, the Water Supplies Department, or the various public utility companies, if investigations are proposed near submerged tunnels, pipelines or utilities.

Where the proposed ground investigation works fall within a gazetted historical site, permission must be obtained from the Antiquities & Monuments Office of the Government Secretariat before commencement of any work. The Antiquities & Monuments Office should also be consulted before any historical site is entered, even if it is not gazetted.

## A.9 References

Government of Hong Kong (1974). *Waterworks Ordinance (and Waterworks Regulations)*. *Laws of Hong Kong, Chapter 102, revised edition 1974*. Hong Kong Government Printer, 45 p. (Amended from time to time).

Government of Hong Kong (1981a). *Fire Services Ordinance (and Fire Services Regulation)*. *Laws of Hong Kong, Chapter 95, revised edition 1981*. Hong Kong Government Printer, 45 p. (Amended from time to time).

Government of Hong Kong (1981b). *Summary Offences Ordinance (and Subsidiary Legislation)*. *Laws of Hong Kong, Chapter 228, revised edition 1981*. Hong Kong Government Printer, 26 p. (Amended from time to time).

Government of Hong Kong (1983). *Dangerous Goods Ordinance (and Dangerous Goods Regulations)*. *Laws of Hong Kong, Chapter 295, revised edition 1983*. Hong Kong Government Printer, 278 p. (Amended from time to time).

Government of Hong Kong (1985). *Buildings Ordinance (and Building Regulations)*. *Laws of Hong Kong, Chapter 123, revised edition 1985*. Hong Kong Government Printer, 387 p. (Amended from time to time).

Appendix B  
Sources of Information

[Amd GG2/01/2017]

## Contents

	Page No.
Title Page	307
Contents	308
B.1 Generals	310
B.2 Slope-related Information Systems and Databases	310
B.2.1 Slope Information System (SIS)	310
B.2.2 Catalogue of Slopes	310
B.2.3 Slope Maintenance Responsibility Information System (SMRIS) Maintained by the Lands Department	310
B.2.4 Rainfall Database	311
B.2.5 Landslide Database	311
B.2.6 Enhanced Natural Terrain Landslide Inventory (ENTLI)	311
B.2.7 Boulder Field Inventory	311
B.2.8 Large Landslide Study	311
B.3 Topographical Maps, Plans and Aerial Photographs	312
B.3.1 Maps and Plans Produced by the Survey & Mapping Office	312
B.3.2 Other Maps	312
B.3.3 Aerial Photographs	313
B.4 Geological and Related Maps and Memoirs	313
B.4.1 Geological Maps and Memoirs	313
B.4.2 Terrain Classification and Engineering Geology Maps	313
B.4.3 Other Geological Records and Information	314
B.5 Nautical Charts and Marine Department Notices	314
B.6 Meteorological, Seismological and Tidal Information	314
B.7 Hydrological Information	315
B.8 Past Records	315
B.8.1 Records from Previous Investigations	315
B.8.2 Design and Construction Records	315

	Page No.
B.8.3 Hong Kong Rainfall and Landslide Studies	316
B.8.4 Slope Maintenance Records	317
B.8.5 Other Public Records	317
B.9 Notes and Circulars Related to Ground Investigation Works	317
B.10 Scheduled and Designated Areas and Other Concerned Areas	318
B.10.1 Mid-levels Scheduled Area	318
B.10.2 North-western New Territories and Ma On Shan Areas	318
B.10.3 Mass Transit Railway Areas	318
B.10.4 Sewage Tunnel Protection Areas	319
B.10.5 Designated Area of Northshore Lantau	319
B.10.6 Water Gathering Grounds (WGG)	319
B.10.7 Marine Ground Investigation in Difficult Ground Areas	320
B.11 Services and Utilities	320
B.12 Local Libraries	320
B.12.1 The Civil Engineering Library and the Geotechnical Information Unit	320
B.12.2 Other Libraries	321
B.13 Addresses of Local Organizations	322
B.14 References	325

## **B.1 Generals**

This document gives important sources of information for the planning of site investigation in Hong Kong, in addition to the publications and guidance documents prepared by the GEO. A complete list of GEO publications and a list of TGNs, which are continually updated, can be found at the website <http://www.cedd.gov.hk>. Other information that could be useful for planning, design, construction and maintenance of geotechnical works can be found at the Hong Kong Slope Safety Website <http://hkss.cedd.gov.hk>.

## **B.2 Slope-related Information Systems and Databases**

### **B.2.1 Slope Information System (SIS)**

The SIS is a geographical information system developed by the GEO to enable on-line examination and analysis of information on slopes and the surrounding ground. It contains computerised information including the catalogue of slopes (see Section B.2.2 below), slope maps, locations of previous landslide incidents reported to GEO and ground investigation stations, geology, natural terrain landslides and selected geotechnical information for the various districts in Hong Kong. The SIS can be accessed through the SIS terminals in the Civil Engineering and Development Building and also via the Hong Kong Slope Safety Website (<http://hkss.cedd.gov.hk>). The GEO Slope Safety Division can be contacted for up-to-date information on the development of the SIS.

### **B.2.2 Catalogue of Slopes**

The Catalogue of Slopes contains information on physical properties, conditions and histories of over 57,000 sizeable man-made slopes in Hong Kong (e.g. slope type, slope geometry, type of surface protection, signs of seepage, movements and previous failures). Information on slopes in the Catalogue can be retrieved from SIS terminals in the Civil Engineering and Development Building, via the Hong Kong Slope Safety Website (<http://hkss.cedd.gov.hk>), or by application in writing to the GEO Slope Safety Division.

### **B.2.3 Slope Maintenance Responsibility Information System (SMRIS) Maintained by the Lands Department**

The SMRIS, which is maintained by the Lands Department, systematically identifies the maintenance responsibility of all man-made slopes registered in the Catalogue of Slopes. The most up-to-date information of maintenance responsibility can be accessed via the Lands Department or at the Lands Department's Website (<http://www.landsd.gov.hk>). Where the land status of a slope is not available in SMRIS, the Systematic Identification of Maintenance Responsibility of Slopes (SIMAR) Unit or the respective DLO of Lands Department should be consulted.

#### **B.2.4 Rainfall Database**

The GEO in collaboration with the Hong Kong Observatory (HKO) has established and maintains a network of automatic raingauges throughout Hong Kong. Rainfall data have been recorded at 5-minute intervals at these raingauges since 1984. In 1999, the GEO automatic rain gauge system was upgraded and expanded to include 86 GEO raingauges (Pang et al, 2000). Verified rainfall data are available either from the HKO or the GEO Standards and Testing Division.

#### **B.2.5 Landslide Database**

An Incident Report contains information on the date, time (where known) and location of the incident, the type, size, possible causes contributing to and consequence of the failure, the advice given, evidence of past instabilities, photographs taken of the failure, etc. If the failure mass exceeds 50 m<sup>3</sup> or where a fatality is involved, a Landslip Card, which contains more detailed information, is also prepared and is available for inspection in the Public Section of the Civil Engineering Library (CEL) (Section B.12.1). A computerised landslide database containing data from the Incident Reports and Landslip Cards is available and is accessible via the SIS. The database is maintained and updated by the GEO Landslip Preventive Measures Division 1.

#### **B.2.6 Enhanced Natural Terrain Landslide Inventory (ENTLI)**

The ENTLI contains information on over 105,000 landslides occurred on natural terrain. Comprehensive information is recorded in Geographical Information System for each landslide record including the dates of the aerial photographs when the landslide was first observed, width and length of the landslide scar, slope gradient, and nature of vegetation cover across the landslide source. The ENTLI is available for inspection as 1:5 000 scale map sheet paper copies in the CEL and the digital copy of the data is held in the GEO Planning Division.

#### **B.2.7 Boulder Field Inventory**

A series of fifteen 1:20 000 scale boulder field inventory maps covering the Hong Kong Special Administrative Region (HKSAR) is available for viewing in GEO Planning Division and the CEL and a digitised version is available in the SIS. A multiple attribute mapping technique was adopted to present the results. Four attributes were mapped—percentage area covered by boulders, boulder type, boulder size and boulder shape.

#### **B.2.8 Large Landslide Study**

In this study, covering the whole of Hong Kong, a geomorphological interpretation was conducted to identify features thought to be landslides with source areas greater than 20 m wide (Scott Wilson (Hong Kong) Ltd., 1999a, 1999b). The 1:5 000 scale maps containing the features are available for viewing in the GEO Planning Division.



### **B.3 Topographical Maps, Plans and Aerial Photographs**

#### **B.3.1 Maps and Plans Produced by the Survey & Mapping Office**

The Survey & Mapping Office (SMO) of the Lands Department provides maps and plans in various scales and for various purposes in both digital and paper forms. A list of the currently available plans and maps, and their coverage, is given in Table B1.

The Land Information Centre of the SMO operates a Computerised Land Information System (CLIS) and maintains the topographic mapping database covering the whole territory of Hong Kong. Many utility companies, engineering consultants, computing system consultants and education institutes have established their own automated mapping, facilities management, customer support and geographic information systems using the digital maps provided by the SMO as their common reference. The digital map data are available in four different formats, namely E00, DGN, DXF and DWG, to suit applications in different platforms.

Services offered by the SMO include the supply of photographic copies of available maps, plans and aerial photographs, as well as producing enlargements and reductions. Updated information on map products and related publications, data map products and map price catalogue, etc., can also be found at the Lands Department Website (<http://www.landsd.gov.hk/mapping/en/pro&ser/products.htm>).

#### **B.3.2 Other Maps**

Other map sources include the following:

- (a) Early maps of Hong Kong are held for reference by the Survey & Mapping Office and the Government Records Service (GRS).
- (b) The Antiquities and Monuments Office (AMO) of Leisure and Cultural Services Department (LCSD) holds research files covering declared monuments, historic buildings, structures and boundaries of archaeological sites. Most of these research materials can be accessed by the public in AMO by appointment. Declared monuments, historic buildings, structures and boundaries of archaeological sites may also be indicated in non-statutory plans which are available for sale in the Map Publications Centres of the Survey & Mapping Office of the Lands Department (Section B.3.1).

### **B.3.3 Aerial Photographs**

The availability of vertical aerial photographs is summarised in Tables B.2a and B.2b. In general the aerial photograph scales range from 1:2 500 down to 1:50 000. The low altitude aerial photographs, mainly in the range of 1:6 000 to 1:10 000, are the most useful scale for the majority of aerial photograph interpretation undertaken.

The GEO Aerial Photograph Library contains over 280,000 aerial photographs including oblique aerial photographs. They can be borrowed by GEO staff as well as consultants working on Government projects. A GIS-based computerised aerial photograph retrieval system is now available for users to identify the photograph collection at a workstation in the Library. The Library, which is housed in the GEO Planning Division on the 11th Floor of the Civil Engineering and Development Building, is accessible by staff of the HKSAR Government and also non-Government staff engaged in Government projects.

A similar system for searching aerial photographs is also available in the SIS.

Aerial photographs can be purchased directly from the Map Publications Centres of the Lands Department.

## **B.4 Geological and Related Maps and Memoirs**

### **B.4.1 Geological Maps and Memoirs**

Geological surveying in Hong Kong is carried out by the Hong Kong Geological Survey (HKGS) of the GEO. Thirty-four maps and six sheet reports have been published to date and the Sheet Reports are available (free of charge) either from the GEO Planning Division or downloaded from the CEDD Website (<http://www.cedd.gov.hk>). In 2003, the HKGS embarked on a programme to update the 1:20 000 scale geological maps and to release them in digital form. The coverage of the maps, memoirs and reports is shown in Figure B1. The maps and memoirs (except those which are free of charge) can be obtained from the Map Publications Centres of the Survey and Mapping Office while the memoirs are also available from the online Government Bookstore at <http://www.bookstore.gov.hk>.

### **B.4.2 Terrain Classification and Engineering Geology Maps**

A series of eleven 1:20 000 scale terrain classification maps (TCM) covering the whole of the HKSAR was produced by the GEO in the 1980s. Each map covers an irregular area based on catchment boundaries. Derivative maps and accompanying reports have been published for each area as the Geotechnical Area Studies Programme (GASP) series. The series contains 12 volumes, of which Volume XII is a summary report for the whole of the HKSAR. They are available for viewing in the Geotechnical Information Unit (GIU) of the CEL. Limited copies are available for sale at the Map Publications Centres of the Survey and Mapping Office, and online Government Bookstore.

Nine catchments with extensive colluvial deposits were also identified for GAS mapping at 1:2 500 scale. These maps contain details of old landslide scars. In 1990, a 1:5 000 scale

terrain classification mapping exercise was carried out for eleven 1:5 000 scale map sheets in North Lantau. These are available for viewing in the CEL and have been incorporated into three Engineering Geology Reports on the North Lantau Area (Franks, 1991, 1992; Woods, 1992).

### **B.4.3 Other Geological Records and Information**

The GEO Planning Division is the repository for geological records for the HKSAR. These include the field observations embodied in the geological maps and memoirs, manuscript geological maps, and offshore data. Requests for information should be directed to the Chief Geotechnical Engineer of the Planning Division. The GEO also holds a collection of representative rock types and thin sections. These are available for inspection by arrangement. An on-line version of the geology of Hong Kong, based on the two memoirs but with additions from the current map updating programme now underway, has been published on the internet (Lee & Sewell, 2007). The on-line geological memoir of Hong Kong can be accessed at [http://www.cedd.gov.hk/eng/about/organisation/org\\_geo\\_pln\\_map.htm](http://www.cedd.gov.hk/eng/about/organisation/org_geo_pln_map.htm). A summary of the nature and occurrence of Hong Kong rocks and superficial deposits is also given in Appendix A of Geoguide 3 (GEO, 2017).

### **B.5 Nautical Charts and Marine Department Notices**

The Hydrographic Office of the Marine Department compiles and publishes paper charts and electronic navigational charts. Further information on the products and services of the Hydrographic Office can be found at the website <http://www.mardep.gov.hk>.

Marine Department Notices are issued as and when required concerning information relating to navigational safety and other marine activities in Hong Kong waters. Copies of the Notices can be downloaded from the website <http://www.mardep.gov.hk>.

### **B.6 Meteorological, Seismological and Tidal Information**

The Hong Kong Observatory (HKO) collects and publishes meteorological information in Hong Kong. It issues daily weather reports and forecasts as well as warnings on tropical cyclone, thunderstorm, rainstorm, landslip, strong monsoon, fire danger, frost, tsunami, cold and very hot weather. Rainfall records are published monthly and annually. The HKO also maintains a local seismological network to monitor earthquakes near Hong Kong.

Predicted tide levels at selected locations are published annually in 'Tide Tables for Hong Kong' which are available at the online Government Bookstore.

Further information on the services of the HKO can be found at the website <http://www.hko.gov.hk>.

## **B.7 Hydrological Information**

The Drainage Services Department and Water Supplies Department operate and maintain separate systems of stream/river gauging stations in the main catchment areas of the HKSAR.

## **B.8 Past Records**

### **B.8.1 Records from Previous Investigations**

The GIU of the GEO holds reports of previous ground investigation, which usually include borehole logs and sometimes results from geophysical surveys and laboratory testing of soils, rocks and sediments. Digital Geotechnical Information Unit (DGIU) system is also available for fast retrieval of these reports in the CEL.

The GIU also contains a large amount of other information of direct relevance to site investigation, and this is described in Section B.12.1.

### **B.8.2 Design and Construction Records**

Several Government Departments possess information that is of value to the planning and execution of site investigation in Hong Kong, but this is often not readily accessible. However, arrangements can usually be made for specific information to be made available to bona fide users.

For example, each Government Department retains its own files on projects that are carried out under its control. Copies of design reports and record drawings of completed projects are also kept.

A brief summary of information possessed by some of the Government Departments is given below:

Department	Record/Information
Architectural Services Department	Records of Government buildings
Buildings Department	Building plans and related documents of existing buildings in Hong Kong (except for pre-war buildings and New Territories Exempted Houses). These documents may be available for viewing by the public in the Buildings Department upon application.
Environmental Infrastructure Division of the Environmental Protection Department	Records of known landfills
Civil Engineering Library	Plans showing the locations of disused tunnels
Drainage Services Department	Records of sewerage tunnels (see also Section B.10.4)
Geotechnical Engineering Office of the Civil and Engineering and Development Department	<p>Landslip Preventive Measures study reports, information on slopes and records of all known disused tunnels and quarries. Catalogue of Hong Kong Tunnels and Catalogue of Notable Tunnel Failure Case Histories. The Catalogues can be accessed at the CEDD Website</p> <p><a href="http://www.cedd.gov.hk/eng/publications/reference/doc/HK%20Tunnel%20Cat.pdf">http://www.cedd.gov.hk/eng/publications/reference/doc/HK%20Tunnel%20Cat.pdf</a> and</p> <p><a href="http://www.cedd.gov.hk/eng/publications/reference/doc/HK%20NotableTunnel%20Cat.pdf">http://www.cedd.gov.hk/eng/publications/reference/doc/HK%20NotableTunnel%20Cat.pdf</a></p> <p>(Designers should obtain the design and construction details of such tunnels from the relevant owners and maintenance agents.)</p>
Water Supplies Department	Record of water tunnels, water mains, catchwaters, impounding reservoirs, service reservoirs, water treatment works, pumping stations, and ancillary structures.

### B.8.3 Hong Kong Rainfall and Landslide Studies

Since 1984, the GEO has compiled annual reports to document information on rainfall and landslides occurring in the HKSAR. GEO has also prepared detailed/forensic investigation reports on some selected major landslide incidents and incidents involving casualties. Since 1997, GEO has started engaging consultants to carry out investigation of some selected landslides and to prepare landslide study reports. The annual reports, detailed/forensic investigation reports and landslide study reports are either published as GEO Reports or produced as GEO internal reports. GEO Reports can be purchased from the online Government Bookstore or downloaded from the CEDD Website <http://www.cedd.gov.hk>.

GEO internal reports can be viewed in the CEL. Summary of findings of selected landslide studies are also uploaded onto the Hong Kong Slope Safety Website <http://hkss.cedd.gov.hk> for viewing.

#### **B.8.4 Slope Maintenance Records**

Slope maintenance records (e.g. maintenance manuals, records of slope upgrading, records of routine maintenance and Engineer Inspections, records of monitoring of special measures such as permanent prestressed ground anchors and designed horizontal drains) are kept by the slope owners or their maintenance agents (GEO, 2003).

#### **B.8.5 Other Public Records**

The GRS is the central repository for the permanent archives and selected official publications of the HKSAR Government. It maintains catalogued collections of maps and photographs dating from 1860, together with almost complete collections of the Hong Kong Government Gazette, Blue Books, Sessional Papers, Administrative Reports, Historical & Statistical Abstracts of Hong Kong, Legislative Council Minutes, Annual Departmental Reports, Ordinances and Regulations, Hong Kong Hansard and a comprehensive newspaper collection. In November 2002, GRS introduced an integrated information access system to facilitate online searching of all catalogues and access to selected visual images via the Internet. ([http://www.grs.gov.hk/ws/english/es\\_online\\_cata.htm](http://www.grs.gov.hk/ws/english/es_online_cata.htm))

The Photo Library of the Information Services Department has in place some old photographs which may be reproduced for use by members of the public.

Lists of declared monuments and deemed monuments as well as archaeological sites are maintained by the Antiquities & Monuments Office (AMO) of the Leisure and Cultural Services Department (see also Section B.3.2).

### **B.9 Notes and Circulars Related to Ground Investigation Works**

For private development, the general requirements for carrying out ground investigation works, including the site supervision requirements, are given in PNAP APP-49 which can be downloaded from Buildings Department Website <http://www.bd.gov.hk>. For public development, the requirements are given in WBTC No. 13/90. Ground Investigation Note No. 1/2008, which can be downloaded from CEDD Website <http://www.cedd.gov.hk> gives the details of procurement of ground investigation and laboratory testing services provided by CEDD for Government projects. Guidance on specific aspects of site investigation for tunnel works in Hong Kong are given in Sections 10.9, 16.5 and 40.4 of this Geoguide.

## **B.10 Scheduled and Designated Areas and Other Concerned Areas**

### **B.10.1 Mid-levels Scheduled Area**

Ground investigation works in scheduled areas, including the Mid-levels Scheduled Area, are subject to special geotechnical control under the Buildings Ordinance. The Mid-levels Scheduled Area is specified as Area Number 1 of the Scheduled Areas in the Fifth Schedule of the Buildings Ordinance. A plan showing the boundary of the Mid-levels Scheduled Area is on display in Buildings Department and in the GIU of the CEL.

The Mid-levels Consultants' study was summarised in a report entitled "Mid-levels Study: Report on Geology, Hydrology and Soil Properties" (GCO, 1982). The report is available for sale at the online Government Bookstore. All factual data on geology, hydrology and soil properties collected in the course of the Mid-levels Study between 1979 and 1981 are available for inspection in the GIU.

For private development, the requirements on the special geotechnical control for ground investigation works in the Mid-levels Scheduled Area are given in PNAP APP-30. For public development, the requirements are specified in ETWB TC (Works) No. 29/2002A.

### **B.10.2 North-western New Territories and Ma On Shan Areas**

The designated areas in North-western New Territories and Ma On Shan are specified as Area Numbers 2 and 4 respectively of the Scheduled Areas in the Fifth Schedule of the Buildings Ordinance. The plans illustrating the exact extent of these Areas are on display in the Buildings Department and in the GIU.

Considerable information exists on the geology of the Scheduled Areas. Twenty 1:5 000 Geological Map sheets, together with the Hong Kong Geological Survey Sheet Report No. 1 - Geology of Yuen Long, covers Area Number 2. Scheduled Area 4 is covered by 1:5 000 Geological Map Sheets 7-NE-C and 7-NE-D, together with a report on the geology. These can be obtained from the GEO Planning Division.

For private development, the requirements on the special geotechnical control for ground investigation works in these Scheduled Areas are given in PNAP APP-61. For public development, the requirements are specified in ETWB TC (Works) No. 4/2004.

### **B.10.3 Mass Transit Railway Areas**

To safeguard the safety and stability of the Mass Transit Railway (MTR) structures operated and maintained by the MTR Corporation Limited (MTRCL), a "protection boundary" for the railways has been drawn on plans or determined by a figure and a set of building/engineering guidelines produced. The areas within the "protection boundary" are commonly known as the railway protection areas.

The MTR operates a network of railways. Amongst the railway protection areas, some areas are designated as Scheduled Area No. 3 in the Fifth Schedule of the Buildings Ordinance

(Scheduled Area No. 3). The areas within the “protection boundary” have been designated as Scheduled Area No. 3. The plans illustrating the extent of these areas are available for inspection in the Buildings Department (BD) and the MTRCL. Information on the “alignment of the railways as constructed” may be obtained direct from MTRCL. For private development, the additional requirements for ground investigation works within Scheduled Area No. 3 are given in PNAP APP-24 and PNAP APP-131. WB Technical Circular No. 19/2002, ETWB Technical Circular (Works) Nos. 33/2003 and 2/2005 shall be referred to for guidance on ground investigation works near the MTR and liaison with the Railway Protection & Land Survey Manager of the MTRCL.

The Survey and Mapping Office of Lands Department maintains a set of digital land records covering the whole territory of Hong Kong. Useful information, e.g. lot boundaries, the railway reserves and others, is recorded in this database.

#### **B.10.4 Sewage Tunnel Protection Areas**

The sewage tunnel protection areas are designated as Area Number 5 of the Scheduled Areas in the Fifth Schedule of the Buildings Ordinance (Scheduled Area No. 5). The plans illustrating the extent of these areas are available for inspection in the Buildings Department and the Drainage Services Department. For private development, the additional requirements for ground investigation work within Scheduled Area No. 5 are given in PNAP APP-62. For ground investigation works proposals of Government Departments in the vicinity of the sewage tunnels, the project proponents shall refer to ETWB Technical Circular (Works) No. 28/2003 for the procedures for forwarding proposals to Drainage Services Department and GEO for comment/agreement.

#### **B.10.5 Designated Area of Northshore Lantau**

The Designated Area is underlain by locally complex geological conditions that require due attention to be given to the potential problems associated with high-rise buildings and other structures involving deep foundations. Technical recommendations and the plan illustrating the exact extent of the area are given in GEO TGN No. 12.

For private development, administrative procedures and general guidance for ground investigation work in the Designated Area are given in PNAP APP-134. For public development, the requirements are specified in ETWB TC(W) No. 4/2004.

#### **B.10.6 Water Gathering Grounds (WGG)**

Information on the limits of the WGG and the required conditions for protection of the WGG against pollution should be obtained from the relevant regional office of the Water Supplies Department. Maps showing WGG are also held by the relevant District Lands Offices of the Lands Department.



### **B.10.7 Marine Ground Investigation in Difficult Ground Areas**

Difficult ground conditions generally refer to the existence of unfavourable subsoil strata on site. Technical guidelines on the areas and the plan illustrating the extent of the areas are given in Port Works Design Manual issued by CEDD.

### **B.11 Services and Utilities**

Information on gas, electricity, telephone, cable television and similar services, including both the locations and details of existing facilities and the provision of further services, should be sought from the private companies supplying these services (see local telephone directories or the Yellow Pages for their latest addresses and telephone numbers).

Information on the locations of water mains, water tunnels, reservoirs and other waterwork facilities maintained by the Water Supplies Department (WSD) should be sought from the Department. Application forms and further information on the customer services of the WSD can be found at the website <http://www.wsd.gov.hk>.

As-built records of public stormwater drains and foul sewers should be sought from the Drainage Services Department (DSD). Similar records for private lots can be obtained from the Buildings Department. As-built records of exclusive road drainage should be sought from the Highways Department.

Tentative limits of allowable settlement, groundwater drawdown and vibration may be obtained from DSD, WSD, public corporations and private utility undertakers.

### **B.12 Local Libraries**

#### **B.12.1 The Civil Engineering Library and the Geotechnical Information Unit**

The CEL is the central reference library of the Civil Engineering and Development Department. The CEL contains over 150,000 documents, including periodicals, books, conference proceedings, manuals, standards, codes of practice, geotechnical reports, maps, documents submitted to GEO in support of private developments, and documents produced by or for Government Departments.

The GIU forms part of the CEL and comprises a collection of geotechnical data from ground investigations throughout the HKSAR. The following GIU materials are among those available for inspection within the Public Section of the CEL.

- (a) ground investigation and geophysical survey reports;
- (b) reports on the laboratory testing of soil and rock;
- (c) Landslip Cards;
- (d) piezometer monitoring data; and

(e) an inventory of natural terrain landslides.

The Bibliography on the Geology and Geotechnical Engineering of Hong Kong, produced by the GEO, lists more than 4,600 items that are known to have been published specifically on aspects of the geology and geotechnical engineering of Hong Kong. The Bibliography can be found under the Publications Section of the CEDD Website <http://www.cedd.gov.hk/eng/publications/reference/index.htm>.

Members of the public are free to view documents held within the Public Section of the CEL and search for library materials using the Online Public Access Catalogue (OPAC) – V Lib computer terminals. Retrieval of ground investigation and laboratory testing reports can be accessed by the Digital Geotechnical Information Unit (DGIU) system. A user's manual for DGIU is provided in the CEL. Photocopying and printing facilities are available.

Further information on the services of the CEL and GIU can be found under the Public Services Section of the CEDD Website <http://www.cedd.gov.hk/eng/services/library/index.htm>.

### **B.12.2 Other Libraries**

The City Hall Public Library, the Hong Kong Central Library and the Kowloon Public Library each houses a reference section which contains a number of published documents on the geology and geotechnical engineering of Hong Kong, together with some unpublished reports. They also house Hong Kong Collections of considerable interest. Direct access is permitted to the shelved items, and bibliographic information of the items can be accessed through the Online Public Access Catalogue. Photocopying facilities are available for public use.

The University of Hong Kong, the Chinese University of Hong Kong, the Hong Kong Polytechnic University, the Hong Kong University of Science and Technology and the City University of Hong Kong each has a large library which contains a collection of general geological and geotechnical information. The first three, however, can only be accessed by special permission, although for bona fide visitors this is usually not difficult to obtain. The University of Hong Kong maintains the Hong Kong Collection, which contains considerable unpublished information, as well as master and doctoral degree theses on geological and geotechnical topics.

### B.13 Addresses of Local Organizations

Antiquities and Monuments Office,  
Leisure and Cultural Services Department,  
136 Nathan Road, Tsim Sha Tsui, Kowloon.  
(Tel.: 2721 2326)  
(Website: <http://www.amo.gov.hk>)

Buildings Department,  
12th-18th Floors and 21st to 22nd Floors  
Pioneer Centre, 750 Nathan Road, Kowloon.  
(Tel.: 2626 1616)  
(Website: <http://www.bd.gov.hk>)

Chinese University of Hong Kong Library,  
122 Milestone, Tai Po Road,  
Sha Tin, New Territories.  
(Tel.: 2609 7301)  
(Website: <http://www.lib.cuhk.edu.hk>)

Civil Engineering Office,  
Civil Engineering and Development  
Department,  
Civil Engineering and Development Building,  
101 Princess Margaret Road,  
Homantin, Kowloon.  
(Tel.: 2762 5111)  
(Website: <http://www.cedd.gov.hk>)

Drainage Services Department,  
43rd Floor, Revenue Tower,  
5 Gloucester Road,  
Wan Chai, Hong Kong.  
(Tel.: 2877 0660)  
(Website: <http://www.dsd.gov.hk>)

Government Record Service,  
Hong Kong Public Record Building,  
13 Tsui Ping Road,  
Kwun Tong, Kowloon,  
(Tel: 2195 7801)  
(Website: <http://www.grs.gov.hk>)

Architectural Services Department,  
Queensway Government Offices,  
66 Queensway, Hong Kong.  
(Tel.: 2867 3628)  
(Website: <http://www.archsd.gov.hk>)

City Hall Public Library,  
City Hall High Block,  
Edinburgh Place, Hong Kong.  
(Tel.: 2921 2672)  
(Website: <http://www.hkpl.gov.hk>)

City University of Hong Kong,  
Run Run Shaw Library,  
Tat Chee Avenue, Kowloon.  
(Tel.: 2788 8311)  
(Website: <http://www.cityu.edu.hk>)

District Lands Office,  
Lands Department,  
20th Floor, North Point Government  
Offices,  
333 Java Road, North Point,  
Hong Kong  
(Tel: 2525 6694)  
(Website: <http://www.landsd.gov.hk>)

Environmental Infrastructure Division,  
Environmental Protection Department,  
4/F, East Wing, Island West Transfer  
Station,  
88, Victoria Road,  
Kennedy Town, Hong Kong  
(Tel: 2872 1807)  
(Website: <http://www.epd.gov.hk>)

Geotechnical Engineering Office,  
Civil Engineering and Development  
Department,  
Civil Engineering and Department  
Building,  
101 Princess Margaret Road,  
Homantin, Kowloon.  
(Tel.: 2762 5111)  
(Website: <http://www.cedd.gov.hk>)

Geotechnical Information Unit,  
Civil Engineering Library, LG1, Civil  
Engineering and Development Building,  
101 Princess Margaret Road,  
Homantin, Kowloon.  
(Tel.: 2762 5148)  
(Email: librarian@cedd.gov.hk)

Highways Department,  
5th Floor, Homantin Government Offices,  
88 Chung Hau Street,  
Homantin, Kowloon.  
(Tel.: 2926 4111)  
(Website: <http://www.hyd.gov.hk>)

Hong Kong Central Library,  
55 Causeway Road, Hong Kong,  
(Tel: 2921 0222)  
(Website: <http://www.hkpl.gov.hk>)

Hong Kong Polytechnic University Library,  
Pao Yue-kong Library,  
Yuk Choi Road,  
Hung Hom, Kowloon.  
(Tel.: 2766 6863)  
(Website: <http://www.lib.polyu.edu.hk>)

Kowloon Public Library,  
5 Pui Ching Road,  
Homantin,  
Kowloon.  
(Tel.: 2926 4062)  
(Website: <http://www.hkpl.gov.hk>)

Lands Information Centre,  
Survey and Mapping Office,  
Lands Department,  
23rd Floor, North Point Government Offices,  
333 Java Road,  
North Point, Hong Kong,  
(Tel: 2231 3452)  
(Website: <http://www.landsd.gov.hk>)

Geotechnical Projects Division, GEO,  
23rd Floor, 410 Kwun Tong Road,  
Kwun Tong, Kowloon,  
(Tel: 2716 8612)  
(Email: anthonylam@cedd.gov.hk)

Hong Kong Observatory,  
134A Nathan Road,  
Tsim Sha Tsui,  
Kowloon.  
(Tel: 2926 8200)  
(Website: <http://www.hko.gov.hk>)

Hong Kong Geological Survey,  
Geotechnical Engineering Office,  
11th Floor, Civil Engineering and  
Development Building,  
101 Princess Margaret Road,  
Homantin, Kowloon,  
(Tel: 2762 5380)  
(Email: jsewell@cedd.gov.hk)

Hong Kong University of Science &  
Technology Library,  
Clear Water Bay,  
Kowloon.  
(Tel.: 2358 6762)  
(Website: <http://library.ust.hk>)

Lands Department,  
1st, 2nd, 6th, 18th to 24th Floors,  
North Point Government Offices,  
333 Java Road, North Point, Hong Kong.  
(Tel.: 2231 3294)  
(Website: <http://www.landsd.gov.hk>)

Landslip Preventive Measures Division 1,  
GEO, 1st Floor, Civil Engineering and  
Development Building,  
101 Princess Margaret Road,  
Homantin, Kowloon.  
(Tel.: 2760 5778)  
(E-mail: dominiclo@cedd.gov.hk)

Leisure and Cultural Services Department,  
1-3 Pai Tau Street,  
Sha Tin,  
New Territories.  
(Tel.: 2603 4567)  
(Website: <http://www.lcsd.gov.hk>)

Map Publications Centre (Kowloon),  
Survey and Mapping Office,  
Lands Department  
382 Nathan Road,  
Yau Ma Tei, Kowloon.  
(Tel.: 2780 0981)  
(E-mail: [smosale2@landsd.gov.hk](mailto:smosale2@landsd.gov.hk))

Mines Division, GEO,  
25th Floor, 410 Kwun Tong Road,  
Kwun Tong, Kowloon.  
(Tel.: 2716 8666)  
(E-mail: [mines@cedd.gov.hk](mailto:mines@cedd.gov.hk))

Online Geological Memoir  
(Website: [http://www.cedd.gov.hk/eng/about/organisation/org\\_geo\\_pln\\_map.htm](http://www.cedd.gov.hk/eng/about/organisation/org_geo_pln_map.htm))

Planning Division, GEO,  
11th Floor, Civil Engineering and Development  
Building,  
101 Princess Margaret Road,  
Homantin, Kowloon.  
(Tel.: 2762 5400)  
(E-mail: [tonyykho@cedd.gov.hk](mailto:tonyykho@cedd.gov.hk))

Slope Maintenance Responsibility Information  
Centre,  
Lands Department,  
1st Floor, North Point Government Offices,  
333, Java Road, North Point, Hong Kong.  
(Tel.: 2231 3333)  
(Website: <http://www.landsgov.hk>)

Map Publications Centre (Hong Kong),  
Survey and Mapping Office  
Lands Department  
23rd Floor, North Point Government  
Offices,  
333 Java Road, North Point, Hong Kong.  
(Tel.: 2231 3187)  
(E-mail: [smosale1@landsd.gov.hk](mailto:smosale1@landsd.gov.hk))

Marine Department,  
Harbour Building,  
38 Pier Road, Hong Kong.  
(Tel.: 2542 3711)  
(Website: <http://www.mardep.gov.hk>)

MTR Corporation Limited  
MTR Tower Telford Plaza,  
Kowloon Bay, Kowloon.  
(Tel.: 2993 2111)  
(Website: [http://www.mtr.com.hk/engtxt/airway/protection\\_index.html](http://www.mtr.com.hk/engtxt/airway/protection_index.html))

Online Government Bookstore,  
(Website: <http://www.bookstore.gov.hk>)

Publications Sales Unit,  
Information Services Department,  
Room 402, 4th Floor, Murray Building,  
Garden Road, Central, Hong Kong.  
(Tel.: 2537 1910)  
(Website: <http://www.isd.gov.hk>)

Slope Safety Division, GEO,  
7th Floor, Civil Engineering and  
Development Building,  
101 Princess Margaret Road,  
Homantin, Kowloon.  
(Tel.: 2760 5760)  
(Hong Kong Slope Safety Website:  
<http://hkss.cedd.gov.hk>)  
(E-mail: [hkss@cedd.gov.hk](mailto:hkss@cedd.gov.hk))

Standards and Testing Division, GEO,  
12th Floor, Civil Engineering and Development  
Building,  
101 Princess Margaret Road,  
Homantin, Kowloon.  
(Tel.: 2762 5345)  
(E-mail: [juliankwon@cedd.gov.hk](mailto:juliankwon@cedd.gov.hk))

The University of Hong Kong Library,  
Pokfulam Road,  
Hong Kong.  
(Tel.: 2859 2203)  
(Website: <http://lib.hku.hk>)

Water Supplies Department,  
48th, Floor, Immigration Tower,  
7 Gloucester Road,  
Wan Chai, Hong Kong.  
(Tel.: 2829 4500)  
(Website: <http://www.wsd.gov.hk>)

Waste Facilities Business Unit,  
Environmental Protection Department,  
4th Floor, West Wing, 88 Victoria Road,  
Kennedy Town, Hong Kong.  
(Tel.: 2872 1888)  
(Website: <http://www.epd.gov.hk>)

## B.14 References

- Allen, P.M. & Stephens, E.A. (1971). *Report on the Geological Survey of Hong Kong, 1967-1969*. Hong Kong Government Press, 116 p, plus 2 maps.
- Fyfe, J.A., Shaw, R., Campbell, S.D.G., Lai, K.W. & Kirk, P.A. (2000). *The Quaternary Geology of Hong Kong*. Geotechnical Engineering Office, Hong Kong, 208 p. plus 6 maps.
- Franks, C.A.M. (1991). *Engineering Geology of North Lantau: Tsing Chau Tsai Peninsula to Ta Pang Po (Special Project Report SPR 4/91)*. Geotechnical Engineering Office, Hong Kong, 148 p. plus 9 drgs.
- Franks, C.A.M. (1992). *Engineering Geology of North Lantau: Ta Pang Po to Tai Ho Wan (Special Project Report SPR 2/92)*. Geotechnical Engineering Office, Hong Kong, 109 p. plus 5 drgs.
- GCO (1982). *Mid-levels Study: Report on Geology, Hydrology and Soil Properties (1982)*. Geotechnical Control Office, Hong Kong, 265 p. plus 54 drgs.
- GEO (1998), *GEO Emergency Manual*, Geotechnical Engineering Office, Hong Kong (Amended from time to time)
- GEO (2003) *Guide to Slope Maintenance (Geoguide 5). (Third Edition)* Geotechnical Engineering Office, Hong Kong, 132 p
- GEO (2017). *Guide to Rock and Soil Descriptions (Geoguide 3)*. (Continuously Updated E-Version released on 29 August 2017). Geotechnical Engineering Office, Civil Engineering and Development Department, HKSAR Government, 171 p.
- King, J.P. (1999). *Natural Terrain Landslide Study, the Natural Terrain Landslide Inventory (GEO Report No. 74)*. Geotechnical Engineering Office, Hong Kong, 127 p.

- Lee, C.W. & Sewell, R.J. (2007). *On-line Geological Memoir of Hong Kong*. Episodes, vol. 30, no.1, 62 p.
- Pang, P.L.R., Evans, N.C., Lam, T.W.K., Au, D. & Man, K.S. (2000). Upgrading of an automatic raingauge system. *Proceedings of the Symposium on Slope Hazards and their Prevention*, Hong Kong, pp 297-302.
- Scott Wilson (Hong Kong) Ltd (1999a). *Specialist API Services for the Natural Terrain Landslide Study – Task B Factual Report*. Report to Geotechnical Engineering Office, Hong Kong, 9 p. plus 4 Appendices.
- Scott Wilson (Hong Kong) Ltd (1999b). *Specialist API Services for the Natural Terrain Landslide Study – Interpretive Report*. Report to Geotechnical Engineering Office, Hong Kong, 32 p. plus 6 Appendices.
- Sewell, R.J., Campbell, S.D.G., Fletcher, C.J.N., Lai, K.W. & Kirk, P.A. (2000). *The Pre-Quaternary Geology of Hong Kong*. Geotechnical Engineering Office, Hong Kong, 181 p. plus 4 maps
- Woods, N.W. (1992). *Engineering Geology of North Lantau: Tung Chung, Vol. I & II (Special Project Report SPR 1/93)*. Geotechnical Engineering Office, Hong Kong, 94 p. plus 8 drgs.

**Table B1 - Selected Maps, Plans and Aerial Photographs Available from the Lands Department**

Map/Plan	Coverage	Paper Map Products				Digital Map Products	
		Series No.	Size (mm)	No. of Sheets	Colour	Product Name	No. of Sheets
<b>Topographic Maps</b>							
1. 1:1 000	Full	HPIC	750 x 850	3254	B&W	B1000	3254
2. 1:5 000	Full	HP5C	750 x 850	166	B&W	B5000	189
3. 1:10 000 (Street Map)	Full	SM10C	685 x 980	59	B&W	B10000	57
4. 1:20 000	Full	HM20C	685 x 980	16	Colour	B20000	16
5. 1:50 000	Full	HM50CL	1010 x 690	2	Colour	N.A.	N.A.
6. 1:100 000	Full	HM100CL	655 x 850	1	Colour	N.A.	N.A.
7. 1:200 000	Full	HM200CL	327 x 425	1	Colour	N.A.	N.A.
8. 1:300 000 (Hong Kong in its regional setting)	As per title	HM300C	610 x 860	1	Colour	N.A.	N.A.
<b>Digital Orthophotos / Orthophoto Maps</b>							
1. 1:5 000	Full	N.A.	N.A.	N.A.	N.A.	DOP5000	189
2. 1:10 000	Full	N.A.	N.A.	N.A.	N.A.	DOP10000	55
3. 1:50 000	Full	OPM50	1080 x 1400	1	Colour	N.A.	N.A.
4. 1:100 000	Full	OPM100	600 x 770	1	Colour	N.A.	N.A.
Aerial Photos	Full#	N.A.	250 x 250	Numerous	B & W / Colour	DAP	numerous
<b>Geological Maps</b>							
1. 1:5 000*	Selective Areas	HGP5, 5A, 5B	760 x 1000	34	Colour	N.A.	N.A.
2. 1:20 000*	Full	HGM20 & 20S	775 x 1000	14 & 1	Colour	N.A.	N.A.
2a. 1:20 000	Full	HGM20	700 x 1000	1	Colour	N.A.	N.A.
3. 1:100 000	Full	HGM100	660 x 1000	1	Colour	N.A.	N.A.
Town Planning Plan by Planning Department	N.A.	471	Various	Various	B & W	N.A.	N.A.
Legend:							
* See Figure B1 for area coverage							
# See Table B2 for further details							

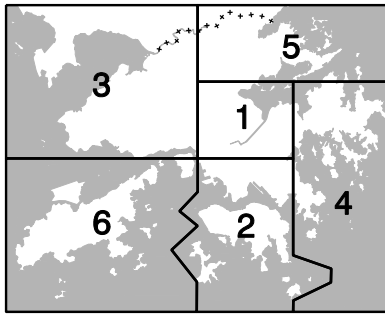


**Table B2 - Aerial Photographs Available from the Lands Department  
(Low Attitude Photographs) (Sheet 1 of 2)**

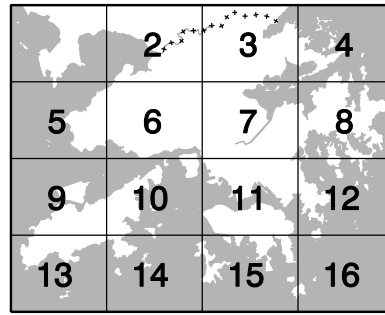
Year	Scale(s)	Approximate Coverage (%)			Remarks
		HKI	K	NT	
1924	Approx. 1:14 000	60	10	30	Medium to low resolution, single frames with incidental stereo overlap.
1945	1:12 000	95	60	95	Medium to good resolution. Almost all areas except east-west strip from Tuen Mun to Sai Kung.
1949	1:4 800 1:11 600	100	95	30	Good resolution. Excellent coverage of north-west New Territories. Good coverage of lowland areas.
1956 1959	1:10 000 1:13 300	10	50	5	Good resolution; some stereo overlap.
1961-1962	1:10 000	100	100	10	Good resolution; small relief exaggeration.
1963	NT = 1:7 800 HKI + K = 1:5 400	100	100	95	Excellent resolution, full stereo coverage. Coverage of all areas except Mai Po to Sha Tau Kok.
1964	1:3 600	5	5	10	Coverage of trunk roads.
1967	1:7 800 - 1:12 500	90	90	20	Coverage of main Urban Area only.
1968-1970	1:5 000 - 1:10 000	40	100	20	Coverage of Urban Areas.
1972	1:6 000 - 1:13 000	40	80	20	Coverage of trunk road.
1973	1:3 000 1:10 000 - 1:12 000	70 70	100 100	5 90	Urban Areas only. Most of HKSAR.
1974	1:5 000	10	70	30	Coverage of north-west and west New Territories.
1975	1:4 600 - 1:10 000	5	40	30	Coverage of north-west and west New Territories.
1976	1:2 000 - 1:8000	100	100	40	Coverage of Urban Areas and New Towns.
1977	1:2 800 - 1:8 000	100	100	50	Detailed coverage of north-west and north New Territories plus New Towns.
1978-1987	1:4 000 - 1:8 000	100	100	60	Annual coverage of Urban Areas including New Towns and lowland areas.
1988 to present	1:2 000 - 1:12 000	100	100	45-90	Annual coverage of New Territories varies from year to year.
Note: Colour aerial photographs have also been taken routinely since 1993.					

**Table B2 - Aerial Photographs Available from the Lands Department  
(High Altitude Photographs) (Sheet 2 of 2)**

Year	Scale(s)	Approximate Coverage (%)			Remarks
		HKI	K	NT	
1954	1:60 000	2	80	90	Good resolution.
1964	1:25 000	100	100	100	Excellent resolution. Mosaic of aerial photographs available. East to west flight lines, 4 to 5 km apart.
1973	1:25 000	100	100	90	Good resolution. East to west flight lines 3 to 5 km apart.
1974-1976	1:25 000	100	100	100	Good resolution. Annual coverage. East to west flight lines, 1 to 4 km apart.
1977	1:25 000	20		20	Obliques only of Urban Area. Coverage of Lantau, west New Territories and Sha Tin.
1978	1:25 000	100	100	100	Complete coverage.
1979	1:20 000	100	100	100	Complete coverage.
1980	1:20 000	100	80	20	Southern half of HKSAR only.
1981	1:20 000 1:50 000	100 80	100 80	100 10	Complete coverage. Urban Area and Lantau only.
1982	1:20 000	100	100	100	Complete coverage
1983	1:20 000 1:40 000	100 100	100 100	100 95	Complete coverage. Almost complete coverage.
1984	1:20 000	30	40	15	Coverage of Urban Area, Clearwater Bay and Sai Kung Peninsula.
1985	1:20000 1:30 000	100	100	100	Complete coverage
1986	1:20 000	100	100	100	Complete coverage.
1987	1:40 000	100	100	100	Complete coverage.
1988 – 1997*	1:20 000 - 1:40 000	100	100	100	Complete coverage.
1998 to present	1:16 000 - 1:40000	100	100	100	Complete coverage.
<p>Note: Colour aerial photographs have also been taken routinely since 1993. *Year 1996: only 1:20 000 available</p>					

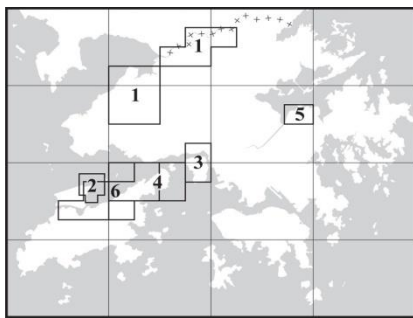


Geological Memoir Nos.

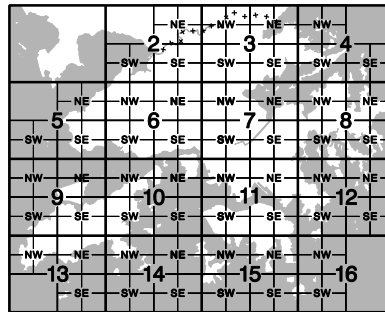


1:20 000 Map Sheet Nos.

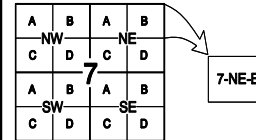
Geological Memoir Nos.	Area of Coverage	Map Coverage 1:20 000 Sheet Nos.
1	Sha Tin	7
2	Hong Kong Island and Kowloon	10, 11, 14, 15, 16
3	Western New Territories	2, 5, 6
4	Sai Kung and Clearwater Bay	8, 12, 16
5	Northeastern New Territories	3, 4
6	Lantau District	9, 10, 13, 14



Sheet Report Nos.



1:5 000 Map Sheet Nos.



Numbering System of  
1:5 000 Series

Sheet Report Nos.	Area of Coverage	Map Coverage 1:5 000 Sheet Nos.
1	Yuen Long - Scheduled Area No. 2	14 map sheets
2	Chek Lap Kok	9-NE-C and 9-NE-D
3	Tsing Yi and surrounding offshore area	6-SE-B and 10-NE-B,D
4	North Lantau Island and Ma Wan	10-NE-A,C, 10-NW-B,C,D, and 10-SW-A
5	Ma On Shan - Scheduled Area No. 4	7-NE-D and 7-NE-C
6	Tung Chung and Northshore Lantau Island	9-SE-A, 9-SE-B and 5 offshore part map sheets

**Figure B1 - Geological Maps, Memoirs and Sheet Reports**

Appendix C

Notes on Site Reconnaissance

**Contents**

	Page No.
Title Page	331
Contents	332
C.1 General	333
C.2 Preparatory Work	333
C.3 General Procedure	333
C.4 Information on Ground Conditions	334
C.5 Site Inspection Prior to Commencement of Ground Investigations	335

## C.1 General

The purpose of the site reconnaissance is to confirm and supplement the information collected during the desk study (see Section 4.2). The site reconnaissance may include both site inspection and local enquiries concerning existing and proposed features on and adjacent to the site.

Although site reconnaissance is normally carried out after completion of a thorough desk study (see Section 4.2 and Appendix A), an early site visit/reconnaissance preceding the desk study may sometimes be very useful.

## C.2 Preparatory Work

Prior to undertaking the site reconnaissance, the following preparations should be made :

- (a) Permission to gain access to the site should have been obtained from both the owner and occupier.
- (b) The site plan, topographic and geological maps and the necessary equipment should be available; for example, notebook, pencil, large clip board, camera, measuring tape, geological compass (compass and clinometer), geological hammer, penknife and hand lens (x10). For large sites, a range finder and binoculars may also be useful. Any equipment necessary to ensure the safety of field personnel should also be included.

## C.3 General Procedure

Where appropriate, the following procedure may be adopted :

- (a) The whole area should be traversed, preferably on foot, and photographs should be taken of selected features of the site and its surroundings.
- (b) The proposed location of work shown on plans should be set-out.
- (c) Differences and omissions on plans and maps (e.g. site boundaries, buildings, roads, etc.) should be recorded.
- (d) An inspection should be made of the details of all existing structures, and, where appropriate, records should be made.
- (e) Potential obstructions (e.g. transmission lines, telephone lines, historical features, large trees, gas and water pipes, electricity

cables and sewers) should be recorded.

- (f) Access, including the effects of construction traffic and heavy construction loads on existing roads, bridges and services, should be checked.
- (g) Water levels, direction and rate of flow in nullahs and streams, and also flood levels and tidal and other fluctuations, should be noted where relevant.
- (h) Features of the adjacent property should be recorded, and the likelihood of these being affected by proposed works should be assessed.
- (i) Old structures, and any other features, should be inspected and relevant records should be made.
- (j) Local inhabitants should be interviewed about the past uses of the site, structural damage to buildings on or near the site, flooding and land instability. Such information should be treated with due caution, but should be recorded and evaluated.

#### **C.4 Information on Ground Conditions**

Data on and relating to ground conditions should be gathered and recorded, as follows :

- (a) Surface features, both on site and nearby should be studied and recorded, preferably in conjunction with geological maps and aerial photographs. The following should be noted.
  - (i) Slope angles, types of slope (convex or concave) and sudden changes in slope.
  - (ii) Comparison of topography with previous map records or aerial photographs to check for the presence of erosion, cut slopes, fill or buried stream courses.
  - (iii) Surface features which may indicate geological faults, shear zones, previous slope instability or karst formation.
  - (iv) Positions and extent of tension cracks or other features which may indicate impending slope instability.
- (b) An inspection should be made of soil and rock outcrops and cut slope exposures, both on site and nearby. Relevant details should be recorded.

- (c) Where relevant, groundwater levels, positions of wells and springs, the occurrence of seepage, and any evidence of seepage erosion, including soil pipes and sinkholes, should be assessed and recorded.
- (d) The surface drainage pattern and any evidence of active soil erosion from surface water (e.g. gullies) should be noted.
- (e) The nature and distribution of vegetation on the site should be studied and noted; this information may provide an indication of soil and groundwater conditions.
- (f) The condition of embankments, buildings and other structures (e.g. tunnel portals and ventilation shafts) in the vicinity should be studied and recorded.
- (g) On extensive or more complex projects, a site reconnaissance survey should be carried out, followed by the production of engineering geological maps and/or plans and an evaluation of the terrain based on the underlying soils, vegetation cover, and other features (see Chapter 9). This type of mapping should be carried out with the assistance of an engineering geologist.

### **C.5 Site Inspection Prior to Commencement of Ground Investigations**

A supplementary site visit will often be necessary just prior to commencement of the actual ground investigations. Where appropriate, this should include the following activities :

- (a) The locations and conditions of access to the working sites should be inspected and recorded.
- (b) Obstructions, such as power cables, telephone lines, boundary fences and trenches, should be located and recorded.
- (c) Areas for sample storage should be identified.
- (d) Where applicable, suitable points of water supply and electricity supply should be located and recorded.



## Appendix D

### Information Required for Design and Construction

**Contents**

	Page No.
Title Page	336
Contents	337
D.1 General	338
D.2 Detailed Land Survey and Engineering Assessment	338
D.3 Hydrographic and Hydraulic Data	338
D.4 Influences of Weather	339
D.5 Material Sources	340
D.6 Disposal of Waste and Surplus Materials	340

## **D.1 General**

In addition to the determination of ground conditions at the site, which are considered elsewhere in this Geoguide, other information that may be required for design and construction is briefly summarised in the following sections.

The items listed in this Appendix are by no means exhaustive, and relevant guidance documents on the information requirements for design and construction should be consulted for additional advice. Time constraints may limit the extent of detailed study that can be given to the project, in which case allowance should be made in the design, e.g. by adopting conservative assumptions for design parameters.

## **D.2 Detailed Land Survey and Engineering Assessment**

A detailed survey of the site and its boundaries, showing means of access, utilities and services, easements and drainage networks, will be necessary. Survey coordinates should be referenced to the 1980 Hong Kong Metric Grid and levels to the Hong Kong Principal Datum. Exact locations of site boundaries should be ascertained from the appropriate District Lands Office (see Appendix A.8). The following may also be required :

- (a) Particulars of existing structures or obstructions, and whether they have to be demolished or maintained.
- (b) Particulars of adjacent or nearby structures that may be affected by works on the site, including building heights, floor levels, types of foundations, structural condition, and other pertinent information.
- (c) Particulars of adjacent slopes and retaining walls that may affect the site, including assessment of stability and details of any necessary support or remedial works. This assessment should include boulders that may pose a hazard to the site or the work.
- (d) Locations and depths of any underground obstructions or features, such as tunnels or cavities, where known, with supporting details.
- (e) Locations of survey markers and bench marks near the site, with accompanying details; documentation of site markers and bench marks.

## **D.3 Hydrographic and Hydraulic Data**

The design of structures in, adjoining or near the sea, nullahs or streams may require information on the following :

- (a) Marine survey data, to supplement the Admiralty charts and other available data.
- (b) Detailed information about nullah or stream flows, size and nature of catchment areas, tidal limits, flood levels and their relation to the Hong Kong Chart Datum.
- (c) Observations on tide levels (referred to Chart Datum) and the rate of tidal fluctuations, velocity and direction of currents, and wave data.
- (d) Information on scour and siltation, movement of foreshore material by drift; stability conditions of beaches, breakwaters and training works.
- (e) Locations and details of existing nullahs, streams and marine structures, wrecks and other obstructions above and below the water line; the effect of obstructions and floating debris on permanent and temporary works, including clearances of obstructions.
- (f) Observations on the condition of existing structures, such as attack by marine growth and borers, corrosion of metal work, disintegration of concrete and attrition by floating debris or bed movements.
- (g) Data on water quality.

#### **D.4 Influences of Weather**

Information on the following may be necessary :

- (a) Predictions of surface water flows and groundwater levels resulting from rainfall events with return periods of 10, 50 and 200 years, or from more extreme rainfall events.
- (b) Groundwater responses to major rainstorms, including projections or assessments of response to a one-in-ten year rainfall event.
- (c) Local wind speeds and wave heights generated during tropical cyclones.
- (d) Range of temperature, seasonal and diurnal.

## **D.5 Material Sources**

Sources of materials for construction may need to be located and proven, including:

- (a) fill and filter materials for earthworks and reclamation,
- (b) road base and surfacing materials,
- (c) concrete aggregates,
- (d) stone for building, pitching, or riprap,
- (e) water,
- (f) topsoil for landscaping.

## **D.6 Disposal of Waste and Surplus Materials**

Sites for disposal of wastes or surplus materials may need to be located, and methods of disposal resolved, for such materials as :

- (a) excavated soil and rock,
- (b) dredged materials,
- (c) building debris and construction wastes,
- (d) liquid wastes.

Access to controlled tips and public dumping areas must be determined, as well as transport requirements and environmental controls.

Appendix E  
Safety Precautions

**Contents**

	Page No.
Title Page	341
Contents	342
E.1 General	343
E.2 Safety Regulations	343
E.3 Services and Utilities	344
E.4 Work Disrupting Roads, Streets or Footpaths	344
E.5 References	345

## **E.1 General**

The prime factors required to ensure safe working conditions are supervision by a competent person and the engagement of a suitably experienced contractor who possesses adequate resources for the project in hand.

Emergency procedures should be decided at the commencement of a job. A first aid kit should be readily accessible, and should include items suited to the working conditions. Efficient communications with outside services (police, fire and hospital) should be established. Safety helmets, gloves, safety footwear, goggles and masks should always be worn when required.

Reference should always be made to relevant Ordinances and Safety Regulations, and to the British Standards and Codes of Practice for advice on the manufacture and use of equipment.

## **E.2 Safety Regulations**

A comprehensive set of regulations exists in Hong Kong governing the safety, health and welfare of personnel employed in construction works. For construction sites generally, the principal statutory requirements are given in the Factories and Industrial Undertaking Ordinance and its subsidiary Regulations (Government of Hong Kong, 1985), and the Construction Sites (Safety) Regulations (Government of Hong Kong, 1983a). These statutes cover general as well as specific areas of construction works, including :

- (a) Excavations, caissons and shafts, dealt with under Part VI of the Construction Sites (Safety) Regulations.
- (b) Construction sites situated on or adjacent to water, dealt with under Regulation 52A in Part VII of the Construction Sites (Safety) Regulations.
- (c) Use of lifting appliances and lifting gears, dealt with under Parts II, III and V of the Construction Sites (Safety) Regulations.
- (d) Working in the vicinity of cables, dealt with under Regulation 47 in Part VII of the Construction Sites (Safety) Regulations.

The use of explosives and compressed gas (for example, in seismic surveys) is dealt with under the Dangerous Goods Ordinance and its subsidiary Regulations (Government of Hong Kong, 1983b).

The use of equipment incorporating radioactive sources is dealt with under the Radiation Ordinance and its subsidiary Regulations (Government of Hong Kong, 1982). Such equipment should always be used fully in accordance with the manufacturers' recommendations.



Reference should also be made to the following publications :

- (a) A Guide to the Construction Sites (Safety) Regulations (Labour Department, 1985), which briefly sets out the provisions of the Construction Sites (Safety) Regulations and explains the law in simple language. This is designed so that, besides serving as a handy reference, it also serves as a check-list of matters requiring attention.
- (b) Reference Manual for Construction Sites Inspection Report (Labour Department, 1986), which contains most of the requirements that are necessary to maintain a favourable working environment for the workforce and to comply with the provisions of the Construction Sites (Safety) Regulations.
- (c) BS 8008: Safety Precautions and Procedures for the Construction and Descent of Machine-bored Shafts for Piling and Other Purposes (BSI, 2008). This describes the safety precautions that should be taken, the specific safety requirements for the equipment to be used, and the gas hazards which might be encountered in deep and large diameter boreholes. [Amd GG2/01/2017]
- (d) Guidance Notes on Hand-dug Caissons (HKIE, 1981), which deals with the safety and technical aspects of hand-dug caissons.

### **E.3 Services and Utilities**

In urban areas, significant hazards may be encountered from underground services such as electricity and gas. Particular attention should be paid to the hazards resulting from damage to high voltage power cables, gas pipelines and associated installations. Before any trial pits, probes or boreholes are commenced in areas where there may be underground services, hand-excavated inspection pits should be used to establish the presence or otherwise of all such services. Hand-operated power tools may be necessary in inspection pits to assist excavation through hard materials, but should be used with extreme care.

### **E.4 Works Disrupting Roads, Streets or Footpaths**

For works on or adjacent to public roads and pavements, the requirements of the Road Traffic (Traffic Control) Regulations (Government of Hong Kong, 1983c) must be complied with. Reference should also be made to the Code of Practice for the Lighting, Signing & Guarding of Road Works (Highways Office, 1984).

## E.5 References

[Amd GG2/01/2017]

BSI (2008). *Safety Precautions and Procedures for the Construction and Descent of Machine-bored Shafts for Piling and Other Purposes (BS 8008:1996+A1:2008)*. British Standards Institution, London, 20 p. [Amd GG2/01/2017]

Government of Hong Kong (1982). *Radiation Ordinance (and Radiation Regulations). Laws of Hong Kong, Chapter 303, revised edition 1982*. Hong Kong Government Printer, 47 p. (Amended from time to time).

Government of Hong Kong (1983a). *Construction Sites (Safety) Regulations. Laws of Hong Kong, Chapter 59, revised edition 1983*. Hong Kong Government Printer, 58 p. (Amended from time to time).

Government of Hong Kong (1983b). *Dangerous Goods Ordinance (and Dangerous Goods Regulations). Laws of Hong Kong, Chapter 295, revised edition 1983*. Hong Kong Government Printer, 278 p. (Amended from time to time).

Government of Hong Kong (1983c). *Road Traffic (Traffic Control) Regulations. Laws of Hong Kong, Chapter 374, revised edition 1983*. Hong Kong Government Printer, 134 p. (Amended from time to time).

Government of Hong Kong (1985). *Factories and Industrial Undertakings Ordinance (and Subsidiary Legislation). Laws of Hong Kong, Chapter 59, revised edition 1985*. Hong Kong Government Printer, 270 p. (Amended from time to time).

Highways Office (1984). *Code of Practice for the Lighting, Signing & Guarding of Road Works*. Hong Kong Government Printer, 41 p.

HKIE (1981). *Guidance Notes on Hand-dug Caissons*. Hong Kong Institution of Engineers, 15 p.

Labour Department (1985). *A Guide to the Construction Sites (Safety) Regulations*. Hong Kong Government Printer, 48 p.

Labour Department (1986). *Reference Manual for Construction Sites Inspection Report*. Hong Kong Government Printer, 24 p.

## Appendix F

### Supplementary Information on Ground Investigation Techniques

[Amd GG2/01/2017]

**Contents**

	Page No.
Title Page	346
Contents	347
F.1 Geophysics	348
F.2 Vertical and Inclined Boreholes	348
F.3 Horizontal Boreholes	348
F.4 Directional Coring Techniques	349
F.5 Other Aspects	349

## **F.1 Geophysics**

Non-invasive surveying methods using geophysics techniques are comparatively inexpensive compared with invasive ground investigation. Furthermore, they can often be completed within a short time, without major conflict over land use, and can cover large areas.

Magnetic surveys to identify faults have been successful in offshore areas in Hong Kong (Sewell et al, 2000 and references therein). Confirmatory boreholes and insitu testing should be carried out to verify the interpretation obtained from the survey.

Geophysical surveys do not provide direct measurement of engineering properties such as strength and permeability. They may not detect small-scale geological features. The interpretation and translation of the survey data into engineering geological information requires expertise and professional judgement.

## **F.2 Vertical and Inclined Boreholes**

Although vertical boreholes are the most commonly used method of ground investigation, the samples and logging obtained may only indicate very localised characteristics of the ground along a tunnel alignment.

Inclined boreholes may give comparatively more information along the tunnel alignment than vertical boreholes. Where the orientation of suspected subvertical fault zones or other significant geological features is known, targeting an inclined borehole in a direction roughly perpendicular to the feature may give a useful indication of the location, overall thickness and engineering properties of the feature.

The relative inclinations of the borehole and the feature being investigated govern the success of the inclined borehole. Faults in Hong Kong are commonly discontinuous and typically have variable dip, dip direction, width and weathering characteristics. These factors may affect the effectiveness of inclined boreholes.

## **F.3 Horizontal Boreholes**

Drilling of horizontal boreholes can be carried out either from the excavation face, an intermediate shaft or from the other end of the tunnel to investigate the ground conditions, in particular to check whether suspected features of poor ground are present and if so their nature and extent.

There are limitations to the maximum length that the horizontal borehole can be driven, depending on the ground conditions, the size of the hole and the power of the drilling rig. 'N' and 'H' size cores have been obtained from an 800 m long hole in Hong Kong.

Drilling of a horizontal borehole during the planning and design stage is often not feasible due to lack of access to the tunnel level; usually, for deep tunnels, the construction of vertical access shafts will not have commenced at this stage.

During the construction stage, drilling of horizontal boreholes from the tunnel face can affect the rate of progress of the excavation; hence alternative access points should be investigated and the cost-effectiveness of the operation needs to be carefully assessed in the light of the adequacy of ground data for the design and risk management.

#### **F.4 Directional Coring Techniques**

Directional coring techniques are now available to drill from ground level to great depth and then along a horizontal alignment. This method does not require provision of working space at the tunnel level and can be very useful for investigating deep tunnels.

These techniques could provide continuous information of the geological conditions along the alignment of a tunnel. In situ tests could also be carried out for assessing the actual conditions of the ground to be excavated. The information along the alignment would minimize uncertainty of the tunnel works and enhance the management of risks for the project.

There may be limitations as to the maximum depth and length that a directional corehole can reach as well as the type of core samples that can be taken and the type of geotechnical tests that can be performed. These matters, as well as drilling location accuracy, cost, mobilisation considerations and drilling rate should be examined as early as possible in a tunnel project.

#### **F.5 Other Aspects**

To avoid creating preferential flow paths and obstructions in the ground that could pose hazards to the tunnel excavation, for boreholes that are close to or intercept the tunnel, the person supervising the ground investigation should ensure that all metal casings are removed and the boreholes are properly grouted after completion of sampling and testing.

For long boreholes, probe holes and core holes, the position of which could impact on the design and construction, the specification should require the orientation (dip and dip direction) and the position of the holes to be checked regularly as drilling progresses to ensure that they follow the intended alignment.

## GEO PUBLICATIONS AND ORDERING INFORMATION

### 土力工程處刊物及訂購資料

An up-to-date full list of GEO publications can be found at the CEDD Website <http://www.cedd.gov.hk> on the Internet under "Publications". The following GEO publications can also be downloaded from the CEDD Website:

- i. Manuals, Guides and Specifications
- ii. GEO technical guidance notes
- iii. GEO reports
- iv. Geotechnical area studies programme
- v. Geological survey memoirs
- vi. Geological survey sheet reports

**Copies of some GEO publications (except geological maps and other publications which are free of charge) can be purchased either by:**

#### Writing to

Publications Sales Unit,  
Information Services Department,  
Room 626, 6th Floor,  
North Point Government Offices,  
333 Java Road, North Point, Hong Kong.

#### or

- Calling the Publications Sales Section of Information Services Department (ISD) at (852) 2537 1910
- Visiting the online Government Bookstore at <http://www.bookstore.gov.hk>
- Downloading the order form from the ISD website at <http://www.isd.gov.hk> and submitting the order online or by fax to (852) 2523 7195
- Placing order with ISD by e-mail at [puborder@isd.gov.hk](mailto:puborder@isd.gov.hk)

**1:100 000, 1:20 000 and 1:5 000 geological maps can be purchased from:**

Map Publications Centre/HK,  
Survey & Mapping Office, Lands Department,  
23th Floor, North Point Government Offices,  
333 Java Road, North Point, Hong Kong.  
Tel: (852) 2231 3187  
Fax: (852) 2116 0774

**Any enquires on GEO publications should be directed to:**

Chief Geotechnical Engineer/Standards and Testing,  
Geotechnical Engineering Office,  
Civil Engineering and Development Department,  
Civil Engineering and Development Building,  
101 Princess Margaret Road,  
Homantin, Kowloon, Hong Kong.  
Tel: (852) 2762 5365  
Fax: (852) 2714 0275  
E-mail: [mklo@cedd.gov.hk](mailto:mklo@cedd.gov.hk)

詳盡及最新的土力工程處刊物目錄，已登載於土木工程拓展署的互聯網網頁<http://www.cedd.gov.hk> 的“刊物”版面之內。以下的土力工程處刊物亦可於該網頁下載：

- i. 指南、指引及規格
- ii. 土力工程處技術指引
- iii. 土力工程處報告
- iv. 岩土工程地區研究計劃
- v. 地質研究報告
- vi. 地質調查圖表報告

**讀者可採用以下方法購買部分土力工程處刊物(地質圖及免費刊物除外):**

#### 書面訂購

香港北角渣華道333號  
北角政府合署6樓626室  
政府新聞處  
刊物銷售組

#### 或

- 致電政府新聞處刊物銷售小組訂購 (電話：(852) 2537 1910)
- 進入網上「政府書店」選購，網址為 <http://www.bookstore.gov.hk>
- 透過政府新聞處的網站 (<http://www.isd.gov.hk>) 於網上遞交訂購表格，或將表格傳真至刊物銷售小組 (傳真：(852) 2523 7195)
- 以電郵方式訂購 (電郵地址：[puborder@isd.gov.hk](mailto:puborder@isd.gov.hk))

**讀者可於下列地點購買1:100 000、1:20 000及1:5 000地質圖：**

香港北角渣華道333號  
北角政府合署23樓  
地政總署測繪處  
電話: (852) 2231 3187  
傳真: (852) 2116 0774

**如對本處刊物有任何查詢，請致函：**

香港九龍何文田公主道101號  
土木工程拓展署大樓  
土木工程拓展署  
土力工程處  
標準及測試部總土力工程師  
電話: (852) 2762 5365  
傳真: (852) 2714 0275  
電子郵件: [mklo@cedd.gov.hk](mailto:mklo@cedd.gov.hk)

