

BELL LABORATORIES
Record

January 1975

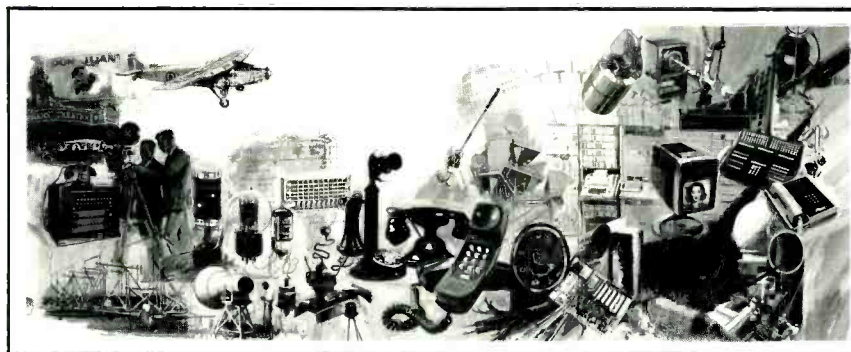

Bell Labs' First 50 Years: Prelude to Tomorrow



About the cover — In this artist's conception of achievements by Bell Labs since its founding in 1925, we see in the discoveries and techniques of the early years (back cover) the beginnings of our telephone system as we know it today and expect it to evolve (front cover and overleaf). Through the years, continuing developments have changed our ways of talking

with one another—shrinking the earth to a global village, bringing business associates and friends into our homes and offices, and exploding into a thousand new technologies that project us into the future. At Bell Laboratories we speak not of the "past" 50 years but of the "first" 50 years.

Editorial Board

Clifford A. Warren, *Chairman*
William D. Bulloch
Eugene I. Gordon
Joe H. Hunt, *AT&T Co.*
Ira Jacobs
Jack R. Logie, Jr.
William B. Macurdy
C. Kumar N. Patel
W. Eli Strich, *AT&T Co.*
Mark A. Townsend
Thomas L. Triolo

Editorial Staff

Donald L. Raymond, *Editor*
Alex M. Bobotis, *Managing Editor*
Lucy C. Carson, *Associate Editor*
William P. Shvidrik, *Associate Editor*
George F. Watson, *Associate Editor*
Jane C. Theberge, *Assistant Editor*
Francis E. Piellusch, *Art Editor*
Fred J. Schwetje, *Circulation*

THE BELL LABORATORIES RECORD

is published eleven times a year by Bell Telephone Laboratories, Incorporated, 600 Mountain Avenue, Murray Hill, N. J. 07974. W. O. Baker, President; F. C. Cheston, Secretary and Treasurer. Subscription: \$7.00 per year, plus \$1.00 foreign postage; single copies, \$1.00. Checks should be made payable to Bell Laboratories RECORD and addressed to the Circulation Manager. Printed in U.S.A. ©1974 by Bell Telephone Laboratories, Incorporated. Permission to reprint material from the RECORD may be obtained from the Editor.

Contents

● Introduction / p. 2

● The Network: Forging Nationwide Telephone Links / p. 4

William B. Macurdy and Alistair E. Ritchie

In a very real sense, the American telephone network constitutes a national resource. Composed of all the transmission and switching facilities connecting residential and business telephones in the United States, this network has been carefully planned, developed, and expanded over the years, so that today there exists a hierarchy of switching offices and interconnecting paths over which calls are routed automatically and efficiently. Today's network also offers direct nationwide dialing for almost all Bell System customers, automatic recording of billing information, and computerized collecting and analysis of network data.

● Alpha and Omega of the Network: Customer Products / p. 16

J. W. Schaefer

Where we are, how we got here, where we're going: This article surveys Bell Laboratories' role in the development of a line of customer products that spans PBXs, key telephone systems, data sets, residential sets—in fact, the full complement of equipment that the Bell System offers the public. The origins of these products, the reasons for bringing them into being, and a look at our plans for the future—for both the American business community and our residential customers—are interwoven into a pattern of commitment to ever-improving service.

● Switching / p. 30

Amos E. Joel, Jr.

Switching technology at Bell Labs has kept step with—and often anticipated—the needs of the American telecommunications network. Thus, the step-by-step system brought automatic switching to towns, the panel system brought automatic switching to large cities, and No. 4 ESS is bringing electronic switching to long-distance calls. This increasing technological sophistication reflects the growing demand for telephone services—a demand that is growing in kind as well as in quantity. Switching devices, too, have evolved from electromechanical units with large motion to miniature relays to compact, densely packed solid-state devices. The evolution in switching has been accompanied by advances in related areas, for example, in Automatic Message Accounting (AMA) and signaling by tones.

● Exchange Area and Local Loop Transmission / p. 40

Warren E. Danielson

Highlights of progress in exchange area and local loop transmission include extension of the analytical approach to engineering of loops and trunks, taking into account the full array of transmission-affecting factors; more accurate measuring techniques; more economical materials and equipment; widely usable carrier and repeater techniques (made possible by the economies of solid-state electronics); digital transmission; centralized testing and maintenance (aided by minicomputers). For the future, equally far-reaching developments can be expected. For example, optical transmission over glass fibers appears to be a real possibility.

● Radio and Long-Haul Transmission / p. 50

Eugene F. O'Neill

Bell Labs' work in long-distance telephony has followed two directions: (1) exploitation of old media to increase capacity and reduce costs; (2) exploration of new, completely different media. Highlights of the work in the first direction are the use of ever higher frequencies, the invention of the feedback amplifier with its ultralinity and stability, and the use of new modulation techniques. Our efforts in the second direction have yielded broadband coaxial cable, microwave radio, and waveguide transmission. The future promises domestic communications satellites and progress in such media as optical fibers.

● Materials / p. 60

William P. Slichter

The importance of the mastery of materials to the Bell System can hardly be overemphasized. Not only does the performance of the Bell System's incredibly complex equipment depend upon this mastery, but so does the ongoing potential for making things better and cheaper, and for satisfying completely new demands. Bell Laboratories, since its inception, has striven to ensure that the Bell System has available to it all the benefits of modern materials research and engineering.

● Device Development / p. 70

Willard S. Boyle

A major trend of our technological age—spotlighted by Bell Labs' invention and development of the transistor—is that technical progress comes from

teamwork and from new fundamental understanding of nature. In particular, the development of electronic devices—from their conception to final systems application—depends on the coordinated efforts of specialists in basic science, development, manufacture, and application. The power of this approach has been demonstrated most vividly at Bell Laboratories.

● **Theory and Principles:
The Intellectual Framework / p. 82**

Brockway McMillan

Underlying the network of cables, switches, and telephone sets is another network basic to the telecommunications industry—the network of theory and principles that helps engineers explore the contours of physical reality and define the limits of the possible. Bell Labs scientists played a prominent role in creating this body of theory, without which the telephone network as we know it would be impossible. Their contributions include the analysis of inductive loading, Harold Black's principle of negative feedback, Nyquist's and Bode's criteria and laws, and the now-classical statistical techniques of quality control and traffic theory.

● **Computers and Computer-
Based Systems / p. 90**

Victor A. Vyssotsky

For 30 years, Bell Laboratories has been one of the major contributors to computing science and technology. In recent years, Bell Labs has focused much of its efforts on computer-based systems to help Bell System Companies in their day-to-day operations—by improving service, increasing the efficiency of the work force and the utilization of

plant, and providing better information to management. Computerized record-keeping systems and facility-assignment programs are just two products of those efforts. Additional systems are under development or in use. Goals for the future: computer systems of diverse types that can communicate with each other; better understanding of computer theory; more "robust" software; and greater productivity in software development.

● **In Defense of the Nation / p. 96**

Clifford A. Warren

The Bell System has responded in times of national emergency as a responsibility owed to the country. Thus, during World War II the Bell Laboratories/Western Electric team supplied, among other things, over half of all U. S. radar, a highly effective acoustic torpedo, and a computer-controlled antiaircraft gun director. In the postwar years the same team developed missile defense systems, from the early AJAX to the current SAFEGUARD series, and also a command-guidance system which was used for the TITAN ICBM, for launching the Echo and Telstar™ satellites, and for many other peacetime space shots. Defense activities are today only a small part of Bell Labs' total effort, and future projects will depend on international relations.

**Highlights of Bell Labs'
Contributions to Early Radio / p. 108**

Some Notable Achievements / p. 110

The Authors / p. 112

Introduction

The intentions of large industrial research and development organizations can never be wholly fulfilled. For if their accomplishments over the years bear fruit, they also produce new seeds. The unfolding of new knowledge opens ever new paths to be pursued so that there remains always a body of work to be engaged, wrestled with, mastered. This is as it should be. Awareness suggests purpose, and purpose leads to achievement and continuity of function.

It is this *process* of challenge-achievement-further challenge that underlies the research and development work undertaken by Bell Laboratories. In its initial span of fifty years, its scientists and engineers have applied their skills and creative

powers to advancing the telecommunications art in all its forms. The achievements noted in the various articles in this anniversary issue attest to that commitment. If we momentarily pause at this anniversary time, as is the custom, it is to recount for our readers some of the elements that constitute this commitment and achievement.

When Bell Laboratories was formed as a corporate entity in 1925 from the Western Electric Engineering Department, the nation was in a prosperous condition, its mood exuberant, its outlook confident. Growth was the keynote of industry. The production ethic of saving and self-denial in order to accumulate capital for new ventures was giving way to the consumption ethic that was needed to fulfill aspirations to the better life. The telephone industry itself was advancing along with the nation, providing the means of rapid communication so essential to business and social progress. It was a fitting time for the Bell System to establish a research and development organization that could devote its energies not only to solving the technical problems of a fast-growing industry but to providing orderly planning for the future. This capability was further strengthened in 1934 when the Development and Research Department of AT&T was consolidated with Bell Laboratories.

The fifty years that have elapsed since 1925 have seen some of the most profound technological and social changes encountered by society—economic depression, cataclysmic war, the development of nuclear energy and computer science, space travel, moon landings. The technological developments have been as astonishing as they have been rapid. Whatever statistical yardstick is used, the conclusion is always the same: growth involves complexity, and complexity demands the most penetrating and persistent application of knowledge to the solution of both short-range and long-range problems.

Tracing the growth of Bell Labs through any facet of telecommunications science and engineering—from research to device development to

transmission methods to network control—is to observe the workings of a scientific community in action. But studying the accomplishments of Bell Laboratories means looking beyond the highly visible and recognized achievements, such as the transistor, television transmission, direct distance dialing, and digital and satellite communications, to the lesser understood but equally significant achievements, such as the development of special materials that provide higher efficiencies and greater bandwidth for improved transmission or the intellectual concepts involving mathematics and physics that underlie electronic switching. In the innovative process it is often the obscure, seemingly impractical discovery that may be grasped, developed, and made useful.

But none of what has been accomplished could have been done without an effective organizational structure tailored to do the job. The pre-eminence of the Bell System in telecommunications is achieved by the combination of research, engineering, manufacturing, and service components in one service industry with but one goal: to serve the public's communications needs. It is not so much a question of size as it is of an integrated composition of parts, each supporting the other and giving meaning to the whole. This combination gives practical outlet to Bell Labs activities and helps focus and direct what might otherwise be a discontinuity of separate functions.

This issue of the RECORD, therefore, celebrates not only the achievements of individual Bell Laboratories inventors, scientists, and engineers engaged in a common purpose over the years but the vision of the founders who saw the need for an organization dedicated to supporting and advancing the telecommunications art through mission-oriented research and development. The future is bright with attractive challenges and ever-widening circles of knowledge to be studied and understood. Bell Laboratories is set to meet those challenges.

THE EDITORS



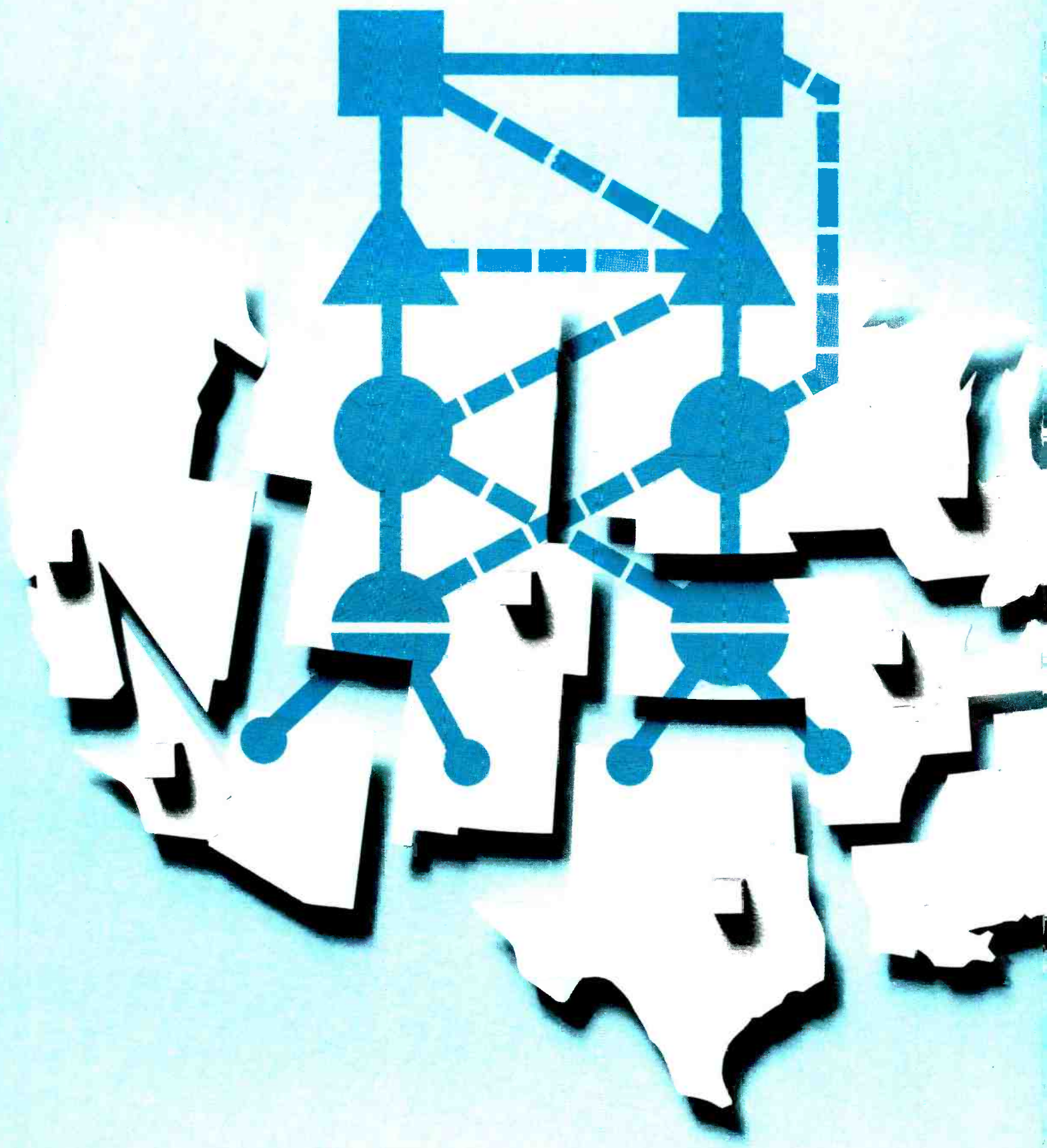

Throughout the last century, under the leadership of AT&T, a telephone network of unparalleled size and complexity evolved. Noteworthy among the changes in the network since 1925 are nationwide direct dialing from almost every Bell System telephone, computerized collecting and processing of network data, and substantial improvements in the quality of transmission.



The Network: Forging Nationwide Telephone Links

WILLIAM B. MACURDY and ALISTAIR E. RITCHIE

WHEN BELL COMMUNICATED the first telephone message to Watson in Boston, their embryonic system did not include a “network”; but as soon as a third telephone was added, the telephone network was born. In the years since, the network of connected communication terminals—primarily telephones—has evolved into an instrument of unparalleled size and complexity. The United States network is an integral part of a global system interconnecting almost 313 million telephones (as of January 1973), of which all but 1.7 percent connect with the Bell System’s 100-million-plus phones.

Interwoven with the basic network are subnetworks—interconnecting computers, teletypewriters, television studios, data sets, and so on—which may be restricted to certain customers or limited in scope. From the point of view of this article, however, the network is the United States telephone network—all the switching and transmission facilities to which customer telephones connect. The account will briefly trace the history and evolution of this network, particularly in

relation to Bell System and Bell Laboratories contributions. Attention will then focus on the changes that were necessary to incorporate nationwide customer dialing in the network, and finally on Bell System objectives and achievements related to improving the quality of performance.

The invention of the telephone in 1876 was followed almost immediately by construction of manual switchboards to interconnect telephone lines. It is interesting to note that an automatic system was patented as early as 1879, although the first commercial "machine switching" office (using Strowger's step-by-step system) was not placed in service until 1892. Local telephone networks developed rapidly in the United States. For example, following the opening of the first experimental switchboard in Boston in May 1877, exchanges in both New York and California opened early in 1878. Interconnection of the local networks spread as quickly as advances in the art of transmission permitted. Circuits were first placed in service between the East and West coasts in 1915.

The First Network Plan

During the years leading up to the founding of Bell Laboratories in 1925, dial telephones were in the minority. In 1925 they still numbered only about 1.5 million out of a total of 12 million. Local central offices consisted of a variety of manual switchboards, and step-by-step and panel dial systems.

In many local areas with dense telephone development, extensive networks involving trunk-switching tandem offices had come into being by 1925 to interconnect local offices. These tandem offices—similar in design to local switching systems—included manual switchboards, trains of step-by-step switches, and, in New York City and some other large cities, specialized arrangements of panel equipment. In the tandem networks, which combined manual and dial operation, complex signaling facilities were used to permit machines to "talk" efficiently to operators.

There was a natural tendency to extend these local tandem networks to include short-haul toll connections. However, toll service in the mid-1920s, particularly "long distance," was usually handled by operators at specialized switchboards following rather involved operating procedures. Both the switchboards and the procedures were designed to make most efficient use of the costly toll circuits.

Callers were requested to hang up, and their calls were queued under control of a different operator until a circuit was free. Then the operator would ring the calling party and complete the connection. A noteworthy event in 1925 was the introduction of the Combined Line and Recording (CLR) method of handling toll calls, by which the same operator received the call from the customer, recorded charge details, and handled the connection.

Although toll connections were generally made through plug-and-jack switchboards, a few operator-controlled dial networks for intercity toll calls developed in various parts of the country beginning early in the 1900s. Most of these networks used step-by-step equipment, but panel switches were used in some areas.

By the late '20s, the need for a master plan to control the growth of this nationwide network was clearly evident. At the heart of the problem were difficulties in connecting widely scattered points with small traffic demand. Calls between such areas tended to require switching through several intermediate offices, with consequent decreases in the speed and the quality of performance. In 1930 AT&T announced a mandatory General Toll Switching Plan. It established a hierarchy of toll switching offices, limiting the number used on any connection to six including the toll centers to which the local offices connected. The plan included direct routes wherever economically justified, and it specified transmission requirements to assure that all connections would be satisfactory (see illustration, opposite page).

Evolution of the System

The ensuing 20 years were marked by the natural growth of the Bell System, together with many technical innovations contributed by Bell Laboratories. Among the more important changes from 1930 to 1950 (as shown in the graphs on page 8) were the following:

- The number of telephones increased from 15.6 million to 36.5 million. More significantly, the percentage of telephones in dial areas increased from 31.9 percent to 76.1 percent.
- Long-distance calls per year increased from 512 million to 1.5 billion.
- The number of miles of long-haul circuits increased from 6.9 million to 26.5 million.
- The types and usage of carrier facilities grew, improving performance and reducing cost per circuit mile.

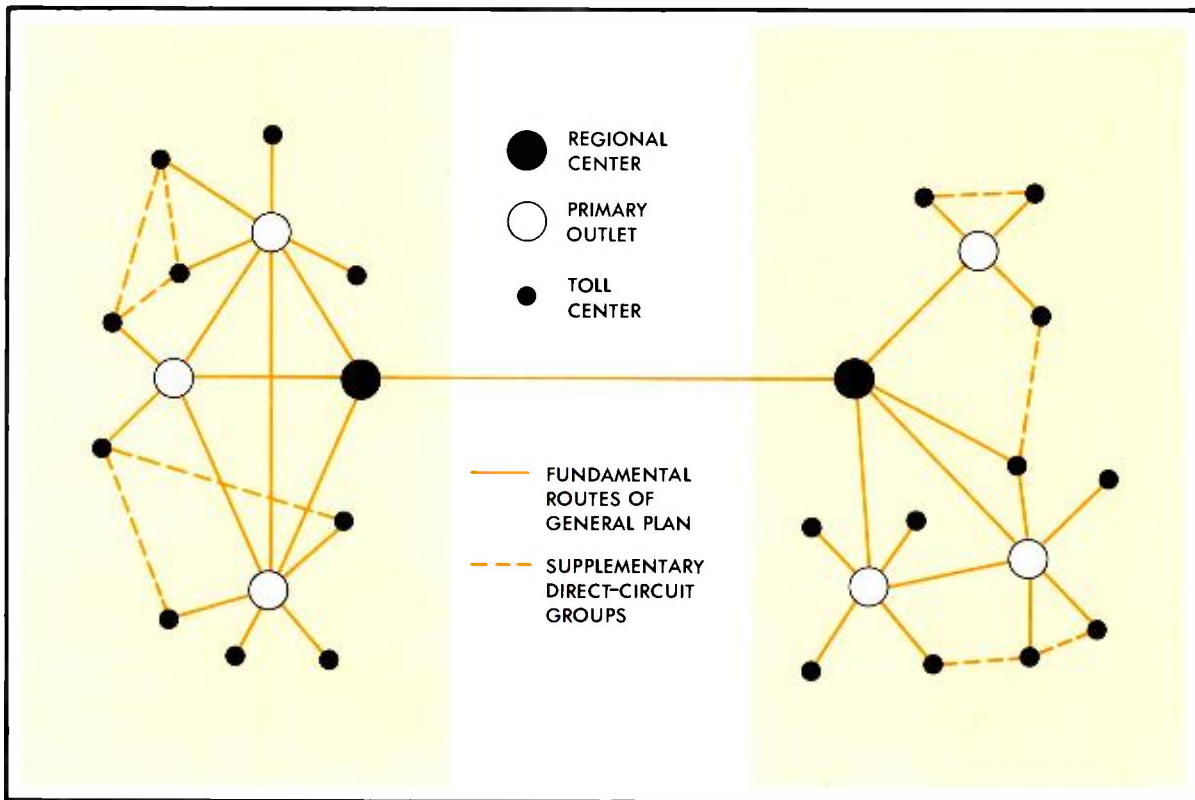

The General Toll Switching Plan of 1930 established fundamental routes between important switching offices (solid lines) and supplementary direct-circuit routes (dashed lines). The plan

also specified requirements to ensure transmission quality. In 1930, in the United States and eastern Canada, there were 2500 toll centers: 150 were primary outlets, including 8 regional centers.

- Full-fledged common-control switching systems with capability of automatic alternate routing were introduced (No. 1 and No. 5 crossbar, crossbar tandem, and No. 4 toll crossbar).
- Comparatively fast, reliable tone-signaling systems applicable to any voiceband transmission path were introduced—single-frequency signaling at 2600 hertz for supervisory purposes and, for transmitting address digits, 2/6-tone multi-frequency signaling, which encodes digits by using the fifteen combinations of two frequencies chosen from a total of six.

These changes paved the way for transforming the network to the form we know today.

Nationwide customer dialing had been an ultimate objective of long-range communications planners since at least the 1920s. By the decade of the '40s, technical capability had reached the stage where network planning and system development to reach this objec-

tive could realistically proceed. Key elements in the overall plan, as discussed in the paragraphs below, included:

1. A nationwide numbering plan
2. A revised toll switching and trunking plan
3. An associated transmission plan
4. Design of appropriate switching and signaling equipment
5. Automatic charging arrangements.

For many years, central offices were named, and local telephone numbering relied on alphabetic codes for the names, followed by from three to five digits. Toll routing employed geographical names, which were translated to arbitrary routing codes where operator toll dialing was involved. Clearly, these schemes were unacceptable for customer toll dialing. The universal numbering plan devised to re-

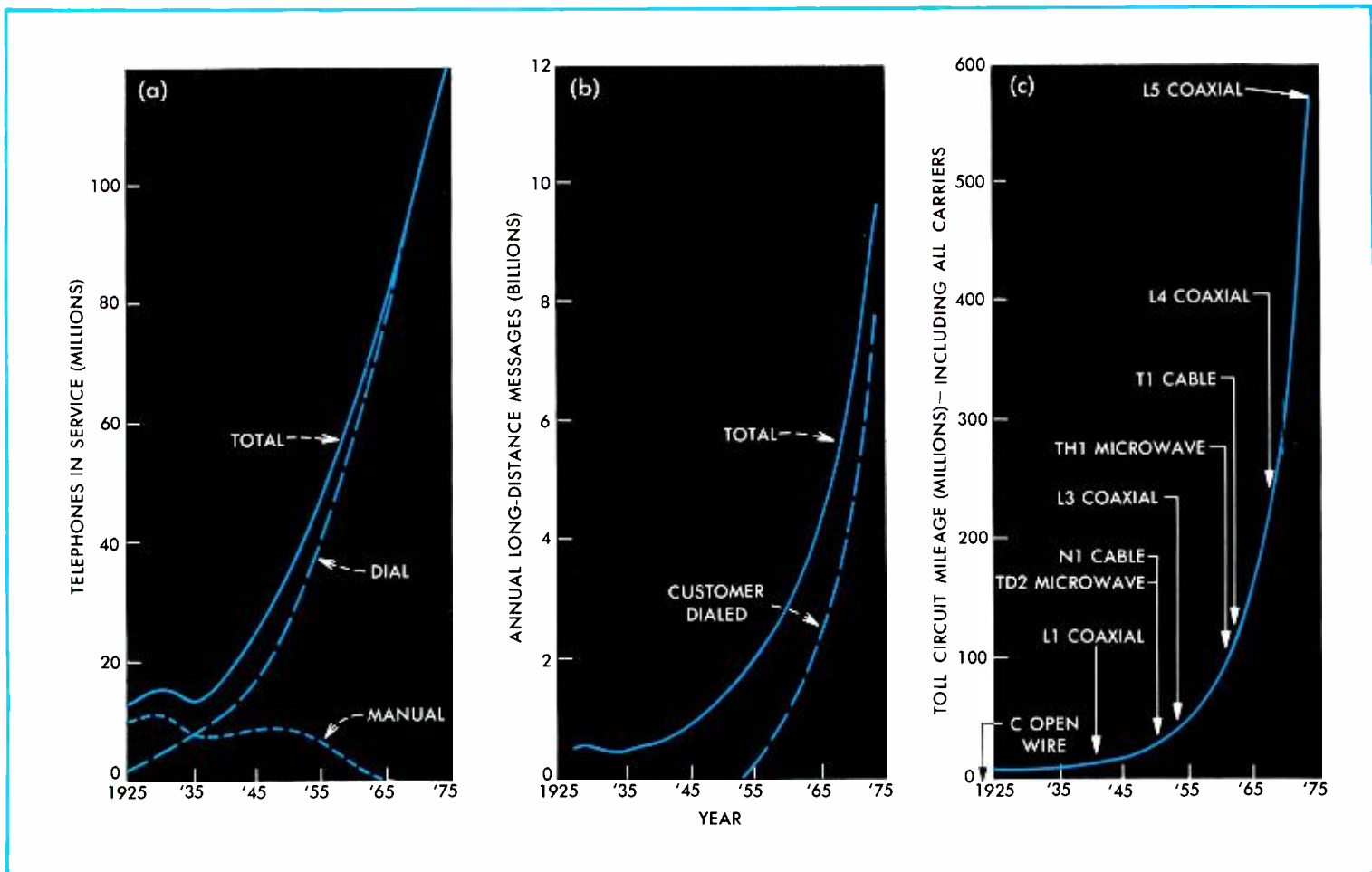

Growth of the Bell System during the fifty years of Bell Laboratories is shown in terms of (a) the number of telephones in service (including those of Southern New England Telephone and Bell Canada), (b) the number of annual long-distance calls, and (c) the number of miles of long-haul circuits in

service. Curve (c) also indicates when significant new transmission systems were introduced, although these were not necessarily related to the accelerating growth shown by the curve. All systems are analog except for T1, the first of the digital PCM (pulse-code modulation) systems.

place them embodied the familiar ten-digit identification, where the first three digits represent a numbering plan area encompassing a state or a subdivision of a state; the next three represent a central office; and the last four, a line or telephone number (see the table on page 10).

The numbering plan serves Canada, parts of Mexico, and the Caribbean islands in addition to the United States. Growth in the number of telephone lines in this whole region has been so phenomenal that the original numbering plan has become inadequate. Modifications to increase the available numbers are based on using a common set of three-digit numbers for both areas and offices. But numbers used for both will need to be distinguished from each other by timing the interval after seven digits or by requiring the caller to dial a pre-

fix (generally the digit one) before dialing a ten-digit number.

Today's Network Plan

The toll switching and trunking plan devised to allow nationwide customer dialing is a natural outgrowth of the 1930 model. It consists of a five-level hierarchy of switching offices within each of ten regions of the United States, with interconnections among offices established according to certain traffic and routing rules. (For the basic pattern involving two regions, see "Network Hierarchy in the United States," page 11.) The original plans included a sixth level of the hierarchy—a single national center to which the ten regional centers would connect. But the national center has never been implemented because it has never proved to be sufficiently

more attractive than the fully interconnected regional centers.

This switching plan specifies that a maximum of nine links may be used between end offices on any call. Such a limit necessitates a revised transmission plan as well. The new plan apportions losses among the paths of the network so as to ensure good quality on the longest connection without allowing too much variation in quality from longest to shortest.

In addition to the basic capabilities required in any switching system—exchanging information between central offices and with customers, storing and interpreting telephone numbers, and setting up connections—the switching and numbering plans outlined above require complex controls in at least the higher-level switching centers. Most important of these specific capabilities are three- and six-digit translation for routing, automatic alternate routing, and the ability to delete, add, and change digits in the address codes. The translation feature, for interpreting area and office codes, is necessary for efficient and flexible control of routing. Automatic alternate routing is required during call setup for hunting rapidly over busy trunk groups to locate an available idle trunk, in accordance with a predetermined route advance plan. Digit manipulation, which comes into play as a call advances from office to office, is used to drop (or in some cases add) an area code, or to convert address digits to a different set required for routing through certain offices.

Meeting the Challenge

Fortunately, by the late 1940s, switching technology at Bell Laboratories was able to deal with these problems. The Bell Labs family of crossbar switches furnished the equipment and control philosophy. In preparation for nationwide customer dialing, the No. 4 crossbar system—a pre-World War II system—was adapted to the expanded requirements. The most significant change in this system was the introduction of the card translator, a large electromechanical device for performing three- and six-digit translation. The card translator uses metal cards, prepunched with holes for routing and control information, together with light beams and phototransistors for reading the data. This modified system, known as No. 4A toll crossbar, is still the principal large machine for toll switching in the Bell System. It has continued to evolve in features and switching capacity, the most im-

January 1975

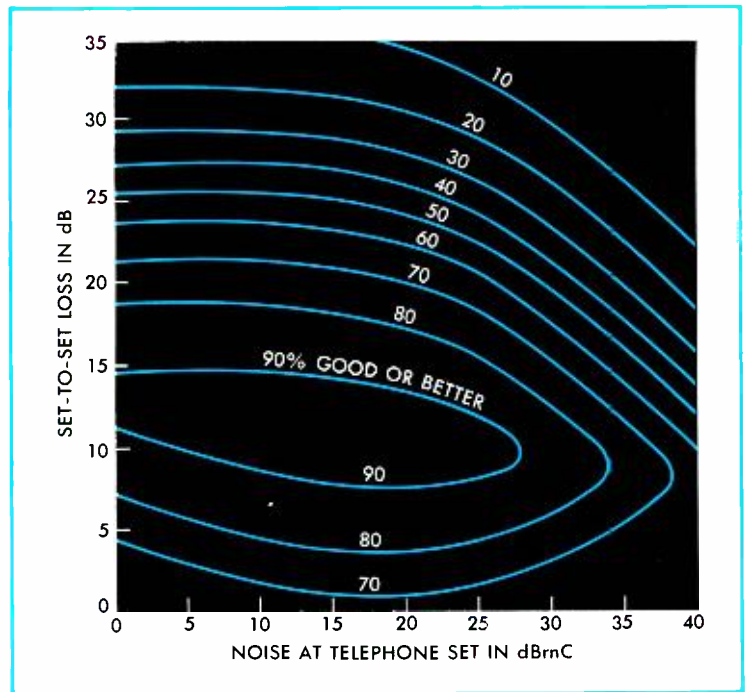

To help evaluate engineering alternatives, researchers ask people to rate transmission quality for various values of transmission parameters. In a test involving varying values of noise and loss, 90 percent of the test subjects rated quality as good or better when loss varied between 10 and 15 dB and noise was less than about 28 dBrnC (a standard measure of circuit noise). Such tests help determine network objectives and set requirements for new transmission and switching systems.

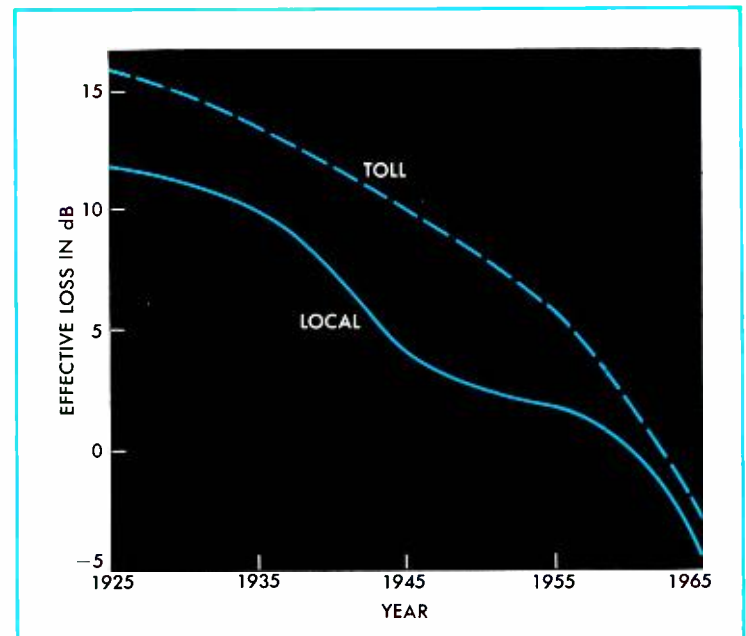

In this graph showing estimated improvement in transmission quality, effective loss is an expression of loss, noise, frequency response, and sidetone in terms of equivalent loss. Although this method has been replaced by techniques considered more appropriate for modern networks, its use here illustrates the substantial gain in quality achieved between 1925 and 1965.

	Numbering Plan Area			Office Code			Line Code				
	2	0	1	K	L	5	1	2	1	2	
PREVIOUS	Any Digit 2 thru 9	Either 0 or 1	Any Digit 0 thru 9	Any Digit 2 thru 9		Any Digit 0 thru 9					
	640 Combinations										
PRESENT	152 Combinations			Any Digit 2 thru 9	Any Digit 0 thru 9		Any Digit 0 thru 9 10,000 Combinations				
FUTURE	Any Digit 2 thru 9	Any Digit 0 thru 9		792 Combinations							
	792 Combinations										

The first two digits of the office code were originally represented by the first two letters of a central office name (see the familiar telephone dial for correspondence between letters and numbers). This scheme, which restricted the number of available codes, has been largely replaced

by all number calling (ANC). Three-digit numbers in which the last two digits are one's are excluded from the totals because they are service codes (411, for example, is the code for directory assistance). The digit zero is used to obtain operator assistance.

portant recent change being the replacement of the card translators with the Electronic Translator System (ETS), beginning in 1969.

Another development essential to customer toll dialing was automatic recording of billing information in a form suitable for automatic data processing. A system devised at Bell

Laboratories for this purpose, known as Automatic Message Accounting (AMA), was installed in the first No. 5 crossbar local office in 1948. This same type of office, equipped for ten-digit dialing, was later used in the initial trial of Direct Distance Dialing (DDD). Subsequent developments have enabled all dial toll calls to access AMA equipment at either the originating local or toll switching office.

Thus, a few short years after World War II, planning and design had progressed enough for a trial of long-distance customer dialing to begin on November 10, 1951, in Englewood, New Jersey. Since the first customer DDD call, dialed to a phone in California, automation of the network has extended DDD calling to essentially all of the Bell System's 115 million telephones. The original network planning was of such quality that subsequent improvements have focused on refinement rather than on basic changes to the plan.

Since the start of DDD, not only have essentially all local offices been equipped with features for customer toll dialing, but, in addition, new toll switching systems have been developed. In particular, toll features were added during the 1950s to the crossbar tandem system, as common-control adjuncts to the step-by-step intertoll train, and as auxiliary functions to No. 5 crossbar and No. 1 ESS local systems for use as combined local/toll offices. (The table at left shows, by class, the

SWITCHING ENTITIES IN SERVICE IN THE BELL SYSTEM, JANUARY 1975 (ESTIMATED)	
Class 1	10 No.4A Crossbar
Toll,	Class 2 65 Predominantly No.4A Crossbar
	Class 3 245 Predominantly No.4A Crossbar, Crossbar Tandem
	Class 4 865* Predominantly Step-by-Step, No.5 Crossbar
Local, Class 5	9900* Predominantly Step-by-Step, No.5 Crossbar, No. 1 ESS
Operator Assistance	115 Traffic Service Position System (TSP) No.1, Crossbar Tandem -TSP
*Many (approximately 400) entities perform both a class 4 and a class 5 function and are included in both counts. In addition, many local and toll offices also perform a local tandem switching function.	

switching systems in service throughout the network in early 1975.)

A good measure of accomplishment in the network today is the proportion of long-distance calls dialed by customers. Of the total 8.5 billion long-distance calls made through the Bell System in 1973, 82.6 percent were customer-dialed, including 4.6 percent that also required operator assistance (such as person-to-person calls). The remainder were placed by an operator. Despite the high degree of mechanization, the network still includes about 64,000 switchboard "positions"; approximately 25 percent of these are modern, cordless Traffic Service Positions.

Routing Considerations

But new developments also require new Operating Company methods. The introduction of alternate routing, particularly into the toll network, required new engineering procedures for determining circuit quantities and controlling the quality of service. Previously, trunk group sizes were determined by two different methods. For local dial operation, sufficient trunks were provided to ensure a very small probability—typically one percent during busy hours in the average busy season—that a call would be blocked and result in an "all circuits busy" signal to the caller.

Intertoll trunk groups, on the other hand, were usually run at higher blocking levels, under the control of a toll operator. Requiring operators—and therefore customers—to queue for the more costly toll trunks kept these circuits occupied a greater percentage of time; the greater the occupancy, of course, the longer the queuing delay. Engineered delay of 30 seconds for accessing a trunk group was typical in 1950 before the introduction of DDD.

Because "delay" operation was impractical without an operator, converting to DDD required a change to low blocking on toll networks, as on local networks. Since low blocking implied lower circuit occupancy, the challenge was to introduce DDD without significantly increasing the investment in toll circuits. Alternate routing—redirecting calls to another trunk group when all the trunks in a direct group are busy—provided the answer. For one thing, alternate routing allows one "final" trunk group, by handling the overflow traffic from many high-usage routes, to be operated both at high occupancy and at sufficiently low blocking to guarantee low overall blocking to customers. Second, a judicious di-

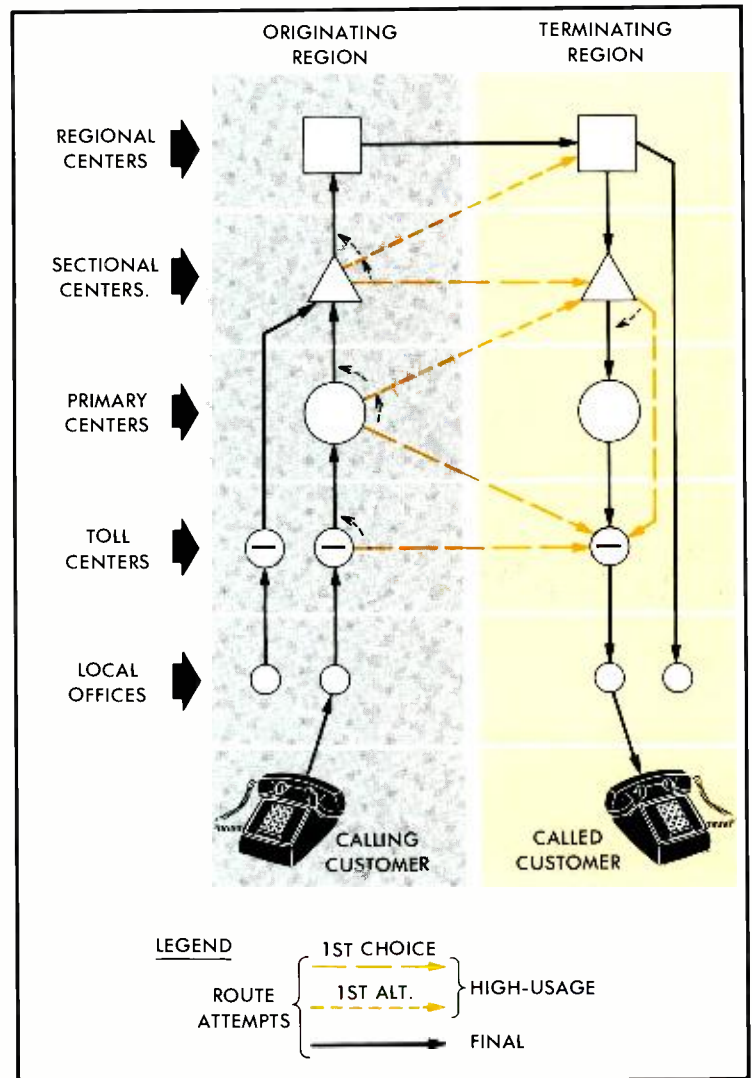

NETWORK HIERARCHY IN THE UNITED STATES

During the late 1940s, planning for nationwide customer dialing required that the 1930 network plan be revised. The new plan established ten regions (see the map on pages 4-5) and a five-level hierarchy of switching offices centering on the regional offices (as shown above).

Two basic classes of interconnecting paths connect these offices. High-usage trunk groups (dashed lines) connect any two offices that have sufficient traffic between them to make a direct route economical. Final routes are the paths between each office and its immediate superior in the hierarchy, together with the routes interconnecting all the regional centers (solid lines). The sketch shows typical but not all-inclusive trunking patterns among offices.

For network economy, the high-usage trunk groups are sized to handle only a portion of the traffic directed to them; the switching offices are designed to redirect traffic by automatic alternate routing to a different trunk group when all circuits of a high-usage group are busy. At each stage, the alternate routing plan shifts overflow calls from the most direct route toward the final route, as shown by the arrows. Final groups are designed to handle (during busy hours) their own direct traffic plus overflow traffic from high-usage groups at a level consistent with good service—such as an average loss of one call in a hundred. The routing pattern precludes switching calls back on themselves or using an excessive number of trunks on a call.

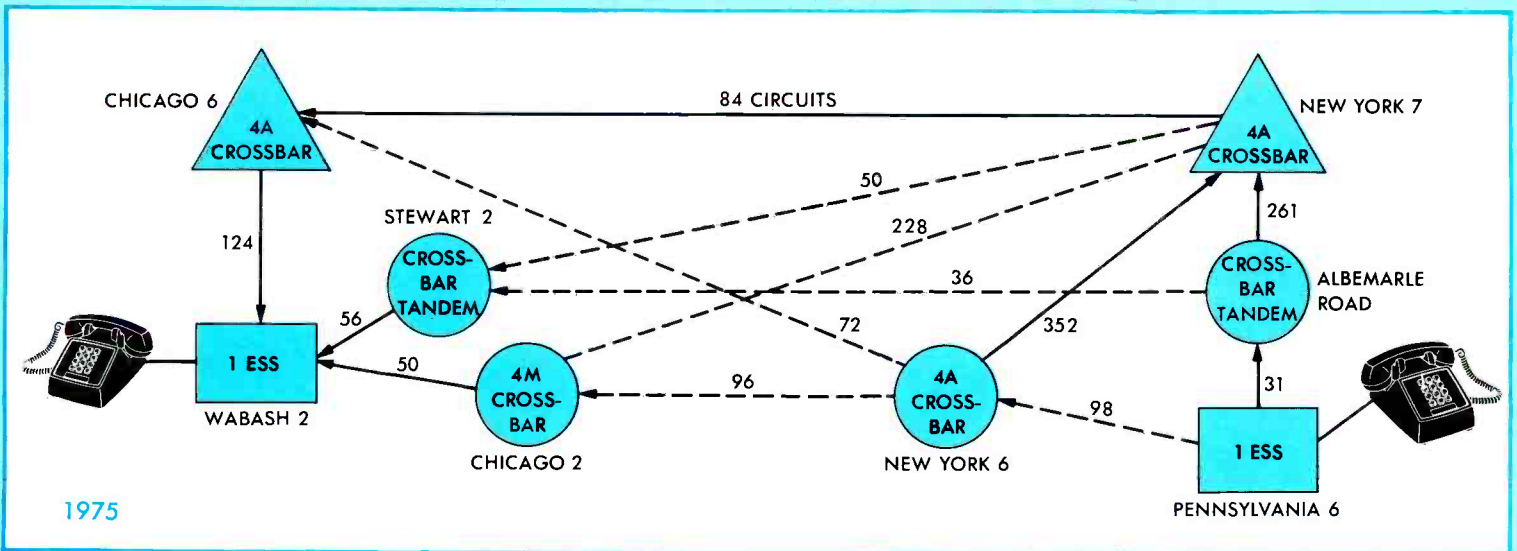
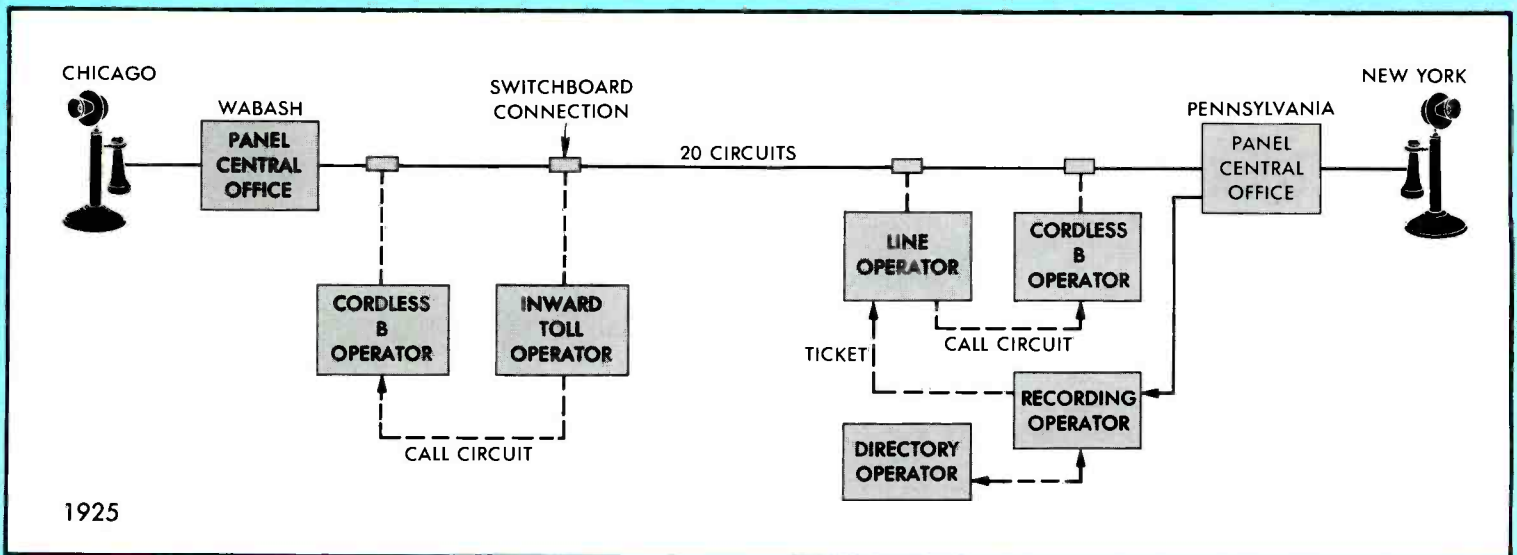

vision of the traffic load between direct and alternate routes yields a network costing less than a nonalternate route network carrying the same amount of traffic.

Methods of determining the optimum size of final and direct trunk groups have also improved, as the means for gathering and processing traffic data have steadily progressed. Manual counting of calls on the monthly "peg count" day has evolved into modern data-collection systems. For example, EADAS (Engineering and Administrative Data Acquisition

System) is a computer-based system that automatically gathers network data in real time (see *Acquiring Data for Network Planning and Control*, RECORD, October 1974); Business Information Systems computers sort and process the data for use by network administrators and traffic engineers. These new systems enable Operating Telephone Companies to cope economically with the volume of data and the complex calculations now needed to ensure uniformly good service at lowest network cost.

CROSS-COUNTRY TELEPHONE CONNECTIONS— 1925 AND 1975

In 1925, a call from Bill Weaver in New York to Joe Campbell in Chicago required 7½ minutes to place. Comparing that call, from the Pennsylvania office in Manhattan to the Wabash office in downtown Chicago, with the same call made in 1975 illustrates dramatically the changes that have taken place in the telephone network in 50 years.

In 1925 (see upper diagram), both offices were “machine switching” offices using the latest panel equipment to furnish local dial service. To place the call, Bill dialed 211 in New York (top right) to reach the recording operator, who, if necessary, called the directory operator to obtain Joe’s number and then prepared a toll ticket. After recording the details of the call and asking Bill to hang up, the recording operator sent the ticket to the line operator via pneumatic tube—or perhaps a messenger on roller skates. In preparation for setting up the call, the line operator reserved a path to the calling number by contacting the panel “cordless B” operator, who—without ringing the calling line—set up a connection via a toll switching trunk to the line operator.

When one of the 20 New York-to-Chicago circuits became available for this call, the line operator seized it and signaled the Chicago inward operator (left). The inward operator then established a connection to the Campbell telephone via the cordless B operator in the Wabash office. The sequence of ringing both customers followed local procedures. Under this mode of operation, setup time for a typical call was 7½ minutes.

Today (see lower diagram) customers in both these offices are served by No. 1 ESS (Electronic Switching System). Instead of 20 circuits between the New York and Chicago metropolitan areas, there are 2000 intertoll trunks between the more-limited 212 and 312 numbering plan areas. Today’s Pennsylvania 6 customer has access to 566

of these circuits for a call to Wabash 2. When a customer dials a ten-digit Chicago number, the Penn 6 ESS (lower right) automatically records the details of the call for billing and attempts to route the call to New York 6 (lower route). New York 6 is a 4A ETS (that is, a No. 4A crossbar with an Electronic Translator System) with access to 96 circuits to Chicago 2, a No. 4M crossbar having 50 direct circuits to the Wabash office. If this first-choice routing is successful, the Wabash 2 customer’s telephone will ring about 8.7 seconds after the end of dialing in New York. This faster-than-average setup time is due to the exclusive use in this route of modern multi-frequency signaling and the immediate ringing that is a feature of ESS. Typical setup time for a toll call in 1975 is about 12 seconds.

If the 98 circuits from Penn 6 to New York 6 are busy, the ESS alternate-routes the call to the Albemarle Road crossbar tandem, which attempts to complete the call via the Stewart tandem in Chicago (center route). Final routing, if necessary, is through the New York 7 and Chicago 6 sectional centers (upper route), also equipped with No. 4A crossbar. This particular example illustrates the routing flexibility that is available and widely employed in the modern hierarchical network. First, the 84-trunk final group from New York 7 is large enough that there is no advantage in additional alternate routing. So the Penn 6-Wabash 2 traffic never reaches the Class 1 regional centers at White Plains, New York, and Norway, Illinois. This truncation of the network, where large volumes of traffic can be carried economically at low levels in the hierarchy, protects the upper levels from unexpected surges of high-volume overflow traffic. Second, while the discipline of hierarchical routing is strictly observed, variations in the familiar five-level hierarchy are evident in the example. Such variations are found throughout the network.

Measuring Performance

As for transmission, service between the East and West Coasts was well established by 1925, and the technical problem of loss of volume due to attenuation over a long distance had been solved. So the major improvements since 1925 have been primarily in quality of service. Along with these improvements have come changes in the methods of measuring transmission quality. Early ratings in terms of “miles of standard cable” gave way to the “effective transmission loss” method—a

method of measuring the subjective effect of a particular transmission impairment in terms of the loss (in dB) in a defined reference circuit required to produce a comparable subjective effect. As network quality improved, however, the method became less appropriate as a means of measuring transmission quality, more difficult to use, and therefore less useful. For measuring the combined effects of noise, loss, and echo, it has now been replaced by the “percent good or better” criterion—the percentage of people, determined by laboratory or



At the Network Management Center on East 38th Street, New York City, consoles and display boards help personnel monitor and control the operation of the downstate New York network. The Center is jointly operated by New York Telephone and AT&T Long Lines.

field testing, who rate a distinctive set of transmission parameters as either good or excellent (see the illustration at the top of page 9).

Although obsolete, the effective loss method does provide an approximate way to quantify long-term improvements in transmission quality. Since 1925, reductions in effective loss average 17 dB in local networks and 19 dB in toll networks (lower illustration, page 9). These reductions result in part from improvements in transmission equipment aimed at controlling such parameters as loss, noise, echo, and distortion. Advances in telephone design have contributed substantially. Early desk-stand telephones employed a highly peaked gain-frequency characteristic to help in combatting circuit loss. But the increasing use of repeaters and other technological advances made this less necessary and led to the introduction of, first, the 200-type phone and, by 1937, the 302-type phone. Further improvements in performance were introduced in 1949 by the 500-type set, whose increased overall sensitivity also reduced network costs by allowing finer-gauge wire and longer loop lengths.

Controlling Echo

Of particular value in improving transmission quality is control of the annoying echoes produced by energy reflected at points of impedance discontinuity, such as the hybrid circuits converting between two-wire and four-wire operation. By 1925, echo and its subjective effects were well understood; engineers knew that the acceptable level of echo decreases with longer echo delay. Thus echo effects could be reduced either by decreasing the delay or by intentionally increasing the loss on the longer connections. Under the Via Net Loss (VNL) method developed later for DDD, a fixed amount of loss is introduced into each trunk circuit depending on expected circuit delay. While providing low-cost echo control, the VNL method also accommodates the wide variety of connections available in an alternate-routing network. Modern transmission surveillance systems such as CAROT (Centralized Automatic Reporting On Trunks) test trunks automatically to help in maintaining design loss and transmission quality in the field.

In longer circuits, where excessive fixed loss would be needed to compensate for longer delays, echo suppressors—a more costly method

of dealing with echo—are required. The continuing growth of broadband carrier systems in the toll network has had a direct effect on the network design rules for using suppressors. The increasing proportion of higher-speed transmission facilities reduces the average time delay for echo in the network. Based on new field measurements, the length of trunks beyond which echo suppressors must be used has been increased from 1565 to 1850 miles. The resulting reduction in the number of echo suppressors needed in the network decreases costs with no degradation in transmission performance to the customer.

On to Tomorrow

The history of the network is thus an account of increasing quality, increasing speed, and convenience for customers (see "Cross-Country Telephone Connections—1925 and 1975," page 13), and increasing access to telephones around the world. The U.S., Canadian, Mexican, and Caribbean networks are already well integrated. Access from the U.S. network to the rest of the world and vice versa is through seven gateway offices via submarine cable and satellite links. Traffic with overseas points is increasing at a rate of about 25 percent per year and, although most of it is now handled by operators, a growing percentage is customer-dialed. Modifications now being incorporated in the Traffic Service Position System will accelerate this trend.

Other major developments now under way in Bell Laboratories will have a profound effect on future evolution of the network:

- No. 4 ESS—a very large toll switching system, greater than three times the size of No. 4A crossbar, characterized by a time-division network compatible with pulse-code modulation (PCM) transmission (see the article by A. E. Joel in this issue).
- Large, long-haul PCM transmission systems—for example, the WT4 waveguide system, approximately three times the size of L5 (see the article by E. F. O'Neill in this issue).
- CCIS (Common Control Interoffice Signaling)—a high-speed, high-capacity signaling system for linking electronic switching offices.

Together, these developments—relying on digital technology—will sustain the pace of improvements in network efficiency, service quality, and advanced customer features. □

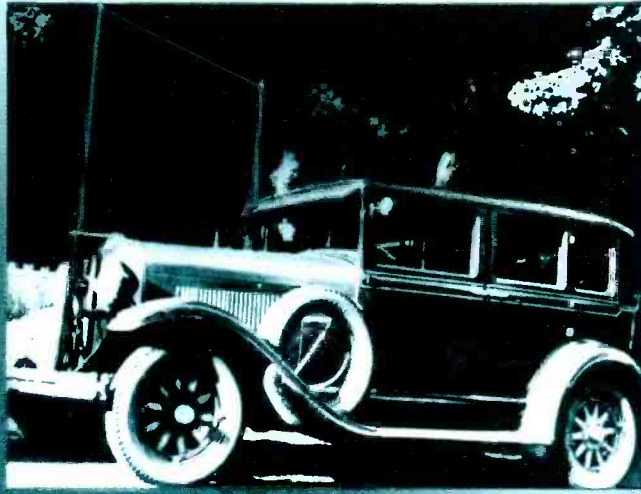

Alpha and Omega of the Network: Customer Products

J. W. SCHAEFER

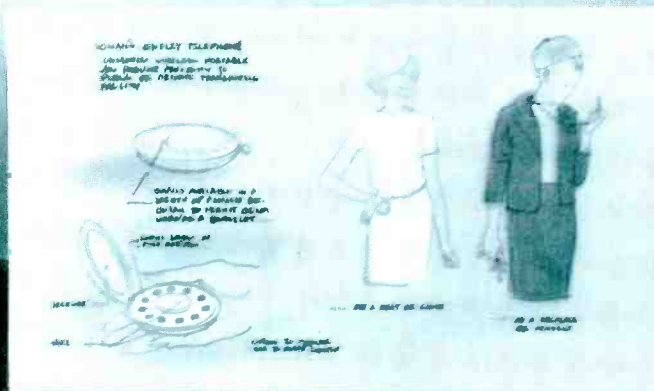

In its first 50 years, Bell Laboratories has given an excellent account of itself in the customer products arena. It has put a tremendous variety of products literally into the hands of Bell System customers. The evolution of today's versatile business systems and residential sets is a history of innovation and dedication to good service.

WHAT IS THE "BELL SYSTEM" to our customers? It's the equipment—and the service that is its natural accompaniment—which they see and use in their own homes, factories, and offices. This terminal equipment, called customer products in telephone language, has characteristics quite different from much of the rest of the telephone "plant." It's on the customer's premises and hence it's highly visible, so it must have a pleasing appearance. Each customer pays for the full use of this kind of equipment, and since its use is shared with no one else, it is extremely cost-sensitive. Customer products are the telephone system's interface with its human users; consequently, the design of the equipment heavily involves human factors and is directly subject to changes in perceived needs. Further, it must be highly reliable, since getting craft personnel to its location makes repairs expensive—and can inconvenience the customer. Finally, today it is in direct competition with products from other sources, from mail-order houses, department stores, and well informed salesmen—so it's got to be good.

The Early Years

Since the day Bell Laboratories came into being, we have worked to make the Bell System's customer products the best. And Bell Labs came into being in the very midst of a boom. The climate of the 1920s was one of op-

timism and progress. Despite a semi-official government policy of political isolationism, foreign trade and travel increased. Automobiles and electric power were changing our way of life. Americans in both business and private life were stepping into a broader, faster-moving world, and it was inevitable that they would need—and demand—more and better communication facilities. It was the role of Bell Labs engineers to aid the Bell System to be one step ahead of these demands, by continually improving the telephone system they inherited from their predecessors at AT&T and Western Electric.

In their efforts to anticipate and satisfy these demands, Bell Labs often saw solutions to problems outside the accepted definition of customer products. For example, during these early years they conceived new products, such as electronic hearing aids and talking motion pictures. Though much of the development was delegated to others, some of these non-telephone customer products were pursued to fruition and revolutionized daily life. (See "Extracurricular Adventures in Customer Products," page 21.)

Business people, in particular, were ready for improved, expanded telephone service and especially for new and better terminals. Except for some locally improvised wiring, they were limited to the single-line telephone; an executive needing more than one line would often have a battery of sets on his desk—and all these instruments actually afforded less service than is available today from one standard, six-button business telephone set. Now the Bell System offers a broad spectrum of products: private branch exchanges (PBXs) with many optional features, data sets, key systems, specialized telephone terminals, to name a few. In fact, our business in PBXs and key telephone systems has grown to the point where well over one million lines of Western Electric equipment are installed each year.

PBX: Communication Hub

Simply stated, a PBX is a switching machine on a customer's premises. It interconnects a number of telephones, permitting their users to call each other as well as the outside world, over relatively few lines to the Operating Company's central office. The PBX also includes an attendant's console to facilitate operation. Over the years, PBX service has evolved from manual through electromechanical to electronic switching. We have matched this

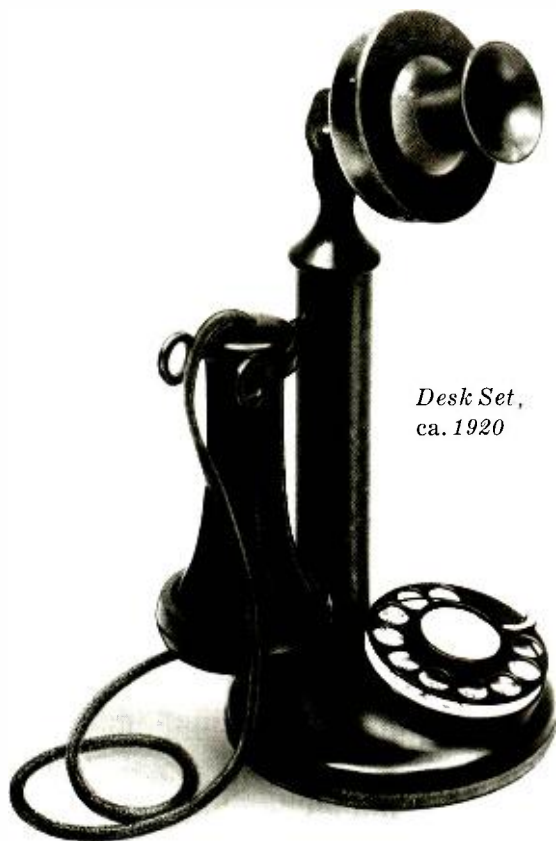

*Desk Set,
ca. 1920*

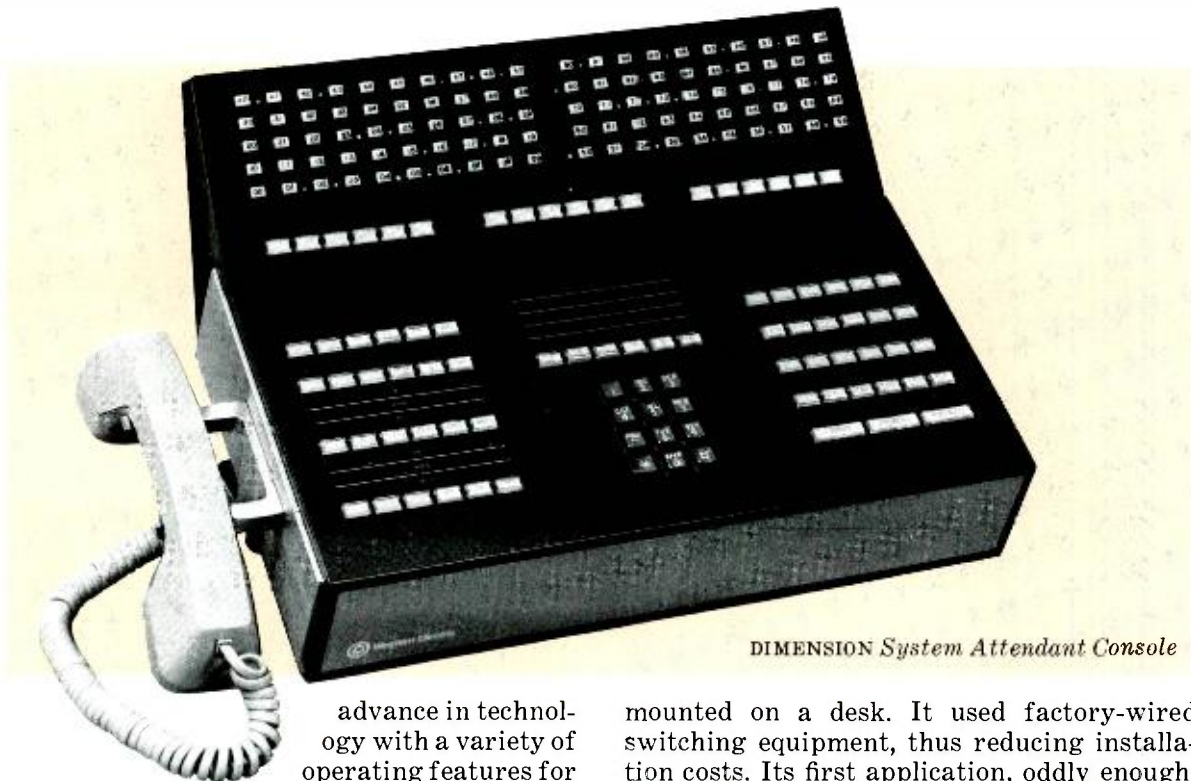

DIMENSION System Attendant Console

advance in technology with a variety of operating features for both PBX attendants and station-set users that make the interface between human and machine much simpler and more effective. Take, for example, the Bell System's latest customer switching system, the new DIMENSION* system (its technical name is CSS-201). This system has the flexibility of stored-program control and the advantages of modern, solid-state electronics. The initial machine serves customers with from 50 to 360 lines; ultimately Dimension systems will be able to satisfy those with up to 2000 lines. Its numerous features allow it to be customized to match specific needs. Installation and maintenance are simplified; for instance, built-in diagnostic programs help locate and identify troubles. The cabinet and consoles have contemporary styling and decorator options. The "human factors" that are incorporated in its design have made the console easier to use, even though the number of features far exceeds those of any other system. Light-emitting diodes (LEDs) tell the attendant at a glance the status of any call under console control.

This new system is a far cry from the first PBX that Bell Labs designed 50 years ago. The 740A, which made its debut in 1926, featured a cordless "turret," compact enough to be

mounted on a desk. It used factory-wired switching equipment, thus reducing installation costs. Its first application, oddly enough, was not in the business community but in the residence of Edsel Ford, and its primary markets in the booming 1920s were large estates that needed many telephones and wanted equipment to harmonize with the luxurious decor of the times.

The "turret" is part of history now, but a good many of the other multiline systems that followed it are still in service. One is the 701A PBX, introduced in 1928 and still used today,

740A "Turret" PBX



*Trademark of the AT&T Co.

primarily for very large installations. It uses step-by-step switches which permit uniform installation and straightforward troubleshooting. Some of our early crossbar PBX systems, too, are still in service—the popular 755A, for instance, which first appeared in 1938 and bore witness to our continuing efforts in development despite the disastrously negative effects of the Depression. The 755A is a dial exchange handling 20 lines and was used with some of the first six-button telephone sets.

World War II diverted our resources to military development, but when it was over we returned quickly to the telephone business. One of the first products was the 555 PBX—a manually operated cord switchboard with a capacity of 20 lines and first to use plug-in units that minimize field maintenance and centralize repair.

Two PBXs in very different styles went into service in the 1950s. The post-war, revitalized economy, despite a sometimes up-and-down trend, was looking aggressively at the future and expansion was the byword of business. Customers wanted equipment with more versatility—but they wanted it smaller, too; office space translated directly into dollars. We responded first by designing the 756A crossbar PBX, for 20 to 60 lines, housed in two modular cabinets and featuring an attendant's console with pushbutton keys—the first such console since the "turret," small and attractive enough for table or desk-top mounting. For businesses anticipating future growth, we designed the 608A cord-type multiple switchboard, with flexibility as a major advantage: It can be used with or without dial equipment and can handle from 80 to 2400 station sets. The 608A,

when it was introduced, occupied less space than former systems, offered new services, and had modern, decorator styling. Pushbuttons replaced the usual lever-type keys, and plug-in units were used for all cord relays.

Also during the 1950s, the application of Bell Labs' famous brainchild, the transistor, produced extraordinary advances in the art of telephony. Bell Labs began the development of electronic switching systems for central offices, and customer-equipment designers capitalized on the new technology to bring to a speed-conscious market the No. 101 ESS. This system has a common-control unit in the central office and can serve several business customers in the 80- to 2000-line size range with switching units on the customer's premises. These local switching units are controlled over data channels by the central-office control unit. The No. 101 offered more features than any other system of its day, including TOUCH-TONE® calling, speed calling, conference calling, individual call transfer, and other custom calling features. It is still one of our most deluxe business services.

The 800A and its successor, the 801A, were introduced in 1966 and 1971, respectively. They offer the small size and quiet operation of electronics in a customer-premises unit. Serving from less than 80 to 270 station lines, these PBXs use modular principles in system, circuit, and physical design, including hybrid integrated circuits mounted on plug-in cards, and can include a large number of features. A smaller model, the 805A, introduced in 1970, is an inexpensive electronic PBX for customers who require only basic dial service.

The need for a new, economical, medium-

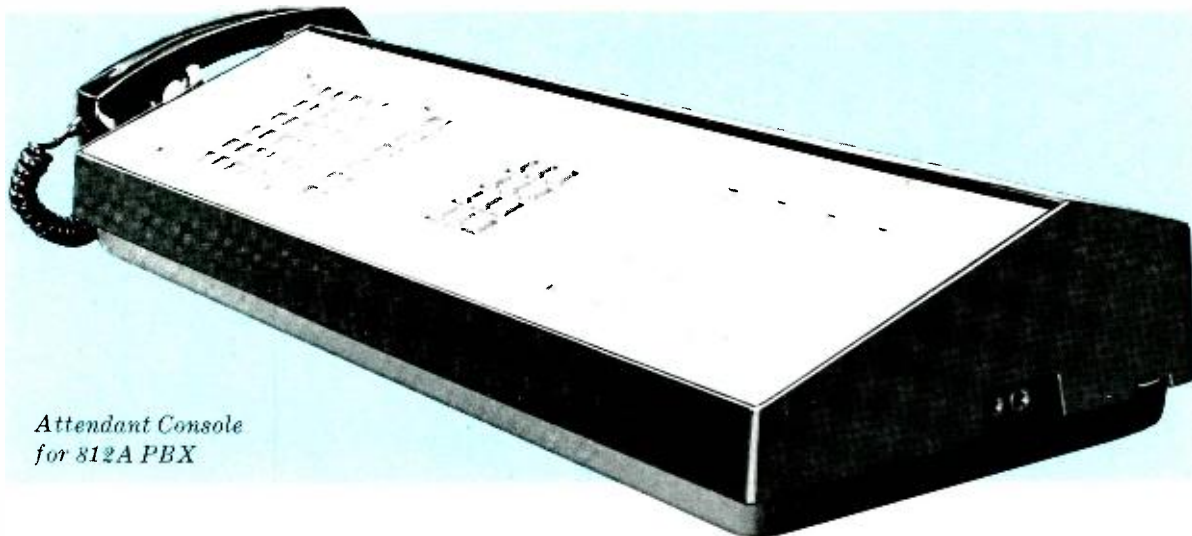

*Attendant Console
for 812A PBX*

size, general-purpose PBX prompted Western Electric to introduce the 770A in 1971. It has found widespread use throughout the Bell System. The 770A is a crossbar machine with an electromechanical common control. It offers an expanded complement of features, improvements in performance, and low cost.

The 812A PBX, introduced in 1972, is the first major system conceived and developed at Bell Laboratories' Denver facility. This was a tightly coordinated effort by Western Electric and Bell Labs and was accomplished in an extremely short development interval. This machine offers a full complement of features to customers requiring up to 2000 lines. It uses integrated circuits in its common control and miniature crossbar switches in its network. The 812A is enjoying a growing success with Operating Telephone Companies.

Our pace continues to quicken with the introduction of our most advanced customer switching machine, the new Dimension system mentioned earlier. The needs of business for future switching machines cannot be predicted accurately, but we certainly must continue to work to satisfy expanding requirements and to produce more versatile, trouble-free, economical communication equipment.

Before leaving this abbreviated story of PBX development, we should mention the PBX's sister service, called centrex. This system, introduced in 1961, brings to large customers services very similar to those of a PBX, but the individual stations are connected directly to the central office. The only equipment on the customer's premises are the stations themselves and attendant consoles with their associated control apparatus. Although a centrex system requires many more loops from the central office to the customer, the advantages in maintenance and the easy availability of features make it very attractive. Early in 1973 the Bell System introduced a simplified form of centrex (using the 50A Customer Premises System as the console equipment), extending the advantages of centrex service to businesses with a very small number of stations.

Another Plus: The KTS

A service closely related to PBX is the key telephone system, or KTS, in which more than one line is available at a telephone. Its name comes from the buttons, originally called "keys," with which users of these telephones perform switching operations. For many small

EXTRACURRICULAR ADVENTURES IN CUSTOMER PRODUCTS

In the early days of Bell Laboratories' existence, it was only natural that the expertise we gained through telephone research would result in pioneering contributions to other communications media. Inevitably, sideline pursuits would blossom, consistent with patent-license agreements and a self-imposed dedication to provide the world's best telephone system. In the climate of those early days, Bell Labs management visualized giving the public the benefit of any and all improved communication capabilities that grew out of telephone development. Wherever such systems or devices were clearly outside the telephone business, the cost of their development would be segregated and recovered through sale of the products or licenses to others so that their cost would not be borne by the telephone customer. And thus another form of "customer products" was born.

Bell Labs became involved in commercial radio design, specializing in high-powered transmitters, tubes, microphones, and loudspeakers—all manufactured by Western Electric. By 1926 there were 150 WE-equipped broadcasting stations. Hundreds of public-address installations had also been custom-engineered by this time.

These "diversions" outside the strict bounds of telephony were some of the first of a number of Bell Laboratories developments that had profound effects on the way of life of America and, indeed, of the Western world. For example, Bell System engineers designed the Orthophonic phonograph and, in 1925, Victor and Columbia were licensed to use its recording and reproducing developments. This reversed the declining popularity of the heretofore all-acoustically recorded and reproduced phonograph records, which had suffered from the public's enthusiasm for the new, more realistic quality of live radio. In time, these improvements, aided by the radio "disc jockey," restored

record popularity and revitalized the whole recording industry.

Without a commercial application in mind, Bell Laboratories also developed wire-line television, as an offshoot of efforts to add picture to sound for the telephone user. Its first public demonstration was in 1927 over a New York-to-Washington link. A natural parallel development, using many of the same principles, was to add sound to motion pictures—something others had been trying to do, without success, for many years. Unforeseen was the bear-by-the-tail situation that this would become for the Bell System.

The basic elements needed for this new endeavor, such as high-quality sound pickup and high-level sound diffusion in auditoriums, were already being applied in radio broadcasting and public-address systems before Bell Labs was established. AT&T and Western Electric scientists, who would become the staff of Bell Laboratories, had begun the development of electromagnetic disc recording and sound-on-disc movies. An ingenious motor-control system was designed that was, in many ways, a forerunner of the sophisticated “servo” systems of World War II. It admirably did the job of synchronizing camera and recorder, and projector and reproducer, when coupled with the clever and elaborate filtering mechanisms needed to make higher-frequency flutter undetectable at slow (33 $\frac{1}{3}$ rpm) turntable speed. And, because loss of synchronization was still a definite hazard in the disc system for other reasons—the strong possibility of film breaks, for example—a backup sound-on-film system was developed simultaneously with disc.

By early 1924 talking motion pictures were ready for practical application with sound on either disc or film, although greater experience with disc tended to favor that medium for initial commercial trial. But it wasn't until 1926, the year after Bell Laboratories was formally established, that the motion-picture industry reluctantly accepted sound.

The big producing companies were not only uninterested; they were antagonistic. The business was already very profitable—why rock the boat and incur vast new expense for studios and theaters? Directors, artists, and producers felt that the silent picture was a pantomime art in its own right and should not compete with the live theater. Besides, a huge inventory of silent films existed whose value would depreciate to zero if made obsolete.

Finally, a Western Electric employee in the Pacific Coast Radio Division negotiated the first contract. He knew that Warner Brothers was in

shaky financial condition and was losing ground to the other big producing companies, and he convinced them that pioneering “talkies” could be a lifesaver. They grasped at the straw, signed an agreement, and in April 1926 formed the subsidiary Vitaphone Corporation to produce the first sound picture.

In August 1926, “Don Juan,” a silent picture with synchronized-disc musical scoring, was run in several specially equipped Warner theaters. It received good notices from the critics, but this use of sound was not dramatic enough to impress the public. It took another year to erect sound stages and produce “The Jazz Singer,” released in October 1927. This time, synchronized singing and dialogue amply demonstrated the dramatic capabilities of the new medium. The success was huge, and the Hollywood panic was on.

To insulate itself, to some degree, from the peculiarities of the movie industry, and to avoid mixing the financing of commercial offshoots with the telephone investment base, in January 1927 the Bell System formed Electrical Research Products, Inc. (ERPI) to handle all facets of this obstreperous market. It became the Bell System's licensing agency and party to all contracts in the entertainment field. With the success of “The Jazz Singer,” everybody wanted in, so by May 1928 ERPI had agreements with all the big producers and most theater chains for recording and reproducing equipment.

Competition was not absent. Fox equipped its theaters with Western Electric reproducing machines, but its new “Movietone” was recorded on other manufacturers' equipment. Others entered the market—GE, Westinghouse, and RCA among them. By 1928, as many as 230 companies manufactured and installed theater sound equipment, some of it quite marginal in performance.

The frantic pace of the “Keystone Cops” might be compared with that of the next two years, for tooling and manufacturing by Western Electric and for installation and refinement by ERPI, which had to hire and train hundreds of engineers. By the end of 1930, all major studios and 13,500 theaters in the United States were equipped for sound, the majority using WE installations. The recording disc was completely supplanted by the sound track on the motion picture film, even Vitaphone succumbing to the editing simplicity of film.

As the U.S. market saturated, effort turned to other parts of the world, and ERPI's “talking pictures” became as well known as American soda pop. Half of ERPI became a theater-service organization, which AT&T sold in 1934. The other half, contracting as the Depression deepened, turned

to developing commercial products, in addition to vastly improving sound-recording equipment and techniques. With Bell Laboratories consultants, ERPI advanced the technology of such diverse products as 16mm sound equipment, photoelectric and high-speed camera devices of several kinds, watch timing equipment, acoustic measuring instrumentation, vertical-cut (hill-and-dale) disc recording/reproducing equipment, and airport surveillance recorders.

There was often glamour and always variety associated with ERPI's activities. For example, a musical library, created to demonstrate the superior quality of vertical-cut discs, became the foundation of Muzak (wired sound in stores, restaurants, etc.). Industrial and educational pictures were produced to sell 16mm sound. ERPI even took over a bankrupt motion picture studio, manned it with key personnel, negotiated contracts with big independent producers, and operated as the top such facility in Hollywood for eight years.

Finally, in 1937, the Bell System eased out of all these sidelines, selling them off. ERPI was reduced to Hollywood R&D activities which were obligatory under its license agreements, and to foreign operations. In essence, the commercial-products era of the Bell System was fading. ERPI was finally dissolved after World War II, and by the 1950s our extracurricular adventures were over. In today's climate, a Bell System trespass along such forbidden paths is unthinkable, but the roller coaster ride it took was a glorious adventure for those who participated.

(This material was extracted from a paper by John G. Matthews, who began his Bell System career with ERPI in 1928 and joined Bell Laboratories in 1942. He retired in 1972.)



customers, a key telephone system can supply most of the PBX functions. Key systems are also used extensively with PBXs; most business offices use key systems to make their PBX lines more versatile.

Key telephone is one of the fastest growing segments of the business-communications market. Western Electric now builds about two million line circuits for key telephone systems annually. The impressive surge of interest in KTS came after World War II, but the Bell System was offering single-set, multi-function service long before that. As a matter of fact, in the 1920s telephone-company installers were making special wiring arrangements to give customers pick-up, hold, and signaling features for a number of incoming lines. To do this, Operating Companies standardized a number of wiring plans, each having a fixed number of lines and stations and a fixed set of operating features. As customer needs became more complex, more plans were added, and in the 1930s AT&T standardized about 30 such plans for the Bell System. However, those arrangements did not meet all customer requirements, and telephone companies continued to engineer plans of their own which were usually variations of the standard schemes. (The New York company, for instance, had hundreds of locally designed arrangements.) These plans tended to lack flexibility and made installation, change, and removal difficult and expensive.

In 1938 Bell Laboratories replaced the cumbersome wiring plans with a family of station-switching arrangements using telephones with built-in switching keys and standardized equipment and apparatus. In this, the 1A Key Telephone System, separate units with specific capabilities could be assembled to give a customer the desired features—and thus, the “building block,” or modular, concept came into being. The 1A KTS was popular with the Bell System's customers and greatly simplified telephone-company operations. Later (after World War II), we improved the 1A system with the addition of illuminated buttons, or lamp signals.

The 1A1 Key Telephone System, which was brought out in 1952, extended the building-block flexibility of the 1A and made larger systems—over six lines—more compact, lower in cost, and easier to install. The 1A1 includes, among other features, two illuminated buttons, a winking lamp signal for lines being held, a dial intercom, and several factory-

wired packages of interconnected “Key Service Units” for various combinations of features.

The 1A2 System, a product of the 1960s, offers even more features, using solid-state devices and miniature relays in a modernized package. Today most of our key telephone customers use the 1A2; we have about 10 million such lines in service! And the ComKey* systems, introduced in 1973, bring together the most popular key-system features in packages that are wired and tested in the factory to further reduce installation costs. They also include many new features—voice signaling, for instance. ComKey systems can serve from 2 to 14 lines with up to 34 stations.

A still smaller system is aimed at the businesses that need four lines or less. For them, Bell Labs developed the Small Telephone System (STS), which offers key-system capabilities without the usual switching gear in a closet—everything is completely within the telephone sets. STS successfully completed field trials in 1974 and will become a system standard in the near future. The unit, designed with contemporary styling, has a “hands-free receive” feature and LED indicators for line status. This system is simple to install, and its smart packaging and popular features make it most attractive to small-business customers.

Bell Labs is developing further additions to 1A2 and the ComKey and STS telephone systems, as well as exploring new physical designs and new signaling systems—all aimed at anticipating and meeting the demands of a dynamic business community.

*Trademark of the AT&T Co.



A Station in the Small Telephone System (STS)

Model 2 Digital Subset

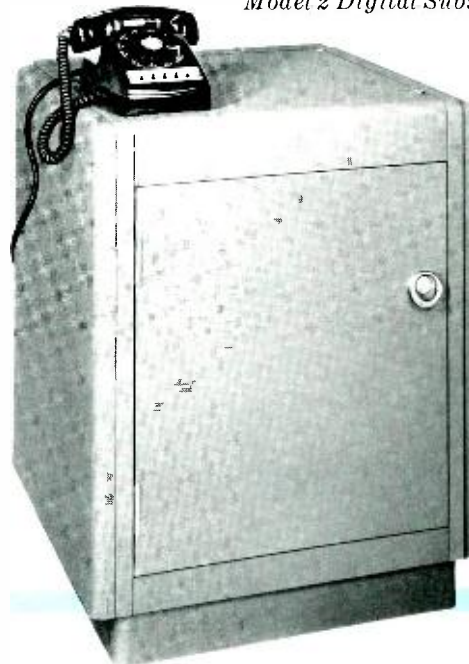

Newest: The Data Set

The youngest member of the Bell System customer-product line is the data set. Although conceptually the dial telephone was the first true data set, it was in the early 1960s that the Bell System introduced data sets as we now know them, and today Western Electric is producing over 100,000 sets per year.

The genesis of present-day data sets—and how they permit business machines to converse with each other over the Bell System’s voice facilities—is a tale in itself and must be detailed elsewhere. Here we can only note that data communication is a descendant of telegraphy, which had its beginnings about a century ago with the adoption of the Morse code. By the time of Bell Labs’ founding, the change from telegraphy to teletypewriters was well underway. The Bell System’s early emphasis was on the provision of full-time, private-line service, with Western Union and others offering public message service. In 1931 the Bell System inaugurated a public, switched, teletypewriter network, called TWX. This service was sold to Western Union 40 years later at the direction of the FCC. Early TWX systems used dc signaling, but later ac carrier methods became the immediate forerunners of modern data communications.

Bell Laboratories Record



209A (above) and 202S Data Sets

In the early 1950s, Bell Laboratories, responding to government needs, designed data-transmission systems for anti-aircraft direction and control. Some of the expertise applied to designing new systems for business came from those military developments. The Model 2 Digital Subset, brought out in the 1950s, was one early product of such effort—but today it seems like a big, clumsy box when compared to its modern, more versatile cousin, the 202S.

The name “DATAPHONE” was first used for data sets that interface with the dial switching network in the same manner as a telephone. These sets transform the data into a format that permits transmission over voice facilities and, at the receiving end, reproduce the original form of the information.

The Bell System’s 200 series data sets operate on voice channels at a variety of speeds, or data rates. The 202S transmits 1200 bits per second in asynchronous transmission; the 209A, 9600 bits per second. Even faster, the 300 series of equipment uses broadband facilities (wider bandwidth than a voice channel) to transmit data at rates up to 250 kilobits per second. The 400 series, which uses tone (i.e., voiceband parallel) signaling, trades off some of this high-speed capability for greater economy, serving businesses which originate relatively short messages.

The data sets now in service give only a glimpse of their potential. Today it is possible to transmit the text and control the printing of a newspaper by data signals from a remote location. In the foreseeable future, data sets may be used for a myriad of business and household monitoring tasks. Or they could give the customer the capability to control, via data signals, various functions of the home from a remote location (to turn on an air conditioner or adjust a furnace thermostat, for example). It would seem that data sets are destined to become an important part of our daily lives.

Soon, the Visual Telephone

Even though the transmission of voice and data signals has made tremendous strides in the past fifty years, another product being developed by Bell Labs, the PICTUREPHONE[®] Visual Telephone, has stimulated as much general comment and enthusiastic anticipation as any other member of the Bell System’s product line.

The 2C Picturephone set, now in limited use in Chicago, can do much more than transmit the image of a person. Bell Labs engineers have developed modifications to the standard set so that it can accommodate any of the many commercially available lenses to com-

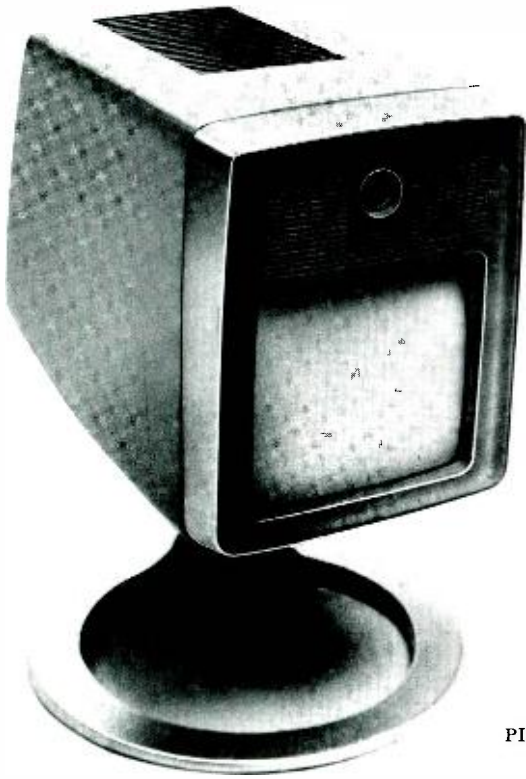

Mod 2C
PICTUREPHONE
Station

plement the fixed-focus lens of the standard Picturephone set to transmit such diverse images as 35-millimeter slides, electrocardiograms, charts, typewritten pages, and newspaper. The set can also be used to display data from a computer.

Herbert Hoover, the first user of video transmission, would be awed by today's developments. Hoover (then Secretary of Commerce) made the first video telephone call from Washington, D.C. to AT&T President Walter S. Gifford in New York in 1927 using equipment developed by Bell Labs. The Picturephone equipment of today is the direct descendant of that primitive system.

Bell Labs exhibited the first system to transmit and receive clear, recognizable pictures over ordinary telephone lines in 1956 before the Institute of Radio Engineers. By 1963 the advent of transistor technology made possible the development of a prototype Picturephone set suitable for commercial use.

This new Picturephone set drew enthusiastic crowds at the New York World's Fair in 1964, and that year the Bell System placed it into limited commercial booth service between New York, Chicago, and Washington, D.C. More modifications were made, new trials conducted, and by 1968 an improved "Mod II" was ready for experimental service between

AT&T headquarters in New York and three Bell Labs locations. By then the Picturephone set could transmit face-to-face conversations and images of written or printed documents. It could also serve as an interface between man and computer (the computer being interrogated from a Touch-Tone set with the results displayed on the Picturephone screen). Refinements to the Mod II brought us to the 2C set which was introduced into commercial service in mid-1970.

Although it seems clear that the Picturephone Visual Telephone will eventually become an essential tool for business customers and a vital means of communication for everyone, the present slow growth of commercial service has made us realize that the introduction of such a radically new means of communication presents its own set of special problems. The combination of relatively high costs and the dependence of the usefulness of the service upon the number of people having sets has presented us with a dilemma in the start-up phase.

In an effort to understand how to make video telephone service a viable, growing service, a special marketing organization has been created at AT&T to explore the needs of different market segments for visual communication. With Bell Labs support by development of a variety of possible video telephone systems for market exploration trials, it is anticipated that the combined effort will result in the Picturephone Visual Telephone—perhaps with color images—becoming an important communications service in the future.

First Video Telephone Call

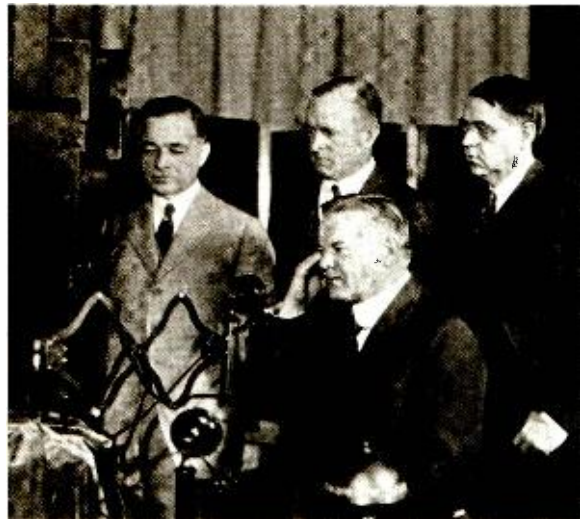



Desk Set ca. 1928



"500" Type Desk Set

Core of the Bell System

In the final analysis, though, the beginning and end of the telephone network is the telephone set itself—and 100 million telephones are the interface between the Bell System and its users. To them, the telephone *is* the Bell System. Our continued effort to improve the telephone set has multiple goals: to improve voice transmission; to expand its capabilities in the kind of services it performs; to provide a selection of attractively styled telephone sets that meet the personal needs and tastes of their varied users; and to make each version as economical as possible.

Today's telephone sets can do much more than the handset which came into general use during Bell Labs' early years. The current sets do a better job of transmitting voice signals, and some have optional features to make them more useful—Touch-Tone dialing and automatic dialing of frequently called numbers, for instance. They also come in attractive styles and colors to complement their surroundings.

The "300" and "500" sets, introduced in 1937 and 1949, respectively, brought with them not only new styling but better transmission and improved dials and ringers. The Bell System's PRINCESS® telephone set, brought out first in 1959, introduced a new concept in styling, built around miniature components. TRIMLINE® telephone sets, now second only to the basic 500 set in popularity, brought even more attractive styling, made possible by further advances in the design of components. The modular telephone, introduced just a year or so ago, incorporates a plug-and-jack design

to facilitate installation and replacement of cords and handsets. And the Bell System's new Design Line* telephones offer customers a number of decorator styles with the same proven components used in our other sets.

We have also developed special equipment for customers whose needs are special. Speakerphones offer hands-free and conferencing convenience for both business and residential customers. The Bell System introduced the 1A and 2A Speakerphones in the early 1950s, and the more generally used 3A model in 1958. These sets were adjuncts to the standard telephone. The new 4A Speakerphone combines the loudspeaker and telephone functions in a single unit and has markedly improved performance.

*Trademark of the AT&T Co.



*TRIMLINE Telephone with
TOUCH-TONE Dialing*



TOUCH-A-MATIC
Repertory Dialer

The first repertory dialing unit, the Card Dialer introduced in 1961, uses perforated plastic cards to “store” telephone numbers for future dialing. We advanced the design by using magnetic tape to increase storage capacity in the later CALL-A-MATIC® dialer. And the latest addition to this product line, the TOUCH-A-MATIC® repertory dialer, uses large-scale integrated circuits as the storage medium. This newest dialer, introduced in 1974, is much easier to use, has a lower initial cost than its immediate predecessor, and also promises much lower maintenance. It stores in its memory 31 telephone numbers plus a “last number dialed.”

Mobile Service Too

Americans are always on the go—and the Bell System is offering a service that can go with them. We are now developing a greatly improved mobile telephone system using a radio link between our ground station and the customer telephone in an automobile.

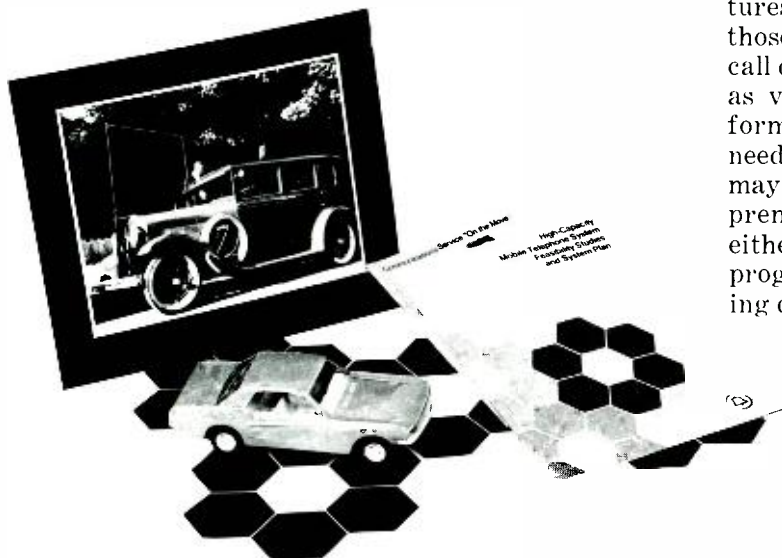

Coming: High-Capacity Mobile Telecommunication System

The history of growth of previous mobile systems has been slower than that of our other customer products, because of limitations on frequency allotments. The Bell System first offered mobile service in 1946, but it was confined to a narrow frequency band containing only a few voice channels. Improved systems have been developed and offered during the intervening period, but always with only enough spectrum for just a few voice channels. However, in 1974 the FCC allocated 40 megahertz between 800 and 900 megahertz for the wire-line common carriers, and another 20 megahertz was held in reserve. Such a spectrum gives us the resource necessary to implement our long-delayed plans for a nationwide, universal service for millions of mobile customers.

Today the Bell System has about 35,000 mobile customers, with long waiting lists in every major city. The new system now being developed will offer mobile service with wire-line quality and at economical rates in literally millions of vehicles. We have a fast-paced development project now underway, with a field trial planned for 1978.

Wide Horizons

The telephone is destined to become even more common than it is today. In the future, people will not need to be tied to the wire-line network to stay in touch. Advances in electronics could lead to such innovations as a telephone that can be carried in a shirt pocket or purse. The new mobile-telephone system offers the means for such portable telephones to connect to the switching network.

Businesses will have switching systems with greatly enhanced flexibility and many new features. These systems will combine the features normally associated with PBXs, plus those of key telephone systems and automatic call distributors. They will handle data as well as voice, route calls expeditiously, and perform other services tailored to the customer's needs. This complete communication service may operate from a machine on the customer's premises or from a nearby central office. In either case, it will be controlled by a stored program which can easily be adapted to changing demands.

Bell Laboratories Record

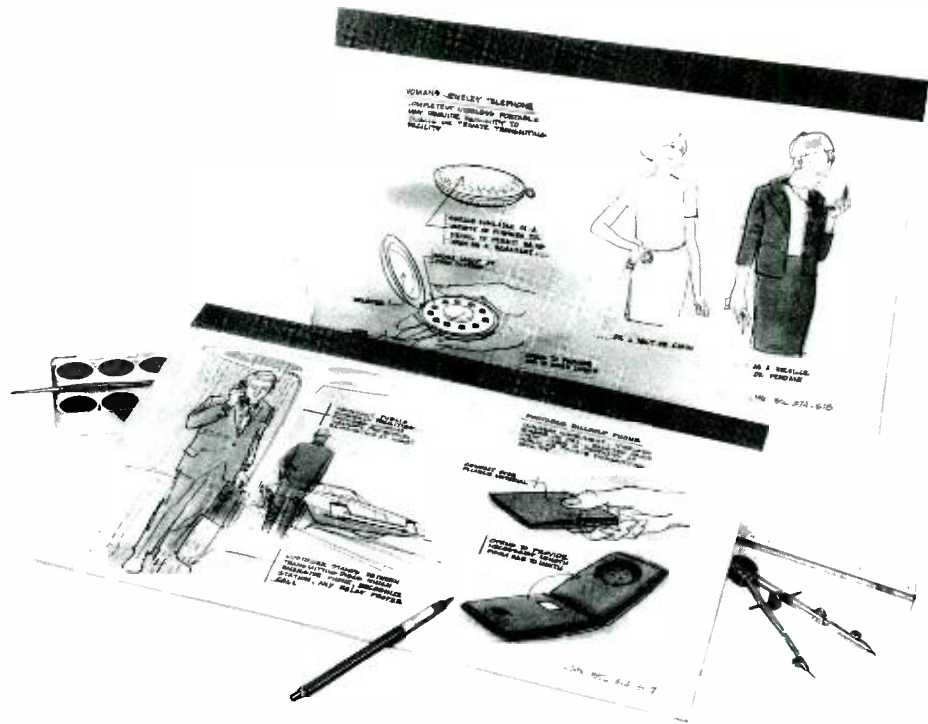

The many pressures on customer products in recent years has brought us much closer to our sister Bell System organizations. The Operating Companies are a constant source of information and consultation for us, and we work very closely with AT&T Marketing and Engineering departments to establish development programs and forecast needs. We integrate our design efforts closely with Western Electric to be sure that economical products can be manufactured in minimum time. This fruitful interaction has not only produced better products in shorter intervals; it has stimulated the creativity and productivity of Bell Labs engineers.

In this short story about customer products—a subject that has a long and rich history—we can only touch upon a few highlights of an extremely diversified category of equipment. It should be clear, though, that the customer-product field has evolved into a huge and rapidly changing business, with a few disappointments and many successes. We cannot predict the exact nature of its future, but we know the current growth trend will continue, and we will offer customer products that will help make life more productive, profitable, and pleasant.

Both the business community and the Bell System's residential customers are becoming more knowledgeable about the potential of communications, and more demanding in their desires for features customized to their needs. It is—as it has always been—the job of Bell Laboratories to anticipate these needs and to aid in the design and development of Bell System products and have them ready when the demands materialize. □

*Exploratory
Electronic
Key Telephone*

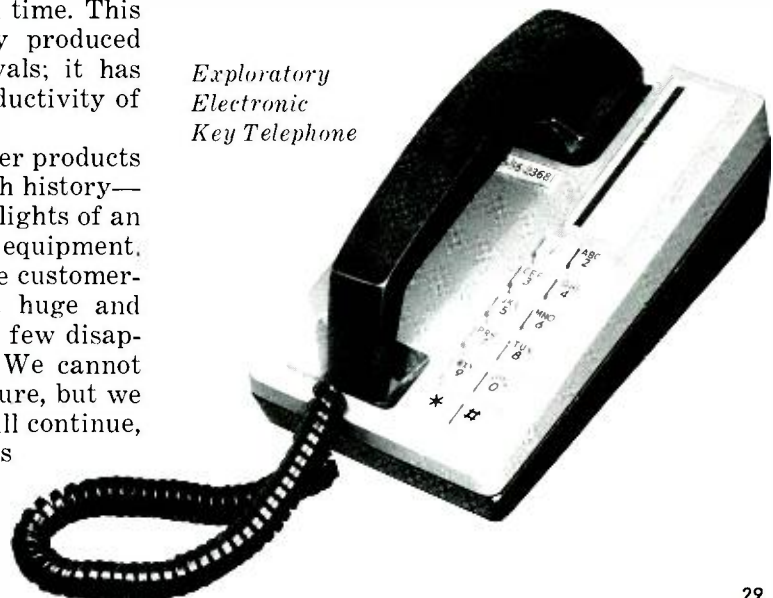

Switching

AMOS E. JOEL, JR.

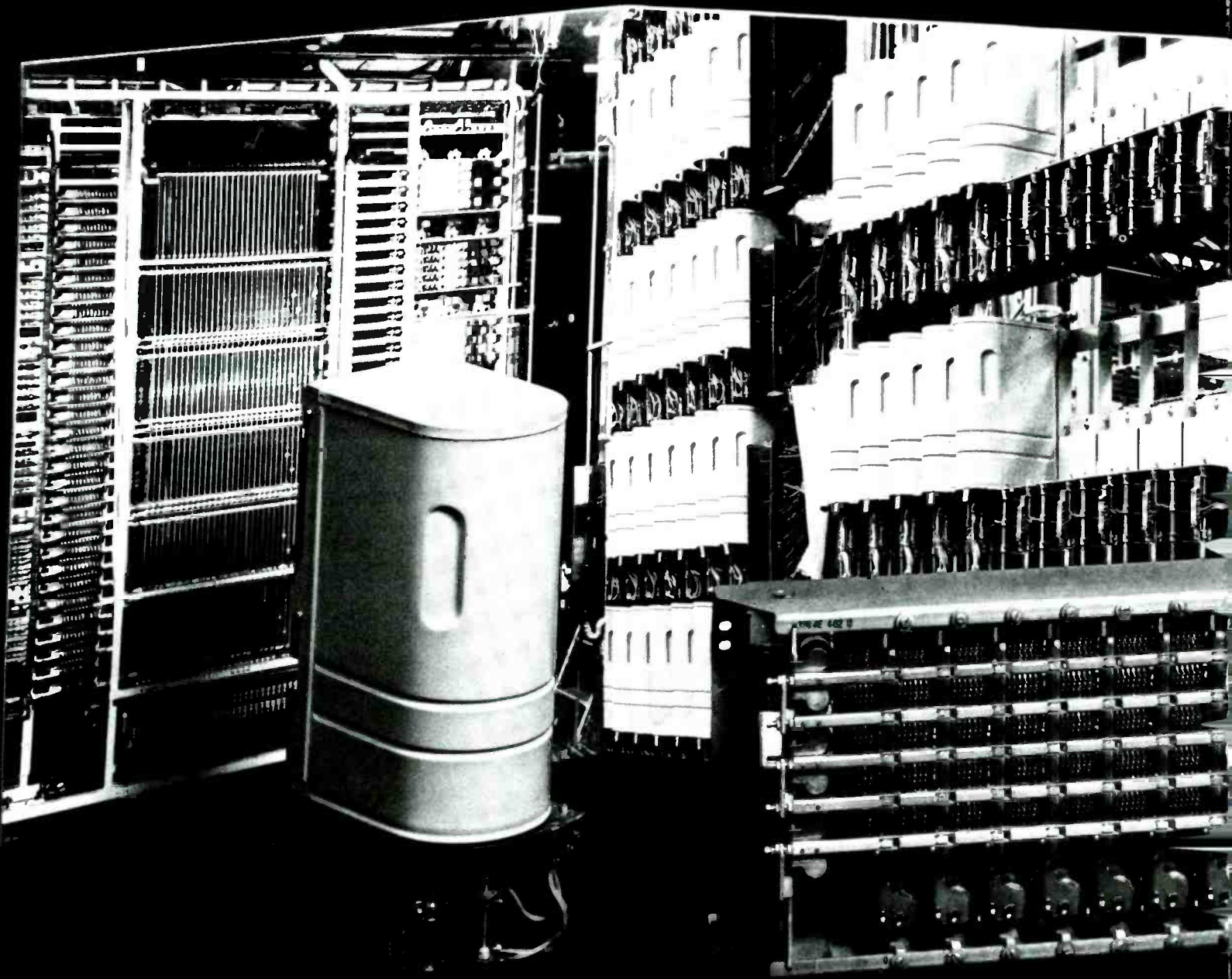

As demands on switching systems have grown, the systems have become less mechanical and more electronic, as exemplified by the evolution of switching from electro-mechanical devices (such as panel and crossbar switches) to semiconductor devices.

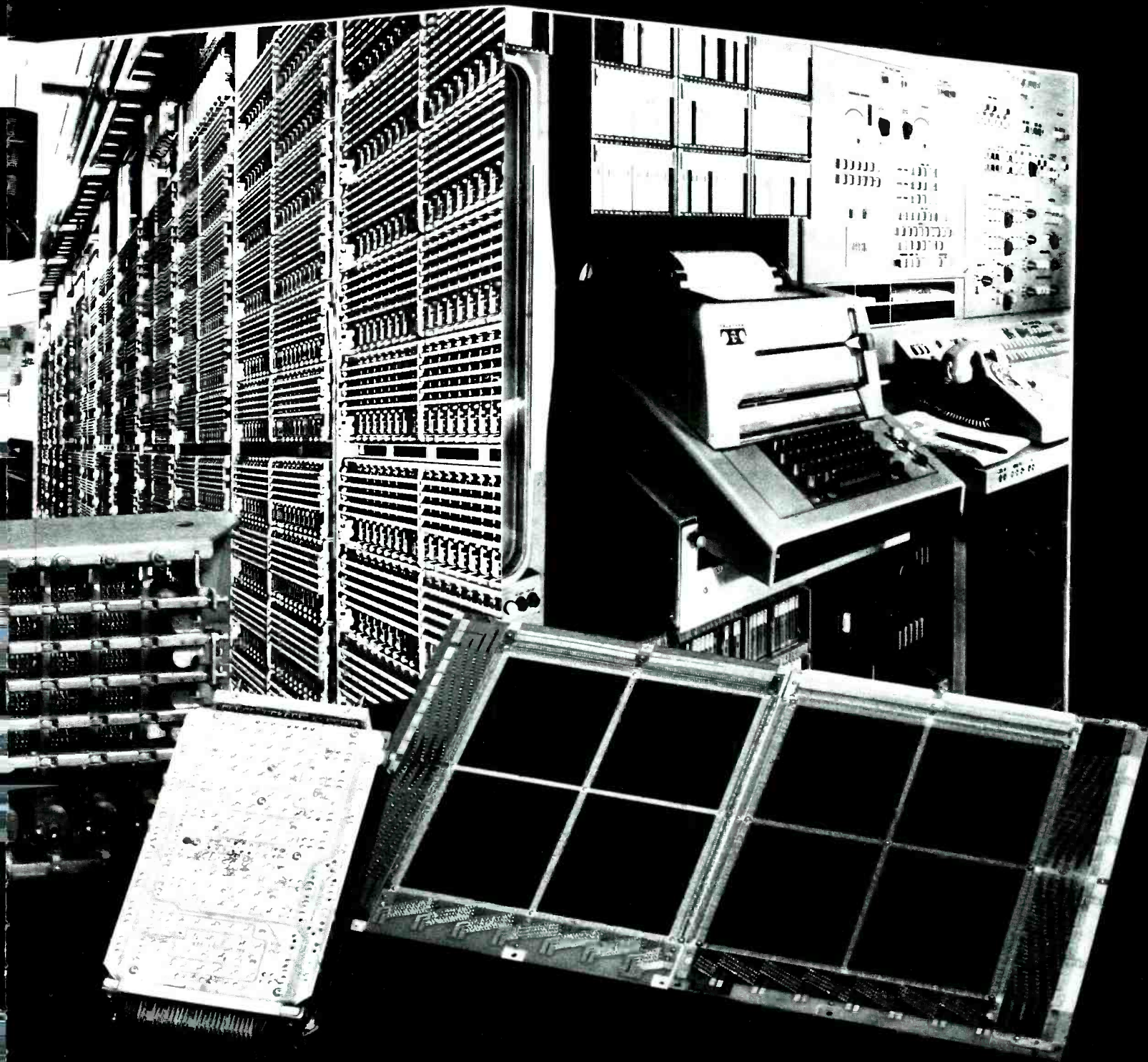

IN THE 50 YEARS of Bell Telephone Laboratories' existence, we have witnessed almost a complete life cycle of one important local automatic switching system—the panel dial system. Other switching systems such as crossbar and electronic are in different phases of their development. The first commercial dial system, step-by-step, is similar to panel but with a much longer commercial life cycle. Today, electronic switching is at about the same point in its development life cycle as panel was when Bell Telephone Laboratories was formed in 1925.

The switching technology of 50 years ago—indeed until the invention of the transistor—was unique to this phase of telecommunications. Selector switches, such as step-by-step, panel, and crossbar were designed specifically for the needs of switching. By comparison, electronics is a broader technology, one that applies to many fields in addition to switching. In this context, the current array of some ten varieties of electronic switching systems has provided a continuum of new technology for switching, rather than the discrete steps which were evident during the era of electromechanical technology (see “The Major Switching Systems,” page 38).

Fewer than one million telephone lines were switched automatically when Bell Laboratories was formed. Only about one-half million lines of this switching equipment was produced by Western Electric and all of it was of the panel type.

The larger cities were growing and the demand for telephone service expanding rapidly. The community of interest in these cities was widespread so that networks with large trunk groups were needed. It was realized that the wide variation and size needs could be better served by a large access selector (the

panel switch has 500 terminals with a maximum access to 90 trunks in a group as compared with the 100-terminal, 10-trunk access of the step-by-step switch).

The panel switch provided a low-cost, large-access selector with a minimum of individual parts. The selectors were rods with multiple (five) brushes that moved over vertical flat banks of terminals. Up and down movement was provided by electric motor drives that served one or more frames of 60 selectors.

To control these selectors, an early Bell System invention was employed: the register-“sender,” which stored the number dialed by the caller. After consulting a mechanical translator, the “sender” used a signaling method that positioned the selectors by a servo or reverse control known as “revertive” pulsing. Fundamental to the panel system's use in large cities was the ability of its senders to send forward to an intermediate or tandem office by another form of pulsing the complete called number, including the office code.

The development and use of the panel system had reached an advanced state at the time

Bell Laboratories was formed. But with a radically new technology such as that introduced into switching by the panel system, it is not unusual for a succeeding generation of equipment to be developed—a generation that builds on the experiences and improves the cost and features of the original system.

One of the first new switching systems to be developed under the Bell Laboratories masthead was known as the BCO panel system. (BCO means “battery” on the winding of the “cut-off” relays of the customer line circuits.) In this system, individual small stepping switches provided for each line were replaced by frames of panel selectors each of which served several hundred

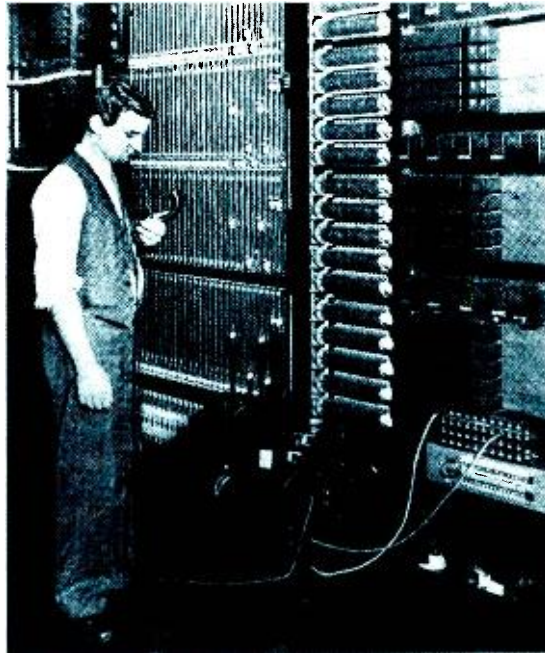

In 1925, when Bell Laboratories was founded, the panel switching system was a radically new technology that would go through a series of refinements to improve cost and performance over the next several years. Pictured here is an incoming selector frame and panel system.

lines. These were known as "line finders." The small stepping switches and mechanical translators used in the register-senders were replaced by relay storage and translator circuits. The translation was performed by a small group of relay circuits known as "decoders," which served an entire office since they required only 0.3 second to serve each call.

Other improvements enabled the panel system to be fabricated more economically, extended the signaling reliability and range, and improved the system's interworking with remaining manual offices in metropolitan areas.

The step-by-step system was also improved at Bell Laboratories to permit large-scale production by Western Electric, and to incorporate new design standards, many of which were learned from laboratory and field experience with the panel system. One important innovative concept which was adapted from the improved panel system was the line finder. Here, by adding a vertical commutator (a feature of the panel switch) to the step-by-step switch and by employing a simple common allotter circuit, engineers could replace the earlier switches which were required for each line to reach the first stage of step-by-step switching.

The adaptation of step-by-step in the Bell System fostered the development of the many features required for universal application to serve very small towns as well as to serve in moderate-size cities (some of which, like Los Angeles, became metropolises). Trunks to connect the smaller installations with distant switchboards required features for the remote control of coin telephones, for line-busy verification, and for serving inward and outward toll calls. An intensive period of signaling improvements ensued, at first based on direct current methods, but culminating with the development in the 1940s of tone (single frequency and multifrequency) signaling, which could be sent reliably as far as the voice.

Having established the viability of complex automatic switching systems, Bell Laboratories system designers pressed forward for further automation, recognizing that the same incentives of growth that spelled the end of manual local switching would also occur in toll switching. As systems became larger and more reliable, the trends toward greater automation were recognized in the need to detect and locate troubles when they did occur. The reliability of complex relay circuits was proved by the all-relay panel senders and de-

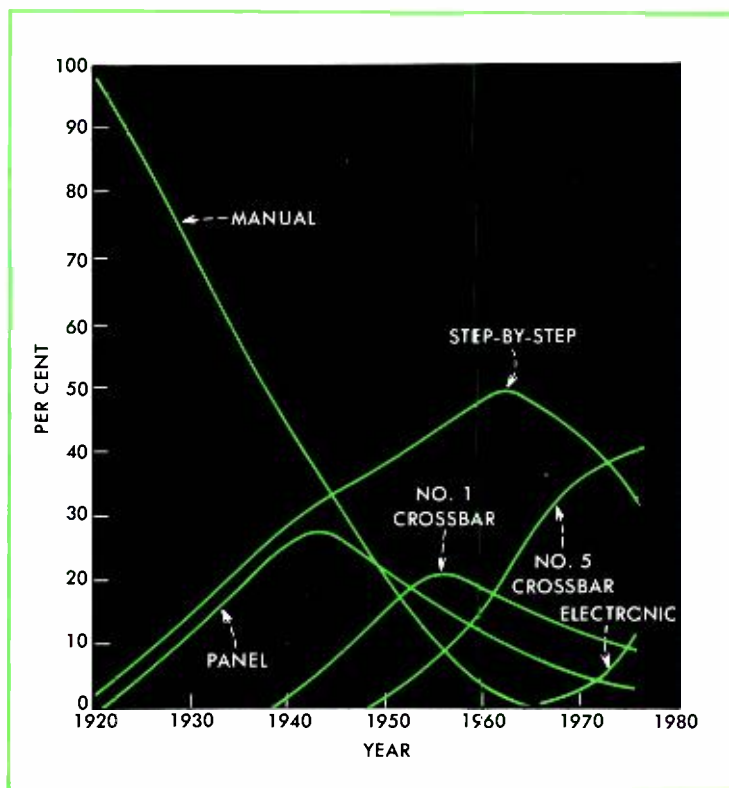

Switching system designs have life cycles. The successive generations of manual systems, from magneto to so-called "feature" common-battery switchboards, were replaced by automatic systems. Each new system is developed, supplemented to improve its performance and reduce its cost, and eventually superseded by the application of new technology.

coders. An earlier system experiment known as the "coordinate system" demonstrated that selector matrices with small-motion relay-like contacts could provide switching with less routine maintenance and without the noise produced in telephonic transmission by large-motion switches with phosphor-bronze contacts.

Crossbar

By the early 1930s the coordinate principle was adapted in a small unit known as the "crossbar switch." This switch was part of a new generation of relay apparatus (a new technology, if you will) using bifurcated (twin) precious-metal contacts to further improve reliability by reducing the probability of open contacts.

In switching systems, connections are established through a network of successive stages of crossbar switches. These switches are controlled by complex relay logic circuits that are designed on the self-checking principle with a second trial, preferably with different control circuits, if the checks fail and

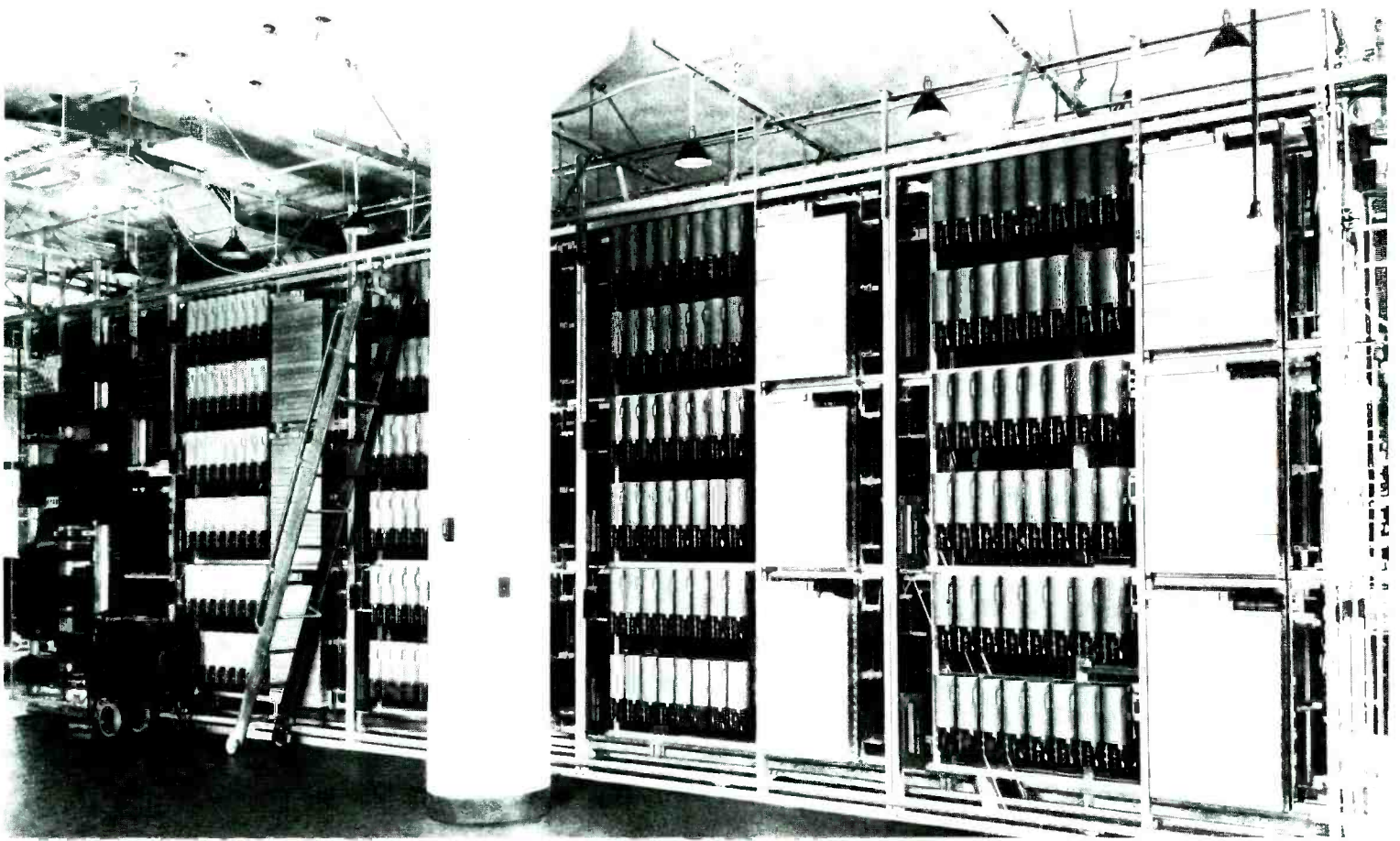

The step-by-step switching system, circa 1928, brought the advantages of automatic dialing to small towns and medium-size cities. Shown above are line-finder frames in a step-by-step

central office. Each group of 200 lines could be served by 16 line finders. The trend to ever smaller mechanical motion in switching is evident in the crossbar system, which used new

also with an automatic lamp indication when the troubles occur.

Large multicontact relays were required so that the connections could be extended to control the individual crossbar switches. To provide sufficient call-carrying capacity, a plurality of control circuits (called "markers"), functioning in less than 1 second per call, were required to operate simultaneously within the same switching network.

The marker has the ability to select an idle trunk to the desired destination before establishing a connection to it. This enables the routing of traffic to a tandem office if all direct trunks to the called office are busy. Similarly, for terminating calls no connection is established until it has been determined that the called line is idle. This permits heavy call volumes to be distributed to large PBX trunk groups without establishing connections to each trunk to determine its busy or idle condition. Traffic could then be spread evenly over all switching equipment, independent of the telephone numbers assigned to the customers.

The first, or No. 1, crossbar system, placed

in service in 1938, was designed for large city offices. The design concepts developed for this new system proved to be so attractive that systems were devised to cover the entire range of applications, with the hope of eliminating the need for extending step-by-step switching. The initial smaller systems such as the No. 380 Community Dial Office (CDO) and the No. 2 crossbar for suburban offices did not prove economically feasible. Work to find a viable solution to the problem was interrupted by World War II.

Tandem Offices

However, the application of crossbar technology to the tandem offices provided many important new advantages. More offices could be reached than was possible with panel office selector type tandems, since the signaling no longer had to represent panel selector settings. Since, in general, tandem offices reached more distant points in large metropolitan areas, it was possible to provide at that central point a remote charging arrangement for operating subscriber message registers in the local of-

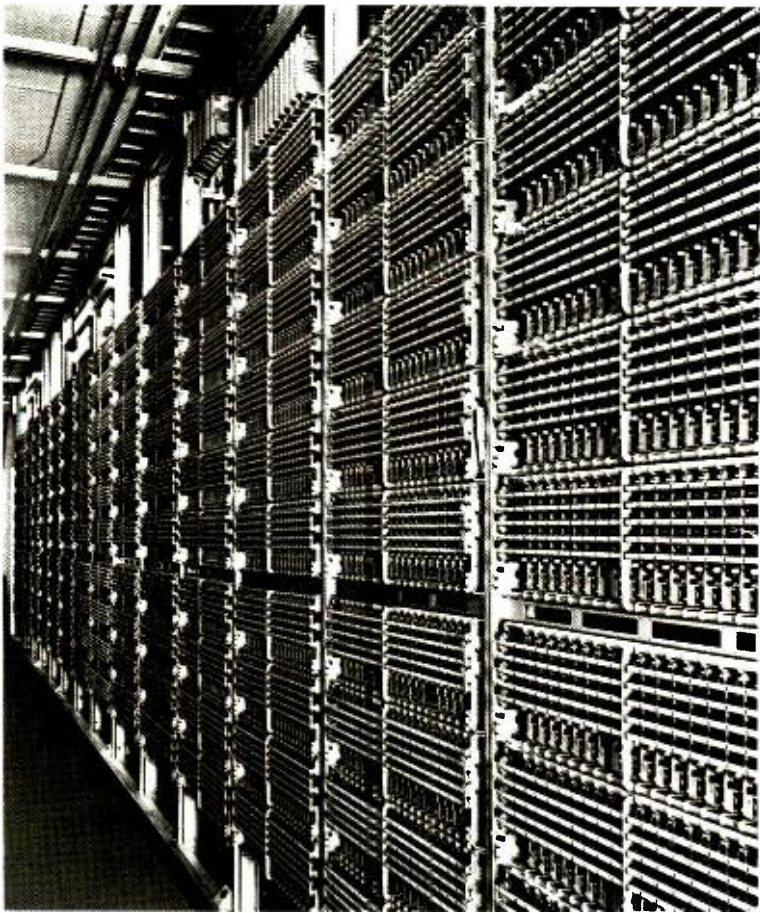

relay technology. The first system went in service in 1938. By 1948, when the photo at far right of a No. 5 crossbar switching maintenance center was taken in Media, Pennsylvania,

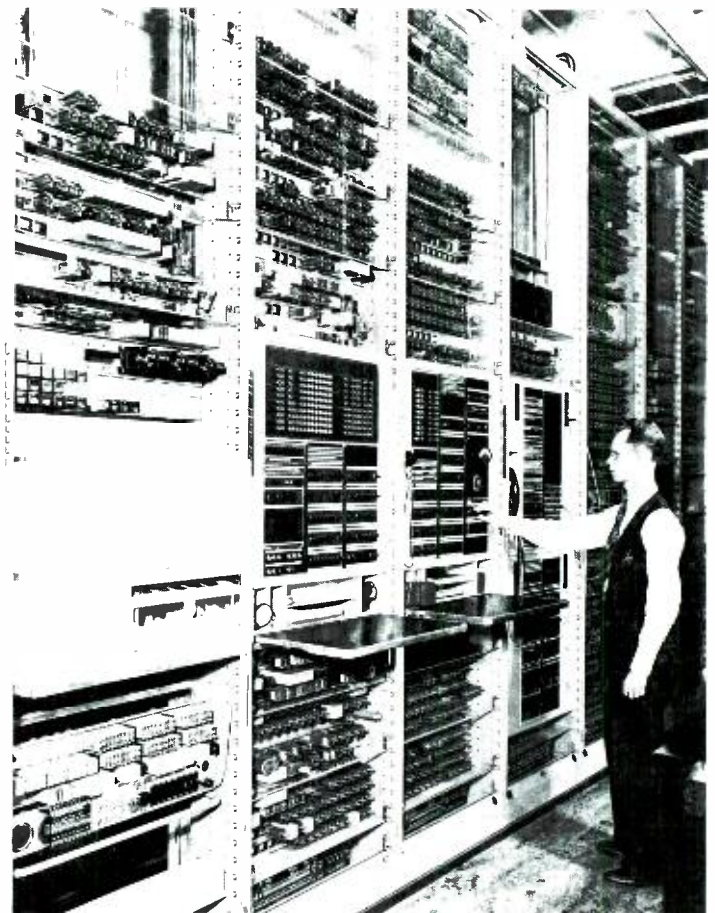

crossbar switching had been progressively improved to include such revolutionary features as automatic charge recording and signaling by tones. Center photo shows crossbar switch bays.

office for those calls that require initial charges of more than one unit.

With the increase in dialing range available with tone signaling, a system for automatically ticketing longer distance calls originating in large step-by-step offices—including register-senders and Automatic Number Identification (ANI)—was developed and placed in service in 1943.

The close working relationship at Bell Labs between transmission and switching engineering, together with the unique properties of crossbar technology, led to an elaborate plan to introduce nationwide operator toll dialing. In addition to providing quiet transmission, crossbar switching made possible four-wire connections that eliminate the need for the two-wire to four-wire hybrids required when carrier transmission systems are interconnected through two-wire switching systems.

The No. 4 crossbar system provided initially for four-wire switching under the control of operators. Where distant operators could not dial directly into the system, operators at switchboard positions (where calls are han-

dled by keys instead of by cords) placed the called number into the system. The system also provided means for signaling to all types of switching offices, including (1) the ability to add and subtract digits on calls to and through step-by-step offices, (2) automatic ringing (ringdown signaling) on calls to inward manual toll switchboards, and (3) the ability to control transmission loss by the automatic insertion of attenuators (pads) and amplifiers (repeaters).

During and after World War II it became evident that, while local switching for major urban centers had been automated, the manual suburban offices, which were growing rapidly, also needed to be automated. To enable these offices to route traffic to the central city two features were required—a form of automatic charge recording and signaling flexibility to operate with all types of systems in the city and in the rural areas adjacent to the suburbs. It was with these requirements in mind that the No. 5 crossbar system emerged. It was first placed in service in 1948, and has become so successful that it stimulated the introduc-



tion of worldwide crossbar switching. The message recording on a continuous paper tape, which included a means for translating from equipment number to directory number, is now known as Automatic Message Accounting, AMA, and as the name implies, included an accounting center. The first No. 5 crossbar office included a trial of pushbutton dialing.

With the availability of AMA and tone signaling it was now possible to implement a plan for nationwide customer dialing of toll calls with the objective of decreasing call completion time from 50-85 seconds to 12-20 seconds. The No. 4 crossbar system was modified to provide multiple alternate routing so that calls could be routed over a four-level hierarchical network. End offices not equipped with AMA were modified to furnish calling line (ANI) information which was sent forward to centralized AMA tandem or toll switching centers.

In the early days, automatic switching for large cities was made practicable by the addition of letters to the dial to aid users in remembering and dialing seven digits. In a similar sense more sophisticated system planning created the area codes and the means for their interpretation to permit nationwide dialing. A translator was developed—the first application of transistors in the Bell System—to simultaneously interpret the area and central office codes (six digits). This became the No. 4A crossbar system, an improved design which was based upon the earlier pre-war development.

Today the general public dials 30 million calls over a nationwide network daily. The network was made possible by the culmination of the developments just described, namely, the nationwide numbering plan; common control switching with provision for the sophisticated interpretation, translation, and generation of the digits needed to complete calls by any one of several routes through succeeding offices; a method for recording call billing information; and signaling methods that could reach across the nation rapidly.

Electronic Devices

For years switching engineers had had a growing desire to replace switching contacts with electronic devices, which had been employed much earlier in transmission. This was difficult because of the high cost and power

dissipation of vacuum tubes. The invention of the transistor further stimulated Bell Laboratories engineers to reach this goal. New ideas poured forth. At no other time since the first exciting days of automatic telephony had switching research and development been so stimulated and productive. The principles of one-at-a-time divided control as well as the time-divided connections in the switching center network were fully explored. Mass memories using magnetic drums, storage tubes and photographic plates read by cathode ray tubes, known as "flying-spot stores," all were combined to provide the technology for the first electronic central office development.

For the talking path the application of transistors was explored. But gas diodes, at the time, appeared to offer greater operating margins.

Stored Programs

But, over the years, automatic switching had changed. No longer was automation the only objective of switching system design. The switching system, particularly as applied to the needs of the Bell System, was the center where the features and services were implemented. And the list of services and features was growing rapidly. At this point the most important contribution in the use of electronic technology was conceived by Bell engineers. It has become known as Stored Program Control or SPC. SPC for the first time enabled the implementation of the service requirements of the system to be divorced from its equipment and circuit implementation. Now, the ever-growing complexity of features and services was organized using the data processing technique of programming. With SPC systems, however, unlike commercial data processing systems, the programs are required to perform functions in real time.

Taking advantage of the speed of semiconductors reduced the number of system controls, thereby saving space. But reducing the number of system controls also provided a challenge: that of designing and building a system that can remain in service throughout its life—24 hours each and every day—as the system is expanded, as customers are connected and disconnected, as the program is changed and updated, and as components fail. This challenge has been met successfully.

As development of electronic switching progressed, the modern crossbar systems became a moving target for the developers of

The electronic switching systems of the 1960s exploited the data processing technique of programming to offer unprecedented speed and reliability, and a host of new services that can be added by modifying the program. This fisheye-lens photo shows frames in a typical No. 1 ESS office.

THE MAJOR SWITCHING SYSTEMS

As the art and technology of switching have progressed throughout the 50 years of Bell Laboratories history, important changes have taken place in two important areas:

1. Switching systems have, with time, required less and less mechanical motion to make and break electrical connections. As more sophisticated electrical (and now electronic) circuitry was introduced, speed of operation increased.
2. Common control—still in its rudimentary form in 1925—has increased greatly in its power to control switching networks with high efficiency.

The concepts employed in the switching hardware have changed radically:

Step-by-step—essentially a direct-control system requiring considerable movement of multiple contact arms to establish a switching path through a central office.

Panel—still required large-scale motion of contact arms to establish connections. But with the introduction of senders (temporary memories) and number-translation, the panel system incorporated an early form of common control. With this added feature, complex electrical functions needed only for brief periods during a telephone call are not held out of service for the duration of the call, but are instead used in rapid sequence to service many calls.

Crossbar—in a crossbar switch, the mechanical motion needed to establish an electrical connection is reduced to a very small amount. Two arms, each rotating through small angles, make connections at any x-y position in a coordinate array and thus speed up the operation of a switching network considerably. Several calls may share the same switch at the same time. In addition, the common-control units greatly extended the power and versatility of crossbar systems.

Electronic (local)—with the development of Electronic Switching Systems, or ESS, use is made in the switching network of glass-enclosed reeds: small strips of metal which, in their protected environment, operate reliably at high speed upon the application of magnetic fields. In ESS the concept of common control advanced to the idea of Stored Program Control (SPC)—an all-electronic control which is revised by reprogramming techniques instead of by physically re-wiring circuits. With SPC, as pointed out in the accompanying article, the requirements for a central office are divorced from the office's specific, physical items of equipment.

Electronic (toll)—in the new No. 4 ESS, even less mechanical action is needed than in local ESS. Network switching (of pulsed codes representing speech signals) takes place to a large extent in all-electronic form. No. 4 ESS is scheduled for first commercial use in 1976.

electronic systems. With each passing year more features and services were developed, such as TOUCH-TONE® calling, centrex service, call waiting service, centralized AMA, Wide Area Telephone Service (WATS), mechanized teletypewriter exchange service ("TWX"), common control switching arrangements for private line services, prepay dial-tone-first coin service, 911 emergency service, and automatic call distribution for bureaus with a large number of incoming calls.

At the same time, the technology of electro-mechanical switching was improved. Wire spring, miniature, and reed relays and smaller crossbar switches were developed.

In the 1960s stored program electronic switching emerged. The Morris, Illinois, electronic central office in 1960 was the precursor. The Morris office proved not only the feasibility and advantages of SPC, but also the adaptability of electronic switching to offer new services—such as abbreviated dialing and automatic call transfer—more economically than is possible in electromechanical systems.

Electronic Systems

The floodgates of new electronic systems for production opened after Morris, each with a new application, and many with new technology concepts. The last vestiges of electron tubes used in Morris were eliminated by magnetic memories for the semipermanent program, translation information, and for the storage of call information.

No. 101 ESS provided remote time-division switching units under centralized stored program control in 1963. No. 1 ESS made its debut as a standard commercial system in 1965 and spawned many new variations, differing primarily in the programs used for control: a four-wire military leased service system, a centrex system, a system with preprocessing (i.e., a signal processor) to more than double the system call-attempt capacity, and a system for store and forward message switching, called No. 1 ESS Arranged with Data Features, or ADF.

The same principles and much of the same technology were applied to a smaller version of ESS, known as No. 2, and to an operator system known as a "Traffic Service Position System," or TSPS, using a console developed earlier for use in the crossbar tandem switching system. The processor for No. 2 ESS was also used in an audio response system for automatic call intercept (Automatic Intercept

System, or AIS), while the processor for TSPS was also used for applying Stored Program Control to the No. 4A crossbar as an electronic translator.

Even today, the stored program control concept is being applied to existing electromechanical switching systems to improve their performance. Examples are new systems for traffic data gathering, AMA magnetic recording, maintenance data recording, and centralization of maintenance functions.

The application of electronics to switching has introduced a new era in switching development. The subsystems of which SPC systems themselves are composed evolve as technology that offers lower cost, greater flexibility, smaller size, and improved performance becomes available.

The devices used in electronic switching center networks were originally unique magnetic latching reed contact relays known as ferreeds. The magnetic path for these devices is external to the contacts. Now devices called remreeds are used, with the magnetic path in the reed contacts.

Similarly, the call stores in the systems originally used a form of magnetic storage known as "ferrite sheets," but now magnetic cores are employed. Similar evolution is taking place in most hardware, with new central processing units using integrated circuits currently under development for both No. 1 and No. 2 ESS. These will more than double the call attempt capacity of each system.

In the late 1950s, as the fruits of research were being applied to the first generation of Electronic Switching Systems, the concept of digital time-division switching was explored.

As the Bell System plant introduced more digital transmission and as higher-speed integrated circuits became available, a new switching system has emerged for switching in the growing digital transmission environment. This is No. 4 ESS, scheduled for commercial service in 1976.

The Future

This development points the way to the future. No. 4 ESS is a system of very large capacity and takes full advantage of the latest in technology, SPC techniques, and centralized maintenance. No. 4 ESS offices, together with No. 4A crossbar offices equipped with SPC, will be able to communicate with one another by a common signaling channel, thereby eliminating the need for signaling over the trunks used for individual calls. Thus, we have come full cycle, since under a different name, such "call wires" were employed in the early manual switching systems.

Whether the ideas and technology are old or new, Bell Laboratories engineers have during their past 50 years provided a stream of developments to cope with, and usually to anticipate, the needs of an ever-growing and increasingly complex switching service of the American telecommunications network. Just as panel switching enabled the Bell System to provide automatic switching in the large cities, more than 1000 SPC systems are now providing or ready to provide for the complex service needs of the future. From the foresight and plans of Bell Laboratories engineers has grown the great network of 12,000 switching entities, 5.5 million trunks serving 65 million lines. □

CHRONOLOGY OF BELL LABORATORIES DESIGNED AUTOMATIC SWITCHING SYSTEMS

1921—Panel—Ground Cut-off
1925—*Coordinate System
1927—No. 350A, 360, and No. 1 Step-by-Step Systems
1928—Panel—Battery Cut-off
1938—No. 1 Crossbar
1939—*No. 2 and 380A Crossbar
1939—No. 355A Step-by-Step System
1940—Crossbar Tandem
1942—No. 4 Crossbar—Operator Dialing
1943—Automatic Ticketing
1948—No. 5 Crossbar with Flat Spring Relays
1952—No. 4A Crossbar—Nationwide Customer Dialing
1956—No. 5 Crossbar with Wire Spring Relays
1960—*Morris Electronic Central Office
1962—No. 5 Crossbar System—4-Wire

1963—No. 101 ESS
1965—No. 1 ESS
1965—Step-by-Step Common Control System
1966—No. 1 ESS—4-Wire
1967—No. 1 ESS — Signal Processor
1967—No. 1 ESS—Centrex
1969—TSPS No. 1
1969—No. 4A Crossbar Electronic Translator
1969—*No. 1 ESS Arranged for Data Features
1970—No. 2 ESS
1971—Automatic Intercept System No. 1A
1972—No. 5A Crossbar
1974—No. 3 Crossbar

—————
*Not placed in production.

Compact low-cost electronics, new cable materials, and advances in the minicomputer art have been keys to improved transmission, to economic digital carrier techniques, and to transmission maintenance and controls.

Exchange Area and Local Loop Transmission

WARREN E. DANIELSON

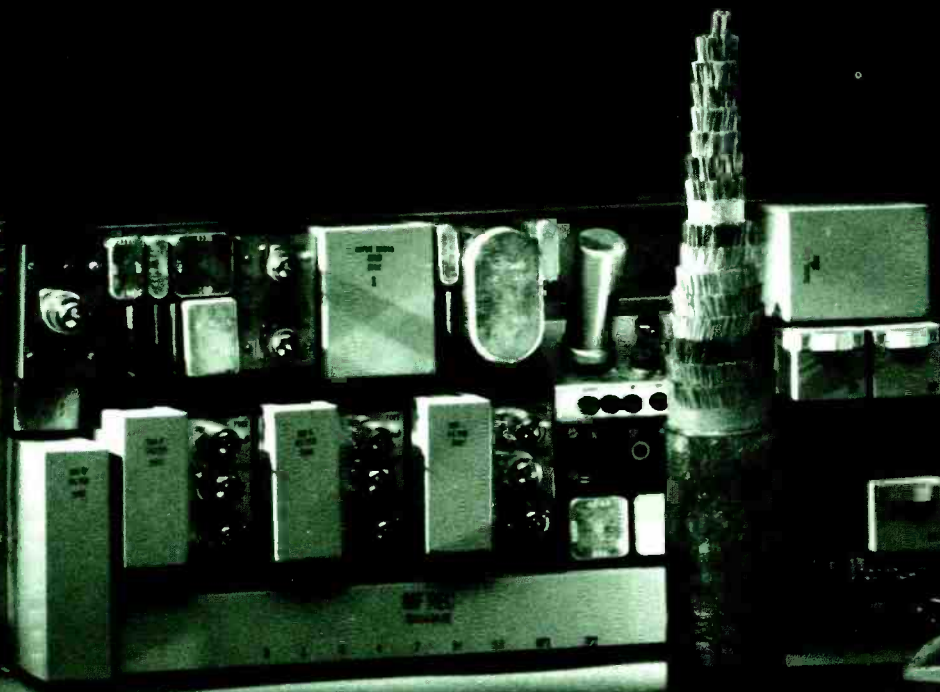
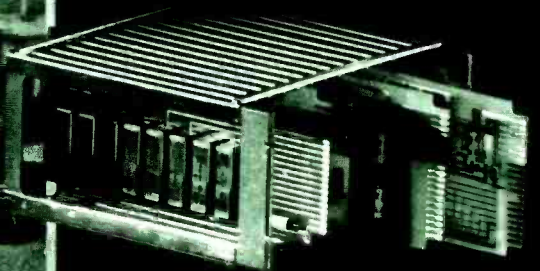

ME 10 11 50
ME 10 12 50
ME 10 13 50
ME 10 14 50
ME 10 15 50
ME 10 16 50
ME 10 17 50
ME 10 18 50
ME 10 19 50
ME 10 20 50
ME 10 21 50
ME 10 22 50
ME 10 23 50
ME 10 24 50
ME 10 25 50
ME 10 26 50
ME 10 27 50
ME 10 28 50
ME 10 29 50
ME 10 30 50
ME 10 31 50
ME 10 32 50
ME 10 33 50
ME 10 34 50
ME 10 35 50
ME 10 36 50
ME 10 37 50
ME 10 38 50
ME 10 39 50
ME 10 40 50
ME 10 41 50
ME 10 42 50
ME 10 43 50
ME 10 44 50
ME 10 45 50
ME 10 46 50
ME 10 47 50
ME 10 48 50
ME 10 49 50
ME 10 50 50

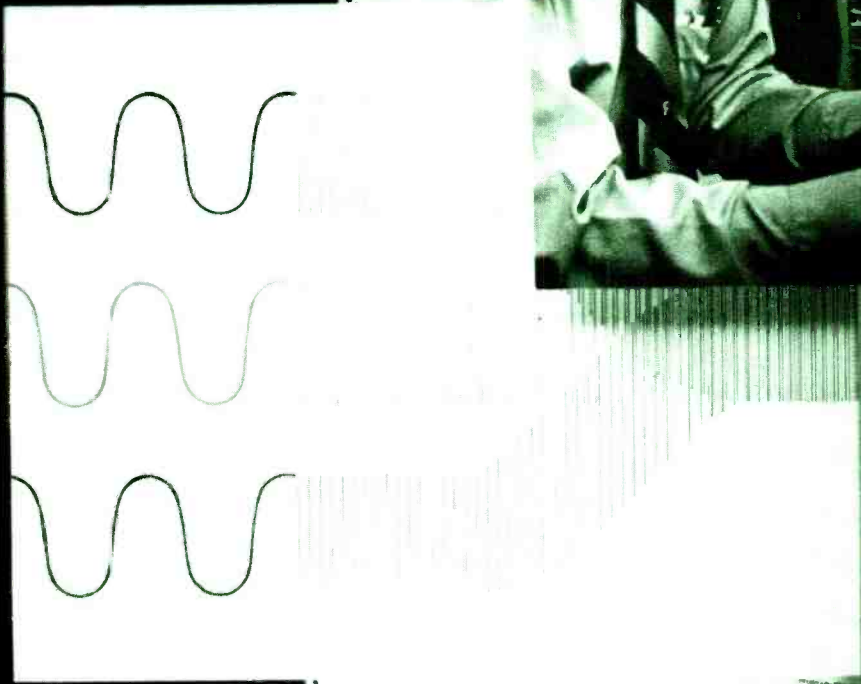

ME 10 11 50
ME 10 12 50
ME 10 13 50
ME 10 14 50
ME 10 15 50
ME 10 16 50
ME 10 17 50
ME 10 18 50
ME 10 19 50
ME 10 20 50
ME 10 21 50
ME 10 22 50
ME 10 23 50
ME 10 24 50
ME 10 25 50
ME 10 26 50
ME 10 27 50
ME 10 28 50
ME 10 29 50
ME 10 30 50
ME 10 31 50
ME 10 32 50
ME 10 33 50
ME 10 34 50
ME 10 35 50
ME 10 36 50
ME 10 37 50
ME 10 38 50
ME 10 39 50
ME 10 40 50
ME 10 41 50
ME 10 42 50
ME 10 43 50
ME 10 44 50
ME 10 45 50
ME 10 46 50
ME 10 47 50
ME 10 48 50
ME 10 49 50
ME 10 50 50

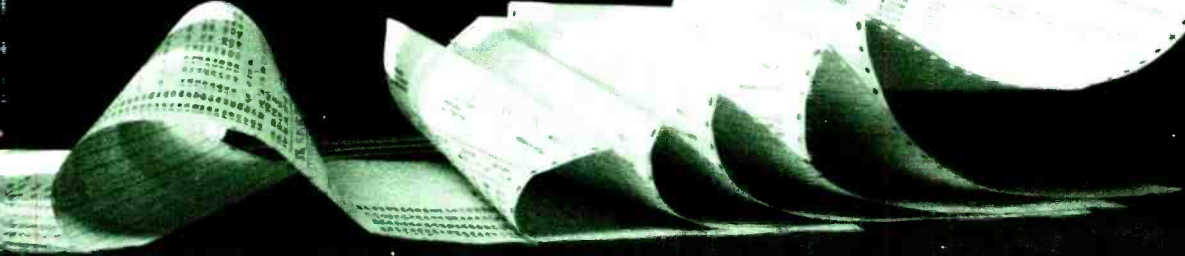

BY 1920—FIVE YEARS BEFORE Bell Labs was formed—considerations of appearance, reliability, and sheer numbers of wires in metropolitan areas were already forcing changes in the transmission medium from open wire to underground cable for both loops and trunks. Almost all new urban construction for exchange transmission used lead-sheathed cables in subterranean clay ducts. Carrier techniques were economical only for toll circuits, where the “pair gain” resulting from sharing of long miles of copper conductor by many voice circuits produced savings in excess of the substantial costs for modulation, frequency multiplexing, and amplification. Such a trade-off was not advantageous for short distances. Exchange loops and trunks, therefore, were strictly voice frequency. Even the terminal costs to form “phantom circuits”—third voice circuits superimposed on two two-wire voice circuits with the aid of repeater coils—were too great for them to find use in a metropolitan area. Techniques for fabrication, insulation, and splicing of cables were adequate to the times. Loading coils were in widespread use.

In this plant environment, the principal challenges in exchange and loop transmission during Bell Laboratories’ first two decades were to improve the quality and to cut the cost of voice transmission.

The challenge to improve quality arose as a consequence of the earlier successful struggle for distance. To maximize distance, transmission designs were tailored for speech loudness, and in the process, naturalness of speech and ease of conversing had been severely compromised. The effective bandwidth for a long toll call in the 'teens was typically only 700 or 800 Hertz. But in the early '20s, long-life vacuum tube modulators and amplifiers were introduced in sufficient numbers to revolutionize the toll plant. Beginning in the mid-'20s, it became possible to revise transmission characteristics for a favorable trade-off between loudness and overall quality of transmission.

The theoretical foundations of wire transmission had already been laid. A highly skilled and innovative group of scientists and engineers had developed a common telecommunications language and complementary points of view. Chance invention and garret experiments were largely superseded by solid theory and field evaluation. Brought together in the newly formed Bell Laboratories organization, scientists and engineers were able to spark

advances in several areas of exchange transmission. Some of these significant advances in the era before World War II:

- Careful research into the speech and hearing processes during the '20s led to a basic understanding of the design requirements for effective speech transmission. An early payoff was the new handset designed in 1927—the first to meet performance requirements that were set in advance.
- Working with the new handset, and using the deeper understanding of the parameters of effective speech, skillful Bell Labs engineers were able to formulate a balanced set of transmission standards for loop and exchange application. This was, however, a difficult and complex task involving extensive subjective testing to find the practical configurations that would effect the best compromise between lower cost and improved performance. For the first time, it became possible to engineer the growing network of loops and trunks with due attention to a full array of transmission-affecting parameters such as wire size, capacitance, leakage, crosstalk, signal level, and noise. This analytical engineer-

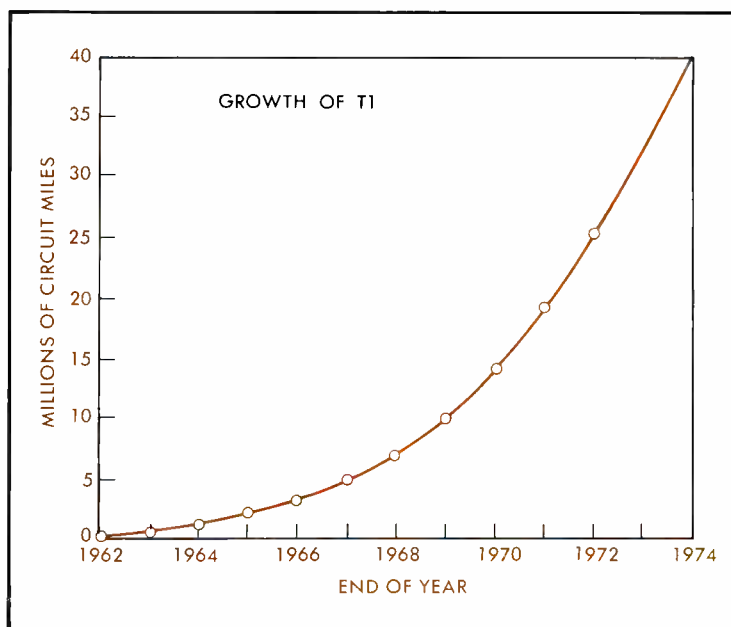

Nearly all the carrier systems added to the exchange plant and toll-connecting plant in recent years have been the T1 type, which transmits 24 digitally encoded voice circuits as a single stream of 1½ million pulses per second on a twisted pair. New systems in the T-carrier family can be expected.

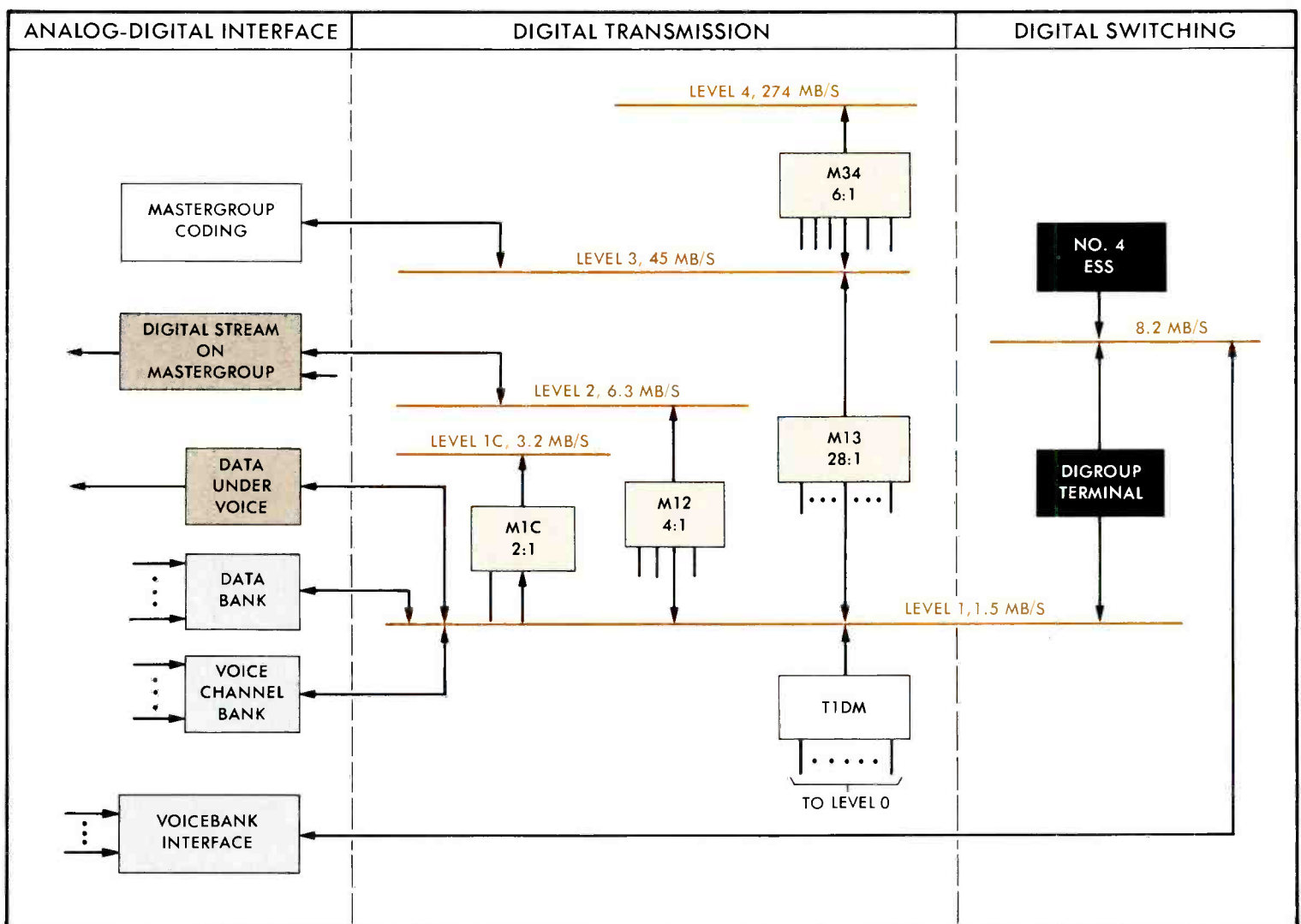

THE DIGITAL HIERARCHY

The "digital hierarchy" is a structural idea that creates a single network fabric from the many varieties of digital systems. It sets up orderly and efficient relationships among the individual systems, allowing each to meet its own design goals while enjoying the benefit of ready interconnection with the others.

The principal feature of the hierarchy is its set of digital transmission rates (called levels). Levels 1, 1C, and 2 correspond to digital transmission lines using wire pairs, and Level 4 to coaxial cable, microwave radio, and waveguide systems. Digital multiplexes such as M12 and M34 provide easy transition from one rate to another.

Because speech waveforms are analog, a conversion to digital form is required to take advantage of digital transmission. This is accomplished in voice channel banks which sample and code analog signals. Speech samples are represented by eight-bit code words generated 8000 times a second. Many data signals are coded with asynchronous techniques that match the several bandwidths commonly used. In the long distance network, message channels are often handled in *mastergroups* of 600 channels, and these can be coded (without first recovering the individual channels) by a high-speed mastergroup coder. Level 3 provides an entry for coded mastergroups.

For a more efficient match to digital transmission lines, data signals may also be generated synchronously at their

source. No coding is required, but multiplexing is used to reach Level 1 since the data speeds fall in a range from 2.4 to 56 kilobits per second. Level 0 designates the basic 64 kb/s channel used for digital data services.

Digital signals need not be confined to digital transmission lines but may be transmitted over analog systems such as frequency-modulated radio by means of a suitable modem. Data Under Voice (DUV) converts the Level 1 signal into a transmission format that can be combined with the usual radio system analog load, thus achieving digital connection to any location served by radio systems. Other arrangements for placing digital signals on radio and cable are possible as well. Using analog systems this way is very attractive for transmitting data signals.

Digital technology brings benefits to switching, too. Fast-acting synchronous time-division switches can rearrange the eight-bit code words appearing in digital bit streams, performing the switching task without requiring each individual channel to be decoded and connected to a physically separate termination. The results are major breakthroughs in readily attainable switching capacity and in the investment required for each trunk. Trunk terminal costs are very low when a digital facility meets a digital switch, via the Digroup Terminal. For analog facilities, conversion to digital form must be added—a function performed by the Voiceband Interface.

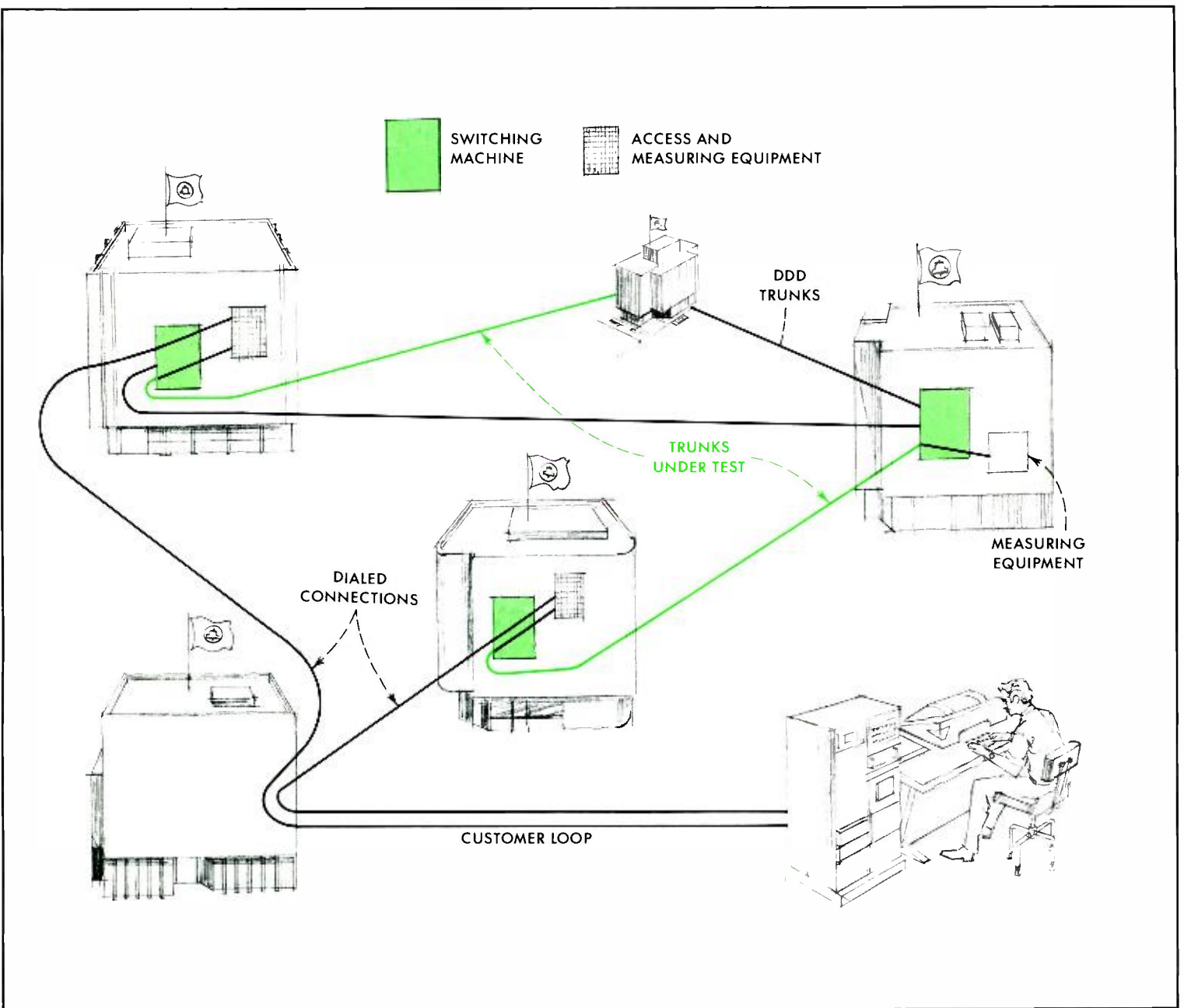

CAROT (Centralized Automatic Reporting On Trunks) is one of several systems that together centralize and simplify a wide range of transmission maintenance and control. A minicomputer at the CAROT control center is programmed to test the quality of transmission on as many as 15,000 trunks each night. These trunks can be between any pair of offices which have been equipped with remote access and measuring equipment. The

measured transmission characteristics for each trunk are compared with the characteristics stored in the computer memory for that same trunk. If the trunk is out of limits, it will appear on the printout of all such problems which the office work force will clear up the next morning. CAROT accessories are also available to help a human operator at the console carry out tests to isolate trouble in greater detail.

ing, in turn, was a first step toward fundamental planning for the network as a whole.

- Improved measuring equipment and measuring methods were developed as a key element in upgrading transmission quality. (The ability to measure precisely has indeed been a fundamental characteristic of nearly every significant forward step in telecommunica-

tions. Without this ability, the degree of standardization that is the foundation of our nationwide transmission network could not be realized.) Representative examples include a master transmission reference system that was precise, stable, and almost distortion-free, and the first reliable noise-measuring sets.

- Important and continuing cost reductions

were realized through Western Electric manufacturing innovations and through close collaboration between Bell Labs and Western Electric on improved designs and better materials. A prime example is the economical manufacture of pulp-insulated cable that in 1930 superseded the more expensive paper-wrap insulation that was then standard.

- An evolving *network* plan, based on definitive transmission standards, provided a sound frame of reference in which future innovations could be efficiently exploited. The dramatic end-to-end performance improvement that came with the introduction of the new 300-type telephone in the '30s is an example.

As previously noted, pre-war vacuum tube amplifiers and carrier techniques were too costly to find regular use in loop and exchange applications. However, there were special circumstances in which spillover of voice-frequency amplifier, range extension, and carrier techniques from toll to exchange use did prove economical. Examples include long interconnections between PBX and central office, range extension for long loops, and certain special services applications—those which carry program material for broadcasters, for example.

Even though the average quality of loop and exchange transmission had improved impressively in the period from 1925 to World War II, and the number of loops and short trunks had about doubled, the associated transmission media and terminal equipment had not undergone much basic change. This pattern was eventually broken in the late '50s by the solid-state revolution that had been touched off in 1947.

As a further byproduct of the toll transmission development of the '30s and '40s, vacuum tube circuits found important exchange use in the negative impedance repeater developed in the late '40s. By this time, even the terminal costs for analog *carrier* were low enough to allow economical usage of carrier in certain exchange applications. Quite naturally, the first designs using solid state devices were aimed at the same electronic functions previously satisfied by tubes. Within a few years, however, completely new approaches were also being taken.

Solid State

The first major impact of solid state electronics in the exchange area was the introduction of low-cost voice transmission using

Time-Division Multiplex (TDM). But the path was not a smooth one. The idea of deriving voice channels by sending interleaved samples from several sources over a single line and sorting them out at the far end had been suggested and carefully evaluated before 1920, but the scheme did not then appear economically attractive.

During the '30s, there was new interest in TDM for possible application in microwave radio or coaxial systems, and several techniques for digital encoding of the sampled information were proposed. Still no payoff. Just prior to and during World War II, the need for a truly effective method for secret transmission of speech generated considerable interest at Bell Labs. By applying Pulse Code Modulation (PCM) techniques to digitally coded speech, and by adding the same random binary key at source and destination, Bell Labs engineers obtained a viable answer. This work provided a solid base for new post-war looks at PCM, and the late '40s saw the invention of a variety of accurate high-speed vacuum tube devices and circuitry for pulse application.

The possible economic use of PCM for voice circuits on *existing* wire pairs in congested metropolitan ducts was recognized in the mid-'40s. The missing ingredient was a *small-size, low-cost, low-power, long-life, stable* device to permit economical circuits for encoding and multiplexing the voice signals. Enter the transistor. But the real world demands delivery—not just promises—and it took many years to transform the potential of transistors into a reliable, economical actuality in the field. In 1962, after six years of exploratory development and careful field evaluation, the T1 PCM system with its low-cost channel banks, its 24 one-way circuits carried as a single 1.5-megabit-per-second pulse stream on a twisted cable pair, and regenerators spaced at 6000 feet, saw initial service. Today, with some 2½ million circuits in place, T1 supplies almost all the carrier growth in metropolitan areas.

With a growing web of T1 systems in each part of a megalopolis, the payoff for intercity and express-route digital lines to interconnect these T1 webs becomes attractive. This calls for interleaving of many nonsynchronous T1 bitstreams to form a single, high-bit-rate system. Bell Labs engineers developed the technique of "pulse stuffing" in the 1960s to make this kind of interleaving possible. Increasing scales of semiconductor logic integration,

lowering electronics costs, and associated analytical, circuit, and system design work all played a part in the gradual realization of an economic family of digital multiplexers. The first application was in 1972, when T2, which carries four multiplexed T1 streams as a single 6.3-megabit-per-second stream, was placed in intercity service. Today a coaxial system, with 168 multiplexed T1 streams in each tube within an 18- or 22-tube sheath, is undergoing final tests between New York and Newark to provide express-route trunking in April 1975. Digital techniques have also been applied to radio systems, and the interconnection of digital lines is at the heart of the new Digital Data Service. An entire hierarchy of digital multiplexing has been designed and is being implemented (see panel, page 43).

Digital systems are also finding application in the customer loop. A loop multiplex system, introduced in 1973, enables up to 80 single-party lines in a rural area to be served over a digital line using T1 repeaters. New systems of the same family will provide still greater economies. Other electronics inroads into the loop plant include range extension (for both ringing and dialing) and voice-frequency gain.

The '50s and '60s also brought major cost-saving innovations in nonelectronic portions of transmission exchange plant, particularly the new cable designs using plastic insulation to replace pulp and the new metal-plastic composite cable sheathing to replace lead sheathing. In the last few years, cables have been made waterproof by a water-repellent filling compound, a centralized automatic system has been introduced for monitoring air pressure in more conventional cables, and several families of tools and quick-clip connectors for easier cable emplacement and splicing have been developed.

To make it easier to serve growing, changing communities with high-performance loops, the Serving Area Concept—a new approach to providing planning and interconnection between feeder cable and distribution cable—was developed in the late '60s.

Just as the speed and accuracy of the electronic computer enabled us to solve scientific and engineering problems having a new degree of complexity, so the flexibility of computer processing and control has allowed a fresh approach to performance measurement and to design for reliability and economical maintenance. What are the major trends and how did they come about?

Growth of electronics in toll transmission introduced a new sophistication and flexibility in electronic test gear, and in the '50s and '60s large numbers of small companies developed competence in the general area. Under these circumstances, it was possible to assure availability of adequate test equipment for many transmission maintenance purposes through development of general test specifications and guidelines by Bell Labs and AT&T for use by prospective suppliers. We at Bell Labs could then devote more of our special design expertise and system knowledge to the economical realization of centralized transmission maintenance.

Minicomputers

Remote measurement, comparison with expected value, analysis and reporting of results, and alerting of the work force to take proper corrective action are all operations that can be controlled by a computer-based system. The advent of the high-performance minicomputer about 1968 added great flexibility and scope to the centralization concepts that were already emerging. This opportunity to free telephone people from many routine aspects of circuit and network maintenance proved economical both in terms of better maintenance (a greater variety of measurements performed more reliably and more often) and in focusing more attention on overall operational efficiency. Key trunk-related building blocks included systems which provide automatic measurement of trunk and carrier transmission, a telemetry system which provides remote data gathering and remote contact closure, a special switching arrangement for centralized test access, and a system for

The diagram at far right on the opposite page shows how serving areas are laid out. The region is divided into eight serving areas, each with a serving area interface. The enlarged diagram at lower right is a detailed layout of a distribution network for one serving area. The cable pairs from this network are joined to the main feeder route running through the center of the diagram to the central office. The photo at left shows wiring changes being made on the serving area interface. The panels contain distribution wires to the customers' households. The center panel terminates wiring from the central office. One of the important features of the serving area interface is the accuracy and speed with which it allows personnel to identify wire terminations.

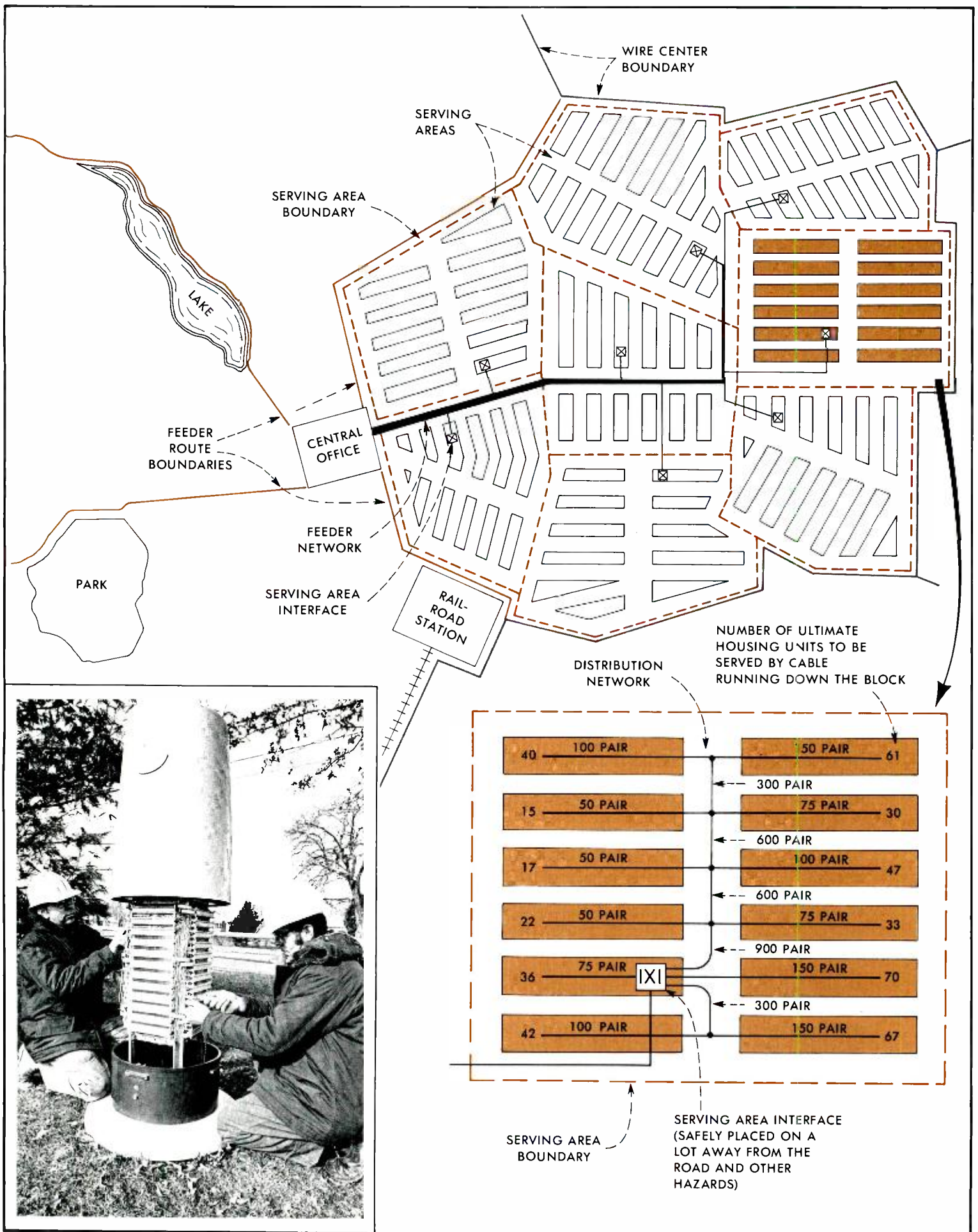

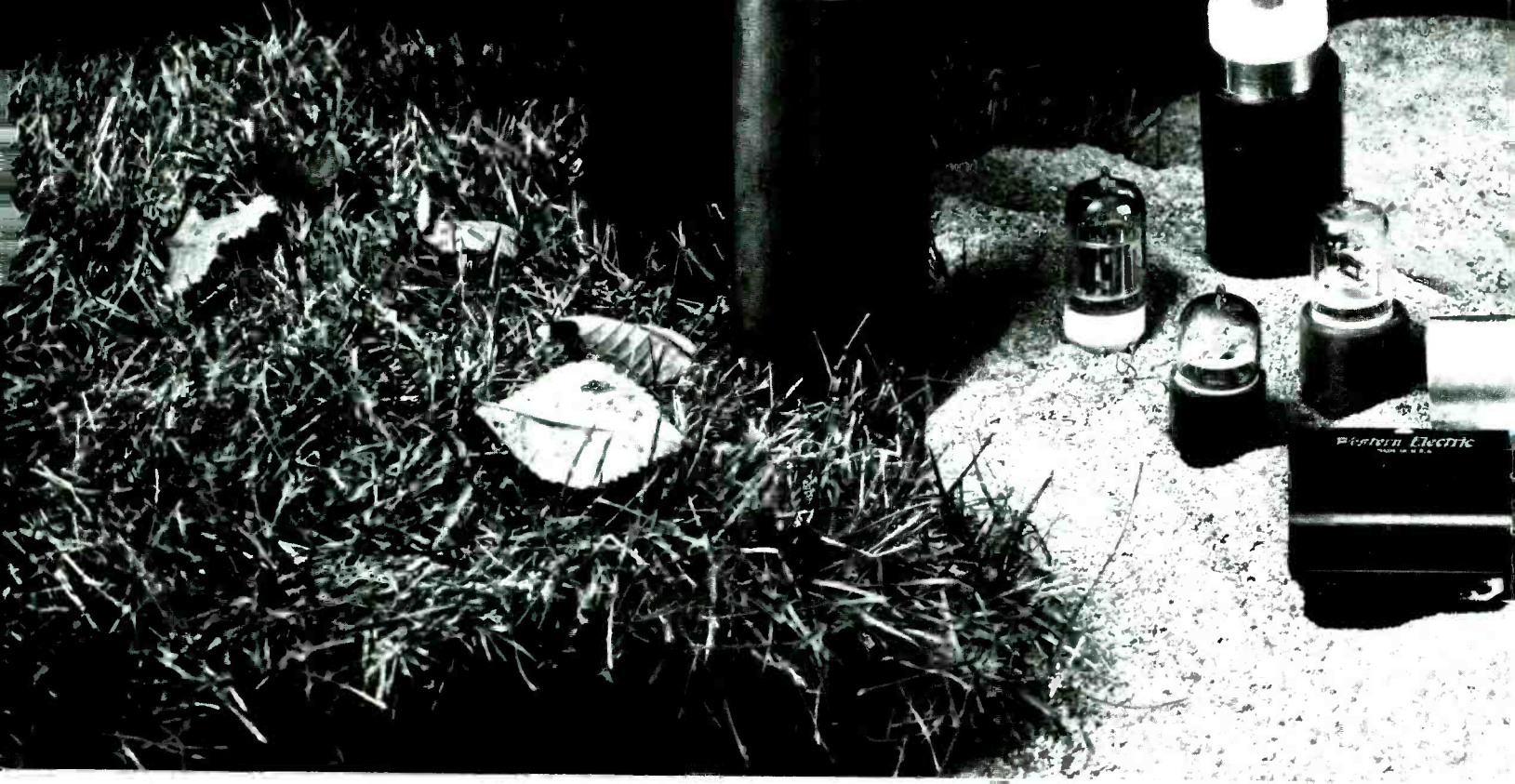
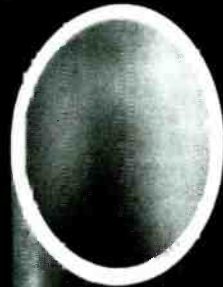
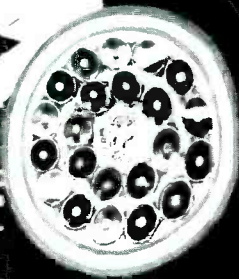
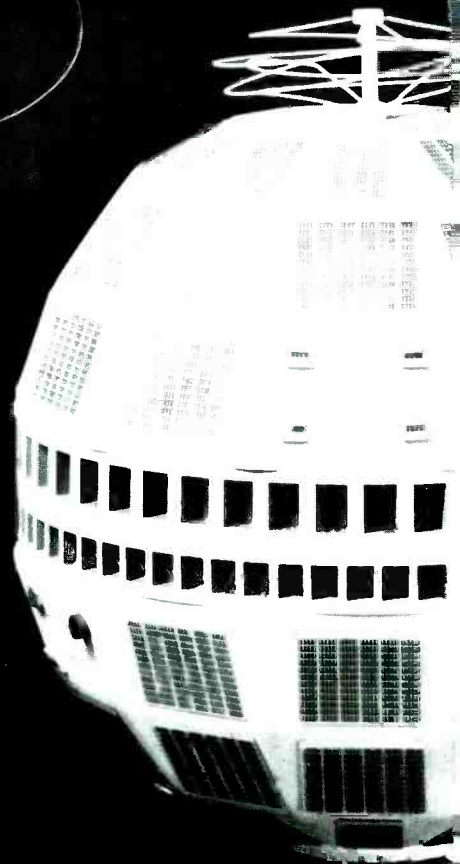
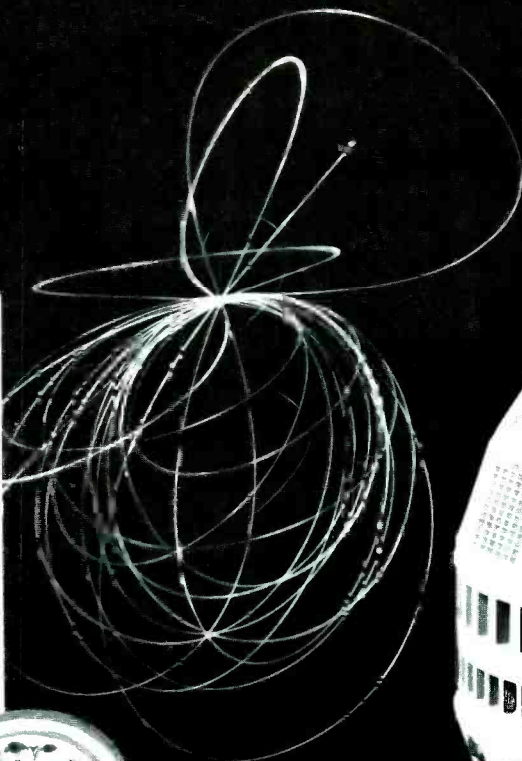
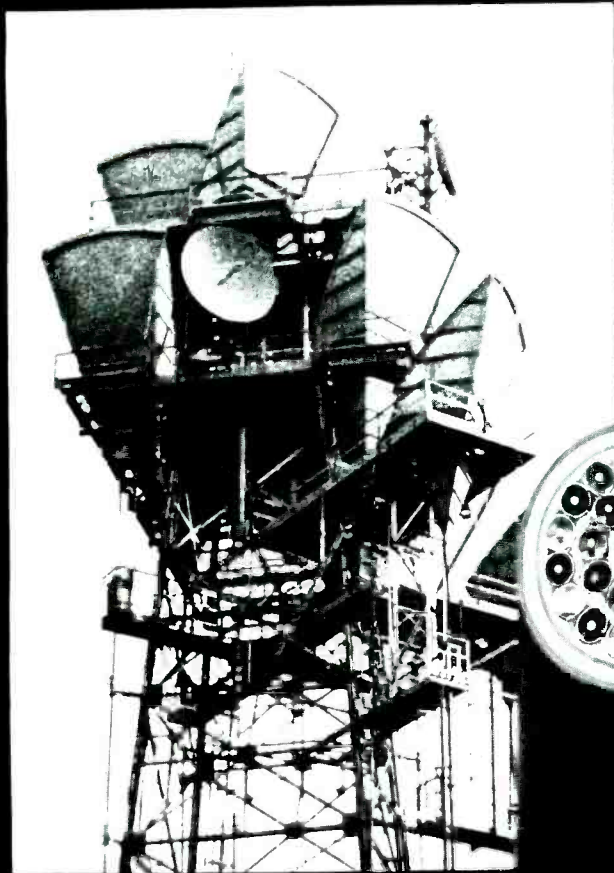

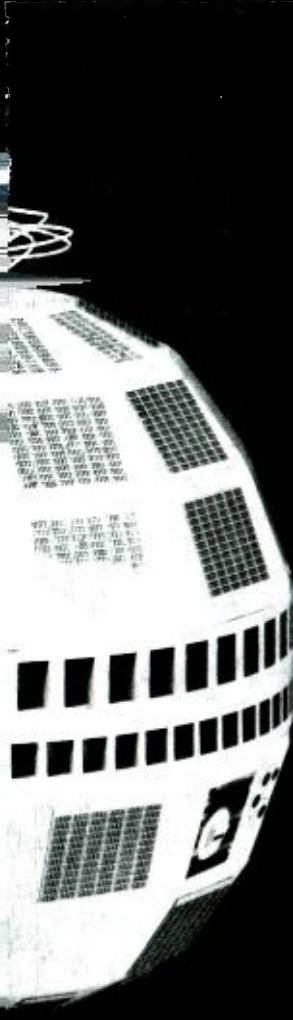

The continual demand for increased capacity for long distance telephony has produced a steady stream of improvements in existing transmission systems as well as a variety of new systems. Symbols of progress in long-haul communications range from microwave radio to undersea cable.

Radio and Long-Haul Transmission

EUGENE F. O'NEILL

LONG DISTANCE CALLING is almost as old as the telephone —calls over distances as great as 75 miles were made within a few months after the first successful transmission over a few feet of wire. These calls, however, were in the nature of experiments or demonstrations over existing telegraph lines. True "toll" telephone lines came a few years later, as the local networks expanded and the need for intercity connections grew. Transmission over the longer lines brought new problems and the effort to solve them was a powerful stimulus to technology. One of the first advances was the two-wire "metallic" circuit for toll trunks to reduce the intolerable crosstalk and induction that occurred with the single wire with ground return, which was then standard for telegraph and short telephone lines.

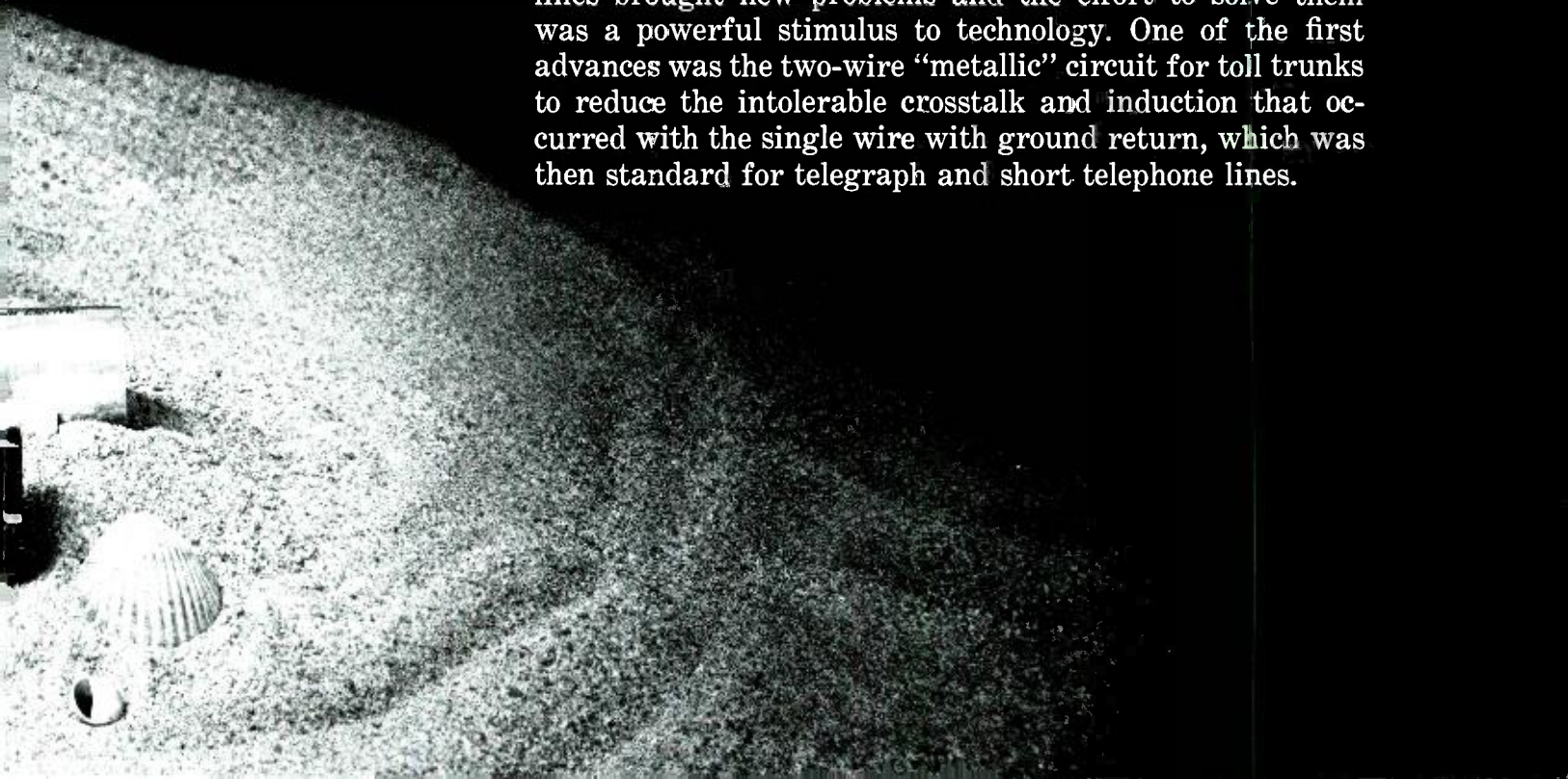

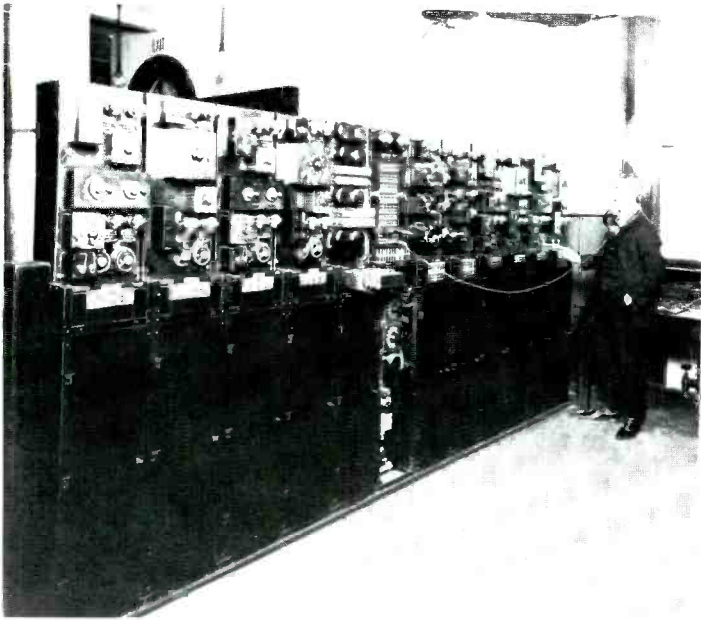

The Chicago terminal of one of the earliest carrier systems, installed between Harrisburg and Chicago shortly after World War I. The system could carry four conversations simultaneously over a single pair of wires.

Almost from the outset, a few farsighted people, including Alexander Graham Bell, foresaw the establishment of a nationwide, or even a worldwide, network. The early growth of long distance lines seemed to justify their optimism. Toll lines several hundred miles in length were in use well before 1900, but a truly nationwide network required means for transmitting voice signals over longer distances than the available technology permitted. Our predecessors addressed themselves to this problem with energy and imagination

A four-channel short-wave transmitting station for commercial radiotelephone service to Europe and South America. This

—qualities which, we like to think, have characterized the efforts on long distance communications ever since.

The subsequent history of “Long Distance” can be roughly divided into two stages. In the early one, consisting of approximately the first 40 or 50 years, the object was the conquest of distance, to make it possible for people to talk by telephone from any place in the United States to any other. By the date Bell Laboratories was founded, this first battle had been substantially won. A major contribution was the invention of loading around the turn of the century, but a far more significant milestone was the invention and perfection of the high-vacuum tube. It was the vacuum tube that made possible the first transcontinental voice transmission on an open-wire line in 1915. And, in the same year, this revolutionary device was used for the first overseas voice transmission by radio from Arlington, Virginia, to Paris and to Hawaii.

The vacuum tube made an enormous contribution to voice-frequency transmission. In 1900, all long toll transmission was on heavy open-wire pairs on pole lines. Transmission on cable pairs—attractive because they used lower-cost, finer-gauge wires and were protected from the weather—was well established at an early date for short distances, but was prohibitively “lossy” for long circuits, even when the pairs were loaded. Good vacuum tube amplifiers, much improved in quality and reduced in size and cost compared to the crude early ones, made long-haul voice-

aerial photograph of the transmitting station, which is located at Lawrenceville, New Jersey, was made in 1928.

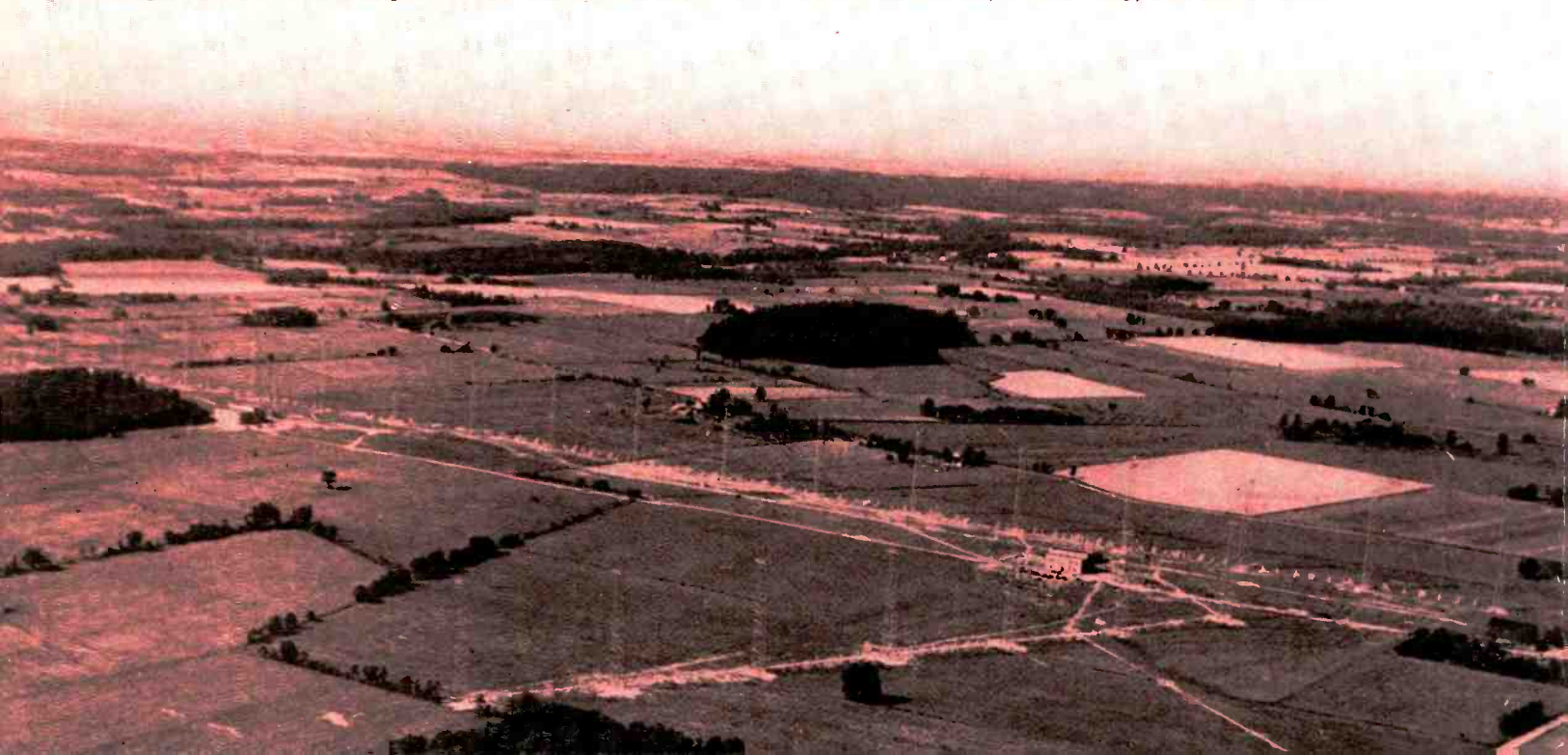



This experimental 1935 installation of large coaxial conductor lines near Phoenixville, Pennsylvania, was the forerunner of

the first commercial coaxial line (extending between Stevens Point, Wisconsin, and Minneapolis) in 1941.

frequency cable transmission possible and were in wide use by 1925. By 1926, the Bell System boasted of 3 million voice-circuit-miles for long distance, 45 percent in cable.

The practical vacuum tube did more than just extend the range of transmission, however. Even the early tubes could generate, amplify, and modulate frequencies much higher than the few kilohertz required for voice signals. The perfection of these tubes was the key to the start and rapid spread of radio broadcasting, an activity in which Bell Labs played a considerable role. But more important to our purposes, the vacuum tube plus the selective wave filter, invented at about the same time, made carrier telephony possible and really launched the second major phase of long-haul development: the assault on cost.

Multiplex carrier transmission, the simultaneous transmission of several signals separated in frequency over a single line, was demonstrated as early as 1914 and used as a wartime measure in 1918. By the founding of Bell Labs in 1925, a three-channel-plus-voice system for open wire, called C-carrier, was standardized and in use. C-carrier was highly successful and widely used, but by the late 1920s, with traffic growing by leaps and bounds, it was evident that something much better was needed. The subsequent depression and World War II greatly slowed growth and delayed the installation of new facilities, but by any measure, the 1930s were a fertile seedbed of new ideas whose fruit is still being harvested.

The technical attack took two directions. One was an attempt to increase the number

of channels transmitted over more or less conventional open wire or cable pairs by extending the transmitted band to higher frequencies. The other was to explore the possibilities offered by new and completely different media.

Extending the frequency band immediately intensified problems long familiar to those who had worked on the earlier systems. The loss in pairs increases with frequency, necessitating closer spacing of—and hence more—repeaters in a given distance. Each repeater adds some noise and distortion, however small. Since the overall performance requirements were unchanged (in fact, the end-to-end quality standards were being raised), the impair-



In this photo taken in 1936, G. C. Southworth holds one of the resonant chambers used for tests of waveguide transmission. Behind him are two experimental transmission lines.

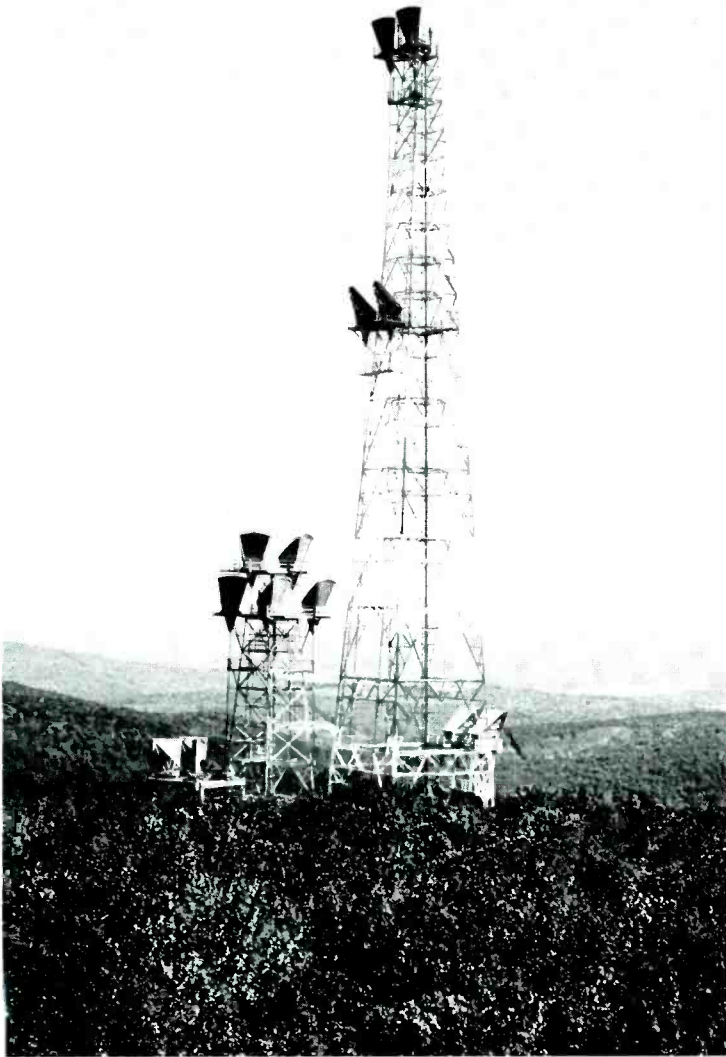

Present microwave station at Jackie Jones, New York—one of the original sites for the trial microwave radio relay system in 1947. The original trial antenna is just visible over the treetops at left of the towers.



Cable Ship Long Lines has placed many thousands of miles of deep-sea cable in the Atlantic, Pacific, and Caribbean.

UNDERSEA CABLE SYSTEMS

	First Service	Number of Cables Per System	3-kHz Channel Capacity
SA	1950	2	24
SB	1956	2	48
SD	1963	1	140
SF	1968	1	845
SG	1976	1	4000

MICROWAVE RADIO SYSTEMS

System	Date Introduced	Number of Two-way Radio Channels	Voice Circuits Per Channel	Frequency Band in GHz
TD2	1948	5	480	3.7-4.2
TH1	1959	8	1860	5.9-6.4
TD3	1966	12	1200	3.7-4.2
TD2	1973	12	1500	3.7-4.2

ments allowed per repeater were correspondingly reduced. Many improvements were made but amplifiers of the required stability and linearity were just not feasible until the brilliant and timely invention of the feedback amplifier by H. S. Black in 1927. Using feedback amplifiers, 12-channel systems on both cable and open-wire lines were designed and installed by the late 1930s.

Unfortunately, overcoming loss and distortion was not enough. The use of pairs at high frequencies is limited even more by crosstalk, the coupling between carrier signals in the same cable or on the same open-wire line.

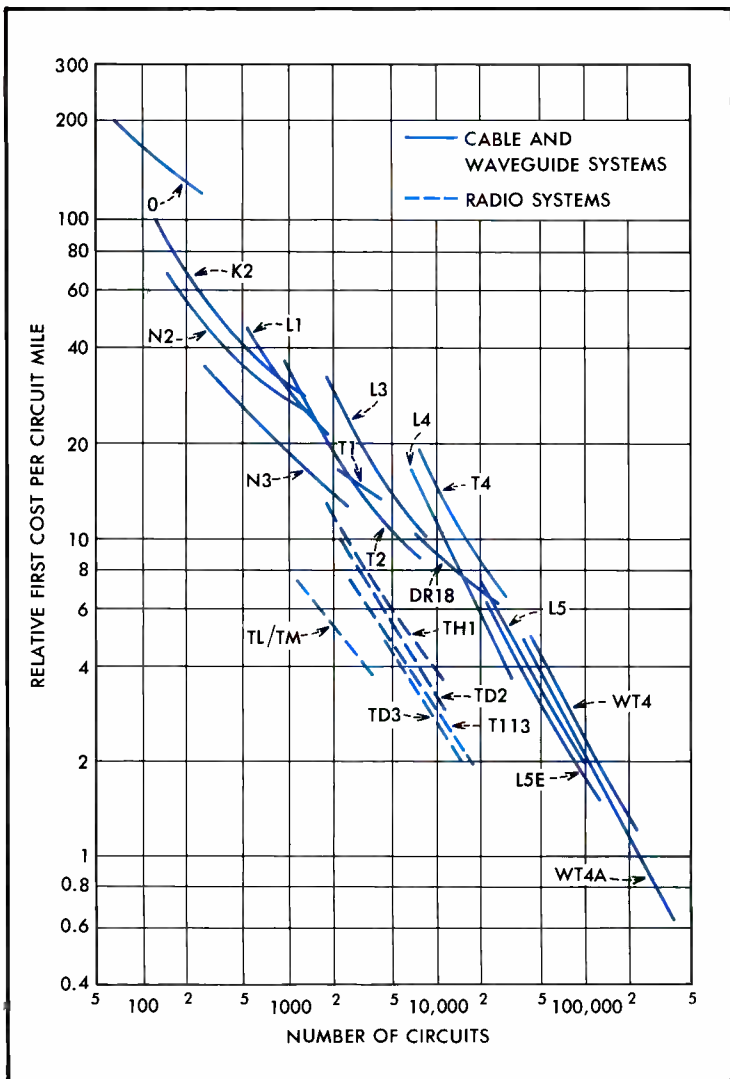

The "Economy of Scale" relationship. The cost per circuit, exclusive of terminals, tends to decrease as the capacity of the transmission system increases. Thus, at full load, the L5 coaxial cable system and the WT4 millimeter waveguide system are substantially larger and more economical than their predecessors.

Means were found to control crosstalk for the 12-channel systems, but only by careful transpositions on open wire and elaborate adjustable networks for cable.

Crosstalk limitations made the use of pairs for more than 12 channels look very unpromising. In addition, signals other than voice were being considered. The growth of radio broadcasting in the 1920s had been paralleled with a Bell System nationwide program network. Even in those early days, it was anticipated that the Bell System would supply a similar facility for television when it was required. As early as 1927, experiments and

demonstrations of embryonic television at Bell Labs had created an awareness that rendering a picture in reasonable detail would require bandwidths of a megahertz or more—several hundred to a thousand times greater than for voice. These problems set Bell Labs people to examining the other broad option: what other media were available?

The results were astonishing. Within a few years a patent had been granted to H. A. Affel and Lloyd Espenschied for a broadband system on coaxial cable; Carl R. Englund, Harald T. Friis, and their associates were demonstrating the possibilities of microwave radio; and George C. Southworth had demonstrated waveguide transmission. And in all three cases, significant analytic contributions were made by Sergei Schelkunoff. The concept of Bell Labs—research, free to range over the entire field of communications, coupled with engineering design and development for service, in an organization tied into the manufacturing and operating parts of the system—was living up to the hopes of its founders.

Birth of Coax

The self-shielding properties of the coaxial structure were especially attractive and its demonstration and use came first. The loss was made small by using moderately large coaxial tubes, one-quarter inch or more in diameter, with the center conductor supported on low-loss spaced disks, leaving mostly air as the dielectric. By 1936, a two-tube cable had been installed between New York and Philadelphia with unattended feedback repeaters every 10 miles. Its capacity of several hundred simultaneous telephone calls was confirmed, and in 1937, rudimentary 240-line TV transmission was demonstrated. This cable, with additional repeaters and the band extended to almost 3 MHz, transmitted video that approached current standards from the 1940 "We Want Willkie" Republican Convention in Philadelphia to New York for broadcast. A commercial 3-MHz coaxial system was placed in service between Stevens Point, Wisconsin, and Minneapolis in June, 1941. The war notwithstanding, expansion was vital, and by 1945, 2000 miles of coaxial were in place or under construction. In 1946, TV coverage of the Army-Navy football game was transmitted to New York for broadcast. The first transcontinental system was completed in 1948 and a new era had begun.

Commercial telephony by radio is almost

as old as Bell Labs. In 1927, overseas service to England by “long wave” (50 to 60 kHz), and in 1929, multichannel service to England and to Buenos Aires on “short wave” (10 to 20 MHz) was initiated. In the years that followed, Bell Labs research groups explored the properties of higher and higher frequencies. By the late 1930s, they were generating and experimenting with frequencies above 1 GHz, corresponding to wavelengths of 30 cm or less—the so-called “microwaves.”

Enter Microwaves

The virtues of microwaves for telephone transmission by radio were recognized from the start. Lots of bandwidth was available and high-gain, highly directive antennas of moderate size could be built. The waves were not reflected by the ionosphere or propagated much beyond the optical horizon. Therefore, signals had to be transmitted from tower to tower on an optical line-of-sight and relayed along to the next station 25 to 30 miles away. These properties and mode of transmission, which at first thought might seem to be awkward disadvantages, are, in fact, the great

virtues of these high frequencies. Because of the line-of-sight propagation and directive antennas, the large microwave bands—unlike the lower frequencies—can be reused within relatively small geographic areas. A vast new communications resource had become available. The concept was well advanced and the components to demonstrate such a system were assembled before World War II broke out.

Military needs, especially radar, absorbed almost all the microwave talents of Bell Labs during the war, but in April 1944, even before the war ended, AT&T announced its intention to build a New York-to-Boston microwave system operating at 4 GHz. An experimental system, covering the distance in seven tower-to-tower hops, was built, and both telephone and television transmission was demonstrated in November 1947. Regular service to Boston was established the following year. Even before the experimental phase was completed, work was under way on TD2, a more commercially practical design. A coast-to-coast TD2 route was ready in time to carry TV coverage of the Japanese Peace Treaty Proceedings from San Francisco, in September 1951.

With the successful development of the first coaxial cable and microwave radio systems, the stage was set for what proved to be a vir-

The major long distance communication highways in the Bell System today consist almost entirely of microwave radio relay networks (shown in color) and coaxial cables (shown in black).

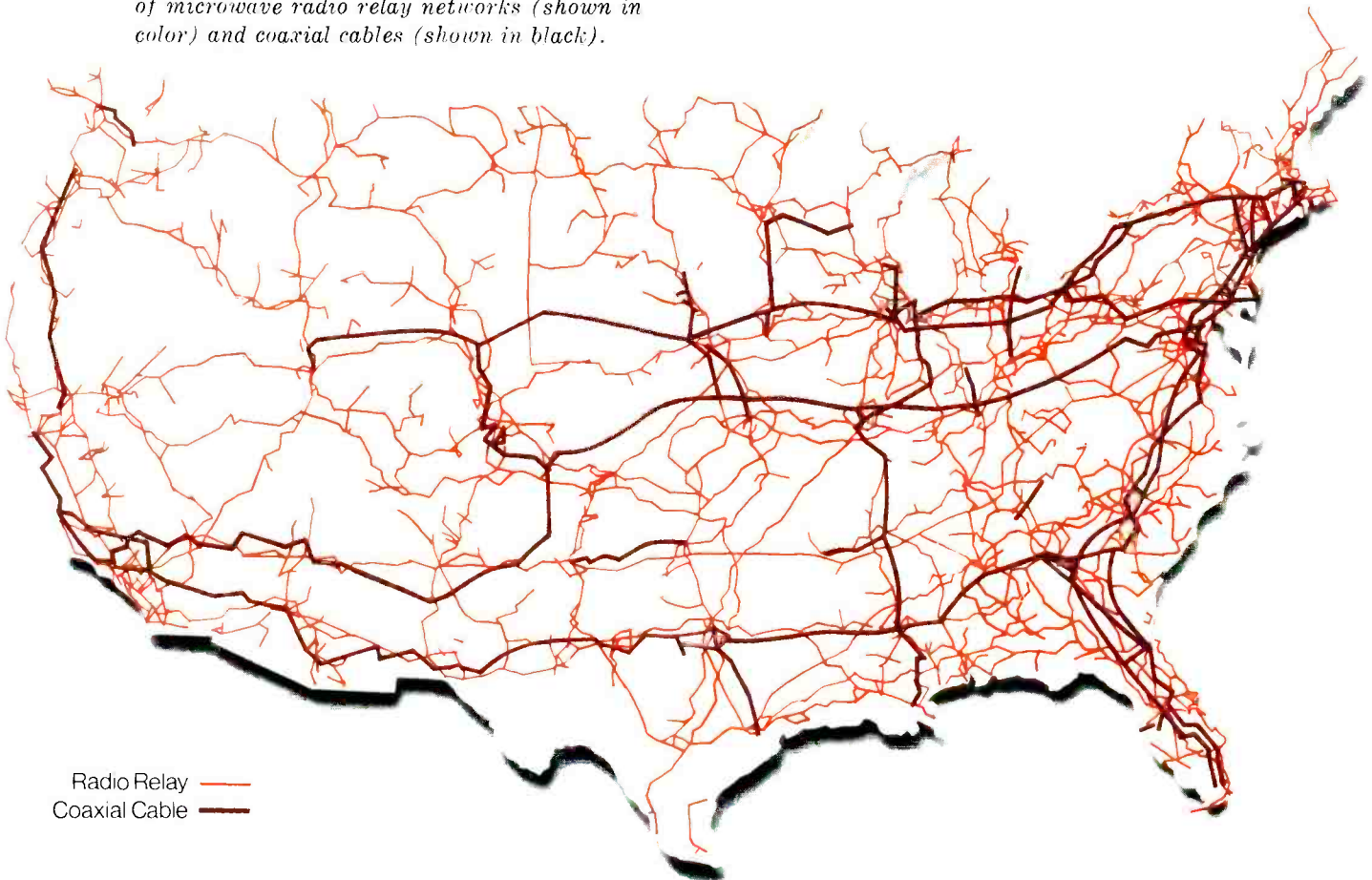

tual explosion in long-haul growth. During the early post-war years, the pent-up demand for telephone service and the new demand for a nationwide TV network strained capacity to provide facilities. Later, the stimulation of a new service, Direct Distance Dialing, and the long economic boom continued the trend. By 1949, 9 million voice-circuit-miles were in service in the long-haul plant, most of it, in that early period of coaxial and radio development, still on wire pairs. Today, the capacity exceeds 500 million voice-circuit-miles and all but an insignificant amount is on coaxial and radio systems. The new facilities have spread geographically until every quarter of the country is covered by a comprehensive network of broadband facilities and every major U.S. city is served by a coaxial or radio route.

Growth in Depth

The geographic or "horizontal" growth of the network has been accompanied by a growth in "depth." Over the years, while the nationwide network was being installed, successive generations of design have produced enormous increases in route capacity. Coaxial cables have grown from 4 to 22 tubes (11 coaxial pairs) per sheath and in L5, the latest design, each tube can carry 10,800 channels for a total route capacity of 108,000 channels. (Ten coaxial pairs are used for service and the eleventh for protection.)

Radio has experienced similar growth in capacity. Horn reflector antennas, in place of the original lens antennas, and better filters have permitted cross-polarized "interstitial" channels, doubling the number of channels in the 4-GHz band. Further improvements in antennas, transmitters, receivers, and equalizers have increased the capacity per channel from 480 voice circuits in 1950 to 1500 today, while improving the quality. In the late 1950s, a 6-GHz system, TH1, was placed in service. TH1 can be "overbuilt" on TD2 routes; that is, the same buildings, towers and antennas can be used, and only repeater bays and combining networks need be added. A fully equipped TD/TH route can provide 29,000 voice circuits with current designs.

The developments leading to systems of higher and higher capacity on coaxial and radio have been the main factor in the successful effort to lower costs in long-haul transmission. A very substantial part of the expense for any long-haul system is in the basic land, buildings, and equipment that are needed for



Cross-section view of the 22-tube coaxial cable, part of the L5 transmission system. This super-capacity transmission facility can carry 108,000 simultaneous telephone conversations—more than three times the capacity of previous cable systems.

COAXIAL CABLE SYSTEMS				
Type	Year of Introduction	Repeater Spacing	Voice-Frequency Channels Per Coaxial	Voice-Frequency Channels Per Route
L1	1940	8 Miles	600	1,800
L3	1953	4 Miles	1860	16,740
L4	1967	2 Miles	3600	32,400
L5	1973	1 Mile	10,800	108,000

whatever system is used. Thus, any cable system requires the medium itself, right-of-way, trenches, and repeater stations. Any radio system requires land, buildings, towers, antennas and power. The successive developments in both coaxial and radio require only relatively moderate increases in the cost of electronics and divide the heavy fixed expenses among larger and larger numbers of circuits. This leads to the often observed "Economy of Scale" in transmission which, over the decades since the first carrier systems, has reduced cost per mile of long-haul circuits by almost three orders of magnitude.

Coaxial cable and microwave radio techniques have been extended to overseas transmission in two very special—and important—

developments: submarine cables and satellites for telecommunications.

Short voice-frequency submarine cables were in service at an early date. In 1931, a version of C-carrier was applied to a cable from Key West to Havana, with all the electronics on dry land. About the same time, some consideration was given to a single-channel transatlantic cable, but the project was deferred because of improvements in high-frequency radio and the restrictions of the depression years. By the time of World War II, the ability to design and manufacture vacuum tubes with the life and reliability needed for submerged repeaters had been demonstrated. Work was started on a multichannel system with repeaters powered over the cable from the shore.

A system with submerged repeaters was laid between Key West and Havana in 1950 and was followed by the first transatlantic system in 1956. This system consisted of two separate cables, one for each direction of transmission. With high-gain amplifiers spaced approximately 40 miles apart, 36 two-way channels were provided. Subsequent terminal development increased the number of channels to 48 and this number was further increased by the installation of speech interpolation terminals (Time Assignment Speech Interpolation, or TASI) in 1960.

Later generations of submarine cables have employed single cables using different frequency bands for opposite directions of transmission, and successive design generations have followed the pattern of increasing capacity already noted in the land-based coaxial systems. The reliability, life, and stability inherent in transistors was of basic importance in realizing the 800-channel "SF" design. The "SG" system, providing 4000 two-way channels, will be installed from the United States to France in 1976.

Today, satellite communication is commonplace. The events of the first moon landing were watched "live" on TV by the largest audience ever assembled and nearly everyone has seen the amazing close-up pictures of Mars and other planets. To a very large extent, these communication "spectaculars" are the outcome of research, invention, and development at Bell Laboratories. The transistor, invented in 1947, was fol-

lowed by the much improved junction transistor in 1951. The solar cell, for the direct conversion of sunlight to electricity, followed in 1954. The traveling wave tube, an efficient and very broadband amplifier, was invented by Rudolph Kompfner in England during the war and its design technique worked out and improved by J. R. Pierce and his associates at Bell Labs in the postwar years. The maser, invented by C. H. Townes of Columbia University in 1954, provided a receiver of extremely low noise. Work by D. C. Hogg and others at Holmdel established the basic "transparency" of the atmosphere to microwaves at all angles of elevation. Even before the first Sputnik orbited in 1957, Pierce pointed out in a series of papers that all the elements for successful communication via satellite were in hand.

Satellite Communications

Many of these elements were assembled to communicate via signals reflected off the Echo satellite balloon in August 1960. Work on an active satellite, already under way in the Research Area, was intensified and extended, and resulted in the Telstar™ demonstrations of transoceanic multichannel telephony and television in 1962. Commercial transoceanic service was established in a few years by Comsat, a new entity established by the government to render this service. The first satellites for domestic communications have been launched and a large scale system—a venture planned jointly by AT&T, Comsat, and General Telephone and Electronics—has been proposed to the FCC.

What lies ahead?
Are the battles
won? Is this
the end
of an
era?

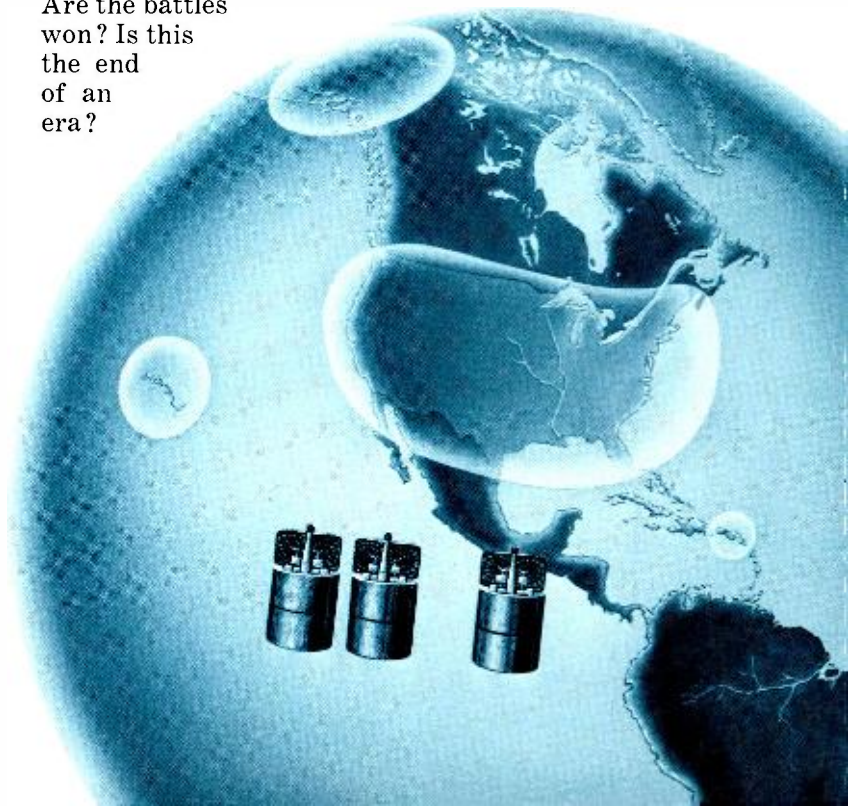

The proposed domestic satellite system—a joint enterprise of AT&T, Comsat, and General Telephone and Electronics—will offer a total of 28,800 telephone circuits. The system is designed primarily for serving major cities in the contiguous U.S., with additional service to Alaska, Hawaii, and Puerto Rico.

Perhaps. But, if so, it appears that a new era is about to begin. Projections of the rate of telephone traffic growth, while not as high as in the booming postwar years, still indicate a need for 5 to 10 times the present capacity by 1990. Between 80 and 90 per cent of that plant has yet to be built! And, just as in the 1930s, new services, new media, and new modes of transmission are the subject of research, development, and design. Our early experiments in PICTUREPHONE® transmission have not resulted in a spread of this mode of communication. The costs were just too high for the additional value to our customers. But these costs will come down sharply. Progress in integrated electronics and new ideas for imaging devices will have a large effect on the cost of the customer's equipment. Band compression techniques promise to reduce the band required on the transmission lines, but even a modest spread of Picturephone will require a large expansion of the transmission plant.

Work continues on exploiting coaxial cables and 4- and 6-GHz radio paths. The prospect of wider-band systems than L5 and single-side-band AM transmission on radio promises an increase by a factor of 2 to 3 in the capacity of these media. Work on waveguide has never stopped, although the pace has changed from time to time. It now appears that the need and the technology are matched. Development of a commercial system was resumed in 1969 and a field test of 8 miles of guide and most of the items needed for a commercial system is under way near Netcong, New Jersey. The capacity of this design is 230,000 channels. With new terminals and repeaters—but no other changes in the expensive “outside plant” parts of the line—an increase to 460,000 channels is planned for the 1980s. Optical fibers (“light guides”) of extraordinary transparency, transmitting frequencies 10,000 times higher than conventional microwaves, are another exciting prospect. They are the subject of an intensive research and development effort which includes transmitters, receivers, modulators, and all the other elements of a working transmission system. It appears that their first application is likely to be in the crowded urban environment, but they may be an important long-haul contender as well in the years ahead. Waveguide and optical fibers also promise to introduce digital transmission to the long-haul plant, finally providing the long-sought long-haul digital link between the rapidly expanding digital exchange network

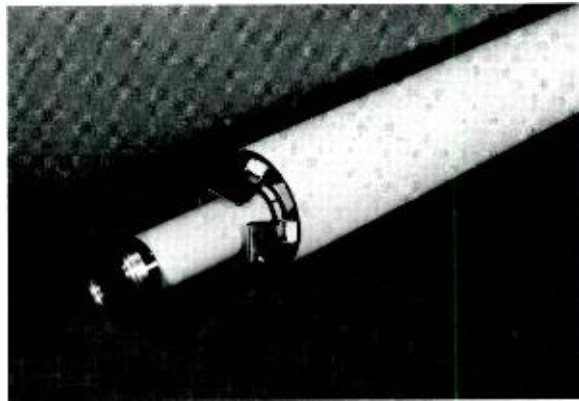

Waveguide for the new WT4 millimeter waveguide transmission system is supported in a steel sheath by rollers. The system will be able to carry 230,000 simultaneous conversations.

and new time-division No. 4 ESS toll switches.

This article has been a broad review of the history and status of long-haul transmission progress in the Bell System in which the various major end products—the long-haul lines—were used as milestones along the way. Paralleling these developments were, of course, the equally important advances in high capacity multiplex terminals. It is also impossible in such a necessarily brief account to give proper credit to a host of other activities—activities as important as the direct effort on the systems themselves—that underlie the working systems and make them possible. Some mention has been made of major device milestones, but a host of contributions in realizing better, cheaper, and more precise elements has not been mentioned. The development of measuring techniques of greater precision and the automation of these techniques are of basic importance. Systems Engineering people have contributed at every stage in developing techniques of subjective testing, transmission quality, and defining the parameters of the working environment such as tolerable levels of interference and crosstalk. Finally, the development of a method by means of which service needs are identified, new designs are manufactured, installed, placed in operation, and maintained, with all the necessary coordination with existing equipment and training of people by the Bell Labs, Western Electric, AT&T, Long Lines, and Operating Company teams is worth a story in itself. Without the efforts of all these people, the end result would never have been realized. □

Materials

WILLIAM P. SLICHTER



One of the major factors influencing the performance of telecommunications equipment is the performance of the materials used in its construction. Plastics for outdoor cables, magnetic alloys, and synthetic single crystals are three of the principal areas in which Bell Labs discoveries and investigations have influenced telecommunications greatly.

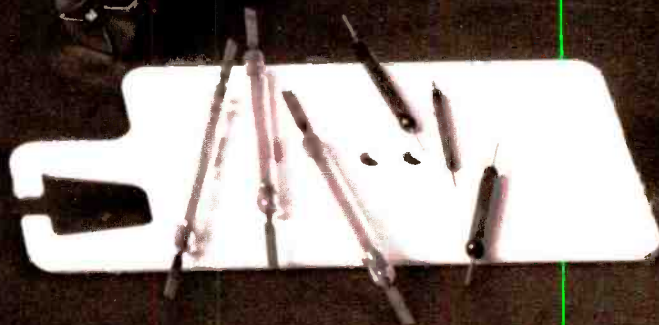
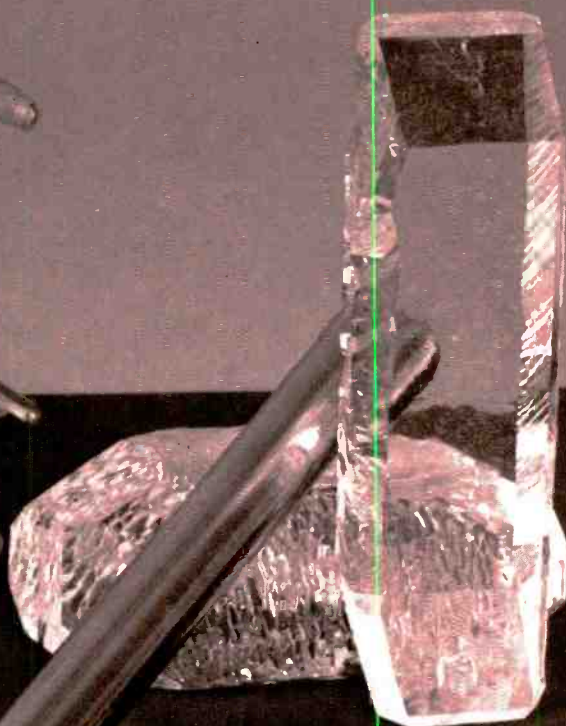
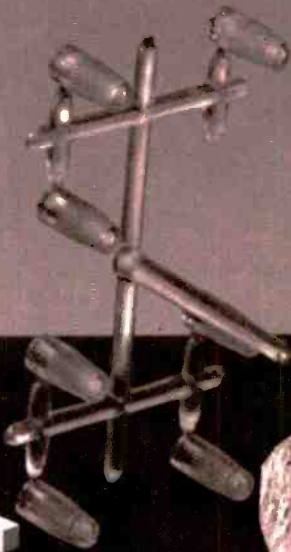
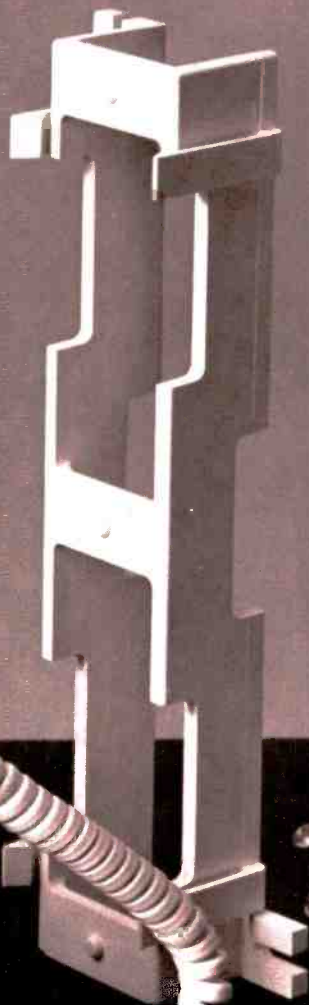

THE GROWTH OF CIVILIZATION has often been labeled in terms of how far mankind has progressed in the discovery and use of materials. Terms such as Stone Age and Bronze Age give real measures of the development of human achievement. It would be fair to say that nearly every major step in the development of civilization has been constrained by the capacity of people to find materials good enough to handle new technological challenges—for example, the development of steels for railroads. In the same spirit, discoveries of new properties of materials have often stimulated fresh ventures in science and technology—for example, the discoveries of materials that are broadly called plastics.

To sum up the work of Bell Laboratories on materials would be a severe exercise even in a treatise because materials research is basic to telecommunications and encompasses nearly every conceivable kind of material—solid, liquid, and gas. This account therefore seeks only to note in three areas of materials science—plastics, magnetic alloys, and single crystals—some highlights of discovery of these substances. These three areas are clearly important to broad endeavors in communications, and are of both historical and current interest. It is a testimony to the breadth and vigor of Bell Laboratories that many other activities dependent upon materials could just as well have been named.

Plastics for Outdoor Cable

Because the word “plastic” is so common in our language today, few people realize that plastics and related substances have been understood and widely used for only a few decades. “Plastics” is a term for synthetic substances—man-made by combining small molecules into large ones known as polymers—derived from the vast chemistry of petroleum. This chemistry is simply a logical consequence of petroleum’s emergence over coal, wood, rubber, and other substances as the basis for our carbon-containing raw material.

In the beginnings of electricity, telegraphy, and telephony, the insulation on wires consisted of rubber, cotton, or silk—all of which are materials found in nature. The basic faults of such materials as insulation were first realized around 1920 when the Bell System was considering the use of transatlantic telegraph cable for telephony. F. B. Jewett, the first president of Bell Laboratories, recognized that the problem had to do with the inadequacy

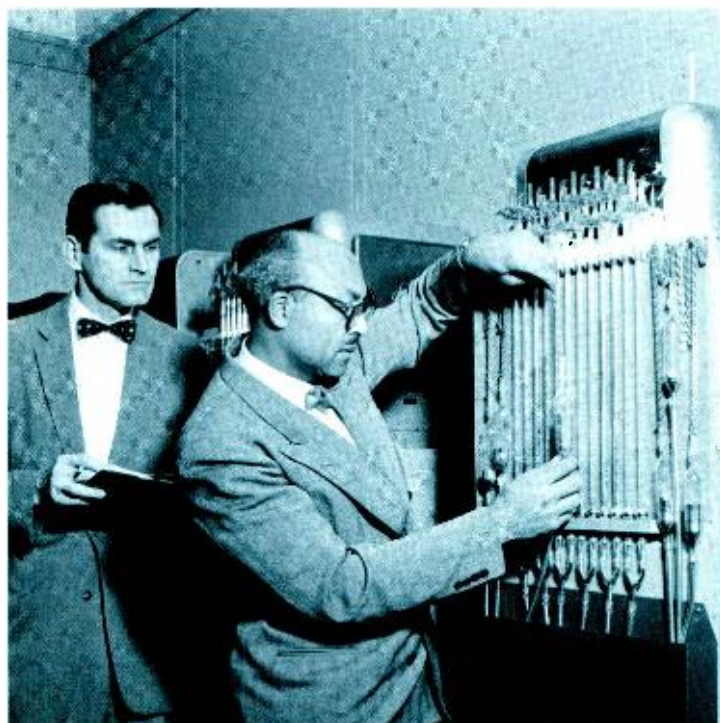

During the 1950s, protective agents called “antioxidants” were developed by Bell Labs scientists to prevent polyethylene-insulated cable from being degraded by the high temperatures encountered during fabrication and exposure to hot climates. Here, in 1958, F. H. Winslow (left) and W. L. Hawkins conduct accelerated tests on polyethylene to determine the effectiveness of various antioxidants.

of the cable’s insulating material, gutta percha, which is a natural product closely related to rubber. This led R. R. Williams, chemical director of the newly formed Bell Telephone Laboratories, to set, as one of his first objectives, the goal of finding an improved dielectric, or insulation, for use in submarine cable. Investigations by A. R. Kemp, G. T. Kohman, and H. H. Lowry showed that proteins and other impurities were responsible for the poor performance of rubber and gutta percha in water. A successful telephone cable, using properly purified dielectrics, was installed in the early 1930s between Florida and Cuba. The role of molecular motion in the behavior of dielectrics, for use in cable and in capacitors, was studied by Kohman, S. O. Morgan, and A. H. White. This work provided much of the experimental basis for theoretical understanding of dielectric behavior.



The long search for a "waterproof" cable neared its end in about 1966 when M. C. Biskeborn advocated a British concept of using a petroleum jelly blend to fill the air spaces inside a cable. Even with the outer sheath of such a cable perforated and the cable completely submerged in water, tests such as that being performed here by Ambrose Vallyely cannot detect any appreciable entrance of water.

In the late 1930s, scientists at Imperial Chemical Industries in England caused an upheaval in the uses of organic materials by their discovery of polyethylene—the most widely used plastic in the world today. Polyethylene came into major use in the Bell System years before it found general acceptance. The first commercial use of this plastic took place in 1939 when the Bell System used it to insulate coaxial cable in a trial run between Washington and Baltimore. Until then, ceramic beads had been used for this insulation.

Around 1945, concern developed in the Bell Labs Outside Plant Department to find a replacement for lead in cable sheath. The need arose because of the rising cost of lead and the uncertainty that its supply would meet the swiftly expanding demand for new telephone plant. At this time, the Bell System was using polyethylene that contained about one percent

carbon black to screen out potentially harmful rays of the sun. Without this protection, polyethylene sheath becomes brittle and its useful life is shortened drastically. Working closely with chemical manufacturers, W. J. Clarke, J. B. DeCoste, F. S. Malm, and V. T. Wallder developed formulations suitable for extrusion onto cable. In late 1947, Western Electric began commercial manufacture of polyethylene-jacketed cable.

Almost at once, however, field reports came in that the sheath was developing large cracks during or after installation. F. H. Horn, C. F. Wiebusch, and Wallder conducted tests in the laboratory to duplicate this disastrous phenomenon, which came to be known as "stress cracking." These investigators soon found that the destruction was induced by a combination of mechanical stresses and the presence of a variety of surface-active agents such as soaps, greases, etc. The molecular explanation was found by W. O. Baker, I. L. Hopkins, and J. B. Howard, who showed that when an excessive number of short polyethylene molecules was present among the large ones in the cable sheath, the plastic became vulnerable to environmental stress cracking. The remedy was to get the chemical manufacturers to make polymers with higher average molecular weights (larger polymer chains). This problem of stress cracking comes and goes, each time in a different guise. But the knowledge of practical chemistry, through the work of Howard, and the basic understanding of the relation of mechanical properties to molecular architecture, through studies by S. Matsuoka, H. D. Keith, and F. J. Padden, have shown the way to solutions.

Polyethylene was introduced as an alternative for pulp insulation on wire in about 1954. Plastic insulated cable is attractive because it does not require a hermetically sealed sheath and can be spliced or terminated easily by outside plant craftspeople. However, the manufacture of pulp-insulated wire continues today because it is readily maintained in the conduit environment; that is, faults are easy to locate and repairs can be made quickly. In addition, pulp insulation is often preferred for applications where space is at a premium because more pulp-insulated conductors can be packed into a given diameter cable than plastic-insulated conductors.

At about this time it became apparent to materials researchers that polyethylene needs protection in hot climates and from the high

temperatures encountered during the sheath extrusion process. Concern over the stability of polyethylene involved work by B. S. Biggs, W. L. Hawkins, J. B. Howard, V. L. Lanza, F. H. Winslow, and others. Without some kind of chemical protection, the plastic loses its mechanical strength through oxidation. To prevent this, protective agents called "antioxidants" were studied to learn the fundamental chemical mechanisms of their activity. Hawkins and Lanza found that certain antioxidants, in the presence of the carbon black that shields the sheath from the effects of sunlight, afford protection that far surpasses the action of the antioxidants themselves. Despite the development and widespread use of antioxidants, the chemistry of this "synergistic effect" is not yet understood and poses a challenge for future study.

Water is a great enemy of plastic insulated cable. Once water enters a cable core through a leaky splice or damaged sheath, it can increase transmission loss, cause noisy circuits, and corrode the conductors. Furthermore, finding the water and getting it out is a formidable undertaking. A concept that originated in England and came to Bell Laboratories through M. C. Biskeborn's efforts in about 1966 was to fill the air space inside the cable—about half the space inside a cable is air—with a substance such as a petroleum jelly which would deny entrance and flow of water. Development of such a "blocking" compound with the right properties for "waterproofing" cable was undertaken and realized by R. Sabia. Western Electric is now manufacturing this "waterproof" cable in large quantities.

Magnetic Alloys

Magnetic materials have always played an important role in electrical communications. Before the 1920s the telephone system used primarily iron or iron with a little silicon for purposes requiring "soft" or easily magnetized materials. Steels with carbon, tungsten, and chromium were used for "hard" or permanent magnet applications. With the growing sophistication of telephone apparatus, however, the need arose for tailoring materials to meet new requirements. Work along these lines began in the Engineering Department of Western Electric in the 1910s, and has continued with ever-increasing variety in Bell Laboratories to this day.

The discovery of a family of nickel-iron alloys, the permalloys, afforded magnetic per-



In 1938 E. A. Nesbitt invented a family of permanent magnet materials known as Vicalloys, which are used in the twistor memories of electronic switching systems. Here he demonstrates, in 1968, the strength of one of the most powerful small magnets ever made—"a rare earth" alloy which he helped develop.

meabilities greater than those of iron or any other material then known (the higher the permeability of a material, the easier the material is to magnetize). The early work was in the hands of H. D. Arnold and G. W. Elmen, and was strongly carried forward by them after the founding of Bell Laboratories. The variety of magnetic properties available in the permalloys comes from changing the nickel-iron ratio, from introducing small amounts of third components such as molybdenum, and from special heat treatments. Permalloys found quick use in the continuous loading of submarine telegraph cable, thereby adding uniform inductance to the circuit and greatly increasing the message capacity. One form of permalloy, an insulated powder, replaced powdered iron as the core material in telephone loading coils. The result was a vast improvement in the quality and a reduction in the cost of long distance telephony. Further development extended the useful frequency range of permalloy to carrier and radio transmission systems. By World War II—through the work of O. L. Boothby, R. M. Bozorth, and D. H. Wenny on Supermalloy, a molybdenum-nickel permalloy—permalloys with initial permeabilities in excess of 100,000 were known. (Compare this with permeabilities of 2000 for silicon steel in 1915, 8500 for permalloy in 1920, and 20,000 for a permalloy variant in 1923.) Variants of the original permalloys are to be found throughout modern technology.

A major improvement in the area of magnetic materials came in 1938 with the invention by E. A. Nesbitt of the Vicalloys, a family of iron-cobalt-vanadium alloys which are both magnetically permanent and ductile. This feature of ductility makes the Vicalloys particularly valuable because most magnetically hard alloys are brittle. In its first commercial application, speech recording, Vicalloy was used in the form of a ribbon. More recently, it has been used for the card of the permanent magnet twistor memory in electronic switching systems. From this same family of alloys, J. H. White and C. V. Wahl had previously invented 2V-Permendur, a ductile and magnetically soft alloy used in telephone receiver diaphragms.

Reed switches serve the Bell System in vast numbers, interconnecting customer lines, trunks, and various service circuits such as dial pulse receivers and ringing circuits. These switches consist of two or more movable metal

reeds, with contacts, sealed in a glass capsule. When a magnetic field is applied to the reeds, the contacts close. In one type of switch, the contacts return to their rest or "open" position when the magnetic field is removed; in another type, the Ferreed, the presence of a magnetic material having a substantial "remanent" magnetization keeps the contacts closed until a reverse magnetic field is applied.

By 1963 D. H. Wenny, with the collaboration of H. L. B. Gould, had adapted cobalt-iron-vanadium remanent alloys, which he termed "Remendur," for use as the remanent element of Ferreeds. Unlike most permanently magnetic materials, Remendur does not require a high field strength to reduce or "coerce" the magnetization to zero. Remendur was first used as the external remanent plate or magnet in Ferreed switches for No. 1 ESS (each switch "crosspoint" includes both sealed contacts and external remanent plates). In a subsequent design, called the Remreed switch, this magnetic alloy was adapted to the reeds themselves—thus eliminating the need for an external magnet because the reeds are magnetized by sending control pulses through them. The resultant savings in both space and cost are huge. Dealing with such alloys is no simple matter, however, because complicated mechanical and thermal sequences are required to prepare them for final use. Nevertheless, this complexity has been unraveled through the practical approaches of K. M. Olsen and the fundamental studies of G. Y. Chin, S. Mahajan, and others.

New advances in magnetic alloys continue to offer great promise for the future. One example: the work initiated by Nesbitt and J. H. Wernick during the late 1950s led to the discovery in 1968 of alloys which combine rare earth elements with cobalt and copper. These rare earth alloys have coercive forces and energy products greater than those found in any other permanently magnetic alloy of commercial interest. The practical uses of novel alloys such as these will undoubtedly stimulate new ventures in the design and application of telephone systems.

Synthetic Single Crystals

Nature produces single crystals in great variety—gem stones, quartz, and other minerals. Yet in just three decades, people have learned to excel nature in the size, perfection, and controlled composition of many crystals—and, in fact, have produced other crystals that

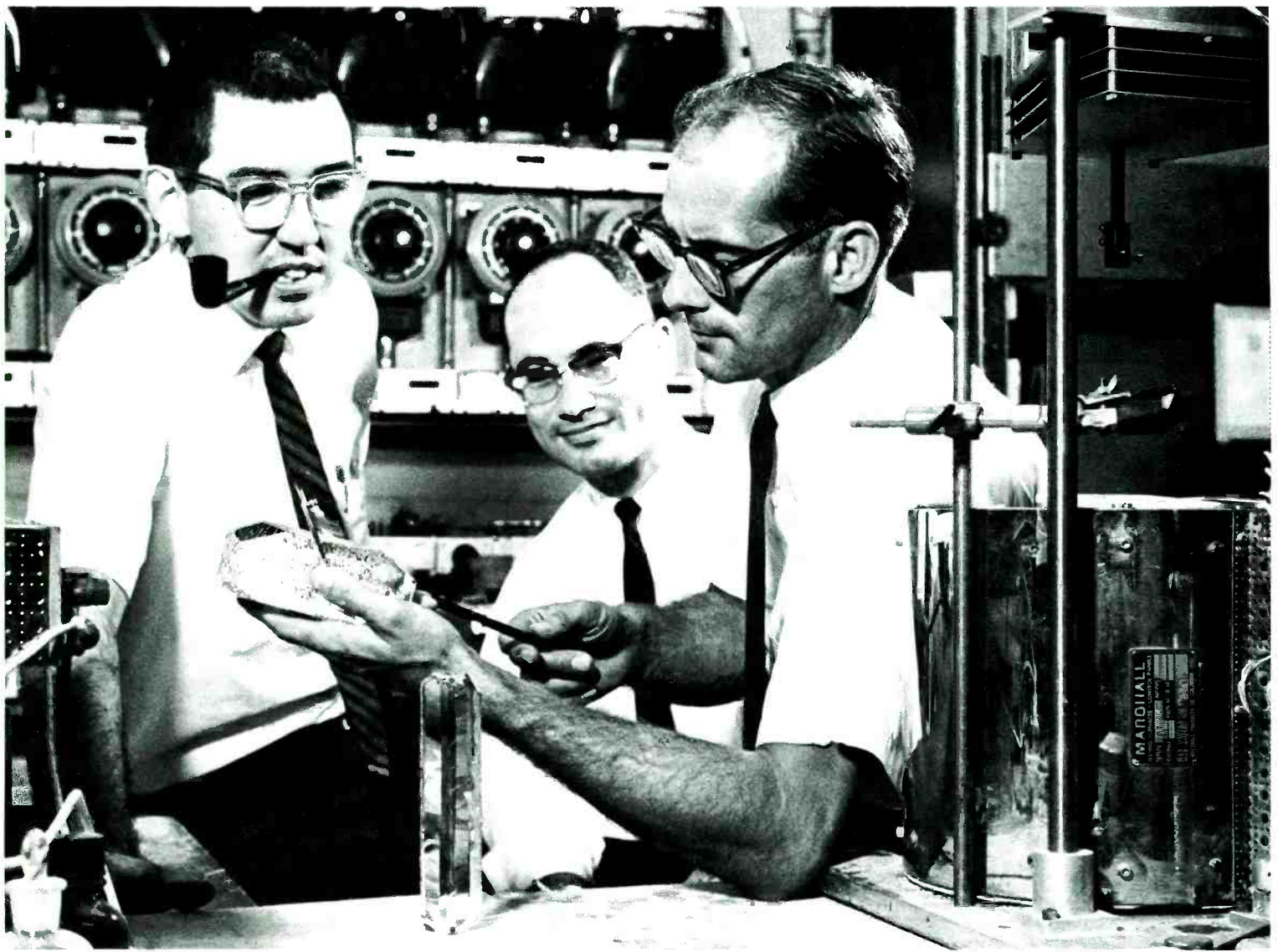

An improved method of growing synthetic quartz crystals for communications use was developed in the 1960s by R. A. Laudise (left), A. A. Ballman (right), and J. C. King (not shown) of Bell Laboratories and D. W. Rudd (center) of

Western Electric. Their method is based on introducing small amounts of lithium to the crystal-growing solution to produce man-made crystals that control frequencies with the same stability and precision as natural quartz.

have no counterpart in nature. The impact of these accomplishments upon telecommunications and upon the modern electronics industry in general is beyond measure since these crystals are used in practically every type of modern communications system. Bell Labs has been at the forefront of this advancing science and technology since its inception.

The major work in Bell Laboratories on single crystals began with an endeavor to find a synthetic quartz of high quality. This was prompted by the fact that pure natural quartz comes chiefly from Brazil, whose supply to other countries was sharply cut during World War II by the hazards to ocean transport. By then quartz was already firmly established as

a means for controlling the frequency of radio oscillators and affording precise frequency selection in channel filters for carrier telephone systems. The wartime shortages of quartz were bridged by the successes of A. N. Holden and others in developing certain synthetic organic crystals to serve as substitutes for some applications, primarily for transducers in sonar work. After the war Bell Laboratories and several other organizations began searching in earnest for a way to make high quality synthetic quartz. Although the United States has vast amounts of quartz in impure form, the quality of the deposits is not good enough for electrical use. The challenge, then, was to find a way to grow perfect crys-

tals from impure raw material. By the early 1950s, A. C. Walker, G. T. Kohman, and E. Buehler had developed the hydrothermal method of crystal growth, which closely approximates nature's process. Ordinarily, quartz is insoluble in water. However, alkaline water will dissolve quartz slowly at high temperatures of about 400°C. To keep the solution from turning into steam, it is placed in a steel vessel—the bottom of which is kept hotter than the top—and the system is pressurized to about 20,000 pounds per square inch. Small "seed" crystals of pure quartz are suspended from the top. The impure quartz dissolves in the bottom region while pure quartz deposits on the seeds at the top.

By 1957, R. A. Laudise had studied the process variables thoroughly and, in conjunction with R. A. Sullivan of Western Electric, had set up a pilot plant facility at Merrimack Valley. The chemistry and engineering soon became well understood, enabling Western Electric to begin full production in 1958. Subsequent studies by Laudise, A. A. Ballman, and J. C. King, in collaboration with D. W. Rudd of Western Electric, showed that the addition of small amounts of lithium leads to a product that is superior in some essential ways to the best that nature provides. The hydrothermal method of crystal growth has been extended successfully to a variety of other substances, such as ruby, sapphire, and certain garnets.

Another method of growing single crystals is to solidify the crystal from a molten pool of the same substance. The crystallization is begun by first lowering a "seed" crystal into the melt. The single crystal is then grown by pulling the seed out of the melt with a proper balance of temperature, speed of lifting, and quantity of melt. This general technique is called the Czochralski method. Its application to germanium, soon after the invention of the transistor in 1947, provided a vital supply of high quality single crystals. Prior to this, crystals for transistors had to be cut laboriously from polycrystalline ingots. The application of this method to germanium, and later to silicon, was the achievement of G. K. Teal, E. Buehler, and J. B. Little. The purity of these crystals was crucial to the development of transistor materials, but no less important was the control of minor additions of other elements ("dopants") to regulate the type (P-type or N-type) and degree of conductivity in germanium and silicon. It was also neces-

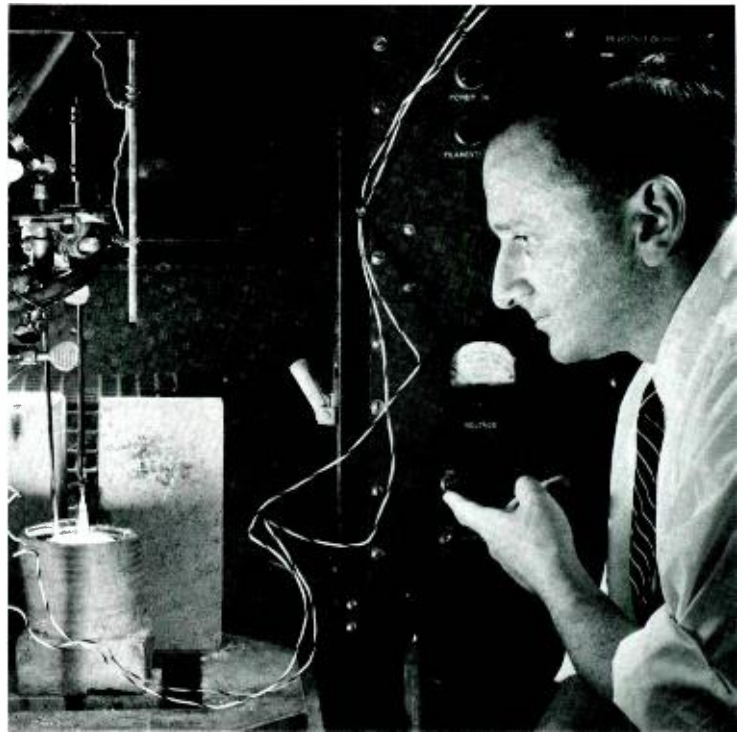

Bell Labs scientists have discovered many important materials that are helping to make a practical optical communications system possible. This crystal being pulled from the melt by K. Nassau is lithium niobate—a promising material for use as a harmonic generator at optical frequencies. Nassau and his coworkers also prepared single crystals of calcium tungstate doped with neodymium to produce the first solid-state laser to operate continuously at room temperature.

sary to learn how to characterize these materials. This activity was carried out under the leadership of A. H. White, and involved the contributions of J. A. Burton, C. S. Fuller, N. B. Hannay, E. D. Kolb, W. P. Slichter, M. Sparks, and many others. (The terms P-type and N-type, now universally used in the language of semiconductors, were invented by J. H. Scaff and R. S. Ohl in 1941 to identify the easy direction for current flow from a contact into a semiconductor. Thus, a P-type semiconductor shows good conductivity when it is electrically positive with respect to an external contact.)

The technique of "pulling" crystals from the melt has found many other applications, particularly with respect to optical communications. In the 1960s L. G. Van Uitert and A. A. Ballman explored this technique for a variety of oxides. L. F. Johnson and K. Nassau discovered that the neodymium ion can be excited and made to fluoresce strongly in single crystals of calcium tungstate grown by the Czochralski technique. Johnson, Nassau, and others prepared single crystals of calcium

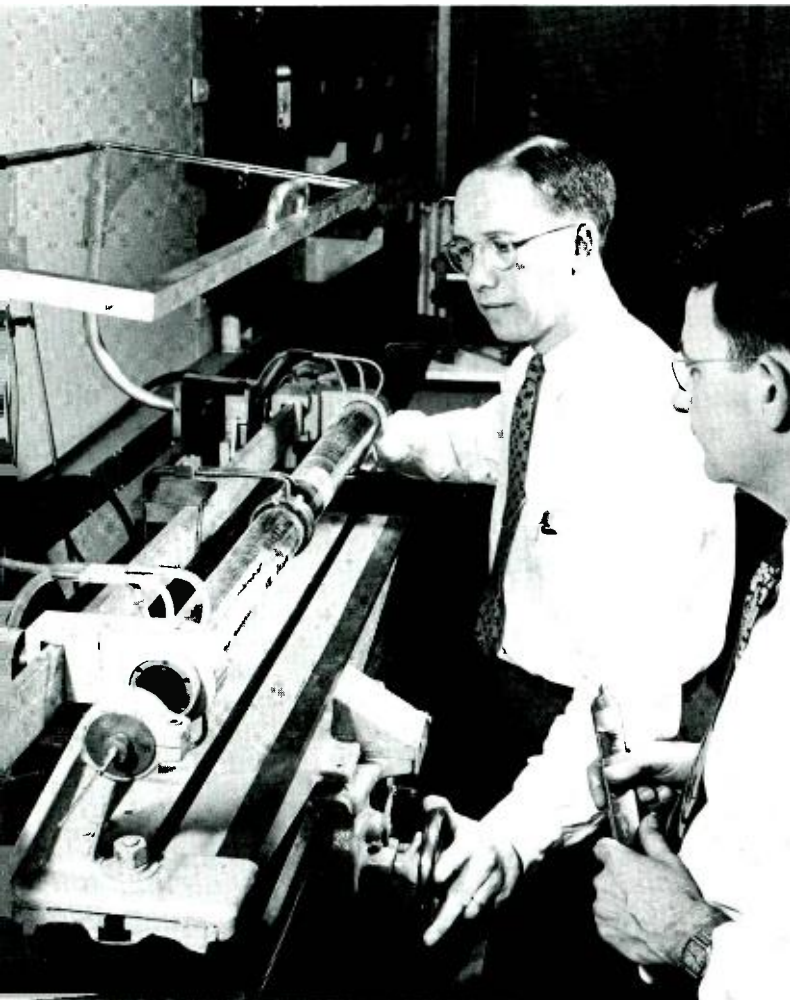

The development of zone refining techniques in 1951 by W. G. Pfann, left, became a critical step in the making of pure semiconductor crystals for use as transistors. Here Pfann operates the refining equipment while J. H. Scaff, closely associated with the development, holds a large single crystal of germanium purified by this technique.

tungstate containing about 0.5 percent of neodymium and developed the first solid-state laser capable of operating continuously at room temperature. This opened the way to other new laser materials—such as yttrium aluminum garnet doped with neodymium—and nonlinear optical materials—such as lithium niobate—for use as modulators and harmonic generators.

A major activity in the development of highly pure semiconductors came from the pioneering work of W. G. Pfann, who discovered the process of zone refining. Knowing



In 1974 Bell Labs scientists, working with Western Electric engineers, developed a way to recycle plastics from discarded telephone housings and handsets. The discarded housings are ground up into pellets which are then fed into a machine that separates the plastic from the dust, paper, small metal clips, and other materials present in the scrap. At left, Jerry Hardiman feeds housings into the grinding machine while Philip Hubbauer checks the resulting pellets.

that a crystal growing from the melt usually rejects the impurities dissolved in the liquid phase, Pfann devised a scheme whereby an externally heated band of molten material is passed through a long ingot of solid material, thus sweeping out the impurities. Although germanium was the first object of interest, the technique has been widely applied to the purification of materials. Pfann also extended the method to “zone leveling,” growing a material of uniform concentration, and to growing large single crystals from a seed crystal. Another important development was the “float-

ing zone" method, invented by H. C. Theurer, which avoided a source of contamination by eliminating the need for vessels to hold the molten material—the molten material being supported by surface tension during the refining process.

Certain crystals, however, cannot be grown from the melt. J. P. Remeika was a pioneer in the use of molten oxides and salts as solvents for the growth of refractory crystals. These solvents, or "fluxes" as they are commonly called, lower the melting point of the crystals. For example, Remeika used a flux of potassium fluoride from which to grow a single crystalline form of barium titanate, a useful ferroelectric which cannot be grown from the melt. Similarly, J. W. Nielsen and E. F. Dearborn were able to grow yttrium iron garnet from a flux of molten lead oxide. Since this garnet decomposes at its melting point, using flux as a solvent was the key to success.

Magnetic "bubbles" have caught the attention of scientists and engineers who look for new and improved ways to implement logic, memory, and switching functions. "Bubble" materials—substances in which tiny bubble-like magnetic regions can be used to store and process information in vast quantities and at high speeds—have been known since the late 1960s. The materials first applied to this use by A. H. Bobeck were thin wafers of yttrium orthoferrite cut from single crystals grown from fluxes by L. G. Van Uitert. The potential of bubble devices to compete economically with alternative devices was greatly improved by the subsequent development of rare earth garnets deposited by refined techniques as thin films on nonmagnetic substrates.

The People

This fragment of the history of finding new materials touches on only a few Bell Laboratories accomplishments. It mentions some people and, of necessity, leaves out many more of equal importance. Nevertheless, a major reason for the success of Bell Laboratories has been that the organization embraces a great many materials-oriented skills, each impacting on others within the company and also coupling with those at universities and other industries. As the needs of telecommunications become steadily more demanding, and as some of the world's natural resources become ever more limited, it will be the combined ingenuity of these people that will supply the materials to do the job. □

MATERIALS TODAY

During the past five years, industry has been greatly concerned about the shortages of certain materials and the integrity of the environment. As a result, the Bell System—in designing systems and equipment—now considers resources and environmental factors along with the traditional factors of cost and function (see *Resources, the Environment, and the Bell System*, RECORD, October 1972). To help accomplish this, the Materials Research and Engineering Division at Bell Labs interacts closely with Western Electric in pointing the way to new designs and alternative production methods and in selecting substitutes for critical materials. This means the Bell System is placing more emphasis on such things as scrap recovery, control of particle and gaseous pollutants from combustion, auto exhaust emissions, environmental control and analysis, and the modeling of complex chemical systems.

The Bell System today has redoubled its efforts in reclaiming materials to the point where we are now reclaiming plastics—materials once considered expendable. Plastics are increasingly being used as substitutes for many metals, except for steels and some aluminum alloys whose cost and availability trends are still favorable. Another example of materials substitution is the use of aluminum conductors instead of copper in certain cables, aluminum being substantially more abundant than copper. Such substitutions are welcome because they conserve metals for more essential purposes. Certain applications, however, use materials for which there are no substitutes now—for example, the mercury in mercury-wetted sealed contacts. In these cases, the materials must be utilized more efficiently and new sources identified.

While efforts to conserve, recycle, and use materials efficiently are becoming more important, so too are the economics. New ways are being sought, for example, to bring down the cost of recycling materials—a process whose expense has until now prohibited many materials from being recycled. And in the case of a dwindling resource such as copper, anything that can be done to increase the percentage of its recovery from scrap—about 30 percent of the copper used in manufacture by Western Electric plants comes from reclamation by Nassau Smelting and Refining—becomes a pressing concern.

It is clear then that the design of systems and equipment for the Bell System must now include factors that help to conserve resources and minimize environmental damage—the degree of success being determined largely by the materials and manufacturing processes we select.

Device Development

WILLARD S. BOYLE

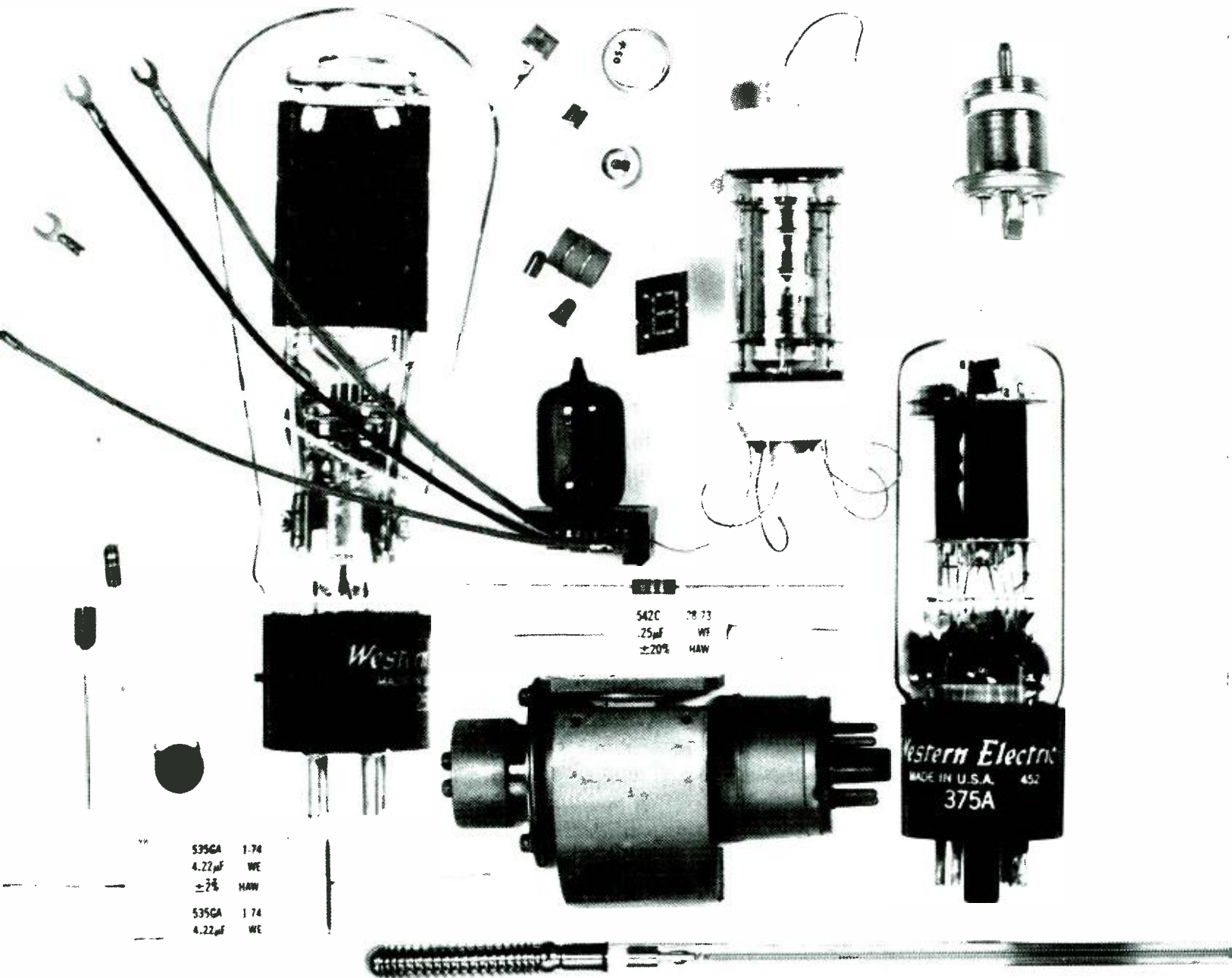

535GA	1.74
4.22 μ f	WE
$\pm 2\%$	HAW
535GA	1.74
4.22 μ f	WE

542C	08.73
.25 μ f	WF
$\pm 20\%$	HAW

Western Electric
MADE IN U.S.A. 452
375A

Electronic devices are the basic building blocks of all telecommunications systems. Since its beginning, Bell Labs has helped shape the evolution of device technology—the most dramatic contribution being the discovery of the transistor effect and the subsequent development of transistor-based electronics.

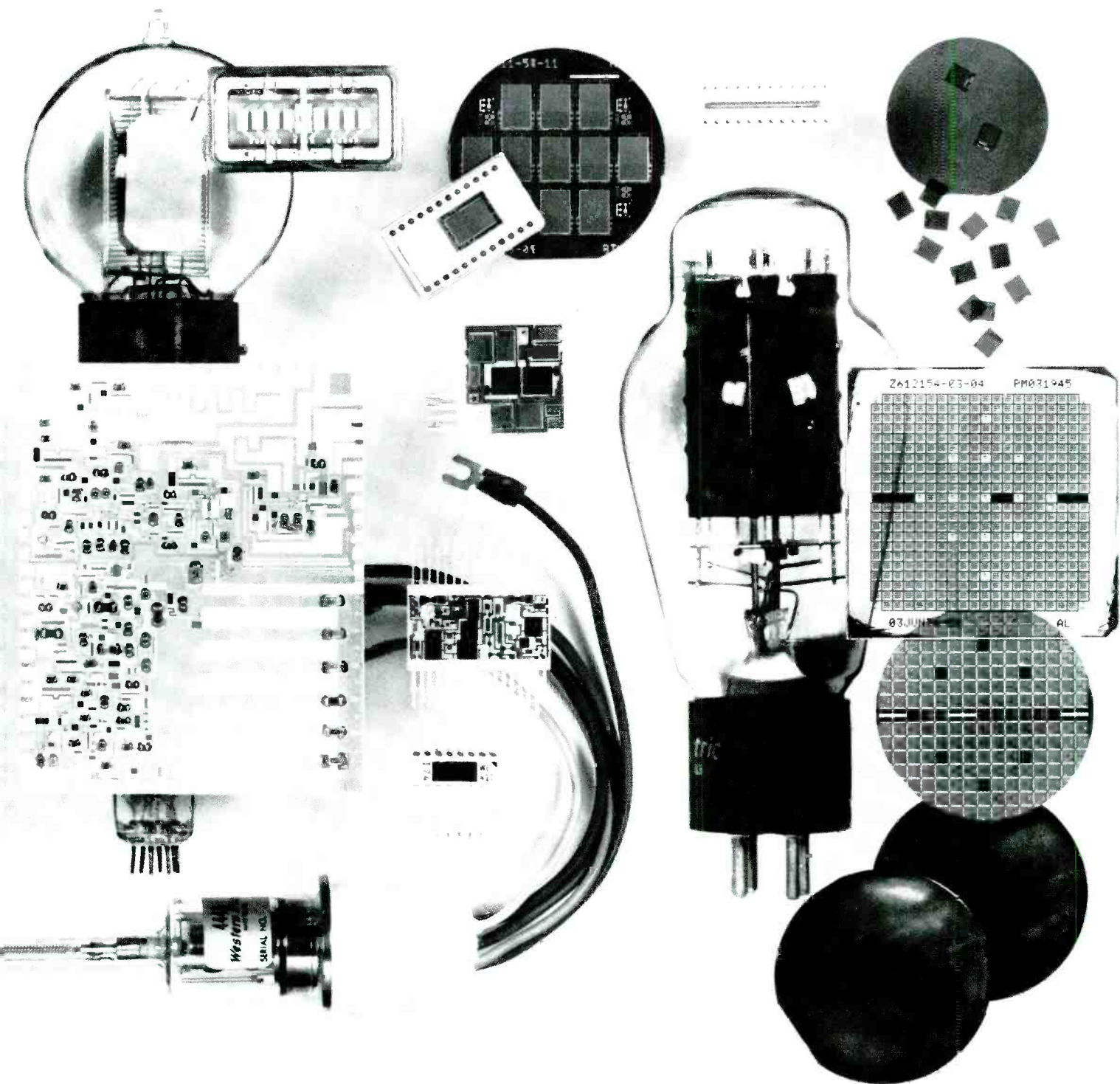

DURING THE HALF CENTURY of Bell Laboratories' existence, two major device technologies prevailed: first the vacuum tube and later the transistor and solid-state technologies derived from it. Communications technology for the first 23 years was dominated by the vacuum tube, improvements to which were achieved by a very imaginative use and detailed understanding of the interaction of space-charge controlled electrons with electromagnetic fields. Then in 1947, Walter Brattain, John Bardeen, and William Shockley discovered the transistor effect, triggering a new era in communications technology in which the operation of electronic devices is dominated by the subtle chemistry and physics of semiconductors and other materials, particularly at surfaces and interfaces.

Despite the fact that the transistor transcended the vacuum tube, these two technologies both share a common element: their success was largely dependent on the interaction of skills in the basic sciences with skills in the development, manufacture, and application of devices. Today these interactions are more important than ever before, as the correlated efforts of specialists in materials, components, circuits, and systems are essential in dealing with the complexities of modern semiconductor electronics.

This article illustrates how device development is carried out at Bell Laboratories by focusing on a few events and the people that caused them. Instead of trying to single out all the major contributions made to device technology over the past fifty years, we have selected examples that emphasize important ideas and interactions. These examples point out that, almost without exception, the stimulus to invent and develop a device comes from a need or a surmised opportunity. The need comes from a specific system requirement, while the opportunity is defined in the mind of an inventor by a knowledge of what is possible and what is ultimately practical based on the existing state of scientific knowledge.

Early Vacuum Tubes

At the time Bell Labs was formed in 1925, vacuum tube amplifiers had already made the first transcontinental telephone message possible. Thus, it was clear by then that the negative-grid vacuum tube was to play an extremely important role in telephony. In 1926, M. J. Kelly, later to become president of Bell Labs, was taking pride in his tube shop which

had 15 codes of tubes in manufacture. Kelly's tube shop was in the Western Electric building on Hudson Street in New York City, not far from the Bell Labs location on West Street. Kelly often pointed out then that a close relationship between Western Electric and Bell Labs people was an important factor in meeting the needs of the Bell System with this new technology. His early tube shop experience undoubtedly influenced him over the years because in 1947, as Bell Labs executive vice president, he established the first branch laboratory at Allentown, Pennsylvania—sending a group from the Bell Labs' Electronics Apparatus Development Department to work at the Electronics Shop of Western Electric.

Demonstration of Wave Nature

Both engineering development and fundamental research were devoted to improving vacuum tubes. For example, while trying to get a better understanding of the life of the electron tube, L. H. Germer—under C. J. Davisson's direction—was studying the behavior of nickel surfaces being bombarded by an electron beam. These experiments yielded remarkable results. Some components of the electron beam that reflected off the nickel surface were particularly intense in a small number of directions. Moreover, the angles formed between the incident beam and the intense reflected beams varied with the energy of the incoming electrons—a curious undulating relationship that could not be explained readily with contemporary theory. At this time the theoretical formulations of quantum mechanics—a mathematical scheme for describing how matter behaves as particles and as waves—were just being developed. Davisson was quick to realize that the data he and Germer had obtained was a demonstration of the wave nature of electrons and that this data could provide experimental confirmation of the new quantum theory. For this work Davisson received the Nobel Prize in Physics in 1937.

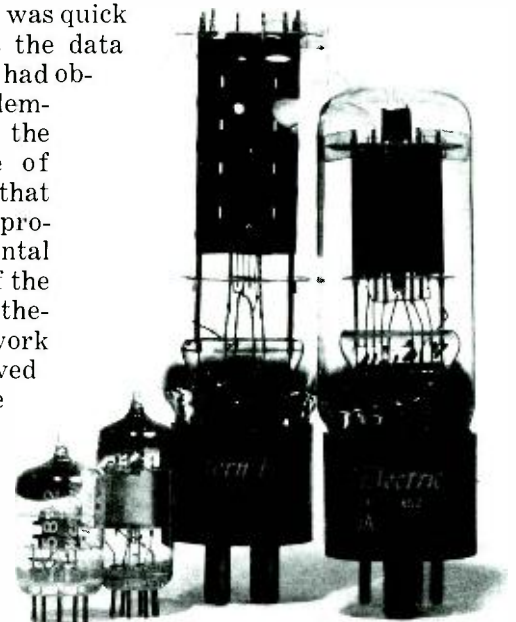

Co-discoverers of the transistor effect in semiconductors, John Bardeen, William Shockley, and Walter H. Brattain (left to right) were awarded the Nobel Prize in Physics in 1956. The three scientists are shown here in 1948 with the apparatus used in their first investigations that led to the invention of the transistor.



In 1927 C. J. Davisson and L. H. Germer demonstrated in an experiment at Bell Labs that electrons could behave like waves as well as particles. For this work Davisson, holding the electron tube used in the now-famous "electron-diffraction" experiment, shared the 1937 Nobel Prize in Physics.



Early in 1957 Bell Labs scientists (from left) Harold Seidel, George Feher, and Derrick Scovil demonstrated that maser action could take place in a solid. Their experiment led to the ultrasensitive ruby maser amplifier used in the TelstarTM satellite system for communications.

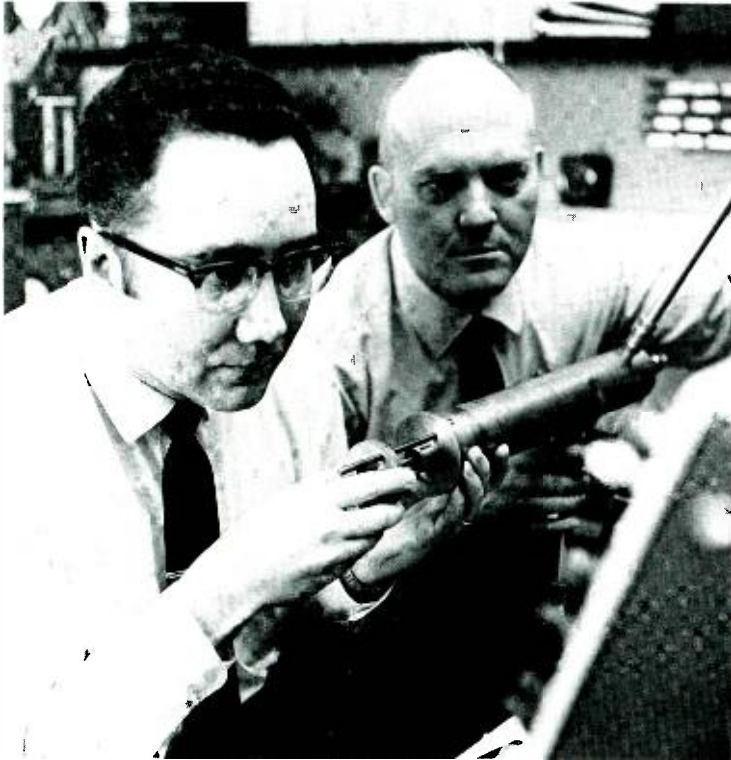

Researchers have sought a usable solid-state source of microwave and millimeter wave frequencies for many years. One of the most promising devices so far developed is the IMPATT (for IMPact Avalanche and Transit Time) diode. In 1964 Bernard C. DeLoach (left) and Ralph L. Johnston became the first to observe power generated in an IMPATT device.

The fact that Davisson and Germer were seeking to improve vacuum tubes was ironical, because their work provided one of the experimental cornerstones of quantum theory which later led to advances in solid state physics, the invention of the transistor, and the eventual demise of the vacuum tube as the prime building block of electronic systems.

While Davisson and Germer were studying physical processes, J. B. Johnson was making electrical measurements in circuits. Particularly troublesome at that time was the background noise that appeared when many amplifiers were used in cascade on long-distance routes. Using high quality tubes from M. J. Kelly's tube shop, Johnson demonstrated that the tube was not always the culprit, but that an inherent thermal property of electrical circuits also contributes to the noise. He was able to show that the noise in his circuits originated from the resistors. In a series of simple but definitive experiments, he found that the noise

depended on the temperature of the resistors and the frequency range, or bandwidth, of his amplifying circuits. Today electrical engineers are familiar with the terms "Johnson noise" and "noise-bandwidth product" because these are factors that set the performance limits of most communications devices. Johnson's experiments provided a key physical basis for C. E. Shannon's information theory which was to come twenty years later.

Higher Power and Higher Frequencies

During the 1930s the power output of vacuum tubes was being increased and the high frequency limits of their operation were being explored. To operate at high power levels, the large amounts of heat generated in the tubes had to be carried away. The development of water-cooled tubes accomplished this and thus provided the technology necessary for radio transmitters. The 50-kilowatt tube designed by Bell Labs made broadcast radio a nationwide medium.

By the end of the 1930s, tubes and circuits had been developed that could operate at frequencies approaching those used in radar systems during World War II. The background of understanding developed by Bell Labs engineers in components and circuits enabled them to make major contributions to the war effort (see *In Defense of the Nation*, beginning on page 96).

After World War II it was clear to Bell Labs engineers that important needs for long haul transmission could be met if amplifiers and power oscillators could be developed to operate

MAJOR MILESTONES IN TRANSISTOR ELECTRONICS	
POINT CONTACT TRANSISTOR	1948
SINGLE-CRYSTAL GERMANIUM	1950
GROWN JUNCTION TRANSISTOR	1951
ALLOY JUNCTION TRANSISTOR	1952
ZONE MELTING AND REFINING	1952
SINGLE-CRYSTAL SILICON	1952
DIFFUSED-BASE TRANSISTORS	1955
OXIDE MASKING	1957
PLANAR TRANSISTOR	1960
MOS TRANSISTOR	1960
EPITAXIAL TRANSISTOR	1960
INTEGRATED CIRCUITS	1961

at microwave frequencies. Shortly after the war, J. A. Morton embarked on an ambitious program to develop a microwave triode. Design theory showed that the fabrication of this triode—the performance of which was based on using electrodes that are spaced extremely close together—would require an exquisite control of dimension far exceeding that of any other tube then being manufactured. It is a tribute to Morton's engineering judgment and leadership that now, thirty years after its development, the Morton triode is still widely used in microwave systems such as the TD2.

The operating frequency of three-element devices—be they a negative grid vacuum tube, such as the Morton tube, or a transistor—is usually limited by how rapidly the charge carriers can be controlled. The limit arises from the inertial mass of the charge carrier that manifests itself as a time delay or transit time effect. In a vacuum tube the transit time is the time it takes an electron to cross the distance between cathode and anode; in a junction transistor it is the time it takes for minority carriers to travel from emitter to collector. These effects give rise to decreasing gain and increasing phase shift as the operating frequency increases.

Improving Device Performance

Reducing the size of a device is one way to offset degraded performance. In the Morton tube, for example, the grid is made of thin wire that is 0.0003 inch in diameter (one-tenth the thickness of a human hair) and spaced only 0.0005 inch from the cathode. Modern high-frequency transistors have spacings one-tenth as large.

Several ways have been found to get around the extremely small dimensions brought about by the transit time limitations of three-element devices. Traveling wave tubes, klystrons, and magnetrons are examples of high-frequency electron tubes which were developed in the 1940s. These tubes operate by modulating the flow of electrons from cathode to anode at a rate that allows for and takes advantage of the total transit time. In 1958 W. T. Read showed that a solid-state diode could generate microwave power at extremely high frequencies by combining the mechanisms of "avalanche" current and transit time delay. Read predicted that when a sufficiently high voltage was applied across a diode it would break down electrically in one region and produce an avalanche or pulse of current. This

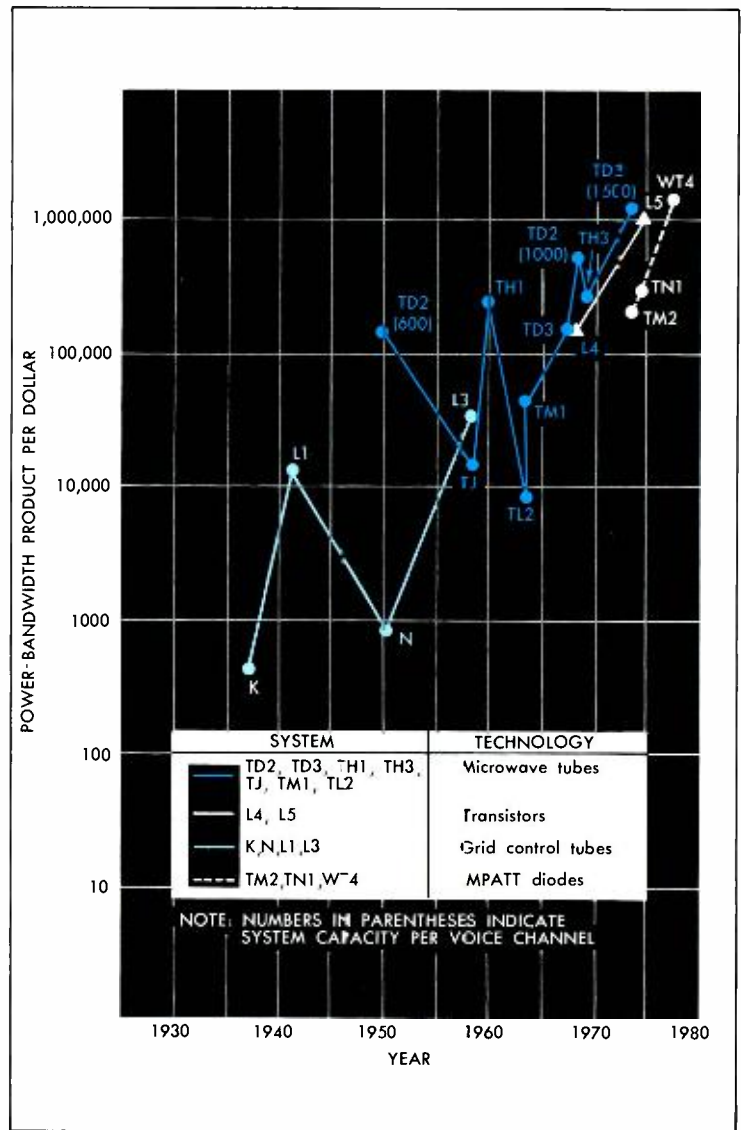

A MEASURE OF PROGRESS

It isn't easy to measure quantitatively the advances in device development over the past fifty years because many different factors are involved. In a transmission system application, for example, noise level, linearity, power output, bandwidth, reliability, and cost are all important. Nevertheless, the particular data shown here is one way to illustrate the dramatic improvements that have been made. The power-bandwidth product per dollar (plotted on the vertical scale) is a first approximation of how the number of voice channels attained per dollar has increased over the years—and includes the tacit assumption that standards of reliability, noise, etc., have been met. This plot is based on the costs of devices only. Therefore, no conclusions should be drawn from them about the relative costs of one transmission system versus another because many considerations other than devices enter into total system costs.

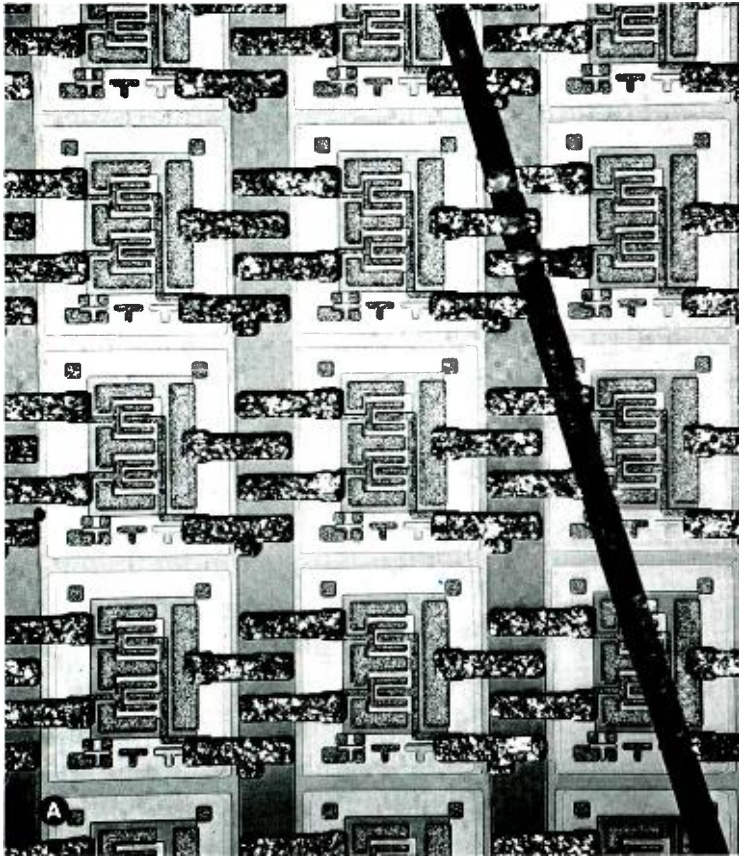

Over the past decade, refinements in the manufacture of transistors and integrated circuits have given us the capability to fabricate more and more devices and circuits

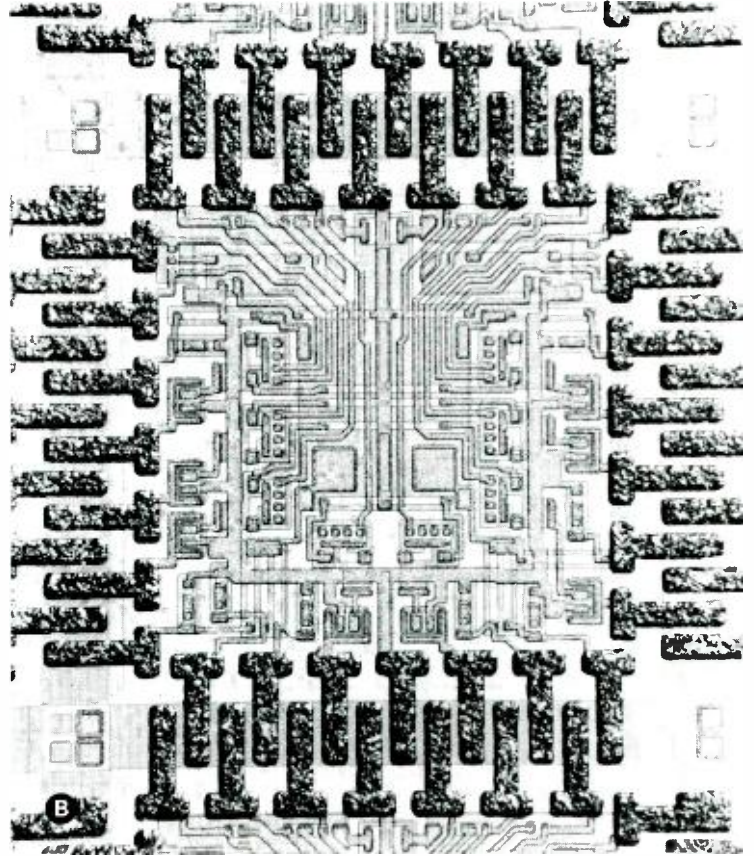

on a single disc of silicon. Shown here are highly magnified views of samples that clearly illustrate this increasing scale of integration. From the simplest device,

effect, in combination with the time it takes the pulse to move through the other part of the diode, would result in a net negative resistance at high frequencies.

B. C. DeLoach and R. L. Johnston were the first to generate microwave power by the mechanism which Read suggested. This type of device has been called an IMPATT diode for IMPact Avalanche and Transit Time. Bell Labs engineers recognized that IMPATT diodes would be an ideal—and perhaps the only—practical source of power for millimeter waves. Consequently these IMPATT diodes are now being fabricated for the Bell System's new

WT4 millimeter wave transmission system.

The Dynamics of an Electron

To produce semiconductor devices, engineers and scientists must deal with the properties of materials on the atomic level and sometimes in trace quantities. This means that the motion of electrons in a material's atomic structure must be understood completely and the material's properties controlled with a perfection far exceeding that achieved by any other product used by man. The zone refining techniques of W. G. Pfann have been essential for producing the large and near-perfect

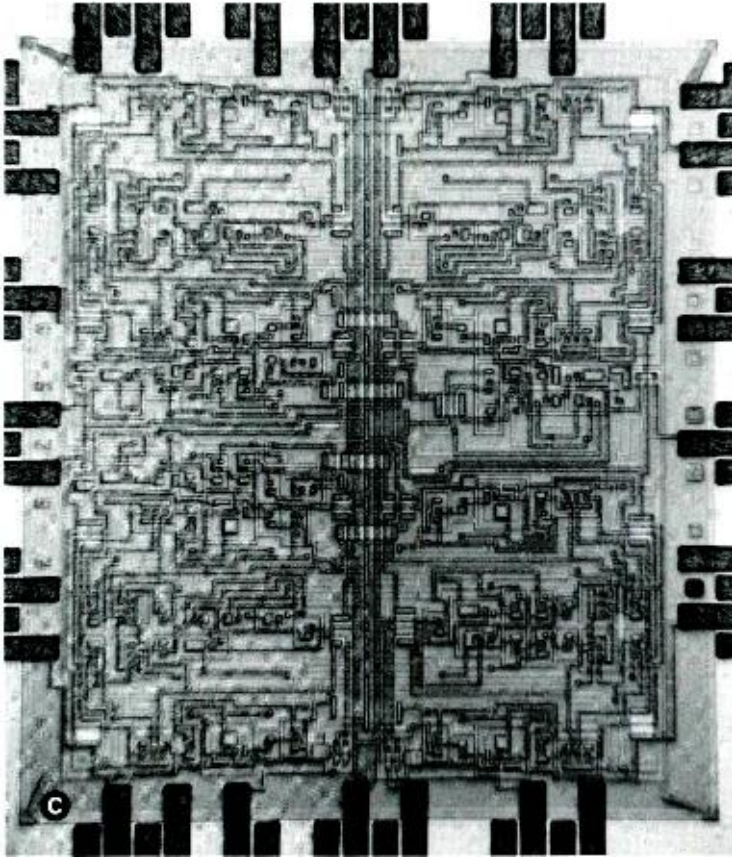

at far left, to the most complex integrated circuit, at far right: (A) a number of simple transistor pairs with a human hair positioned across the silicon disc for

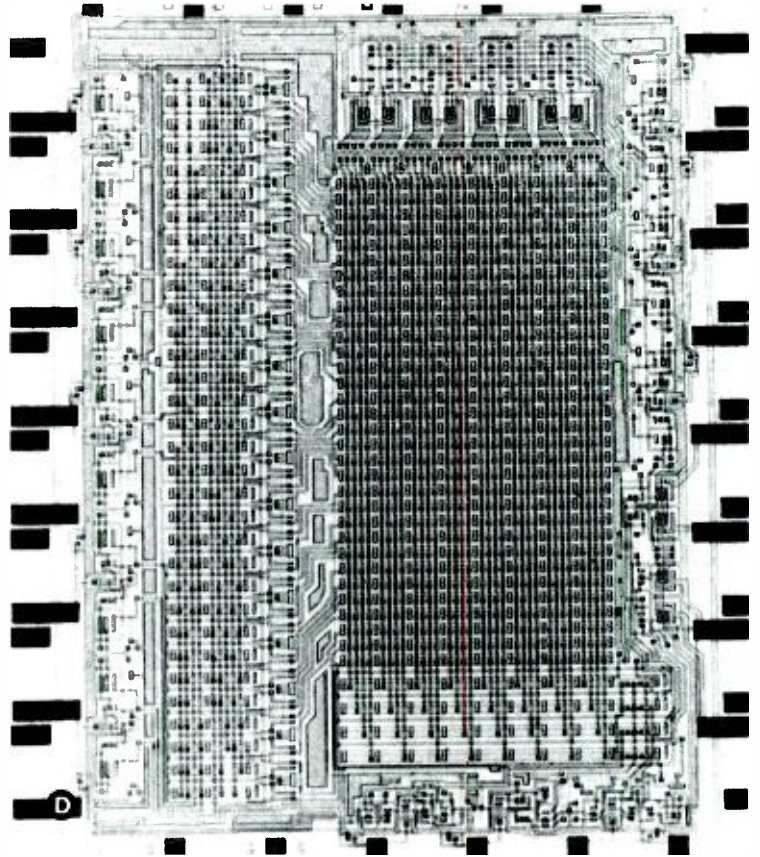

realistic size comparison, (B) a transistor-transistor logic circuit, (C) a collector diffusion-isolation circuit, and (D) a bipolar read-only memory circuit.

crystals needed for semiconductor devices. Equally important have been the tools that measure material properties and the theoretical models that were created to interpret results, organize information, and predict behavior beyond the range of readily accessible experimentation.

The designer's understanding of how a single electron behaves statistically in the neighborhood of a single impurity atom—in an otherwise perfect crystal surrounding—is central to being able to predict how any semiconductor device will operate. Information of this kind enables the device designer to know

how many electrons will be available, how fast they will move under applied electrical fields, and how far they will travel before having their direction changed.

During the early 1950s George Feher, J. K. Galt, R. C. Fletcher, and their colleagues studied the response of electrons to microwave fields, and subsequently D. G. Thomas, J. J. Hopfield, and J. R. Haynes carried out similar studies at optical frequencies. Their work has yielded not only the sought-after information about the dynamics of electrons, but also some side benefits. Feher, working with H. E. D. Scovil and H. Seidel, used

PERSPECTIVE ON DEVICES

Electronic devices are the basic building blocks of all telecommunications systems—customer equipment, switching, and transmission. Each device has a particular role in controlling the flow of electrons in a circuit so that the completed circuit performs some desired function. Passive devices—resistors, capacitors, and inductors—shape and store electrical energy. In so doing they diminish the strength of the electrical signals they process. Active devices—transistors and vacuum tubes—have the essential property of generating, amplifying, or switching signal energy.

While only a few basic types of devices exist, they are used in huge numbers. A typical electronic switching office, for example, contains 60,000 transistors and 150,000 diodes, transistor-like devices that switch signals through electrical networks. The performance of devices largely determines the ultimate technical capability of the systems they make up, while the cost and reliability of devices largely determine the economics of these systems.

One of the most important and useful inventions of the twentieth century was a device—the transistor. This amazing invention not only overcame the recognized limitations of the vacuum tube in meeting the future demands for communications services, but it has impacted on our daily lives so powerfully that its name has become a household word.

The invention of the transistor at Bell Labs marked the beginning of the semiconductor electronics industry in which the modern electronic computer, medical electronics, electronic switching, digital transmission, and much more became possible and practical. The technological advances in semiconductor devices stimulated the electronics industry in the United States to grow by a factor of ten over the past two decades, the United States remaining the technological leader throughout the worldwide electronics revolution spawned by the transistor.

Many of the technological advances that led to today's highly sophisticated devices have come from Bell Laboratories. The discovery of the point contact transistor was followed by a series of Bell Labs contributions that were pivotal in shaping the course of device technology. Most of the basic device structures—bipolar, MOS, solar cell, and silicon-controlled rectifier—originated at Bell Labs.

The most recent addition to this series is the charge-coupled device, which is still under development for performing imaging, logic, and memory functions.

Not only did the transistor spark the formation of a semiconductor electronics industry, but it stimulated scientists to such a degree that it practically created the science of solid-state physics. From this science has come the understanding of many diverse phenomena such as superconductivity and the magnetic properties of materials. This understanding, in turn, is leading to new solid-state devices such as magnetic bubbles and superconducting junctions.

The essence of today's "integrated electronics" technology is batch processing. Instead of making, protecting, testing, and assembling individual devices one at a time, we now make large groupings of these devices, together with their interconnections, all at once. The resulting entity is an assembly of devices interconnected into circuits, networks, or even subsystems. Thus, for a given system function, the number of separate devices has been greatly reduced.

One of the prime objectives of integrated electronics is to get more and more function into a single slice of semiconductor. This means cramming more circuit elements (devices) into smaller areas. At the same time, manufacturing yield becomes extremely important because one defective device, for example, ruins an entire circuit—a situation that can be time consuming and expensive to remedy. The important thing is to maximize the amount of function that can be processed per dollar.

Not only is integrated electronics concerned with producing more functions per slice of material, but also with exploring new types of functions and new material systems. Two examples of new functional technology are magnetic bubbles and charge-coupled devices (see text) which perform digital functions but which have no identifiable circuit elements such as capacitors, resistors, etc.

What about the future? The consequences of transistor-based technology are so great and the potentialities so enormous that future device development will undoubtedly surpass today's best. It is probably safe to say that we can expect to introduce, as well as to make economical, new communications services and functions which in the past had been well outside our reach.

exactly the same equipment to demonstrate the first solid-state maser, while the work of Hopfield and Thomas provided information essential to the design of efficient light-emitting diodes of gallium phosphide.

Mechanical Switch to Digital Electronics

In digital communications, information signals are expressed in the form of electrical pulses rather than continuous waveforms. This technology is used by the Bell System in electronic switching systems and, increasingly, in transmission systems including the new millimeter wave system now under development. Outside the Bell System, digital electronics is used primarily in the computer field.

A close relationship exists between electronic digital devices and the mechanical switches and relays found in electromechanical switching centers. Both perform similar functions in that they deal with electrical pulses or binary states. All the elements of logic and memory found in modern digital computers had their origins in electromechanical switching systems. Even Boolean algebra, the language used to design a computer, was first used to describe switching systems.

The performance advantages of solid-state electronics were essential to introducing digital communications on a broad scale. The low power, small size, and reliability of transistors have all been important factors in making electronic switching and digital transmission a cost-effective alternative to electromechanical switching and analog transmission. Interestingly enough, Bell Labs made the transition directly from electromechanical switching to solid-state electronic switching without any significant intermediate use of vacuum tubes for digital applications.

While it is still too early to say with certainty, the new Bell Labs magnetic bubble technology, and its first cousin in semiconductors, the charge-coupled device (CCD), may signal a new direction in device development—a direction that provides opportunities for discovering new kinds of electronic functions and at lower cost. These new device technologies depart from the classical way of processing digital signals which is based on using identifiable circuit elements of resistors, capacitors, and transistors. Digital signals are processed in bubble devices by manipulating tiny bubble-like magnetic domains in a thin film of magnetic material and in CCDs by manipulating small packets of electrical charge

in a slice of semiconductor. The bubble or CCD device thus represents digital signals by a simple binary code based on the presence or absence of the bubble entity or charge packet itself.

The transistor was in manufacture by Western Electric within four years after its invention—the early applications being in switching systems. By the time the transistor was five years old, it was being used to generate signaling tones in the first office that provided direct long-distance dialing by the customer. In rapid succession, new transistor structures were developed that simplified manufacture and provided improved device performance (see page 74 for some of the major milestones in transistor technology). While each advance was important in its own right, oxide masking has continued to remain the essential element in fabricating all modern silicon transistors, both in discrete and integrated form.

Oxide Masking

In 1957 Carl Frosch and Link Derrick observed that the normal oxide layer on silicon acted as a barrier, or mask, to the dopants introduced through the surface in a heat treatment process. This barrier action, combined with work that Jules Andrus was doing in etching patterns on semiconductors by photolithographic techniques, provided the process technology with which to localize with optical precision the dopants needed for transistor action. In essence, a pattern of holes is etched in the oxide to achieve the desired electrical properties, the holes in the oxide acting as “windows” which allow dopants to be introduced into the silicon.

The oxide masking step is repeated for each kind of dopant. Finally, after all the different dopants have been introduced, a wiring pattern is formed by evaporating metal all over the device surface and then defining it by the same type of photolithography and etching step used in oxide masking. Because the dopants can be localized with great precision, and the wiring pattern can be formed with intricate detail, many devices or integrated circuits can be fabricated simultaneously on a single disc of silicon. This process, called “batch fabrication,” is the essence of modern semiconductor electronics.

Steady progress has been made in refining the oxide masking and photolithographic process over the past ten years (see illustrations on pages 76 and 77). Although many detailed



The manufacture and assembly of integrated circuits takes place today in ultra clean facilities such as this Design Development Laboratory (DDL) at Allentown, Pennsylvania. Bell Labs and Western Electric engineers share responsibility for technical supervision, while highly skilled personnel from Western Electric operate the facilities.

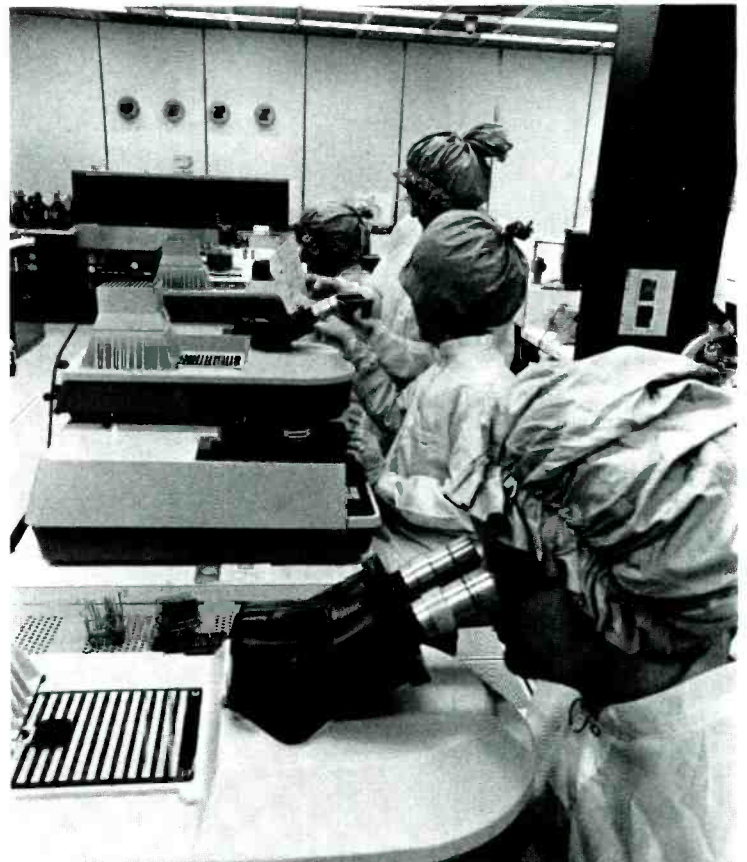

technical problems had to be solved to make today's microscopic circuits, the most dramatic changes took place during the first ten years following the transistor's invention.

Design and Development for Manufacture

This article has already illustrated some of the relationships that existed in the past between device development and manufacture. Examples included the organizational procedures used by M. J. Kelly to operate his tube shop jointly with Western Electric, the manufacturing process of batch fabrication which was made possible by oxide masking, and the special dimensional tolerances required to make the Morton triode. Each of these examples, and many others as well, have their current counterparts.

To make integrated circuits today, Western Electric and Bell Labs share sophisticated manufacturing and assembly facilities such as shown on the opposite page. Western Electric provides the highly skilled personnel needed to operate these facilities, while engineers from Bell Labs and Western Electric share responsibilities for technical supervision.

The very small dimensions of integrated circuits demand that utmost care be taken during all stages of device fabrication. For example, entire batches of devices would be ruined if airborne dust particles fell onto the devices while they were going through the many intricate processing steps. To prevent this, air in the manufacturing and assembly rooms is carefully filtrated to reduce greatly the number of particles present. (By comparison, a typically "clean" office would contain about 100,000 times more airborne particles than found in a manufacturing "clean" room.) All critical operations such as controlling the purity of chemicals and the temperatures of the furnaces are carefully monitored by the engineering staff.

One of the new tools used during manufacture of integrated circuits is the laser, which is playing an increasingly important role in the shaping and scribing of circuit patterns. In one application, the laser's precisely-focused beam is used to produce and measure the photolithographic plates used in the oxide masking process. In another application, a laser beam scribes patterns directly in the metal films of thin film circuits. Using this technique, Western Electric engineers have eliminated some of the costly tuning procedures encountered during the manufacture of

thin film filters. In fact, the same laser equipment can be used to produce a family of filters that operate at many different frequencies.

From examples such as these, we can see that advances in device technology are becoming more closely dependent on the procedures, tools, and skills of manufacturing engineers.

In Retrospect

Traveling the route from device concept to final systems application requires the skills and talents of many people. We have seen, for example, that a close interaction between system designer and device engineer is needed to recognize the possibility of transmitting information over millimeter waves and to define the devices needed for its realization. Also required are manufacturing engineers who are capable of controlling ultraprecise chemical processes. Even a little good luck now and then helps, such as that which occurred when the equipment necessary for demonstrating maser action in solids was already available because of an ongoing study of semiconductor impurities.

An encyclopedic treatment would have been necessary in this article to single out the major contributors to the advancement of devices over the past fifty years. Instead we have focused on just some of the events and the people involved to bring out the flavor of device development and to illustrate why it has flourished. For flourish it did, because without modern electronic devices the telephone service we enjoy today would either be unavailable or prohibitively costly. □

Magnetic bubble memory—from substrate ingot, bubble wafer, and circuit chips to completed memory plane.

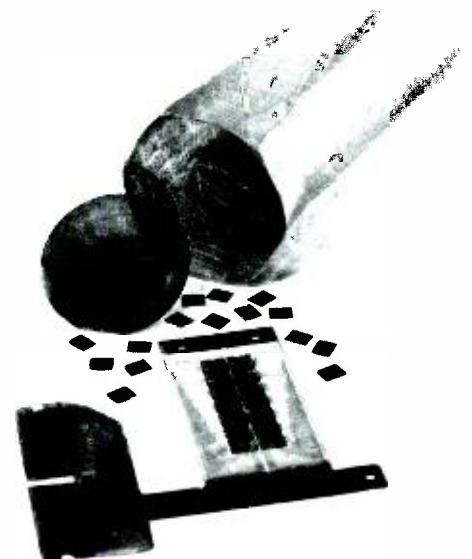

“... theory and principles ...
help explore the contours
of physical reality and
define the limits of the
possible. The completeness ...
is in fact illusory ...”

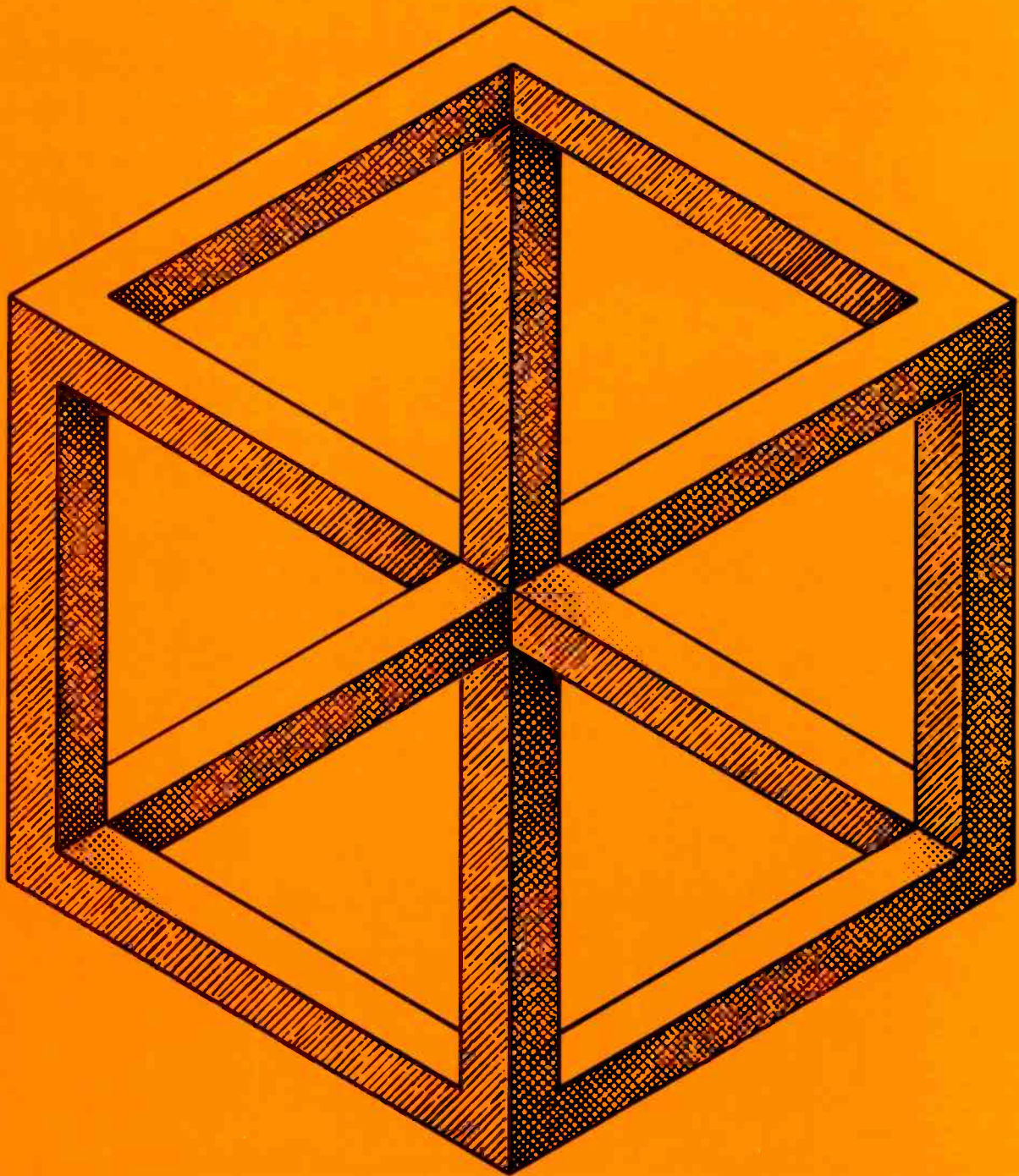

Theory and Principles: The Intellectual Framework

BROCKWAY MCMILLAN

The theory that underlies telephone communications emanates from the work of many innovative scientists—a number of them from Bell Labs. Inductive loading, negative feedback, information theory, and quality control—all are products of their creativity.

THE WHOLE INTELLECTUAL STRUCTURE within which communications engineers work is furnished by a body of theory, theory so fundamental and so pervasive that working engineers are likely to take much of it for fact, regarding its constructs as though they were material objects and accepting its basic language as their own. Though our natural interest at this time centers on those advancements in theory associated with the 50 years of Bell Laboratories, at least some description is warranted of where we were when Bell Labs was founded, with perhaps a hint at how we got there.

In 1873, James Clerk Maxwell published a definitive theory of the electromagnetic field that was to have a strong impact on telephone communications. At that time, Alexander Graham Bell was working diligently to build what he called a “harmonic multiple telegraph.” In doing this work, and later when he had set it aside to devote his full efforts to perfecting a working telephone, Bell was concerned with the problem of transmitting what he called “undulatory currents” over long wire paths—that is, currents whose variation with time carried the information to be conveyed. Although Bell emphasized a distinction be-

tween “undulatory currents” and the on-off currents of telegraphy, telegraphers had in fact been facing the same problem for over 30 years. Their long circuits were plagued with distortion, so that telegraphy over long paths was limited to very low speeds to keep the dots and spaces from blurring, running together, and becoming indecipherable at the receiving end.

In the year that Bell first demonstrated a working telephone—1876—the English physicist Oliver Heaviside, with Maxwell’s basic theory as a foundation, presented a brilliant analysis of signal distortion in telegraph lines and laid the basis for a theory of the transmission of Bell’s “undulatory signals.” Heaviside’s theory was to be essential in analyzing and designing circuits for transmitting telephone signals. Thus Bell’s telephone and the key to understanding the transmission of voice signals over long wire paths were born in the same year and grew up together.

By the turn of the century, with the example of Bell’s researches fresh before them, AT&T managers had attracted to their staff creative men who understood the theory then extant and had the motivation to apply their knowledge and talents to the problems of mak-

ing telephone service better and more economical. With the same vision with which they brought Bell Laboratories into being a quarter of a century later, these managers extended to their talented scientists the opportunity and encouragement to seek out and solve fundamental problems.

Important among these scientists during the first quarter of the century were George A. Campbell, John R. Carson, and O. J. Zobel, all of whom transferred to Bell Laboratories in 1934. These men—along with many others, including Heaviside himself—made important contributions to forging the tools of analysis from the basic raw materials in Heaviside's original work. They applied those tools to the practical design of loaded transmission lines—lines having added inductance—for improved long-distance transmission of telephone signals at voice frequencies. In addition, they used analytical tools to study not only long lines, loaded and unloaded, but also what are often called lumped electrical networks—circuits made up of interconnected coils, capacitors, resistors, and transformers. Out of these studies came Campbell's invention of the electric wave filter and Zobel's perfection

of design techniques for filters. Even today, Zobel's techniques are used in designing filters to separate the individual voice signals in multiple (carrier) telephony—a function that stands at the heart of today's long-distance telephone plant.

As important to telephony as these practical developments is the fact that, as of 1925, the working electrical engineer concerned with communications had a foundation of basic theory—a language for describing problems and methods of calculating that could be used to solve these problems. Thanks not only to Heaviside but also to Campbell and Carson, engineers already knew that, to characterize the response of a network to any signal, it was sufficient to know how the network responded to signals that varied periodically. Furthermore, the engineer, given a physical description of the circuit of interest to him, knew how to determine its response to periodic signals by calculating in terms of complex numbers. For example, an impedance, which determines the voltage developed when a unit current flows through a circuit, is completely described by a complex number, depending on the frequency or period of the current. From the real

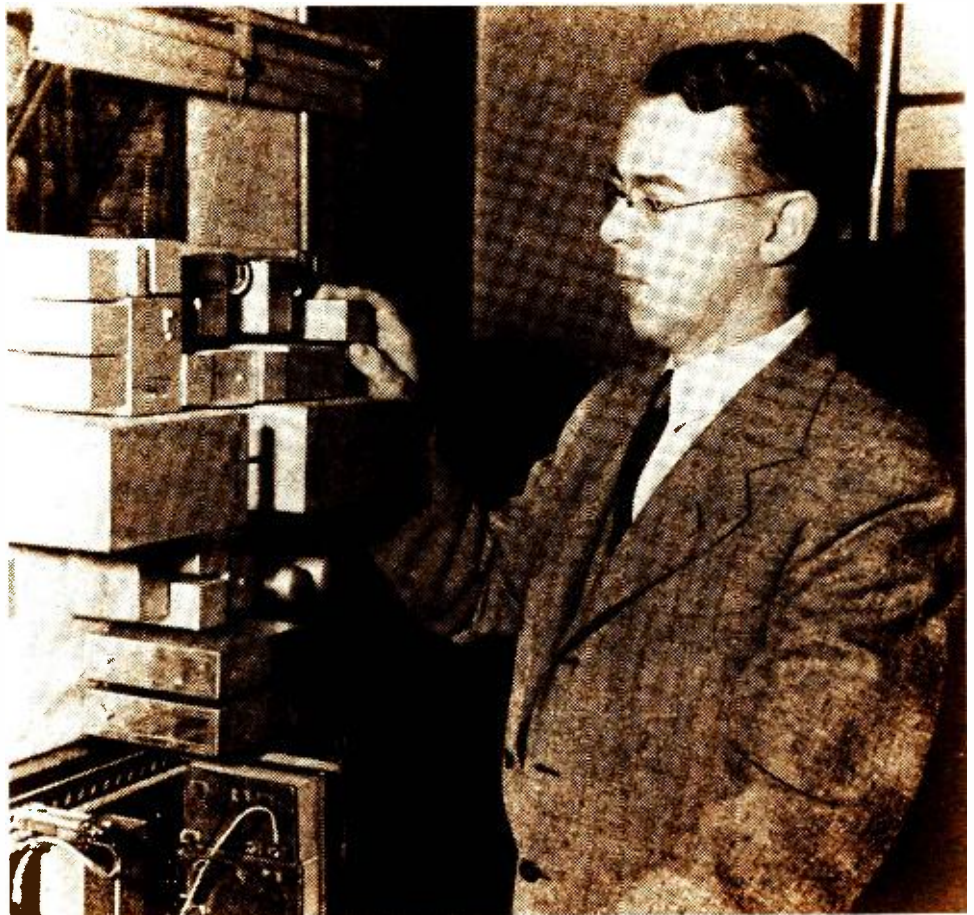

Reversing some of an amplifier's output and feeding it back into the input reduces distortion in an electronic amplifier. In 1927, by inventing this principle of negative feedback, Harold S. Black (shown in his laboratory) paved the way for multichannel telephone transmission across the continent.

and imaginary parts of this number, the engineer could determine the magnitude of the periodically varying voltage, and the phase lag or lead of the voltage relative to the impressed current. Also, in the work of Campbell and Zobel, engineers found explicit prescriptions for applying these calculations in designing filters and other circuits. Thus they were able to accomplish functions that are important to practical telephony, such as equalization, channel selection, or rejection of unwanted signals.

Since 1925, Zobel's techniques have been elaborated upon by many engineers at Bell Laboratories—H. W. Bode, Sydney Darlington, R. L. Dietzold, E. L. Norton, and Zobel himself—motivated by the stringent requirements of long-haul carrier systems for voice and television. In a system such as L4, for example, a single voice or television signal may pass through as many as 4,000 sections of line-plus-repeater. Any distortion of the signal systematically present in each section could be multiplied in its effect 4,000-fold in passing through the whole system. Clearly, then, engineers must take extreme measures to design for minimum distortion in each section, and to “mop up” residual distortions before they accumulate unacceptably.

In 1925, carrier systems for telephony were still in their infancy, but already there were many long-distance voice-frequency circuits using periodically loaded lines and vacuum-tube repeaters. The problem just mentioned, of cumulative distortion in such systems, was very much on the minds of Bell Laboratories engineers. In 1927, one of them—young Harold S. Black—conceived of a way to reduce the distortion and noise introduced by the vacuum tubes of a repeater. His invention of the principle of negative feedback, which led to a basic patent, gave a new turn and emphasis to the development of network theory at Bell Labs (see photo, opposite page).

Although this new turn is our next subject of interest, we should perhaps note in passing that the development of basic network theory did not stop with the invention of feedback. Bode, Darlington, Zobel, R. M. Foster, and others at Bell Laboratories made important contributions to describing the properties of an electrical circuit that could (or could not) be achieved by using only coils, capacitors, resistors, and transformers. Through their efforts and the efforts of many others in the United States, Germany, France, and Japan,

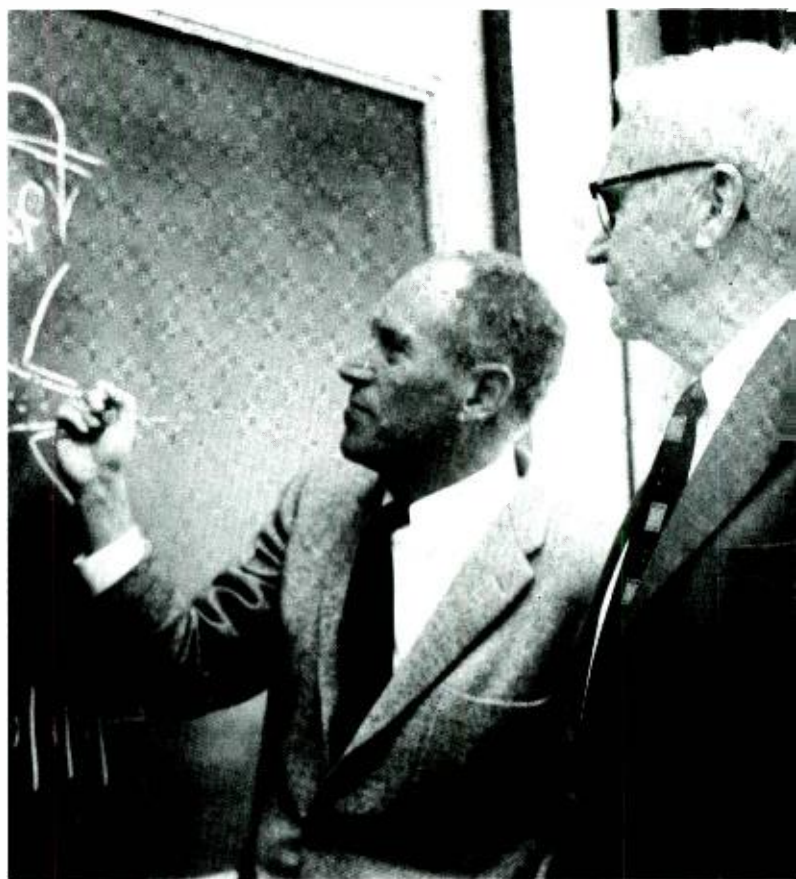

Harry Nyquist (right) showed engineers how to calculate whether or not an amplifier would be stable from the design of the circuits and the properties of the amplifying devices. With him is Rudolph Kompfner, Bell Labs scientist who invented the traveling wave tube.

communications engineers now understand very well what can be accomplished in a circuit by a network made up of lumped “passive” elements (coils, capacitors, resistors, transformers and, in recent years, gyrators). Furthermore, prescriptive techniques that are theoretically complete and often practically useful are available for designing networks to accomplish a specified function.

Harold Black's feedback amplifier had its problems. Feedback created the possibility of self-oscillation, or singing, a possibility not present in passive networks because they contain no sources of energy. To use Black's invention in practical telephone systems, engineers needed to know how to design amplifiers that did not sing—stable amplifiers. Harry Nyquist took the first important step in 1932. Nyquist adapted to engineering terms the so-called Argument Principle of the classical mathematical theory of functions of a complex variable. He showed his colleagues how the stability or instability of a specific amplifier design could be verified by an explicit calcula-

tion, given the design of the circuits and the properties of the amplifying devices (see photo, page 85). Now universally known as Nyquist's criterion, this technique for assessing stability has remained for 40 years a basic tool in analyzing vacuum-tube and solid-state amplifiers, servo-mechanisms, and even such intrinsically nonlinear circuits as bistable "flip flops" and many kinds of logic gates.

As always, synthesis derives from analysis. Hendrik W. Bode, whom we have already mentioned, was one of the early recruits to the newly founded Bell Laboratories. Working from Nyquist's criterion, Bode during the 1930s developed explicit design techniques that could assure designers that the results of their efforts would be stable amplifiers, having—or at least approximating—the desired transmission characteristics. Furthermore, Bode described the performance characteristics that theoretically can be achieved in amplifiers of various designs and established fundamental limits on the performance of many kinds of networks, both active and passive. These limits often tell engineers even before they start their designs, how well they can expect to reach particular design objectives. Limits thus give engineers guidance and reassure them when they have (perhaps approximately) attained their goals. Indeed, Bode can be said to have discovered the basic physical laws that active networks, such as amplifiers, must obey if they are to be stable and not break into self-oscillation.

As a by-product, Bode showed how to use amplifiers to make networks that substitute for or improve upon passive devices. These were more or less novelties at the time. Long before the transistor was invented, they offered ways, for example, to synthesize bulky and expensive inductances out of networks having only resistors, capacitors, and amplifiers. Now that we have the transistor—small, rugged, and economical of power—such active simulations of passive devices are often used.

Nyquist's and Bode's criteria and Bode's basic laws adapt at once to general linear control systems and to other so-called servo-mechanisms. During World War II, Bode was a leader in applying his techniques to the practical design of computers for gunfire control. Drawing upon these activities, Bell Laboratories has since developed a number of precise guidance and control systems for air vehicles and for boosters used in launching space vehicles (see photo above).



Contributions to theory made by H. Nyquist and H. W. Bode made precise guidance and control of air vehicles possible. Here, a crew at Cape Canaveral monitors the command guidance system that launched the Telstar™ communications satellites.

Modern control theory has flowered from the pioneering discoveries of Nyquist and Bode, which in turn were stimulated by the need to understand Black's feedback amplifier and to realize its potential for improving the quality and extending the range of telephone transmission. It is also interesting to see the evolution in thought exemplified in Bode's now classical book, *Network Analysis and Feedback Amplifier Design* (published jointly by Van Nostrand and Bell Laboratories in 1945). From Campbell's wave filter of 1917 and Zobel's more general structures of the 1920s, Bode's thinking has evolved to the point where he, as a designer, first determines what his circuit should do, using the now completely known properties of passive networks and of basic amplifying configurations. He controls the behavior of the circuit under design by specifying the properties of certain quantities that are expressed as complex numbers depending on a frequency parameter. Only later, as determined by practical design convenience, does the designer become concerned with the specific configuration of a network to accom-

plish these rather abstractly stated objectives.

Today, many signals are represented not by “undulatory currents” but by sequences of numbers in digital form, representing periodic snapshots or samples of the value of the original, continuously variable, quantity. The tasks once performed by Campbell’s and Zobel’s filters are now accomplished by numerical operations on these numbers, carried out by tiny high-speed computers built from integrated solid-state circuits. The “realization” of such a digital filter bears no outward resemblance to the ladder and lattice structures of the 1920s and 1930s. But the same fundamental laws of physical realizability and stability (in the end, essentially equivalent notions) apply, and the designer still describes the properties wanted in the filter, within the limits allowed by stability, in terms of complex numbers that depend upon the signal frequency. And today a whole new body of theory is evolving—analogue to the theory of physical filter structures that evolved in the 1920s and 1930s—delineating the kinds of computing algorithms that lead simply or economically to desired performance objectives, and that control the effects of errors due to round-off in the computations.

We now turn to examine another elegant and essentially complete domain of theory—information theory. For a more extensive and delightfully readable account of these matters, see John R. Pierce’s article “The Early Days of Information Theory” in Volume IT 19 of *IEEE Transactions on Information Theory* (January, 1973). Pierce provides extensive references. Here we shall first present the culminating or climactic creation of the theory, since that indeed did come forth almost without premonitory signs. Then we shall trace some of the preparatory thought, again going back to a time before the founding of Bell Laboratories.

Claude Elwood Shannon of Bell Laboratories (see photo at right) published his two-part paper, “A Mathematical Theory of Communication,” in 1948 in the *Bell System Technical Journal* (July and October issues). Pierce characterizes this publication as “a bomb, and something of a delayed action bomb.” In it, as with one stroke, Shannon put forth a complete mathematical model of the communication process as viewed by a communications engineer, and set down in specific quantitative terms the laws that govern that process. As Pierce suggests, it took some years for com-

munications engineers, on the one hand, or mathematicians, on the other, to appreciate fully what had happened.

Shannon’s model describes, in universally applicable terms that are independent of the physical details of any particular transmission system, the two essential elements of the communications process. First is the message source, representing the collection, or statistical universe, of all possible messages that conceivably could be offered for transmission; with each is associated its own probability of occurrence.

Second is the transmission channel, which at its input accepts signals and at its output presents approximate versions of those signals—perturbed, however, by noise introduced in the transmission. The manner in which the noise perturbs the signal is also presented in completely general terms as something governed only by statistical laws.

In terms of the postulated probability laws, Shannon defines two numbers—the rate, H , of the source and the capacity, C , of the channel.

In 1948, Claude Shannon published—almost without prior contributions from other theorists—a complete mathematical model of the communication process and the laws that govern it. In a later experiment (below), he used switching relays like those used in dial telephone systems for logic and memory experiments.

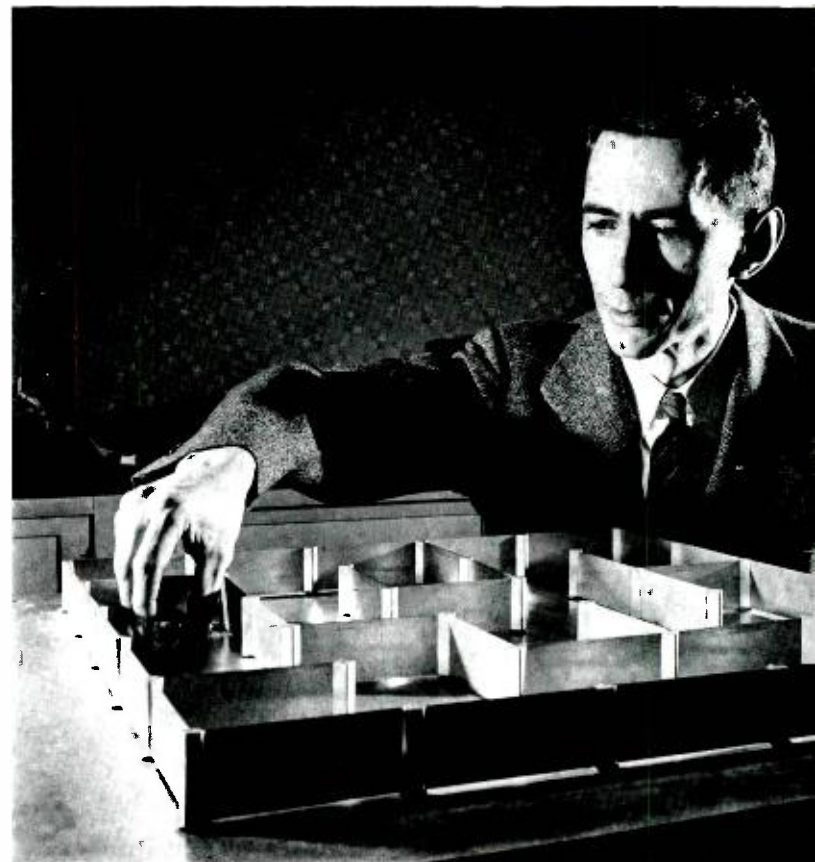



During a long and productive career in the Bell System (from 1901 until he retired in 1942), E. C. Molina contributed to many fields with both theory and inventions. After retirement, he continued his work in his extensive home library.

The meaning of these is made clear by Shannon's beautifully general and fundamental result: if a source has rate H and a channel has capacity C , and if C is greater than H (a minute excess will do, in principle), then one can design an encoder for fitting messages to the channel and a decoder for the receiving end, so that at the receiver *the messages can be decoded with negligible probability of error*—more exactly, with a probability of error that can, by design, be made as small as the designer chooses. If C is smaller than H , errors are inevitable.

Though Shannon's mathematical concepts were beautifully simple and elegantly appropriate, they were essentially without precedent or prior hint in the work of others. True, the idea that noise is a factor limiting the speed of communication was not new (as we shall note in a moment). Shannon's specific

quantitative measure of the effect of noise, embodied in his measure of channel capacity C , however, was such as to make this idea precise and quantitative in a completely general context. His basic result, that within the limits established by C the effect of noise could be reduced arbitrarily, was startling. Actually, what Shannon's argument showed was that the effect of noise could be arbitrarily reduced only at the expense of increasing the complexity of the encoder, and therefore at the expense of an inevitable delay in the encoding process. He later derived mathematical bounds relating the probability of error at the receiver to the delay in the (optimum) encoder.

Hidden in our description is the concept of the redundancy present in natural sources of messages, but this concept is explicit in Shannon's paper. Hence Shannon's information rate, H , for a source is the absolutely minimum average telegraphic speed needed to transmit successive messages from the source in such a way that they can be precisely decoded. It is not necessarily the rate at which an actual telegrapher would have to work to transmit the messages verbatim.

With hindsight, we can find a glimmering of this idea, and a tacit recognition that the message source is governed by statistical rather than deterministic laws, in Samuel F. B. Morse's telegraph alphabet. He assigned the shortest symbols to the letters that occurred most frequently in ordinary English text, thus attempting to minimize the average channel-time per letter.

In 1928, Ralph V. L. Hartley of Bell Laboratories explicitly recognized channel-time as a resource over which the designer could, and should, exercise control. Hartley showed that—in the presence of a somewhat tacitly defined universe of "noise"—channel-time, T , and bandwidth, W , could be exchanged as long as the product WT was held fixed. Actually, by 1928, Harvey Fletcher and his co-workers had been studying the redundancy of natural speech for several years, first in Western Electric's Engineering Department and then at Bell Labs. The usefulness of redundancy in counteracting the effects of noise was at least qualitatively understood in many specific examples, including speech.

Channel bandwidth, as a resource, had been fairly explicitly evident since Campbell's theoretical and experimental work on periodic inductive loading. Carson had found that bandwidth had inevitably widened whenever a

signal was superimposed onto a carrier by what is now called double-sideband modulation. He had then invented single-sideband modulation, by which bandwidth was preserved but not increased.

Both Hartley and Nyquist had recognized that noise was a limiting factor in the speed achievable over a telegraph line, and Nyquist had found an explicit relationship among speed, noise, and power in a simple model. With the invention in the 1930s of wideband frequency modulation by Col. E. H. Armstrong, a pioneering inventor in the field of radio, and later with the use of pulse modulation in radar systems, it became evident that signal-to-noise ratio and bandwidth could also be exchanged. It remained, however, for Shannon's theory to put all of these exchanges together into a unified, general, and precisely quantified theory.

And from Shannon's theory came the fundamental result that no one had foreseen: that even a noisy channel, having limited bandwidth and a limited power level, had a non-zero capacity for error-free transmission.

We have looked at three fundamental domains of theory—all interrelated, each in its own way elegant and satisfactorily complete in a logical sense. Each serves the communications engineer by providing a logical framework for problems and a precise language in which to state them. Network theory, one of the three theoretical structures, also serves the engineer immediately and practically by furnishing explicit means to solve the problems that it describes. To all three, Bell System engineers and Bell Labs engineers in particular have made definitive contributions.

There are many theoretical domains of great practical importance in designing, manufacturing, and operating the telephone plant and in furnishing telephone service that we do not have space to discuss. Our grossest injustice in these omissions is probably to the statisticians and others who think in terms of probabilities.

Walter Shewhart, while in the Engineering Department of Western Electric, conceived of a simple statistician's model of the manufacturing process and invented the technique of statistical quality control. This is a technique for economically monitoring the quality of a repetitively manufactured product and for ensuring a continuing high standard of product. First put into practice in Western Electric, these techniques are now almost universally

used. Long before Shewhart retired from Bell Laboratories, the American Society for Quality Control was founded to promote the development and application of these techniques in American industry.

Noise has been mentioned many times in this article. J. B. Johnson of Bell Laboratories discovered the presence in all circuits of what is now called thermal noise. Within a few weeks, Nyquist showed on thermodynamic grounds that thermal noise is inevitable. The effects of noise—from thermal and other sources—on communication devices and circuits are often of critical interest to design engineers. S. O. Rice and W. R. Bennett of Bell Laboratories pioneered in many difficult calculations to analyze such effects in important contexts.

What is today often known as "queueing theory" grew out of analyses of telephone traffic problems, which were undertaken by M. C. Rorty of AT&T as early as 1903. E. C. Molina, who joined AT&T in 1901, improved on Rorty's early work and—though self-taught and without formal college education—provided the first theoretical bases for the previously empirical methods of the early traffic engineers (see photo, opposite page). Traffic theory and its modern consequences developed rapidly in many places. Bell Laboratories, for example, has actively pursued ways to design switching systems for handling telephone calls efficiently and without appreciable delay. Today, one of the four centers in the Switching Systems Engineering Division is devoted to such work, along with closely related work on engineering operator services (another part of the plant where many customers share common resources).

But with this we must close. What is going on at Bell Labs today in the development of analytical techniques for understanding and solving the engineering problems of the telephone system is so manifold and so diverse that it is simply not possible for one author, in one article, to comprehend it whole. Instead, we have looked mostly at the work of the past—simpler, because it is older and better understood, and more dramatic because it is more complete. The completeness that we have stressed, however, is in fact illusory, and even the appearance of completeness is temporary. The demanding problems of telephony today, the rich technology that we have to work with, and the restless minds of Bell Laboratories engineers will see to that. □

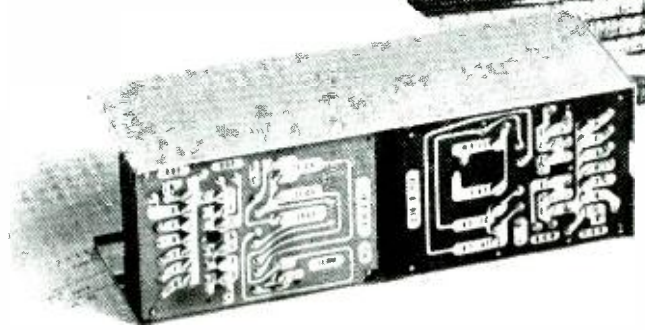
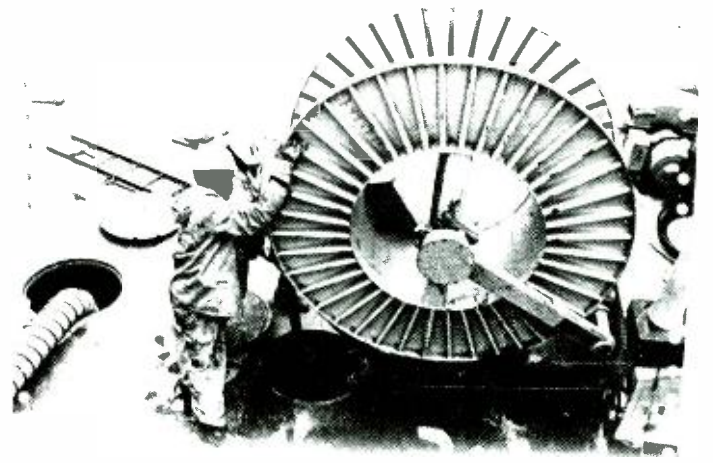

Computer systems developed at Bell Labs are now serving Operating Telephone Companies in a variety of intensely practical ways—by improving service, making the work force more efficient, utilizing plant more effectively, and providing better information to management. Dozens of such systems are already under development or in use.

Computers and Computer-Based Systems

VICTOR A. VYSSOTSKY

WORK AT BELL LABS on computing technology, progressing steadily for more than 30 years, has enabled Bell System Companies to make major improvements in the operation of their business. But regardless of the achievements to date (see, for example, "Highlights of Bell Labs Contributions," page 95, and the RECORD articles in the series *Bell Labs: A Pioneer in Computing Technology*, December 1973, January 1974, and February 1974), major opportunities lie in the future. In this article, therefore, I shall take a forward-looking view rather than a historical one. I shall touch on where we stand, mention a few of the computer-based systems already in use, and consider where some of our future opportunities lie in this field. I shall also mention a few problems we must surmount if we are to be fully successful.

One can approach the subject of computer-based systems for the Operating Telephone Companies from various points of view. Such systems can increase the efficiency of the work force, reduce error rates, improve service, minimize capital requirements by improving plant utilization, and provide better information to management. These effects are typically intermingled, and few systems have one

of these effects without any of the others. In what follows, I shall use productivity as a thread of continuity, and mention other effects as they apply to particular systems.

The illustration on page 92 shows a dramatic decrease since 1945 in the traffic force as a fraction of the Telephone Company total. The decrease is primarily because of replacement of manual operator positions by automatic equipment or computer-assisted positions. In 1945 more than half of all Bell System central offices were manual; today almost none is. The spread of Direct Distance Dialing (DDD) and more recently of such systems as the Traffic Service Position System (TSPS) and the Automatic Intercept System (AIS), has enabled the Bell System to continue the trend begun with conversion of manual offices to dial service. The traffic force has not decreased much in absolute numbers; in fact, it is almost exactly the same size today as it was back in 1945 (illustration, page 92). But it is significant that the same number of people can meet the needs of five times as many calls as there were in 1945, and of a more complex pattern of calling.

The work-force-percentage illustration on page 92 also shows that accounting has de-

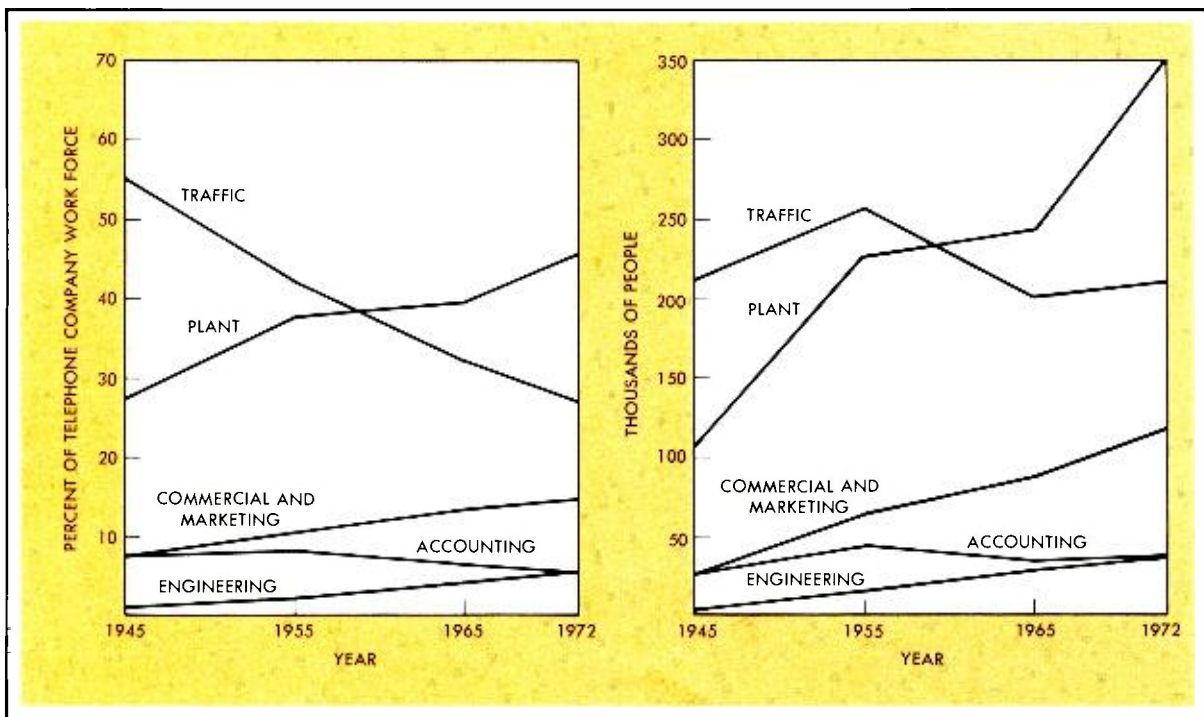

The percentage of people working in traffic in the Bell System has decreased dramatically, whereas the plant and commercial-marketing percentages have increased substantially (left diagram). In

absolute terms (right diagram), the traffic force today is essentially what it was in 1945—but the same number of people handle five times as many calls as were handled in 1945.

creased slightly as a fraction of the work force. The decrease is largely a result of the introduction of computers for payroll, for customer records and billing, and for keeping property and cost records. These computer systems, implemented by the Operating Companies with guidance and advice from AT&T, have made it possible to improve the timeliness, accuracy, and detail of accounting work, and to cope with a load of increasing volume and complexity with a work force which has been stable in numbers since 1955.

By contrast, the plant force has more than tripled since 1945, and the telephone company engineering force has increased more than tenfold. Operating Company plant and engineering work focuses around equipment designed at Bell Labs. The increasing complexity of the equipment, of the network, and of the services these provide exerts constant pressure on the ability of the Operating Companies to provide, configure, and maintain the plant. Clearly, the plant and engineering force cannot continue to grow indefinitely at past rates. But to limit growth poses a challenge. We at Bell Labs must provide, along with our hardware designs, better aids to the Operating Company engineers and craft force, so that the Bell System's ability to serve does not become limited by the availability and cost of

the work force which makes the equipment available to customers.

We have always provided test sets and similar aids to go with our designs, but the effectiveness of such tools is inherently limited by the time and effort required for manual access to records, for manually controlling tests, and for logging and analyzing results. Furthermore, when large numbers of records are kept by hand, errors creep in. Errors in the records result in extra work for the plant people, under-utilization of plant, and impaired service to customers.

From these comments, it is evident that Bell Labs must provide computerized systems which keep the equipment records and related information, and which automatically perform as much as possible of the repetitive routine associated with plant and engineering work. Literally dozens of computer-based systems to address various aspects of this problem are in some stage of planning or development at Bell Labs, or of field deployment; I shall mention only a few.

In the mid-1960s AT&T concluded that, with the advent of third-generation computer equipment, it was feasible to put the great bulk of plant records into computer memory. Two systems currently in the field are a product of the effort Bell Labs undertook in 1967

in response to AT&T's request. The Plug-in Inventory Control System (PICS) keeps track of an Operating Company's inventory of plug-in modules, both working and spare. Using PICS, an Operating Company's central stock coordinator can quickly dispatch plug-ins from a central stock to where they are needed. PICS offers a number of advantages to the Operating Companies. The most dramatic advantage is that it enables a company to reduce its stock of spare plug-ins without jeopardizing service; for the Bell System this reduction is expected to result in a savings of 750 million dollars over a ten-year period. The Trunks Integrated Record-Keeping System (TIRKS) is a computer system which keeps track of the Operating Company's inventory of message-trunk and special-service circuits, and the equipment and facilities which make up those circuits. By installing TIRKS, a company gets better plant utilization and faster processing of circuit orders, because the record base is more accurate. Once the record base is mechanized and these benefits obtained, other potential benefits become foreseeable. A joint AT&T/Bell Labs task force is currently studying methods for tying together TIRKS and various minicomputer systems used for trunk administration and maintenance, such as Centralized Automatic Reporting On Trunks (CAROT) and T-Carrier Administration System (TCAS). The goal is to make update information, entered manually or automatically into any of the computer systems associated with trunks, quickly available for planning, installation, testing or maintenance.

The benefits of netting computers together this way can be illustrated by considering the computer-based Loop Maintenance Operating System (LMOS) and the automated repair service bureau, which are now in final development in Bell Labs. LMOS, as shown in the illustration on page 94, provides the repair service bureau with automatic test capability controlled by a minicomputer. The minicomputer, in turn, has access to a record base kept on a larger computer in another location. With this arrangement it is possible to change the manner in which the repair service bureau operates. The repair service attendant is able to determine the status of a line or initiate automatic tests of the line before writing a trouble ticket. Thus, in many cases the trouble can be diagnosed while the repair service attendant is talking to the customer. Not only does this reduce the work load in the repair service

bureau by eliminating many call-backs to the customer, duplicate trouble tickets, and "trouble-not-found" conditions, but it also reduces the number of cases in which the customer is dissatisfied with the response. Beyond this, LMOS makes possible rapid testing of large numbers of lines and identification of patterns of symptoms, reducing the effort to identify problems involving an entire cable.

From these examples, it is evident that introduction of computers into Telephone Company operations does not just mechanize old ways of doing things. Introduction of PICS requires the creation of a new job which did not exist before—that of plug-in central stock coordinator. Introduction of LMOS changes the role of the repair service attendant, who for the first time becomes able to determine the status of a line and report it to the customer. The implications go beyond these. A recent joint study conducted by AT&T, Bell of Pennsylvania, and Bell Labs has shown that the introduction of minicomputer systems for monitoring and maintenance of central office equipment requires careful reconsideration of the organizational structure of the operating area. This is as one would expect. Since a primary motivation for introducing computers is to mechanize the routine aspects of people's work, these systems inevitably change the balance and division of people's activities and, hence, also may change the organizational structure best matched to the work of the overall team.

As we have seen, dozens of computer-based systems are in development or in the field. Yet even when the systems are completely implemented, much will remain to be done, for several reasons. First, in many cases the various systems, as initially delivered, cannot communicate directly with one another, so that data already in one computer system must be manually reentered into others. Clearly this can only be a transitional phase. However, achieving complete internetting of all of the systems will be a major undertaking. Second, systems of the sort we have been considering must be able to exchange data with the accounting systems developed by AT&T and the Operating Companies, and this also implies a large effort. Third, the existence of such systems opens up opportunities for further applications. For example, although PICS maintains inventory records on plug-in modules, the initial version does not itself do inventory control in the classic sense. However,

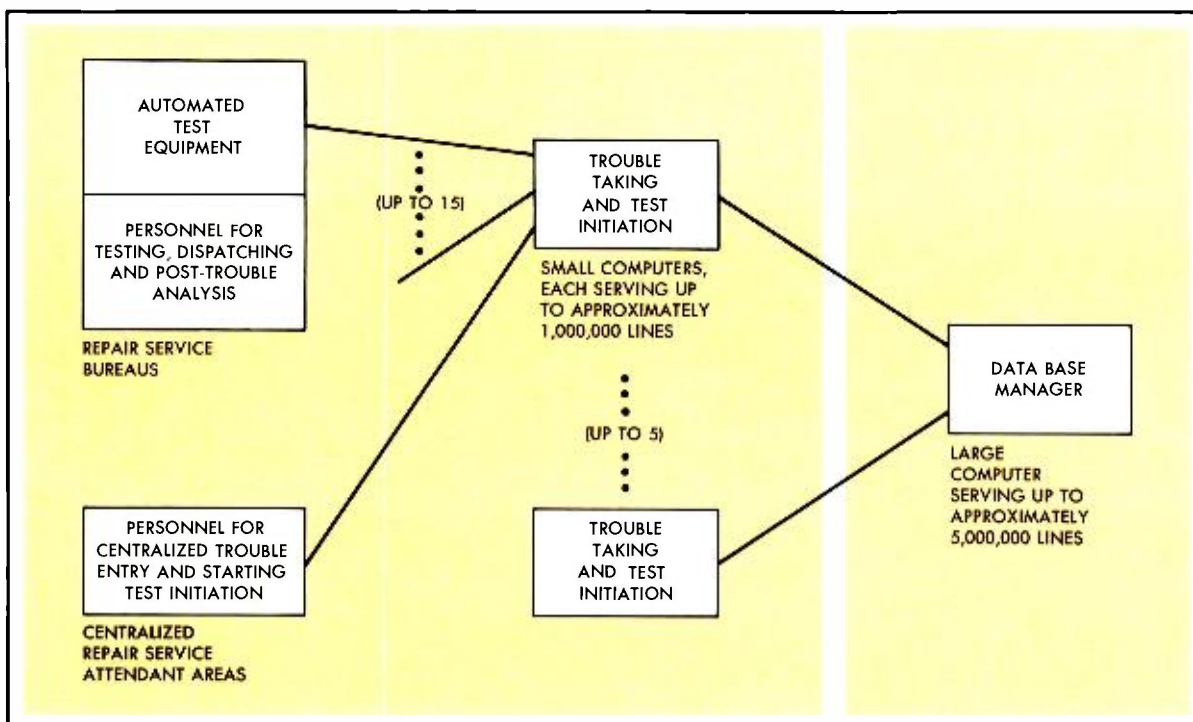

LMOS, the Loop Maintenance Operating System, allows repair service bureaus to make automatic tests, under minicomputer control, of customer

lines. The minicomputers have access to data stored in a large computer in another location. Often, trouble can be diagnosed almost instantly.

once a central stock exists and there are accurate records in the computer of what plugs are where, and how they are being used, it becomes attractive to consider putting programs for inventory control into PICS; this is now being done in one PICS installation. Finally, as the illustration on page 92 shows, the commercial and marketing force is a growing fraction of the work force, like plant and engineering. For some time, the Telephone Companies have been developing computer systems which assist the people in the business office; these systems must interface to both plant and accounting systems, and in some cases it is not clear what the interface should be, or even where the boundary should be.

So we can foresee a continuing major effort to define systems and interfaces between systems, to implement systems and introduce them in the field and net them together. The potential benefits are very large, but there are also some special pitfalls to be avoided. Consider a collection of computers netted together, containing within them a major part of an Operating Company's records, and working with people in real time to provide service and monitor the condition of the network. The amount of data in the computers is very large, and paper records do not suffice as a backup medium if the on-line record base becomes garbled. The checkpoint, restart, and update strategy evolved in batch computing over the

years is also inadequate, because the time required to recover such a massive record base is too great to be acceptable in a real-time environment. Our current solutions to this problem are adequate for the systems we are now putting into use, but our understanding must evolve in pace with the increasing complexity we expect in the future. Similarly, we must increase our understanding of how to protect data in a computer system from erroneous input by people or another system.

These are exciting problems that are incompletely solved and will continue to receive much attention in the future. Various other problems in computer science and software technology will also have to be addressed on a continuing basis. We will consider three of them briefly.

The performance of digital computers has increased steadily for 30 years, and it will continue to do so, but some applications of the sort we are considering still strain the capability of current computers, or imply very large costs for hardware, or both. Increased efficiency of use of the hardware is likely to accrue, not only from adroit programming but also from a better understanding of resource allocation, traffic, and queuing; that is, of the way in which data and demands for processing load down the various parts of a computer system, and of the interaction between these loads. Little of the traffic theory

developed for telephone switching systems can be applied directly to the design and performance analysis of data processing systems; therefore new models and terminology and techniques will be needed. Some pertinent theory is emerging, and is being used to optimize performance of computer systems, but many years of work lie ahead in this area before we exhaust the potential improvements.

Robustness of software has been a chronic problem in the computer field. Although ESS is a striking example of the fact that software can be relatively free from errors, and resistant to the effects of hardware or human errors, the development of software which works reliably is a poorly understood art. It is clear that many of the computer-based systems developed for telephone company use must come closer to ESS software in this respect than to typical commercial software. Today we build robustness into software by relying on the experience of our most knowl-

edgeable designers. It is not clear how systematic design techniques will evolve to allow us to develop robust software as a routine, well understood discipline. But such an evolution is very important to our work on computer-based systems.

Finally, we can look forward to progress in increasing the productivity of software developers. Our ability to put computer-based systems into the field, and our ability to respond quickly to requests for changes and enhancements, is currently limited by the ability of developers to design, implement, and test software systems. As we find systematic ways to analyze performance of computer systems and to design robust software, and as we develop more powerful design languages, improved algorithmic methods, better validation techniques and control procedures, and improved tools for software developers to use, we can expect to develop better systems more quickly and more cheaply. □

HIGHLIGHTS OF BELL LABS' CONTRIBUTIONS TO DIGITAL COMPUTING TECHNOLOGY

- 1937**—Application of Boolean algebra to the design of logic circuitry.
- 1939**—Complex Number Calculator (Model I Relay Computer)—the first electrical digital computer built of relays.
- 1941**—OR circuit.
- 1942**—AND circuit.
- 1943**—Model II Relay Computer—produced punched paper tapes for dynamic tests on fire-control equipment. Included error-checking capability.
- 1944**—Model III—relay computer for fire-control problems. Could hunt through paper tapes for address of a block of data.
- 1945**—Model IV—relay computer for fire control problems for ship-mounted guns. Could calculate trigonometric functions.
- 1946**—Model V—general purpose relay computer with two processors, permanently wired math tables, floating decimal point, conditional transfer capability.
- 1948**—AMA (Automatic Message Accounting)—relay computer for extracting billing information from phone calls.
- 1949**—Transistorized gating circuitry.
- 1950**—Model VI—last of line of relay computers. Solved telephone R&D problems. Had automatic secondary feature, useful for unattended operation. Air-cushioned magnetic recording head. Widely applied in commercial drum and disk storage systems.
- 1956**—L1 and L2 (also known as Bell 1 and Bell 2) allowed users to communicate with computers in a language far simpler than basic machine language.
- 1959**—Leprechaun. Had 5500 transistors and 18,000 memory cores in 15 cu. ft. volume. Ran on 160 watts. Macro instructions; allowed programmers to add terms not included in the original programming language.
- 1960**—TPLOT, programs for producing computer-generated plots and graphs on microfilm. SNOBOL, a programming language for manipulating strings of characters.
- 1961**—ALTRAN, language for making symbolic computations on algebraic data.
- 1963**—GRAPHIC 1 system allowed user to communicate with a computer through a cathode-ray tube display. BLODI, program that allowed circuit designers to test circuit designs without actually building them.
- 1965**—SWAP, universal assembler program containing many features previously available only in separate programs. Fast Fourier Transform algorithm for efficiently processing complex signals in real time. L⁶, programming language that allowed programmers to manipulate complexly linked data, write faster-running programs, and use computer storage more efficiently.
- 1968**—GRAPHIC 2, advanced version of GRAPHIC 1 for use by drafting personnel, circuit designers and engineers.
- 1969**—UNIX, a time-shared software system for minicomputers. Used for such diverse purposes as text editing, general computing and switching system trouble reporting.

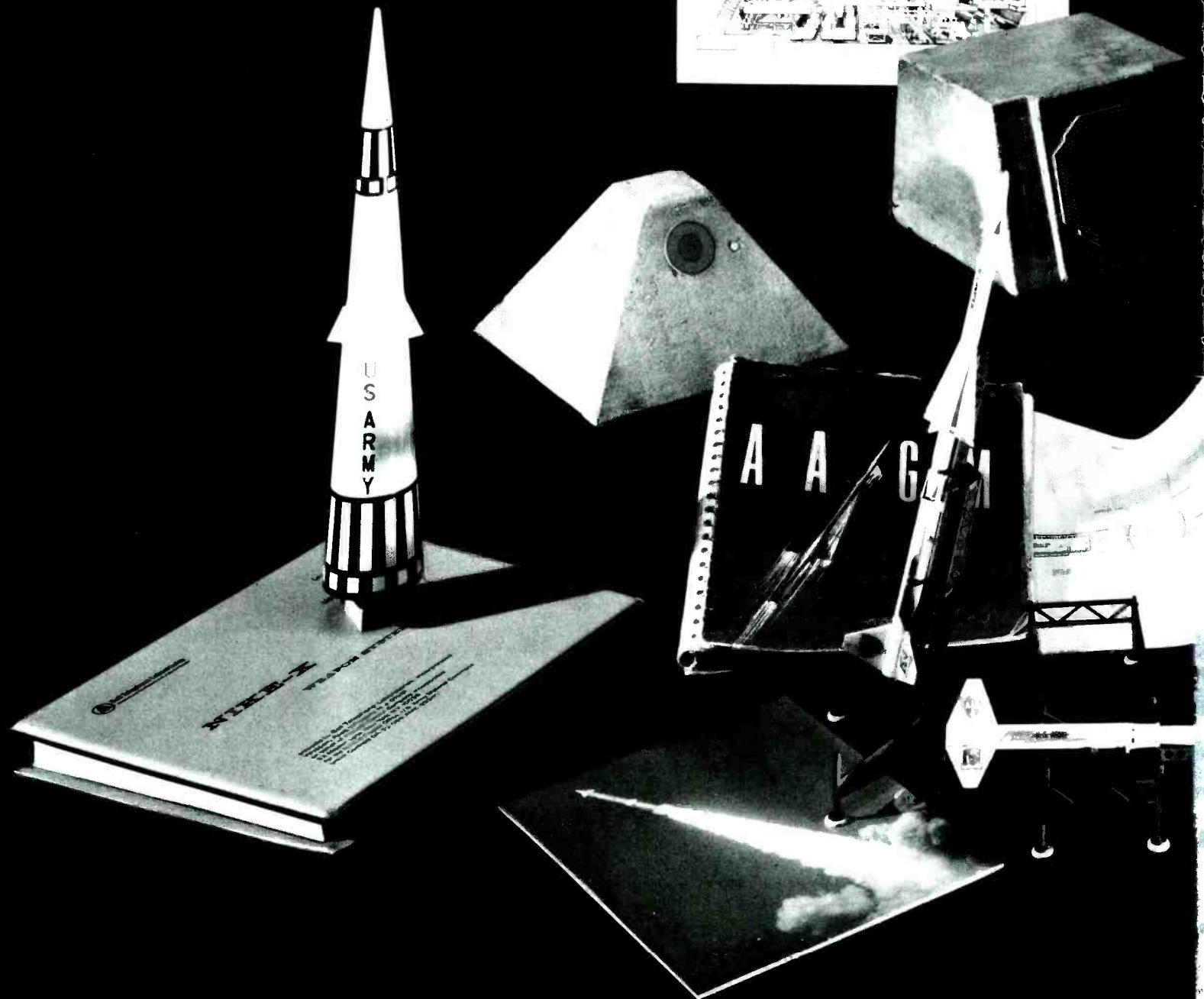
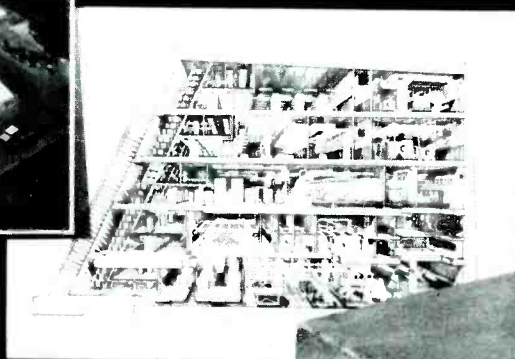
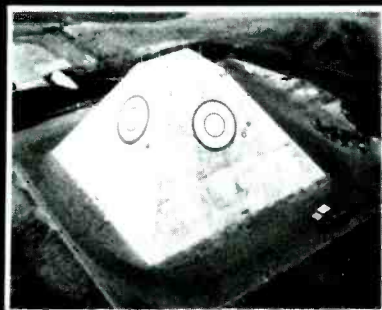

In Defense of the Nation

CLIFFORD A. WARREN

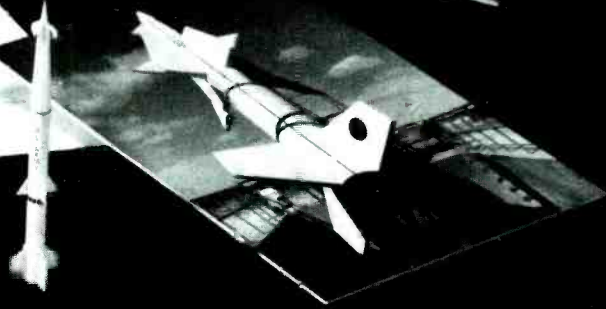
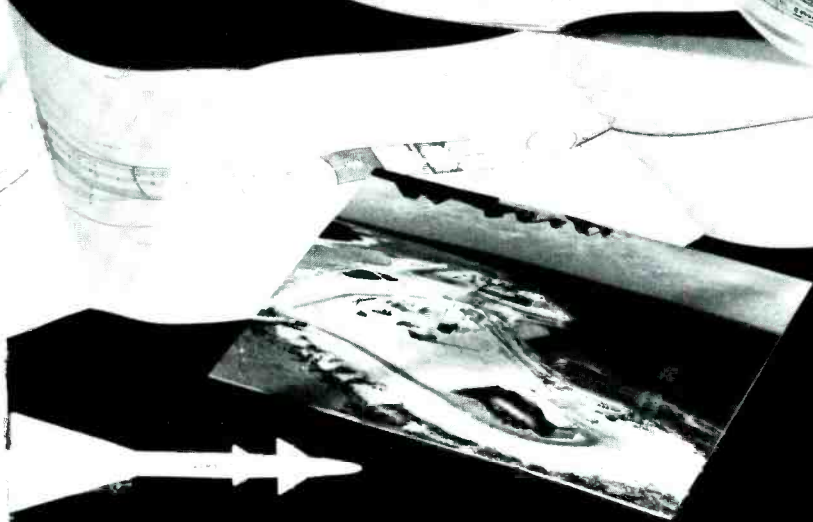

When the government has asked us to take on defense work, and where our expertise makes us uniquely qualified, the Bell Labs/Western Electric team has historically responded to military emergencies. The result: major contributions to the nation's security.

OVER THE YEARS, Bell Laboratories' military research and development has followed the central theme that we do work for the government in a spirit of public service. The Bell System's policy was summarized in 1970 by the late H. I. Romnes, Chairman of the AT&T Board, at a shareowners' meeting when he said:

"The Bell System engages in military work as a responsibility we owe our country. . . We make available some of the communications expertise of Bell Telephone Laboratories and the Western Electric Company to carry out programs for which responsible agencies of the government have defined a need. Profit is not our motivation for undertaking this work."

In the mid-30s the initial Bell Labs military effort was a by-product of the Western Electric/Bell Labs commercial work at that time on mobile radio for the airlines, police, "ship to shore," etc., and on high-power audio systems for sound motion pictures. High-power radio transmitting equipment was developed for Navy flying boats and transmitter/receiver command sets for the Army Air Corps. These projects required innovative component designs to meet, over a wide tem-

perature range, the stability requirements for tunable oscillators. At about the same time Bell Laboratories, after completing noise surveys of ships and carrying out intelligibility tests to determine the optimum frequency response and compression characteristics under combat conditions, was asked to design battle announcing systems. For a large aircraft carrier, the system designed consisted of two 500-watt amplifiers driving high-power loudspeakers on flight decks. Several such speakers on a ship's island structure covered the entire flight deck and permitted flight control to give orders to the pilots and deck crews while the airplane engines were warming up (see RECORD, July 1945). The quality of the battle announcing systems provided is illustrated by a telegram sent to Western Electric later in World War II by Rear Admiral Cochrane, Chief of Bureau of Ships:

"The reliability and effectiveness of this equipment was forcibly demonstrated during and after extended periods of battle, when many of the sound-powered telephone systems were severed and the automatic ship's service telephone was rendered inoperative, leaving the Battle Announcing System the only remaining method of disseminating informa-

Percent of Bell Labs employees engaged in military work. Trends reflect problems in international relations and desire of

the government to take advantage of the combined Bell Laboratories/Western Electric experience and capabilities.

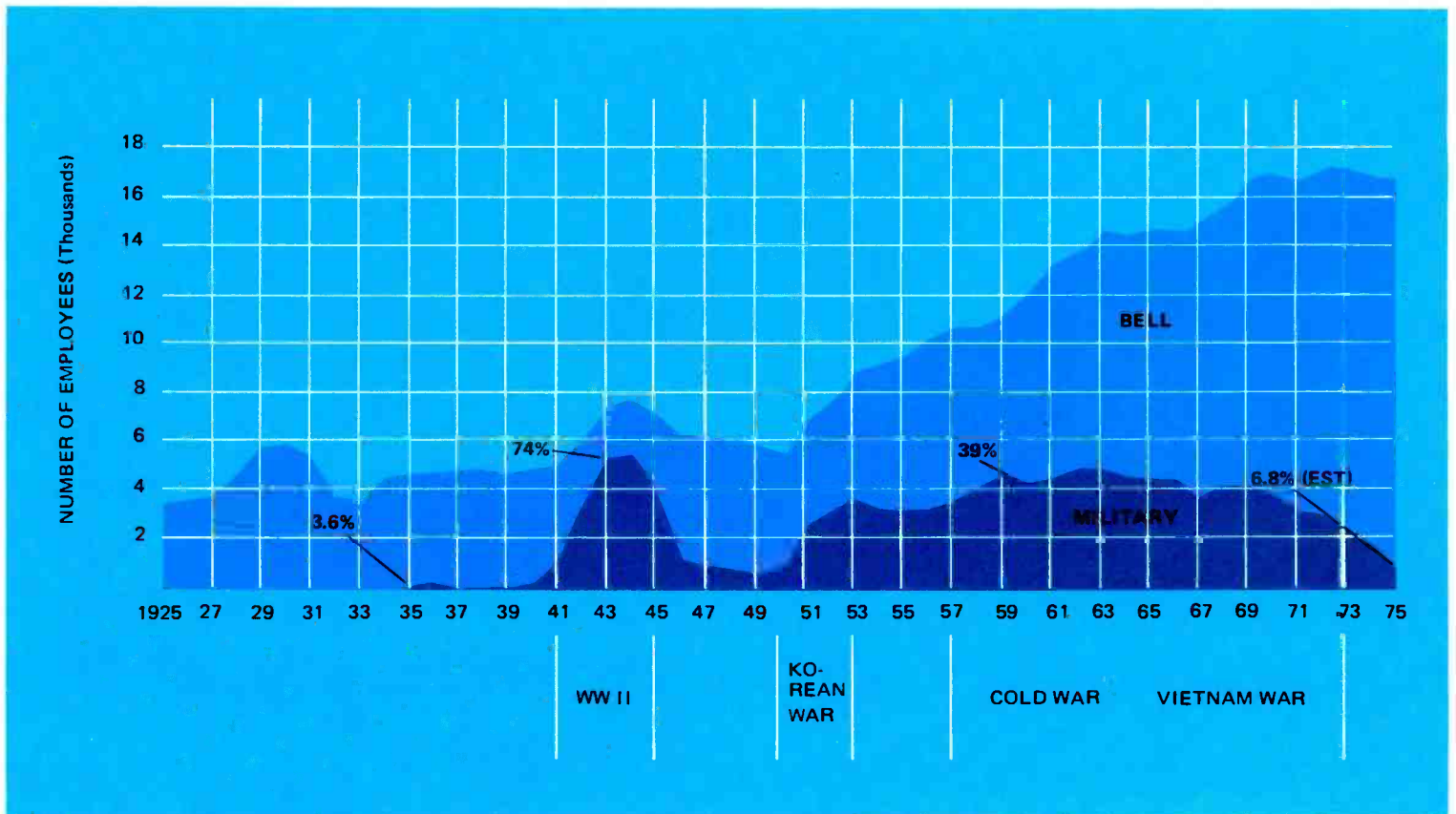

tion. From this it is clear that the quality you build into Western Electric communication equipment can be just as important to our fighting ships as the accuracy of their guns. You are to be commended for keeping the quality and quantity of your production on a high level.”

Radar's Beginning

From 1934 through 1937, radio detection and ranging—subsequently called “radar”—was developed in the government’s Naval Research Laboratory and the Army Signal Corps Laboratory. This early radar work employed transmitters and receivers operating in the vicinity of 100-200 MHz using large antennas (over 20 feet). However, it was clear that much higher frequencies would be required to extend the potential of this new technology from early-warning applications to the accuracies needed for control of gunfire. Higher frequencies would permit narrow antenna beamwidths with manageable antenna structures aboard ship. Yet components for higher frequencies were not then available.

With this need in mind, the Navy approached high officials of the AT&T Company in 1937 and asked if they might obtain the help of Bell Laboratories on a highly secret project of great importance to the nation. The Navy looked to Bell Labs for help because of our pioneering work in radio research at the Holmdel and Deal, N. J., laboratories in pushing the usable frequency spectrum upward for communications systems and because of our

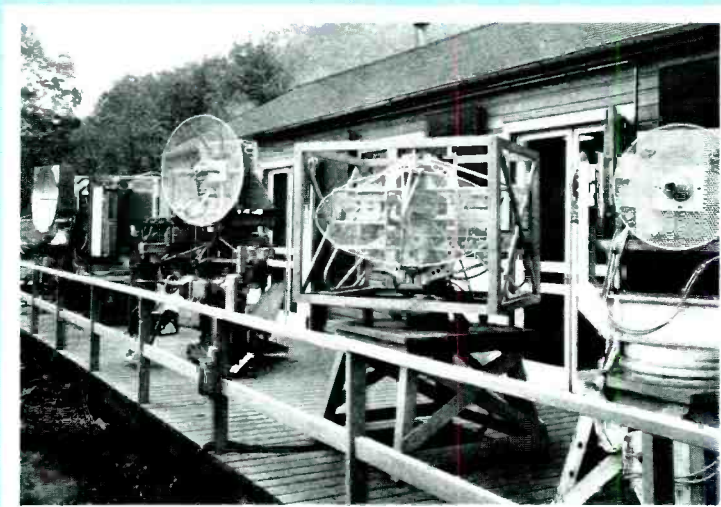

From this Atlantic Highlands, N. J., cottage on a bluff overlooking the Ambrose Channel, engineers from Bell Laboratories successfully tested the first radar system that was specifically designed to plot ship movements at night.

associated work on directive antennas. And the Navy was well aware of the enormous capacity of Western Electric to manufacture such equipment on a large scale should the need arise—as it soon did!

Because of the obvious importance to national defense, AT&T authorized Bell Laboratories to explore possibilities for a year with a promise to report back to the Navy on the results of our investigation. Thus in early 1938 a small group of highly skilled engineers was assigned to Bell Labs’ Whippany, N. J., laboratory, about 30 miles west of New York City. The isolated rural setting met requirements for absolute secrecy and had the open terrain needed for field testing. The group had

Composite rendering of a World War II battleship, marked to indicate radars and sonar produced by Bell Labs/Western Electric.

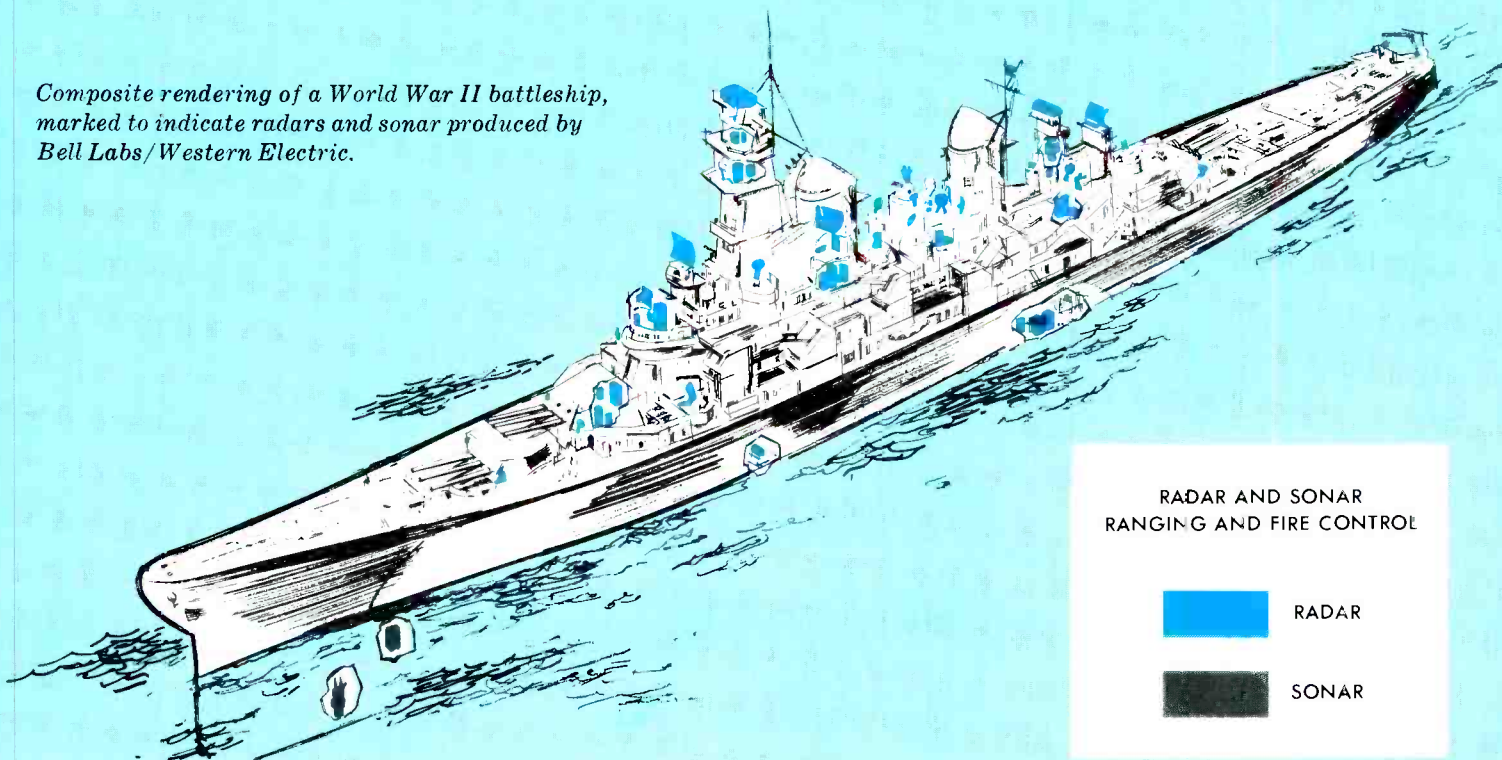



The M9 gun director, which incorporated an electrical analog computer. M9 batteries were very effective in the defense of England against V1 buzz bombs.

to start from “scratch,” designing and building their own instruments; none were commercially available in the frequency range to be explored. Transmitters, receivers, antennas, and cathode ray indicators were devised and a model built to show what might be done.

In July 1939, the crude model, operating at 700 MHz, was set up at a site on an 80-foot bluff at Atlantic Highlands, N. J., overlooking New York harbor. Late into the night following the installation, Bell Laboratories engineers were thrilled to plot quite accurately the movement of ships coming and going in the Ambrose Channel—not fully knowing the impact such tracking would soon play in naval battles in the Pacific. Later in the month, the equipment was successfully demonstrated to the Navy and Army and to high officials of the Bell System. The demonstration resulted in a Navy contract with Western Electric for a production version to be developed by Bell Laboratories. The first of these, known as CXAS in the experimental models and as FA or MARK I in production, was installed on the cruiser *Wichita* in June 1941, and several more installations were underway on ships of the fleet at Pearl Harbor when the Japanese attacked on December 7, 1941.

Radar was a major contributor to victory in WW II. About half of the total Bell Labs military effort was devoted to developing about one hundred major radar types. Some sixty of these were produced in large quantities by Western Electric and found use in combat. In fact, President Truman credited Western Electric with producing more than half of all radar manufactured in this country dur-

ing the war. Included were all the fire control radars on Navy ships, all but one of the five submarine radars, mobile radars for the Marine Corps, various types of navigation and bombing radars for the Air Force, and Army radars including an integrated search and, for the first time, fully automatic track radar.

The 700 MHz Mark III and IV radars, variations of the Mark I, were in production at Western Electric’s Hawthorne (Illinois) plant before Pearl Harbor and, in spite of more advanced designs going on new ships for several years, there were still three hundred in operation in the fleet on VJ Day. One example of the value of the Mark IV radar in antiaircraft control was the attack on the battleship *South Dakota*, which shot down thirty-eight out of thirty-eight attacking aircraft on October 16, 1942, in the South Pacific.

System-Wide Effort

During WW II Bell System contributions were as varied as they were massive—from the deeply scientific at Bell Laboratories to expedited production of hundreds of millions of dollars worth of highly sophisticated electronic equipment by Western Electric. For conciseness, a number of them are merely listed here (see “When Needed, We Were There,” page 107). They were made possible by the integrated partnership of Bell Labs and Western Electric that brought to bear in early 1940 the full spectrum of technology from basic science through exploratory development and systems engineering, engineering design, production, installation, and field tests. Among the “unsung heroes,” one group should be singled out for special mention—the Western Electric Field Engineering Force or FEF with many of its members recruited from Operating Telephone Companies. FEF’s dedica-

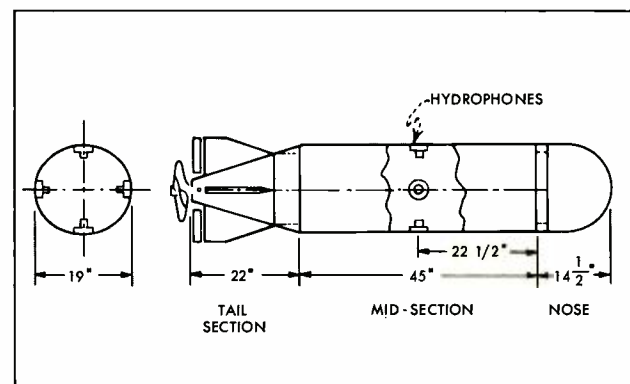

Sketch of acoustic torpedo developed and produced during World War II. It was credited with sinking 37 U-boats and seriously damaging 18 others.



A Nike Ajax missile approaching (from the left) and destroying a drone B17 bomber (at right) in tests at the White Sands Missile Range, New Mexico, in 1952.

tion, technical competence, and initiative were indispensable to the application of new technology on the battlefronts of the war.

During WW II, Bell Laboratories was called upon to design, and in some cases produce, the first units of critically needed radars in the shortest possible time. In one instance a high-power S-band (about 3000 MHz) search radar was needed by the submarine fleet in the Pacific for aircraft detection to replace a low-frequency search radar that enemy aircraft were homing on. Within six months from scratch, the design was completed and the first unit shipped from a special Bell Labs model shop. Only months later thirty units were produced from the Bell Labs shop before manufacture continued at Western Electric. In another case, enemy air attacks on the Pacific Fleet at low altitudes showed that something had to be done quickly to improve the Mark IV's accuracy at low elevation angles. Using a number of subsystem components from Western Electric manufacture, a 10,000 MHz radar with narrow elevation beamwidth was blitzed through development and manufacture and added to the Mark IV system to close the Navy air defense gap.

Teamwork with Britain

An event of utmost significance for U.S. radar development occurred at the Bell Labs Whippany location in October 1940, when Dr. E. G. Bowen of England brought over in

greatest secrecy a microwave multicavity magnetron. Pulse power in the vicinity of 10 kilowatts was measured at 3000 MHz—power levels unheard of at microwave frequencies at the time! With this high-power British tube and the many microwave components such as waveguide, converters, diodes, and antennas developed by Harald Friis and George Southworth at the Bell Laboratories radio laboratory at Holmdel, the way was paved to push radar into the microwave region. Immediately, Bell Laboratories vacuum tube experts, under the guidance of past Bell Labs President James B. Fisk, scaled the British magnetron to operate at 700 MHz to make a major improvement in the performance of the Mark III and Mark IV. Work also began on other microwave designs for systems not yet conceived.

The interchange of technology with the British was made possible by the formation in June 1940 of the National Defense Research Committee (NDRC) under the chairmanship of Dr. Vannevar Bush. Dr. F. B. Jewett, then President of Bell Laboratories, was also president of the National Academy of Science and served on NDRC in that capacity. NDRC brought into being the Radiation Laboratory at MIT, whose purpose was to mobilize the nation's universities for defense. Results of the microwave work at the Holmdel Radio Laboratory on components and propagation measurements carried out during the 1930s for broadband communications were fully disclosed to



Kwajalein Island in the Pacific (top photo), where a Bell Labs/Western Electric team has, for 15 years, maintained a defense, data-gathering, and test installation. The systems tested have been continuously upgraded, the current system representing key elements of the SAFEGUARD system now at Grand Forks, N. D. We expect to complete our assignment at Kwajalein by early 1976. Lower photo shows an intercept of an ICBM near Kwajalein in 1963. Upper long streak is the oncoming ICBM. Short streak at right angles is the defense missile, and point of interception represents a successful intercept. Lower, brighter streak is from the booster rocket.

Radiation Laboratory personnel at the time of that laboratory's formation, and close collaboration between the two organizations continued throughout the war.

Of equal importance to the Allied successes against air attack was the invention and development by Bell Laboratories—and quantity manufacture by Western Electric—of the electrical analog computer. When associated with radar for target-tracking and proximity fuses for the shells, the combination proved of inestimable value in the defense of Britain.

Computers for Gun Direction

At Bell Laboratories, D. B. Parkinson and C. A. Lovell in 1940 had been engaged in the design of precise testing apparatus for telephone equipment. Unaware of the state of the art of mechanical computers—and indeed equally unaware of their very existence—young Parkinson had a dream one night that contained the germ of the idea. He dreamed he was a member of an anti-aircraft gun crew and, using a tapered potentiometer moving with the trunnion of the gun, the crew shot down every aircraft engaged. With that nebulous idea, Parkinson and Lovell worked continuously for two weeks to specify the system's features using shaped potentiometers, tube feedback amplifiers, differentiators, etc.

Their ideas seemed to have sufficient merit to warrant an approach by Bell Laboratories to the Army in June 1940. A detailed description was also given to the full membership of the NDRC in October 1940. By November 1940 Bell Labs was authorized to start development of a system later named the M9 Gun Director. Approximately a year later, a model was field tested, and the first production units were shipped from the Western Electric Hawthorne plant in December 1942. The M9 became a standard Allied gun director, and the first production units were shipped overseas for the critical air defense of Britain. Of the thousands of V1 buzz bombs directed through M9 defense sectors, 76 percent were shot down.

One of the most top secret projects carried out during the war was the development of an air-launched, antisubmarine, acoustic homing torpedo. Extreme urgency was behind the program since, during the period April to December 1941, U-boats were sinking 175,000 tons of Allied shipping each month and this would (and did) increase. After early exploratory work carried out at Harvard and Bell Laboratories on acoustic guidance, Bell

Laboratories was authorized on May 15, 1942 to start development and design for production. The project originally had the code name "FIDO" but with a Top Secret classification the name was considered too indicative and ended up being coded Mine Mark 24. In a demonstration to the Navy at Key West, a submarine was equipped with a protective cage around her propellers and towed a marker buoy astern. Six torpedoes armed with plaster instead of explosive were loaded on planes, but after the first three hit the submarine, the captain in command called off further tests, swore everyone to secrecy and advised them to stay out of submarines.

Western Electric was given the sole contract for production, and the design was frozen by October 1942. The first production model was delivered to the Navy in March 1943 and 500 units were delivered by May 1943. Successive lots for a total of 8000 were made with the unit price of the last lot of \$1800, which was a small fraction of the unit price of previous non-homing torpedoes. The torpedo was an important factor in breaking the back of the submarine menace. By the end of the war, 340 were dropped by all Allied Forces with 264 attacks resulting in 37 U-boats sunk and 18 seriously damaged.

Preparedness in Peacetime

After World War II there were four or five years during which the United States could rest at ease, in the military sense, because of our perfected bombing fleets and our monopoly of nuclear weapons. The defense effort at Bell Laboratories dropped off to about 13 percent of total staff during this period with most of the effort directed to longer range projects. One of these was the development of the K5 Radar Bombsight which became the Strategic Air Command's standard equipment. The other major project was R & D work to improve air defense. In 1945 Bell Laboratories was asked by the Army Ordnance and Air Corps to explore the possibility of an anti-aircraft defense weapon which could attack high-speed maneuverable bombers far beyond the range of effectiveness of anti-aircraft guns. A target was specified as a 600 mph bomber at altitudes up to 60,000 feet and capable of 3g evasive maneuvers.

An early examination of this problem made it clear that a guided missile system was needed to meet altitude and maneuver requirements. There ensued a five-month period of

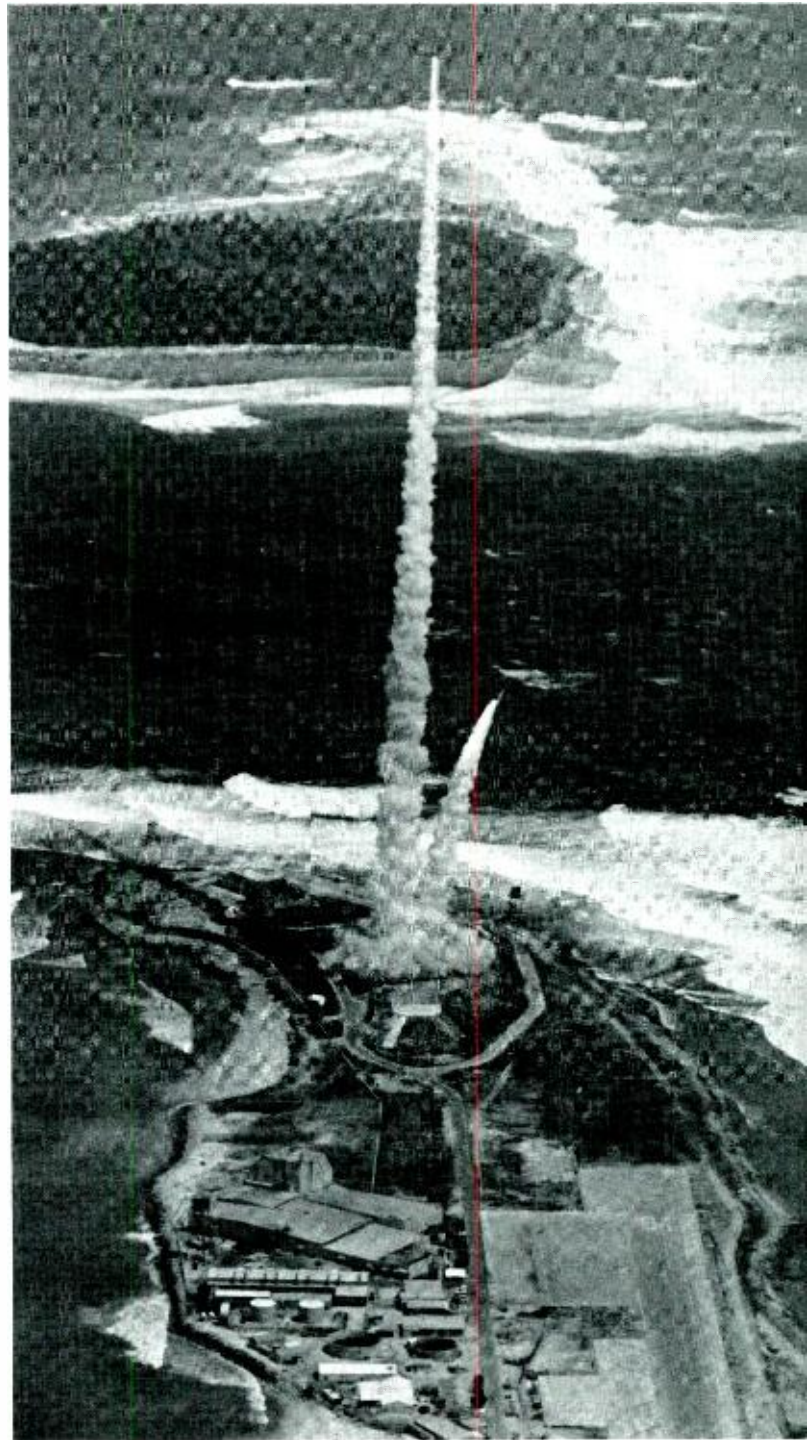

A view of Meek Island, part of the Kwajalein atoll in the Pacific, showing salvo launch of Sprint missiles.

intensive study and calculation by Bell Laboratories engineers and scientists. The result was the "AAGM" (A Study of an Anti-Aircraft Guided Missile system) Report. Subsequently, six years of intensive development under the sponsorship of Army Ordnance were required to reduce to practice the findings of the report and to create an experimental system at the

White Sands Missile Range, N.M., for system demonstration. Bell Laboratories was given full system responsibility for the project, named "NIKE," and the Douglas Aircraft Company (now McDonnell Douglas) was brought in as a full partner under subcontract to Bell Labs. Bell Labs undertook the study and development of the radars, computers, and missile controls and electronics for which it was best qualified, while it entrusted the missile, booster, launcher, and aerodynamic work to the specialists in this field at Douglas.

Starting with the 1945 AAGM Report, a major defense effort at Bell Laboratories and Western Electric during the past 30 years has been concerned with developing air defense systems. About a year before we could demonstrate the NIKE System's effectiveness, as shown in the photograph on page 101, the Korean War started and we no longer had a monopoly of the nuclear weapon. With concern for defense against high-altitude bombers, the Department of Defense and the Army asked Western Electric and Bell Labs to produce as soon as possible a tactical version of the NIKE System—called NIKE I and later NIKE-AJAX. We responded with a fully integrated team effort that made it possible to complete a first production system in 1953, two years after authorization of production. Departments at Bell Labs engaged in Bell System work were recruited to expedite the tactical designs because of schedule urgency. Western Electric's North Carolina Works produced 358 ground batteries of the NIKE I/AJAX System and delivered about 14,000 missile control and electric guidance units to Douglas.

In 1953-54, the threat of closely spaced waves of strategic bombers able to confuse radar tracking and to saturate the NIKE I/AJAX System caused the Army to ask Bell Labs and Douglas to study the addition of a larger missile to the NIKE System capable of carrying a nuclear warhead and extending the range of the system from 25 to 100 miles. The kill radius of such a warhead would force any enemy to space its attackers to avoid multiple losses. This system, initially called NIKE-B and later NIKE-HERCULES, was modified so that its ground system could fire both the NIKE I missile and the larger, longer-range nuclear warhead missile NIKE-HERCULES. Some 393 NIKE-HERCULES ground systems were produced by Western Electric at North Carolina and over 9000 guidance units for the Douglas HERCULES missile. The system was tested at the White



Grand Forks, N. D., site of the Safeguard Ballistic Missile Defense System (top), and view of the Perimeter Acquisition Radar (bottom) at Grand Forks.

Sands Missile Range over a wide range of threat possibilities including the interception of the supersonic HERCULES missile used as a test target. Although the NIKE-HERCULES System has been phased out of most continental U.S. air defense areas, today—twenty years later—a large portion of the HERCULES batteries produced are still operational.

In 1955 the Army asked Bell Labs to look at a future air defense system primarily to meet the threat of Intercontinental Ballistic Missiles. Compared to a strategic bomber, the ICBM posed a threat twenty-five times faster with radar cross sections 1/1000 the size.

Many people said an ICBM defense was like trying to “hit a bullet with a bullet.” Bell Labs agreed to conduct, with the help of Douglas Aircraft, an 18-month system and laboratory study on the feasibility of such a system. Based on the same technology used in both NIKE-AJAX and HERCULES, a system proposed to the Army and Air Force used large, powerful acquisition and track radars, digital computers, and a super-speed missile with both aerodynamic and jet thrust control. In 1957 the Army authorized Western Electric/Bell Labs to start development. Other subcontractors besides Douglas Aircraft had to be enlisted to carry out design of various subsystems of the radars. The field testing of the system, named NIKE-ZEUS, required subsystem installations at the White Sands Missile Range, Point Mugu, California, and Ascension Island in the South Atlantic, with the full system installation at Kwajalein Island in the Pacific. The full range of Western Electric’s expertise in transportation, logistics, equipment engineering, and installation and test was essential to the success of such a large R & D test program. During 1961-1962, at Kwajalein Island, the ZEUS System successfully intercepted eight ICBMs fired from Vandenberg in California into the Kwajalein area some 4500 miles or 25 minutes flight time away—the first such intercepts certainly in the free world. The photo on page 102 shows one of them.

New Threats, New Needs

Subsequent ICBM developments led to even more sophisticated requirements for future defense systems. Thus the Department of Defense decided in 1963 not to deploy NIKE-ZEUS but instead asked Bell Labs/Western Electric to continue R & D studies and exploratory developments. During 1963-1967, accelerated R & D anti-ballistic missile effort at Bell Labs pointed up the need for (1) an electronically steered radar of the multi-function, phased array type, (2) a short-range and high-acceleration defensive missile (later named SPRINT), and (3) an advanced high-capacity computing system. With the cooperation of subcontractors, an initial multi-function phased array radar, MAR I, was successfully tested during 1965. Other more powerful phased array radars were developed—the MAR II for search and identification and the MSR (Missile Site Radar) for tracking missiles and targets. The ability to steer the antenna beam to any point in the sky in about a

millionth of a second made it possible simultaneously to search, track hundreds of incoming targets, and track and control many defense missiles from a single radar.

To control such radars and carry out the tactical defense actions in real time, Bell Labs with the help of UNIVAC developed a multi-processor computer to perform up to 20 million calculations per second and meet extreme reliability requirements—performance not then available commercially. A Bell Labs/Western Electric team provided the integrated circuit unit that was the heart of the computer.

Work on the computer system was in some ways a culmination of defense-related computers beginning with some of the very early Bell Labs relay-type computers and extending through TRADIC and Leprechaun. TRADIC (TRANSistorized Airborne DIGital Computer) was an historic milestone in the development of military systems—the first completely transistorized experimental computer, designed at Bell Labs in 1954 as part of an Air Force bombing and navigation system. A follow-on computer, using the more stable junction tran-

Bell Laboratories command guidance system launching a Thor rocket at Cape Kennedy in 1959. System was also used for the Titan ICBM and for launching the Echo and Telstar satellites.

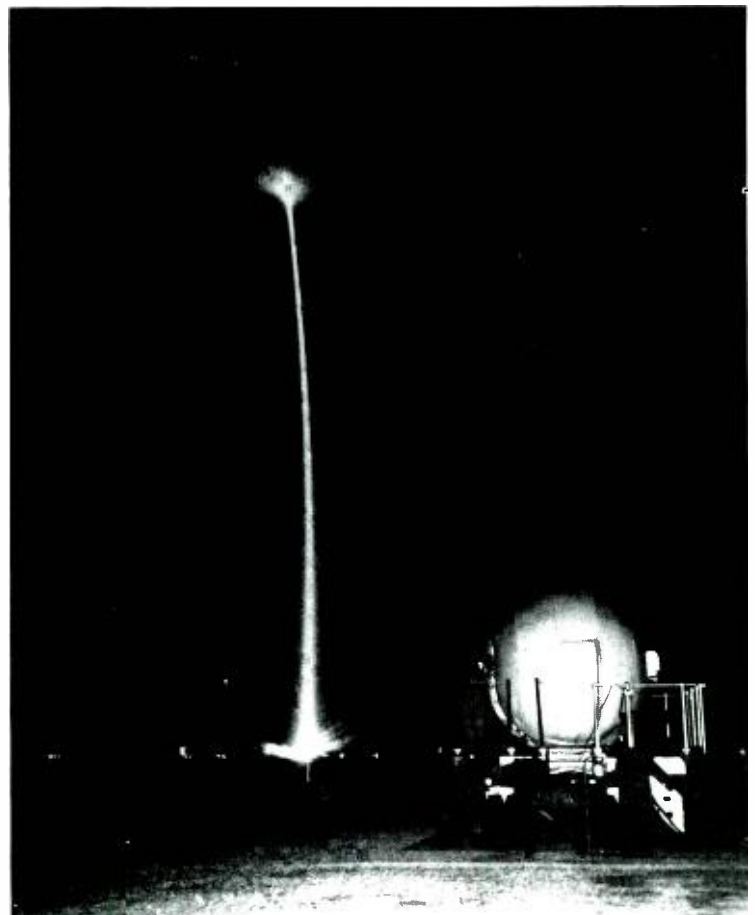

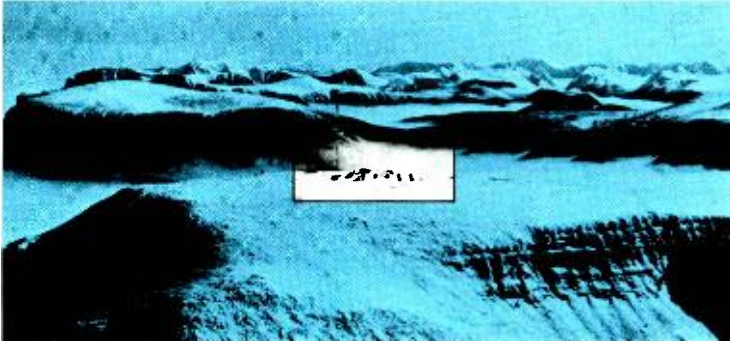
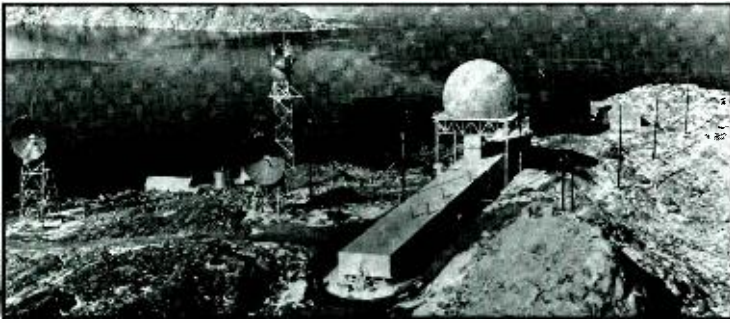

This station on Baffin Island, Canada, is at the eastern extreme of the Distant Early Warning (DEW) line, a network of communication stations in Alaska, northern Canada, and Greenland. A crisscrossed plastic dome protects the search radar antenna from winds that whip across the tundra at up to 130 miles per hour. Towering mountains, plunging fjords, and jagged terrain forced its builders to bring in the first construction equipment by helicopter.

sistor, was known as Leprechaun and was delivered to the Air Force in 1959.

Concurrently with the ABM system and hardware design effort described above, Bell Labs organized a program to probe in depth the chemistry and physics of the phenomenon of missile reentry into the atmosphere as related to discrimination among multiple objects aimed at a target. This research program continued through 1969, with the cooperation of the Army, Air Force, Lincoln Laboratory, and several subcontractors.

In November 1967, the Secretary of Defense asked the Bell System to start production and deployment of a defense system for the entire country against an accidental launch and a low-level ICBM attack. The system, called "SENTINEL," was to comprise the SPRINT missile, MSR, and the computing system described above, plus the long-range ZEUS missile modified to carry a larger warhead and renamed SPARTAN, and a new radar named PAR (Perimeter Acquisition Radar) for identifying and tracking targets at long range. In 1969 the deployment priorities were changed to the defense of MINUTEMAN missiles from four sites, starting with the first in the vicinity of Grand

Forks, N. D. The system, renamed SAFEGUARD, played a key role in the Strategic Arms Limitation Talks, SALT I, when agreement was reached with the Soviet Union to limit ABM deployment to the respective capitals and one ICBM defense site. With this agreement, the United States decided to limit the deployment to the Grand Forks site that was turned over by Western Electric to the Army on schedule.

Radio Links for Defense

Radar and missile systems may have tended to overshadow other government activities during the war years and thereafter. Nevertheless, hundreds of projects were carried out for military agencies in the broad field of general communications—from straightforward improvement of existing systems to exploratory studies of new concepts. It is not possible to cite all of these tasks, but one of the largest undertakings in the postwar period was the development and installation of a complex generally referred to as the Far North Communication and Detection System. Rapid expansion of the global communications and aircraft detection network was deemed necessary for the national security in the post-WW II period, and Bell Labs was responsible for design and engineering of the basic systems which now stretch halfway around the world. These included major programs such as those designated Polevault, White Alice, and the Distant Early Warning (DEW) line, the last having continental, Aleutian, and transatlantic segments. Bell Labs also had engineering responsibility for the far-flung communication system linking the Ballistic Missile Early Warning System (BMEWS) radars to continental command headquarters.

These projects involved exploration in a new mode of radio propagation, tropospheric scatter, pioneered by Bell Laboratories in the late 1940s. By this method, radio frequencies in the VHF, UHF, and SHF spectra can be transmitted to distances far beyond the horizon.

The DEW line was a network of radar and communication stations in Northern Canada, Alaska, and Greenland for alerting the defenses in the case of an air attack. This project is of particular note because it had to be built under the most difficult logistic and environmental conditions, and it brought to bear the full spectrum of expertise of Bell Labs and Western Electric. After a trial installation in 1952 showed the practicality of the proposal, the Air Force asked Western Electric to build

the complete line. Bell Labs planned the network, designed a large portion of the equipment, and acted as consultant to Western Electric.

In 1955 the Air Force high command asked Bell Laboratories to develop command guidance equipment for the TITAN I (ICBM) and THOR (IRBM) missiles. This program capitalized on our NIKE experience. The ground equipment used a modified NIKE-HERCULES radar with a precision-tracking antenna in an underground silo; it could be elevated above ground in seconds as required. Major effort at Bell Labs and Western Electric was directed to the development and production of highly reliable missile guidance equipment. Guided flight tests started in 1959 at Cape Canaveral (1961 at Vandenberg) with 58 TITAN tests. The use of this guidance equipment was expanded to handle space flights and has been responsible to date for guiding more than one-half of the free-world unmanned satellites. A total of 402 successful flights have been completed to date with no Western Electric/Bell Labs airborne equipment failures. Among the many guided space shots were ECHO I and Telstar I and II.

At approximately the same time in 1945 that the Army Ordnance and Air Corps asked Bell Labs to look at air defense of land areas, the Navy asked Bell Labs to study the air defense of ships. The project eventually came to be known as the Mark 65 program. The system developed, known as Automatic Target Evaluation and Weapon Assignment (ATEWA), was designed to process information automatically so as to insure that the highest priority of threatening targets would be given first call on defense weapons. The widespread acceptance of the philosophy and concepts developed under this early program proved the system's basic soundness, and its concepts are found today in missile control systems for the Army, Air Force, and Navy.

Similar to Bell Labs effort on air defense for the Army has been the work for the last 23 years for the Navy on ocean sonar systems to detect surface and subsurface vessels. Starting in 1952, a continuous program at Bell Laboratories—capitalizing on our research in acoustics and signal processing—has resulted in step by step improvements in performance as more sophisticated processing tools and hardware have been developed. These under-sea programs use the combined talents of both Bell Laboratories and Western Electric who

have been responsible for the system's installation and tests.

For the future, Bell Labs and Western Electric will continue to support the country's defense where our special technical expertise, generated from our research and Bell System development work, makes us uniquely qualified, or where we are specifically asked by the government to take on the work. As in the past, the level of our involvement will depend critically upon the international situation.

The author wishes to acknowledge the work of Messrs. W. C. Tinus, W. H. C. Higgins, C. F. Wiebusch, and many others who since retirement have been gathering historical material concerning Bell Labs' defense effort in WW II. Their material was drawn upon for the shortened story of the WW II work presented here. □

WHEN NEEDED, WE WERE THERE

Below are listed a number of the more important contributions by the Bell System during World War II. Many of the inventions originated at Bell Labs, but the total effort involved close cooperation of all units of the Bell System:

- Training schools for the Armed Forces
- Sending trained field engineers to every theater of war
- Maintenance of the nation's communications system in the face of shortages of men and materials
- Development of new magnetic materials
- High-volume production of frequency-stabilizing quartz crystals
- Development of radar systems for land, sea, and air
- Modern quality-control methods in the manufacture of shell cases
- Special radio and wire-line communications systems for the front lines
- Aircraft training simulators
- Sonar systems
- Homing torpedoes
- Airborne magnetic detection equipment for submarine location
- Electronic computers for gunfire control
- The Bazooka*
- Control systems for rocket launchers
- Intercommunication systems for noisy aircraft
- Electronic countermeasures equipment
- Highly complex secrecy systems for communications among the highest levels of the Allied Governments

*The contributions of individual members of Bell Laboratories to national defense were often recognized by the Government. For instance, Clarence Hickman received the President's Medal of Honor from Harry S. Truman for "the studies that led to . . . the recoilless gun (or Bazooka) and the high-velocity aircraft rocket."

Highlights of Bell Labs' Contributions to Early Radio

Commercial Broadcasting

1925 Water-cooled transmitting tube.

- Technical consulting to purchasers of Western Electric's broadcast equipment—stations such as KFI, Los Angeles, WSB, Atlanta, WOC, Davenport, Iowa, WLS, Chicago.
- 1-kilowatt radio transmitter for moderate-size broadcast areas; filled the gap between high- and low-power transmitters.

1926 Experimental radio station at Whippany, New Jersey.

- 50-kilowatt transmitter.
- Installation of five radio stations in South America and the West Indies.

1928 Piezoelectric crystal circuit for controlling carrier frequency.

- **1929** 100%-modulation transmitters that greatly reduced noise interference.

1930 Stations WHO (Des Moines) and WOC (Davenport)—153 miles apart—operated at a stabilized common frequency to prevent interference.

1931 50 kW transmitter installed for WABC—the first of such power in the New York metropolitan area.

1932 Frequency-monitoring unit for broadcast stations.

1933 5000-volt mercury vapor rectifier for transmitters.

1935 New 50-kW high-fidelity transmitter for WOR with controlled radiation, aiming maximum power toward New York and Philadelphia, minimum power toward the Atlantic Ocean and the sparsely populated New Jersey-Pennsylvania mountains.

- High-fidelity 5-kW transmitter employing stabilized feedback. First installation: WSAI, Cincinnati.
- High-efficiency linear power amplifier for broadcast transmitter from 500 watts to 500 kW invented by W. H. Doherty (U.S. Patent No. 2,210,028). A major step in saving power and minimizing cooling problems.

1938 Circuits to protect transmitters from lightning damage.

- "Cardioid" microphone allowed broadcast engineers to select sounds from any direction and to suppress the effects of unwanted noise.

1940 FM radio transmitter.

1946 Family of 1 to 10 kW FM transmitters for the newly established 88 to 108 MHz band.

- "Cloverleaf" antenna for FM broadcasting concentrates radiated energy in service area.

Aircraft Radio

1927 "Flying laboratory"—a Fairchild cabin monoplane—used in radiotelephone and radio beacon experiments.

1928 Study of air-to-air and air-to-ground telephony with the Chicago-San Francisco Airway and the Boeing Air Transport Co.

- Receiver for radio beacons and weather reports.
- Ford Tri-motor airplane purchased—another flying laboratory.

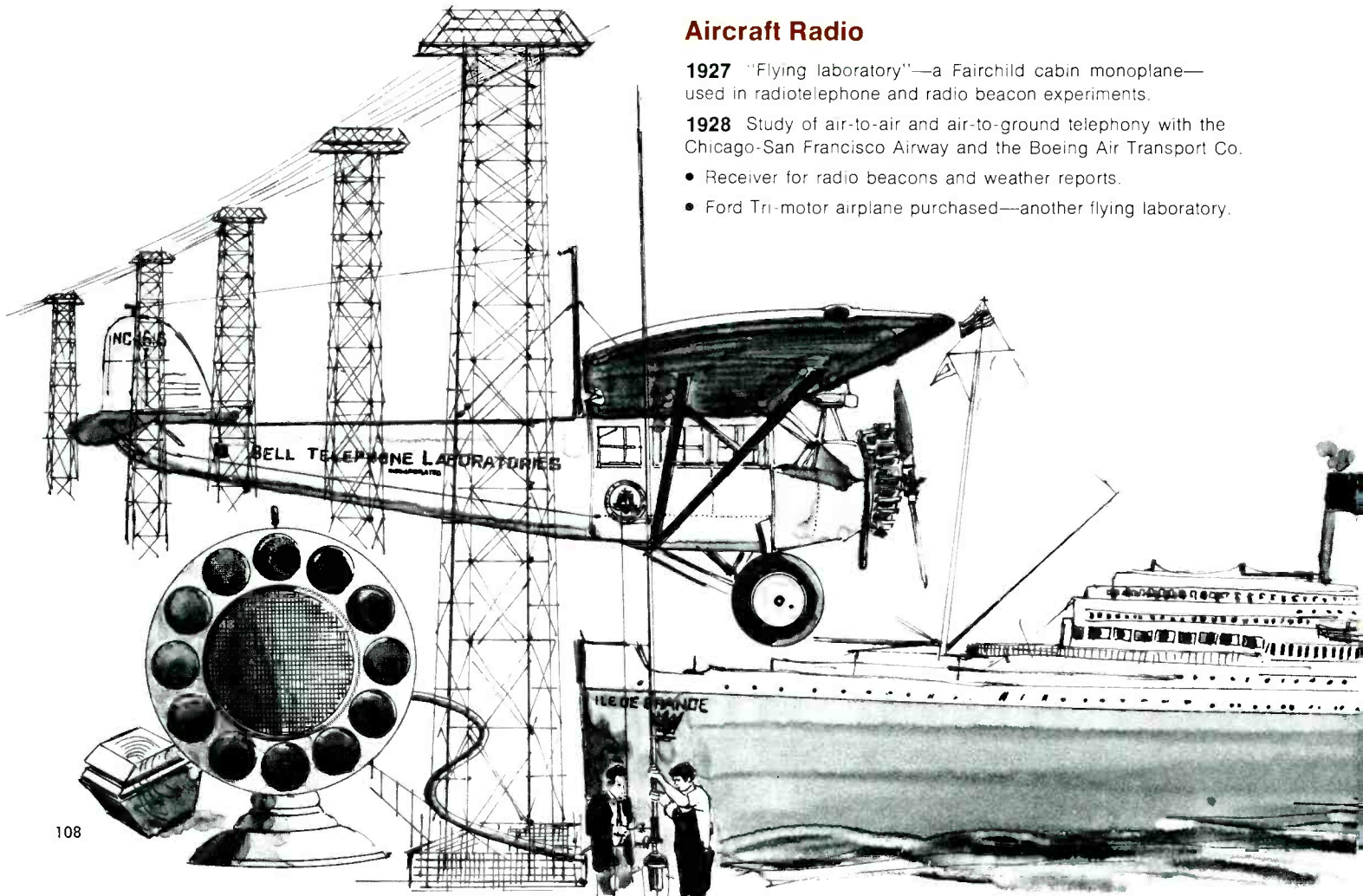

1929 Frank Hawks made record-breaking 18-hour, 22-minute flight from Los Angeles to New York. He used a Bell Labs-developed aircraft radio receiving set.

1930 Strut antenna for Western Air Express aircraft.

- Compact, lightweight transmitter and receiver (the 8A and 9A) for commercial aircraft communication with 8B and 9B ground transmitter over a range of at least 100 miles.

- Constant speed wind-driven generator powers aircraft radio.

1932 Improved quartz crystal unit kept radio transmitters in the frequency channel assigned to them within 0.01 percent. Ordered by United Air Lines, American Airways, Transcontinental and Western Air, and Western Air Express.

- Small, lightweight transformers with permalloy cores.

- New 208A radiotelephone allowed frequency to be changed in flight and gave greater selectivity. Weighed 15 percent less than previous equipment.

1933 The first Condor and Lockheed transport planes designed to include Bell Labs-developed radiotelephone and beacon apparatus as standard equipment.

1934 New radio receiver installed at Newark Airport employs highly selective superheterodyne circuitry to tune in channels separated in frequency by less than one percent.

- New high-selectivity receiver for aircraft attenuates a signal 55 dB if it is separated from the desired frequency by as little as 6 kHz.

- Remote tuning control for aircraft receivers.

1935 Transmitter and receiver for private airplanes.

- Aircraft radio compass.

1936 Dialed, multifrequency radio transmitter installed for Eastern Airlines at Newark Airport. Allows selection by telephone dial of ten carrier frequencies for best transmission.

- All-purpose receiver for small airplanes—beacon, broadcast, and short-wave bands. Suitable for vessels operating in coastal waters, too.

1937 Bell Labs-developed radio equipment installed in Amelia Earhart's airplane.

- Shielded loop antenna eliminates interference from "static" created by rain, snow, sleet, and dust.

1938 Multifrequency transmitter for private planes.

- Western Electric and Bell Labs selected by U.S. airlines to develop elaborate fully integrated radio system for air service on new Douglas DC4. Includes separate receivers for communication, beacon, weather, and marker services, and a 250-watt, ten-channel transmitter.

- Static-free ultra-high-frequency transmission successfully tested on TWA's New York-Pittsburgh route.

- Demonstration of tracking of airplanes on cathode-ray tube.

- Radio altimeter demonstrated on United Air Lines plane.

1941 Ten-frequency airplane transmitter and receiver made available to U.S. airlines.

- Azimuth-indicating receiver for ground stations.

- Throat microphone for pilots.

Ship-to-Shore Radio

1929 Demonstration of ship-to-shore radio communication with United States Lines' steamship *Leviathan*, 200 miles at sea, followed by commercial service.

1931 Trial of radiotelephone between Libby, McNeill and Libby cannery in Libbyville, Alaska, and salmon fishing boats in Bristol Bay near the Aleutian Peninsula.

- 35-watt transmitter for small Coast Guard patrol boats.

1932 Radiotelephone service for fishing fleets in Boston area.

- Service established with Italian Line's S.S. *Rex*—a first for the southern route to Europe.

1933 The *Ile de France* becomes the 19th ocean liner equipped for radiotelephone service.

1935 Marine radio compass.

- Ultra-high-frequency harborcraft radiotelephone service in Philadelphia. Used for dispatching tug boats to escort tankers to refineries.

1936 Selective dialing and ringing of calls to ships at sea.

1938 New marine radio for coastal service (200-mile range) employs voice-controlled switching instead of "press-to-talk" switching, selective ringing, and automatic volume control.

1939 Radio compass for small vessels.

1943 Complete coastal radio system in use—14 shore stations from Maine, through the Gulf Coast, and up the Pacific Coast to Seattle.

1946 Marine radar installed aboard S.S. *John J. Hutchinson*, new Great Lakes vessel.

Police Radio

1931 Traffic observed and reported to New York City Police Headquarters by radiotelephone from Bell Labs' Ford plane.

1932 1000-watt radio transmitter in New York City Police Headquarters for communication to cruising police cars. (Previously, 400-watt transmitters had been installed in Washington, Louisville, Toledo, and other cities.)

1934 Ultra-high-frequency police radio installed in Newark, N. J. Antenna installed atop the 100-ft. flagpole of the National Newark and Essex Bank Building.

1935 100-watt transmitter for small- to medium-size cities.

- Evansville, Indiana, police cars equipped with ultra-high-frequency two-way radio.

1939 Short-wave receiver and 15-watt transmitter operable from police-car battery—a three-fold increase in power.

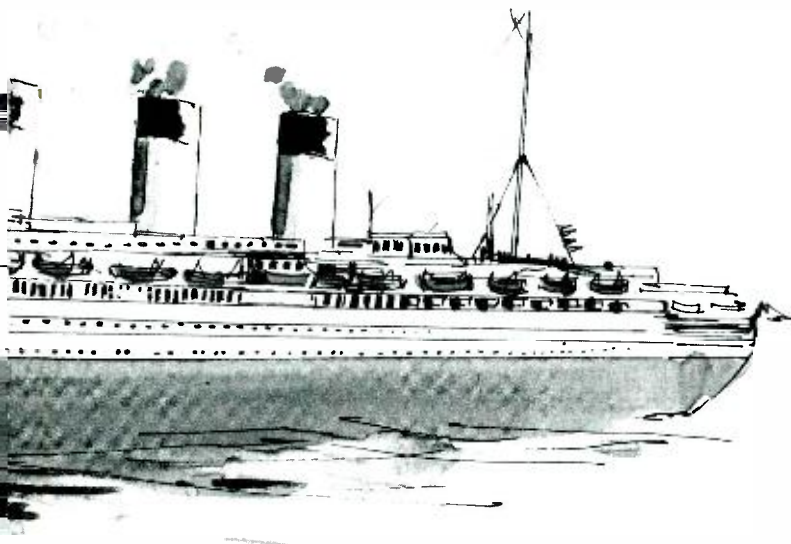

Some Notable Achievements

During a half century of work dedicated to advancing communications, Bell Laboratories people generated a number of outstanding discoveries and inventions in many fields. Here are some of them.



Development of Oxide Masking

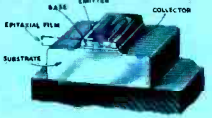

Invention of Epitaxial Transistor



Research on Synthetic Garnets



Origination of Sound Motion Pictures

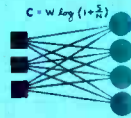

Creation of Information Theory



Laser Inventions

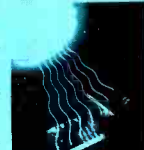

Invention of the Solar Battery



Demonstration of First High-Fidelity Sound Recording



Development of Sound Spectrograph

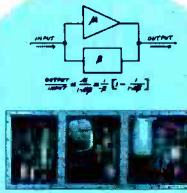

Invention of Negative Feedback Amplifier



Development of Zone Refining Techniques

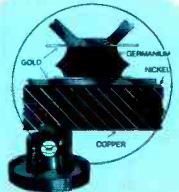

Invention of the "IMPATT" Diode



Development of Radio Astronomy



Scientific Approach to Quality Control



Development of Quartz Crystal Filters

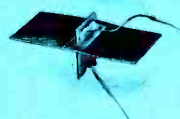

Invention of Field-Effect Transistor



Invention of Charge-Coupled Devices (CCDs)



Discovery of Wave Nature of Matter



Research on Superconductivity



Invention of the Transistor



Development of Close-Spaced Triode



Invention of Magnetic Bubble Devices



Contributions to Light-Emitting Diode Technology

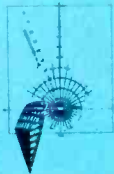

Formulation of Antenna Theory



Development of Telstar™ Communications Satellites



Development of Electronic Switching Systems



Origination of Error-Correcting Codes



Development of Solderless-Wrapped Connections

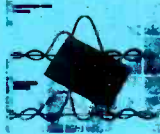

Invention of Automatic Equalizer

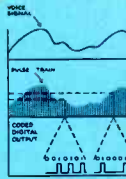

Development of Digital Transmission Systems



Development of PICTUREPHONE® System



Development of Computer Operating Systems



Introduction of Polyethylene Cable Sheath and Wire Insulation



Development of Coaxial Cable Carrier System



Development of Electronic Systems for the Loop Plant



Development of TOUCH-TONE® Telephone



Development of Computer Graphic Techniques



First Long-Distance TV Transmission



Development of Improved Traveling-Wave Tube



Development of the Waveguide Transmission System



Development of DATAPHONE® Sets



Development of U.S. WW II Radar



Contributions to Communications Network Theory



Development of Micro-wave Technology



Development of Common Control Crossbar Switching



Invention of the Electrical Digital Computer



Development of Air Defense Systems

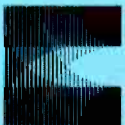

Contributions to Transmission



Development of Transatlantic Telephone Cable System



Origination of Direct Distance Dialing Service



Conception of the Electronic Analog Computer



Development of Command Guidance System

THE AUTHORS



W. B. Macurdy



A. E. Ritchie



J. W. Schaefer

William B. Macurdy (coauthor *The Network: Forging Nationwide Telephone Links*) is Director of the Traffic Network Planning Center at Bell Labs' Holmdel, New Jersey location. He received the A.B. degree from Dartmouth College in 1955 and the M.S. degree in engineering from the same college in 1957, when he joined the Switching Systems Engineering organization at Bell Laboratories. Later he received the M.S.E.E. degree from New York University (1959) and the Ph.D. degree in communication theory from Massachusetts Institute of Technology (1962).

At Bell Labs, Mr. Macurdy participated in planning the central office arrangement for the TOUCH-TONE[®] telephone. In 1963 he was appointed supervisor of a group that contributed to the design of the stored-program control used in the Traffic Service Position System and in the Electronic Translator System for No. 4A toll crossbar.

In 1966 Mr. Macurdy became head of the PICTUREPHONE[®] and Broadband Switching Studies department. In 1969 he was appointed Director of the Switching Engineering Center, where his duties included responsibility for systems engineering of central office maintenance systems. He assumed his present position in 1970.

Alistair E. Ritchie (coauthor *The Network: Forging Nationwide Telephone Links*) is Director of the Toll Switching Engineering Center at Bell Laboratories, Holm-

del, New Jersey. He studied at Dartmouth College, where he received the A.B. degree in 1935 and the A.M. degree in 1937, shortly before joining the technical staff of Bell Labs.

Mr. Ritchie was initially engaged in testing new designs of switching circuits. Subsequently, he set up and taught courses in Bell Laboratories educational programs, and in 1949-50 he conducted a graduate course in the principles and design of switching circuits at Massachusetts Institute of Technology.

A later assignment involved planning traffic measuring equipment, and in 1953 he took charge of various defense communications and government projects. Appointed systems planning engineer in 1955, he engaged in early studies of the application of TOUCH-TONE[®] telephones and line concentrators. In 1958 he became Director of Switching Systems Engineering, with responsibility for engineering planning of electromechanical telephone switching systems. He assumed his present post in 1965.

Mr. Ritchie is a senior member of IEEE.

J. W. Schaefer (*Alpha and Omega of the Network: Customer Products*) is Executive Director of the Customer Switching Services Division at Bell Labs, Holmdel, New Jersey. His responsibilities include the engineering and development of private branch exchange, key telephone, private line,

and mobile telephone systems.

Mr. Schaefer joined Bell Laboratories in 1941 and was initially concerned with the design of the M9 electronic antiaircraft gun director. He later served in management positions at the Whippany, New Jersey, laboratory.

In 1963, he was appointed Director of the company's Kwajalein Field Station in the Marshall Islands. For his "exceptional and meritorious performance of duties as Director of Bell Telephone Laboratories' Kwajalein Field Station," Mr. Schaefer was given the Army's highest award for non-military personnel, the United States Army's Outstanding Civilian Service Medal.

Mr. Schaefer returned from Kwajalein in 1965 and was appointed Director of Bell Labs' Data Communications Laboratory in Holmdel. He was appointed Executive Director of the Customer Systems Division on March 15, 1968 and assumed his present post on September 1, 1970.

For more than 23 years, Mr. Schaefer was involved in work on air defense systems. During World War II, while on a military leave of absence from Bell Labs and serving with the U. S. Army Ordnance Corps, he proposed an anti-aircraft missile system which included the principle of command guidance. The NIKE family of air defense weapons evolved from this invention.

A native of Iowa, Mr. Schaefer received a bachelor's degree in



A. E. Joel, Jr.



W. E. Danielson



E. F. O'Neill

mechanical engineering from the Engineering College of Ohio State University in 1941. He was named a "Distinguished Alumnus" of the university in 1966. He is a member of Tau Beta Pi, Phi Eta Sigma, and Sigma Xi.

Amos E. Joel, Jr. (*Switching*) received the B.S. and M.S. degrees from Massachusetts Institute of Technology in 1940 and 1942. Joining Bell Laboratories in 1940, he worked for a time in the fields of relay engineering and crossbar system testing, and on fundamental studies of telephone switching systems. During World War II, he designed circuits for early relay digital computers and for cryptographic and cryptanalysis machines. Subsequently, he prepared texts for switching design and taught the subject, designed automatic message accounting computer circuits, and made engineering studies of new switching systems.

He was head of a department responsible for the development planning of the Bell System's first electronic telephone switching systems. Mr. Joel served as Director of the Common Systems Switching Laboratory from 1961 to 1967.

At the present time, Mr. Joel is a switching consultant at Bell Laboratories in Holmdel, New Jersey. He holds more than 50 patents on his work. He is a fellow member of IEEE, a licensed Professional Engineer in the State of New York, a member of Sigma Xi, the Association for Computing Machinery,

and the American Association for the Advancement of Science.

In 1972 Mr. Joel received the Achievement Award of the IEEE Communications Society in recognition of his outstanding inventiveness and leadership in the field of telephone switching. In 1974, he was elected president of the IEEE Communications Society.

Warren E. Danielson (*Exchange Area and Local Loop Transmission*) is Executive Director of the Exchange Area Transmission Division at Bell Laboratories, Holmdel, New Jersey. He is responsible for the following laboratories: Digital Terminal; Digital Transmission; Voice-Frequency Transmission and Office Maintenance; Transmission Technology; Signaling, Voice-Frequency Terminals, and Telemetry.

Mr. Danielson joined Bell Laboratories in 1952. He studied microwave noise in beam-type traveling wave tubes, designed electron guns, developed X-band and millimeter-band traveling wave amplifiers, and supervised work on parametric amplifiers for low-noise amplification at microwave frequencies. In 1958, he turned to military research work and was appointed Director of the Military Research Laboratory in 1960. He was promoted to his present post in 1966. He has directed several major transmission projects, including high-speed digital systems for coaxial cable and wave-

guide, PICTUREPHONE® transmission, submarine cable systems, and computer-aided systems for transmission measurement and control.

Mr. Danielson attended California Institute of Technology. He received the B.S. degree in 1949, the M.S. degree in 1950, and the Ph.D. degree, magna cum laude, in 1952.

Eugene F. O'Neill (*Radio and Long-Haul Transmission*) is Executive Director of the Toll Transmission Division, Bell Laboratories, Holmdel, New Jersey. He is responsible for long-haul transmission development for the Bell System.

He received the B.S. and M.S. degrees in electrical engineering from Columbia University in 1940 and 1941. He joined Bell Labs in 1941. His early work was in the development of radar, overland coaxial cable, radio relay, and submarine cable systems. From 1956 to 1960 he headed a group responsible for developing Time Assignment Speech Interpolation (TASI) terminals for undersea telephone cables.

In 1961, Mr. O'Neill became Director of Satellite Communications and served as Bell Labs' project manager for the Telstar™ satellite communications program.

In 1966, he became Executive Director of the Transmission Division at Merrimack Valley responsible for development of coaxial cable and radio relay systems and for the "T" carrier digital trans-



W. P. Slichter



W. S. Boyle



B. McMillan

mission systems. He assumed his present post in May 1971.

William P. Slichter (*Materials*) is Executive Director of the Research, Materials Science and Engineering Division at Bell Laboratories. He is responsible for fundamental studies in chemistry, metallurgy, and materials science, and for the associated developmental and engineering activities involving materials important to the Bell System.

Mr. Slichter joined Bell Laboratories in 1950 as a research scientist, initially investigating the physical chemistry of polymers. He was later involved in fundamental studies of the growth of semiconductor crystals, and in fundamental research on the structure and physical properties of polymers. He served as head of the Chemical Physics Research department and Director of the Chemical Research Laboratory before being appointed to his present post.

Mr. Slichter received the A.B. degree in chemistry from Harvard College in 1944 and the Ph.D. degree in chemical physics from Harvard University in 1950. He is a fellow of the American Physical Society and the American Association for the Advancement of Science, and is a member of the American Chemical Society, the Faraday Society, and Sigma Xi.

Willard S. Boyle (*Device Development*) is Executive Director of the Pennsylvania Laboratories Divi-

sion located at Allentown and Reading, Pennsylvania. He is responsible for the transistors and semiconductor integrated circuits developed in Pennsylvania and for the development of all Bell System semiconductor memories, thin film and hybrid integrated circuits, and submarine cable components. He is also responsible for consultation on the economic trade-offs among various device technologies.

Mr. Boyle joined the Solid State Spectroscopy department of Bell Labs in 1953 as a research scientist. He later became head of a department studying optical masers and the electronic properties of semiconductors. In 1962 he was named Director of Space Science and Exploratory Studies at Bellcomm, working in support of the U.S. manned lunar program. He returned to Bell Labs in 1964, serving as Director of the Semiconductor Device Development Laboratory, Executive Director of the Electronic Materials and Processes Division, and Executive Director of the Semiconductor Components Division before assuming his present post in 1973.

Mr. Boyle is co-developer of the first continuously operating ruby laser and co-inventor of Charge-Coupled Devices (CCDs), a new family of semiconductor devices that have potential for wide use in communications technology. For his work on CCDs, he received the Franklin Institute's Stuart Ballantine Award in 1973 and the IEEE's Morris Liebmann Award in 1974. He is author of numerous

technical articles and holds sixteen patents.

He received the B.Sc., M.Sc., and Ph.D. degrees in physics from McGill University in 1947, 1948, and 1950, respectively. He is a Fellow of the IEEE and the American Physical Society, and a member of the National Academy of Engineering.

Brockway McMillan (*Theory and Principles: The Intellectual Framework*) is Vice President of Military Systems at Bell Laboratories. He is in charge of the Ocean Systems Division and the SAFEGUARD Development and Design Divisions. He received the B.S. and Ph.D. degrees in mathematics in 1936 and 1939 from Massachusetts Institute of Technology, and served as an instructor at that institution and at Princeton University before going on active duty with the Navy in 1943.

Mr. McMillan joined Bell Labs in 1946 as a research mathematician. Later, he became Assistant Director of Systems Engineering and, in 1959, Executive Director of Military Research. As a consultant, he was associated with the Office of the Assistant Secretary of Defense for Research and Development, the Office of Defense Mobilization, and the Weapons System Evaluation Group of the Joint Chiefs of Staff. In 1958-59, he served as Consultant to the White House Office reporting to the President's Special Assistant for Science and Technology.

In 1961 Mr. McMillan resigned



Items of interest for Bell System readers

● New Capabilities for the 770A PBX

The reliable and inexpensive 770A PBX is now sporting a new repertoire of optional features that are making it even more useful and attractive to business customers. One important option is the addition of centrex features, including DID (Direct Inward Dialing—dialing direct to an extension from outside the PBX system) and AIOD (Automatic Identified Outward Dialing). Although centrex features were not available until early 1974, by midyear several dozen installations were already in service in various parts of the country.

Another new option is centralized attendant service, which allows an attendant in a geographically central location to perform attendant services for a number of dispersed locations. Installations incorporating this feature are already in operation in department stores in Indiana and North Carolina.

Several of the new features are designed to give customers greater flexibility. A person who has called outside the PBX system and has finished his conversation, for instance, may wish to use Outgoing Call Transfer. This feature allows him to transfer the called party to another extension in his PBX system. In addition, a company may choose either Executive Override or Executive Ringback, which will allow their busy executives either to interrupt an employee's call or to request ringback when the employee has completed the call. Another feature, Timed Reminders, automatically reminds the PBX attendant to reassure a caller that the called number is still ringing or that the call is still on hold. Business customers may also wish the option of periodically testing all their own

high-usage trunk circuits by means of the Customer Trunk Test feature.

Development is continuing at the Denver location of Bell Labs, where members of the 770A and 812A PBX department are designing additional features. One new option makes the 770A compatible with Common-Control Switching Arrangement (CCSA), which allows customers to share central office equipment. This compatibility will permit attendant control and Series 300 features on CCSA network calls. Engineers from Bell Labs and Northwestern Bell field-tested this feature last summer. About 30 systems compatible with CCSA are planned for installation in Georgia. The first will be cut over in early 1975.

● Operating Companies Learning COSMOS

About a hundred people from six Bell System Operating Companies have been meeting at Bell Labs' Whippany location for a series of three-week intensive training courses on the COSMOS system. COSMOS—Computer System for Mainframe Operations—was developed by Bell Laboratories to help assign terminals for jumper wires and maintain records of existing jumpers on main distributing frames (MDFs) (see **A COSMIC Approach to Untangling Problems in Main Distributing Frames**, RECORD, March 1974). Part of a plan to bring COSMOS to the Operating Companies on an "early application" basis, the courses began in October 1974 and will run through March 1975. Bell Labs and Western Electric engineers are conducting the sessions for supervisors in the Plant Assignment, Traffic, MDF, and Repair Service areas. These supervisors will, in turn, train other personnel in the operation of the COSMOS system.

● Date Set for Mobile Service Field Trial

In three years—January 1, 1978—the Bell Labs-designed High-Capacity Mobile Telecommunications System is scheduled for a field trial in Chicago, Illinois. Several hundred potential customers will be invited to participate in the trial, which is expected to last about a year. Service is then expected to expand to several thousand Chicago customers and to other cities.

On May 2, 1974 the FCC allocated 40 megahertz of radio-frequency spectrum in the 850-megahertz band to wire-line common carriers (including Bell System companies) for mobile communication systems, thus making it possible to implement the Bell System's plan to offer high-capacity, high-quality mobile telephone service that will make the most efficient use of the radio-frequency spectrum.

The features of this system include the ability to use a given channel simultaneously for several different conversations in a metropolitan coverage area. In the Bell System's plan, a service area is divided into hexagonal, contiguous sections, or cells. A call to a mobile is carried over wire lines to the base station nearest the mobile customer, and the path between calling and called parties is then completed with relatively low rf power. The signals to the moving vehicle are radiated only to the small area—the cell—where the mobile customer is located. To follow the vehicle in travel, the call is automatically transferred from cell to cell, and from base station to base station as required. To accomplish a transfer, or "handoff," of the mobile call from one base station to another, the mobile receiver is sent and automatically

New Products / The DIMENSION* System

An entirely new business switching system, with features never offered before, will soon be available to Bell System customers. Called the DIMENSION* system, the new line of all-electronic equipment lets customers choose from dozens of services—all the popular features of present Bell System PBX and centrex systems plus many new options.

Because the Dimension system operates under stored-program control, a customer may select only the services he needs. All programs needed for the selected features, along with customer specifications and diagnostic routines for system maintenance, are read into memory from magnetic tape. In many cases, adding services merely requires reading in a new tape containing the necessary data.

With this system it is easy to add not only features but also telephone lines. A single cabinet contains the switching circuits for installations of about 120 lines (depending on the amount of traffic), and more cabinets can be installed as needed. The initial configurations will offer up to about 400 lines, but models able to handle over 2000 lines are planned.

Operating Company people should find the system attractive for its simplified engineering and installation, built-in diagnostic aids for maintenance, and simplified procedures for growth and change. Uniform operational features for all models will simplify training for customers, and for marketing, engineering, traffic, and plant personnel. Equally important, the system will be offered at a competitive price.

One new feature is "automatic call back"—on request, the system automatically redials a busy extension, ringing both called and calling extensions when both are free. Another feature allows a customer away from his office to tie into the system remotely from any TOUCH-TONE® telephone, a feature that is especially valuable to customers having WATS lines or tie lines.

If all outgoing trunk lines are busy, the caller can be signaled as soon as the next outgoing line becomes free and automatically connected to it. A caller can also be signaled when he receives an incoming call during an ongoing phone call. In addition, special features will be available

for special segments of the market—hospitals and the hotel/motel industry, for example.

An attendant console with modern styling has been designed especially for the Dimension system. Its alphanumeric displays are lighted by solid-state lamps that are reliable and long-lasting. The cabinet that holds the equipment for the system is small and is decorator-designed to blend with almost any office decor.

The Dimension customer switching system is truly a product of Bell System cooperation. From the earliest marketing studies, representatives of AT&T, Western Electric, and Bell Laboratories have taken part in every aspect of design and development. Representatives of several Operating Telephone Companies also made recommendations on features and operating characteristics before the final designs were approved. The new system, scheduled for introduction in 1975, will be manufactured by Western Electric at its Denver, Colorado, Works.



*Trademark of the AT&T Co.

executes commands to tune to a new channel (frequency).

The mobile system is controlled through the modified facilities of a No. 1 ESS. The stored-program features of this electronic switching system make it possible to carry out, efficiently and economically, the complicated decision processes required for the administration of a high-capacity system of this sort. In addition, through the application of ESS technology, substantially all of the custom-calling options now available to fixed-station customers will be available to customers on the move.

As part of the preparations for the Chicago trial, Bell Labs, in cooperation with New Jersey Bell, is studying and refining the mobile system's cellular concept at Newark, New Jersey. This field operation does not include customer service, nor does it provide access to the Direct Distance Dialing (DDD) network; the sole purpose is to study transmission of signals within and between cells in base-station coverage areas.

Except for the rf generating and receiving apparatus, Western Electric will manufacture the base-station and supplementary equipment for the high-capacity system. All equipment for customers' vehicles—the mobile telephone instruments—will be manufactured by companies outside the Bell System.

● Short Cut to Budget Analysis

Commercial Departments in Operating Telephone Companies will now be able to spend more time analyzing their budgets and less time compiling the figures. Bell Laboratories has developed a computer system called BOMIS, for Business-Office Management Information System, which mechanizes budget and work-force planning.

This new program, which is based on a packaged management-information system called the Off-the-Shelf System, allows the user to monitor a budget throughout the year on several levels—business office, district, division, area, or company. Particularly at the business-office level, where the greatest portion of the Commercial budget is spent, BOMIS facilitates the best allocation of resources. The system takes projected work-volume figures for each business-office unit, applies productivity objectives, and comes up with the total dollars and personnel needed to handle the projected workload. Before BOMIS, much of this computation was done manually and, because of the size of the clerical job, Commercial Departments rarely were able to achieve business-office manager accountability in budget and force planning.

BOMIS helps to pinpoint problem areas, and enables the Operating Company to adjust budget and force procedures for different types of offices. The program also permits users to examine the results of various budget strategies, the data for which would have taken a clerical staff much time to compile.

New Jersey Bell and C&P of Maryland are now using BOMIS, and Mountain Bell and New England Telephone are in the process of converting to the system.

● ACD for New York and Seattle

Automatic Call Distributor (ACD) service was recently provided directly from a No. 1 ESS central office to Bloomingdale's department store and Alaskan Airlines. Bloomingdale's has a 47-agent-position system in operation in New York City for taking orders and answering billing questions. Alaskan Airlines has a 12-agent-position system in Seattle for making reservations. ACD service from a No. 1 ESS central office was made possible by three features added to the basic (generic) No. 1 ESS centrex program. This is the sixth major issue of this program, called CTX-6. The new features are Uniform Call Distribution for Lines, Queuing for Lines, and Delay Announcement.

Bell System readers are invited to use this card to offer comments, to ask questions about Bell Labs projects, and to request additional information about items in this section.

Reader Response Card

Name _____

Company _____

Address _____

Telephone _____ Zip _____

January 1975

(If possible, please type or use black pen.)

These features were first developed to furnish centrex service to small-business customers. During the development planning stage it became evident that—with a little additional development—the same features could be adapted to ACD service as well, thereby minimizing floor space on the customer's premises and yielding the economies of centralized maintenance and administration to the Operating Telephone Company.

● Crossbar Maintenance Gets an Assist

Operating Companies will soon have a better way of finding equipment troubles in No. 1 and No. 5 Crossbar offices, thanks to a minicomputer-based system known as ATA (Automatic Trouble Analysis).

The new system will take trouble reports directly from indicators or recorders in No. 1 and No. 5 central offices, analyze the data, and then send trouble reports via teletypewriter directly to the central office and to centralized locations. The ATA trouble reports identify both the type of trouble and the equipment involved, and are issued as soon as a sufficient amount of trouble data is collected. Without ATA, this entire procedure is performed manually.

ATA's feasibility was demonstrated in August and September of 1974

during a five-week trial involving people from Bell Labs, New York Tel, Illinois Bell, and New England Telephone. The trial was conducted at five central offices in Long Island.

The Automatic Trouble Analysis system for local crossbar offices is one of several mechanization projects that will be used by Operating Companies in their Switching Control Centers (SCCs). Many Operating Companies are planning for SCCs.

● New "Glassy" Metals May Be Useful in Communications Industry

A technique developed at Bell Labs about five years ago is now being used to produce a new family of "glassy" metals with unusual magnetic properties—for example, they do not shrink or expand in a magnetic field. Such properties may make glassy magnetic metals useful in the Bell System for transformers and inductors. Made into fine wire, these materials are as supple, springy, hard, and strong as steel piano wire.

The new metals—alloys of iron, nickel, cobalt, chromium, vanadium, gold, and palladium—are called glassy because they have an irregular (amorphous) atomic arrangement, like that of glass. They also have thermal and viscous flow properties very similar to those of glass.

The earliest technique for making glassy metals, developed at Cal Tech about 15 years ago, was to shoot small drops of molten metal onto a cold surface. But the thin flakes of metal obtained by this method were too small and irregular to be of practical use.

The more recent technique, called "roller-quenching," involves cooling, or quenching, a fine stream of molten metal by letting it flow between two rapidly rotating metal rollers at room temperature. The technique produces continuous metal strips of uniform thickness. Each strip that spins from the rollers is "glassy" if the proper alloy mixture is used at the proper temperature. The glassy nature can be seen in x-rays, which reveal the irregular atomic structure of the metal.

● Field Rep Changes

Changes in Bell Labs Field Representative assignments were recently made at the Philadelphia and Boston Field Offices. Joe Trecker has been assigned to Philadelphia, replacing Joe Gilbreth, and Ian Durand has replaced Joe Boller at Boston. Additional assignments as assistants to Field Representatives have been made in other cities as well: Atlanta, Birmingham, Denver, Newark, and Omaha.

First Class
U.S. Postage
PAID
Murray Hill, N.J.
Permit No. 5

BUSINESS REPLY MAIL

No Postage Stamp Necessary if Mailed in the United States

Postage Will Be Paid By

Editor, Bell Laboratories Record
Room 3B-309
Bell Laboratories
600 Mountain Avenue
Murray Hill, N. J. 07974



V. A. Vyssotsky



C. A. Warren

from Bell Labs to become Assistant Secretary for Research and Development of the U.S. Air Force and later, in 1963, Under Secretary of the Air Force. He returned to Bell Labs in 1965 as Executive Director of the Military Research Division and assumed his present position in May 1969.

He is a member and past president of the Society for Industrial and Applied Mathematics, a fellow of IEEE, and a member of the American Mathematical Society, the Mathematical Association of America, the Institute of Mathematical Statistics, and the American Association for the Advancement of Science. In 1969 he was elected to the National Academy of Engineering.

Victor A. Vyssotsky (*Computers and Computer-Based Systems*) is Executive Director, Business Information Systems—Support Division at Bell Labs' Raritan River Center, Piscataway, New Jersey. He is concerned with mechanization of the business procedures of Operating Telephone Companies.

He joined Bell Labs in 1956, at first doing research on automatic recognition of speech sounds and on speech transmission systems. Later, he became involved in systems programming, including development of a compiler and planning and supervision of software and hardware for a computation center. In 1968, he became head of a department that developed basic software for a large real-time data processing system and in 1969

served as Director of planning and development for the same system. He assumed his present responsibilities in 1972.

Mr. Vyssotsky studied at the University of Chicago, where he received the B.A. degree in liberal arts in 1950 and the M.S. degree in mathematics in 1956.

Clifford A. Warren (*In Defense of the Nation*) received the B.S. degree from Cooper Union and the M.S. E.E. degree from Stevens Institute of Technology. He joined Bell Laboratories in 1931 and first worked on aircraft radio. Since 1939 his work has been primarily on military systems, including work on naval radar during World War II, for which he received the Naval Ordnance Development Award.

In 1951 Mr. Warren began work on the NIKE project and supervised some of the earliest NIKE/AJAX test firings. He later became Project Engineer for the development of NIKE/HERCULES and in 1957 was appointed Director of the NIKE/ZEUS project. Subsequently he had developmental responsibility for this project as the program was reoriented to NIKE-X, SENTINEL, and now SAFEGUARD.

In 1967 Mr. Warren became Executive Director of the SENTINEL/SAFEGUARD development program. He is responsible for the development of SAFEGUARD equipment installed at the Grand Forks, North Dakota, site. In addition, he is responsible for the Ballistic Missile Defense Test Program and missile

firings at the Pacific Kwajalein Test Site. In 1969 he was awarded the Army's Outstanding Civilian Service Award for his leadership on the SENTINEL program, and in 1972 he received a similar award for his efforts on the SAFEGUARD program. Mr. Warren was awarded patents for antenna lobe switching, for minor lobe suppression of a radar antenna, and for a phase adjuster. He is a fellow of the IEEE and a member of the American Defense Preparedness Association, formerly called American Ordnance Association.

Recalling his early work on military systems, Mr. Warren relates his experience to that of new members of the Bell Labs staff:

"As a young BTL engineer just prior to and during WW II, I had the experience of developing Navy radars and then being called upon to spend time testing their performance on Navy ships and submarines at sea. You soon discover, in a fire control director on top of a rolling destroyer or in the tight quarters of a submarine, how you would design equipment differently, particularly for maintenance, if you had had this field experience earlier. For this reason I heartily endorse any opportunity our young engineers have to observe operation and maintenance of existing equipment in the Operating Telephone Companies and hence be better prepared to carry out new design work. Field experience early makes fundamental impressions that stay with you throughout your Bell Labs career."



600 Mountain Avenue, Murray Hill, N. J. 07974
Return Postage Guaranteed

401

WIRTZ, R J
MV3F43

40601 4321

Bulk Rate
U.S. Postage

PAID

Lancaster, Pa.
Permit No. 1347



*This unit was the
in the following*

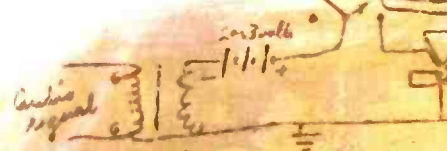

*261 B
125,000,000*

*This circuit
was and
will in
most*